

RADIO *& Television* RETAILING

**ELECTRICAL
APPLIANCES
FOR GIFTS**

See Pages
44, 45, 46, 47

CALDWELL-CLEMENTS, INC. ★ OCTOBER 1945



Once Again You Can

MAKE THIS A RADIO CHRISTMAS!

News of New Home Receivers, FM, Servicing, Records



APPLAUSE...

and No Wonder!

IT was the first 8-contact vibrator to be commercially made—and it still ranks first among service engineers for all heavy load conditions.

An interrupter type, this Mallory vibrator has 8 contacts (4 pairs) which divide the operating current load so that longer life is insured. That's why service men use it for heavy-duty power supply replacements—they know that it can "take it!"

Mallory replacement vibrators are also made in 8-contact synchronous or self-rectifying

types and in 4-contact interrupter types. Several are also available with the patented hermetic seal—this for replacements where corrosive fumes, excessive moisture or high altitude conditions must be combated.

All in all, Mallory manufactures 65 different vibrator units. They replace 101 former types—and 12 vibrators in the group are able to meet about 90% of replacement needs. Ask your distributor for the Mallory Vibrator Standardization Chart for up-to-date data on the subject. For trouble-free operation *anytime*, ask him for Mallory vibrators.

P. R. MALLORY & CO., Inc., INDIANAPOLIS 6, INDIANA



*More than ever—
ALWAYS
INSIST ON*

P. R. MALLORY & CO. Inc.
MALLORY
APPROVED
PRECISION PRODUCTS

**VIBRATORS • VIBRAPACKS® • CONDENSERS
VOLUME CONTROLS • SWITCHES • RESISTORS
FILTERS • RECTIFIERS • POWER SUPPLIES**

ALSO MALLORY "TROPICAL" DRY BATTERIES, ORIGINALLY DEVELOPED BY MALLORY FOR THE U. S. ARMY SIGNAL CORPS. NOT PRESENTLY AVAILABLE FOR CIVILIAN USE.

®Trademark.

"Head Start" with
1,000,000,000
"Order Now"
ADVERTISING MESSAGES



DRIVING POWER back of the new, post-war Emerson Radio — this in 2 months, with more to follow.

Big copy in 300 leading newspapers. Full-page ads in national magazines. Big billboard advertising. Dramatic point-of-sale promotion.

With constructive policies and equitable sharing of merchandise, Emerson dealers are **TAKING ORDERS NOW.**

With 3 TIMES pre-war production facilities—with **BETTER** Style, Tone, Performance and Value—Emerson holds its position as **World's Largest Maker of Small Radio.**

These are the high spots of the proposition which has taken America by storm. Call or write your Emerson Radio distributor now.



The New Post-War
Emerson Radio
and Television



EMERSON RADIO AND PHONOGRAPH CORPORATION, NEW YORK 11, N. Y.

RADIO & Television RETAILING • October, 1945



For last minute
dependable
information on

NEW SET DELIVERY

WRITE, WIRE OR PHONE YOUR

Motorola
Radio Distributor

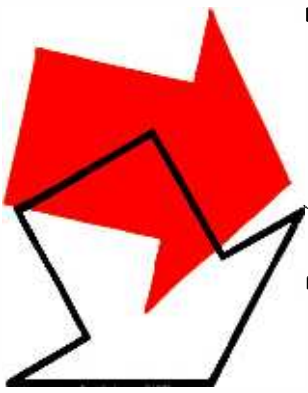

HERE IS THE COMPLETE LIST BY STATES • ALPHABETICALLY

**ILLINOIS**

Motorola-Chicago Co.
1330 W. Washington Bl.
Chicago 7, Illinois

Lofgren Distr. Co.
1202 Fourth Ave.
Moline, Ill.

Seltzer Company
604 Fulton St.
Peoria 2, Ill.

INDIANA

Wall Distributing Co.
241 Pearl St.
Fort Wayne 2, Ind.

Radio Distributing Co.
1013 N. Capitol Ave.
Indianapolis 4, Ind.

Radio Distr. Co.
Monroe & Carroll Sts.
South Bend, Ind.

IOWA

Gifford-Brown, Inc.
106 First St., S. W.
Cedar Rapids, Iowa

Gifford-Brown, Inc.
1216-18 Grand Ave.
Des Moines, Iowa

Duke's Radio Co.
114 W. Fourth St.
Sioux City 6, Iowa

KANSAS

McGrew Distr. Co.
1312 E. Douglas Ave.
Wichita 7, Kan.

KENTUCKY

Falls City Supply Co.
315 Roland Ave.
Louisville 3, Ky.

Strickland Distr. Co.
615 Jefferson St.
Paducah, Ky.

LOUISIANA

Higgins Industries, Inc.
Appliance Division
521 City Park Ave.
New Orleans 19, La.

Dunckelman-Pace
1417 Louisiana Ave.
Shreveport, La.

MAINE

Radio Service Lab.
45 Haymarket Sq.
Bangor, Maine

Radio Service Lab.
45A Free St.
Portland 3, Maine

MARYLAND

Simon Distributing Corp.
615 Pennsylvania Ave.
Washington 4, D. C.

MASSACHUSETTS

Metro Distribs., Inc.
884 Commonwealth Av.
Boston 15, Mass.

MICHIGAN

Ingram Distr. Co.
4490 Cass Ave.
Detroit 1, Mich.

Republic Distr. Co.
72-74 N. Division Ave.
Grand Rapids, Mich.

Offenhauer Co.
227 W. Washtenow St.
Lansing, Mich.
Radio Sales Co.
816 East Genesee A
Saginaw, Mich. vs.

MISSISSIPPI

Higgins Industries, Inc.
Appliance Division
521 City Park Ave.
New Orleans 19, La.
Mills-Morris Co.
171 S. Dudley St.
Memphis 1, Tenn.

MINNESOTA

Forster Distr. Co.
1122 Harmon Pl.
Minneapolis 3, Minn.

MISSOURI

Motor Radio Co., Inc.
2440 Charlotte St.
Kansas City 8, Mo.
Disco Distr. Co.
2843 Washington Blvd.
St. Louis 3, Mo.

MONTANA

Pasley & Spitzer Co.
20 N. 33rd St.
Billings, Mont.

NEBRASKA

Mueller & Selby Co.
2549 Farnam St.
Omaha 2, Nebr.

NEVADA

Nevada Distr., Inc.
P. O. Box 1047
Reno, Nevada

NEW HAMPSHIRE

Radio Service Lab.
1191 Elm St.
Manchester, N. H.

NEW JERSEY

Kearns Auto Radio Serv.
25 North Albany Ave.
Atlantic City, N. J.
Motorola-New Jersey, Inc.
177 Central Ave.
Newark 4, N. J.

NEW YORK

Hudson Valley
Asbestos Corp.
170 Central Ave.
Albany, N. Y.
Battery & Starter Co., Inc.
2505 Main St.
Buffalo 14, N. Y.
Motorola-New York, Inc.
33 West 60th St.
New York City 23, N. Y.
Kemp Equipment Co.
39-57 Mt. Hope Ave.
Rochester 7, N. Y.

NEW MEXICO

Oakes Batt. & Elec. Co.
423 Texas St.
El Paso, Tex.

Mitchell Products
495 W. Water St.
Santa Fe, N. M.

NORTH CAROLINA

Freck Radio & Sup. Co.
38 Billmore Ave.
Asheville, N. Car.

Carolina Appliance Co.
208 E. Fifth St.
Charlotte 1, N. Car.

Tire Sales & Serv. Co.
401 Hillsboro St.
Raleigh, N. Car.

NORTH DAKOTA

Fargo Paper Co.
26-28 Eighth St., No.
Fargo, North Dakota

OHIO

Lockie & Glenn
2110 Gilbert Ave.
Cincinnati 6, O.

The M & M Co.
5200 Prospect Ave.
Cleveland 3, O.

The M & M Co.
214 E. Goy St.
Columbus, O.

Moore Equipment Co.
226 W. Third St.
Dayton 2, O.

Christian-Sheidler Co.
Adams & 20th Sts.
Toledo, O.

OKLAHOMA

Wm. Mee Co.
120 E. Grand Ave.
Oklahoma City, Okla.

OREGON

C & H Supply Co.
1316 S. W.
Washington St.
Portland 5, Ore.

PENNSYLVANIA

Dibert Radio Distr. Co.
1802-11th Ave.
Altoona, Pa.

Specialty Sales Co.
116 W. Chestnut St.
Lancaster, Pa.

Goldner Distr. Co.
46-50 N. 5th St.
Philadelphia 6, Pa.

Moto Radio Distr. Co.
5732 Baum Blvd.
Pittsburgh 6, Pa.

Big Boys Auto Parts Co.
123-129 S. Second St.
Sunbury, Pa.

RHODE ISLAND

I. Feldman Co.
186 Broadway
Providence 3, R. I.

SOUTH CAROLINA

A. H. Wherry, Jr.
Chester, S. Car.

SOUTH DAKOTA

Graff Motor Sup. Co.
122-24 W. Seventh St.
Sioux Falls, S. Dak.

TENNESSEE

Bryant & Trimble
406 Broad St.
Chattanooga, Tenn.

Bryant & Trimble
324 W. Magnolia St.
Knoxville, Tenn.

Mills-Morris Co.
171 S. Dudley St.
Memphis 1, Tenn.

Currey's
179 & West End Ave.
Nashville 3, Tenn.

TEXAS

McDonald Auto Sup. Co.
2nd & Polk Sts.
Amarillo, Tex.

Porter Burgess Co.
815 N. Pearl St.
Dallas 1, Tex.

Oakes Batt. & Elec. Co.
423 Texas St.
El Paso, Tex.

Fort Worth Battery Co.
615 Lamar St.
Fort Worth, Tex.

Moore Bros. Co.
1515 Milam St.
Houston, Tex.

Krisch-Delavan Co.
801 Main Ave.
San Antonio 2, Tex.

UTAH

S. R. Ross
1212 S. State St.
Salt Lake City 4, Utah

VERMONT

Radio Service Lab.
1191 Elm St.
Manchester, N. H.

VIRGINIA

Ashman Distr. Co.
807 Granby St.
Norfolk 10, Va.

Lee Distr. Co.
1126 North Blvd.
Richmond 20, Va.

Western Va. Sales Co.
P. O. Box 1506
Roanoke, Virginia

WASHINGTON

Motorola Distr. Co.
620 Eastlake Ave.
Seattle 9, Wash.

WEST VIRGINIA

Wilson Radio Distr. Co.
1116 Central Ave.
Charleston 4, W. Va.

Jones-Cornett Elec. Co.
Welch, W. Va.

WISCONSIN

Electro-Pliance Distr.,
Inc.
2458 W. Lisbon Ave.
Milwaukee 5, Wis.

GALVIN

 MANUFACTURING CORPORATION • CHICAGO 51, ILL.

F-M & A-M HOME RADIO • AUTO RADIO • AUTOMATIC PHONOGRAPHS • TELEVISION • AIRCRAFT RADIO • POLICE RADIO • RADAR
RADIO & Television RETAILING • October, 1945

RADIO * Television RETAILING

Including Radio and Television Today

MEMBER AUDIT BUREAU of CIRCULATIONS

OCTOBER, 1945

COVER—Although available in limited quantities only, electrical appliances and radios are once again appearing in dealers' stores. But with production still slow in starting, the dealer will continue to have a rationing problem this Fall. (See pp. 38-39)

- 35 A Good Time to "Clean House"
- 36 Radio and Appliances Today
- 38 "Shortage-Neurosis"
- 40 Modern Store at Modest Cost
- 42 Electrical Appliance Profits
- 44 **Electrical Appliances Section of RTR**
- 48 Sample the Customer
- 50 Xmas Deals for the Dealer
- 52 First Radio Merchandise
- 54 Sound Profits in "Sound"
- 56 System Spells Profit
- 62 Dealers Set for Sales
- 66 Keeping Sales Humming
- 68 Double Barrelled Sales
- 74 Ready for Selling
- 79 Repairs Reap Rewards
- 82 Servicing Tampered Sets
- 86 Service Notes
- 92 New Products Offered
- 100 Jobber Notes
- 106 Television Today
- 112-146 News of the Industry

RADIO & Television RETAILING, October, 1945, Vol. 30, No. 10. 25 cents a copy. Published monthly by Caldwell-Clements, Inc., 480 Lexington Ave., New York 17, N. Y. M. Clements, president; Orestes H. Caldwell, treasurer. Subscription rates United States and Latin American countries, \$1.00 for one year, \$2.00 for three years. Canada \$1.50 for one year, \$3.00 for three years. All other countries \$2.00 for one year, \$4.00 for three years. Printed in U. S. A. Re-entered as second class matter April 21, 1944, at the Post Office at New York, N. Y., under the act of March 3, 1879. Member of Audit Bureau of Circulations. Copyright by Caldwell-Clements, Inc., 1945.

*Trade-Mark Reg. U. S. Pat. Off.

ORESTES H. CALDWELL

Editor

M. CLEMENTS

Publisher

John L. Stoutenburgh, Managing Editor
William E. Moulis, Technical Editor
Helen Thurman, Associate Editor
Charles F. Dreyer, Art Director
Assistant Editors

Ruth Morris	Nathaniel J. Kern
Solomon Heller	E. T. Bennett
Stephen I. Hall, Consulting Editor	
M. H. Newton	J. A. Samborn
B. V. Spinetta	O. H. Sutter
I. Candy	W. W. Swigert
E. Duggan	J. Cosin

Lee Robinson, Sales Manager
Ben Morris, Promotion Manager

BRANCH OFFICES

Chicago 6, R. Y. Fitzpatrick, 201 N. Wells St., RAN, 9225; Cleveland 14, Dudley B. Trott, Citizens Bldg., 850 Euclid Ave., MAin 8270; Los Angeles 14, Robert W. Walker, Walker & Minton, 403 W. 8th St., VAndike 9348; San Francisco 4, Ell C. Minton, Walker & Minton, 68 Post St., Sutter 5568.

Editorial and Executive Offices

Telephone PLaza 3-1340
480 Lexington Avenue, New York 17, N. Y.

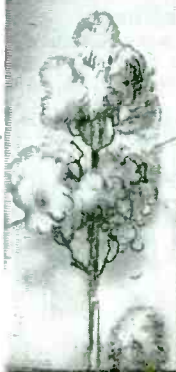

MERIT COIL & TRANSFORMER CORP.

TELEPHONE

4427 North Clark St. Long Beach 6311 CHICAGO 40, ILL.

**MECK DEALERS
ARE**

First



—in Meck National Advertising



—with the Merchandise

and **FIRST** with a price

First Radio receivers to receive price approval . . . Meck Radios are now in Meck Dealers hands . . . Proof again that Meck Production and Sales Policies are engineered for the benefit of Meck Dealers. Cash in on this big program . . . Ask your Meck Distributor.



MECK RADIOS

TABLE MODELS • PORTABLES • AM-FM • TELEVISION
CONSOLE COMBINATIONS • PHONOGRAPHS

The Reader's Digest, in its Aug., 1941 issue, ran an article saying that investigators on its staff found that radio service-dealers cheated the public on 64 out of 100 repair jobs. After citing several examples, the article ended with a warning that radio owners should "beware" of the repair man.

N. Y. HERALD TRIBUNE
JANUARY 24, 1945

City License Law Urged For Radio Repair Men

Magistrate James A. Blanchfield declared yesterday in Flatbush Court that he would ask the City Council for a law requiring

SHOULD RADIO SERVICE DEALERS BE LICENSED?

THE NEW YORK TIMES
JANUARY 24, 1945

RADIO RACKETEERS ASSAILED BY COURT

Says Repair Men Should Be Licensed

bonded in order to do business.

N. Y. WORLD-TELEGRAM
JANUARY 23, 1945

Irked Magistrate Lashes at Racket in Radio Repairs

Declaring that radio repairmen were fleecing customers by charging all the traffic would bear. Magistrate James A. Blanchfield in Flatbush Court, Brooklyn, took up the

RAYTHEON
HAS THE ANSWER!
watch for announcement
to be made soon

No intelligent radio service-dealer will deny the fact that the reputation of his industry has suffered in recent years.

Unethical servicemen who have taken advantage of manpower and parts shortages have done great damage to public opinion. They have caused so much adverse publicity in national magazines and influential newspapers that dealer-licensing, federal regulation and even finger-printing are being suggested for the public's protection.

Raytheon began many months ago to remedy this situation, and now has the answer in a strong merchandising program to be announced soon.

It will be revolutionary in every respect, enabling the public to tell which service-dealers deserve complete trust and confidence.

Dealers who can qualify will immediately have a tremendous competitive advantage. Watch for our announcement!

Raytheon Manufacturing Company
RADIO RECEIVING TUBE DIVISION
NEWTON, MASS. • LOS ANGELES • NEW YORK • CHICAGO • ATLANTA

DEVOTED TO RESEARCH AND THE MANUFACTURE OF TUBES AND EQUIPMENT FOR THE NEW ERA OF ELECTRONICS

Listen to
"MEET YOUR NAVY"
AMERICAN BROADCASTING CO.
Every Monday Night
Coast to Coast
181 Stations

All Four Divisions Have
Been Awarded Army-Navy
"E" With Stars



RAYTHEON
Radio Tubes

KEN-RAD

METAL TUBES



Better Than Ever

Ken-Rad Tubes have played a vital part in bringing about higher standards of home radio reception . . . Now, to tube quality already foremost, are added great new research and engineering facilities . . . Ken-Rad Radio Tubes consequently are *better than ever*, increasing the desirability and profit opportunities of the Ken-Rad sales franchise.

Write for your copy of
"Essential Characteristics"
the most complete digest of tube
information available.

178-011 8E50

KEN-RAD

DIVISION OF GENERAL ELECTRIC COMPANY
OWENSBORO, KENTUCKY

WHERE *can you solve your postwar selling problems?*

In the rich, strategic Chicago Area! Compact, fortified against reconversion problems, easily accessible to salesmen and factory shipments, the \$4,496,734,000 Chicago market is ideally located at the very heart of America.

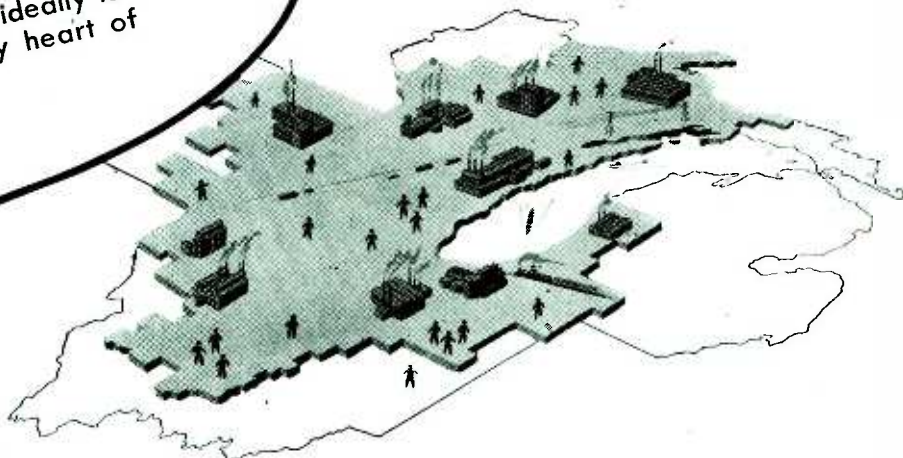

WHAT *does this great market offer?*

A tremendous pent-up demand for autos, washing machines, refrigerators and "big unit" products generally. Dealer and consumer surveys reveal a buying demand running into the billions. Here is a market well fortified by diversified income and huge savings . . . famous for its responsiveness to advertising and its record-breaking volume buying.

WHY *is the CHICAGO TRIBUNE your best medium?*

One out of every 3 families in 756 cities and towns of 1,000 or more population in this vital area reads the Tribune on weekdays—on Sundays, it is practically every other family. Bought, read and bought from as is no other medium in the Chicago market, the Tribune is a powerhouse among dealers and consumers. Seven days a week it hits with a selling impact that gets action. Only the Tribune gives you a choice of monochrome, color, comic, newsprint color, or black and white — at milline rates which are among the lowest in the country.

HOW *can you get started fast with volume sales?*

In this one compact market there is more postwar business than will be available in 13 states combined. The Chicago area offers enough business to take the entire output of some manufacturers. Here you can get immediate volume and at the same time build solidly for a continuing, profitable operation.

WHEN *can you get going?*

Today! Now available for your study and use is a specific sales program based on the findings of an auto and household appliance investigation among consumers and dealers. To get these pertinent facts, address C. S. Benham, Manager, National Advertising, Chicago Tribune, Tribune Tower, Chicago 11, Ill.

CHICAGO TRIBUNE

THE WORLD'S GREATEST NEWSPAPER

August average net paid total circulation: Daily, over 1,025,000—Sunday, over 1,300,000



Yes, FADA is back in the groove, ready to take care of pent-up civilian radio requirements!

FADA radios will offer a combination of modern technical experience, forged in the crucible of wartime necessity, plus a thorough understanding of civilian wants and modern merchandising principles, acquired over a long period of time in the making of hundreds of thousands of radios.

FADA is proud of its achievements in the Radio Industry over a period of many years. You, too, will be proud to display the new FADA line of radio receivers.

We suggest that you contact your distributor to learn more about FADA's profit-building merchandising plans. Or — write to us direct!

PLACE YOUR FAITH IN THE

FADA Radio

OF THE FUTURE

Famous Since Broadcasting Began!



FADA RADIO AND ELECTRIC COMPANY, INC., LONG ISLAND CITY, N. Y.

**DAY AFTER DAY...KNOWING FOLKS SAY...
 Recordio Discs AND Recordioint NEEDLES
 ENCORE SALES AGAIN, AGAIN, AGAIN!**



● Here is the "soundest buy in sound" for today's rapidly growing home and commercial recording business. RECORDIO Discs and RECORDIOPOINT Needles are the finest instantaneous discs, cutting and playback needles available today... into them has gone all the distinctiveness, the quality and the precision of all products by Wilcox-Gay, manufacturer of the first successful home recorder.

The market is limitless... those who send "voices from home" to waiting men in the armed services... who compile albums of history-making speeches... who record forever the special fun of parties at home... those whose career is furthered by vocal training... whose hobby is "making a record of it"... all these, their relatives and friends want the superior fidelity of tone and longer playback life of RECORDIO Discs... again and again.

The swing of the country toward history-making by sound can play a jingling tune for you if you carry this "soundest buy in sound." Your local distributor has information you need. Call him.

On its way!



The greatest RECORDIO you've ever seen... the world's newest, finest Home Recording Instrument... made possible only by the outstanding genius of Wilcox-Gay engineers. Selling RECORDIO will be like hitching your wagon to a star... possibilities are tremendous. Now is the time to plan for R-Day... the day you start selling RECORDIO.

Recordio

RECORDING INSTRUMENTS FOR HOME, COMMERCIAL AND PROFESSIONAL USE

Manufactured by

**WILCOX-GAY CORPORATION
 CHARLOTTE, MICHIGAN**

DEALERS: Mail This Today!

WILCOX-GAY CORPORATION
 Charlotte, Michigan

Gentlemen: Tell me more about the coming RECORDIO opportunity that is still open in my territory.

Store name.....

Address.....

City.....Zone...State.....



STEAM HEAT!

... and she can take it with her

WITTIE PORTABLE ELECTRIC *Steam* HEATER

THE MIRACLE of modern heating! Small but mighty comforting when a room has the chills . . . that's a Wittie Portable Electric *Steam* Heater—in "fan-blow" and convection types. Either model provides economical, luxurious warmth on cold days. The "fan-blow" Wittie *Steam* Heater pours out heat, rapidly warming any room. The convection model is ideal for smaller areas.

Made to answer a critical need for small heating units in homes, offices, farms, hotels and tourist courts . . . the demand for Wittie Electric *Steam* Heaters is immediate, urgent . . . huge! And the market will be primed still further by concentrated national advertising to consumers.

Don't put it off . . . prompt action now means sales and profits later. Write or wire *today* for full information.

LOOK AT THESE FAST SELLING FEATURES:

- | | |
|--|---|
| Automatic safety shut-off | Fan-blow and convection models |
| 2-stage heat regulator | Clean steam heat . . . healthful and safe |
| Portable . . . luggage design . . . light in weight. | No danger of fire or burn |
| Compact . . . 21 1/2" long, 17" high, 7 3/4" wide | Heats room in a few minutes |
| Honeycomb core radiator | Costs but a few cents a day to operate |
| | Operates on AC and DC current |
| | Finished in three attractive colors |



WITTIE MFG. & SALES CO. 1414 S. Wabash Ave. Chicago 5, Ill.
General Offices and Plant
Branch Offices and Representatives in New York, Kansas City, Los Angeles and Detroit



more efficient
...in miniature



ACTUAL SIZE

The early camera addict had to be both patient and rugged. He carried a bulky camera in one yellow stained hand and a case containing his plates, tripod and cloth in the other. He would laboriously "set up," struggle with focusing and try to keep subjects still for long time exposures. Compare the size of his equipment, his efforts and the results he obtained with those of the user of the modern camera.

Yet the pocket camera of today is no better example of greater efficiency in miniature than is the modern Electronic Tube. In most high frequency circuits TUNG-SOL miniatures function far better than the larger conventional tubes. Because of

shorter elements they are more rigid and their lesser mass makes them less prone to distortion as the result of vibration.

Now, as new radio sets and other Electronic devices come on the market, miniature tubes, as well as the older type tubes, will be needed for service purposes. TUNG-SOL offers radio parts Jobbers and Dealers a dependable source of supply for tubes to service every type of equipment.

TUNG-SOL

vibration-tested

ELECTRONIC TUBES

TUNG-SOL LAMP WORKS INC., NEWARK 4, NEW JERSEY
Also Manufacturers of Miniature Incandescent Lamps, All-Glass Sealed Beam Headlight Lamps and Current Intermittors



S • PHILCO • RADIOS • REFRIGER

COMING SOON!



Yes, the great day is coming soon when the people of your community will flock to your store to get the story of the

SENSATIONAL NEW RADIO AND PHONOGRAPH DEVELOPMENTS FROM PHILCO, THE LEADER

REMEMBER THIS NAME

THE MUSITRON

**READY
FOR
QUICK
DELIVERY**

***It Means Extra Profits to
Portable Phonograph Dealers***

Experience in producing tens of thousands of fine instruments for America's Armed Forces has resulted in the creation of instruments of a quality previously unknown.

These superb Post-War model Musitrons are available NOW for quick delivery—in plenty of time for your Holiday trade.

Eight splendid models, designed and priced to appeal to all types of your customers. Everything from hand-wound models to fully automatic record changers.

We are now setting up our sales organization and are looking for aggressive Dealers and Distributors.



If interested in
Distributorship, Dealership,
or Jobbing proposition, write,
wire or phone today.



L. M. SANDWICK ASSOCIATES

Manufacturers of Sound Equipment

223 West Erie Street • Chicago 10, Illinois • Telephone DELaware 1290

TURNER TURNS TO COLOR

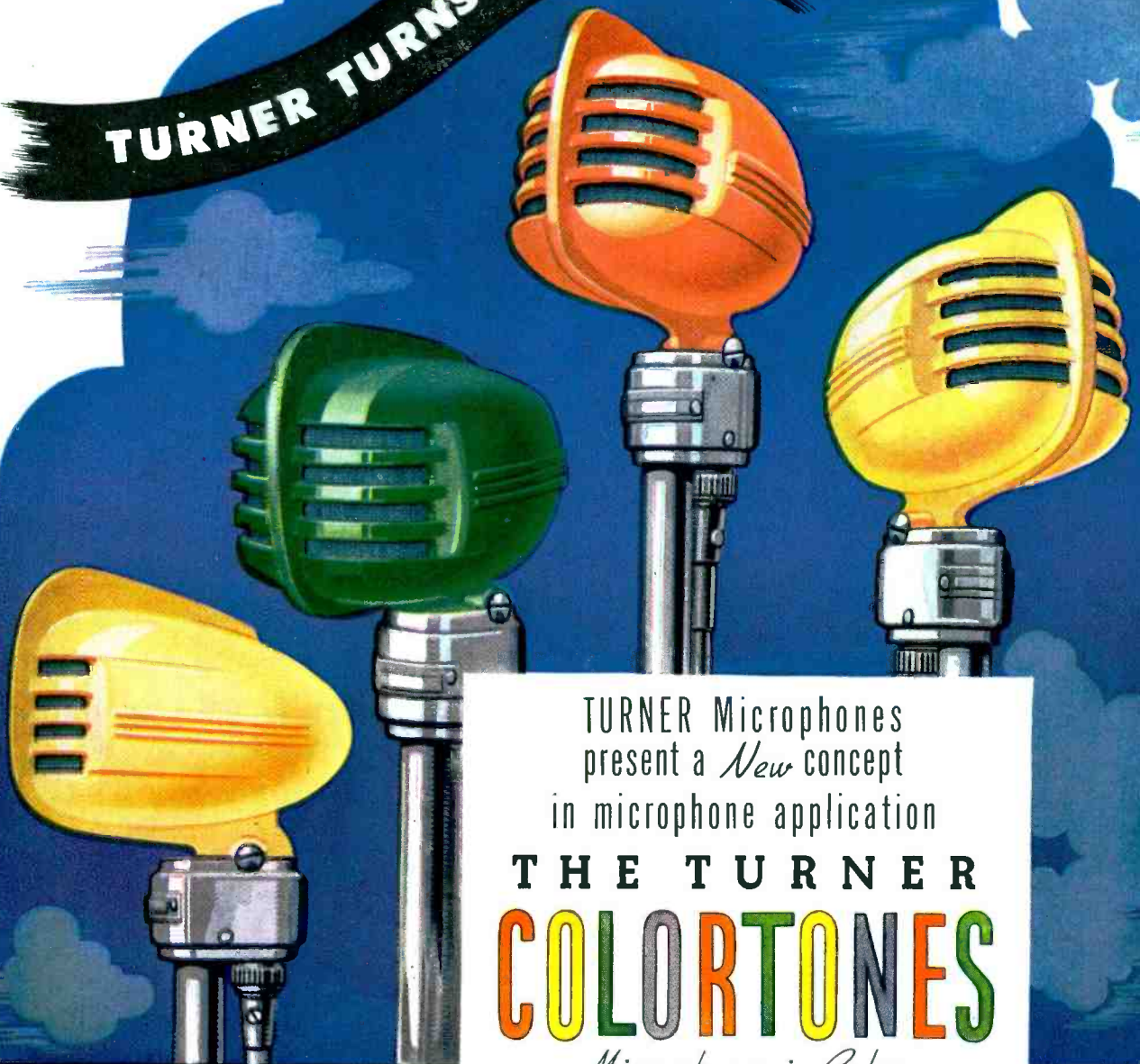

TURNER Microphones
present a *New* concept
in microphone application

THE TURNER COLORTONES

Microphones in Color

DESIGNED BY ARTHUR C. HAGSTROM,
INDUSTRIAL DESIGNER, ROCKFORD, ILLINOIS

BLAZING new tails in the field of practical microphone application, Turner introduces the Colortones. . . . New Crystal and Dynamic Microphones in a choice of rich color finishes. Conceived to meet the demands for functional color, their sparkling, streamlined beauty blends with modern electronic communications equipment. Executed in tough, rugged plastic,

they incorporate all those sound engineering principles which have won Turner's world-wide reputation for faithful performance under difficult acoustic and climatic conditions. Now in the final stages of manufacture, Turner Colortones will be available soon. Write today for particulars and specifications.



THE TURNER COMPANY — Cedar Rapids, Iowa

PIONEERS IN THE COMMUNICATIONS FIELD

Licensed under U.S. Patents of the American Telephone and Telegraph Company and the Western Electric Company, Incorporated. Crystals licensed under Patents of the Brush Development Company.

GAROD NOW... *and later*

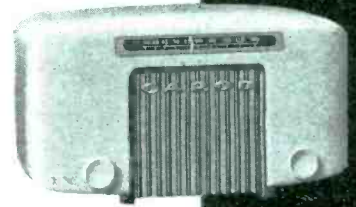

The radios illustrated are only a few from the complete GAROD line, which includes portables, table sets, radio-phonograph combinations, farm sets, AM, FM, etc. You'll sell them now when selling is easy—and you'll sell them later when competition is keener—because GAROD quality and GAROD beauty are a *natural* go-getting team. Starting with an extra-fast-selling group of table models, the GAROD line will include all models competitively up to \$350.00. Order from your local GAROD distributor now.



GAROD



RADIO

GAROD RADIO CORPORATION • 70 WASHINGTON STREET • BROOKLYN 1, N. Y.

www.americanradiohistory.com



**A WAR-TIME DEVELOPMENT
BRINGS US A POST-WAR
ELECTRONIC ACHIEVEMENT!**

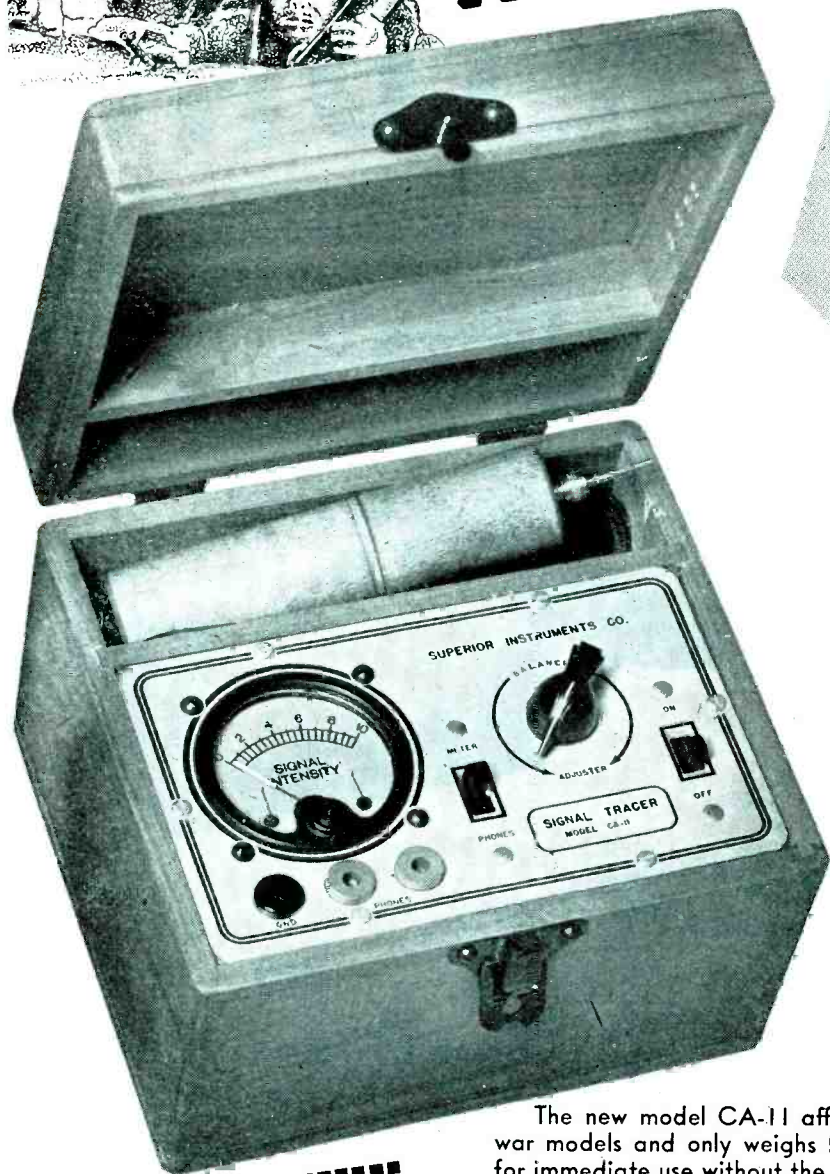

THE MODEL CA-11
**SIGNAL
TRACER**

Features:

- **SIMPLE TO OPERATE**—only 1 connecting cable — **NO TUNING CONTROLS.**
- **HIGHLY SENSITIVE**—uses an improved Vacuum Tube Voltmeter circuit. Tube and resistor-capacity network are built into the Detector Probe.
- **COMPLETELY PORTABLE** — weighs 5 lbs. and measures 5"x6"x7".
- Comparative Signal Intensity readings are indicated directly on the meter as the Detector Probe is moved to follow the Signal from Antenna to Speaker.
- Provision is made for insertion of phones. Introduced in 1939-1940 Signal Tracing, the "short-cut" method of Radio Servicing became established as the accepted method of localizing the cause of trouble in defective radio receivers. Most of the pre-war testers (including ours) were bulky and required a number of connections before the unit was "set for operation" and included a tuned amplifier which had to be "retuned" to compensate for signal shift.

The new model CA-11 affords all the advantages offered by the pre-war models and only weighs 5 lbs. and measures 5"x6"x7". Always ready for immediate use without the necessity of connecting cables, this amazingly versatile unit has **NO TUNING CONTROLS.**

Essentially "Signal Tracing" means following the signal in a radio receiver and using the signal itself as a basis of measurement and a means of locating the cause of trouble. In the CA-11 the Detector Probe is used to follow the signal from the antenna to the speaker — with relative signal intensity readings available on the scale of the meter which is calibrated to permit constant comparison of signal intensity as the probe is moved to follow the signal through the various stages.

**NOW AVAILABLE FOR
IMMEDIATE DELIVERY!**

The Model CA-11 comes housed in a beautiful hand-rubbed wooden cabinet. Complete with Probe test leads and instructions.

NET
PRICE

\$18⁷⁵

Please place your order with your regular radio parts jobber. If your local jobber cannot supply you kindly write for a list of jobbers in your state who do distribute our instruments or send your order directly to us.

Superior
INSTRUMENTS CO.

Dept. RT., 227 Fulton St., New York 7, N. Y.



Be FIRST in TELEVISION with VIEWTONE!

First

...with low-cost television. Receivers priced at approximately \$100—Television for everyone!

First

...with its offer to dealers of a well balanced line of radios, combinations, record players and television sets embodying postwar engineering marvels, brilliant new design, cabinet beauty, amazing tone, and sensational price structure.

First

...with the announcement to the public of definite plans for production of television receivers for the mass market, incorporating all advance features possible at low cost—as well as the full story on the rest of the line.

First

...with a public "mass demonstration" of its entire line, including "\$100" television.

Approximately
\$100

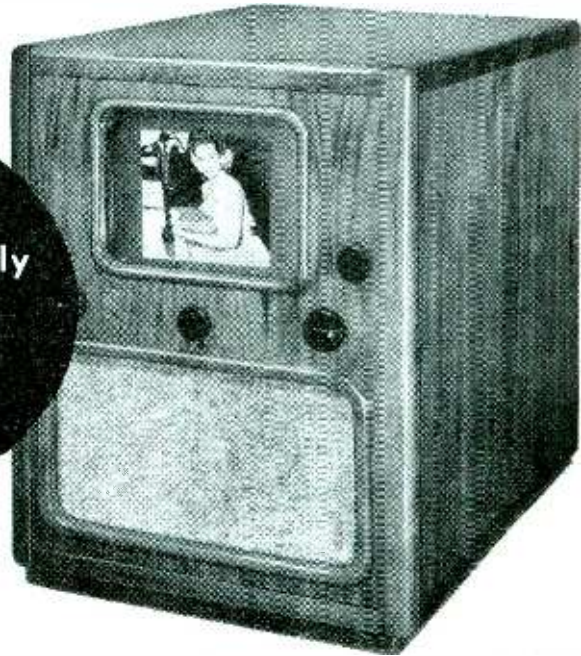

The photograph shows a small part of the enthusiastic audience of over 6000 people who saw a performance demonstration of VIEWTONE LOW COST PRACTICAL TELEVISION in a New York department store. Public acceptance was terrific. People wanted to buy right then and there. VIEWTONE TELEVISION proved itself at its first presentation to the public.

Get your share of immediate sales—big profits from the View-tone line. America's most talked about Television and Radio Sets



WRITE FOR THE FACTS TODAY

VIEWTONE COMPANY

Office: 203 E. 18th St., New York 3, N.Y. • Factory Site: B'klyn, N.Y.



ON THE SERVICE SIDE

OF RADIO ROW

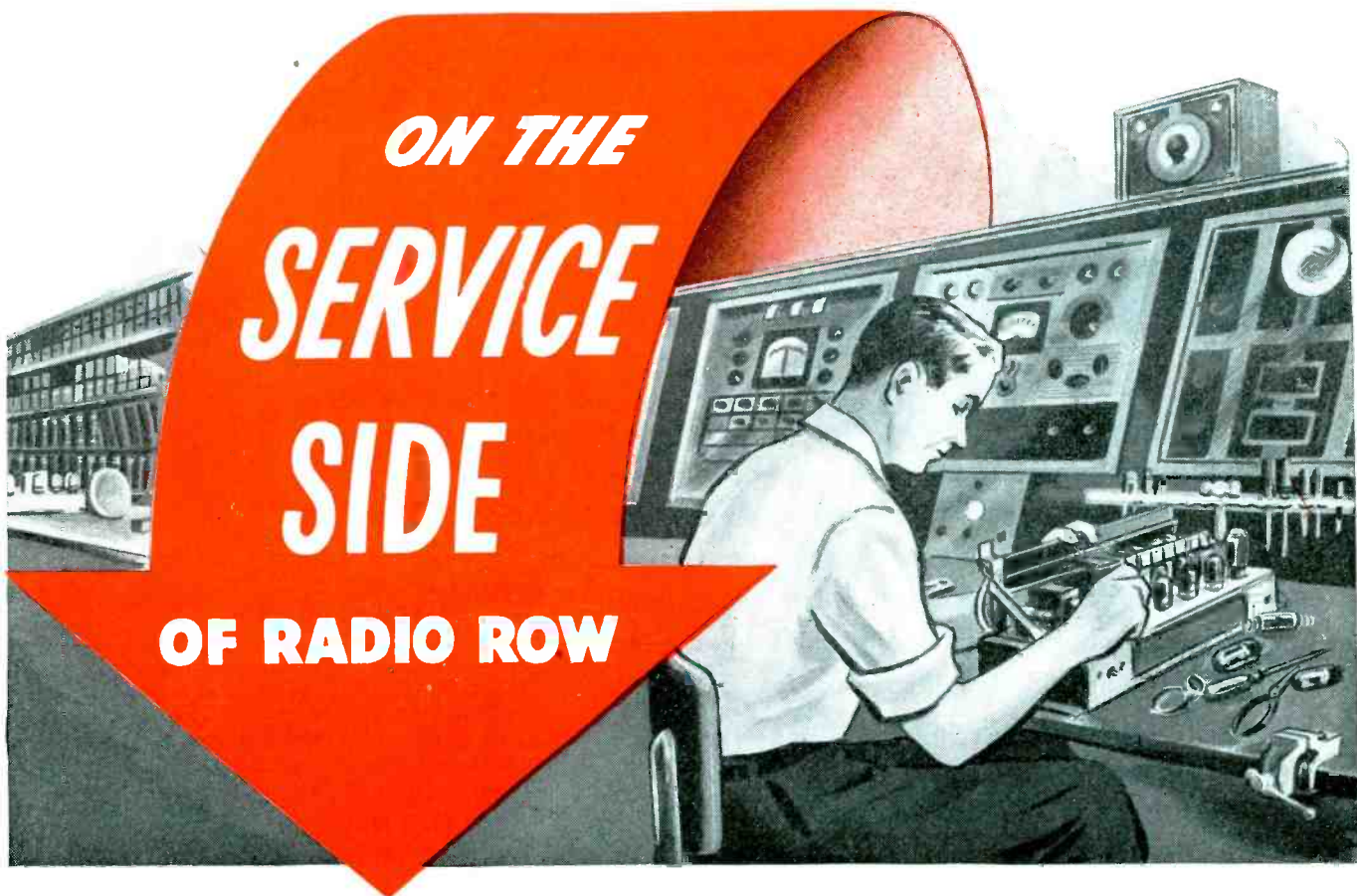

**THROUGH THE N. U. EQUIPMENT PLAN SERVICE DEALERS
RECEIVED 60,000 PIECES OF FINE TEST EQUIPMENT**



Since 1930, National Union has been the only radio tube and parts manufacturer whose entire merchandising program has been designed 100% to support the "service side of radio row" exclusively!

You know how the N. U. Equipment Plan brought 60,000 pieces of the finest test equipment to radio service dealers—free! You know how N. U. national and cooperative advertising, promotions, literature, displays and other business-builders helped dealers and jobbers prosper.

**AFTER THE WAR . . .
MORE THAN BEFORE!**

Count on National Union for even more help . . . a wider selection of tubes and parts, even better equipment deals, powerful new merchandising plans, more technical service information . . . to make business prosperous for all "on the service side of radio row"!
NATIONAL UNION RADIO CORPORATION • NEWARK 2, N. J.



NATIONAL UNION RADIO AND ELECTRON TUBES

Transmitting • Cathode Ray, Receiving, Special Purpose Tubes • Condensers • Volume Controls • Photo Electric Cells • Panel Lamps • Flashlight Bulbs

3 BIG STEPS AHEAD!

IT'S engineering that counts these days—and it's engineering that Sprague Electric Company gives you in fullest measure! From the smallest Sprague tubular or Atom replacement type to unique, giant capacitors developed for difficult war services, you'll find Sprague engineering leading the way in assuring such essential characteristics as greater dependability in smaller size, longer life, and outstanding electrical performance.

The three exclusive Sprague developments shown here are typical of many that have played a big part in helping Sprague become a FIVE TIME WINNER of the coveted Army-Navy "E" Award. And they're typical of the kind of engineering that goes into every Sprague Capacitor or Koolohm Resistor that leaves the plant!

See the Sprague Trading Post Advertisement on Page 118

Harry Kalber
Sales Manager

SPRAGUE PRODUCTS COMPANY
North Adams, Mass.

(Jobbing Sales Organization for Products of the Sprague Electric Co.)

SPRAGUE



1 *VITAMIN Q. This unique impregnant is Sprague's answer to high-voltage, high-temperature problems. Although small in size, Vitamin Q Capacitors operate satisfactorily at thousands of volts at ambients as high as 105° C. Leakage resistance at room temperature is 20,000 megohms per microfarad—at least five times better than that of previous types!

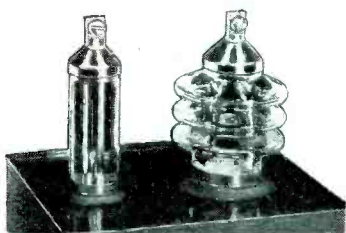

2 GLASS-TO-METAL SEALS

Under this exclusive Sprague method, glass capacitor bushings are welded directly to the metal container. On certain Sprague Koolohm Resistor types, the units are encased in glass tubes which are then processed to the metal ends. The resulting seals are leak-proof, shock-proof, humidity-proof and fungus-proof!

3 *CEROC 200

Much electrical equipment can now be designed for 200° C. continuous operation, thanks to Sprague CEROC 200, a Class C flexible ceramic insulation for wire. Smaller equipment can be designed to do bigger jobs.



*Trademarks registered U. S. Patent Office

CAPACITORS FOR EVERY SERVICE, AMATEUR, AND EXPERIMENTAL NEED



Exquisite Beauty - Superb Entertainment

HOWARD Radios with

* *Acousticolor Tone*



Backed by Powerful Consumer Advertising

In leading, big circulation magazines—American Home, Liberty, House Beautiful, House and Garden, Redbook, Cosmopolitan—Howard consumer advertising is selling your prospects on the new Howard Radios. All over the nation, Howard franchised dealers are getting set to cash-

in on this outstanding sales-stimulating publicity. If you want a complete radio line, including midgets, portables and other popular radios and phono-combinations that will bring you the cream of sales in your territory, write for the name of the nearest Howard distributor.

* *Acousticolor Tone—a new Howard refinement for your listening pleasure—the exclusive electronic development that makes it possible to recreate the tonal balance, beauty and brilliance of the finest music right in your own home.*

HOWARD RADIO COMPANY
1731-35 Belmont Avenue, Chicago 13, Illinois

Pioneers In
FM Radio

America's Oldest Radio Manufacturer



**"Singers always have
a favorite critic**

...mine is a

PRESTO RECORDING!"

"I know of no better check on my work than hearing it with my own ears," says Morton Downey of the famed tenor voice. "That's why I have each of my Coca-Cola programs transcribed. I feel that a Presto Recording—with its fine, clear reproduction and fidelity to musical tones—gives me a reliable basis for improvement."

Presto sound recording and transcription equipment is used by major broadcasting stations from coast to coast. Schools, colleges and business organizations, too, depend on Presto to help train students and personnel. A Presto Recorder is easy to operate. It stands up under hard usage. In short, it's a precision instrument designed to produce consistently superior results. Write for complete information.



PRESTO

RECORDING CORPORATION

242 West 55th Street, New York 19, N. Y.

Walter P. Downs, Ltd., in Canada



WORLD'S LARGEST MANUFACTURER OF INSTANTANEOUS SOUND RECORDING EQUIPMENT AND DISCS

NO BUBBLE!

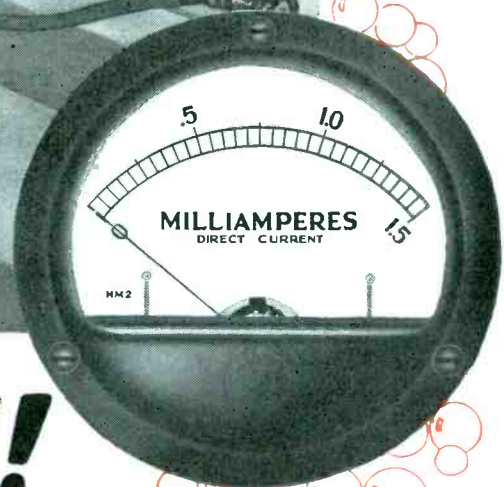

NO TROUBLE!

Production vacuum checking of Marion Glass-to-Metal Hermetically Sealed Electrical Indicating Instruments is no haphazard operation . . . After sealing in our dehydrating rooms, the instruments are submerged in glass jars which are partially filled with alcohol. A vacuum of 25 inches is drawn in accordance with newest JAN-1-6 specifications. During the test we watch for air bubbles — no bubble means no trouble. Spot checks for a period of four hours are made in a 29 inch vacuum.

The testing apparatus, illustrated above, is a Marion development, and demonstrates our sincerity of purpose in producing hermetically sealed instruments. We take nothing for granted — we neither suppose nor assume. Because imperfectly sealed instruments entrap condensation, we make certain that every hermetic instrument bearing our name is — perfectly sealed.

Marion Glass-to-Metal Truly Hermetically Sealed 2½" and 3½" Electrical Indicating Instruments

For complete details regarding a Marion Franchise, write to our Jobber Sales Division.



MARION ELECTRICAL INSTRUMENT CO.

MANCHESTER, NEW HAMPSHIRE

Jobber Sales Division: Electrical Instrument Distributing Co.
458 BROADWAY NEW YORK, N. Y.

Boost radio sales with

built-in Telechron Selectors

HERE'S a double-duty timer to give your radio receivers the extra appeal needed for successful post-war selling. It's *much more* than an absolutely accurate electric clock. It turns on the set automatically at any pre-selected time in the morning to waken the owner with music. It switches the set on for favorite programs during the day and evening—then shuts it off at bedtime.

The cost to set makers is remarkably small—less than \$4. Installation expense is low, too. Volume producers are already choosing it for moderate-price sets.

Radio listeners will like the Telechron Selector's easy finger-tip control. There are no knobs to turn and no difficult calculations. Programs are selected for any

15-minute period by flipping out one of the 48 keys around the large, legible clock dial. Keys are automatically reset to "off" position after timing periods are passed. Programs can be selected 10 hours in advance.

The C-28 Telechron Selector is only one of the full line of automatic timing and control devices we can supply for the sets you're now building or planning. *All use famed Telechron movements and self-starting synchronous motors for accuracy, dependability and long life.*

For full information about the C-28 Selector and other Telechron timers, wire or write Automatic Control Division, Dept. M.

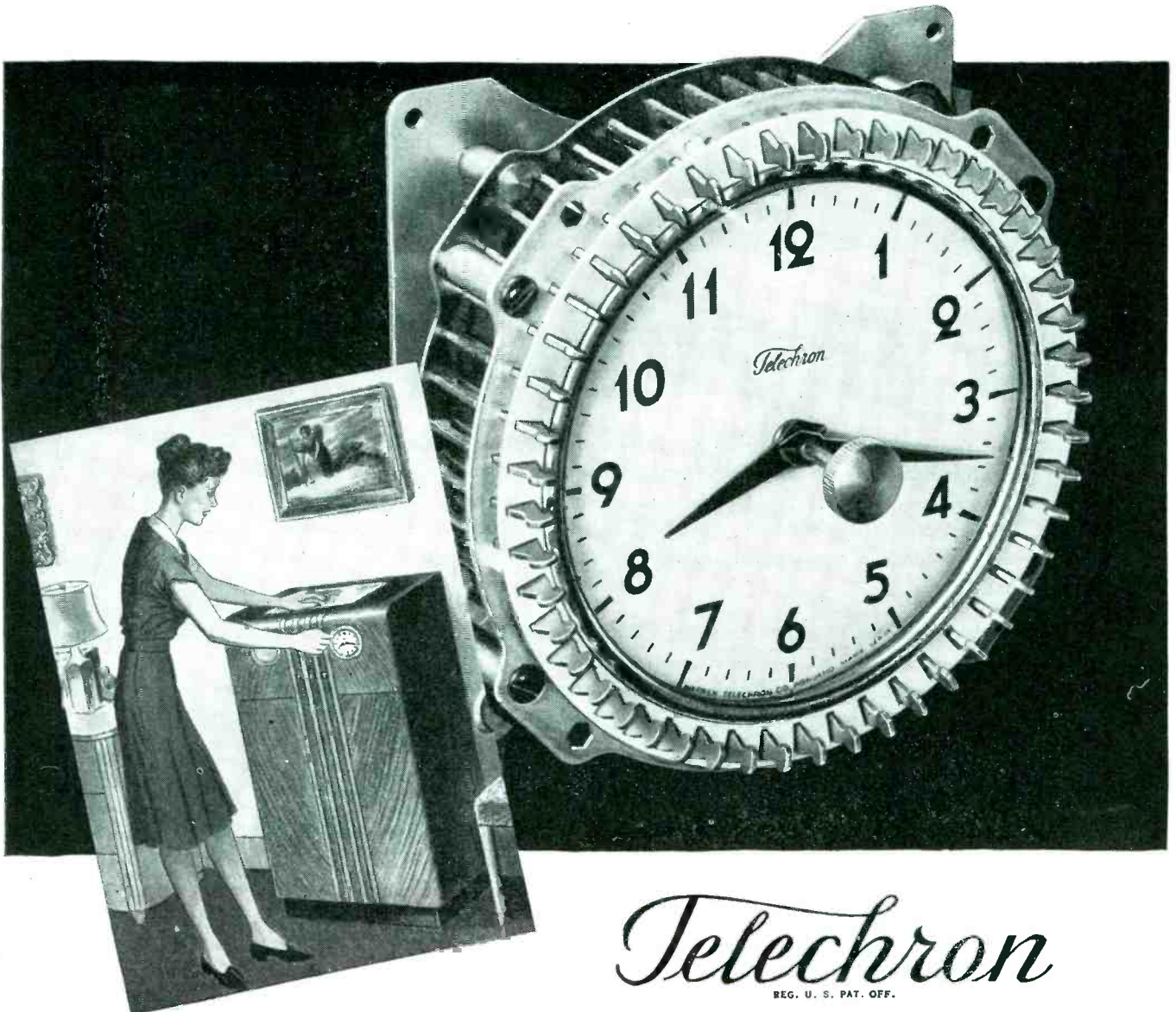

Telechron

REG. U. S. PAT. OFF.

WARREN TELECHRON COMPANY

• ASHLAND, MASSACHUSETTS

RADIO & Television RETAILING • October, 1945

**THIS IS A GOOD TRICK—
IF YOU CAN DO IT**



*F*RANKLY, we're not even tempted to try.

We won't straddle several "horses" in the race for the radio-buying public's favor.

Our business is small radios and small radio-phonographs exclusively. Our principals are long on experience in the small radio field, having been identified prominently and actively with the greatest developments in that field during the prewar era.

This experience, coupled with precious wartime experience in the manufacture of delicate materiel for America's armed forces, may well serve as a guide to the finest in small radios.

Made right, designed right, priced right — TELETONE radios will embody every worthwhile feature plus several new and exclusive ones born of our intensive wartime research. Everything, that is, to establish TELETONE as the *first* name in *small* radios!

TELETONE

RADIO • TELEVISION • FM

TELETONE RADIO COMPANY • 609 WEST 51st STREET, NEW YORK 19, N. Y.

Producers of Small Radios and Small Radio-Phonographs Exclusively

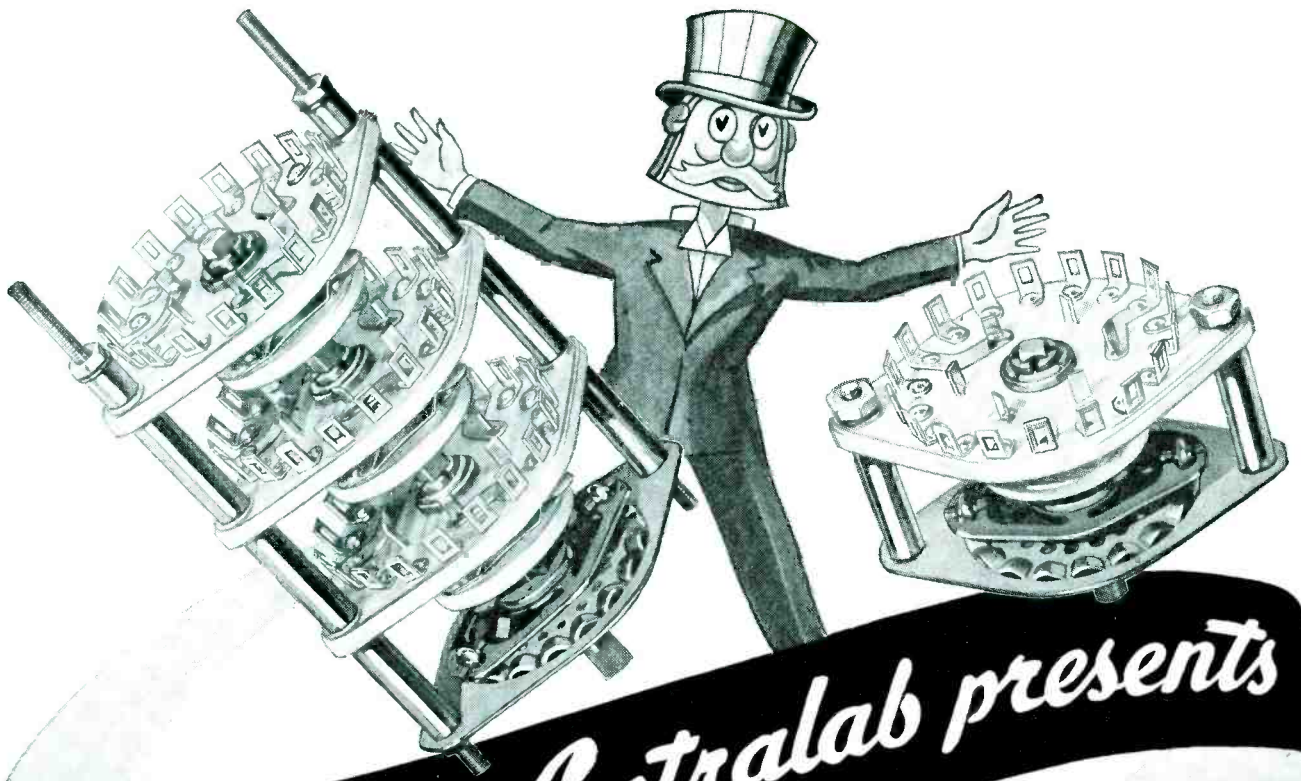

Old Man Centralab presents

Medium Duty Power Switches

BUILT to meet the exacting standards set up by Old Man Centralab . . . these already famous Medium Duty Power Switches are now available at your jobbers in single or multiple sections up to 6 sections.

Ideal for transmitters, power supply converters and special industrial and electronic uses. Rated at 7½ amperes at 60 cycles, 115 volts. 3 pole, 5 positions . . . or 1 pole, 17 positions or 18 positions continuous rotation . . . shorting or non-shorting contacts.

Producers of:

- Variable Resistors
- Selector Switches
- Ceramic Capacitors,
- Fixed and Variable
- Steatite Insulators
- and Silver Mica But-
- ton-type Capacitors.



Write for Bulletin 815.

Centralab

Division of GLOBE-UNION INC., Milwaukee

IN THE RACE FOR PUBLIC ACCEPTANCE...



Bendix Radio will be out in Front with the Leaders!

Thanks to unsurpassed manufacturing facilities plus production "know-how" gained in building more radio equipment in a single year than the industry's greatest prewar home set dollar output, Bendix will be one of the first major producers to ship its postwar models to dealers. Backing Bendix Radio dealers will be a national advertising and merchandising program of well over a

million dollars! • Leading dealers all over America—dealers who know radio and who, after looking at the facts of what Bendix has to offer, have signed "The Franchise With a Future." The starting gun has been fired and if you, too, want to tie up with a leader write direct to Bendix Radio Division, Baltimore 4, Maryland, for the name and address of your distributor.

BUILD BEST WITH BENDIX . . . FOR PRESTIGE . . . PROFITS . . . PERMANENCE!



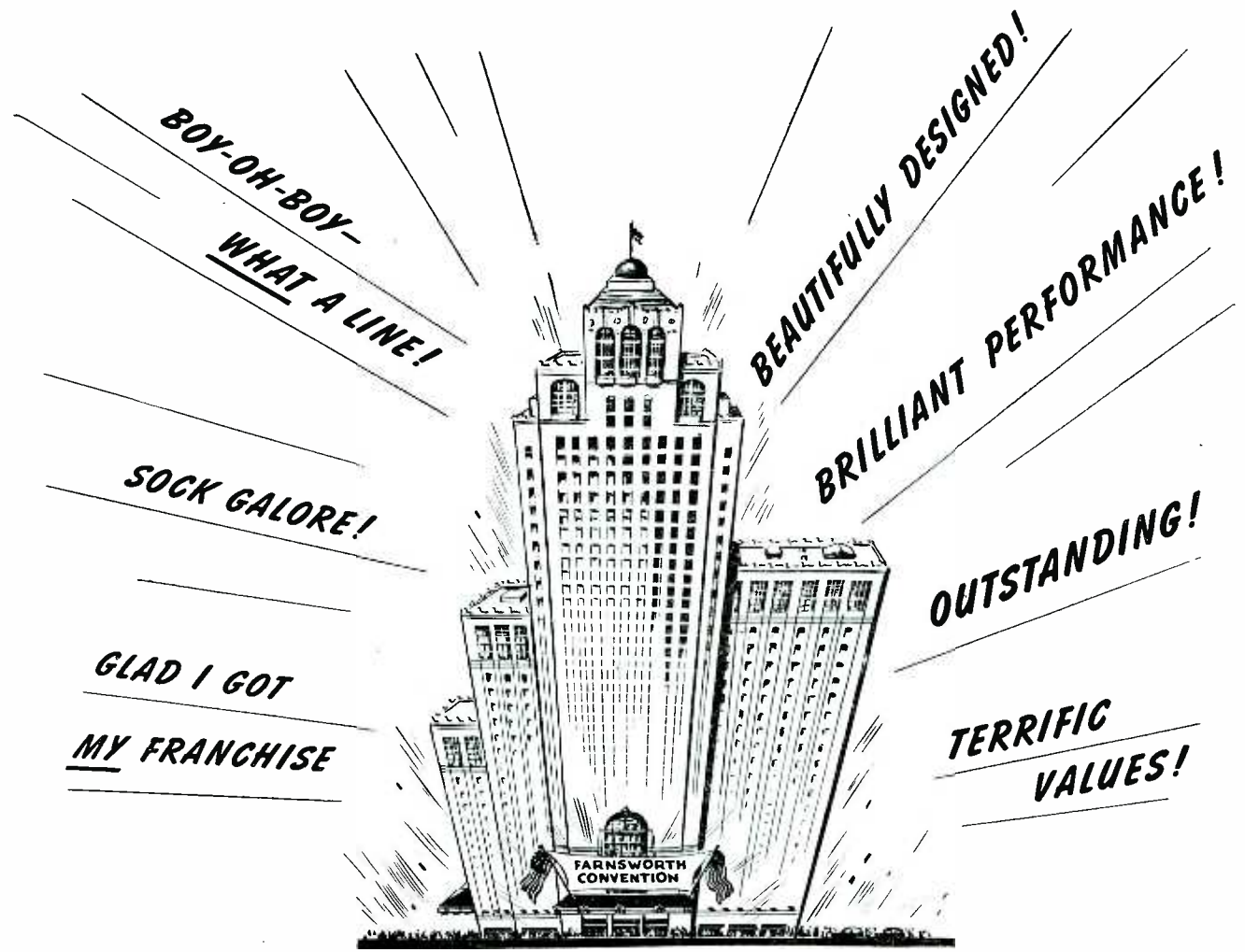

Hear what they're saying about
the new FARNSWORTH LINE!

No wonder they're enthusiastic! Farnsworth's new line of radios, phonograph-radios and phonographs is a positive sensation!

Every one's a stand-out! From the smart "idea" cabinets in the smaller models, to the truly modern and the graceful period designs of the floor models!

Those distributors and dealers who've already seen the Farnsworth "streamlined" line, are loud

in their praise. And delighted, too, with the Farnsworth Selected Dealer Program.

We're sending the Farnsworth show to every distributor point in the country. Farnsworth Franchised dealers who have yet to see it have "really something" to look forward to—and when they do, will, more than ever, be glad they signed with Farnsworth.

FARNSWORTH

**TELEVISION &
 RADIO CORPORATION
 FORT WAYNE 1, IND.**

Farnsworth Radio and Television Receivers and Transmitters. Aircraft Radio Equipment • Farnsworth Television Tubes • Halstead Mobile Communications and Traffic Control Systems for Rail and Highway • the Farnsworth Phonograph-Radio • the Capehart • the Capehart-Panamuse

There's a

BIG market

waiting for

Phonola

**ACOUSTIC AND ELECTRONIC
PHONOGRAPHS**

**Sell Phonolas for
RECORD SESSIONS**



**Sell Phonolas for
APARTMENTS**



**Sell Phonolas for
PICNICS**



**Sell Phonolas for
SUMMER CABINS**



... and for many other uses!

- When Phonolas are again available (and we're promising you it will be soon!) you'll find a big demand for the musical joy they will bring. Recorded music was never before so popular . . . tone reproduction never before so important to listeners—and that makes Phonola a "natural" to build your sales volume and profits.
- The new Phonolas will be better than ever—the result of our wartime experience with sound reproduction systems and our rich background of 29 years as America's leading manufacturers of phonographs. In designs, in tone quality, in dependable workmanship, the new Phonola line is the finest you can offer to your customers.

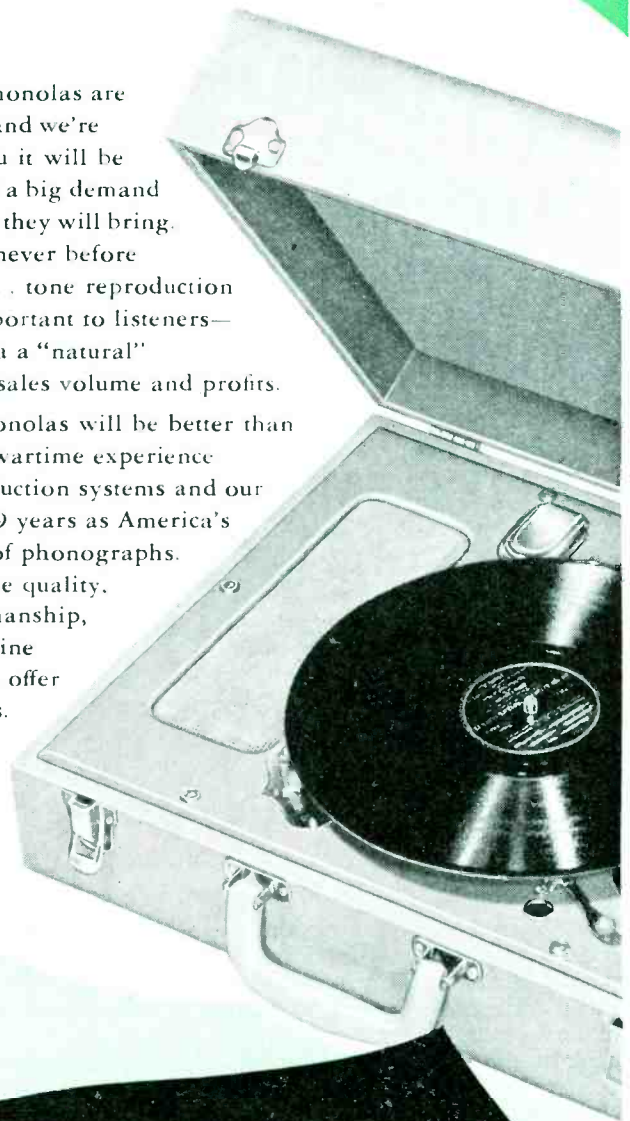

WATERS CONLEY COMPANY
ROCHESTER, MINNESOTA

Eastern and Export Sales Office
17 E. 42nd Street, New York City, VA. 5 2079

Midwestern and Western Sales Office
224 S. Michigan Ave., Chicago, HAR. 1880

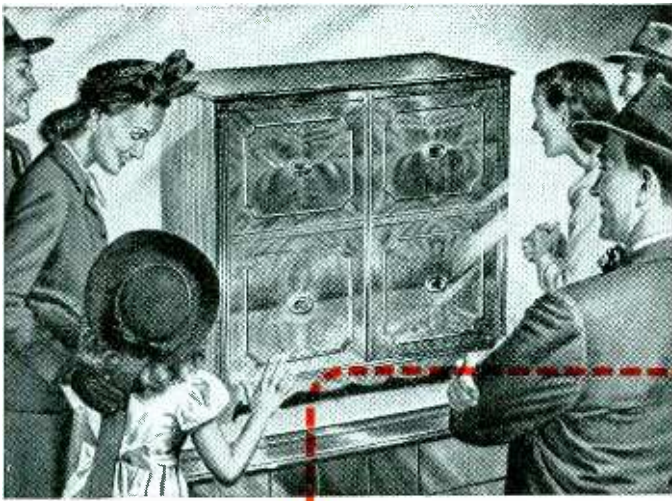

Soon you'll be able

to offer a

STROMBERG-CARLSON

for the Main Radio

in any home

proving more than ever

there's nothing

finer than a



Stromberg-Carlson

New Stromberg-Carlson models, and new Stromberg-Carlson prices soon to be announced, will place some type of Stromberg-Carlson within the reach of practically anyone desiring a fine musical instrument for the *main radio* in his home. This main radio may take the form of a simple table model, a handsome console, or a magnificent radio-phonograph combination, for, whatever its type, there's nothing finer than a Stromberg-Carlson.

Take advantage of Stromberg-Carlson's widened market, and the increased demand spurred on by vigorous advertising with some 475,000,000 impressions in

thirteen leading magazines during 1945. Ask your Stromberg-Carlson distributor for details of the very favorable Franchise Agreement now being offered, or write us directly. For Stromberg-Carlson is:

- the important radio unit
- the radio unit carrying real profit opportunity
- the radio unit with easy-selling public acceptance.

Become an Authorized Dealer now. Then make the Stromberg-Carlson the main radio in your showroom, and build your postwar business right around the Stromberg-Carlson *main radio* theme.

STROMBERG-CARLSON

ROCHESTER 3, N. Y.

RADIOS . . . RADIO PHONOGRAPHS . . . AND TELEVISION

RADIO & Television RETAILING

Including Radio and Television Today

O. H. CALDWELL, Editor * M. CLEMENTS, Publisher * 480 LEXINGTON AVE., NEW YORK 17, N.Y.

A Good Time to "Clean House"

Recent talks with leading distributors and retailers have been gratifying.

We see a definite and *earnest* trend toward better understanding and better business practices between the independent retailer and the independent wholesaler.

Many of the country's prominent jobbers are pledging themselves to put into effect certain much-needed reforms. Leading retailers are announcing that they will strive to maintain better relationships with their distributors.



This healthy desire is as encouraging as it is refreshing.

Better future relationships between the jobber and retailer will cut down dealer mortality rates and will make more money for the wholesaler. Co-operation and understanding between these "first cousins" in merchandising will perpetuate their existences as necessary cogs in our economic structure.

Employment of chiseling methods, chicanery and financial finagling between the two will be just what the "chains" and similar organizations would have made to order for the independents—financial loss and chaos in general.

It's a good thing to face the issue fairly and squarely in this day of comparative lull between dribbles of merchandise now and the great flood of radios and appliances coming tomorrow.

The jobber who "overloads" the dealer; pushes the sale of slow-moving items or delib-

erately stocks the merchant with out-moded models, is ruinous to the retailer and ruinous to his own business.

The wholesaler who gives greater discounts or more liberal credit terms to "pets," is cheating his other customers.

The jobber who sells "retail" at wholesale prices is playing into the hands of the "chains"; robbing the dealer of business that could be his.

The retailer who fails to keep payment promises to the jobber is cutting his own throat. When he makes unreasonable requests to the jobber to "take back merchandise," he cannot expect to continue in the good graces of the wholesale house.

Dealers and distributors who fail to live up to franchise and territory agreements are making room for other merchandising outfits to "chisel" in.



Distributors and dealers know the type of *poison* to administer in order to make business *sick*—they know it to be unprofitable and unsatisfactory. They know the right *medicine* to use in keeping business *healthy* and *wealthy*.

The honest decision on the part of the jobber and retailer to use *medicine* instead of *poison* is a welcome one. It is a sign that the "independents" are big enough to see their past faults—are willing to do something about correcting them in order to secure a better, happier and more profitable era in selling radios and electrical appliances.



RADIO, Electrical Appliances,

RADIO-APPLIANCE "TIME-TABLE"—Radios will reach pre-war rate of output by Xmas, but so great is demand this may seem a mere trickle in meeting dealer needs—Refrigerators, in good production, but being "stock-piled"—Freezers, farm and home, in good production—Washers, not nearly enough to go 'round till after 1st of year—Ranges, fair supply soon—Cleaners, fair supply soon—Hand irons, supply should increase rapidly from now on—Small appliances will be on dealers' shelves in increasing quantities before Xmas.

LITTLE INTEREST IN SHORT-WAVE bands on home sets right now, say dealers, despite fact that recent wars should have stepped up desire by set owners to be able to hear from foreign lands. Apparently, many are satisfied with re-broadcasts they receive.

TRENDS IN NEW SETS by-pass tuning "gimmicks"; soft-pedal pushbuttons as features. Better tone, more volume without too much dependence on antenna; simplified, cleaner circuits and conservatively designed cabinets being featured in first peacetime home sets.

"SAMPLE ONLY—DO NOT SELL"—That's what some manufacturers and jobbers are telling the dealers who are receiving one radio or appliance. Retailers are told that shoppers will make all sorts of bids to buy the display item. "Take an order, but hang onto your only demonstrator," is the advice to retailers.

CHICAGO'S ELECTRIC ASSOCIATION is sponsoring a postwar electrical appliance and radio show in the entire first floor showroom of the Commonwealth Edison Co. The event will run through the month of October—possibly longer.

POCKET-SIZE RADIOTELEPHONE for civilian use which will sell for about \$25 and will be about six inches long, weighing a half-pound, will be placed on the market within a few months, Richard Mahler, vice-president and general manager of the Harvey-Wells Communications, Inc., Southbridge, Mass., has announced. Device, it was stated, will be effective for distances up to three miles.

TUBES IN NEW SETS—Tubes to be required in the new radio sets with FM bands and television reception, compared with pre-war sets, are estimated by Raytheon's L. K. Marshall:

	Number of Tubes
Pre-war radio set in \$50 retail price range.....	6-8
Comparable new set with FM band.....	8-9
Low-cost television set.....	18-20
High-quality television set with FM band and record changer.....	25-30

REFRIGERATOR PRODUCTION still being stock-piled for essential uses. Dealers are expected to have some models for general retail sale sometime next month (November).

CAPTIVE BALLOON AS TELE ANTENNA being tried out by Crosley's experimental station W8XCT from studio atop Cincinnati's 47-story Carew Tower.

MORE HAMS—OLD AND NEW—It is expected that the post-war period will develop a new crop of "hams" that will double the pre-war figures of licenses and sales. So far there is no indication of radical changes in the designs of ham sets. It seems, however, that only one of the manufacturers of communications receivers has grasped, and profited by, the psychological effect of having a low-priced set for beginners, followed by a series of models that step up the specifications and price gradually with the mental and financial growth of the "ham."

HOW TELEVISION WORKS: Television itself will probably get first crack at showing of Army Signal Corp film, "This is Television." Designed for showing to Army personnel, it takes viewers inside studios, explaining in lay language all phases from transmitter to receiver. Our Editor is the narrator, and shots include Gen. David Sarnoff, Gilbert Seldes and Dr. Vladimir Zworykin.

EUREKA CORDLESS IRON is now coming off the lines. Production started the end of September. Initial delivery is due very soon.



Let Him Sell for You!

SALESMAN SELL THYSELF—According to the National Assn. of Music Merchants, radio-music stores all over the country should offer opportunities to returning vets as salesmen. Stating that "we know the stores need new young blood in their sales work," William A. Mills, NAMM executive secretary, urges the sales-minded vet to "sell the merchant that he needs another salesman and that that particular G.I. is his 'guy.'"

PHILHARMONIC RADIO CORP. WILL RE-ENTER the home radio manufacturing field, Zeus Soucek, president, reports. Firm will make receivers for other sources only and plans no distribution of its own. Sets will have either private brand label, or Philharmonic's, and retail at \$50 to \$175. Initial production, to start about November 15, includes 5 models. Future plans call for return to pre-war set-up, and for manufacture and distribution of sets retailing near \$1,000.

Records, and Television, **TODAY**

RETURNING GI'S MOSTLY WANT JOBS—Surveys of mustered-out servicemen show that two-thirds are looking merely for jobs—jobs in the same lines they formerly worked in. Only one-third, however, expect to return to former employers. A bare 10 per cent want to go into business for themselves; about same percentage plan to buy and operate farms. Earnings of \$200 to \$250 per month is job bracket most generally asked for.

TELEVISIONS CONGRESS—The House of Representatives has granted first definitely-assigned position for television cameras to NBC, whose cameras—motion picture and television—will be placed alongside cameras of the film companies, in the House gallery. Position assigned NBC "mikes" is to right of clock in the gallery, directly facing the Speaker. Thus all activities on House floor will come clearly within focus for NBC television broadcasts.

Now I'll live
to an old-but
not ripe-age

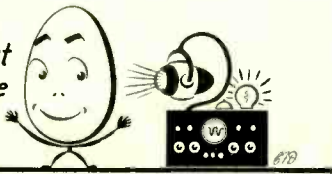

DEVICE WHICH IMPROVES EGGS is a high-frequency machine for sterilizing eggs, under development at the University of California Farm, at Davis, Calif. In principle, somewhere between radio and diathermy, the device uses oscillations that cook an egg hard in about 9 minutes, but with only a ten-second exposure, the egg germ is killed, giving better keeping quality; certain bacteria on the shell are also destroyed; the egg's albumen is slightly stiffened, so that when broken in the pan, the yolk stands out above it. If brought to a commercial stage, the machine probably would improve keeping quality, and appearance of eggs, and fit in with oil preservation. Experts are not ready to make claims.

BROADCASTING 25 YEARS OLD—Next month the radio industry will complete 25 years of broadcasting. It was the November election-night of 1920 that pioneer KDKA went on the air to announce President Harding as the winner. A few home receiving sets had been especially manufactured by the Westinghouse company, and these, tuned in around Pittsburgh, picked up the first newscast that eventful November evening. RMA and NAB have recently been working on plans for celebrating this 25th anniversary; meanwhile in November radio dealers can feature the occasion in their own show-windows, using early pieces of radio equipment as centers of displays, with suitable explanatory placards.

530,000 AT RADIO MFG. PEAK—Confirming our own statistics issued early in 1945, WPB's Harold Sharp now officially estimates "over 500,000" as the peak of radio employment at that time. By July 1, he said, the total had fallen to 470,000. Of this number, 335,000 were employed by "regular" radio manufacturers. Mr. Sharp also confirmed our own statistical estimates of pre-war employment by radio manufacturers at about 110,000.



CLOTHES MAY MAKE THE MAN but they don't always dress up the landscape. "The aesthetic value of the rear verandas overlooking a landscaped courtyard at 100 Lanark Road is not enhanced by washing hanging from clotheslines," ruled Judge Donahue in Suffolk (Mass.) Superior Court, as reported in Boston Herald. "Smart work by clothes dryer propagandists," suggests William Shaw of American Washer & Ironer Mfrs. Assn., Chicago.

WOULD AFFECT DISCOUNT RATES—"If manufacturers need increases over their pre-war prices because their production costs have risen so much that there is no reasonable prospect of profitable operation, we will continue to make sure that those increases are absorbed wholly or partially by wholesalers and retailers."—OPA's Chester Bowles.

THOSE 268 LICENSEES—Some alarm was created in the industry by recent newspaper announcements that RCA now has 268 licensees to manufacture radios. This figure of course applies to the total number of licensees for manufacture of transmitter equipment, commercial apparatus, sound-recording, sound-studio apparatus, and theatre equipment. The number of radio receiver licensees is now 108.

SALESMEN PSYCHED—One large appliance maker is using the most up to date psychological methods in selecting its salesmen who are to introduce its line. A special question and answer form is required to be filled in by the applicant and this is then submitted to the psychological corporation which charges \$10 per head for advising whether applicant is suited for job.

FOR LATEST ELECTRICAL APPLIANCES, SEE PAGES 44, 45, 46, 47



Get "Chips" Off Xmas Customers' Shoulders Adroitly, "Painlessly." There's a Job Ahead, with Not Enough to Go 'Round.

Many Shoppers Have "Shortage-Neurosis"

• One of the first and most important things the independent retailer must do now is to get that chip off the customer's shoulder.

But he can't *knock* it off! He must get it off adroitly and "painlessly."

With the return of merchandise to his shelves and showroom floor, the retailer will be brought face-to-face with a totally new sort of consumer—a consumer recently in the throes of "battle-fatigue" in the fight to obtain the commonest necessities of life.

"Shortage-neurosis" is a very real consumer affliction. This condition has brought about in many people an embittered and skeptical feeling toward *all* merchants.

Some Good-Will Lost

As we have pointed out in past issues of this publication, radio and appliance dealers have, for the most part, placed themselves in strong and wholesome positions with consumers.

These dealers have kept radios

playing and appliances working, and by and large their services have been appreciated. But they have fallen heir to some of the ill-feeling on the part of the people. Though the ill-will generally felt toward *all* merchants on the parts of some consumers may not be merited by the radio-appliance merchant, he'll have to bear a certain amount of it.

Use Tact With Consumers

Acting upon the safe premise that his customers will be "touchy," to say the least, the dealer will want to avoid all pitfalls associated with selling the first merchandise.

Since it seems doubtful at this time that he will have enough merchandise to satisfy the demands which will be placed upon him between now and Christmas, the dealer must plan to handle this emergency skillfully and intelligently.

The customer who offers objection to a pre-war vacuum cleaner, mustn't be told that he's "lucky to get any-

thing." Instead of pursuing this out-of-date wartime alibi, the merchant should stress the merits of the cleaner; the fact that it contains no "ersatz" materials, and the remote possibility of later models in the near future.

While most consumers will be willing to take pre-war merchandise, certain numbers will not, and there will be a considerable number of prospective purchasers who will express themselves as "willing to wait."

Salesmanship will have to be employed in selling many radios and appliances even in this "seller's market." The smart dealer is not so much interested in selling merchandise he expects to get some time in the future as he is in moving the stock he has presently on hand.

Need for Salesmanship

Merchandise must be attractively shown and skilfully demonstrated by the dealer. All efforts must be made to sell those customers who express



There will be more shoppers than merchandise this Christmas season. Skilful salesmanship must be used to insure future business.

RTR DEALER HELPS FOR CHRISTMAS BUSINESS

Plan show window displays. Start installing them right after Thanksgiving and change at least once a week.

A few suggestions: Mass displays of minor appliances, featuring prices—attractive displays of large radios, appliances—miniature village backgrounds or foregrounds, made by dealer—outside trim around show windows made of real evergreen branches, laurel, etc.—motion in window, such as electric train with track winding in and out of various displays—unusual lighting effects, using flasher buttons, tree strings of lights, etc.

In-window decorated Xmas trees (keep butts in water)—frost effects on windows (use Epsom salts saturated in stale beer)—background of crepe paper, wreaths—use fireproof cotton to cover pedestals, stands, etc.

Many dealers will meet competition in Xmas tree light business by the five-and-dime's, etc., through (1) Featuring high-quality outfits only. (2) Offering free testing service on customer's old strings. (3) Through offering to dress customer's living trees, doorways, etc. Large profits in tree light business sales and service. Don't over-buy. If you are near a supply house, purchase Xmas tree light stock on a day-to-day basis.

In-store decorations are very important. They help keep the customer in a holiday shopping mood. Garlands, wreaths and decorated show-cases and display pieces give your store the desired Xmas atmosphere.

To facilitate handling the Christmas shopping rush, arrange stock so that you can get at it easily and quickly. Where space permits, packaged items may be placed under display shelves, etc., beneath similar items.

Keep empty appliance containers, cartons and boxes, clean and in an attractive condition. If you do this, customers won't object to accepting items on display if you are obliged to sell them when stock runs low.

a desire to "come back when you have more models." Such shoppers may walk out of one store and purchase forthwith in another.

Optimism and courtesy must prevail in the store today whose owner expects to sell the "chip-on-shoulder" customer. Great care must be exercised when supplies have been exhausted. The "better-buy-this-it's-the-best-you-can-get" attitude is one to be avoided by the smart merchant.

Optimism must be employed in dealing with the customer who makes consistent efforts to buy something from the merchant—repeatedly inquiring "when do you think you'll have such-and-such refrigerator?"

Optimism the Keynote

"Soon, we hope. Any day now. We'll try to find out definitely for you within the next two days," etc., are much better phrases than gloomy predictions, conversion-problem alibis or crying to the customer that his suppliers are playing favorites.

To deal with today's "shortage-conscious" buyers, the dealer should avoid the "shortage" angle from all conversation. Belligerency, whining and independent attitudes will prove sales-killing barbs.

Cheerfulness, encouraging news
(Continued on page 96)

California Dealer Readies Establishment for Sales Rush with Small Outlay. Much Money Saved in Remodeling Store

MODERN Store

• One California dealer has a successful store modernization plan the chief "ingredient" of which is *ingenuity*.

Other constituents making up the formula for readying the store for the coming sales rush, include LOTS of

hard work and a LITTLE money.

To accomplish two things—obtain a first-class job and save money—Norman Urquhart, 1227 Fourth Ave., San Diego, Calif., drew a set of plans and then called in a contractor. The contractor wanted \$2,500 for

the job. Dealer Urquhart, considering the price too steep, rolled up his sleeves and did the job himself.

And all it cost him was \$1,200!

With a little paint, some lumber, chromium piping, and drapes, he has created a new store out of the old. He has enlarged his display area 50 per cent merely by removing the old partition and putting the new one up 25 feet to the rear. (The narrow store was only 50 feet long, but it is now 75.) The new rear partition makes an attractive service counter and display case, in addition to creating an unobtrusive spot for the office desk and small items shelf.

Retailer Urquhart holds a few of his orders for goods while waiting for new merchandise to arrive at any moment. Deposits have already been paid for refrigerators, radios, ironers, etc.



Displays Lessen Labor

Urquhart is going after more sales business than ever before, and he definitely expects to get it. But having developed his business from scratch in 1937, he knows just how tough the competition can be. For that reason he has designed his store so that there is room for several salesmen and lots of display space.

The display window is on the floor level so that heavy merchandise can be moved about by one man. Display shelves are flexible and can be easily moved from the front to the rear of the store to make way for seasonal promotion of heavy merchandise.

Many Electrical Outlets

Urquhart installed a multitude of electrical outlets so that any and all appliances can be plugged in conveniently. Another feature of this remodeling job is the use of plenty of light to accentuate the appliances. A dealer in only the best lines of merchandise, Norman is convinced that good radios and appliances deserve the best of surroundings.

at **MODEST** Cost

▲ Dealer Urquhart will soon raise the curtain on new merchandise, which he expects any day. Space is already provided.

➤ The biggest part of the revamping job was tearing out a partition and building a service counter 25 feet to the rear. Note built-in table appliance display.

▼ This is the store front as it appears after remodeling. Full length display window permits better view of interior. Store floor and window display on same level is helpful by making arranging easier.

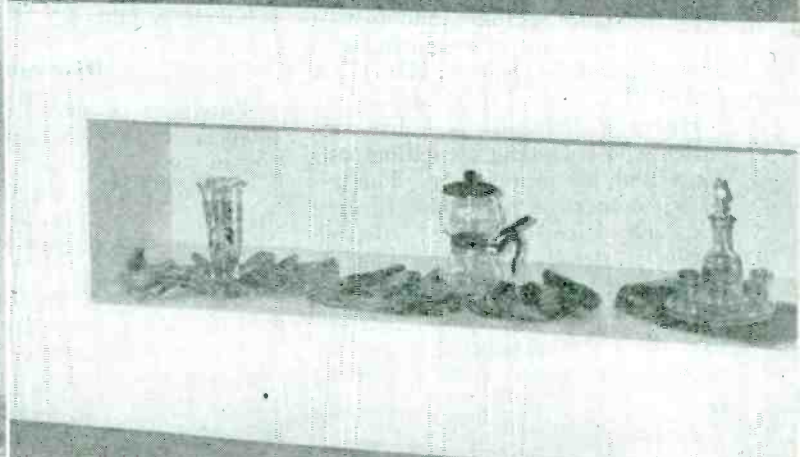

Formula

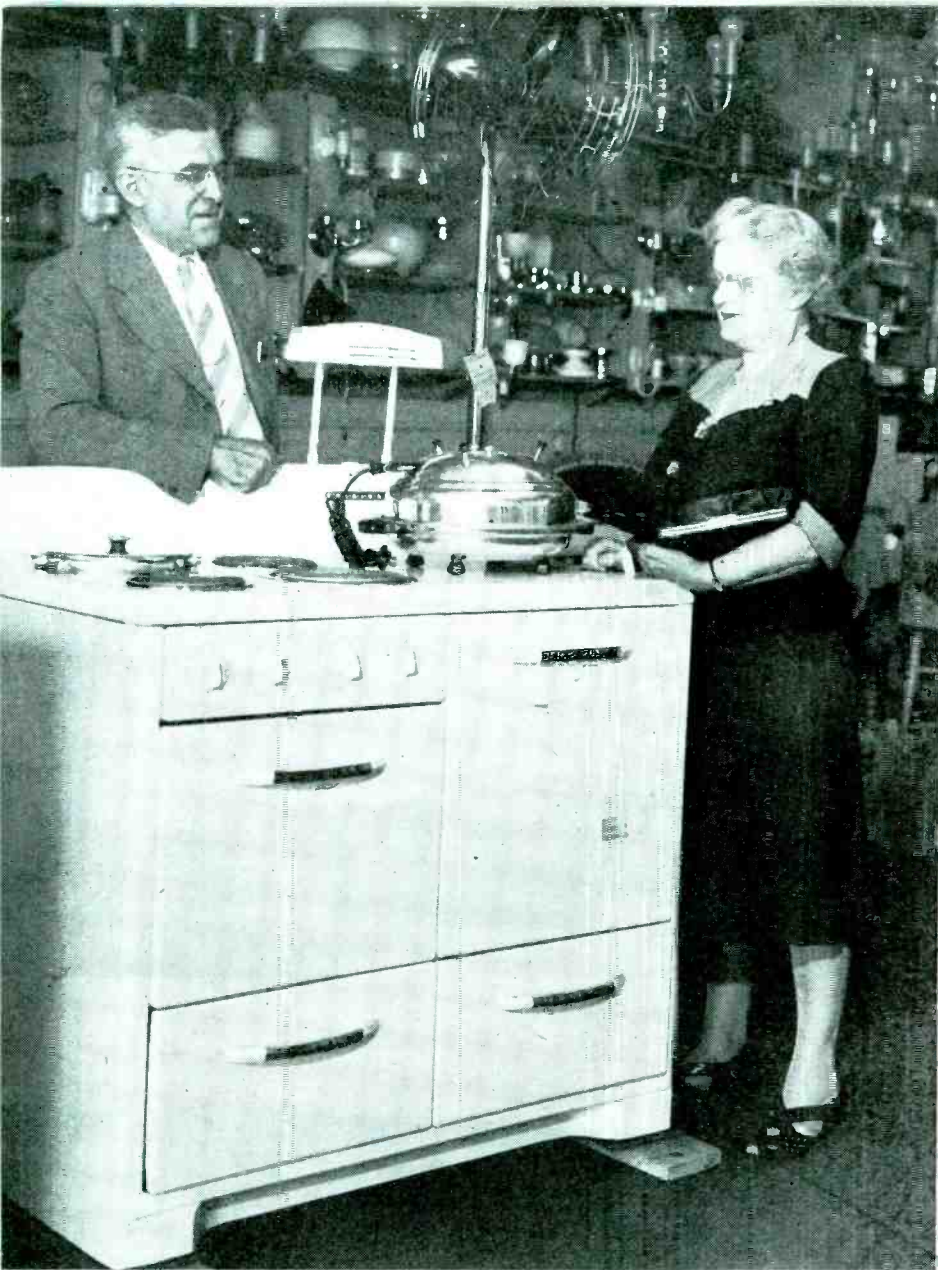

Retailer Murphy selling a customer new appliances. He follows up sales with good service.

is especially true at the present time. Murphy feels that with quantity selling and a fast stock turnover rate in sight, he can show a greater profit at the end of the year by taking advantage of the discounts offered by paying cash.

Discounting his bills has also helped the store's owner in other ways. For example, it has helped to build a better relationship between radio-appliance distributors, manufacturers, and his firm.

In addition to paying cash for goods bought, the store finances its own consumer installment paper as far as it is able. With consumer installment buying on a large scale predicted by many merchandisers, however, Murphy may get more assistance from finance companies or banks in the future.

Profitless home demonstrations are definitely *out*, this merchant declares. "Almost without exception, we will close radio and appliance sales on the floor," Murphy asserted. "Demonstrations away from the store which do not result in sales mean more expenses and less profit for us. We do our best to discourage home trials on appliances."

Electrical Dealer Cuts Costs, Increases Sales. Gets EXTRA CASH by Careful Buying and Selling.

● Smart merchandising plus good service is a successful recipe for electrical appliance selling. Add to that means of keeping costs down to a minimum and the result is: **HIGHER PROFITS.**

Henry F. Murphy is a live-wire dealer who is keeping his selling costs *down* and his income *up*. This retailer, owner of Murphy Electric Co., 12 Riverside Ave., Bristol, Conn., is already practicing what he preaches about increasing profits.

With appliances beginning to arrive, the store has started to put the squeeze on excess costs. Getting

larger earnings from sales is fact, not guess-work with this dealer. This is how he is doing it.

Discounts His Bills

Purchases of new radios and appliances made by the store are paid for in cash. Murphy discounts all his bills. Gross expenses, thereby, are cut; the savings resulting from buying on a cash basis are passed on to the dealer.

With new merchandise starting to fill the store—although slowly, at first—discounting bills is an important step toward pruning costs. This

The firm has its own method of handling those who canvass every appliance store in town before buying. This is the establishment's technique in "screening" shoppers who want home demonstrations, and who later return the demonstrated appliances to the store:

When a prospective purchaser who is unknown to the dealer enters the store, his readiness to buy without home trials is judged. Then the following sales strategy is applied.

Customer: "I like this washing machine. Will you demonstrate it in my home?"

for **MORE PROFITS** from **Electrical Appliances**

HOW DEALER MURPHY CUTS COSTS

Discounts his bills

Finances some of his own install-
ment paper

No wasted home demonstrations

"Screens" no-profit customers

Puts price limits on trade-ins

Does not cut prices

HOW THIS RETAILER INCREASES SALES

Backs up sales with service

Fair distribution of new goods

Spends \$1,000 yearly on adver-
tising

Does large open account business

Builds good-will constantly

Gives premiums to customers'
children

attract new ones, some dealers may be forced to accept appliances in trade which will cut their profits.

Murphy pulls no sales punches in dealing with the trade-in headache. He grabs the trade-in bull by the tail

and meets the problem squarely. An honest customer approach on this topic is the best one, this merchant declares.

The store's owner avoids profit-
(Continued on page 96)

Murphy's proposed floor plan. Center island will feature small radios and traffic items.

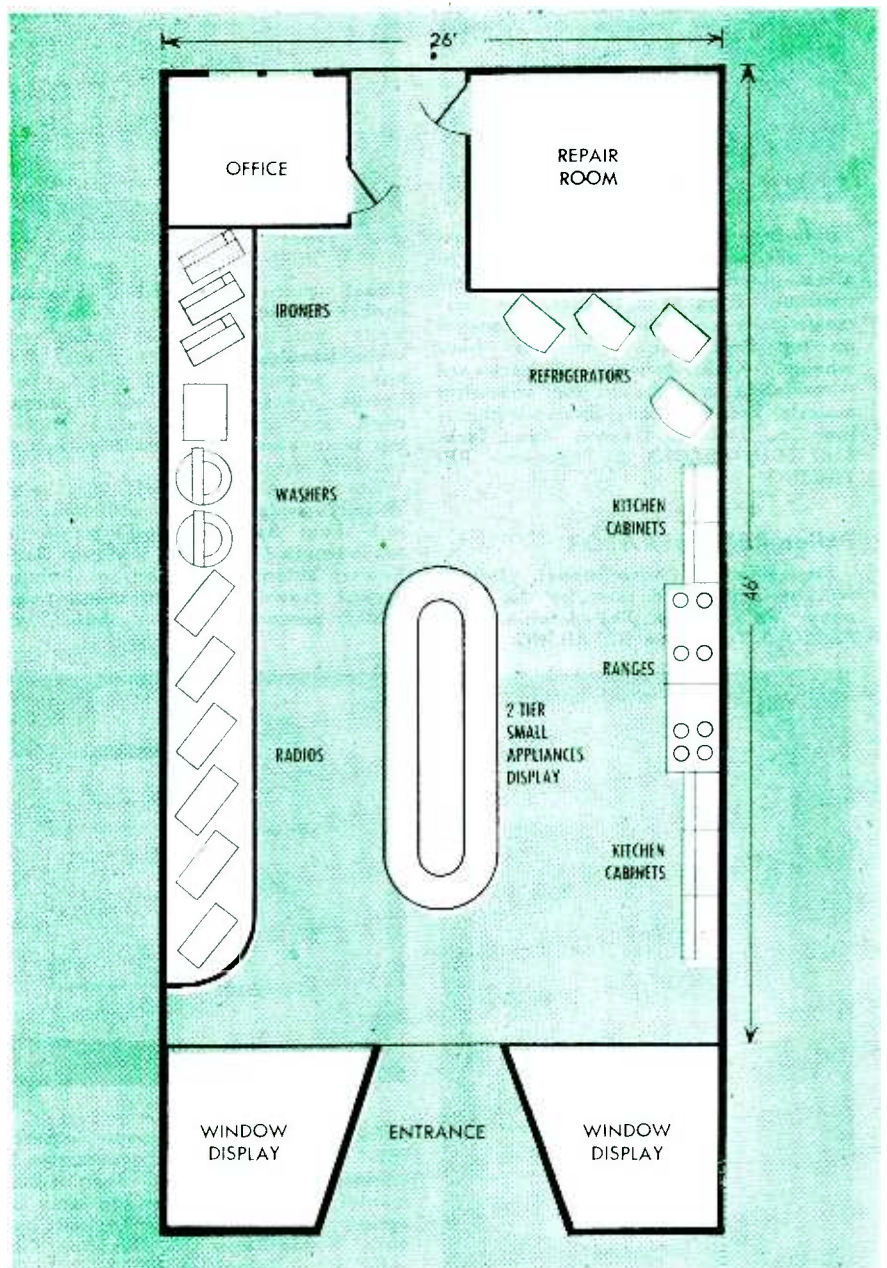

Dealer: "Yes, we will."

Customer: "That's fine. I'd like to see it in my home as soon as possible."

Dealer: "Very well. What is your name and address? How much deposit will you leave?"

Customer: "Deposit? I want to try it for a short time and then decide. I thought you gave home demonstrations on appliances."

Dealer: "We do; but you *are* going to buy? And if this appliance doesn't meet with your approval, we have others."

The foregoing is another example of how the store closes sales and chops selling costs further.

Trade-ins, even now, may present a problem to radio-appliance retailers. In order to keep old customers and

ELECTRICAL APPLIANCES

Presenting Manufacturers' Newest

Sparton PORTABLE IRONER

Model 10. Roll size: 6" in diameter, 22" long; shoe size: 5" wide, 22" long; overall size: 29" x 11" x 10"; weight: approximately 37 lbs.

Automatic operation of shoe by internal mechanism. Control lever, fully automatic and removable. Operated by touch of knee or hand. Instant roll stopping by pressure on control lever.

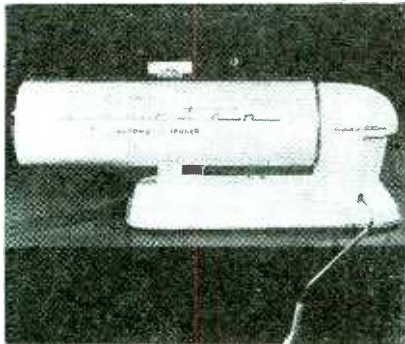

Safety lever releases shoe from contact with roll, and tilts ironing shoe back to allow placement of clothes for hand pressing. High shoe temperature thermostatically controlled by dial located on top center of shoe. Roll "free-wheels" either forward or backward when shoe is released for arranging material being ironed. Sparks-Withington Co., 2100 E. Ganson Ave., Jackson, Mich.—RADIO & Television RETAILING.

Philco REFRIGERATOR

First postwar Philco model. Details will be announced later by the company. Philco Corp., Philadelphia, Pa.—RADIO & Television RETAILING

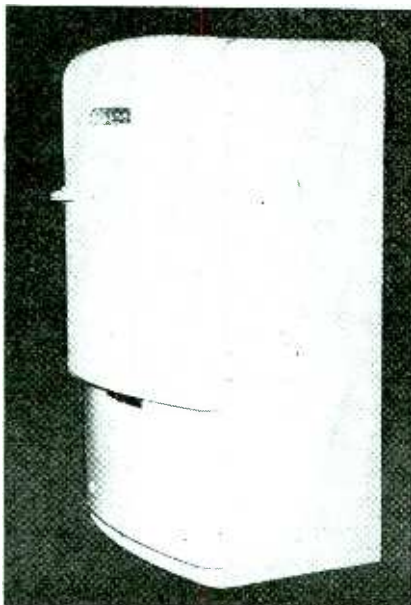

Estate RANGES

The Montrose, model 616, below. Full-size, heavily insulated oven; light in oven; single-dial oven heat control, 6-heat Bar-B-Kewer with extra-deep porcelain enameled pan. One-piece work surface and mantel back; three



6-heat surface units and 6-heat electric-cooker. Utensil drawer; pedestal base; white porcelain enamel finish with white handles and switch dials. Floor space required is 38" x 25". Extra charge accessories include: automatic oven time control with built-in cooking top lamp assembly; oven time control; cooking top lamp.

The Sweetbriar, model 1703, below. Heavily-insulated oven, with heat control. Four Speedex high-low cooking top burners (3 regular, 1 giant); Bar-B-Kewer; automatic top burner lighting; utensil drawer; standard mantel back. White porcelain enamel finish with

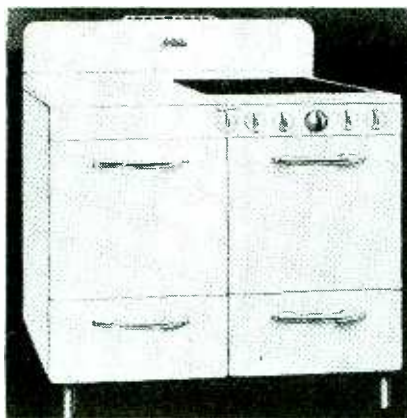

black handles. Floor space required: 26 $\frac{7}{8}$ " x 38". Extra charge accessories include: window in oven door; deluxe mantel back with cooking top lamp and spring wound interval timer; front base strip. Estate Stove Co., Hamilton, Ohio—RADIO & Television RETAILING

Hotpoint DISHWASHER

This dishwasher can be placed under any sink that has a single basin and working surface extending over cabinet space. Automatic storage water heater is on the right, insulated to provide a working surface not warmer than other surfaces in the room. Edison General Electric Appliance Co., 5600 West Taylor St., Chicago 44, Ill.—RADIO & Television RETAILING.



Hotpoint ELECTRIC RANGE

Hostess model RB-17 shown. Equipped with automatic clock control and timer, vanity Venetian lights, indicating switch dials, 6-quart Thrift cooker, and Calrod heating units. The floor space occupied is width 37", depth 25". Entire meal can be placed in the oven to be cooked; when it is done heat goes off and meal is ready. This range moderately priced.

Not shown is a deluxe model, the



Hotpoint Masterpiece, model RC-8. This range will have fully automatic clock control timer, Calrod heating units and Calrod Thrift cooker. Floor space: width 39", depth 25".

A range to sell in the lowest price

CES Section of

Devices for the Home

**RADIO & Television
RETAILING**

class will be the Hotpoint Century, Model RC-15. Overall floor space is 37" wide and 25" deep. Edison General Electric Appliance Co., Inc., 5600 West Taylor St., Chicago 44, Ill.—RADIO & Television RETAILING

Gibson REFRIGERATOR

Deluxe freez'r shelf refrigerator. Overall dimensions: height 61 15/16", width 30 1/8", depth 27 5/16". Interior: height 39 11/16", width 23 3/8", depth 14 1/2". Net capacity, 7.14 cu. ft.; shelf area, 14.05 sq. ft. Scheduled for Fall production. Gibson Refrigerator Co., Greenville, Mich.—RADIO & Television RETAILING



Gibson REFRIGERATOR

Freez'r shelf refrigerator, Model No. F-666. Overall dimensions: height 56 29/32", width 30 1/8", depth 27 5/16". Interior: height 35 29/32", width 23 3/8", depth 14 1/2". Net capacity, 6.73 cu. ft.



shelf area, 12 sq. ft. Production scheduled for this Fall. Gibson Refrigerator Co., Greenville, Mich.—RADIO & Television RETAILING

Westinghouse ROASTER

Electric Roaster with 18 quart capacity. Decorated with blue trim and has polished aluminum top covers with "look-in" glass panel, which enables user to see food cook without lifting the lid. Equipped with oven dishes; one for meat and two for vegetables. A



Time-Temp shelf, which slides from the base of the roaster, lists all essential cooking times and temperatures. May also be used as a shelf for hot dishes. Comes equipped with a set of three oven cooking dishes. (Photo shows employe assembling outer covering of roaster on the production line.) Westinghouse Electric and Mfg. Co., Appliance Division, Mansfield, Ohio—RADIO & Television RETAILING.

Westinghouse IRON

Production of electric irons is under way, manufacturer states. Westinghouse Electric and Mfg. Co., Mansfield, Ohio.—RADIO & Television RETAILING



Frigidaire REFRIGERATOR

Cold Wall 9, incorporating cold wall principle makes it unnecessary to cover foods. Large super-freezer chest with shelf type door. Freezes food, makes 12 pounds of ice. Two glass-topped, sliding Hydrators; all-metal trays with instant cube release; one double-width tray for frozen desserts; full-width, adjustable



shelves; 17.8 square feet shelf space; interior adjustable to 16 arrangements; large utility storage bin below. Other Frigidaire cold wall and standard models will have from 7 to 13.5 cubic feet capacity. Frigidaire Division, General Motors Corp., Dayton, O.—RTR

Servel REFRIGERATOR

New line of gas refrigerators by Servel to reach market soon. New group will include five models running from four to eight cu. ft. capacity. No moving parts, and operates on continuous absorption principle of refrigeration. Servel, Inc., Evansville, Ind.—RADIO & Television RETAILING

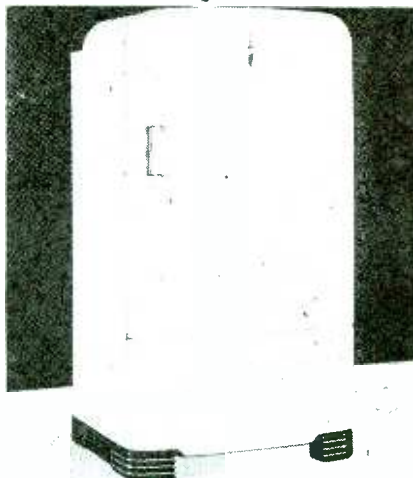

(Continued on page 46)

Continuing **Electrical Appliances**

Norge **PORTABLE WATER COOLER**

Small, transportable water cooler, adaptable for use in offices, homes, hospitals, hotels, clubs, etc. Capacity of 1½ gallons can be cooled in one hour. Powered with 1/12 h.p. hermetically-



sealed "rollator" unit. Approximately 22" wide, 13" high, 12" deep. Can be carried by average individual.

Water compartment styled to hold one-gallon bottle, or can be filled from pitcher. Five-gallon bottles may also be used. Cup dispenser attached to front of cabinet. Norge Division, Borg-Warner Corp., Detroit, Mich.—**RADIO & Television RETAILING**

Hoover **VACUUM CLEANER**

Model 27 is a new cleaner never offered before to the public. Outstanding feature is the "instant conversion" feature which enables housewife to convert the Hoover from a rug cleaner to a cleaner for draperies, upholstery, etc., by inserting the cleaning tools in the side of the cleaner. "Air cushioned vibration," a cleaning principle that gently dislodges the dirt and brings it to the top where suction carries it away, is provided for in this model. Maroon and grey. Hoover Co., Chicago, Ill.—**RADIO & Television RETAILING**



Eureka **WAXER and POLISHER**

Featured in the Eureka complete home cleaning system, is this power-driven waxer and polisher for use on bare floors, linoleum and hard floor finishes. Photo shows insertion of waxer



and polisher brush into undercarriage of lightweight upright cleaner.

Complete Eureka unit consists of upright vacuum cleaner for floor coverings; a tank-type unit for "above-the-floor" cleaning, and various other interchangeable cleaning devices for both vacuum units. Manufacturer planning on Fall deliveries. Eureka Vacuum Cleaner Co., 6060 Hamilton Ave., Detroit, Mich.—**RADIO & Television RETAILING**

Universal **HAND CLEANER**

Standard model hand cleaner is shown, can be used for cleaning car interiors, homes, apartments and stores. Has deodorizer, moth exterminator and



blower attachment. Weighs four pounds. Dust proof bag, with sleeve valve, prevents dust from falling back into nozzle. Landers, Frary & Clark, New Britain, Conn.—**RADIO & Television RETAILING**

Universal **BRUSH CLEANER**

Conventional brush type cleaner shown. Motor driven oil-less bearing brush, ball bearing motor, single nozzle adjustment tilting device on side of handle ball, envelope type easy-to-empty



bag. Attachments will include an 8' web covered hose, 30" extension tube, 7" drapery nozzle, and utility brush and radiator tool. Weight packed in 2 cartons, 19½ pounds. Manufacturer hopes to allocate limited quantities of cleaners during last quarter of 1945. Landers, Frary & Clark, New Britain, Conn.—**RADIO & Television RETAILING**

Juice King **HOME JUICER**

New "Single Stroke" handle and "Juice-All" strainer aids operating efficiency. Patented ribbing on strainer holds fruit pulp in position, to eliminate wastage and facilitate rapid squeezing. Interlocking device, easily cleaned.



keeps strainer anchored to cup and prevents seeds from slipping into glass. Glossy chrome and enamel finish facilitates cleaning. Included in line are models retailing at \$3.95, \$4.95, and \$9.95. National Die Casting Co., Touhy Ave. at Lawndale, Chicago, Ill.—**RADIO & Television RETAILING**

nces Section of

**RADIO & Television
RETAILING**

GE ELECTRIC RANGE

Stratoliner range, highest priced model in GE's pre-war line. 39" long, three 5-heat Calrod surface units, high-speed, 5-heat, 7-quart Calrod thrift cooker. Tel-A-Cook lights in color tell which units are on and at what speed. Built-in timer automatically turns the oven on and off. No-Stain oven vent helps maintain proper humidity for best

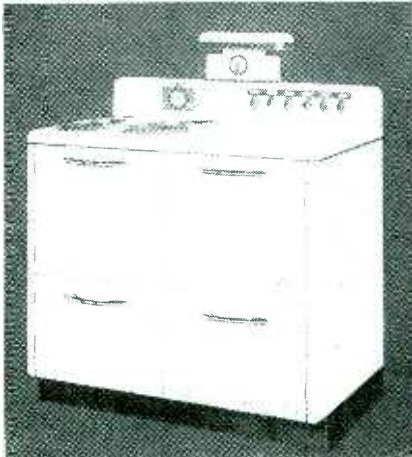

baking and roasting results, and helps keep kitchen clean.

A lamp assembly mounted on the back-splasher behind the surface units incorporates a mechanical Minute-Minder with a bell signal and matched salt and pepper shakers. Three storage drawers and a utensil tray. Equipment for range includes a deep-fat fry basket, plate-warming rack, and dessert pan. General Electric Co., 1285 Boston Ave., Bridgeport 2, Conn.—RADIO & Television RETAILING

Frigid-Freeze FOOD FREEZER

10 cu. ft. frozen food locker, made to retail for approximately \$350.00. Refrigeration Corp. of America, 241 W. 64 St., New York City—RADIO & Television RETAILING

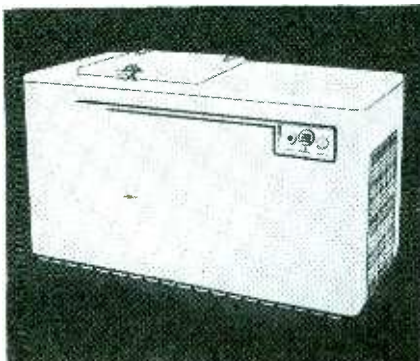

GE FLATPLATE IRONER

Model AF-12. Three hundred sq. in. of ironing surface and up to 400 lbs. of hydraulic pressure combined in this ironer. GE Thrustor supplies necessary ironing pressure. No oiling required.

Ironer operated by pulling control handle, bringing shoe completely above ironing surface and closing motor

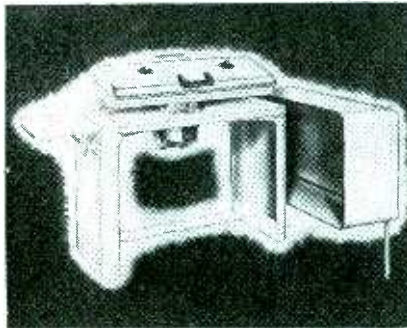

switch. This, in turn, causes Thrustor to operate, which provides pressure for ironing. Pressure released by pushing handle. Motor is disconnected and pressure is relieved. Two heating elements clamped to the shoe; two thermostats provide individual temperature control for each end of shoe. Cabinet is of console type, the top affording a flat work surface. General Electric Co., 1285 Boston Ave., Bridgeport, Conn.—RADIO & Television RETAILING

Telechron ELECTRIC CLOCK

The "Telalarm Jr.," cased in ivory plastic, will retail for \$3.95. Manufacturers expect clock to be on market in late December. Self-starting motor sealed in oil.

Two other clocks to be offered by

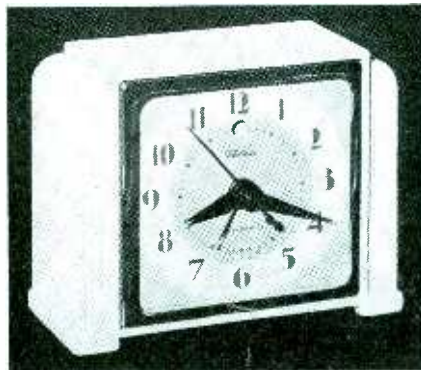

the same manufacturer are the "Buffet," a kitchen clock cased in red, green, ivory and white to retail at \$3.50; and the "Embassy," a wood case alarm clock with colonial motif, priced at \$6.95. Warren Telechron Co., 75 Homer Ave., Ashland, Mass.—RADIO & Television RETAILING

Arvin AUTOMATIC IRON

1000 watt, 3 lb. electric iron, having ironing surface of 26 sq. inches. Tem-



perature range 120 to 550 degrees on selector dial. Built-in cord set. Has 9 selling features. Noblitt-Sparks Industries, Inc., Columbus, Ind.—RADIO & Television RETAILING.

Sylvania FLUORESCENT XMAS TREE LAMPS

Fluorescent lamps, in pastel shades of blue, green, coral and maize are round in shape, and need no auxiliary equipment in order to operate. The lamps come eight to a string, have a screw-type base and are independently operated. A string of fluorescent lamps may be added to a string of incan-



descent Christmas tree bulbs by just plugging it into the socket.

Each lamp draws about five watts of current and each has an approximate life of 1,000 hours. Lamps burn cool, and can be used on either indoor or outdoor trees. String of eight lamps sells for about \$7.50, with replacement lamps costing 60 cents apiece. Royal Electric Co. and Miller Electric Co., Pawtucket, R. I., will manufacture Xmas tree sets using new fluorescent lamps, which were developed by Sylvania Electric Products Inc., Emporium, Pa.—RADIO & Television RETAILING

FOR LATEST RADIO MERCHANDISE SEE PP. 52, 53.

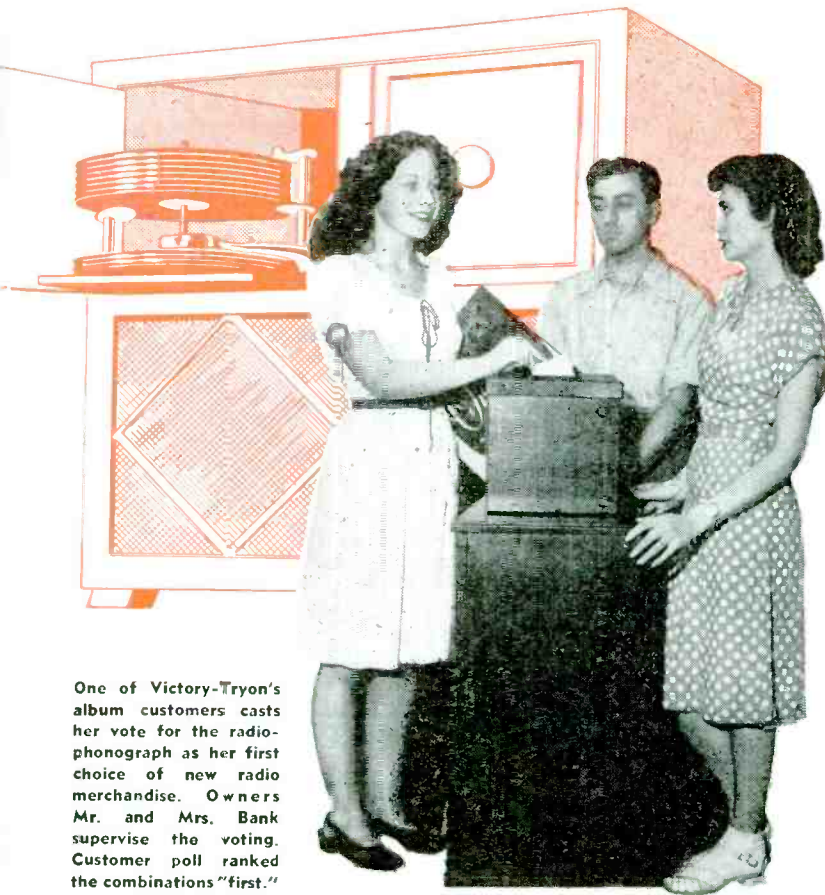

One of Victory-Tryon's album customers casts her vote for the radio-phonograph as her first choice of new radio merchandise. Owners Mr. and Mrs. Bank supervise the voting. Customer poll ranked the combinations "first."

Sample the

War-time Record Retailer Has Plans for the Radio-Phono Combinations

a radio-phonograph combination in a poll taken in the store over a one week period. Television sets ranked second, and the Banks report that the public is eagerly awaiting the arrival of this new merchandise.

Located in a residential section of New York City at 762 West 181st St., Victory-Tryon Radio Co. offered its customers excellent variety in record merchandise and efficient radio repair service during the war period, and the owners believe this will help them in developing a successful radio-record-appliance business in the busy days ahead.

● Close attention to customer contacts by Mr. and Mrs. Bank, owners of Victory-Tryon Radio Co., has given them high respect for "what the customer wants," and has proved a basic aid to good merchandising.

Examples of this technique in merchandising methods are the customer polls the Banks conducted. Of all the customers who plan to buy new radios as soon as they are available, 65 per cent declared they will buy

"Combine" for Sales

"Give your store a pleasing 'personality' charm and attractive appearance, efficient service, courtesy, reliability, put your customer at ease,

Store layout at Victory-Tryon for record sales and radio service. Rearrangement of space is now underway for accommodation of new merchandise.



Customer

and selling should be easy," is the sound thinking on which the Banks base their merchandising plans for a thriving business.

Another good pointer illustrated by this selling team's experience is that "in order to sell anything successfully, complete knowledge of the article is necessary." Service work on radios during wartime has proved of value here, and a backlog of 12 years experience in the radio receiver field, and in both popular and classical music, have stood Mr. and Mrs. Bank in good stead.

From Pops to Classics

Mrs. Bank reports a successful response from customers shown the proper attention in record merchandising. She has had excellent results in persuading purchasers of popular records to expand their libraries to include classical music, as well.

Young men are even more quickly interested in classical music than young women, she has discovered. Many have acquired a taste for this type of music while in the armed forces.

Promotes Albums

Mrs. Bank proceeds on the basis that young people who buy the populars naturally have a liking for music, and she finds they welcome unobtrusive guidance into the world of classic compositions. Her recommendations for the novice include such record purchases as Tschaiakovsky's Nutcracker Suite, Liszt's Second Hungarian Rhapsody, Grieg's Piano Concerto, Tschaiakovsky's Piano Concerto, and Tschaiakovsky's Fourth and Fifth Symphonies.

Next, Mrs. Bank suggests that the student be guided toward the discovery of Brahms' and Beethoven's works. Beethoven's Fifth Symphony or Violin Concerto are popular in this respect.

"When the customer finally becomes far enough advanced in his knowledge of music to begin to look for and recognize style, then he is



Victory-Tryon's modern store front is synonymous with its forward-looking merchandising plans.

ready for Bach," says Mrs. Bank, "and, once you've sold him Bach, he's a true convert!"

Doubles Display Appeal

From then on the customer finds a new interest in exploring further for himself the large variety of recorded music available; and strategic display of albums combined with their eye-catching covers are enabled to do an even better selling job.

Opera, of course, is not to be overlooked, cautions Mrs. Bank, but opera fans are mostly a special class of customers, and are interested in vocal music to a decided extent.

Expansion Plans

In their belief that records will do a great deal to sell the "combinations," Victory-Tryon's owners have

not overlooked any selling plans for other radio models, and ambitious store promotions and rearrangement of space to accommodate new merchandise are under way. Victory-Tryon will also put plenty of sales effort behind its electrical appliances department. Its franchises include Admiral, Crosley, Stromberg-Carlson, Zenith, Bendix, and General Electric.

Bright Future

Modern store, inside and out—franchises readied—prospect lists in order—sales procedure planned! These are the pillars upon which Victory-Tryon will base its foundation for a sure-fire success in the radio-record-appliance field.

When the big rush starts, we are confident that this smart couple will not be caught napping!

NATIONAL RADIO WEEK NOV. 4-10. SEE PAGES 37, 132!

CHRISTMAS DEALS for

Record Manufacturers Have Plenty to Put in the Dealer's Christmas Stocking. Promotions Readied for the Holiday Season. New Disc Makes Its Bow for Yuletide.

• Now that Victory is won and the Buying Spirit is back, radio-music retailers can get busy and do a real selling job this Christmas!

And, record manufacturers are ready to give the retailers every possible assistance in making this gift-buying season a record-buying season for the public, a top-flight one in sales for the dealers.

Columbia offers 3-dimensional window display material, depicting

a home scene, complete with Santa; mailing pieces; hangers; holly store decorations; special children's poster; placard for album display and news mats.

Gift suggestion list for handy check-off by the dealer includes Columbia's popular albums, masterworks, children's discs, Christmas music and foreign language records. A special new children's book, containing one disc of music from the film "Anchors Aweigh" is the story of the movie and will be introduced by Columbia.

Columbia initiates a retailer window display contest this October. 3 prizes will be offered monthly—

Victory Bonds of \$100, \$50 and \$25—for the best window display using an all-Columbia kit. Pictures of the first contest must be submitted to Columbia before Oct. 25. You can get com-

plete details from your distributor.

Decca has plenty of holiday cheer in the making for dealers. Reindeers are the motif of the die-cut display piece delivered on dealers' request. Hangers illustrated with Decca and Brunswick albums are also offered. And national advertising in magazines and newspapers will be intensified by ads in *Life*, *Saturday Evening Post* and 95 newspapers throughout the country during October.

Special for the kiddies is Decca's new triumph, Loretta Young reading the story of "The Littlest Angel," allegorical fairy tale. Grown-ups like it, too! (Release date: 1st week of October.) Another Decca hit is Bing Crosby's album, "Going My Way," from the Paramount movie.

Victor's contribution to the retailers' first peacetime Xmas holds plenty of punch for Christmas sales. Victor's merchandising helps for dealers available through distributors will include a special children's display, the Children's Music House, which calls up memories of the gingerbread house in "Hansel and Gretel," ready in November. Companion piece is

Top left, In Cosmopolitan Records' star line-up: Gertrude Niesen of Broadway's hit "Follow the Girls." Right, Victor's ever glamorous Gladys Swarthout is one of its artists. Victor will feature in national magazine advertising during October.



The DEALER



the special folder on children's albums and single discs. Printed in 2 colors the folder will be ready for counter use and mailing to your customers middle of this month.

Also ready for dealers early in October is Victor's Christmas window display, a tree trimmed with reproductions of album covers in 4 colors. Five and a half feet in height, it can be used as a window centerpiece for disc and album holiday displays.

Victor's new Stensgaard merchandising aids of which the Children's Music House is one, are scheduled for October delivery to dealers, on request. See your distributor. These also include effective single disc and album group display pieces.

Victor's new plastic record, the Red Seal DeLuxe, is an opportunity for record retailers to do some smart merchandising on a much needed high-priced unit in discs. Music recorded on the new plastic records will precede the same recordings on

Above left, Rise Stevens, top-liner on discs for Columbia, often guest-starred on the air. Center, Loretta Young of movie fame has recorded for Decca Charles Tazewell's allegorical fairy tale, "The Littlest Angel." Below, Capitol's Jo Stafford opened her Fall season of personal appearances at New York's glittering nightery, the Martinique. She is also heard on the Ford show airing on NBC 2:00 to 2:30 PM Sundays.

the shellac discs. Currently made only in the 12" size, these new records retail at \$2.00. Outstanding features: practically no surface noise; show less wear-and-tear from use on record changers. Your record library collectors should go for them! First release: 2-record album, Strauss' "Till Eulenspiegel's Merry Pranks."

Asch's bow to the dealer for promotion during the Christmas season is its offer of holiday promotions

through its distributors, and its first operatic recording, "Prince Igor," recorded on their new "Vynalite" records, album to retail at \$12.50. This is the first of a Russian series.

Capitol is tying up its "Christmas Package" for the dealer. It is to be asked for under just that name, is

(Continued on page 146)

First Radio Merchandise

Stewart-Warner RADIO-PHONOGRAPH

Model 9004-G is a 7-tube, two band, ac phono-radio combination. Stewart-Warner, Chicago 14, Ill.—RADIO & Television RETAILING



ac unit, with two bands, domestic and foreign reception, tone control, and large speaker. Automatic 2 post record-changer accommodates 12 10-in. or 10 12-in. records on one loading. Hide-away radio for easy tuning. Available in walnut as well as bleached mahogany. Record space provided.

Other models include the 6FS2, Farm Console, which contains a 1,000-hour battery pack; the 8BPY6, which is a combination housed in a Breakfront cabinet; and the 5A2, a 5-tube ac-dc superhet with a plastic cabinet. Garod Electronics Corp., 70 Washington Street, Brooklyn 1, N. Y.—RADIO & Television RETAILING

Sonora RADIO

Has patented inner construction designed to eliminate "boxy" tone often present on small sets. Automatic vol-



ume and tone controls have been added, and the dial simplified for more selective tuning. Cabinets are fashioned from choice walnut veneers, offered in light or dark finishes. Sonora Radio & Television Corp., 77 West Washington Blvd., Chicago, Ill.—RADIO & Television RETAILING

Masco PORTABLE RECORD CHANGER

Model RC 1 is an automatic record changer housed in all wood portable case, covered with Du Pont fabric. Changer plays either 12 10-in. records or 10 12-in. records. Low pressure Astatic pickup has a high fidelity cartridge with permanent sapphire stylus. Changer is mounted on spring shock absorbers, and all controls are incorporated on one switch. 6 feet of shielded cable and 6 feet of line cord are included. Unit is suitable for use with all standard amplifiers. List price: \$110 plus Federal excise tax. Mark Simpson Mfg. Co., 186-194 West Fourth Street, New York 14, N. Y.—RADIO & Television RETAILING

Temple RADIO

Console radio-phonograph, model E-623. Two band radio, 535 to 1700 kc and 6 to 17 mc. Record changer plays



ten and twelve in. records automatically. Push-pull, 5 watt output, 8 in. speaker. Self-contained loop antenna for broadcast and dipole for short wave; high sensitivity in both bands. Lists at approximately \$130. Templetone Radio Mfg. Corp., New London, Conn.—RADIO & Television RETAILING

Admiral RECORD CHANGER ATTACHMENT

Consists of a phonograph turntable, tone arm, and automatic changer, electrically operated and mounted in one unit. Can be connected to any type of home radio. Unit is portable, and may be placed on top of, or alongside the radio, and attached or detached at will.

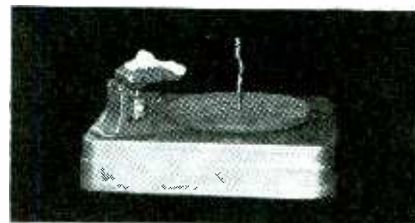

Automatic changer completes the operation of changing a record in five seconds, as compared with pre-war time of 10 to 15 seconds. New design provides for only three moving parts during a change cycle. Changer is so constructed that the tone arm can be picked up while playing and moved in any direction without affecting the operation of the mechanism. Playing load is 12 10-in. or 10 12-in. discs. Admiral Corp., 3800 Cortland Street, Chicago 47, Ill.—RADIO & Television RETAILING

Garod RADIOS

Model 6A1 is a 6-tube ac-dc superhet, with untuned r-f stage, large pm speaker and concealed loop. Cabinet is catalin, in two-tone colors. Translucent



"drop" handle is provided for easy portability. Lucite dial scale has easy to read numerals.

Model 6DPS3 is a chairside combination radio-phonograph. 6-tube straight

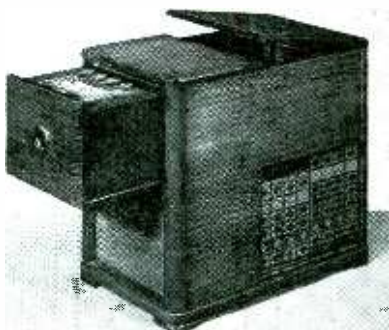

from Assembly Lines

Howard RADIO

Model 901 is a 5-tube ac-dc set, receiving on 540 to 1720 kc, with a 5 in. dynamic speaker and built-in loop antenna. AVC action. Plastic cabinet



in ivory or walnut color. Dimensions: 6½ x 9½ x 5¼ in.

Model 902 is identical with 901, but has 2 tuning bands, 540-1720 kc and 6-18 mc. Howard Radio Co., Chicago 13, Ill.—RADIO & Retailing RETAILING

Webster Chicago RECORD CHANGER

Webster Model 56 is a single post, floating spindle, automatic record changer that plays single records, up to 12 10-in. records, or 10 12-in. records, without interchanging parts. Change cycle is approximately 4 seconds. Automatic shut-off occurs after last record has been played. Maximum protection



to records is provided by floating spindle, light needle pressure, soft, heavy pile turntable covering, and positive air-cushion record drop. Heavy duty four-pole balanced armature motor is used. Velocity trip eliminates need for eccentric groove in records to operate change mechanism. Webster Chicago, Electronics Division, 3825 Armington Avenue, Chicago 47, Ill.—RADIO & Television RETAILING

Arvin RADIO-PHONOGRAPH

Model 670 is a 6-tube straight ac floor combination. Two bands, for domestic and foreign reception. Five push buttons for "favorite stations" supplement fast-action dial tuning knob. Built-in loop antenna, with connection for external aerial, if desired. Speaker is 10-in. heavy-duty type. Automatic record

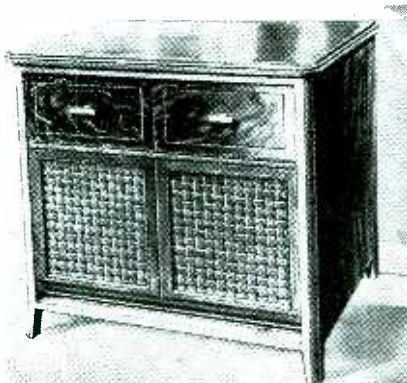

changer plays twelve 10-in. or ten 12-in. records. Phonograph motor is self-starting. Noblitt-Sparks Industries, Inc., Columbus, Ind.—RADIO & Television RETAILING

RCA PLASTIC RECORDS

Red Seal De Luxe—non-breakable, high fidelity plastic phonograph records, for home use. Surface sound greatly reduced by omission of mineral



filler used in shellac records. Greater uniformity of thickness among these new units than on the shellac types. Dimension shift caused by warping also less. Available at present only in the 12-in. size. Retail price \$2.00. Will be issued in album form as well as in singles. RCA Victor, Camden, N. J.—RADIO & Television RETAILING

Stromberg Carlson RADIOS

Model shown is the New World, a radio phonograph console type. 11-tube superheterodyne receiver, with both standard broadcast and short wave bands, old and new FM bands. Set



is provided with push-button and manual tuning. Audio output is ten watts. Speaker is 12-in. electrodynamic type, in floating suspension. Cabinet size is 32 in. high by 36 in. wide by 18 in. deep. Shift in production plans will delay manufacture of this model; will probably be on sale late in January, '46.

The Dynatomic is a table model receiver designed for personal radio reception. Superhet with 6 tubes, 4 of which are amplifiers, 1 a rectifier-amplifier, another a power rectifier. Can be used on either ac or dc power supplies. Tuned radio frequency stage is present. Antenna is built-in loop type. Speaker is electrodynamic. Stromberg Carlson Company, Rochester 3, N. Y.—RADIO & Television RETAILING

Hallicrafter H-F RECEIVER

Recent lifting of government controls has made these radios available in limited quantities. Reception on both



broadcast and short-wave bands is possible with this high-frequency receiver. Hallicrafters Co., 43 East Ohio Street, Chicago 11, Ill.—RADIO & Television RETAILING

FOR LATEST ELECTRICAL APPLIANCES SEE PP. 44, 45, 46, 47.

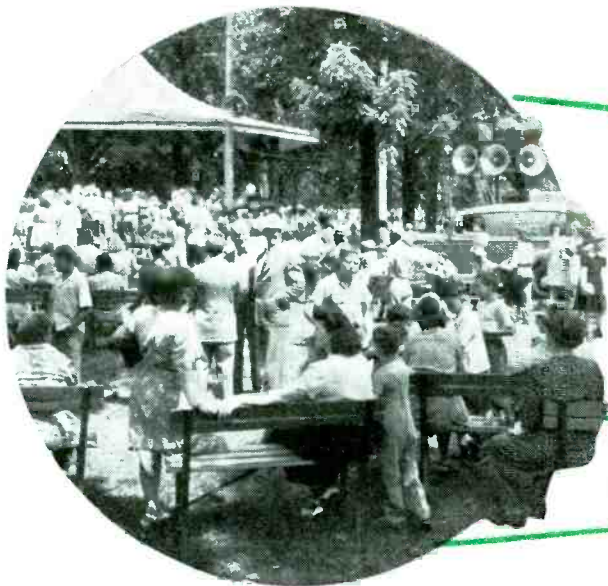

Sound Profits

"Custom Made" PA Service for Every Job Brings Rewards. Dealer Stresses Dependable Work

Crowds at a large event listening to "Carroll's sound."

• It is a "sound" proposition for the electronic specialist to strive for a completely-equipped, expertly-manned department if he is to prosper in the field.

So opines Arthur Carroll, a competent radio and "sound" man who has swung with characteristic energy into the operation of a sound and radio service in Topeka, Kansas. In two brief years, Carroll has received recognition in the form of steadily increasing trade in the city to which he is comparatively a newcomer.

Sound is Carroll's specialty, and when he moved into Topeka from Coffeyville, Kansas, it was his intention to devote all of his efforts toward offering Topeka a professional sound service that would function smoothly at public events.

At any special event within a hundred-mile radius of Topeka you will find Carroll's sound system installed, giving the customary smooth performance. Bob Hope's show at the nearby army air base, country club events, high school graduations, football games, horse shows, country fairs, and all of the outdoor and indoor affairs that warrant an amplification system carry the Carroll trademark.

Reputation Builds Sales

A sound car, and truck, Western Electric "mikes" and amplifiers, including one 2,500-watt amplifier, plus other first-rate accessories make up the type of reliable equipment on which he places his approval.

When the legislators at the State House Capitol in Topeka became annoyed at the undependability of the sound system which they had pur-

chased several years before, it was natural that they should counsel Arthur Carroll. His proposal that he be contracted to furnish them a sound system and a well-trained operator for three dollars per hour was immediately accepted. Kansans have learned to lean on Arthur Carroll's broad shoulders on matters pertaining to radio repair and sound.

"Tailor-made sound service, fashioned to fit the occasion, and of a quality at least equal to that of radio broadcasting," is Arthur Carroll's rejoinder to the poser as to his success.

What standout traits characterized the war-time radio service at Carroll's? A look behind the scenes here revealed several interesting ramifications as a result of the avalanche of war-time business.

An Everyone-Waits-His-Turn policy on set repairing was rigidly followed and there were no ghosts in Carroll's closet as far as this program was concerned. A customer's

prominence or the extent of a radio's disorder weren't considerations, and every set moved in its place in line.

Arthur Carroll gives his men an abundance of time to deal with each set's problems; makes no definite promises as to when a set will be released for active duty.

In-Store Repairs Only

Disgruntled patrons are made from disappointments that occur when sets aren't ready on the day the repairman promises, hence there is a big time margin at Carroll's.

Drivers of the pick-up delivery trucks for the firm are termed "ambassadors of good will" by Carroll because they are completely trained to sell radio service and line up future sales. They are capable of cheerfully citing the advantages of radio service as purveyed by Carroll. Delivery charges range from \$1 to \$1.50, according to distance.

Arthur is not sold on the merits

Carroll, left, is primarily a "sound" technician, but Topeka residents bring him many sets to repair.

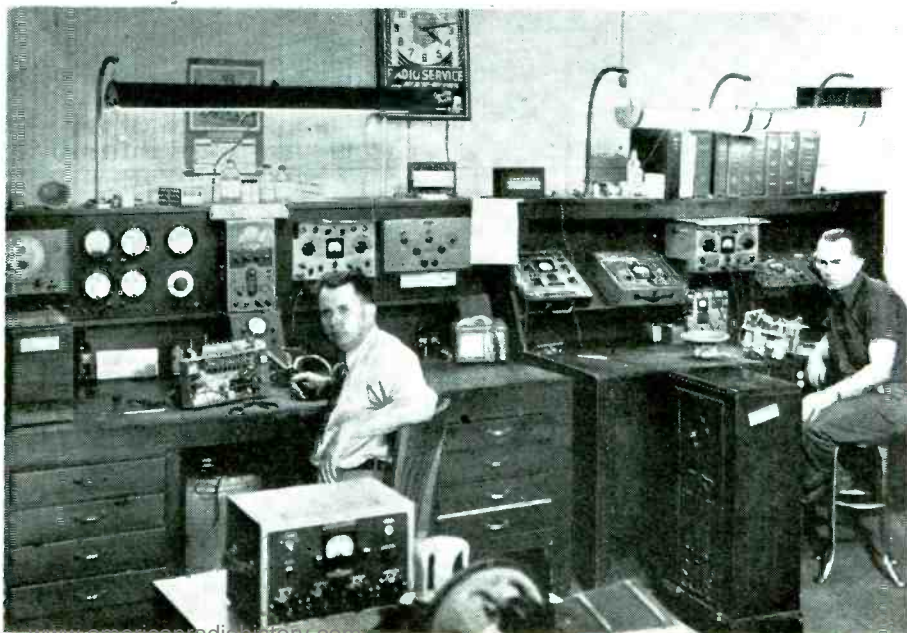

in "Sound"

of offering radio repair in homes. This style of service gets a very emphatic "no" from the repairman.

Carroll cites these wearisome features of parlor repair work:

This dealer's sound cars are seen at every worthwhile event within a hundred-mile area. First class equipment only is used. The firm's plans include expansion of territory and larger audiences.

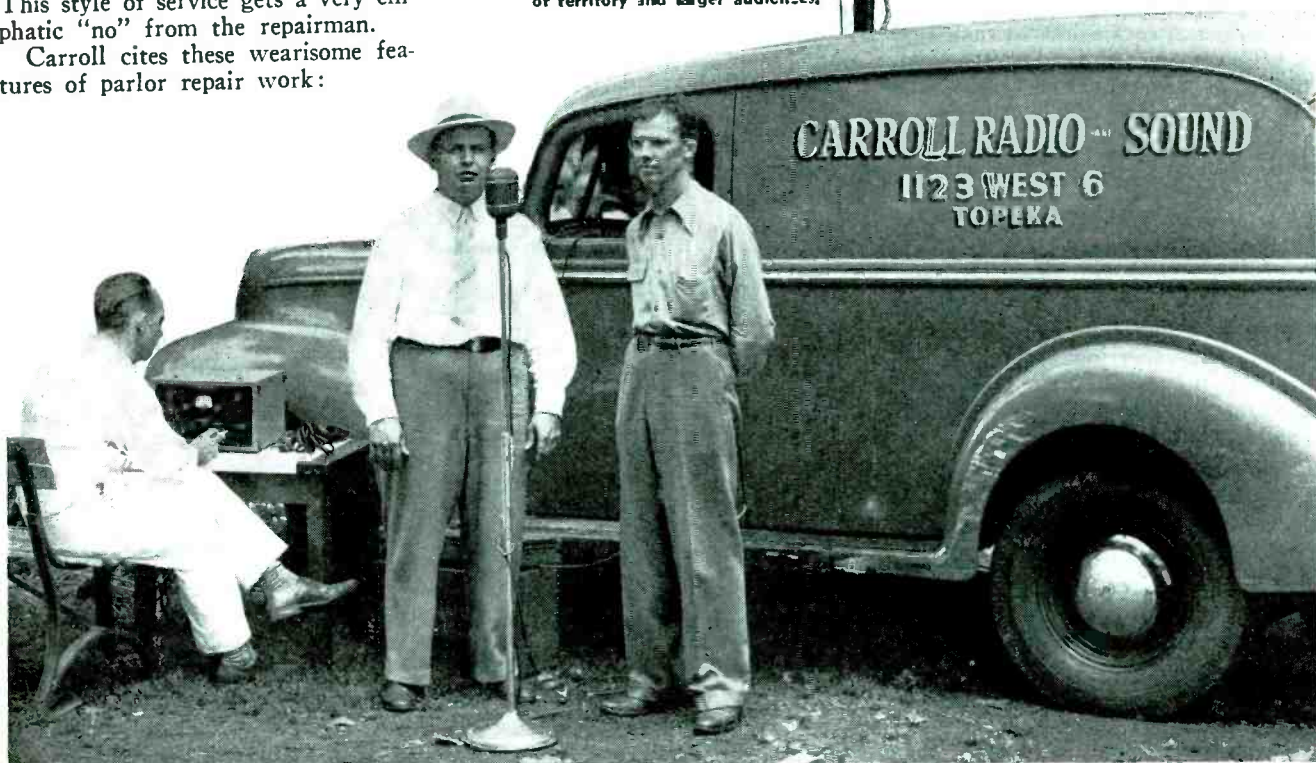

1. Attempts to make a workshop out of the patron's front room usually result in a mess. You don't endear yourself to the tidy housewife by your untidy visit.
2. You can't possibly keep the excellence of your work up to par, because half of the time you don't have the proper tools along for the job. Average front room repairmen will lessen the quality of their work in order to keep from driving back to the shop for needed tools.
3. There is always the possibility of losing vital parts, since the

average living room offers many "escape outlets" for odds and ends.

Like so many other radiomen's wives, Mrs. A. Carroll is pinch-hitting in the front end of the store as a combination bookkeeper, telephone answerer, and chief assistant to her husband.

Plans Expansion

Speaking of sound, Arthur Carroll says the finest compliment that can be paid him by those who have listened to a program over his system is when they say, "I heard perfectly, but it didn't seem as if I were listening in over a speaker system." He runs his sound business on a rental basis only.

More audiences of 2,000 or over, both indoor and outdoor events, and a territory that will include almost the entire state of Kansas, are on the peacetime agenda at Carroll's.

There will be a few new items of sound equipment because modern sound equipment has a well-defined spot on Arthur Carroll's program.

He intends to graduate more radiomen who return from the armed forces from his personally conducted "sound school," and will employ them in broadening his efforts in this field. He is going to take a "flyer" in auto radio repairing, and will install a dry bin. A remodeled laboratory is also among those things listed in his present plans.

SYSTEM Spells PROFIT

Greater Sales Will Not Bring More Earnings Unless You Have Proper Records to Control Your Operations

• The more merchandise you sell the more profit you should make. Yet it does not always work out that way.

Often money goes out like sand through a sieve. You get only what's left.

Retailing consists of three functions—buying, selling and control. The success of all three depends upon good records.

These are the reasons why Landers, Frary & Clark of New Britain, Conn., have prepared for free distribution a guide to store operation called "Systemeering." This dealer help by the makers of "Universal" appliances describes the systems and records you need to run your store profitably.

Your Buying Job

It first analyzes your buying job. To buy intelligently, you must determine what to buy. Then you need to decide where to buy. Finally, you use good procedures in placing the order and in receiving and stocking the goods.

An essential form for a good buying job is a simple *want slip*. This is a pad on which you and your sales force may record customer requests for merchandise out-of-stock.

Another essential buying form is a *purchase order form*. This enables you to stipulate conditions of the order. It provides shipping instructions which may speed up the shipment or reduce its cost.

A *receiving record* controls the marking, stocking and paying for incoming merchandise.

A *permanent accounts payable record* is retained for your future guidance and makes possible prompt payment of each purchase.

"Systemeering" next examines your selling job. This function involves knowing who your customers are and

what they want to buy. It requires effective selling and sales promotion. It includes keeping your store clean and presenting your merchandise attractively. It means operating a practical system which records the details of the selling process such as sales, receiving cash, time payments and lay-away sales.

Sales Records

The first sales record you need is a good *prospect file*. It should include both regular and prospective customers. It is your official mailing list.

The *sales check* is the original record of every sales transaction. This should be made out in at least three copies. The original is posted to bookkeeping records and filed by date. The duplicate is the audit copy left in the sales book. The triplicate is the customer's copy. More copies may be needed in larger stores.

In addition to the sales check a *cash register* will give you a record of cash sales by employees and help prevent loss of money. Another system that will give you good cash control is the combination sales check register and cash drawer.

Daily Recordings

The sales check is used to provide a record not only of cash, but also of C.O.D. and charge sales, merchandise returns and, if no separate form is desired, payments on account.

All these transactions should be recorded on *daily transaction report*.

The charge sales, returns and payments should be entered on the various accounts these transactions affect in your ledger. It is from this ledger that you learn each day the total amount outstanding, so you may determine collection methods.

It is also the source from which you make up and mail monthly your *customer's statement*.

"Systemeering" defines your control job. With proper control you pay your bills promptly. You collect from your customer promptly. You measure the individual production of your employees. You keep tab on your expenses. You are able to prepare accurate balance sheets and profit and loss statements.

All these things mean that you know where you stand at all times. To control your operations you need records to supplement the ones already described. You need a *purchase journal* in which to enter each day all the receiving records which were described under "Your Buying Job."

Payment Methods

All types of payments, such as for merchandise, expenses and payrolls, may be handled by an *accounts payable voucher check*. This form is made out in at least two copies. You send the first copy, a check-and-voucher perforated for separation, to your vendor. Staple your second or voucher copy to the vendor's invoice and file numerically by your check number.

If you have a third copy in your voucher plan, this is filed alphabetically by vendor. If you do not, post the payment to the vendor's *account record*.

If you have a large store, bookkeeping machines will eliminate much tedious original-entry and ledger-posting work. Moreover, you may buy accounting systems from the companies which co-operated in the preparation of "Systemeering." These systems will give you detailed reports which will enable you to manage and direct the more complex large-store operations.

A million letters

come to her from women each year



Betty Crocker

Betty Crocker's mail floods in from every corner of America . . . asking advice . . . expressing gratitude . . . revealing a depth of loyalty, friendship and confidence that is a potent selling force.

Through this correspondence . . . through her radio program, the oldest on the networks today . . . through constructive services to homemakers . . . Betty Crocker as the personalized representative of the General Mills Home Service Staff has won a place in millions of lives as the best known, most helpful home service authority in the world . . . has helped win the tremendous sales volume of 400,000,000 packages of General Mills products last year.

The loyalty Betty Crocker has generated . . . the friendship and confidence she has inspired, offer a rich pre-sold and ever-widening market to General Mills appliances and housewares dealers . . . hold promise of constantly growing profit possibilities for you.

COUNT ON GREAT THINGS FROM GENERAL MILLS

Count on a great family of home appliances and housewares . . . distinctive in design . . . exclusive in principle . . . each with patented features that mean new usability and extra value to consumers. Count on powerful advertising, alert merchandising, sound selling. Count on vigorous support for dealers. Count on profits!



General Mills
makes news

BETTY CROCKER IS A REGISTERED TRADE MARK OF GENERAL MILLS, INC

GENERAL MILLS, INC., HOME APPLIANCE DEPARTMENT • MINNEAPOLIS 13, MINNESOTA
RADIO & Television RETAILING • October, 1945



***In the Frigid Arctic...
or the Steaming Tropics***

THROUGHOUT our service to the Armed Forces, Eastern has always delivered every piece of equipment to the highest Government standards. Now Eastern's wartime "proving ground" is converted to simulate normal *peacetime conditions* in our laboratories, assuring you of

precision, quality and performance.

Every product bearing the Eastern trade mark will conform to the most exacting requirements. The Eastern Amplifier line will include standard items and many exceptional innovations. For complete details, write our Sales Manager, Department 10-A

Buy War Bonds

EASTERN AMPLIFIERS

U. S. Reg'n. Applied For

EASTERN AMPLIFIER CORPORATION
794 EAST 140th STREET • NEW YORK 54, N. Y.



THIS TRADE MARK IS
YOUR GUIDE TO SUPERB
QUALITY IN PERFECTLY

Designed



TRANSFORMERS

*Limited Quantities
are Available NOW!*

SWAIN NELSON
Company

GLENVIEW, ILLINOIS

SPARTON WAS READY WITH TELEVISION IN '39

A WAY back in 1939, Sparton sold television sets. At that time only four other major manufacturers were ready with television equipment.

This is but one of many examples of Sparton's engineering initiative. Many radio firsts — contributions that helped sell radios in volume — are credited to Sparton technicians, i.e.: —

The first all-electric set; push button tuning and the Viso-Glo — so important to close tuning and better reception — were Sparton developments.

The engineers responsible for these outstanding selling features can be counted on to keep Sparton sets highly competitive.

Sparton radios are sold under the *SCMP to one dealer in each community. If you are interested in being the *exclusive* Sparton dealer in your community write—

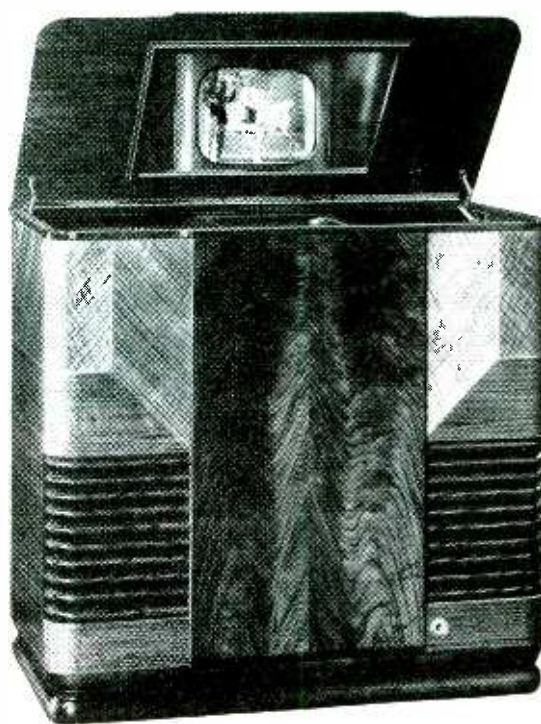

Army-Navy "E" awarded five Sparton plants simultaneously for excellence in war production.

Mr. Ed. Bonia, Sales Manager

THE SPARKS-WITHINGTON CO., JACKSON, MICH.

SPARTON

RADIO'S RICHEST VOICE SINCE 1926

* Sparton Co-operative Merchandising Plan

**Esquire
delivers
exceptional
results
for leading
radio
advertisers**

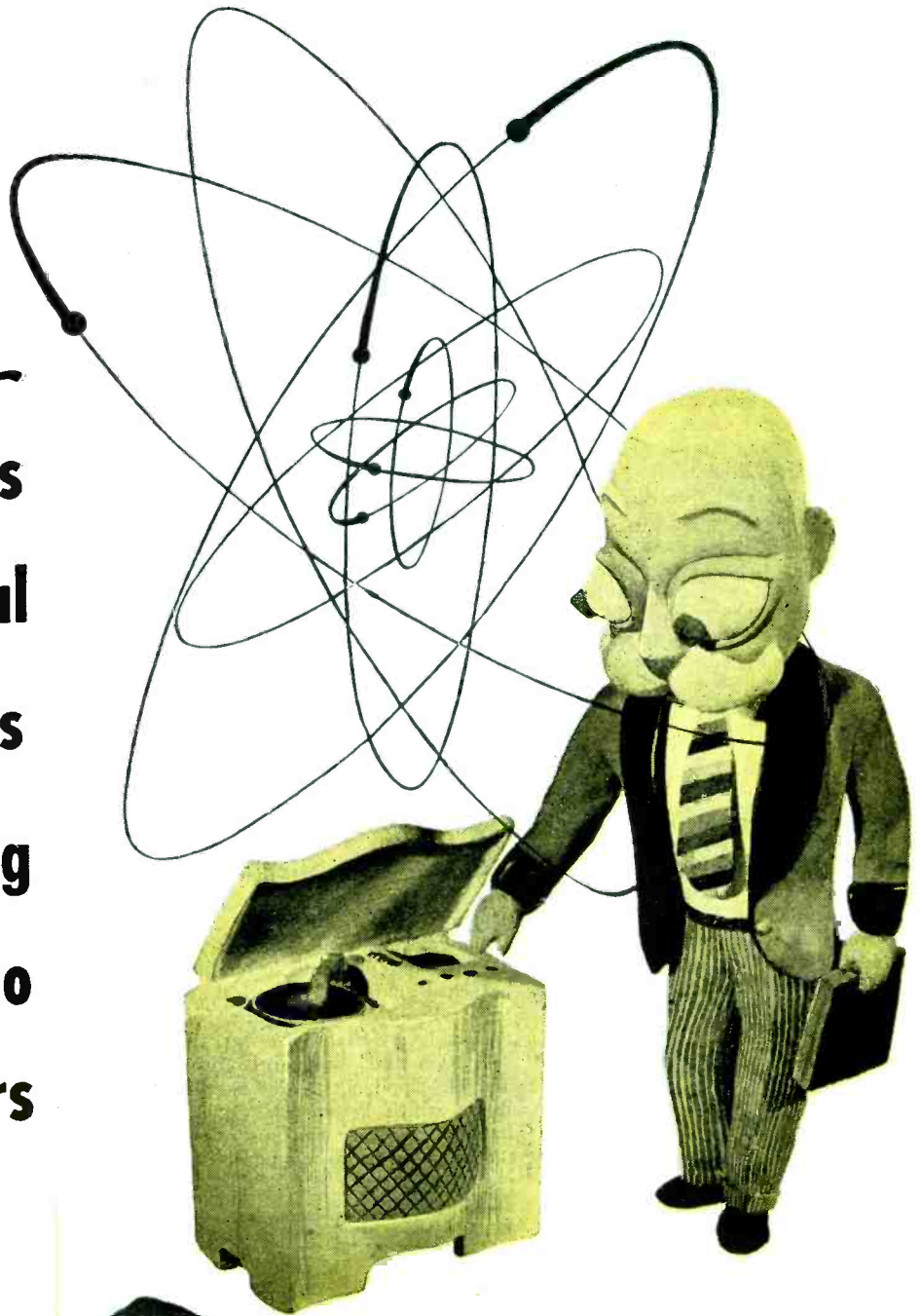

Esquire



puts a man in the mood to buy

Esquire also delivers exceptional results for national advertisers of many other products in virtually every field.

** and millions of women, too*

Dealers Set for Sales

RADIO

APPLIANCES

RECORDS

MERCHANDISING

SERVICE

FM

Nation's Retailers Prepare for Bright Future

PRESCOTT, Ariz.—Vyne Bros. Electric Co., Inc., 142-4-6 N. Cortez St., in business since 1910, is getting set now for the active radio and appliance merchandising policies it intends to put into effect. The store, service and storage floor area included, is about 6000 sq. ft., of which 50' x 30' of the establishment's area is used for display and selling.

Vyne Bros. were exclusive Philco radio dealers for 12 years, and also handled various refrigerator lines. Fred W. Gegg, manager and buyer, feels that alertness in buying and selling are important factors to watch for in the coming competitive market. Attractive window displays, excellent location, and good treatment of customers who bring in repairs, accounts for a steady flow of store traffic which is an indispensable "must" for success in business, says Gegg.

JAMAICA, N. Y.—M. Biderman, 90-19 Sutphin Blvd., is advertising and merchandising a simple inter-communication system for use in the home. It consists of a small microphone, 6-volt battery, and a speaker. This suggests a possible slow-season selling item for dealers in general. Idea: Why not push inexpensive, novel radio devices, whether distributor-supplied or home-made?

METTER, Ga.—George O. Franklin, Jr., and J. T. Trapnell, have purchased the Bowen Radio & Electric Co. The new name of the establishment will be the Metter Radio & Electric Co., and will be managed by J. T. Trapnell, who is also manager of the Franklin Radio Repair Service Co. of this city. Former employees will continue in the same capacity with the new firm. Plans are being made to redecorate the store into an up-to-date radio-appliance center.

INDIANAPOLIS, Ind.—Situated in the heart of this city's automobile sales district is the Skinner Radio Co., 1001 N. Meridian St. Because of its location, this organization is centrally situated for merchandising and repairing auto radios. Miss Martha Beard, co-proprietor with E. M. McCormick, declared that the firm does auto radio installation and repair for many of the auto dealers in this area.

A drive-in station, accommodating six cars at once, facilitates work on car receivers. In addition, a parking lot is situated adjacent to the firm, where autos awaiting radio servicing can be kept.

Miss Beard is an efficient radio tech-

nician herself, and does competent servicing on receivers, particularly auto sets. She is also a capable merchandiser, and before the war sold home and car radios, in addition to major and small appliances.

The firm does maintenance work on two-way radio for the Federal Bureau of Investigation in this area. This service is performed on a contract basis.

MERIDEN, Conn.—"We're putting our priority lists to work," declare Harold and Max L. Rischall, co-owners of the Rischall Electric Co., 52 E. Main St.

With appliances beginning to arrive, the store is contacting customers who have waited patiently for sorely-needed electrical goods.

To insure high radio-appliance sales, the store places ads frequently in local newspapers. Also, the firm has contracted with station WELI, New Haven, for spot announcements for one year's duration.

KALAMAZOO, Mich.—C. H. Brown, who operates the firm of C. H. Brown & Son, 154 W. Michigan, has been in the radio game since its infancy. Originally a radio and phonograph retailer, Brown branched into the electrical appliance field when this merchandise became increasingly important. Pre-war, this dealer sold RCA and Stromberg-Carlson radios, and GE appliances. The excellent reputation which Brown has established for himself will serve him in good stead now that merchandise is available.

CHICAGO, Ill.—All the comforts of home are provided for the employees of Lyon & Healy, 243 S. Wabash, as part of the firm's employer-employee good-will program. This record merchandising establishment has equipped recreation rooms and a modern kitchen in which meals may be cooked for the benefit of its employees, and coffee is contributed by the management.

POTTSTOWN, Pa.—Leon and Frank Levitz, co-proprietors of the Levitz Furniture Co., 212 High St., have their plans readied for handling radio and appliance trade-ins. The owners maintain a separate outlet store in which they will sell secondhand merchandise only.

This outlet branch is located near the main store, and also houses the firm's warehouse.

To promote the sale of goods taken in trade, the store will advertise often. In this way, the firm not only hopes to accommodate trade-ins, but also to make a profit on them.

BROCKTON, Mass.—Dave Harris opened a new radio store in the center of town after operating a similar establishment in Brockton's suburbs for six years. Located on a principal street, directly in front of a bus terminal, Harris finds that his new business is doing extraordinarily well. He has signed up to be a Westinghouse dealer. (See picture below.)



Roy Johnson, left, and Bert Butler, technicians at work in the service department of the Harris Radio Sales and Service store. (See item above.)

You haven't met her?

... you should!



● She's about 26.

She's married, been married about seven years.

She has two children — both very young.

Generally she's a housewife, but she worked in an office once. Sometimes she still works there.

She manages the \$4,000 family income well. Their nice home is proof of how well.

She and her husband expect to build their own home.

She has flair that can wear the new styles. She's up on the fads, but she shops with her head.

She needs a magazine especially built to serve *young* women like her, because she forms one of America's greatest markets.

She's going to get *her* magazine *very* soon. It's called **Today's Woman**

DESIGNED FOR

Selling

DESIGNED FOR

Selling

The Coventry model shown is one of 12 Modern and Period models which comprise the complete post-war Ansley Dynaphone line. Designed to harmonize with 18th Century period furnishings, it enhances the beauty of any room furnished in this decor.

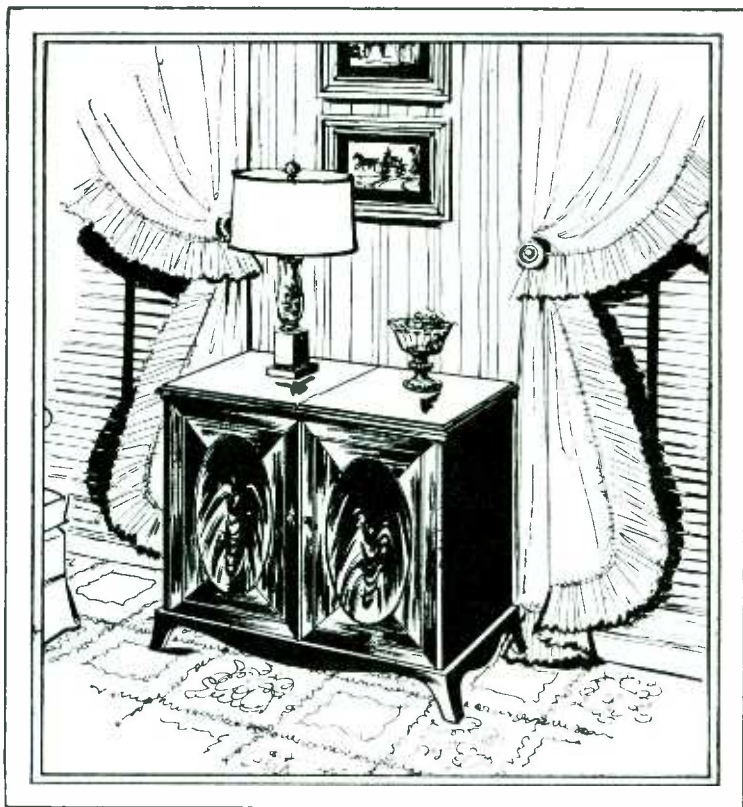

The cabinet artistry that distinguishes every Ansley

Dynaphone places it beyond competitive approach.

Because your customers see a radio-phonograph before they

hear it, Ansley makes that all-important *first impression* a lastingly

favorable one. Ansley Period Cabinets are designed with Old World

grace and authenticity, and executed with the painstaking skill of the

Old Masters. The result is matchless beauty of *line* equalled only by the

matchless Ansley fidelity of tone . . . a fact your customers will readily appreciate!

ANSLEY RADIO

CORPORATION

"Superb Tone from Records and Radio"

21-10 49th Avenue, Long Island City 1, N. Y.

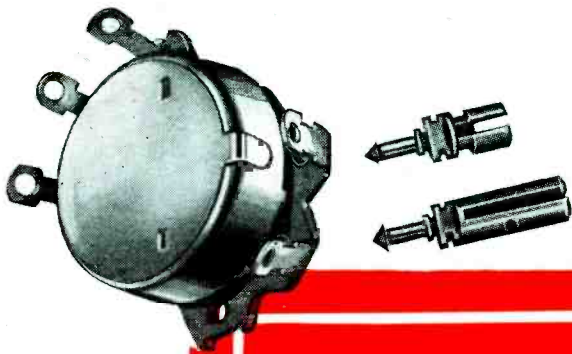

*Streamlined...
and Fool-Proof!*

MALLORY Replacement VOLUME CONTROLS

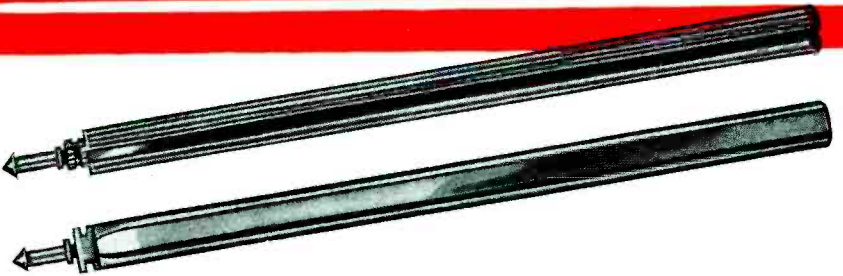
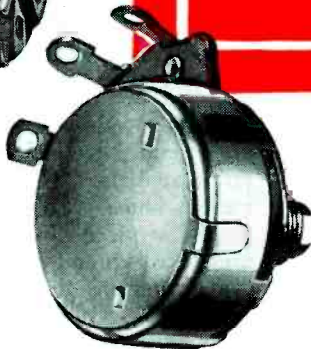
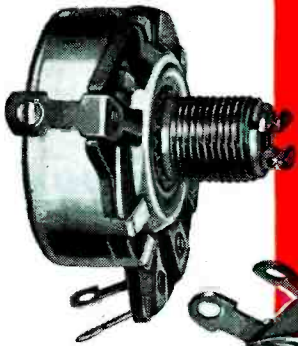

The perfect size for every application!



Precision-built like a fine watch!



Rugged strength for years of service!



The A-C switch that snaps on and stays on!



MALLORY Tapped Volume Controls have put an end to confusion and worries. Together with a surprisingly small number of plug-in shafts, they not only replace original controls but *duplicate* them mechanically and electrically. In fact, 16 controls fill approximately 85% of your replacement requirements!

Installation is easy and fool-proof, too! The plug-in shafts can't pull or twist loose. The A-C switch *snaps* on. There's no assembly work required!

What's more, Mallery controls mean quiet operation and gradual increase or decrease of volume. And they require a lower inventory investment than any other controls on the market! See your Mallery distributor. Have him help you select a streamlined kit to answer nearly all your service needs.

P. R. MALLORY & CO., Inc., INDIANAPOLIS 6, INDIANA



*More than ever—
ALWAYS
INSIST ON*

P. R. MALLORY & CO. Inc.
MALLORY
APPROVED
PRECISION PRODUCTS

VIBRATORS • VIBRAPACKS* • CONDENSERS
VOLUME CONTROLS • SWITCHES • RESISTORS
FILTERS • RECTIFIERS • POWER SUPPLIES

ALSO MALLORY "TROPICAL"™ DRY BATTERIES, ORIGINALLY DEVELOPED BY MALLORY FOR THE U. S. ARMY SIGNAL CORPS, NOT PRESENTLY AVAILABLE FOR CIVILIAN USE.

*Trademarks



Charles Carson, right, being interviewed by a representative of this magazine. While awaiting new goods, the store is being "set for action."

Keeping Sales Humming

Available Goods Provide Profitable Volume. Store-Front Revamped. Direct Mail Builds Customer Good-Will

• Justifiably proud of his position as an independent radio-appliance retailer is Charles Carson, co-proprietor with his brother Max, of Carson Bros., 518 South St., Philadelphia, Pa.

"Manufacturers and distributors of receivers and appliances should take notice of the fact that independent dealers have been able to earn a profit during the war period when there was little to sell," Carson declared. "That is positive proof of their merchandising skill."

Situated on a busy street in the downtown section of the city, the firm is retailing radios, appliances, records, furniture, and other goods, and during war-time succeeded in keeping its profits well in excess of expenses.

As a step forward toward realizing its store modernization plans, the store-front and windows of the store have been enlarged and revamped. This arrangement will permit an advantageous window display of radios and appliances now that this merchandise is again arriving at the store.

Looks Well-Stocked

Utilizing to the utmost the advantage of being located on a high traffic thoroughfare, the establishment is currently featuring attractive displays of available merchandise in its spacious windows.

The street-level department of this store still retains a "pre-war appearance," and exhibits an abundant display of records, furniture, table lamps and other items. The "visiting lines" of furniture which the firm has sold were "borrowed" from the organiza-

tion's retail furniture store which is operated near this establishment.

As radios and appliances return, these goods will be merchandised exclusively, and the unrelated lines will be returned to Carson's other store.

The main floor is doing well with discs and record accessories such as needles, record racks, etc. Classical and popular platters are equally in demand, and are aiding in maintaining the sales volume. For the convenience of patrons, two record listening stations are available. Discs sold by this establishment include Decca, Victor, Capitol, etc.

Effective Slogan

"Welcome to Carson City" is the slogan which greets the prospective purchaser as he surveys the store's second floor showroom. Sufficient space, near the main flow of store traffic, in which to properly display new radios and appliances is a vital "must" to dealers who want to earn more profits. This roomy department will enable Carson to exhibit his merchandise to the best advantage, and in a "warm" atmosphere, thereby helping to solve the space problem.

Service Department

To keep in repair the full line of sets and appliances which were sold by the store prior to the war, a service department is maintained on the third floor of the building. Realizing the importance of keeping electrical goods in his area in working condition, the owners of this establishment maintain a staff of three technicians engaged in this important work.

Both outside and inside repair jobs are attended to, and service work on large appliances is done in the customer's home. Those sets which cannot be serviced away from the store are picked up and delivered. Two of the technicians devote their time to "in shop" servicing, while the third takes care of outside jobs.

Maintains Contacts

Many radio-appliance firms today have become so concerned with their service operations that they have forgotten (or else lacked the time—or the desire) to maintain close customer contact. With the arrival of new merchandise virtually "around the corner," retailers must get to know their customers better if they want their patrons to know them.

Carson keeps in touch with his patrons by the simple expedient of direct mail. This reminder, which is sent to customers four times a year, informs them that he still wishes to "know" them despite the scarcity of goods, and keeps them posted on the merchandise currently being sold. In addition to increasing sales of available goods, this policy is also building a customer list for future use.

To supplement his direct mail promotion, this dealer also advertises daily in the newspapers, and sponsors a spot announcement over the air.

Carson's plans at the moment include the remodeling of the store, and a rearrangement of display areas. Having already taken the initial step in modernizing his place of business by improving the store-front, he is preparing to recondition the interior in preparation for a "selling" business.

Really Rolling!

Geared to go fast...that's Stewart-Warner's new, high speed, straight-line manufacturing plant. Finished sets are now coming off this modern production line to give Stewart-Warner distributors the jump on competition. This will be more important than ever during the first wave of civilian demand.

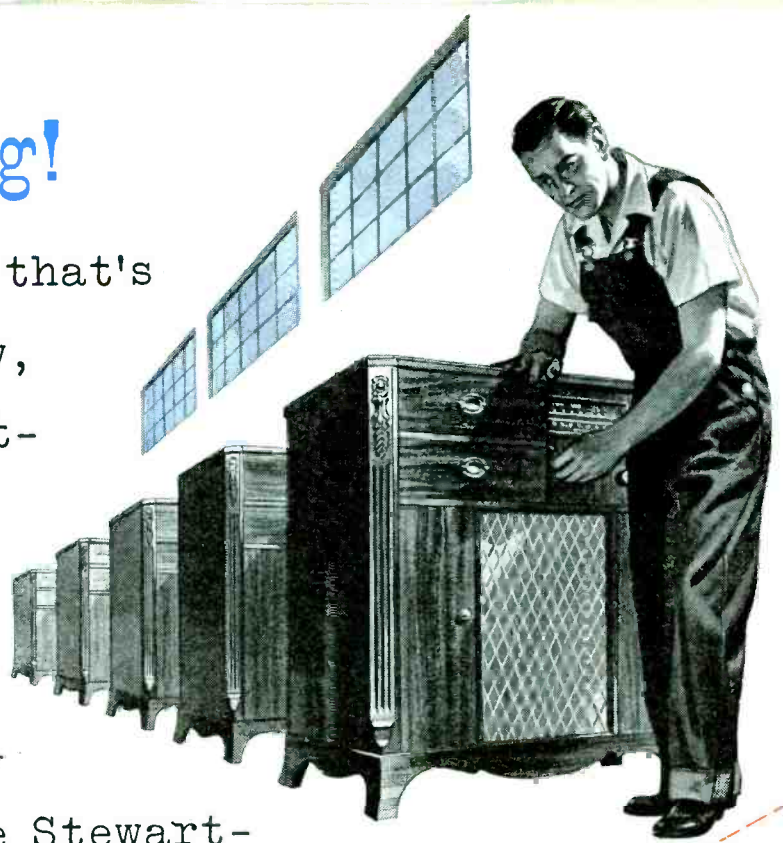

**STEWART-
WARNER**
Radios

CHICAGO 14, ILLINOIS



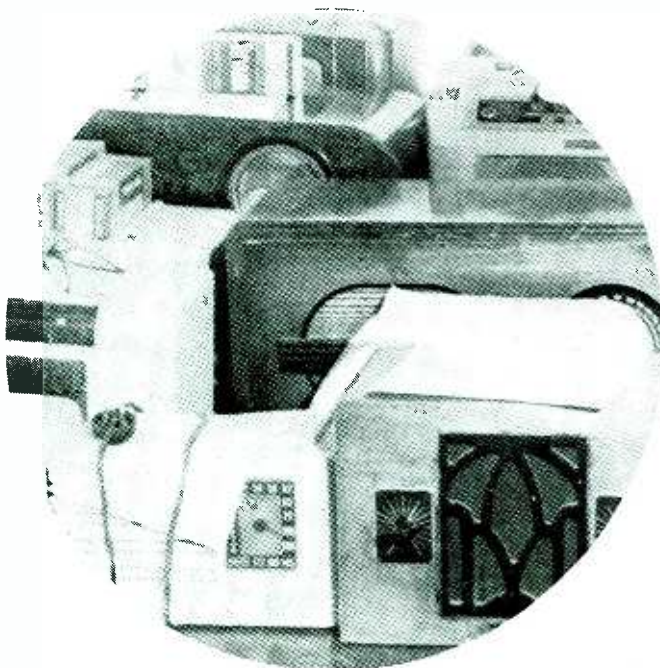

These will spell c-a-s-h for this retailer.

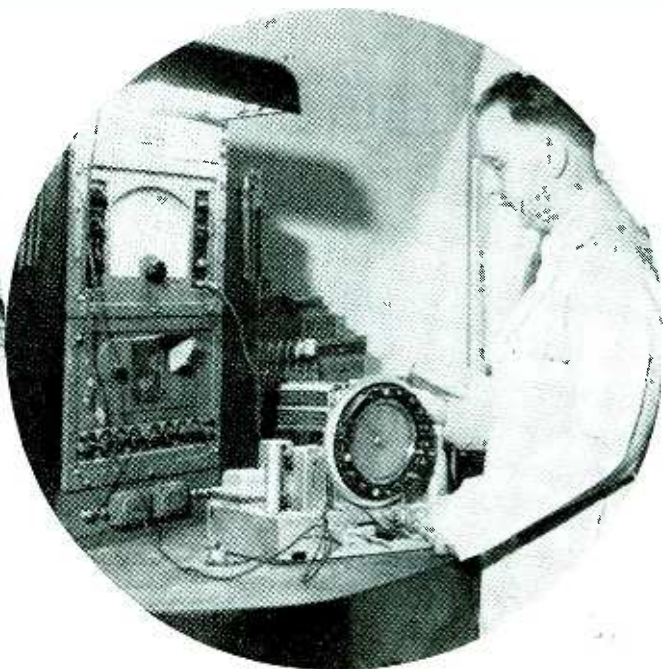

Watts at work on one of his repair jobs.

Double Barrelled Sales

Dealer Watts Aiming at High Profits from Selling and Service

● In this postwar period, package items which the customer can carry out will comprise about 20 per cent of the inventory of the Watts radio store, 524 E. Fourth St., Duluth, Minn. The business is owned and operated by Howard S. Watts.

"I believe that these smaller electric appliances will have large sale," said Mr. Watts, "and will be instrumental in bringing many new people into our store. Once in, they will be exposed to purchase of radios, which will remain our principal business."

Moved to New Location

Watts' business, which he has conducted for about 15 years, has, in normal times, consisted of approximately 50 per cent radio sales, 50 per cent repair work.

At the outbreak of the war, when it became evident that sales of radios would drop sharply, he moved his business into a smaller place nearby, and prepared to increase his repair work to make up in a measure for the lost sales volume. He had to work longer, and he had to see more work come in than could be readily taken care of. But percentage of profit grew, and all the time his store was becoming better known.

When conditions are right, the business will be moved to larger quar-

ters so that small appliances can be given a section of their own, with radios in another roomy section, and a repair shop at the rear. Mr. Watts plans to continue repair work as a strong feature of his shop.

During the war Dealer Watts developed sales of intercommunication systems and the servicing of them. This business will be continued in the days ahead.

The store Watts is planning will be completely modern in every respect, and he will take on, as they become available, all of the new improvements in the appliance and radio field.

In the meantime, the present shop is kept busy with radio repairs. A limit is placed on the amount allowed to pile up ahead, however, as Watts believes it is not to the future best interests of the store to have a large list of impatient customers.

Students Work in Store

The store picks up and delivers at regular periods, using its own trucks. Small sets are brought into the shop and called for by customers.

Part of the labor problem has been solved by using high school boys who come in after school. While they are not technicians, Mr. Watts has found he can train them to do many things

which save time for the repair men. Other workers come in for part time when they have finished at regular jobs in other industries. In this way, repairs are speeded.

Unlike many other businesses, Watts sets no definite time when work will be done, as some radios need only minor repair work, others a complete overhaul. The little jobs are finished first, so that customers do not have to wait while some big job is finished. When the work is completed the customer is notified over the telephone and date is set for delivery, or when the customer will come in for it.

Allots Space for Sets

Between ten and twelve radios a day, comprising large and small jobs, are completed ready for delivery.

The completed radios are placed at the front of the store if they are to be called for by the owner; those which are to be delivered are placed at the rear of the shop convenient to the trucks. Finished work is placed on shelves at the side. These shelves are always full—evidence of the large amount of work brought in.

The work bench is at the rear of the shop. An oscillograph, which is used to find distortion of tone, is placed at one side near the bench.



TRUE BEAUTY IS *AGELESS*

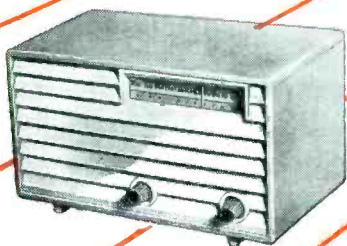

● Symbolizing Winged Victory, Nike from Samothrace is a masterpiece of sculpture of 280 B.C., treasured throughout the ages by all peoples for sheer, simple, lasting beauty.

Pride of craftsmanship is represented by idealism in conception and execution of Detrola radio receivers, automatic record changers and other electronic instruments . . . all of unsurpassed beauty and value . . . developed especially for the world's outstanding merchants and their customers.

DETROLA RADIO DIVISION  OF INTERNATIONAL DETROLA CORPORATION, DETROIT 9, MICHIGAN

Detrola Radio



*From Every
Angle -*



a Safe Heater ... a Proved Profit Builder



SPECIFICATIONS:

19½ in. wide, 18¼ in. in height and 9¼ in. in depth . . . weight 19 pounds . . . wattage 1200 at standard household voltage (110-120) either AC or DC . . . Trilmont carries the Underwriters' Seal of Approval. Colors — Ivory or Brown.

MODEL "A"

Only \$33 includes

- DETACHABLE CORD SET
- FEDERAL EXCISE TAX

At and West of the Mississippi, 95c extra

Not just another heater, but an entirely new principle of heating with household current. Non-glowing (black heat) coils which should never need replacement are incorporated in a dual-walled cabinet of exceptional design. These activate seven vertical air streams which result in a natural circulation of air throughout the room. No fan, no noise, no danger regardless of heater's position. Cannot burn children or fabrics in contact with the cabinet . . . The Trilmont is ideal for additional warmth in chilly rooms throughout the year. Available now! Be the first in your community to display and sell this revolutionary electric space heater.

Write or wire today for nearest Distributor

TRILMONT PRODUCTS CO.
WALNUT STREET AT 24th • PHILADELPHIA 3, PA.



"Sure she's happy—
she just
ran into a door!"



And what a door! That Shelvador* on the Crosley, Tom, is a salesman's dream. You don't have to say anything. You let the refrigerator do the talking and does it talk!

First thing, show the customer the side-by-side refrigerators. You have the Demonstration Blind pulled down over the Shelvador*. You explain that both are excellent refrigerators—with all modern improvements, gadgets and so on.

Then you raise the blind on the Shelvador* and step back. Bang! She gets it right away. Not much left to do but get out the order book and ask, "Name and address, Madam?" The Crosley looks like two refrigerators with that double front-row storage space.

SEEING is Believing

AS SOON AS we go into production, we are confident the Crosley Refrigerator with the patented, exclusive Shelvador* will again be the talk of the trade.

You can expect refrigerators with every modern improvement and development in home refrigeration plus the Shelvador*—the door that sells itself. Typical of all Crosley home appliances. Crosley gives you not only the Shelvador* but radios, radio combinations, and household appliances with features the customer can see, hear, or feel—features that let you profit handsomely.



That's just the beginning. Because a new refrigerator is an event in any home and every woman loves to show it off to her friends. And when her friends get a load of that Shelvador* with all that storage space—brother, they come in to see me. You just can't beat a product that delivers its own sales message!

*REG. U.S. PAT. OFF.

CROSLEY
THE CROSLEY CORPORATION, CINCINNATI 25, OHIO



RADIOS • RADIO-PHONOGRAPHS • FM • TELEVISION • SHORT WAVE • ELECTRONICS • RADAR • REFRIGERATORS • HOME FREEZERS
LAUNDRY EQUIPMENT • RANGES • KITCHEN SINKS & CABINETS • HOME OF WLW, "THE NATION'S STATION"

RADIO & Television RETAILING • October, 1945

IRC PRESENTS



the "Book of the Year"

FOR SERVICEMEN

Get your free copy from your
IRC Distributor or write direct

UP TO THE MINUTE DATA ON IRC RESISTORS

Every well-posted Serviceman will want his own personal copy of this new IRC Service Catalog. Profusely illustrated with useful charts, diagrams, tables and product pictures, it contains the kind of material a busy man likes to have right at his fingertips.

Among the interesting features in this catalog you'll find the complete story on the new smaller size BTS ($\frac{1}{2}$ watt) and BTA (1 watt) resistors, as well as useful data on the entire BT and BW resistor lines. Now in RMA Preferred Number Ranges as standard Dis-

tributors' stock, these quality resistors are quoted at new low prices.

Also included are pertinent facts on IRC's "Century Line" of volume controls . . . 100 controls that will solve over 90% of your problems in this category. But these are only the highlights of this helpful new catalog. You'll want to see and read it all.

Make sure that you get your copy by stopping in at your nearest IRC Distributor or, if more convenient, drop a card to Dept. 21-J.

International Resistance Co.

401 NORTH BROAD STREET, PHILADELPHIA 8, PA.



IRC MAKES MORE TYPES OF RESISTANCE UNITS, IN MORE SHAPES FOR MORE APPLICATIONS THAN ANY OTHER MANUFACTURER IN THE WORLD





The **TRADE MARK** *that Stops Them . . .*

What's in a name? Ask the man who sells KODAK . . . FRIGIDAIRE . . . or BUICK cars. . . . Over and above fine engineering, beautiful, modern designs and a complete line of models, CLARION RADIO carries a name and a dramatic trade-mark, that sticks firmly in the prospect's memory. . . . For the Dealer who is rounding out his merchandising program today, CLARION has an especially interesting proposition. Write for the name of the CLARION distributor in your territory. Some desirable territory still open.

WARWICK MANUFACTURING CORPORATION

4640-50 West Harrison St.

Chicago 44, Illinois

YEARS OF PROVED PERFORMANCE



Retailer Schutte at his service bench. Turns out more than 200 repair jobs monthly. He keeps his customers posted on the radios and appliances the store will carry soon.

Ready for Selling

"Tell Customers NOW What You Will Sell LATER," Advises Dealer

• How about those customers who called at the store for their repaired radio sets in war-time? What are you doing to get them to think of you now that postwar radios and other appliances are available?

Lester Schutte, operator of the North End Radio Shop, Clinton, Iowa, is now asking all *his* customers what appliances they are going to buy, as he awaits receipt of first merchandise.

Quizzes Purchasers

Then when they tell him what they are going to buy, Mr. Schutte tells those customers that he intends to stock a large line. Thus he gets the customer thinking definitely about his postwar purchases, in connection with the store. And he believes this latter thought is very important.

"The average business in this field has acquired a lot of new customers during war-time," declares Schutte. "Many of my customers bought their radios and other appliances at other stores in other localities and towns. In many instances they do not even know if the radio dealer who services their sets in war-time is going to sell appliances in the postwar era. I have had folks say to me, 'Oh, are you going to sell radios and washing machines after the war? I'm glad you told me so.' I have lots of answers like that, and it is one reason why I think it pays to talk about sales now with one's customers."

Dealer Schutte doesn't take any definite orders for postwar appliances,

but he does leave the customer with the thought that here is a place where postwar appliances can be purchased. And if the customer is satisfied with the way the repaired radio operates, he is going to think of the dealer very often and in a friendly, grateful way, Mr. Schutte believes.

Has "Preference List"

"I figure that never again will I get a chance to talk to so many prospects in so short a time," declares Mr. Schutte. "I service about 200 or more radios per month. That runs into 2,500 sets or so a year. Just a word to each of those 2,500 customers will set up a fine future sales program as I see it.

"Many customers have told us that they are going to see us first before buying. In many instances we record the preferences of such customers for postwar appliances. This information will prove valuable to us when we are trying to sell them."

Schutte points out that many war-time service customers are one-time customers so far as that one radio set is concerned. If a good repair job is done, the set may last for the duration. The dealer therefore does not get another opportunity to see that satisfied service customer.

"A lot of customers think that because we've been servicing exclusively, we are going to do only that in this peacetime era," says Schutte. "The retailer who intends to sell radios and appliances now has to combat that idea. The time to combat it is right

now—with every customer who comes to the store."

Schutte has been working alone at his bench during the war years, but has trained his wife to do considerable repairing, too. Mrs. Schutte has shown considerable aptitude for the work and also works long hours when necessary to get the radio jobs done. Often she handles the office calls as well so as to let Schutte stay at his work during these busy times. Assistance such as this has upped output considerably, Schutte reports, and he greatly appreciates his wife's help.

To handle his delivery problem, Schutte sets aside one day a week to pick up and deliver sets which customers cannot bring in themselves. These are usually large receivers.

By holding his outside work to one day a week, Schutte is able to keep up a strenuous schedule which really results in turning out a lot of work.

Repairs War Vets' Sets

Schutte also spends one day a month at the Schick General Hospital, a government institution, taking care of war veterans' radios.

For this repair work the soldier pays if he can. If unable to pay, the soldier finds that the American Red Cross is willing to handle the bill for him. Schutte always works hard to get all these radios in perfect working order, for he says these boys who have fought in World War II and been disabled deserve the best of attention.

HERE'S WHAT YOU'LL GET FROM RCA IN PROJECTION- TELEVISION TUBES--



How the RCA Television Optical System Provides Newspaper-Size Images from a Specially Developed 5-Inch Kinescope Tube.

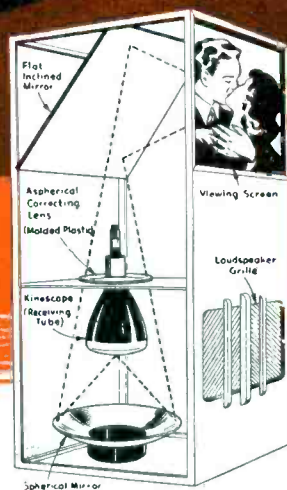

LOWER COST OF TUBES: Simple bulb design in soft glass lends itself to low-cost quantity production.

LOW-COST POWER SUPPLY: New electrostatic-focus electron gun avoids cost of a magnetic-focus coil and, at the same time, permits use of a low-cost power supply having moderate regulation.

HIGH CONTRAST AND HIGH LIGHT OUTPUT: New method of applying fluorescent particles to the glass face results in high contrast and high light output.

HIGH RESOLUTION: Improved gun design provides high resolution.

TAILORED TO PROJECTION OPTICS: Spherical face of RCA projection kinescopes matches RCA reflection-type optical system.

Already, RCA has demonstrated to hundreds of engineers and radio experts television of tomorrow as made possible by these new tubes. Screens as large as a news-

paper page, with clear, bright images, enable dozens of persons to see the program . . . and this is but one example of RCA electron-tube development, engineering and leadership.

Make sure you have the advantage of this leadership in building your radio and television service business. Carry the tubes with the best-known name . . . RCA.



RADIO CORPORATION OF AMERICA

TUBE DIVISION, HARRISON, N. J.

LEADS THE WAY . . . In Radio . . . Television . . . Tubes . . .
Phonographs . . . Records . . . Electronics

The Fountainhead of Modern Tube Development Is RCA



RCA VICTOR

with New "Kick-Off" Line Pack Terrific Sales Wallop

THIS is *more* than you expected *so soon*—not just prewar designs to catch the quick trade—but everything your customers have hoped for in up-to-the-minute styling, tone quality and long-range performance†. Each and every one of the nine models strikes a new note in *value* and *quality*, made possible by RCA's vast wartime experience in the mass production of precision electronic equipment. Look them over—read the specifications—and you'll see why the "kick-off" line is a winning team.



The Tiny "Personal" Gives Real Reception

RCA Victor 54B can be carried in a topcoat pocket! One-third less cubic content than the RCA Victor prewar "Personal." Gives room-sized volume. Uses 4 RCA Victor miniature-type tubes giving "6-tube" performance†. Camera-type construction, polished chromium trim. Only 3¼" high, 4¼" wide, 6¼" long. Weighs 3½ lbs. Tunes 540-1600 kc. List price approx.: \$25.00.

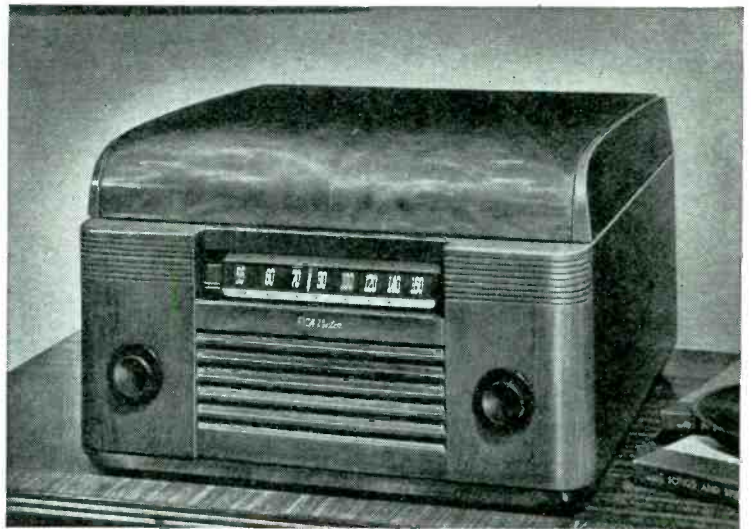

Your Customers Will Cheer for This One

Victrola* 55U is almost ⅓ smaller than RCA Victor prewar radio-phonographs. Cabinet of walnut in classical modern design. 5 RCA Victor Preferred-Type tubes (giving "7-tube" performance†). Magic Loop antenna. Powerful dynamic speaker. Straight-line dial and controls on front of cabinet. Automatic record changer plays up to 12 records. Permanent-point pick-up. List price approx.: \$79.95.



The No. 1 Value in Low-Priced Radios

RCA Victor 56X uses 6 RCA Victor Preferred-Type tubes (giving "7-tube" performance†). Has extra-large Magic Loop and Selective Superheterodyne Circuit for strong, clear reception. Husky 5-inch dynamic speaker. Cabinet molded of rich walnut plastic. Has recessed angle-vision dial and new "bull's eye" pointer. Tunes 540-1620 kc. 7¾" high, 12" wide and 6¾" deep. List price approx.: \$24.95.

Contact your RCA Victor Distributor today for final prices and news of RCA Victor's sensational new promotion aids—finest in the industry.



TAKES THE FIELD...

of Post-War Radios—Nine Outstanding Models— ... Production All Set to Roll!

EVERY MODEL PRICED FOR PROFIT

From the "Personal" Radio with room-sized volume, to the exquisite Model 59V1 with "Roll-out" record changer—every one is priced to sell at liberal profit to you. A model in every type and price class.

BACKED BY BIG ADVERTISING

RCA Victor will be running interference for you all along the line. A big, hard-hitting advertising campaign in major media—leading off with a smashing color spread in the November 26 issue of Life magazine—will clear your way to the most profitable market in the history of radio! So—get on RCA Victor's fast-moving team now—and be in on the sales-winning kick-off. It's the chance of a lifetime.



There Isn't A Finer Radio Phonograph!

*Victrola** 59V1 is housed in a Chippendale style cabinet of fine walnut and mahogany veneers. "Roll-out" record changer accommodates twelve 10" or ten 12" records. Permanent-point pick-up. 9 RCA Victor Preferred-Type tubes. 3 Bands. American and foreign reception. Continuous tone control. No lids to lift. Height: 36 1-16". Width: 35 3/8". Depth: 17 7/8". List price approx.: \$200.00.



**The Lowest-Priced
RCA Victor Console**

*Victrola** 58V radio-phonograph is housed in a smart low-boy cabinet of fine walnut or mahogany veneers. Lids over automatic record changer and radio raise independently. Spread on 19, 25, and 31 meters. Push-button tuning. 5 watts output! 12-inch dynamic speaker! Built-in antennae. List price approx.: \$179.95.



**The Radio
With A Touch of Tomorrow**

RCA Victor 56X3 follows the new functional design. Has recessed-angle, spread-vision dial. Uses 6 RCA Victor Preferred-Type tubes (with "7-tube" performance†). Extra-large Magic Loop has antenna coil connection for weak signal areas. Tunes 540-1620 kc. 8 1/4" high, 14 1/4" wide and 7 1/4" deep. List price approx.: \$29.95.



The "12,000 Miler"

RCA Victor 56X5 is a real distance-getter. Uses 6 RCA Victor Preferred-Type tubes giving "8-tube" performance†. Has Television-Type Amplification and provides foreign band coverage from 8900 to 12,000 kc., including "spread" feature on the 31- and 25-meter bands. Modern cabinet of rich walnut finish. 8 1/2" high, 14 3/4" wide, 7 1/8" deep. List price approx.: \$34.95.



**The Radio
With "Post-War" Appeal**

RCA Victor 56X2 is housed in exquisite cabinet of molded plastic finished in antique ivory enamel. Uses 6 RCA Victor Preferred-Type tubes that give "7-tube" performance†. Straight-line dial set at angle for full vision. Tunes 540-1620 kc. 7 3/4" high, 12" wide and 6 3/4" deep. List price approx.: \$26.95.



**A Battery Set
Convertible To Line Power!**

RCA Victor 55F can be readily converted to 105-125 volt AC operation by the RCA Victor "Electrofier." Features 5 RCA Victor Preferred-Type low-drain tubes and On-and-Off "Battery-saver" indicator. Tunes 540-1720 kc. Batteries required: 1.5 volts "A" and 90 volts "B." Cabinet 9 1/4" high, 18" wide, 10 1/2" deep. List price approx.: \$32.50.

RCA VICTOR

RADIO CORPORATION OF AMERICA

†Accomplished by the use of dual-purpose tubes.

*TM Reg. U. S. Pat. Off.

How the RCA type

162-C

CHANALYST

Helps Radio Men
Do Many Jobs



FASTER and **EASIER**

THE RCA Type 162-C *simplifies and speeds up* many types of radio design, testing and repair jobs—saves worry, work and time.

Shown here are pages from a bulletin that tells why you need the Chanalyst...what it does...how to use it.

This bulletin is interesting—instructive—and it's yours for the asking. Write for it, or fill in and mail the coupon below and we'll promptly send you your copy.

True, RCA Chanalysts may still be hard to get in your locality. But you can get in line to own one by consulting your RCA Test Equipment Distributor about this labor-saving, money-saving instrument. Send for the bulletin...today.



TEST AND MEASURING EQUIPMENT SECTION

Radio Corporation of America
Camden, N. J.

Please send me more information about the RCA 162-C CHANALYST.

Name.....

Street Address.....

City and State.....



RADIO CORPORATION OF AMERICA

RCA VICTOR DIVISION • CAMDEN, N. J.

In Canada, RCA VICTOR COMPANY LIMITED, Montreal

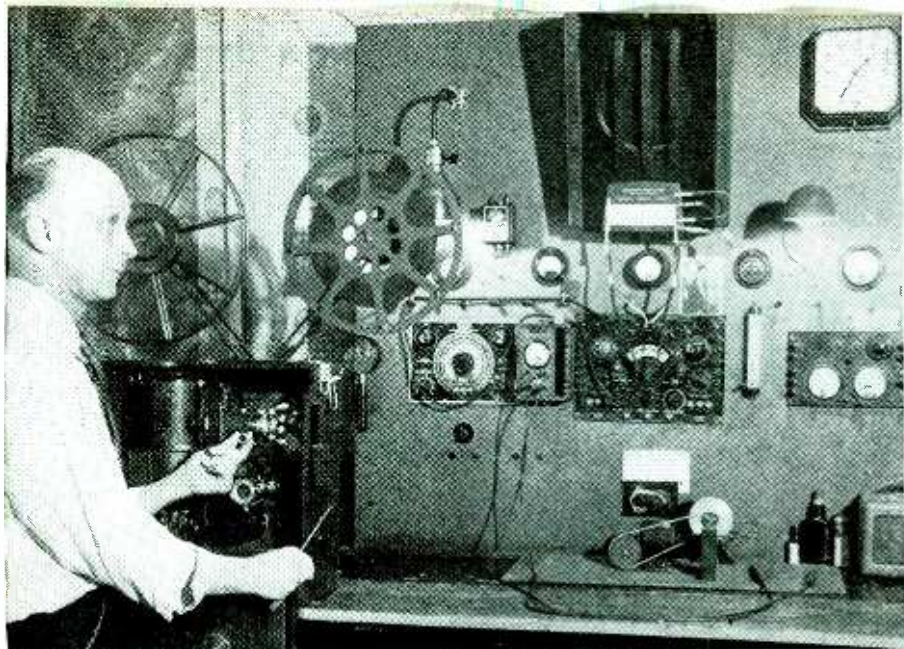

**“Repeat” Sales Guaranteed
by Satisfactory Service;
Alert to Customers’ Needs**

Set and movie projector servicing proves profitable for Eyler; helps him to build volume.

Repairs Reap Rewards

● Maintenance of radios, and movie projector repair work is keeping Owen B. Eyler, proprietor of Eyler's Radio & Movie Service, 70 E. Washington St., Hagerstown, Md., fully occupied during this period of merchandise scarcity.

This firm's policy of rendering excellent service is not only enabling it to survive war-borne shortages, but is also providing the stepping-stones over which it will reach a high volume of business in the postwar period.

Situated at a corner of a busy intersection in a high traffic area, the store benefits from the large number of passers-by and busy shoppers. Because of its central location in the heart of the city, the establishment's pick-up and delivery problem is considerably eased. Many buses stop near the store, thereby enabling customers to bring sets which are not too large to the store.

“Tags” Each Radio

To build a source of “repeat” service customers, and to create a good prospective-purchaser file, Eyler attaches his business card to each set serviced. The card reads: “Super Service at Eyler's; phone, 288-M; or call at 70 E. Washington St.”

As each completely repaired receiver leaves the store, the tag, which bears the date of servicing, is fixed to the radio. If a set returns for repairs after three years have elapsed, the old card is removed and a new one affixed. In addition to creating good-will, and supplying potential customers for future radio sales, the dealer is able

DEALER EYLER:

Has Central Location

Keeps Prospect File

Studies Business Methods

Cuts Unnecessary Expenses

Ready for Set Selling

to keep “tabs” on when the set was originally serviced and the nature of the work.

The war period with the accompanying disappearance of civilian merchandise may have caused hardship for radio dealers, but it has also been a blessing in disguise, Eyler declared. “War-time operation has tested the dealer's ingenuity and his intelligence to the utmost. In order to keep in business, many retailers have had to demonstrate their business sense, alertness to changing conditions, and resourcefulness.

“That is why I believe,” he continued, “that dealers who survived the war period will profit from future radio merchandising. These merchants will develop large sales volumes, and they will earn their just profits. Their capacity for staying in business, profitably, has been amply proved.

“Doing a thoroughly satisfactory service job is my method of protecting my business at present,” he stated. “A satisfied customer is our best advertisement.

“By keeping our patrons' receivers in first-class operating condition during the days when people were eager for the latest war news, we were laying the foundation for an active peacetime business. Technicians and dealers have insured their future sales volume by rendering expert service work at that time,” Eyler asserted.

He feels that the country's technicians have provided an enviable service to the public. He stated that radio repairing is not only a war-time necessity, but is also very important during normal times. In the role of a morale builder, the technician has contributed to a great extent. His ability to repair sets quickly and efficiently has been instrumental in helping to satiate the public's hunger for news, he concluded.

Keeps Expenses Down

The rising costs of living, and the increased expenses in conducting a radio repair business during these days, served to illustrate to this dealer the value of specialized training. In order to keep overhead and other costs to a minimum, business study and training have been Eyler's tools for eliminating unnecessary expenses. This has also aided in providing consumers with service at reasonable charges.

The proprietor of the store is an old-timer in the radio field. He has been acquainted with receiver operation from the time when radio was considered a “toy.” His long experience in radio servicing will serve to his advantage these days, now that merchandise is returning.

AMPHENOL

ANTENNAS

Promise . . . New Improvements In Postwar F-M and Television Reception

AMPHENOL F-M DIPOLE ANTENNAS WILL PROVIDE

- High gain that means better pick-up and reception.
- Directional array that will eliminate interference from the reflector side.
- Trouble-free reception in the F-M bands.
- Swivel feature will reduce or eliminate undesirable reflections that cause multipath distortion in television.
- New idea in parallel lo-loss transmission line.

For every improvement the antenna array can bring to future F-M and television reception—look to Amphenol. With a background of wartime experience in special research and engineering for the Armed Forces on dipole broad band reception, Amphenol has amplified its long production experience that began in the early days of radio.

When Amphenol is free to convert its output to peacetime products, Amphenol's F-M Dipole Antennas in kit form will offer a new top efficiency that is in advance of all present developments in the field.

Features will include all-steel construction for supporting parts and hi-strength aluminum dipole and reflector rods.

Your commitments should be made now to secure early deliveries.

AMERICAN PHENOLIC CORPORATION

Chicago 50, Illinois

In Canada • Amphenol Limited • Toronto

U. H. F. Cables and Connectors • Conduit • Fittings • Connectors (A-M, U. H. F., British) • Cable Assemblies • Radio Parts • Plastics for Industry

Depend upon

AMPHENOL

Quality



POWER

HIGH VOLTAGE POWER SUPPLY

This is the RA-38 power supply—another of the numerous valuable items in the group of government radio and electronic supplies offered for general distribution through the Hallicrafters Co., agents for RFC under Contract SIA-3-24.

Output voltage continuously variable from 0 to 15,000 volts. Can be easily adapted to deliver up to 6,000 volts at 1 ampere. Excellent power supply for laboratory work or can be used as power source for broadcast stations, induction heating equipment, vacuum tube life tests and many other industrial applications.

THESE VALUABLE ITEMS

Available Now

or very soon. Write, wire or phone for further information.

- head phones • test equipment • component parts • marine transmitters and receivers • code practice equipment • sound detecting equipment
- vehicular operation police and command sets • radio beacons and airborne landing equipment.

hallicrafters RADIO

HALLICRAFTERS CO., AGENTS OF RFC UNDER CONTRACT SA1-3-24
MANUFACTURERS OF RADIO AND ELECTRONIC EQUIPMENT

CLIP THIS COUPON NOW

RFC DEPARTMENT 200, HALLICRAFTERS
5025 West 65th Street • Chicago 38, Illinois

- Send further details and price on RA-38 Power Supply
 Send listings of other available items

Especially interested in.....

NAME.....

ADDRESS.....

CITY.....ZONE.....

STATE.....

Servicing Tampered Sets

Second of Two Parts. Correcting "Messed-Up" Circuits. Checking Wilful Damage to Sets

• Our discussion of tampered or "messed-up" sets in the September issue of RADIO & Television RETAILING was limited to tubes. This month we shall discuss results of tampering involving other components.

Cases where tampering is both gross and obvious need little comment. Probably every radioman has received sets for repair in which the set owner, or some other "expert," has replaced a resistance cord with a line cord, blowing out one or more tubes as a result. Almost as common is the use of a 400 ohm speaker to replace a 3,000 ohm unit, making still another speaker replacement necessary. We may, in passing, recommend for honorable mention in the Messers-Up Hall of Fame, the set owner who unsoldered most of the connections in his radio, and joined them back together with radio cement.

When tampering is gross, but not

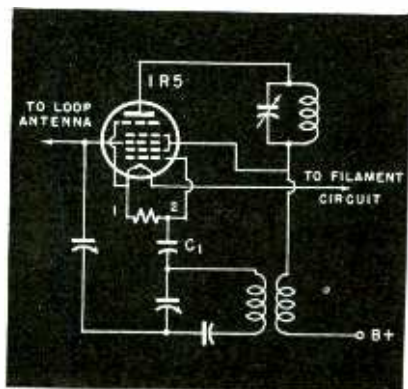

FIG. 1.—Voltage between points 1 and 2, when measured by a v-t voltmeter, would be very low if C1 was open, or missing, since C1 is in a grid-leak circuit.

obvious, service is not quite as simple. To illustrate, an instance may be cited where an oscillator coupling capacitor had been removed from a camera-type portable. Extensive voltage, resistance, and other tests were made before the radioman realized that the capacitor was missing.

Service would have been simplified if the radioman had possessed a vacuum-tube voltmeter. Grid bias measurement with this meter would have

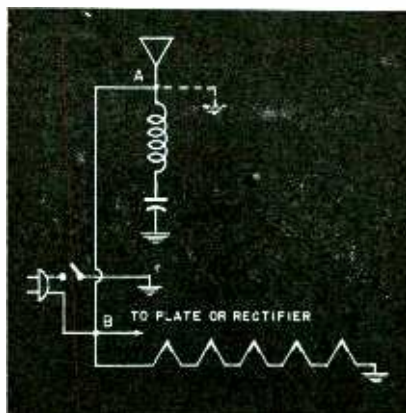

FIG. 2.—Improper connection of the aerial lead to the ungrounded side of the line became readily apparent when A was shorted to ground, resulting in fuse blow-out.

shown an abnormally low negative voltage to cathode from the oscillator grid (see Fig. 1). The next step would have been to check the coupling capacitor for a decrease in capacity, which would have resulted in quick discovery of the unit's absence.

The 1,000 ohm-per-volt meter actually used, however, gave an inaccurate contact voltage reading which was interpreted as correct merely because it was negative, and led the radioman to go on to check other circuits. This case underscores the need

for a wide variety of reliable test instruments in servicing messed-up receivers.

Another instance of gross, but not too obvious tampering, was found in the connection of an aerial to one side of the power line. This occurred on a set in which the external aerial is mechanically, but not electrically, connected to the line cord, and is normally left unterminated at the plug. An electrician, noticing the unconnected wire, thought it had worked itself loose from the plug, and attached it there. The result was a decrease in volume that led the owner to take his set to a more competent technician.

The radioman suspected that the antenna coil primary was defective, and shorted it to B— to see if volume was affected. The resultant fuse blow-out led to quick location of the trouble (see Fig. 2).

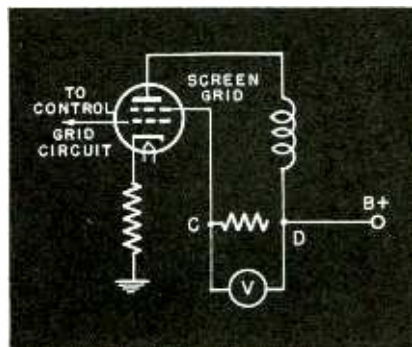

FIG. 3.—Flexible resistor C-D opened at its slack end only when set was right side up. When set was turned over for testing, the resistor had to be gently tugged after heating up, before the intermittent registered an absence of voltage between C and D.

RADIO SABOTEURS

Reputable dealers sometimes receive sets for repair that have been considerably damaged by irresponsible repairmen. The "messaging-up" is wilful, and is intended to make service of the set so difficult or expensive, that the dealer into whose hands it falls will not be able to underbid the first repairman's estimate. This Kamikaze tactic spells business suicide for its practitioner, as well as headaches for the next repairer. If a better method of committing hara-kiri exists, only the Japs know about it.

Intentional tampering is sometimes encountered. Here is what to look for on sets that have gone through this mill:

Extreme misalignment. This is the quickest, and therefore the most usual form of sabotage.

I-F coils cut through. In some cases, terminals of these damaged coils are connected with a simple wire, so that a continuity reading will be obtained. Check all coils for proper resistance

values before giving any estimates on these sets, to avoid future trouble.

Intermittently defective tubes. The cleverer type of saboteur does not replace his customer's tubes with bad ones, but substitutes intermittent tubes that test perfect on the meter. Your estimate will be completely off if you don't take this possibility into account. A wise procedure is to place all of the tubes in the suspect set into a similar, repaired receiver, and check them in that way.

Damaged power transformers. In one case, the transformer smoked, and seemed to be shorted. The radioman investigated, even though he did not suspect any tampering, because the burnt odor that generally accompanies a shorted power transformer was absent.

After a careful search, he found a filament lead from the transformer obscurely nicked, so that it shorted against the transformer shell to ground. It was a sly, well-disguised case of sabotage, perpetrated by a repairer who wanted to minimize the possibility of detection.

Going back to unintentional damage caused by incompetent service—when one or more intermittent troubles are also present in these sets, trouble-shooting may become quite difficult.

Triple Trouble

Take the case of a 3-way battery portable, which had been misaligned by its owner, and which had, in addition, two intermittent defects. One was a screen resistor that opened only when the set was right side up, and closed when the radio was turned over for testing. The other was a 1A7 that tested perfect, but became inoperative soon after the switch was turned on.

The combination was too much for one radioman. A second technician's procedure, however, enabled him to fix the set very quickly.

The defective screen resistor was a wire-wound, flexible type, and had a slack, unwound section of wire at one terminal. When the set was overturned, the weight of the resistor caused it to open at this end. The second technician was immediately suspicious of this resistor because the loose wire looked weak. Placing his voltmeter test prods from screen to B+ (see Fig. 3), he tugged gently at the resistor, waited for it to heat up, then tugged at it again. On the second trial, an intermittent reading occurred on the voltmeter. Replacement of the unit followed.

CHECKING "MESSED-UP" CIRCUITS FOR COMMON ERRORS

Look for:

1. **Glued-in voice coil.**
2. **Wrong value speaker.**
3. **Incorrect attachment of filter capacitors, especially common positive types.**
4. **Incorrectly attached volume control.**
5. **Reversed antenna coil connections.**

The first repairman, on the other hand, tested the resistor once, assumed it was ok, then went on to other tests. He lacked the imagination, or perhaps the suspicious nature, of the second technician, who took nothing for granted.

had been cleared up, and the new 1A7 tube was permanently installed.

Some of the most difficult problems arise from incorrect replacements of defective units by inexperienced repairmen. Use of an output transformer with an incorrect inductance value, in one case, produced a distortion which was very difficult to diagnose. Pure hunch, based on signs that the transformer had been recently replaced, led the technician to substitute another transformer.

The difficulty of course, in these cases, lies in knowing what to look for. Any detective who was confronted with as many possible suspects as a radio serviceman is in dealing with a tampered set, would tear out his toupee and take up movie writing.

Using Oscilloscope

Radiomen who own oscilloscopes can use them to good advantage on many of these repairs. An incorrect volume control replacement in a duodiode triode detector circuit may introduce a mysterious distortion that

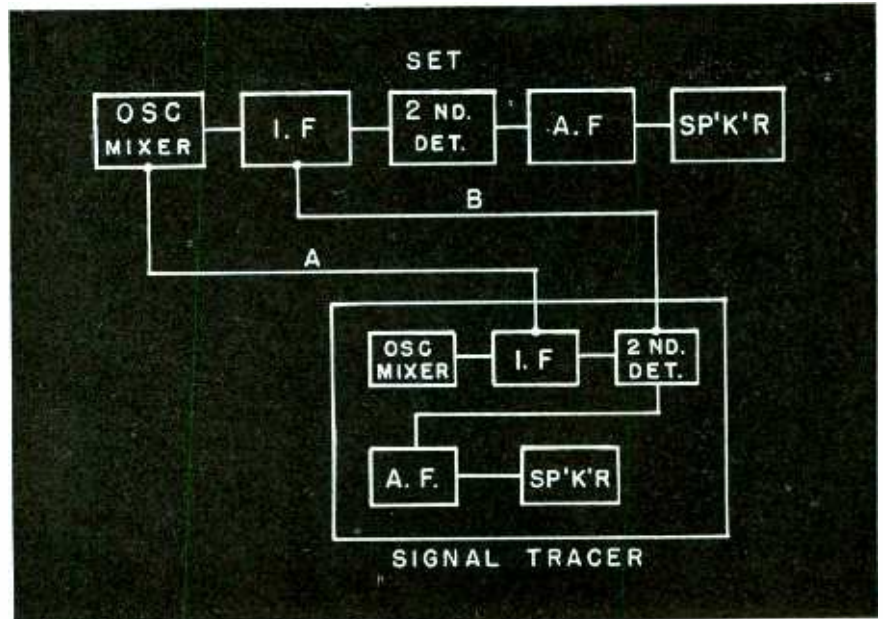

FIG. 4.—When signal comes through undistorted from osc. mixer, and distorted from the i-f stage, the i-f is obviously the source of trouble. A and B are connected alternately.

The second repairman also replaced the 1A7 at the very outset with a new one—for test purposes—because 1A7s are notorious producers of intermittents, and he was determined to eliminate any suspicious components at the very beginning. Correction of the misalignment was the only service job that remained, and that was fairly simple. When the original 1A7 was replaced, its faultiness became quickly evident now that the other troubles

does not readily give up its secret: The 'scope can, probably more quickly than any other instrument, locate the source of the trouble. Signal input at the high side of the control may be compared with that at the plate of the preceding tube, localizing the source of the distortion.

An audio signal tracer may prove useful in servicing tampered radios. On one set, the repairer had made an

(Continued on page 86)

Radio
Masterpieces are
yours to keep on

*"The Wire
 that Remembers"*

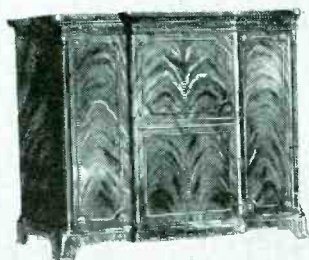

Designed
 and Made in Grand Rapids



The stirring finale crashes to a close—the work of the master conductor is over—the broadcast has ended. It was a spectacular outstanding interpretation. But it's gone.

How wonderful to have this music—this particular performance—to hear over and over—as often as you wish—with all its superior qualities preserved for years.

This is not farfetched. Today it is a reality. Simply! Easily! With as little effort as snapping a switch.

How? With a development of Lear—a new way of recording—the wire that remembers.

As this slim wire speeds across the poles of a magnet, it gathers these masterpieces of music, the dramas, your favorite broadcasts from the air. Or it records your own voice, the songs of children, the fun of your friends.

It gives you all this to keep forever if you want to. What you don't want is quickly erased—

simply by recording something else over it.

You've never seen anything like the Lear wire that remembers. In fact, you've never seen a radio like Lear's—a master radio creation which brings you the finest achievements in FM, television, easily tuned, world-wide short wave, and phonograph-combination automatic recording-changing. It is the only kind of radio that will satisfy you. Make it a point to see and hear the Lear Radio just as soon as your dealer has them in his showcase.



Listen to Orson Welles every
 Sunday afternoon 1:15 EWT
 on your local station of the
 American Broadcasting System

LEAR RADIO

LEAR, Incorporated

Home Radio Sales: 230 E. Ohio St., Chicago 11, Illinois—Radio Division: Grand Rapids 2, Michigan

Here's the latest advertisement in Lear's national magazine campaign introducing Lear Home Radios and Learecording. Again the readers of America's favorite periodicals are reminded that an entirely new radio is on its way.

And that's not all! Every Sunday over the American Broadcasting Company network, from 1:15 PM to 1:30 PM, EWT, Lear presents

the Orson Welles' Almanac featuring this noted actor, writer and narrator.

These promotion campaigns — magazine, radio, newspaper — are building up a huge acceptance for Lear Radios. If you are interested in being able to offer these fine radios to your customers, write for information on the Lear Franchise.

TESTIMONIAL TO PERFORMANCE!

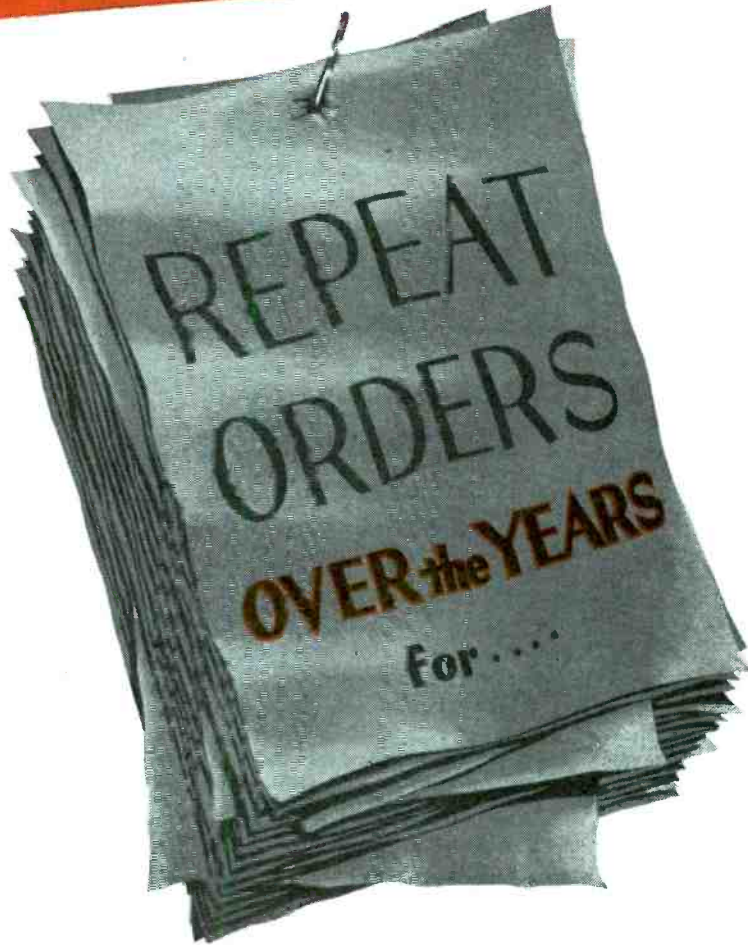

. . . THORDARSON TRANSFORMERS

The quality of a product and its performance over the years can best be judged by the repeat orders received. Repeat orders mean one thing above everything else . . . *customer satisfaction!*

For over 50 years, Thordarson has supplied transformers and other electronic products constantly to many of the most prominent manufacturers in industry. Yes, Thordarson has always enjoyed a large repeat order business.

At Thordarson . . . continuous research, progressive design and engineering are responsible for the development of the excellent transformers that have earned for Thordarson this reputation for fine performance.

Try Thordarson for your transformer requirements. Then you, too, will know why the many long-time users of Thordarson show their approval by repeat orders. New sales and distribution policies make Thordarson products available to everyone, everywhere.

500 WEST HURON ST., CHICAGO, ILL.

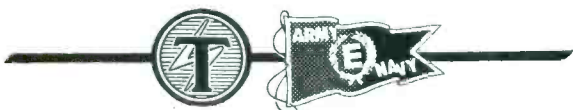

ORIGINATORS OF TRU-FIDELITY AMPLIFIERS

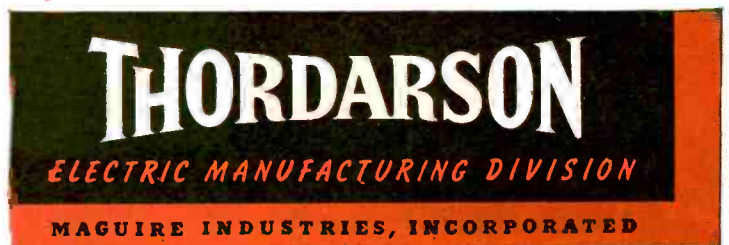

Service Notes

Defective Electrolytic

Intermittent distortion, hum, and low volume appeared on this set. Reception was perfect while set was right side up. When chassis was turned upside down, however, symptoms described appeared. Crossing the filter capacitor with a new one restored set to normal. What was probably happening was an improper distribution, or concentration, of the dielectric fluid in the wet electrolytic capacitor when the set was turned over, causing an open capacitor effect.

Fading 1LE3

When fading is the complaint on 3-way portables using 2 1LE3s, the trouble may often be eliminated by switching the 1LE3s around. One of these tubes is used as a converter—the other as an i-f amplifier. When the converter's transconductance drops, the tube may fail to oscillate at all times, causing fading. The defective 1LE3 converter, however, can still function perfectly well as an i-f amplifier, while the 1LE3 previously used as an i-f amplifier may have an unimpaired transconductance. Switching the tubes, thus, may clear up the fading, and avoid the necessity of replacing a hard-to-get tube. This procedure, of course, is helpful only when the trouble has been definitely traced to a defective converter tube.

Defective 25Z5

Tube-testers are often inadequate, as every experienced radioman knows. On one recent service job, inoperation was the complaint. There was zero voltage from the cathode of the 25Z5 to B—. No shorts, or open filter capacitors, were present. The 25Z5 was tested. Reading was in the "good" section. The radioman suspected the tube in spite of the clean bill of health the tester had given it. On close inspection, the connecting wire going from one of the tube prongs to the cathode was seen to be open. No emission, thus, was possible. Why had the tube checked o.k.? The only possible deduction was that a momentary short between cathode and filament occurred while the tube was in the tester, causing a reading when the emission button was pressed. The upper portion of the melted cathode wire could have easily contacted the filament, completing the

cathode circuit and making momentary emission possible. This short must have occurred only when the emission button was pressed, because the indicator didn't light on "short" test.

Philco 620

Bakelite capacitors are apt to fade on this set. Test by forcing a screwdriver against them. Screwdriver should be held vertical, and considerable pressure exerted.

(More Service Notes on page 88)

Servicing Tampered Sets

(Continued from page 83)

attempt to rewind an i-f coil, but had not wound sufficient turns on it. Since the coil was enclosed in a shield can, the amateurish job was not visible. Voltage tests gave no clue.

Signal substitution tests, however, revealed the trouble. Signal from the stage preceding the faulty one was fed into the appropriate stage in the tracer, and was amplified without distortion, and was amplified without distortion. Signal introduced from the defective stage into the tracer's amplifier, however, came through distorted (see Fig. 4).

A test oscillator was then used in conjunction with a v-t voltmeter to test the resonance response of the

tuned circuit under suspicion. The highest output was not obtained at 465 kc, but at 450 kc or thereabouts (see Fig. 5). This led the radioman to remove the coil from its shield can and inspect it. The amateur rewinding job then became readily apparent.

Some readers may possibly feel that it should have been simple to compare the two identical i-f coils in the set for resistance readings, and deduce a defect in one of them if the readings were not the same. It should be noted that the technician did not suspect this sort of trouble, so that it never occurred to him to make such a comparison. Then again, a difference in windings sufficient to produce distortion might not necessarily result in a noticeable change in resistance.

Profit and Loss

Tampered sets generally bring small sums onto the black side of the ledger, and not infrequently appear on the red side, in terms of time lost in their repair. From a technical viewpoint, however, they may bring the technician a great deal of additional knowledge. Radiomen who can quickly and satisfactorily repair every tampered set that comes into their shop, can award themselves an "E" for excellence—in skill, ingenuity, and alertness. Those whose repair records are not as good, may still cite themselves for a purple heart, for mental wounds received in the line of duty.

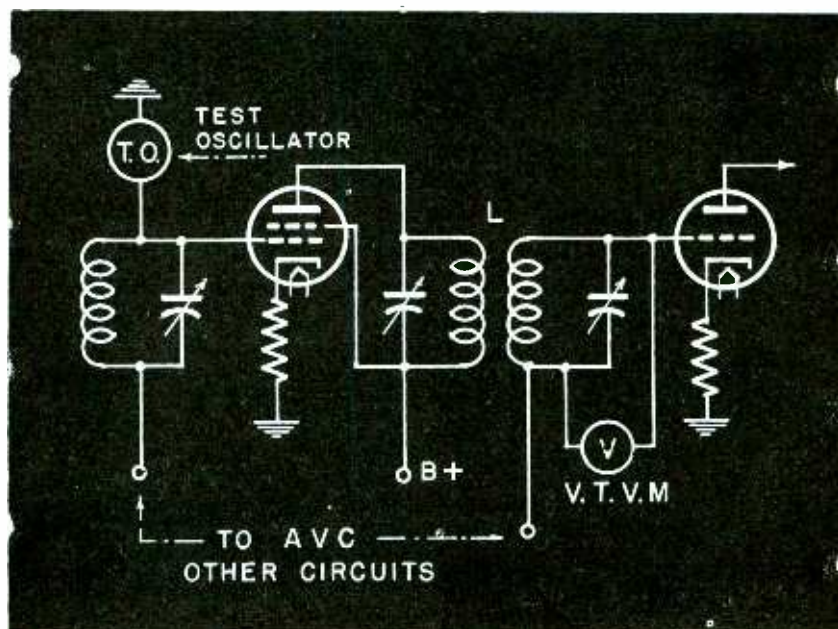
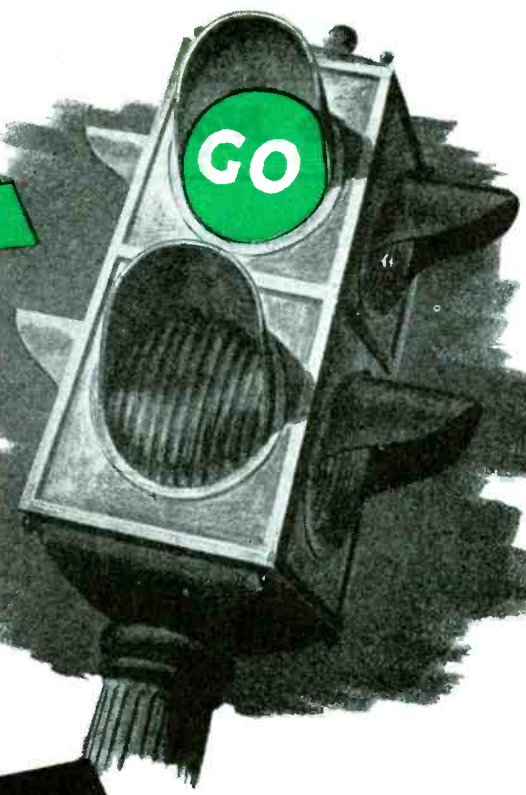

FIG. 5.—Signals of varying frequency but the same amplitude may be introduced into the grid circuit of the stage preceding the one containing i-f coil L, and the output across the secondary measured with a v.t.v.m. Highest output will not be received at the i-f frequency if either the coil or capacitor is defective.

THE LIGHT IS GREEN!



*Arvin is driving
full speed ahead
to bring you*

ARVIN
Top Flight
RADIOS
FOR EACH AND EVERY ONE

NEXT MONTH in this magazine . . .
you'll see *the line!*
GET SET TO GO . . . with ARVIN

NOBLITT-SPARKS INDUSTRIES, INC. • COLUMBUS, INDIANA



UPSTAIRS



DOWNSTAIRS



ALL THROUGH THE HOUSE



OUTDOORS, TOO

Service Notes

Smelling Out Trouble

• Too often radio servicemen are prone to look for their bugs with the most complete phenomena in mind. The simple approach of visual inspection is often lost in the desire to prove a farfetched theory. Sometimes, use of the senses may, however, be better than signal tracing and continuity checks.

A good general visual check may not be the answer to a problem; but it paves the way for a more technical approach, for usually when the trouble cannot be seen, it must be tracked down.

Army repairmen are taught first to be resourceful and secondly to be technical. It is remarkable how sharp eyes, tuned ears and sensitive noses serve more acutely than test equipment in some cases.

Field Problem

There was a time in Oregon during a field problem when the net control station had to go off the air because a good sense of smell was lacking. The operators knew their transmitter was off due to a high ammeter reading. They closed the station to await repairs; but a good whiff would have placed the operator in a position to alleviate the difficulty. A repairman soon arrived. He loaded up the transmitter again to see for himself. He contemplated tearing out the ammeter, checking the antenna circuit, or even possibly overhauling the entire set.

The net control station was closed down twelve hours because a repairman did not take time out to inhale the smell of burning insulation. Two wires were crossed in the tuning unit; intensive heat disintegrated the insulation.

Mountainous Molehill

Another incident which illustrates the necessity for the visual approach in repair occurred when a BC 312 broke down. Careful inspection disclosed no apparent difficulty. A continuity check localized the trouble within the 1st r-f. Resistor and capacitor measurements located no defunct material faults. Endless checks merely proved negative.

A piece of solder lodged within the ganged air condenser soon was sighted to unveil the trouble.

There is a prevalent need for newcomers to realize the value of listening to the oscillating hum of a bad tube, determine the smell of burnt insulation, feel the shock of a discharging condenser, and see the need for sound soldering.

Tube Loose in Socket

The usual remedy for poor socket contacts is to tighten them. On large, complicated sets, however, which may take some time to take apart, try using a new tube. Tube prongs are not always identical in size, and a larger-pronged tube may be found which will fit the socket perfectly. It may prove more economical to replace the tube, than to spend the time necessary to take the set apart and repair the socket.

Book Reviews

Introduction to Practical Radio

By Durward J. Tucker, published by the Macmillan Company, New York, 322 pages—price \$3.00

This new book on elementary radio is proposed by the author to serve as a single text covering the basic fundamentals of radio by confining the text to material on first principles and providing at each step, the necessary mathematical tools as required. The first chapter includes the relationship of radio to electricity, some mathematics and sample problems in electricity. The second chapter deals with elementary electricity, giving the electron theory, symbols, Ohm law relationships and examples in electrical circuits. Common electrical component parts illustrations are included. Additional chapters include more complex resistance circuits, direct current power, equipment wiring, Kirchhoff's laws, magnetism, electromagnetism, alternating current, electrical instruments, inductance, capacitance, impedance and an appendix of logarithms, trigonometric functions and a table of powers, roots and reciprocals.

A complete list of the symbols as used in the text precedes the first chapter. The illustrations in the book include a number of photographs of component parts and a number of schematic circuit drawings. Considerably more emphasis is placed on the electrical relationships in radio than on radio equipment itself.

Rider Volume 14 Issue

The perpetual trouble shooter's manual, volume 14, covering the receivers, amplifiers and civilian radio equipment built prior to the production line shutdown was recently released by John F. Rider, 404 4th Ave., New York 16, N. Y. The manual is bound in the customary loose leaf holder and is comparable in size with previous volumes. An index to volume 14 is included. This volume contains nearly 1400 pages and the net price is \$11.00.

Supplement Issued on Radio Tube Substitution Book

Supplement No. 1 to Wartime Radio Service, a book of tube substitution notes has recently been published by City Radio Co., Phoenix, Ariz. The supplement includes service notes for changing battery radios to ac-dc circuits.

Typical of the notes is the one quoted below:

There are a good many Silvertone and other makes of 2 volt battery radios with octal sockets and from 4 to 7 tubes which differ only a little from the ones described, which can be electrified in the same manner.

In every case the 1C7 must be changed to 1D7 and the output tube changed to a 60 mil type or a 50 mil with suitable shunt resistor to by-pass the extra ten mils.

Checking Bias

Grid returns should be examined to see that bias is not too high. If in doubt return the grid of any but output tube to its own negative filament and the grid of output tube to a point on the filament circuit some 3 or 4 volts negative with respect to its own filament. If grid of output tube is returned to ground the bias will be a little less than the total voltage of the filament string, or so near cut off that it will not work. The detector may be biased about the same as output.

The low end of volume control generally has to be moved to a point near the middle of the filament string. You can easily find the point where it works best and with least distortion.

In case you wish to make up a dummy set of tubes to test out filament voltage before putting tubes in, the resistance of a 2v 60 mil filament is 33 ohms and a 1.4v 60 mil tube is 23 ohms; and a 2.8v filament shunted to pull 60 mils is 46 ohms.

"MR. BIG" in radio phonograph features— THE NEW G-E ELECTRONIC REPRODUCER!

FOR SUPERB
RECORD REPRODUCTION

make sure

THIS SEAL IS ON THE
PHONO-COMBINATIONS YOU SELL!



ANOTHER
OF THE 8 BIG REASONS*
WHY AMERICA
WILL BUY THE NEW

 *Electronic*
RADIO LINE

Your Answer to Quick Sales... Customer Satisfaction

● The new G-E radio line! Packed with paying features! Outstanding among these features is the entirely new and sensational G-E Electronic Reproducer. Each music-loving American will want the radio-phonograph that obtains such brilliant, true-to-life performance from every record.

Here's what the experts think: At a presentation in New York at the Waldorf Astoria on June 27, 1945, before a large group of celebrities from the musical world and a score of top-notch music critics, the new G-E Electronic Reproducer was ac-

claimed as one of the most notable achievements since electronics and the phonograph were combined.

The new G-E line is complete. It's made by the men who produced more wartime radio and radar than any other home radio manufacturer. It's backed by the greatest consumer advertising campaign of any home radio manufacturer. For quick turn-over, customer satisfaction, profits . . . consult your nearest G-E Radio Distributor or write Electronics Department, General Electric Company, Bridgeport, Conn.

*G. E. is first in
Radio and
Television
FIRSTS!*

* 1. G-E Alnico 5 Speakers 3. G-E Superior Quality 5. (See next Ad) 7. (See coming Ad)
2. G-E Radio-Phonographs 4. G-E Electronic Reproducer 6. (See coming Ad) 8. (See coming Ad)

GENERAL  ELECTRIC
175-D10

PORTABLES • TABLE MODELS • CONSOLES • FARM SETS
AUTOMATIC PHONOGRAPH COMBINATIONS • TELEVISION

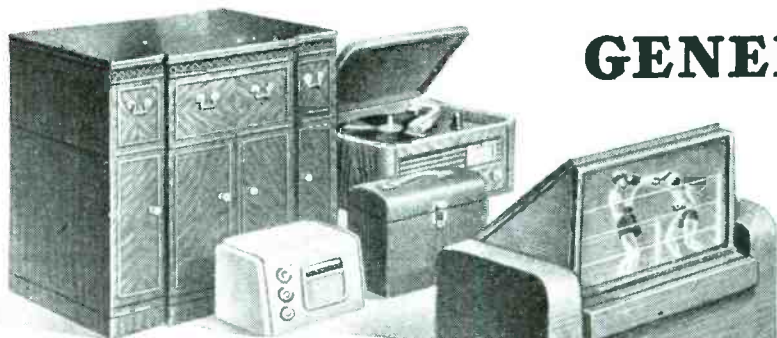

SYLVANIA NEWS

RADIO RETAILER EDITION

OCT. Published by SYLVANIA ELECTRIC PRODUCTS INC., Emporium, Pa.

1945

SYLVANIA "BUSINESS AND TAX" BOOK AVAILABLE

Shows Retailer How To Keep Simple, Exact Records

Established radio retailers will experience an unprecedented volume of business during the months to come, while large numbers of returning radio-trained veterans (from the Signal Corps and related activities) will be setting up their own shops.

Although many servicemen now have wider technical experience than ever before, they will find it increasingly important to have a good working knowledge of business methods — to make the best of a profitable situation and become firmly placed as part of the community's radio trade.

As one of its helps to oldtimers during this upswing of activity in radio sales and repair — as well as to newcomers with limited experience as shop owners — Sylvania has devised a simplified accounting system entitled "Business Record for Income Tax Purposes." This book is ideal for keeping a complete and accurate record of business transactions, payroll, profit-and-loss — and making out income tax returns quickly and easily. Available now at your Sylvania distributor, and priced nominally at \$1.00, you can start using this handy system immediately. Order yours today.



Free competition is the life
of trade . . . and progress;

Only independent means of distribution
preserves freedom of competition;

There will always be a place at the top
for independents who work together to provide
an even higher standard of American living.

SYLVANIA ELECTRIC PRODUCTS INC.

Appearing in special advertisements, this plaque reaffirms Sylvania's basic policy of merchandising its products through independent wholesaler channels — as the most efficient and economical means of distribution.

RETAILER + DISTRIBUTOR = MARKET EXPANSION

Sylvania Distributors Offer Many Merchandising Aids for Greater Sales

Now that wartime restrictions on radios and parts have been greatly relaxed, dealers will depend more than ever on free-flowing channels of distribution for an efficient and economical supply of merchandise.

That is the reason for Sylvania's sponsorship of even closer co-operation among the independent distributors, radio dealers and servicemen. Through advertisements on the above "Declaration for Independents," Sylvania is urging even further teamwork than before.

And Sylvania is backing up these ads with real aid to the radio men. Simple and exact bookkeeping methods, technical information, better business sugges-

tions, point-of-sale material and many other helpful ideas are available through Sylvania Electric distributors. One of these aids to more effective business methods is the "Business Record for Income Tax Purposes" — a unique Sylvania idea to solve the radio man's bookkeeping problems. Among the many other items is the "Sylvania Tube Complement Book" which lists complements of tubes for all makes of radios — plus much other valuable data, business stationery imprinted with the name of the dealer's shop, order forms, free advertising mats, circulars, posters, window stickers — to mention only a few.

See your Sylvania distributor now about these new opportunities.

SYLVANIA ELECTRIC

Emporium, Pa.

MAKERS OF RADIO TUBES; CATHODE RAY TUBES; ELECTRONIC DEVICES; FLUORESCENT LAMPS, FIXTURES, WIRING DEVICES; ELECTRIC LIGHT BULBS

**WAR
IS HELL**
on Batteries too!



but again
RAY-O-VAC RADIO BATTERIES
prove their dependability!

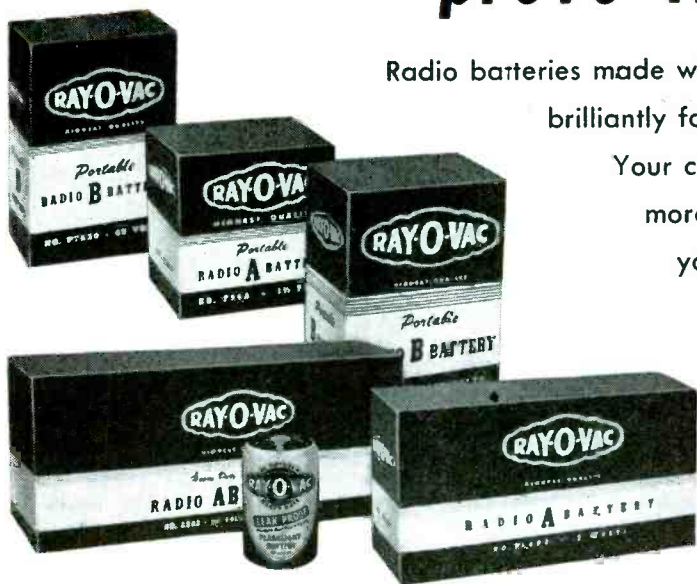

Radio batteries made with the very same cells that are performing so brilliantly for our fighting men NOW ARE AVAILABLE.

Your customers want the radio batteries that deliver more hours of dependable service — that's why you should feature war-proved RAY-O-VACS!

RAY-O-VAC
BATTERIES

RAY-O-VAC COMPANY, MADISON 4, WISCONSIN

OTHER FACTORIES AT CLINTON, MASS. • LANCASTER, OHIO • SIOUX CITY, IOWA • FOND DU LAC, WIS. • MILWAUKEE, WIS. • KANSAS CITY, MO.

New Products Offered

Turner MICROPHONES

Crystal and dynamic mikes in choice of varied color finishes. Rugged plastic construction. Colors are integral with



the plastic, and cannot be rubbed off or washed away. Constant handling does not mar finish. Turner Co., Cedar Rapids, Iowa—RADIO & Television RETAILING

National RADIO

New mechanical features are present in this Navy-intended receiver, that can be readily adapted to commercial models, including wall-flush home sets.



Maximum accessibility of parts for maintenance and service is provided. Set is mounted on a drawer-slide, which does away with the necessity of removing receiver from cabinet. With set pulled out on this slide, it can be tilted into three different positions, so that all components can be easily reached. Front of the receiver is equipped with lock-handles, which eliminates the necessity of using screws to fasten the front panel to the cabinet. National Radio Company, Malden, Mass.—RADIO & Television RETAILING

Metropolitan MULTIMETER

Model PB-200 measures ac and dc voltage, dc current, capacity, decibels, and resistance. Push-button operation

is featured. Pressing one button selects the service; pressing another button selects the range. A 4½ in. square 0-200 microamp meter is used. Net price, complete with leatherette portable cabinet and cover, is \$35.75. Metropolitan Electronic & Instrument Co., 277 Broadway, New York 7, N. Y.—RADIO & Television RETAILING

Caltron MAGNETIC PHONO-PICKUP

New high fidelity magnetic pickup with smooth response to 6,000 cps and a sharp cutoff beyond top frequency. Unit has no bearings, pivots, or needle



chuck. Will track fully modulated pressings with 15 grams needle pressure. Has extremely low needle talk. No scratch filter is needed in the amplifier with this pickup. Caltron Co., 11746 West Pico Boulevard, Los Angeles 34, Calif.—RADIO & Television RETAILING

Triplet VOLT-OHM-MILLIAMMETER

Model 625-N has dc voltage ranges with dual sensitivity (10,000 and 20,000

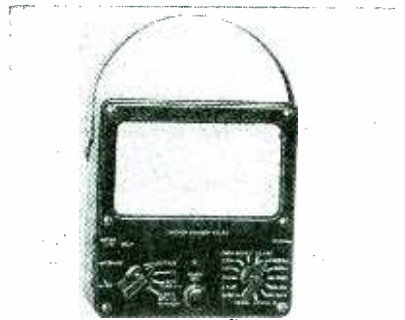

ohms per volt), thus providing double the number of full scale readings of the average tester. Unit is suited for testing television and other high resistance dc circuits. Ac voltage ranges, at 10,000 ohms per volt, permit checking many audio and high impedance ac circuits that usually require a vacuum tube voltmeter. Triplet Electrical Instrument Co., Bluffton, Ohio—RADIO & Television RETAILING

Universal MICROPHONE STAND

Model A 63 uses three upright sections, with knurled adjustment satin chrome plated collars, and a base of



cast iron with black wrinkle finish. It can be used with any microphone that has ⅝-in-27 thread. Range of the adjustable height is 26 to 64 in. Unit may be employed as a table or floor stand, with portable equipment and p.a. systems. List is \$12.50. Universal Microphone Co., Inglewood, Calif.—RADIO & Television RETAILING

Ansley Paneltone RADIO

Designed for built-in installations. Built on heavy steel panel. Requires only 4½ in. of depth. Two models are

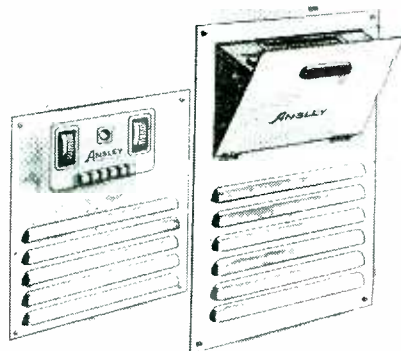

available: 7-tube set on a 14x14 in. panel, and a 17-tube de luxe model offering both FM and AM broadcast reception, and requiring 14x26 in. Tentative retail prices are \$99.50 for the 7-tube model, \$250 for the 17-tube set. Distributed through the Paneltone Corp., 1841 Broadway, N.Y.—RADIO & Television RETAILING

SEE PAGES 44, 45, 46, 47 FOR NEW ELECTRICAL APPLIANCES; AND PAGES 52, 53 FOR NEW RADIOS.

He made a New York delicatessen

famous the world over



“●●● And another pound of that good mayonnaise your wife makes, please. I certainly do envy her that recipe.”

Customers were always saying that to Richard Hellmann in the early 1900's. The mayonnaise his wife made was just about the most popular thing he sold in his little delicatessen on New York's Columbus Avenue. People certainly liked it.

They liked it so much that in 1912 Hellmann gave up his grocery and started manufacturing mayonnaise.

Hellmann's Mayonnaise soon became widely famous. The quality of the mayonnaise itself, and the powerful national advertising which made it one of the most trusted, most wanted brands in the country, built up a huge demand for it as the years passed. More and more Hellmann's Mayonnaise had to be produced. The price dropped from about \$1.00 a quart (in the twenties) to about 59¢ today.

The real importance of this success story, of course, is how Hellmann's brand advertising benefited us. It made American housewives appreciate quality mayonnaise. It made them want Hellmann's. It brought about mass production that pushed the price of Hellmann's down, down, down through the years.

Brand advertising consistently saves your household money. Canned soup once cost 25¢—nationally advertised quality soups now cost 10¢. Nationally advertised bathing suits averaged \$25 once—just before the war they were \$4.95. Electric refrigerator prices slid from \$310 to \$130 in fourteen years—electric washing machines from \$154 to \$69. Gasoline for your car costs 40% less now than in 1925.

You couldn't get along without the savings and comfort you get from brand-advertised products. If you think so, try it. You probably won't try it long.

It happened to PHILCO

\$167.50 in 1928, \$9.95 in 1941

Philco has done a great job of brand advertising radios into America's homes. The demand created by radio brand advertising has brought about the mass production which made it possible for you to get a radio in 1941 for less than a fraction of what you paid in 1928!



FREE REPRINTS OF THESE STORIES OF "WHY AMERICA'S GREAT"

This series of newspaper and magazine advertisements is offered as a public service by Fawcett Publications, Inc., 295 Madison Avenue, New York 17, N. Y. Write for free proofs.

FAWCETT PUBLICATIONS, INC.

WORLD'S LARGEST PUBLISHERS OF MONTHLY MAGAZINES





The most honored instrument of the war

This is not our own appraisal of the Simpson 260. We knew, before the war, that it was a fine instrument but, frankly, we didn't know *how* good it was until war wrote the record. Now the story of the 260 is written into the records of such wartime industrial developments as that of synthetic rubber, and into the vast and secret research and servicing of radar.

Originally designed as a radio serviceman's test unit, the Simpson 260, because of its sensitivity and wide range was found adaptable to general service duties in the entire electronics and electrical fields. Not a warborn instrument, the 260 was given thousands of essential war jobs in the production and servicing of communications equipment. It made a vital contribution to the success of tactical operations.

Over 300 government agencies and university laboratories of the United States and Canada procured every one of these test instruments Simpson could deliver on an expanded war production schedule. They were turned out by the thousands. Every

branch of the armed services—Army, Navy, Marines, Coast Guard—carried them to the far ends of the earth. They were compelled to perform under conditions often so arduous that testimonials of amazement at their ability to function at all became commonplace as the record grew.

Chosen on its merits, the Simpson 260 became uniquely *the* test instrument of the war.

AVAILABLE NOW TO YOU

Now the Model 260, always the preferred instrument of radio servicemen, is available again to a widened field of peacetime services. We ask you to remember its record as an example of the quality and advanced engineering that goes into all Simpson instruments, as evidence that other new Simpson developments are well worth waiting for. They will be released as soon as Simpson standards for their manufacture are satisfied. They will continue the leadership that has given Simpson a world-wide reputation for "instruments that *stay* accurate" with ideas that *stay* ahead.

SIMPSON ELECTRIC COMPANY
5200-5218 W. KINZIE ST., CHICAGO 44, ILL.

Simpson

INSTRUMENTS THAT STAY ACCURATE

SIMPSON 260, HIGH SENSITIVITY SET TESTER FOR TELEVISION AND RADIO SERVICING Ranges to 5000 Volts—Both A.C. and D.C. 20,000 Ohms per Volt D.C.—1000 Ohms per Volt A.C.

At 20,000 ohms per volt, this instrument is far more sensitive than any other instrument even approaching its price and quality. The practically negligible current consumption assures remarkably accurate full scale voltage readings. Current readings as low as 1 microampere and up to 500 milliamperes are available.

Resistance readings are equally dependable. Tests up to 10 megohms and as low as 1/2 ohm can be made. With this super sensitive instrument you can measure automatic frequency control diode balance-

ing circuits, grid currents of oscillator tubes and power tube, bias of power detectors, automatic volume control diode currents, rectified radio frequency current, high- μ triode plate voltage and a wide range of unusual conditions which cannot be checked by ordinary servicing instruments. Ranges of Model 260 are shown below.

Price, complete with test leads.....\$33.25
Carrying case 4.25

ASK YOUR JOBBER

Volts D.C. (At 20,000 ohms per volt)	Volts A.C. (At 1,000 ohms per volt)	Output	Milliamperes	Microamperes	Ohms
2.5	2.5	2.5 V.	D.C.	100	0-1000 (12 ohms center)
10	10	10 V.	10	100	0-100,000 (1200 ohms center)
50	50	50 V.	500	0-10 Megohms (120,000 ohms center)	
250	250	250 V.			
1000	1000	1000 V.			
5000	5000	5000 V.			

(5 Decibel ranges: -10 to +52 DB)

WATCH FOR NEW SIMPSON DEVELOPMENTS. THEY WILL BE WORTH WAITING FOR!

Opportunities for Vets

• The electronic industries comprise the fields of radio communication, broadcasting (FM as well as AM), television, and all the countless applications of vacuum tubes in industry, laboratories and instrumentation.

To the man who is qualified with radio and electronic knowledge, these fields offer good opportunities. But to evaluate them properly they must be shorn of the glamour that has been thrown around them by recent imaginative publicity.

The biggest part of the electronic art is still encompassed in radio and communications.

The qualified veteran applicant can find employment in manufacturing plants producing radio receivers and radio transmitters. He can go in for production supervision, plant management, sales or even engineering and design if he has the technical training. He may be engaged in the manufacture of raw materials, parts or components, or he may develop, design, sell or install, electronic equipment for control applications.

Chance to Be Own Boss

The radio-electronic prospect may prefer to go into the operating side of communications stations.

If the returning veteran prefers to go into business for himself, opening a store to sell and service radio and television sets for the general public, he should give careful consideration to his own fitness.

He must have a background of both business and technical knowledge and he must in addition be able to lay his hands on enough capital to launch his new enterprise and keep

it above water until the business is self-supporting. Town and street location are important to consider. Presence of other radio and television retail stores must also be taken into account.

In addition to possessing the required capital, knowledge of receivers, electrical goods, and business know-how, the veteran will need further qualifications. These consist of resourcefulness, ingenuity, imagination, and tenacity.

Army "Screening"

Doubtlessly, some veterans who are ill-prepared for radio merchandising, or other retail selling fields, may invest unwisely. To help minimize the number of GIs who are unqualified for business, the Army rehabilitation program in conjunction with many local business associations and institutions is prepared to sift out and screen veterans who are entering merchandising fields.

There is a tremendous market for new radios and radio equipment. New dealers from the ranks of the armed forces, in addition to established retailers, will unite to satisfy the consumer's hunger for merchandise. There is room in selling for all competent and aggressive radio merchants.

There are great opportunities for all who go into all the radio and electronic industries. But such men must be technically well qualified, possess sound common sense, and be willing to work indefatigably to develop the opportunities on every hand into their full potentialities in terms of money return and human service.

Shoppers

(Continued from page 39)

about wanted equipment and attractive presentation of available goods will put the customer in a frame of mind where it will not be necessary to remind him that the war is over.

"This is the best we can get under present conditions" is a very poor way to present any merchandise, and is just the sort of customer treatment to be avoided. "This is the very best and latest on the market" is a description bound to make the prospective purchaser feel that he's getting his money's worth with no alibis thrown in.

Dealers face a tough job in deal-

ing with the coming Christmas shoppers, but they should strive at all times to make this Christmas season appear to be Christmas as usual. They can substitute good cheer, salesmanship and friendship for the lack of merchandise. They can win over many a "shortage-conscious" purchaser to the credit side of their ledgers.

Some dealers see in the "gift certificate" the way out of goods shortage situations. A suggested form appears on page 38.

The gift certificate may help solve a lot of Christmas shopping problems for your customers and it will also offer the possibility of making permanent customers of the recipients.

Certainly, gift certificates should make your customers feel a lot better about shortages and help them forget the "shopping jitters" they've been experiencing for a number of years.

There are many plans the retailer may put into effect to re-build customer good-will. Some will give inexpensive gifts to children accompanied by adults. Others will use PA systems to play Christmas carols and all alert merchants will provide for their customers attractively decorated stores, manned by efficient and courteous salespeople.

Yes, alert radio-appliance merchants will do their part in breaking down war-brought skepticism and distrust on the part of the consuming public and condition their businesses for active participation in the great coming market.

Profits from Appliances

(Continued from page 43)

killing trade-ins as far as it is possible. He informs his customers, quite frankly and courteously, that he is in business to sell new merchandise—not to buy second-hand goods.

When an article must be taken in trade in order to retain a customer, Murphy will offer a maximum amount of 5 per cent of the list price towards the purchase of a new appliance. "A dealer cannot give his money away and still have it," he said.

No Price Cutting

There is no place for price cutting in the store's operation. "Price paring is as bad as too liberal trade-ins. We will keep our prices on a profitable level—now and in the future," declares this retailer.

"In our method of merchandising, we stick to fundamentals," Murphy stated.

"First we get the attention of new and old customers by constant newspaper advertising. We advertise our radios and appliances *all the time*. Ads placed spasmodically mean money thrown away. We keep hammering away at the public that we sell well-known appliances.

"Ads are inserted in newspapers about three times a week. We spend about \$1,000 a year on this form of publicity. And it pays off, too—in cash.

"When a customer comes into the store, we assume that he is ready

(Continued on page 148)

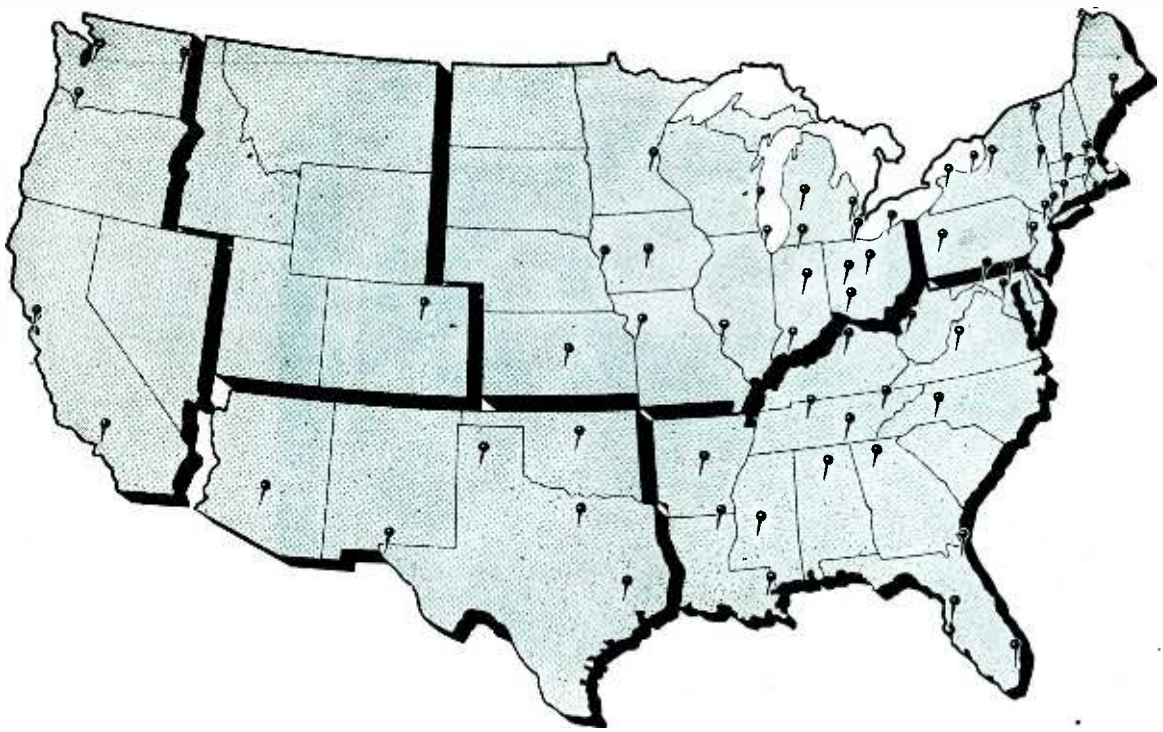

Take a Look at Majestic's Powerful Distributing Organization

Here it is—the powerful distributing organization through which Majestic Radios, Majestic Radio-Phonographs, and Majestic Records will soon be flowing to dealers in every section of the United States:

EAST

ALBANY, N. Y. . . . Reines-Freeman Distributors
BUFFALO . . . Mutual Appliance Distributors
CAMDEN, ME. Camden Shipbuilding & Marine Railway Co.
NEWARK, N. J. . . . Igoe Brothers, Inc.
NEW HAVEN, CONN. . . . Mory Sales Corp.
NEW YORK Colen-Gruhn Co., Inc.
PHILADELPHIA J. J. Pocock, Inc.
PITTSBURGH J. E. Miller Co.
PLATTSBURG, N. Y. . . . A. H. Marshall Co., Inc.
ROCHESTER . . . Harmon Automotive Corp.
SPRINGFIELD, MASS. . . . B. H. Spinney Co.
SYRACUSE, N. Y. B. H. Spinney Co.
WATERTOWN, MASS. . Major Appliance Corp.

CENTRAL

CHICAGO Chicago-Majestic, Inc.
CINCINNATI Kelley-Mason, Inc.
CLEVELAND Elliott & Evans, Inc.
COLUMBUS Thompson & Hamilton, Inc.
DAYTON Gem City Appliances, Inc.
DES MOINES Sidles Company
DETROIT . LaSalle Electrical & Mill Supply Co.
EVANSVILLE, IND. Allied Appliance Distributors
GRAND RAPIDS State Distributing Co.
INDIANAPOLIS Kiefer-Stewart Co.
KANSAS CITY . . . Maco Appliance Distributors
MILWAUKEE . . . Moe Brothers Milwaukee Co.

RADIO & Television RETAILING • October, 1945

MINNEAPOLIS . . . Northwest Distributing Co.
MITCHELL, S. D. . . . Automotive Supply Co.
OMAHA Sidles Company
RAPID CITY, S. D. . . . Wallahan Co.
ROCK ISLAND, ILL. . Tri-City Radio Supply Co.
ST. LOUIS Recordit Distributing Co.
SOUTH BEND, IND. . . . Femco Distributing Co.
TOLEDO Gerlinger Equipment Co.
WICHITA Home Appliance Co.

SOUTH

ATLANTA Crawford & Thompson
BALTIMORE J. B. Mitchell Co.
BIRMINGHAM Birmingham Electric Battery Co.
CHARLOTTE, N. C. . . . Southern Appliances, Inc.
CHATTANOOGA, TENN. . Allied Appl. Dstrbrs.
HAGERSTOWN, MD. . . Bohman-Warne, Inc.
HUNTINGTON, W. VA. . Modern Dstrbrs., Inc.
JACKSON, MISS. . . . Mississippi Appliance Co.
JACKSONVILLE. . Major Appliances, Inc. (Ra.)
KNOXVILLE . . . Allied Appliance Distributors
LITTLE ROCK 555, Inc.
LOUISVILLE Bomar Manufacturing Co.
MEMPHIS Allied Distributors
MIAMI Shelley Distributing Co.
MONROE, LA. United Electric Service
NASHVILLE Allied Appliance Distributors
NEW ORLEANS United Distributors, Inc.
ROANOKE, VA. Dowdy Electric Co.
TAMPA Major Appliances, Inc. (Ra.)
WASHINGTON Mehen Distributing Co.

WEST

DENVER, COLO. The Parker Co.

SOUTHWEST

AMARILLO, TEX. . . . Amarillo Hardware Co.
DALLAS Lone Star Wholesalers, Inc.
HOUSTON Electrical Equipment, Inc.
OKLAHOMA CITY Hales-Mullaly Co.
PHOENIX . . . Electrical Equipment Co. of Ariz.

PACIFIC COAST

LOS ANGELES Roach-Driver Co.
PORTLAND F. B. Connelly Co.
SAN FRANCISCO McCormack & Co.
SEATTLE F. B. Connelly Co.
SPOKANE Prudential Distributors, Inc.

Strong distributor support is only one advantage of the Majestic franchise. If you'd like to learn about all the advantages Majestic offers to selected radio dealers, write today. We will put you in touch with the Majestic distributor for your territory. Majestic Radio & Television Corporation, St. Charles, Illinois.



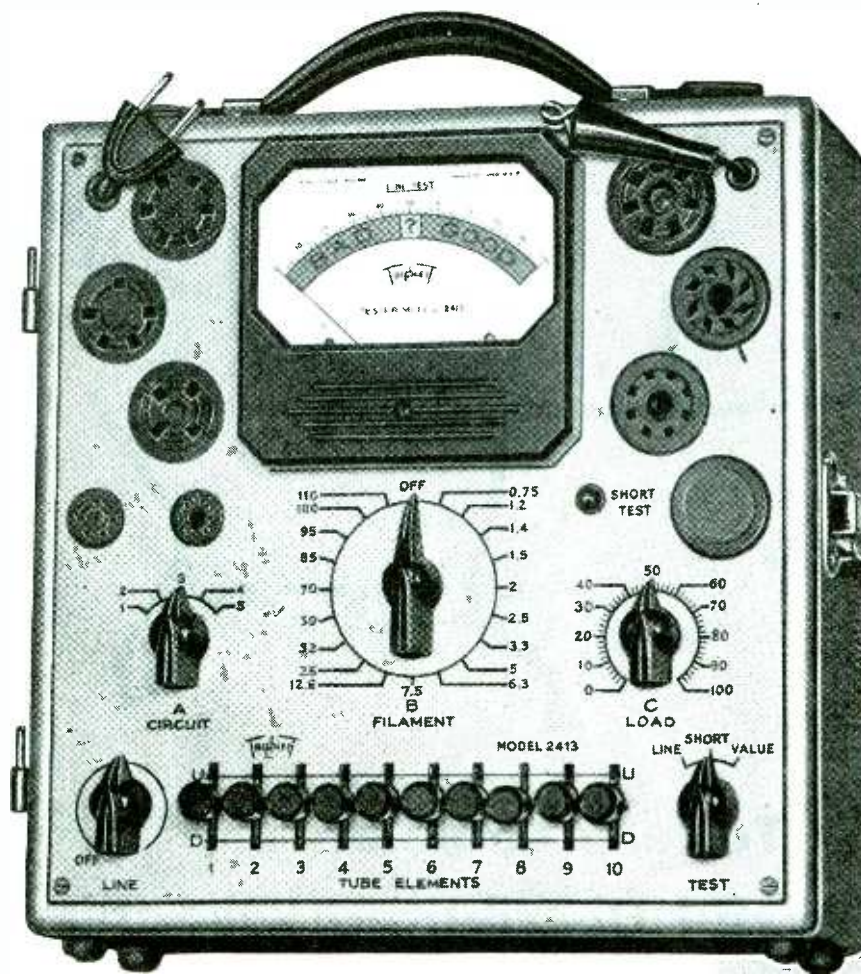

MODEL 2413

is another
member of the
NEW TRIPLETT
Square Line

The New Speed-Chek Tube Tester

MORE FLEXIBLE • FAR FASTER • MORE ACCURATE

Three-position lever switching makes this sensational new model one of the most flexible and speediest of all tube testers. Its multi-purpose test circuit provides for standardized VALUE test; SHORT AND OPEN element test and TRANSCONDUCTANCE comparison test. Large 4" square RED•DOT life-time guaranteed meter.

Simplicity of operation provides for the fastest settings ever developed for practical tube testing. Gives individual control of each tube element.

New SQUARE LINE series metal case 10" x 10" x 5½", striking two-tone hammered baked-on enamel finish. Detachable cover. Tube chart 8" x 9" with the simple settings marked in large easy to read type. Attractively priced. Write for details.

Additional Features

- Authoritative tests for tube value; shorts, open elements, and transconductance (mutual conductance) comparison for matching tubes.
- Flexible lever-switching gives individual control for each tube element; provides for roaming elements, dual cathode structures, multi-purpose tubes, etc.
- Line voltage adjustment control.
- Filament Voltages, 0.75 to 110 volts, through 19 steps.
- Sockets: One only each kind required socket plus one spare.
- Distinctive appearance with 4" meter makes impressive counter tester — also suitable for portable use.



Triplett

ELECTRICAL INSTRUMENT CO. BLUFFTON, OHIO





**EACH UTAH VIBRATOR
MAKES AND BREAKS MORE
THAN A *billion* CONTACTS
DURING ITS LIFETIME**

All of the well known Utah qualities of workmanship and design go into Utah vibrators, yet they cost no more than ordinary vibrators.

- ★ 70 vibrator replacement types.
- ★ 39 different hook-up diagrams.
- ★ Servicing 3651 different auto and farm radio models.
- ★ More than a million radio sets are equipped with Utah vibrators.



There is a Utah vibrator for every replacement requirement!

UTAH RADIO PRODUCTS COMPANY • 820 ORLEANS STREET • CHICAGO 10, ILLINOIS

Utah Electronics (Canada) Ltd., 300 Chambly Road, Longueuil, Montreal (23) P. Q. • Jeco Radio, S. A., Misiones 48, Buenos Aires.

JOBBER NOTES

Ohio Jobber Pledges "Wholesale Only" Policy

In a letter to members of its organization, Ohio Appliances, Inc., Cincinnati, Ohio, distributor, states that it will sell its goods wholesale only. The firm de-



Vice-president A. V. Bice

clares that it will sell its franchised lines exclusively to its dealer organization.

Excerpts from the company's statement reveal that:

1. Appliance wholesalers do not want to indulge in the practice of backdoor selling or retailing at wholesale prices; but some believe they are compelled to do so in order to retain the good will of certain individuals, industrial organizations, personal friends, or just acquaintances.

2. In many of these instances the person asking for the discount can be turned down successfully without the loss of his good will if someone in the wholesaler's organization would take the time to extend the courtesy of a thorough explanation of their reasons for the turn down.

3. These discount seekers are potential dealer prospects and the dealer should be given an opportunity to contact them.

4. Obviously a plan to overcome this backdoor practice cannot be dependent upon the bosses' ability to see all comers because he is not always available.

Opens Branch Office

The Clark Supply Co., Milwaukee, electrical appliance distributor for the state of Wisconsin, has announced the opening of a branch office in St. Paul, Minn. This new branch is under the managership of R. S. Bennett, and will serve the states of Minnesota and western Wisconsin. A full line of electrical home appliances will be distributed by the company in this area.

Ewald Personnel Changes

Ewald Distributing Co., distributor of RCA products, Apex electrical appliances, and Coolerator refrigerators, has announced four additions to its sales organization in connection with its activities in Kentucky, southern Indiana, and eastern Illinois.

C. W. Neal, Jr., has become manager of the record department; David T. Potter is now wholesale manager of the appliance department; Wallace Wilson is taking up sales duties as representative for the firm; and E. J. Moakler has become manager of the parts and tube department.

New Line for Kinney Bros.

Kinney Bros., Los Angeles, distributors of household appliances throughout California, with branches at Fresno and San Diego, announce their appointment as distributors of sewing machines manufactured by the National Sewing Machine Co., Belvidere, Ill.

Connecticut Jobber Expands Business

Lines of receivers including RCA, Philco, Motorola, Emerson, etc., will be handled by Mac's Radio and Electronic Supply Co., Waterbury, Conn., wholesalers. Also to be included in its new stock will be inter-office communication equipment, microphones, amplifiers, and other products.

During war-time the firm's sales volume was increased by public address installation work for bond rallies, "E" awards, and other functions.

Missouri Distributor's Remodeled Store



This is a view of the main section of the attractive Harry Reed Radio & Supply Co. store, Springfield, Mo., newly-appointed jobber for John Meck Industries. Display racks and bins containing the most popular items are located in front and on top of the main counter at the rear.

Arizona Distributor Buys Jobber's Business

The Southwest Wholesale Radio & Appliance Co., 122 S. 3rd St., Phoenix, Ariz., is a newly created radio-appliance and electronic parts distributing organization in the southwest.

To start its activities, the firm has taken over the wholesale business of the City Radio Co., E. Washington at 5th St., in this city.

Among the brands distributed by the new firm are Garod, National Union, JFD, Electro-Voice, etc. Harold R. Silvey is the general manager of the company.

Joins Raymond Rosen

J. J. McCormick, district rationing executive of the OPA for Philadelphia, has been named to the staff of Raymond Rosen & Co., as merchandising manager of the Kelvinator products department.

Emerson Jobber Sales Rep

Ira Kaplan, sales manager of Emerson-New York, Inc., announces the appointment of Philip G. Horton as company sales representative for Westchester County, N. Y.

Jobber Sales Campaign

Krisch-Radisco, Newark, N. J., is carrying on active sales promotion campaigns for the following lines which it distributes in the state of New Jersey: Norge, Eureka, RCA, Bendix, Ironite, American, and New Home.

(More jobber news on following pages.)

Adman IN WONDER LAND

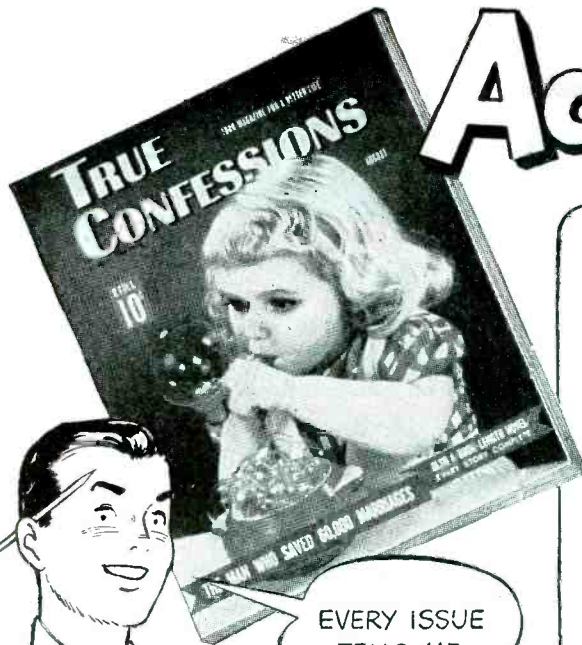

EVERY ISSUE TELLS ME MORE

HE HAS SAVED
60,000
MARRIAGES

By Charles Dexter

Michigan's law is unique because it tries to prevent divorce, instead of making it easier. Edward Pokorny, "Friend of the Court," an official, under state law, has the job of trying to reconcile couples *before* the case is set for hearing. He is no reformer who preaches down to troubled men and women. He is like a good, old-fashioned father. "I have no cure-all for divorce," he told me. "I merely strive to do my best." His "best" has saved 60,000 marriages.

LIKE A CHINESE DOCTOR—PAID TO KEEP YOU WELL

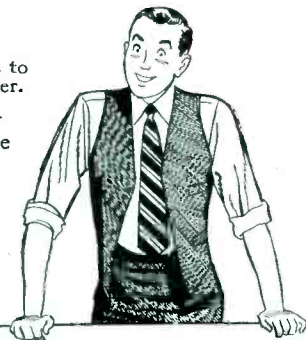

IS IT TOO LATE FOR THE TRUTH?

ARE ANY PROBLEMS REALLY LITTLE?

I love my wife and baby dearly. I know that my life would be ruined if I should become separated from them, but I also love my older boy. I yearn to tell him that he is really my son, but I dread the effect this would have on my wife, because I have never told her that this handsome boy she and her first husband adopted before I married her, is really my son—I never told her that Paula's people had my schoolboy marriage annulled. Can I, dare I, tell them? I don't know what to do.



Take Widow

LIKE A CASE BILL TOLD ABOUT

"Thank God he's safe!" I cried hysterically. Mrs. Nelson crossed to me quickly. "You must forget him," she said. "Stanley is married." I strove desperately to compose myself. "Stanley is married to me, Mrs. Nelson. We were married secretly. This Sara Drake is an impostor." She was just about to say, "I don't believe it," when Fred walked into the room. What he said was the final proof. "We've found that Sara Drake's racket was to pretend to be the widow of a boy killed in action. She did it for the insurance and the monthly payments. News that Fred is alive has scared her off. Now she'll have to find another victim. Wartime secret marriages are making rackets like hers easy."

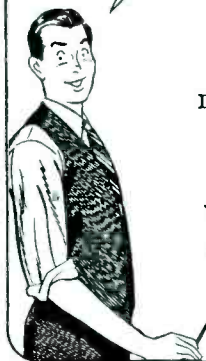

Are you LOYAL to old friends?

By Dorothy Sara

You may think it unsophisticated to have an "old friends are best" attitude, but loyalty and kindness do not go out of fashion. When a crisis has to be met, or even if there is a minor problem to be solved, the new friend can be helpful and understanding, but the old friend *knows*. Shakespeare put it pretty well:

Those friends thou hast, and their adoption tried,
Grapple them to thy soul with hoops of steel.

BETTER GIVE JACK A RING



True Confessions is concerned with everything that concerns anybody. Its stories and articles grow from the everyday lives of average people. What happens each month in its pages has happened to someone, maybe to you. Each issue is filled with experience—that is why every issue is helpful. "Your Magazine for a Better Life" is not just a claim on the cover. Inside the covers is *proof*.

TRUE CONFESSIONS

Bought at newsstands by 2,000,000 women a month for the living service it gives

New...

A Complete Merchandising Manual

for

RADIO and ELECTRICAL APPLIANCE DEALERS

Free

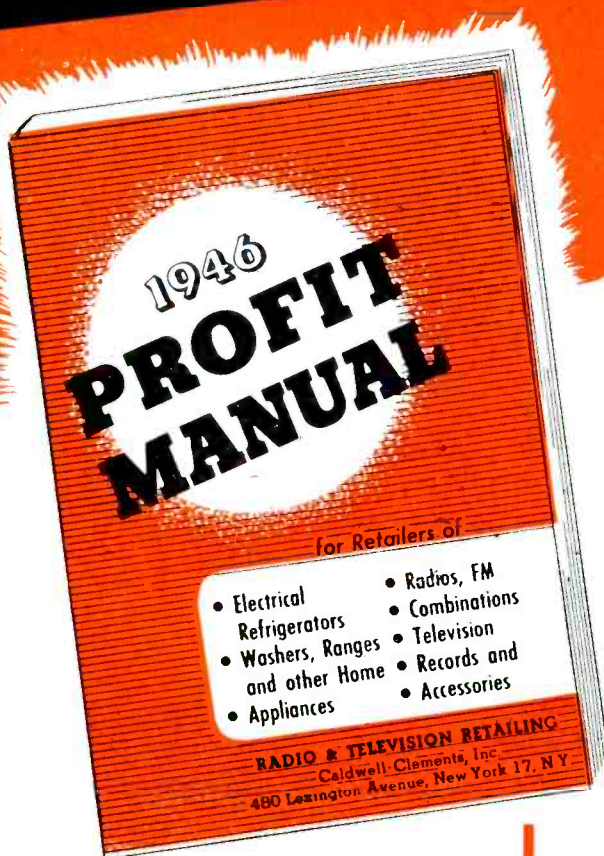

Here's the first authoritative, up-to-date, complete, detailed manual on *profitable business operation* written exclusively for Electrical Appliance and Radio Retailers.

The "1946 PROFIT MANUAL" is unique — the only book of its kind. Here, in a single, convenient, easy-to-use volume are all the *fundamental rules of successful operation* in the electrical appliance and radio field.

The "1946 PROFIT MANUAL" is crammed with down-to-earth, usable, every-day material. It contains rules and principles that were true yesterday, are true today and will hold true as long as you retail radios and electrical appliances. *Also, included in the PROFIT MANUAL is a complete list of electrical Appliance and Radio Set Manufacturers with addresses.*

Get this permanent reference book free of charge, with your new or renewal subscription to RADIO & Television RETAILING for three years at \$2.00. The "1946 PROFIT MANUAL" is not for sale. It is *not available* with 1-year subscriptions at \$1.00.

Actual Size of Book, 6 x 9 Inches
Over 160 Pages

Photos • Drawings
Diagrams • Tables

The "1946 PROFIT MANUAL" is written exclusively for retailers of electrical appliances and radios. 18 Sections cover every angle of your business operation. The Manual is practically an encyclopaedia on merchandising electrical appliances and radios.

Based on extensive field surveys and actual operating practices in your own field, the "1946 PROFIT MANUAL" gives you the facts you must have to make the most of your opportunities for profitable business.

The edition of the "1946 PROFIT MANUAL" will be limited. It is available only to three-year subscribers (new or renewal) to RADIO & Television RETAILING. This offer may be withdrawn without notice. Policy of "first come, first served" prevails. To be sure of your copy — send your acceptance *at once* to

DIRECTOR OF CIRCULATION

RADIO & TELEVISION RETAILING

Published by
CALDWELL-CLEMENTS, INC.
480 LEXINGTON AVENUE
NEW YORK 17, N. Y.

OLYMPIC FLIES CROSS-COUNTRY TO SHOW NEW RADIO MODELS

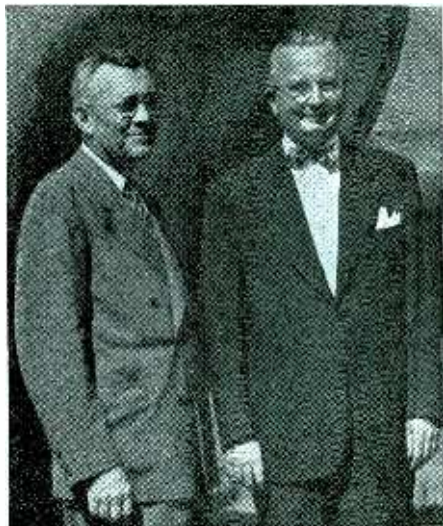

Jack F. Crossin (right), national sales director of Olympic Radio, and Sam C. Mitchell, Olympic sales and promotion manager, ready to board the Lockheed Electra for their cross-country flight to show new Olympic Radio Models with "tru-base." Every major marketing area was covered, yet the flight took only 19 days, just 43 hours flying time.

Dealers Enthusiastically Hail Exclusive "Tru-Base" Tone

Dealers in every state recently greeted with enthusiasm the new radio models demonstrated by Olympic on an airplane flight across the country.

Said a major store buyer in San Francisco, "Olympic Radio with 'tru-base' is just what the doctor ordered. Every survey has shown that customers want better tone in small sets, and 'tru-base' sure gives it to them!"

A Chicago chain store buyer exclaimed, "These are the kind of radio sets that will sell. I never heard such rich bass tones in table models until Olympic with 'tru-base' came along!"

And another large department store executive in Atlanta, Georgia, told Olympic men, "These 25 Olympic models cover every type of radio set, and every price range that people want. They'll sell like hotcakes!"

Don't delay. Get in on Olympic Radio with "tru-base" now. Send for full details today—plus the much discussed Olympic Radio brochure, "A Man Has To Think Twice." Just mail coupon below.

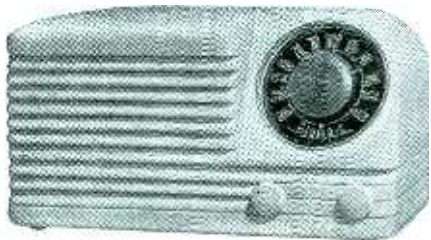

A moderately priced Olympic table model radio that should prove a popular seller. 5-tube AC-DC. With high amplification to pull in stations, and super-selectivity to cut down on station interference. Handsomely styled in colorful plastic.



One of the 25 Olympic Radios that made the flight. A 5-tube Olympic combination radio-phonograph with improved automatic record-changer that holds 12 records. And miracle "tru-base," the Olympic feature that restores all the full bass tones.

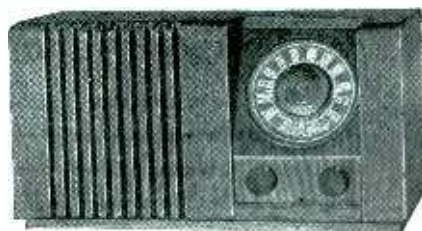

Another Olympic best-selling 5-tube AC-DC model. With greatly increased sensitivity that makes it a "natural" for selling in smaller communities. In an attractive cabinet of finest polished hardwood, designed by a famous American design engineer.

Olympic
 The only Radio with Tru-Base

MAIL THIS COUPON TODAY!

Olympic Radio & Television Division
 Hamilton Radio Corp., Dept. R-105
 510 Sixth Avenue
 New York 11, N. Y.

Please send full details on Olympic Radio and the brochure, "A Man Has To Think Twice."

Name _____ Title _____

Store Name _____

Street Address _____

City _____ State _____

**ready
for
action
now!**

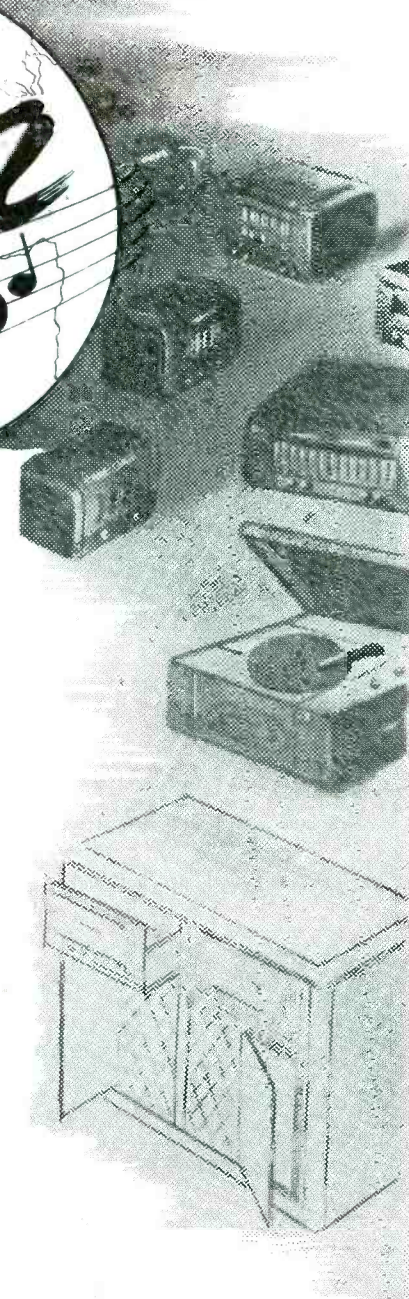

A WORLD OF VALUES

in a brilliant new Radio line . . .

Product of a 21 year background in radio — enriched by precision war production — embodying the most advanced electronic innovations — introducing exclusive ECA Radio features — assuring true, rich tonal perfection . . . in new cabinet designs of exquisite beauty.

A WORLD OF BENEFITS

in a profit-building Dealer Franchise . . .

Bringing you a complete line of models . . . sold direct, to selected dealers (freight paid to your city). Heavier deliveries assured . . . because fewer dealers will be appointed. Prices maintained . . . to protect your profits. Promotional help prepared by retail experts . . . and customers pre-sold through powerful publicity and unusual national advertising.

Get set for sales action, NOW — a few territories still open — write for details TODAY!



FREE — 36 page illustrated book tells the "inside" story of the atom and electrons. Write for a copy.

SEND THIS COUPON FOR DETAILS

ELECTRONIC CORP. OF AMERICA
45 West 18th St., New York 11, N. Y.

Gentlemen: Please send full details on the ECA Radio Franchise, without obligation.

Store Name _____

Address _____

City _____ State _____

T-10

ELECTRONIC CORP. OF AMERICA

45 WEST 18TH ST., NEW YORK 11, N. Y.

Came Upon The Midnight Clear

Hark! The Herald Angels Sing

Silent Night

God Rest You Merry, Gentlemen

The First Nowell

Adeste Fideles

Deck The Hall

Good King Wenceslas

Tannenbaum

Joy To The World

Away In The Manger

O Little Town of Bethlehem

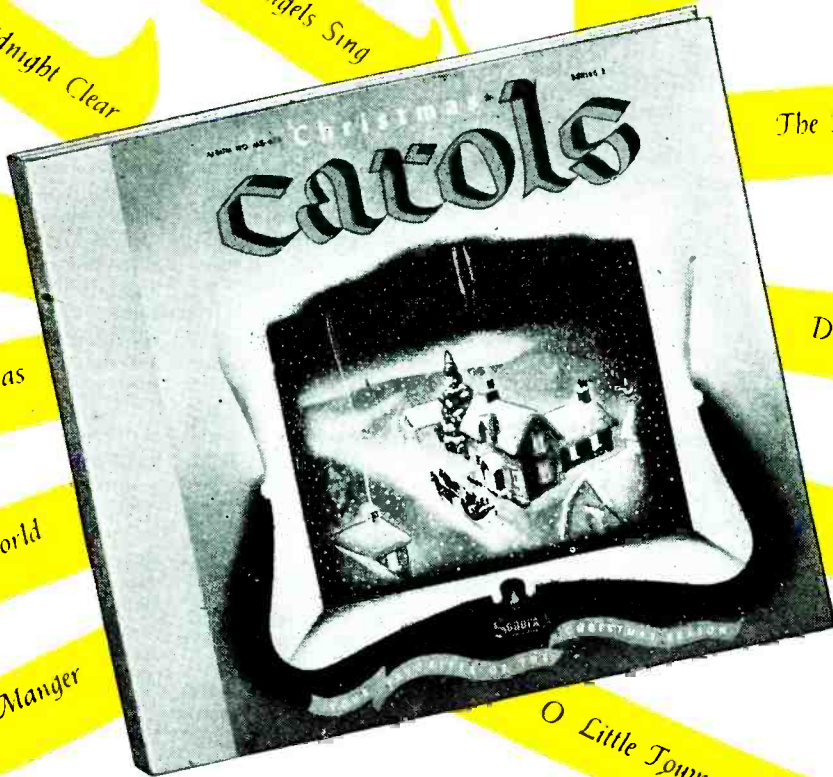

Order Sonora's New Album Now— *Christmas Carols*

CHRISTMAS CAROLS Sung by THE SONORA CHORISTERS

Under the Direction of
EUGENE MOTT

Adeste Fideles
Silent Night

The First Nowell

Away In The Manger

Good King Wenceslas

Tannenbaum

Deck The Hall

O Little Town Of Bethlehem

God Rest You Merry, Gentlemen

Joy To The World

It Came Upon The Midnight Clear

Hark! The Herald Angels Sing

Here are the traditional Yuletide favorites. Their warming harmonies are superbly sung by the 20 voices of the SONORA Choristers, richly blended under the magnificent direction of Eugene Mott of the St. Louis Municipal Opera.

Sonora's "Christmas Carols" is a distinguished—a different—collection. And it is backed by powerful advertising in the nation's leading magazines. It's an album that is sure to sell—in volume. So don't delay. Order "Christmas Carols" from your SONORA record distributor today.

SONORA PRODUCTS, INC

2023 West Carroll Avenue

Chicago 12, Illinois

Sonora Records

Clear as a Bell

HOME ENTERTAINMENT AT ITS BEST

RADIOS • FM • TELEVISION SETS • RECORDS • PHONOGRAPHS • RECORDERS

RADIO & Television RETAILING • October, 1945

105

TELEVISION TODAY

Jolliffe Predicts Vast Relay Station Network

A system of radio relay stations, blanketing the country, carrying telephone and telegraph messages, broadcast programs, facsimile and television simultaneously, was envisaged by Dr. C. B. Jolliffe, vice-president in charge of RCA laboratories.

Discussing television, he said, "It does not take much imagination to see television as a possible five or ten billion dollar enterprise, employing thousands of men and women, directly and indirectly."

RTR Staff Member Reports Video Experiences

Several members of the staff of RADIO & Television RETAILING have television sets which they are operating nightly to become thoroughly familiar with the technical and program problems of the new art.

One man has just completed a year's use of television in his own home, and now sums up his experiences. Similar reports could be made by other staff members as the result of their own experiences as members of the video audience. The year's report follows:

"Last evening being Saturday, with no television programs on the air, I went to a movie. For 75 cents I sat in a 'loge' seat, so far back that the entire screen could be totally hidden by a postage stamp held at normal reading distance, 12 inches from my eye (as determined by actual measurement there on the spot).

Video 16 Times Movie Screen

"In other words, the moving picture, from where I sat, appeared to be no larger than one of Uncle Sam's gummed steel engravings pasted on a newspaper at ordinary reading distance for fine type. (In contrast, as I normally sit before my 9 x 12 in. home television screen, its size on my retina is just 16 times as large as was that movie screen from my 75-cent seat!)

"This movie experience—my first full cinema visit in many months—started me to figuring just how much it would have cost for movie tickets for all those evenings our home television set has been pouring forth its studio plays, news events, sports, westerns, educational films and variety acts.

\$950 for Shows!

"During the past year we have operated the television set at least 300 evenings or afternoons, with an average of two to three hours per day. The average audience has been five viewers. Had we bought that number of tickets (1,500) at, say 50 cents each, the year's outlay would have been \$750.

"Our nearest cinemas are 4 miles away

—8 miles, the round trip. To go by car would have entailed 2,400 miles of automobile travel, costing at least \$200 more for gas and tires.

"So we have had television entertainment during the year that would have cost us \$750 to \$950 had we gone to the nearest movie. Also we saved three-quarters hour of travel time coming and going (225 hours per year) as well as inconvenience, and exposure to rain, snow and cold. Instead, with television we were able to enjoy ourselves relaxed in our own living room to the accompaniment of smokes, cool drinks, shoes off and minimum dress. And this is the kind of television enjoyment that is awaiting everyone in all of the 30,000,000 American homes that now have radios, and who eventually will be *seeing* as well as listening."

Allen B. DuMont on Television Set Prices

"What will you pay for television?" asks Dr. Allen B. DuMont, head of the company bearing his name. Dr. DuMont goes on to say: "That remains the question-mark in the early commercialization of this new entertainment means. Likewise the grounds for much confusion since on the one hand you are offered a small-screen televisor for say one hundred dollars, while on the other you are asked to pay over a thousand dollars for the projector-type large-image televisor, with prices and models scattered between these two price limits in bewildering profusion.

"However, it's the old story of getting precisely what you pay for. A hundred

dollars will buy a full hundred dollars' worth. In fact, while my own organization may not be directly interested in very low priced television sets, I more than welcome the advent of such sets because, sold in tremendous numbers, they will provide that basic television audience of hundreds of thousands which is absolutely essential if we are to get and sustain high quality television programs. Such programs, in turn, will justify the high-priced television receivers in many homes. Obviously, program sponsors are not interested in spending large sums unless they are assured of a sizable audience.

"Again, the average family with cash to spare is not going to invest hundreds of dollars in a set unless the programs are fully worth such money.

"Therefore, as a pioneer telecaster, I welcome the low-priced televisors as a means of securing a large and worthwhile audience quickly. But as a televisor manufacturer, on the other hand, I much prefer to concentrate on quality and that means higher prices. There's room for both kinds of efforts. We'll have the 'Fords' and the 'Cadillacs' of television, I'm sure."

CBS Plans Color Tele Soon

The Columbia Broadcasting System expects to demonstrate a new, finer-definition high frequency television in full color and in black and white, with actual broadcasting in New York City before the end of the year.

(More television news on following pages)

Future View of Television Living Room

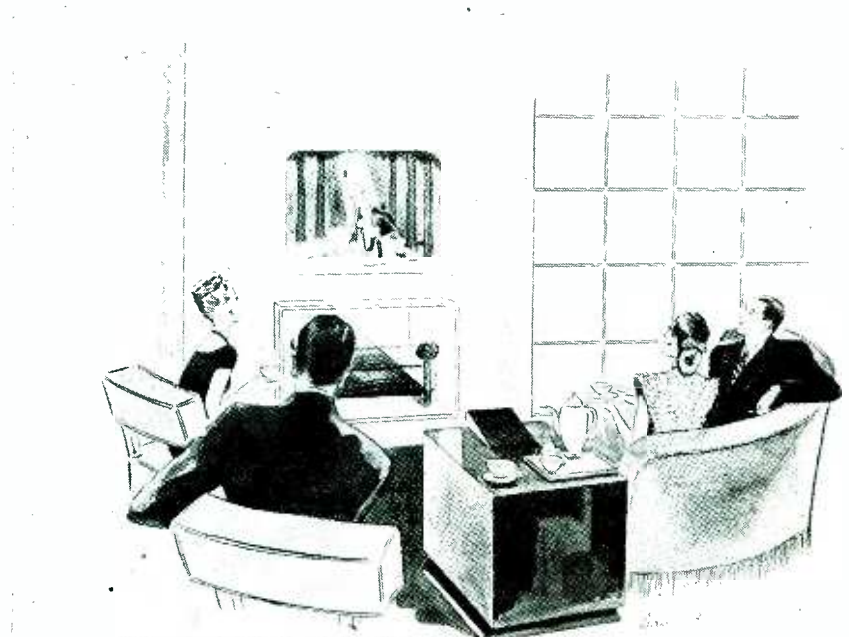

Here is how the Radio Manufacturers Assn. visualizes tomorrow's video receiver reception. Guests view opera performance, projected on smooth wall, while sipping their after-dinner coffee.

BETTY ("Incendiary Blonde") HUTTON *Says*

**"I'LL BE PRACTICALLY IN YOUR LAP --
ON DUMONT TELEVISION!"**

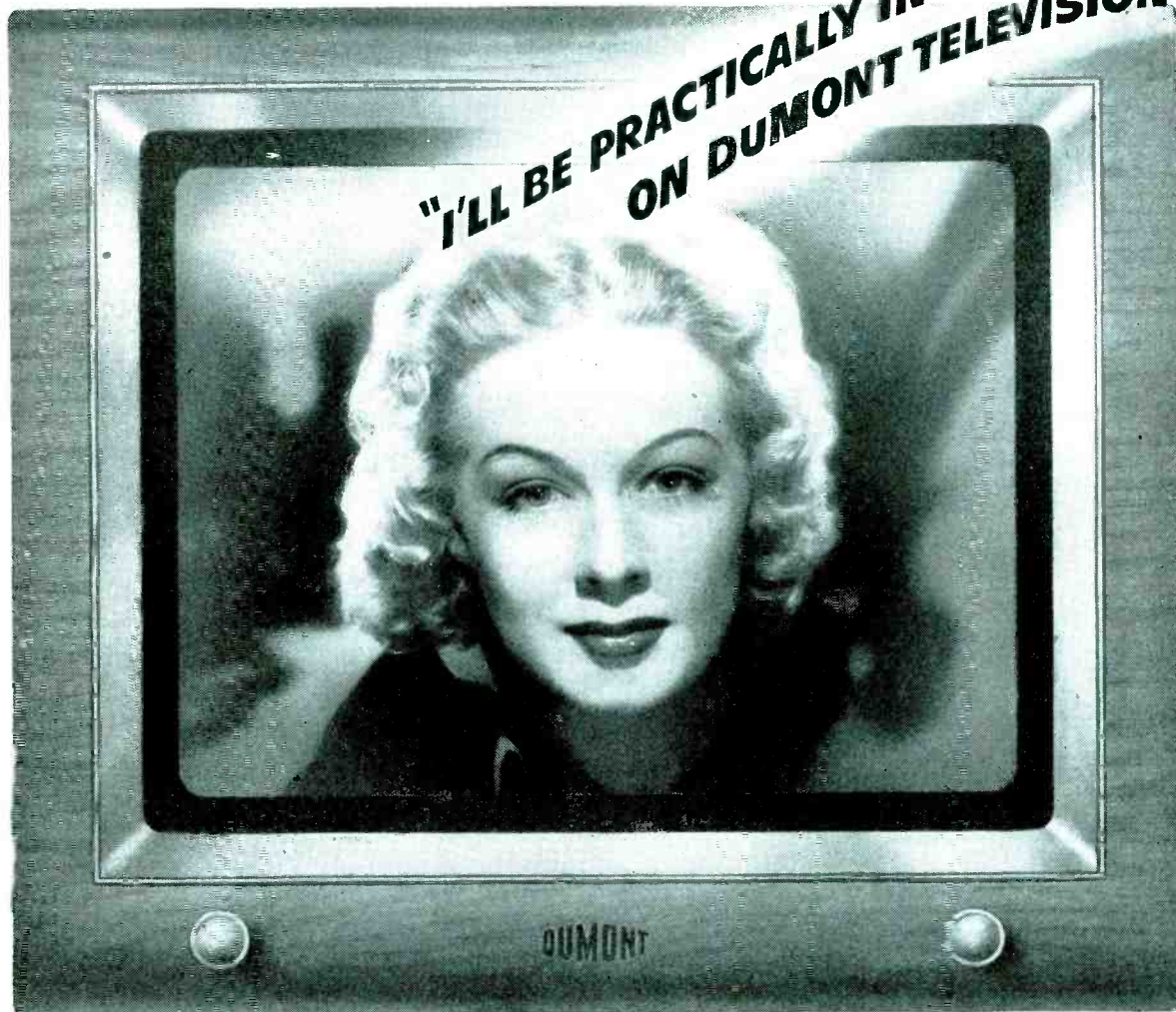

Wise dealers will agree with Miss Hutton. For DuMont-engineered Television-FM receivers assure extraordinary reception — incredibly clear pictures and exquisite FM tonal quality! This peacetime promise exists today in well-tested working models—*ready for quantity production!*

For 14 years, DuMont pioneering leadership has ad-

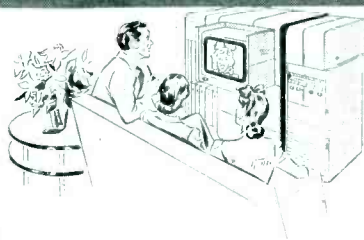

vanced radio-electronics—contributing developments which made commercial television practical! This rich experience, plus advantageous patents, backs

our pledge of Television-FM reception quality above and beyond comparison. And you will share the prestige, pleasure and profit that go with handling the finest when you display and sell DuMont Telesets!†

*"INCENDIARY BLONDE" in Technicolor, starring BETTY HUTTON, released by Paramount Pictures Inc.

†Trade-mark Reg.

Copyright 1945, Allen B. DuMont Laboratories, Inc.

DUMONT



Precision Electronics and Television

ALLEN B. DUMONT LABORATORIES, INC., GENERAL OFFICES AND PLANT, 2 MAIN AVENUE, PASSAIC, N. J.
TELEVISION STUDIOS AND STATION WABD, 515 MADISON AVENUE, NEW YORK 22, NEW YORK

Good Will

"Headquarters for Mechanical Cooling since 1885," this Jersey distributor and engineer makes full use of Commercial Credit facilities.

"Without any question, we have received from Commercial Credit Company a much closer co-operation on all our business transactions than from any other similar financial institution. We have had your sales representatives meet with our sales group and instruct them concerning good financing plans for our customers. Your credit and collection follow-up has always been satisfactory and you have effected collections for us always maintaining the **Good Will** of the customer. We do not hesitate to recommend Commercial Credit Company as the friendly finance company in this section.

"Proof of our feeling toward your concern is that now, as we are doing some post-war planning on our sales activities, we have called you in on the discussions."



Richard L. Hughes

Richard L. Hughes

ELECTRICAL PRODUCTS, Inc.
Jersey City, N. J.

Distributor of York Refrigerating
and Air Conditioning Equipment.

COMMERCIAL CREDIT COMPANY

BALTIMORE 2, MARYLAND

Capital and Surplus more than \$65,000,000

RCA VICTOR ... *1st again!*

**IT'S HERE! GREATEST IMPROVEMENT IN
PHONOGRAPH RECORDS IN 45 YEARS**

The Sensational New
RCA VICTOR
'Red Seal' DE LUXE
Non-Breakable
Record



*Non-breakable... life-like, concert-hall fidelity... quiet surface...
an entirely new kind of record now brought to you by RCA VICTOR*

Here is the most sensational phonograph record development in forty-five years—RCA Victor's Red Seal *De Luxe* Record! This new kind of record is the fruit of eleven years of research by the great RCA Victor laboratories. It's a rich ruby red... and you can see light right through it. It brings you all these advantages...



Non-Breakable!

Drop it, sit on it, bend it—the Red Seal *De Luxe* Record won't break under any normal use. Cherished masterpieces may be preserved indefinitely!

Amazing Fidelity!

You'll be thrilled by the life-like, concert-hall realism... the pure, clear tone of the new RCA Victor Red Seal *De Luxe* Record!



Far Less Surface Noise!

Record surface noise is reduced to a new low point in the new RCA Victor Red Seal *De Luxe* Record. You can enjoy music to the full!



Soon you will be able to hear the new RCA Victor Red Seal *De Luxe* Records at your dealer's. You'll agree that the higher price is well worthwhile. Since only a limited quantity can be made available at the present time, RCA Victor will continue to bring you its standard Red Seal Records, which have set the standard for quality for almost half a century.

Watch for the announcement that RCA Victor Red Seal *De Luxe* Records are actually in stock at your dealer's—then hear them as soon as possible. If you call early enough, you will be able to own one of these thrilling recordings.

You'll discover that the name, "RCA Victor Red Seal *De Luxe*" means crystal-clear, true-to-life recordings... that are yours for keeps!

 THE WORLD'S GREATEST ARTISTS ARE ON RCA VICTOR RED SEAL RECORDS

**This advertisement appeared September 2 in major newspapers
from coast to coast... heralding another RCA Victor "first"**

"WHAT RECEIVING TYPES DO YOU NEED MOST?"

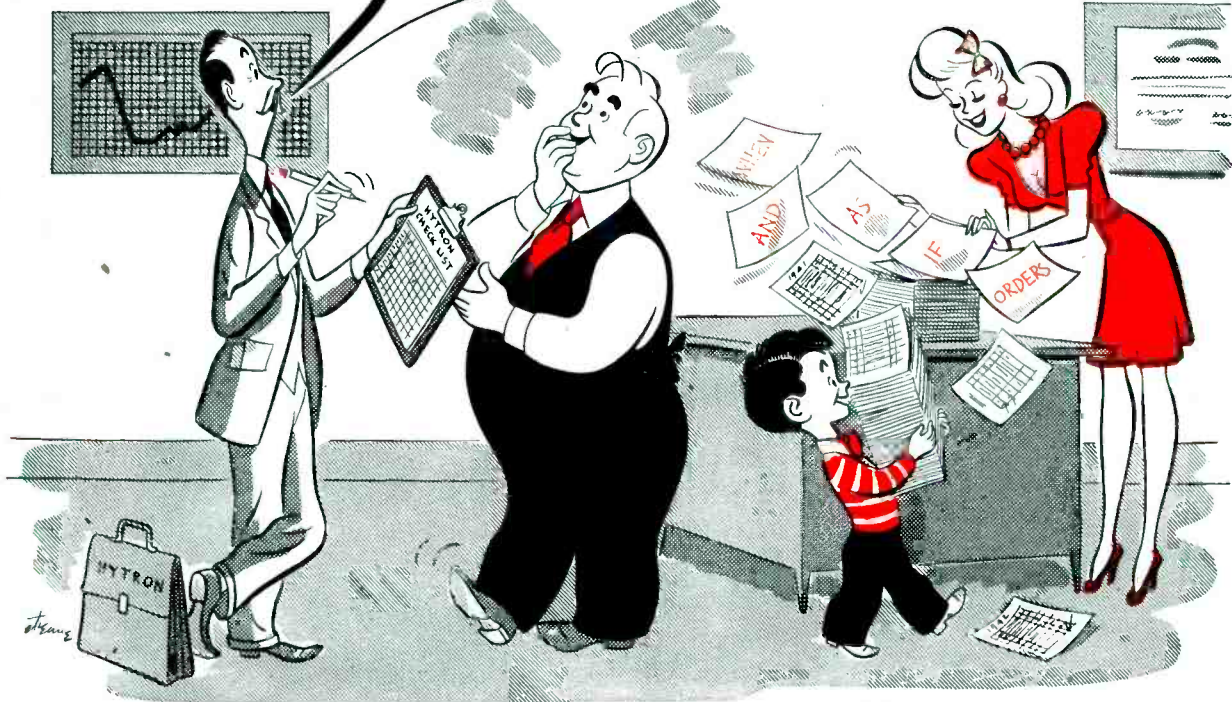

Right now we cannot give you *all* the receiving tubes you need. With your help, however, we can do our best to give you types for which your customers clamor loudest. You Hytron jobbers and dealers know best which these types are. Only you can specify exactly your local demands.

Hytron is emphasizing production of GT types which fortunately are in great demand by both the Services and you. As it becomes possible to increase gradually availability of civilian types, we want to pick those you want most. Each Hytron dealer can help by sending to his jobber a list of types in the order needed. Hytron jobbers can then inform us with confidence of the types required first.

Will you help? It will take only a few minutes. If you do co-operate, you can be sure Hytron will do its best to pull demand and supply together. We'll be looking forward to receiving the information we need to plan for you.



OLDEST MANUFACTURER SPECIALIZING IN RADIO RECEIVING TUBES

HYTRON
RADIO AND ELECTRONICS CORP.

MAIN OFFICE: SALEM, MASSACHUSETTS
PLANTS: SALEM, NEWBURYPORT, BEVERLY & LAWRENCE

HYTRON HYLIGHTS



IF WE HAD A CRYSTAL BALL

If we had a crystal ball, we could predict how many tubes you may expect to get. We could, in fact, predict the end of the war. (Perhaps it will be over when you read this.) As it is, we can only say: Hytron is ready to step up production for you the minute the green light flashes. WPB favors shipment of replacement tubes over those for new home receivers.* If the war goes well, your shelves should gradually be filling up with those Hytron tubes you have waited for so long.

* WPB Limitation Order L-265 as amended July 26, 1945.



BUY ANOTHER WAR BOND

WHY CARRY LARGE VIBRATOR STOCKS?



... when **4** E-L Vibrators Meet 95%
of All Auto Radio Replacement Needs!



Model 1703 serves 738 auto-radios Model 2089 serves 237 auto-radios Model 2047 serves 75 auto-radios Model 2088 serves 72 auto-radios

YES, it's true! You need stock only *four* models of E-L Vibrators to serve the 1,122 auto-radio models comprising 95% of the replacement demand! Result: much smaller inventory, faster turnover, and greater profits for dealers and distributors.

Standardization with Higher Quality - This unique E-L Vibrator standardization plan is the product of exhaustive research into auto-radio requirements . . . and of adapting to those requirements E-L models whose design and exclusive features have been perfected and proved in the toughest military applications.

These E-L Vibrators are of the balanced resonance type, with 8 contacts instead of 4—*twice* as many as other makes.

Tests show they provide 33% longer vibrator life, with output and starting voltages held virtually constant at all times.

See Your E-L Distributor - Your E-L distributor will fill your orders as soon as possible, considering the fact that his stocks are limited due to military demands.

With your order, you'll receive your copy of the new E-L Auto-Radio Vibrator Replacement Guide. Designed to hang on your wall, it will tell you instantly which E-L Vibrator to use for most auto-radios as far back as 1936. See your E-L distributor!



Electronic
LABORATORIES, INC.
INDIANAPOLIS

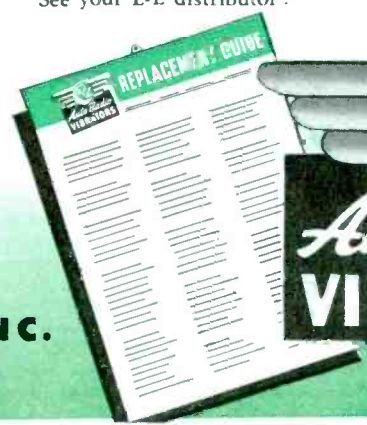

VIBRATORS AND VIBRATOR POWER EQUIPMENT FOR LIGHTING, COMMUNICATIONS, ELECTRIC AND ELECTRONIC APPLICATIONS

TRADE TALK

Stromberg Stresses FM; Names Price Range

FM will play a large part in Stromberg-Carlson's efforts to provide dealers with radio instruments as quickly as possible, Lee McCaune, vice-president and general manager, states.

He revealed that designs had been prepared for all possible allocations, and now that the new band is definite, have been incorporated in three new chassis units. Each provide reception on AM, short wave and FM. These will be housed in more than 20 different models, covering a price range from \$100 to \$500.

Emerson Acquires Radio Speakers, Inc.

Emerson Radio & Phonograph Corp. announces the acquisition of Radio Speakers, Inc., Chicago, Ill. Henry C. Forster resigned as president and director of the purchased company. He will remain with the acquiring firm in the capacity of consultant. Max Abrams was elected president of the corporation and Morton E. Ornitz was elected vice-president and treasurer.

Servel Names Two

W. J. Aulsebrook, sales manager of the Electric refrigeration division of Servel, Inc., Evansville, Ind., has announced the appointment of Harry F. Bell and Carl L. Olin as eastern sales manager and western sales manager, respectively.

These appointments are being made in

connection with an expansion of Servel's electric refrigeration program.

Set Selling Methods Have Changed, Says Nate Hast

The business of selling a radio to a customer today is an entirely different proposition from what it was in the early days of radio, and, to some extent, even to the days before the war, according to Nate Hast, merchandise manager in charge of the Lear home radio division.

"Before the war," Mr. Hast says, "selling a radio was pretty much a job of convincing the buyer that he needed a set to add to the beauty of his living room; or he needed that extra table model because his neighbor, Jones, had two radio sets in the house. It was a luxury item then. Today, however, radio has proven itself to be an essential part of the household; just as important as the refrigerator, or the telephone, or the electric light."

New Kelvinator Brochure

To make available to its dealers the latest in modern store design and appliance display the Kelvinator division of the Nash-Kelvinator Corp., Detroit, Mich., has issued a large and colorful brochure entitled "Displaying Appliances of Tomorrow." Store Layouts, interiors, exteriors, merchandise displays, etc., are illustrated and discussed in this literature.

Representing Howard

Howard Radio Co., Chicago, announces the appointment of L. S. Gershon, 436

Ridge Building, Kansas City, Mo., as factory sales representative. Mr. Gershon will direct the appointment of Howard radio distributors and the franchising of the firm's dealers in the states of Missouri, Iowa, Kansas and Nebraska.

Westinghouse Appointee

Appointment of R. H. McMann, a veteran of more than 20 years in the radio receiver merchandising field, as eastern district manager of the home radio division, Westinghouse Electric Corp. is an-



Eastern district manager, R. H. McMann

nounced at Sunbury, Pa., by Harold B. Donley, manager of the division. McMann will be located at Westinghouse New York headquarters, 40 Wall St., and serve all of New England, New York and northern New Jersey.

Gets Hallicrafters Post

William J. Halligan, president of the Hallicrafters Co., announces the appointment of Paul H. Eckstein as sales manager of the firm's Echophone division, through which will be handled the company's output of home radio receivers.

Rep for Magnavox, Radel

Herb Young & Associates have been appointed representatives for the components division of the Magnavox Co. on loud speakers, capacitors, etc., for the metropolitan New York area. This organization will also represent the Radel Mfg. Co., Cleveland, Ohio, for its auto antennas in northern New Jersey, New York State, and New England.

Health-Mor Dealer Helps

Health-Mor, Inc., Chicago, makers of Filter Queen vacuum cleaners, is urging its dealers to make use of its advertising material. These include advertising mats, circulars, and "demonstration in print" booklets. This advertising matter stresses the features of the firm's bagless vacuum cleaner.

RMA Advertising Committee Meeting



The Admiral Corp., Chicago, was host to the members of the Radio Manufacturers Association Advertising Committee meeting in Chicago, to discuss various phases of advertising and publicity. Seated left to right at the table are: S. D. Mahan, advertising manager, Crosley Corp.; L. E. Pettit, advertising manager, Electronics Div., General Elec. Co.-Bridgeport; Lee Chesley, Theo Sills Co.; Theo Sills, Theo Sills Co.; Bond Geddes, exec. V. P., Radio Manufacturers Assn.; Richard H. Hooper, sales promotion mgr., Radio Corp. of America; Seymour Mintz, director of advertising, Admiral Corp.; John Garceau, director of advertising, Farnsworth Television & Radio Corp.; E. I. Eger, Cruttenberg & Eger; Hugh Burros, Theo Sills Co.; Victor Irvine, advertising manager, Galvin Mfg. Corp. (Motorola); W. B. McGill, advertising mgr., Electronics Div., Westinghouse Radio Stations; W. E. Kress, regional mgr., Philco Corp.; Edgar Hermann, V. P. in charge advertising, Zenith Radio Corp.

The easiest tube to sell...



because the
G-E monogram
is a household
symbol of
dependability



The people at the right all require new radio tubes from time to time . . . and they are favorably disposed to G.E. because *that's the name that spells quality and dependability to them!* Multiply such radio-owners by millions, and you have America's biggest tube market. YOU can share importantly in that market, and in the profits that go with it. Arrange to stock and sell G-E tubes as a top money-making opportunity for you. Write for information about G-E tube selling rights to *Electronics Department, General Electric Company, Schenectady 5, N. Y.*

Hear the G-E radio programs: "The World Today" news, Monday through Friday, CBS. "The G-E All-Girl Orchestra," Sunday, NBC. "The G-E House Party," Monday through Friday, CBS.

GENERAL ELECTRIC

176-D4-B 850



MOTHER relies on her G-E radio for household hints. The refrigerator and electric iron which she uses also carry the G-E monogram.



FATHER listens regularly to G-E newscasts. General Electric is a familiar name to him; he has bought G-E lamps as long as he can remember.



SON TOM is interested in amateur radio work. Tom knows electricity and electronics—knows that General Electric leads in both.



DAUGHTER PEGGY carries her G-E portable radio everywhere. Peggy has a G-E fan in her room—a G-E fluorescent lamp over her vanity table.

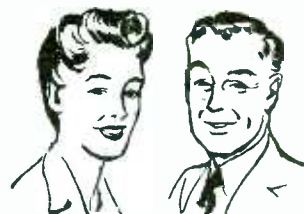

AUNT AND UNCLE are music-lovers. Their G-E radio-phonograph has given them many hours of pleasure. Buying G-E is second nature with them.

SELL RCA

ENGINEERED FOR RADIO AND BACKED BY THE BIGGEST NAME IN RADIO!

RCA batteries give you an outstanding sales-volume builder

1. CUSTOMER ACCEPTANCE — RCA is the greatest name in radio. Your customers know that the RCA label means a quality product.

2. CUSTOMER SATISFACTION — RCA batteries are *Radio-Engineered* for extra listening hours. If RCA engineers have put their OK on a radio battery — 'nough said.

3. SMALL INVENTORY REQUIRED — Only 35 RCA *Preferred-Type* batteries fit 99% of all battery-operated radios. You can meet all customers' requirements with a minimum inventory investment. Also gives fast turnover of fresh batteries.

4. DOUBLE PULLING POWER — RCA batteries and RCA tubes give your customers two reasons to come to you.

5. CUSTOMER PREFERENCE — Smart packaging, competitive prices, RCA quality, extra listening hours, and "engineered for radio," add up to predominant customer preference.

Listen to
"THE RCA SHOW",
Sundays, 4:30 P. M.,
EST, NBC Network

62-6736-105



RADIO CORPORATION OF AMERICA

TUBE DIVISION • HARRISON, N. J.

LEADS THE WAY... In Radio... Television... Tubes...
Phonographs... Records... Electronics

BATTERIES



RCA Radio-Engineered Batteries for All Types of Sets
...and a Complete Line of Other RCA Dry Batteries

BUY VICTORY BONDS

AND HERE'S WHAT TO DO ABOUT IT . . .

If you have not already done so, mail this coupon to your RCA tube distributor today. It's your request for a personal preview of RCA's battery plans for you. He will send you a complete explanation, telling just what to do to get set for big profits from RCA batteries.

MAIL THIS RESERVATION TODAY!

Dear Mr. RCA Tube Distributor:

I'm interested in increasing my battery profits by handling the new line of RCA Radio-Engineered batteries. Please mail me all details of the RCA battery plan as soon as possible.

Name

Company

Address



Watch for important news
from Jensen



Jensen
 SPEAKERS WITH

ALNICO 5

FREE to the Armed
 Forces, Colleges,
 Technical Schools,
 Libraries.

5 MONOGRAPHS AVAILABLE

1. Loud Speaker Frequency-Response Measurements.
2. Impedance Matching and Power Distribution.
3. Frequency Range in Music Reproduction.
4. Effective Reproduction of Speech.
5. Horn Type Loud Speaker.

25^c
 Each

Specialists in Design and Manufacture of Fine Acoustic Equipment

JENSEN RADIO MANUFACTURING COMPANY • 6625 SOUTH LARAMIE AVENUE, CHICAGO 38, ILLINOIS
 IN CANADA—COPPER WIRE PRODUCTS, LTD., 137 RONCESVALLES AVENUE, TORONTO

watch Sonora go places!



RCU-208—6-tube AC-DC superhet table model. Big-set tone, made possible by newly-perfected patented chassis circuit that brings out bass. In-laid striping and unusual dial treatment accentuate graceful beauty of walnut cabinet.



RDU-209—6-tube AC-DC superhet de luxe table model. Beautifully styled cabinet available in walnut or blonde prima vera. Big dynamic speaker. 2-position bass control. Deep, mellow tone—sounds like a console!



RBU-207—5-tube AC-DC superhet table model. Choice walnut cabinet features full-view slide-rule dial. Dynamic speaker. "Sonorascope" loop—no aerial or ground needed. An outstanding value!

The chips are down. From now on, only performance will pay off. And that's where SONORA dealers have a big advantage. For SONORA radios, such as the three shown here, will actually *demonstrate* tone superiority, and it's *tone* that makes the *sale*! SONORA has been telling America about SONORA's "Clear as a Bell" tone . . . inviting comparison . . . building demand that's sure to mean store traffic—and sales—for SONORA dealers. Watch SONORA—and SONORA dealers—go places!

THE RADIO QUESTION OF THE MONTH

The question is selected from the many asked by dealers. The answer is provided by Mr. Joseph Gerl, president of Sonora, and veteran in the radio industry.

- Q.: What is your opinion on the FCC attitude toward limiting FM sets to the new channel only?
- A.: In view of the fact that all FM broadcasters will change to the new channel as rapidly as possible, and transmitting on the old band will cease shortly, it is unfair to sell radios with an extra band that will very soon be obsolete. It would mislead the consumer, it would waste his money, and it would cause ill will toward the dealer who made the sale.

Joseph Gerl

Sonora

Clear as a Bell



SONORA RADIO & TELEVISION CORPORATION
325 North Hoyne Avenue, Chicago 12, Illinois

HOME ENTERTAINMENT AT ITS BEST

RADIOS . . . F M COMBINATIONS . . . TELEVISION SETS . . . RECORDS . . . PHONOGRAPHS . . . RECORDERS

SPRAGUE TRADING POST

A FREE Buy-Exchange-Sell Service for Radio Men



READ WHAT THESE SERVICEMEN SAY!

"I'll never forget the favor you did for me through the Sprague Trading Post!" A. L., Salem, Ill.

"Thanks a million! I only hope I can again sell and install your excellent products after this emergency!" Cpl. S. S., Louisiana.

"The results were terrific! I'll not forget Sprague's 100% service." B. R. S., Ohio.

"Thanks for running my ad. It

was very successful. This service of yours should and will keep Sprague in the minds of all radio men after the war!" C. J. S., New York.

"I used Sprague Condensers before the war, and intend using them as long as I can get them during the war and after it!" E. A. F., Georgia.

"Thank you again—and be assured I'll not forget this favor when making my purchases!" L. C., Miss.

SELL OR TRADE—125 assorted Pop. Mechanic, Pop. Science, Modern Mechanics Illustrated and Radio Craft; also Triplett 1220 analyzer for radio parts and eqpt. McDowell Radio Service, Bolivar, Pa.

FOR SALE—Supreme CA-10 sig. tracer \$12 or will trade for new tubes. Dustin Radio Service, 521 Gayle Ave., Kalamazoo 18, Mich.

WANTED—Used Sky Buddy receiver or equivalent HAM receiver, also Argus or Kodak 35mm camera. Alex L. Perreault, 3426 Humboldt St., Denver 5, Colo.

FOR SALE—Cough-Brengle OCA R-F sig. gen. and Triplett tube tester ca. \$35; Dayrad 57 multimeter \$30 and instruction books for sig. gen. and multimeter. Want Rider's manuals 1, 2, 3 and 5 to 13 incl. Frank Pump, 403 King St., Ravenna, Ohio

WANTED—Short-wave receiver. Have for sale 24v. 6 amp. motors and Radio City frequency ammeters .5, 2.5, and 3 amps. City Radio Service, 507 State St., Madison 3, Wis.

FOR SALE—Radio City 2663A V.T.V.M. multimeter almost new. \$58. A. F. Whisler, Kenard, Ind.

FOR SALE—Continental resistors; Weston 301 voltmeter; 2354 and 2506 voltmeters; Jenkins 6" convex television lens and Universal BB mike. Walter Gerber, 52-37—79th St., Elmhurst, Long Island, N. Y.

FOR SALE—Dynamotor 12v d-c input and 750v d-c output; also 24v meter a-c receiver and 2 ac-dc receivers. Twilley Electronics, 505 Riverside Drive, Baltimore 21, Md.

FOR SALE—Portable 4-tube battery radio, \$30; Supreme 235 tube tester, \$30; Marlon 3" 0-1 milliammeter, \$9; and both new and used tubes. Write for list. William E. Hagara, P.O. Box 224, Slickville, Pa.

WANTED—Late model tube tester and 50L6; 35L6 tubes. Cash or will trade Superior channel analyzer. C. M. Hughes, 2230 Cruzen Ave., Nashville 11, Tenn.

FOR SALE—High-fidelity input trans. Amperite LGP match 50 or 200 ohms to bi-impedance \$6; Thordarson T8822 input trans. mike to grid \$2; 2-5Z3 and 1 ea 2A3, 56, 58 2A7 tubes. D. F. Crinkley, 1701 Michigan Ave., Winter Park, Fla.

URGENTLY NEEDED—Echophone EC-1 and Hallcrafters S-30, Cpl. Ken. L. Clouse, Sqd. Box 879, MacDill Field, Fla.

FOR SALE—Superhetrodyne sets 4 and 5 tube \$23. F.O.B. Martin Ludwig, 1418 Conlyo St., Apt. 420, Philadelphia 41, Pa.

WANTED—Radio News 1939 through 1944. State what you have to trade. Loren Van Alstine, 1 Dudley Ave., Cohoes, N. Y.

SELL OR TRADE—Philco console battery radio with or without batteries. Want V-O-M. Art's Radio Service, 2304 Lodge Ave., Rt. 210 Evansville, Ind.

FOR SALE—Large supply of tubes. Send list of your needs. B. Salmonsens, 12 Deerfield Drive, Manchester, Conn.

WANTED—Rider's manuals 1 to 14 incl. and test eqpt. Sam Torrisi, 57 Mechanic St., Lawrence, Mass.

WILL TRADE—Ghirardi's 1937 Radio Physics Course, \$3, or 25A7GT tube. Pat Rose, 2206 Parkway, Austin 21, Texas.

FOR SALE—United Motors 3" oscilloscope. Sam Pinosky, 15 Oak St., Charleston, S. C.

WANTED—Green Flyer motor for 16" transcriptions; G.I. home recording unit with crystal cutting head and playback pickup; also tube checkers. What do you need? H. & H. Radio Electronics Service, 173 Van Buren St., Staten Island 1, N. Y.

FOR SALE—Superior channel analyzer like new \$25. O. Port, 1211 W. 14th St., Chicago 23, Ill.

WANTED—Recording head and feed screw, recording turntable and xformer to match 8 or 500 ohms to cutting head. K. L. Cox, Radioman, c/o F.P.O. San Francisco, Calif.

WILL TRADE—Green Flyer phono motor with 12" turntable. Want 12-6SC7 or 7F7 tubes. Dorsey H. Corun, Jefferson, Md.

FOR SALE—RCA 50w booster amp, \$40; 2 short-wave tubes \$10; code oscillator \$5; portable 10w amplifier \$25; high-fi. PA. tuner, 6 tubes, \$15; Exp. parts for electric eye assemblies \$5; portable code osc. with key phones and batteries; \$20. R. E. Almen, 3525—2nd Ave., S. Minneapolis 8, Minn.

FOR SALE—Riders 1 to 8; Triplett tube tester 21502-1503; Jackson \$420 universal oscillator and \$650 condenser tester. All for \$150. John's Radio Service, 9206 McCracken Blvd., Garfield Hts. 5, Ohio.

URGENTLY NEEDED—25A7G, GT, or 32L7 or substitutions. Bill Denton, Box 1199, McLoughlin Heights, Vancouver, Wash.

FOR SALE—Two new RCA 813 transmitting tubes. D. L. Bishop, Liberty, Sask., Canada.

SELL OR TRADE—Car radio, headphones, radio course, photoelectric eqpt., electrical books; magazines, etc. Want small radio. O. H. Klingfelter, 42 Stephen St., Glen Ridge, N. J.

WANTED—Philco battery operated sig. gen., frequency range 110 to 20,000 KC, also modern tube checker. Joseph Jordan, 850 N. Wabash Ave., Chicago 11, Ill.

FOR SALE—Weston thermo-galvanometer 2425; Weston voltmeter 2301 and 2-43, 1-2A5, 1 Raytheon B11 tubes. Want Philco or G-E record player. Frederick H. Peran, 16 Tracy Ave., Batavia, N. Y.

FOR SALE—National NC-80X communications receiver, 5 bands including broadcast, with tubes, crystal, beat frequency oscillator \$85; National SW3 short wave receiver with tubes and 5 pair plug in coils \$60. Rocco Gomes, 9 Woodrow Ave., Yonkers 3, N. Y.

WANTED—EC-1 or Sky Buddy. P.F.C., J. Makus, T'k, B'n Boat Basin, Ocean-side, Calif.

FOR SALE—Electronic Designs VTVM with leads, d-c probe and instructions. Willard Hall, RFD 5, Peoria 8, Ill.

FOR SALE—Supreme multimeter 2542. A. Magistro, 1630—81st St., Brooklyn, N. Y.

WANTED—New or used tube checker also recording mechanism with crystal cutting head. Norman Greaves, 626 McPherson Ave., Saskatoon, Sask., Canada.

FOR SALE—Used parts; var. condenser, knobs, tube sockets, fixed condensers coils, etc., 10 lbs \$4. Jimmy Mowry, R. R. 22, Princeton, Ind.

SELL OR TRADE—One 0-500v d-c Triplett 2321, Two 0-1 mill, 2 3/4" sq. Marlon meters; two VR 105/30 RCA tubes; one heavy duty G-E phono motor; and pr. Trimm phones. Want Superior sig. gen. or channel analyzer. Joe's Radio Service, Box 66, Mount Holly Springs, Pa.

WANTED—Late model battery operated sig. gen. Cash or will trade 1A7GT/G, 1L6, 34, 1H4G, 1N5G, 1N5GT, 1E4G, 1C6GT, 1C5GT, 1T5GT, 1A5GT, 1Q5GT and 15 used tubes. John W. Ferguson, Ferguson Lake, Richmond Co. N/S. Canada.

FOR SALE—National PB-7 with power supply; National Type N and VK full vision dials, parts; Superior 1130S set and tube tester; Motorola 280 car radio, etc. Glenn Watt, Chamute, Kans.

WANTED—"Service" magazines from 1935 to date. Aug. Steve, 128 Dundee St., Buffalo 20, N. Y.

WANTED—Complete set Rider Manuals. Have Mercury 3.5 35mm camera to trade. R. N. Wallace, Box 175, Richland Radio, Richland, Mo.

URGENTLY NEEDED—Phonograph motors, electric; either amplifier, wireless or plug-in type; record changer and Echophone EC-1 receiver. V. R. Hein, 418 Gregory St., Rockford, Ill.

FOR SALE—Sky Buddy and National short wave 3 with 110v power pack, phones, speaker, 3 band coils. B. R. O'Brien, Box 348, Missoula, Mont.

YOUR OWN AD RUN FREE!

During the past three years, over 9,000 buy-trade-sell advertisements have been run free of charge in The Sprague Trading Post—and as long as the need exists this unique service to members of the radio profession will be continued. Send your ad today. Confine it to scarce radio materials. WRITE CAREFULLY or print. Hold it to 40 words or less. Sprague, of course, reserves the right to rewrite ads as necessary, or to reject those which do not fit in with the spirit of this service.

HARRY RALKER, Sales Manager

Dept. RRT-105, SPRAGUE PRODUCTS CO., North Adams, Mass.

(Jobbing Distributing Organization for Products of the Sprague Electric Company)



SPRAGUE CONDENSERS KOOLOHM RESISTORS

TM. REGISTERED U. S. PATENT OFFICE

**THERE IS NO OTHER
RADIO MANUFACTURER
LIKE HALLICRAFTERS**

hallicrafters
*manufacturers of high precision, high
frequency radio and electronic equipment.*

Hallicrafters is the world's largest exclusive manufacturer of short wave radio communications equipment. In all the exciting history of the development of the science of radio communications in America there is no story like the Hallicrafters story.

Before the war Hallicrafters built high frequency receivers and transmitters used by 33 governments and sold in 89 countries. Now, in a world that will necessarily be held together by improved communications, Hallicrafters will be demanded by hundreds of thousands—here and around the world.

Hallicrafters receivers and transmitters will be used in all sorts of transportation communications systems—land, sea and air. This equipment will be used as a scientific control and research instrument as FM and television experiments move onward and upward, and it will be in great popular demand by discriminating radio listeners who want distance, clarity, sensitivity and stability combined to a degree that no other radio can offer.

In Past Performance

In Engineering

In Outlook

In Future Possibilities

hallicrafters RADIO



THE HALLICRAFTERS CO., MANUFACTURERS OF RADIO AND ELECTRONIC EQUIPMENT, CHICAGO 16, U.S.A.
COPYRIGHT 1945 THE HALLICRAFTERS CO.

NEW!

"HQ-129-A"

\$129⁰⁰ AMATEUR
NET
LESS SPEAKER



PRICES SUBJECT TO CHANGE
WITHOUT NOTICE

WRITE TODAY

A postcard will bring description
of this outstanding new receiver.

FINEST LOW COST RECEIVER

By all measurement this is unquestionably one of the greatest values ever offered to amateurs . . . Here is "ham" communication at its best, streamlined for highest performance at a modest cost . . .

WRITE TODAY. Send card for descriptive folder.

HAMMARLUND

THE HAMMARLUND MFG. CO., INC., 460 W. 34TH ST., NEW YORK 1, N.Y.
MANUFACTURERS OF PRECISION COMMUNICATIONS EQUIPMENT

PRECISION is a weapon in MT. CARMEL, ILL.

They use it effectively, too, these men and women who make up Meissner's *precision-el*, for many of them have sons, brothers and loved ones on the battle fronts. The photographs on this page show a few of these precisioneers who fight on the home front with precision and electronic skill as their weapons.



Precision is a family affair at Meissner. Here a letter from the front lines affects two families, and you can see that it's good news that will be reflected in the quality of their work when their rest period is over.

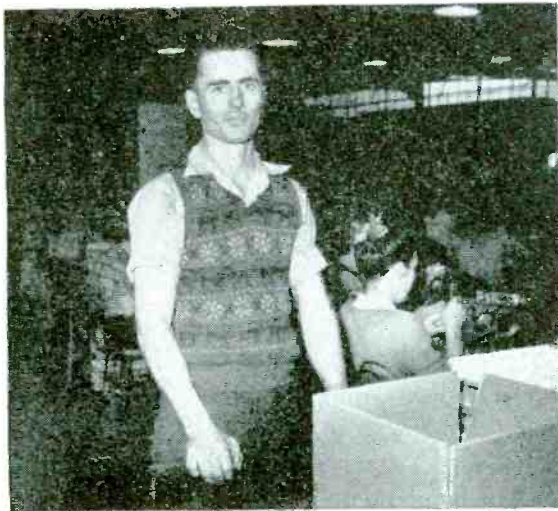

He's a veteran back from active service in the Pacific, but he's still fighting—this time on the home front with the men and women of Meissner. The traditions of precision quality he's learning here will be a weapon he can use after peace.

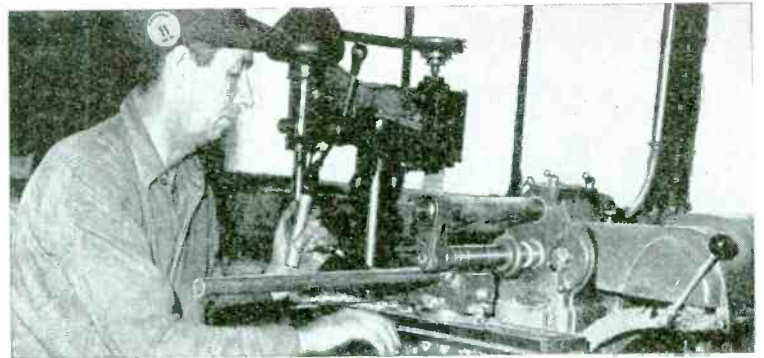

He splits thousandths of an inch as he does his war job. The "know how" that he and hundreds of Meissner *precision-el* have acquired is one more reason why you will be able to depend on Meissner quality after V-Day.



On the way to battle are these cartons of electronic war equipment. He sends them off with a smile, for he knows that the work of Meissner's *precision-el* will help bring his family together again soon.

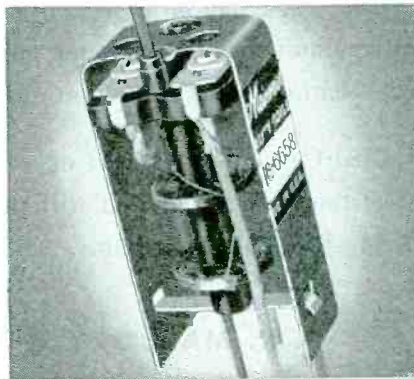

"Step Up" Old Receivers!

These Meissner Ferrocart I. F. input and output transformers are getting top results in stepping up performance of old worn receivers. Special powdered iron core permits higher "Q" with a resultant increase in selectivity and gain, now available for frequency range 127-206. Ask for numbers 16-5728 input, 16-5730 output. List \$2.20 each.



MEISSNER

MANUFACTURING COMPANY • MT. CARMEL, ILL.

ADVANCED ELECTRONIC RESEARCH AND MANUFACTURE

Export Division: 25 Warren St., New York; Cable: Simontrice



DUALS

with Lugs



They're GOOD and SMALL

Smaller than a cigarette—*smaller, in fact, than some of the smallest cardboard capacitors made!* But aluminum-cased, hermetically sealed! Long-lived, dependable! That's the story of the new Mallory Duals.

Notice those lugs at top and bottom! They eliminate broken leads, difficult skinning operations . . . make handy anchors for other wiring.

Notice especially the bottom capacitor in the upper left-hand picture. That's the Mallory "TCS," each section of which is independent of the other. It will replace units of common negative, common positive or separate section construction—yet it's the *smallest* separate section unit ever made!

These Mallory Dual Capacitors are part of a *complete new line*, including pint-sized single units too. Get acquainted with the entire family! See them—buy them at your nearest Mallory distributor.

P. R. MALLORY & CO., Inc.
 INDIANAPOLIS 6, INDIANA



*More than ever—
 ALWAYS
 INSIST ON*

P. R. MALLORY & CO. Inc.
MALLORY
 APPROVED
 PRECISION PRODUCTS

**VIBRATORS • VIBRAPACKS* • CONDENSERS
 VOLUME CONTROLS • SWITCHES • RESISTORS
 FILTERS • RECTIFIERS • POWER SUPPLIES**

ALSO MALLORY "TROPICAL"* DRY BATTERIES, ORIGINALLY DEVELOPED BY MALLORY FOR THE U. S. ARMY SIGNAL CORPS, NOT PRESENTLY AVAILABLE FOR CIVILIAN USE.

*Trademarks

The best of all that's new in home radios



Yes, there will be F-M and A-M Delco home radios . . . combinations, too . . . styled to win the eye and engineered to delight the ear . . . in console models, table models and portables that cover the range of customer demand. Delco home radios and Delco auto radios will offer the best of all that's new . . . backed by Delco Radio's long experience in radio building and merchandising . . . distinguished by the combination of *engineering vision* and *manufacturing precision* that made Delco Radio a major supplier of radio and electronic equipment for the armed forces.

ENGINEERING VISION——MANUFACTURING PRECISION

BUY VICTORY BONDS
FOR A LASTING PEACE

DELCO RADIO  A UNITED MOTORS LINE

Delco Radio
DIVISION OF
GENERAL MOTORS

Gibson

**FREEZ'R SHELF
REFRIGERATORS
KOOKALL ELECTRIC
RANGES
HOME FREEZERS**

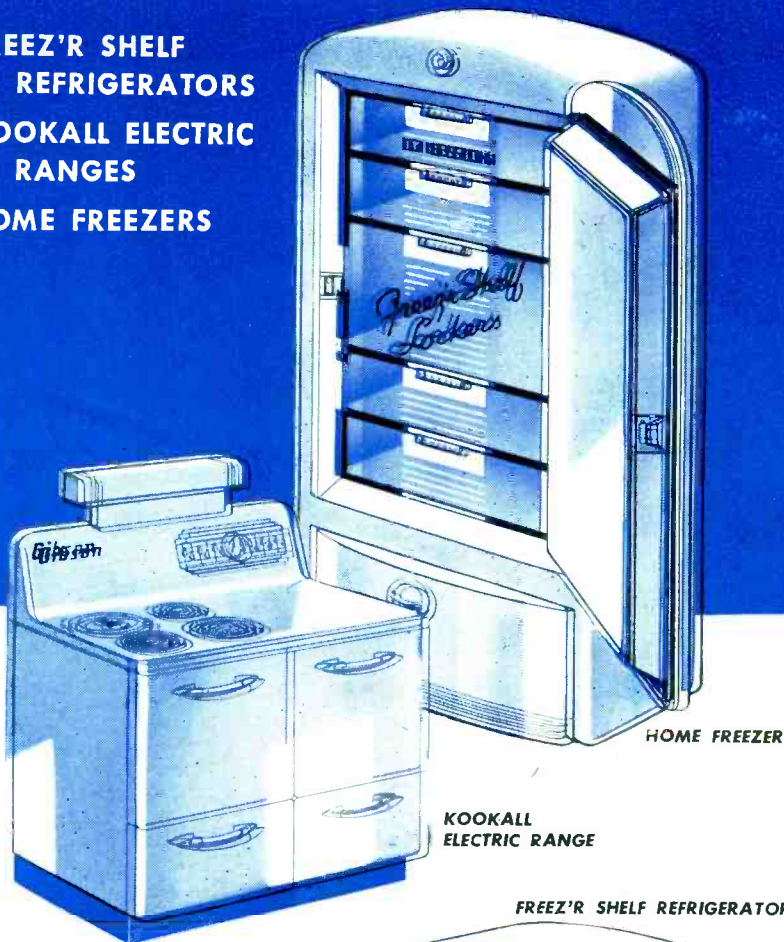

GIBSON HOME FREEZER

Vertical design—more convenient. No "diving" for frozen food packages in a deep well. Four Freez'r Shelves provide extra direct contact for faster freezing. Uses only half the floor space required by the long, low "deep box" design.

GIBSON KOOKALL ELECTRIC RANGE

Automatic control . . . turns itself on and off . . . uses stored-up heat . . . Only range with the Ups-A-Daisy feature, the innovation housewives demanded.

GIBSON FREEZ'R SHELF REFRIGERATOR

Provides different Strata-Zones—separate layers of conditioned cold, different temperatures, different humidities. Easy-to-reach shelves with Freez'r Locker and Moist Chiller.

1. Gibson has 68 years manufacturing experience.
2. Gibson is the fastest-growing refrigerator manufacturer.
3. The Gibson line meets the needs of independent dealers for a short, fast-selling line with exclusive features that discerning customers want.

**GIBSON REFRIGERATOR COMPANY
GREENVILLE, MICHIGAN**

Kuch Leaves Aerovox

Paul L. Kuch, advertising and sales promotion manager of Aerovox Corp., New Bedford, Mass., has resigned his



Paul L. Kuch

position. He will establish an advertising and sales promotion agency, specializing in industrial advertising, in the Olympia Building in that city.

Bruno-New York Host to Bendix Retailers

An enthusiastic group of retailers from the metropolitan area of New York attended a Bendix meeting staged by Bruno-New York, Bendix distributors, at the Hotel Astor. Sales, delivery and manufacturing plans were discussed by Lynn Eaton, Bendix eastern sales manager. Bruno-New York officials Jerry Kaye and Ira Schwartz explained franchise plans, advertising and sales helps available to the retailers.

Features of the new Bendix washer, as well as those of the new ironer and clothes dryer to be manufactured by the company, were described in detail.

Irving Sarnoff, Bruno-New York vice-president, told his listeners that the distributing firm would operate under the state Fair Trade laws. He also assured his hearers that Bendix would not make any "private brands."

Graybar Names Brown

Vern A. Brown recently returned to the Graybar Electric Co. as St. Louis sales promotion manager in the merchandising department. In this newly-created position he will coordinate manufacturers' sales plans with Graybar distribution in the St. Louis area. He will confine his efforts to promoting the sale of radios and appliances through dealer outlets and will work closely with Graybar merchandising manager, Robert F. Janda.

Shrader Joins Rucher

Joseph L. Shrader, formerly associated with Western Auto Stores, has been named merchandising manager, in charge of all purchasing activities, of the Rucher Radio Wholesalers, 1312 14th St., Washington, D. C. Leslie C. Rucher is general manager.

Wisconsin Radio Jobbers in Future Expansion

Merian Ira White, and George Habley, who are partners and owners of the Radio Service & Supply Co., 115 Fourth Street, Wausau, Wis., announce that the business is growing steadily and the number and character of the lines carried are improving. Plans are now being made to take bigger quarters, because of the lack of space.

Future plans include establishment of definite lines, including radio parts, tubes and equipment; wholesale distribution of radios, phonographs, and recorders; intercommunication installations; commercial transmitters; amateur equipment supplies; aeronautical communication specialties, and industrial electronic equipment.

Dealers Come First

Chicago's Commonwealth Edison will not attempt to get radios and appliances until dealers are supplied. This utility has started a dealers' sales promotion department. Utility will not sell small appliances door to door, as in pre-war days, and will help retailers in many other ways.

More Westinghouse Volume

Major appliances for homes are expected to begin rolling off the lines of the Westinghouse Electric Corp. in considerable numbers in October and November, the company reports.

Globe's New Model

Globe American Co., Kokomo, Ind., pre-war makers of gas and electric ranges, will specialize in gas ranges at this time, bringing out an automatic heat-retaining model. Trade mark is Dutch Oven.

Zenith Official

Harry J. Wines, general manager since 1943, has been elected vice-president of Zenith Radionics Corp., Zenith distributors for New York area.

Stromberg Sales Rep



William C. Miles, who has been named a radio sales representative for the San Francisco office of the Stromberg-Carlson Company.

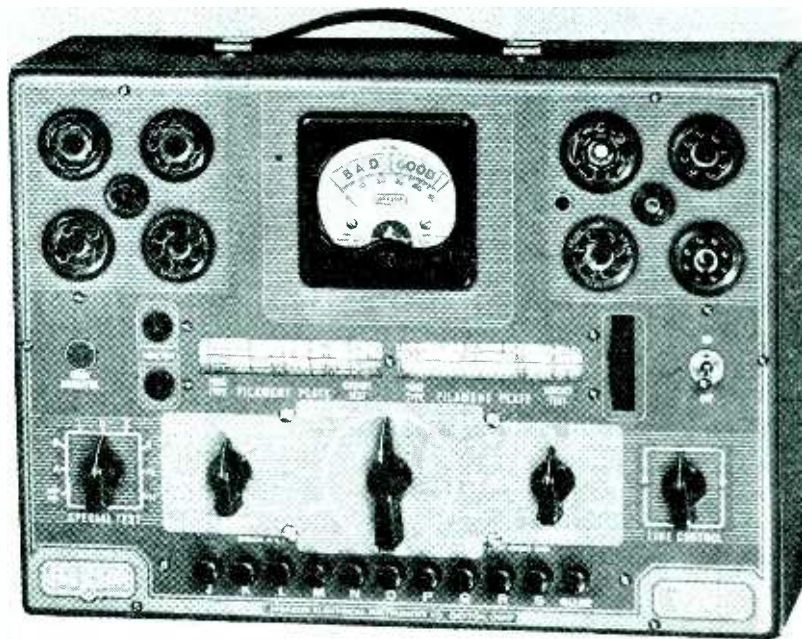

Model 636 Dynamic[™] Tube Tester

With Built In Rotary Tube Chart

Tops in design and performance including the latest Jackson patented switching circuits.

Modern in every feature of construction, appearance and operation.

Complete with every valuable feature. Up to date for all newest tube types.

SPECIFICATIONS

"Dynamic" Method of Test—Makes a better test on every tube. The "Dynamic" method is more accurate, frequently finding "poor" tubes which might pass for "good" in ordinary testers.

Tests All Tubes—All of the popular receiving types and television amplifiers, including *Bambams*—*Loctals*—*Single Ended*—*High Voltage Filament Types and Miniatures*. Provision for many more. The tester

is protected against obsolescence in every possible feature.

Roll Chart tube index—simplifies correct settings.

Full Range Filament Selection—marked directly in volts.

• • •

Bench Model 636-B (illustrated) is installed in welded steel cabinet. This instrument is also furnished (portable model 636) in a French grey leatherette case with removable lid—matched in dimensions and finish to other testing instruments in the Jackson line. It can be assembled with them in the Jackson Service Lab. Buy now with an eye ahead—on a *matched* Jackson testing set.

* TRADE MARK REG.

BUY WAR BONDS

AND STAMPS TODAY

JACKSON

Fine Electrical Testing Instruments

JACKSON ELECTRICAL INSTRUMENT COMPANY, DAYTON, OHIO

"Columbia" is a reliable source

SPECIALS!
Available without priority



PLASTIC PARALLEL RIP CORD
2 CONDUCTOR—No. 18 Ga. Stranded

Easy to strip—easy to separate. The finest obtainable for radios, lamps, appliances, etc. Approximately 3000 ft. on reel.
Per 1000 ft.\$14.95

OR
250 ft. Metal Spools. Per 100 ft.\$1.65

2 CONDUCTOR MICROPHONE CABLE

The best mike cable available fully shielded—live, flexible buna rubber outer jacket.

Random lengths from 25 ft. to 250 ft., while quantity lasts. Per 1000 ft.\$37.50

INSULATED ELECTRICAL WIRE

Gauges #22 to #4

Available for immediate delivery from stock in single and multi-conductors.

18 CONDUCTOR CABLE

Plastic paired conductors. One conductor of each color is ribbed for easy identification, and can be used either paired or coded. Shielded with Synthetic Rubber outer jacket.

Approximately 1500 ft. on large wood reel.

Per 1000 ft.\$100.00
Per 100 ft.\$12.50

Write for Complete Circular No. 6

COLUMBIA WIRE & SUPPLY CO.

4104 N. PULASKI RD., CHICAGO 41, ILLINOIS



BATTERY ELIMINATORS



Announcing! Our New Models P and Q. They include every achievement of wartime ingenuity, and lift battery radio reception to new heights of satisfaction. Cost but a few cents per hundred hours of operation. Sturdily constructed—no liquids or moving parts—operate in any position. Completely filtered, hum free and silent in operation. Universal plugs and sockets to fit any radio.

MODEL P—For use in any place where normal AC is available. Operates any 1.4 volt—4, 5 or 6 tube battery radio from 115 v. 60 cy. source.

MODEL Q—For use wherever AC lines are not available—Farms, cottages, camps, or in car, motorboat, etc. Operates any 1.4 volt—4, 5 or 6 tube radio from 6 volt DC source.

NOTE: Due to War Production Board restrictions on Material our production is necessarily limited and deliveries at this time can be made only through established Jobbers. Canadian representative, Atlas Radio Corp., Toronto, Canada.

ELECTRO PRODUCTS LABORATORIES

Pioneer Manufacturers of Battery Eliminators

549 WEST RANDOLPH STREET

CHICAGO 6, ILL.

Electricity

Models range from 350 to 35,000 watts. A. C. types from 115 to 600 volts, 50, 60, 160 cycles, single or three-phase and 400, 500 and 830 cycles, single phase. D. C. types from 6 to 4000 volts. Also available in dual voltage and special frequency types.

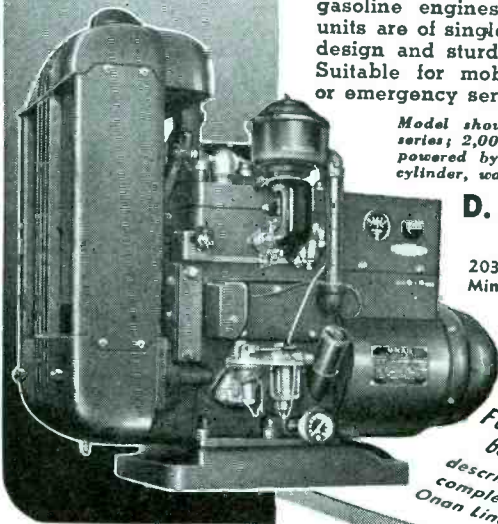

FOR RADIO AND ELECTRONIC APPLICATIONS

• ONAN ELECTRIC GENERATING PLANTS supply reliable, economical electrical service for electronics and television applications as well as for scores of general uses.

Driven by Onan-built, 4-cycle gasoline engines, these power units are of single-unit, compact design and sturdy construction. Suitable for mobile, stationary or emergency service.

Model shown is from W2C series; 2,000 to 3,500 watts; powered by Onan-built, two-cylinder, water-cooled engine.

D. W. ONAN & SONS

2036 Royalston Ave. Minneapolis 5, Minn.

Write For Folder 690-A describing complete Onan Line

Greater fidelity to records
Finer reproduction
Filtered record scratch
Patented self-locking design
Longer needle life
Floating point construction
Horizontal and vertical shock absorption

All These Benefits
shower down on users of the
Fidelitone Master
FLOATING POINT PHONOGRAPH NEEDLE

\$1.50
ABRASIVELY PACKAGED IN A USEFUL RECORD BRUSH

FM benefits turn into long green—profit—for dealers who prominently display the overwhelmingly popular Fidelitone MASTER longlife needle.

PERMO Incorporated 6415 Ravenswood Ave. Chicago 26

ads Teletone Radio Co.



S. W. Gross, president of the Teletone Radio Co., New York. The firm is currently producing small radio and radio-phonographs. Associated with Mr. Gross in the capacity of general sales manager is John S. Mills.

Jobber Appointments

COSMOPOLITAN RECORDS, INC., New York, New York, has named the following distributors: • Allied Music Sales Co., Detroit, for Mich., Ohio, and western Pa. areas • Associated Music Co., Denver, for Colo., Utah, and Wyo. areas • James H. Martin Co., Chicago, for Ill., Ind., Minn., Mo., and Wis. areas • Interstate Music Supplies, New York City, for N. Y. state and northeastern states • Howlett Distributing Co., Austin, Texas • Herbe E. Zobrist Co., Seattle, Wash., for states of Mont., Idaho, Wash., and Ore.

ELECTRONIC LABORATORIES, INC., Indianapolis, Ind., announces the following list of its new jobbers: • Radio Wire Television, Inc., Boston, Mass. • Radio Products Sales, Denver, Colo. • Radio Electric Products, Buffalo, N. Y. • Radio Products Sales, Los Angeles, Calif. • Scott Radio Supply, Long Beach, Calif. • Hatry & Young, Hartford, Conn. • Roehr Distributing Co., St. Louis, Mo. • R. & R. Supply Co., Inc., Lubbock, Tex. • Central Missouri Distributing Co., Jefferson City, Mo.

MULLINS MFG. CORP., makers of Youngstown kitchens, Warren, Ohio, have appointed the following distributors: • Crouch Appliance Co., El Paso, Tex. • Devlin-Drew Co., Fresno, Calif. • Foster Supply Co., Buffalo, N. Y. • Gem City Appliances, Inc., Dayton, Ohio. • General Pipe & Brass Co., St. Louis, Mo. • Pioneer Appliance Co., San Francisco, Calif. • Raco Appliance Co., Dallas, Tex. • Saviers Electrical Products Corp., Reno, Nev. • L. S. Hart, Birmingham, Ala.

GAROD RADIO CO., Brooklyn, N. Y., has named the Lifetime Sound Equipment Co., Toledo, Ohio, as distributor for its receivers and television sets in 18 counties of northwestern Ohio and southeastern Michigan.

New Book Issued "Your G-E Appliance Store"

• A new book, "Your G-E Appliance Store," is being sent to dealers by the appliance and merchandise department of the General Electric Co., Bridgeport, Conn.

Described as "a scientific approach for better appliance and radio merchandising," this book gives suggestions on how to relocate, plan and revamp a retail store.

For dealers planning to move, the book contains sections suggesting how to "count noses" and estimate the size of store they will need.

Dealers planning to remodel will find "before-and-after pictures" that will be applicable to any of the five basic types of store fronts. Similarly, for several basic types of interiors, the book presents photo-

graphs of scale models in which miniature replicas of appliances, radios and store fixtures have been placed just as they would be in an actual store.

New conceptions of "display merchandisers" for traffic appliances are shown. The book presents blueprints in an envelope which show how local carpenters can make these display fixtures.

Distributors are being charged a small fee for the book due to numerous requests for it, GE states.

Seth Thomas Appointment

General Time Instrument Corp., Thomaston, Conn., announces the appointment of Charles Gillman as general sales manager of Seth Thomas clocks. Mr. Gillman was formerly sales manager for Westclox.

BELL



Nation-wide Acceptance RUNS INTERFERENCE FOR YOU!

Proved in war and peace, BELL Sound Systems offer you advantages that give you a head start in meeting the sound needs of every prospective sound user. You'll throw competition for a loss when you let BELL nation-wide acceptance run interference for you. BELL matched units combine readily to fill the requirements of every application — and they are priced right.

BELL Equipment includes BELLone Intercom Systems . . . Industrial Voice-Paging and Broadcasting Equipment . . . Permanent and Portable Amplifying Systems . . . Recording and Disc Playing Units . . . Electronic Sound Devices . . . Many Others. Contact one of the BELL Representatives listed here for complete information.



— a new and better approach to long-profit, high-volume Sound Equipment Sales!

BELL
SOUND SYSTEMS, INC.
1186 Essex Ave. Cols. 3, Ohio
Export Office: 4900 Euclid Ave.
Cleveland 3, Ohio

BELL REPRESENTATIVES

- ATLANTA, GA., Henry W. & Abby N. Burwell
105 Forrest Ave., N.E.
- BOSTON 9, MASS., H. A. Chamberlin
31 Milk St.
- CHICAGO, ILL., Paul H. Miles
333 N. Michigan Ave.
- CLEVELAND, OHIO, John O. Olsen
1456 Waterbury Pl., Lakewood
- DETROIT 26, MICH., J. P. Davenport
604 Kerr Bldg.
- FORT WAYNE 3, IND., B. L. MacPherson
1724 Alabama Ave.
- GREELEY, COLO., Gordon G. Moss
Post Office Box 428
- HOUSTON, TEXAS, G. G. Willison
Tex-O-La Sales Co., West Bldg.
- KANSAS CITY 6, MO., Maury E. Bettis & Co.
Rm. 400, B. M. A. Bldg.
- LOS ANGELES, CALIF., Harry A. Lasure
7216 W. 11th St.
- MEMPHIS, TENN., J. M. Cartwright
1276 Peabody Ave.
- MINNEAPOLIS, MINN., M. E. Foster
Andrews Hotel
- NEW YORK, N. Y., Wesley Scharp
67 W. 44th St.
- PHILADELPHIA, PA., J. E. McKinley
628 Terminal Bldg., 401 N. Broad St.
- PORTLAND 1, OREGON, Dale G. Weber
7026 S. W. Capitol Highway
- SAN FRANCISCO 3, CAL., Hodges and Glomb
1264 Folsom St.
- TORONTO ONT., CANADA, Howard N. Reid
L. D. Cahoon and Co. Ltd.
2271 Danforth Ave.

Hotpoint Survey Results: Washers in Production

More than 25 per cent of all home laundry equipment will be sold in ensembles for "out-of-basement" installation, according to results of a survey released by Fred C. Margolf, manager of the home laundry sales division, Edison General Electric Appliance Co. He announced at the same time that Hotpoint washing machines were in limited manufacture again for the first time since 1942, and will be available in early 1946.

In analyzing possible trends reflected in the survey, Mr. Margolf called attention to the figure showing that 79.2 per cent of the dealers would sell automatic washers, noting that 46.6 per cent had sold them previously. He said that all home

laundry activities would benefit from the interest centered upon this new appliance.

E-L to Manufacture Toys

Norman A. Kevers, chairman of the board of Electronic Laboratories announces that the company has inaugurated a new division to manufacture toys operated by electronic devices. The name of the new division is Elec-Toy. The company expects to be in production of some items in time for the Christmas market.

With Florida Wholesaler

Florida Radio & Appliance Corp. distributors, with offices in Miami, Jacksonville and Tampa, announce the appointment of Marshall L. Foreman as manager of its Tampa division.

Olympic Production Plans

P. L. Schoenen, executive vice-president of Hamilton Radio Corp. told questioners, "We have every reason to believe that we will be producing our civilian Olympic radio line within a very short time. Most of these," he declared, "will be table sets."

"As quickly as conditions permit, the Olympic line will be expanded to include every type of radio, from consoles on down through portables. We will also put a television line on the market, just as soon as circumstances warrant."

33 well overlapped ranges . . .

plus long-life dependability!

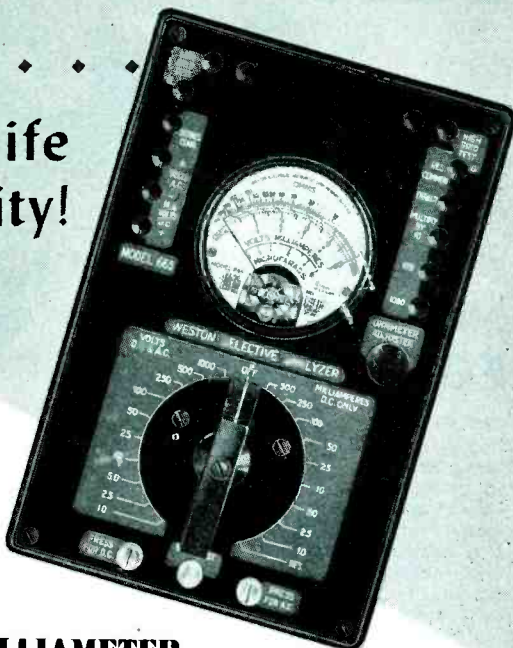

WESTON

(Model 665 Type 1)

VOLT-OHM-MILLIAMETER

Its compactness, versatility and rugged dependability make Model 665 the ideal instrument for use in the field, or in the shop . . . whether servicing communications equipment, testing electrical components in production, or research or maintenance work. Provides 33 AC and DC voltage, DC current, and resistance ranges . . . with simplified switching arrangement for rapid operation. Built to WESTON standards to assure dependable measurement accuracy throughout the years. Full details on request. Weston Electrical Instrument Corporation, 605 Frelinghuysen Avenue, Newark 5, N. J.

WESTON Instruments

Low-Priced Television Sets

Editor, RADIO & Television

RETAILING:

Recent announcements of television receivers to sell at prices between \$100 and \$200, have brought forth a variety of comment. Such sets before long may be a real factor. On the other hand, many companies who have not heretofore produced television or even radio equipment may rush into the market, offering goods with low price tags, but later be unable to deliver or go into bankruptcy.

Most radiomen's opinions concerning selling prices for television receivers are based partly on what they pay for a comparable radio receiver and partly on the prices advertised by leading companies. We know from experience, however, that small companies with low overhead and one or two clever engineers can "cut corners" in a manner hardly noticeable to the non-technical television buyer, with the result that the sales price may be from 20 to 50 per cent lower than a receiver giving an equal sized picture produced by a well known manufacturer. There may be more such companies in the future television field than there were in the early days of radio broadcast receivers.

In fact, if some of these smaller companies realized at the present time that there are 33,500 five-inch cathode-ray tubes of one type which are being disposed of by the Office of Surplus Properties, at Washington, naturally at a very large discount from its catalogue price, they would purchase the entire lot, build a television receiver around the tube (which is really better fitted for radar than television) with the result of a very low cost receiver. This illustrates how we might have low-cost television sets, and furthermore draws attention to the fact that there may be as much as thirty million dollars of surplus government radio equipment overhanging the market.

TELEVISION DEALER

New York, N. Y.

Start New Philco Plant



Philco officials check plans as ground is broken for new building near present plant. L. to r., William Balderston, vice-president charge of operations, William Peltz, Phila. radio div. prod. mgr., H. N. Johnston, maintenance dept. mgr., John Ballantyne, president, Joseph H. Gillies, vice-president charge of radio production.

R. I. Wholesaler Moves; Takes on New Lines

Republic Distributing Co., Providence, R. I., has moved to new and spacious quarters at 159 Clifford St. At the new location, the firm will have increased office, display, and warehouse facilities. The company's previous address was 170 Westminister St.

In addition to distributing Bendix radios, the firm announces that it will also handle Automatic washers, Everhot appliances, Victor fans, Mirro-Matic pressure cookers, as well as other leading lines.

Magnavox Names Fiebig



O. A. Fiebig has been appointed assistant sales manager of the radio-phonograph division of the Magnavox Co., it is announced by N. B. Sherrill, Jr., sales manager. The Magnavox sales program, in addition to merchandising the new line, includes a sales and service training course for dealers and salesmen.

Raytheon Names Ellis

Laurence K. Marshall, president of Raytheon Mfg. Co., announces that Ray C. Ellis, former director of the WPB radar-division, has been appointed vice-president of Raytheon.

OPA Price Policy Slows Production, Says Gerl

The action of the OPA in refusing to allow component parts manufacturers to raise their prices to meet higher production costs was denounced in two speeches as "an amateur attempt to run the radio business into the ground." The speaker, Joseph Gerl, president of Sonora Radio & Television Corp., also maintained that this action "has already post-

poned civilian radio production for at least four weeks."

Gerl addressed mid-western radio dealers in Kansas City, Missouri and Omaha, Nebraska.

Illinois Distributor Expands Facilities

The Suttle Equipment Co., Lawrenceville, Ill., announces that it will occupy a new building, now under construction, in December. Being built at an estimated cost of \$40,000, the structure is being erected at the firm's present site.

The new building will be 145 ft. long, and 86 ft. wide, and will provide floor area of over 50,000 sq. ft. The firm distributes electrical appliances and equipment in this area.



Our Hat Is Off...

Our hat is off to those radio men, both military and civilian, who contributed so much to the successful completion of the war. Too, our hat is off to those radio servicemen and jobbers who were patient and understanding of the shortage of Rider Books caused by wartime restrictions, now removed.

Our hat is off (and our coat too), ready to tackle the peacetime radio problems in the civilian field. In the light of our wartime experiences we have planned a five year program which is right now developing in our own laboratories. From this research will result many innovations -- and one of the most ambitious publishing programs we ever scheduled. It will bring to the student, the amateur, the serviceman, yes even the radio engineer the very information each must have if he is to understand, and work in radio and the new fields of television and microwaves that will be commonplace in

coming years. This is not a program of the future, it is functioning today. Next month will witness the publishing of the first of these new Rider Books. Announcements will carry complete details. Yes, our hat is off -- and it's great to be back!



John F. Rider

JOHN F. RIDER PUBLISHER, INC., 404 FOURTH AVE., NEW YORK 16, N. Y.
"Publishers of Radio Technical Books Exclusively"

**"You'll
HEAR MORE
from Astatic"**

Featherweight
PRESSURE



OUTSTANDING CHARACTERISTIC OF ASTATIC PICKUPS

Astatic Low Pressure Crystal Pickups have contributed, as no other phonograph part, to long record life and quality reproduction of recorded sound. An even higher standard of phonograph performance is assured with Astatic Pickups of tomorrow, incorporating not only the principle of featherweight pressure, originally introduced by Astatic, but dramatically new and improved features for increased enjoyment of modern recordings. In the measure that FM will contribute to the improvement of radio reception, so will Astatic's finer Crystal Pickups advance the fidelity of phonograph record reproduction.

ASTATIC Crystal Devices
manufactured under Brush
Development Co. patents.

THE
Astatic
ASTATIC CORPORATION
CONNEAUT, OHIO

IN CANADA. CANADIAN ASTATIC LTD., TORONTO, ONTARIO

Jett Advises Listeners to Buy AM-FM Radio Sets

Radio listeners were advised by FCC Commissioner E. K. Jett, in a radio speech, to buy combination AM-FM sets when the new models appear.

Declaring that the speed with which FM broadcasting develops will depend on "how rapidly you, the listeners, accept this new method of program transmissions," Mr. Jett said:

"During the transition period from AM to FM most of the receivers offered for sale to the public will incorporate both systems of broadcasting. The added cost for the FM feature will not be great—perhaps no more than you have been accustomed to pay for the short-wave international broadcasting range in your existing pre-war receiver. It is, therefore, to your advantage to obtain a combination set which will receive both AM and FM when the new models appear on the market. If your present receiver is in good condition you may wish to consider purchasing an FM adapter, or a receiver capable of FM reception only."

FM Future

Commissioner Jett predicted that within four or five years after civilian production is resumed "at least half of the homes of America will be equipped to receive FM broadcasts." In metropolitan areas, he said, "FM eventually will replace local and regional AM reception." However, he added, the high-power clear-channel AM stations "must be retained throughout the years to serve rural audiences which cannot get good reception from FM stations."

Mr. Jett also predicted that within two to three years some 500 FM stations will be in operation.

McAllister in Production

McAllister bagless vacuum cleaners will be on sale in stores all over the country this month, H. J. McAllister, vice-president of the Franklin-McAllister Corp., Chicago, has announced.

The retail price is based on volume production, and products will be available at pre-war price levels.

Rejoins Terminal Radio



First Lieut. Robert Corenthal has returned to the Terminal Radio Corp., New York radio suppliers, as advertising and sales manager.

IMMEDIATE DELIVERY FROM STOCK

TRIPLETT

Volt-Ohm-Milliammeters



TRIPLETT 666.....	15.25
TRIPLETT 666-H.....	16.00
TRIPLETT 1200-S.....	34.67

Service men's Priority

MASCO AMPLIFIERS



Complete with tubes.

17 Watt	30.30
25 Watt	42.60
35 Watt	54.60
50 Watt	70.50
17 Watt with Phono-top.....	42.30
25 Watt with Phono-top.....	52.20
35 Watt with Record-changer.....	89.10

TURNER MICROPHONES

Model	Type	Cord	Level	Each
BX	Crystal	7'	-55	\$5.85
22X	Crystal	7'	-52	10.88
33X	Crystal	20'	-52	13.23
BD	Dynamic	7'	-52	8.53
33D	Dynam.	20'	-54	14.70



SPEAKER BUYS!



4" PM square.....	\$1.33
4" 450 ohm square.....	2.40
5" PM 2 watt.....	1.23
5" 450 ohm.....	1.50
10" PM 11 watt.....	7.20
12" PM 16 watt.....	10.14
12" PM 17 watt.....	14.23

SPRAGUE - CORNELL DUBILIER AEROVOX CONDENSERS

8 mfd 450v Upright can	76¢
16 mfd 450v Upright can	1.12
20 mfd 450v Upright can	1.23
8 mfd 450v Tubular	44¢
16 mfd 450v Tubular	65¢
20 mfd 150v Tubular	44¢
20-20 mfd 150v Tubular	76¢
40-20 mfd 150v Tubular	82¢
30-30 mfd 150v Tubular	79¢
50-30 mfd 150v Tubular	94¢



RADIART VIBRATORS

Type	Equal	Each
S-1	4-4	\$1.35
5300	204	2.09
5326P	509P	1.76
5334	868	2.09
5341M	801M	1.76
5400	248	3.50
5420	716	3.50

ORDER OTHERS BY MAKE AND SET MODEL

CRYSTALS.....M22	2.94	L40	2.35	LP6	4.70
PICKUPS.....	2.97,	3.30,	3.90		
MOTORS.....	3.17,	3.33			

PHILCO BEAM OF LIGHT

Selenium Cell only, no holder 1.80

20% deposit required on all C.O.D. orders. 2% transportation allowance on orders of \$25.00 or more accompanied by payment in full.

Write for FREE CATALOG

RADIO SUPPLY & ENGINEERING CO., Inc.
128 SELDEN AVE. DETROIT 1, MICH.

RADIART VIBRATORS...

Individually Engineered

FOR PROPER REPLACEMENT!

HIGH QUALITY MATERIALS . . .

For the past six months Radiart Vibrators have been equal or superior to prewar vibrators in quality and performance.

Ask your jobber for a RADIART VIBRATOR Catalog — the most complete vibrator Guide on the market.

Physical Characteristics —

Wherever required, RADIART VIBRATORS are the same physical size as the original, thereby eliminating additional attachments for electrical grounding or for holding the vibrator in the socket.

Electrical Characteristics —

RADIART VIBRATORS are engineered to correctly match the individual requirements of each circuit application, taking into consideration every operating essential such as frequency, current carrying capacity, points and reeds properly tuned to match transformer-buffer circuit requirements.

This individual engineering guarantees much longer life than could possibly be obtained if any of these characteristics were compromised for the sake of vibrator type simplification.

RADIART VIBRATORS assure minimum R.F. interference, low level of mechanical noise and starting under adverse battery conditions.

Manufactured by makers of famous RADIART Rust Proof Aerials.

Radiart Corporation
3571 W. 62nd STREET • CLEVELAND 2, OHIO
Export Division: 25 Warren St., New York 7, N.Y.
Canadian Office: 455 Craig St., W., Montreal, Canada

BE SURE... Standardize on STANCOR Transformers

Call your nearest Stancor Jobber... or write us for his address

STANDARD TRANSFORMER CORPORATION
1500 N. HALSTED STREET • CHICAGO

Aireon Buys Two Firms

Aireon Mfg. Corp., Kansas City and Burbank, Calif., announces that it has purchased the Oxford-Tartak Co. and the Cinaudagraph Corp., Chicago. Both companies are manufacturers of radio speakers. Randolph C. Walker, president of Aireon, is president of both companies.

Free Dealer Display

A display card, 11" x 14", which radio-men can have without charge is available through Cornell-Dubilier distributors. Copy on the card emphasizes that "we use only genuine, new replacement parts, no war-weary surplus."

The display can also be had by writing to Cornell-Dubilier Electric Corp., New Bedford, Mass.

NATIONAL RADIO WEEK, NOV. 4-10

National Radio Week, observing broadcasting's 25th anniversary, will be week of Nov. 4, date selected by NAB public relations committee and network anniversary committee. (See note bottom page 37). Commemorative statuette is to be presented by RMA, with replicas to all stations and networks. Reported that RMA plans big advertising and publicity campaign in national and local media to observe Radio Week.

Raytheon Reviews Year

Raytheon Mfg. Co., Newton, Mass., has issued a comprehensive report outlining the firm's activities for the past fiscal year. Included in the brochure is an account of the Belmont Radio Corp., Raytheon subsidiary.

Southwest Admiral Jobber

Wallace C. Johnson, manager field activities, Admiral Corp., announced the appointment of the Sun City Distributors, El Paso, Tex., as exclusive distributors of Admiral radios, refrigerators, electric ranges and home freezers for the El Paso, Tex., and Albuquerque, New Mex., territories.

To Miracle Products Post

It is announced that G. A. Boivin has been named to supervise the sales and advertising of the Miracle Electric Co., division of Miracle Products, Inc., Chicago, Ill. Mr. Boivin was previously general sales manager for the Dormeyer Corp.

Artists Sign With Cosmopolitan Records

Cosmopolitan Records, Inc., 745 5th Ave., New York, Harry W. Bank, president, announces the exclusive signing of several well-known artists. These are:

Joan Edwards star of the Lucky Strike Hit Parade; Jerry Wayne, of the Borden's radio show; Gertrude Niesen, of "Follow the Girls" fame; Barry Wood, of the Phillip Morris program; 4 Chicks and Chuck, of the Kate Smith and Allen Young shows; Oscar Strauss, composer of the "Chocolate Soldier," Enric Madriguera, Coleman Hawkins, and Del Courtney's orchestras; Jimmy Carroll, of the Squibb show; and Henry Busse and his orchestra.

Orders are now being shipped to distributors located in Detroit, Denver, Chicago, New York, Austin, Tex., Seattle, and Baltimore.

Sonora Dealer Plaque



Shown is the plaque which the Sonora Radio & Television Corp., Chicago, Ill., is presenting to each of its franchised retailers.

We are RECONVERTING, too!

The November issue of
RADIO & Television RETAILING
marks the return of this magazine to

● LARGER PAGE SIZE

8⁷/₈ x 11³/₄ inches, permitting use of 9 x 12 plates for bleed pages; retaining 7 x 10 type size for standard pages.

● HEAVIER COATED STOCK

White 50# and 60#, with fine surface and good opacity for high grade halftone printing. New screen for run-of-book, 110 instead of 100.

● IMPROVED FORMAT

Restyling of layout and typography to get full effectiveness from the new page size, margins and paper quality.

And also —

● CIRCULATION INCREASE

25,000 guaranteed, including 22,000 dealers.

CLOSING DATES

Last day for setting, proofs, etc.....15th of preceding month
Last day for complete plates.....20th of preceding month

**RADIO Television
RETAILING**

CALDWELL-CLEMENTS, INC.

480 Lexington Ave., New York 17, N. Y.—PLaza 3-1340

Check These Exclusive

KWIKHEAT

SOLDERING

IRON Advantages!

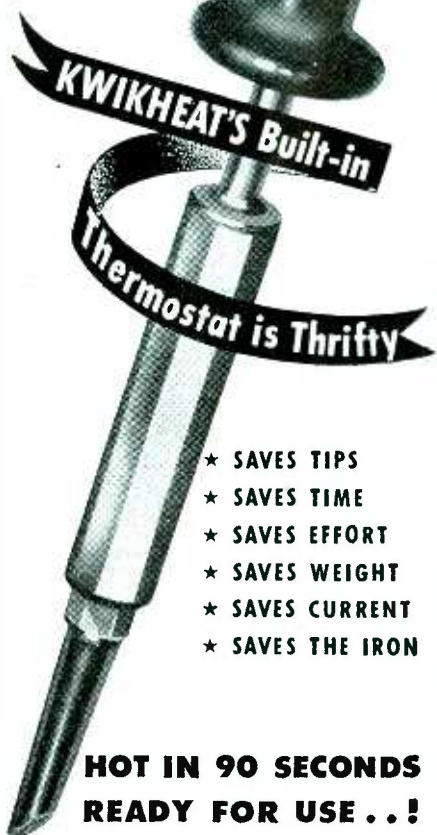

- ★ SAVES TIPS
- ★ SAVES TIME
- ★ SAVES EFFORT
- ★ SAVES WEIGHT
- ★ SAVES CURRENT
- ★ SAVES THE IRON

**HOT IN 90 SECONDS
READY FOR USE . . . !**

Its many exclusive features put the Kwikheat Soldering Iron in a class by itself. That's why it wins enthusiastic praise from those who use it—why Kwikheat is fast becoming America's most talked-about iron—why you certainly want to stock it . . . lists at \$11. Write today for complete information.

6 TIP STYLES
Interchangeable



WRITE FOR DETAILS

To Electromaster Post



Electromaster, Inc., has appointed Roy B. Blanchard advertising director in charge of advertising and sales promotion, it is announced by Gerald Hulett, vice-president.

Garod Announces Its Sales Representatives

The Garod Radio Corporation announces the appointment of the following sales representatives:

C. R. "Connie" Strassner of Los Angeles, Cal., who has offices in San Francisco and Los Angeles. He will cover the entire states of California and Arizona.

Pete Bach, with headquarters in Portland, Ore., will represent Garod in Oregon and Washington.

The area of eastern Pennsylvania, Maryland and Virginia will be handled by Sam Levine, with offices in Philadelphia.

Pat Haggerty has been appointed to represent Garod in Michigan, the north-western corner of Ohio, including Toledo.

Assigned to the South, with offices in Atlanta, is Reid H. Cox.

Universal Division Making New Product

Universal Microphone Co., Inglewood, Cal., has converted parts of its two plants to production for its new Robolite division, according to joint announcement from James L. Fouch and Cecil L. Sly, co-partners.

Dee Breen, Universal sales manager, will distribute through regular jobbing and retail channels.

The Robolite is a small lamp or dim glow light that operates on all currents.

Made Export Agent

Morhan Exporting Co., 458 Broadway, New York, has been appointed exclusive export agent to all countries in the world, except Canada, for Marion Electrical Instrument Co., Manchester, N. H.

Merchandiser Wanted

Smart NYC Madison Avenue store selling radios, phonographs, records and electrical appliances, wants experienced merchandiser to assist general manager. Must have successful record; state salary and experience in letter. Address Box 288, care RADIO & Television RETAILING.



MELODISC

The Professional
Home Recording Blank

IS READY... ARE YOU?

Hundreds of thousands of recording machines and phono-recorder combinations will now quickly move to market. Millions of blank recording discs will move along with them—after that, millions more in repeat sales.

Are you ready for this business? To answer "yes" you should have MELODISC blanks in stock.

MELODISC producers are pioneers in the recording blank field having manufactured discs since 1931. Mounting sales prove that MELODISC has no peer in the popular priced home and commercial recording field. This is no accident. The raw materials, base stock quality, manufacturing methods and supervision, together with a highly specialized inspection department—all go to produce MELODISC, the professional home recording blank. Nothing is sacrificed in the interest of economy—no compromise with quality.

Ask your Distributor for samples and prices

HOME RECORDING CO.

699 EAST 135TH STREET
BRONX 54, NEW YORK

JOB AHEAD

"... as brilliant Sol through stubborn clouds
his dauntless will imposes"

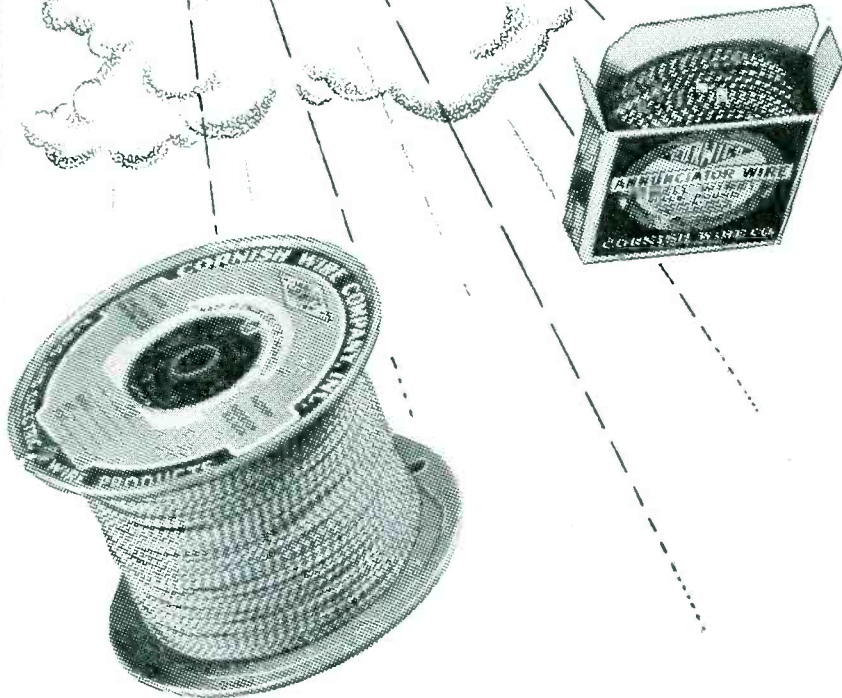

RECONVERSION to national peacetime economy is on the march . . . perhaps not as swift as you and we would like it. Vast displacements, inevitable as we "shift our gears", must be absorbed and neutralized . . . in short, there's a JOB ahead.

Each day supplies of famous CORWICO Wire, so important in the war and so important now, will be made available for civilian use.

Patience! We've moved mountains before



cornish
WIRE COMPANY, INC.

15 Park Row, New York City, New York

"Made by Engineers for Engineers"

Get McAllister Cleaner



H. J. McAllister, left, vice-president of Franklin-McAllister Corp., delivers the firm's new vacuum cleaner to H. A. Renholm, vice-president RCA Victor Distribution Corp. Looking on are H. C. Chapman (rear left) and C. W. Strawn, Detroit manager for RCA Victor.

Bendix Appliances Holds Jobber Sales Meeting

Bendix Home Appliances, Inc., South Bend, Ind., held a distributor sales training meeting for jobbers' in the eastern divisions including the following markets, Washington, D. C.; New York, N. Y.; Baltimore, Md.; Philadelphia, Pa.; New Haven, Conn.; Hartford, Conn.; Springfield, Mass.; Boston, Mass.; Portland, Me.; and Newark, N. J.

Krich-Radisco, Inc., Newark, N. J., distributor for Bendix in northern New Jersey, was host to the distributor sales managers.

Lynn Eaton, eastern sales manager, conducted the two-day session.

The purpose of the meeting was to acquaint those present with this sales training program, so that they may conduct similar meetings with their dealer and retail salesmen's organizations.

Rejoins Magnavox as Rep

Captain Jerre Neislar has been placed on an inactive duty status by the Army Air Force and will return to The Magnavox Co. as sales representative of the southwestern district, according to an announcement made by N. B. Sherrill, Jr., sales manager.

Reps for Carter Motor

The appointment of Holliday-Hathaway Sales Co., 176 Federal St., Boston 10, Mass., as representatives in the states of Massachusetts, Maine, Vermont, Rhode Island, Connecticut and New Hampshire, was announced by Robert W. Carter, managing director of Carter Motor Co., Chicago, Ill.

Maguire War Products

With government permission, Russell Maguire, president of Maguire Industries, Inc., disclosed that its war goods included test devices for both Army and Navy to keep radar functioning, receivers to detect radar, jamming equipment to neutralize enemy communications.

A Better Selection
of

RADIO CABINETS & PARTS

from

LAKE!



Portable Phonograph case in brown leatherette covering. Inside dimensions 17" long, 14" wide, 8 1/2" high. Has blank motor board and opening for speaker. As illustrated at left, specially priced at...

\$8.95

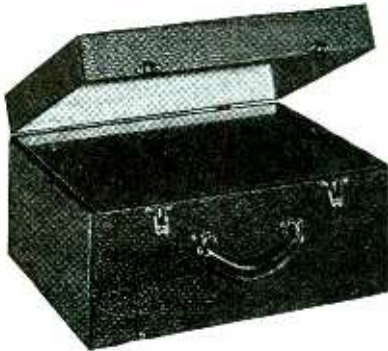

Portable Phonograph case, of sturdy durable plywood, in handsome brown leatherette finish. Inside dimensions 16 1/2" long, 14" wide, 9 1/2" high. Has blank motor board. As illustrated above, specially priced at...

\$6.95

Also blank table cabinets of walnut veneer in the following sizes, with speaker opening on left front side: (*Note: *7 has center speaker grill.)

#1	8 1/4"	L x 5 1/2"	H x 4"	D \$1.95
#2	10 1/4"	L x 6 1/2"	H x 5"	D \$2.75
#3	13 1/4"	L x 7 1/2"	H x 6 1/4"	D \$3.25
#7	10 1/2"	L x 7"	H x 5 1/2"	D \$2.50
#8	17"	L x 9"	H x 9 1/2"	D \$4.50
#9	21"	L x 9 1/4"	H x 10 1/2"	D \$5.50

*Speaker Opening in center of front side. Cabinets available in Ivory color and Swedish Modern. Write for prices.

POWER TRANSFORMERS

4, 5, or 6 Tube—6.3V at 2 amp.	\$2.45
50 Mill Power Transformer....	
7, 8, or 9 Tube—6.3V at 3 amp.	\$2.65
70 Mill Power Transformer....	

All types of radio cabinets and parts are available at Lake's Lower prices. A large stock is listed in our catalog.



SERVICEMEN—RETAILERS
Join our customer list today.

Write for Our Free, New Illustrated Catalog!
Dept. B

Lake Radio Sales Co.
615 W. Randolph Street
Chicago 6, Ill.

NOW... an exclusive, tested way to increase your record sales!

**Customers Order Direct
From The Record Review**

Store after store has discovered that new and old customers come in with the RECORD REVIEW in their hands and actually order right from its pages.

It not only wins new customers, but helps all customers, old and new, to choose the right records at the right time. That means more satisfied customers and more repeat sales. Read these typical comments:
STEINWAY & SONS, NEW YORK—"It is our best form of advertising. We depend on it."



ACT PROMPTLY and you can have exclusive rights in your city to the RECORD REVIEW, a tested monthly sales-builder that is regularly paying off for record shops and departments all over the country.



**Your Own Magazine—
It Builds Your Name Only**

Here's the kind of timely record information music lovers tell us they want—edited by leading experts in easy-to-read form. It's the sure-fire way to build a following and give that extra service your competitor cannot give. RECORD REVIEW comes to you complete, printed with your own distinctive front cover design in color and your full page advertisement on the back cover. Nothing for you to do but mail it!



THE RECORD SHOP, PHILADELPHIA—"We are delighted with it—would like to renew our contract."

LIBERTY MUSIC SHOP, ANN ARBOR—"I don't know of a more effective and at the same time more dignified means of advertising our store and the merchandise we sell."

DES MOINES MUSIC HOUSE, DES MOINES—"The magazine is fine. Keep up the good work."

THE RECORD SHOP, DALLAS—"Our customers have expressed their pleasure in receiving the magazine to which we have traced additional sales."



Be a "Publisher" at a cost of a few pennies—mail coupon TODAY!

RECORD REVIEW
Frederick Kugel Co.
600 Madison Avenue, New York 22, N. Y.

Please keep.....open for me until I receive
(Name of City)

full details about the RECORD REVIEW:

NAME.....

ADDRESS.....

Now an entirely new line!

*Quality
sound equipment
by
Newcomb*

PRESENTING our newest line of amplifiers... they offer you greater excellence in sound reproduction than has ever before been available to the public address field. Designed and produced by an organization devoted exclusively, for more than seven years, to the perfection of fine sound equipment, they embody all the practical benefits of today's

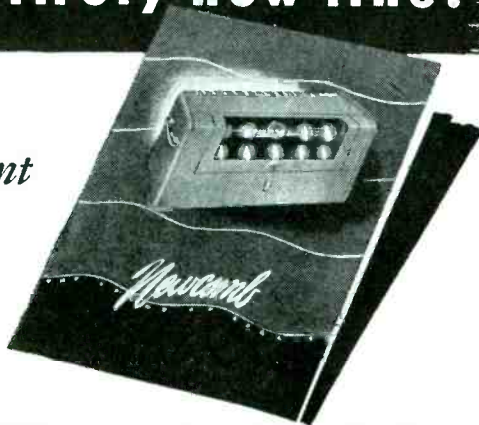

most advanced electronic achievements.

Send for the catalog... compare Newcomb with others... you'll find no other amplifier has so many advantages.

T H E S O U N D O F Q U A L I T Y

Newcomb

AUDIO PRODUCTS CO.

MANUFACTURERS

DEPT. A 2815 S. HILL STREET, LOS ANGELES 7, CALIFORNIA

Here, Mr. Radio Service Man Is a Natural for You

Descriptive Literature Sent on Request

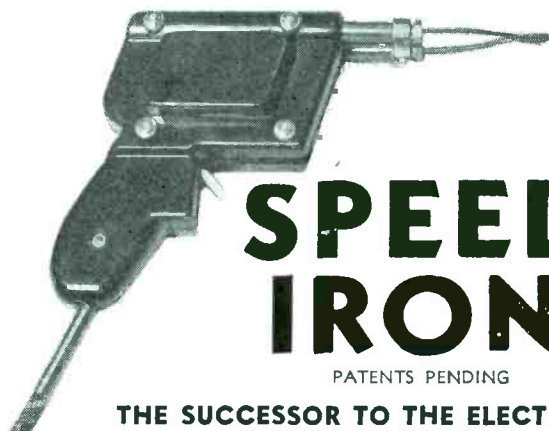

SPEED IRON

PATENTS PENDING

THE SUCCESSOR TO THE ELECTRIC SOLDERING IRON

115 Volt, 60 Cycle, 100 Watt

IT'S REALLY FAST!

Soldering Heat in 5 Seconds After Pressing the Trigger!

You don't wait for the SPEED IRON to heat. It waits on your bench, cold, for you. When you pick it up and press the trigger it goes to work with a surge of power and speed that is amazing.

SPEED IRONS have been tested and used in hundreds of war plant applications over a four-year period and are now available to radio repairmen.

If Your Radio Parts Distributor Does Not Yet Have Speed Irons in Stock Write

WELLER MANUFACTURING CO., DEPT. R, EASTON, PA.

Stress Service, Maytag Executive Tells Dealers

In a statement addressed to the firm's retailers, Verne R Martin, general sales manager, The Maytag Co., Newton, Iowa, declared:

"During the balance of 1945, all dealers should look upon the sale of new merchandise as PLUS MERCHANDISE, and continue to aggressively solicit rebuilding jobs and service work. The user of a good rebuilt Maytag, giving trouble-free service, isn't going to be 'pushing the reins' for a new washer, but will still be there waiting for you to sell her a new washer a few years hence—remember, you will still be in business two or twenty years from now."

Ship First Meck Sets

The John Meck Industries, Plymouth, Ind., has made the first shipment of radios by air, fast mail and express to all its dealers. To speed deliveries, the firm is shipping direct to each store.

A kit which consists of a five tube AC-DC superheterodyne table model set in a plastic cabinet that is expected to list for less than \$20, a ribbon display piece for the window, a package of advertising material with streamers, posters and folders, advertising mats, price tag and dealer order blank has been shipped to each retailer.

News About the "Reps"

James Millar, secretary of the Dixie-land chapter of the Representatives of Radio Parts Manufacturers, Inc., has announced that 5 new members have been acquired by that branch. They are:

William Chaddock Cartwright, 1276 Peabody Ave., Memphis, 4, Tenn.; C. W. Chapman, 314 Luckie St., N.W., Atlanta, Ga.; Frank C. Fassett, P. O. Box 1335, Tampa 1, Florida.; J. T. Fulwiler, 314 Luckie St., N.W., Atlanta, Ga.; Rolfe H. Van Dusen, 940 Lake Elbert Drive, Winter Haven, Fla.

Other reports from the "Reps" state that Frank W. Taylor's office has been moved to his new address at 131 Orvilton Drive, DeWitt, New York and H. A. Roes & Co. is now located at its new quarters in Room 518, City Bank Building, 1805 Grand Ave., Kansas City 8, Mo.

Remember This Emblem



The lapel button illustrated is the Honorable Service Emblem awarded to veterans of the present war, holding honorable discharges.

Joins New England Jobber



Ralph S. Cron, has been named vice-president and general manager of the Youngstown Equipment Co., Boston, Mass., it has been announced by Samuel Dane, president.

RecordDisc Polls Value of Home Recording to Dealer

The results of a survey of the home recording field have been disclosed by the RecordDisc Corp., New York. Sidney S. Gould, president, states: "It is our opinion that home recording can easily become a vital and integral part of the radio business through a volume of millions of dollars per year. This will be achieved, however, only if certain things are done to stimulate the sale of recording equipment.

- (1) "The present quality of home recording discs should be improved.
- (2) "The price of the discs should be reduced to about one-third of present levels in order to make home recording an inexpensive pastime and hobby."

Gets Retail Stores Post

The appointment of C. H. Courtleigh as comptroller of Associated Stores in Florida is announced by Herbert A. Brennan, vice-president and general manager.

Mr. Courtleigh was formerly with Philco Distributors, Inc., a branch of Philco Radio & Television Corp. of Philadelphia.

Majestic's New Plant

Majestic Radio & Television Corp. will soon occupy its third plant, E. A. Tracey, president of the firm, has announced. The new factory will be built on land recently acquired by Majestic just north of the Elgin (Ill.) city limits.

Western Rep's New Office

Norman B. Neely Enterprises, western factory representatives for Hewlett-Packard Co., Kaar Engineering Co., Presto Recording Corp., Radio Engineering Laboratories, Inc., Sensitive Research Instrument Co., and the Webster Electric Co., has moved into modern and larger quarters, according to Norman B. Neely, owner. The new building is located at 7422 Melrose Ave., Hollywood, Calif.

Tone...

Always a Deciding Factor

In the selection of any musical instrument, tone is of vital importance. Cinaudagraph Speaker Engineers have kept pace with every tone advancement — pioneered many new developments. That's why you'll want tomorrow's, better than ever, Cinaudagraph Speakers in every fine receiver — every quality sound unit.

Cinaudagraph Speakers, Inc.
 3911 S. Michigan Ave., Chicago
 Export Div., 13 E. 40th St., New York 16, N. Y.

"No Finer Speaker in all the World"

BAFFLED?

DON'T BE

FAIRFIELD



LUMBER CO.

WE are already in production on RADIO SPEAKER Baffles

COMPLETE WITH MOUNTING SCREWS

We are now supplying leading radio manufacturers with speaker baffles and are prepared to fill orders of any quantity or specification. Mail your blueprints today for Quotations.

The Fairfield Lumber Co.

1700 POST ROAD

FAIRFIELD, CONN.

Manufacturers of Wood Products

ALLIANCE "Even-Speed" Phono-motors



We're Going Strong!

For reliable, positive operation you'll want the time proved

ALLIANCE "Even-Speed" PHONO-MOTORS

Just check these well known advantages!

- Uniform Table Speed — Cool, Smooth Running
- Shock Protection — Quick Starting
- Compact Design — Long Life!

Alliance engineering "know-how" is always ahead! Facilities for high speed uniform production are *unsurpassed!* So plan *now* to drive your turntables, recorders and combination record changers with ALLIANCE "Even-Speed" PHONO-MOTORS.

ALLIANCE MANUFACTURING COMPANY
ALLIANCE, OHIO

WOMAR

Manufacturers of
RADIO, ELECTRICAL AND
ELECTRONIC COMPONENTS

ELECTRONIC PRODUCTS MFG. CORP.
DEXTER, MICHIGAN

Motorola in Action



The Galvin Mfg. Corp.'s SCR-610 vehicular 2-way radio, shown here, is a veteran of many campaigns. One such set kept operating though hit by enemy shells and rifle bullets.

Sylvania "Light Center"

Introducing modern fluorescent lighting styled especially for the home, Sylvania Electric Products Inc. opened its new Sylvania Lighting Center in New York recently.

The Lighting Center provides the company with a laboratory for experimenting with new residential lighting ideas.

NEWA Sales Training Plan

Managing director Chas. G. Pyle announces that the National Electrical Wholesalers Assn. is coordinating its efforts with the Edison Electric Institute (the trade association of the utility companies), in completing a basic sales training program to be made available to all of its members.

Recent NEWA meetings have disclosed a need for sales training material for electrical wholesalers' and appliance distributors' sales organizations.

N. J. Jobber Adds Lines

Announcement is made of the appointment of Krich-Radisco, Inc., of Newark, N. J., as distributor of the complete line of Seth Thomas electric clocks and Knapp-Monarch table appliances in the northern New Jersey territory.

Dealers Franchised at D. W. May Corp. Meetings

The D. W. May Corp., New York, distributor in this area, recently held a series of franchising meetings.

E. H. McCarthy, sales manager of Farnsworth Television and Radio Corp., presented the complete line of the firm's receivers. R. L. Van Hyning, eastern sales mgr., The Coolerator Co., presented the complete line of ice and electric refrigerators and home freezers. Albert E. Kramer, vice-president of Health-Mor, Inc., introduced the Filter-Queen cleaner.

D. W. May presided throughout the meeting. The firm has issued a 10-point code of ethical business practices which it will follow in the future. Included are the company's intentions to sell all its products under state fair trade laws.

DEPENDABLE MUTER PRODUCTS * DEPENDABLE MUTER PRODUCTS



Manufacturers
of Component parts for
the Radio, Electronic
and Communications
Industries

THE **MUTER** CO.
1255 South Michigan Avenue
Chicago, U. S. A.

MUTER PRODUCTS * DEPENDABLE

MUTER PRODUCTS * DEPENDABLE

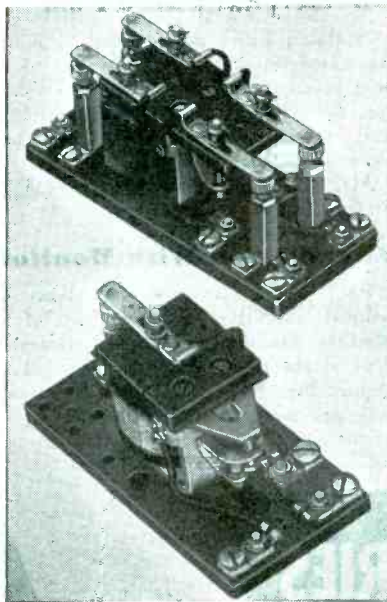

HEAVY DUTY RELAYS

Relays No. 130 are available for radio, electronic and industrial applications. Heavy duty contacts. One to four poles with wide variety of contact arrangements. Molded phenolic bases. New catalog gives complete data. Write for your copy now.

WARD LEONARD ELECTRIC CO.

Radio and Electronic Distributor Division
35 WEST JACKSON BLVD., CHICAGO, ILL.





WARD LEONARD
ACCEPTED MEASURE OF QUALITY

RESISTORS
RHEOSTATS
RELAYS



Busy Days, These -

Industry is plenty busy these days, reconvertng, planning expansions . . . and RAULAND AMPLICALL Paging and Two-Way Communications Systems are playing an increasingly bigger part in these moves. Industry knows and prefers AMPLICALL's engineered quality, multiple features, flexibility of design, and low operation cost. RAULAND's program of nationwide advertising, too is keeping AMPLICALL's many advantages continuously before business executives everywhere — helping RAULAND distributors develop the finest contacts for present and future business.

1. W200 Series AMPLICALL with facilities for up to 24 master stations and up to 12 possible conversations simultaneously.

2. AMPLICALL Paging Control Unit

3. AMPLICALL Weatherproof Speaker

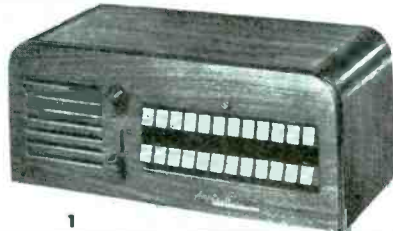

Electroneering is our business

RADIO • RADAR
SOUND



COMMUNICATIONS
TELEVISION

THE RAULAND CORPORATION • CHICAGO 41, ILLINOIS

Bodem Named V.P. of International Detrola

George A. Bodem has been elected a vice-president of International Detrola Corp. and has been placed in executive charge of sales of Detrola radio division, president C. Russell Feldmann announced.

Mr. Bodem has come to International Detrola from the Tung-Sol Lamp Works, Inc., Newark, N. J., by which company he was employed 25 years, resigning the position of general sales manager to accept his new post. In widening Tung-Sol's operations, particularly in the radio tube field, Bodem traveled extensively in this country and Europe and became well acquainted with the radio industry and its distribution problems.

To National Union Post

National Union Radio Corp. announces the appointment of Gail Halliday as district manager for the states of New Mexico, Colorado, Utah, Wyoming, Montana and southern Idaho, including Boise, Pocatello and Twin Falls.

Mr. Halliday is located at 1526 Ivy Street, Denver, Colo.

Zimmerman With Monitor

Paul B. Zimmerman has been appointed executive vice-president of the Monitor Equipment Co., and vice-president of the management company, T. K. Quinn, Inc., New York. Mr. Zimmerman was previously associated with Chrysler as manager of its Airtemp division.

Bendix Appoints Dalton

The appointment of Jack T. Dalton as manager of distribution is announced by Leonard C. Truesdell, general sales manager for radio and television of Bendix Aviation Corp.'s radio division. Mr. Dalton will move from his New York headquarters to Baltimore.

Stromberg Western Rep

E. S. (Brownie) Germain, manager of the Pacific Coast radio division for the Stromberg-Carlson Co., announces that William C. Miles of San Mateo, Calif., has been appointed a radio sales representative in the company's San Francisco branch office.

Eureka Dealer Policies

National distribution of products of Eureka Vacuum Cleaner Co. will be built on a "tailored market coverage" policy designed to assure dealers a maximum sales potential, George T. Stevens, vice-president of the company and manager of its Eureka division announced.

"Selection of a dealer will be based on two factors, geographic location and types of customers served by the individual outlet," Stevens explained.

New RCA Radios

Victrola 55U (shown at top). Contains 5 dual-purpose tubes that give 7-tube performance. Magic loop antenna and dynamic type speaker are used. Dial is straight line. Automatic record changer plays up to 12 records. Permanent point pickup is present. List price approximately \$79.95.



Victrola 59V1 has an automatic "roll-out" record changer that accommodates twelve 10 in. or ten 12 in. records. 9-tube, 3-band radio provides domestic and foreign reception. Automatic electric tuning. List price approx. \$200. RCA Victor Div., Radio Corp. of America, Camden, N. J.—RADIO & Television RETAILING.

(Received after regular pages of "First Radio Merchandise" pp. 52, 53 had gone to press.)

PROMPT DELIVERIES

NOW, ON

MATCHLESS LAMPS

A COMPLETE LINE OF PROVEN
QUALITY MINIATURE LAMPS
FOR

RADIO-ELECTRONICS-
INDICATOR SERVICE-
COIN OPERATED
DEVICES-
FLASHLIGHTS
ETC.

or Wherever Low
Voltage Lamps
are Used



THE
MOST
COMPLETE
LINE
for the

RADIO PARTS JOBBER

MATCHLESS
MAKES GOOD
LAMPS

MATCHLESS ELECTRIC CO.

ESTABLISHED 1912

564 WEST RANDOLPH STREET • CHICAGO 6, ILL.

Plan Farnsworth Meetings; List Production Schedule

Preparations have been completed for a series of coast-to-coast meetings of distributors and dealers of the Farnsworth Television and Radio Corp. and officials of the firm's sales organization, it is announced by E. H. McCarthy, sales manager.

Mr. McCarthy explained the purpose of the meetings was to introduce to the company's dealer and distributor organization actual models of Farnsworth's post-war line and to more fully acquaint the sales personnel with general sales and distribution policies.

Mr. McCarthy stated that Farnsworth will be in production on table models and other small sets early in October and that major console and phonograph-radio models will appear during November. FM and television sets, he said, should be ready for the market by the first of next year.

Webster-Chicago Reps

The following manufacturers representatives appointments have been announced by W. S. Hartford, sales manager, Webster-Chicago Corp.:

Philadelphia - Pittsburgh - Washington: S. K. MacDonald, Liberty Trust Building, Broad and Arch Sts., Philadelphia 7, Pa.; St. Louis: Lee Maynard, 139 North Central, Clayton 5, Mo.; Texas: G. G. Willison, Consulting Technician, West Building, Houston, Tex.; Pacific Northwest: Verner O. Jensen, 2616 Second Ave., Seattle 1, Wash.; S. S. Egert, 27 Park Place continues to handle representation in the metropolitan New York area.

Other representative appointments are under consideration and will be shortly announced.

Admiral Shifts Offices

Admiral Corp. has consolidated its main offices in its principal plant at 3800 W. Cortland St., Chicago. Space previously occupied at 444 Lake Shore Drive will be taken over in its entirety by Appliance Distributors, Inc., the company owned distributor of its products in this area.

Watch OPA Pricing

In a circular sent to dealers, Tom Joyce, general manager of Raymond Rosen & Co., Philadelphia, Pa., suggests that radio-appliance retailers watch OPA pricing policies closely. The letter states that squeezing the dealer's margin means fewer jobs and lower pay scales.

Conlon Sales Appointees

Three veterans in the home laundry equipment sales field will cover the Pacific Coast area for the Conlon Corp., Chicago, according to announcement by I. N. Merritt, vice-president and general manager.

George H. Williams and Arthur C. Maryon will team up to cover California,

Nevada, and Arizona. L. A. Robinson will operate in Oregon, Washington, and Idaho. Mr. Robinson's four sons will rejoin him upon their discharge from war service.

GE Shipping Cleaners

Five thousand vacuum cleaners, the first new General Electric machines since May, 1942, are being sent to distributors across the country, A. L. Atkinson, manager of the company's electric vacuum cleaner division, has announced.

The cleaners, which went into production immediately following the Japs' surrender, will be turned out in increasing volume as the materials supply improves, Mr. Atkinson asserted. By December 1 they will be in full production.

Youngstown Equipment Co. Appoints Guy G. Smith

Guy G. Smith has assumed duties as promotional director of the Youngstown Equipment Co., Boston, Mass., it has been announced by Samuel Dane, vice-president.

The firm is among the newer New England major appliance jobbers that will distribute a full line of major electrical appliances. Lines for which dealers are now being franchised include Youngstown kitchens, Bendix radio, Lauderall automatic washer, York-Heat oil burners, Marion electric ranges, Crown gas ranges, Ben-Hur home freezers, Sunbeam small appliances and others. The firm occupies its own 7-story building with railroad siding, at 111 Berkeley St.

WHY THE FUTURE LOOKS BRIGHT ...for Estate Heatrola Dealers

Yes, I see a new electric range in your future



Hm-m-m... looks like you're going to get a new gas range



You can see a new oil heater in my future! That's fine



Yes, definitely, you're planning on buying a new coal heater



I don't need any crystal ball to know they're all sales for me. Why try to predict what they want? I have it —with the "Fuel-Proof" Line.



Don't lose sales because of fuelish arguments
LINE UP WITH THE "FUEL-PROOF" LINE*

ESTATE

Heatrola

RANGES & HEATERS

RANGES FOR CITY GAS, LP-GAS, ELECTRICITY
SPACE HEATERS FOR COAL, WOOD, OIL

*Estate Heatrola is the ONE line of cooking and heating appliances for ALL FUELS... all sold under one famous, nationally-advertised trade name. (Want the name of your Estate Heatrola distributor? Write or wire.) THE ESTATE STOVE CO., HAMILTON, OHIO • House founded 1842

LEO'S SPECIAL!

Immediate Delivery

Money Back Guarantee on this all-purpose

Multitester

Handles AC and DC Voltmeter, DC Milliammeter, High and Low range Ohmmeter. Size 5 1/2 x 8 x 3 1/4. 3" meter with sturdy D'Aronval movement. Write for priority information.

EVERYTHING IN TEST EQUIPMENT We have it or can get it. Preferred delivery, quick service on all makes, all types. Hundreds of new items on order. Buy from Leo, W9GFQ.

See Leo for WRL Radio Kits priority required



Model WRL 300 ONLY \$1875 Less Leads



Phono Amplifier Kits Complete with tubes, instructions No. 1059... **\$9.50**



Code Oscillator Kits Complete with tube. Size 3"x6". No. 66-200 **\$4.95**

Place Your Order NOW!

Leo is making delivery NOW on

HALLICRAFTERS

For preferred delivery, easy terms, and liberal trade-in allowance, write Leo, W9GFQ

DUAL FIL. TRANSF. Fully Shielded



110 V. Tapped Primary. Secondary, 5 volt @ 3 amp. and 6.3 V.C.T. @ 4 amp. No. 9-551... **\$2.25**

EXCLUSIVE AT LEO'S!

44 Page Parts Flyer... **FREE**

Packed with hard-to-get items. Immediate delivery to radio repairmen. Usual priorities. Experimenters write Leo, W9GFQ, on how to get radio repair parts.

Tube and Circuit Reference Book... 10c

andy Tube-Base calculator... 25c

Giant Radio Reference Map, Size 3 1/2 x 4 1/2 ft 15c

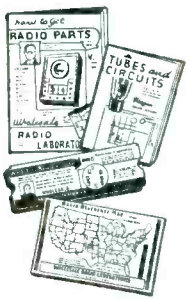

MAIL TODAY

Wholesale Radio Laboratories 744 West Broadway Council Bluffs, Iowa

- Please rush Multitester No. 300, \$18.75 is enclosed, or Enclosed is \$_____, Balance C.O.D.
- Here's 10c, Send "Tubes and Circuits" Book.
- I want a Tube-Base calculator. 25c enclosed.
- Ship me your radio map. 15c enclosed.
- Send me your free flyer of hard-to-get radio parts.

Name _____
 Address _____
 Town _____ State _____
 I am an amateur; experimenter; service man.

QUICK SERVICE
 Your order will receive my own personal attention. You'll get "same day" delivery service from the heart of the nation... on anything in radio.

Sincerely,
 Leo W. Meyerson
 W9GFQ



Wholesale RADIO LABORATORIES

Adaptol



Watch this space for our announcement of an important new product...



ADAPTOL COMPANY

260 Utica Ave., Brooklyn 13, N. Y.

KIT of 60 CONDENSERS

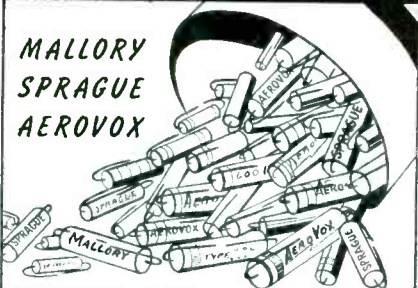

REGULAR LIST VALUE, \$14.75

Our Price, **\$7.50**

Fresh, guaranteed stock. 600-volt condensers. .001, .002, .005, .01, .02, .05, .1, .25 MFD. You also get a FREE Neon Tester with each Kit for checking AC or DC. 60 to 500 volts. Don't miss this swell Olson Bargain!

MAIL THIS COUPON TODAY (Free catalogs on request)

Olson Radio Warehouse
 73-C MILL STREET, AKRON, OHIO
 Please send me _____ Kits of 60 Condensers at \$7.50 each.
 I enclose \$_____ postage paid.
 Send C. O. D.; I will pay postage.
 (Include one Neon Tester FREE with each Kit)

NAME _____
 ADDRESS _____



9,166,281

JUICE KING SALES MESSAGES IN LEADING CONSUMER MAGAZINES

During September and October the imposing total of over nine million sales messages will tell housewives all over the country of JUICE KING quality and superiority.

Watch for this national advertising in Ladies Home Journal and Good Housekeeping—September... Better Homes & Gardens—October... and plan now to feature the popular, fast-moving JUICE KING line.



NATIONAL DIE CASTING COMPANY
 CHICAGO 45, ILL.

Juice King
 FINEST HOME JUICER

SUPREME MODEL 504-A
Tube AND Set
TESTER...

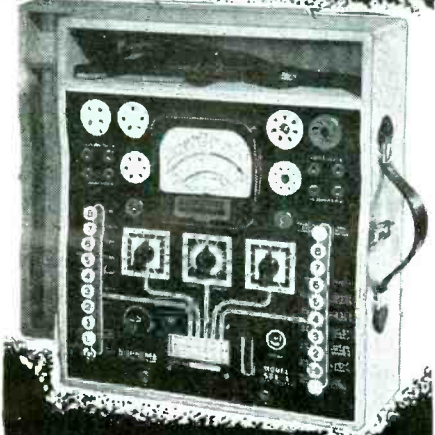

★ **THE PORTABLE LAB**
THAT GIVES YOU
Everything!

- ★ Design proven by over 5 years production of thousands of this model.
- ★ Operation as simple as ABC. Multi-section push-button switches do all work. Simply "follow the arrows" for tube checking. No roaming test leads for the multimeter.
- ★ Open face wide scale 4 1/4-inch rugged meter built especially for this tester—500 microampere sensitivity.
- ★ Each AC and DC range individually calibrated.
- ★ Professional appearance. Solid golden oak carrying case.
- ★ Guaranteed Rectifier.

SPECIFICATIONS

DC MICROAMPERES: 0-500
 DC MILLIAMPERES: 0-2.5-10-50-250
 DC AMPERES: 0-1-10
 DC VOLTS—1000 OHMS PER VOLT:
 0-5-25-100-250-500-1000-2500
 AC VOLTS: 0-5-10-50-250-1000
 OUTPUT VOLTS: 0-5-10-50-250-1000
 OHMMETER: 0-200-2000-20,000 OHMS
 0-2-20 MEGOHMS
 BATTERY TEST: Check Dry Portable "A" and "B" Batteries Under Load
 CONDENSER CHECK: Electrolytics checked on English Reading Scale at Rated Voltages of 25-50-100-200-250-300-450 volts.
 TUBE TESTER: Emission type with noise test floating filaments, easy chart operation. Checks all receiving type tubes.
 POWER SUPPLY: 115 volts 60 cycle. Special voltage and frequency upon request.

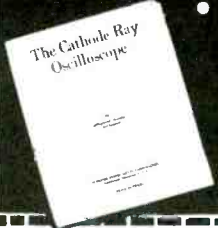

YOU NEED THIS BOOK. "The Cathode Ray Oscilloscope," by Raymond Soward, fully explains basic operating principles of the Oscilloscope. New, 25 pages, written in the Serviceman's language. Send 25c, to cover printing and handling costs, with coupon below.

SUPREME INSTRUMENTS CORPORATION,
 Greenwood, Miss.

I enclose herewith 25c. Please send me your new 25-page booklet, "The Cathode Ray Oscilloscope," by Raymond Soward.

Name.....
 Address.....
 City and State.....

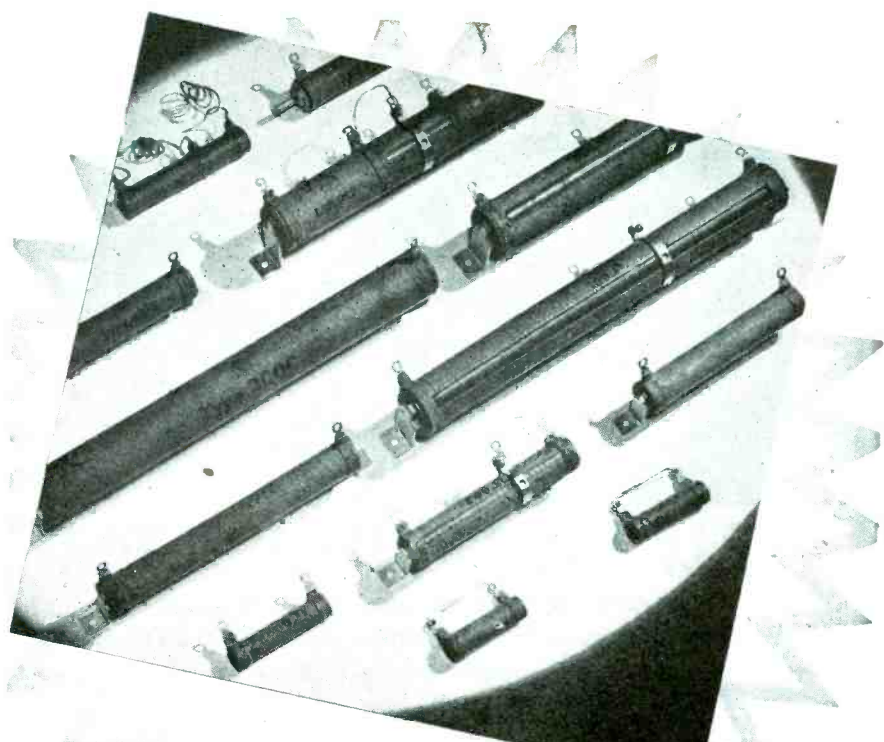

GREENOHMS



Products of
"THE HOUSE OF RESISTORS"

Standard 10 and 20 watt fixed resistors. 1-50,000 and 1-100,000 ohms, respectively.

Standard adjustable resistors. 25 to 200 watts. 1-100,000 ohms. Brackets furnished. Additional sliders available.

Greenohms feature the exclusive Clarostat cold-setting inorganic cement coating. Won't flake, peel, crack, even under serious overload.

Greenohms can take an awful beating. Handle heavy overloads without flinching.

Also available in widest range of windings, terminals, mountings, taps, etc., on special order.

★ GREENOHMS—those green-colored cement-coated Clarostat power resistors—definitely "stay put". You can positively bank on their resistance value. Proof? The fact that they are now found in the finest assemblies—quality instruments, radio transmitters, electronic equipment. The resistance is *right* to start with. And it stays *right*, even after years of use and abuse.

Recently we had occasion to check a batch of Greenohms that had been lying around in a warehouse for years—part of one of our radio show displays. Each and every Greenohm checked "right on the nose". And they make out even better in use and under real abuse. Just try GREENOHMS!

★ **See Our Jobber . . .**

Order your Greenohms from him. Ask for the latest Clarostat Catalog which tells you what to use for profitable servicing and maintenance. Or write us direct.

Controls and Resistors

CLAROSTAT MFG. CO., Inc. · 285-7 N. 6th St., Brooklyn, N. Y.

Another Masco First!!



DE LUXE HI-FIDELITY AMPLIFIER

**Outstanding Engineering Design...for Professional Use
For Faithful Reproduction of Recorded Music, FM and Television**

- 25 watts output on all frequencies from 30 to 15,000 C.P.S. at less than 5% R.M.S. harmonic content.
- Exclusive Masco bass and treble equalizer circuit.
- Designed also as a recording amplifier . . . matching to low or high impedance cutting head.
- Overall circuit stabilized through negative feedback.

SPECIFICATIONS

- **Power Output:** 25 watts
- **Gain:** 77 db (1000 c.p.s.) Bass and treble equalizer at NORMAL
- **Controls:** Three-Volume-Bass-Treble
- **Separate** on-off AC switch.
- **Input:** One-high impedance (low impedance optional)
- **Tubes:** 2-6J5GT/G, 1-7N7, 2-6L6GA, 1-5U4G
- **Output:** Voice coil: 4 and 8 ohms. Line: 250 and 500 ohms.
- **Frequency Response:** $\pm 1\frac{1}{2}$ db, 30 to 15,000 c.p.s. at 25 watts output
- **Hum Level:** 60 db below 25 watts output
- **Power Consumption:** 120 watts
- **Dimensions:** 14 in. x 8 in. x 8 in.

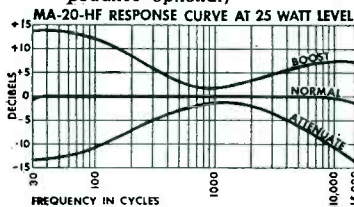

MA-20HF amplifier with cover, tubeslist **117.50**
MA-20HF amplifier same as above but with low impedance input of 250 or 500 Ohms (state preference) list **122.50**

Write for Catalog 45-D

MARK SIMPSON MANUFACTURING CO.

MANUFACTURERS OF

Masco Sound Systems and Accessories

186-194 WEST FOURTH STREET :: NEW YORK 14, N. Y.

Telephone CHelsea 2-7112-3-4

UP FRONT...
Every Time

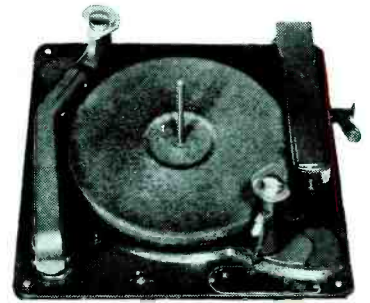

Combination record-changer recorder
Model GI-RC130

You'll like our postwar line of *Smooth Power* motors, recorders and combination record-changer recorders. They are right up in front with high-quality, velvety smooth operation, perfect fidelity in recording or reproduction.

They have the same fine design and built-in qualities that deliver complete satisfaction, as always. There is no skimping of details to give us fast production. You'll have a front seat in the postwar markets with General Industries phonograph mechanisms.

THE GENERAL INDUSTRIES CO.
Dept. M • Elyria, Ohio



THE
GI GENERAL INDUSTRIES COMPANY



Smooth Power

PILOT RADIO



RADIO

*your beacon to a better business
in better radios*

New Radio Manufacturer to Make Midget Sets

The American Communications Corp., 306 Broadway, New York, N. Y., makers of electronic equipment, has entered the radio receiver manufacturing field, it is announced by Eli M. Lurie, president.

The firm will go into production this month. Its receivers will bear the registered symbol of the Statue of Liberty, in addition to its "American" trade mark. Midget radios only will be made by the company at first. Distribution will be through normal jobbing and retailing channels. Two models are scheduled for initial production.

Eureka Deliveries Start

Production of vacuum cleaners made by Eureka Vacuum Cleaner Co. has started, according to H. W. Burritt, president.

"We are prepared to step up production as rapidly as the necessary materials become available," Burritt said, "and we expect to reach our pre-war rate of production peak by the end of this year."

He said initial deliveries will begin this fall.

Meck Continuing Surveys

John S. Meck, president of the John Meck Industries, Plymouth, Ind., announces that as part of the firm's efforts to be helpful to its distributors, it will check total national radio sales through professional research organizations and make the results of that information available to jobbers and retailers.

Sees Job Opportunities in Frozen Food Industry

More than 500,000 individuals should find jobs within the next year or so in the rapidly growing frozen food industry, according to John M. Bess, president of Refrigeration Corp. of America, manufacturers of Frigid-Freeze home lockers.

In explaining the basis for his employment estimate, Mr. Bess indicated that thousands of new workers would be needed in every part of the country by every branch of the industry.

To Tung-Sol Position

Tung-Sol Lamp Works of Newark, N. J., has appointed Hugh J. Casey to the position of export manager.

Masco Patent Agreement

Mark Simpson Mfg. Co., makers of Masco sound equipment and accessories, have completed license negotiations with the Western Electric Co. for the manufacture of amplifiers, sound systems and intercommunication equipment under Western Electric patents.

Elected by Chicago Firm

Lt. Comdr. Lincoln Maytham, former advertising executive, has been elected vice-president of the Wire Recorder Development Corp., Chicago, Ill., Lucius A. Crowell, president of the firm, announces.

Hotpoint Ranges to Sell at or Near 1942 Prices

Edison General Electric (Hotpoint) Appliance Co. officials state that its electric ranges will sell at or near 1942 prices.

The announcement was made as the first models rolled from the production lines. Present production consists of three models, carrying full pre-war bright finish trim on a deluxe model, and other refinements on a moderate cost and a lowest-priced model.

New Turner Microphones

The Turner Co. Cedar Rapids, Iowa, manufacturers of electronic communications equipment, is introducing a new line of microphones in color.

McElroy Division Jobbing Hallcrafters Line

Theodore R. (Ted) McElroy, president of the McElroy Mfg. Co., 82 Brookline Ave., Boston, Mass., has established a distributor division to handle the Hallcrafters line of radio communications equipment, according to an announcement made here by William J. Halligan, Hallcrafters president.

On Emerson Sales Force

Morris Rosenfeld, sales manager of the Emerson Radio and Phonograph Corp., has announced the addition of Harry Schwartz to the firm's sales force. Schwartz will handle the middle Atlantic states territory with headquarters in Baltimore.

MEMO *To my Dealer Friends:*
Here's the NEW EDITION of
my famous Replacement Guide
for Portable & Farm Radios!
Ask for your FREE Copy now!
Homer G. Snoopshaw

BURGESS
REPLACEMENT GUIDE
FOR
PORTABLE & FARM RADIOS

Saves time and trouble!
You quickly find the correct Burgess Battery for every radio replacement need. Lists 1000 Portable and Farm Radios. Ask your Burgess distributor for your copy or send coupon today!

BURGESS BATTERIES

HOMER G. SNOOPSHAW, Dept. 5, Burgess Battery Company, Freeport, Illinois.
Please send me a copy of your Replacement Guide for Portable and Farm Radios.

NAME _____

ADDRESS _____

CITY _____ STATE _____

"Hams" Back on Air

The FCC has ruled that approximately 60,000 amateur radio operators who were compelled to leave the air at the outset of the war may now operate. Until November 15 of this year, "hams" may utilize the 112 to 115.5 mc band. Other channels will be available to amateurs when conditions permit.

ECA Appoints Tom Ward

Electronic Corp. of America has announced the appointment of Thomas W. Ward as assistant sales manager for the nationwide introduction of the company's line of home radios and musical novelties.

According to Jack Geartner, in charge of all ECA sales, Mr. Ward will shortly

begin a coast to coast trip, visiting dealers who have expressed a desire to obtain the ECA radio dealer franchise.

Changes in Hoffman Staff

Changes in the sales organization of the Hoffman Radio Corp., have been announced by H. Leslie Hoffman, president.

R. J. McNeely, sales manager, will fill the newly created post of general sales manager; D. D. Spence becomes assistant sales manager; Earl Noyes, company employment director, will transfer to sales to supervise the Los Angeles sales territory, the San Bernardino county, and the coast from Paso Robles south to San Juan Capistrano. Harlan Bassett and E. H. Knox have transferred to sales,

20 Years Ago

From the October, 1925, Issue of Radio Retailing

BROADCASTING OF NEWS MAY PROVE RADIO'S "WHITE HOPE"—This editorial calls for "brief, last minute news reports 'on tap' at definite periods throughout the day, including the time when the head of the home is at his breakfast table. . . ."

SERVICE IS SOLID FOUNDATION FOR FUTURE SALES—Headline.

EVERY FARMER NEEDS A RADIO SET—Make an Effort to Sell to Farmers. There is still room for aggressive salesmanship in reaching the farm market.

GAVE AWAY DOLLAR BILLS FOR FIFTY CENTS—In an effort to build confidence in his store, a California dealer offered dollar bills for 50 cents. Only one out of 500 accepted the offer.

MOVING WINDOW DISPLAYS—Action Makes Passers-by Stop, Look and Listen.

INTEREST WOMEN IN RADIO—Radio Retailing Starts a Campaign.

TRADE, NOT LABORATORY, MUST OF NECESSITY CENSOR NEW PRODUCTS—Readers are encouraged to criticize new merchandise advertised, as a publication cannot set itself up as a jury to decide what is, or what is not, truth in advertising in terms of new devices.



12 Models.. **ALL LENGTHS — ALL STYLES**
PLEASURE AND POLICE TYPES



Get a copy of the new RADIART AERIAL CATALOG from your Distributor — available now.

Made from RADIART Quality materials throughout, these Aerials will meet every expectation for ease of installation — durable construction — perfect insulation and rustproof finish.

They are worthy of the name RADIART and are another example of why RADIART AERIALS HAVE ALWAYS BEEN THE STANDARD OF COMPARISON.

If you have not already done so, send your order to your Distributor for a stock of these new, glamorous RADIART AERIALS now.

Manufactured by the makers of RADIART Exact Duplicate Vibrators.

Radiart Corporation

3571 W. 62nd STREET • CLEVELAND 2, OHIO
Export Division 455 CRAIK ST., W. MONTREAL, CANADA
25 Warren St., New York 7, N.Y.

Xmas Deals

(Continued from page 51)

free, and includes holiday window display, streamers with photos of albums, and individual gift wrap-around strips for customers' use.

Capitol's surprise for the dealer's Xmas stocking is something NEW in children's records, to be announced.

Cosmopolitan Records, Inc., with headquarters at 745 5th Ave., New York, is a new company, and it promises deliveries to the dealers for Xmas sales. Featuring artists of national radio network fame, they have recorded Joan Edwards, Jerry Wayne, Gertrude Niesen, Barry Wood, among others. Cosmopolitan Records is already shipping to distributors.

For the record, you should have a Merry Christmas, Mr. Dealer!

Webster Electric Pickups are Precision-Built for Flawless Tone Reproduction

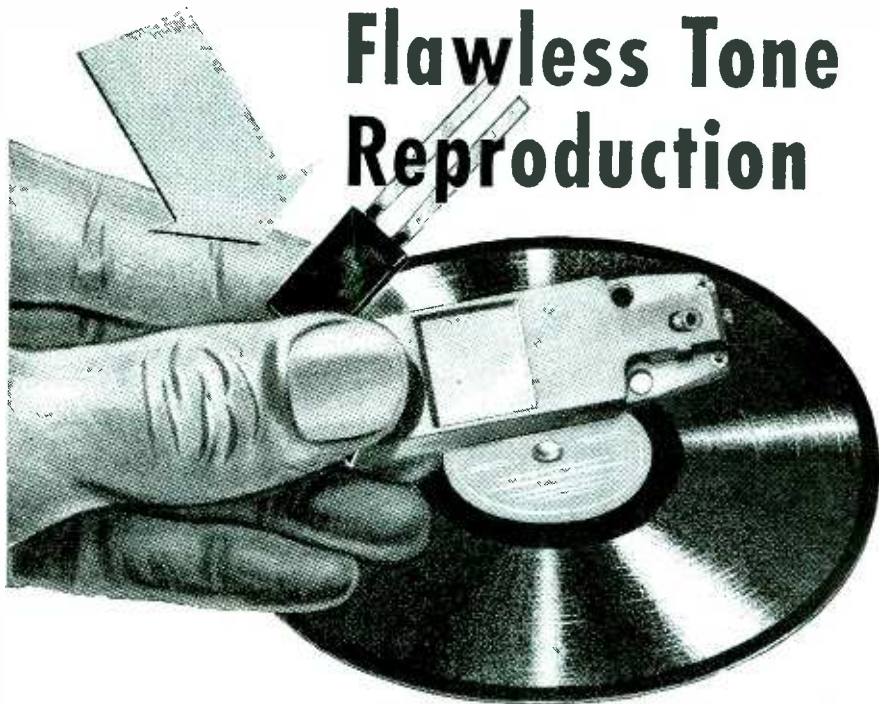

There is a large and profitable market in every community right now for the replacement of pickups in radio-phonograph combinations. Thousands of owners of high-grade, expensive instruments are discouraged by the unsatisfactory reproduction of their choice records . . . a defect quickly remedied when a new Webster Electric Pickup is installed.

Webster Electric Pickups . . . delicate, sensitive, responsive to every tone shading over the entire vocal and orchestral range . . . are unsurpassed in quality and performance. They actually make many radio-phonograph combinations play records better than when the instruments were new!

By supplying Webster Electric Pickups and Cartridges to your trade, you build good will and substantially increase your profits. They are available in models to fit most standard makes. Our Service Chart RC-147 will help you select the right Webster Electric Pickup for replacement use. Send for it today.

Let's All Back the Attack
Buy Extra War Bonds



(Licensed under patents of the Brush
Development Company)

WEBSTER ELECTRIC

Racine, Wisconsin, U.S.A. • Established 1909 • Export Dept.: 13 E. 40th Street, New York (16), N.Y.: Cable Address "ARLAB" New York City

"Where Quality is a Responsibility and Fair Dealing an Obligation"

Appliances

(Continued from page 96)

to buy. Two-thirds of a sale is closed when the prospective purchaser shows interest in an appliance. By careful customer handling, the salesman supplies the other one-third to close the deal," Murphy concluded.

After a radio or electrical appliance is sold, the store follows up each sale with *service*. "Customers expect good service on merchandise they buy," Dealer Murphy declared. "As an independent retailer, I could not sell many appliances if I did not keep our customers' appliances in working condition."

The firm depends on three conditions to keep its profits high:

1. Keeping costs of selling down.
2. Selling good merchandise at fair prices.
3. Backing up sales with service.

Customers "Charge It"

A high percentage of the goods and services sold at this establishment is transacted on a charge account basis. Approximately 80 per cent of the store's customers tell the dealer to "charge it." The large amount of open account sales is explained by the volume of business which the store does in electrical contract work.

When an appliance is sold to a charge customer, the sale is entered on a card by the salesman. This amount is then transferred to the firm's day book. Customers are billed and payment is requested in 60 days from the date of sale.

"We find that if an item is properly sold, we experience no difficulty in collecting our bills," Murphy declared.

First deliveries of new radios and appliances are now arriving at the dealer's store. To distribute these new goods fairly, this retailer is now making use of his customer priority list.

Premiums for Kiddies

A standard practice of the store is the distributing of free premiums to customers' children. This policy is followed throughout the year. The free premium method is *not* advertised. Gifts such as pencils, rulers, etc., are given with discrimination.

"It is surprising how these inexpensive premiums have helped us," Murphy stated. "The psychology behind free premiums is simple. The same effect is achieved when a baker gives a cookie to a child. Children are pleased with free premiums, and—what is more important—a hit is made with their parents."

INDEX To Advertisers

October, 1945

	Page		Page
Adaptol Co.	142	Meissner Mfg. Co.	121
Aerovox Corp.	10	Merit Coil & Transformer Corp.	4
Alliance Mfg. Co.	138	Muter Co.	139
American Phenolic Corp.	80	National Die Casting Co.	142
Ansley Radio Corp.	64	National Union Radio Corp.	23
Astatic Corp.	130	National War Fund	18
Automatic Radio Mfg. Co., Inc.	9	Newcomb Audio Products Co.	136
Bell Sound Systems, Inc.	127	Noblitt Sparks Industries, Inc.	87
Bendix Radio Div. of Bendix Aviation Corp.	31	Olson Radio Warehouse	142
Burgess Battery Co.	145	Onan & Sons, D. W.	126
Burstein-Applebee Co.	147	Permo, Inc.	126
Caldwell-Clements, Inc.	102, 132, 147	Philco Corp.	15
Centralab	30	Pilot Radio Corp.	144
Chicago Tribune	8	Presto Recording Corp.	26
Cinaudagraph Speakers, Inc.	137	Quam-Nichols Co.	149
Clarostat Mfg. Co.	143	Radiart Corp.	131, 146
Columbia Wire & Supply Co.	126	Radio Corp. of America: RCA Victor Division	75, 76, 77, 109, 114, 115
Commercial Credit Co.	108	RCA Engineering Products Division	78
Cornish Wire Co., Inc.	134	Radio Supply & Engineering Co., Inc.	131
Crosley Corp.	71	Rauland Corp.	139
Delco Radio Div., General Motors	123	Ray-O-Vac Co.	91
Detrola Radio Div., International Detrola Co.	69	Raytheon Mfg. Co.	6
DuMont Laboratories, Inc., Allen B.	107	Rider Publisher, Inc., John F.	129
Eastern Amplifier Corp.	58	Sandwick Associates, L. M.	16
Electro Products Laboratories	126	Seeburg Corp., J. P.	Cover 3
Electronic Corp. of America	104	Simpson Electric Co.	94, 95
Electronic Laboratories, Inc.	111	Simpson Mfg. Co., Mark	144
Electronic Products Mfg. Corp.	138	Snyder Mfg. Co.	147
Emerson Radio & Phonograph Corp.	1	Sonora Radio & Television Corp.	105, 117
Esquire	61	Sound Equipment Corp.	133
Estate Stove Co.	141	Sparks-Withington Co.	60
Fada Radio & Electric Co.	11	Sprague Products Co.	24, 118
Fairfield Lumber Co.	137	Standard Transformer Corp.	131
Farnsworth Television & Radio Corp.	32	Stewart-Warner Corp.	67
Fawcett Publications, Inc.	93	Stromberg-Carlson Co.	34
Galvin Mfg. Corp.	2, 3, Cover 4	Superior Instruments Co.	21
Garod Radio Corp.	20	Supreme Instruments Corp.	143
General Electric Co.	89, 113	Swain Nelson Co.	59
General Industries Co.	144	Sylvania Electric Products, Inc.	90
General Mills, Inc.	57	Teletone Radio Co.	29
Gibson Refrigerator Co.	124	Templeton Radio Mfg. Corp.	19
Graybar Electric Co.	150	Today's Woman	63
Hallcrafters Co.	81, 119	Trilmont Products Co.	70
Hamilton Radio Corp.	103	Triplet Electrical Instrument Co.	98
Hammarlund Mfg. Co., Inc.	120	True Confessions	101
Howard Radio Co.	25	Tung-Sol Lamp Works, Inc.	14
Home Recording Co.	133	Turner Co.	17
Hytron Radio & Electronics Corp.	110	Utah Radio Products Co.	99
International Resistance Co.	72	Viewtone Co.	22
Jackson Electrical Instrument Co.	125	Ward Leonard Electric Co.	139
Jensen Radio Mfg. Co.	116	Ward Products Corp.	147
Ken-Rad, Div. General Electric Co.	7	Warren Telechron Co.	28
Kugel Co., Frederick	135	Warwick Mfg. Corp.	73
Lake Radio Sales Co.	135	Waters Conley Co.	33
Lear, Inc.	84	Webster Electric Co.	148
Maguire Industries, Inc., Thordarson Div.	85	Weller Mfg. Co.	136
Majestic Radio & Television Corp.	97	Weston Electrical Instrument Corp.	128
Mallory & Co., Inc., P. R.	Cover 2, 65, 122	Wholesale Radio Laboratories	142
Marion Electrical Instrument Co.	27	Wilcox-Gay Corp.	12
Matchless Electric Co.	140	Wittie Mfg. & Sales Co.	13
Meck Industries, Inc., John	5		

While every precaution is taken to insure accuracy, we cannot guarantee against the possibility of an occasional change or omission in the preparation of this index.

WATCH FOR THE

QUAM
Advertisers Come

QUAM-NICHOLS CO., 33rd Place and Cottage Grove, Chicago 16, Illinois

A Revolutionary New Speaker for the
Post-War Market, to be announced soon



**"IT'S THE ONLY ONE EQUIPPED TO
FILTER-OUT SINGING COMMERCIALS."**

FOR LINES THAT WILL KEEP ON SELLING MAKE GRAYBAR YOUR RADIO SOURCE

RADIO, RADIO-PHONO, AND TELEVISION SETS

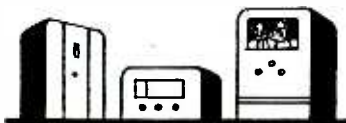

MAJOR APPLIANCES

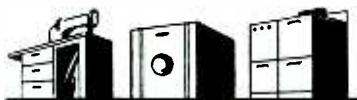

SMALL APPLIANCES



Any new-model radio is going to sell fast — at first. But your best future lies in those radio and appliance lines that will keep the cash register ringing after the initial rush-to-buy is over.

That's why you'll be wise to choose the "via-Graybar" lines. For Graybar distributes only those radios and appliances which (1) are products of responsible manufacturers, (2) have features of universal buy-appeal, (3) are backed by effective consumer advertising.

Graybar's Merchandising Specialists can show you how to turn these features into new sales records. *Graybar Electric Company — in over 80 principal cities. Executive offices: Graybar*

Building, New York 17.

4573

DISTRIBUTION IS MERCHANDISE *and Men*



Meet D. H. ("Cap") Capelli, our District Merchandising Manager at Los Angeles — one of the specialists throughout the nation who are guiding Graybar dealers toward new sales records.

"Cap's" ten years with Graybar — following wide experience as sales manager of a radio-and-appliance concern — qualify him as a merchandising expert *par excellence*.

Membership in three electrical clubs has added to his "inside" knowledge of electric products — rounding out his understanding of dealers' sales and service problems.

via
Graybar

Merchandising Department

THIS IS WHAT WE ^{WILL} SELL!



**SEEBURG
RECORD
CHANGERS**

**SEEBURG *Wire*
RECORDERS**



It will be necessary . . . for radio manufacturers to make provision in their circuits to accommodate the Seeburg Wire Recorder and we therefore invite prompt inquiries from interested radio manufacturers.



Awarded to the J. P. Seeburg Corporation for outstanding production of war materials in each of its four plants.

SIMPLE . . . DEPENDABLE . . . TROUBLE-FREE OPERATION . . . three vitally important factors in the manufacture of a mechanical device! The post-war line of new Dependable SEEBURG RECORD CHANGERS has been designed with fewer moving parts. As rapidly as restrictions are lifted and materials become available, production on our SEEBURG RECORD CHANGERS will be started.

The SEEBURG WIRE RECORDER is as new and recent as today's newspaper! This amazing electronic engineering achievement is an established and accepted recording medium. One simple control knob operates the SEEBURG WIRE RECORDER to reproduce or record speeches, plays, meetings, music, programs off the air, etc. There are no needles or discs used.

Seeburg

J. P. SEEBURG CORPORATION • CHICAGO

How a radio dealer should prepare for **D-DAY** (DELIVERY DAY)



➡ No matter how few or how many radios you have on your floor . . . be sure they are radios with names that have national character and are known to consumers!

➡ Chances are you won't have enough radios to take care of even a small portion of the demand . . . so be ready with a sound, workable priority system. Take orders and put your customers on a waiting list in which they will have confidence.

➡ **DON'T BE** an "eager beaver". It will do you a lot more good to say, "Sorry, you'll have to wait for the nationally advertised radio you wanted" . . . than to deliver some nameless orphan whose "parents" will have run away when quality and performance are found lacking!

P. S. *Thousands* of dealers from coast to coast have already indicated their preference for Motorola Radios because *millions* of Motorolas in homes and cars have performed beautifully with minimum servicing during the war. There is sales power and profit in a favorably known name like *Motorola*

GALVIN MFG. CORP., CHICAGO 51

 **Motorola** **A-M**
F-M **Radio**

FOR HOME AND CAR

F-M & A-M HOME RADIO • AUTO RADIO • PHONOGRAPHS • TELEVISION • AIRCRAFT RADIO • POLICE RADIO • RADAR • MILITARY RADIO