

RADIO *& Television* RETAILING

CALDWELL-CLEMENTS, INC.

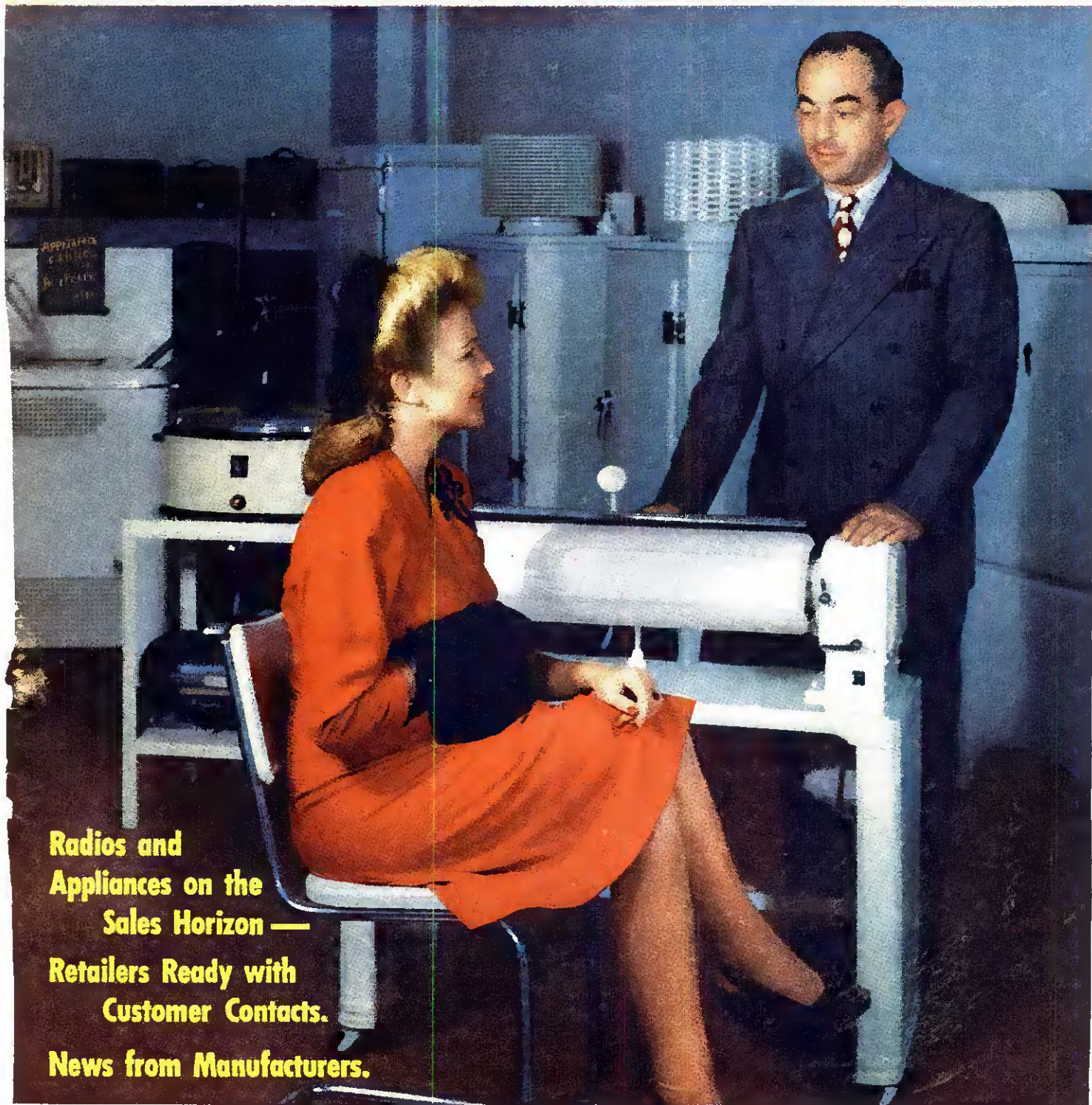

JULY 1945



**Radios and
Appliances on the
Sales Horizon —
Retailers Ready with
Customer Contacts.
News from Manufacturers.**

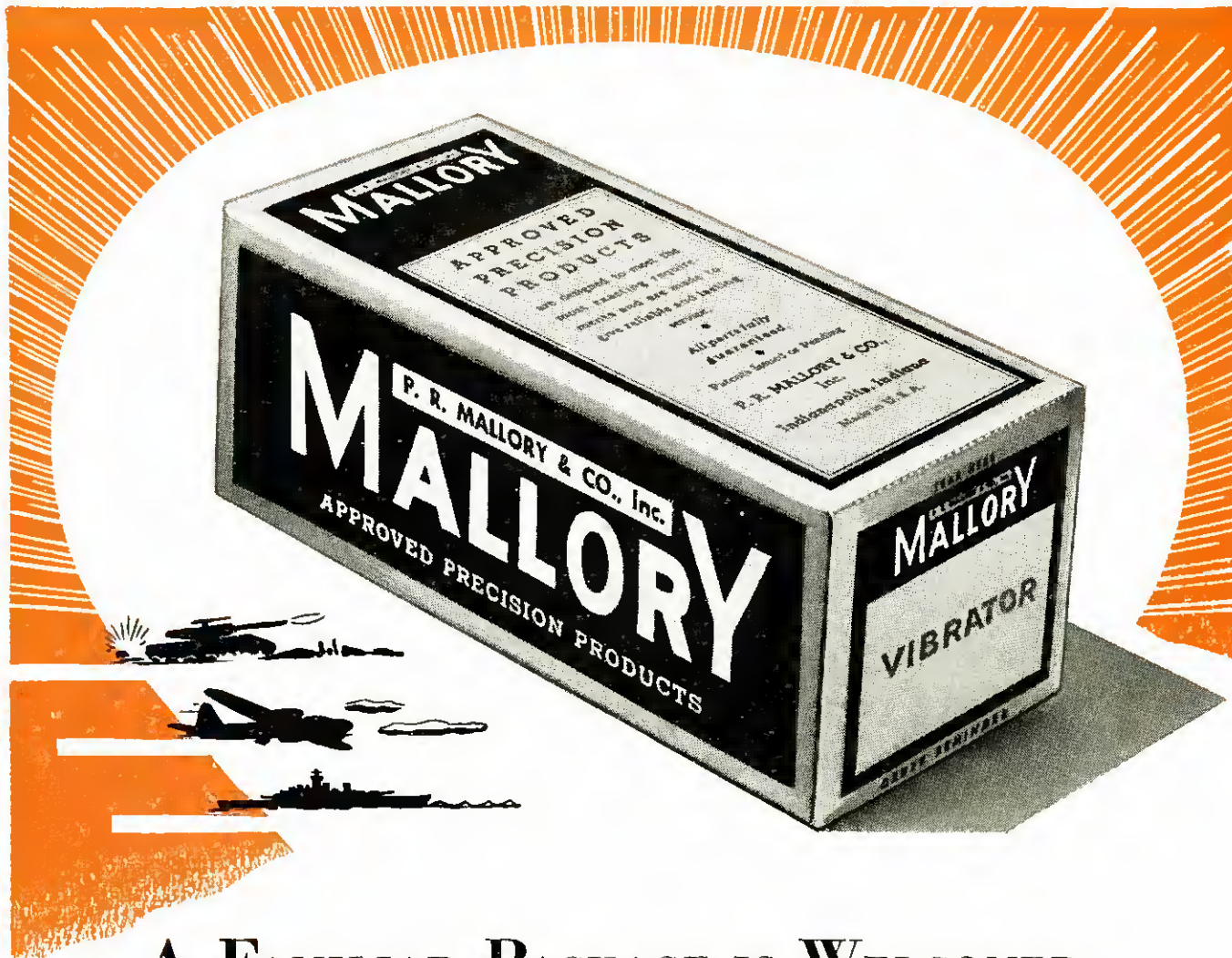

A FAMILIAR PACKAGE IS WELCOMED BACK TO DISTRIBUTORS' SHELVES

DUE to the military demands of American and Allied fighting forces, distributors' shelves have frequently been bare of Mallory vibrators in the past two years. But now the familiar orange and blue cartons are back in stock. Mallory vibrators have returned—to give you even better service than ever!

They have passed all required military tests . . . they have been adopted by the Navy, the Coast Guard, the Signal Corps, the Air Corps, the Marine Corps and other Government agencies . . . they have benefited from 14 years of Mallory

"know how," enormously extended by the demands of war.

And the same careful selection of materials . . . the skill in manufacturing . . . the precise adjustment . . . the rigid testing and inspection methods . . . assure you, as always, of a dependable, trouble-free product.

Incidentally, when you order these vibrators from your Mallory distributor, ask him for a copy of the Mallory Vibrator Standardization Chart. It will show you how 65 Mallory Vibrators now replace 101 different types . . . how 90% of your replacement needs can be met with only 12 vibrators!

P. R. MALLORY & CO., Inc., INDIANAPOLIS 6, INDIANA



*More than ever—
ALWAYS
INSIST ON*

P. R. MALLORY & CO. Inc.
MALLORY
APPROVED
PRECISION PRODUCTS

**VIBRATORS • VIBRAPACKS* • CONDENSERS
VOLUME CONTROLS • SWITCHES • RESISTORS
FILTERS • RECTIFIERS • POWER SUPPLIES**

ALSO MALLORY "TROPICAL"™ DRY BATTERIES, ORIGINALLY DEVELOPED BY MALLORY FOR THE U. S. ARMY SIGNAL CORPS NOT PRESENTLY AVAILABLE FOR CIVILIAN USE.

* Trademark

READY *today*... a 3-Step "Package" from

Admiral

To Help You Make Postwar Sales NOW!

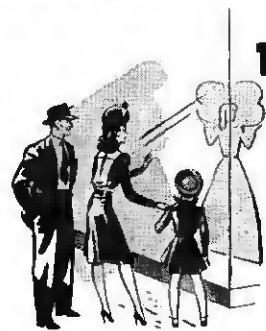
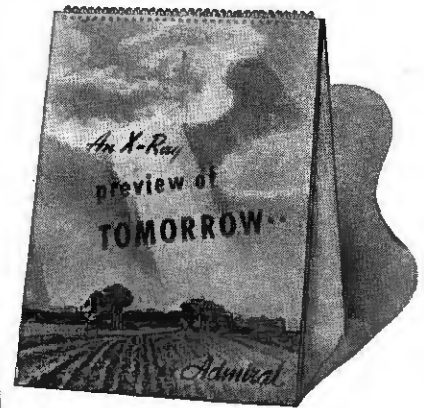

1 Step off in the race for postwar sales with ADMIRAL's big, new, 4-piece window display. Invite people into your store *now* for an exciting X-RAY presentation of ADMIRAL postwar merchandise. Display is in full color... 48 in. high. "On and off" shadow box illuminates "Slide-A-Way" Radio Phonograph and "Dual-Temp" Freezing Locker.

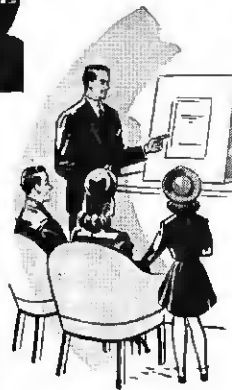

2

Here's the second step in ADMIRAL's program to help you make postwar sales now: a 28-page, full color book with "X-RAY" views that tell the inside story of ADMIRAL radio-phonographs, record changers, refrigerators, electric ranges and home freezers. Builds *real* consumer acceptance for ADMIRAL products.



3

The third step: ADMIRAL's new, 16-page, 4-color booklet, "It's a Promise from Admiral." Gives the story of ADMIRAL products and highlights exclusive ADMIRAL selling features. For use as a mailout or give-away and to supplement your X-RAY presentation of ADMIRAL merchandise. Special counter display card invites customers to ask for a copy. For full information concerning ADMIRAL's 3-step "package," see your nearby ADMIRAL Distributor.

TUNE IN
Every Sunday—Admiral
"World News Today"
CBS, 2:30 P.M. EWT.



Admiral Corporation CHICAGO 47, ILL.



World's Largest Manufacturer of Radio-Phonographs with Automatic Record Changers • Manufacturers of Radios • Refrigerators • Home Freezers • Electric Ranges

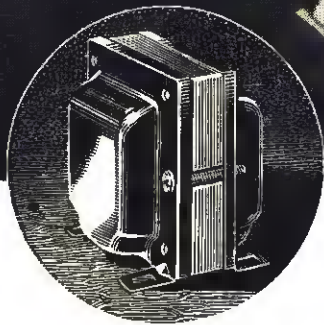

★ *This speaks for itself: Utah is its own transformer supplier for speakers, vibrators, wire recorders, etcetera.*

WHEN UTAH SAYS... "OK-SHIP"

It's like putting a big liner into water. Like a launching. Only here at Utah, we don't take time for celebration. Radio makers and electronics dealers appreciate the highly specialized product that has been manufactured . . . the way a skipper appreciates a fine craft. Radio listeners, like ships' passengers take all this precision for granted.

Here at Utah our workers (assisted by

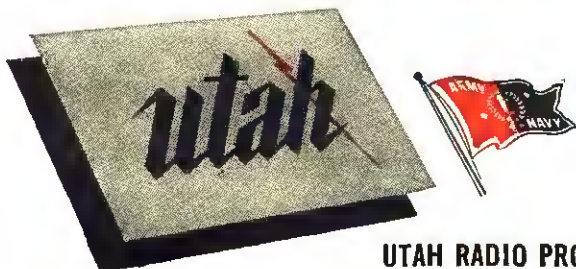

Utalins*) begin with nothing but the raw materials from which they make the tools that turn out Utah radio parts and electronic devices. At each step in manufacture . . . punch press, electroplating, welding, coil winding . . . from the beginning through to the finished product, Utah workers check, re-check, test and prove to Utah standards. When Utah says . . . "OK-SHIP" products of quality that stand up under every condition known to man leave to broadcast Utah performance around the world.

*Utah's Helpers

UTAH RADIO PRODUCTS COMPANY, 820 ORLEANS ST., CHICAGO 10, ILL.

Utah Electronics (Canada) Ltd., 300 Chambly Road, Longueuil, Montreal (23) P.Q. • Ucoa Radio, S.A., Misiones 48, Buenos Aires

Philco is Proud of its "Service Record"



Proud as Philco is of its big wartime job of supplying radar and other electronic equipment to the Army and Navy... there is another "service record" worthy of some special attention.

It's the job done by Philco distributors, dealers and servicemen in maintaining high standards of service on all Philco products.

They have done a great job... despite critical shortages of manpower... due to the urgent need of the armed forces for men with the training and experience which always characterized Philco servicemen.



While we pay tribute to the way Philco dealers have overcome so many difficulties... it might not be out of place to mention that their ability to maintain those standards of service was due in no small part to foresighted planning by the Philco Service Division.

NOW LET'S LOOK TO THE FUTURE!



All the record of accomplishment that has marked the maintenance of Philco Service through the war years will be eclipsed by the Greater Philco Service of the future!

That is not a forecast... or a bit of wishful thinking. At this very moment... this Greater Philco Service is a reality! It is not a dream of tomorrow... but an actuality *as of today!*

At Philco Service Division Headquarters in Philadelphia, "pilot plants" are already in full working operation... to serve as models for the service shops of Philco dealers. The Greater Philco Service Organization is away past the blueprint stage. It's at the service of Philco dealers and servicemen right now!

Philco Field Service Engineers are already travelling the country... building the greatest international service organization radio and refrigeration has ever known!

The post-war Philco Service Program will be miles ahead of any past performance. And best of all... **IT'S ON THE JOB RIGHT NOW!**

PHILCO



Radios • Phonographs • FM • Television • Refrigerators • Freezer Chests • Air Conditioners



Our New Booklet—

**"MERIT SALUTES
THE SIGNAL CORPS"**

with illustrations
in four colors
is now available

Please write for your copy



MERIT COIL & TRANSFORMER CORP.

TELEPHONE

4427 North Clark St. Long Beach 6311 CHICAGO 40, ILL.

**RADIO
Television
RETAILING**

Including Radio and Television Today

MEMBER AUDIT BUREAU of CIRCULATIONS

JULY, 1945

COVER—*Selling is on the way back! Retailers ready to reap sales harvest from faithful war-time service. (Dealer Ray Kline, owner of Ray Kline, Inc., White Plains, N. Y.—see front cover).*

- 29 Retailers and the Utilities
- 30 Radios and Appliances Today
- 32 Merchandising Do's and Don'ts
- 34 Sales in Six Figures
- 36 Live Wire Appliance Dealer
- 38 Outdoor Sound
- 40 Publicity for Sales
- 42 Retailers' Postwar Plans
- 44 Rhapsody for Record Sales
- 46 Paving the Way to Profit
- 48 Radio-Appliance Outlook
- 50 Platter Profits Climb
- 56 Spotlight on Selling
- 60 Servicer Saves Time
- 65 Display Guides for Discs
- 66 Selling Is Coming Back!
- 72 Servicing Detectors, II
- 80 New Merchandise
- 84 Jobber Jottings
- 88 Television Today
- 97-119 Trade Talk

RADIO & Television RETAILING, July, 1945, Vol. 30, No. 7. 25 cents a copy. Published monthly by Caldwell-Clements, Inc., 480 Lexington Ave., New York 17, N. Y. M. Clements, president; Orestes H. Caldwell, treasurer. Subscription rates United States and Latin American countries, \$1.00 for one year, \$2.00 for three years, Canada \$1.50 for one year, \$3.00 for three years. All other countries \$2.00 for one year, \$4.00 for three years. Printed in U. S. A. Re-entered as second class matter April 21, 1944, at the Post Office at New York, N. Y., under the act of March 3, 1879. Member of Audit Bureau of Circulations. Copyright by Caldwell-Clements, Inc., 1945.

*Trade-Mark Reg. U. S. Pat. Off.

ORESTES H. CALDWELL
Editor

M. CLEMENTS
Publisher

John L. Stoutenburgh, Managing Editor
William E. Moulie, Technical Editor
Helen Thurman, Associate Editor
Charles F. Dreyer, Art Director
Assistant Editors
Ruth Morris, Nathaniel J. Kern
Solomon Heller, E. T. Bennett
Stephen I. Hall, Consulting Editor

M. H. Newton, J. A. Samborn
B. V. Spinetta, O. H. Sutter
I. Candy, W. W. Swigert
E. Duggan, J. Cosin

Lee Robinson, Sales Manager
Ben Morris, Promotion Manager
R. Y. Fitzpatrick, Western Manager
Chicago, 201 N. Wells St.
Telephone RANdolph 9225
Dudley B. Trott, Cleveland Manager
Citizens Building, 850 Euclid Ave.
Telephone MAin 8270

Editorial and Executive Offices
Telephone PLaza 3-1340
480 Lexington Avenue
New York 17, N. Y.

WHERE THE CONSUMER'S

RADIO DOLLAR

WILL BE SPENT

5%
WILL BUY FROM
X TYPE STORES

25% WILL BUY FROM
THE
"RADIO DEALER"

6%
WILL BUY FROM
Y TYPE STORES

64% OF YOUR CUSTOMERS DON'T KNOW
WHERE THEY'LL BUY THEIR NEW
RADIO SET



Here's Why

MECK NATIONAL ADVERTISING
SELLS THE PUBLIC ON THE DEALER

You, Mr. Independent Dealer, have the "edge" on the huge radio market that naturally belongs to you.

But the "undecided" 64% of the buyers in your community could easily change their buying habits—and shift the volume elsewhere.

The only manufacturer who is actively fighting this battle for the Independent Dealer—is Meck. It will pay you to tie in with this program. Ask about the Meck Preferential Dealer Plan.



John Meck

JOHN MECK INDUSTRIES, Inc., PLYMOUTH, INDIANA



MECK RADIOS

TABLE MODELS • PORTABLES • AM-FM • CONSOLE COMBINATIONS • PHONOGRAPHS

WARWICK MANUFACTURING CORPORATION

4640-50 W. HARRISON STREET



TELEPHONE ESTEBROOK 2727

CHICAGO 44, ILLINOIS



**TO THE DEALER
WHO IS BUILDING
HIS POSTWAR
FENCES TODAY**



Production is my responsibility. I believe every CLARION dealer will be interested to know what we have done to be ready for your orders when we are allowed to make civilian radios again.

First, let me tell you briefly about our production organization. The war has given us broad experience in new manufacturing methods. We have acquired new skills . . . new techniques . . . new test procedures . . . all of which will be readily recognizable in finer CLARION receivers. For example, our "battleship type" construction will find its way into our peacetime products. In the strictest sense of the word the new CLARION will be "built to take it."

The next point I believe every CLARION dealer is interested in is the fact that our personnel has developed into a seasoned hard-hitting organization. This means that no untried, unproven production methods or techniques will be necessary. There will be no need for production experiments.

The third and final point I want to make to you is that we enjoy excellent relations with our suppliers, our employees and with the other divisions of our organization. Put in another way—ours is "a happy family."

All of these things together have but one meaning to you. CLARION will be a good radio—staunchly built—priced right for ready sale.

Sincerely yours,
WARWICK MFG. CORP.

Gordon G. Brittan
Vice President



YEARS OF PROVED PERFORMANCE

KEN-RAD

Little Giant MINIATURE TUBES



Better than ever

● Everywhere the sturdy performance of portable radios is a tribute to the quality and dependability of Ken-Rad Miniature Tubes...Now that important new research and manufacturing facilities have been added, Ken-Rad users will benefit in tube performance and value that are *better than ever*... Ken-Rad dealers will reap still larger profits.

Write for your copy of
"Essential Characteristics"
the most complete digest of
tube information available.

178-05-0650

KEN-RAD

OWENSBORO, KENTUCKY

Down an invisible road in the sky

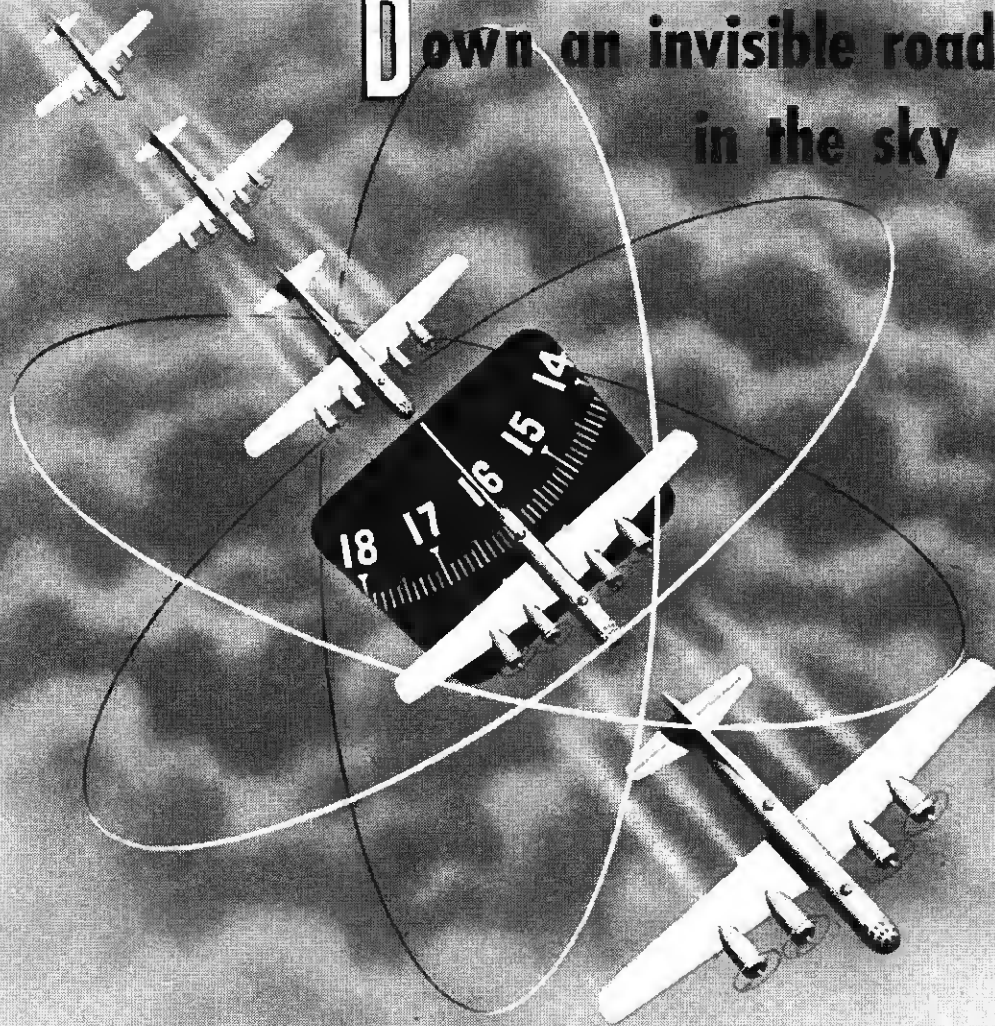

There are no road signs on clouds, yet Allied fliers, aided by electronic impulses, are daily arriving over the target after long flights over endless water. On accuracy in aerial navigation depends the success of a bombing run on Tokyo—and a safe return home. High-frequency impulses assure steady communication, aid in locating planes and ships, and coordinate movements of aircraft, armies and ships. Delco Radio Division is proud of its contribution to final Victory through the development and production of compact mobile radio sets and highly specialized electronic and radar equipment. Delco Radio Division, General Motors Corporation, Kokomo, Indiana.

Delco Radio
DIVISION OF
GENERAL MOTORS

WAR BONDS ARE FIGHTING BONDS

RADIO & Television RETAILING • July, 1945



THORDARSON

*celebrates its 50th. Anniversary
by joining hands with.*

MAGUIRE INDUSTRIES

A
GREAT PAST
LINKED TO

A
GREATER
FUTURE
1895 - 1945

Throughout the past half century, the name "THORDARSON" has been a synonym for highest quality in transformers and other electrical equipment.

Under the banner of Maguire Industries, this tradition of leadership will be maintained in even fuller measure.

Thordarson's new plans include outstanding improvements in present lines... new products and services to meet the expanding needs of the radio and electronic industries... vigorous and liberal merchandising policies... and a generally forward-looking viewpoint with regard to all of the industries we are privileged to serve.



A Subsidiary of Maguire Industries

THORDARSON
ELECTRIC MFG. COMPANY
500 WEST HURON STREET
CHICAGO 10, ILLINOIS



Majestic dealers are walking on air these days...

NO WONDER Majestic dealers are so enthusiastic about their profit-prospects! They have the franchise of the entire radio industry, a franchise that gives them all the advantages of—

A NAME—Majestic Radio—proved by independent research to be familiar to 88.2% of the public... yes, to practically 9 persons out of every 10.

A PLAN—Controlled Distribution—that makes it possible for Majestic dealers to take their proper profit on every Majestic sale they make.

MANAGEMENT that's young, forward-looking, fast-moving... with the retailing

background essential to sympathetic understanding of dealers' problems.

PRODUCTS—Majestic Radios and Radio-Phonographs—that will incorporate the most desirable and the most practicable of wartime advances. Products styled and engineered to combine quick turnover and maximum profit-per-sale.

SALES NOW! Majestic Records are now building valuable store traffic for Majestic dealers... are now building up the Majestic name with those who will soon be customers for Majestic Radios and Radio-Phonographs!

Write today for complete information about Majestic... and about the Majestic franchise. See why Majestic dealers are so enthusiastic about their profit-prospects that they're "walking on air." Majestic Radio & Television Corporation, St. Charles, Illinois.

Majestic means business...and lots of it!



CONSOLIDATED VULTEE USES **RAYTHEON** TUBES

in Electronic Recorder for Flight Testing

No more tedious pencil notations . . . no more bulky camera equipment! An amazing "electric brain" developed by Consolidated Vultee Aircraft Corporation now helps this firm test its new planes *electronically*.

This remarkable device, consisting of a transmission unit in the plane and a receiving-recording station on the ground, employs a large number of famous Raytheon High-Fidelity Tubes.

It's just one of thousands of examples that prove an important point: *where dependable performance is vital, you will find Raytheon Tubes.* That means Raytheon Tubes can be relied upon to help you do your best service work and thus build your business steadily.

Switch to Raytheon Tubes *now* . . . and watch for a revolutionary merchandising program that Raytheon is developing for your benefit!

Increased turnover and profits, plus easier stock control, are benefits which you may enjoy as a result of the Raytheon standardized tube type program, which is part of our continued planning for the future.

**Raytheon Manufacturing
Company**

RADIO RECEIVING
TUBE DIVISION
Newton, Mass. • Los Angeles
New York
Chicago • Atlanta

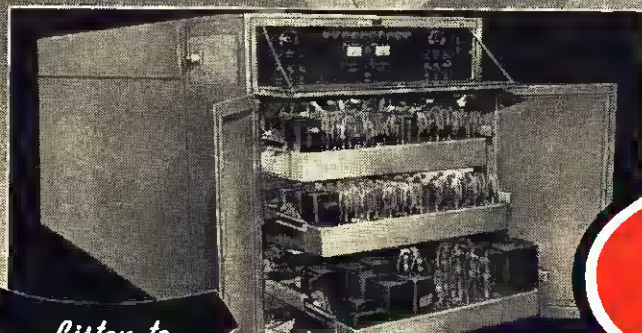

Listen to
"MEET YOUR NAVY"
AMERICAN BROADCASTING CO.
Every Monday Night
Coast to Coast
181 Stations

ALL FOUR DIVISIONS HAVE BEEN
AWARDED ARMY-NAVY "E" WITH STARS

Devoted to Research and the Manufacture of Tubes for the New Era of Electronics

2½ times more powerful new G-E Loud Speakers!

POWERED WITH THE NEW G-E
ALNICO 5 MAGNET MATERIAL...
A DISCOVERY AND DEVELOPMENT
OF GENERAL ELECTRIC RESEARCH

Remember the strength of
the magnet itself determines
the output of the loud speaker!

EVERY ONE OF THE COMING
GENERAL ELECTRIC AM, FM,
PHONOGRAPH-COMBINATION RADIOS
AND TELEVISION INSTRUMENTS WILL
HAVE SUPER-DUTY G-E ALNICO 5
LOUD SPEAKERS

ONE OF THE 8 BIG REASONS*
WHY POST-WAR AMERICA
WILL BUY THE COMING

Electronic
RADIO LINE

*G-E is first in
Radio and
Television
FIRSTS!*

• G-E Alnico 5—another of G.E.'s many great contributions to more perfect radio reception and performance—is more compact and 2½ times more powerful than any other magnetic material used in speakers before the war. Alnico 5 makes possible the equivalent of a much larger and more powerful loud speaker in all sets and especially in

those smaller AC-DC models where heretofore power output has been limited.

Plan to sell the coming line of G-E radios that will have so many sensational features. Get in touch with your nearest G-E Radio Distributor today or write now to *Electronics Department, General Electric, Bridgeport, Connecticut.*

*See subsequent General Electric ads for all 8 money-making features of the coming G-E Electronic Radio Line.



GENERAL ELECTRIC

178-D7

PORTABLES • TABLE MODELS • CONSOLES • FARM SETS
AUTOMATIC PHONOGRAPH COMBINATIONS • TELEVISION

Another
**N. U. SERVICE
 FOR SERVICE
 MEN**



UP-TO-THE-MINUTE TECHNICAL BULLETINS

● Now available from coast to coast at National Union Distributors, is this big book of N. U. Service Engineering Bulletins. It is loaded with timely technical tips, troubleshooting short cuts and service suggestions, prepared by top notch N. U. engineers with all the newest radio facts at their finger tips. And all so easy to get at—arranged on handy separate bulletin sheets covering one subject at a time.

A ready reference file of N. U. Service Engineering Bulletins is now on hand at your National Union Distributor. You are invited to refer to it regularly. Bulletins in which you are particularly interested, may be obtained FREE from your N. U. Distributor. *National Union Radio Corporation, Newark 2, N. J.*

Typical Bulletin subject matter

- N. U. 7A4 as a high frequency oscillator
- 3B 7/1291 Ultra high frequency double triode
- 35Z5 filament burnouts
- A simple Loktal to Octal adapter
- Tube substitution data for 25B5
- Replacements for special purpose tubes

After the War, MORE than Before!

**NATIONAL UNION
 RADIO AND ELECTRON TUBES**

Transmitting, Cathode Ray, Receiving, Special Purpose Tubes • Condensers • Volume Controls • Photo Electric Cells • Panel Lamps • Flashlight Bulbs



*Grandma could
have had one
on her corset...*

ONE day, back in 1893, after Grandpa had grunted, sworn, tugged, shoved, and finally got Grandma laced into her corset, they went to the Chicago World's Fair. Grandpa saw something there that made him mad.

"I don't see why they don't put one of *those* things on corsets," he growled. "One of *those* things" was the first slide fastener. A man named Judson was displaying it at the Fair. He had invented it that year to fasten the tops of his shoes.

It took *brand advertising* to put the slide fastener permanently into everyday American lives.

Talon, Inc., largest manufacturer of slide fasteners in the world today, has done much of the job. Brand advertising has helped to create mass desire for Talon slide fasteners, and resulted in the mass production of better slide fasteners at constantly lowered prices. More than 100 million Talon slide fasteners were being used as far back as 1935—and year after year, have cost less.

The story of brand advertising's results is always the story of benefits to the public. Only 17 years after it cost you, on the average, \$600 for an electric refrigerator, you could get a better, nationally advertised one for \$170. The average radio cost \$125 in 1927; a better, nationally advertised one averaged \$31 just before the war. Gillette Safety Razors dropped from \$5.00 in 1906 to 49c (with five Blue Blades!) in thirty years of brand advertising.

This wouldn't be—couldn't be—America, if brand advertising hadn't helped create mass production, cut costs, and provide all of us with the better things we want to live with.



It happened to Congoleum Rugs

\$18.00 in 1920 but \$6.95 in 1942

Congoleum *brand advertising*, with its emphasis on quality through the years, is one big reason why the mushrooming demand for Congoleum Rugs necessitated a constantly expanding mass production that cut the price. That's the natural result of brand advertising.

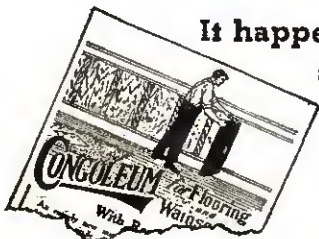

FREE REPRINTS OF THESE STORIES OF "WHY AMERICA'S GREAT"

This series of newspaper and magazine advertisements is offered as a public service by Fawcett Publications, Inc., 295 Madison Avenue, New York 17, N. Y. Write for free proofs.

FAWCETT PUBLICATIONS, INC.

WORLD'S LARGEST PUBLISHERS OF MONTHLY MAGAZINES

"PEACE PACT."



Now that V-E day is past, we look forward to the time when all our battle-scarred warriors return to their anxious families.

As quickly as Government restrictions are modified, Fada's great productive capacity will be ready to make available the finest in radio receivers.

The Fada dealer franchise will become a typical "Peace Pact" assuring you of your share of profitable business on Fada's electronic developments.

If your jobber has not told you about Fada's merchandising plan contact him or write us directly.

PLACE YOUR FAITH IN THE

FADA Radio

OF THE FUTURE

Famous Since Broadcasting Began!

FADA RADIO AND ELECTRIC COMPANY, INC., LONG ISLAND CITY, N. Y.



THIS FAMOUS WEBSTER RECORD CHANGER
ASSURES A *flawless flow* OF RECORDED MUSIC

...it's **NOW AVAILABLE** on Rated Orders

The value of Webster Model 26 Record Changer can be measured by the following outstanding features—all of which combine to produce a flawless flow of music and enjoyment.

- ★ Capacity to handle a large stack of standard phonograph records. Ten 12"—or twelve 10" records can be loaded at one time.
- ★ Light needle pressure—means longer record life, more enjoyment, greater economy.
- ★ Thirty-five minutes of musical pleasure at one sitting—a greatly appreciated convenience.
- ★ No noise distraction—Model 26 operates quietly.
- ★ Easy on records is the velvet soft, heavy pile turntable covering.
- ★ Dependable, trouble free operation—it will last for years.

**BUY AN EXTRA
WAR BOND
TODAY**
SPEED VICTORY ON ITS WAY



**ASK YOUR
DISTRIBUTOR
ABOUT IT!**

WEBSTER  CHICAGO

**3825 W. ARMITAGE AVENUE
CHICAGO 47, ILLINOIS**

31 YEARS OF CONTINUOUS SUCCESSFUL MANUFACTURING

RADIO & Television RETAILING • July, 1945



LEAR RADIO *takes pleasure in announcing*

E. B. LATHAM & COMPANY

*as exclusive distributor for Lear Home Radios and Lear Television
in the New York metropolitan area.*

*In accepting the distributorship for Lear Home Radios,
Mr. L. E. Latham, President, writes:*

ESTABLISHED 1896

E. B. LATHAM & COMPANY

NEW YORK, N. Y.

PRESIDENT

May 16, 1945

We are pleased to announce to the trade that after several months' investigation and discussion with a number of radio manufacturers, we have concluded a wholesale distributing agreement with Lear, Inc., for the distribution of their new line of home radio equipment for the New York metropolitan area. This territory will embrace all of Greater New York, Westchester County and the Long Island Counties of Nassau and Suffolk.

We are most favorably impressed by the company's long and favorable background of experience in the manufacture of high-grade aircraft radio and electronic equipment, and their ability to adapt this valuable manufacturing experience to the production of home radio, television and wire recording.

We are equally impressed with the high calibre of the management, personnel and manufacturing facilities of this fine company whose aim it is to produce a quality product, second to none in the industry, at a price range that will be in keeping with prices of legitimate competition.

As soon as conditions permit, and the War Production Board sees fit to release certain essential critical components for the production of home radio equipment, Lear will be ready to convert its facilities and be among the first in the field to announce their line. We in turn will present Lear Radio to franchise dealers in the territory we will serve.

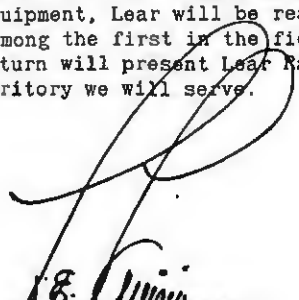

L. E. Latham, President

lel/mjb



Mr. L. E. Latham, President, E. B. Latham & Company
Offices and Warehouse, 250 4th Ave., New York, N. Y.

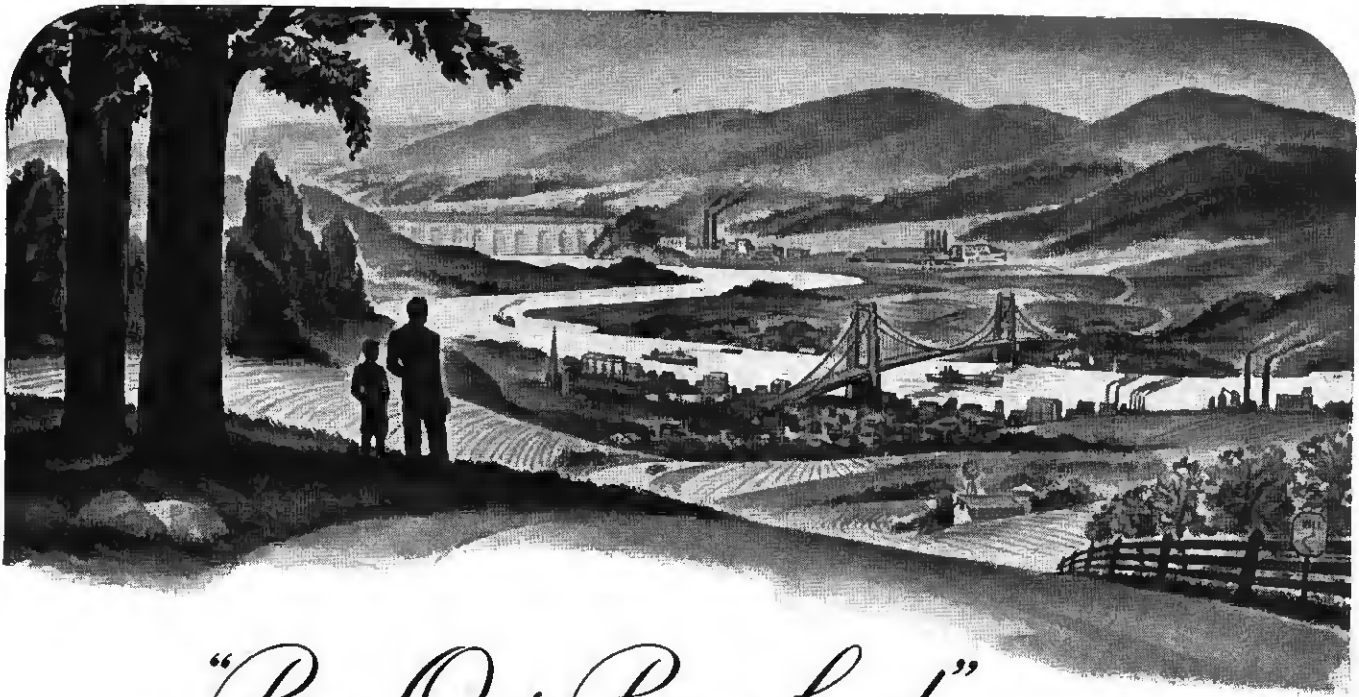

"Ring Out, Brave Land"

...LET'S CREATE NEW MARKETS

Only by the creation of new markets, can we, as a nation, keep a high standard of living.

No longer is it sufficient to exploit only the existing markets, many of which are already worn thin. To create new markets should be the goal of all Industry—not only from a sense of duty to the peoples of this country, but from a plain common-sense dollars and cents viewpoint.

One of the best and surest ways to accomplish the most good for the nation—and more sales for the electric appliance industry—is the intensive development of our natural resources.

THE TVA PLAN HAS SHOWN THE WAY

It's hard to put TVA into words. It is not just the generation of electric power, nor flood control alone, or merely soil conservation. All these are a part of TVA—but basically it is the growth of a people and the growth of the soil they live on. It has metamorphosed a stunted region and backward people into a new economy—profitable both from a humane as well as a commercial standpoint.

Cheap electricity, a prime result of TVA, has been one of the important elements that have enabled the people of the TVA region to become prosperous and to lead a life more in keeping with the American way. And inevitably, it *created an entirely new market* for the sale of electrical appliances and machinery.

A market, for instance, that showed a 374% increase in the sale of electric ranges over the preceding year; water heaters by 774%, refrigerators by 329%! This, from a former undeveloped "poor market" area!

Every one of the electric farm machines, washers, refrigerators, ranges, radios and other appliances that went into the Tennessee Valley provided work and income for the dealers, distributors and service men who sold, installed and maintained them; jobs and profits for the workmen and manufacturers who produced them—Yes and for you and us.

ESTABLISH A MISSOURI VALLEY AUTHORITY

Now that TVA has shown the way, what is more logical than to follow up with an MVA? The Missouri River Basin, about one-sixth of the land area of the nation, has problems similar to the Tennessee Valley. It presents a definite challenge to a forward-looking nation. *And an unprecedented profit opportunity for the manufacturers of electric machinery and appliances!*

So let us urge Congress to set up a Missouri Valley Authority to develop all the resources of this vast region for the benefit of all the nation. Let us urge Congress to act immediately, so that when the war is over, the plans will have been made, and we can go forward. For further information, send for free booklet.

First of a series of advertisements designed to encourage the creation of new markets.



GENERAL TRANSFORMER CORPORATION

1250 West Van Buren Street • Chicago 7, Illinois

RADIO & Television RETAILING • July, 1945

THE HUGE CABINET PLANT
AT MYSTIC, CONN.
Where Temple cabinets will be made.

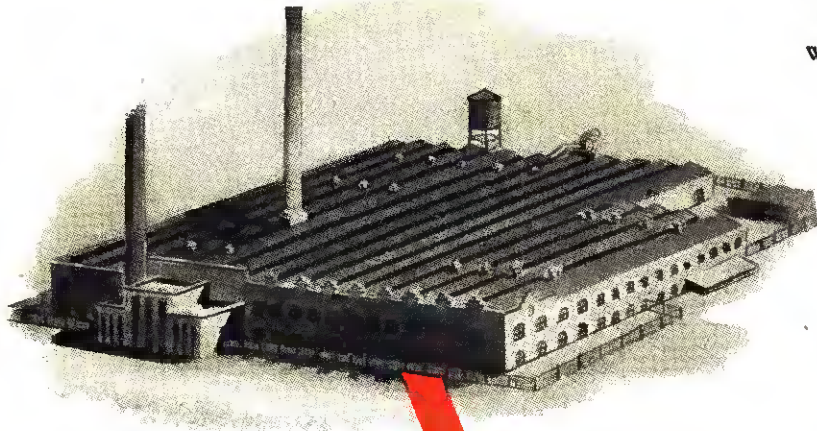

NO WASTE MOTION!

Temple will produce
BOTH
Chassis and Cabinets

Never in all radio history has a manufacturer been so completely equipped to both make and *deliver* quality radios as is Temple today. With its two great plants—one to be devoted exclusively to producing the fine Temple chassis, the other concentrating entirely on the cabinets that will house them—there will be no waste motion in making and delivering Temple Radios. Which means there should be no waste motion among Temple Dealers to cash in on the Temple line.

*"Where **FM** will also mean **Finest Made**"*

FM . . . TELEVISION . . . RADIO-PHONO' COMBINATIONS



TEMPLETONE RADIO MFG. CORP.
NEW LONDON, CONN.

THE VAST RADIO PLANT
AT NEW LONDON, CONN.
Where Temple chassis will be made.

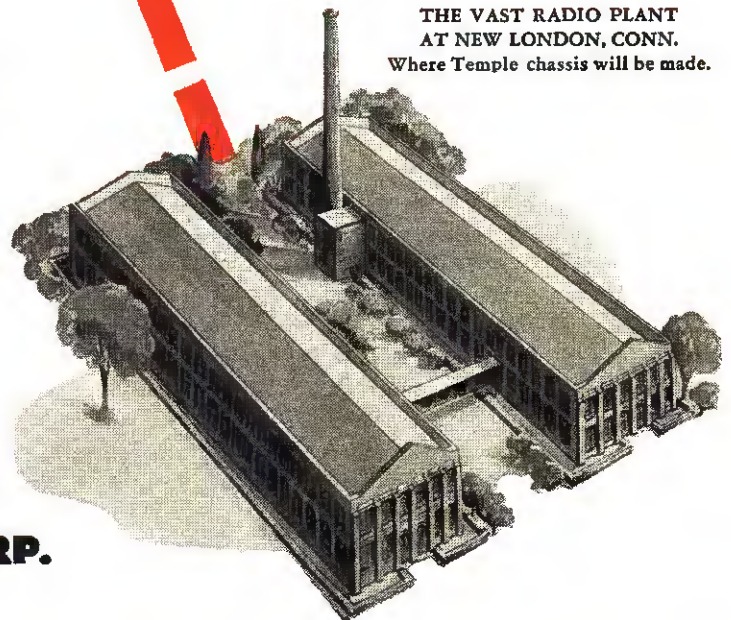

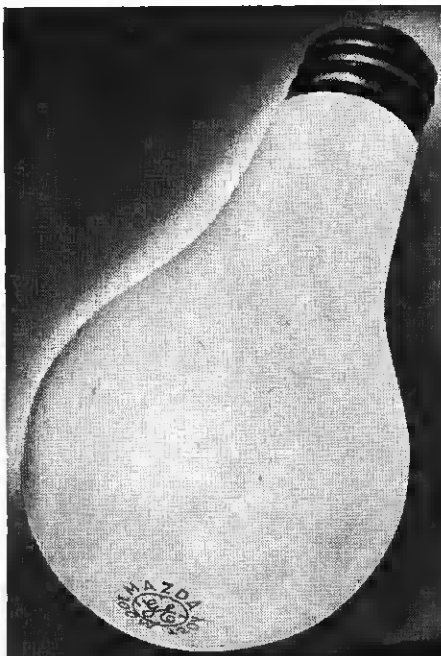

PRESTIGE
+ POPULARITY
= PROFITS

PLAN NOW FOR PROFITS— From tomorrow's big market for G-E electronic tubes!

IT'S time NOW to look ahead—plan ahead—to when electronic tubes will again be available in volume to increase the figures on the profit side of your ledger.

People then, as always, will buy what they know—and respect. They have known and bought G-E Mazda lamps for decades, until this name has become a symbol for light. Now they see G-E electronic tubes in full-page General Electric radio advertisements that run in 19 leading national magazines reaching

30,000,000 readers every month.

In addition, G-E tubes each week reach the attention of listeners in 7,000,000 radio homes. Under the very eyes of radio dealers and service men a big, profitable market tomorrow—when G-E tubes can be supplied to all who want them—is being built. Retailers who look confidently ahead to prosperous times, are making G-E tubes a "must" for their post-war stocks. Think back over the years to how G-E Mazda lamps have swelled the cash receipts

of thousands of stores! Then think forward to the new, identical opportunity offered to radio dealers and service men by G-E electronic tubes! Soon this opportunity will be yours. Prepare to take early advantage of what it offers you in the way of assured income and fullest participation in the benefits of G-E leadership. Write for the name of your nearest G-E tube distributor. Address *Electronics Department, General Electric, Schenectady 5, N. Y.*

Hear the G-E radio programs: "The World Today" news, Monday through Friday, 6:45 p. m., EWT, CBS. "The G-E All-Girl Orchestra," Sunday 10 p. m., EWT, NBC. "The G-E House Party," Monday through Friday, 4 p. m., EWT, CBS.

GENERAL  ELECTRIC

176-D1-8850

Acclaimed as the "Sweetest" Sales Building Idea in the Past 10 Years

GAROD IMPROVED PERMATONE PHONO NEEDLES

... PACKED IN SMART, BEAUTIFUL, SELF-SELLING
DOUBLE-PURPOSE PLASTIC CASES ... *At no increase in cost!*

Designed for
BEAUTY and
UTILITY

THESE NEW PLASTIC CASES COMPLEMENT THE RICH, BRILLIANT TONE OF GAROD PERMATONE PHONO NEEDLES

These colorful plastic cases are just about the gayest, most practical idea in needle packaging in the past ten years. In addition to serving as a showpiece for the Permatone needle, they have in the "Superior" and "De Luxe" styles, a felt brush on the reverse side for cleaning records. They may also be used to hold pins and small jewels. All-plastic, even to the protective, transparent lucite window, these cases come in three different styles in four different colors. Equally important, they are provided at no extra charge.

Special Note! All Garod Permatone Phono Needles are provided with a flat on their shafts for easy installation in all record-playing instruments.

PERMATONE
"DE LUXE"

Precious "osmium" tipping. Bent shank for easy riding. Spring action. Specially designed shank to minimize shock and surface scratching. Double-purpose plastic case, with "built-in" record brush



\$1.50

PERMATONE
"SUPERIOR"

Bent shank makes for smooth sailing through record grooves. Non-corrosive, precious metal alloy tips. Filter trap absorbs shock and reduces scratches. Spring action. Double-purpose plastic case, with "built-in" record brush

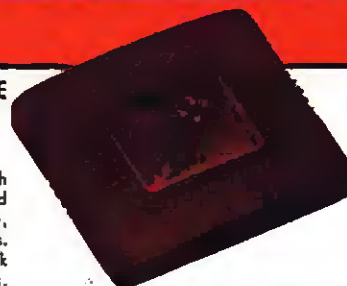

\$1.00

PERMATONE
"STANDARD"

Scientifically designed to provide finer tonal qualities with minimum surface noises. Tailored to fit perfectly into the record grooves. Packed in plastic case



50c

FREE! Built-in Record Brush on back of each "Superior" and "De Luxe" package.

FREE! Four-color counter cards.

Three-color consumer folders.



GAROD



RADIO

GAROD ELECTRONICS CORPORATION • 70 WASHINGTON ST., BROOKLYN 1, N. Y.

★ Westinghouse has always been a leader in putting electronics to work in industry.

★ Westinghouse built the **1st** high-power radio broadcasting station and has continued to lead in this field.

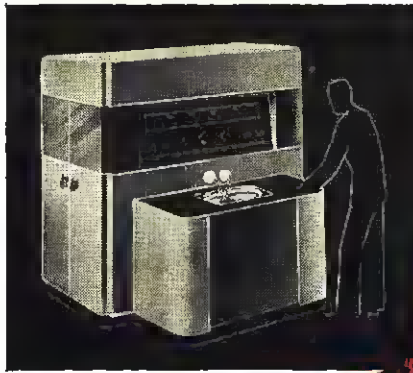
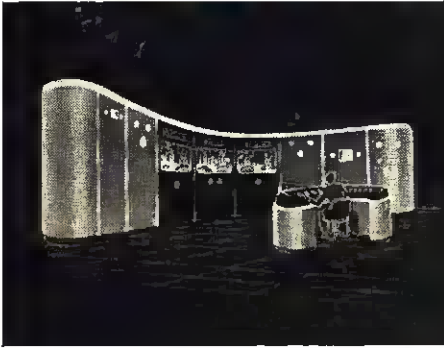

★ Westinghouse developed the key electronic tube for the Army's **1st** radar.

★ Westinghouse built the **1st** short-wave radio for ocean going vessels.



A FEW EXAMPLES OF WESTINGHOUSE RADIO

Originality

- ★ Westinghouse put on the world's **1st** radio broadcast.
- ★ Westinghouse built the **1st** factory-made home radio.
- ★ Westinghouse developed the tubes that made it possible to operate radios from house current instead of batteries.

Radio's

TODAY AS FOR 25 YEARS

★ Westinghouse is a leader in aviation radio and electronic navigation equipment.

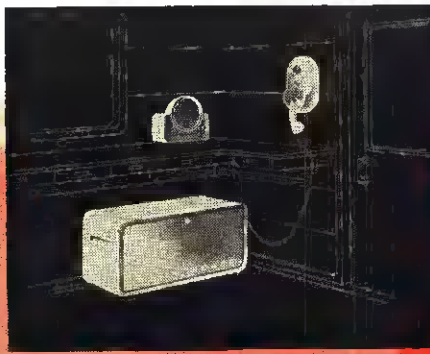
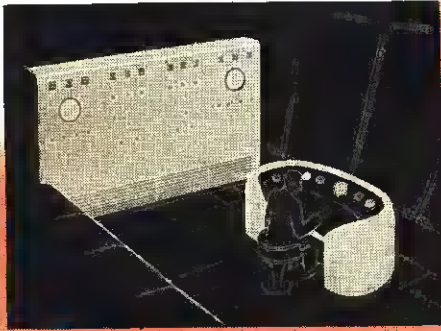

★ Westinghouse built the **1st** railroad radio equipment—and continues to lead in this field.

★ Westinghouse built the Navy's **1st** walkie-talkie . . . and is one of the world's largest builders of military radio and radar.

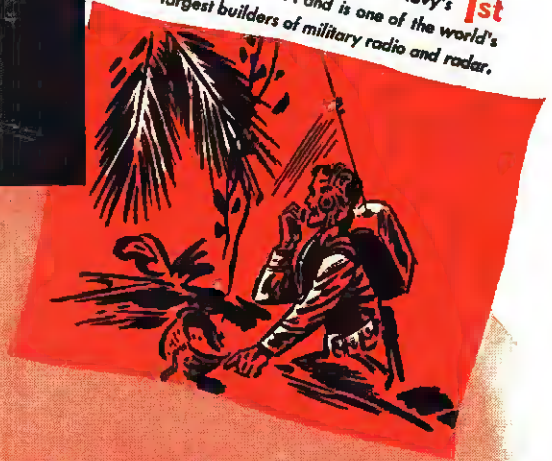

**DEPEND ON
WESTINGHOUSE RADIO
FOR**

Originality

IN ENGINEERING

**It makes the difference
between "talking points" and
real sales advantages.**

We will be glad to tell you about the WESTINGHOUSE RADIO DEALER FRANCHISE PLAN. Send for free booklet that tells how you can put the strength of this famous name behind your radio business. Address Home Radio Division, Westinghouse Electric Corporation, Sunbury, Penna.

TUNE IN: John Charles Thomas—Sunday, 2:30 P. M., EWT—NBC.
Ted Malone—Monday through Friday, 11:45 A. M., EWT—Blue Network.

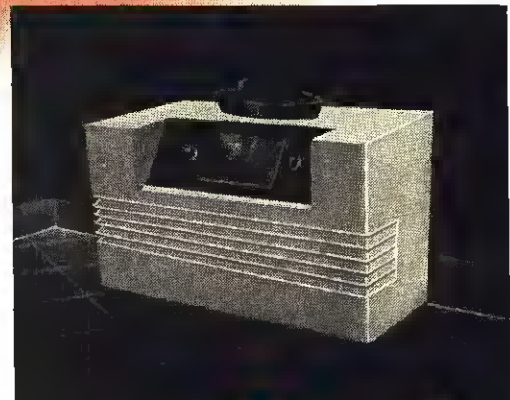

★ Westinghouse built the **1st** electronic television transmitter and receiver . . . pioneering tomorrow's television.

first name is

Westinghouse
PLANTS IN 25 CITIES . . . OFFICES EVERYWHERE

You'll hear it over and over again



KEEP YOUR EYES ON BELMONT

People are looking to Belmont for noteworthy contributions to peacetime electronics. And their confidence will be fully justified. Belmont skills that have been heightened by their successful application to wartime electronics will yield new benefits for millions of buyers. And Belmont's national advertising is telling the public about these coming benefits now.

Belmont will offer the magic of television on large screen receivers. There will be Belmont radios inspiring in performance and beauty. Music lovers will be able to enjoy new worlds of tone delight with Belmont FM receivers and Belmont Radio and Phonograph combinations. Keep your eyes on Belmont! Belmont Radio Corp., 5931 W. Dickens Ave., Chicago 39, Illinois.

Belmont Radio

RADAR * TELEVISION * F.M. * ELECTRONICS

Get this **DOUBLE RETURN** from your first year's selling!

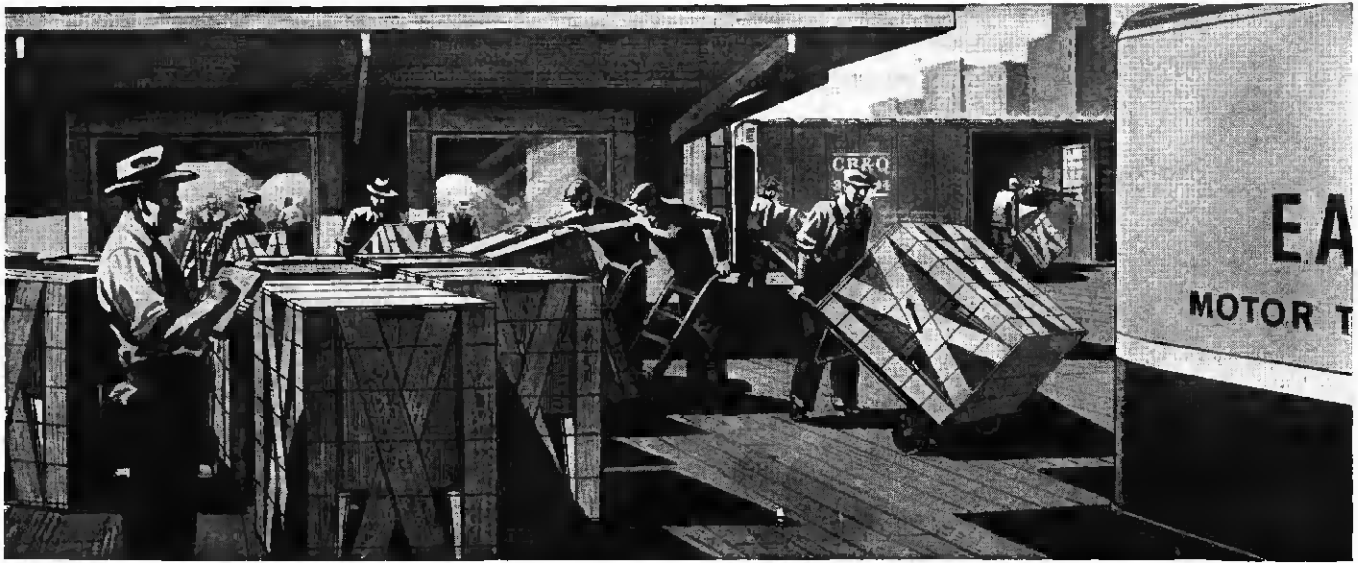

• Build the volume sales you will need at once during reconversion



• Get set solidly with dealers and consumers when competition intensifies

How you can get going fast with your first year's output... and get set for the days when selling gets tough

Surveys in the \$4,496,734,000 Chicago market show that sales potentials for "big unit" products generally are tremendous... enough to absorb the entire production of many a manufacturer. The Chicago market is famous for its big volume buying. Favored by high, diversified income from factory, farm and trade... backed by huge savings... it is strongly reinforced against reconversion and instantly responsive to selling.

Reached through a single medium

Here is an area quickly accessible to salesmen and warehouse shipments. You can take advantage of this quick distribution and volume sales at one low cost through a single powerful advertising medium—the Chicago Tribune.

Bought, read and bought from as is no other

medium in the Chicago market, the Tribune is a powerhouse among dealers and consumers. One out of every three families in 756 cities and towns of 1,000 or more population reads the Tribune daily—on Sundays, almost every other family!

Low milline rate

The Tribune offers you monoroto, coloroto, comicolor, newsprint color, or black and white—at one of the lowest milline rates in the country.

Whether your production is large or small, big unit or packaged goods, here is a strategic market far too important to leave wide open to competitors. With the Tribune you can build solidly for long-term, successful business.

For market facts and merchandising ideas, call a Tribune representative.

The Chicago Area: located at the heart of America; famous for its wealth and huge buying activity, big enough to absorb all that many a factory can make.

Available for your study and use is a specific sales program based on the findings of an auto and household appliance investigation among consumers and dealers. To get these pertinent facts, address C. S. Benham, Manager, National Advertising, Chicago Tribune, Tribune Tower, Chicago 11, Illinois.

Chicago Tribune

THE WORLD'S GREATEST NEWSPAPER

May average net paid total circulation: Daily, over 1,000,000; Sunday, over 1,300,000.

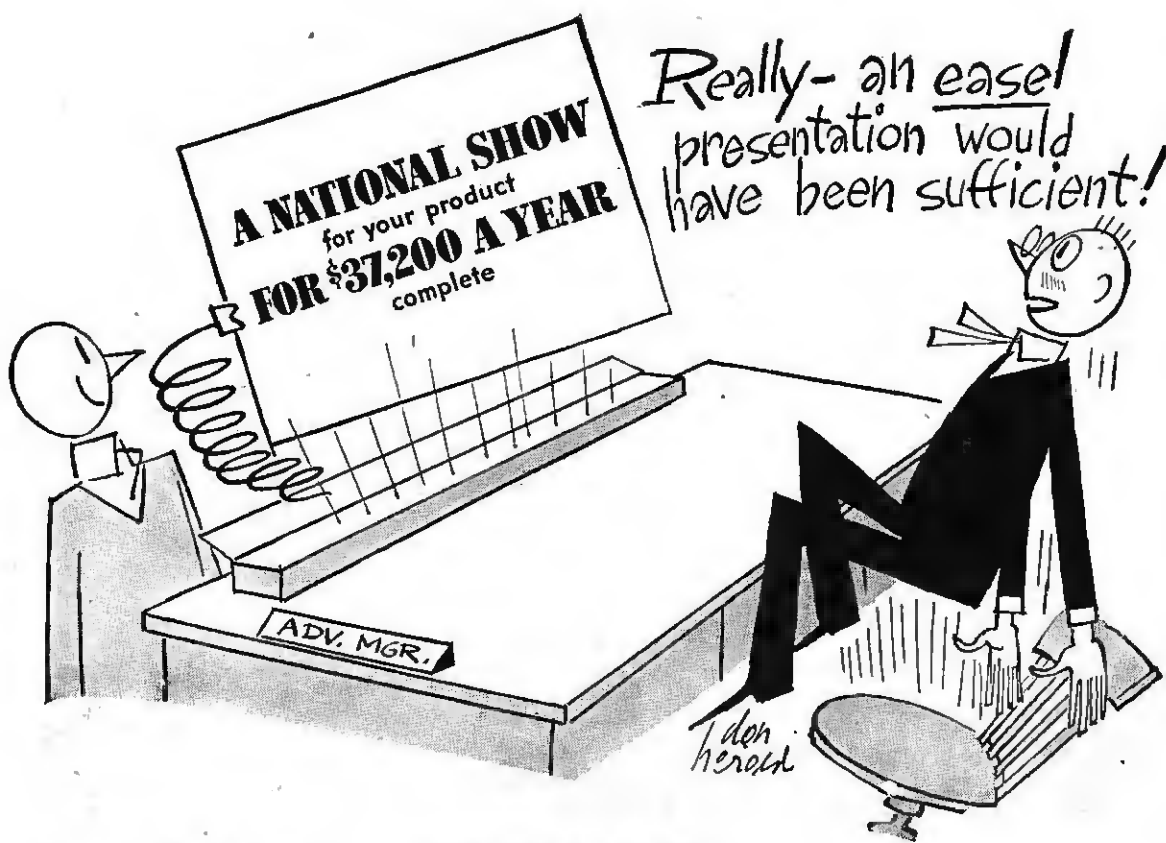

Here's how to OUTSMART instead of OUTSPEND competition

CLIENT: My — that's startling!

ACCOUNT EXEC: I'm glad you like it. It's the spring from a broken alarm clock.

CLIENT: I mean the statement—"A NATIONAL SHOW FOR MY PRODUCT FOR \$37,200 A YEAR COMPLETE."

ACCOUNT EXEC: To tell you the truth, it kind of startled me too when I first read it.

CLIENT: Let's talk facts and figures. I find it exhilarating.

ACCOUNT EXEC: Redbook's NATIONAL SHOW reaches a cohesive and important audience of 1,500,000 families who enjoy good reading. That's a lot of *basic audience* for your money.

CLIENT: S-a-y, that's a self-selected audience too. It *spends* to be entertained!

ACCOUNT EXEC: Yes—and Redbook's 25¢ selling price contributes nearly \$4,000,000 yearly toward pay-

ing for this show... and that's a lot of **READER INTEREST!**

CLIENT: Reader Interest—what's that?

ACCOUNT EXEC: That's the result of both Redbook's *high editorial content* which creates cover-to-cover effectiveness and Redbook's Reader Research.

CLIENT: Reader Research?

ACCOUNT EXEC: It's Redbook's *thumb on the pulse of its public.*

CLIENT: Aptly put — and what about coverage?

ACCOUNT EXEC: You get *complete coverage* of your audience... twelve insertions for only \$37,200 a year.

CLIENT: Good! Let's...

ACCOUNT EXEC: Ah... ah, although Redbook space is sold out at the moment, smart advertisers are making plans for the future. So why not include **REDBOOK** in *our* future plans?

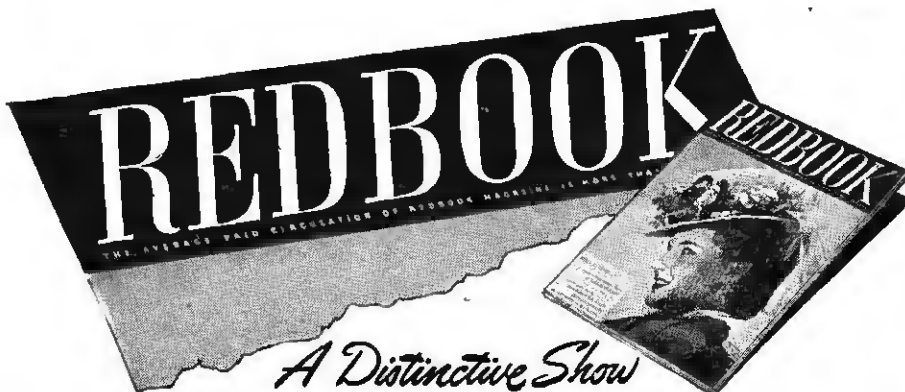

To Nearly 1/5 of America —
A Program of proven Sales Power.

Redbook, Cosmopolitan, and American, THE 6 MILLION GROUP, reach nearly six million families with less than 15% duplication—approximately one out of every 5 in the United States. *And a full page in every issue of all 3 magazines costs only \$160,000 a year.*



ESQUIRE!

AMERICAN!

NEWSWEEK!

AMERICAN HOME!

RED BOOK!

HOUSE and GARDEN!

COSMOPOLITAN!

LIBERTY!

Look what's back of every Sonora merchant!

Colorful, dramatic, powerful advertisements in the nation's leading magazines, PLUS a new campaign in newspapers all over the country focussing attention on SONORA dealers! That's the kind of hard-hitting support SONORA puts behind the SONORA dealer!

But that's not all! When SONORA radios start to roll off the production lines, there'll be sensational co-operative advertising plans for SONORA dealers, and a wealth of streamers, banners, signs, displays, and other advertising material.

Yes, SONORA backs up the dealer with an advertising and merchandising push that means business for the man who does the business—the dealer himself.

That's why it's good business to sign up *now* for the SONORA franchise... the franchise that's backed by a name that's been famous for more than 30 years, a complete line of radios—37 models—distinguished for "Clear As A Bell" tone, and advertising—lots of it! Get in touch with your SONORA distributor today. SONORA RADIO AND TELEVISION CORP., 325 N. Hoyne Avenue, Chicago 12, Illinois.



HOME ENTERTAINMENT AT ITS BEST

RADIO • TELEVISION SETS • RECORDS • PHONOGRAPHS • RECORDERS

With **STROMBERG-CARLSON**
 the Main Radio in your customer's
 mind . . .



You'll want to make **STROMBERG-CARLSON**
 the Main Radio Line in your showroom!

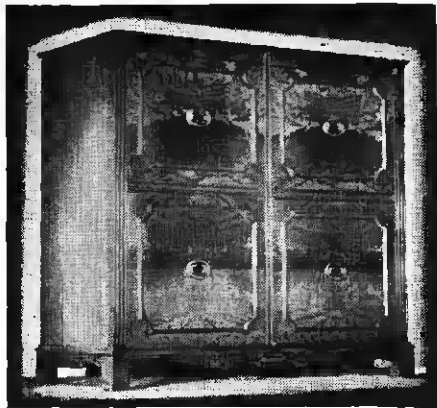

There's a pent-up demand for Stromberg-Carlson radios—fine musical instruments for the *main radio* in any home. This is currently being stimulated even farther by vigorous national advertising which carries the *main radio* message to your customers through some 475,000,000 impressions in thirteen leading magazines.

Make this profitable market your own, by becoming an authorized Stromberg-Carlson dealer under the very favorable Franchise Agreement now being offered. Get in touch with your local distributor for details, or write us at once. For Stromberg-Carlson is:

- the important radio unit — the radio unit carrying real profit opportunity
- the radio unit with easy-selling public acceptance.

Become an Authorized Dealer now, and organize your postwar business around the Stromberg-Carlson *main radio*—a consistent profit maker whether in an outstanding table model, console, or radio-phonograph combination.

STROMBERG-CARLSON • ROCHESTER 3, N. Y.
 RADIOS, TELEVISION, TELEPHONES, AND SOUND EQUIPMENT

RADIO & Television RETAILING

Including Radio and Television Today

O. H. CALDWELL, Editor * M. CLEMENTS, Publisher * 480 LEXINGTON AVE., NEW YORK 17, N.Y.

Independent Retailer and the Utility Company

In sections where utility companies have sold radios, appliances and service, the independent retailer is well aware of the punch behind this type of competition.

Now, with production of radios and appliances for the home about to be resumed, many an independent dealer is eyeing with the utmost interest the merchandising plans of the "utility" in his vicinity. Trends appear to indicate there will be many changes in utility company policies throughout the nation. Some have decided to step out of the merchandising field, while others are avowedly girding themselves for bigger-than-ever selling campaigns.

Dealers Protest "Unfair Competition"

Dealers in localities where the utility company practiced certain high-pressure methods in appliance selling are earnestly hoping for a discontinuance of techniques which they, the dealers, consider unfair competition.

Among the practices employed by some utilities which the independent merchants protest against are:

1. "Package deals". (Although some "participating" dealers approve this method.)

2. "Overboard" service and guarantee inducements.
3. The offering of too-liberal "put-it-on-your-bill" terms.
4. The "every-customer's credit is good" attitude.

Utilities Have Strong Sales Position

Independent dealers realize that the utility companies have every right to sell radios and appliances in this land of free enterprise. But, the independent retailers feel that the "ethical" selling tools already in the hands of the utility companies should be sales power enough to satisfy said utilities. These sales tools are large advertising appropriations, prestige, elaborate and spacious display rooms, and the ability to secure franchises from top-flight manufacturers.

Dealers have the highest praise for those utility companies that have co-operated with them, and some of the utility groups have even been instrumental in setting up dealer organizations to handle radio-appliance sales. But the dealers hope that those companies which contributed in causing chaos in retail selling fields in the past will turn over a new leaf in the future.

THE UTILITY'S DEBT TO THE RADIO-APPLIANCE DEALER



Every time the independent dealer sells a radio set or an electrical appliance, he is building continuing future load and income for the local utility. From radio sets, in fact, the utilities are deriving a larger annual income for electricity supply, than do the broadcasting stations which supply the programs, news and entertainment. This income has been created for the utilities by the radio trade, without the utilities themselves spending a dollar of sales expense.

Utility managers should remember this indebtedness in planning their postwar relations with the independent dealers in communities throughout the country.

RADIO, Electrical Appliances,

RADIO INDUSTRY UNITES ON ALTERNATE NO. 1—FCC's proposal of three alternate allocation plans for FM and Television, with the prospect that engineering tests and studies may delay action until late in 1945, thus imperiling the whole postwar start of FM and video, has brought about a united front in the radio industry. All groups are now urging immediate FCC authorization of Alternate No. 1. (See page 35, our June issue.)

FCC MAY ACT IN JULY—*The FM and television broadcaster groups initiated the move to get immediate action on No. 1 as the best compromise. RTPB meetings supported this position. The independent pioneer FM manufacturers petitioned FCC for prompt authorization and RMA members have discussed similar action. As the result of this united industry demand, it is learned that FCC may consider ratification of the No. 1 arrangement before July is over.*

FREEZER UNITS are now definitely being planned for in blueprints of the homes of tomorrow! Space is allotted in the pantries of the smaller homes, and in storage rooms of the larger types.

CROSLY NEW SERVICE WRINKLE—*The Crosley Corp. has authorized a number of its wholesale outlets to repair Crosley hermetically-sealed refrigerating units on their own premises.*

NEW WESTINGHOUSE FREEZERS will start with 6-cubic foot size. Since the freezers will be "reach-in" upright models, the maker claims they will take up no more room than comparable size conventional refrigerators.

LION MAY BE THE LABEL on new discs soon to be manufactured by Metro-Goldwyn-Mayer, who has Robbins' songs and MGM's talent to draw from. Frank B. Walker, formerly of RCA, will direct the activities of this new set-up.

APPLIANCES AS MORTGAGE SECURITY—The first nationally-operating mortgage lending institution to endorse complete house program is the National Life Insurance Co., of Vermont. Firm announces it will include gas and electric appliances as part of mortgage security in nearly every state in the Union.

RADIO VALUED AT THREE TIMES PHONE—*Minneapolis householders were asked by Tribune editors "If you had to do without either a telephone or a radio in your home, which one would you rather give up?" About two-thirds or 63 per cent replied they would rather give up the telephone, 27 per cent would give up their radios, 10 per cent were undecided.*

CUT-BACKS AND UNEMPLOYMENT—Full force of Army cut-backs is scheduled to be felt in August and September. Resulting cuts in employment are expected to change public and government psychology. By that time, Washington will be hustling to find civilian ways to restore jobs. Result will be more liberal attitude encouraging all possible production of civilian radios and appliances,—with no government agency willing to be caught standing in way of prompt conversion. Smaller radio manufacturers, not building complex radar equipment, will be first to get "full green-light" on home radios.



AMERICAN JIGSAW PUZZLE—*"Our economy is a jigsaw puzzle of interlocking buyers and sellers, producers and consumers. The pieces of the jigsaw will move into place best if we give people scope and leeway—with a minimum of rules, regulations and production controls."*—J. A. Krug, WWPB chairman.

PLASTIC "MOCK-UPS" for easy model kitchen demonstration. Hotpoint is said to be planning to put plastic equipment in retail stores in order that clerks will be enabled to move imitation appliances, cabinets, etc., about to show customers various arrangements suitable for their own kitchens.

NEWCOMER FROM MISSISSIPPI—*W. S. Terry Co., 301 McClinnis Ave., Moss Point, Miss., headed by W. S. Terry, plans to manufacture sets, "combinations," amplifiers, etc., as soon as materials become available.*

EMERSON RADIO WANTS FM—Application has been filed with FCC by Emerson Radio & Phonograph Co., of New York, for a 500-watt FM station to be located in New York City.

NEW TUBE STOCK ANGLE—An Orange, N. J., radioman suggests that a reduction in tube types may not be an unalloyed blessing to the radio dealer. Large tube stocks, requiring as they do the investment of one or two thousand dollars, constitute the major obstacle to the success of basement radio servicemen and other marginal operators, who might otherwise attract more business away from established radio repair shops.

Records, and Television, **TODAY**

COSGROVE SEES SET BAN OFF OCT. 1—R. G. Cosgrove, RMA president and Crosley vice-president, says he believes all restrictions on civilian receiver production will be lifted by WPB about Oct. 1. He also predicted that there would be twice as many set makers after reconversion as there were before the war, and he urges quick removal of price controls. "There is grave danger of industry overproduction. No price control is needed because of the competitive character of the industry," declares Mr. Cosgrove.

ORCHIDS TO SONORA are due for the high type dealer meetings being held throughout the country. Sponsored jointly with their distributors, Sonora is inviting the leading radio dealers in each area to a dinner and conference. Joseph Gerl, president, is giving informative talks in which he answers questions uppermost in the minds of dealers. And—our reporter heard no attempt made to high-pressure the guests into Sonora franchises!

INFLATION PREVENTATIVE—"All that is needed is for Congress to tell OPA clearly and unmistakably that their job is simply to prevent prices for scarce essential goods which permit profit margins greater than those prevailing just before the war."—Howard E. Blood, president Norge division, Borg-Warner Corp.

EASY WASHER postwar planning includes the production of a new automatic washer, a new portable washer and a newly-designed clothes dryer.

APPLIANCE DEALERS ARE BEING URGED by distributors of the Speed Queen ironers and washers to display the life-sized blowups of postwar models of laundry equipment, available at a cost of \$2.75 each.

ADMIRAL REFRIGERATOR compressors will be made exclusively by Tecumseh Products, whose Michigan plant is one of the largest and finest equipped in the country.

HOOVER GETS REFRIGERATION PATENTS—A number of refrigerator patents have been assigned to The Hoover Co., Canton, O. Some of the numbers, 2,368,374; 2,366,550; 2,363,399; 2,363,435.

NEW RADIO SET MAKER—Walter L. Eckhardt, well-known figure in the radio-music industry, has announced the formation and incorporation of the Music Master Radio Corp., Hartford, Conn., and 82 Beaver St., New York. The new company will make radios and television. Mr. Eckhardt is president.

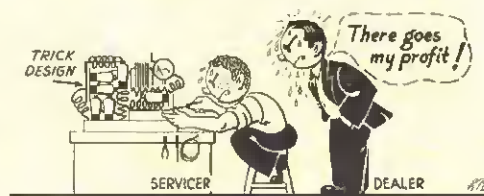

EASY-TO-SERVICE SETS—Suggestions that radio manufacturers design sets that are readily serviced, are being stressed by dealers. Sets that present unusual service difficulties will not be enthusiastically pushed by dealers. "Call-backs on newly sold sets that are not easy to repair will be doubly unpleasant," comments one dealer. "On older sets, hard-to-service models eat up profits, in spite of higher repair charges. The dissatisfaction of customer and dealer will ultimately be felt by the manufacturer, whether he realizes it or not, and will depress sales on the unsatisfactory models."

ADVICE TO DEALERS. In recent issues of this year, we urged retailers to prepare to get rid of slow-moving war-time "visiting" items, re-built used items, etc. With production of civilian goods near at hand, the need for carrying out this chore is more than ever apparent. "What will such merchandise be worth in the coming market?" is the \$64-plus question the smart retailer should ask himself today.

FM-TELE ALTERNATIVE NO. 1 ON WHICH RADIO GROUPS UNITE—AND PRESENT SET-UP

ALTERNATIVE #1	Am	F	Ed. FM	FM	T	N	T	T	T	T	T	T		
	44	48 50	54	68	74	78	84	90	96	102	108			
PRESENT	Ed. FM	FM	T	Am	T	T	G	T	T	G	Ed. FM	G	T	T
	42 43	50	56	60	66	72	78	84	90	93 94.5	96	102	108	

Frequencies in megacycles—Am, Amateur; F, Facsimile; T, Television; G, Government; N, Non-Government fixed and mobile

Here is the FCC's No. 1 Alternative for FM and television, which all groups in radio—broadcasters, manufacturers and engineers—are now petitioning the Commission to adopt without delay. For comparison, the present set-up in the same frequency channels, is also shown. There seems a possibility that the new FM-tele allocation may be made official by FCC during the present month. (Engineers have further proposed, however, that if No. 1 is to be adopted, a slight modification would start FM with its present band, so that existing FM sets could continue to receive future FM broadcasts in part, at least).

Merchandising DON'TS for

There Will Be Profits and Pitfalls in After-War Retailing—Here Is a Review of Some Basic Business Practices

● Despite the tremendous public appetite existing for consumer goods, many experts believe that postwar merchandising is not going to be the reckless buying spree some over-optimistic persons foresee. Not only will there be more competition than ever before—particularly after full civilian production gets under way—but there will also be pitfalls in poor business operation which will trap many an unwary and unsuspecting retailer.

Stick to Fundamentals

During the days following Victory, dealers will have to adhere to certain time-tested, time-proven principles of operation. Failure to observe these fundamentals, may mean financial disaster for some radio-appliance merchants.

With the seller's market that is in effect today, and with the consumer ever so eager to please the retailer, some dealers have become lax and indifferent about basic business policies. When civilian goods are available in large quantities and John Q. Public begins to build up sales resistance, some merchants are due to experience an abrupt awakening.

Make Plans Now

The time to "snap out of it," and plan for future operations, is now! When the distributor's truck rolls up to the dealer's door, he may find himself too pressed for time to plan carefully. There is no time like the present to formulate future merchandising methods. So, if the radio-appliance merchant has fallen into a rut, he had better get out of it—fast.

There are some important rules for the retailer to observe—some "do's and don'ts," the value of which cannot be minimized or underestimated. It must seem like ages ago to some merchants since they last sold fine merchandise. Some retailers may have become "rusty" on business techniques, and therefore welcome "refresher courses" to help them "brush-up."

Great care should be taken by the

astute dealer in selecting his postwar lines. Before making any commitments, he must be aware of some important factors which may affect him particularly. He must know the financial status of the people residing in his community. He should know their buying habits. Will the consumers in his area purchase consoles, radio-phonographs, table models, portables? Will they want automatic or non-automatic washers? What size refrigerator will be most in demand?

The retailer should know in advance how much his customers will pay for radios and appliances. What their favorite brands are. Do they want push-button tuning, and short-wave? These are important facts the radio merchant must know if he

overhead which is out of proportion to his income. If the retailer is going to earn some money—and that's the reason he is in business—he must not permit his costs of operation to eat up his profits.

The dealer's expense must be planned—and controlled. Administrative costs, rent, depreciation on equipment, taxes, deliveries, and other expenses must be kept within bounds, if the retailer is to stay out of the red. Do keep an eye on overhead, and be sure to budget your costs.

Radio-appliance merchants can maintain control of their affairs by keeping accurate records of their activities. Detailed figures of salaries, commissions, advertising, and other costs incurred by the dealer must be recorded so that rising or declining

DO'S

Do buy lines carefully

Do select merchandise customers want

Do watch your overhead

Do keep accurate records

Do maintain inventory control

Do insist on high rate of turnover

Do watch all expenses

wants to buy wisely and sell intelligently, and show a profit. If the retailer succeeds in successfully merchandising a specific brand or product, he must be assured that he will get an uninterrupted flow of this item. *Buy your postwar lines carefully!*

A radio-appliance merchant may have good merchandise to sell, do a good volume of business, and yet fail to show a profit. The answer is excessive costs of operation, and runaway overhead. Gross profit will not mean a thing if the merchant has an

costs can be detected. And it is important also to keep track of incidental expenses.

Aside from keeping tabs on expenses, records should be kept which reveal the progress of a store. Data on merchandising activities such as number of sales made, stock shortages, returns, amount of the average sale made, and other statistics will keep the merchant up-to-date on all phases of the store's doings. Records of this type will also enable the retailer to make comparisons from time to time. *Do* keep records.

DO'S and Postwar Market

Inventory taking is an important part of merchandising. Proper inventories will reveal hidden losses, show what goods are unprofitable to carry, and will provide information for paying proper taxes on earnings. At the present time, for many dealers, there just isn't anything to take inventory of. However, after "M Day," inventory taking will be important to dealers, and plans should be made to accomplish this purpose. When the time arrives, *do* keep accurate inventories.

What Not to Do

In the above paragraphs, we discussed the do's of postwar merchandising. When goods become plentiful, these rules will be valuable to the radio retailer. These principles should aid him to make a profit on the goods he sells. However, there are things the merchant should not do. What are the pitfalls and don'ts the dealer should be careful to avoid? Let's scrutinize some of these factors which year after year drive many a merchant out of business.

Don't overload your inventory by handling too many lines you are not familiar with, or by purchasing excessive quantities of any particular item. In the postwar days to come, some retailers may be tempted to buy whatever they can get hold of. This policy may lead to financial chaos.

Careful Buying

Carrying stocks of merchandise out of proportion to the merchant's needs may force the careless retailer to slash his prices on these goods, offer unfair (to himself) discounts, or pay ridiculous prices for trade-ins. These practices will devour any profits the retailer has made on other items, and leave him "holding the bag" at the end of the year.

For the same reasons as outlined above, every effort should be made by the shrewd merchandiser to prevent obsolescence of any of his goods. If the dealer wishes to stay out of the second hand merchandise business, he must carefully pre-determine

DON'TS

- Don't overload inventory**
- Don't handle too many "unfamiliar lines"**
- Don't permit obsolescence**
- Don't cut prices**
- Don't get reckless on trade-ins**
- Don't make extravagant claims for goods**
- Don't "knock" competitors**

his customer's needs for the future.

When goods become plentiful, intelligent radio and appliance merchants must insist on a high rate of turnover for their lines. This factor is important to remember for dealers who want to make money. Rapid turnover is just as important to the retailer as his margin of profit is, since he cannot realize a profit on an article until he has sold it.

Let the merchant beware of devil-may-care price-cutting and selling at a loss for the sake of volume. The dealer who slashes prices below the profit level may succeed only in cutting his own throat.

Trade-ins also present a serious postwar merchandising problem. Before the war, most radio-appliance retailers gave allowances for trade-ins. To what extent this practice will be carried in the future is hard to predict. However, it is safe to say that many dealers will be forced to handle trade-ins.

There are dangers in permitting too large an allowance on trade-ins, also. Being too benevolent on prices offered for this merchandise may be as dangerous as "wild cat" cutting. This practice may soak up the income earned from other goods. In addition, beware of the "we'll-take-anything-no-matter-what-it-looks-like" trade-in policy.

In selling up some of your items

don't "knock" your lower priced goods. Telling the customer that the cheaper merchandise is of poor quality is a poor policy. This practice may back-fire on the merchant, by leading the purchaser to think that all of the retailer's goods are inferior.

Don't make extravagant claims for the items sold. Failure of a receiver or an appliance to live up to the dealer's promises will bring an irate customer storming to the dealer's door. Returned merchandise also bodes no good for the retailer eager to make money and establish a reputation.

Good Advice

Above all, do not tell the customer that dealer so-and-so is unethical, or sells inferior goods, etc. A retailer using this unfair and ill-advised technique is committing financial suicide, besides injuring the already high standards of the independent radio-appliance merchant.

As previously stated, this article is intended as a "refresher" for dealers whose businesses may have become stagnant from lack of merchandise and the terrific consumer demand for goods during the war years. The time to shift into high gear for "all-out" merchandising is rapidly approaching. In the days of competitive selling to come, retailers will do well to watch their business practices.



Harry E. Callaway, vice-president and manager of Thearle's, who finds that systematic radio-record merchandising pays off in greenbacks.

Sales in Six Figures

San Diego Radio Dealer Stresses Employee Training; Promotion Valuable.

• Speak of the Thearle Music Company of San Diego, Cal., and you speak of one of southern California's largest dealers in the record business.

That its annual disc sales run into tens of thousands of units, that its dollar volume runs well into six figures each year is not the result of booming war conditions alone. Neither is it luck, for Thearle's is among the oldest record dealers on the Pacific Coast and has long been one of the leaders in the business.

Good Store Layout

The Thearle Music Company is located in a large three-story business building which occupies the entire half of the block between Sixth and Seventh Streets on San Diego's main street of Broadway. A large part of the building forms the store-front, with generous allowance for window space; large open areas for radio and cabinet display, a sheet music department and a record department—the latter boasting ten comfortable listening rooms, and three small listening "posts"—are provided.

Radios and combinations are also

displayed in thickly carpeted rooms with soft lights, which give a home-like atmosphere to the setting and show the models at their best. Upstairs departments display pianos and organs, while the balcony is used for stringed instruments, wood-winds, brasses, etc. The large building also provides ample studio space for artists and music teachers.

A small auditorium on the second floor is available for recitals and music receptions where, for many years, Thearle's presented Saturday morning concerts of recorded music to which the public—particularly young people—were invited free.

These concerts were preceded by short talks on composers and historical background of the concert numbers. Noted musical commentators and lecturers were presented.

The effect of these many policies over the years has been to establish Thearle's as the music center for San Diego. It is small wonder then that this store has become a regional leader of record sales. It is small wonder too, that while the majority of radio dealers find it more profitable to stock the lighter classics and pop-

ular records, Thearle's does a classical record business amounting to nearly 75 per cent of total sales.

Ads appear in the daily newspapers at least once a week throughout the year. Printed theatre and concert programs carry Thearle's invitation to visit its well-stocked record department. Leading members of the community are caught by the press camera as they gather about a radio combination listening to recorded numbers of a coming "Benefit Concert." (There's always an album or a record or two held by one of the photographed subjects).

Publicity "Angle"

Thearle's has discovered, too, that children's records are worthy of more than the Yule season promotion. One of the contributors to the company's heavy volume of sales is a small, but colorful, children's record section where the albums with all their gay color are prominently displayed. This exhibit draws attention throughout the year.

When Thearle's celebrated its fiftieth anniversary in 1937, many well-known musical celebrities at-

tended the birthday party. They came decked in Gay Nineties costumes, and were escorted from the train to the store by a surrey-and-four. Newspaper editors are always alert to such publicity that has real news value or a "different slant."

Year-around window displays advertise new albums, new releases and new artists. These displays are made timely by tying them in with current events. When the show "Winged Victory" appeared in the city, a display of "Winged Victory" albums was exhibited in the window. When well-known artists appear, recorded albums of their works are featured, as well as selections from the compositions to be played on their programs.

Theatres Cooperate

Musical hits from current movies provide other tie-in themes. Theatres are only too glad to receive "the plug" and are more than willing to provide advance information so that sufficient stocks can be obtained in time. At the conclusion of the run of "A Song to Remember" every single Chopin record and Chopin album on Thearle's shelves had been sold!

Still another record-sale stimulus is the appearance of recording artists to autograph customers' records. Such arrangements are made with leading record companies in advance.

The training and education of sales personnel is a vital policy that contributed to greater record sales. One hour each week is devoted to the training and musical education of the eight to ten record department sales people. The education periods are devoted to brief studies of each composer, his life, and his most famous works. As a result the salesmen and saleswomen never return from the record stockroom empty-handed during these days of shortages with the answer, "We don't have it." Instead, they reappear with one or two other well-known works of the composer or compositions "somewhat like it." Result: More sales.

Planning for Future

Sales people for the record departments are frequently drawn from local high school and college students who are studying music.

When war came and the display counters for table radios looked woefully vacant, Thearle's placed boxes of records and rows of albums along the open counters to camouflage

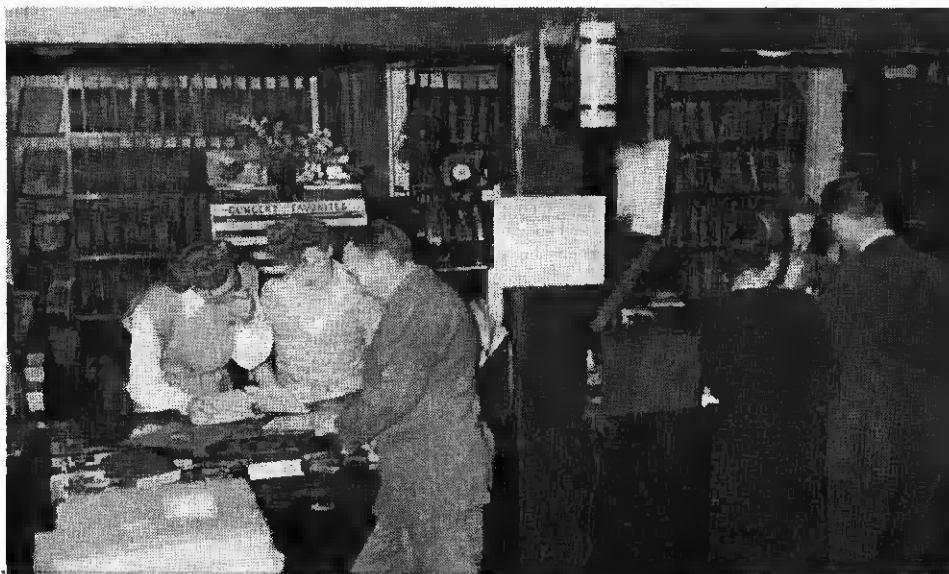

Tens of thousands of single discs and albums are sold over these counters each year. Classics supply the bulk of the record volume. Personal appearances of recording artists boost sales.

the bareness. The public quickly took the idea. They enjoyed the opportunity to browse through stock, choosing a record or an album that otherwise might have been forgotten. The already booming record department sales received an added boost, and Thearle's postwar plans call for a "Serve Yourself" record counter.

Postwar plans? After the war, the firm will once more push radio-combinations, for it knows that every combination sold means a market for records. Its spacious and comfortable lounge will again display standard

makes, as well as lines in the deluxe, high-fidelity class. It will continue to offer free floor space, display, and ticket-selling space to impresarios and concert artists—all in the interest of promoting good music.

Thearle's president A. D. LaMotte, vice-president and manager Harry E. Callaway, and advertising manager and sales director of the record department Orion "Whiz" Nobles, know that these policies which have worked out in the past are worth continuing in the future. They've got the dollars and cents to prove it.



Shown is the area which was formerly used for the display and sale of table model radios prior to the war. Musical instrument selling and music instruction are also important activities here.

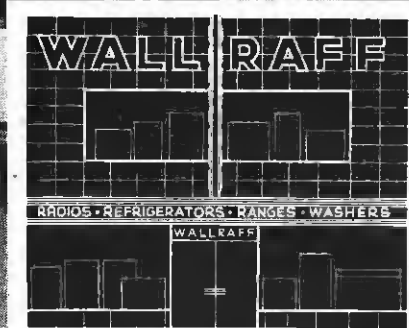
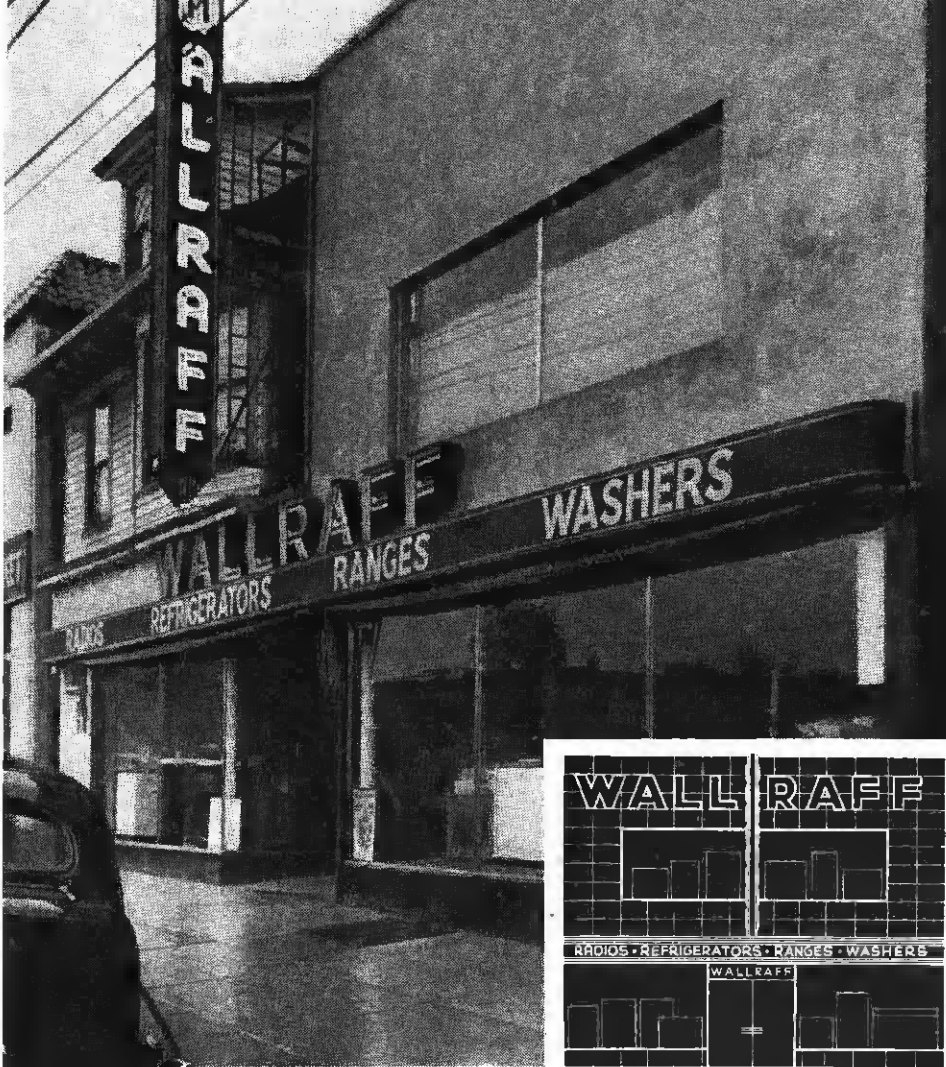

Store-front will be remodeled as soon as materials are available. Inset shows how outside will look when construction is completed. Colored porcelain blocks will be used extensively.

Large Scale Operator; Freezers a Specialty; Commercial Electrical Sales and Service Mainstay Today

• Radio and appliance merchandising is "big business" with Louis E. Wallraff, proprietor of Wallraff Appliance & Sales Co., 1224 Springfield Ave., Irvington, N. J. When goods are again available in abundance, this dealer will be a large volume purchaser, and plans to buy appliances in carload lots as he did in the past.

As an indication of the size of the business transacted at this store, Wallraff states that he sold between 1,500 and 1,700 refrigerators annually, plus countless receivers, pre-war.

To operate an appliance business on this scale requires sufficient store space, with enough room for proper display of merchandise. Wallraff's establishment has a large amount of floor area at present, and will have even more when his modernization plans are put into effect.

The street-level floor of the store measures 110 feet long by 50 feet wide. The second floor showroom is 80 feet in length and 50 feet wide, but this department will be expanded when the release of manpower and priorities enables the firm to remodel.

Complete Repair Work

The current activities of the organization are divided into two parts: (1) Consumer sales and service; (2) Commercial appliance merchandising and maintenance. These functions are keeping the firm active until radios and appliances are once again available in quantity.

An important phase of Wallraff's operation is the complete rebuilding and refinishing of all major appliances. The firm's well-equipped and

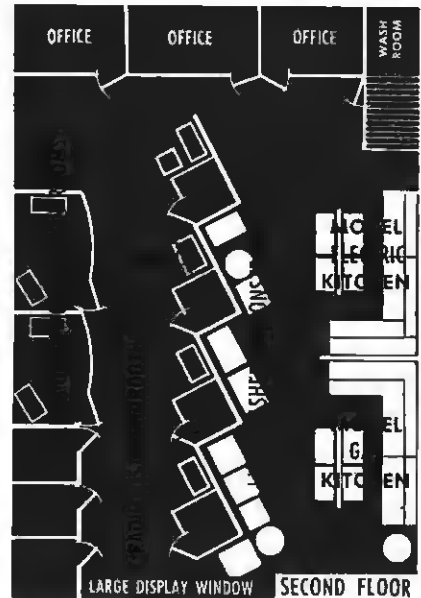

A future floor plan of upper story features kitchen and appliances for their own use. Kitchen in the extension. Part of floor will also use wall paper, hand-painted.

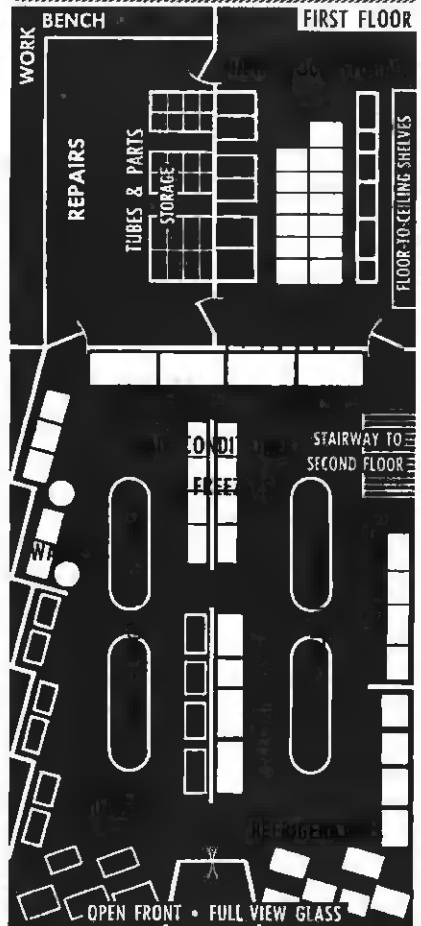

WIRE" Appliance Dealer

well-stocked workrooms make it possible for the company to do a complete job in appliance servicing and rebuilding. Appliance reconditioning is not a new field to the organization, as before the war a lively volume of business was maintained in buying and selling refrigerators which were rebuilt by the store's technicians.

Sales of home appliances are few today, but some articles such as sinks and kitchen cabinets are sold when they are obtainable. However, repairing is keeping the firm's technicians fully occupied until new merchandise is manufactured.

Current Display

Merchandising and servicing commercial appliances has always represented an important part of this organization's business. Commercial refrigerators and freezers are being sold today—whatever is left of them—and most of the store's floor space is devoted to displaying these goods. Nevertheless, even today the store preserves its prosperous and well-stocked appearance.

Wallraff was always very much interested in merchandising home freezers and frozen food cabinets. Foreseeing an excellent market, he actively promoted the sale of these goods. This dealer's long experience with freezers should prove very valuable to him, as he intends to go "all out" on this merchandise—both home and commercial—in the future.

Maintains Warehouses

From his experience with major appliances, this merchant believes that an important factor in refrigerator retailing in the days to come will be the size of the frozen food compartment—at least in his trading area. In addition to selling freezers to consumers, pre-war, Wallraff also sold wholesale, and was distributor for "Deepfreeze" in Essex county in this state.

When sales of radios and appliances were brisk prior to the war, this establishment employed twelve persons—including technicians and office help. Today, this number has been whittled down to three technicians, who devote their full time to overhauling urgently needed appliances.

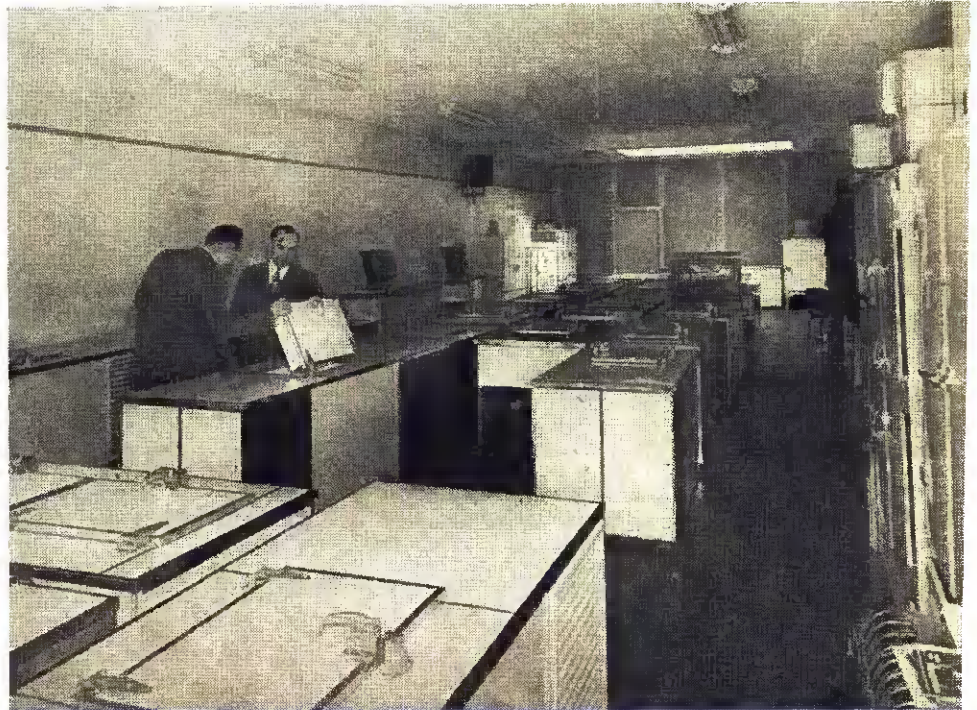

▲ Wallraff, right, explains details of a freezer to a customer. There is a large demand for these appliances in this locality. Wall at left will be removed when modernization is begun.
▼ The store's proprietor directing Harold and Morris Kargen, father and son technicians.

As the firm is prepared to do almost any repair job on electrical merchandise, including motor, compressor and cabinet servicing, a separate stock room is located on the premises.

In normal times, there is not sufficient room in the store to stock the many lines of radios and appliances which the organization handles—despite the large size of the establishment. To provide for storage, the store utilizes two warehouses which it owns, and which are located in nearby towns.

To facilitate the merchandising of new appliances, and to keep the number of home demonstrations down to a minimum, the upper floor of the store displayed a complete kitchen in actual operation, before the war. "Live" demonstrations of both electrical and gas appliances were exhibited. Displays of this nature aided the firm in closing many sales—particularly on washers.

In the near future, Wallraff again intends to include a display of a model kitchen, as this has proven to be a very valuable appliance mer-

(Continued on page 98)





Actor's eye view of crowd in Garfield Park listening to a summer concert. Note mike at right for front stage pickup of orchestra. Two 50-watt amplifiers are used to cover the park.

OUTDOOR SOUND

Installation Details of Indiana Amphitheater Sound System. Microphone Placement and Control Methods

● In the Garfield Park Amphitheater located in the southern part of Indianapolis, Ind., sound reinforcing equipment has been installed during the last two seasons for a series of summer concerts and performances of "The Pirates of Penzance." Due to the type of stage presentation and the use of an "outdoor" stage, several interesting and unique problems were presented.

The Amphitheater consists of a large covered outdoor stage, an orchestra pit and a bowl with a seating capacity of approximately 2,000 persons. The stage opening is 60 feet wide and 40 feet deep. A loft over the stage makes it practical to fly the microphones.

Mike Placement

As high fidelity was desired on this installation, all microphones were low impedance. Two of the pressure type microphones were mounted on a double hanger. This hanger was hung just back of the traveling curtain. Two of the junior type velocity microphones were hung about eight feet in from the back-drop at the left

and right wings to cover two entrances—one at each rear corner of the stage. These two up-stage microphones proved invaluable in covering the corner entrances and exits as well as the offstage singing which played a large part in the performances.

Amplifier Set-Up

The velocity microphones, because they are bi-directional, also picked up sound from the two dead front corners not covered by the front center microphones. The microphones were all approximately eight feet off the floor.

A total of five microphones was used. The fifth one was used on a floor stand as an announce microphone, being placed in the center of the stage, and as a pickup microphone for the overtures.

From past experience with microphones it was decided that the microphone should be suspended instead of being placed in the footlights, in order to obtain deeper stage coverage and less floor noise. When band concerts were presented in the Amphitheater

it was found that a velocity microphone on a tall stand between the woodwind and the bass sections, with one of the dead sides facing the trumpet section, together with a pressure type announcing microphone, gave excellent results. At all times two spare velocity microphones were mounted on stands and kept in the wings (one on each side of the stage) to take care of piano-vocalist and other specialty numbers.

The amplifying equipment consisted of a speech input four-channel mixer feeding a speech input portable remote pre-amplifier. The portable remote pre-amplifier fed a 500 ohm line which was used as a feeder for the two 50-watt power amplifiers.

Control Desk

Input equipment was mounted on a control desk in the first row of seats in the Amphitheater where the operator had a good view of the stage. A 28 db pad was used in the 500 ohm line to allow the VU meter on the four-channel mixer to swing to full scale without over-driv-

ing the power amplifiers at the normal required operating output of ten watts. This allowed a dynamic override of 10 db in the power stage without causing distortion. This is one feature which is often overlooked in the engineering of such installations. The normal power output required is always a great deal less than that needed on the peaks and therefore if the power output is calculated for the average load, distortion is encountered on peak loads.

Coax Speakers

On this installation quality was desired on the peak loads and therefore plenty of reserve power was installed.

It was found that on this installation a flat response from 30 to 10,000 cycles within plus or minus 1 db gave the most natural reproduction. The distortion measured at 400 cycles never exceeded 5 per cent even when the amplifiers were driven to their full output of 100 watts. For the 10 watts normal output distortion was below 2 per cent.

Coaxial reproducers, consisting of a high and low frequency mechanism with a crossover at approximately 600 cycles, were used. These units were mounted twenty-five feet off the ground and one was placed on each side of the stage. The horizontal center lines of the speakers were on a line with the last row of seats and permitted adequate coverage of all the permanent seats plus the thousands of patrons who sat on the tem-

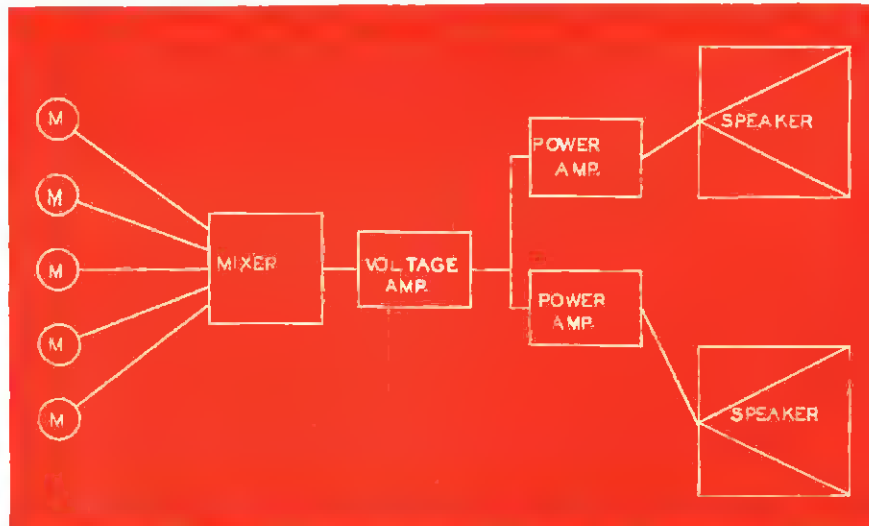

Block diagram of equipment used in this outdoor sound job. Power amplifiers are rated at 50-watt each.

porary seats or on the grass in back of the permanent seats.

Due to the great amount of activity on the stage during the presentation of the "Pirates of Penzance" it was found necessary to have two operators on the controls of the sound reinforcing system, one watching the stage action and bringing into play the microphones required, and the other riding gain and watching the VU meter. It was found that the best balance was obtained with the system when all microphones except the one being used were attenuated 10 db.

For special messages the announcing microphone was switched into the

system whenever it was necessary.

With the placement of the microphones described, sufficient pickup was obtained to amply reinforce the orchestra. When the curtain was drawn the "announce" microphone was used for the pickup of the orchestra.

From the comments made by the audiences it was judged that this installation was very satisfactory and that the results obtained warranted the care and engineering effort expended in planning the system, and placing the speakers and microphones.

The above article was written by L. E. Kelsey, RCA Victor sound engineer, just before his recent death.

Stage view of amphitheater showing six mikes for complete pickup.





Modern sales techniques pay Herb Names good profits in spite of goods shortages.

● In spite of merchandise shortages and other war-born obstacles, Dealer Herb Names has succeeded in making a name for himself in Denver business circles and he has been able to make profits through stepped-up service methods and the employment of modern sales techniques.

In 1940 Herb Names resigned his position as head of the radio department of the Charles E. Wells Music Co., Denver, Col., and went into business for himself. He established Herb Names, Inc., 1532 Stout St., with a line of radios, refrigerators and electrical appliances. With experience gained in his connection with the Wells company and other Denver musical instrument firms over a period of years, Names was well qualified to operate his own business.

Service to the Fore

The store got away to a good start. Business was good from the opening day. Then came the war. New radios and other items of merchandise began disappearing from the market. This was a bad break for the new business venture. This dealer, however, was determined to make a success of his business, and began giving the matter sober thought. He hit on a plan that was put into effect and which has served to keep his establishment listed on the business map of Denver.

Names knew that the removal from the market of new merchandise

Denver Knows His

Publicity - Minded Colorado Merchant Show Windows Attract Radio-Appliance

would call for a lot of repair work to keep the radios and electrical appliances of his city operating. That was where his plan entered the picture.

He moved his repair department up front from the rear of the store. Directly into one of the firm's display windows went the service department. The entrance of the Herb Names store is in the form of a horseshoe. At the back of the horseshoe is the entrance, while at each side is window display space, as shown in one of the photographs accompanying this article. One of these window spaces—the one at the right of the entrance—was fitted for the repair department. Work bench and test equipment, etc., were placed in the window where it could be seen from the sidewalk. Thus, the repair work brought into the store is done

right in full view of the hundreds of people passing the store each day.

This was a novelty—nothing like it had ever been done in Denver before. As a result, the window drew attention. People stopped and watched the technicians at work. Then, when they had a radio or electrical appliance which needed repairs they thought of the store downtown where they saw the work being done in the window. As a result the store got a lot of business that otherwise might not have been brought to the store.

Moving Displays Pay

The fact that movement in a window display draws more notice than a stationary exhibit has always been recognized by window trimmers. The Names store has a window display with motion in it—men at work on

The interior of the Names' store carries its atmosphere of stability and sincerity to the customer in this modern establishment. Well-known radios, refrigerators and other appliances are featured.



Name!

Plugs Own Business. Makes Buyers. Builds Following

radios and electrical appliances. This feature attracted attention which consequently brought in new customers.

If a customer cares, he can take a radio to the store and watch the repairs being made. In fact, Names tells of one customer who came in with a receiver to be serviced and then stood nearly two hours in front of the window watching the technician work on his set. Of course, that person told friends and neighbors, and other customers were obtained as a result.

To open the novel repair department, the store was represented in local newspapers with large advertisements calling attention to the new idea.

The window arrangement was extended inside the store, as shown in another photo. The first section of this window display extension is a

it in the open technical department is
ll be actively merchandised here.

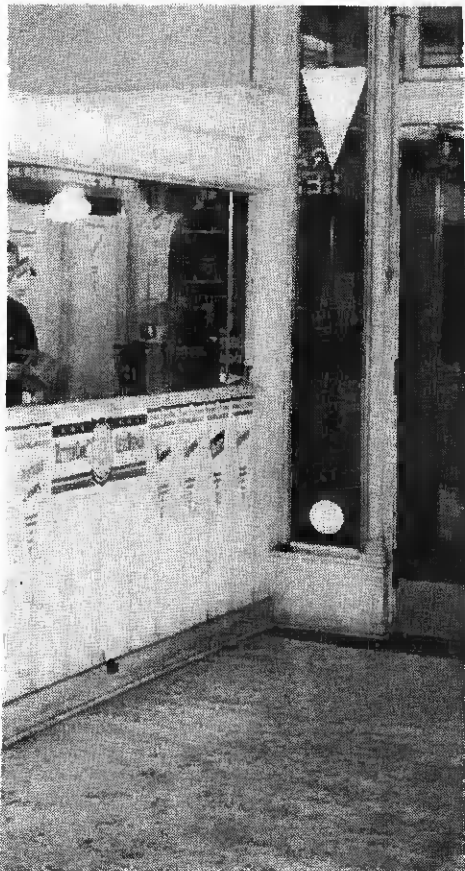

Technicians work right in these windows—Keep Herb Names' name in the public eye.

glass enclosed compartment well-fitted with shelves and cabinets in which is kept radio and electrical appliance parts. Outside this compartment is a counter where radios and other items are received for repair. The signs back of this counter point out that the store does not make free radio service calls, that all service work and parts are strictly cash and that not more than two sets of batteries will be sold to a customer.

"Right from the start," said Dealer Names, "our repair work showed a definite increase, and it has jumped to five times what it used to be in normal times."

Window Servicing

At first, he declared, the employees were a little backward about the idea. They didn't take too well to the idea of working right "out in public." It wasn't long, however, until they changed in this respect and began to like their "glorified" positions. They were right up front—in the limelight, so to speak. They were playing an important part in the general scheme of things at the store. Attention was centered upon them, and they liked it.

Since November 1, 1942, when the repair department was moved into a display window at the Names establishment, repair business has been

good. What of the department after the war? Well, that is a question that has not been decided as yet at the store. Names says that the repair men feel that they have earned their place "up front." Perhaps they will stay there. Again, the department may be returned to the rear of the store.

Ready for Selling

It will not be a great many months now until new radios and other items will begin coming into retail stores. The arrival of goods will call for display and merchandising, and the window space may be needed for that purpose. Retailer Names is giving some thought, also, to placing the repair department just inside the door.

The Herb Names store handles Philco, Stromberg-Carlson and Ansley radios, and the proprietor is of the opinion that somewhere around 6 months from now new models will be on the market again. He is making his plans with that idea in mind. This Denver merchant, along with hundreds of other business men, realizes that the postwar period will witness the keenest competition the industry has ever seen. The men who have weathered the war-time scarcities have built a firm foundation upon which to erect their postwar merchandising campaigns.

Dealers Decide on

RADIO

APPLIANCES

RECORDS

MERCHANDISING

SERVICE

FM

MEMPHIS, Tenn.—Harold Ridgway, of the Ridgway Radio & Television Co., 3699 Southern Ave., is another of the many radio store proprietors who has his postwar plans definitely underway. He located his store in the eastern part of the city, keeping in mind eventual city expansion in that direction, and the present exposure to suburban shoppers. The store front was remodeled and repainted in accordance with the latest ideas on modern design. In addition, the very fact that "television" is included in the store's name, Ridgway feels, impresses people with the fact that he is looking to the future, and keeping one step ahead of competitors.

He expects to sell radios and home appliances as soon as these are available, and already has a franchise for the Admiral line. Ridgway advertises in the neighborhood theater, school paper and occasionally in the local daily paper.

DAVENPORT, Iowa—"Know your customers by their first names," advises Albert M. Munchrath, owner of the Munchrath Appliance Shop, 524 Brady St. Being on the very best of terms with his customers, means more friends—and more sales—for this dealer. For the major portion of his advertising, Munchrath depends on this "friend-tells-friend," word-of-mouth form of publicity.

Prior to the war, the firm sold radios, refrigerators, washing machines, ranges, etc. Today, servicing of receivers, and appliances is keeping the store fully occupied. Repairs average about 50 per cent for radios, and approximately 50 per

cent for major appliances. This retailer makes a specialty of refrigerator servicing, and the bulk of the appliance repair is on this equipment.

OWATONNA, Minn.—F. J. and R. G. Stephenson have opened a thoroughly new and modern music store here. It is called the Stephenson Music Shop.

KALAMAZOO, Mich.—In addition to radios and appliances, Triestram's, 605 S. Burdick, carried a small line of table lamps and lamp shades prior to Pearl Harbor. When most civilian goods vanished from the market, the firm expanded these lines—and with a great deal of success, too.

The proprietress of this establishment, Mrs. E. C. Triestram, asserted that she will continue to merchandise table lamps and promote these items, along with radios and appliances, postwar, for five reasons: (1) they are profitable; (2) they are attractive and serve to brighten the store; (3) lamps and shades are small items and do not consume too much room; (4) this merchandise can help cover the costs of overhead; (5) only a few samples need be displayed, while the balance of the goods can remain in the stock room.

ALBANY, Ga.—A branch of the Crocker Piano Co. recently opened in this vicinity. The owner, C. J. Crocker, also operates music stores in Dothan and Andalusia, Ala.

CHICAGO, Ill.—The Portage Park Household Appliance Shop, 4026 Milwaukee Ave., is making the best of its empty floor space by roping off a section of the store, and placing a sign in the center reading: "Reserved for Postwar Electrical Appliances." Frank Wuerner, manager of the store which was established eighteen years ago, is taking orders now for refrigerators and other items which are on display, but not for sale. "By obtaining the names of future customers we built up a strong clientele listing," claims Wuerner. "When production of electrical goods gets under way we will inform the people who had previously registered with us, that we are now ready to serve them."

INDIANAPOLIS, Ind.—When merchandise was available, sales of home and auto radios kept things humming at the Eddey Radio Service, 317 N. Delaware St., although radio servicing also played an important role. Today, says F. I. Eddey, who operates the establishment, receiver repairs supply the lifeblood of the organization; auto radio particularly. To accommodate car radio work, a driveway is available, and motorists can drive into the establishment and leave their cars there for radio servicing or installation.

EAST MOLINE, Ill.—Back in 1941, when war with the Axis seemed imminent, Frank R. Almquist, owner of the East Moline Home Appliance Co., 655 15th Ave., bought all the appliances on which he could lay his hands. This stock of merchandise sold rapidly until six months after Pearl Harbor, when the supply was exhausted.

When all his appliances were sold, Almquist took in substitute lines, consisting of paint, new furniture, table lamps, mirrors, pictures, linoleum, etc. These goods, together with radio and appliance servicing, have maintained the firm's volume, and have kept the business out of the red ink.

Another line which has augmented the store's income is bottled gas. This branch of the business is conducted on a cash and carry basis only, thereby eliminating any cost, both to himself and the customer, incurred through picking up and delivering.

With the prospect of new merchandise looming on the horizon, Almquist has purchased the store which is immediately adjacent to his in preparation for "M Day."



NEW BRITAIN, Conn.—Window display at Moran's stresses furniture and small appliances. This Main St. dealer was a large radio and major appliance merchandiser pre-war, and intends to go back to these lines as soon as the products are available.

Definite Postwar Plans

TELEVISION

REFRIGERATORS

WASHERS

REPAIRS

SIDELINES

POSTWAR PLANS

Part of the wall separating the two stores was removed, and both shops were combined into one large establishment. When radios and appliances become available, this retailer will have adequate room for the proper display of these goods.

Almquist feels that a dealer should be advertising his business at all times. "It makes no difference where a retailer is, and wherever he finds himself, whether in social or business circles, he ought to tell people who he is and what he sells," he declared. "Of course," Almquist added, "in non-business circles, this calls for a certain amount of discretion and tact."

This merchant is looking forward to doing a business that is bigger and more profitable than ever in the days following the war. His past merchandising ability has demonstrated that his forecast for the business future seems bright and accurate.

PRESTON, Idaho—C. C. Adamson, proprietor of the C. C. Adamson Co., is at present handling milkers, water pumps, and electrical appliances in his new store. He has signed up as an authorized dealer for the complete Westinghouse appliance line, Conde milkers and Fairbanks-Morse pumps.

GARDEN CITY, Kan.—The Mullins Stores, also located in Larned, Liberal, Dodge City and Great Bend, are capitalizing on the pent-up demand for radios by taking orders from prospective customers now. Primarily furniture establishments with large radio departments, the Mullins stores list returning soldiers who want radios at the top of their preferred list. Next in preference are civilian buyers who pay cash for their sets now. Buyers who have paid no money, but who signed a contract to purchase when sets are available, are next. Last are customers who want radios, but have not paid or signed a contract for them. In the event that the customer should change his mind or obtain a radio at an earlier date, the Mullins brothers will refund any money paid to them.

HAGERSTOWN, Md.—Joseph and Lehmann Tarbart, 517 Salem Ave., believe advertising to be an indispensable factor in keeping their name familiar to former and future customers. Specialists in automobile radio sales, the Tarbarts are currently publicizing their satisfactory service guarantee, and ability to recondition radios of all makes.

ELMHURST, Ill.—Throughout the war the Electronics Service Shop, 120 North York St., has been building postwar patronage by giving superior workmanship, itemizing all charges on bills and, above all, always aiming to please the customer. A. C. Wolf, technician, says, "Our customers will definitely remember and trust us when they go out to buy electrical appliances, because of our present friendly attitude." Wolf makes it a practice not to give advance estimates when repairing sets, because of the time involved in determining costs accurately. Customers are satisfied with this arrangement, because they have faith in the good-will business policy of the Electronics Service Shop.

MINOT, N. D.—The Northwest Piano Co. has moved its salesroom to 121 Main St.

WASHINGTON, D. C.—The Park Radio Co., 2146 P St., N. W., has as its slogan, "We Do More Than Make Your Radio Play!" John Moore and Henry Hart, the owners, are firm believers in the value of advertising, and point out that the "Park Radio Co. Gives the Better Type of Radio Service." They specialize in RCA, Philco, Capehart, Stromberg-Carlson, etc.

BUFFALO, N. Y.—The North Park Appliance Co., has in its employ two disabled veterans of this war. Through the local U. S. Employment office, the management contacts discharged veterans who wish to enter the radio field. Some of these men may have had previous Signal Corps training, but in many instances they know nothing about the business. Employment of discharged soldiers is an excellent source of untapped personnel, the North Park Appliance Co. finds.

QUINCY, Mass.—"A Winner Never Quits, and a Quitter Never Wins," is the motto of the World Appliance Co., 7 Granite St. H. C. Smith and R. F. Hendrickson, who have been established as radio and appliance dealers in Quincy since 1929, own and operate the store. They recently moved into the present new and larger quarters, which occupies space 25 feet wide by 110 feet deep. They intend to continue their specialty of radio service and, as soon as possible, to merchandise radios, appliances and television.

FREEPORT, N. Y.—M. Marans and A. Nickelsberg are the new owners of the Sunrise Music Shop, formerly known as the Freeport Temple of Music. In addition to radios and records, the firm will carry a complete line of electrical home appliances when such merchandise becomes available.



HOMWOOD, Ala.—J. Childress, right, proprietor of the Homewood Radio & Electric Co., put a used display case to good use, by converting it into a radio repair bench.

SEAFORD, Del.—Thomas R. Young, of Salisbury, Md., will open a musical merchandising branch store in this town.

HARTFORD, Conn.—The Hurwit Furniture Co., 539-543 Park St., is located in a shopping area of its own, about one mile from the center of Hartford. Owned by James S. and Benj. J. Hurwit, the company carries refrigerators, washers, ironers, radios, stoves and water heaters when these are available. The Hurwit brothers say that "home owners make good customers because they are permanent residents," and these dealers direct much of their good-will effort toward this group.

DULUTH, Minn.—Walt's Radio Service, newly opened store at 10 North Fifth Ave., features forty-eight hour radio repair service. Both delivery and pick-up are included in this speedy service. Extensive newspaper advertising enabled Walt's to get off to an exceptionally good start.

Rhapsody

**September Tie-In for Record Retailers.
Check Stocks NOW for Harvest in Disc Sales.**



Al Jolson, popular recording artist in his own right, was the first outstanding performer on New York's Broadway to introduce the first Gershwin hit—"Swanee"—way back in the "roaring twenties." From then on George Gershwin's melodies became musical history. BELOW, scene from the Warner Bros. film "Rhapsody in Blue," depicts the scene from an early edition of George White's Scandals, and represents Gershwin's attempt to give the public their first real taste of "blues." George Gershwin continued to write many pieces of music, both popular and classic, and forever endeared himself to the hearts of the American record-buying public.

• With this summer spent at home — by order of ODT, July days deep in summer tranquility stretch before the record-buying public with an invitation to relax.

Music is the best relaxer we know of, and the music the public wants will provide relaxation from the radio's tension of war news and today's weighty problems. Music on records will keep the radio-phonograph combinations playing and the record retailers busy selling! Disc makers continue to juggle wartime shortages and still manage to get out a goodly stock of recorded music for dealers' customers to choose from.

SCOOP for Sept. 29th!—The Warner Bros. picture "Rhapsody in Blue" previewed by your reporter just prior to this writing, opened in New York June 29, along with the Paul Whiteman sponsored Gershwin Week. *This picture will be released nationally on September 29th.*

Here is a picture tie-in for dealers that is really out of this world! Get out all your Gershwin tunes, in all their glamorous variety, and now is the time to reorder on those you do not have.

The motion picture "Rhapsody in Blue" is the story of George Gershwin's life and is packed with his music; and if ever a picture were



for Record Sales



ABOVE, Paul Whiteman in a scene from the Warner Bros. film, "Rhapsody in Blue," representing the initial Gershwin concert. BELOW: left, Hazel Scott, right, Oscar Levant, both recording artists, and their appearance in the Gershwin picture will sell their own discs as well as the Gershwin recorded music.



a perfect sales vehicle for recorded music, **THIS IS IT!** The public will want to walk right out of the theatre and into your store to buy the records, **IF** you are prepared and have dressed your window in a "step this way" manner!

Victor is offering an exceedingly extensive Gershwin cooperative campaign to its retailers. National radio time will be programmed in September on RCA's regular NBC show-time, and in addition to the music, actual incidents from the Gershwin film will be broadcast. National advertising in full pages will appear, and a galaxy of Gershwin displays are available to retailers tying in with the movie.

Decca will tie-in with the film's New York premiere via mounted 2-color display card featuring stills from the picture, and with mats for dealer newspaper ads. In connection with the national release, Decca plans a 3-color poster featuring all its Gershwin records, easel-backed, blow-up of Porgy & Bess Album, counter cards duplicating all Gershwin



album covers, and newspaper ad mats.

Columbia will run full page national ads in color in *Life Magazine* and *Newsweek*. Cooperative ads will
(Continued on page 111)



The front of the Independence, Mo., store. Windows stress music featured in local theatres.

selling records, a feat that is accomplished by listing in each ad about 50 records-in-stock. It works, says Mr. Cochran, because a dozen or so customers a day come in with ads with titles checked, and say, "I want these!" This merchant also points with pride to the whole-hearted job he does with the direct mail material he receives from disc jobbers and manufacturers. A mimeograph machine will go into action here shortly and will be used in furnishing regular customers with a complete catalog of records, and other merchandise in stock. Easy to insert supplements to the catalogs will be mailed each week.

An example of the Cochran merchandising skill is reflected in the way the organization in both stores clicked at the job of selling more needles, a small item that can swell cash register receipts considerably if handled properly. Each clerk is instructed that after each record sale he must ask the customer about his

Paving the Way to

Music Store's Entry into Radio - Record Field "Clicks." Suggested-Selling Plan Builds Volume

• Six hundred guitar and accordion pupils, half of whom own record players, were the stimuli that influenced musical instructor E. A. Cochran to penetrate the musical merchandising field three years ago; the impetus that moved him to open two record retailing stores in Kansas City, Mo., and suburban Independence. As students trek upstairs to classrooms to receive instruction in guitar and accordion, they pass the stock of records, often perceive some disc that appeals to them, which they ultimately buy.

It isn't an accident that the stores are arranged so that pupils must pass the record racks to go to classrooms, because Dealer Cochran is a shrewd businessman as well as an efficient musical instructor, as is evidenced by the hustling record trade of the Cochran Music Stores. It is natural that when a student has difficulty mastering "El Capitan" for example, that the instructor suggests that he buy a recording of the piece in order to simplify the matter of learning. And it is natural that the

student buy the record from the "head master," because the tie between instructor and pupil is very warm, very close, and the average pupil's sense of loyalty is quite strong.

Records, and related merchandise, comprise the stock now, but later there will be radios (Cochran has already lined up some franchises), and a vast array of musical instruments, including pianos. The firm plans to do an active selling job.

Modernistic fixtures adorn the interior of both the Kansas City and Independence stores. The latter establishment is managed here by Mrs. Cochran and the Kansas City branch is supervised from 9 A.M. until 3.30 P.M. by her capable husband.

Ads Bring Results

There is nothing apathetic about the advertising program here. Half-hearted advertising is "Pet Peeve No. 1" with Mr. Cochran. He sponsors whole-page ads in two popular community newspapers, one in Independence, the other in Kansas City. Present ads have the primary job of

needle supply. If a clerk is forgetful, Cochran, or his wife, interrupts the sale to question the customer. Needle sales are booming!

Takes Cue from Movies

In each store, an attractive, strategically-located rack of sheet music is part of the interior equipment. Handy, self-selling racks are an important cog in the merchandising machine here, and sheet music sales have prospered since they were moved to a front-of-the-store spot. Cochran watches the movies for cues, stocks heavily on pieces the movies spotlight. He finds using the theatre as a key to future popularity has proved worthwhile. In the case of Debussy's "Clare de Lune," a number nicely played up in "Music For Millions," Cochran anticipated the bright future for both sheet and record sales of this number. He was able to stock the sheet, but, because of a manufacturers' shortage, couldn't get the records. However, he plugged the sheet in window displays and on the interior rack and had his reward in the



E. A. Cochran, proprietor, right, and Mal Linneville, promotion director, shown with two members of the staff of the Kansas City, Mo., store.

Profit

lush dividends that came his way immediately after the movie ran in Kansas City.

Adult music lovers, who graciously liberate some ten or fifteen dollars for records for each visit to his stores are

cliente favorites with Cochran, but he doesn't shun the business of the teenagers who flock to the store after school and during the noon hour. It is frequently the habit of this juvenile trade to play records for hours, with sales receipts from their visits totaling almost nil. But, to quote Cochran, musical habits of the younger generation run in moods, and are also affected by their "allowance" release dates. Perhaps fifteen or twenty of

these "bobby-soxers" will walk out with only one record, a very poor sales average, but it pays to coddle these young customers since they can recommend the firm to their parents, according to this retailer.

Ruefully, Cochran declared that he could sell 150 "singles" of the Tommy Dorsey recording of "Stardust" each day if he could get them, so great is the general appeal of this perennial hit. The record by itself contributes to the nice sales the Tommy Dorsey album enjoys here.

"Handle with Care"

Discriminating folk who call consistently for discs of the classics take a special type of sales treatment, and in both stores a competent clerk, with well-rounded knowledge of classical music, cares for those with a taste for such music. Cochran says the classical trade is made up of sensitive people who must be carefully handled, and the sales clerk exercises care when dealing with this trade. In addition, he says, there is much "walk-in" casual trade for the populars, but the record retailer must develop his classical business because it comes from regular patrons who shop consistently at one store.

Included in Cochran's plans is the opening of a downtown building in Kansas City. The present store is in a South Kansas City business district. He is quite pleased with the excellent showing his organization has made in three short, but well-filled, years.



Interior view of the Independence branch of the firm. Record sales are booming here, and the store has a well-established trade. Active needle merchandising also helps to boost volume.

Radio-Appliance Outlook

Latest News from Manufacturers on Reconversion Plans.

BENDIX AVIATION—The general trend of events indicates that there will be some radios on the market this Fall.

LEONARD C. TRUESDELL,
Radio Division

WILCOX-GAY CORP.—Our civilian products will be ready for delivery within a 60-day period after all necessary components are made available and WPB authorization received.

WARREN HASEMEIER,
Charlotte, Mich.

SONORA—Sonora Radio & Television Corp., Chicago, promises delivery on 37 assorted models from portable to radio-phonograph combination to the dealers by early Fall.

EUREKA VACUUM CLEANER CO.

—First deliveries of vacuum cleaners are expected this Fall. While our volume of war production will continue so long as it is needed by the armed forces, favorable war conditions indicate that limited consumer goods manufacturing will soon be possible so that the public will get some of these long-needed appliances.

As soon as conditions permit, we will offer for the first time a complete home cleaning system consisting of an upright unit for rugs and carpets, a tank-type cleaner for "above the floor cleaning," and a set of attachments, including a power-driven floor waxer.

GEORGE T. STEVENS,
Detroit, Mich.

Last month's issue of this publication carried estimates from leading manufacturers on the production picture. More on this page.

LANDERS, FRARY & CLARK—

We estimate that in general 4 to 5 months will be required for the actual production of merchandise after WPB authorization is received.

This length of time may vary depending upon item involved.

W. J. CASHMAN,
New Britain, Conn.

MOTOR PRODUCTS CORP.—

While the industry has been given the go ahead on products, there has been no program set up for the allocation of necessary materials and the component parts. Until this point is decided and until the manpower situation is clarified, it is our belief that it is impossible for any manufacturer to tell you exactly when he can have products ready for civilian market.

We believe the Deepfreeze Division of the Motor Products Corp. will be in as favorable a position and in many cases a more favorable position than manufacturers of similar products to produce and have home freezing equipment on the market for civilian use.

R. V. NEWBELL,
No. Chicago, Ill.

F. L. JACOBS CO.—Production of new electric washing machine will be under way in the F. L. Jacobs Co. plants by the first of October. Very considerable production will be reached by the beginning of 1946.

REX C. JACOBS.

FADA RADIO—Contingent upon the WPB allocating materials for civilian use and contingent upon the proper price arrangements being established by the OPA, providing the manufacturer with a fair profit under his current cost and pricing arrangement, and conditional upon our being able to obtain complete complement of all components necessary to complete the building of radio receivers, I should say that as far as our production lines are concerned, we should have radios available for the market within 72 hours after receipt of all component materials.

The main information you are seeking in response to your query is how soon do we expect we will have all available materials on hand from component manufacturers after WPB removes restrictions now in effect under Regulation L 265 . . . three months would appear to be a reasonable premise and certainly not more than four; hence, either three months and three days or four months and three days after we receive all components, we can be ready to release radios to the civilian market.

J. M. MARKS,
Long Island City, N. Y.

FCC Adopts FM-Tele Alternative No. 3 with Revisions. Turns Down Industry Plan

(Correction of items on pages 30 and 31)

In a surprise decision, and acting without delay so that prospective radio-set manufacture may go ahead when authorized by WPB, the Federal Communications Commission on June 27 finally adopted what is virtually a fourth alternative plan for FM and television allocations. The plan authorized follows the No. 3 alternative from 44 to 72 megacycles, beyond which the assignments are shuffled so that FM is pushed even further "upstairs" than in the original No. 3 alternative. Following are the final Television-FM allocations as authorized June 27:

44 - 50 mc	Television No. 1	72 - 76 mc	Non-Gov. Fixed and Mobile
50 - 54 mc	Amateur	76 - 82 mc	Television No. 5
54 - 60 mc	Television No. 2	82 - 88 mc	Television No. 6
60 - 66 mc	Television No. 3	88 - 92 mc	Educational FM
66 - 72 mc	Television No. 4	92 - 106 mc	Commercial FM
	106 - 108 mc Facsimile		

The above information supplants the first two items on page 30 and the chart on page 31 of this issue, which pages were already printed when the FCC took its unexpected action on June 27.

NOW . . .

RECORDIO DISCS AND *Recordioint* NEEDLES

SOON THE NEW
RECORDIO

When the Wilcox-Gay RECORDIO was designed it opened an entirely new field of useful home entertainment. People could hear how they sounded to others — "a mirror for sound" had been created. Salesmen started using RECORDIO to improve their selling ability. Public speakers rehearsed their speeches. Musicians could check the rough spots in their performances. Hundreds of uses were discovered — then RECORDIO went to war . . . it will soon return to civilian life with a history of even finer achievements — because, it is a FINER RECORDIO. At present RECORDIO DISCS and Recordioint NEEDLES are available and furnishing dealers with profit making products to sell. It will pay you to contact your RECORDIO distributors for full information.



"SELL RECORDIO ACCESSORIES for MORE PROFIT IN YOUR POCKET"



RECORDIO

Recording instruments for home, commercial and professional use.

MANUFACTURED BY
WILCOX-GAY CORPORATION
CHARLOTTE MICHIGAN, U. S. A.



Leon A. Osborne and Mrs. Osborne in record dept. of new store. This dealer has sold over 15,000 radios; repaired 50,000 sets.

Platter Profits Climb

Osborne of New Hampshire Offers Sales Success Formula

• Confident of the coming expansion of sales in the radio-appliance field, and eager to play an important part in this industry, Leon A. Osborne, proprietor of the Phonograph & Radio Shop, has moved into roomier quarters at 207 Hanover St., Manchester, N. H.

Measuring 20 feet wide by 40 feet deep, this new store will provide this dealer with sufficient space with which to do a real merchandising job in the future. The front 35 feet of the establishment has been set aside in anticipation of obtaining receivers and major appliances. Approximately 15 feet in the rear of the store will be devoted to the all-important job of servicing.

As repairing calls for parts of all types, a stock room occupies the space between the sales and service departments. This efficient arrangement should facilitate merchandising.

Record Stock Grows

Before radios disappeared from the market, Osborne did a large volume of business in receivers. However, by acquiring more space he hopes to avoid the congestion which he endured several years ago when his place of business was filled with sets waiting to be delivered to customers. Among the brands sold by this firm were Philco, Emerson, Stewart-Warner, GE, and other noted makes.

In 1940, this dealer "took a

chance" by going into record merchandising. Starting with a modest stock of discs valued at \$50, this phase of Osborne's business has grown to sizeable proportions. The store's present stock of platters is worth about \$5,000, which gives a good indication of the progress that has been made. Several well-known brands, such as Decca, Victor, Harmonic, etc., are sold to record-hungry "fans." The disc department is under the supervision of Mrs. Osborne.

Juke Box Tips

An important and lucrative part of this establishment's business is the rental of juke boxes. Starting with one machine in 1940, Osborne now has six in operation. This merchant reports that this activity alone furnishes him with a substantial income.

However, there are pitfalls in juke box operation. This dealer's experience with renting record machines has taught him that six or eight machines is the maximum that a retailer of his type can safely operate.

Competition for locations is so keen, this dealer points out, that haphazard operation will result in the loss of the location, and a subsequent drop in income. Nevertheless, the juke box field represents an opportunity for the aggressive retailer to earn extra profits.

The revenue of Osborne's store is obtained from three sources: (1)

servicing; (2) selling of records; (3) operating juke boxes. Each phase of this business is very active these days, and all combine to keep the sales volume at a profitable level.

Methods Pay Well

The owner of this establishment estimates that the time necessary to repair radios in his store has increased 1,000 per cent. But, he declares, in view of the fact that all servicing charges are made on a time basis, receiver repairing is profitable.

Since his entry into the radio retailing field, nineteen years ago, Osborne estimates that he has sold 15,000 receivers, and serviced over 50,000 sets. This merchant is regarded to be one of the leading radio-appliance dealers in this area.

The two principal ingredients which Osborne offers as a success formula for profitable radio merchandising, based on his own experience, are personalized customer relations, and rendering unexcelled service. This method of operation has consistently "paid-off" for this retailer.

With an attractive store currently at his disposal, Osborne is prepared to do a first-rate merchandising job. Lines of goods which he intends to sell in addition to radios, appliances, and records, include movie cameras and projectors. This dealer is also looking forward to maintaining a motion picture film library.

THE NEW POST-WAR

Emerson

Radio and Television

*The Big News
Breaks This Month!*

WATCH FOR THE
SENSATIONAL
ANNOUNCEMENT

Note: Only Franchised Emerson Radio Dealers
will be authorized to participate in the forthcoming
campaign. Call your Emerson Distributor today.



EMERSON RADIO AND PHONOGRAPH CORPORATION, NEW YORK 11, N. Y.
WORLD'S LARGEST MAKER OF SMALL RADIO



FOR A JOB

Well Done...

THIS button, soon to be worn by thirteen million men and women—honorably discharged members of the Armed Forces of the United States—is a symbol of honor, an insignia of respect.

Wherever it is worn, it eloquently proclaims a victorious fight for Country and principles. It is indeed the chevron of service—the reward for a job done well.



Specialists in Design and Manufacture of Acoustic Equipment

JENSEN RADIO MANUFACTURING COMPANY • 6601 SOUTH LARAMIE AVENUE, CHICAGO 38, ILLINOIS

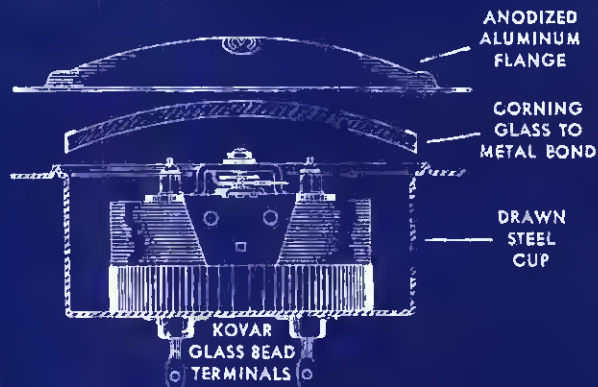

YES! They're totally sealed. The Marion design and glass-to-metal sealing process assure true hermetic sealing. And the bond between the metallized glass rim and the steel case is capable of withstanding extreme thermal shock.

YES! They're interchangeable. Magnetic shielding permits interchangeability on any type of panel without affecting calibration. The Type HM 2 is directly interchangeable with AWS Types MR 24 and 25. The Type HM 3 is directly interchangeable with AWS Types MR 34 and 35.

YES! They're priced right. As a matter of fact, Marion Glass-to-Metal Truly Hermetically Sealed Electrical Indicating Instruments cost no more than standard unsealed instruments — yet, they'll perform more satisfactorily over a longer period of time.

YES! They're a postwar potential. Because they afford complete protection against the effects of temperature and humidity, these instruments can simplify many production problems, particularly in regard to export sales. Call us. Our hermetic sealing experience may be of value to you.

Marion Glass-to-Metal Truly Hermetically Sealed 2½" and 3½" Electrical Indicating Instruments

Write today for complete information. Not only do we offer these instruments in standard ranges, but we also specialize in supplying them with special and unusual characteristics for new and unusual applications.



MARION ELECTRICAL INSTRUMENT CO.

MANCHESTER, NEW HAMPSHIRE

Jobber Sales Division: Electrical Instrument Distributing Co.
458 BROADWAY NEW YORK, N. Y.

Be the ONLY Sparton Dealer in Your Town

HERE'S WHAT THE S.C.M.P. CAN DO FOR YOU

- 1 If you qualify as a Sparton Radio dealer, you will be given an *exclusive* franchise for your community.
- 2 All radio shipments will be made to you *direct from the factory*, at dealer-delivered prices.
- 3 You will be sure of a dependable source of supply.
- 4 You will be able to offer customers a full line of fine radios—consoles, table models and combinations—some with FM (Frequency Modulation)—at lower-than-usual prices.
- 5 You will be relieved of the necessity of offering special discounts or costly trade-in allowances.
- 6 And last—but not least—your selling effort will be backed up with seasonal promotional helps and a powerful campaign of national advertising.

Think what a relief it would be, if you wiped away the headaches!

Think what it would mean to you in sales and profits, if you were able to offer top-quality nationally-accepted radios in direct competition with the biggest retail outlets!

Are you interested in the S.C.M.P.?

Then — here's what to do about it!

Additional dealer appointments are now being made. *But — only a few territories are open.*

So — act fast!

Ask if the Sparton franchise is still available in your community.

ADDRESS: Ed. Bonia, Sales Manager, Radio and Appliance Division

THE SPARKS-WITHINGTON CO., JACKSON, MICH.

SPARTON

RADIO'S RICHEST VOICE SINCE 1926



FIRST in Research
FIRST in Development
FIRST in the Shops of
Service Engineers

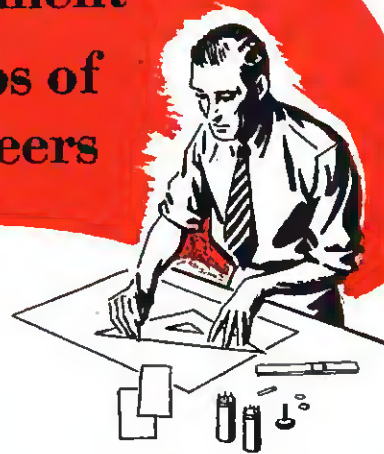

Pioneering by MALLORY Has Resulted in These History-Making Developments:

1. High voltage dry electrolytic capacitors.
2. Dry electrolytic capacitors in cardboard containers.
3. Etched plate A.C. capacitors.
4. Dry electrolytic capacitors for operation at temperatures as high as + 85 degrees centigrade.
5. Toroidal type A.C. capacitors.
6. High surge characteristics of dry electrolytic capacitors by employing cellophane separators.
7. F.P. (fabricated plate) capacitors.
8. Capacitors with self-mounting features.
9. Multiple dry electrolytic capacitors with controlled coupling characteristics.
10. Complete information for determining physical size of dry electrolytic capacitors of given rating.
11. Completely standard dry electrolytic filter capacitors.
12. Standard, close capacity tolerances on A.C. capacitors.
13. A standard line of A.C. capacitors in plastic containers.
14. Dry electrolytic capacitors with satisfactory performance at temperatures as low as -40 degrees centigrade.

These are a few of the many reasons why Mallory dry electrolytic capacitors have a deserved reputation for quality—why millions are in service today. Moreover, the Mallory line of capacitors is *complete*, and its distributors are ready to help solve your problems. Avail yourself of this service—begin today by asking for a copy of the Mallory Catalog of Approved Precision Products.

P. R. MALLORY & CO., Inc., INDIANAPOLIS 6, INDIANA



*More than ever—
 ALWAYS
 INSIST ON*

P. R. MALLORY & CO. Inc.
MALLORY
 APPROVED
 PRECISION PRODUCTS

VIBRATORS • VIBRAPACKS* • CONDENSERS
 VOLUME CONTROLS • SWITCHES • RESISTORS
 FILTERS • RECTIFIERS • POWER SUPPLIES

ALSO MALLORY "TROPICAL" DRY BATTERIES, ORIGINALLY DEVELOPED BY MALLORY FOR THE U. S. ARMY SIGNAL CORPS, NOT PRESENTLY AVAILABLE FOR CIVILIAN USE.

*Trademarks

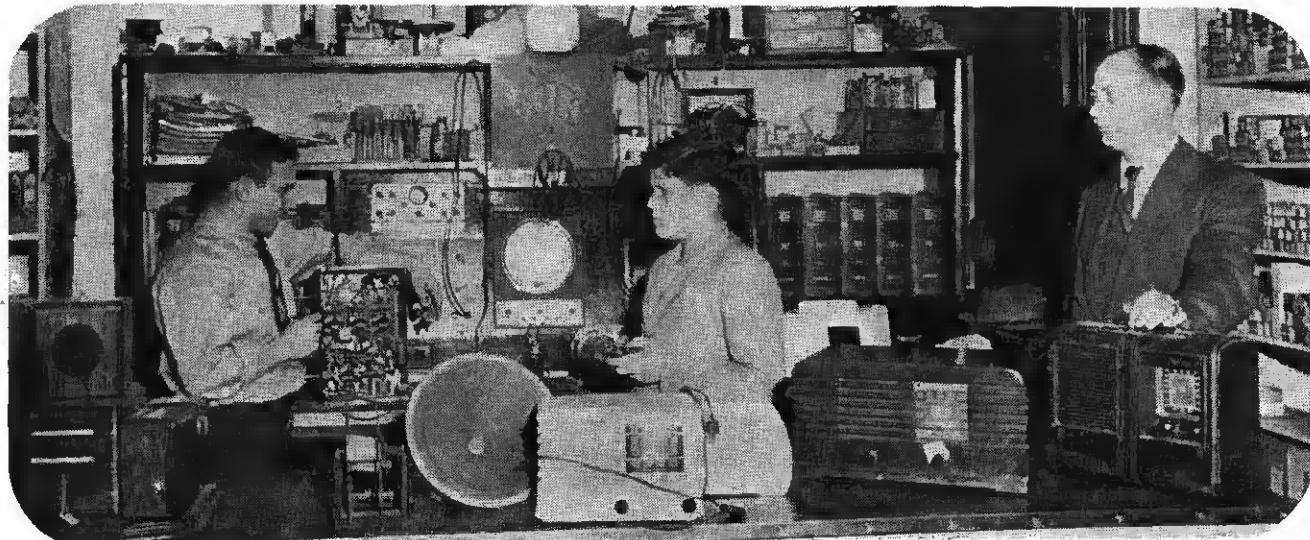

Ralph H. Plummer, right, shown with his assistants. Radio repair and merchandising of sidelines are keeping the firm active at present.

Spotlight on Selling

Plans Store Modernization—Interior to “Show-Off” New Goods

• In recognition of the belief that purchasers of radios and appliances will prefer to buy in modern and attractive establishments, Ralph H. Plummer, proprietor of the Radio Service & Supply, Martinsburg, W. Va., is preparing his store modernization plans.

Plummer's first step in revamping his establishment will be the remodeling of the store's exterior. This is of special significance to this dealer, as his business is located in a relatively high traffic area, adjacent to the Post Office. It is imperative, this dealer maintains, that the store-front be particularly appealing, in order to catch the eye of the passer-by.

Windows Important

A streamlined, attention-stopping exterior is therefore of primary concern to this radio-appliance dealer. However, Plummer is well aware that an appealing store front is only half the job if the store does not cling to the customers' memory.

In the future, Plummer will endeavor to create attractive and well-balanced window displays. Every effort will be made by this merchant to compel and focus attention toward his radio-appliance window display.

"The need for brightening outside displays," states Plummer, "was effectively demonstrated to me a few months ago. At that time, I had a few electric irons haphazardly on view on the counter inside the store. As an experiment, I decided to con-

struct a window display in order to concentrate attention directly upon these irons. Result: one hour after the goods had been exposed to the public they were all sold.

"In the future," this retailer continued, "the store's window displays will draw the customer inside the establishment. Once the prospective purchaser has entered the store, every effort will be made to assure his comfort and to encourage browsing.

"Through the use of indirect lighting, glass fixtures, and other modern appointments, the customer will be encouraged to buy whatever merchandise is on display. Related exhibits of goods will be shown to induce Mr. Customer to purchase more than one item," Plummer concluded.

Radio and television receivers will occupy the limelight in this dealer's post-conversion pattern. Most of the floor space will be devoted to displaying AM, FM, and video sets.

Actual Demonstrations

In the rear of the establishment, a full line of major and small appliances will be sold. To provide for a home-like atmosphere, and for live demonstrations, a complete, wired-in model kitchen will be on display. Included in this exhibit will be such items as sinks, garbage disposal units, and other popular appliances.

With this as a background, Plummer will stress the many time-saving, labor-saving features of modern electrical appliances. He feels that noth-

ing is so important as realism in displaying merchandise, and that the model kitchen in actual operation will greatly aid the efforts of the salesman in closing the sale.

The current mainstay at the store today is radio servicing. To supplement the income received from repair work, various sidelines such as intercommunication equipment, microphones, light bulbs and other electrical items are sold.

Prefers One Brand

Also merchandised are non-related lines which include paints and varnishes, all of which aid in maintaining a profitable volume of sales. The firm finds that renting floor sanding machines is another activity which is helping it weather this period of merchandise famine.

On the subject of brands which he expects to carry in the future, Plummer declared that he prefers one specific make in preference to a number of others. When questioned by a representative of this publication as to why he was more favorably disposed to this manufacturer than to others, he asserted his reasons:

(1) The company gives the dealers more than an even break; (2) Extensive advertising helps to build public acceptance of the manufacturer's product; (3) Despite the fact that its merchandise is already well known, and that the public is "sold" on its name, the firm continues to build confidence and good-will.

Pioneer Suspender Company

PHILADELPHIA 1, PA.

EXECUTIVE OFFICES
315 TO 323 N. TWELFTH STREET

May 17, 1945

Mr. George W. Jones, Advertising Manager
Fawcett Publications, Inc.
295 Madison Avenue
New York, 17, N. Y.

Dear Mr. Jones:

Your letter of May 11 came to my desk this morning. I read it, and then stopped to think about True. I thought perhaps you would be interested to hear from us as one of your advertisers.

We have had wonderful reception to your book, both from the consumer, as well as the trade. I don't believe we have had as much spontaneous, enthusiastic reception of any medium that we have advertised in for a good many years, as we have had with True.

Our salesmen like it, and what pleases them most is that their buyers like it, so congratulations on a swell book. If you follow along the lines that you have been working, I am sure that True, in post-war, will become a dominating influence in the men's market.

Yours very truly,

PIONEER SUSPENDER COMPANY

Robert W. Neely, Jr.
Robert W. Neely, Jr.
Executive Vice President and
Sales Director

RN:DC

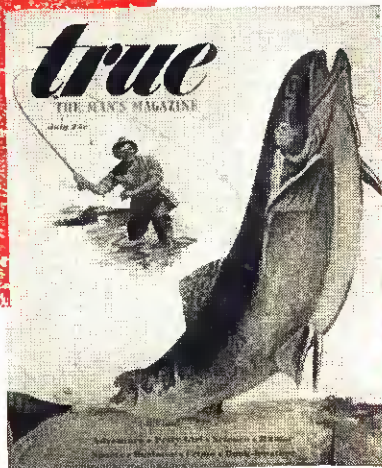

"our salesmen like it..."
"our buyers like it..."

Just an editorial gleam two years ago, TRUE, the Man's Magazine, is selling 600,000 copies monthly, and dropped by paper supply. Almost an unknown in the men's wear field a year ago, this year TRUE carries more than 50 advertisers who sell in men's wear stores. If you don't know why you don't know TRUE! And you should! A Fawcett Publication, 295 Madison Ave., New York 17, N.Y.

true...the man's magazine

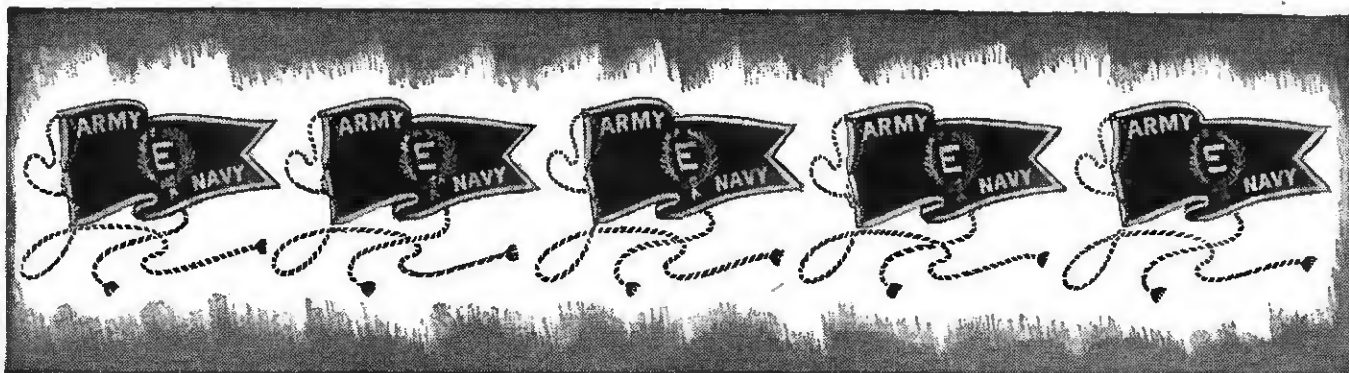

FOR OUR NINE "E" AWARDS...

THANKS A MILLION

TO OUR SUPPLIERS

IT'S A GREAT satisfaction to receive nine "E" awards. But only a fraction of that satisfaction belongs to us. The greater share belongs to you . . . our suppliers. Without your cooperation, your fairness and your fine products we couldn't have made the grade.

THANKS A MILLION

True, we met production schedules and quotas and shipping dates. But only because you

met yours and got the stuff on our floors when it was needed.

THANKS A MILLION

One day we will frame our nine "E" awards and place them where all can see. Those peaceful days will, for us, be days for remembering too. We will always be reminded of you who helped us do our share in helping to win Victory.

STEWART-WARNER CORPORATION

CHICAGO 14, ILLINOIS



THANKS A MILLION

Abana Products Company
 Abart Gear Company
 Abrasive Company
 Abrasive Machine Tool Company
 Acklin Stamping Company
 Acme Industrial Company
 Acme Screw & Mfg. Company
 A. C. Spark Plug Company
 Adams Plating Company
 Adel Precision Products Corporation
 Advance Aluminum Casting Company
 Aerovox Corporation
 Airway Electric Appliance Corporation
 Aladdin Radio Industries, Inc.
 Allegheny Ludlum Steel Corporation
 Alliance Hose & Rubber Company
 Allied Control Company, Inc.
 Allied Screw Products Company
 Alto Mfg. Company
 Aluminum Company of America
 Aluminum Finishing Corporation
 Aluminum Goods Mfg. Company
 American Brass Company
 American Can Company
 American Chain & Cable Company
 American Coil Spring Company
 American Decalcomania Company
 American Electric Cable Company

American Lava Company
 American Leather Belting Company
 American Metalcraft Company
 American Metal Hose Company
 American Phenolic Corporation
 American Steel & Wire Company
 Amplex Division Chrysler Corporation
 Amsco Wire Products Company

THANKS A MILLION

Anchor Coupling Mfg. Company
 Anchor Packing Company
 The Anderson Company
 Anderson & White Supply Company
 Apex Smelting Company
 Armstrong Cork Company
 Atol & Son Tool & Die Works
 Atlantic India Rubber Works, Inc.
 Auto Radiator Mfg. Co.
 Badger Meter Company
 Barber-Coleman Company
 L. J. Barwood Company
 Bastian Blessing Company
 Bauer & Black
 E. A. Baumbach Mfg. Company
 Belden Mfg. Company
 Bethlehem Steel Company

Bliss & Laughlin, Inc.
 E. W. Bliss Company
 Boots Aircraft Nut Corporation
 Bopp Steel Company
 Bound Brook Oil-Less Bearing Co.
 Braeburn Alloy Steel Corporation
 H. M. Brewster
 R. Brewster Company
 Bridgeport Brass & Copper Company
 Briggs & Stratton Corporation
 Bristol Brass Corporation
 Brown & Sharpe Company
 Brunner Compressor Company
 Bullard Screw Products Company
 Bundy Tubing Company
 Burnside Steel Foundry Company
 Burroughs Adding Machine Company
 Bussmann Mfg. Company
 B-W Superchargers, Inc.

THANKS A MILLION

Cannon Electric Development Company
 Carnegie-Illinois Steel Company
 The Carpenter Steel Corporation
 A. M. Castle & Company
 Centralab Company
 Central Scientific Company

Central Steel & Wire Company
 W. M. Chace Company
 H. Channon Company
 Charles Products Company
 Chase Brass & Copper Company
 Chicago Die Mold Company
 Chicago Extruded Metals Company
 Chicago Hardware Foundry Company
 Chicago Latrobe Twist Drill Works
 Chicago Lock Company
 Chicago Metals Company
 Chicago Miniature Lamp Works
 Chicago Molded Products Corporation
 Chicago Rawhide Mfg. Company
 Chicago Rivet & Machine Company
 Chicago Sanitary Rag Company
 Chicago Steel Service Company
 Chicago Thrift Company
 Chicago Transformer Corporation
 Chicago Tube & Iron Company
 Chippewa Paper Products Company
 Chrome-Rite Company
 Cinch Mfg. Corporation
 Cincinnati Milling Machine Company
 City Engineering Company, Inc.
 Clarage Fan Company
 Collins Radio Company
 Commerce Pattern Foundry & Mach. Co.

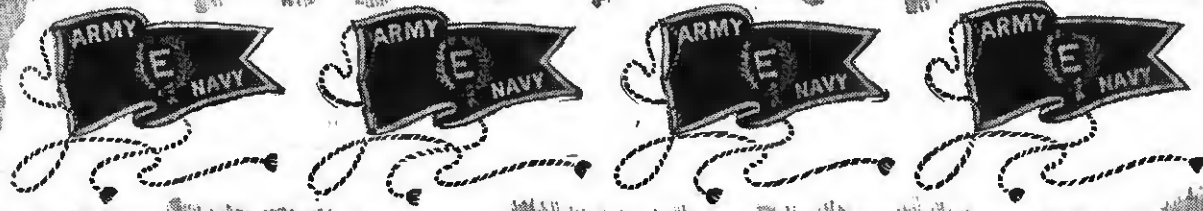

Commercial Chemical Company
Commercial Filter Corporation
Commonwealth Edison Company
Container Corporation
Continental Diamond Fibre Company
Continental Nipple Mfg. Company
Continental Screw Company
Cook Paint & Varnish Company
Cornell-Dubilier Electric Corporation
Cornell Forge Company
Crane Company
Crucible Steel Company of America
Cutler Hammer, Inc.

THANKS A MILLION

Danly Machine Spec. Company
Davenport Machine Company
Davison Chemical Company
Dearborn Glass Company
DeFoe Finishing Company
Detroit Gasket & Mfg. Company
The DeVilbiss Company
Die & Tool Company
Diversey Foundry Company
Doall Midwest Company
Dale Valve Company
Dow Chemical Company
Driscoll and Company
Driver Harris Company
Duer Tube Bending Company
E. I. DuPont de Nemours & Company
Duro-Chrome of Chicago, Inc.
Eaton Mfg. Company
Eisemann Corporation
Elastic Stop Nut Corporation
Electric Hose & Rubber Company
Electric Supply Corporation
Emmerson Electric Company
Engis Equipment Company
Erie Resistor Corporation
Essex Wire Corporation
E. L. Essley Machinery Company
Etico Tool Company, Inc.
Van W. Evans
Fansteel Metallurgical Corporation
Farrell-Argast Electric Company
John E. Fast & Company
Federal Machinery Sales Co.
Fenwal, Inc.
Ferrocarril Corporation of America
Firestone Industrial Products Company
Fitzgerald Mfg. Company
The Formica Insulation Company
Fort Dearborn Mfg. Company
Fort Howard Steel & Wire
R. S. Foster Lumber Company
Foxboro Company
Fractional Motors Company
Franke Gear Works
Fulton-Sylphon Company

THANKS A MILLION

Garlock Packing Company
Gates Rubber Company
Gavitt Mfg. Company
C. H. Gemmill Company
General Ceramics & Stealite Corp.
General Controls
General Electric Company
General Instrument Corporation
General Laminated Products, Inc. of Ill.
General Steel Warehouse Co., Inc.
Gephart Mfg. Company
Gauder, Paeschke & Frey Company
Wm. D. Gibson Co.
Gisholt Machine Company
Globe Tool & Molded Products Co.
B. F. Goodrich Company
L. F. Grammes & Sons, Inc.
Grasselli Chemical Division
Graybar Electric Company
Grayton & Knight Company
Great Lakes Varnish Works, Inc.
Greenlee Foundry Company
Groov—Pin Corporation
Guardian Electric Mfg. Company
E. I. Guthman & Company, Inc.
Hamilton Associated Industries
Hammarlund Mfg. Company
Hammond Instrument Company
Hanson VanWinkle Munning Company
Hardinge Brothers, Inc.
Samuel Harris & Company

Harshaw Chemical Company
Hartford Steel Ball Company
Hawkins Electric Company
Heald Machine Company
The Hendey Machine Company
Hilfinger Company, Inc.
W. J. Holliday Company
Hooker Glass & Paint Mfg. Company
Horton Mfg. Company
Howard Foundry Company
Huml Bros.
Hyland Electrical Supply Company
Ideal Engineering Company
Indiana Screw & Bolt Company
Indianapolis Machinery & Supply Co.
Indianapolis Screw Products Company
Ilg Electric Ventilating Company
Illinois Coil Spring Company
Illinois Tool Works
The Imperial Brass Mfg. Company
Industrial Spring Company
Ingersoll Rand, Inc.
Inland Steel Container Company
International Business Machine Co.
International Conveyor & Washer Corp.
International Harvester Company
International Resistance Company
Isolantite, Inc.
D. O. James Mfg. Company
William F. Jobbins, Inc.
Johns-Manville
Chester Johnson Electric Company
E. F. Johnson Company
Johnson Solvents Company
Howard B. Jones Company
Jones & Lamson Company
Jones & Laughlin Steel Corporation

THANKS A MILLION

Kearney & Trecker Company
Kelley-Koett Manufacturing Co.
Ken-Rad Tube & Lamp Corp.
Keystone Steel & Wire Company
Kingsbury Machine & Tool Company
Kraft Chemical Company
Kropp Forge Company
Lakeside Malleable Casting Company
Lamicoid Fabricators, Inc.
Lamson & Sessions Company
Lands Machine Company
Lanzit Corrugated Box Company
Lapham Hickey Company
LaSalle Steel Company
Latrobe Electric Steel Company
Lauson Company
Lavelle Rubber Company
R. Lavin & Sons, Inc.
Leash Relay Company, Inc.
Lectrohm, Inc.
Harry Lee & Sons
Leeds & Northrup
Leland Electric Company
Lenz Electric Mfg. Company
Lilly Varnish Company
Link Belt Company
Littelfuse, Inc.
Logan Plating Company
Macco Products Company
MacKenzie Walton Company
Norman Malcolm & Son
P. R. Mallory & Company, Inc.
F. N. Manross & Sons
Mfg. Screw Products
C. W. Marsh Company
J. P. Marsh Corporation
Master Machine Tool & Die Works
Matchless Metal Polish Company
Maxwell Brothers
Geo. J. Mayer Company
Maywood Mould & Machine Co.
McCard Radiator & Mfg. Company
McGean Chemical Company
Mechanical Plating Company
Meissner Mfg. Company
Merco Company
Merz Engineering Company
Metal Products Mfg. Company
Micamald Radio Corporation
Micarta Fabricators, Inc.
Micro Switch Division
Midwest Spring Mfg. Company
Midwestern Tool Company
Michigan Tag Company

Midwest Molding & Mfg. Company
Milk Bottle Crate Company
Milwaukee Stamping Company
Minneapolis-Honeywell Regulator Co.
Modena Die & Drop Forge Company
Moore Boxes
National Acme Company
National Fabricated Products
National Flexible Shaft Company
National Lead Company
National Lock Company
National Medical Supply Company
National Screw & Mfg. Company
National Sewing Machine Company
Nelsen Steel & Wire Company
Neptune Meter Company
New Britain Machine Company
New Departure Division G. M. Corp.
New Jersey Zinc Sales Company
Norton Company
Novelty Foundry & Iron Works, Inc.

THANKS A MILLION

Oak Mfg. Company
Ohio Nut & Bolt Company
Ohmite Mfg. Company
Okee Die & Tool Company
Samuel Olson Mfg. Co.
Otis Elevator Company
Paasche Airbrush Company
Parisian Novelty Company
Parker Appliance Company
Parker Kalon Corporation
Peerless Mould & Machine Company
Penn Rivet Company
Penneys Gas Light & Coke Company
Phelps-Dodge Copper Products Co.
Pheoll Mfg. Company
Philips Petroleum Company
Phoenix Tool & Bolt Company
The Pinkerton Box Company
Pinnell Lumber Company
Pioneer Gen-E-Motor Corp.
Pittsburgh Plate Glass Company
Paray, Inc.
Frederick Post Company
Process Engineering Corporation
Prehler Electrical Insulation Co.
Quaker Chemical Products
Radiotechnic Laboratory
Rapinwax Paper Co.
Raytheon Mfg. Company
R-B-M Mfg. Company
RCA Mfg. Company
A. G. Redmond Company
Reliance Steel Division
Remington Rand Company
Republic Steel Corporation
Revere Copper & Brass Company
Reynolds Metal Company
James H. Rhodes & Company
The Richardson Company
Rickert & Shafer Company
R. M. Ring Company
Risher Fire Brick Company
C. A. Roberts Company
Rockbestos Products Corp.
Rome Cable Corporation
Roots—Cannerville Blower Corp.
Rockford Screw Products Company
Rolled Thread Die Company
Royal Typewriter Company, Inc.
Russell, Burdall & Ward Bolt & Nut Co.
Russell Electric Company
Jos. T. Ryerson & Sons

THANKS A MILLION

S & E Chemical Company
St. Joseph Lead Company
Sangamo Electric Company
E. H. Sargent Company
Saunders & Company
Schneider Metal Mfg. Company
A. Schrader's Son
Schulhof Company
Scovill Mfg. Company
Sears-Roebuck Company
J. P. Seeburg Corporation
Sentinel Radio Corporation
Service Steel Company
Shakeproof, Inc.

Sheet Aluminum Corporation
Sheffield Corporation
Shellmar Products Company
Sherwin Williams Company
E. C. Schrader & Company
F. W. Sickles Company
Signode Steel Strapping Company
Simonds Saw & Steel Company
S.K.F. Ball Bearing Company
Skinner Purifiers
Solter Mfg. Company
Sonora Radio & Television Corporation
Soreng Mfg. Corporation
Spaulding Fibre Company, Inc.
Speer Carbon Company
Spencer Thermostat Company
Sprague Electric Company
Stackpole Carbon Company
Standard Casting Corporation
Standard Steel & Wire Corporation
Standard Transformer Corporation
Standard Winding Company
Steel & Tubes, Inc.
Steel Sales Corporation
Steel Warehousing Corporation
Sterling-Midland Coal Company
Sterling Silica Gel Company
Chas. G. Stevens Company
Streator Electric Company
Geo. A. Stutz Mfg. Company
Sueske Brass & Copper Company
Superior Plating Works
Supplies, Inc.
Swedish-Crucible Steel Company
Stewart & Fryer Printers
Sylvania Electric Products, Inc.

THANKS A MILLION

Tanner & Company
Teleradio Engineering Corporation
Terre Haute Malleable & Mfg. Corp.
Thermoid Company
Thompson-Bremer Company
Thompson Wire Company
Tillotson Mfg. Company
Tingstall Company
Toledo Industrial Rubber Company
Toledo Steel Tube Company
Torrington Company
Triangle Electric Company
Tung-Sol Lamp Works, Inc.
Underwood Electric & Mfg. Company
Union Drawn Steel Corporation
United Carr Fastener Corporation
United Screw & Bolt Corporation
United Shoe Machinery Corporation
U. S. Blueprint Company
U. S. Reduction Company
U. S. Rubber Company
Universal Cyclops Steel Company
Universal Tool & Engineering
Vaughn Scott Glove Company
Vellumoid Company
Vickers, Inc.
Victor Gasket & Mfg. Company
Ward Leonard Electric Company
Wagner Electric Company
C. A. Wales Company
Edgar T. Ward & Sons
Warner & Swasey Company
Waterbury Brass Company
Weatherhead Company
Webster-Chicago Corporation
Weirton Steel Company
Wells-Gardner Company
Western Felt Works
Western Metal Spinning Works
Western Packing Company
Western Rubber Company
West Irving Tool & Die Company
Weston Electrical Instrument Corp.
Wheelock, Lovejoy & Company, Inc.
S. S. White Dental Mfg. Company
Wico Electric Company
Wilmington Fibre Company
H. A. Wilson Company
Wincharger Corporation
Ludwig Wilson Company
Woodstock Metal Products
Wyckoff Steel Company
Youngstown Sheet & Tube Company
Zetterlund Engineering Works

**Missouri Radio Dealer
Tells How to Make
Every Minute Count**



P. J. Null, owner of Null Radio Service, Mexico, Mo., checks a radio receiver.

Service Saves Time

● P. J. Null, Jr., owner of Null Radio Service, Mexico, Mo., finds that by increasing his work output during war-time, he is able to handle most of the radio repair business that comes to his shop.

To eliminate any lost motion, Null has placed his radio service department well toward the front of the store. When a customer enters, Null doesn't have to get up from the bench. He can keep right on working, while the visitor can step forward a few feet and talk to Null. This radio technician does not have to leave his work, unless it is absolutely necessary. This alone is a time-saving feature, and customers don't feel one bit slighted during these times by this type of treatment.

Customers Cooperate

"I am always glad to talk to any customer," this dealer declares, "but many who come into the shop are looking for tubes, and parts we haven't got. I could waste a lot of time if I wasn't careful."

Another time-saving measure for his establishment is that of requiring customers to bring in their own radios for repairs, and to call for them when

finished. This gives Null a lot more time at his work bench and enables him to turn out many more receivers. Customers as a rule are very glad to bring in their sets and thus help relieve the local pickup and delivery problem. For heavier models, local deliverymen can be hired by the customer to bring sets to the Null Radio Service.

Time Is Money

"By taking a number of short cuts, I can often repair from 10 to 20 more radio sets during a week," says Null. "That runs into a lot of receivers each month and helps me to make this business profitable."

This Missouri dealer's work bench is so arranged that he can get everything very quickly, as needed. His soldering iron, for example, is fitted into a special slot in his bench wall, where he can easily obtain it when he wants it.

Null has been in the radio repair business for many years. He is located in the principal area in Mexico, a city of about 9,000. This city has a number of industries, with large payrolls, and nearby there is also an excellent agricultural region. Mexico is

the shopping center for this section of Missouri. This means that a great many farmers who come to town regularly bring their radios in to be repaired.

Some of these receivers from rural districts are battery operated. Null makes a special effort to serve the farm trade, realizing their transportation difficulties. This consideration is appreciated by rural folk.

As a rule Null, through his time-saving policies, is able to handle most radio repair jobs at the present time within a week to ten days. He has 50 or more sets awaiting repairs most of the time. Frequently, he comes to his store several nights weekly, when necessary, to get "caught-up."

Postwar Sales Plans

This radio technician sees good opportunities for merchandising after Victory, and plans to conduct an intensive sales campaign on new goods. He already has many prospects for new sets, he states. His service record during war-time has helped him win many new customers, most of whom will buy new radios in the future, and they intend to give this retailer their postwar business.

IN **TELEVISION,** MORE THAN EVER, IT WILL PAY TO

SELL THE TUBES WITH THE BEST-KNOWN NAME

Television servicing is going to be big business.

It's also going to be profitable business. For it's a complex and skillful operation and your customers are going to pay more . . . and *expect* to pay more . . . than for ordinary radio servicing.

Renewal tubes will account for a large share of the increased cost, for television sets require many more tubes. In addition, each set must have a large picture tube which, while costing much less than pre-war types, thanks to continuing RCA research, is bound to be many times the price of the ordinary receiving tube.

When your customer pays out that kind of money for a single tube, you can bet he'll insist on having *the best*. And the prestige of the tubes you give him will go a long way towards establishing your shop in his mind as *the place* for television service.

RCA tubes give you the prestige you need to make *occasional* customers *regular* customers. RCA tubes are accepted . . . your customers know them and rate them tops, because, year after year, the RCA name has been associated with leadership in tubes.

Television is no exception. RCA television-tube developments like these *made electronic television possible* . . . and they will bring television profits to you years earlier. They also built television prestige for RCA, which, in turn, is passed on to you every time you display the RCA seal . . . every time you put an RCA tube in a customer's set.

Give your servicing business every break you can after the war. Make the most of your chances by identifying yourself with the *best-known name in tubes*.

The Fountainhead of Modern Tube Development is RCA

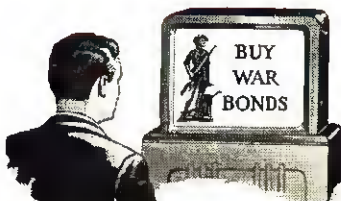

Listen to "THE MUSIC AMERICA LOVES BEST,"
Sundays,
4:30 PM, EWT,
NBC Network

RADIO & Television RETAILING • July, 1945

RCA TUBE ADVANCES THAT MADE TELEVISION HISTORY



Iconoscope Tubes

—the camera tubes that made all-electronic television possible, bringing high definition to the television screen.



Kinescope Tubes

—first step in electronic television—have been speeded in development by RCA research.

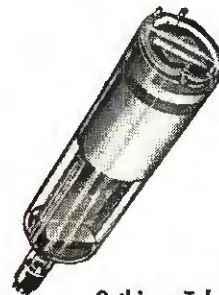

Orthicon Tubes

—specially developed by RCA as camera tubes for outdoor work where light intensity cannot be controlled—a big step forward in outside pickups of special events.



**High-Intensity
Projection Tubes**

—an exclusive RCA development that helped make possible large-screen television for home use, as demonstrated by RCA early this year.



62-6036-04

RADIO CORPORATION OF AMERICA

RCA VICTOR DIVISION • CAMDEN, NEW JERSEY

LEADS THE WAY . . . In Radio . . . Television . . . Tubes
Phonographs . . . Records . . . Electronics

STARTING THIS MONTH! A campaign of full pages in LIFE . . . SATURDAY EVENING POST . . . COLLIER'S . . . LOOK . . . HARPER'S BAZAAR . . . FARM JOURNAL and COUNTRY GENTLEMAN! This and other ads to follow will tell your customers the story of quality and leadership found only in RCA Victor—a combination of great tradition and technical leadership. It's a story that builds *your* prestige.

3 Great

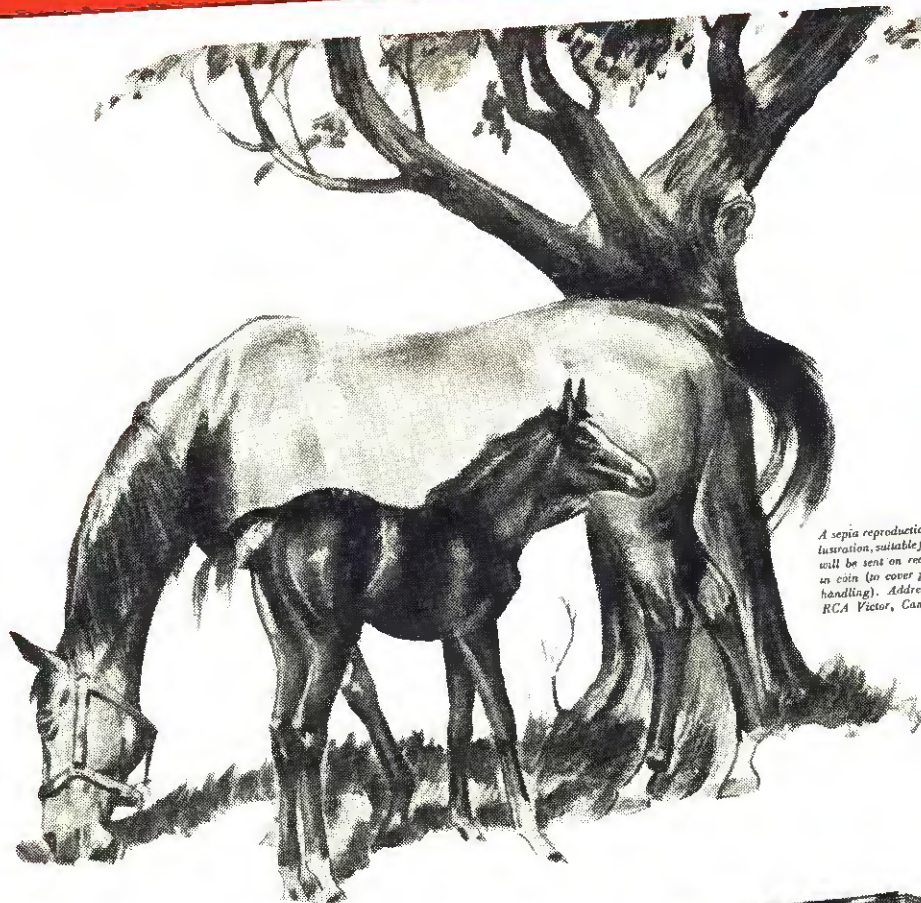

A sepia reproduction of this illustration, suitable for framing, will be sent on receipt of 10¢ in coin (to cover postage and handling). Address Dept. F, RCA Victor, Camden, N. J.

There's something in heredity....

IT MIGHT make a good movie to have the horse that was taken off a milk wagon win the Kentucky Derby . . . *But it just doesn't happen that way!* Champions are the result of applying known principles of selection to established blood lines running back many years. Heredity counts!

Your first postwar radio set—whatever its name—will also be the result of the background and experience of its makers. Can you think of any better engineering background in the

radio field than that of the Radio Corporation of America?—Can you think of any name in the field of recorded music equal to Victor?

Can you imagine what the combination of those two names will mean to you in radio satisfaction as soon as sets are available?

THE NEW RCA VICTOR SETS will include many great improvements—the result of experience gained in building 350 different types of war equip-

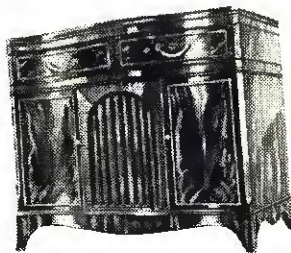

ment, none of it ever manufactured by anyone before . . . FM and television, of course. Radios and the famous trade-marked Victrola will range from excellent low-priced table models to fine automatic consoles. See your RCA Victor dealer before you buy.



RCA·VICTOR

RADIO CORPORATION OF AMERICA

tis
Go
Sell Y
Victor
. . . to
Answ
to P
P

Big Campaigns

**SPELLING POWER, PRESTIGE
AND PROFIT FOR YOU!**

**3 Big,
Smashing Adver-
tising Campaigns Now
Available All at Once to Pre-
pare Your Customers on RCA
Radios and "Victrolas" to
Give America the Right
Preparation on Television...and
You in the Preferred
Position for Post-
war Sales**

Television...your ticket to the World's Great Shows



Tomorrow you'll enjoy television in pictures so large a roomful of people can view them comfortably



That's the benefit of an answer to the question, "How can we get the most out of our RCA Victor television?" The answer is simple: by getting the most out of our RCA Victor television. That's the benefit of an answer to the question, "How can we get the most out of our RCA Victor television?" The answer is simple: by getting the most out of our RCA Victor television.

That's the benefit of an answer to the question, "How can we get the most out of our RCA Victor television?" The answer is simple: by getting the most out of our RCA Victor television. That's the benefit of an answer to the question, "How can we get the most out of our RCA Victor television?" The answer is simple: by getting the most out of our RCA Victor television.

Teddlings Improved
Our new wide-screen television sets, the RCA Victor television sets, are the most advanced in the world. They are the most advanced in the world. They are the most advanced in the world.



IN FULL SWING! A special campaign in Time magazine, aimed at the leaders in political thought, business, education, religion and other walks of life who will be the pacesetters of television's expansion.

NON-STOP! "The RCA Show" headlining Tommy Dorsey is featured nationwide over NBC every Sunday afternoon... week in and week out putting extra sales power into every product that bears the RCA Victor name.



RCA VICTOR

RADIO CORPORATION OF AMERICA • RCA VICTOR DIVISION • CAMDEN, N. J.

"Victrola" T. M. Reg. U. S. Pat. Off.

In Canada: RCA VICTOR COMPANY LIMITED, Montreal

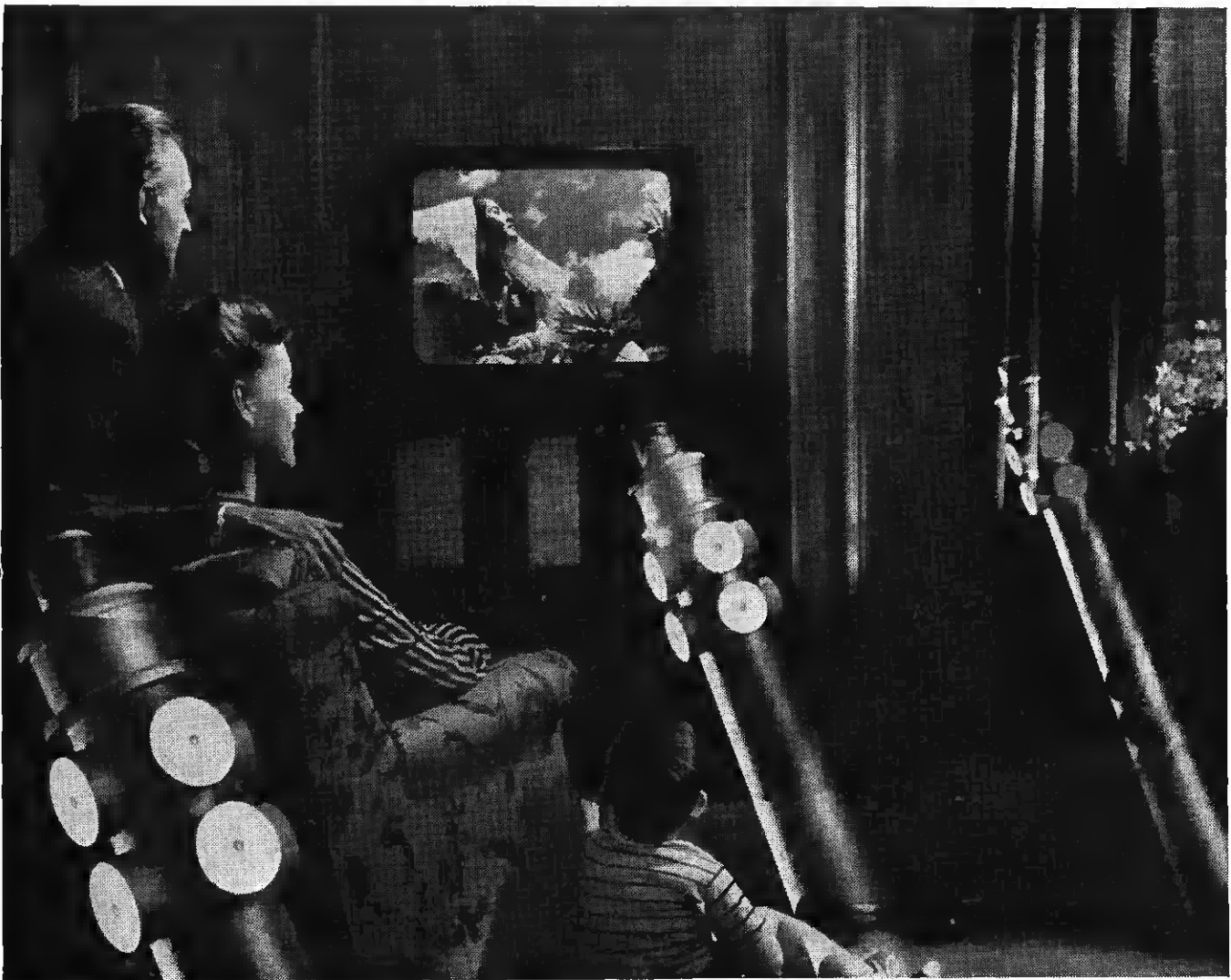

RCA radio-relay towers—like those phantomed above—will leap the hurdle of *distance* in post-war television.

Coast-to-Coast Television...through "Radio-Relay"

For a long time it looked as though post-war television might be confined to local stations. Only persons within a fifty-mile radius of New York, for example, would see the important television broadcasts from NBC's pioneer station WNBC, atop the Empire State Building.

That was because the ultra short waves that carry television do not bend with the curvature of the earth. They go in a straight line out to the horizon—and then keep on going into the sky.

But today, television's big handicap of short range has been completely overcome—by RCA scientists and engineers.

The *radio-relay* was developed—a tower that "bounces" television programs to the

next tower 30 to 50 miles away. Through a network of these automatic, unattended, radio-relays, coast-to-coast television is made practical.

This is but one more example of how RCA research constantly "makes things better." Such research is reflected in *all* RCA products. And when you buy a television set, or radio-phonograph, or anything made by RCA, you enjoy a unique pride of ownership. For if it's an RCA you can be sure it is one of the finest instruments of its kind that science has achieved.

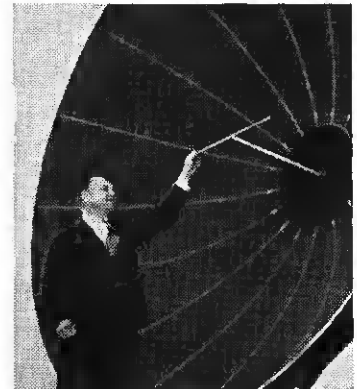

C. W. Hansell, RCA specialist in transmitters and relays, is shown here with a radio-relay reflector that can "bounce" radio messages, radiophotos and Frequency Modulation programs at the same time that it relays television!

RADIO CORPORATION of AMERICA

PIONEERS IN PROGRESS



RADIO & Television RETAILING • July, 1945



Lazarus Glassman, and brother Sam, co-owners of the store, have tested their selling methods.

Display Guides Disc Customers

"Visual Merchandising" Stimulates Buying

● In order to compensate for the loss of radio-appliance sales volume during the war period, the co-proprietors of the Radio Doctors Store, 213 W. Wells St., Milwaukee, Wis., have instituted an intensive merchandising campaign on records. The store's efforts have been amply rewarded, as this establishment is considered to be one of the finest record stores in this area.

Mounting sales of discs here have indicated that the public knows that it can buy its favorite platters at this establishment. However, as the volume of records, or other merchandise, does not climb unaided, co-owners Lazaar M. Glassman and his brother Sam have organized a three-point disc-selling program. This plan has aided them in hearing that pocket-warming ring of the cash register more often. Here are the winning features of their effective design for more record sales:

1. These merchants believe that the disc customer likes to see what titles are available *before* he enters the store. In this way he can be induced to buy without first aimlessly browsing and groping his way around the record racks. For this reason, a special "Records in Stock" display has been installed in the window, with a listing of a large number of popular discs in stock, including the names of the orchestras.

"Outside" Record List

Exhibiting the list of records in stock in the "open" has resulted in increased business, assert the Glassmans. Prospective purchasers pause outside the store studying the display; then come in and buy, requesting a specific record by name. This has helped materially to obtain new customers, and speed sales as well.

Whenever a new list of records in stock is placed in view of passers-by, sales of those discs have leaped.

2. The Glassmans have experimented frequently with various types of record displays. After many trials and errors, they have clung to an idea which is a consistent business-builder.

This involves placing a number of discs of one title in individual display boxes on tables and counters. To each display is attached a large, easy to read sign which lists the names of the records (both sides) in every box. "Customers will head for those displays the moment they enter the store," declares Lazaar Glassman. "Apparently, they like the 'easy selection' idea."

"Our volume in records," this dealer continued, "has advanced considerably since we adopted this method of merchandising discs. Customers don't like to thumb through a stack of records. They prefer to see them openly displayed and appropriately named. Any platters which we place in these individual boxes sell fast. If people want to browse around the store, and look at the various records, well, the signs assist them. Our customers see more platters, and we see more profits."

Sectional Racks

3. This establishment has maintained an enviable volume of album sales throughout the war years, largely by means of display and suggestive selling. An attempt is made to exhibit the albums in a novel, but effective, manner. Individual racks, each with step-up levels, have sufficient room for displaying five albums. Each rack is about 15 inches wide.

The significant aspect of this rack is that it can be moved to a separate part of the store, or placed in the window. In addition, each rack can be placed in line with other identical units to make a single, large, effective display.

Recently, one such display had eight individual album units lined up in a single display area to make

a unified showing of more than 40 albums.

In order to obtain variety of arrangement, the display units are used in ensembles for a period of time, and then separated and placed in various parts of the store. This "change of pace" display makes it possible to utilize the entire establishment for record merchandising. Movable units make it convenient to brighten different areas of the store with colorful albums. Also, these displays have proven effective in maintaining sales.

Reputation Aids Sales

Early in the war period, the store did extensive advertising in a large-circulation daily newspaper. Today, however, this method of record promotion has been discontinued in favor of word-of-mouth advertising. Intelligent merchandising has succeeded in creating for this establishment a large list of regular customers, many of whom frequently bring their friends to this store.

Despite the fact that the store does an appreciable volume of business in records, it does not depend exclusively on this operation for its income. Radio servicing is an important adjunct of this firm's activities, and additional revenue is obtained from this source. With the aid of two full-time technicians and one part-time worker, the store is turning out a large amount of repair work.

When the establishment first opened its doors for business fifteen years ago, it was essentially engaged in selling amateur radio supplies. Even today, the store retains some of this merchandise, and finds it to be an excellent traffic-builder.

Radio and appliance retailing will be given primary consideration in this firm's future plans. An influx of major electrical goods into the store's showroom may limit the space available for efficiently promoting records. Nevertheless, the Glassmans have proven that discs are profit-makers, and they will strive to continue this branch of their business in the active merchandising days ahead.

Selling is Coming Back

"Order-Taking" Begins Exit. Tips on Reconditioning Sales Techniques. Competition Looms.

• Retail *selling* is on the way back to replace retail *order-taking*.

Retail selling in the radio-appliance field of the near future promises to become a "field day"—an era of more sales, larger sales and increased profits.

But, because of the rosy prospects this great new market holds out, more and more merchants—independents, chains, mail-order houses and department stores—are planning to participate.

Race for Sales

Planned participation by so many skilled merchandisers is bound to increase the intensity of competition as *production* of civilian goods nears a neck-and-neck position with *demand*.

How soon supply and demand will balance the scale in retailing is anyone's guess, but with sufficient cut-backs confronting manufacturers having *inflated* payrolls and vastly improved production techniques, that day may come sooner than any of us think.

At all events, the wise radio-appli-

ance dealer is oiling and reconditioning his selling machinery *now*. He's planning to *fight* for sales once again, even though he realizes that a large proportion of the early business may consist of "set-ups." He's not going to be fooled by any *early trends* in consumer buying. He knows that our great nation, capable of *overwhelming* its enemies with mass-production know-how, is equally capable of catching up with any civilian demand, even upon a world-wide basis.

One of the first steps the retailer needs to take in overhauling his selling machinery is to give his salespeople a refresher course in salesmanship.

Even if merchandise continues to be scarce for a long time, and buyers continue to clamor for goods for a long time, good salesmanship techniques should be the order of the day. Practicing the fundamentals of efficient selling is necessary at all times and under all conditions.

Listed on this page are ten important selling tips. The editors feel that they will help your salespeople

sell more radios and appliances, and, at the same time will help keep more of your customers "sold" on you as a dealer, and on your business as a headquarters where only ethical transactions are conducted.

Ten ways to more sales—More customer friends are:

1. Talk *with* the customer, not *to* him.
2. Never judge the customer's buying ability by his appearance.
3. When your new merchandise begins coming in "drips and drabs" don't employ the time-worn *shortage alibi*. Soft-pedal the scarcity angle.

Basis for "Repeats"

4. Display merchandise attractively in order that customers who come in to buy *one thing* will want to buy others. A noted merchant declares that *40 per cent* of all retail purchases are *impulse sales*.

5. Strive to insure "repeat" business. "One-shot" sales are "one-shot" profits. Whether you make the sale or not, the customer you try to "rope and hog-tie" will often scratch your name from his visiting list.

6. Don't scoff at the customer's expressed objections to a radio or appliance. Though uninformed, he is usually sincere. Your job is to break down these "notions" adroitly and considerately—not belligerently. Make the customer feel important—not ignorant.

7. If you have to make a refund or a price adjustment, do so *gracefully*. Make such transactions *an asset* to you rather than a liability to you and to *your customer*.

8. "Ask for the order *early* and *frequently*" is fundamental advice and has lost none of its punch through the years. *But* ask for it calmly, courteously and carefully. Don't blurt out the request and permit the customer to sense that you're all keyed up. Don't be an *eager beaver*.

Fundamental Advice

9. Attempt to prevent the customer from using a *definite negative* answer to your request to decide now. Once having said "no" it is an affront to the buyer's ego to make him change his mind—and it's often a tough job for the sales-person to accomplish.

10. Be honest in all dealings. One can make *just as many sales* through legitimate representations as he'll make through "conniving." Honesty in retail selling is the best "insurance" policy—"insurance" that you will maintain your customer goodwill.

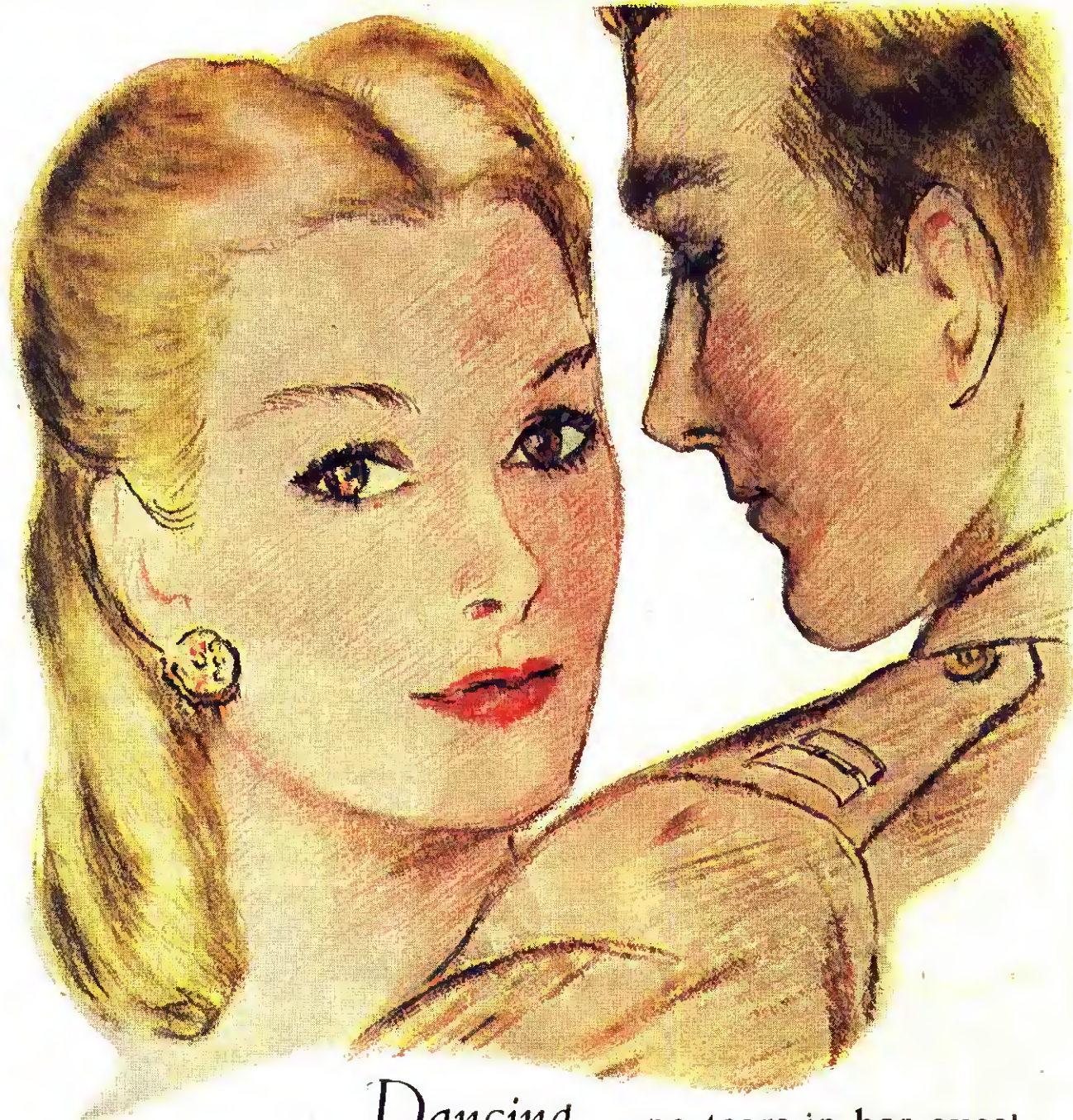

Dancing... no tears in her eyes!

Not so long ago she was pretty young... assuming much, accepting everything with small awareness of obligation or return... half-spoiled, self centered as many American girls were.

War brought reality with a wallop... telescoped time, matured her beyond her age or appearance... made her a worker or war wife, taught her new values and standards, taught her to think of others—and to think! Today she is an influence on her orbit of friends, a maker of styles and opinions... one to be reckoned with by the makers of everything.

More than two years ago, the editors of *Life Story* perceived the changing prospect and picked the young woman of wartime as the pattern maker of present day pursuits, purchases — and publishing... began

to model this magazine to her needs and interests. Leading writers were assigned to gear *Life Story's* articles and fiction to her thinking, focus on her problems, tailor a new periodical to her purposes and pleasures...

Today *Life Story* sells more than 500,000 copies, at 25¢, with 94% newsstand sales... has an audience of its own, and evidence of quick response to both editorial and advertising messages... evidence that will interest advertisers who want to sell over half a million of America's smart, discriminating, young women... *LIFE STORY*, a Fawcett Publication... 295 Madison Avenue, New York 17, N. Y.

LIFE STORY

We're traveling in high
for the armed forces now . . .

So we'll be in gear
to speed finer
PHONOLAS
to you and your customers



Phonola

**ACOUSTIC AND ELECTRONIC
PHONOGRAPHS**

- We've *stayed on the job* all through the war, making special Phonolas and communications devices for the Armed Forces. And because we did, we'll be ready to give you Phonolas *faster* now that war restrictions are beginning to lift.

- We don't know how soon materials will be available . . . but the moment they are, we'll be heading in your direction. And as more materials are released to us for civilian use, we'll bring you more and more new-found improvements, the kind of improvements your customers have come to expect of Phonola—the leader among portable phonographs since 1916.



EASTERN AND EXPORT SALES OFFICE: ★
17 E. 42nd St., New York City, VA. 6-2079

WESTERN SALES OFFICE:
224 So. Michigan Ave., Chicago, HAR. 1880

WATERS CONLEY COMPANY
ROCHESTER, MINNESOTA

ADMAN IN WONDER LAND

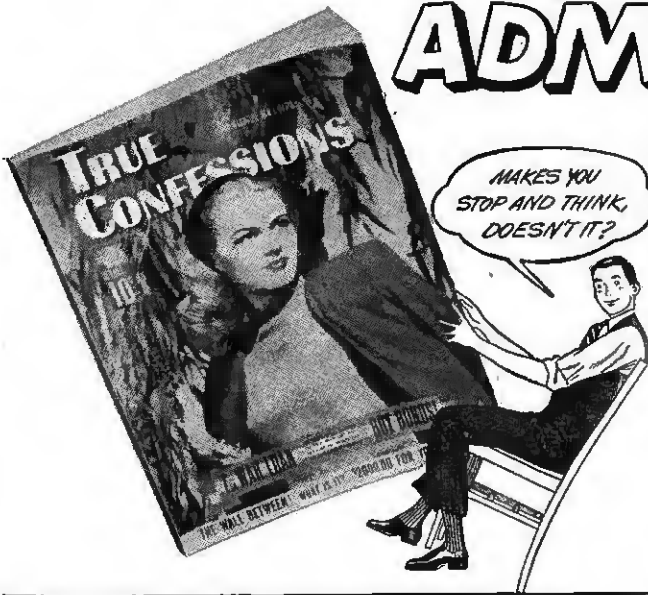

IS YOUR MIND A HAUNTED HOUSE?

by Channing Pollock

Some people's minds are haunted houses frightened by what may never happen, and wouldn't matter anyway if it did. Flesh-and-blood misfortunes are less hard to bear than the shadows they cast before them, and the only non-existent things that need ever trouble us are the kind words that we didn't speak, the generous acts we didn't perform, and the brave deeds we didn't do.

ARE YOU LISTENING, MAMA?

by Mary Margaret McBride



With the first money I saved in New York I sent for Mama to come from our home farm for her first visit to the city. That was the startling beginning of an amazing experience. My city friends positively fought to be with her. Everyone turned to her for comfort and strength. She confided to me that she believed most of them were downright homesick. It was a great adventure knowing Mama.

WE ARE READY TO TAKE OVER THE WORLD

by ALICE KROSS

16-year-old Delegate to the Youth Conference

Lots of people talk about "youth" as if we were some special kind of creatures who can't think for ourselves. We're individuals. Deep in our hearts we are burning to learn, to succeed, to become wholesome, hard-working citizens of a democracy, with our share of those 60,000,000 jobs they promised after the war—sixty million good jobs well done.

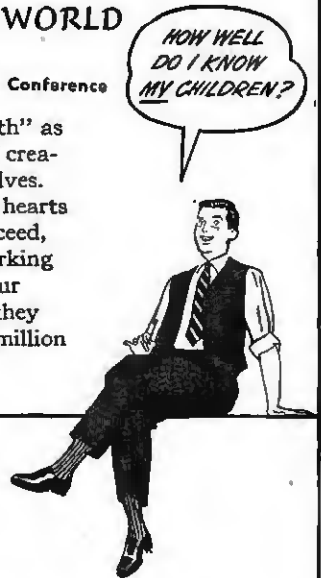

A Day To Remember

The face that turned toward us when we stopped was very black. Link Potter was a Negro. "Link!" Pete shouted, almost jumping out of the car. "Link Potter! Home on furlough?" Link beamed—"I'm home to stay. I kind of forgot to bring my leg back from over there in Italy. But they gave me a good leg in swap. Good as new!"... "You get right into this car, Link Potter," Gram said, and then she turned to me—"Link's great grandfather is ninety-seven. He was a slave till Lincoln freed him." Almost without knowing it, I found myself saying aloud, "Here is the whole history of America and the world, here in this little car, rolling along a prairie road."



GOOD NEWS FOR THE DEAF

by Donald G. Cooley

A relatively new operation on the inner ear is working miracle transformations. Deafened persons who have got along only with the help of hearing aids for twenty years have been given "new ears" they never dreamed of. About 90% of the operations have been successful, and the hearing restoration is probably permanent.

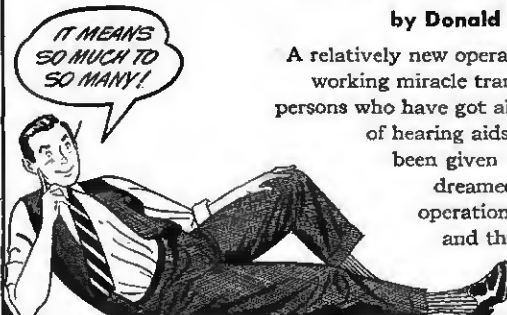

True Confessions tries, in the stories and articles that fill every issue, to give much help to many people. Look at any monthly table of contents—see the wide variety of *problems important to average people* that are always discussed in "Your Magazine for a Better Life." True Confessions is a great friend of the family in the good homes where you want to be known.

TRUE CONFESSIONS
Bought at newsstands by 2,000,000 women a month for the living service it gives

FAWCETT PUBLICATIONS, INC., 295 Madison Ave., New York 17, N.Y., World's Largest Publishers of Monthly Magazines

SYLVANIA NEWS

RADIO RETAILER EDITION

JULY

Published by SYLVANIA ELECTRIC PRODUCTS INC., Emporium, Pa.

1945

NEW BOOKLET SUMMARIZES AND STIMULATES POSTWAR RADIO MARKET

Radio Retailers Can Obtain Helpful Survey Information On Nation-Wide Radio Trends

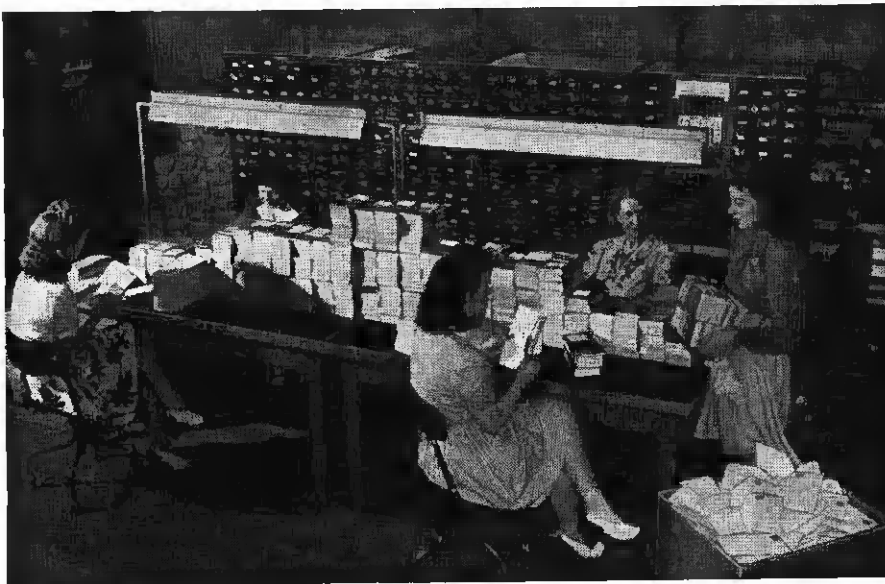

In further support of Sylvania's big advertising campaign designed to broaden the postwar radio market, Sylvania Electric is widely distributing the new survey booklet "They Know What They Want."

In it the radio retailer will find the answers to questions concerning consumer interest in Television, F.M., how many people are planning to buy a new radio after the war, and many more—giving him a variety of pertinent facts aimed to make it easier for retailers to sell.

In addition, general consumer distribution of "They Know What They Want" is expected to intensify popular interest in postwar radio sets of all types—an interest that will influence postwar sales.

Send for this new booklet and receive a handy summary of the public's future radio wants. *Sylvania Electric Products Inc., Emporium, Pa.*



Consumers are receiving new booklet on postwar radio trends in response to requests stimulated by Sylvania national questionnaire-type advertisements.

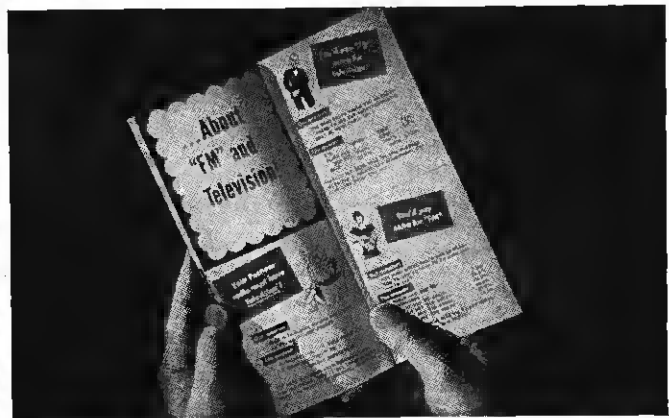

Typical two-page spread of Sylvania Electric's new booklet "They Know What They Want," containing a summary of the public's radio wants and making the retailer's job easier.

SYLVANIA ELECTRIC

Emporium, Pa.

MAKERS OF RADIO TUBES; CATHODE RAY TUBES; ELECTRONIC DEVICES; FLUORESCENT LAMPS, FIXTURES, ACCESSORIES; ELECTRIC LIGHT BULBS



Automatic *will be the* **BUY**

Yes, Automatic will soon be the buy! Get our postwar plans before making your final decision.

While Automatic is still geared to mass production for our fighting forces, Automatic can promise you that when Uncle Sam gives the go-ahead sign for peace-time production, it will only be a short time before you will again be receiving Automatic and Tom Thumb Radios.

Plans have already been made to convert Automatic's expanded facilities quickly, and this means more Automatic and Tom Thumb Radios will be available to meet the demand.

Radios that will set a new high in performance — distinctive cabinets — tonal refinements—all priced to clinch that all-important sale.

Talk to Automatic before deciding—see a real profit-making proposition. Act now!!!



Automatic

RADIO MANUFACTURING CO., Inc.
122 Brookline Avenue, Boston, Mass.



Servicing Detectors, II

Troubleshooting distortion and hum. Signal tracing procedure. Testing in AVC circuit.

• In the June issue of *RADIO & Television RETAILING*, we discussed plate and diode detection, and the servicing of fading and distortion troubles. This month, we will continue with distortion troubles, and also consider hum, signal tracing in detector circuits, and the servicing of simple AVC circuits.

Distortion Causes

An open cathode resistor on the detector tube will generally produce distortion. This distortion is very marked. Reception is usually muffled, razy, and unrecognizable. Other common defects do not result in reception as distorted as this—which should serve as a helpful clue in recognizing this trouble.

Increases or decreases in value of the load resistor of plate detectors often cause distortion. This type of defect is common to carbon resistors of $\frac{1}{2}$ meg of more. Increases or decreases in plate voltage on the detector tube result, and the operating point of the tube's e_c-i_b curve is shifted. Decreased volume as well as distortion may occur. Try substituting other values of resistance if this type of trouble is suspected.

A high-pitched hum may be caused by loose or missing shield cans on detector tubes. A b-r-r sound is often present in these cases. Induction between an unshielded detector-grid lead and the power tube may create hum or squeals. Moving the grid lead about and observing if noise is increased or decreased will help locate this trouble. Pilot light leads that are too close to the detector tube may produce a 60 cycle hum.

Faulty detector tubes that test perfect in the tube-checker are often sources of hum. On 3-way portables, the 1H5 is a common offender. Intermittent microphonic noises, as well as hum, may often be traced to this tube. On old-type TRF and superhet midjets, tubes like the 6C6 and 77 frequently cause hum, as well as noise.

Infrequently, an open cathode bypass capacitor on a detector tube may cause a perceptible hum. Generally, however, only decreased volume, due to feed-back, is produced by an open of this type.

Opens in diode coils are not infrequent. These commonly develop at the coil terminals, where tension causes the end of a wire to snap off. Reception in such cases is often very

low and distorted; only a few stations may be received.

A rough test for such an open is to place the external aerial lead first to the diode plate, and then to the center tap or high side terminal of the volume control. (We are considering a duo-diode triode detector only.) If noise response is much greater at the volume control terminal than at the diode plate, the diode coil may be open. A resistance test across the coil will verify this.

Using Signal Tracer

Signal tracing equipment will indicate opens or shorts in the diode coil, or the capacitor across it, very quickly and accurately. When circuit conditions are normal, the 465 KC signal voltage present between diode plate and B- is generally $\frac{1}{2}$ to $\frac{1}{3}$ of the signal voltage present between the plate of the preceding IF tube and B-. The reason for this decrease, instead of the usual step-up, is that the coupling factor is changed, due to the loading of the secondary (L_1 in Fig. 1.) when diode current is passed. Any short or open in L_1 or C_1 would reduce this 465 KC signal to a point considerably below $\frac{1}{2}$ to $\frac{1}{3}$

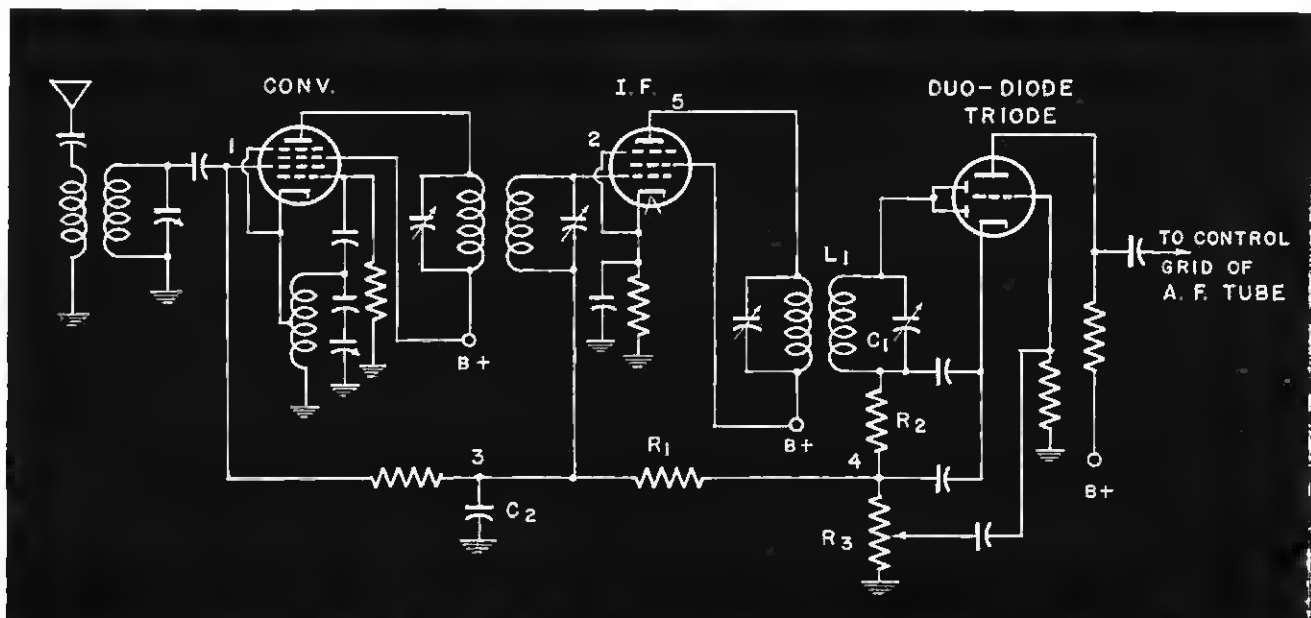

FIG. 1—Locating defects with signal tracer. 1, 2, 3, 4, and 5 are suggested test points. Cathode of detector is normally grounded.

of the signal present at the plate of the IF tube (point 5, Fig. 1).

An open in C_1 would make it impossible to tune the $L_1 C_1$ circuit to resonance. A weak 465 KC signal then would be present at the diode plate. A short in C_1 would eliminate the signal at the plate entirely. A short from the lower end of C_1 or L_1 to the coil can, possibly by a loose piece of solder, would cause greater diode current to flow, reduce coupling in the coil, and thus decrease the strength of the signal transferred to the diode plate.

Open IF Capacitor

When an IF filter capacitor opens, the signal tracer will readily indicate the trouble. In this case, the 465 KC signal is no longer by-passed from the volume control (see Fig. 2.), but drops across it. (We are taking a case where only one IF filter capacitor is present.) Less signal is therefore left at the diode plate. The signal tracer will readily indicate this decrease. It will also indicate the presence of 465 KC signal at point 1 (Fig. 2A.), where it should normally be absent, because the filter capacitor should short it back to cathode at

Common Causes of Trouble in Plate and Diode Detectors	
Hum	Clues
1. Defective detector tube.	Shorting control grid to ground eliminates hum.
2. Dirty volume control.	Tapping or rotating control causes hum to stop.
3. Open IF filter capacitor.	High-pitched hum, reception rather shrill, volume decreased.
Low Volume	Clues
1. Open coupling capacitor	Reception low but clear.
2. Open blocking capacitor	Volume control has no effect.
3. Open cathode by-pass capacitor on detector tube.	Volume decreased about 25 to 40%.
Distortion	Clues
1. Shorted coupling capacitor	Positive voltage from 1st AF grid to B—generally present.
2. Open AVC filter capacitor.	Low noise level between stations.
3. Shorted cathode by-pass capacitor on detector tube.	Distortion rather slight; cathode to B—voltage lower than normal.

set tuned off a station, then with set tuned to a strong broadcast signal—that is, a powerful station. If the AVC is working properly, the voltage measured should be higher in the second case than the first, since the

opens are present, because no current flows in the circuit, and no voltage drops therefore occur. Capacitor leakage, and short or open-circuits will affect the voltage readings at these points.

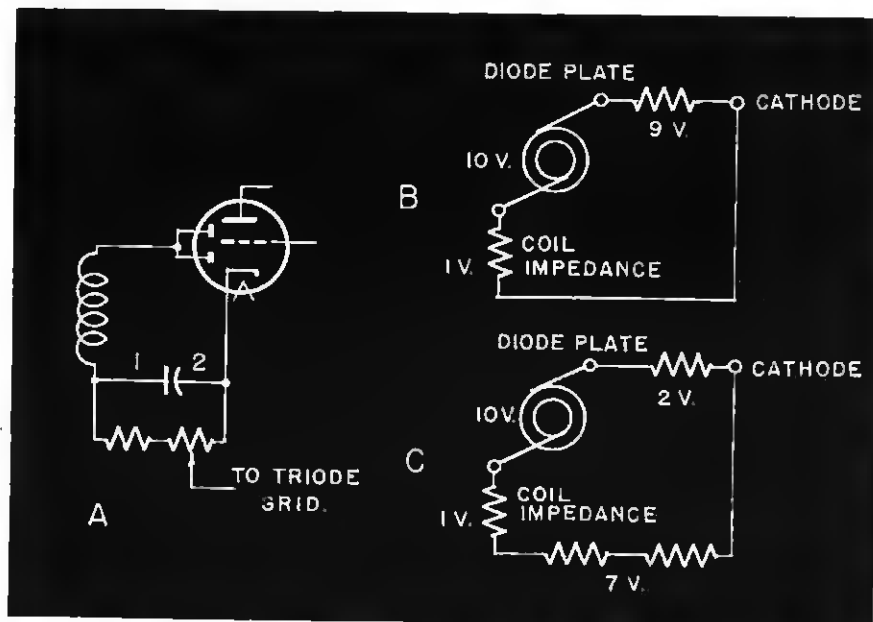

FIG. 2—A shows IF filter circuit in diode detector. B indicates signal voltage distribution when IF filter capacitor is normal. C gives the changed signal voltage drops when the IF filter capacitor opens.

that point.

For a general check on the operation of the AVC stage in a diode-triode detector, take a voltage measurement with a vacuum tube voltmeter from any AVC-controlled grid (points 1,2, in Fig. 1), first with

stronger input signal will produce the greater control voltage.

More specific voltage tests may be made. The rectified DC voltage developed across R_3 by diode action should be the same at points 1,2,3, and 4 (see Fig. 1.) if no shorts or

AVC Defects

Suppose C_2 is leaky. Since DC will pass through this leak path to B-, the voltage at point 3 will not be the same as at 4. If R_1 is open, no direct voltage—except a small contact potential—will be present at points 3 and 1 to B-, although voltage to B- from point 4 will be normal.

These DC measurement should be made with a vacuum tube voltmeter having an input of 10 megs or more, to prevent loading of the circuit. Next best substitute is a 20,000 ohm-per-volt meter. An isolating probe should be used when areas where RF signal is present are tested, otherwise detuning, and incorrect voltage reading, may result. A strong signal input should be present when voltage measurements are taken in AVC circuits.

Defects in AVC circuits will be readily revealed by signal tracing equipment. Suppose C_2 is partially open. Audio signal then will be noticeably present at the ungrounded side of C_2 , whereas it is normally negligible there. In general, audio signal should be much lower at point 3 than at point 4, because of the filter action of R_1 and C_2 .

If R_1 has decreased in resistance, or is partially or wholly short-cir-

(Continued on page 76)

Quality, Economy and Durability are Assured

*with Capacitors
by Magnavox*

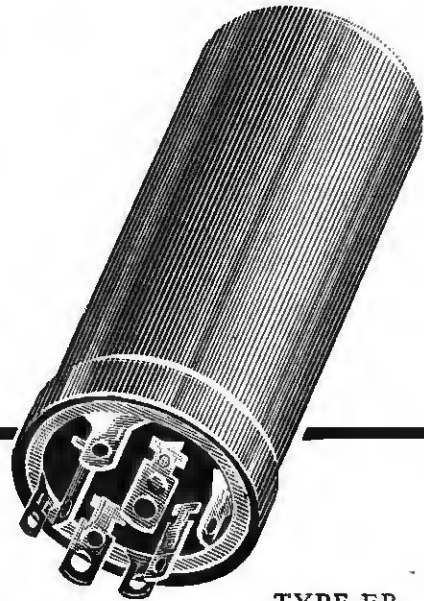

TYPE FP

Improved processing technique insures fine performance, long life, economy, speedy delivery

FOR 34 years Magnavox has served the radio industry—supplying the finest quality components and perfecting advanced engineering techniques.

★ ★ Engaged now in supplying demands of the armed services, Magnavox will again serve the radio industry in the traditional manner after conversion.

★ ★ Specializing in FP (fabricated plate) Electrolytic Capacitors, Magnavox is able to effect a full standardization program with all the advantages that it provides. Our technical department is available for individual consultation regarding capacitors for special applications.

★ ★ Thirty-four years experience, plus the additional advantages of new Magnavox developments and the superb equipment in our modern six-acre plant, is your guarantee of the best in quality components now and in reconverted civilian production.

The MAGNAVOX Company, Components Division



★ ★ ★ ★ Fort Wayne 4, Indiana

Magnavox

THE OLDEST NAME IN RADIO

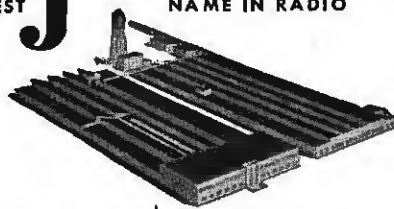

SPEAKERS • CAPACITORS • SOLENOIDS • ELECTRONIC EQUIPMENT

HYTRON TUBES ARE GOOD - SO WHAT?



Sure, Hytron tubes are good — so what! All tubes made for Uncle Sam are good. They have to be, or he wouldn't accept them.

But Hytron goes further. Not satisfied just to meet Uncle Sam's JAN-1A specifications, it always sets factory testing specifications to tighter tolerances than the Services require. In this way, Hytron assures top quality despite

slight meter inaccuracies and the human element. When more uniform adherence to specifications can be attained, tests simulating actual equipment performance are added.

This same insistence on the best will continue after the war. Then, too, we shall say, "Hytron tubes are good — so what! They have to be good to be good enough for you."

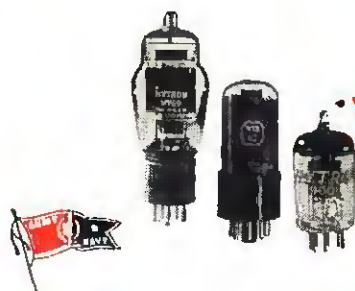

OLDEST EXCLUSIVE MANUFACTURER OF RADIO RECEIVING TUBES

HYTRON

RADIO AND ELECTRONICS CORP.



MAIN OFFICE: SALEM, MASSACHUSETTS
PLANTS: SALEM, NEWBURYPORT, BEVERLY & LAWRENCE

BUY ANOTHER WAR BOND

DETECTORS

(Continued from page 73)

cuted, or a lesser value of R_1 than required is being used, audio signal will be present noticeably at the ungrounded side of C_2 . The presence of audio signal at point 3, then, can be due to a defect in either C_2 or R_1 . A capacity test of C_2 will help determine which of the two units are at fault. If no capacity tester is available, bridging C_2 with another equivalent capacitor will be a good check for an open in C_2 ; a resistance test with an ohmmeter will indicate whether or not C_2 is shorted.

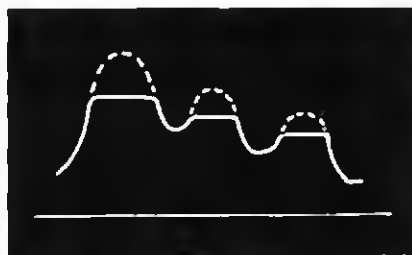

FIG. 3—Flattening of audio signal results when AVC filter capacitor is either too small, or has lost capacitance.

An open in C_2 will generally manifest itself aurally by the presence of a low noise level between stations. Greatest sensitivity in a set having simple AVC occurs between stations, where no signal is present, and AVC bias is therefore least. Electrical noises picked up by the antenna system are, as a result, amplified most, and noise level is highest, at between station settings. When C_2 opens, the AVC stops functioning, and noise level drops.

When servicing complicated AVC systems with the signal tracer, a good rule to remember is that audio bypass capacitors to ground should not have appreciable audio signals at their ungrounded side, if they are functioning properly. Neither should rf bypass capacitors to ground have rf signal at their ungrounded side. Both types of capacitors should offer short-circuit paths for the respective signals being by-passed.

AVC Filter Capacitor

Mechanics sometimes replace the AVC filter capacitor with another one of incorrect value. This may occur because the capacitor marking has been obliterated, or perhaps it was never there to start with. To figure out the correct capacitance required in such a case, use the formula $T=RC$, where T is the time required,

in seconds, for the AVC filter capacitor to charge or discharge; R is the total resistance, in megohms, through which the capacitor charges or discharges; and C is the capacitor's value in microfarads.

R_2 , R_3 , and R_1 determine the value of R . C_2 charges through R_2 and R_1 (see Fig. 1.) and discharges through R_1 and R_3 . Since R_2 and R_3 , however, are small compared to R_1 , they may be neglected in ordinary calculations, and R_1 alone substituted for R in the equation.

Say the value of C is unknown, R is 2 megs. T may be considered .1 second, the usual time constant value. Then

$$\begin{aligned} T &= RC \\ .1 &= 2C \\ C &= \frac{.1}{2} = .05 \text{ mfd.} \end{aligned}$$

Too Large Capacitance

If the filter capacitor replacement is too large, AVC voltage will not charge up the capacitor as quickly as required, and momentary blasting will occur when a strong station is tuned in. When going from a strong station to a weak one, the AVC voltage developed by the strong station will not discharge as fast as it should, and will thus reduce the sensitivity of the receiver momentarily. Weak signals may be passed over during tuning as a result.

Too Small Capacitance

If the AVC capacitor is too small, low audio frequencies will have time to charge it, and affect the bias on the grids of the AVC-controlled tubes. The audio modulation will thus be affected—audio signal highs will be flattened, and distortion will result, as well as decreased volume. (See Fig. 3.)

Another source of distortion will come from the modulation of the IF signal by the low audio frequencies. Feedback, manifesting itself in squeals or whistles, may also be produced when the capacitor replacement is too small. The symptoms described are, of course, markedly present when the AVC filter capacitor opens, partially or wholly.

More complicated detector circuits than the ones discussed in these pages will sometimes be encountered. An understanding of the basic fundamentals of second detector action, and the ability to use the wide variety of test instruments available, should minimize difficulties in servicing these circuits.

Service Notes

Intermittent Socket

When a set is being checked for intermittent operation, it is a good policy to take voltage readings from the tube prongs to B-, not the socket contacts to B-. Poor contact between socket and prong will show up by intermittent absence of voltage on a tube prong. When readings are taken from the socket contact, however, the pressure of the test prod may improve a bad contact, and cause a steady voltage reading to appear on test. The intermittent contact, thus, will not be readily apparent.

Isolating Hum

The complaint on a Zenith broadcast and short-wave portable was a low, steady hum. The store in which the set was being serviced was noisy, and it was not easy to note any improvement when the filters were crossed with other capacitors. To add to the difficulty, the signal was as loud as, or louder than the hum, even with the volume control turned down to minimum. To separate the hum from the signal, the set was switched from broadcast to short-wave, and the built-in antenna was disconnected. With the volume control turned down to minimum, signal reception became inaudible, but the hum remained plainly evident. Improvement now was more easily noted, when capacitor tests were made. As a further check, the radioman's fingers were lightly placed on the speaker cone, and vibration intensity noted, first with old filter capacitor, than with new one. Hum-caused vibration was less when new filter capacitor was crossed over old one, verifying that the old filter had lost capacitance.

Cleaning Tuning Capacitors

When noisy ganged tuning capacitors were cleaned with a commercial preparation on this repair, there were some unexpected results. Symptoms of misalignment appeared. Inspection showed that this was due to the presence of an oil base in the cleaning fluid being used. The oil clung to plates of the tuning capacitors, changing the effective capacity between them, and misaligning the RF and oscillator tuned circuits. Pure carbon tetrachloride was used to clean off the oil.

DUMONT

Electrolytics



- END SEALED IN WITH DUMONT RESINOID
- DURALASTIC TREATED TUBES
- IDEAL FOR HIGH TEMPERATURE OPERATION
- HIGHLY MOISTURE-PROOF
- LONG LIFE ASSURED

○ Sold through Exclusive territory Arrangement only.
Write for our proposition to-day



DUMONT

ELECTRIC CO.

MEM'S OF
CAPACITORS FOR EVERY REQUIREMENT

34 HUBERT STREET
NEW YORK, N. Y.

NEW



**MODELS, METHODS, MATERIALS,
MARKETS, MERCHANDISING AND PROFITS!**

Sentinel RADIO

For Studio Tone in Your Home

*for EVERY
Room in EVERY
Home!*

On Tomorrow's Buying Fronts Sentinel will again be first with a complete new line of home radios—better radios—radios built with war-learned precision, with war-perfected methods and materials!

A tremendous, pent-up demand already exists. Sentinel is keeping it alive with powerful, consumer advertising, even though Sentinel is still engaged 100 per cent in war production.

But when the Go Ahead! signal is flashed—Sentinel will be ready—ready with new models, new merchandising, new dealer helps!

Get set NOW for post-war profits—with Sentinel!



Sentinel **RADIO CORPORATION**

2020 Ridge Avenue, Evanston, Illinois

RADIO & Television RETAILING • July, 1945

IT'S A HUNDRED TO ONE YOU'LL FIND THE

RIGHT CONTROL

In IRC'S New CENTURY LINE

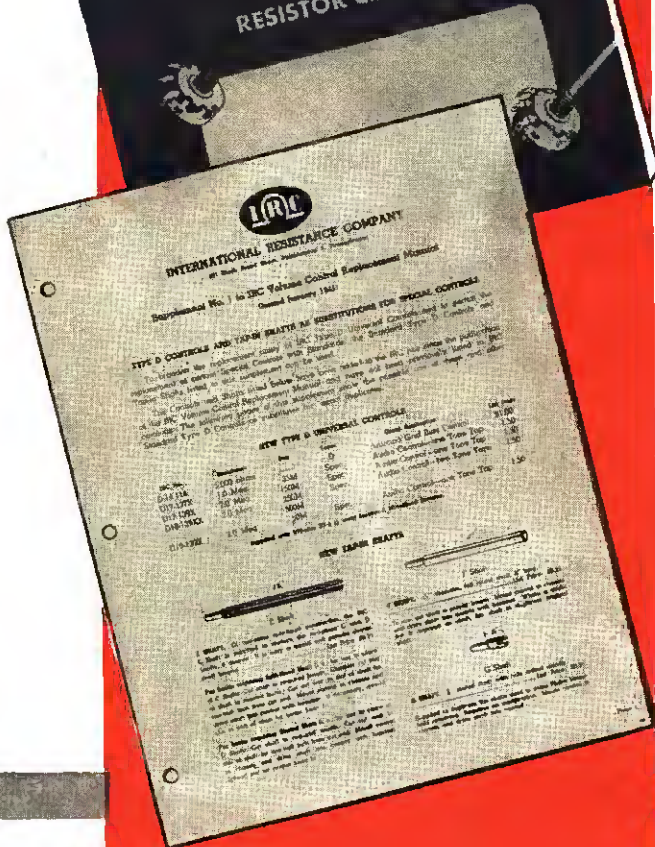

HERE'S WHY ... In order to keep Servicemen supplied with the volume controls they require for a vast majority of their replacement needs, IRC recently introduced the "Century Line." Through concentration of manufacturing efforts on these carefully selected, one hundred controls you are assured sufficient quantities in a selection that will solve over 90% of your day-to-day service problems. All controls included in the "Century Line" are of the same high IRC quality for which the industry has always shown preference.

HERE'S HOW ... To select the right control for the job at hand, look up the make and model of the set in the alphabetical listing in IRC's Volume Control Replacement Manual. Chances are you'll find the IRC control number listed right there. If however, an exact duplicate is called for, one further step is necessary. Look up the "J" number (exact duplicate) in Supplement No. 1. Directly opposite the duplicate part number you'll find the IRC "Century Line" number you can use for satisfactory replacement. It's as easy as that!

If you do not have an IRC Volume Control Replacement Manual or a copy of Supplement No. 1 you can readily obtain one from your IRC Distributor—or by writing direct to Dept. 21G.



INTERNATIONAL RESISTANCE CO.
 401 N. BROAD STREET • PHILADELPHIA 8, PA.

IRC makes more types of resistor units, in more shapes, for more applications than any other manufacturer in the world.

New Merchandise the

Samson IRON

No. 5000N 3-Speed automatic iron with 1000-watt steel rock heat unit; magic eye which lights up when current is on and blacks out when off; precision thermostat; heat con-



trol dial to facilitate selecting amount of heat needed for particular fabric, and speed at which it is to be ironed. Built-in cord. Light weight. Samson United Corp., Rochester, N. Y.—RTR

Allied P. A. SYSTEM

This all-purpose amplifying system delivers 60 w of undistorted output and features 4 individually controlled microphone channels, 2 individually controlled phono channels, universal output for matching any arrangement of speakers, individual controls for high and low frequencies and optional phono top. Allied Radio Corp., 833 W. Jackson Blvd., Chicago 7, Ill.—RTR

Westinghouse ELECTRIC FAN

Available in limited numbers to essential users only is the "Power-Aire" 12-inch oscillating desk-bracket fan with a three-speed switch,

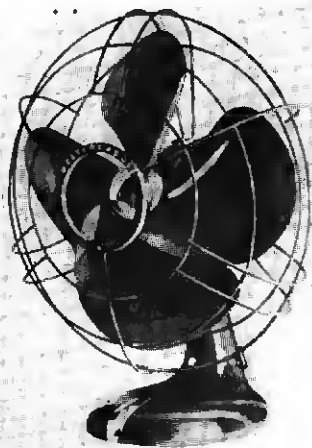

powerful motor, quiet Micarta blades, and fully-enclosed automatic clutch. Also available (not shown) is the "Pacemaker" 16-inch oscillating desk-bracket fan with three-speed switch, 75° oscillation arc. Has adjustable center. Westinghouse Electric Corp., Sunbury, Pa.—RTR

General Detroit FIRE EXTINGUISHER

Corrosion-resistant, copper finish Red Star soda-acid fire extinguisher. Immediate manufacture to begin on soda-acid and following types: carbon dioxide, vaporizing liquid (C.T.C.), foam, 2½ and 5-gallon pump, and telescope pump types. F. Dale Bacon, general



manager industrial division, shown holding first extinguisher to roll off assembly lines. General Detroit Corp., 2270 East Jefferson Ave., Detroit, Mich.—RTR

Weston AC METERS

Weston electrical measuring instruments can be furnished with special forms of compensation to maintain their accuracy over the broad frequency range of from 25 to 3000

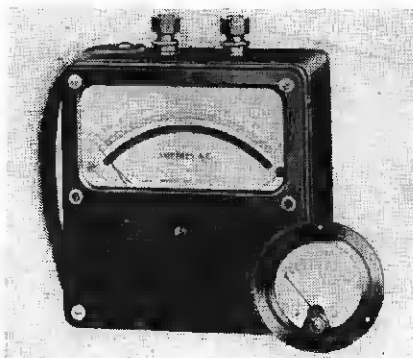

cycles. These basic moving iron vane and dynamometer type instruments are furnished as ammeters, voltmeters and wattmeters, in both the portable and switchboard types; flat compensated up to 1000, 2000 and 3000 cycles. Weston Electrical Instrument Corp., 617 Frelinghuysen Ave., Newark 5, N. J.—RTR

Hamilton Beach VACUUM CLEANER

No. 26 vacuum cleaner, cylinder-type with suction floor nozzle. Suction regulator, four-wheel carriage for easy manipulation. Swivel wall and floor brush permits tube to be lowered nearer to floor level. Cleaning tools are

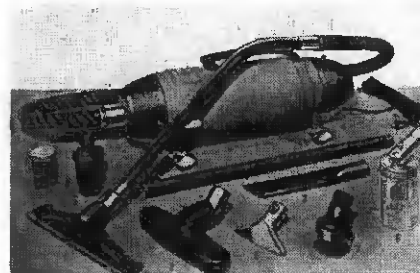

(1) Magic suction floor nozzle, (2) Floor and wall brush, (3) Upholstery nozzle, (4) Utility brush, (5) Radiator tool, (6) Gas dispenser, (7) Sprayer, (8) Extension Tube, (9) Hose. Housed in rolled sheet steel with durable platinum gray, baked enamel finish. Hamilton Beach Co., Racine, Wis.—RTR

Ritz Commander ELECTRIC BROILER

Table broiler No. 1945, of polished aluminum. High heat of 800 watts and low heat



of 300 watts. Handles of wood in a walnut finish. Cord set not furnished at present time. Marlun Mfg. Co., 37-39 East 21st St., N. Y., N. Y.—RTR

Hexacon SOLDERING IRON

Can be operated from batteries or line. Irons are available in 100 or 200 w sizes wound for either 12 or 24 v, with either 6 ft. or 12 ft. cords, and with the conventional plug cap or battery clips. Damage proof hexagon shaped barrels and scale resistant element cores are used. Hexacon Electric Co., 120 W. Clay Ave., Roselle Park, N. J.—RTR

Manufacturers Offer

Stancor SLIDE-RULE

This multi-slide rule features all the values of the regular slide rule, plus 8 mathematical tables. It is made of durable stock, clear-print and has a transparent plastic indicator. \$1.00 charge includes carrying case. Standard Transformer Corp., 1500 N. Halsted St., Chicago, Ill.—RTR

Metropolitan SIGNAL TRACER

Model CA-10 is furnished with a detector probe. A 1T4 tube used in conjunction with an rc network comprises the complete assembly housed within the probe itself. The probe may be used on both rf and if stages with negligible loading and is sufficiently sensitive to respond to a signal picked up by an antenna without amplification. An impedance matching transformer, suitable for all audio stages, is used. An attenuator control mounted on the front panel permits variation of the signal level. A neon lamp, also on the front panel, is used to compare the relative power and voltage of audio circuits. An ordinary single or double headset may be used to "listen in" when tracing for noise or distortion in either the rf or audio sections. Metropolitan Electronic & Instrument Co., 277 Broadway, New York 7, N. Y.—RTR

Duo-Therm FUEL-OIL HEATER

"Power-Air" gives air-flow for thorough heat circulation. Removable grille can be turned to direct air flow in any direction. Heavy duty motor, mounted on rubber outside the heater

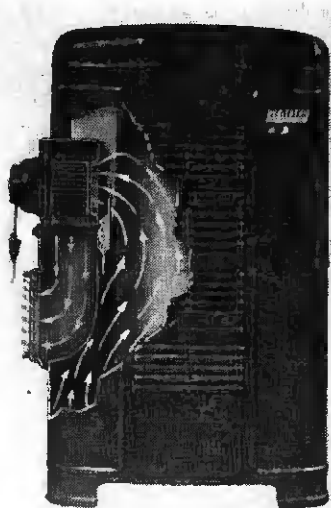

for better cooling and accessibility for oiling. Switch for turning on and off. Positive forced circulation. Chromium-plated wheel corrected for perfect static and dynamic balance. Adjustable velocity control to coordinate amount of air output to amount of desired heat circulation. Streamline metal casing to house unit and provide direct passage for outward flow of air. Duo Therm Division, Motor Wheel Corp., Lansing, Mich.—RTR



Crosley KITCHEN

Postwar kitchen illustrating one of many possible arrangements of new-style kitchen cabinet sinks, and floor and wall kitchen cabinet units. Flexibility is the outstanding characteristic of the line. Equipment consists of a pre-fabricated line of 12 steel units, which are not "built-in" to specific wall and floor dimensions, but are movable, and can be arranged to conform to space available.

The cabinets are mounted on steel strips attached to the wall and can be placed at any height. The 12 units of sinks and cabinets include five types of sinks and sink cabinets from 42" to 66" wide; six types of wall cabinets from 24" to 66" wide; and one type of base cabinet, 24" wide. Crosley Corp., Cincinnati, Ohio—RTR

Premier FURNACE AND BOILER CLEANERS

Model 174 $\frac{5}{8}$ HP., 35 in. water lift; model 175, 46 in. water lift, 1 HP. Air-cooled motor for continuous operation without heating. Dirt and soot deposited in container. Bag has ample filtering area. Easily emptied. Model 174, 60 lbs., at \$74.50. Model 175, 65 lbs., is \$89.50. F.O.B. Cleveland. Electric Vacuum Cleaner Co., Inc., 1734 Ivanhoe Rd., Cleveland, Ohio.—RTR

Allied CALCULATOR

This parallel resistance and series capacitance calculator is designed to provide a rapid and accurate means of determining the reciprocal of the sum of 2 reciprocals. A single setting of the slide automatically aligns all pairs of a and b values which will satisfy the equation for any given value of x. The calculator indicates in one setting the numerous pairs of resistances which may be connected in parallel, or capacitances in series, to provide any required resistance or capacitance value. Range is 1 ohm to 10 megohms; 10 mmfd to 10 mfd. Capacitance and resistance figures on the face of the rule can also represent inductance, impedance, reactance, or other units. Priced at 25c. Allied Radio Corp., 833 W. Jackson Blvd., Chicago 7, Ill.—RTR

McAllister BAGLESS VACUUM CLEANER

Handles either suds and water or dry dirt. All dirt deposited into easily detachable reservoir. Cleans surface and deep-seated dirt.



Can be used for moth-proofing, spraying paint, airing beds and closets, and drying hair. Franklin-McAllister Corp., 135 South LaSalle St. Chicago, Ill.—RTR



Right across the "Board"



We've been "burning the midnight oil" . . . not only to deliver to Uncle Sam all the Eastern amplification equipment needed for Army Air Forces bombers and U. S. Navy planes and PT boats, but also to translate our extensive wartime experience into sound amplification equipment for peacetime use.

Our post-war production is *right* on the drawing board! We are ready to manufacture just as

soon as Uncle Sam gives the "go-ahead."

To aid the war effort against Japan, our engineers are standing by to consult on any problem of sound amplification. Until the day of final Victory, our resources will be devoted to the design and production of vital war equipment.

Let us send you a series of useful articles prepared by our engineering staff on the newest developments in amplification related to sound systems. Ask for Series 7A

Buy War Bonds



U. S. Reg'n. Applied For

794 EAST 140th STREET • NEW YORK 54, N. Y.

PERSONAL RADIO

TABLE RADIO

TABLE
COMBINATIONS

F. M. RADIO

CONSOLE
COMBINATIONS

AC - DC
PORTABLES

TELEVISION

COMMERCIAL
COMMUNICATION
EQUIPMENT

PUBLIC
ADDRESS
EQUIPMENT

AUTOMATIC
RECORD
CHANGERS

HERE'S WHAT IS BACK OF THE

MAGUIRE RADIO FRANCHISE

EVERYWHERE DEALERS AND DISTRIBUTORS ARE ASKING ABOUT MAGUIRE HOME RADIO. HERE ARE THE ANSWERS TO YOUR QUESTIONS:

THE MAGUIRE RECORD

Maguire came to prominence as a manufacturer of essential wartime equipment. Maguire won the Army and Navy "E" award with two stars. Maguire electronics business continues to increase yearly.

MAGUIRE FACILITIES

Maguire has grown from one small unit to six imposing plants, housing the most modern machinery; new electronically-controlled production lines plus especially designed laboratory and testing equipments.

MAGUIRE QUALITY

The finest in research, design, engineering and manufacturing talent; the use of only the best component parts; rigid inspection before, during and after manufacture . . . will assure continued high quality.

THE MAGUIRE FRANCHISE

The Maguire franchise assures a profitable operation for dealers and distributors. Maguire post-war radio will be backed by aggressive advertising, planned promotion, displays and masterful merchandising.

LOOK TO MAGUIRE

For post-war radio, designed for eye-appeal and priced to fit all pocketbooks . . . look to Maguire. For all details write Maguire Industries, Inc., Sales Department, Greenwich, Connecticut.

A NEW NOTE IN HOME RADIO



Maguire

INDUSTRIES • INCORPORATED

ELECTRONICS • DIVISION

PLANTS. BRIDGEPORT • STAMFORD • GREENWICH • CHICAGO • BROOKLYN • CLIFTON • NEW YORK
RADIO & Television RETAILING • July, 1945

JOBBER JOTTINGS

Erskine-Healy in Business 25 Years

Don Erskine and Raymond Healy, Rochester, N. Y., distributors of electrical appliances have devoted a long period of time to intensive dealer sales work. Established a quarter century ago, Erskine-Healy's first venture was selling radio tubes. Eventually a complete line of major appliances, headed by Norge, Emerson, Royal Sunbeam, Telechron and Sylvania lamps and fixtures were carried. When goods became scarce, Erskine-Healy sold merchandise they had saved for their dealers at 1941 prices, allotting goods on the basis of previous trade with the firm. A twenty-year old policy that has paid dividends is selling only to authorized dealers. The firm is now getting set for the future, and a continuation of its good-will policies.

Ind. Jobber Offers 3-Point Dealer Pledge

Associated Distributors, 211 S. Illinois St., Indianapolis, RCA jobbers, has issued a statement of its policies to dealer-customers. The firm declares that: "We will sell products that offer our dealers an advantage; we will sell products that offer an adequate margin of profit; we will sell products that are correctly designed, expertly manufactured with precision methods that require low service expense.

"We will offer that sound advantage of diversified lines, selling each product on its own merit and not require any dealer to put 'all his eggs in one basket'; we will maintain a sales staff old enough to offer our dealers sound merchandising counsel—yet young enough to enthuse

your selling organization; we will sell exclusively wholesale to bona fide dealers of appliances; we will adequately and faithfully serve the requirements of our dealers; we will welcome you to our sales and service office at any time."

Serve-Yourself Plan Used by Sylvania Jobber

Customer self-service is the merchandising method used at the Southeastern Radio Supply Co., Sylvania distributor located at 411 Hillsboro St., Raleigh, N. C. The firm recently moved to this new location, which it has purchased, and has converted it into a modern sales-room.

The stock in this establishment is clearly marked and well lighted by fluorescent lamps. Ample counter space facilitates self-service operation.

The business is owned by brothers Phil, Al, and Bob Rothstein. While Phil and Bob are serving with the Army, Al is the active general manager. The company's plans for rendering excellent service to its customers, postwar, include an educational program for radio repairmen conducted by competent technicians and engineers.

On Wholesaler's Staff

Milbender Distributors, Inc., Boston, Mass., radio and appliance jobber, has announced the appointment of Martin Horwitz as sales manager. Mr. Horwitz comes to the firm after having represented many manufacturers in New England on appliances, radios and lighting equipment.

Distributor Joins NEDA

Lake Radio Sales Co., 615 West Randolph St., Chicago, Ill., has recently become a member of the National Electronic Distributors Assn. This was announced by Hy Goldberg and Bernard Friedman, co-owners of the company.

N. Y. "Reps" Entertain at Dinner-Meeting

80 representatives, jobbers and manufacturers met recently in New York for an evening of fun. The 23 members of the New York Chapter of the Representatives acted as host to the 57 others who attended. Among those present were:

Dan Bittan, Bob Breuer, Larry Braun, Ben Burns, Bill Carduner, Len Carduner, Charlie Cooper, Nels Case, Hy Davis, R. G. Brookfield, H. J. Dostal, Sam Egert, Irving Finkel, Bill Filler, Marty Camber, John Forshay, Adolph Friedman, Jack Fields, David Israel, H. J. Fairbanks, M. S. Feldman, Isador Golden, Bill Gold, S. W. Gross, Lester Hirtenstein, Milton Fischer, Jung Herold, Arthur M. Harris, Tom Douglas, Ben Joseph, John Kopple, Jack Klein Martin Kroll, Sam Kavesh, G. Kilpatrick, Ben Lehman, Adolph Langer, Charlie Lienan, Ben M. Moser, Nat Marks, Ben Miller, Charles Newman, Dr. Lichter, Irv. Nevins, J. L. Payne, Sol Predeger, Jack Ravdin, Milton Landau, Rudolph F. Reinitz, Jack Rosenbaum, A. George Roger, Perry Saftler, E. Lee Sigmund, Max Stark, Mike Scott, Bill Sharp, Joseph Stantley, Leroy Schenck, Jules Sussman, M. H. Samm, Ben Singer, Tom Sewel, Joe Sprung, Hy Steinberg, George Taylor, Jr., Al Wellington, Jack Weber. (See photo below.)



New York "Representatives" act as hosts to manufacturers and others at get-together for fun, food and entertainment.

Seeing

IS HALF THE SELLING

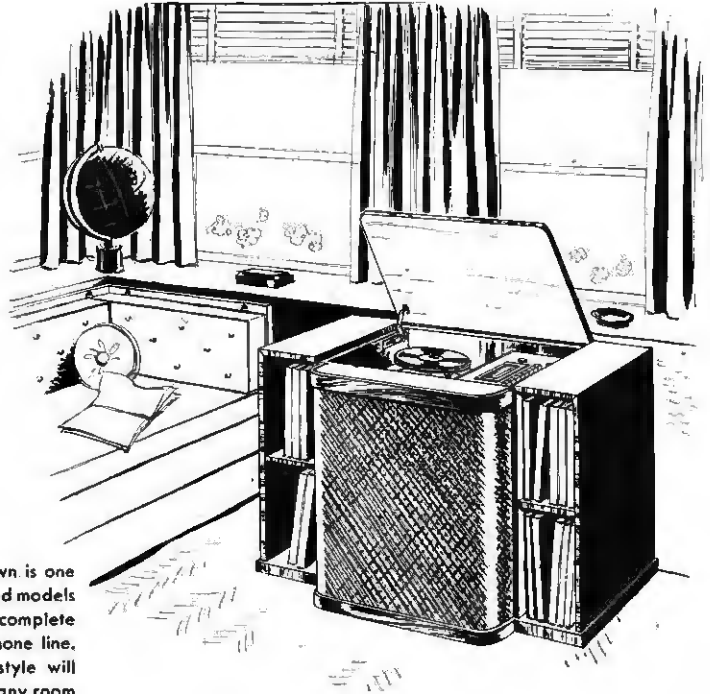

The Skyline model shown is one of 12 Modern and Period models which comprise the complete postwar Anasley Dynaphone line. Its authentic modern style will enhance the beauty of any room furnished in this decor.

Because consumers see the cabinet before they hear the tone, Anasley Dynaphones have always been designed with infallible eye appeal. So true are their lines, so inherently beautiful, that in this important respect they are well beyond competition. When customers see an Anasley they are half sold — when they hear it they are completely sold.

ANSLEY RADIO

CORPORATION

Superb Tone from Records and Radio
21-10 49th Ave., Long Island City 1, N.Y.

"REPEAT BUSINESS"

A Denver dealer points out
how our methods of service
help him develop sales.

"During the years that I have used your service, many competitive deals have been offered me and I have reviewed them carefully, but in my opinion none has afforded the complete advantages of Commercial Credit plans and facilities.

"Your speed in investigating and passing credits is a very real help in closing our sales. Your collection system keeps past-dues at a minimum and still retains customer goodwill. We have particularly noticed that your personnel is trained to expedite the dealer's sales and to treat his buyers with every reasonable consideration so that all possible **REPEAT BUSINESS** will be developed."



Herb Names Pres.
Herb Names, Inc.
Denver, Colo.

COMMERCIAL CREDIT COMPANY

BALTIMORE 2, MARYLAND

Capital and Surplus more than \$65,000,000

\$25,000,000



Which radio sets will sell readily in the postwar period?

Those bearing the Stewart-Warner name will; because \$25,000,000 has been spent in advance to popularize this trade-mark,

and 21 years of peace and wartime radio experience go into the making of these famous sets.

A red rectangular advertisement. At the top, the words 'STEWART-WARNER' are written in a bold, black, sans-serif font. Below this, the word 'Radios' is written in a large, elegant, black cursive script. Underneath 'Radios', the text 'CHICAGO 14, ILLINOIS' is printed in a smaller, black, sans-serif font. At the bottom of the advertisement is a small version of the Stewart-Warner logo, featuring the 'SW' shield and wings.



TELEVISION TODAY

Allen B. Du Mont on Direct-Viewing Merits

The merits of direct-viewing television systems were set forth by Allen B. Du Mont, who heads his own company engaged in the development and manufacture of cathode-ray tubes and equipment, including television receivers and transmitters, at the June IRE meeting in New York. Stated Dr. Du Mont:

"In the past, and also at the present time, the direct-viewing cathode-ray tube has been used almost universally in all oscillograph, television and radar applications with very satisfactory results. The tubes that have been used previously for television ranged in size from 5" in diameter to 14" in diameter. Because of the desire on the part of television viewers for a larger picture, a 20" tube has been developed with a reasonably flat face. This tube utilizes a pressed face in order to economize on manufacture and insure uniformity of product. It is possible with this tube to obtain a picture 13½" x 18", which our experience has shown is of a satisfactory size for any ordinary home living room."

Saving for Tele Sets

A survey conducted by the Chicago Tribune reveals that in the Chicago area alone, some \$34,057,000 has been set aside by residents to purchase television sets within a year after the war. Similar interests in television receivers has been reflected in postwar saving accounts at banks in Long Island, N. Y., and elsewhere throughout the United States.

Ask New Philco Station

The Philco Radio and Television Corp., Philadelphia, Pa., has filed an application with the Federal Communications Commission for permission to erect an experimental video station in Springfield Township, Pa., to operate on a 20 megacycle band between 524 and 544 megacycles. The station will operate on one kilowatt of power.

Davega Will Feature Television in 30 Stores

As soon as television sets are available, Davega will put them in every one of its store units, said a Davega official recently in discussing the outlook.

"Each of our thirty stores will display a television set in the window, and each will have a display and demonstration room. That's how much in earnest we are about television. In fact, go to any of our stores today and you can see that we still have our aerials up. And Davega will be ready to back television with local advertising as soon as retail sales become possible."

Expands CBS Tele Set-Up

CBS television station WCBW-New York, has added 3,000 square feet of floor space and is making extensive alterations of its premises in the Grand Central Terminal, New York City, to permit expansion of operations. The augmented quarters will give the video station a total of 25,000 square feet for offices, studios, workshops and storage.

Video's Role in Peace Stressed by Stettinius

"Radio is making a great contribution to the winning of the war.

"Radio and television have an even greater obligation to the future in the winning of the peace. The homes of the world must be made into one great, common living room for the family of nations. The challenge is a great one, but I am certain that the men and women responsible for the functioning of this great medium of communication are equal to the task."

—Secretary of State, E. R. STETTINIUS

Merryman of NBC Urges Present Tele Development

Every rule of common sense dictates that postwar television should go ahead on its present basis, said Philip I. Merryman, NBC director of facilities development and research, in a talk before the New York chapter of the Institute of Radio Engineers. Merryman asserted that we should go ahead in developing postwar television in the present six megacycle black and white method of transmission.

He pointed out that recently the BBC announced that its postwar service expansions were based on the use of 405-line standards.

Immediate Service

"This decision did not exclude the possibility of rapid development of a higher definition television system," Merryman said. "It simply recognized that if the British public is to have immediate postwar television service it would have to start with six megacycle black and white pictures. That should be the program in the United States."

Merryman predicted that within ten years more than 400 cities in the United States will have television stations—all operating at a profit.

Sonora Plans Tele Sets

In a recent statement, Joseph Gerl, president of the Sonora Radio & Television Corp., declared that his firm will produce television receivers approximately one year after civilian manufacturing is resumed.

At the outset, Mr. Gerl asserted, the company will make a table model set, with a 7 or 8 inch screen, retailing for about \$150, and a console model which will sell for \$400, with a 16 x 21" picture. With the advent of large production, he added, there is a strong possibility of the price being reduced to \$100 and \$300 for each receiver.

In the future, he said, television will play a major role in maintaining high employment roles.

We Report on Video Shows



TELEVISION APPLAUSE CARD

We enjoyed seeing you on Television Station _____

(LOCATION OF TELESET) _____ (OBSERVER) _____

TELEVISION OBSERVING STAFF • CALDWELL-CLEMENTS, INC.
Publishers of Radio & Television Retailing, Radar,
Electronic Industries, Television Today
480 Lexington Avenue, New York 17, N. Y. • PLaza 3-1340

Those who watched the development of radio during its early days undoubtedly recall the "applause cards" sent to radio stations telling of good reception. Six members of the staff of Caldwell-Clements, Inc., now have television sets in their homes, and are using applause cards like that above, to tell artists, station operators and program directors about their likes and dislikes of shows now on the air.

FRED ALLEN* *Says:*

**"DUMONT TELEVISION IS
RIGHT UP ALLEN'S ALLEY"**

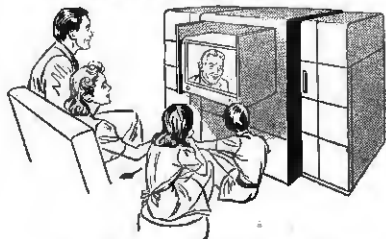

And right up *your* alley, too, if your clientele demands the finest. For the achievement-starred DuMont pioneering that made commercial television practical—and also piled up a 14-year backlog of precision "know how"—assures inspired craftsmanship in DuMONT TELESETS.† DuMont's war-born sales features will soon be yours ...incredibly lifelike television pictures, sharp and clear from any angle... exquisite tone... dependable electronic engineering... outstanding cabinet artistry... performance above and beyond comparison!

*Star of United Artists' Release "It's in the Bag."

†Trade-mark Reg.

Copyright 1945, Allen B. DuMont Laboratories, Inc.

DUMONT



Precision Electronics and Television

ALLEN B. DUMONT LABORATORIES, INC., GENERAL OFFICES AND PLANT, 2 MAIN AVENUE, PASSAIC, N. J.
TELEVISION STUDIOS AND STATION WABD, 515 MADISON AVENUE, NEW YORK 22, NEW YORK

ALWAYS SPECIFY

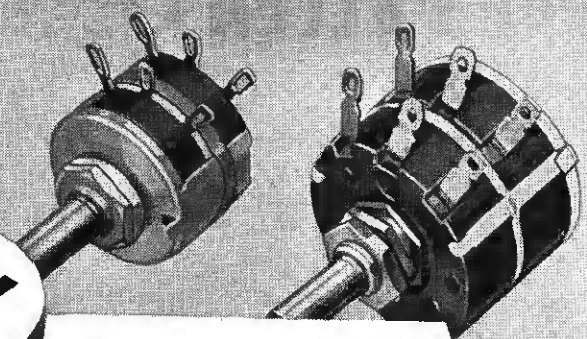
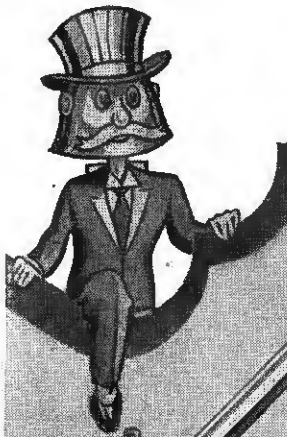

Centralab

- Volume Control
- Selector Switches
- Lever Action Switches

Old Man Centralab urges you today, as he has for the past two decades, to "always specify CENTRALAB" Replacements.

Your jobber or supplier has comparatively ample stocks of the famous RADIOHMS, Selector Switches (Bakelite or Steatite insulation) in kit form or standard completely assembled and individually cartoned Tone Switches and Lever Action Switches.

... and because there is no substitute for quality be sure to "always specify CENTRALAB"



Send for Catalog No. 24.

Centralab

Division of GLOBE-UNION INC., Milwaukee

Producers of: Variable Resistors • Selector Switches • Ceramic Capacitors, Fixed and Variable • Steatite Insulators and Silver Mica Capacitors.

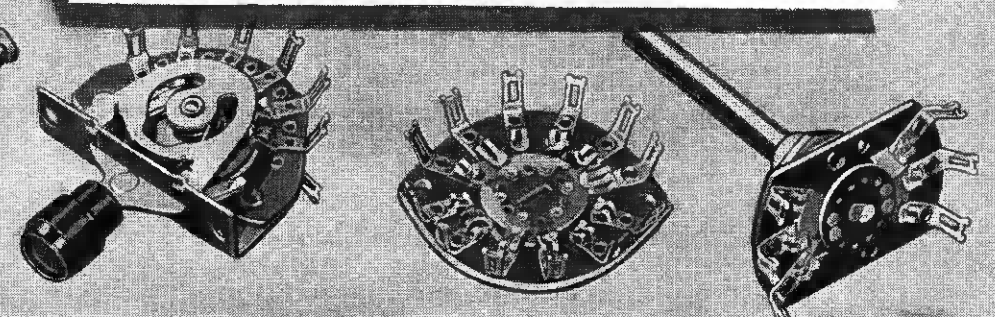
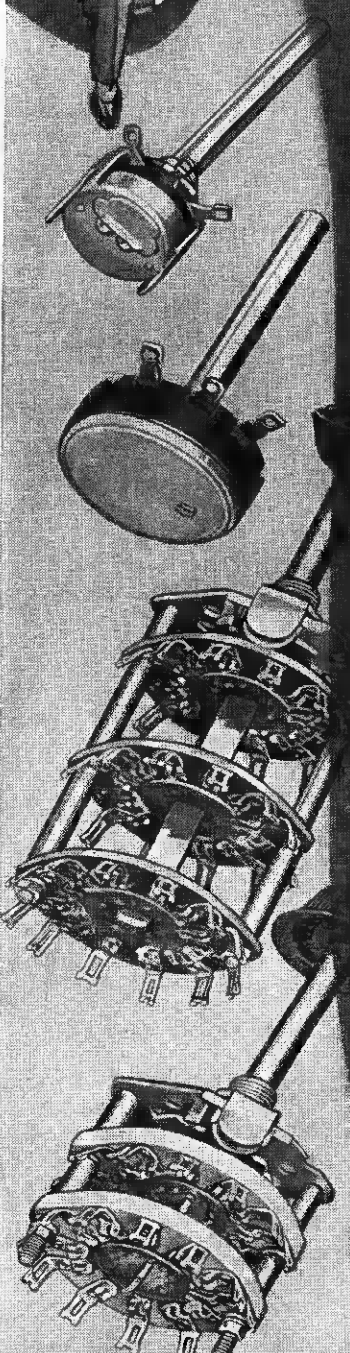

Depend on
ARVIN
for Sales Help

Family desires for the coming ARVIN Products are being pre-sold now—through many different full-page advertisements in leading national magazines. The page reproduced below is appearing currently in LIFE Magazine, COLLIER'S Weekly, and COUNTRY GENTLEMAN. ARVIN Policies include products with real appeal—backed by effective sales help for the trade.



What do I want?

"I'm MOTHER: I want a new little Arvin Radio for my kitchen—another for our bedroom—and a fine, big one for the living room, with an automatic record changer, FM and everything."

"I'm JIM: After foxholes and slit trenches—and no company but my rifle—I want a good bed with a radio beside it (Arvin, please)—so I can snooze and be entertained as long as I like."



P. S. "MOTHER, again: I want some other things—an automatic electric iron, those roll-a-round laundry tubs, an electric heater for the bathroom, some new metal lawn chairs—and one of those gay metal-chrome dinette sets (every one of them ARVIN). I'm not asking too much, am I?"

"I'm SIS (So the family calls me). I want an Arvin Radio of my own, too—for my room. And maybe we could have a little radio-phono combination for the playroom. (If I'm not over-playing my hand, I'm going to sweet-talk Dad into a portable—for the lawn and our picnics. They're wonderful.)"



"I'm DAD, the bill-payer: Looks like this is all on me—and I can't fuss about a single item. This is where the bonds I bought to help win the war will help keep the peace around our home. (I'm going to have one of those fine little Arvin table radios of my own, too.)"



ALL THIS—and more, too—will be coming from the eleven plants of Noblitt-Sparks Industries—when war work is done. There'll be Arvin Top Flight Radios—tiny ones, big ones, middle-size ones, table models, radio-phono combinations with AM and FM, floor models, portables and farm battery sets. With them, you can radio-furnish your home completely—and economically—upstairs, downstairs, all through the house and outdoors, too. And there'll be many other fine Arvin Products—well worth buying more War Bonds for now



ARVIN is the Name on Products Coming from NOBLITT-SPARKS INDUSTRIES, INC., Columbus, Indiana
Eleven plants in five Indiana cities—25 years' experience in manufacturing

"CQ..."

*we'll hear it
again—SOON*

**THE HAM IS
COMING BACK...
STRONGER THAN EVER**

Who Said The "Ham" Is Finished?

THERE have been rumors to the effect that the radio Amateurs were going to be denied their old frequency bands, and given new bands of such high frequency as to be useless for medium and long distance communication.

Some rumors say "Remember the last War? We are going to get the same treatment this time!"

Now, we don't believe the "Hams" should be denied their rightful place on the air in bands suitable for communication beyond the horizon—and further, we do not believe that our Government would want to see those privileges denied.

Are not the "Hams" fighting on many battlefronts, working in war factories and laboratories for a New World wherein the individual will be able to live and enjoy his hobbies, his church and other personal freedoms which go to make up a healthy, happy world?

It is well-known among Government officials whose task it was to build our great war-time communications system that from the rank and file of amateurs came executives, instructors and thousands of engineers and operators. Without this nucleus of experienced men, it would no doubt have taken a much longer time to reach the present high degree of perfection in the communications branch of our fighting forces.

In every emergency Amateurs have proved their ability and willingness to come to the aid of their Country—who would be so unjust as to want to deny them their small place in the radio spectrum? We do not believe these rumors that the "Ham" will be denied his privileges, we believe rather that those who speak so much of justice coming out of this war will see to it that the Amateur receives his just reward.

The entire radio industry knows well, and appreciates the many contributions "Hams" have made for the advancement of high frequency radio communications, and surely they too can be counted on to assist the "Ham" in regaining his privileges when the right time comes.

HAMMARLUND MANUFACTURING CO., Inc.
460 West 34th Street, New York 1, N. Y.

THIS AD APPEARED IN MARCH, 1944

WE never lost faith in the friends of amateur radio. We believe progress up to this very moment indicates that Hams have many friends in high places. Of course, there is a lot of romance to Ham radio, but the place won by the Ham in the hearts and minds of important people is the result of a very practical demonstration of real worth—real American ability.

We wish to openly express our sincere appreciation for the wisdom of those whose job it was to guide amateur radio through these troubled times. And those who have given Hams a just portion of the spectrum are to be commended for their farsightedness.

American amateurs can be thankful they live in a country where ability receives its just reward.

LLOYD A. HAMMARLUND, President

HAMMARLUND MFG. CO., INC., 460 W. 34th ST., NEW YORK 1, N. Y.

SPRAGUE TRADING POST

A FREE Buy-Exchange-Sell Service for Radio Men

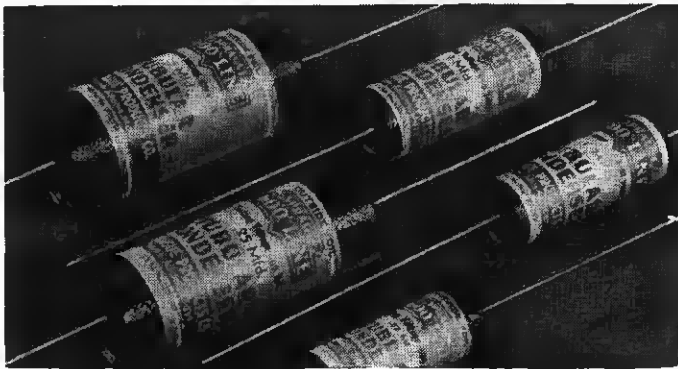

SPRAGUE T C TUBULARS

The most famous, most widely used by-pass capacitors in the entire history of Radio. Ask for them by name!

"NOT A FAILURE IN A MILLION"

WANTED—Hard to get tubes and ear-phones. Allen Meyer, R#2, Box 203B, Anaheim, Calif.

FOR SALE—Philco R.T.C. tube tester with modernizer \$50; used 4v. and 6v. tubes; some 12, 35 and 50v tubes. Want Rider's, 2, 3, 8, 10, 11 and 12 and 8AF7 target tube. A. N. Johnson, 110 Virginia St., Baytown, Texas.

WANTED—Riders manuals 7 to 14. Tony Stragal, 2160 N. Mason Ave., Chicago 39, Ill.

FOR SALE—Complete radio test and repair equipment; tubes; Rider's and 36 radios. Service Electric Co., Redding, Calif.

FOR SALE—Audak high fidelity magnetic pickup for 12" records and 16" transcriptions #1-18, \$35. Carl Hovland, 3502 Gunston Rd., Alexandria, Va.

WANTED—Disc recorder with or without amplifier. Dural turntable speed. James McVey, P. O. Box 65, Brunswick, Ga.

FOR SALE—2 Amerite #RBH Hi-Imp velocity mikes with 12" rubber cable, new mike \$21 and used mike \$18. Leroy Hackmann, 1208 Lee St., Jefferson City, Mo.

FOR SALE—Webster crystal phono pickup; Audak magnetic phono pickup; case for phono motor assembly; amplifier carrying case; Universal motor a-c and d-c 1800 rpm \$15. 1/4 H.P.; phonograph motor a-c and d-c, turntable, and magnetic pickup. M. J. Diffin, 1698 Lexington Ave., New York 29, N. Y.

FOR SALE—Weston #522 d-c milliammeter; d-c voltmeter #503; Asiatic crystal pickup D-9; heavy duty spring wound phonograph motor with turntable and accessories; Victor G. Whitten, Box 397, Eagle Lake, Fla.

WANTED—Voltmeter; receiver and 35Z5, 35L6, 55L6GT tubes. C. Horton, 16 Auburn Place, Athol, Mass.

FOR SALE—6 tube oscilloscope; 6-6v farm radios; coil forms, test prods, etc. Send for list. Super Radio Service Co., 138 Vine St., Plymouth, Pa.

FOR SALE—New RCA #117 sig. gen.; Weston 0-100 milliammeter; 0-7.5, 0-150v d-c voltmeter. Want V-O-M or analyzer. Doyle McCall, P. O. Box 175, Retsil, Wash.

WANTED—Rider's manuals 1 to 14 complete. Feldman's Radio Service, 218 E. Burnside Ave., Bronx 57, N. Y.

FOR SALE OR TRADE—Used RCA #1TY-97B sig. gen., battery operated; \$15 or trade used V-O-M meter in fair condition. Marvin Culvert, 1310 S. 9th St., Lawrenceville, Ill.

WANTED—0-1 d-c milliammeter new or used and #917 photo tube. Erwin Spear, Box 95, New Hampton, N. H.

FOR SALE—Webber #30 tube tester. Leonard Pearlman, Downers Grove, Ill.

WANTED—Superior #1200 pocket laboratory; #1230 sig. gen.; #1240 tube tester; and channel analyzer. Riders 5 and up. Robert Campbell, Manchester, Iowa.

FOR SALE—Clough Brengle audio oscillator #79C; Philco sig. gen. with batteries; R.C.P. electronic multimeter #622; Detect-O-Ray photo electric switch #1-162; Junior Executive 2-way inter-communication call system; Janette rotary converter. Earl H. Stevens, R #1, Bourbonnais, Ill.

WANTED—For stock, tubes of all kinds, easy as well as hard to find. Send list. M. Kingsley, Chestertown, Md.

FOR SALE—Radio shop in Florida—tubes, testing equipment Rider manuals, condensers, vibrators, transformers, etc. 30% off list. R. C. Packard, Radio Hospital, Box 5166, Pensacola, Fla.

FOR TRADE—1LC6, 1LN5, 11A4, 1N5, 1H5, 1A7, and 3Q8. Want foundation meter (3 to 4 1/2" preferred) Charles C. Hall, 4-C-1 Upshur Drive, Wilmington, N. C.

WANTED—Recorder W.T.C. S-18; S-19; S-20. Mike stand, Intercom. Kelly, Box 3, Wilmerding, Pa.

FOR SALE—Philco 1941 home recording kits with cutting heads. A. K. Sutton, Inc., Charlotte 1, N. C.

WANTED FOR CASH—V.T.V.M. Milford Thomas, P. O. Box #31, Canebrake, W. Va.

WILL TRADE—Photo supplies, cameras, equipment for all type radio material equipment. I. V. Jennett, 1205 Grand Ave., Des Moines 8, Iowa.

FOR SALE—Superior channel analyzer with original instructions, new tubes, new leads \$30. P. Calabrese, 725 Elton Ave., Bronx 55, N. Y.

WANTED—Radio City #802 tube and set tester; 12SA7, 12SK7, 12SQ7, 50L6, 35Z5 tubes; power pack for Majestic 90 receiver, Riders 5 to 8. Have for sale Echlin & Echlin 0-10 ma. Thomas J. Ambrose, 211 Farren Ave., New Haven 13, Conn.

WILL TRADE—Complete Sprayberry training course for N.R.I. or National in good condition. L. Jones, 157 Nicholas St., Ottawa, Ont., Canada.

URGENTLY NEEDED—Radio tubes any make, G or GT—1A7, 1N5, 1H5, 1A5, 35Z5, 70L7. Crystal mike, ac-dc pocket multimeter, Toshiba Kusumoto, Anahola, Kauai, T. Hawaii.

FOR SALE OR TRADE—Radio tubes, speakers, books, audio transformer and parts. Want radio tube tester or combination record player. Will repair all make radios. John Cobb, Box 302, Rocky Mount, N. C.

WANTED—New or used 1N5G, 1A5G tubes; midjet trimmer condenser 3-30 mfd., midjet R.F.C. 2.1 M.H. John Neudecker, Moodus, Conn.

FOR SALE OR TRADE—Official Radio Service Manual vol. 7. Harold W. Shumaker, Bourbon, Ind.

WANTED—Hallicrafters S-29 Skytraveler or similar. A/c Moore Reese, Flight 2C-125, Selman Field, La.

FOR SALE—#32 and #34 battery tubes; 200 watt Sunbeam soldering iron; 2 pr. 6" Klein cutting pliers; bench drill press 1/2" capacity-less motor. M. A. Porter, 1713 Larrabee St., Chicago 14, Ill.

WANTED—EC-1 or Skybuddy for shut-in SWL. William Elliott, 822 E. 219th St., New York 67, N. Y.

FOR SALE—5 9002 and 3 HY14 tubes. Also 8 Millen dial lights. Fox Radio Service, 435 S. 5th St., Richmond, Ind.

WANTED FOR CASH—Checker for all latest tubes. Edwin C. Johnson, 3304 Charlotte St., Erie, Pa.

FOR SALE—Turner 33D Dynamic mike with floor stand and 20' cord and plug; Utah G12P 12" PM speaker, 46 oz. magnet; General Industries phono motor, 33 1/3 RPM with 12" turntable; 4A oil damp pick-up head W. E. pick-up arm. W. E. John J. Spankowitch, 239 N. 8th St., Allentown, Pa.

WANTED—Any quantity 70L7, 32L7 117L7, 117Z6 new tubes in sealed cartons. Will pay cash or trade for other tubes. Leading Radio Service, 114 E. Third St., Mt. Vernon, N. Y.

FOR SALE—Record player with low pressure hi-fidelity crystal pick-up and permanent needle, heavy duty electric motor in cabinet, \$29.50. D. Jarden, 7149 Ardleigh St., Philadelphia 19, Pa.

WANTED—50L6, 35L6, 35Z5, 25Z5, 12SA7, 50Y6, 70L6 tubes; comb. table model radio and Rider Manuals, J. Musu, 206 E. 40th St., New York 18, N. Y.

FOR SALE—Majestic Super-B, B-battery eliminator; Atwater Kent #46 receiver. Want checker for octal tubes. John H. Shaffer, R. D. #1, York, Pa.

WANTED—Sig. gen.; V-O-M and tube tester. Cash or will trade radio books, tubes and wrist watch. Arthur Benmour, 515 Riverdale Ave., Brooklyn 7, N. Y.

FOR SALE—#500 Precision tube tester, needs ohm scale, \$65; Bendix Dayrad tube tester perfect; #333 Supreme analyzer with adapters and instructions \$50. 8 tube Freed-Elseman radio, \$45. Want 1.5v, 6v and 12v tubes. Franklin C. J. Slay, 243 West 107th St., New York 25, N. Y.

SEND US YOUR OWN AD TODAY!

For over two years now, the Sprague Trading Post has been helping radio men get the materials they need or dispose of radio materials they do not need. Literally thousands of transactions have been made through this service. Hundreds of servicemen have expressed their sincere appreciation of the help thus rendered.

Send your own ad to us today. Write PLAINLY—hold it to 40 words or less—confine it to radio materials. If acceptable, we'll gladly run it FREE OF CHARGE in the first available issue of one of the five radio magazines wherein the Trading Post appears every month.

HARRY KALKER, Sales Manager.

Dept. RRT-75, SPRAGUE PRODUCTS CO., North Adams, Mass.

(Jobbing Sales Organization for Products of the Sprague Electric Company)



SPRAGUE CONDENSERS KOOLOHM RESISTORS

TM, REGISTERED U. S. PATENT OFFICE

Obviously, Sprague cannot assume any responsibility, or guarantee goods, services, etc., which might be exchanged through the above advertisements



more efficient
... in miniature

The modern high speed grinder can perform many tasks that are impossible with the old fashioned grindstone. Like the miniature electronic tube, it is a striking example of the modern trend of increased efficiency with reduced size.

TUNG-SOL foresees great possibilities in the use of miniature tubes. In most circuits miniatures do a better job than large tubes. Their lower capacity and high mutual conductance and their shorter leads with resulting lower lead inductance make them practically essential for many high-frequency applications.

The added advantages of miniatures are their small size and reduced weight.

The new radio sets and other electronic devices will undoubtedly use a large number of miniatures. When this equipment is on the market, TUNG-SOL Jobbers and Dealers will be in a position to supply miniatures as well as the G-GT's-metal and large glass tubes for serving every type of equipment.



ACTUAL SIZE

TUNG-SOL
vibration-tested
ELECTRONIC TUBES



TUNG-SOL LAMP WORKS INC., NEWARK 4, NEW JERSEY
Also Manufacturers of Miniature Incandescent Lamps, All-Glass Sealed Beam Headlight Lamps and Current Intermittors

RADIO & Television RETAILING • July, 1945

PERFECTION IS OUR ONLY AIM!



REMEMBER AND BUY IN THE 7TH!



Japan knows the magical efficiency of Detrola-built mine detectors and other electronic devices. With the eclipse of the Rising Sun, Detrola will manufacture distinctive radio and television receivers... sturdy record changers... all of unparalleled value.

DETROLA RADIO

DIVISION OF INTERNATIONAL DETROLA CORPORATION
DETROIT 9, MICHIGAN



Eugene Ormandy listens . . .

And Finds New Tonal Quality In Recordings Played By The Meissner

Listen to the majestic beauty of Beethoven . . . to the clear, full tone of each instrument in the hands of a virtuoso . . . to the inspired reading that comes only under the guiding hand of a great conductor . . .

This is a great orchestra . . . Eugene Ormandy himself is directing . . . yet the setting is not a concert hall but a spacious apartment . . . this performance is being reproduced from records!

Listen as each stirring crescendo brings the thrill that comes only from the sheer impact of beautifully blended sound . . . blood-tingling in its excitement . . . this is reproduction of recorded music at its finest . . . this is the voice

of the great new Meissner radio-phonograph.

Eugene Ormandy, the noted conductor of the Philadelphia Orchestra heard these same records played by the Meissner. "I had the feeling I was listening to a concert performance in the historic Academy of Music," he said, "I heard every detail of the Orchestra's performance with perfect clarity."

☆ ☆ ☆

You, too, will find new thrills in recorded music with your postwar Meissner. The Meissner's Automatic Record Changer — playing *both* sides of any record in sequence — will astound you with its mechanical perfection. The Meissner's AM, FM and Super Short-wave radio reception will enable you to hear the world's finest broadcasts.

Today, only one Meissner exists. Perfected before the war, it is now on loan to the high school of Mt. Carmel, Ill., the Meissner's home. When the services of Meissner are no longer required for war production, they will turn again to producing the great new Meissner that will introduce you to this new world of sound.

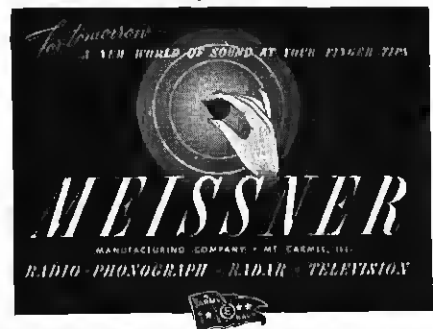

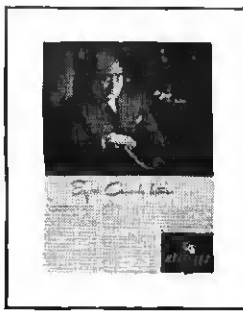

Your Community will point with pride to its Meissner Dealer

Why? Because the man who will be the Meissner dealer in your community has already established a reputation for quality and service with a clientele that appreciates the finest in any product. He has the facilities, the ability and the financial strength required to add an instrument such as the Meissner electronic radio-phonograph to his present line. He knows that the many people in his community who have responded to advertising like that shown here will naturally look to him for their postwar Meissner.

☆ ☆ ☆

You may be the Meissner dealer in your community. In many areas, Meissner exclusive dealer franchises are still available. The men who obtain these franchises will find new profits and prestige during the postwar period, and an *immediate* group of prospects who have been attracted to the Meissner by an extensive national advertising campaign.

If you meet the requirements outlined above, write to our Chicago office—936-B North Michigan Avenue, Chicago, Ill. today. An executive of our company will contact you at the earliest possible opportunity.

MEISSNER
MANUFACTURING COMPANY • MT. CARMEL, ILL.

Please address your inquiries
to Chicago Office:

936-B NORTH MICHIGAN AVENUE
CHICAGO, ILLINOIS

F. L. Marshall Appointed

The appointment of Frank L. Marshall to the sales staff of Aerovox Corp., New Bedford, Mass., is announced. Former assistant sales manager of Bundy Tubing Company of Detroit, he now assumes his new duties as assistant sales manager, in the handling of sales to equipment manufacturers.

Sprague "E" Award

The Sprague Electric Co. has been awarded a fourth star for its Army-Navy "E" pennant. Including the original flag award, this makes 5 separate citations for distinguished service in meeting war requirements, each award covering all of the spacious Sprague North Adams, Mass. plants.

Jobber Appointments

STEWART-WARNER RADIOS, Chicago, Ill., has named the following distributors: • Bright Distributing Co., Knoxville, Tenn. • Kile-Jacobs & Co., Wilkes-Barre, Pa. • Philadelphia Distributors, Philadelphia, Pa.

HOFFMAN RADIO CORP., Los Angeles, Cal., has appointed two new distributors. Radio Products Sales Co., Denver, Col. • Radio Supply Co., Salt Lake City, Utah.

WATERS CONLEY CO., Rochester, N. Y., announces the following firms who have been named as distributors of the Phonola line of phonographs: • Ray Thomas, Los Angeles, Cal. • H. R. Basford, San Francisco, Cal. • Sunset Electric Co., Seattle, Wash. • Sunset Electric Co., Portland, Ore. • Flint Distributing Co., Salt Lake City, Utah.

STROMBERG-CARLSON CO., Rochester, N. Y., Clifford J. Hunt, manager of radio sales, announces that the Padgett Distributing Co., Dallas, Texas, has been appointed distributor for the company's postwar radio, FM and television line.

STEWART-WARNER RADIOS, Chicago, Ill., has named the Northrup Supply Corp., Binghamton, N. Y., as an additional distributor for its postwar line of radios.

HAMILTON RADIO CORP., New York, N. Y., has announced additional franchised distributors for Olympic Radio & Television: • Lee's, Baltimore, Md. • Graybar Electric Co., Inc., Cincinnati, Ohio • Butler Bros., Chicago and Minneapolis • Economy Electric Supply Co., Atlanta, Ga. • Stewart Distributing Co., western Ky. and southern Ind. • Jenkins Jewelry Co., Inc., Jacksonville, Fla. • American Mattress Co., New Orleans, La. • Cate-McLaurin Co., Columbia, S. C. • Supplee-Biddle Co., Philadelphia, Pa. • Burhans & Black, Inc., Syracuse, N. Y. • W. A. Case & Son, Inc., Erie, Pa. • Toledo Merchandise Co., Toledo, Ohio • Harris & Pierce, Omaha, Neb. • Cardinal Distributors, Inc., St. Louis, Mo. • Delaney Specialty Co., Mobile, Ala. • Riskey-Lelte Co., New Haven, Conn. • Alfred Stidham Tire Co., Washington, D. C. • Wehle Electric Co., Binghamton, N. Y. • Litscher's Wholesale Electric Co., Grand Rapids, Mich. • Rhode Island Distributing Co., Pawtucket, R. I.

BENDIX RADIO DIVISION, of the Bendix Aviation Corp., Baltimore, Md., Leonard C. Truesdell, general sales manager for home radio, announces the appointment of the D'Elia Electric Co.,

Bridgeport, Conn., as distributor for the forthcoming line of Bendix AM and FM radios and radio-phonograph combinations.

LEAR, INC., Home Radio Division, Chicago, Ill., Nate Hast, merchandise manager, has named the following as distributors for the Lear home radio line: • E. B. Latham & Co., New York City • Wood Distributing Co., Eldorado and Little Rock, Ark. • Approved Appliance Co., Indianapolis, Ind.

JOHN MECK INDUSTRIES, INC., Plymouth, Ind., has announced additional jobbers to handle distribution of Meck radios and phonographs: • Arvedon Electric Supply Co., Inc., Boston, Mass. • Pittsfield Radio Co., Pittsfield, Mass. • Springfield Radio Co., Springfield, Mass. • Radio Electronic Sales Co., Worcester, Mass. • Wedemeyer Electronic Supply, Ann Arbor, Mich. • Radio Electronic Supply Co., Detroit, Mich. • Radio Electronic Supply Co., Grand Rapids, Mich. • Ralph M. Ralston Co., Kalamazoo, Mich. • Industrial Electric Supply Co., Muskegon, Mich. • Kinde Distributing Co., Sebawaing, Mich. • Sterling Electric Co., Minneapolis, Minn. • Radiolab, Kansas City, Mo. • Harry Reed Radio & Supply Co., Springfield, Mo. • Tom Brown Radio Co., St. Louis, Mo. • The Radio Equipment Co., Albuquerque, N. M. • Aaron Lippman & Co., Newark, N. J. • Chanrose Radio Stores, Jamaica, N. Y. • Masline Radio & Electronic Equip., Rochester, N. Y. • Southeastern Radio Supply Co., Raleigh, N. C. • Burroughs Radio Co., Canton, Ohio • United Radio, Inc., Cincinnati, Ohio • Goldhamer, Inc., Cleveland, Ohio • Hughes-Peters, Inc., Columbus, Ohio • Joseph B. Smith Co., Toledo, Ohio • Radio Supply, Inc., Oklahoma City, Okla. • R & S Distributors, Tulsa, Okla. • Bargelt Supply, Portland, Ore. • Radio Elec. Service Co. of Penn., Philadelphia, Pa. • Dixie Radio Supply Co., Columbia, S. C. • Curle Radio Supply, Chattanooga, Tenn. • Chemeity Radio & Electric Co., Knoxville, Tenn. • Frost Electric Co., Nashville, Tenn. • Amarillo Electric Co., Amarillo, Texas • All-State Distributing Co., Dallas, Texas • United Appliance, Fort Worth, Texas • R. C. & L. F. Hall, Houston, Texas • S. R. Ross, Salt Lake City, Utah • Snyder & Snyder, Norfolk, Va. • Seattle Radio Co., Seattle, Wash. • Roy R. White, Spokane, Wash. • Sigmon Radio Supply, Charleston, W. Va. • Randle & Hornbrook, Parkersburg, W. Va. • Appleton Radio Supply, Appleton, Wis. • Reed & Co., Milwaukee, Wis.

Wallraff's

(Continued from page 37)

chandising help. Among the many brands which this establishment has sold are Crosley, GE, Frigidaire, RCA Kelvinator, Bendix, etc.

Also of importance to the store is the current display of available appliances in the establishment's windows. As the firm is located on an important highway, many passing motorists make inquiries about these goods.

While Wallraff placed a great deal of effort behind appliance merchandising, he also concentrated on radio sales. Due to a rapid turnover on receivers, profits in set sales mounted steadily in volume. During a busy four-month period before the scarcity of radios set in, this dealer estimates that his gross volume in receivers amounted to between \$30,000 and \$40,000.

Two Selling Methods

In the future, Wallraff intends to employ a different technique in selling radios than the one which he will use in appliances. He feels that the same customer-approach and sales methods cannot be used to sell both types of goods. Therefore, he will modify his merchandising methods in accordance with the nature of the commodity sold, and the habits of the purchaser.

Included in the firm's plans for modernization is the construction of separate display rooms for demonstrating and selling AM, FM, and television receivers.

Wallraff is convinced on the value of newspaper advertising. He declares that his store has been advertised consistently for almost twenty years in daily newspapers. To supplement this promotion, the establishment has also successfully employed radio broadcasting, and the distribution of throwaways from house to house.

Utility Credit Terms

A threat to independent radio and appliance retailing, as this dealer sees it, is the establishment of long term finance arrangements which may be offered to consumers by some utility companies. This proprietor asserts he voices the opinions of innumerable retailers when he maintains that utilities which sell appliances at prices below the profit level, and on extended payments which run for five years or more, are harmful to business.

Wallraff hopes that the utilities will abandon these practices, and adhere to fair and ethical merchandising principles instead.



Backed
by the real
"KNOW-HOW"

- As rapidly as conditions permit and without detracting from its all-out war effort, Aerovox is making available those long-missed metal-can electrolytics and other heavy-duty types.

More than that, Aerovox is compiling and releasing the real "know-how" on capacitors and their latest applications to radio-electronic functions, in the form of the monthly AEROVOX RESEARCH WORKER. This combination—the right capacitor plus the right data—spells more jobs, greater opportunities and more attractive profits for you.

● SEE OUR JOBBER ...

Ask him to help you select the most suitable Aerovox capacitor types now available for your work. Ask for latest catalog and the Aerovox Research Worker. Or write us direct.

Yours for the asking!

Because of your professional standing in the radio-electronic field, you are entitled to a FREE subscription to the monthly AEROVOX RESEARCH WORKER. Each issue is chockful of practical data. Ask your Aerovox jobber for your FREE subscription.



Capacitors

INDIVIDUALLY TESTED

AEROVOX CORPORATION, NEW BEDFORD, MASS., U. S. A. • SALES OFFICES IN ALL PRINCIPAL CITIES

Export: 13 E. 40 ST., NEW YORK 16, N. Y. • Cable: 'ARLAB' • In Canada: AEROVOX CANADA LTD., HAMILTON, ONT.

tru·base

REG. U. S. PAT. OFF.



restores
the
"lost"
bass
tones

area of
acoustic loss

"Big Set" Tone in "Compact" Sets

In Olympic's "tru-base" system, new electronic principles replace, within the electrical circuit, the rich bass tones — heretofore "lost" in all but large, costly consoles.

By restoring true resonance to the bass register, "tru-base" releases "ear-balanced" realism throughout the entire tonal scale. "Tru-base" will be available in modestly-priced, brilliantly styled Olympic table sets and radio-phonograph combinations. Register your interest by writing to: Olympic Radio & Television, 510 Sixth Ave., New York 11, N. Y.

and only **Olympic** has tru·base



DIVISION OF HAMILTON RADIO CORPORATION

RADIO & Television RETAILING • July, 1945

Estate Stove Holds Postwar Sales Course

The Estate Stove Co., Hamilton, Ohio, held a three-day refresher sales course for district sales managers who have returned to the company after a leave of absence of several years. The five men who will form the nucleus of the postwar Estate sales force are Frederic A. Deininger, district sales manager, central Atlantic division; Walter S. Rowe, merchandising manager; Cecil M. Dunn, assistant sales manager; J. Noble Edmonson, district sales manager, southern division; S. C. Bernhardt, vice-president in charge of sales; John W. Holzman, district sales manager, central division; D. P. Eggenberger, district sales manager, north Atlantic division; L. W. Brate, district sales manager, western division; R. C. Thomas, manager, Estate Distributing Co., Cincinnati.

Back to Hallierafters!

Tech. Sgt. Walter R. Paskon, Chicago, wounded veteran of the air battles over Germany, regards the job of supplying the Pacific battlefronts with short-wave radio equipment as such a vital one that he has given up the leisure of a well-earned 60-day furlough to take his place on the assembly line at the Hallierafters Co. plant, Chicago.

An employee of the company before entering service, Sgt. Paskon chose to take his place with his "buddies on the production front" rather than spend his furlough doing, as he said, "nothing."

Admiral Officials Confer



Planning Admiral's merchandising program are, left to right, R. A. Graver, vice-president, radio division; W. C. Johnson, manager of field activities; L. H. D. Baker, appliances division, and Seymour Mintz, advertising manager.

New Meissner Official

Godfrey Wetterlow has been named eastern sales manager of the radio-phonograph division of the Meissner Mfg. Co., Mt. Carmel and Chicago, Ill., it was announced by Oden F. Jester, vice-president. Mr. Wetterlow was formerly assistant to the president of Philharmonic Radio Corp., New York.

Nate Hast Announces Added Lear Reps

Nate Hast, merchandise manager of Lear, Inc., announced a number of new appointments to the list of factory representatives who will represent Lear home radios and wire recorder in various territories. The following have been added to Mr. Hast's organization:

Ernie Camos, for St. Louis territory; Frank Russell for Baltimore, Washington and Philadelphia territory; William R. Connors for Denver, to cover the Rocky Mountain district; and Allen Dunlap, for the state of Ohio.

Mr. Hast's sales organization is practically complete, with the exception of a few distributing territories in which final commitments have not been made. The consumer advertising campaign, in leading magazines, is already under way, and distributors have received plans for the direct promotional work which Lear will carry on as an aid to its distributors and retailers.

Philco to Resume Refrigerator Production

Philco Corp. will resume production of household refrigerators in the quarter beginning July 1st in accordance with the WPB program for the industry, it is announced by John Ballantyne, president.

"Arrangements have been completed to increase Philco production of radio receiving sets and refrigerators very considerably above pre-war levels as soon as government regulations permit," Mr. Ballantyne said.

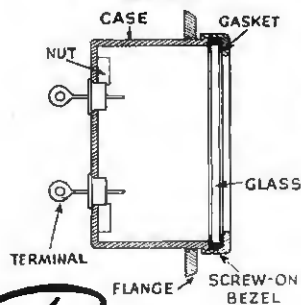

Introducing the
NEW TRIPLETT LINE
of
HERMETICALLY SEALED INSTRUMENTS

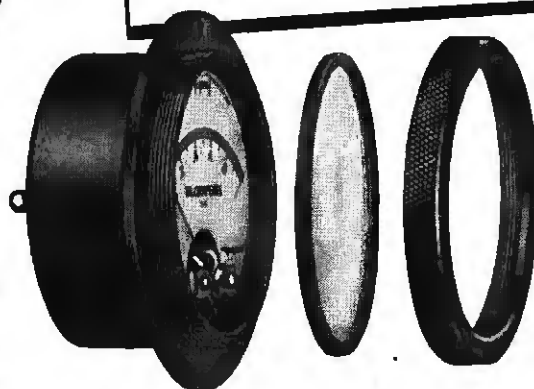

All the features of standard instruments retained. Withstand submersion tests at 30 feet. Comply with thermal shock, pressure and vibration tests. Resistant to corrosion. Conform to S. C. No. 71-3159 and A.W. S. C-39.2-1944 specifications. 1½", 2½" and 3½" metal cases with 1/16" thick walls, in standard ranges. D.C. moving coil, A.C. moving iron and thermocouple types. Write for circular.

*Precision first
...to last*

Triplett

ELECTRICAL INSTRUMENT CO. BLUFFTON, OHIO

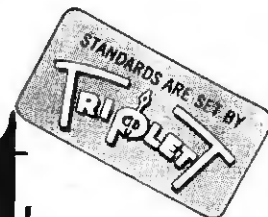

heard about this coming new FARM TYPE RADIO BATTERY?

SAME SERVICE LIFE

**30% SMALLER
30% LIGHTER**

OLD

NEW



No. 748 1½-volt "A," 90-volt "B" A-B Pack.
Dimensions, 15 13/16" x 6 15/16" x 4 15/32"
Weight, 23 lbs., 11 oz.



No. 758 1½-volt "A," 90-volt "B" A-B Pack.
Dimensions, 10 11/16" x 6 13/16" x 4 1/8".
Weight, 16 lbs., 13 oz.

IT WILL be much more than just a "smaller" battery! For the first time, an "Eveready" "Mini-Max" B battery will become part of a farm-type radio A-B Pack. As a result, you're going to see a 30% smaller, 30% lighter "Eveready" "Mini-Max" farm type battery pack with the same service life as the conventional pre-war packs, such as our own "Eveready" No. 748 A-B Pack.

Think what this means! Smaller, less expensive radios . . . more easily carried from room to room . . . can be built around it. Or farm radios of present-day size with larger, better speakers using space formerly taken up by bigger batteries having no greater service life.

These and other advantages will mean more profits in both radio and battery-pack sales for you!

The name of the battery is "Eveready" No. 758 A-B Pack. It will take its place on a growing list of startling

postwar "Eveready" batteries . . . based on National Carbon's exclusive principles of battery construction as used in the "Mini-Max" battery.

"EVEREADY"

TRADE-MARKS

MINI-MAX

RADIO "B" BATTERIES

NATIONAL CARBON COMPANY, INC.

Unit of Union Carbide and Carbon Corporation



General Offices: NEW YORK, N. Y.

The trade-marks "Eveready" and "Mini-Max" distinguish products of National Carbon Company, Inc.



Bendix Radio

LOOMING LARGER EVERY DAY AS . . .

*... "THE FRANCHISE
WITH A FUTURE!"*



BUILD BEST WITH BENDIX . . . FOR

RADIO & Television RETAILING • July, 1945



GREAT — IN EVERYTHING IT TAKES FOR YOUR SUCCESS

NAME . . .

For 27 years the fine products of Bendix Aviation Corporation have created a name known to millions of homes in America . . . the greatest name in aircraft radio . . . *famous among millions of civilians and servicemen.*

STAYING POWER

Bendix is big in resources—a vast organization of widely diversified interests . . . superbly equipped in every way to weather any economic changes the future may bring. *When you build with Bendix you build for keeps.*

MANUFACTURING
CAPACITY

As a leading producer of wartime radio, Bendix has the facilities, the experience and the *will* to build precision products on a volume basis. You can expect the best from Bendix at the right prices in the right quantities.

MERCHANDISING
"KNOW-HOW"

Bendix is now embarked on one of the largest advertising and promotion programs in the industry. The Bendix merchandising program is aggressive yet sound, providing a franchise that will be increasingly profitable and valuable.

AND PRODUCT

Bendix will build a complete line—outstanding in quality, appearance and performance. You'll do best with Bendix because Bendix is best with all that it takes to help you get your full share of the postwar market. *Write for full information on The Franchise With a Future.*

Bendix Radio Division • Baltimore 4, Maryland

PRODUCT OF

Bendix

AVIATION CORPORATION

PRESTIGE . . . PROFITS . . . PERMANENCE!

Westinghouse Confident of Meeting Consumer Demands

A moderate increase in cutbacks of war contracts at the Westinghouse Electric Corp. already reflects in part the tapering off of military requirements, A. W. Robertson, chairman, disclosed. He expressed confidence, however, that "there will be a steady increase in the production of large electric power equipment for civilian use as well as necessary household appliances, to fill partially the employment gap created by the end of the war in Europe."

Plans for reconverting the company's appliance manufacturing plants to civilian goods production have been completed, and Mr. Robertson estimated that production of refrigerators—the first large appliance

item expected to be produced—could get under way within four to five months after government authorization is received. He indicated that manufacture of electric irons would begin first since they would require the least delay and shortest re-training program.

Also within two to three months after authorization, the firm estimates, some models of radio receivers will be leaving the production lines of the company's newly formed home radio division, Sunbury, Pa.

Mr. Robertson said he thought production of consumer goods would be authorized quickly by the government, but he anticipates that certain critical materials will be a bottleneck. He cited the still heavy war demand for steel, tin, rubber, lumber and paper.

New Dealer Association

Radio & Electronic Dealers & Servicemen's Assn., is the title of a new group formed to operate in the New York metropolitan area. Some of the purposes of the association are to promote substantial business, improve selling and servicing techniques, foster cooperation, raise the standards of the industry, and to carry on a public relations program designed to acquaint the public with the aims and objectives of the members. Names of the directors pro-tem, are: Ben Soskel, Irving P. Horowitz, Percy Dolson, Zackary Krates and Bernard Fried.

The group will hold a mass rally on the evening of July 25, at Temple Auditorium, 251 Rochester Ave., Brooklyn, at 8:15.

ESTATE HEATROLA POSTWAR PROFIT TIP: *Don't be Fuel-ish...*

BE BEST MAN TO ALL FOUR!

I do promise to buy you a wonderful new **ELECTRIC** range



But remember... it has to be a modern **GAS** range, dear



...but not unless he promises to buy me a new **OIL** heater



...and we'll have a thrifty new **COAL** heater for our little nest



I'll be the **best man** for all of 'em to see... I'll have Estate Heatrola appliances for **ALL** fuels



Don't lose sales because of fuelish arguments
LINE UP WITH THE "FUEL-PROOF" LINE*

ESTATE
Heatrola
RANGES & HEATERS

RANGES FOR CITY GAS, LP-GAS, ELECTRICITY
SPACE HEATERS FOR COAL, WOOD, OIL

*Estate Heatrola is the ONE line of cooking and heating appliances for ALL fuels... all sold under one famous, nationally-advertised trade name. (Want the name of your Estate Heatrola distributor? Write us.)

THE ESTATE STOVE COMPANY, HAMILTON, OHIO • Established 1842

Crosley Preparing for Added Postwar Volume

That the Crosley Corp., Cincinnati, Ohio, has its house in order and is ready to reconvert part of its manufacturing operations to the production of civilian goods just as rapidly as government regulations will permit and as materials are available was stated by R. C. Cosgrove, vice-president and general manager.

Cosgrove disclosed that all of the firm's plants in Cincinnati will be devoted to radio receiver production, while the manufacture of Crosley Shelvador refrigerators will be concentrated at the company's plant in Richmond, Ind.

"We hope to achieve a volume of about \$50,000,000 a year," he pointed out. In 1941, the company's best recent pre-war year, annual sales amounted to about \$27,000,000. In 1944, the company produced war goods with a dollar value of more than \$98,000,000.

"We will be able to produce 1,300,000 radio sets a year very easily, and we will make a lot of the larger sets, too," Cosgrove said.

Heads Eberhard Division



Andrew C. Kienly, who has been named to manage the re-established appliance, housewares and hardware specialties division of the Geo. H. Eberhard Co., West Coast wholesalers.

HOWARD *Radios*

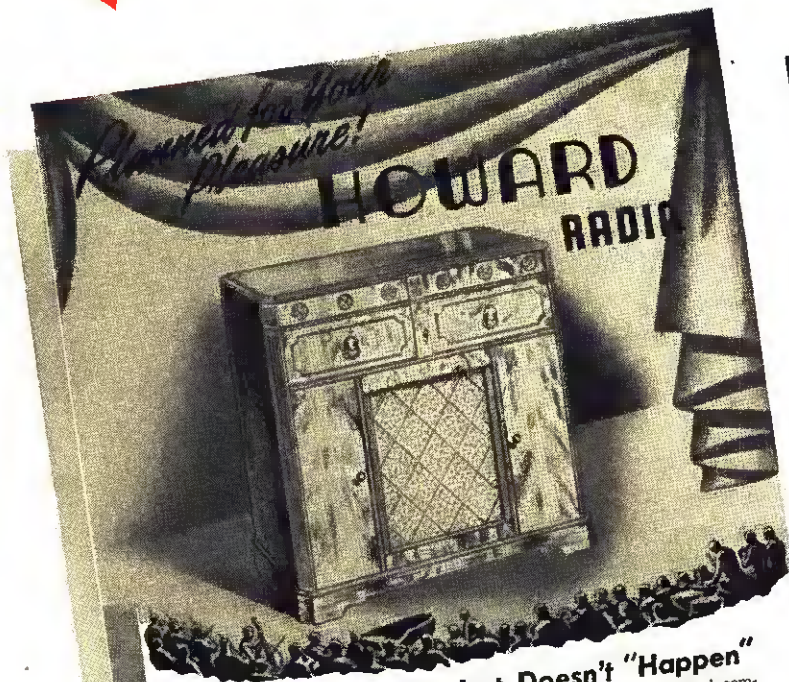

**PRE-SOLD
WITH
POWERFUL
ADVERTISING
IN NATIONAL
MAGAZINES!**

Quality in a Radio Just Doesn't "Happen"

• You'll thrill to the beautiful new Howard FM-AM Radios with *Acousticolor*—the exclusive electronic development that makes it possible to recreate the tonal balance and brilliance of fine music right in your own home. The enjoyment you will receive from your new Howard will reflect the experiences of over a quarter century in build-

ing quality radios and phonograph combinations, and in addition, the practical knowledge gained from producing thousands of Frequency Modulation receivers before the war. Howard is a pioneer in FM. If you want exquisite cabinetry, superb reception and genuine value—make a date to see and hear the new Howards just as soon as they become available.

HOWARD RADIO COMPANY
1731-35 BELMONT AVENUE
CHICAGO 13, ILLINOIS

Buy **WAR BONDS**

America's Oldest Radio Manufacturer

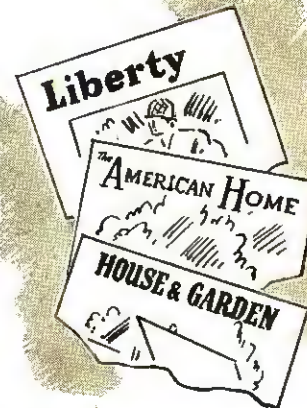

Howard is carrying on a consistent large scale consumer advertising campaign. Advertisements contracted for in other magazines will appear when publishers' paper supplies permit.

Millions Will Hear About the New Howards with **ACOUSTICOLOR** Tone

This nationally advertised Howard development that makes it possible to recreate the tonal balance and brilliance of fine music right in the listener's own home will be a powerful sales factor in helping you sell Howard Radios. Beautiful cabinets, superb FM, and dozens of other outstanding features will contribute their share in creating steady consumer demand. Line up with Howard now for a larger share of radio sales.

HOWARD RADIO COMPANY
1731-35 BELMONT AVENUE • CHICAGO 13, ILLINOIS

America's Oldest Radio Manufacturer

ASK YOURSELF



"Why Should I Be Satisfied With Less Than *Everything*"?

Ask yourself this one, too. . . . "Why should I lose out on profitable business because I cannot meet every inter-communication requirement?"

No reason why you *should* be satisfied . . . why you *should* miss fire on sales. Because Talk-A-Phone, the World's Most Advanced and Complete line of Inter-communication "Has Everything" specialized engineering skill can provide in convenience, flexibility, efficiency and carefree operation. And there's a unit for every need . . . no matter how simple or complex. Easy to install. Extensively advertised. Good deliveries now. See your jobber for complete details. Don't be satisfied with *less* than "Everything"!

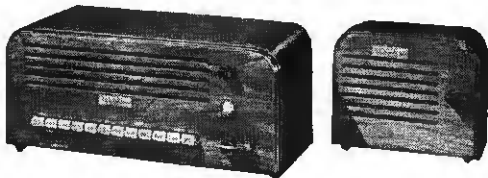

Talk-A-Phone Mfg. Co.

1512 So. Pulaski Rd. Chicago 23, Ill.

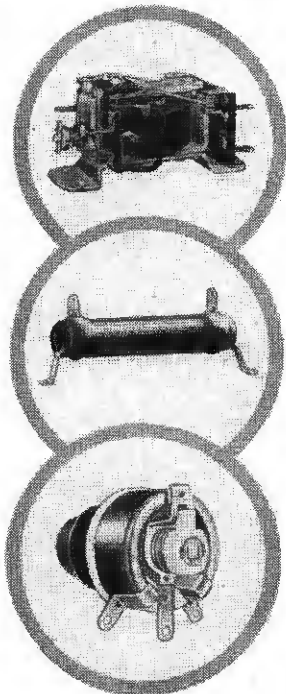

for design
for repair
for maintenance

Use Ward Leonard Vitrohm Wire-Wound Resistors and Rheostats—made to conform to the most rigid specifications for use in any application—in transmitters and industrial equipment. Relays, too, are built to the same exacting standard that marks all Ward Leonard products. Write us for our new catalog now being compiled. A copy will be sent you as soon as it is off the press.

WARD LEONARD ELECTRIC CO.

Radio and Electronic Distributor Division
53 WEST JACKSON BLVD., CHICAGO, ILL.



WARD LEONARD
ACCEPTED MEASURE OF QUALITY

**RESISTORS
RHEOSTATS
RELAYS**

Bright Sales Future Promised Retailers

Speaking on "Television and Some of Its Economic Aspects," Dr. Lee de Forest told 200 members of San Diego's Bureau of Radio and Electrical Appliances that, "the most suitable subjects for 'live' telecasts will be concerts, commentators, educational talks and home-economics demonstrations." He also predicted that with television advertisers will have the most potent sales weapon they have ever used.

On the same program was San Diego Gas & Electric Company's sales vice-pres-



L. to R.: J. Clark Chamberlain, Dr. Lee de Forest, and Wm. Powell.

ident, A. E. Holloway, who told the assembled radio and appliance dealers that tremendous opportunity lay ahead for them in a rapidly expanding rural market where dealers would find a rich market for electric pumps, water systems, wiring, storage cabinets, home and farm freeze units, brooders, and lighting equipment, as well as many electrical household appliances.

Steve Maher, manager appliance distributing branch, General Electric Co., urged the dealers to check their store locations for floor traffic, remodel their store fronts in order to create the most attractive displays possible, and take advantage of tremendous national advertising by carrying the manufacturer's identity on their store fronts. Included on the packed afternoon and evening program was a "manufacturer-distributor bull session."

William A. Powell, Bureau president, opened the meeting, and Clark Chamberlain, Bureau secretary-manager presided.

Ken-Rad Resumes Identity

After an absence of some time, Ken-Rad of Owensboro, Ky., manufacturer of metal self-shielding radio receiver tubes, is resuming its national trade advertising on a large scale. Officials announce that Ken-Rad intends to maintain its rank as a leader in the manufacture of home radio tubes.

As previously reported, the radio-tube division of the old Ken-Rad company was purchased by the General Electric Co., and the Ken-Rad incandescent-lamp division was recently bought by the Westinghouse interests.

Ask Set Pricing by OPA

The RMA, in a telegram to Chester A. Bowles, has urged the OPA to formulate an acceptable pricing policy on household radio sets and equipment.

Dealers Will Serve On NAMM Committee

E. R. McDuff, president of the National Association of Music Merchants, has appointed a committee on national policy to consider several important questions submitted to member organizations by the Chamber of Commerce of the U. S. Thirty-six questions of national policy will be reviewed by the committee and their recommendations considered by the Board of Control when it meets in Chicago early in July.

Those invited to serve as members of the committee are: S. H. Almanrode, J. & S. Music Co., Inc., Shreveport, La.; A. P. Avery, Avery's Piano Store, Providence, R I.; Neil M. Bischoff, St. Louis Band Instrument Co., St. Louis, Mo.; Isaac Bledsoe, San Antonio Music Co., San Antonio, Texas; Ted Brown, Brown Music Co., Tacoma, Wash.; J. A. Gregory, Cumberland Valley Music Co., Harlan, Ky.; Charles H. Jackson, Cable Piano Company, Minneapolis, Minn.; M. B. Leichter, Loomis Temple of Music, New Haven, Conn.; Louis V. Lennon, Paine Furniture Co., Boston, Mass.; Luke H. Moore, N. Stetson Co., Philadelphia, Pa.; Benjamin E. Neal, Neal-Clark-Neal, Buffalo, New York; Marshall S. Philpitt, S. Ernest Philpitt & Son, Miami, Fla.; William H. Richardson, Birkel-Richardson Co., Los Angeles, Cal.; J. M. Riddick, Baldwin Piano Salesrooms, Indianapolis, Ind.; M. D. Ritchey, Ritchey's Music Shop, Huron, S. D.; W. W. Smith, Smith's Music Store, Jackson, Miss.; James A. Terry, Terry's Music Store, LaCrosse, Wis.; John D. Vance, Vance Music Co., Mason City, Iowa; Edward J. Walt, Edw. J. Walt & Son, Lincoln, Neb.; Hugo Worch, Jr., Hugo Worch, Washington, D. C.

Charles W. Rexford



Appointed central division sales manager of the Apex Rotarex Corp., it was announced by A. C. Scott, vice-president in charge of sales.



This is a new three-story addition to our Hickok Plant No. 1. It is designed with glass block and equipped with the latest fluorescent lighting equipment, as well as being dustproof and air-conditioned.

It is the home of Dynamic Mutual Conductance tube testers, radio service equipment and electrical indicating instruments. The Hickok line embraces many new innovations, including internal pivot meters, waterproof meters, electrical battery testers and many others.

We regret that the pressure of war production makes it impossible to take care of all your demands now; but when peace returns you can again have your first choice in instruments known for higher accuracy and longer life.

THE HICKOK ELECTRICAL INSTRUMENT Company

10523 Dupont Ave. Cleveland 8, O.

New GE Appointments

A. L. Scaife has been appointed advertising and sales promotion manager of the General Electric Co.'s appliance and merchandise department, it was announced today by C. R. Pritchard, general sales manager. Scaife, who succeeds B. W. Bullock, who has resigned, will also continue to serve as merchandising manager for the department. In his new capacity, he will be in charge of all advertising, sales promotion and merchandising plans connected with the sale of GE major appliances, traffic appliances and construction material. He will be responsible to Mr. Pritchard.

Assistant manager of the division will be George B. Park. E. F. Vickery will be operating manager.

"Ultratone" Phonographs

Audio Industries of Michigan City, Ind., will concentrate its entire production facilities in the manufacture of phonograph record players according to an announcement by Paul W. Dolembro, president of the company. Audio Industries, a new name for an old company, manufactured hearing aids and audio amplifiers in addition to phonographs for many years under the name of the Hearing Aid Laboratories.

The Ultratone phonograph line will include models for every requirement, non-automatic and automatic record changer models; portables, table models, battery amplified, spring driven models and wireless record players.

Frank Folsom Elected to New RCA Position

Frank M. Folsom, who has been vice-president in charge of RCA Victor division since January, 1944, was elected executive vice-president in charge of RCA

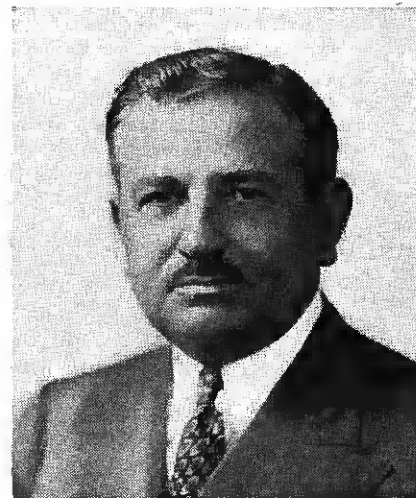

Frank M. Folsom

Victor division, it was announced by Brig. Gen. David Sarnoff, president of RCA. At the same time, John G. Wilson was elected operating vice-president of RCA Victor division.

Mr. Folsom joined the company after serving in Washington as chief of the procurement branch of the Navy Department.

Mr. Wilson has been in charge of financial administration at the RCA Victor division for the last year.

Admiral Refrigerators in 90-120 Days of WPB "Go"

Not more than 90-120 days after July 1 will be required by Admiral Corp., Chicago, to begin turning out postwar electric refrigerators. This was the time figure given by L. H. D. Baker, vice-president in charge of Admiral's appliance division. Baker is confident that the firm will begin delivery of new units by late October, and possibly earlier, under the WPB's July "go" signal for the refrigerator industry. He said that the company already has applied to the WPB for its manufacturing priority and its third and fourth period quotas.

"Our plans have been in the making for some time and are pretty well laid," Baker declared. "We definitely will start with a postwar, not a pre-war model, one that will remain an integral part of our peacetime line. As far as re-tooling and the installation of new machinery are concerned, we believe we could start immediately without impeding the plant's present output of war materials. All re-conversion steps will have the full approval of WPB."

Admiral has capacity to make 300,000 refrigerators in its first full peacetime year, according to Baker. It will make a standard model, a new type deluxe conventional and the "Dual-Temp."



You WON'T MISS
POST-WAR "SOUND" Opportunities
When You
Feature the BELL LINE



a new approach to
long-profit, high volume
Sound Equipment Sales!

BELL REPRESENTATIVES

- ATLANTA, GA., Henry W. & Abby N. Burwell, 105 Forrest Ave. N. E.
- BOSTON 9, MASS., H. A. Chamberlin, 31 Milk St.
- CHICAGO, ILL., Paul H. Miles, 333 N. Michigan Ave.
- CLEVELAND, OHIO, John O. Olsen, 1456 Waterbury Pl., Lakewood
- DETROIT 26, MICH., J. P. Davenport, 604 Kerr Bldg.
- FORT WAYNE 3, IND., B. L. MacPherson, 1724 Alabama Ave.
- GREELEY, COLO., Gordon G. Moss, Post Office Box 428
- HOUSTON, TEXAS, G. G. Willison, Tex-O-La Sales Co., West Bldg.
- KANSAS CITY 6, MO., Maury E. Bettis & Co., Rm. 400, B.M.A. Bldg.
- LOS ANGELES, CALIF., Harry A. Lasure, 2216 W. 11th St.
- MEMPHIS, TENN., J. M. Cartwright, 1276 Peabody Ave.
- MINNEAPOLIS, MINN., M. E. Foster, Andrews Hotel
- NEW YORK, N. Y., Wesley Scharp, 67 W. 44th St.
- PHILADELPHIA, PA., J. E. McKinley, 628 Terminal Bldg., 401 N. Broad St.
- PORTLAND 1, OREGON, Dale G. Weber, 7026 S. W. Capital Hgy.
- SAN FRANCISCO 3, CALIF., Hodges and Glomb, 1264 Folsom St.
- TORONTO ONT., CANADA, Howard N. Reid, L. D. Cahoon and Co. Ltd., 2271 Danforth Ave.



You won't need to rope your prospects when you sell BELL! You won't need to spend day and night in the saddle hunting for prospects either, for every business, large and small, is a prospect for BELL Sound Equipment. At the right you will find a list of BELL representatives. They are prepared to give you complete information on the BELL line. Contact your Bell Representative today and prepare for the post-war BELL boom. You'll find there are greater profits for you in BELL Sound Systems.

Here are a few of the BELL products . . . BELfone intercom systems . . . Industrial Voice-Paging and Broadcasting Equipment . . . Permanent and Portable Amplifying Systems . . . Recording and Disc-Playing Units . . . Electronic Controls . . . Operating Sequence Recorders . . . Other Special Electronic Devices.

BELL SOUND SYSTEMS, INC.

1186 ESSEX AVE. COLUMBUS 3, OHIO
EXPORT OFFICE: 4900 EUCLID AVE., CLEVELAND 3, O.

Pioneer FM Makers Urge No. 1 Plan

Representatives of 11 pioneer manufacturers of FM receivers and transmitters attended a conference at New York's hotel Waldorf-Astoria in June, at which Arthur Freed, general manager of Freed Radio, was elected chairman, and voted to pass a resolution to the Federal Communications Commission protesting the FCC's delay in determining the final FM channel allocations.

Citing that further postponement on the part of the FCC in allocating these FM channels represents a serious threat to the postwar future of the entire radio industry, creating, as it will, widespread unemployment, and thereby adding to the general confusion which already exists for the reconversion period now facing radio manufacturers, broadcasters, wholesalers and retailers, the resolution urged that an immediate decision be made by the commission authorizing its No. 1 Alternative Allocation. Copies of the resolution were forwarded to: Broadcasters, Inc., Radio Manufacturers Assn. and the War Production Board.

In attendance at the conference were:

Arthur C. Ansley, Ansley Radio Corp.; Harold Shevers, Espey Mfg. Co., Inc.; Arthur Freed, Freed Radio Corp.; B. S. Trott and Maurice Raphael, Garod Radio Corp.; W. R. David, General Electric Co.; Godfrey Wetherlow, Meissner Mfg. Co.; L. C. Shapiro, Pilot Radio Corp.; Frank A. Gunther, Radio Engineering Labs., Inc.; Marvin Hobbs and J. O. Ashton, Scott Radio Labs., Inc.; W. F. Cotter, Stromberg-Carlson Co.; and H. J. Wines, Zenith Radio Corp.

Proctor's New Managers

Robert M. Oliver, vice-president in charge of sales for Proctor Electric Co., Philadelphia, announces the appointments of the following district managers: Baltimore, Walter H. Kelly; Florida, Frank C. Barrington; Buffalo, Kenneth W. Bullen; Cincinnati, C. Hap Hunter; and Detroit, Wm. H. Bond.

Major Walter Trittipio has been named central sales manager.

Representing Stromberg



Jack Tepfer, Tepfer Appliance Co., Cincinnati, O., recently appointed distributor for the Stromberg-Carlson line of radio and tele sets.

Don't Overlook These Profits On Your Very Doorstep!

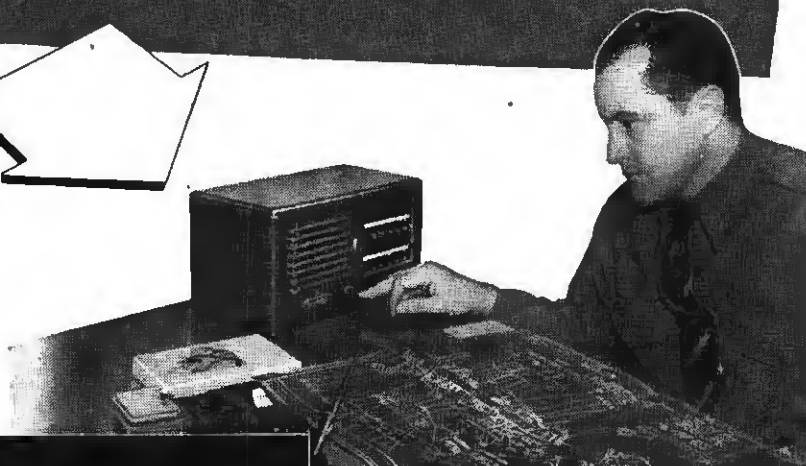

TELE
WEBSTER ELECTRIC
Teletalk
REG. U.S. PAT. OFFICE
... Adds hours to your work week

According to Mr. T. L. Carson, Chief Engineer, the use of Teletalk increases production and saves time and energy for the Power Service Company of Denver. The installation comprises five master sets, and connects the engineering department and front office with production, motor rebuilding, parts and shipping departments.

There is no more logical adjunct to the sale of radio than the promotion and sale of Teletalk Intercommunication Systems. For Teletalk—like radio—is primarily an electronic device of almost unlimited potential marketing possibilities.

Right in your own town... your own neighborhood... on your very doorstep... are business concerns such as offices, stores, banks, factories—all in need of this outstanding system of voice-to-voice communication between individuals and departments. Every business house, hospital, school, and institution suffers from wasted time, lost energy, confusion and delays caused by needless running around. Teletalk can—and *does*—end these costly practices.

Teletalk is modest in first cost; is quick and easy to install; is powered from the regular light circuit; requires little or no servicing. Made in types and models to suit smallest or largest requirements.

Take advantage of this big, close-by, profitable market by selling Teletalk as a major part of your business. It's a "natural" for the radio trade. Write for catalog and full information.

Let's All Back the Attack
Buy Extra War Bonds



Licensed under U. S. Patents of Western Electric Company, Incorporated, and American Telephone and Telegraph Company

WEBSTER ELECTRIC

Racine, Wisconsin, U.S.A. • Established 1909 • Export Dept.: 13 E. 40th Street, New York (18), N.Y. Cable Address "ARLAB" New York City

"Where Quality is a Responsibility and Fair Dealing an Obligation"

ALLIANCE "Even-Speed" Phono-motors



Good News!

ALLIANCE RESUMES PRODUCTION on One Standard Model

• We are now able to return to production of one standard variation of Alliance Model 80 Phono-motor, according to the following definite specifications and on the production plan explained below.

STANDARD SPECIFICATION No. 811—Turntable No. Y-278-S2; 110 Volt, 60 cycle, 9" Model 80

Production must be on the following practical basis under present conditions where there are no large volume priority orders—namely, by accumulating a sufficient quantity of small orders with necessary priority and making periodical single production runs at such time as the quantity of accumulated orders is enough to make this practical. Priority orders (currently only orders of AA-3 or higher, with GOVERNMENT CONTRACT NUMBER and MILITARY END USE, or where certified to be used in Sound Systems, Intercommunicating or Paging Systems, as exempted from order M-9-C) must allow delivery time required to obtain a minimum practical production run; to procure material for all orders in hand, and make one production run of the one type standard unit only, for shipment on the various accumulated orders. • Check the above against your requirements, and if you have proper priority, communicate with us.

REMEMBER ALLIANCE—Your Ally in War as in Peace!

AFTER THE WAR IS WON, WE WILL TELL YOU ABOUT SOME NEW AND STARTLING IDEAS IN PHONO-MOTORS

ALLIANCE MANUFACTURING COMPANY
ALLIANCE, OHIO

WOMAR

Manufacturers of
RADIO, ELECTRICAL AND
ELECTRONIC COMPONENTS

ELECTRONIC PRODUCTS MFG. CORP.
DEXTER, MICHIGAN

Sanial with Atlas Sound

Arthur Sanial has been made chief engineer of Atlas Sound Corp., Brooklyn, N. Y. Mr. Sanial was associated with RCA for several years, in the loud speaker engineering and manufacturing department.

Visit Adaptol N. Y. Office

Sid Cohen, California representative of Adaptol Co., Brooklyn, N. Y., producers of tube adapters, made a trip to the home office recently. So did Morris Taylor, head of the firm bearing his name, which represents Adaptol in the eastern area. As this company has announced that it will produce the much-wanted loktal base type of adapter, Harry Waldman, Adaptol sales manager, expects good business along this line, and invites consultation on special types of adapters with or without built-in resistors.

Hickok Adds to Plant

The Hickock Electrical Instrument Co., has expanded in preparation for postwar business with a new three-story addition to plant No. 1. This company, makers of precision electrical instruments, has pioneered dynamic mutual conductance tube testers, water-proof meters and also builds internal pivot meters designed for removability of both pivots.

Operadio Sales Rep

Anticipating increased sound equipment sales activity, Operadio Mfg. Co., St. Charles, Ill., has appointed H. H. Van Luven of Los Angeles as sales representative for the firm's commercial sound division in southern California and Arizona, it was announced by F. D. Wilson, sales manager of the division. Van Luven will not only act as a sales representative but also intends to maintain a complete line of Operadio equipment. Although present restrictions will limit this policy, Van Luven will stock the company's plant-broadcasters, Flexifone inter-office communication systems, loudspeakers and amplifiers as soon as priority regulations are relaxed.

Joins Sparks-Withington



Bernard S. "Tommy" Tucker has been appointed California district merchandiser of Sperton's radio and appliance division.

Lear Distributors



Ross Fey, president of Fey & Krause, signing contract for distribution of Lear home radios in southern Cal. L. to r.: Wm. P. Lear, president, Lear, Inc.; Bill Sutoff, sales manager Fey & Krause; Bert Caygill, Lear's rep in southern Cal.; and Nate Hast, home radio merchandising manager of Lear.

Zenith Completes Plans

The day is fast approaching when production of civilian radios can be resumed, and Zenith Radio Corp. has completed its plans for a postwar expansion of its export business, according to E. E. Loucks, sales manager of the company's export division. Loucks said that Zenith will be in production on a completely new line of radio receivers for the export trade within a few weeks after the government permits resumption of civilian manufacture.

Rhapsody in Records

(Continued from page 45)

break in New York papers during the week of the show's premiere, and cooperative window displays will be arranged with New York's leading music stores. In addition special flash posters are being prepared for dealers and an outstanding variety of captivating nation-wide Gershwin window display ideas and material will be made available to Columbia dealers.

The final roundup of the really successful campaign now being prepared for you by these large disc manufacturers will be made by the all-out efforts of Warner Bros., who will see to it that your local theatre manager understands fully all that is available to his city's record retailers. See your local theatre manager, and check up NOW on your reorders for Sept. 29th!

Opportunity and the help of experts in record merchandising will be available to you. The point-of-sale to the public is YOU!



HOMER G. SNOOPSHAW says:
"Here's good news for everyone! And Burgess sells the story while it's red-hot! National magazines and newspapers are telling your customers that their favorite Burgess Batteries are back!"

AVAILABLE!

BURGESS BATTERIES
at your Dealers now for your
FLASHLIGHT
RADIO
HEARING AID



*Voted **FIRST***
in Nation-wide poll of
ELECTRONIC EXPERTS

BATTERIES STILL GO TO WAR—Although war conditions now permit us to make batteries for civilian use, some are still going to the fighting fronts.

BURGESS BATTERIES

FOR FLASHLIGHTS • RADIO • HEARING AID • IGNITION • TELEPHONE • INDUSTRIAL
 BURGESS BATTERY COMPANY • FREEPORT, ILLINOIS

SERVICE TO SERVICEMEN... THAT'S STANCOR'S RECORD

Standardize

ON

STANCOR

Transformers

Call your nearest Stancor Jobber...
or write us for his address



STANDARD TRANSFORMER CORPORATION

1500 N. HALSTED STREET • CHICAGO

IMMEDIATE DELIVERY FROM STOCK

SPRAGUE - CORNELL DUBILIER AEROVOX CONDENSERS



8 mfd 450v Tubular	.. 44¢
10 mfd 450v Tubular	.. 50¢
16 mfd 450v Tubular	.. 68¢
20 mfd 450v Tubular	.. 70¢
20 mfd 150v Tubular	.. 44¢
30 mfd 150v Tubular	.. 47¢
40 mfd 150v Tubular	.. 50¢
20-20 mfd 150v Tubular	.. 76¢
40-20 mfd 150v Tubular	.. 82¢
30-30 mfd 150v Tubular	.. 79¢
50-30 mfd 150v Tubular	.. 94¢
10 mfd 50v Tubular	.. 32¢
25 mfd 25v Tubular	.. 35¢

SPRAGUE Money-Saving Kits

6 ATOMS 8mfd 450v Tubular \$2.56
15 TC-11 .01mfd 600v Tubular 1.59
15 TC-12 .02mfd 600v Tubular 1.59
15 TC-15 .05mfd 600v Tubular 2.12

TEST EQUIPMENT!

Volt-Ohm-Milliammeters
GE UM-3 31.50
Superior PS-100 28.40
Precision 832-3 19.48
 Servicemen's Priority
AA-5 MRO CMP5A
 Delivery—3 weeks



SPEAKER BUYS!



4" PM square \$1.35
4" 450 ohm. square 1.40
5" PM 2 watt. 1.25
5" 450 ohm. 1.50
10" PM 11 watt 7.20
12" PM 16 watt 10.14
12" PM 17 watt 14.25

TURNER MICROPHONES

Model	Type	Cord	Level	Each
BX	Crystal	7'	-55	\$5.85
22X	Crystal	7'	-52	10.88
33X	Crystal	20'	-52	13.23
BD	Dynamic	7'	-52	8.53
33D	Dynam.	20'	-54	14.70



RADIART VIBRATORS

Type	Equal	Base	Size	Used in	Each
S-1	4-4	4 Prong	1½-3½	Universal	\$1.35
5300	284	4 Prong	1½-3½	Universal	2.09
5326P	509P	4 Prong	1½-3½	Philco	1.76
5334	888	4 Prong	1½-3½	DeLoe	2.09
5341M	901M	4 Prong	1½-3½	Motorola	1.76
5400	248	6 Prong	1½-3½	Truetone	3.50
5426	716	6 Prong	1½-3½	Bulck	3.50

ORDER OTHERS BY MAKE AND SET MODEL



TRIMM ACME DELUXE PHONES

2000 ohm \$1.50
 Cannon-Ball Dixie 1.56
 Brandes Superior 1.86
 Brush Crystal Phones
 Type "A" 7.95

CRYSTALS - PICKUPS - MOTORS

CRYSTALS M22 2.94 L40 3.35 LP6 4.70
PICKUPS 2.97, 3.30, 3.90
MOTORS 3.17, 3.33

PHILCO BEAM OF LIGHT

Selenium Cell only, no holder 1.80

AC-DC RESISTANCE CORDS

135-160-180-220-250-290 OHM	
Each 48¢ 10 for 4.50
Universal 22-330 ohm 73¢
560 ohm for 3-way Portable 73¢

BALLAST TUBES

K42B K49B K55B K55C
 K92B L42B L49B L49C
 L49D L56B M61B M73B
 100-70 100-77 100-79
 Each 45¢ 10 for 4.20
 Claretat Universal 23-55A
 (total) each 59¢

20% deposit required on all C. O. D. orders. 2% transportation allowance on orders of \$25.00 or more accompanied by payment in full. Write for FREE CATALOG.

RADIO SUPPLY & ENGINEERING CO., Inc.
 128 SELDEN AVE. DETROIT 1, MICH.

Crosley's 1946 Refrigerator Forecast

Greatly expanded production of electric refrigerators and home radio receivers in the postwar period is planned by The Crosley Corp., James H. Rasmussen, general sales manager, Crosley Mfg. division, informed Crosley regional and merchandising managers at a sales conference.

"Through a two million dollar expansion program, Crosley will greatly increase its refrigerator production capacity in the first year after production is resumed," Rasmussen said. "WPB has now programmed a very limited refrigerator production for the last half of this year but big volume production probably won't get under way until 1946."

Easy Washer Production

Following on the War Production Board's proposed plan under which the washing machine industry will be permitted to manufacture 700,000 washers in the last half of 1945, Easy Washing Machine Corp., Syracuse, N. Y., has acted on its projected program for tooling up, utilizing increased plant facilities and the securing of necessary production materials. This reconversion activity is being carried out while maintaining Easy's full schedules of war contracts.

Until the availability of material problem is clarified, under the reconversion plan of the WPB, the company cannot forecast a definite production starting date. However, plans are being made for a limited number of washers to come off the production lines some time during the third quarter.

G-E Manager Named

R. A. Buescher has been appointed manager of the Great Lakes district of General Electric's appliance and merchandise department, according to an announcement by C. R. Pritchard, general sales manager.

Kramer Music Franchise

George Kramer of C. J. Kramer Music Co., Gary, Ind., has received the Crosley franchise through the Harry Alter Co., Chicago, Crosley distributors.

RMA Officers, 1945-46

President, R. C. Cosgrove, reelected; vice-president and chairman set division, E. A. Nicholas, reelected; vice-president and chairman tube division, M. F. Balcom; vice-president, George Lewis; vice-president and chairman parts division, R. C. Sprague, reelected; vice-president and chairman amplifier and sound equipment division, executive committee, T. A. White, reelected; treasurer, Leslie F. Muter, reelected; executive vice-president, general manager, Bond Geddes, reelected; general counsel, John W. Van Allen, reappointed.

Stolfi Expands Store in Stamford, Conn.

Stolfi's Radio Shop of 19 Stillwater Ave., Stamford, Conn., has purchased from the Vuono Construction Co. and Patrick DeLuca, the one-story brick structure at 36 Richmond Hill Ave., Stamford.

Mr. Stolfi expects to occupy the premises about August 1, where he will handle a complete line of radios, television sets, freezers, washing machines and electrical appliances.

The Stolfi organization is also active in servicing industrial electronic equipment in local factories, and has acted as sales agent for industrial electronic devices.

F. L. Jacobs Official

Charles B. Eisenhower has been elected vice-president and a director of F. L. Jacobs Company, Detroit, Mich., and will be in charge of the company's eight plants under C. S. Jacobs, vice-president and general manager. He was experimental engineer of the Anderson Manufacturing Co., Cambridge, Mass., when it was acquired by Jacobs in 1936.

Detrola Receives "E"

Detrola radio division, International Detrola Corp., Detroit, Mich., was awarded its Army-Navy "E" award with Brig. Gen. J. E. Barzynski giving the principal address. C. Russell Feldmann accepted the award on behalf of his firm.

Distributors Plan Project for Postwar

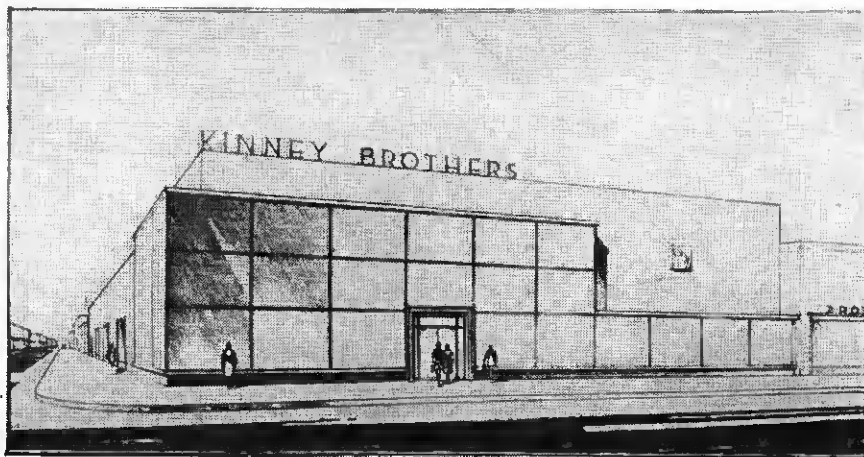

Postwar building project to serve as headquarters of Kinney Bros., Los Angeles, wholesale distributors of household appliances and Stewart-Warner radios in southern California.

Alliance Appoints Two

R. F. Doyle, general manager of The Alliance Mfg. Co., Alliance, Ohio, announces the appointment of John Bentia as sales manager of the manufacturing division of that company. Mr. Bentia has been connected with The Alliance Mfg. Co. for the past 5 years.

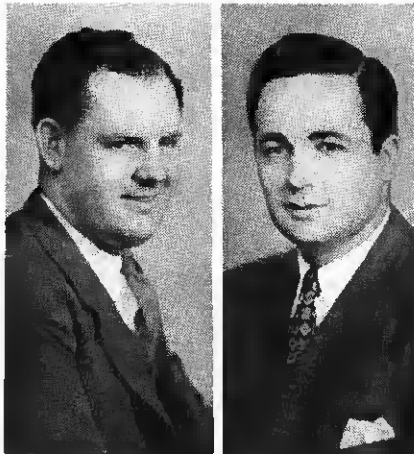

R. J. Wilson

John Bentia

Doyle also announces the appointment of R. J. Wilson as sales manager of the jobber division of this company. Wilson, a captain during World War II, was recently discharged from the army.

The two above appointments are part of organizational changes made by The Alliance Mfg. Co., in recognition of the problem to be faced during the postwar period.

Norge Names Spencer Regional Manager

Dean Spencer, who has been identified with the Norge line of household appliances for the last 14 years, has been appointed southeast regional manager of the Norge division of Borg-Warner Corp. and will have his headquarters in Atlanta, Ga., it was announced by M. G. O'Harra, vice-president and general sales manager. As regional manager he will be responsible for Norge distribution in territories of Charlotte, N. C.; Charleston, S.C.; Atlanta, Ga.; Jacksonville, Fla., and Johnson City, Chattanooga and Knoxville, Tenn.

Snyder Mfg. Praised

A letter of commendation to the workers of the Snyder Mfg. Co., Philadelphia, Pa., from the ranking Signal Corps officer has been made public by Benjamin L. Snyder, plant president. In this statement, the army officer congratulated the firm for its performance in producing antennas.

Clarostat Adds "E"

Another Army-Navy "E" star has been awarded to Clarostat Mfg. Co., Inc., Brooklyn, N. Y., for continuing achievement in the production of resistance devices. Clarostat was among the first radio component manufacturers to earn the "E" in October 1942, and since then has maintained its production record.



**FOR EYE APPEAL
EXECUTIVE PRESTIGE**
and of course that
DEPENDABLE PERFORMANCE
for which MASCO is so well known



MASCO
Executive Series

INTERCOMMUNICATION EQUIPMENT

Now available with suitable priority through your jobber

Radio Dealers! Here is intercommunication equipment you can recommend with confidence.

Units to meet every requirement — featuring: advanced circuit design, balanced line, greater adaptability and flexibility, perfect tonal quality and dependable performance.

Cabinets are streamlined, walnut smoothly finished and designed to enhance the appearance of the Executive's Desk.



Model	Description	List	Model	Description	List
Model 76	6 Position Master-to-Remote	52.50	Model 811	12 Position All-Master	62.50
Model 711	12 Position Master-to-Remote	61.00	Model RS	Remote station, less switch	11.00
Model 86	6 Position All-Master	55.00	Model RS-1	Remote station with press-to-talk switch	13.00

MARK SIMPSON MANUFACTURING CO.

MANUFACTURERS OF

Masco Sound Systems and Accessories

186-194 WEST FOURTH STREET :: NEW YORK 14, N. Y.

Write for Catalog 44 D

Telephone CHelsea 2-7112-3-4



FREE TO YOU COLOR CODE AND OHMS LAW CALCULATOR

A great convenience Easy to work. Solves many problems. Attach coupon to your letterhead Free to radio men, engineers, etc.

BURSTEIN-APPLEBEE COMPANY
1012 McGee St.
Kansas City 6, Mo.

Mail Coupon Now

BURSTEIN-APPLEBEE COMPANY
1012 McGee, Kansas City 6, Mo
Send me FREE Color Code and Ohms Law Calculator along with latest catalog

I am _____
STATE CONNECTION IN INDUSTRY
NAME _____
ADDRESS _____
TOWN _____ STATE _____

HEAVY POWER
225 WATTS

LIGHT WEIGHT
14 OUNCES

made possible by
**KWIKHEAT'S
BUILT-IN
THERMOSTAT**

- * HEATS IN ONLY 90 SECONDS
- * MAINTAINS PROPER HEAT
- * LESS RETINNING NEEDED
- * COOL, SAFE HANDLE
- * TIPS LAST LONGER
- * CAN'T OVERHEAT
- * LIGHT WEIGHT
- * 6 TIP STYLES INTERCHANGEABLE

The Kwikheat Iron is powerful —225 watts. A built-in thermostat maintains ideal temperature for best soldering, prevents overheating, prolongs life of tips, saves retinning time. Kwikheat is hot, ready to use only 90 seconds after plugging in. Light (14 ounces); well-balanced, cool handle. Choice of #0, #1, #2 or #3 tips . . . \$11.00

*patented

kwikheat
THERMOSTATIC SOLDERING IRON
A DIVISION OF
SOUND EQUIPMENT CORP. OF CALIF., GLENDALE 4, CALIF.



Adaptol

ADAPTERS

Permit Use of AVAILABLE Tubes

Transform to scarce type tubes . . . convert for use of such tubes as you HAVE (what a blessing!) . . . eliminate wiring . . . and be SURE of quality, craftsmanship, PRECISION! Almost 200 types, many with BUILT-IN RESISTORS.

Laboratory men, servicers, jobbers, dealers . . . this is your meat! Now the tube shortage won't handicap you nearly so much.

WRITE FOR MORE DETAILS
ADAPTOL COMPANY
Department 27
260 UTICA AVE., BROOKLYN 13, N. Y.

Get an **ADAPTOL**
USE IT WITH THE TUBE YOU HAVE



Bendix Officials Fly to Pacific Coast



Bendix Radio division officials meeting with West Coast distributors announced plans to manufacture radios on the coast in the postwar. Shown in front of the "flying laboratory" in which they flew to the meeting are l. to r.: C. C. DeWees, agency representative; Leonard C. Truesdell, general sales manager for radio and television; W. P. Hilliard, general manager; Paul J. Reed, assistant advertising manager; Earl Hadley, advertising manager; Fred Gutekunst, comptroller; George Eltgroth, patent attorney.

Sprague Business High

Robert C. Sprague, president of the Sprague Electric Co., North Adams, Mass., reports that gross business is continuing at a high rate and for the first three months of 1945 slightly exceeded the business done in the first quarter of 1944. So far the company has been fortunate in having no important net cancellations of war contracts although a considerable amount of readjustment of war work has been experienced. Forward orders on hand and those being currently received indicate a satisfactory sales volume for the balance of the year.

Eureka Vice-President

William A. Matheson was elected a vice-president of the Eureka Vacuum Cleaner Company at an executive meeting held in Detroit, it was announced by H. W. Burritt, president. Matheson formerly was president of the Williams Oil-O-Matic Heating Corp., which was acquired by the Eureka company.

Decca New Appointments

Jack Kapp, president of Decca Records, Inc., has announced the election of Milton R. Rackmil as vice-president of the company, David Kapp, as vice-president in charge of recording, Samuel Yamin as assistant treasurer, and the appointment of Leonard Schneider as director of advertising and sales promotion. Mr. Rackmil will continue to serve also as Decca's treasurer, an office which he has held since the company's inception.

The company's subsidiary, Decca Distributing Corp., has announced the election of Harry Kruse as vice-president in charge of branch office sales; and Brunswick Radio Corp., another subsidiary, made public the election of W. Trembeth Walker as vice-president in charge of plant and production.

Get Spartan Contract

William C. Allen and Associates, South 13th St., Birmingham, Ala., have been appointed district merchandisers by Spartan Radio, Jackson, Mich., for the states of Alabama, Georgia, Tennessee, Mississippi, and northwest Florida.

Robbins Forms Own Firm

Charles W. Robbins, for many years with Emerson Radio as vice-president in charge of sales, has set up his own sales organization known as the Charles W. Robbins Co. The firm will represent manufacturers, and handle television, radio products, electrical appliances and allied items on a national and sectional basis. New York City offices and sales rooms are at 853 Broadway.

Howard Postwar Plans

The Howard Radio Co., Chicago, announces that it has entered into a long-term contract with the Cabinet Craft Corp., Attica, Ind., to supply their cabinet requirements. Joseph M. Muniz, vice-president of the Howard Radio Co., said, "We are trying to foresee all the problems of reconversion, both sales-wise and production-wise."

Hoffman Signing Jobbers

R. J. McNeely, sales manager of the Hoffman Radio Corp., Los Angeles, returned from a business trip to Fresno and Sacramento and then left for Salt Lake City and Denver. He executed franchises for distributors and retailers in these areas for postwar Hoffman combination radio-phono sets and receivers.

Runyon Columbia Official

Commander Mefford R. Runyon has been elected executive vice-president and a director of the Columbia Recording Corp., it was announced by Edward Wallerstein, president of the company. It is expected that Commander Runyon will assume his new responsibilities at the Bridgeport headquarters of the company.

Goldman Ansley Rep

The Ansley Radio Corp. of Long Island City, N. Y., makers of Ansley Dynaphone radio-phonographs and the Ansley Dyna Tone, an electronic piano, has appointed Louis R. Goldman of New York as representative covering Brooklyn, Queens, Long Island, Bronx, Westchester and New Jersey north of but not including Princeton.



*In
War—
In
Peace..*



RADIART VIBRATORS (INDIVIDUALLY ENGINEERED FOR PROPER REPLACEMENT)

GIVE Exceptional Service!

The high quality of RADIART VIBRATORS is well known to servicemen everywhere. That high quality has characterized all Radiart Products that have been and are being used by the Armed Forces on all fronts. As production for civilian users expands it will continue to increase the demand for RADIART VIBRATORS.

LIMITED SUPPLY UNTIL V-J DAY

While production for civilian users may increase gradually, by far the greater part of our production will continue to be required for U.S. Armed Forces. We must and will meet all of their schedules on time.

FEWER VIBRATOR TYPES SIMPLIFIES STOCK PROBLEM

By eliminating many little used types of vibrators Radiart has been able to increase production of all popular types. Now the dozen or so types of RADIART VIBRATORS necessary for over 7/8ths of all replacements are more readily obtainable.

Consult the Radiart Vibrator Catalog for complete information on all vibrators for all installations. The Radiart Line is the most complete for all replacement purposes.



Radiart Corporation

3571 W. 62nd STREET • CLEVELAND 2, OHIO
EXPORT DIVISION: 25 Warren Street • New York 7, N.Y.

RADIO

PRODUCTION
and REPRODUCTION

will be better because of

MONARCH

MEASURING • TESTING • CALIBRATING
EQUIPMENT



2014 N. MAJOR AVE. • CHICAGO 39, ILL.



STILL AT THE OLD STAND

With a New and
Extensive Line of
Portable and Table
Model Phonographs

Demands of war clamped down on the production of phonographs for civilian use. Our manufacturing facilities were diverted to products that would aid in speeding victory.

But we were not asleep! Through the war years our designers and engineers were busily engaged in creating new and vastly improved Talk-A-Phone equipment. Many new features of a revolutionary character have been developed. Beauty has been enhanced with a captivating touch of ultra modern styling. When restrictions are lifted, Talk-A-Phone will again surge into the lead.

Talk-A-Phone Mfg. Co.

1512 So. Pulaski Rd. Chicago 23, Ill.

Meissner Signs Dealer



Oden F. Jester, right, vice-president of Meissner, sees O. R. Coblentz, Barker Bros., Los Angeles, sign southern California franchise. L. B. Brittain, of Barker Bros., looks on.

40% Increase in Dealers for Emerson Jobber

Emerson, New Jersey, Inc., Newark, N. J., distributor of Emerson radios, has completely signed all its dealers. According to Sam Gross, president, 40 per cent more retailers have been franchised in the 14 counties which the firm serves than there were in 1941.

Only stores which are attractive and which will carry representative lines were, and will be, granted franchises. However, Gross explained, the firm will not discriminate unfairly in its distribution policies.

In order to promote the name of Emerson with the consumer, as well as the dealer, the organization is servicing sets which dealers are not prepared or equipped to handle. "We've been marking time for almost four years awaiting the return of major goods, and without doing much merchandising," Gross declared. "But we have created customer good-will, of which we are very proud."

Howard Radio Getting Distributor Set-Up Ready

The Howard Radio Co., Chicago, Ill., is building up its distributor organization to full strength, according to an announcement by Joseph M. Muniz, vice-president in charge of sales for the company. Mr. Muniz also announced the appointment of Harry Byrne as assistant sales manager. Mr. Byrne was previously with Majestic Radio & Television and John Meck Industries.

Clarostat Appoints New Representatives

Two new sales representatives, announced by Clarostat Mfg. Co., Inc., Brooklyn, N. Y., are Wood & Anderson Co., 915 Olive St., St. Louis, Mo., who will represent the Clarostat line in both the industrial and jobbing fields in their territory; and Henry P. Segal Co., 143 Newsbury St., Boston, Mass., who will represent the Clarostat line throughout the New England territory.

SPEED IRON

MODEL B

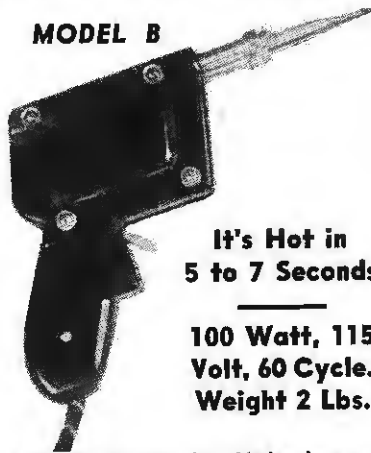

It's Hot in
5 to 7 Seconds

100 Watt, 115
Volt, 60 Cycle.
Weight 2 Lbs.

A new development in soldering irons now makes possible great savings in light soldering operations. Rugged, fast, powerful, built to give years of service, it will do soldering jobs that previously were impossible. A tool that is a "must" for your shop. Perfect for radio repair work.

It consists of a hi-current, lo-voltage transformer with its primary controlled by a trigger switch. To the secondary is connected the soldering tip and heating element, a length of No. 11 copper. The tips are easily replaced and their flexibility permits forming into various shapes to reach difficult connections.

The tool is encased in an attractive plastic housing, comfortable and well balanced.

For more information write Dept. R

WELLER MFG. CO.
EASTON, PA.

Crosley Distributor



Fred Ernst (right) head of Ernst Furniture and Appliance Co., Cincinnati, receives his certificate of appointment from Oscar Schirman, general manager of Modern Distributing Co. (left). Matt Williams, special rep of Modern Distributing is in center.

Ray S. Erlandson with San Antonio Music Co.

Isaac Bledsoe, president and owner of the San Antonio Music Co., announces the appointment of Ray S. Erlandson as vice-president and general manager. Erlandson leaves the position of vice-president and manager of the retail division of the Rudolph Wurlitzer Co., Chicago, to assume this new position.

The San Antonio Music Co. was organized fifty-four years ago by Isaac Bledsoe and during this period of time has built an enviable reputation in the Southwest as one of the foremost music stores in this area. It has branches in Corpus Christi, Harlingen and Austin, Texas. During the more than fifty years of its operation, under the personal direction of its founder and only president, Isaac Bledsoe, it has sold more than \$30,000,000 worth of pianos and musical instruments in the greater Texas area.

In joining the San Antonio Music Co., Erlandson brings to this foremost organization of southwest Texas many years of practical experience in the field of piano, musical instrument and radio merchandising. He joined the Rudolph Wurlitzer Company ten years ago this month, shortly after the reorganization of this establishment under the leadership of R. C. Roling, its present president. During the past ten years he has been largely responsible for the reorganization of retail operations of the Wurlitzer Company and has developed its retail set-up to its present degree of efficiency and success.

The current lines handled by the San Antonio Music Co. include: Hammond organ; Steinway, Chickering, Kimball, Wurlitzer pianos; Capehart, Scott, RCA and Zenith radios; Crosley refrigerators; A. B. C. washers and Conn musical instruments, in addition to a complete sheet music department and a large and comprehensive record department.

Westinghouse Appointee

Appointment of L. E. Septer as manager of replacement tube sales for home radio division, Westinghouse Electric Corp., is announced by Harold B. Donley, division manager.



In Resistors...

OHMITE
EXPERIENCE
MAKES A
DIFFERENCE

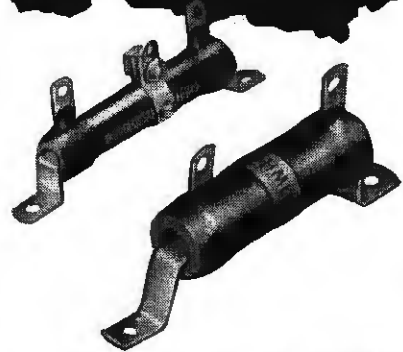

You get the benefit of Ohmite experience in meeting many different requirements... in pioneering new developments... in producing a wide range of types and sizes to best meet each need. Add to this, the long service-record of Ohmite Resistors... their proved ability to function under the most severe operating conditions. Such experience is invaluable in helping you solve your resistance-control problems.

Send for Ohm's Law Calculator



Figures ohms, watts, volts, amperes—easily. Solves any Ohm's Law problem with one setting of the slide. Send only 10¢ in coin.

OHMITE MANUFACTURING CO.
4871 Flournoy Street • Chicago 44, Illinois

Be Right with **OHMITE**
RHEOSTATS • RESISTORS • TAP SWITCHES

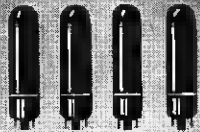

4 STANDARD TYPES

of Amperite Regulators replace over 400 types of AC-DC Ballast Tubes now in use.

Amperites are real REGULATORS... have patented Automatic Starting Resistor which prevents initial surge and saves pilot light.

Ask Your Jobber.

AMPERITE

THE *Simplest*
WAY TO REPLACE

BALLASTS

WRITE FOR REPLACEMENT CHART

AMPERITE CO. 561 BROADWAY, NEW YORK, N. Y.



Plug in
METAL TUBE RESISTORS

★ Clarostat pioneered the plug-in metal tube resistors found today in many compact AC-DC radio sets. These handy resistors serve as voltage reducers and also as resistance networks for supplying a plurality of voltages. Clarostat also makes voltage regulator ballasts in perforated metal cases, either as plug-ins or for permanent mounting.

If you are seeking such handy, accurate, dependable resistors for your electronic or electrical assemblies, please bear in mind that Clarostat means outstanding experience, engineering and production facilities.



★ **Consult Us . . .**

Send those resistance, control or allied problems to us for engineering collaboration, specifications, quotations.



CLAROSTAT MFG. CO., Inc. • 285-7 N. 6th St., Brooklyn, N. Y.

Walker-Jimieson Party for Dave Finn



Dave Finn recently appointed RCA national sales manager of the renewal tube division being congratulated by Ralph Walker (left), W-J president. Grouped around are executives of the two firms.

Admiral Gets Frozen Food Mfr's Approval

L. H. D. Baker, vice-president in charge of appliances, Admiral Corp., Chicago, announces that Admiral's Dual-Temp refrigerator has been granted approval by Birds Eye-Snyder, Inc., and that Admiral is proud to have the approval on Dual-Temp refrigerators from a company which has done so much to pioneer the frosted foods industry.

Philco on Sales Future

Thomas A. Kennally, vice-president in charge of sales, Philco Corp., Philadelphia, Pa., predicts a bright future for the radio industry.

"Surveys," he said, "made by Philco indicate that a pent-up demand for approximately 25,000,000 radio receiving sets already exists. This is nearly twice the industry's all-time high production of 13,000,000 receivers in 1941."

20 Years Ago

From the July, 1925, Issue of Radio Retailing

PAID CIRCULATION LEADERSHIP—Radio Retailing received 8,055 paid subscriptions rolled up during the last six months—despite the "off-season," for the radio dealer. This was far above subscriptions reported by the nearest competitor. New readers are coming in at the rate of 1,000 a month.

RADIO NOW REPEATING HISTORY OF OTHER INDUSTRIES—"Radio is here to stay as an important factor in American life—let there be no mistake about that. . . . We have confidence in the commercial as in the scientific future of this art."

"TUNING-IN FROM SIDEWALK DRAWS THE CROWDS"—People gather to tune in sets, listen, and possibly return to buy.

TRAINED SALESMEN ARE BEST SELLERS—"Care in the selection and training of salesmen has been the outstanding reason for the success of many retail dealers."

ADVICE FOR COMBATTING "THE GYP"—This Illinois radio dealer says: Sell only standard, well-known products; offer a year's free service to obtain additional leads; leave a set in the home for demonstration; sell receivers on the installment plan.

"SERVICE CALLS BUILD SALES"—Free monthly service calls prove successful in getting names of set owners and friends for future follow-up. Telephoning housewife to arrange demonstration at home is a good sales policy for interesting women in features of radio.

WHAT'S NEW IN RADIO—A combined lamp and reproducer with "dictograph" unit concealed in the base so that sound waves travel up inside of column and vibrate against inside of shade.

MANUFACTURERS HELP DEALERS PROMOTE SALES—feature article.

Crosley Bought by the Aviation Corp.

Negotiations have been completed for the purchase of holdings of Powel Crosley, Jr., his family, and the Crosley Corp., makers of radios and appliances, by the Aviation Corp. The purchase price is said to be approximately \$13,625,000.

Victor Emanuel, chairman, and Irving B. Babcock, president of the purchasing company, are expected to assume similar posts with the Crosley Corp. Powel Crosley, Jr., will retain his position as a director of the firm, and Lewis Crosley will continue functioning as vice-president. Raymond C. Cosgrove, vice-president in charge of manufacturing of the Crosley organization, will continue in his present post.

The combining of Crosley and the Aviation Corp. (AVCO) is a step taken by the latter company toward reconversion for civilian manufacture, it was stated by the two AVCO executives. These officials declared that AVCO proposes to present the consuming public with quality radio and appliance merchandise. No changes are being contemplated in the policies, personnel, and methods of operation of the Crosley Corp.

In view of the fact that the Crosley interests own two broadcasting stations in Cincinnati, the sale is subject to the approval of the Federal Communications Commission. The automobile manufacturing division of Crosley was not included in the deal.

RADIO TUBES

We have radio tubes combined with adaptors, sold as complete units, for the following critical numbers:

1A5	1N5	6K7
1C5	3Q5	1T5
1H5	6A7	1Q5
	6A8	
6Q7	GSC7	6X5
6SQ7	6R7	84-6Z4
	75	

\$1.15—lots of dozen
\$1.10—lots of 25 to 49
\$1.05—lots of 50 or more

Regular tubes—not substitutes

7T7	—	\$1.00 each
6SN7	—	.65 each
1T4	—	.75 each
3S4	—	.75 each
1S5	—	.85 each
27	—	.35 each

Signed supplier's certificate #1-265 must accompany all tube orders.

ADAPTORS

We manufacture a complete line of radio tube adaptors. Don't let your old tubes be idle, use our ADAPTORS.

50c each—doz; lots of any one type
 60c each—smaller quantity

Send for our complete list of over 125 different types of adaptors.

Manor
ELECTRIC & APPLIANCE CO.
 323 Southport Ave., Chicago 13, Ill.

Meck Distributor



Joe E. Barnett of the Radio Supply, Inc., Oklahoma City Wholesalers for Meck Ind.

Rosenfeld Temporarily in New Position at Emerson

Morrie W. Rosenfeld, field manager of Emerson Radio and Phonograph Corp., New York City, has temporarily taken over the duties of general sales manager of the company. He succeeds Charles Robbins who occupied that position for many years and who recently resigned to engage in business for himself. Mr. Rosenfeld was formerly district manager of the New England and New York State territory.

Mr. Rosenfeld is now enlarging the sales and field service staffs of Emerson and is directing the company's distributor-dealer-salesmen training program preliminary to the firm's announcement of postwar promotion campaigns.

News of the "Reps"

At a recent meeting of the Buckeye Chapter of the "Reps," the following new officers were elected for the ensuing year: G. O. Tanner, 508 Grant St., Pittsburgh 19, Pa., president; J. O. Olsen, 1456 Waterbury Road, Cleveland 7, Ohio, vice-president; and E. C. Edwards, 530 Erie Bldg., Cleveland 15, Ohio, secretary and treasurer.

H. M. Saul, secretary of the Los Angeles Chapter, recently announced the acquisition of a new member, William G. Patterson of 2223 Malcolm Ave., Los Angeles, Cal.

The application of William J. Johnston of 5550 N. Kenmore Ave., Chicago, Ill., for regular membership in the Chicagoland Chapter was recently accepted. R. Edward Stemm, secretary of the chapter also announces that John B. Higgins has been accepted as associate member.

Florian with Reeves-Ely

Gordon W. Florian, formerly assistant director of design for all GE appliance products, has been appointed director of design for Reeves-Ely Laboratories, Inc., New York, N. Y. Mr. Florian and his staff will engage upon a program of re-design of all Reeves-Ely products including several models of electric irons, mixers and other home electric appliances as well as the company's products in the electrical transformer and communication equipment fields.

DESIGN COUNTS



COMPARE a modern sewing machine with the old-time model shown here. The difference is an example of how careful attention to design brings about a high level of efficiency.

Realizing this, design is one of the most carefully considered factors in the production of antennas at THE WARD PRODUCTS CORPORATION. It is only through superior design that the benefits of experience and the finest production facilities can be best brought to the user.

For the finest antennas for all applications... for home and automobile use... look to WARD.

WARD
Antennas

BUY WAR BONDS

THE WARD PRODUCTS CORPORATION
 1523 EAST 45TH STREET • CLEVELAND 3, OHIO

Export Dept. C. O. BRANDES, Mgr.
 4900 Euclid Avenue
 Cleveland 3, Ohio

Canadian Office ATLAS RADIO CORP.
 560 King Street, W.
 Toronto 1, Ont., Can.

**THERE'S A
VACO
SCREW DRIVER**

with Shock-proof and Break-proof
AMBERYL HANDLE
to fit
**EVERY HAND
and EVERY JOB**

**173
TYPES**

VACO Write for Catalog

PRODUCTS CO.

309 E. ONTARIO ST. • CHICAGO II, ILL.
Canadian Warehouse: 360 KING STREET, WEST • TORONTO 2, ONTARIO

Electro
ELECTRICAL AND RADIO EQUIPMENT

BATTERY ELIMINATORS



Announcing! Our New Models P and Q. They include every achievement of wartime ingenuity, and lift battery radio reception to new heights of satisfaction. Cost but a few cents per hundred hours of operation. Sturdily constructed—no liquids or moving parts—operate in any position. Completely filtered, hum free and silent in operation. Universal plugs and sockets to fit any radio.

MODEL P—For use in any place where normal AC is available. Operates any 1.4 volt—4, 5 or 6 tube battery radio from 115 v. 60 cy. source.

MODEL Q—For use wherever AC lines are not available—Farms, cottages, camps, or in car, motorboat, etc. Operating any 1.4 volt—4, 5 or 6 tube radio from 6 volt DC source.

NOTE: Due to War Production Board restrictions on Material our production is necessarily limited and deliveries at this time can be made only through established jobbers. Canadian representative, Atlas Radio Corp., Toronto, Canada.

ELECTRO PRODUCTS LABORATORIES
Pioneer Manufacturers of Battery Eliminators
549 WEST RANDOLPH STREET CHICAGO 6, ILL.

Electricity

Models range from 250 to 25,000 watts. A. C. types from 115 to 600 volts, 50, 60, 100 cycles, single or three-phase and 400, 500 and 800 cycles. Single phase D. C. types from 2 to 4000 volts. Also available in dual voltage and special frequency types.

FOR RADIO AND ELECTRONIC APPLICATIONS

- ONAN ELECTRIC GENERATING PLANTS supply reliable, economical electrical service for electronics and television applications as well as for scores of general uses.

Driven by Onan-built, 4-cycle gasoline engines, these power units are of single-unit, compact design and sturdy construction. Suitable for mobile, stationary or emergency service.

Model shown is from W2C series; 2,000 to 3,500 watts; powered by Onan-built, two-cylinder, water-cooled engines.

D. W. ONAN & SONS
2033 Royalston Ave.
Minneapolis 5, Minn.



Write For Folder 690-A describing complete Onan Line

CHIEF ENGINEER

Prominent, old and established Radio Manufacturer in the East seeks services of top Chief Engineer, able to take over entire department, thoroughly experienced in designing straightforward radio receivers in small, medium and large brackets; must be up-to-the-minute in knowledge of FM and Television. Salary commensurate with ability. Wonderful opportunity for right man.

Write Box 610
RADIO and Television RETAILING
480 Lexington Ave. New York 17, N. Y.

Wanted—Asst. Sales Manager

Must have jobber sales experience—radio and allied lines preferred but not necessary. Old line company doing \$6,000,000 per year. No reconversion problems. Sales organization already established. Management wishes to strengthen sales organization and our personnel all know of this ad. Write or wire immediately.

•

RADIO & TELEVISION RETAILING, BOX 612
480 Lexington Avenue, New York 17, N. Y.

"Columbia" is a reliable source

IMMEDIATE DELIVERY

**Largest Stock of
INSULATED ELECTRICAL
WIRE**

No. 22 Gauge to No. 12 Gauge

CORD SETS
ready-to-attach assemblies

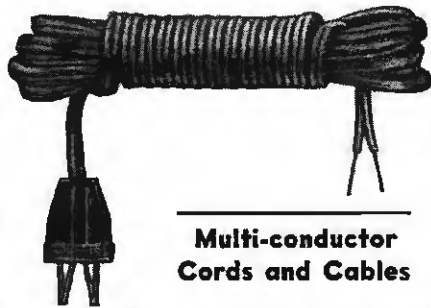

**Multi-conductor
Cords and Cables**

Write for Circular No. 5

COLUMBIA WIRE & SUPPLY CO.
4104 N. PULASKI RD., CHICAGO 41, ILLINOIS



Fidelitone MASTER
provides all these: (1) Floating point construction. (2) Horizontal and vertical shock absorption. (3) Permum! metals tip (four times more costly than gold) assures maximum needle life. (4) Finest re-production. (5) Increased kindness to records. (6) Filtered record-scratch. (7) Patented self-locking insertion design.

Fidelitone DE LUXE
with the Permetal™ Tip. Gives smooth, scratch-free reproduction. Months of satisfactory service. Floating point construction. Kind to records. Patented self-locking design. The best needle a dollar can buy.

Fidelitone FLOATING POINT
worth more than the price. Its floating point construction filters record scratch, and its precious-metals tip assures up to 1000 or more perfect plays with kindness to records.

Fidelitone DE LUXE RECORDING STYLUS
a professional stylus of true Fidelitone quality for home recording. The platinum metals (Permetal!) tip is accurately shaped and precision-ground to scientific specifications. The finest stylus available for home recordings.

PERMO Incorporated
8428 Ravenswood Ave., Chicago 26
The original and world's largest manufacturer of long-life phonograph needles.

ALWAYS GETS A HAND!

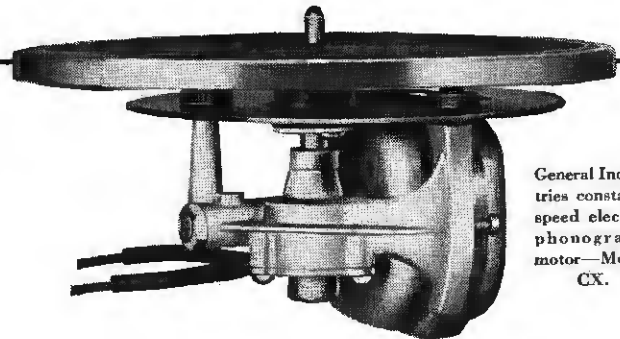

General Industries constant-speed electric phonograph motor—Model CX.

Users and the trade have always given hearty applause to General Industries phonograph mechanisms. Owners like the fine fidelity of every note or syllable—and sales and service departments are strong for their reliability and freedom from maintenance troubles.

You'll get this same old-time satisfaction from our Smooth Power turntable motors, recording assemblies and record-changer-recorder combinations when we return to civilian production. As always, General Industries equipment will earn your approval.



THE GENERAL INDUSTRIES COMPANY
DEPT. M
ELYRIA, OHIO



ONLY ONE LEFT

after
20 Years of Continuous Service
1925 ——— 1945

Only one of the eleven business publications and twelve general magazines serving the radio industry in 1925 of those listed below has survived until the present day. Moreover, RADIO RETAILING founded by Dr. O. H. Caldwell and M. Clements for McGraw-Hill is the only such publication to remain under the management of its founders for so long.

We are honored by this two decades of recognition by the radio industry. We have no intention of resting on our laurels for even a single issue, though.

Leadership carries with it the responsibility of leading.

RADIO & Television RETAILING promises to maintain its position as the most helpful radio-merchandising paper that can be published to serve your needs. We have served you that way in the past. We hope to continue serving you that way in the future.

(Source of above-mentioned publications is June 1925 issue of Standard Rate & Data Service, official directory of media information.)

**24 STARTED . . .
ONE Continues Going Ahead**

TRADE MAGAZINES

~~American Radio Journal~~
~~Photograph Radio Dealer~~
~~Radio Dealer~~
~~Radio Digest Retailer~~
~~Radio Engineering~~
~~Radio Merchandising~~
~~Radio Record~~
~~Radio Retailer and Jobber~~
RADIO RETAILING
~~Radio Trade Directory~~
~~Radio Trade Journal~~
~~Talking Machine World~~

GENERAL MAGAZINES

~~Amateur Radio~~
~~Everybody's Radio~~
~~Popular Radio~~
~~Radio Broadcast~~
~~Radio Digest~~
~~Radio Doings~~
~~Radio in the Home~~
~~Radio Journal~~
~~Radio Progress~~
~~Radio Stories~~
~~Radio World~~
~~Wireless Age~~

RADIO *& Television* RETAILING

CALDWELL-CLEMENTS INC. 480 LEXINGTON AVENUE
NEW YORK 17, N. Y.

INDEX To Advertisers

July 1945

	Page		Page
Adaptol Co.	114	Marion Electrical Instrument Co.	53
Admiral Corp.	1	Meck Industries, Inc., John	5
Aerovox Corp.	98	Meissner Mfg. Co.	96, 97
Alliance Mfg. Co.	110	Merit Coil & Transformer Corp.	4
Amperite Co.	117	Monarch Mfg. Co.	116
Ansley Radio Corp.	85	National Carbon Co., Inc.	101
Automatic Radio Mfg. Co., Inc.	71	National Union Radio Corp.	13
Bell Sound Systems, Inc.	108	Noblitt-Sparks Industries, Inc.	91
Belmont Radio Corp.	24	Dhmitz Mfg. Co.	117
Bendix Radio Div. of Bendix Aviation Corp.	102, 103	Onan & Sons, D. W.	120
Burgess Battery Co.	111	Permo, Inc.	121
Burstein-Applebee Co.	113	Philco Corp.	3
Centralab	90	Quam-Nichols Co.	123
Chicago Tribune	25	Radiart Corp.	115
Clarostat Mfg. Co., Inc.	118	Radio Corp. of America:	
Columbia Wire & Supply Co.	121	RCA Laboratories	64
Commercial Credit Co.	86	RCA Victor Div.	61, 62, 63
Delco Radio Div., General Motors	8	Radio Supply & Engineering Co., Inc.	112
Detrola Radio Div., International Detrola Co.	95	Raytheon Mfg. Co.	11
Dumont Electric Co.	77	Redbook	26
DuMont Laboratories, Inc., Allen B.	89	Seeburg Corp., J. P.	Cover 3
Eastern Amplifier Corp.	82	Sentinel Radio Corp.	78
Electronic Products Mfg. Corp.	110	Simpson Mfg. Co., Mark	113
Electro Products Laboratories	120	Solar Capacitor Sales Corp.	124
Emerson Radio & Phonograph Corp.	51	Senora Radio & Television Corp.	27
Estate Stove Co.	104	Sound Equipment Corp.	114
Fada Radio & Electric Co., Inc.	15	Sparks-Withington Co.	54
Fawcett Publications, Inc.:		Sprague Products Co.	93
Institutional	14	Standard Transformer Corp.	111
Galvin Mfg. Corp.	Cover 4	Stewart-Warner Corp.	58, 59, 87
Garod Electronics Corp.	21	Stromberg-Carlson Co.	28
General Electric Co.	12, 20	Sylvania Electric Products, Inc.	70
General Industries Co.	121	Talk-A-Phone Mfg. Co.	106, 116
General Transformer Corp.	18	Templetone Radio Mfg. Corp.	19
Hamilton Radio Corp.	99	Thordarson Electric Mfg. Corp.	9
Hammarlund Mfg. Co., Inc.	92	Triplett Electrical Instrument Co.	100
Hickok Electrical Instrument Co.	107	True	57
Howard Radio Co.	105	True Confessions	69
Hytron Radio & Electronics Corp.	75	Tung-Sol Lamp Works, Inc.	94
International Resistance Co.	79	Utah Radio Products Co.	2
Jensen Radio Mfg. Co.	52	Vaco Products Co.	120
Ken-Rad	7	Ward Leonard Electric Co.	106
Lear, Inc.	17	Ward Products Corp.	119
Life Story	67	Warwick Mfg. Corp.	6
Magnavox Co.	74	Waters Conley Co.	68
Maguire Industries, Inc., Electronics Div.	83	Webster Chicago Corp.	16
Majestic Radio & Television Corp.	10	Webster Electric Co.	109
Mallory & Co., Inc., P. R.	55, Cover 2	Weller Mfg. Co.	117
Manor Electric & Appliance Co.	119	Westinghouse Electric Corp.	22, 23
		Wilcox-Gay Corp.	49

While every precaution is taken to insure accuracy, we cannot guarantee against the possibility of an occasional change or omission in the preparation of this index.



20th of preceding month

DEADLINE FOR FINAL FORM

Closing date 15th of month for all ads requiring proofs, composition, key changes, foundry work, patches, etc.

RADIO Television RETAILING



Caldwell-Clements, Inc., 480 Lexington Ave., New York 17, N. Y.

P. S. New York Electrotypers have notified us they are unable to block plates other than those made by them, due to the shortage of blocking wood. We regret our inability, therefore, to accept for publication any plates arriving here unblocked, or otherwise not ready to print. May we have your cooperation?

the excellence of your post-war radio engineering
 will be faithfully interpreted for your customers by a **QUAM** Speaker

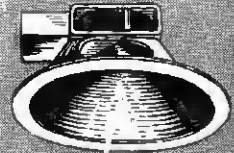
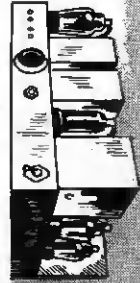

QUAM-NICHOLS CO. 33rd PLACE AT COTTAGE GROVE, CHICAGO

you can't put the squeeze
on SEALDTITE
CAPACITORS



Just try it . . . Take a genuine "Sealdtite" capacitor and try to *squeeze* it. No results. You'll find it has no soft spots, which in ordinary tubulars provide room for moisture, the capacitor's worst enemy, because the Solar capacitor has an internal winding of high quality paper and foil, skillfully *molded into solid plastic*.

No moisture can penetrate this protective case and its substantial construction permits rough handling, assures long and *reliable* service.

Use "Sealdtite" capacitors. Send for your copy of Catalog V-4. Any Climate—Any Atmosphere—Any Service.



BAYONNE PLANT
WEST N.Y. PLANT

A TOTAL OF EIGHT ARMY-NAVY
EXCELLENCE AWARDS

SOLAR CAPACITOR SALES CORP.
285 MADISON AVENUE, NEW YORK CITY

7567

Announcing

THE STARTLING NEW . . .

SEEBURG WIRE RECORDER

In addition to the new reliable line of Seeburg Record Changers — after Victory — Seeburg will make available to combination instrument manufacturers — The Seeburg Wire Recorder — truly an amazing accomplishment for home recording. The Seeburg Wire Recorder is being designed to eliminate many of the past disadvantages heretofore associated with home recording — no recording discs to buy — no skilled knowledge necessary to make perfect home recordings and to take favorite programs off the air. Just one simple control knob to operate.

It will be necessary for radio manufacturers to make provision in their circuits to accommodate the Seeburg Wire Recorder and we therefore invite prompt inquiries from interested radio manufacturers.

**SEEBURG
WIRE
RECORDER**

**SEEBURG
RECORD
CHANGERS**

Seeburg

J. P. SEEBURG CORP. ★ CHICAGO

BUY MORE BONDS!



Awarded to the J. P. Seeburg Corporation for outstanding production of war materials in each of its four plants.





ANOTHER BIG
Motorola

COLOR AD



ADDRESSED TO
**40 MILLION
AMERICANS**



There'll be none
Finer than...

Motorola

Oh what a wonderful changer!

**OVER HALF AN HOUR OF MUSIC
WITHOUT INTERRUPTION**

FEATHERLIGHT

The new Motorola tone arm reduces record scratch and wear to the vanishing point.

STACK 'EM TO HIGH
Play and enjoy 10 ten-inch or 8 twelve-inch records without interruption.

FLOATING ACTION
Motorola changer handles precious records gently, noiselessly, safely!

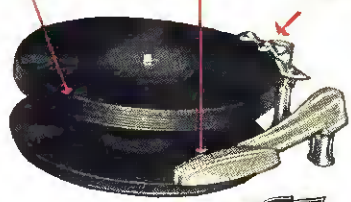

Music at its beautiful best! That's what's in store for you soon after Victory. The broadcast programs you love to listen to will come in richly... with every subtle tone and overtone! And when you're hungry for your favorite recorded music, you'll discover how scientifically perfect a Motorola record changer can be.

Motorola is still devoted to the making of famous "Handie Talkies," originated and developed exclusively by Motorola Radio Engineers. But make a note... to remember! Soon after the war... see and hear a Motorola Phonograph-Radio.

GALVIN Mfg. Corporation • Chicago 51, Illinois

Motorola  *Radio*

☆ FOR HOME AND CAR ☆

F-M & A-M HOME RADIO • AUTO RADIO • AUTOMATIC PHONOGRAPHS • TELEVISION • F-M POLICE RADIO • RADAR • MILITARY RADIO

Announcing

THE STARTLING NEW . . .

SEEBURG WIRE RECORDER

In addition to the new reliable line of Seeburg Record Changers — after Victory — Seeburg will make available to combination instrument manufacturers — The Seeburg Wire Recorder — truly an amazing accomplishment for home recording. The Seeburg Wire Recorder is being designed to eliminate many of the past disadvantages heretofore associated with home recording — no recording discs to buy — no skilled knowledge necessary to make perfect home recordings and to take favorite programs off the air. Just one simple control knob to operate.

It will be necessary for radio manufacturers to make provision in their circuits to accommodate the Seeburg Wire Recorder and we therefore invite prompt inquiries from interested radio manufacturers.

**SEEBURG
WIRE
RECORDER**

**SEEBURG
RECORD
CHANGERS**

Seeburg

J. P. SEEBURG CORP. ★ CHICAGO

BUY MORE BONDS!

Awarded to the J. P. Seeburg Corporation for outstanding production of war materials in each of its four plants.

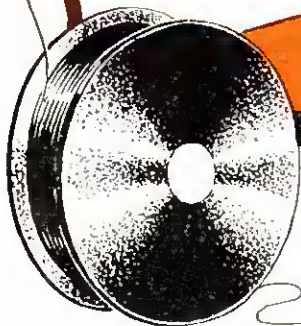



ANOTHER BIG
Motorola

COLOR AD



ADDRESSED TO
**40 MILLION
AMERICANS**



There'll be none
Finer than...

Motorola

Oh what a wonderful changer!

OVER HALF AN HOUR OF MUSIC
WITHOUT INTERRUPTION

FEATHERLIGHT

The new Motorola tone arm reduces record scratch and wear to the vanishing point.

STACK 'EM TO HIGH

Play and enjoy 10 ten-inch or 8 twelve-inch records without interruption.

FLOATING ACTION

Motorola changer handles precious records gently, noiselessly, safely!

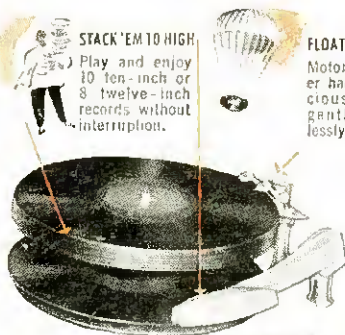

Music at its beautiful best! That's what's in store for you soon after Victory. The broadcast programs you love to listen to will come in richly . . . with every subtle tone and overtone! And when you're hungry for your favorite recorded music, you'll discover how scientifically perfect a Motorola record changer can be.

Motorola is still devoted to the making of famous "Handie Talkies," originated and developed exclusively by Motorola Radio Engineers. But make a note . . . to remember! Soon after the war . . . see and hear a Motorola Phonograph-Radio.

GALVIN Mfg. Corporation • Chicago 51, Illinois

Motorola  *Radio*

☆ FOR HOME AND CAR ☆

F-M & A-M HOME RADIO • AUTO RADIO • AUTOMATIC PHONOGRAPHS • TELEVISION • F-M POLICE RADIO • RADAR • MILITARY RADIO