

RADIO & Television RETAILING

Including Radio and Television Today

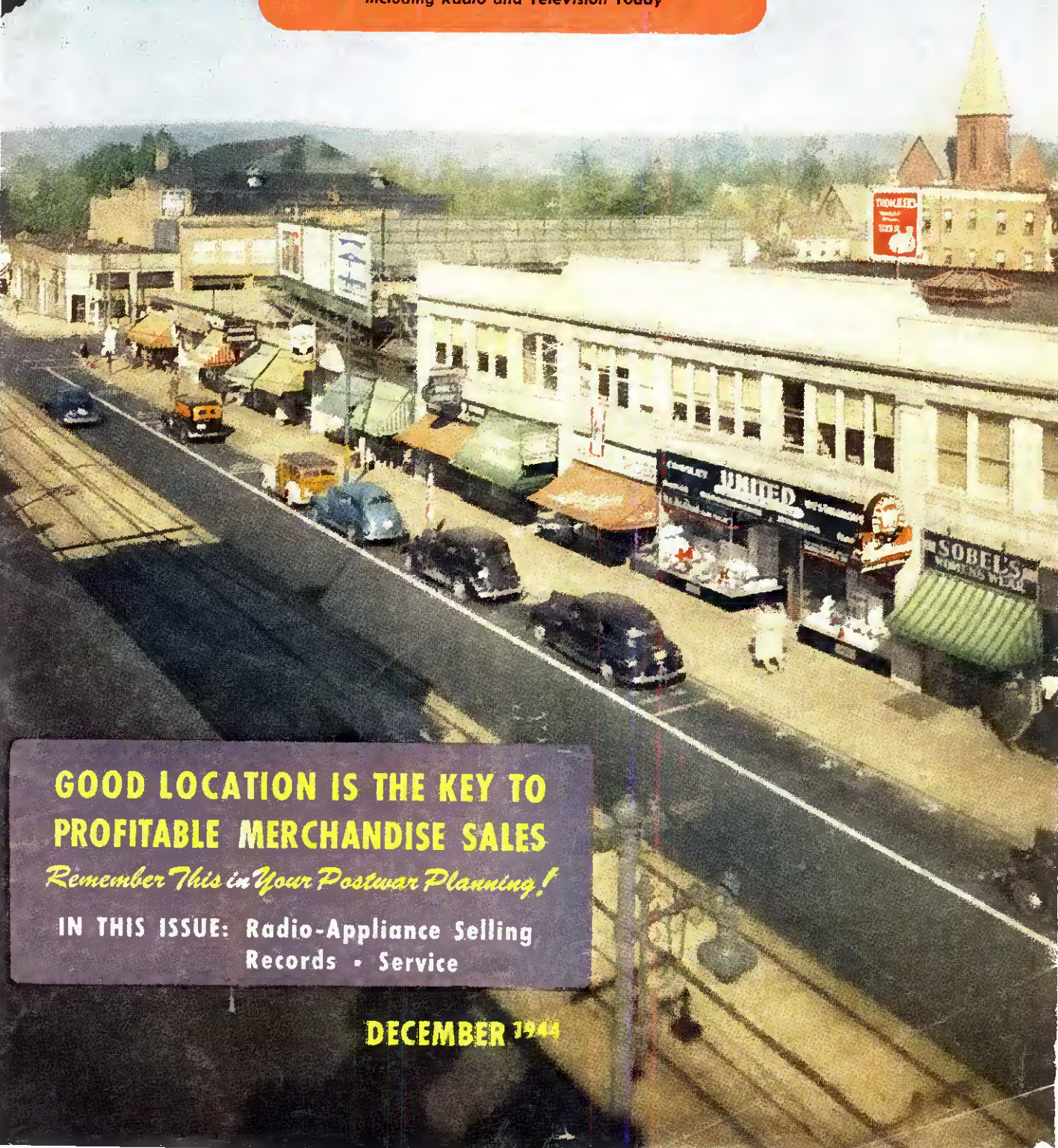

**GOOD LOCATION IS THE KEY TO
PROFITABLE MERCHANDISE SALES**

Remember This in Your Postwar Planning!

**IN THIS ISSUE: Radio-Appliance Selling
Records • Service**

DECEMBER 1944



Up To Your Ears
in Service Orders?

Save Time with
P. R. MALLORY & CO. Inc.
MALLORY
 Replacement Parts

If you're like most service men we know, you wouldn't mind closing shop for a while—just to try to catch up with orders! Of course *that* idea is out of the question. So here's a more practical suggestion:

Use Mallory volume controls, vibrators, capacitors, switches, resistors. They'll help you speed up your work. By concentrating on Mallory precision parts, you'll assure yourself, too, that the job will "stay put."

Mallory approved replacement parts save precious time in at least two ways: Every part is *standardized* so that it fits any of a dozen or more types of receivers. And every part has been *proved in service*—has an *earned* reputation for dependable performance.

Mallory parts are interchangeable. They help get the job done faster. And Mallory parts avoid replacement failures—you won't have to do the job all over again. For a complete catalog of Mallory approved precision products, write direct or see your Mallory distributor.

P. R. MALLORY & CO., Inc., INDIANAPOLIS 6, INDIANA



Speed the Day of Victory.
Buy More War Bonds.

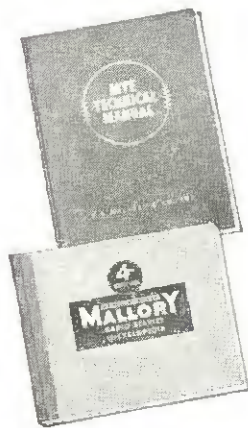

MY TECHNICAL MANUAL
 — 108 pages of complete data on capacitors, noise suppression, receiving tubes, loud speakers, vibrators, phono-radios, automatic tuning and other valuable information. Available from your Mallory distributor... Price, \$2.00.

4TH EDITION RADIO SERVICE ENCYCLOPEDIA . . . Complete information on repairing any make or model of receiver. Circuit references, original part numbers and recommended replacements. Available from your Mallory distributor . . . Price, 95 cents.

P. R. MALLORY & CO. Inc.
MALLORY
 Approved Precision Products

A GAROD FM SET FOR ME

says

Zorina

Vera Zorina, graceful star of stage, screen and the Ballet Theatre, reflects her own sparkling personality in her choice of a postwar radio. "I like things real . . . alive. That's why I've always preferred Garod quality. That's why I'm looking forward to a Garod FM radio when peace comes."

From chassis to cabinet, Garod FM radios will have something exceptional to offer the postwar listening audience. There will be no compromise with tonal quality or range . . . no blurred pictures of sound. Instead, Garod engineering superiority will provide design refinements to make possible true, vivid reproductions along the full scale of music and speech. And Garod merchandising and promotional alertness will supply a carefully thought-out sales program that is bound to click from the very start. In short, we plan not only to build the finest in FM, but the most productive sets from the standpoint of rapid turnover, volume and profit. A few desirable postwar distributorships are still open . . . write today, on your letterhead, for details.

GAROD RADIO



GAROD RADIO CORPORATION • 70 WASHINGTON STREET • BROOKLYN 1, N. Y.

Radio's first

West



**The New Radio
and Television
Sets are Coming**

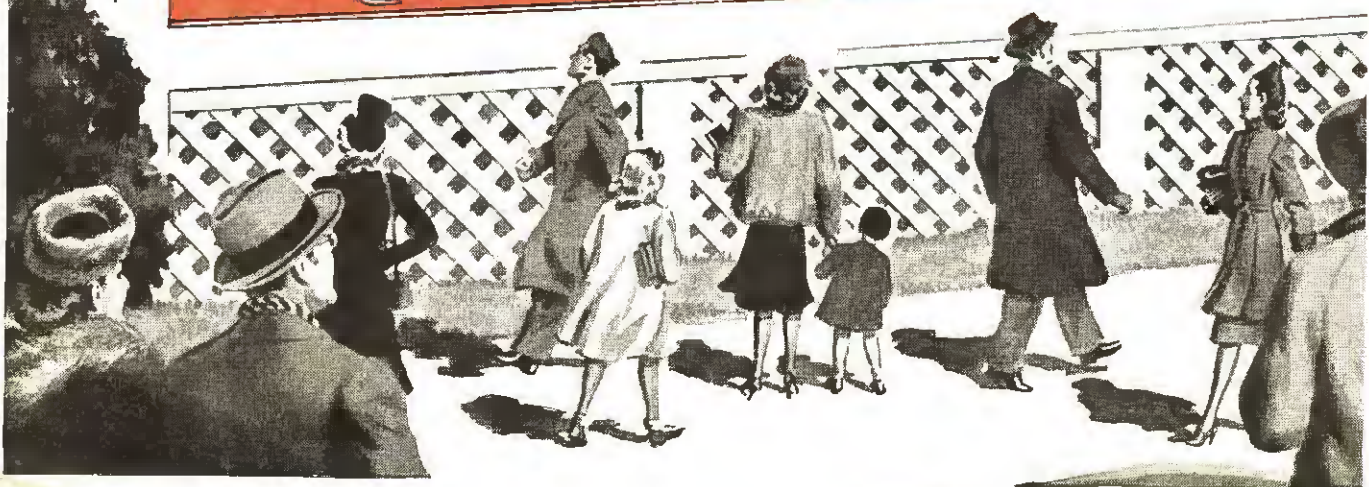

name is inghouse

SIGN THAT AN OLD FRIEND IS COMING WITH SOMETHING NEW

★ ★ ★ Westinghouse will be ready when victory is won... with new and better radio and television receivers.

That's welcome news to the users of 30 million Westinghouse home appliances... because to them Westinghouse is more than a famous name. It is an old friend on whom they've learned they can depend for good products at fair prices.

That's not all. Ask a few of your customers what the name Westinghouse means to them in *radio*. You'll find many an old fan of radio station KDKA, the world's first broadcasting station. You'll find many who remember the famous Aeriola, Jr., as the world's first factory-built set. You'll find many who remember with gratitude that it was Westinghouse who made it possible to operate a

radio simply by plugging it into house current—doing away with batteries.

You'll find those who know that the electronic-beam *iconoscope* (the eye of the television camera) and the cathode-ray picture tube of modern television receivers were both originated in the Westinghouse laboratories.

And when those ten million *new* customers return from the wars, it will be hard to find one who isn't familiar with the name Westinghouse on what he knows to be the finest military radio and radar in the world.

You can depend on Westinghouse to give you the advertising, the promotion, and the product that it takes to achieve leadership in radio and television.

WESTINGHOUSE ELECTRIC & MANUFACTURING COMPANY
PLANTS IN 25 CITIES • OFFICES EVERYWHERE

Westinghouse

RADIO TELEVISION

**PRODUCTS OF
MERIT
SHARE IN THIS
RECOGNITION—**

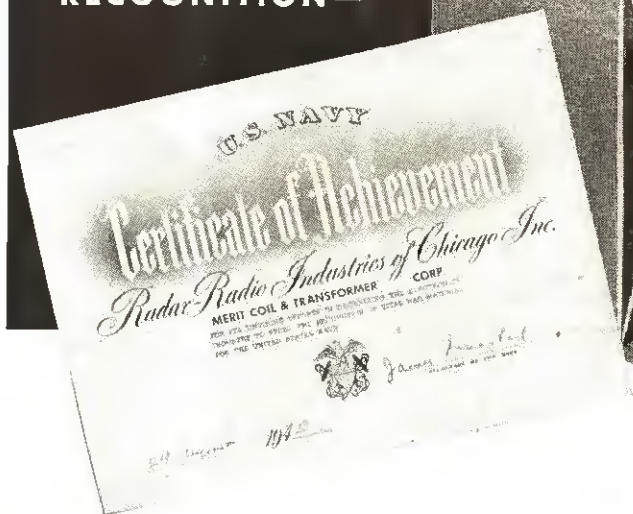

Merit Coil and Transformer Corporation is proud of this U.S. Navy Certificate of Achievement, awarded to us as part of Radar-Radio Industries of Chicago, Inc.

With highly skilled workers and the most modern equipment for manufacturing in accordance with the latest trends in radar-radio production and assembly, Merit has specialized in specific transformer applications for widely varying fields, climates and altitudes.

These same facilities and broad experience are available now for development of your post-war products.

Your inquiries will have prompt attention.



MERIT COIL & TRANSFORMER CORP.

4427 North Clark St.

CHICAGO 40, ILL.

**RADIO
Television
RETAILING**
Including Radio and Television Today

MEMBER AUDIT BUREAU of CIRCULATIONS

DECEMBER, 1944

COVER—Plainfield, N. J., business street scene, shows value of good location on this busy thoroughfare to the United Appliance Stores, Inc. (See story page 26 and Location article on page 28.)

Page	
21	Plan for Postwar Prosperity
22	Radio and Appliances Today
24	Postwar Merchandising of FM
26	Retailer Features Service for Tomorrow's Sales
28	Location Trends in Retailing
30	Radiomen's Wartime Activities
32	Quality Is Success Formula
34	Store Interior Modernization
36	Video-Radio-Sound Expert
38	A Record Christmas
40	Retailers Turn to Repairs
42	Disc Promotions Yield Sales
48	Dealer Prepares for Peacetime
52	Records and Gifts Profitable
57	Inventory Is Important
66	Conversion Specialist
68	Television News
70	Volume Control Service
72	Service Notes
78	What's New
80	Distributor Doings
82-108	Radio Trade News

RADIO & Television RETAILING, December 1944, Vol. 29, No. 12. 25 cents a copy. Published monthly by Caldwell-Clements, Inc., 480 Lexington Ave., New York 17, N. Y. M. Clements, president; Orestes H. Caldwell, treasurer. Subscription rates United States and Latin American countries, \$1.00 for one year, \$2.00 for three years. Canada \$1.50 for one year, \$3.00 for three years. All other countries \$2.00 for one year, \$4.00 for three years. Printed in U.S.A. Re-entered as second class matter April 21, 1944, at the Post Office at New York, N.Y., under the act of March 3, 1879. Member of Audit Bureau of Circulations. Copyright by Caldwell-Clements, Inc., 1944.

ORESTES H. CALDWELL
Editor

M. CLEMENTS
Publisher

H. L. M. Capron, Merchandising, Editor
William E. Moulic, Technical Editor
John L. Stoutenburgh, Managing Editor
Helen Thurman, Associate Editor
Charles F. Dreyer, Art Director

E. T. Bennett	Hope Bedard
M. H. Newton	J. A. Samborn
B. V. Spinetta	O. H. Sutter
N. McAllister	W. W. Swigert
E. Duggan	L. D. Chesson

Lee Robinson, Sales Manager
Ben Morris, Promotion Manager
R. Y. Fitzpatrick, Western Manager
Chicago, 201 N. Wells St.
Telephone RANdolph 9225

Editorial and Executive Offices
Telephone PLaza 3-1340
480 Lexington Avenue
New York 17, N. Y.

"There is a tide in the affairs of men, which, taken at the flood, leads on to fortune."

A
VALUABLE
FRANCHISE

exclusively for

*"The Top
400"*



WHO are "the top 400"? They are the 400 leading quality music, furniture, radio or department stores—stores that have the clientele, finances, experience and facilities for handling the finest in radio-phonographs.

Only these "top 400" stores will have an opportunity to obtain the Freed-Eisemann Protected Franchise, which will be offered on a direct-to-dealer basis. This franchise will be one of the industry's most eagerly sought-after franchises when civilian production is resumed.

This is easy to understand, of course. Before converting to war production, Freed-Eisemann was one of America's leading quality radio manufacturers. Freed-Eisemann radio-phonographs, which retailed up to \$1200, were the *only* line of radio-phonographs in

which *every* model was equipped with FM. The new Freed-Eisemann radio-phonographs will also retail in upper price brackets, and once again *every* model will be FM-equipped. However, this FM will be even finer than before, as a result of Freed-Eisemann war-time engineering research and experience.

In addition to finer FM, there will be finer standard radio, international shortwave and reproduction of recorded music. Cabinets will be outstanding examples of authentic, beautifully styled period and contemporary pieces.

If *you* are one of "the top 400," you may be able to qualify for the Freed-Eisemann Protected Franchise. Your inquiry is invited.

Freed Radio Corporation, 200 Hudson Street, New York 13, New York.

Freed-Eisemann

ONE OF THE WORLD'S GREAT RADIO-PHONOGRAPHS



**in record
changers**

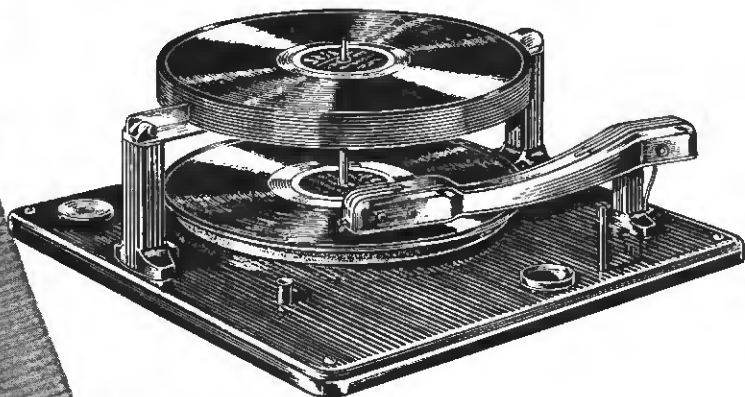

FARNSWORTH

You can safely stake your reputation on Farnsworth record-changers—today accepted as *the* standard for the industry.

Farnsworth has 16 years of pioneering experience in designing, and producing fine, trouble-free, automatic record-changers. It has developed many important inventions and principles that have simplified operation and improved performance.

Farnsworth owners and dealers all say,

"Farnsworth has the most dependable record-changers." Prewar experience will make for postwar confidence and sales. Further record-changer improvements will be featured in the *new* Farnsworth line.

Farnsworth changers are right for the dealer . . . simple, long-lasting, trouble-free and time-proven . . . do away with frequent and costly service. . . . When you sell a Farnsworth, it stays sold!

FARNSWORTH

Television · Radio · Phonographs

Farnsworth Television & Radio Corporation, Fort Wayne 1, Indiana. Farnsworth Radio and Television Transmitters and Receivers; Aircraft Radio Equipment; Farnsworth Television Tubes; The Farnsworth Phonograph-Radio; The Capehart; The Capehart-Panamuse.

The Best
Show
On the Air
Saturday
Night!

"MEET YOUR NAVY"
Now Carries the RAYTHEON Name
into 3,500,000 Radio Homes Each Week!

Free!
Ask your Raytheon distributor
for colorful attention-getting
"Meet Your Navy" display to
tie in with this great program.
Easel-mounted, 17 1/2 x 20 1/2"

Every Saturday Night
ENTIRE BLUE NETWORK
Coast to Coast 181 Stations



RAYTHEON MANUFACTURING COMPANY
Waltham and Newton, Massachusetts



All Four Raytheon Divisions
Have Been Awarded Army-
Navy "E" with Three Stars

RAYTHEON

High Fidelity



ELECTRONIC AND RADIO TUBES



DEVOTED TO RESEARCH AND THE MANUFACTURE OF TUBES AND EQUIPMENT FOR THE NEW ERA OF ELECTRONICS



History of Communications. Number Twelve of a Series

COMMUNICATION BY THE BLINKER



The Blinker, an adaptation of the Heliograph with its own source of light, has been found invaluable for night and day Naval Communications. While limited by "line-of-sight" transmission and the elements of weather, it has been an aid to our cautious convoys during "radio silence."

When Victory is ours and the days of "radio silences" are gone forever, private citizens again will have electronic voice communication equipment for their yachts and other pleasure craft. With the release of civilian radio bands Universal will again offer the many electronic voice components for use in marine craft.

< *FREE—History of Communications Picture Portfolio. Contains over a dozen pictures suitable for office, den, or hobby room. Write for your "Portfolio" today.*



UNIVERSAL MICROPHONE COMPANY
INGLEWOOD, CALIFORNIA



*Perfection in Design
and Performance*

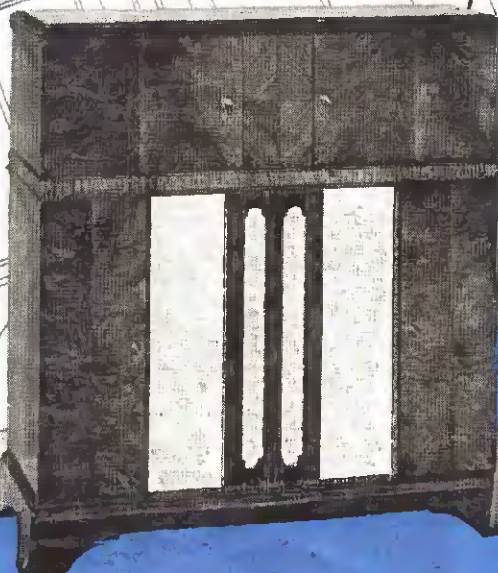

HOWARD

Though our manufacturing facilities are still entirely devoted to vital communications equipment, designs for new Howard Entertainment Radios are flowing freely from the planning boards.

When civilian production lines move forward again, these designs will reflect the background of Howard's tradition to provide the maximum in performance and value.

America's Oldest Radio Manufacturer

HOWARD RADIO COMPANY

1731-35 BELMONT AVE. • CHICAGO 13, ILL.



SYLVANIA NEWS

RADIO RETAILER EDITION

DECEMBER

Published in the Interests of Better Sight and Sound

1944

Sylvania Equipment Soars Aloft With The Boeing B-29s

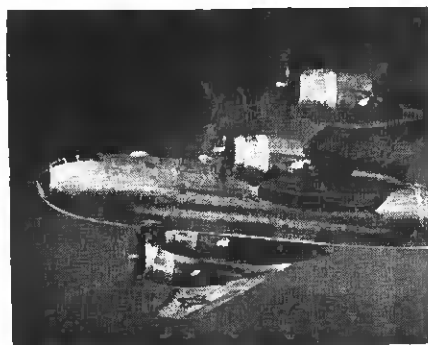

Exterior view of the B-29, which carries electronic equipment such as is made by Sylvania and others. (Boeing Photo.)

Radio communications equipment and electronic navigational aids have been developed to a new pitch of perfection aboard the giant Boeing Superfortresses.

Sylvania has made important contributions to this equipment. Not only are many Sylvania Tubes utilized in the various radio sets on the B-29s, but Sylvania is among the manufacturers supplying electronic equipment for the Superfortresses. (One of the reasons why Sylvania Tubes are in limited supply.)

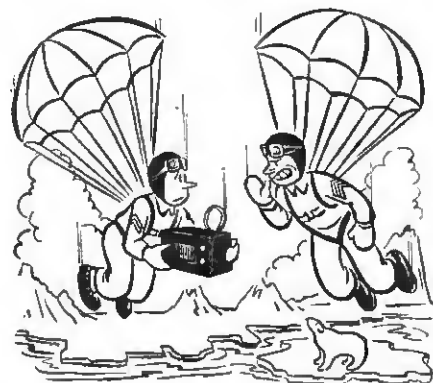

"Next time you bail out, for heaven's sake grab a set with Sylvania Tubes!"

Television, FM Seen Opening Big Market for Sale of Lock-In Tubes

Sylvania Dealers Will Have Opportunity to Cash in on Tubes' Unique Features

With all signs pointing to rapid post-war expansion of television and FM, it is to be expected that new markets will be opened for the sale of Sylvania Lock-In Tubes. When Sylvania engineers initiated the design of the Lock-In Tube in 1936, they devoted special attention to the requirements of ultra-high frequency applications. For this reason, it is probable that many manufacturers of television and FM receivers will incorporate these tubes in their original designs. This, in turn, will open the way for replacement sales by dealers.

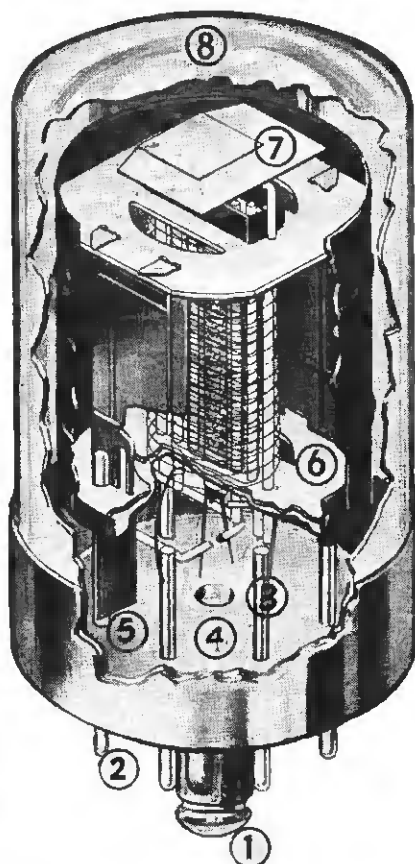

The famous Sylvania Lock-In Tube. Numbers refer to the tube's 9 points of electrical and mechanical superiority. (See article at right.)

FEATURES OF LOCK-IN TUBES

The lock-in feature is but one of the advantages of these tubes, which represent a distinct step forward in tube design. Dealers will want to familiarize themselves with these features, for the benefit of their customers (numbered features correspond with illustrations at left):

1. The lock-in locating lug, which prevents shocks and jars from loosening tube, and acts as a shield between pins.
2. All welded connections for greater durability.
3. Short, direct connections for greater durability.

OTHER ADVANTAGES

4. All-glass header, which decreases losses, and gives better spacing of lead wires.
5. No glass flare, giving unobstructed space for internal shielding.
6. Improved mount support that reduces warping and weaving of elements.
7. Getter location on top, preventing shorts by separating getter material from leads.
8. No top cap connection.
9. Lower over-all height, an important aid to space conservation.

SYLVANIA  **ELECTRIC PRODUCTS INC.**
Radio Division · Emporium, Pa.

MAKERS OF FLUORESCENT LAMPS, FIXTURES, ACCESSORIES, INCANDESCENT LAMPS, RADIO TUBES, CATHODE RAY TUBES, ELECTRONIC DEVICES



1945

1945 dawns clear and bright . . . with new hope on the horizon . . . a hard-to-restrain spirit of optimism rewarding a nation unified in pursuit of Victory. Until Peace has been won, we at FADA are devoting all our resources and energies to the war effort. Our post-war promise will be revealed in performance.

PLACE YOUR FAITH
IN THE

FADA Radio

OF THE FUTURE

Famous Since Broadcasting Began!

FADA RADIO AND ELECTRIC COMPANY, INC., LONG ISLAND CITY, N. Y.

**Even before the war,
the Philco Refrigerator gave you
this Advanced Design . . .**

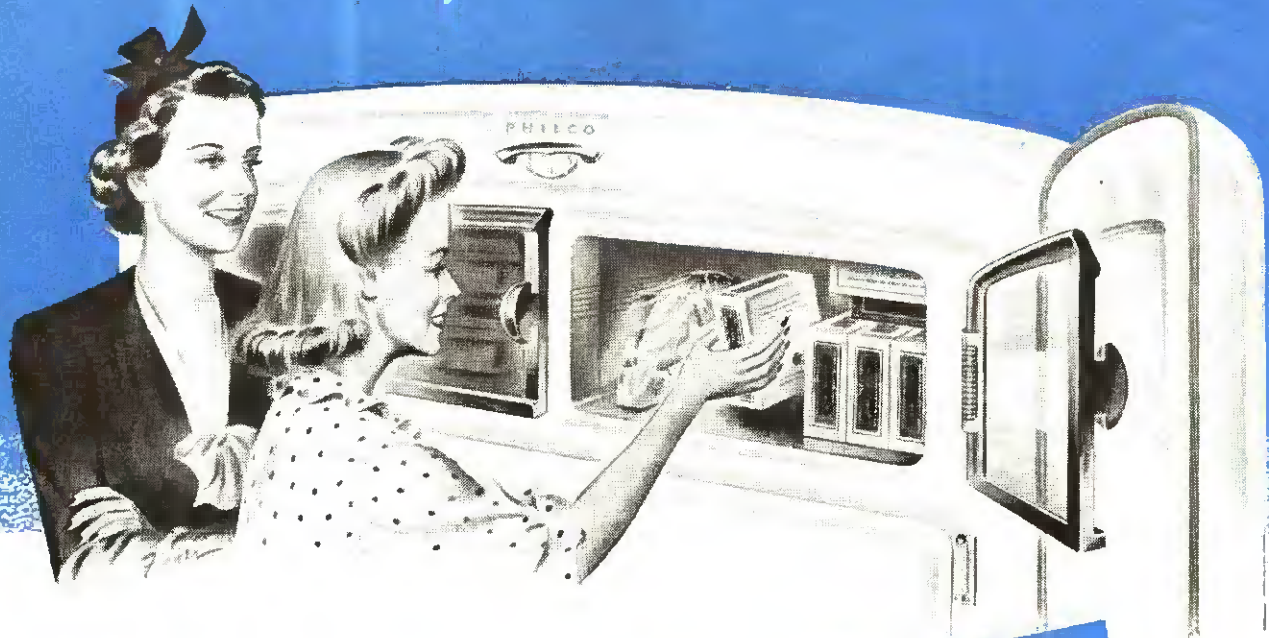

**A FREEZER-LOCKER
SPECIALLY DESIGNED FOR
FOOD FREEZING
AND STORAGE!**

After Victory . . .

PHILCO REFRIGERATORS AND FREEZER CHESTS

WILL GIVE YOU A COMPLETE PROGRAM
TO SUPPLY THE DEMAND FOR HOME
FREEZING AND FROZEN STORAGE

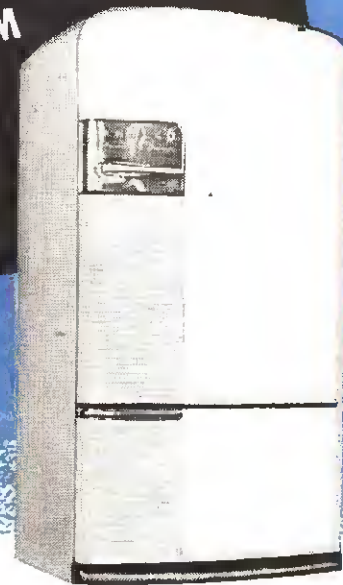

YES, A FULL TWO YEARS before the war, Philco introduced a complete line of refrigerators with full size, built in Freezer-Lockers. Thus Philco was the first to recognize the importance of food freezing and frozen storage in the home. And now, Philco engineers approach their post-war designs with years of pioneering research and experience.

After Victory, frozen storage will be a "must" in refrigerator merchandising. And you can look to the progressive thinking and *experience* of Philco engineers to give you a complete program that will help you take fullest advantage of this new demand and new source of profit. That means not only new, Advanced Design refrigerators but a complete line of Freezer Chests in sizes to meet the needs of every home and family. And they will be backed by the kind of advertising and promotion that has made the Philco name stand for *leadership* in millions of American homes.

PHILCO

Famous for Quality the World Over

Variable Tuning Condensers, Push Button Tuning

Mechanisms and Actuators, Phonograph Record Changers



**A NEW DIVISION
UNDER THE DIRECTION OF
LEE GOLDNER**

identified for more than 20 years with
the manufacture of radio speakers.

Millions of radio components on the far flung battle areas of the world bear the G. I. insignia. What they have accomplished is already in the archives.

Behind General Instrument's record of achievement in the quantity production of electronic equipment for military use, stands nearly a quarter century of highly specialized production and experience in the field of radio components for home receiving sets.

GENERAL ELECTRONIC APPARATUS CORP.

A SUBSIDIARY OF

GENERAL INSTRUMENT CORP.

829 NEWARK AVE., ELIZABETH 3, N. J.

... and now
speakers
by G.I.

The addition of a complete line of speakers is, therefore, not a venture into a new field, but the logical outgrowth of our expanded facilities, developed by wartime activities and increased resources in the radio equipment industry.

The resourcefulness and ingenuity—the expanded and perfected facilities that made this mammoth production possible will be put, without stint, behind our new speakers. Set manufacturers will know what this will mean.





At Your Service!

**91 SONORA RADIO
DISTRIBUTING
CENTERS!**

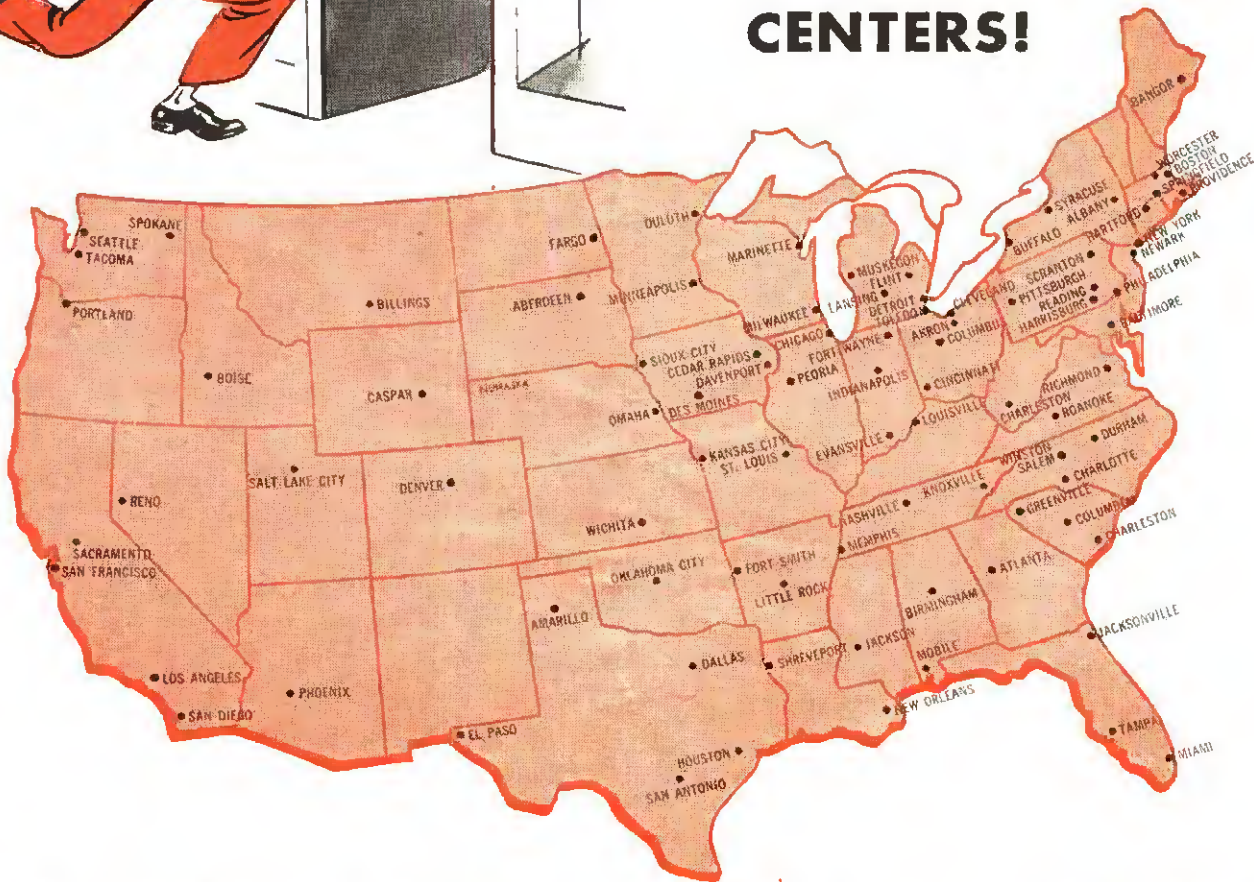

84 already have been appointed—and by the time Uncle Sam gives us the go-ahead to produce civilian radios, 91 of the best-known, best-liked distributors in the industry will be ready with Sonora's complete Home Entertainment line.

Known to consumers as a quality-plus product since 1914—famed for "Clear As A Bell" tonal perfection through all these years—applauded for maintaining a dominant national advertising

campaign in 11 top magazines throughout the War—Sonora today means *Home Entertainment At Its Best* to millions. To you it means prestige and profits far above the average. Sonora is the line for far-sighted merchants who sense the competitive advantages of a complete range of nationally-advertised Home Entertainment products designed, priced and merchandised to please every taste, every purse, every type of customer.



Home Entertainment At Its Best

RADIOS • PHONOGRAPHS • RADIO-PHONOGRAPHS • RECORDS • RADIO-PHONO-RECORDERS

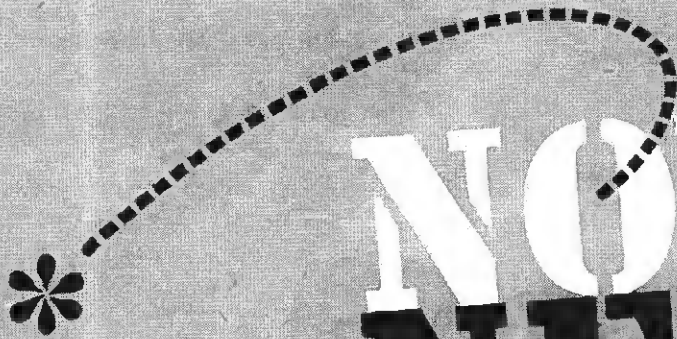

NOW NEW!

● These two "action words" are being used by us to headline this ad for a very definite reason.

● We are NOW ready with a NEW announcement which, we are sure, will be welcomed by hundreds of dealers, radio "hams", jobbers, and industrial organizations of all types who use transformers in the course of their operations.

● We have stated before, and we must reiterate, that our first concern is to do our part in helping to win the war.

● Nevertheless, the time has arrived when we can state that we are now actually engaged in preparing new models of transformers, for civilian use as soon as war conditions permit. These new Thordarson transformers embody ideas based upon our 50 years of leadership in this industry, our war experiences, and our determination to again set the pace in the field when civilian needs can once more be taken care of.

● The new Thordarson transformers will be streamlined, modern . . . in many instances more compact . . . designed with all the skill and ingenuity that can be brought to bear in order to produce more serviceable products. When you see these new designs, you will again be reminded of how Thordarson leadership means more service, more convenience and more all-around satisfaction for you.



THORDARSON

Transformer Specialists Since 1895
ORIGINATORS OF TRU-FIDELITY AMPLIFIERS

THORDARSON ELECTRIC MFG. CO. • 500 W. HURON ST. • CHICAGO 10, ILL.

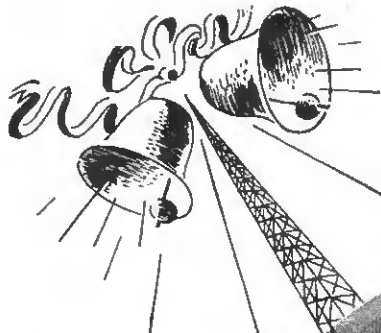

This Christmas our Fighters have Radio!



LISTEN

To JOHN W. VANDERCOOK
Every Saturday afternoon from
5:30 to 5:45 E.W.T. the complete
NBC network carries Sentinel's message
to YOUR customers. See your newspaper
for local time and station.



Sentinel RADIO

Radio in this war, beyond its great military service in hastening victory, has performed another and more human service—it has enabled the soldiers to keep in touch with home. For the first time in history, soldiers on all fronts at Christmas time can listen to the United States—can hear familiar Christmas songs, voices and holiday programs wherever they are. This has been radio's contribution to fighting morale.

The development of radio to its present high peak of efficiency has been shared by Sentinel in research, production and manufacturing skill. During the war, Sentinel's every effort has gone into the creation or betterment of radio and electronic equipment—to aid in the successful prosecution and early conclusion of the war.

Sentinel shares with the entire world a hope that before next Christmas all hostilities will be ended... and new, improved post-war Sentinel radios will be moving rapidly off your shelves.

SENTINEL RADIO CORPORATION

2020 Ridge Avenue, Evanston, Illinois

SPRAGUE TRADING POST



A FREE Buy-Exchange-Sell Service for Radio Men



... from all of us to all of you!

To all our friends, old and new, to those in the armed forces, to all who have entered war work, and to those still on the job at the old stands...

Our best wishes for the 1944 Yuletide and our sincere hope that the year 1945 will see the dawn of a peaceful, better, happier world.

SPRAGUE PRODUCTS CO.

WANTED—One Hughes Mitchell 10 meter mobile transmitter. A. W. Stewart, Chief Engineer, KBWD and KNWV, P.O. Box 372, Brownwood, Texas.

FOR SALE—Three Turner 33D dynamic microphones, \$21.50 ea.; four heavy-duty floor-type microphone stands, \$14 ea.; three E12P Utah 12" PM speakers, \$11.60; three G12P Utah 12" ditto, \$20 ea. Prices F.O.B. John J. Spankowitz, 239 No. 9th St., Allentown, Pa.

URGENTLY NEEDED—Good signal tracer—any std. make but must be in A-1 condition. Also need Rider's Manuals vols. 6, 7, 9, 10, and 11. Paddock Radio Service, Kingsville, Mo.

WANTED—One 50L6 tube. E. C. Rogers, Kingston, Tenn.

WANTED—A 5-tube table model radio, must be in working order. Also want power shifter to change a 6-tube 110v a-c set to 32v d-c. Alfred L. Mergel, Dilley, Texas.

URGENTLY NEEDED FOR CASH—1-tube Philmore pocket battery sets. State quantity and price. Also want transceiver. Ira Jacob Blowitz, 1937 Davidson Ave., Bronx, New York 53, N. Y.

WANTED—RCA type miniature tube, 1S4; also need 100 mmf. var. condenser. Frank Smith, Box 421, Ada, Oklahoma.

WANTED—Late model tube tester and condenser checker, V-O-M, and vibrator tester of good, standard quality. Frank Cirincione, 427 Evans Ave., Reno, Nev.

FOR SALE OR TRADE—Detroitla 5 and 10 meter S-W converter in original cart. Want 45Z3 and 12A7 tubes. A. M. Stump, 311 Marathon Ave., Dayton 6, Ohio.

WANTED—A good multimeter including an a-c, d-c V-O-M (range 10 megohms) and a signal generator and tube tester. Wilmer C. Loyd, General Delivery, Lake City, Fla.

FOR SALE—Brunswick radio and automatic record changer model 15B or 42AC. Set and changer less tubes, \$25 f.o.b. George Greenberg, Radio & Television Service, 321 Porter St., Philadelphia 48, Pa.

WILL TRADE complete I.C.S. Radio Course complete with text and lesson books and charts, like new. Want S-W set of AC-DC type or what have you. Will also swap home-made power supply now used on a Super Wasp receiver. What have you? M. P. Hyatt, 23 Forman St., Cazenovia 1, N. Y.

URGENTLY NEEDED—Pre-grooved recording blanks—any quantity. Cash. Geo. Strack, 532 So. Campbell Ave., Chicago 12, Ill.

FOR SALE OR TRADE—Rider Manuals 1, 2, 3, 4, 5, 6, 13; Gernsback Manuals 31 and 32; microphones, speakers, condensers, Remington Foursons razor (new). Need Supreme Veedolyzer 560A; sig. generator 561. Give full details first letter. Frank J. Moch, 5925 So. Albany Ave., Chicago, Ill.

WANTED—Late signal generator in good working order, also radio shop eqpt., tubes, and Rider's manuals. Amos A. Kujala, 124 Parker St., Maynard, Mass.

FOR SALE—Hallcraft 5-tube 4-band s-w receiver, good condition, \$15; Jewell 2" d-c 0-1 ma., \$6; 21-circuit 4-position PRX telephone switch board; 110v d-c fans, \$5. Want FM receiver, tuner, kit, or what have you? Riley Parsons, Raquette Lake, N. Y.

WILL SWAP Superior \$1250 Volt-Ohm-Millimeter, a-c operated, in good condition, with capacity scale. Want signal generator. Roger Williams, 49 Lucerne Road, Springfield 9, Mass.

TEST EQUIPMENT WANTED—Signal generator, tube tester, and multimeter. What have you? J. B. Haldbrooks, Crossville, Ala.

WANTED—Good tube tester. Describe fully. Herbert Lane, Hdv. Division of Callaway Mills, La Grange, Ga.

FOR SALE OR TRADE—Dynamotor, 5.5v input, 375v output; Transformer and cond. and socket wired up for power supply, no vib. Want condenser checker. F. M. Steiner, 125 Wellington Circle, Oak Ridge, Tenn.

WANTED FOR CASH—Critical tubes; Solar 2-tube condenser tester; Philco sig. generator; late model tube tester. Roy E. Carr, Box 155, Harper, Kans.

FOR SALE—National NC-100 complete with speaker, \$100. Also National NC-101X complete with speaker, \$125. Both in fine condition. Prices f.o.b. Geo. N. Kimm, 2431 "Que" St., Bakersfield, Calif.

FOR SALE OR TRADE—Eight VT-1 tubes, new condition. L. C. Chapman, Rt. 1, Columbus, Miss.

FOR SALE—All-Star Sr. all-wave receiver with BFO complete. Want good recording head or complete eqpt. W. C. Petrie, Box 248, Reidsville, N. C.

WANTED FOR CASH—Hallcraft SX-28 or 32 or Howard 490 receiver. Edward Johnson, 52 E. Willis St., Detroit 1, Mich.

WANTED—RCA oscillator \$150 and RCA oscillograph with 2" scope. Cash. T/Sgt. Ray Wensman, Cottonwood, Idaho.

WANTED—S-8 mfd. condenser; 25,000 ohm 50-watt resistor; R-F choke; National TMS 100 variable condenser; 5Z3 tube. One of each. James C. Richard, 538 Daggett Ave., Pawtucket, R. I.

FOR SALE—American dynamic microphone No. D7T, \$11; Electro voice mike 2V-1, \$11; two Jensen Hypex trumpets with 15-watt driver units, never used. Both mikes are high impedance. Want Shure 5556 mike. Cash or will trade. Patrick Radio & Sound Service, 1818 W. Cermak Rd., Chicago 8, Ill.

URGENTLY NEEDED—Popular radio tubes, late model small radios, surplus radio stocks, and paper condensers. Must be reasonably priced. What have you? Best Radio, 3349 Fulton, Cleveland 9, Ohio.

WANTED—70L7GT radio tube. Jerome Freeman, 2 Birchwood Ave., Port Washington, N. Y.

FOR SALE OR EXCHANGE—Melissner console radio, 12" Magnavox P.M. speaker, 8" Utah dynamic speaker, 1000 ohm field; Thordarson T-13541 and P-57501 output trans., Weston 506 0-5v. D.C. meter, permeability (Aladdin) tuner and complete parts to build 5 T. super, complete kit for Melissner high fidelity tuner; also tubes and other radio parts. Want cameras and photographic equipment. John Kasperski, 807 Front St., E. Hempstead, N. Y.

URGENTLY NEEDED—Hallcrafters "Sky Chumpton" S-20R receiver—also 0-1 ma. milliammeter. Must be perfect. Henry W. Gould, 422 N. 6th Ave., Shea Terrace, Portsmouth, Va.

WANTED—2 phono pickups, 2 phono motors, 6, 12, 35 and 50 tubes, small 5-tube radio, parts and equipment. Have fine old violin for sale. V. D. Letourneau, Jr., 179 Main St., Holyoke, Mass.

FOR SALE—RCA Victor amateur recorder, 24-17M, and Hallcraft receiver, SX-11. H. E. Weintraub, Checker Radio Service, 279 Third St., Jersey City, N. J.

WANTED—Urgently need set of 6-prong plug-in coils and diagram of practice code oscillator. Roy Rickles, 901 1/2 9th St., Alabama City, Ala.

FOR SALE—Tubes, used—but in good condition; W8R, 8BX, 24A UX210, 24A, 45, 6D6, 27, 110-70, CX299, 80, 6C6 and 42. 25 cents each. James Fullerton, 4149 Nebraska Ave., St. Louis 18, Mo.

FOR SALE—Philco tube tester, upright floor model. Will test all metal tubes—sockets for local tubes, not wired. Supreme Radio, 909 Madison Ave., Madison, Ill.

WANTED—Good communications receiver; RCA Iconoscope \$1847 or monoscope \$1898; RCA Kinescope 3AP4/806P4, 5AP4/1805P4, or 5BP4/1802P4; P.A. amplifier; also back copies RADIO NEWS AND RADIO CRAFT. Wm. Irby, 101 W. 8th St., Stroud, Okla.

FOR SALE—Set sig. tracing probes, auto radio, phono-radio comb., S. & D.B. mikes, radio magazines, books, etc. Harry Kay, Rt. 2, Box 255, Inlay City, Mich.

FOR SALE OR SWAP—Sonotone bone contact hearing aid with meter to test batteries, \$35, or will trade for test equipment, cathode ray tubes 5" or larger, television parts or kits, high-voltage power transformers, G. I. recorder-changer or record changer. F. U. Dillion, 1200 North Olive Drive, Hollywood 46, California.

FOR SALE—Following tubes: 951, 950, 1A4, 1C6, 30 and 32. Lloyd's Radio Service, Willmar, Minn.

YOUR OWN AD RUN FREE!

This is Sprague's special wartime advertising service to help radio men get needed parts and equipment, or dispose of radio materials they do not need. Send your ad today. Write PLAINLY or PRINT—hold it to 40 words or less.

Different Trading Post ads appear monthly in Radio Retailing-Today, Radio Service-Dealer, Service, Radio News, and Radio Craft. Sprague reserves the right to reject ads which do not fit in with this service. WHEN BUYING CAPACITORS—PLEASE ASK FOR SPRAGUE'S BY NAME. WE'LL APPRECIATE IT!

HARRY KALKER, Sales Manager

SPRAGUE PRODUCTS CO., DEPT. RRT-124, North Adams, Mass.

(Jobbing distributing organization of products manufactured by SPRAGUE ELECTRIC COMPANY)



SPRAGUE CONDENSERS * KOOLOHM RESISTORS

Obviously, Sprague cannot assume any responsibility, or guarantee goods, services, etc., which might be exchanged through the above advertisements

WHEN "UNCLE" GIVES THE WORD...

You'll Get Radios by STEWART-WARNER

AFTER PEARL HARBOR, the radio division of Stewart-Warner was among the very first to shift entirely into war production.

And, when "Uncle" gives the "go ahead," you can rest assured that Stewart-Warner will be among the first to deliver civilian radios to you!

The secret of Stewart-Warner's ability to shift production speedily lies in highly perfected and flexible methods of plant operation learned in 20 years of radio manufacturing.

These methods have resulted in amazing war production records. In fact, since Pearl Harbor, Stewart-Warner has shipped more than 12,000,000 pounds of radio, communications and direction-finding equipment to Army and Navy forces. This volume totals more than 1200 freight carloads or a train nearly 12 miles long! And *shipped on time!*

All of this equipment is doing a job. And the Stewart-Warner Radios *you* will get will be the last word in performance, workmanship and dollar value. It will pay you in profits to wait and see for yourself.



Look to STEWART-WARNER for the Class of the Radio Field!

- EXPECT great things from Stewart-Warner. You'll not be disappointed. The line will be a "best seller" because each model will be built with that in mind and based on pre-war experience plus trends for post-war. Furthermore, Stewart-Warner Radios will be backed by BIG advertising, merchandising and selling power! So, hold everything until you see what Stewart-Warner has for you to sell.



RADIO DIVISION OF STEWART-WARNER CORPORATION, Chicago 14, Illinois

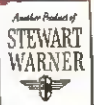

For there's nothing finer than a Stromberg-Carlson, and the *main radio* in any home should be as good a radio as its purchaser can buy—a true musical instrument—a Stromberg-Carlson radio.

That's the story Stromberg-Carlson is currently telling through

50,000,000 impressions in leading magazines. And that is the sales story, we believe, about which you can most profitably build your postwar radio merchandising plans. For Stromberg-Carlson is:

- the *important* radio unit
- the radio unit with easy-selling *public acceptance*

— the radio unit carrying real *profit-opportunity*

Organize your postwar sales around this potent Stromberg-Carlson sales theme. You'll find the Stromberg-Carlson "*main'radio*" a profit maker — whether in an outstanding table model, console, or radio-phonograph combination.

"Make it a Stromberg-Carlson.... HERE



for the main radio in your home"

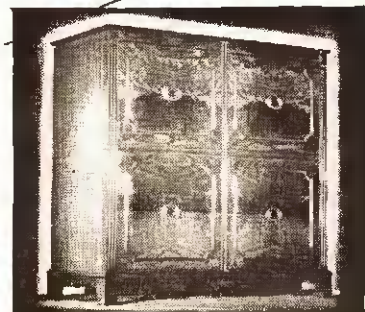

STROMBERG-CARLSON

ROCHESTER 3, NEW YORK
Radios, Television, Telephones, and Sound Equipment

Ten-Point Plan for Postwar Prosperity

In times of war the wise retailer should prepare for peace. In order to get his share of postwar business it is imperative that the dealer lay the groundwork for peacetime selling now.

Careful and constructive planning at this time will permit the dealer to devote all of his efforts toward *selling* radios and appliances as soon as he receives them. If such planning is put off until the merchandise trucks commence unloading at the dealer's front door, general chaos and loss of business is bound to result.

What to Sell Is of Prime Importance

One of the most important questions confronting the radio retailer right now is the choice of brands and lines. There are the technicalities of franchises, the territories, and the makes to be handled to consider. The alert merchant should know now the makes he plans to sell and the lines he plans to carry.

Makes should be chosen with the utmost care. The dealer should consider discounts, factory cooperation and brand-name prominence along with "protected" territory and appliance performance aspects in arriving at his decisions.

Store Improvement Order of the Day

During the impact of war days upon retail business, and a resultant marked shift from sales to service, many dealers have allowed their showrooms and store front to deteriorate. Right now, fortunately, there is a trend toward store improvement, and the necessity for doing a large or small-scale "face-lifting" of store exteriors and interiors is obvious. This magazine is currently publishing valuable suggestions along this line, using staff-drawn illustrations and actual dealer articles.

Now is also the right time to size up the sales and maintenance personnel. Blueprint your plans as to the number of people you plan to employ, methods of compensation, etc.

Plan also your financing set-up. Contact local banks and finance companies. Learn *their* plans. You have three business problems as far as financing is concerned: (a) The means with which to operate your business and carry the general overhead. (b) The means of financing *your* purchases. (c) The means of financing the purchases of your customers.

Another important question to mull over right now is the trade-in problem. "Something new" has been added to the postwar prospective trade-in picture in the shape of antiquated radios and appliances hauled out of cellars, attics and (an honest fact) junk yards. Such out-moded appliances which have been put into operating condition by the ingenious dealer personnel all over the country, will doubtless show up as offered trade-ins in the immediate period after the war.

Other Things to Do in Postwar Planning

Other important things to plan are advertising budgets, up-to-date prospect lists, and how to get your merchandise into the new homes which will crop up all over the country. Close contact with architects and builders is good business now.

Again there are selling plans to make such as door-to-door canvassing, direct mail and telephone calls.

Above all, the merchant must keep clear, all-complete business records. Such records will permit the dealer to know just how he stands financially.

All in all, the plan for postwar prosperity in retail circles calls for action now on the retailer front.

Do These Things Now to Insure Success Tomorrow!

1. Plan what lines and brands to carry.
2. Make store improvement layout.
3. Size up future sales and service personnel.
4. Plan financial set-up.
5. Outline trade-in policies.
6. Map out advertising projects.
7. Work up prospect list.
8. Scan new home business.
9. Settle on selling strategy.
10. Keep accurate records.

RADIO, Appliances, Music,

BIG TELEVISION CONVENTION, Dec. 11-12, at New York, is expected to stimulate industry and public interest in new video art. Television broadcasters are meeting at Commodore Hotel with Dr. Allen B. DuMont presiding. Dr. W. R. G. Baker, GE, and Ralph Beale and E. W. Engstrom, RCA, will be among speakers.

TEN BILLION DOLLARS is the total value of military radio-electronic equipment produced since the defense program started. By years: 1944, \$4,623,000,000; 1943, \$3,455,000,000; 1942, \$1,512,000,000. This compares with the industry's \$250,000,000 output in peacetime, or an increase to nearly 19-fold.

20% SPEED-UP ASKED. L. J. Chatten, chief Radio and Radar Division, War Production Board, is asking radio and electronic manufacturers to make 1945 plans for 18 to 20% increase in production beyond their record 1944 output of \$4,623,000,000. Even if Germany is defeated before March, Mr. Chatten does not expect radio cut-backs to exceed 15%.



"COMPLETE WITH ALL ANTENNAS"—That will be the clinching argument when the real-estate agent shows the prospective buyer his 194x cottage in beautiful Hollyhock Gardens. For antennas will be important to all FM and television installations. And in the event of scattered video transmitters, the householder may need two or three dipoles, properly aimed. Concealed dipoles inside the attic will be a future architectural refinement. "Antennas installed, all ready for tele or FM" will be a new must-line in postwar real estate ads!

1,200,000 MORE "NEW-MARRIED" PAIRS—Because of war conditions the number of marriages that have taken place since Pearl Harbor, 1941, is 1,200,000 ahead of the normal number. This means eventually 1,200,000 additional new homes to purchase radios, tele sets, and appliances.

FIVE MILLION TELE SETS IN FIVE YEARS—that is prediction which Ernest Vogel, Farnsworth exec, has put before American Television Society. Here are the steps postwar as he sees them. First year sales, 250,000 sets; 2nd year, 500,000; 3rd year, 900,000; 4th, 1,500,000; 5th, 2,000,000. Vogel looks for \$150 average retail price, making three-quarter billion dollars in sales in five years—not including 500 transmitters which he expects to see also in operation to complete the 5-year television picture.

PROJECTION TELEVISION, with picture screen 18 x 28 inches, has already been demonstrated to a few small audiences in Camden, Princeton and Manhattan. Some seven of the new projection sets are completed and undergoing tests.

TRUCKERS ARE TRYING OUT radio communication for reaching trucks en route, to change destinations, give pick-up instructions, etc. WPB has authorized equipment, FCC is being asked for both long and short-range channels. Tests begin in the Chicago area.

NOVEMBER ELECTIONS made radio news also. New U. S. Senator from Indiana is Homer E. Capehart, president of Packard Mfg. Co., of Indianapolis, and whose name also titles a fine reproducing instrument now in the Farnsworth group at Ft. Wayne. Chan Gurney, radio broadcaster, was re-elected Senator from South Dakota. And in January, Senator Arthur Walsh, ex-gen'l manager of Edison Industries, West Orange, N. J., will retire from interim appointment by Gov. Charles Edison, as Senator from New Jersey.

SIX THOUSAND JOBS for radio technicians now in Signal Corps and Naval Communications will be available postwar in the shops of America's radio dealers, declares Ben Abrams, based upon replies to Emerson survey questionnaire sent to 20,000 radio dealers.

MEN WHO PLAN BEYOND TOMORROW shouldn't miss the Canadian Whiskey ad in "Life" for November 20, giving advance tip on combination television-facsimile set for postwar home. On the television screen is pictured a three-alarm fire all in lurid colors—while, just below, the facsimile printer is clicking out a radio newspaper with big headlines about the fire, and other news. (Mebbe this is not so far off as you conservatives think!)

WHO'LL BE NEW "SECRETARY OF RADIO"? The Roosevelt Administration is reported as planning to create a new Department of Transportation and Communication, of Cabinet rank. Included in the new Department would be the Interstate Commerce Commission, the Federal Communications Commission, the Maritime Commission, the Civil Aeronautics Administration, the Civil Aeronautics Board, and all other agencies relating to transportation and communication, including the Office of Defense Transportation. Elements in the ODT are back of the program.

RADIO TEST EQUIPMENT for postwar servicing will have to be re-designed in order to test the new tubes which have been built in the last few years and to do an adequate job at the higher frequencies which will be used for television and frequency modulation. Pre-war service equipment will be unable to handle all of the jobs postwar receivers will bring.

and Television TODAY

"THE EX-TRAP-OLATORS" is the name of an exclusive little group of industrial intellectuals who get together monthly to compare and discuss postwar plans of the big companies they represent. Funny name comes from term that is reverse of "interpolate" which, as you know, means to "fill in between known points" on a curve. But when you have to extend a business curve beyond known points, into the future, then you "ex-trap-olate." Paul Ellison, Sylvania, and Herb Metz, Graybar, are among this brainy group of seers and peerers into the future.

"PRESENT TELEVISION SCREEN IS TOO SMALL"—If you hear that about a 9 x 12 inch video picture, just remind the complainant that biggest half-tone pictures he ever saw in *Collier's* or *Satevepost* were no larger—and probably had no more than 545 lines, either!

40% MORE INCOME for U. S., compared with best pre-war record, is estimate for normal post-war years, made for *Crowell-Collier* by Dr. J. F. Dewhurst, who concludes also "The mass market of tomorrow will be the equivalent of the quality market of yesterday."

ELECTRONIC CLOCKS have, at last, reached Greenwich (England) Observatory, time capital of the world. In contrast, U. S. Naval Observatory has kept America on electronic crystal-controlled time ever since 1932!

ELECTRONIC HEARING AIDS can be sold more satisfactorily through radio-appliance dealers, say the latter, declaring that they, for the most part, have an "in" with the hard-of-hearing in their localities since they've been maintaining for years the old carbon-type devices, installing batteries and doing soldering jobs. To keep hearing aids properly sold, however, the dealer must have electronic service immediately available, or be able to offer to lend the customer a set while his goes to the factory for repair.



PHONE IN YOUR POST-WAR FLIVVER—Test autos now running around the streets of New York contain regular dial-telephone sets by which car occupants can, by radio, dial and connect to any telephone in the city. These experiments look to postwar days when telephone company will rent you a telephone in your auto, just as it now rents one in your home or office. New service will come in handy for the tired business man.

FEDERAL HOUSING Administration is reported to have plans for including movable major appliances in the purchase price of house, amortized by payments under one general mortgage. The Wisconsin Radio, Refrigeration & Appliance Assn., seeing in this a "grave danger of passing up the retailer," has adopted a resolution appealing to manufacturers and wholesalers to set up plans for the handling of such possible new business "which will give the retailer a fair and just participation in it."

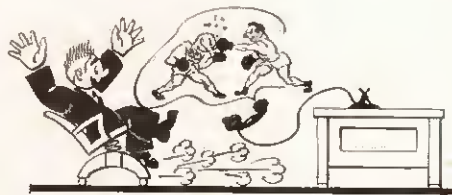

"HELLO CENTRAL—GIMME THE FIGHT"—Those yarns about sending television over telephone lines cause no surprises among video engineers who for several years have been picking-up the Madison Square Garden fistic bouts via regular telephone cables. Only trouble is that television signals are transmitted too well over wires—and over all adjacent phone lines too! In fact, during early tests of phone-wire pick-up, half the phones in Manhattan were found to be delivering a powerful television picture of boxers, referee, squared circle and cheering crowds!

"NEW MANUFACTURERS are expected in many lines, particularly in appliances," believes Albert Haring, Professor of Marketing, Indiana University. "The newcomers from war industry, such as Kaiser, will look for syndicate outlets. Failing to secure these, they will have to turn to wholesalers because of the difficulty of quickly creating a distribution system," declares the Hoosier Prof.

THE RECONVERSION PROBLEM in the electronic field, according to one manufacturer, will be complicated by the shortage of certain materials and components. "I thought we would be ready to roll thirty days after we got the 'go' signal, but the purchasing agent said, 'better make it at least ninety days,'" advises this factory executive. Apparently, manpower, tooling and know-how is easy. Ability to secure materials is the rub!

WESTWARD HO! GE's new electronic manufacturing center postwar will be amid park-like surroundings at Syracuse, N. Y. And RCA's home-radio division is getting ready to leave Camden and trek to Indianapolis and Bloomington, Ind. RCA move was all set to take place several months ago, but rush of Navy orders made inadvisable the shifting of plant machinery which is now scheduled to take place at first lull in naval production demands.

...How to Merchandise It

With Nationwide Broadcasters
Prime their Organizations

AN FM ENTHUSIAST: The following interesting article was especially written for **RADIO & Television RETAILING** by Richard Shryock, proprietor of Shryock Radio and Television Company, 1615 Walnut St., Philadelphia, Pa., whose firm has made over 500 FM and 150 television installations.

• When FM radios first appeared on the market our entire organization became sincerely sold on the technical improvements in acoustical performance inherent in this system of transmission.

First FM was available as optional equipment at extra cost on a number of major lines. From that time on until no merchandise was available, we went all-out for FM with the result that better than 90% of our unit sales over \$100 included FM radios. So great was the public demand for this demonstrably exciting improvement that many of our customers in this area not served by FM purchased it to protect their equip-

ment against obsolescence and the time when this service would become available. We feel that our postwar sales will run almost 100% FM.

The Philadelphia area is fortunate in having 5 FM stations so that almost from the start a substantial amount of program service was available to the public.

Postwar Possibilities

Since the war this service has been substantially curtailed; the broadcasting now being divided among 1 or 2 stations at one time.

We seem to note from observation in our service work on these instru-

(Continued on page 62)

Shryock's, in Philadelphia, offers an engaging window display despite lack of regular merchandise. FM is a must for postwar sales, says Shryock.



• A half-million receivers featuring Frequency Modulation were sold before production was halted by the war. In less than two years FM became firmly established as a profitable, new product for the retailer in the areas served by FM broadcasting. Dealers welcome FM with open arms. Unit sales were larger, a new appeal was made to the buyer whose purchasing appetite at that time was somewhat jaded. Store demonstration of FM was effective in convincing the prospective customer that here was radio reception at its peak—noise-free reception with high fidelity and high-quality programs.

Merchandisers, manufacturers, engineers and broadcasters see FM really going places postwar. There are 4 FM stations now on the air, and more than 300 are planned for after the war. Industry predictions place the postwar demands for FM sets as high as ten million in the first year after the war. Planning already provides listenable FM for 80 per cent of the nation's buying power.

Prominent leaders in the industry declare that the FM structure in the postwar period will embrace three or four times the number of radio stations now on the air, and they forecast as many as ten national networks where four now exist. Paul W. Kesten, Columbia vice-president, expects his FM network to include 175 stations coast-to-coast, and he has asked FCC to provide facilities for 4,000 FM stations. William S. Hedges, NBC vice-president, declares that FM programs will be available in a hundred cities after the war. Mark Woods, Blue Network president, predicts that AM listeners will quickly turn to FM because of its freedom from noise, etc. These men and others visualize FM stations in every community in the country, with as many as 25 or 30 in the larger metropolitan areas.

The means for inter-connecting stations were recently augmented when the American Telephone & Telegraph Company announced it will be able

Postwar

Overage Near, Alert Dealers Participation in Set Sales

pass—over existing circuits linking all the major cities—the high frequencies necessary to transmit the quality of one which FM radio provides.

Seventy-five per cent of the people who intend to buy sets after the war have indicated they want the quality of radio FM will provide.

Dealers who have sold FM know that special installation techniques are often necessary to insure satisfactory performance. They also know the importance of instructing the purchaser how to tune his set for peak results, and if push-button operation is featured on the postwar set, dealers should expect to do an occasional calibration job for the customer to compensate for drift.

The dealer who sells his postwar customer a suitable antenna installation along with the set will often save himself a lot of headaches, and will, incidentally, increase the amount of the sale. If he instructs the owner in the use of the set and installs a proper aerial, he will not only satisfy the customer but will save needless "under warranty" service calls.

Since many dealers who will handle FM after civilian production is under way have not had experience in selling and maintaining FM in the past, RADIO Television RETAILING has asked a number of leading dealers to contribute articles relating their experiences in merchandising and maintaining FM—so their predictions and future plans.

This magazine is preparing a series of articles on FM, and this, the first, is a "guest" article by Richard Shryock and George Lohman, prominent retailers, giving valuable pointers on merchandising Frequency Modulation, which the television promises new thrills for the radio audience and substantial business for the merchant.



George Lohman, president of Haynes-Griffin, New York, and a portion of his store showing smart merchandising in handling of window space. Lohman suggests selling the higher priced units with FM.

FM SALES PROFITABLE: The following article was written by George P. Lohman, president of Haynes-Griffin, 391 Madison Ave., New York, one of the city's leading radio-music shops.

It is our belief that FM is a marvelous advance in radio science and it in no wise added to our problems of selling or servicing radio merchandise. On the contrary, in a market like metropolitan New York, where we can assure a prospective purchaser static-free radio performance, the added cost of FM is no selling obstacle. I would say generally that we have done extremely well in the sale of the higher class instruments with FM.

When radio and phonograph combinations were available, I recall one model, particularly, selling for around \$400. This model did not have FM as a feature. We added FM, by means of an adaptor, mounting same in the record compartment of the cabinet, and for our efforts and tuner, we were able to get \$100 more for the receiver.

FM Sells Quality Sets

Our sales records show that 80 per cent of the FM sets were sold at the \$500 mark. Naturally, FM means a lot to Haynes-Griffin.

It would be well to point out, however, that FM adaptors or tuners offered for sale to owners of high quality instruments, not having FM, is not a sales factor. FM will be sold as an integral part of the set.

Our store is located in a congested

area, where many of the buildings are supplied with direct-current. The New York Central railroad tracks run under our very store. Under these conditions, it is a pleasure to demonstrate a noise-free FM receiver, with its real quality of performance and tone. It is difficult, in view of the disturbance factors mentioned, to demonstrate AM properly.

Installations Easy

Installing FM has not been a great problem to our service department. Only 10 per cent of the installations in our area required real FM aerial installation, for which we charged from \$40 to \$60 each. Seventy-five per cent of sets we sold perform satisfactorily with under-rug aerial or those attached to base-boards. The other 15 per cent operated efficiently with nothing but the regular built-in FM antenna supplied by the manufacturer. In some areas, where sets were located near transmitters, the stations would come in at different points on the dial, and we encountered a certain amount of drifting.

The maintenance of FM has not been a problem either. Once the proper installation has been made, and the customer has been carefully instructed how to tune the set, no special service has been necessary.

(Continued on page 62)

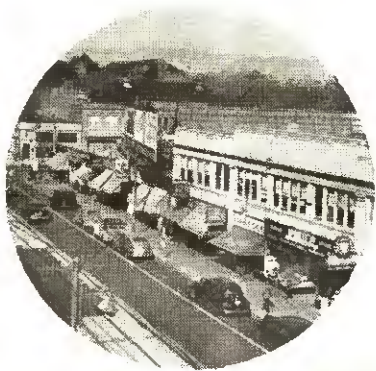

United's location is a working sales factor for top business operation (see front cover).

SOMETHING *New*

Sales Tomorrow Through Service Today—Plainfield Maintain Good Location (see front cover) and

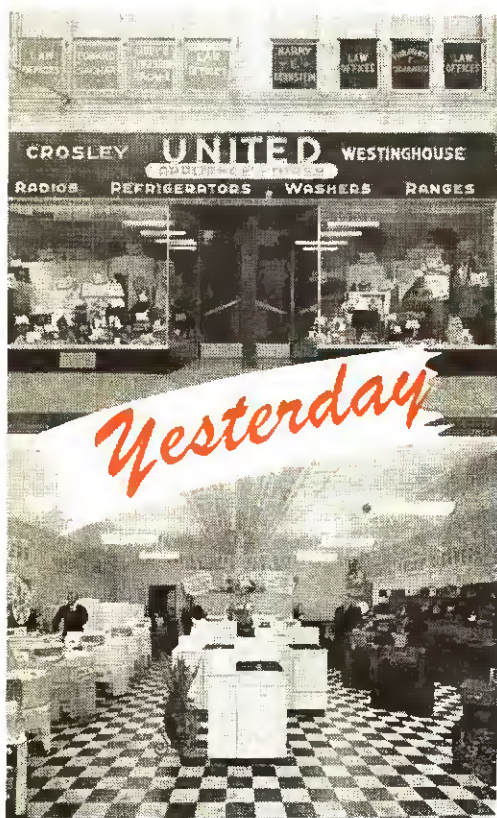

Nevertheless United Appliance's partners, well versed in chain operations for profit, have "reversed the English" in order to apply their knowledge to independent retailing.

Location Important

Chains operate best in the large cities where service is not offered by them in the true sense of the word. Rather, chains depend more upon transient traffic to gain volume sales. And as all good independent retailers know, independents operate best in the suburban or small city areas, where service is a factor, and to be relied upon by all purchasers of radios and appliances.

In these days of merchandise and help shortages, service and repair are harder than ever to maintain, even by the independent merchant. This is where United Appliance shines, because its three partners foresaw this threat to their joint reputation and concentrated on something new, for them, an expert production-line repair, service and rebuilding department for radios and appliances.

While substitute lines now bring continued floor traffic and mean retention of former household customers, every effort has been made, and successfully, to retain and enlarge the service department at United.

Substitute lines of gas ranges, bathroom accessories, china and glassware, coffee makers, oil heaters continue to, in part, replace the sales of outstanding makes of radios and appliances. And, service with a capital S, has meant continued preference by their former customers for this radio-appliance firm.

Location, a big factor in retailing of any kind, must be carefully considered by the independent merchant, as well as by the chains. In this instance, United chose the main street leading from the town's trading center to the high-class residential section. To go even further back, they chose a small city far enough from New York to insure purchases made in the town in preference to New York. Plainfield, with a population of approximately 40,000, has a surrounding trading area totaling 125,000. This has been developed into a fine business by United.

Service Dept. Active

In this size community, United's super-service department answers from 35 to 40 calls daily. Staffed sufficiently to meet these needs, Nat Epstein, service manager, speaks highly of the industrious efforts of his service staff and of its technical competence. This last insures him against trouble on the ample guarantee of one year on any work United's repair and rebuilding department turns out.

Feature for Tomorrow

Service sections of this firm are working overtime today, and will be a permanent part of the business tomorrow, but all three partners look forward eagerly to the release of civilian merchandise so that they can get back into their selling stride.

This firm looks to the day when they can again sell Westinghouse, General Electric, Philco, Crosley, RCA, Apex, White Sewing Machine,

• The owners of the United Appliance Stores, Inc., at 117-119 Watchung Ave., Plainfield, N. J., A. R. Epstein, Nat R. Epstein, and Irving Rosalin, bring excellent experience to their present partnerships. Not only have they all been in the radio-appliance sales field for some years, but each of these partners has had extensive experience in the large chain organizations in this business.

This chain store experience has given United's operators valuable "know-how" in selling, and equips them to meet competition effectively.

HAS BEEN ADDED

eld, N. J. Retailers
ustomer Good Will

Norge, ABC, Admiral, Emerson and other well-known lines of merchandise to the excellent customer lists they have built up in these past years, through current services.

Christmas promotions this year at United are the china and gift items

Yesterday's window and interior at United Appliance Stores in Plainfield, N. J., featured many of the outstanding makes in radios and appliances for the home.

Today United's window is still a strong display factor, although many allied substitute lines are used. Note interior now devoted mostly to featuring service, and at bottom of page, United's appliance repair and rebuilding production line, installed in the basement. Full speed ahead in repairs is today's watchword—tomorrow's builder of sales!

they now carry, and a temporary line of toys and dolls they are putting in for the holiday season. "We keep going now" claim these partners because we know we can do a fine job in the field when normal times return."

Concern is expressed for price-cutting evils of the war and their possible reappearance postwar. But these partners feel confident that manufacturers will take the initiative after the war, when set-ups should be fresh and improved; and, when manufacturers, they hope, will realize that this evil price-cutting and its causes in reality hurts as strongly an manufacturers themselves, as it does on the independent merchant.

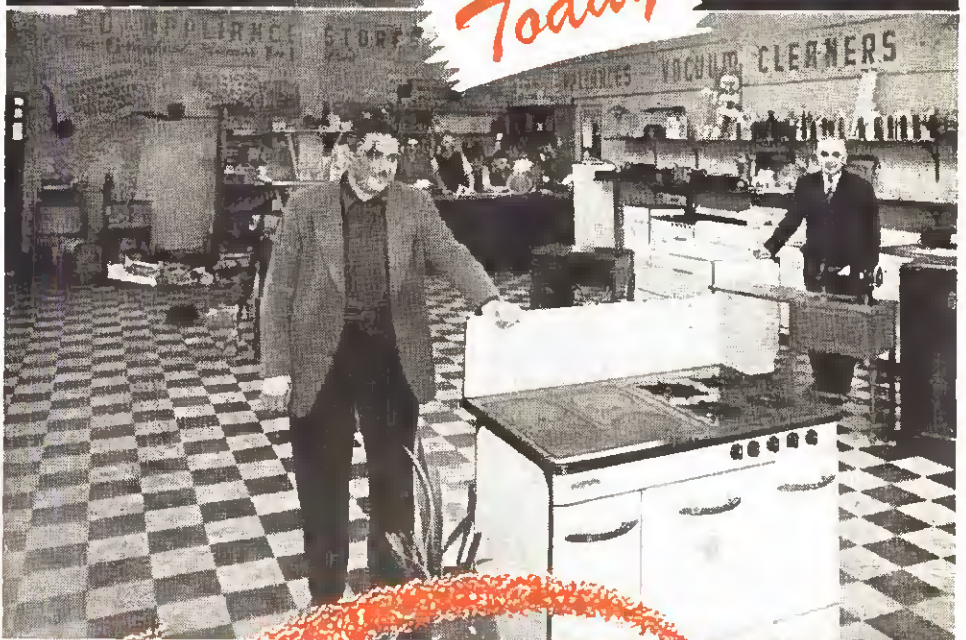

"LOCATION" In

Rental Costs, Store Exposure to Shopper Studied by Merchant. Competition Keen

● One of the most important factors in retail selling is store location, since location directly affects potential business and overhead.

A glance at the accompanying chart of an imaginary town of 15,000, will show a few interesting facts, as follows:

1. Rents are highest where there is the heaviest foot traffic.
2. Rents are usually highest where there is the least parking space.
3. Where virtually unlimited parking facilities are provided, rents run from medium to low figures.
4. Rents are set up upon location and size of store.
5. Neighborhood shops and stores in low-rent residential sections are leased upon low-rental basis.
6. Shop operators attempt to rent near other businesses which they consider will bring them customers.
7. Some store locations are chosen for competitive purposes.
8. Ability to forecast trends which may change location values favorably or unfavorably, valuable to merchant.
9. Ability to orient facts in choosing location important. Will high-rent, with resultant store exposure to many shoppers bring about enough extra sales volume to warrant such move. Or, because of the nature of the business, will a low-priced situation, with increased by-the-door motor traffic, and decreased foot-traffic be more advantageous to profits.
10. Will the postwar municipal parking problem become so acute, that congested high-rent areas will be by-passed by shoppers.

The radio-appliance merchant has a big problem on his hands when it comes to store location.

Following a Trend

In many localities, far-sighted merchants have moved from expensive stores to low-priced ones in out-of-the-way locations which later proved advantageous since certain trends occurred, such as the setting up in the locality of "super" food markets, etc.

With television promising such a bright future, and with the current upped-interest in records, the merchant needs to scan his store location more carefully than ever. As the situ-

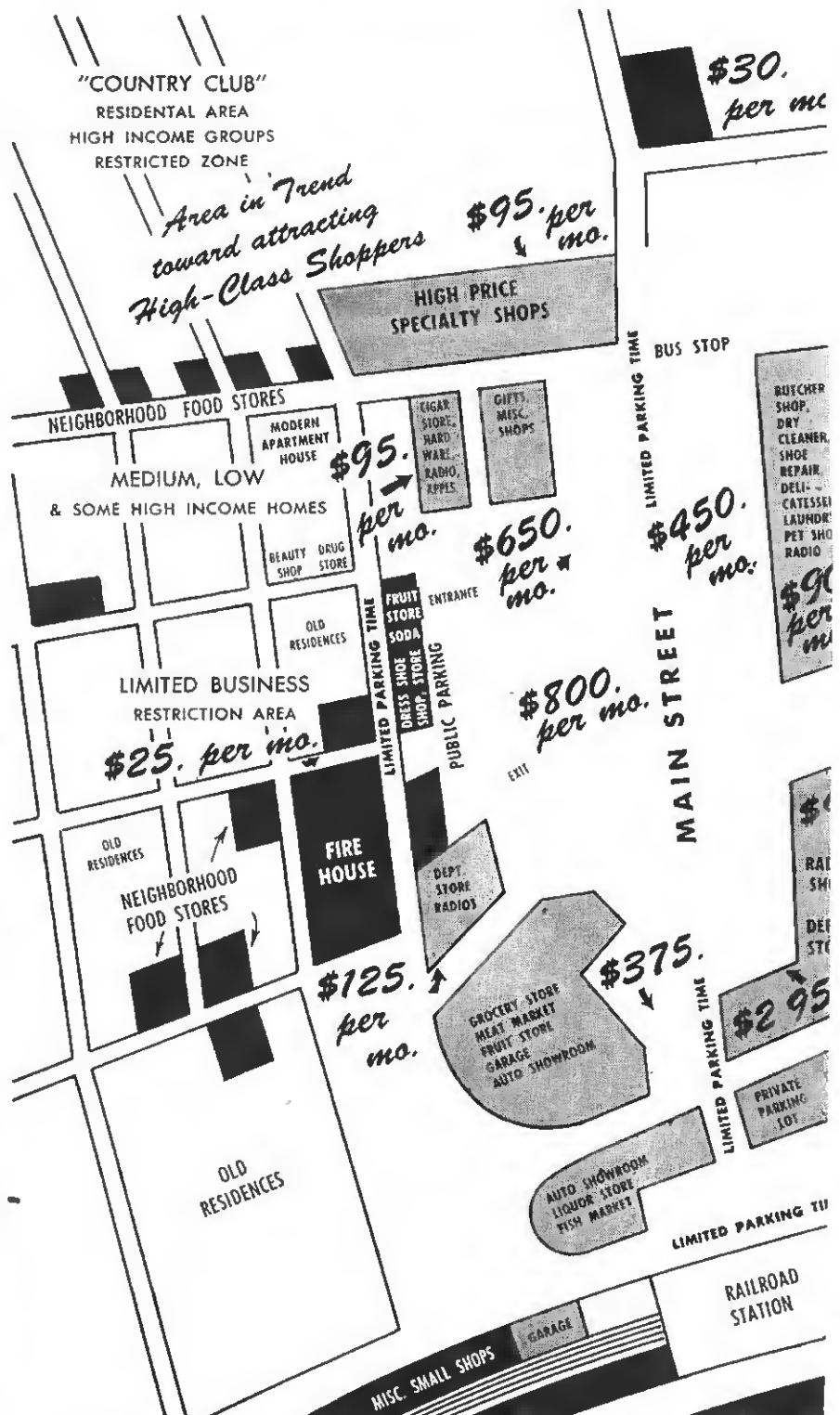

"East side, west side, all around the town" good business sites exist, but you must choose t

RETAILING

Marketing Problems and Trends Should Be
and Overhead Higher in Business Center Areas

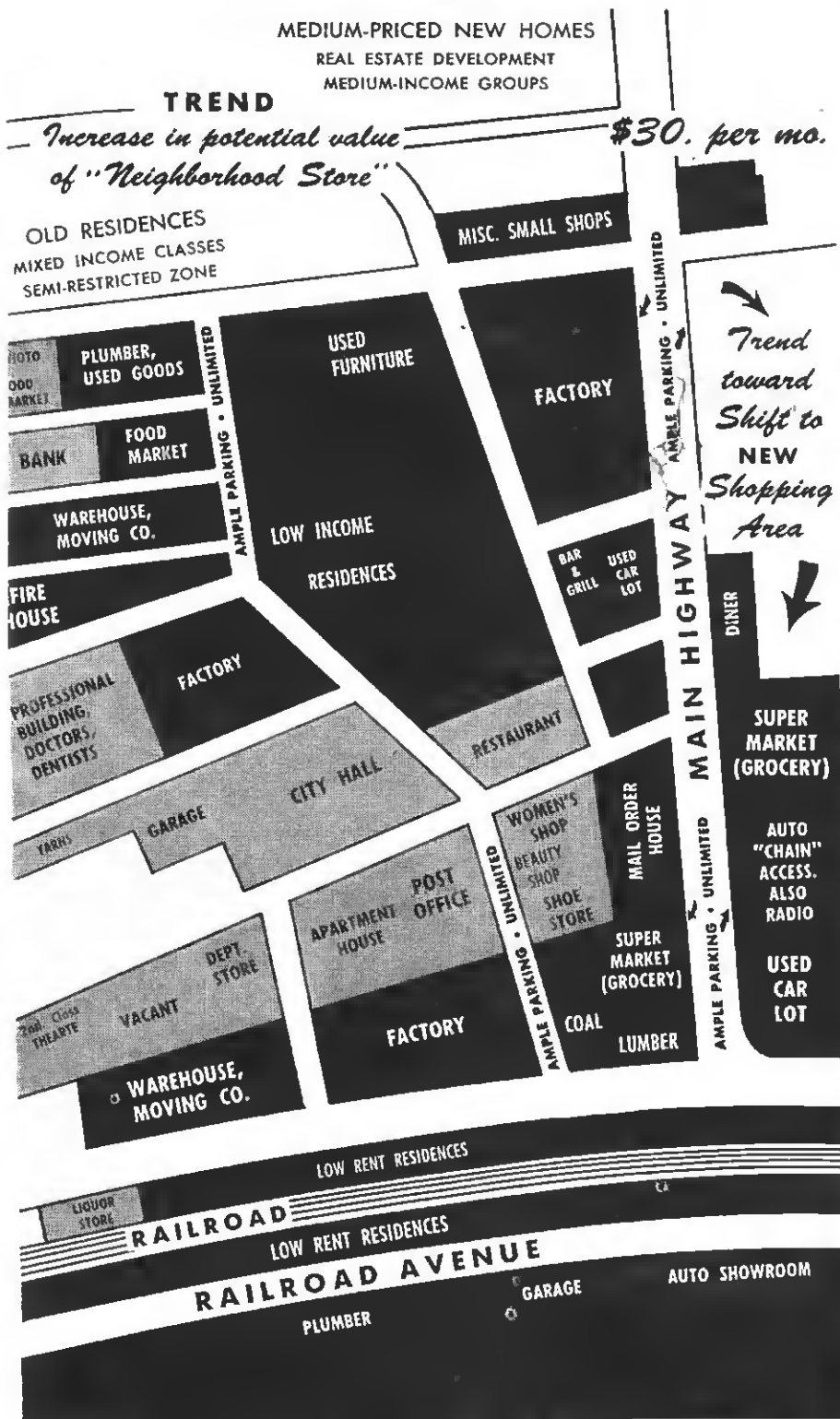

ation appears today, a near-theatre shop selling records and television should be a successful one. Throughout the country at this time, we know, definitely, that more records are sold in the congested high-rental zones.

On the other hand, speaking of television, the out-of-the-way dealer often has a larger store for better demonstration than the fellow in the center of the business area.

What Shoppers Think

Certain average American shoppers possess certain-fixed "notions" about merchandising in connection with store location, and the wise dealer is often able to capitalize on these "notions." For example, many shoppers believe the following statements:

"The neighborhood dealer's prices are higher, but his service is better and, since he depends upon 'repeat' business, his customer-transactions are of a higher ethical nature than those of his competitor in the high-rent district. The latter must stress 'loss-leaders,' which he is reluctant to show, and he isn't above 'cutting corners.'"

Of course we know that the above statements do not and cannot prevail in all communities, but since so many shoppers believe they do, it is a belief the dealer should scrutinize. For example, does the dealer, seeking a new location, want to build up a stable, if small following, which will be willing to pay *more* for his services and goods—or *believe* they pay more—or does he want to go into the expensive-rent location and *compete* with others—and use the competitor's methods?

Location and Sales Volume

The smaller the dealer's customer list, the greater his personal contact with the shopper, is the general rule. The higher the dealer's overhead, the bigger his volume must be if he is to survive. Where his overhead, in terms of rent, is low, then his volume is smaller and his profits are larger.

The first move to make when you consider moving your business is to study your potential trading area carefully, paying particular interest to trends in home, industry and marketing center shifts. It is fairly easy to survey conditions as they presently exist. It is a real feat to be able to translate location trends for tomorrow's business.

carefully. KEY TO RENTALS

MEDIUM ■ LOW

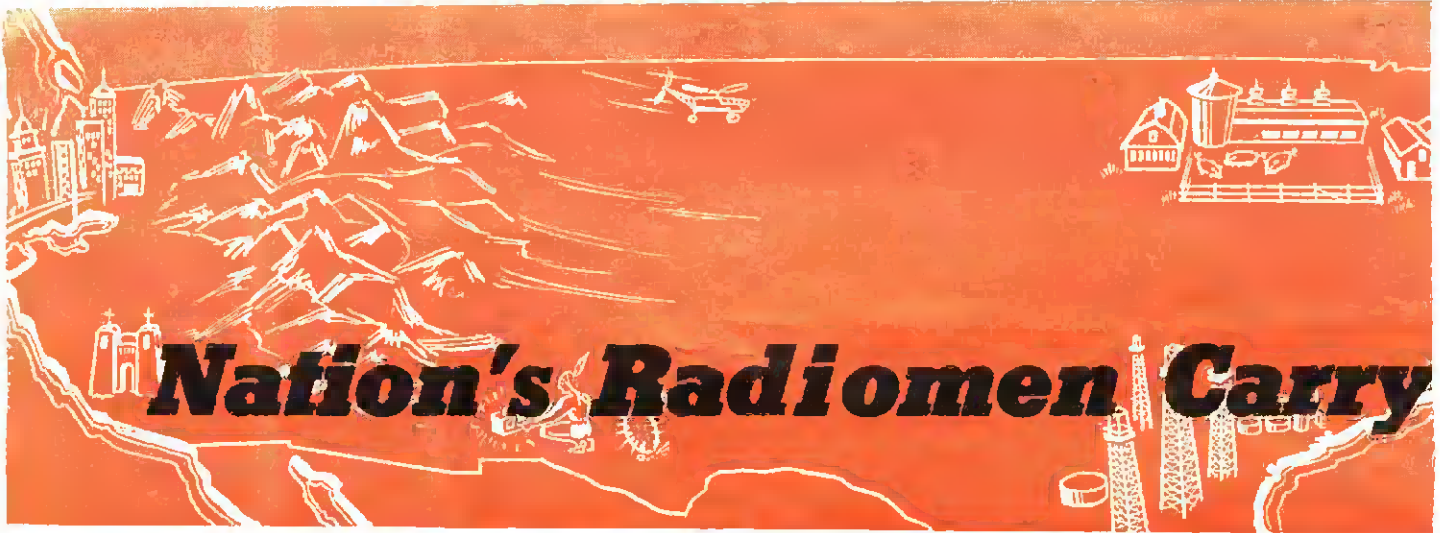

Repair Services, Disc Sales, Supplementary Sidelines and Hig

OELWEIN, Iowa—Dean Merrill is one dealer who never worries about getting a suitable location for his radio sales and service shop. The secret of Merrill's success is his "movable building," measuring 14 x 20 feet, which he had constructed so that it can be moved about from one vicinity to another.

The movable Merrill shop was originally situated in his backyard. When business increased, he moved the structure downtown. At the present time he rents space on one of Oelwein's principal streets for a fee of \$10 per month. "It cost about \$300 to erect this building, with service bench and stock arrangement, just the way I wanted it. If I rented any



Dean Merrill in his "movable shop." Location is no headache for this dealer.

sort of a store I would have to pay from \$25 to \$50 for a similar location," says Merrill. He has been in his present location for over four years.

Merrill has been getting along by himself during the war period by working longer hours and learning to eliminate waste time. He believes that the trying conditions have made him a better technician, because of

the necessity for added ingenuity.

Merrill has operated a radio repair business for over 14 years and he counsels, "The longer I am in business the more I realize that, vital as technical knowledge is, the radioman must be a good manager if he expects to please his customers and make a profit."

CURWENSVILLE, Pa.—Bennington Electric Co., Emerson and Westinghouse dealers in normal times, have on hand only a few small used sets and three or four chassis waiting for parts. Proprietor Chester Frankhouser is just awaiting the day when sets will become available. He concentrates on electric repair work of all kinds and fills in when necessary by servicing other small appliances. He tests and replaces tubes, but avoids building up any stock of used radios. He considers that the time for that is past.

GLOBE, Ariz.—Ussher Radio Shop, 221 N. Broad St., is owned and managed by E. T. Ussher Jr., who has been in radio sixteen years. When he opened his present shop four years ago he intended it to be a store for both sales and service. But since then, service has become the shop's specialty, and a profitable source of income is derived from its policy of "radio service exclusively."

"In the postwar I intend to take on a complete line of radios and appliances as soon as I can get them," Mr. Ussher reports.

The shop has so much radio work that there is not much time for anything else. But Ussher feels, "In normal times radio and appliance servicing should go together. It is a matter of taking complete care of your customers' interests."

Ussher's qualities as a technician, and the reputation he has for fair merchandising practices have spread his name far up into the mountain ranch and mining regions surrounding Globe. Work comes in from points over 100 miles distant. This involves handling quantities of battery sets. "When selling begins again," Ussher says, "I am confident we shall have a good market for battery sets. A lot of ranchers need radios now."

MARTINSBURG, W. Va.—According to Mrs. Donald O'Rourke, local manager of Royal Jewelers, 120 N. Queen, "this shop has found it to its advantage to handle radios." Normally, the Royal Jewelers, with its 11 stores, which are located in various eastern states, do carry attractive floor models and portables in RCA, Emerson, and Zenith makes. Radios in the Martinsburg shop are given a conspicuous place in the store, and when receivers are released for the market, the Royal Jewelers are optimistically planning a greater radio business volume in the postwar.

ST. PAUL, Minn.—Radio Service Laboratories, Sixth near Wabasha St., is supplementing its radio and repair work by giving records an increased amount of attention. The street floor features record displays, and records are stressed in the windows. A recent window display was centered around a full sized radio, with panels of record albums built up beside it, and filling the corners. Single records of popular hits filled in the remainder of the window. Small figurines of musical personalities are a profitable accessory line, and catch the fancy of window-shopping music lovers.

On With Wartime Activities

Hopes for Profitable Postwar Keep Dealers Going Toward M-Day

WASHINGTON, D. C.—The Cleveland Park Radio Service, 3516 Connecticut Ave., N.W., under the efficient handling of its manager, Charles E. Junk, has developed into one of Washington's busiest service centers in the last two years and is doing a thriving business. The shop specializes in record-changer service and caters to the Army and Navy personnel, as well as to a large civilian clientele. Service activities have had to be restricted to a limited area because of the preponderance of work. Manager Junk is already shaping postwar plans for sales expansion, and expects to carry complete lines of electrical appliances as well as radios of standard makes.

CHICAGO, Ill.—S. J. Selgrad, 5957 W. Irving Park Road, has built a profitable trade in records, sales and repair of radios and appliances in the four years the firm has been located at the present address. When the ban on the manufacture of electrical appliances went into effect, Selgrad decided to enlarge the record department to the point where the chief source of income would be derived from this merchandise.

The store is located in a thriving shopping district, and Selgrad makes his window displays especially attractive to take advantage of this pedestrian traffic. Self-service has also worked out to the company's advantage, and record racks are placed at various points in the store.

Present record inventory of the shop amounts to \$3,000, a fine showing for the \$100 beginning. Selgrad repairs about 75 sets per month which brings in a gross return of \$300. He does general electrical repair work, as well as washing machine and refrigerator repairs. Efficient servicing increases merchandise sales.

GRAMPION, Pa.—Ward McDonald goes fishing for spare parts in his stock of salvaged chassis very frequently these days. The parts shortage has boosted his income, and his reputation for making replacements has brought many customers into his shop who are more than willing to pay for the time and work involved.

McDonald does not willingly rewire sets for which tubes are not procurable, preferring to use adapters if he can. He was forced to discontinue newspaper advertising because it resulted in more work than he could handle. The principal lines he sold in peacetime were Zenith, Philco, Emerson and Stromberg-Carlson. For the postwar McDonald intends to continue his business along the same lines, expanding his business wherever it is feasible.

BALTIMORE, Md.—Phil's Radio Service, N. Fulton Ave., is doing a super business in servicing. Its owner, Philip A. Bisesi, credits his 10 point servicing checkup for doing the job. To restore clear reception and tone Phil recommends:

1. Check overall set performances for sensitivity, selectivity, and fidelity.
2. Test and label all tubes.
3. Check speaker and cabinet for rattles.
4. Inspect and test all power connections.
5. Check aerial and ground.
6. Align antenna, detector and oscillator circuits when accessible.
7. Adjust dial to normal kilocycle reading.
8. Check cause of noises.
9. Clean cabinet interior.
10. Make estimate of any additional repairs.



Murphy lists television on store sign.

SUMMIT, N. J.—Wm. D. Murphy, 31 Springfield Ave., pioneered the sale of television sets in his community. During the limited time sets were available Murphy conducted demonstrations, and sold a considerable number. Although he stocks radios, and a variety of sideline items, Murphy realized the importance of records, and features their sale in several unique ways. Murphy, in addition to retaining past customers, has gone all-out for the younger set by donating records for use at community dances, and by offering record album prizes to winners of lucky-number dances and other contests.

Murphy believes in cultivating the friendship of this younger group, as well as their parents, for it will be an asset to his postwar record-radio-television business.



Dealer Rodin S. Horrow, left, explains the features of the milk cooler to a customer.

SALES + S

• Rodin S. Horrow sold around 50,000 appliances in his nine years in business at 132 North Michigan St., South Bend, Ind., operating under the name of Rodin's.

If you ask what basic factors he used to build up sales to these proportions, with an organization of 18 employees before the war, he will tell you that *quality* stands in first place. From the beginning, he handled only quality merchandise, nationally advertised. He stocked and sold the Westinghouse line of major appliances, and RCA, Stromberg-Carlson, Emerson and several other well known radio makes. No off-brand articles were handled, and in the small appliances he also selected the well known quality brands.

"Quality" Vital

Retailer Horrow says his own experience proved that while price is a factor of some importance when you are getting established, the *repeat* business, which is so necessary to continue operating at a profit, comes from satisfied customers who remember the quality long after they have forgotten the price.

Secondly, Horrow pointed out that no matter how good your products are, you still have to *sell*. It must constantly be kept in mind that many other strong forces are at work



Service is a "repeat" sales clincher at Rodin's.

in normal times to turn the sale into other channels. Besides the price angle played up by catalog houses and chain stores, there are vigorous campaigns and personal sales promotion programs being conducted by dealers in *other* merchandise bidding for the consumers' dollars.

To get his share of the business, new and repeat, Horrow employed five salesmen full time on major appliances. The salesmen were trained to sell up. That is, advise the customer to buy the size and grade in the line that would *best* serve his needs. This policy was especially true with refrigerators. As a result, the average size of refrigerator sold was increased from a five ft. capacity unit to seven ft.

This not only increased the dollar sales on each unit, which benefited

the company and the salesmen in the form of higher profits and commissions respectively, but it actually went far towards making better satisfied customers. The mutual benefits here are obvious.

Demonstration Important

Salesmen at Rodin's never used too much persuasion. Good salesmen avoid high pressure tactics, and they believed in demonstration of different models in stock, and in letting the customer see for himself the benefits to be gained. Seeing the lowest priced model on the floor, along with the larger and higher priced units, often turns the sale to a better and larger model.

The same tactful methods were used in selling radio sets, and here

South Bend, Indiana, Retailer Stresses Service and Record Sales NOW. Plans for Postwar Merchandising. Believes in "Selling Up" to Increase Unit \$ Volume.

= Success!



The record stock at Rodin's is one of the largest in the state.

again, demonstration was the store's best salesman.

Service at Rodin's played a helpful part in selling new appliances of all kinds before the war, including major units, radios, and small accessories. And because the management had carefully built up one of the best equipped repair shops in the State, it turned out to be a profitable war-time factor. All testing devices for radio work are in the shop, and the radio repair department is now the main revenue producer here.

Another reason given for the progress of their service departments, is in having competent mechanics. There are three full time men, two skilled mechanics and one helper. Trained men using the time-saving shop equipment and testing devices can turn out more work, and save

further time by eliminating the guesswork. Besides, satisfied customers help build service business, just as in building up merchandise sales.

Carrying a large stock of parts is another important factor that has helped build up service sales, as prompt deliveries do count in building good will and repeat orders. A service charge is made for picking up repair jobs, but most of the work is brought in. Educating customers to do this is a definite part of the service program, as it not only saves the customer money, but enables the firm to turn out more work for more people.

Don't Oversell!

Another Rodin's policy that has worked well in these war-times is: Do not sell more service than the customer needs to keep his radio and

other appliances in good operating condition." This has helped to conserve parts and so helps more people to keep their radios and appliances going.

Dealer Horrow goes on to say that his service shop will play an even greater part in the sales program when peace comes and the appliance manufacturers can again produce for civilian use. Rodin's postwar policy will definitely include an efficient service department through which to build good will and make the repair shop pay a reasonable profit along with merchandise sales.

Service a Factor

His previous operations prove conclusively that the average customer prefers to buy his appliances, large units or small accessories, where he or she *knows* reliable service will be available year in and year out—where replacement parts can be obtained quickly, and where the machine, whether it is a washer, iron, radio, or any other home appliance, can be put back in working order quickly and at a reasonable price.

With the end of the war in sight, optimism prevails that reconversion will soon be at hand, but manufacturers may not be able to produce at full capacity, or to deliver the rush of pent-up orders, which peace-time will bring for months to come. Service, therefore, will continue to be one of the mainstays of the business.

Large Disc Stock

Rodin's is proud of its record department, one of the largest in the State of Indiana. From 50,000 to 60,000 records of the well known makes are stocked at all times. Here again, demonstration is employed to sell records in volume. Ten record-playing booths have been conveniently arranged. Store arrangement is both unique and effective. For example, the store is 20 ft. wide and 165 ft. long. The large stocks of records are kept in convenient shelves along the right side (as customers come in) and extends about two-thirds of the distance from front to rear. The customer can get quick service, as the records are catalogued so that the salespeople can find any requested number quickly. This type of efficiency helps boost sales.

Resumption of record-playing equipment sales is planned at Rodin's as quickly as the industry can resume production and delivery for civilians.

(Continued on page 84)

INTERIOR PLANNING *makes your*

Continuing the suggestions for store remodeling (begun in RTR, October 1944,—“New Fronts”) Radio & Television Retailing’s designer, Charles F. Dreyer, takes you inside these same stores, showing ways to make your interior brighter, more attractive, and more efficient. Your local building contractors will soon have new materials with which you may create new displays, furnishings and structural elements. Design to provide routing of customers to all parts of your store by forceful floor patterns and harmonious blending of merchandise and displays, Glass products, metal stampings and extrusions, plastic materials and plastic-bonded structural materials await exploitation by dealers alive to their sales stimulus.

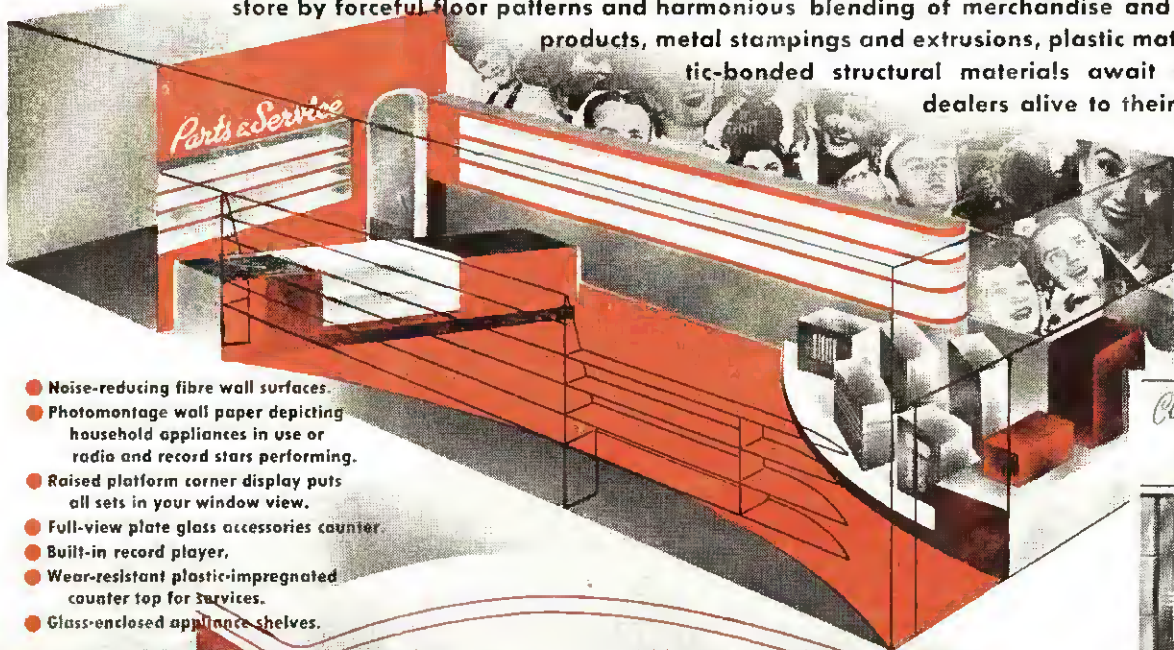

- Noise-reducing fibre wall surfaces.
- Photomontage wall paper depicting household appliances in use or radio and record stars performing.
- Raised platform corner display puts all sets in your window view.
- Full-view plate glass accessories counter.
- Built-in record player.
- Wear-resistant plastic-impregnated counter top for services.
- Glass-enclosed appliance shelves.

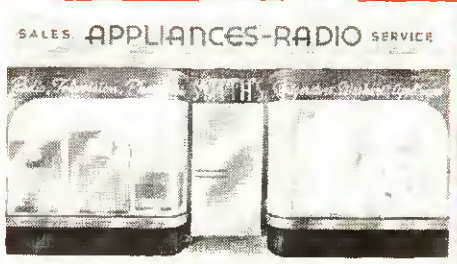
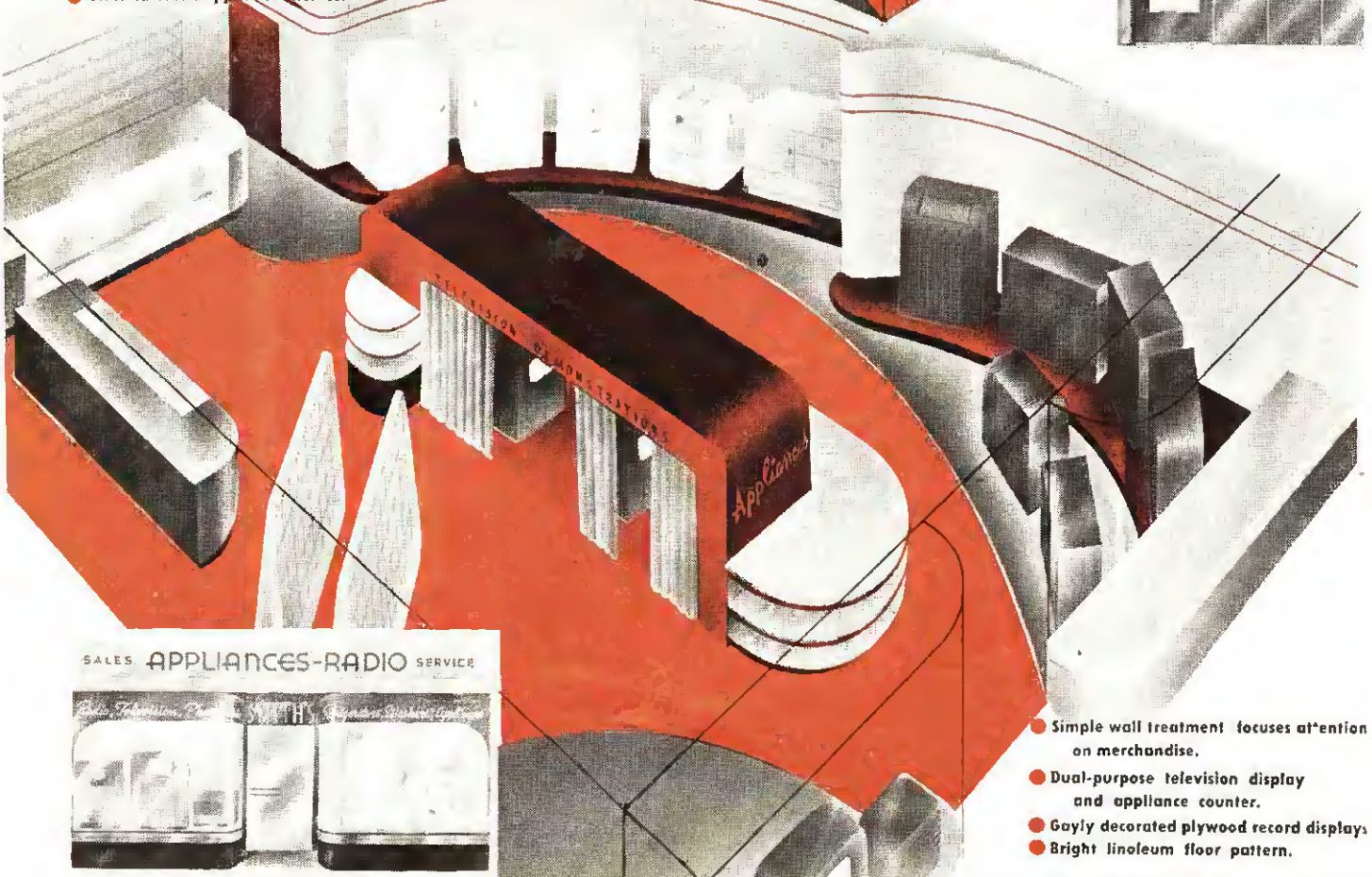

- Simple wall treatment focuses attention on merchandise.
- Dual-purpose television display and appliance counter.
- Gayly decorated plywood record displays.
- Bright linoleum floor pattern.

store "the livest store in town"

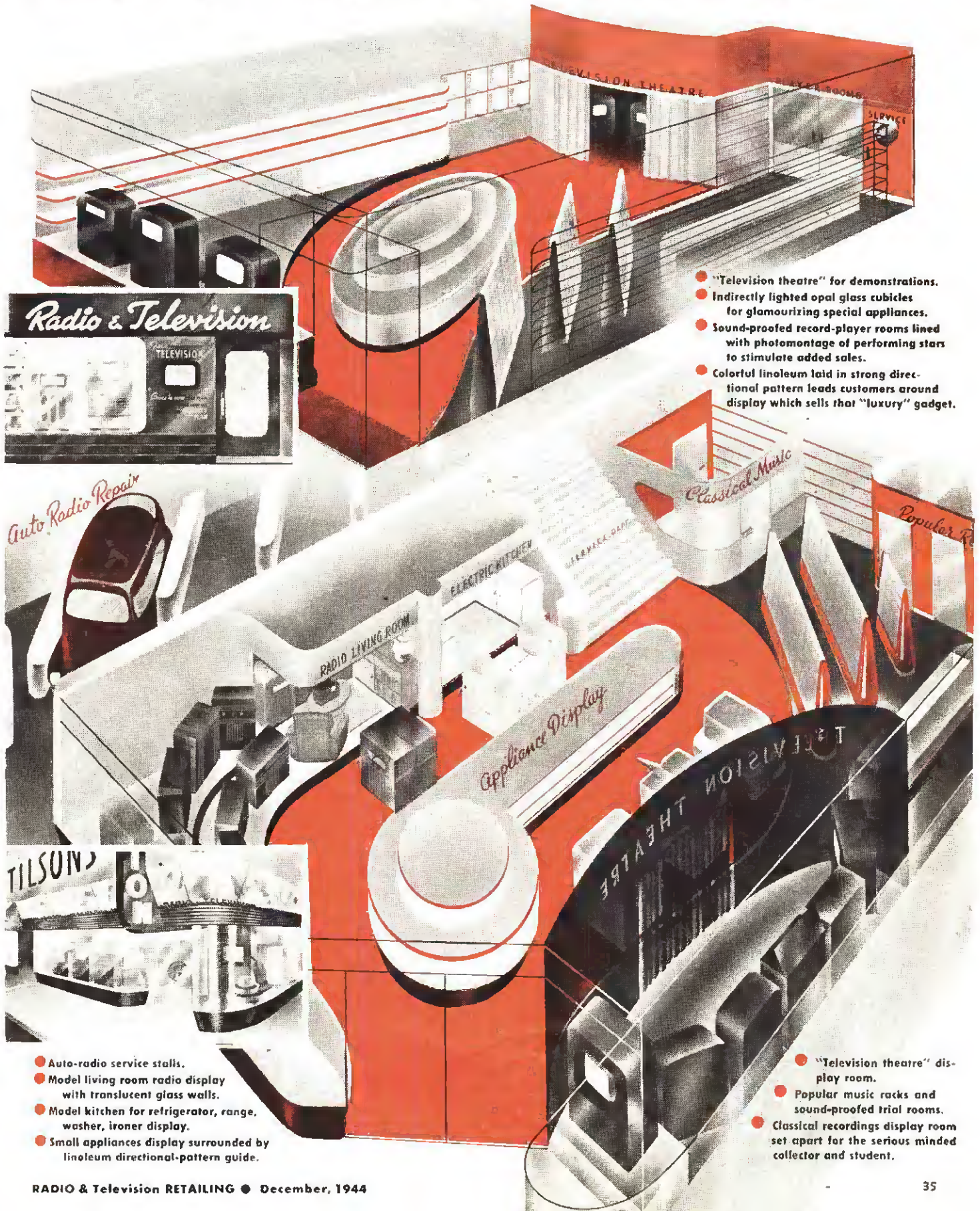

- "Television theatre" for demonstrations.
- Indirectly lighted opal glass cubicles for glamorizing special appliances.
- Sound-proofed record-player rooms lined with photomontage of performing stars to stimulate added sales.
- Colorful linoleum laid in strong directional pattern leads customers around display which sells that "luxury" gadget.



- Auto-radio service stalls.
- Model living room radio display with translucent glass walls.
- Model kitchen for refrigerator, range, washer, ironer display.
- Small appliances display surrounded by linoleum directional-pattern guide.

- "Television theatre" display room.
- Popular music racks and sound-proofed trial rooms.
- Classical recordings display room set apart for the serious minded collector and student.



Bronx technician Rhine works on teletype in New York penthouse apartment.

"Know-How" Reputation Brings Results to Rhine

Dealer Finds Time to Face Sales Problems While Handling Radio, Video, "Sound" Work in Big Area

● Arthur E. Rhine, of A. E. Rhine Radio Engineering Service, 158 to 160 West 230th St., New York, is widely known as a skilled technician in radio, television and commercial electronic work. He is also known as a tireless crusader for closer cooperation and higher ethics among radio service dealers. At one time he was metropolitan president of the Institute of Radio Servicemen, and is a stockholder; the secretary and a director of Television Technicians, Inc., known as "Tel-Tec," an organization composed of 20 top-flight television maintenance men.

Founder of New York's first service shop in 1920, Mr. Rhine later made a great success of a retail business he set up—Inwood Radio Corporation—near his present location. Here, he employed 25 salesmen; a salesmanager; 2 assistant salesmanagers and 9 servicemen, in addition to necessary office, stenographic, telephone, cashiers, credit and book-

keeping personnel; drivers; porters; accountants, and even a page boy to open the door and cater to customers. The firm stocked 21 different makes of radio, and did one of the largest selling jobs in the territory of the 5 boroughs.

Since he possesses the rare combination of sales executive and technical ability, Rhine has ambitious plans for postwar maintenance and merchandising enterprises.

Variety of Work

Mr. Rhine's present four-man organization (he could use 4 more men if they were available) is flooded with work throughout an area which includes all New York City, Westchester County, northern New Jersey, southern Connecticut and Staten Island. Referred calls come into the Rhine organization daily from the trade, manufacturers, armed forces, motion picture and radio advertising companies as well as from old cus-

tomers and those recommended by them. This results in valuable contacts with prominent people who need service for their television, radio and record players.

In addition to work on home sets, representing a considerable volume,—last month the firm started repairing the 1478th receiver for 1944—the Rhine organization services "sound" and other electronic equipment for public schools, the Signal Corps, U. S. Navy, war plants, New York State installations and such colleges as Fordham, Columbia and Hunter.

The firm has furnished many thousands of dollars worth of parts to the U. S. Government for the armed forces, for use in planes, etc. In addition, Rhine, through contacts with important real estate management firms, does work in a number of New York hotels and apartment houses, where master antenna and set maintenance is a profitable and satisfactory undertaking.

Since Rhine specializes in television, sound and record players, his organization is called upon to service equipment for other dealers and merchants also. In order to take care of the avalanche of receivers and electronic equipment brought into his place, Rhine took over an adjacent store, where a shop, equipped with the best testing equipment in the field, has permitted more orderly routing of items in the process of repair, and has speeded up work.

"Referred" Jobs Pay

Much of Mr. Rhine's success in the field and his enviable reputation as an engineer and merchandiser, is the result of his unselfish services on behalf of his fellow radiomen, and upon the ethical methods he has always employed in his own business.

The 20 original members of Television Technicians, Inc., including Mr. Rhine, still consult each other and cooperate in many ways. The corporation was founded by the 20 engineers who attended the special (and first) RCA television course in 1939. George Duvall of Brooklyn is president. Much referred work coming to the members of this corporation, now can be traced back to the time when these men were first known as television experts.

Despite his present busy job, Rhine finds time to make valuable suggestions to the government, and has, by request, contributed a plan for equitable distribution of radio tubes and components, aimed to deal a death-blow to the black market, and is serving as a member of the American Standards Assn. committee, the chairman of which is O. H. Caldwell, editor of RADIO & Television RETAILING. Rhine is consulted by the local OPA price panel when they are in doubt as to the justice of complaints concerning radio service dealer overcharges.

Sales Reforms Needed

Of particular interest to Rhine is the future adjustment of fair trade practices in direct application to postwar selling in all of its aspects, particularly, as they concern price-cutting, obsolescence of models, protection of territories for the independent dealer, preferential discounts; direct selling to consumers by other than authorized dealers; inducement sales and advertising allowances in any form.

Mr. Rhine is urging national legislation to insure the maintenance of list prices in the radio-television-

appliance field when peacetime selling is resumed. He believes that the following practices, if put into effect by law, would prevent a recurrence of pre-war chaotic selling:

1. The (legal) abolition of quantity, inducement, or other hidden forms of discounts.
2. Strict maintenance (by law) of advertised list prices.
3. No "wholesale" selling at "retail." No retail sales except through authorized dealers (and that goes for manufacturers, wholesalers, etc.).
4. Advance information from factory to dealer when new models are planned.

RADIO PIONEER RHINE—

Turns Out Big Work Volume

Plans Postwar Merchandising

Builds Up Large Following

Hits Selling Evils

Urges "Break" for Independents

5. Complete protection against reduced "list" prices (meaning readjustment of dealers' cost, based on new reduced list, to be granted by force of law, for every unsold model in any dealer's stock).

Arthur Rhine's suggestions, forming valuable ideas for the future, are being offered to a number of interested firms and individuals at this time.

Incidentally, several years ago, the then Secretary of Commerce, Daniel Roper, invited Rhine, with 50 other representative New York businessmen, to go to Washington for the purpose of studying 14 different subjects, each of which, when reduced to recommendations, would be incorporated into bills to be introduced, on the theory that these business-

recommended legal changes would be the solution for the continuing depression.

Although no action was taken after these men spent many days of valuable time in Washington, nevertheless, Rhine learned a great deal about many aspects of merchandising which sorely need changing, and he says "When 650 men from over this nation, representing every angle of business, discuss their relations with each other and the public, and conclude frankly that many practices are, at the least, 'unfair' to each other or the public, and finally reduce their findings to suggested legislation, there must exist before such changes are made, serious defects in merchandising.

"It is agreed that the manufacturer suffers least, the wholesaler takes his beating (when manufacturers sell direct to chain or remote-controlled organizations), the dealer is always in the middle and cannot compete with the chain, and the poor consumer is the 'goat.'"

Urges Concerted Action

This one subject, under the title of "Unfair Trade Practices," was the one which Mr. Rhine interested himself in particularly.

Rhine is not alone in his belief that, following this war, it would be but a matter of a single year, when a number of independent dealers would be forced to give up the attempt to establish successful businesses. This would leave the field open to chain operators, resulting in an ideal picture for them and the manufacturers. "A single outlet, a single account or two for the manufacturer, and a cost-plus buying status for the larger operator, whose profits automatically become enormous," declares Mr. Rhine. Rhine says if "opportunity for all" is what we Americans mean, let us immediately act so as to make it impossible for any group to eliminate the small dealer, who now is without defense, and whose fate is inevitable. This seems to be the one and only big problem, otherwise unsolvable, which faces every type of small business, whether it be radio or appliances, groceries or shoes.

Rhine believes that now is the time to act for rectification of these situations so that postwar selling may be resumed with a fresh start. So that the independent dealer may get his just profits, and the slogan "Equal Opportunity for ALL" will prove to be more than just a promise!



Glamorous songbirds like Victor's Dinah Shore and Columbia's Ginny Simms will now be able to record many of the tunes they made popular on their radio shows.

Merry Christmas The Bands



New Flood of "Populars" Provides Opportunity for Super Record Promotions During Holiday Season

• After the 27 months' famine—**NEW RECORDINGS!** Manufacturers now speed records on their way to earliest releases. No better Christmas present for record dealers than this opportunity to get behind the merchandising of discs with full sales impact, at last!

Columbia's first two, released December 1, are Frank Sinatra singing "White Christmas" and "If You Are But A Dream," 36756; and Andre Kostelanetz and Orchestra in the presentation of two famous Ave

Maria's—the Bach-Gounod and Schubert compositions, 7416-M.

These releases, styled for effective Christmas promotion, are amply supported by Columbia's seasonal displays and eye-catching sales helps which are bright with color and holiday spirit.

Issued December 11, was Columbia's first new Kay Kyser recording, "There Goes That Song Again" and "I'm Gonna See My Baby," 36757. Note: Further new cuttings by Harry James and Frankie Carle are scheduled for December 17 and 24.

Other Christmas sales-makers are Columbia's disc "How Deep Is the Ocean," 36754; and "Fiesta in Blue," 36755; with the Benny Goodman Orchestra and Sextette, respectively

The whole family will enjoy any one or all of Columbia's classical releases for December, which include Basil Rathbone's reading of "Treasure Island," with supporting cast and chorus, Set M-MM-553.

Victor's first waxing after the lifting of the ban was of Vaughan Monroe and Orchestra, "The Very Thought of You" and "The Trolley Song," 20-1605, with vocals by Monroe and Marilyn Duke, released No-

Are Back



▼ Decca offers something new in Jascha Heifetz' recording of "White Christmas," 23376, backed by "A La Valse," two popular pieces with definite holiday appeal.



Capitol enters the field of children's recordings with an album of children's stories, and another of popular Christmas carols.

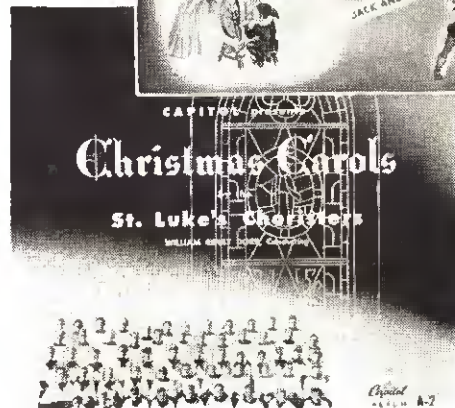
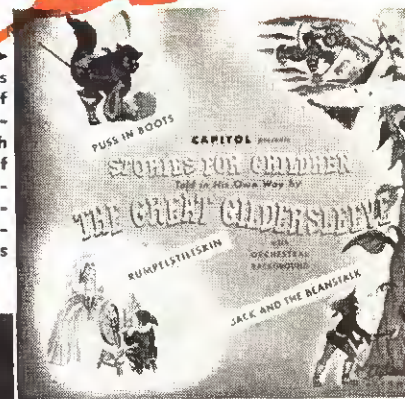

ember 13. This was followed by "Let Me Love You Tonight" and "Too-Ra-Loo-Ra-Loo-Ral" by Charlie Spivak and Orchestra, 20-1603, on November 30. Sammy Kaye recording "There Goes That Song Again" and "You Always Hurt the One You Love," 20-1606, came next on December 2.

In a class by itself is the interesting piano rendition by Jose Iturbi on Victor Musical Masterpiece 10-1127, "Boogie Woogie Etude" and "Blues," both Morton Gould compositions, released November 22.

(Continued on page 84)

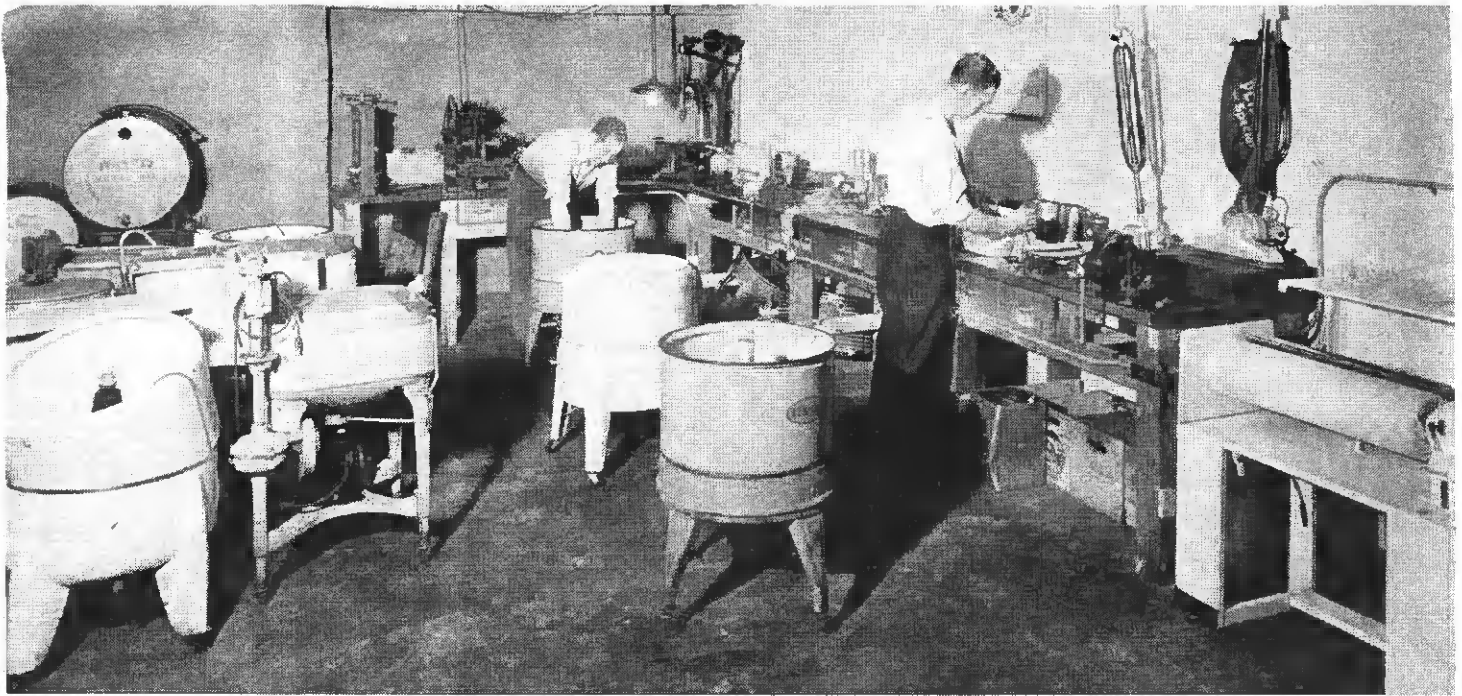

The servicing of washing machines is a Lambert & Simpson specialty today. This department keeps five men busy.

Appliance Specialists

• With nearly every radio and appliance store turning to general repair service these days, the Lambert & Simpson Appliance Shop, 106 E. 6th St., St. Paul, Minn., decided to concentrate on two types of service—washing machine repairs and oil burner maintenance.

This house has been in business in a prominent downtown location for 25 years. In that time it has built a strong following. With the curtailment of radios and other new merchandise, steady customers looked to the shop to keep their electrical items functioning for the duration.

In order to handle this expected (and quickly materialized) increased volume of repair work most efficiently, management changed the layout of the store somewhat and installed a customer counter toward the front of the store. Temporary partitions were put in behind this to provide place for work benches and to form a room which could be used for appliances brought in for repair.

Floor Layout Changed

This gave a more orderly appearance to the front section and provided space where small appliances ready for delivery could be placed for quick pick-up by customers.

Although some business is done

Increased Repair Volume on Refrigerators, Washers Keeps St. Paul Firm Busy

with refrigerator and oil burner replacements, the principal work of the shop today is service, with stress on service on washing machines. The general work rooms of the shop have been located in basement rooms, one under the shop and the other in the basement of the adjoining building. These are large, well laid out rooms, where work can be carried on without disturbance from the receiving room or the offices which are located on the balcony in the front section.

Repairmen Skillful

The washer repair section keeps 5 men employed; the oil burner service 2. When experienced men cannot be obtained, men are trained in the shops under the supervision of the foreman, learning by actual work on appliances. This is, of course, a slow method, but work does get done, though much overtime night work is required.

All methods are taken to bring in appliance work. Newspaper advertising has been extended; window displays and in-shop layout stress repair work. Customers are encouraged to

bring in as much work as possible and to come after it when it is repaired. Although the company operates no vehicles for service work, it does make use of a truckage service which takes care of the combined deliveries when necessary. In case extra work comes in, additional trucks are hired to cover pick-ups and delivery, and at times one of the 4 service cars the company uses for oil burners is commandeered.

Line Up Postwar Sales

Although service work has proved excellent for this critical period, Lambert & Simpson recognize it for what it is, and already are preparing for the day when restrictions are lifted. Files are kept of all persons who inquire about appliances, and of all persons who have had service work done at the shop. Later when the store has its same fine sales lines, all these leads will be followed up. Potential customers will be contacted. The street floor of the company will again be used for selling merchandise. There will be inviting displays.

But now, Lambert & Simpson tend to the job at hand. The satisfaction they give in making a dead toaster work or keeping the oil burner or washer functioning properly spells merchandise customers when the war is won.

With Victory in **SIGHT**

Wilcox-Gay Corporation, designers of the famous Recordio, are engineering plans for a greater home recording future. Distributor and dealer franchises are now being established to serve outlets for the sensational new Recordio. Home recording discs now available.



WILCOX-GAY CORPORATION
CHARLOTTE, MICHIGAN

Manufacturers of the Recordio, Famous Home Recording-Radio-Phonograph Combination

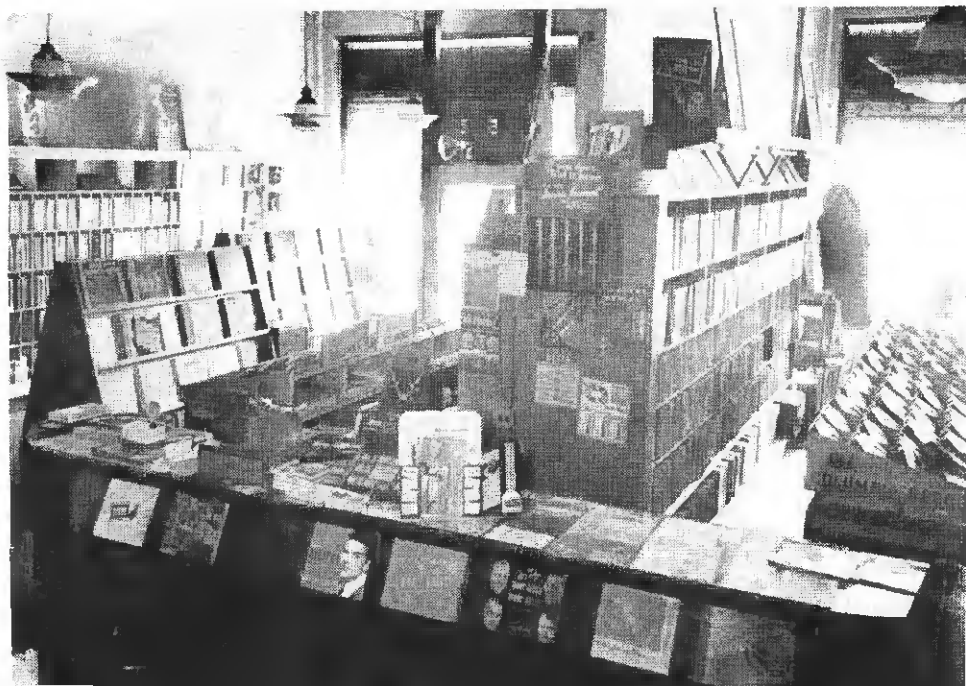

Tuttle's colorful island counter invites sales.

**Tuttle's, Syracuse,
Makes Community
Record Conscious**

EXTRA Sales in DISCS

• Tuttle Electric Co., Syracuse, N. Y., has a formula for making community residents record conscious. Like many another formula this one is a wee bit complex, so we're going to break it down for the benefit of record-vending readers.

First on the menu at Tuttle's is the double-barreled advertising appeal directed at those now or about to be in some branch of the service. Tuttle's secures as many names and correct camp addresses of members of the armed forces as is possible.

Send Gift Reminders

They then send individually typed letters to these people, pointing out that when the folks back home have a birthday, wedding, anniversary, are sick, or some other occasion arises where a gift seems indicated, records make the ideal present.

Tuttle's goes on to say, via the typewriter, that service men and service women may send a remittance of from \$1 to \$25, together with the name and address of the person who is to receive the gift.

Tuttle's then issues a gift certificate allowing the recipient to come in and pick out records to the value of the remittance received. This certificate is mailed special delivery, together with a gift card, by the record dealer. This procedure saves the service member the wear and tear of selecting a present at his post.

At the same time, Tuttle appeals to the married men about to leave for service. "An ideal farewell gift," quotes Tuttle, "is a record album of the tunes your family loves." Again personally typed letters are sent to all on newspaper lists of those taking entrance exams. Also, Tuttle does not ignore the warplant worker. He suggests dealers put in a weekly window display dedicated to a particular local plant. Still photos—products manufactured, etc., are shown in the window. In addition a placard listing "The Hit Parade" of the workers from that factory is shown.

Each week workers from a certain factory are asked to come into the store and vote for the song they feel is their "Hit of the Week." This provides personal contact over a period of time with virtually every worker in the trading area.

Cooperation Sells Classics

Tuttle believes that the "classics" deserve a push because of the profit involved in their sale. In cooperation with local music clubs in the city, a recommended list of light opera favorites, as well as classical symphonies, is displayed every 2 weeks on posters.

In cooperation with second-run neighborhood theatres, a classical recording, lasting but a few moments, is played during every show, matinee and evening. The theatre manage-

ment routes the recording during the pause between double features. A brief PA announcement gives the name of the record dealer.

Everyone goes to the movies these days, and there are always one or two neighborhood show houses ready and willing to help the good cause along.

Stress Children's Discs

Even the children are not neglected. The average elementary schoolroom has access to a phonograph. Tuttle makes it a point to issue a list of records suitable for individual grades from kindergarten through junior high. Working with the grade school and high school music instructor in collaboration with the instructors of the various grades concerned, a lot of records are sold to the school system regularly.

Children give each other gifts for birthdays, at Christmas, etc. Tuttle maintains a "Kiddies' Division" in its advertising, where recordings on a newspaper page just across from the comics reads, "Children—give your friends real records for their birthday."

These promotions do not represent all of the sales plans used by this enterprising dealer, but they do furnish ample food for thought on the part of other dealers who wish to bolster their volume of 1945 record sales.

"We'll get them into your store" says *Emerson Radio*



P.D.Q.
PREFERENCE
DELIVERY
QUOTA

GREAT ENGINEERING IDEAS IN SMALL PACKAGES... COMPACT, EFFICIENT, FINE

The P.D.Q. Plan does it—gets traffic now—for future sales—and present services.

Put up the Emerson P.D.Q. banner. You will be amazed at the results. All over the country people are pouring in by the thousands and thousands to dealers who have taken advantage of this constructive, effective, post war plan.

P.D.Q. PREFERENCE DELIVERY QUOTA Plan—for Franchised Emerson Radio dealers. A complete merchandising set-up that is pulling customers into dealers' stores for service and for goods now on hand—piling up for them "preference" orders for the new "miracle sets" as soon as they come off the line.

P.D.Q. is being featured in Emerson Radio's national advertising. The merchandising "package" includes powerful window and store displays—with impressive Preference Registration Book and tie-up Consumer Certificates for later follow-up—all at no cost to you.

P.D.Q. is the most concrete and constructive promotion plan in radio today. Consumer "preferences" are pouring in by the thousands—building a huge waiting market for Emerson Radios. **P.D.Q.** merits your immediate action. Call your Emerson Radio distributor now for complete details—or write direct to factory.

EMERSON RADIO AND PHONOGRAPH CORP., New York 11, N.Y.



MAIL COUPON, attached to your letterhead, for complete details of Emerson Radio's spectacular P.D.Q. Plan.

Emerson Radio & Phonograph Corporation
Room 1363—111 Eighth Ave., New York 11, N.Y.

Gentlemen:

I have a retail store and am interested in your P.D.Q. plan. Please send details.

Name of Individual _____

Name of Store _____

Street _____

City _____ State _____

RT-3

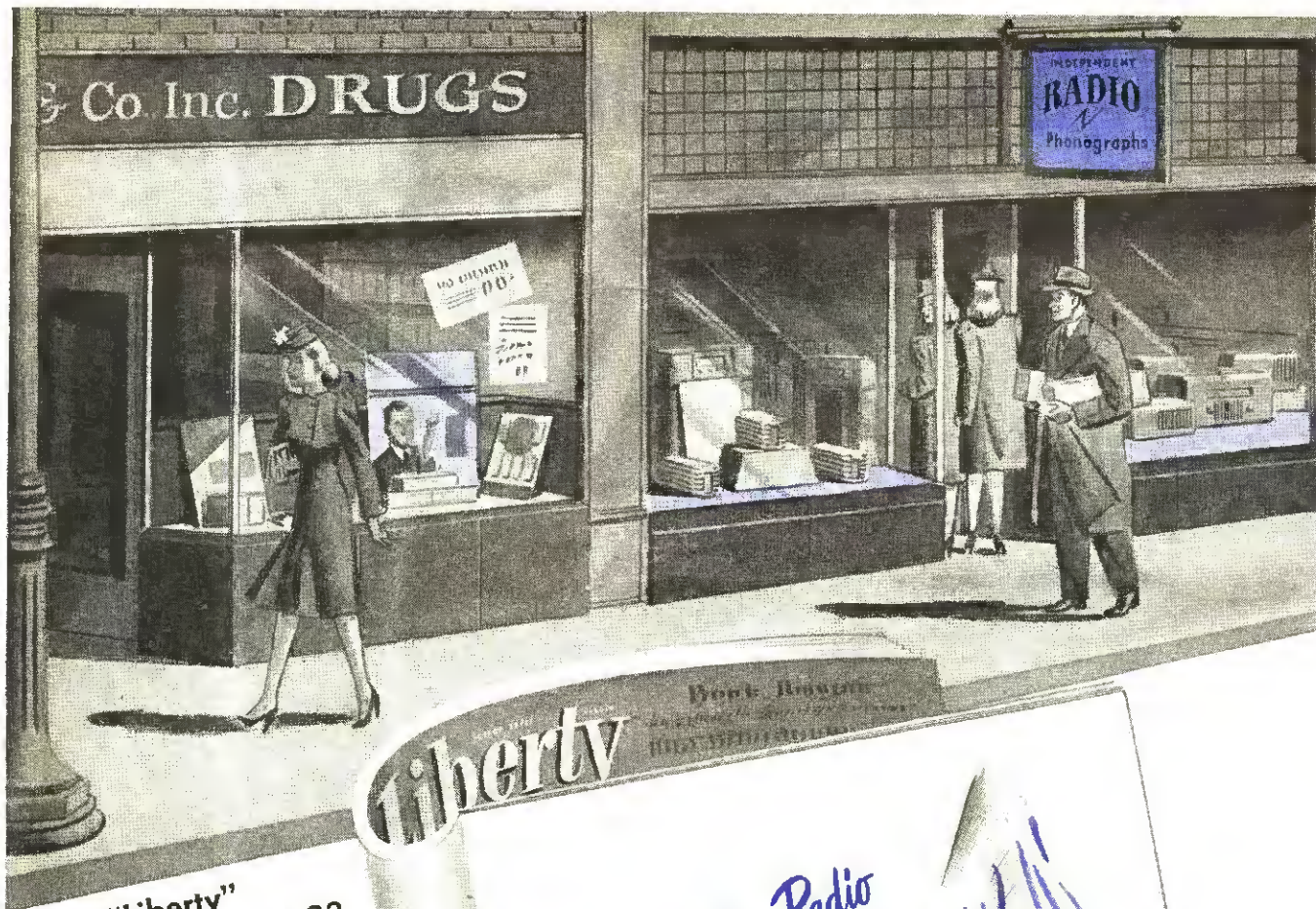

See "Liberty"
December 23



John Meck SAYS:

"You've got the radio dealership now—keep it against postwar competition. As indicated in this advertisement, first of a series appearing in Liberty and other national magazines, Meck is doing everything possible to maintain public acceptance of the dealer."

Liberty

Buy Your New Radio from Your Radio Dealer

"You will get more satisfaction—better value—from a radio bought through a radio specialist—your local radio dealer.
"You will get every word-while improvement—because my years of experience and technical knowledge enable me to choose the best postwar models.
"Many of us dealers have chosen Meck Radios—because they offer you outstanding engineering advancements as well as a reputation for quality firmly established through years of building world-famed electronic products."

FACE TO FACE RECEPTION

ONE OF THE NEW MECK RADIOS

Your Radio Dealer

MECK RADIOS

JOHN MECK INDUSTRIES • PLYMOUTH, INDIANA, U.S.A.

TABLE MODELS • PORTABLES • CONSOLES • PHONOGRAPHS



WHO'S GOING TO GET THE POSTWAR RADIO BUSINESS?

Radio dealers have long been forced to compete with catch-as-catch-can merchandisers who sell everything from goldfish to chinaware—and who include a few radios somewhere between those extremes. When radios go on the market again in the postwar era, it's obvious that the same competition may reappear. Safeguard *your* business through the Meck preferential distribution plan.

CUT YOURSELF A SLICE OF RADIO FACTORY

Your Meck jobber is not only guaranteed an exclusive sales territory, but has an ironclad promise of delivery of his first year's radio requirements. Meck jobbers are booking your orders *now*—for delivery within 60 days of the resumption of unlimited civilian production.

Meck believes that radio dealers are the men best fitted to handle radio sales, and that they deserve the radio business. Meck is, therefore, doing everything possible to maintain their acceptance by the public. National advertising helps to establish the radio dealer as the dependable source for new radios, presells your customers, and paves the way to sound business.

As a Meck dealer, you have the answer to the question, "Who's going to get the postwar radio business?"

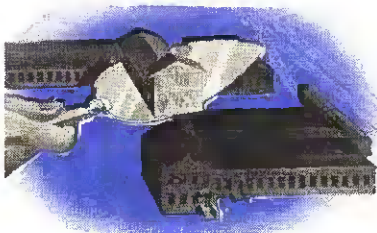

Your greatest postwar problem will be obtaining stock. Ask your jobber about the Meck guaranteed delivery plan—and cut yourself a slice of radio factory. Assure yourself delivery on your first radio requirements—and meet your customers' demands ahead of your competitors.

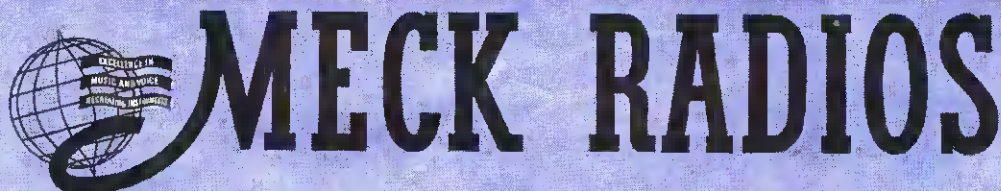

PORTABLES • TABLE MODELS • CONSOLE COMBINATIONS



GI date for a phone call

This G. I. has an important call to make the instant he lands. For the next steps in the gigantic Air Invasion depend upon the reports he sends back . . . on the instructions he receives.

Fortunately, there will be no crowded circuits, no "busy" signals, for on his back this airborne trooper carries the means for instant, dependable Communications. In its way, it's as expertly designed and built as the huge Transport he has just left, as the automatic rifle that he clutches . . . designed and built to give the greatest possible measure of service under the most punishing conditions. It's one of the reasons why our troops are called the most superbly equipped in the world.

★ ★ ★

Supplying Transformers, Coils, Headsets and special Electronic parts is the wartime job of Rola, pioneer manufacturer of Sound-Reproducing Equipment.

THE ROLA COMPANY, INC.

2530 SUPERIOR AVENUE • CLEVELAND 14, OHIO



ROLA

MAKERS OF THE FINEST IN SOUND REPRODUCING AND ELECTRONIC EQUIPMENT

Travel with Trav-Ler

Music... the universal language... that men may understand each other... and, understanding, work forward together. Speaking of forward-working is speaking of the Trav-Ler Radio. Today's experiments with both AM and FM will bring you a postwar Trav-Ler of amazing excellence. Tonal purity... a minimum of interference... programs from many places and many lands right into your living room. Future-minded jobbers and dealers are invited to write.

Ginny Simms, star of NBC's "Johnny Presents."



TRAV-LER

RADIOS

Karenola

RECORD PLAYERS

TRAV-LER KARENOLA RADIO & TELEVISION CORPORATION, 1028-34 W. Van Buren St., Chicago 7, Ill.
RADIO & Television RETAILING • December, 1944



Sun's Place in Postwar

Washington, D. C., Radio Firm Steps Up Tempo for Tomorrow's Sales

• Despite inadequate manpower and prevailing merchandising problems, the Sun Radio Co., 938 F. St., N.W., Washington, D. C., is adjusting its sales program to peacetime.

Pre-war retailers of standard makes of radios, records, refrigerators, washers and other electrical appliances, as well as a camera sideline, Sun Radio's manager, Harold A. Sugar, today effectively utilizes store arrangement to conceal product shortage, and to give the impression of a large stock.

Radios occupy the center aisle. This long line of well waxed chassis is in reality made up of customers' radios, in for repair.

Record Stock Ample

The record department, carrying current recordings and catering to all tastes, is on the left, while the well-equipped tube department is on the right. All aisles lead to the service receiving center in the rear.

Originally, Sun Radio had five retail establishments, located in Rich-

mond, Va.; Baltimore, Md.; and Washington, D. C.; but its owner and president, Emanuel M. Rosenweig, decided it wiser to concentrate effort during war, so only two stores were retained, in the Washington area.

Harold A. Sugar is manager of

the F St. location, and William Peltz is in charge at the E St., N.W., store.

50 per cent of this firm's business is devoted to government contracts and it also caters to the various embassy residents, with orders varying (Continued on page 84)

Every inch of space utilized in busy Sun Radio store.



Engineering right out of war-time radio and radar, plus fresh modern styling

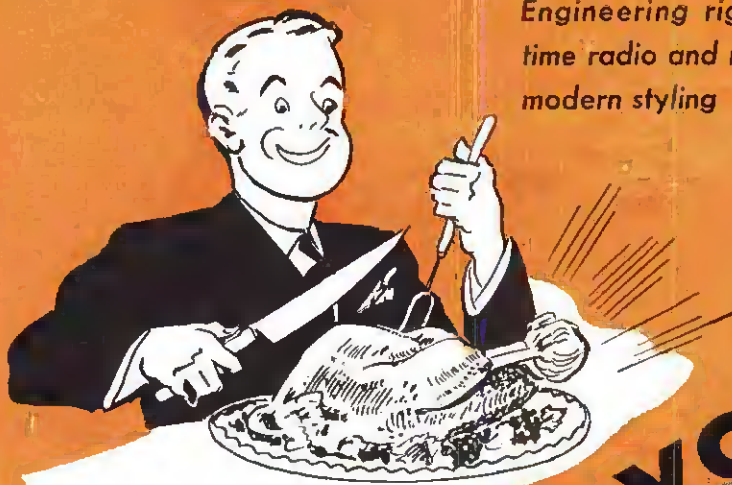

Which do you want?

Re-hash of 1941 plans, dressed up in "stop-gap" cabinets



What will you really get when the shooting stops—genuinely fresh engineering advances—or just a re-hash of what was ready in 1941, dressed up in new model numbers?

It's clear what you'll get from Olympic: No "night-mare" miracles!

But sound, truly-functional design from The Gilbert Rohde Organization . . .

Plus completely fresh engineering that releases all the startling betterments from war-time radio and radar . . .

And you'll get them right away . . . without any time-lag. For an advance pre-view of what home radio will really be like, put your name in Olympic's mailing list now.

Just write: Olympic Radio & Television,
510 Sixth Avenue, New York 11, N. Y.





BENDIX

CENTER OF RADIO RESEARCH . . and production



RADIO DIVISION

WILL Present

for the Aviation Industry

A COMPLETE LINE OF HOME RADIOS
PREPROVEN FOR POPULARITY

As products of an outstanding contributor to radio and electronic development, these new home radios will naturally incorporate important advancements in Performance Appearance Selling Appeal

The advent of Bendix Aviation Corporation into home radio means much more than the addition of a new name to this field. It means that a dynamic new force has entered this great and growing market—equipped with unexcelled research and manufacturing facilities . . . with a unique record for advancements in radio and electronics . . . staffed by the ablest of research personnel . . . backed by a corporation with ample financial resources and an unexampled record of success . . . and with a line of radios and radio phonographs beautiful beyond belief in styling and tonal quality—and *pre-proven for popularity.*

UNPARALLELED EXPERIENCE

As center of research and production for the aviation industry, Bendix Radio Division has always been a step ahead with developments that have played a major part in the advancement of all forms of communication. Focused on home radio, this vast experience will naturally result in the presentation of *trail-blazing improvements.*

UNEXCELLED FACILITIES

As one of the largest suppliers of aviation radio equipment built to the strict requirements of the armed forces, Bendix Radio Division has, of course, unexcelled facilities for volume production, quality craftsmanship, and product development. You can count on it—this line of home radios will be both moderately priced, and *the finest money can build or buy.*

EXCEPTIONAL PROFIT POTENTIAL

Moreover, this new line—with models to suit every purse—will give you Preproven Popularity. For Bendix has sampled the public mind . . . found out what people want . . . and is going forward with a *basic and continuing consumer research program to insure you of a "hot" line.* Add to this that the Bendix merchandising program is based on the knowledge that your first consideration is a worthwhile profit, and you'll understand why you should learn more about this great new line—*coming leader of the home radio field.* Write today for the book—"A Great Name Soars into the Home Radio Field." It's packed with facts you ought to know before you sign *any* radio franchise.

Bendix Radio

DIVISION

BENDIX AVIATION CORPORATION • BALTIMORE 4, MARYLAND

FIRST IN CREATIVE ENGINEERING



When stock display is varied, careful arrangement preserves eye-appeal at Albright's.

Store and Window Displays Aid Albright's Sales

Record and Gift Selling

• A strong believer in dealer franchises for the sale of radios and appliances, W. S. Albright, 84 Albany St., New Brunswick, N. J., is following with close interest manufacturers' postwar promises, and sincerely hopes for stronger manufacturer insistence on protective dealer-distributor operations for the future.

Prewar sales of radios, refrigerators, washing machines, electric vacuum cleaners and the table appliances were outstandingly good at Albright's, but today's sales are of merchandise that is quite different.

Record Display

Records, for one, are a big factor today, and Albright's display is brightly colorful and strictly "self-service". Occupying an entire side wall of the store, the record self-selection racks, which Mr. Albright

designed and built himself, catch the customer's eye and invite inspection.

Right now, Christmas recordings of all kinds are strategically displayed at eye-level on the racks, so that the most timely discs and albums can be moved more quickly.

Records, here, are promoted as gifts, not only during holiday time, but throughout the entire year. The variety of record stock carried by Albright is evidence of the tremendous sales potential in discs. Dramatic readings by famous stars, complete operas, classical music of all kinds, as well as populars, and a complete line of children's records offer selections for all tastes and all ages.

Other substitute lines carried by this retailer are coffee makers, cookie jars, pottery of all kinds, electric lamps and bulbs, fluorescent lights, pictures, frames and mirrors . . .

lines that are allied to household appliances, insofar as the housewife also buys them. Designed to keep the housewife and customer coming back to Albright's until appliance merchandise is again available, these lines do well for dealer Albright.

Gift Promotions

As in the case of the records and albums, all other displays of merchandise are also effectively arranged, and kept dustfree and fresh in appearance. Bright, clean windows permit the passerby to see into the store. The whole store's floor display becomes part of the window!

Service, due to help shortages in this warplant area, is farmed out to one technician who handles a lot of similar work for other retailers in this city. This is typical of radiomen's cooperation everywhere today.

Interior arrangement by dealer Albright segregates many items for consumer selection.



AFTER VICTORY

Cunningham Radio Tubes



**STANDARD
SINCE 1915**
*PREFERRED BY SERVICE MEN
FROM COAST TO COAST*

62-6731-24

A QUALITY PRODUCT OF THE RADIO CORPORATION OF AMERICA

ANOTHER TRUE S

SUBMARINE DIVISION

RADIO CORPORATION OF AMERICA
CAMDEN, NEW JERSEY

DEAR SIR:

FOUR OF US, ALL NAVY RADIO TECHNICIANS, ARE PLANNING ON STARTING A RETAIL RADIO AND ELECTRONIC REPAIR SHOP IMMEDIATELY AFTER THE WAR. WE FEEL THAT WE ARE CAPABLE OF OPERATING A SUCCESSFUL BUSINESS SINCE WE HAVE ALL HAD CONSIDERABLE EXPERIENCE. IN ADDITION TO OUR NAVY EXPERIENCE, TWO OF US ARE EX-HAMS AND RADIO REPAIRMEN. ANOTHER IS A FORMER EMPLOYEE OF THE BELL TELEPHONE SYSTEM.

IN THE COURSE OF THE WAR WE HAVE ALL BEEN SERVING IN THE SUBMARINE FLEET AND HAVE DONE CONSIDERABLE WORK ON NAVY EQUIPMENT. IT HAS BEEN A PLEASURE TO ALL OF US TO WORK ON RCA EQUIPMENT. FOR THIS REASON WE WOULD LIKE TO DEAL WITH YOU AS MUCH AS POSSIBLE.

WE HAVE ABOUT TEN THOUSAND DOLLARS AMONG US FOR INVESTING IN OUR BUSINESS. AT THE PRESENT TIME WE ARE PLANNING ON LOS ANGELES FOR THE LOCATION OF THE ENTERPRISE AND WE HAVE A SUITABLE LOCATION IN MIND.

IF YOU WOULD PLEASE GIVE US AN ESTIMATE ON THE INITIAL COST OF THE STOCK AND SUPPLIES AND THE TERMS YOU OFFER CONCERNING CREDIT BUYING IT WILL HELP IN OUR PLANNING.

WE SHALL WANT A REASONABLE SUPPLY OF RADIOS, PHONOGRAPHS, FM, AND TELEVISION SETS; ALSO AN ADEQUATE SUPPLY OF TUBES, CAPACITORS, RESISTORS, ETC. FOR OUR SHOP, AND THE VARIOUS SPECIALTIES YOU OFFER. MUCH OF THE INFORMATION WE WANT CAN BE SUPPLIED BY ONE OF YOUR WHOLESALERS. INFORMATION YOU CAN SEND US WILL BE GREATLY APPRECIATED.

YOUR

E.



LISTEN TO RCA's radio program, "The Music America Loves Best"...every Sunday, 4:30 p.m., EWT, NBC Network.

TORY!

OF HOW RCA ENGINEERING RANKS
TOPS WITH MEN WHO KNOW
ITS OUTSTANDING WAR RECORD!

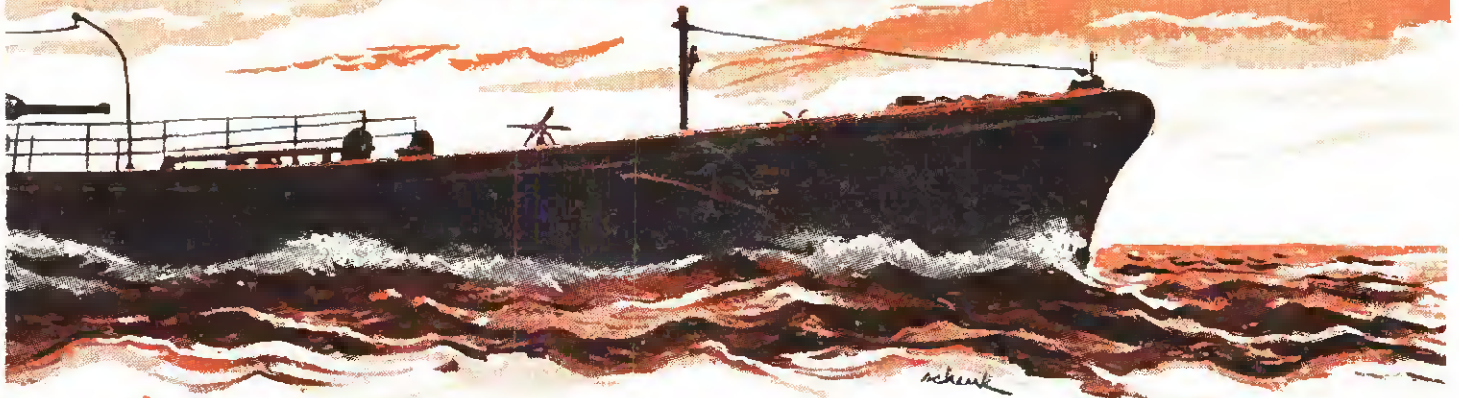

4 NAVY RADIO TECHNICIANS ASK FOR AN RCA POSTWAR DEALERSHIP . . . JOINING THE MANY OTHERS WHO SEE IN RCA THE GREATEST PROMISE FOR RADIO, PHONOGRAPH AND TELEVISION SALES

• What greater tribute could be paid to RCA engineering leadership than this letter from 4 U. S. Navy technicians asking for an RCA dealership after the war. None are in a better position to judge RCA equipment than these men who use it and live with it through days of fighting . . . where the outcome of battles and even their own lives may depend upon its unflinching performance.

After all is said and done, the one greatest single factor in building a solid postwar business will be the *engineering* behind the products you sell . . . the ability to offer your customers instruments with features and performance ahead of all others.

To these Navy technicians and to all others who will be RCA dealers after the war, RCA makes this promise: This same engineering that wins top recog-

nition everywhere will be solidly behind every RCA radio, phonograph or television set. It will put into all of them extra value your customers will know and recognize—and buy!

RCA . . .

FIRST WITH THE THINGS THAT COUNT

It is a matter of record that the really great advances in the radio and radio-phonograph bear the mark of RCA engineering. More than any organization in the industry, RCA is credited with the important "firsts" that step by step have brought radio and radio-phonograph performance to the high level enjoyed today. And in the field of television, the whole electronic system that makes television a "going concern" is largely the result of RCA development work . . . the accomplishment by RCA of the first things first.

RADIO CORPORATION OF AMERICA

RCA VICTOR DIVISION • CAMDEN, N. J.

LEADS THE WAY . . . In Radio . . . Television . . . Tubes . . . Phonographs . . . Records . . . Electronics

RCA's New 170-A Audio Chanalyst

Tests Everything
from Microphones
to Multiple Speakers

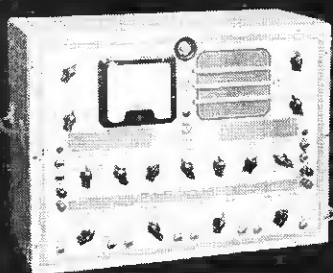

THE new 170-A Audio Chanalyst is a combination testing unit which includes the famous Voltohmyst circuit, a new diode flat through the audio range, a B.F.O. signal source, a gain calibrated amplifier, and speaker and line output connections.

The various channels of the RCA Type 170-A can be used independently or in unison to check

all common defects in audio amplifiers and sound systems. Polarity indication and a.c. can be determined instantly with the new electronic indicator, without danger of overload!

A pamphlet containing full description and specifications of the 170-A Audio Chanalyst will be sent gladly, on request.

Please use this coupon ↘

BUY MORE WAR BONDS



Test & Measuring Equipment, Dept. 97-87J
Radio Corp. of America, Camden, N. J.

Please send the bulletin describing the new RCA 170-A Audio Chanalyst to:

Name
Position
Company
Street City.....

RADIO CORPORATION OF AMERICA

RCA VICTOR DIVISION · CAMDEN, N. J.

In Canada:

RCA VICTOR COMPANY, LTD., MONTREAL

Your Inventory Tells a Story

Breakage, "Robbed Parts," Items Not Charged Out, Change Figures on the Books

● Inventory-taking next month is viewed as a most important business function for the radio retailer to perform. It will enable him to line up his stock on hand, check such merchandise against the records on his books, and examine the goods in the light of possible early replenishment, now that limited production of civilian goods seems nearer than at any other time during the present war.

Discover Discrepancies

Inventory-taking is a must with the dealer for more than one reason. In the first place, in order to comply with various regulations, proper records must be kept. In the second place, the inventory will permit the dealer to know the dollar-and-cents value of his stock, actually, since by taking physical inventory and comparing with bookkeeping records, discrepancies will be uncovered. A physical count of all merchandise on hand will also reveal lines the dealer is overstocked with and items he is short of, which may not show up in such categories on the books.

If proper accounting systems are used, it would not appear possible on the surface that discrepancies could exist between the figures written in the records and the actual quantities of the goods themselves. However, where the business operation is fairly large, and numerous items, used both for sales and repairs, are involved, the physical inventory figures seldom jibe exactly with the figures carried in the books.

As a means of illustrating the importance of the physical inventory to retail business, here are some of the things which might occur in the handling of the stock itself which would create accounting discrepancies:

1. A repairer takes a new condenser out of a bin having a "perpetual" inventory card attached. He

either drops in a used condenser of the same value, or makes no replacement whatever. He "forgets" to make entry on the card.

2. "Scrapped" parts, not carried on the firm's books, are dumped in with new parts, and no record is made.

3. Various new merchandise is sold but descriptions on sales slips are inadequate, and thus they are improperly entered in the bookkeeping system.

4. Some of the new parts used in a repair job are not charged out on a repair ticket.

5. Failure on the part of an employee to report breakage on new merchandise, such as radio components, damaged in repair work, glass coffee-maker parts, phonograph records, etc. Some such items may be carried on the books at their presumed actual values, whereas they may actually be worthless.

How Values Change

"Parts-robbed" appliances have always presented a serious problem to the merchant. Now, in war-times, the problem has become greatly aggravated. In many shops, parts have been removed from new equipment to repair washers, radios, refrigerators, vacuum cleaners, etc. In too many cases the "parts-robbed" appliance is carried on the books at its full value, whereas its value has actually been lowered. A physical inventory helps keep check on true values of "robbed" equipment.

The mechanics of taking a "physical" inventory consists of making a careful count and an intelligent description of all goods on hand. It is also vitally important to state the location of all such merchandise. The speed with which an accurate inventory may be made depends upon an orderly conducted check, and the clarity of the finished report depends

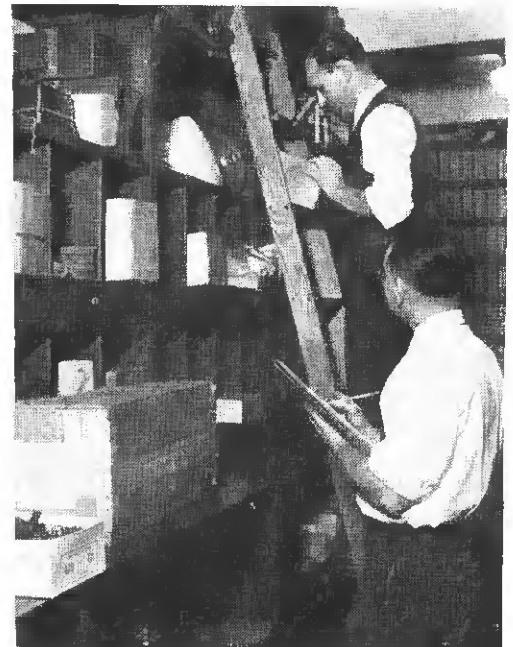

Two are better than one!

upon the inclusion of *all* necessary data. Two people will make better time and a more accurate report. One person counts and calls out the items—the other records them.

Before commencing actual count, some thought should be given to the preparation of the form to be used in the checking. The inventory sheet should be large enough to allow room for all data, and should have proper headings, such as "quantity, shelf number, merchandise description, cost and extension," etc.

When the physical inventory has been completed and totaled, the figures are checked with the figures appearing on the firm's books, or against invoices, etc. At this stage, discrepancies may be dealt with. "Overages" may be picked up and entered in the records—"shortages" charged off, etc.

Some dealers declare that next month's inventory-taking will also include a needed "house-cleaning." Operating at top speed during these troubled times, with appliances breaking down right and left in customers' homes, and with parts and help shortages prevailing, many repair shops and showrooms look as though the devil dumped his pack in them.

Housecleaning Hint

"We're going to take a breathing spell for a few days next January," says one merchant. "We're going to take inventory first, and then we're going to put our place in order. After we have done both jobs, our work will be speeded up as a result, and the good moral effect a clean, orderly place will have upon us all is something we look forward to with a great deal of pleasure."

Ammunition . . .



VICTORY PAPER TUBULARS Aerovox Type 684V

AEROVOX CAT. NO.	A.S.A. SPEC. NO.	D.C. W.V.	CAPACITY M.F.D.	LIST PRICE
684V	VPC-2	600	.001	\$0.20
684V	VPC-3	600	.002	.20
684V	VPC-4	600	.005	.20
684V	VPC-5	600	.01	.20
684V	VPC-6	600	.02	.25
684V	VPC-7	600	.05	.30
684V	VPC-8	600	.1	.45
684V	VPC-9	600	.25	

VICTORY ELECTROLYTICS Aerovox Type PRSV

AEROVOX CAT. NO.	A.S.A. SPEC. NO.	D.C. W.V.	CAPACITY M.F.D.	LIST PRICE
PRSV	VEC-10	25	25	\$0.60
PRSV	VEC-2	50	10	.55
PRSV	VEC-3	150	20	.75
PRSV	VEC-4	150	20-20	1.30
PRSV	VEC-5	150	50	1.10
PRSV	VEC-6	250	20	1.00
PRSV	VEC-7	450	10	.85
PRSV	VEC-8	450	10-10	1.40
PRSV	VEC-9	450	40	1.75

for the HOME RADIO FRONT

• These are Victory Capacitors. Available in voltages and capacitance ratings selected to meet a wide range of servicing requirements. Indeed, these numbers, used singly or in groups, can service about 90% of the usual capacitor replacements, while much critical material and labor are being conserved for the urgent needs of our fighting men.

AEROVOX VICTORY PAPER CAPACITORS are simply certain selected values in the long-established Aerovox Type 684 tubular line. Millions already in daily use. Enviably performance records. Conservatively rated non-inductive vacuum-impregnated paper sections in extra-wax-sealed cartridges. Yellow-black-red varnished label jackets. They are just as good as they look.

AEROVOX VICTORY ELECTROLYTICS are selected values of well-known Aerovox Type PRSV Dandees. Again, millions already in daily use. Conservatively rated dry electrolytic sections in sturdy tubular housings. Extra-wax-sealed. Built for tough going.

For the duration... for dependable servicing... you can count on Aerovox Victory Capacitors: truly ammunition for the home radio front.

SEE OUR JOBBER... Consult him regarding your wartime capacitor requirements. He carries a stock of essential replacements for your regular servicing and maintenance needs. And for your more special needs, if they have a war significance, he can get unusual items on high priorities.



Capacitors

INDIVIDUALLY TESTED

AEROVOX CORPORATION, NEW BEDFORD, MASS., U. S. A.

SALES OFFICES IN ALL PRINCIPAL CITIES

Export: 13 E. 40 St., New York 16, N. Y. • Cable: 'ARLAB' • In Canada: AEROVOX CANADA LTD., HAMILTON, ONT.

THIS IS Phonola's GUISE FOR THE GI'S

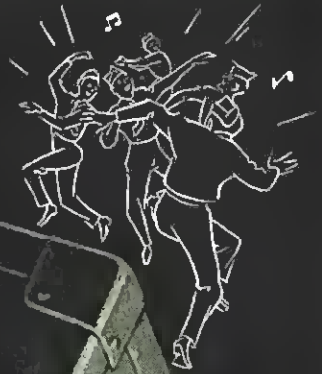

This portable is olive drab and steel-sturdied, but it's still a member of the famous Phonola family. And along with the special electronic communications equipment we are supplying the Armed Forces, it carries to war the twenty-nine-year old tradition of dependability, performance and value that has made Phonolas the finest mechanical and electrically amplified phonographs in the world.

When materials are again available we will immediately resume production of improved units to satisfy consumer demands for fine musical reproducers. Watch for the new Phonolas!

Phonola

PORTABLE PHONOGRAPH

WATERS CONLEY COMPANY
Rochester, Minnesota

Midwestern Sales Office:
224 South Michigan Ave., Chicago HAR 1880
Eastern Sales Office:
17 E. 42nd Street, New York City VA 6-2079

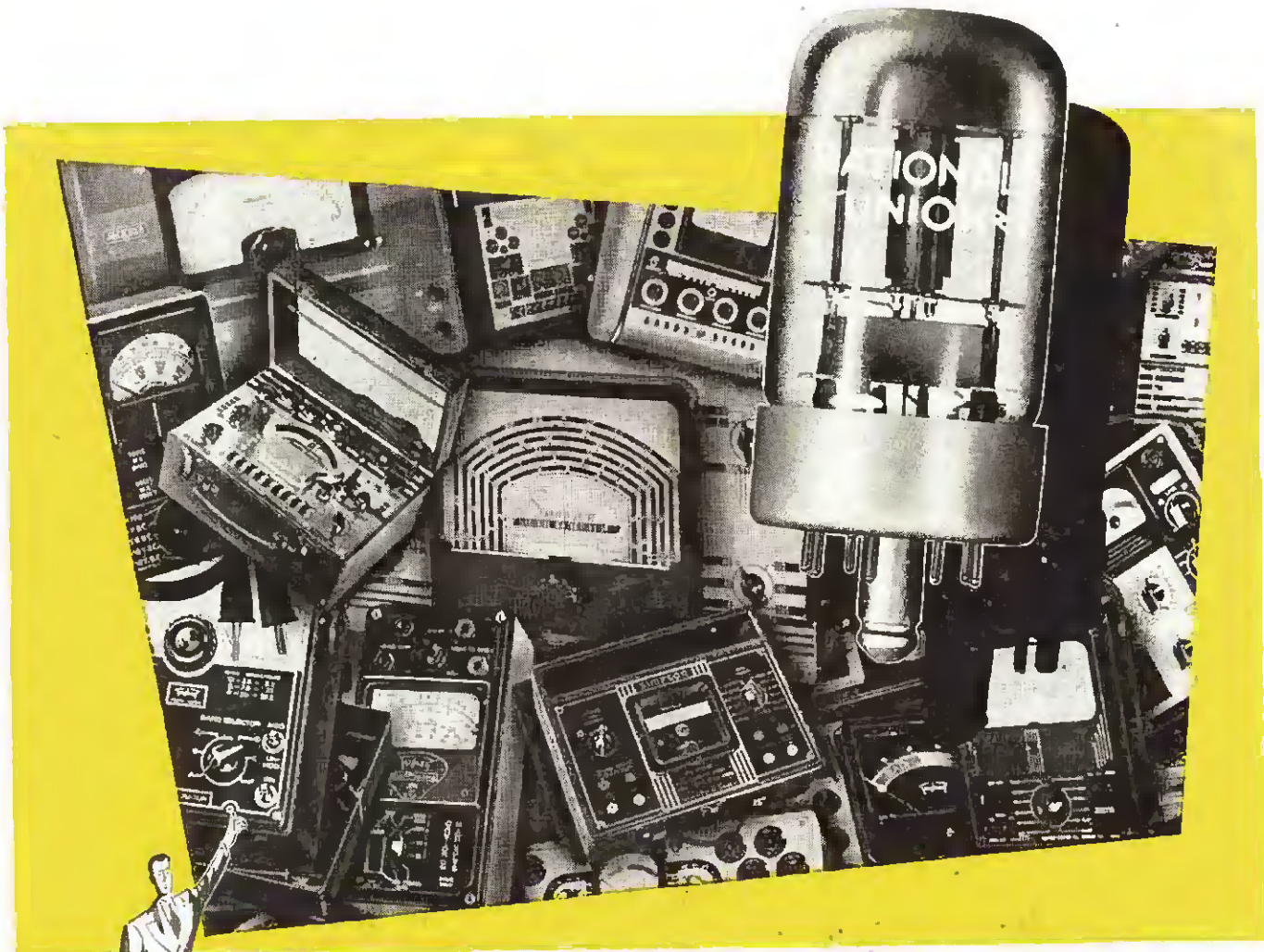

After The war, MORE than before!

COUNT ON THE FAMOUS N. U. EQUIPMENT PLAN

Of course, you'll need new shop equipment to cope with the vastly increased peacetime demand for radio, television and industrial electronic service. You'll want fine, modern instruments, tools, meters. And you'll want them, as before, on the easy-to-get basis provided by the famous N. U. Equipment Plan.

Fifty thousand times this plan was Ok'd by service dealers who used it to equip their shops in the years before the war. So plan now to re-equip for peacetime service, the exclusive N. U. way.

**NATIONAL UNION RADIO CORPORATION
NEWARK 2, NEW JERSEY**

Factories: Newark and Maplewood, N.J.; Lansdale and Robesonia, Pa.



**NATIONAL UNION
RADIO AND ELECTRONIC TUBES**

Transmitting, Cathode Ray, Receiving, Special Purpose Tubes • Condensers • Volume Controls • Photo Electric Cells • Panel Lamps • Flashlight Bulbs

Hats off to the Crosley Loyal Legion

Hats off!—because Crosley distributors and dealers have enabled untold thousands of homes to enjoy dependable service from their Crosley products despite the war-enforced shortages of



replacement parts and manpower skilled in making service repairs.

■ IN COMMUNITIES all over the country these loyal Crosley associates have applied their mechanical ingenuity to making repairs when new parts were not available. They have taught inexperienced workers to do skilled service work. All in all they have done an outstanding war-time-job.

■ AS A RESULT, many thousands of unreplaceable household appliances have been kept in service. Many thousands of families have continued to enjoy the convenience and economy and pleasure of their present radios, refrigera-

tors, ranges, washers, ironers, and other household appliances.

■ CROSLLEY distributors and dealers will serve their communities when Crosley's "postwar" products are available. They know, as no others possibly can, the quality, the dependable performance, and the extra user features that were built into Crosley prewar products* and that will be provided in still larger measure in Crosley products to come.

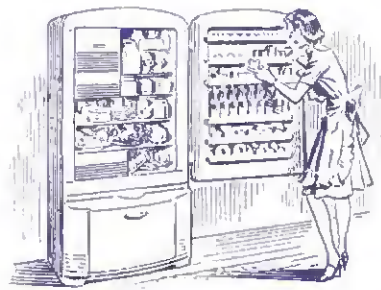

*The Crosley Shelvador† Refrigerator

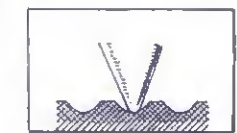
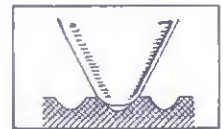

*The Floating Jewel Tone System on Crosley Radio-Phonographs

■ IN BEHALF of the millions of users of all kinds of electrical products, particularly those whose appliances by reason of age, wear or even neglect have needed attention, we say "Hats Off!" — to Crosley distributors and dealers for their outstanding wartime service record."

†Reg. U. S. Pat. Off.

CROSLLEY

THE CROSLLEY CORPORATION
CINCINNATI, OHIO

PERPETUUM MANUFACTURERS OF RADIOS, REFRIGERATORS, HOUSEHOLD APPLIANCES AND THE CROSLLEY CAR • HOME OF WLW "THE NATION'S STATION"

SEE CROSLLEY EXHIBIT, JANUARY 4TH TO 13TH — SPACES 44 TO 48 INCLUSIVE — 17TH FLOOR, AMERICAN FURNITURE MART
RADIO & Television RETAILING • December, 1944

Shryock Tells of FM Selling

(Continued from page 24)

ments in the field, public apathy to the curtailed FM service now available.

The public seems to be divided into two classes; those who like classical music and the higher standard of FM performance use it a great deal; and by far a larger portion, even though they own FM equipment, do not use it because of the curtailed service and a reaction against the "canned" nature of the program material. We feel that public interest will return to a new high as soon as wartime restrictions on FM broadcasting are removed.

Maximum FM Satisfaction

Originally we attempted to furnish and sell with each FM installation a di-pole aerial in order to secure maximum satisfactory performance. A number of the first FM receivers were abnormally deficient in sensitivity in order to get the maximum noise reduction. Hence, the installation had to be extremely close to the transmitter to get satisfactory results. More recently the shortage in both material and manpower changed our attitude so that we overlooked the selling of an aerial installation wherever possible. This has resulted in the following experience: More of the better grade FM receivers gave satisfactory service without special aerial equipment or on existing conventional aerials within a 10 mile radius of the transmitters. At distances greater than 10 miles, depending also on the topography, we found di-poles essential. In some cases reflectors were needed and the installations were critical of accurate orientation.

Room for Improvement

As was to be expected we found later FM performance much better than in the first models, but there is still room for great improvement in receiver design with particular stress on the elimination of drift and more satisfactory operation from the built-in aerials.

Our attitude on the future of FM is one of great expectation, but we choose to think of it in our own modest operation as *fait accompli* rather than something separate and new.

As a firm, we will assume that every prospective purchaser wants this worthwhile new service and believe it is our duty as sincere merchants,

Modernized Service Bench

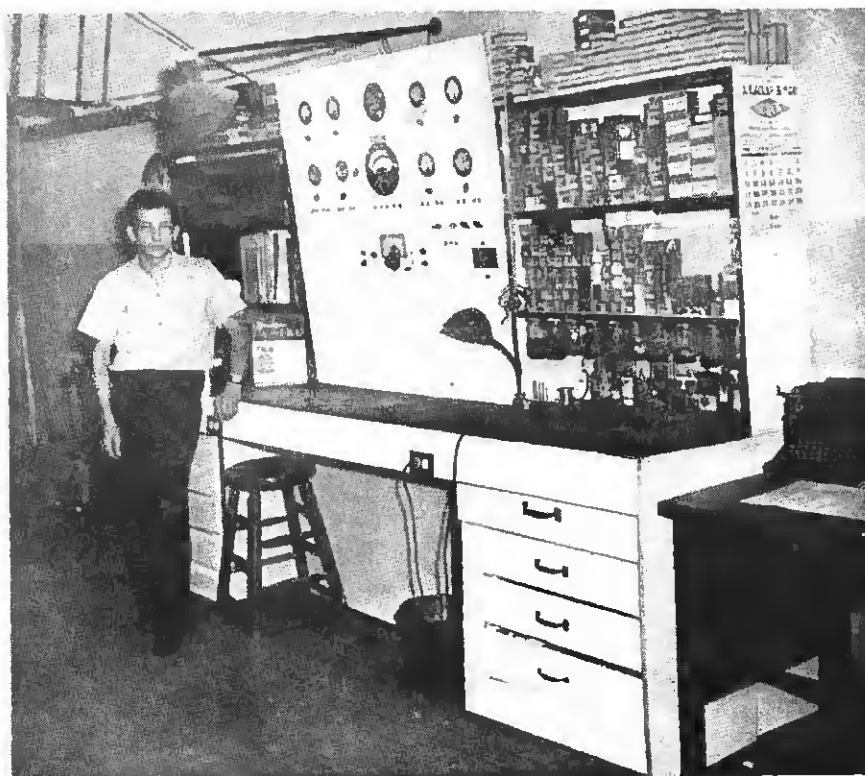

Lyman Brown, owner of Forest Park Radio Co., 405 Dickinson St., Springfield, Mass., at his newly improved service bench. This is a modernization of the service bench pictured in the July '44 issue of RTR, pg. 27. Note the ample shelf space for service manuals, tubes, and glass jar arrangement for parts.

protecting the customer's best interest, to supply it. Therefore, every line and model that we contemplate selling in the postwar period will include FM radio.

Our service department has naturally amassed a considerable amount of field experience in having made over 500 FM and more than 150 television installations.

We will be glad to share this experience with other dealers throughout the country and we will be glad to answer inquiries by mail.

Lohman on FM Merchandising

(Continued from page 25)

However, we have had some customers who had not been particularly keen about the performance of their instruments, but who were eventually satisfied after we had installed special aerials or made suitable adjustments to the existing ones.

Customer reaction to FM is usually favorable. Many are enthusiastic fans. Some customers tell me FM is ideal to play while entertaining, turning volume at low level and using the program as background

music. Some have extra speakers in various parts of the home. Recently, one of our users told us he cannot see any difference between AM and FM, and another feels that the FM programs are beginning to get as "commercial" as the standard ones. But on the whole, FM is well received by the owner.

Good Postwar Market

Since there are more than eight FM stations in this metropolitan area, the future market looks good to us. In fact, we cannot imagine anyone buying a postwar instrument for over \$100 without this feature. FM should, however, be an integral part of the main chassis and not an adaptor or separate tuner. We feel that there has been enough experimentation in FM, and that both receiving units and sending stations are far beyond the experimental stage.

A number of customers I have approached on the subject of FM made it clear that FM is not the only improvement they expect in a postwar set. They do not consider it a particularly new development, but have come to feel that every set should have this staticless feature—plus others.

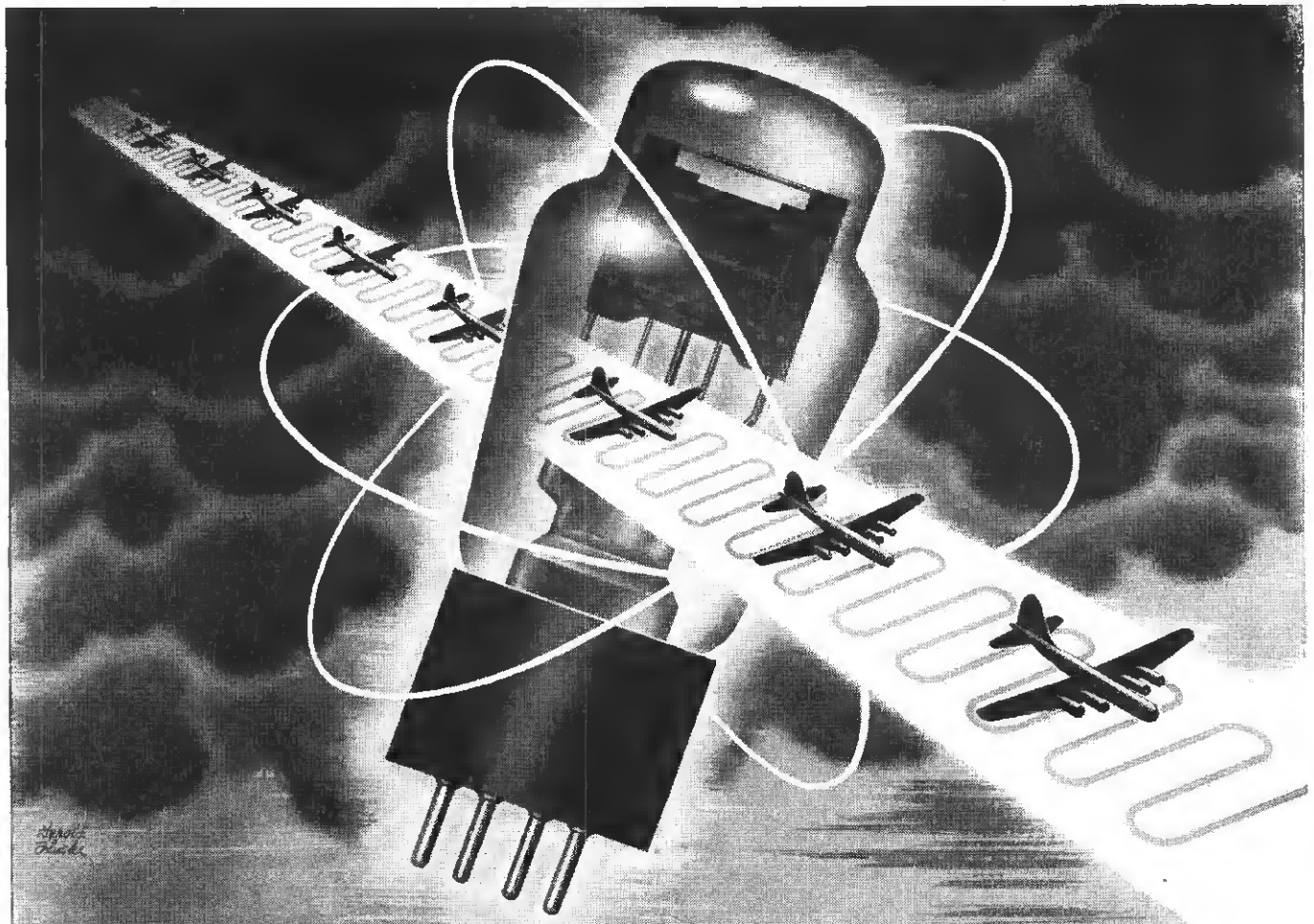

Harold
Parker

Delco Radio Products Mean Fine Performance

From compact auto radio sets to highly intricate radio and electronic equipment for the armed forces, Delco Radio products are distinguished by fine performance. Each unit reflects care and competence in engineering; each part represents advanced techniques in production accuracy.

Tomorrow's civilian needs, like today's military demands, will benefit from Delco Radio's engineering vision, manufacturing precision.

Delco Radio Division, General Motors Corporation, Kokomo, Indiana.

Put Your Dollars in Action—BUY MORE WAR BONDS

Delco Radio
DIVISION OF
GENERAL MOTORS

HYTRON has made them all!



The march of Hytron receiving tube progress down through the years is fascinating. One looks back on tubes, tubes, and more tubes: battery, AC, AC DC, diodes, triodes, pentodes, beam tetrodes, multiple purpose types, G's, MG's, BANTAM GT's — and now the miniatures. Price and size have been drastically cut; quality and performance, amazingly improved.

Hytron has made them all. Its long and varied experience is priceless in a complex industry where probably never will all the answers be known. In making radio tubes, painfully acquired practical experience must supplement the formulae of science.

With an eye to present and future, Hytron is concentrating its production of receiving tubes on preferred BANTAM GT types needed for war — for today's civilian replacements — and ultimately for post-war. Its wartime activities are teaching Hytron new techniques of miniature production. Many potentially popular Hytron miniatures are in development. Typical American dissatisfaction with anything but perfection continues; the parade of Hytron receiving tubes marches on.

HYTRON HYLIGHTS

YOU ARE GETTING MORE THAN YOU THINK

Hytron is shipping you Hytron distributors more MR receiving tubes than you realize. WPB rulings on mandatory exchange of MR tubes between tube manufacturers is not on a tube for tube basis, but on a percentage basis. In other words, Hytron's receiving tube production must be utilized in large measure to maintain percentages for other manufacturers.

For every Hytron branded MR tube, you are also receiving quarterly approximately two and a half times that amount of Hytron tubes under other manufacturers' brands. In short, Hytron is not holding back. When Government regulations are withdrawn, you will instantly become aware of the large Hytron receiving tube production which is serving you.



OLDEST EXCLUSIVE MANUFACTURER OF RADIO RECEIVING TUBES

HYTRON CORPORATION

ELECTRONIC AND RADIO TUBES

MAIN OFFICE: SALEM, MASSACHUSETTS
PLANTS: SALEM, NEWBURYPORT, BEVERLY & LAWRENCE



We've learned a lot in Algiers

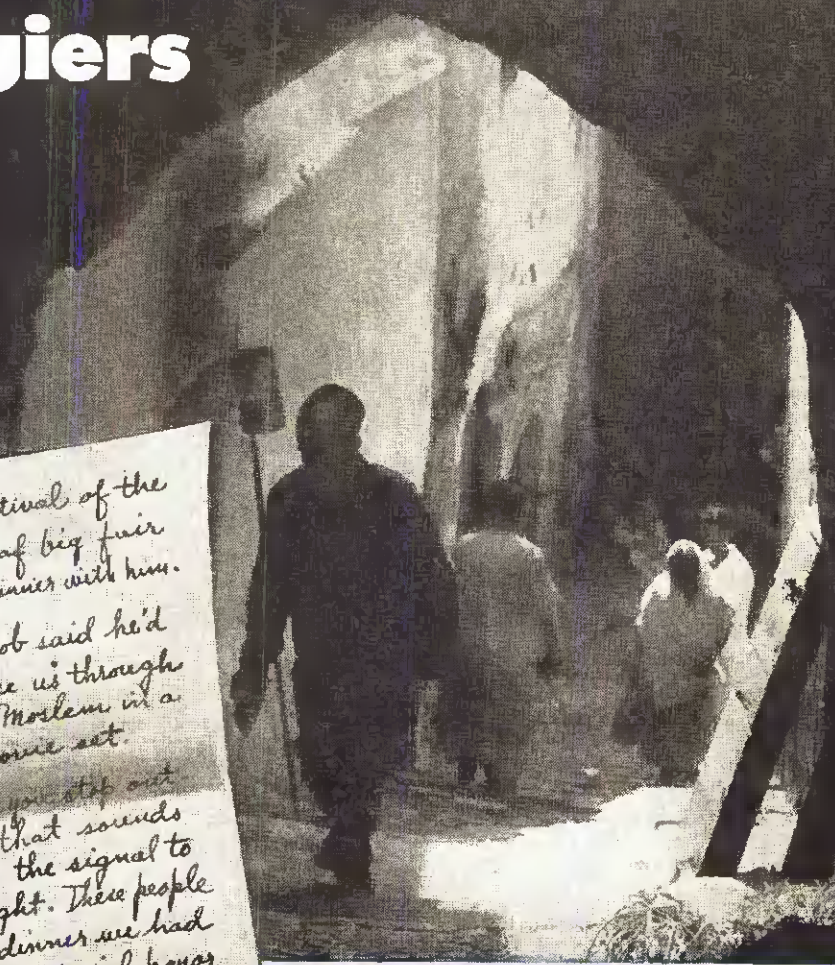

until we met this chap at the festival of the Prophets Ball, which is a sort of big fair and he insisted on our having dinner with him.

I was kind of scared but Bob said he'd been around some and would see us through. So yesterday we dined a la Moslem in a place that looked like a movie set.

When you get to the house you step out side and holler something that sounds like "ta-gat-loo" which is the signal to get the women out of sight. These people are funny that way. For dinner we had barbecued sheep which is a special honor because they eat very little meat. We also had some vegetables very much like ours and cheese made out of curdled goats milk which is terrible but you have to eat some of everything so as not to offend the host. You are also supposed to leave some in the bowl for the women and children and for some reason or other you have to eat with your right hand only. We had Turkish coffee which is like mud and sweet tea with mint in it which I guess is the everyday drink. Incidentally when they give you your third cup of tea in one of these homes it means that it's time to go.

Yes, our boys learned a lot in Algiers . . . and in many another far, strange land. They have not only had hard training in the craft of war but they have had a priceless education in the ways of other people.

AUTOMATIC, too, has had its lessons in war . . . lessons learned in tanks, battleships, planes; in cold, heat, dust, and dampness. AUTOMATIC, too, will benefit from this experience.

This benefit will be passed along to you and to your customers in better AUTOMATIC Radios . . . in greater profits and in greater satisfaction. Consult AUTOMATIC before making post-war commitments.

Automatic

RADIO MANUFACTURING CO., Inc.
122 Brookline Avenue, Boston, Mass.

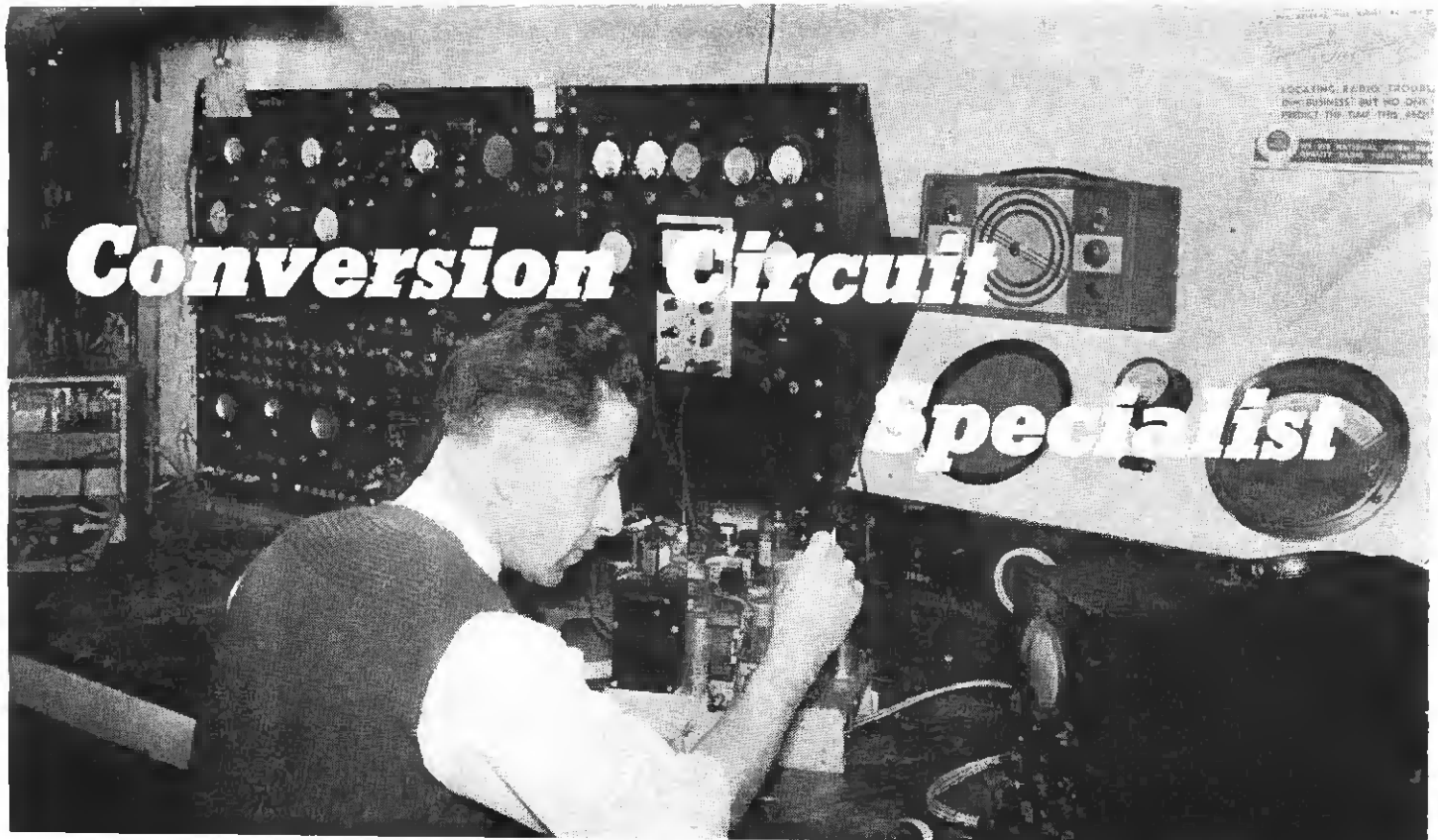

M. G. Goldberg's suggested methods of circuit changing to use available tubes have been of great help to the trade.

St. Paul Radioman's Motto: "If We Can't Fix It, Throw It Away."

• "If We Can't Fix It, Throw It Away," reads a sign on the outside of the Beacon Radio Service Shop, 142 East Fourth St., St. Paul, Minn. For 20 years this shop has been in business in the loop district of the city.

Radios were handled, but sales were a sideline, as the particular interest of the owner, M. G. Goldberg, was in service, the side of the business on which he built his large following that placed him in such a fortunate position when service became the chief source of revenue of most of those in the radio business.

When parts to repair radios became scarce, Mr. Goldberg was hard put to live up to the sign given prominence for so many years. Foreseeing the shortage, he set himself over a year ago to the task of trying to keep radios running with tubes that were available, figuring that the time would come when there would be serious shortages in some types.

Interchanges Tubes

By experimenting, he found that it was practical to interchange tubes by rewiring sockets. These conversion circuits made it possible to use available tubes. Taking tubes that were not designed for certain radios, he changed the wiring and thus kept radios operating. News spread of his

success and his desk is flooded with mail from radio dealers and servicemen who want to learn his methods with certain models and tubes.

Circuit changing brought a great deal of business into his shop—so much, in fact, that work is continually about three weeks behind.

Following the example of jobbers who are interchanging tubes, the Beacon shop has been promoting a plan whereby retail service shops will exchange supplies. This has worked out fairly well, although retailers are not so free in interchange, since many of them are so low in supplies that all that they have can be used in work that comes into their shops. Those that have an excess of one type of supplies, however, are falling in with the idea, which works to the mutual advantage of the shops participating.

Policy of the Beacon shop is to serve oldtime customers first. Every effort is made to finish service work for the regular customer when promised, and to deliver the completed radio in the order received. Beacon will not give repair precedence to the casual customer over the established one.

Although this system prevents the building up of new customers, it does serve to hold the oldtime customer who will continue to bring work to the shop when the war is over. Of

the many persons now shopping around, calling on all service shops to find the tubes they need, most, once the emergency is past, will return to the shops in their neighborhood, but service given to customers of long standing will be remembered by them and will serve to establish the shop more firmly as a regular place for all future work.

Works Overtime Services Sets Himself

Through teaching at the Dunwoody Institute in the Army training program, Mr. Goldberg has been put in touch with mechanically inclined men of whom an occasional one has become available for service work. The largest part of the work, however, Mr. Goldberg does himself, working overtime at the bench late at night and early mornings.

The shop also does repair for some firms which formerly sold radios and wish to give their customers service, but who do not have a service department of their own, or who, because of manpower shortage, have discontinued it.

RADIO AND TELEVISION RETAILING readers have profited from Mr. Goldberg's skill in tube substitution circuits for his methods have been included in the magazine since March, 1943.

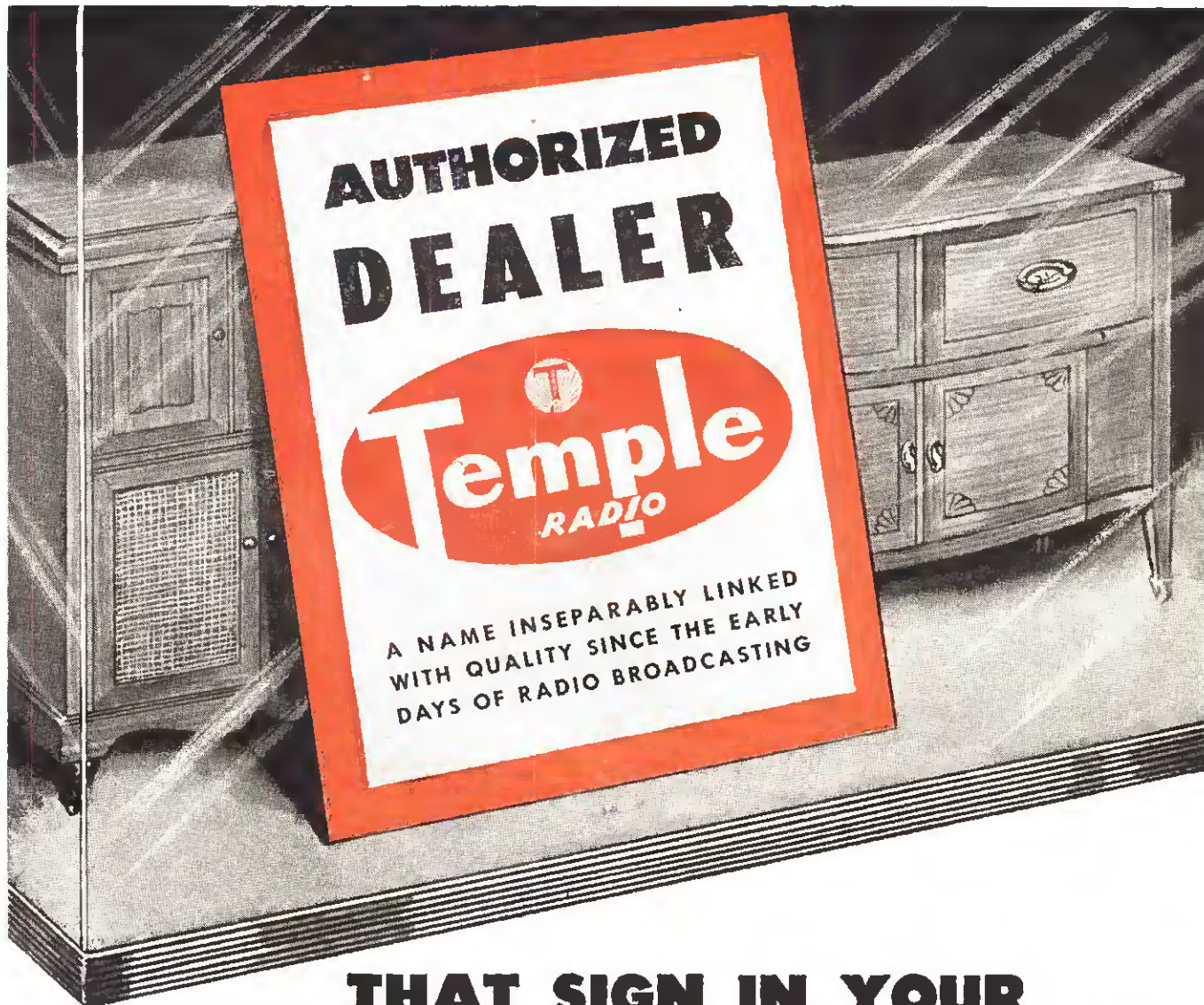

**THAT SIGN IN YOUR
WINDOW, MR. DEALER, WILL ASSURE
BOTH PROFIT AND PERMANENCE**

After the war—just as soon as radios for civilian use are produced—it's going to be easy for you to sell almost any radios you can lay your hands on. We know, however, that the alert, far-sighted retailer must be looking far beyond that initial public stampede and planning to link his store to products that assure both Profit and Permanence. That's why it will pay you to "team up with Temple" from the very start of selling activities.

DISTRIBUTORS

Are invited to communicate with us regarding territorial representation.

**TEMPLE TONE RADIO MFG. CORP.
NEW LONDON, CONN.**

"WHERE FM WILL ALSO MEAN FINEST MADE"

TELEVISION

Tele Broadcasters Hold Their First Conference

The first annual conference of the Television Broadcasters Association, at the Hotel Commodore, New York, December 11 and 12, scheduled as a feature of the two-day meeting the presenting of three gold medal awards for outstanding contribution toward the development of television from the standpoints of individual effort, technical improvement and outstanding program production.

Dr. Allen B. DuMont presided at the principal sessions. Dr. W. R. G. Baker and E. W. Engstrom discussed "New Horizons in Television."

Paul Raibourn, president of Television Productions, Inc., and a member of the board of directors of TBA, served as chairman of the awards committee. Jack R. Poppele, chief engineer of the Bamberger Broadcasting Service, was conference chairman.

The program was designed to interest not only all of the various industries and professions in television but the general public as well.

Farnsworth Man Predicts Large Teleset Sales

There will be hundreds of transmitters and millions of television receivers in operation by 1950, Ernest H. Vogel, vice-president in charge of sales for Farn-

worth Radio & Television Corp., predicted at a meeting of the American Television Society in New York.

Television will arrive more quickly than we can currently appreciate, Mr. Vogel said, but the time of its arrival depends on how soon we can start manufacturing. Factors on which this depends are: (1) the length of the Federal Communications Commission deliberations and the nature of FCC findings; (2) development of moderate-cost, quality programs, and (3) marketing of receivers at the economic level of a lot of people.

Popular-Priced Sets

He cited the example of the low-priced "people's set" sold in England for about \$150 and predicted that, were it not for the war, BBC would today have developed an audience of 800,000 to 1,000,000 homes. "Capital is ready to set up transmitters in almost every major city in America as soon as the public is ready," he reported, assuring television of its place as America's next billion-dollar industry.

In five years after war restrictions are lifted, we will have sold 5,000,000 sets worth \$750,000,000 based on a roughly approximated schedule of: 250,000 receivers in the first full year of production; 500,000 in the second year; 900,000 in the third; 1,500,000 in the fourth and 2,000,000 in the fifth. During these same five



Cel-o-sheen tablecloth commercial featured in telecast at DuMont station WABD, New York.

years, the speaker predicted, we will have built, installed and begun to operate 500 transmitters of varying power. Mr. Vogel characterized these predictions as "not optimistic." As evidence he cited the rise of radio in the years between 1926 and 1930 when \$1,500,000,000 worth of radio equipment was sold and a radio set was installed in one out of every two homes; Vogel's estimates were predicted on television being installed in only one of every six homes. He further recalled that radio at that time was technically imperfect and that few people in 1930 would have guessed that 65,000,000 radio sets would be sold by 1940.

Have Answers to Tele Problems, Says Evans

Commenting on wartime electronic developments, Walter Evans, vice-president in charge of all radio activities for the Westinghouse Electric & Mfg. Co., states television will benefit as a result of the improved production techniques and scientific research. Said Mr. Evans: "It is our considered belief that all of the technical answers are on hand for a usable and acceptable television system. This includes the probability of a reasonably priced receiver, and a practical means of getting shows across the country by means of radio links, or one of the more recently developed types of metal conductors."

Wagman Speaks on Video Sales, Service Problems

Speaking before a New York meeting of the American Television Society, Dave Wagman, of Bruno-New York, declared that specialized selling and maintenance must be employed to protect the public against poor television installations and incomplete service.

He pointed out the necessity for trained salespeople, demonstration booths comparable to those used to sell records in many shops; installation of receivers in public places such as restaurants and taverns, and development of a direct sales tech-

(Continued on page 82)

Admiral Commander-in-Chief

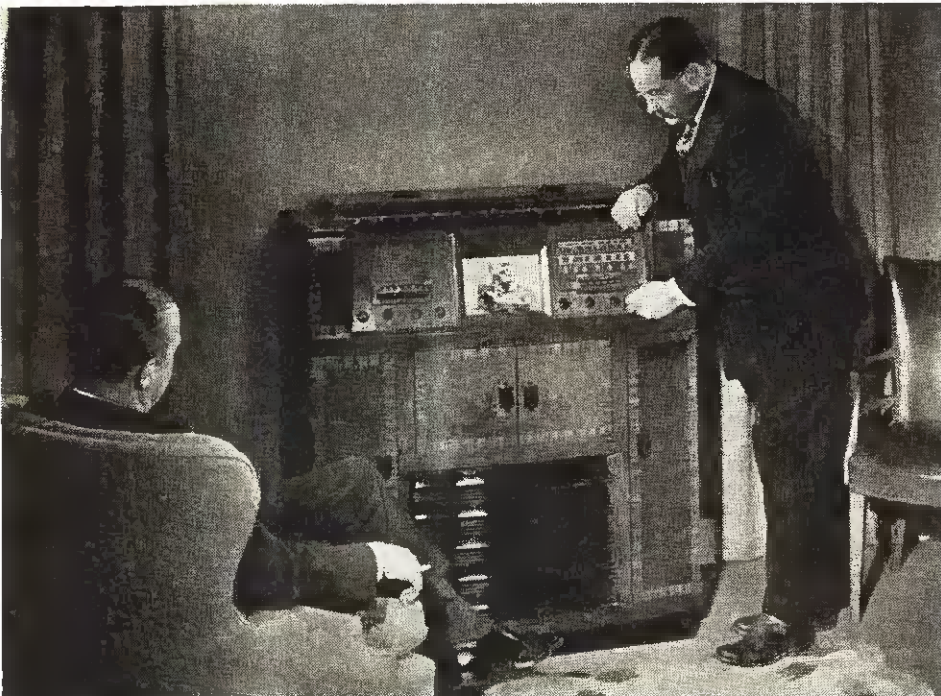

Kenneth Turner, director of engineering and secretary of Admiral Corp., demonstrates to Richard A. Graver, vice-president in charge of the radio division, features of Admiral's Commander-in-Chief model. Housed in one cabinet is a television receiver, FM reception, standard and short wave reception, slide-away phonograph with automatic record changer, home recording apparatus, and space for record storage.



THE GIFT OF TELEVISION

 Think of television as a gift long desired. It is — the answer to man's ageless yearning for eyes and ears to pierce the barrier of distance. It is man's oldest dream come true.

Through the screen of your postwar television receiver, the pleasures of tomorrow's peacetime world will come to you in overflowing measure. You'll see a rich, living tapestry woven from the glamor, the laughter and suspense of the theatre and the sports field. You'll enjoy a new kind of university for all the family...with magic carpet

lessons...and world leaders as teachers. You'll thrill at a Twentieth-Century newspaper that mirrors events as they transpire; conferring on every man the honor of participating in things worthwhile, lifting him to new joy and new dignity in the history of the world.

But for the war, a DuMont Television-Radio Receiver might have been your most exciting gift this Christmas! We shall do our best, God willing, to bring to you and yours the gift of fine quality television before the next Christmas Season.

Copyright 1944, Allen B. DuMont Laboratories, Inc.

DUMONT



Precision Electronics and Television

ALLEN B. DUMONT LABORATORIES, INC., GENERAL OFFICES AND PLANT, 2 MAIN AVENUE, PASSAIC, N. J.
TELEVISION STUDIOS AND STATION WABD, 515 MADISON AVENUE, NEW YORK 22, NEW YORK

Volume Control Service

Servicing Problems of Audio Volume Controls. How Potentiometer Connections Influence Operation

By S. HELLER

• The most common type of volume control circuit in present use is the one shown in Fig. 1. In this circuit, the signal is tapped off R_2 , the volume control resistance, by the movable arm, and introduced through a capacitor, C_1 , to the grid of the detector tube.

C_1 is a blocking capacitor that keeps out the direct voltage which is developed across R_1 and R_2 by diode rectification.

The volume control resistance is used like a voltage divider. Consider

iceman to whom the radio is finally brought does not know how to recognize the symptoms, he may waste a good deal of time tracking down the trouble.

Let us see what would happen if the connections to terminals E and C of a volume control in Fig. 2 were reversed. Fig. 3 indicates what would occur. The signal would be shorted out by the movable arm before it could reach the grid of the detector. No reception would occur.

Suppose terminals A and C were

reversed when the volume control is attached correctly. It is obvious, then, that the volume will be louder when the A and C terminals are reversed.

Distortion is also present when this incorrect connection is made. This distortion is more noticeable on low than on high volume, and is caused by the decrease in the resistance from point A (see Fig. 1) to ground. In the correct hook-up, 500,000 ohms are always present between point A and ground. In the incorrect hook-up, the resistance between point A and ground varies from 500,000 ohms to zero ohms. The less the resistance, the greater the flow of diode current, with a resultant change of bias on the AVC controlled tubes.

When a continuity test between A and C, and E and C (see Fig. 2) shows a gradual deflection of the ohmmeter pointer while the movable arm is being rotated, the volume control tests perfect. If the deflection is not gradual, but jumps abruptly, say, from zero ohms to high ohms, the volume control resistance has an "open" in it.

The symptoms of an open volume control vary, according to the location of the opening. A loud screech at highest volume may indicate an open volume control. Distortion, tunable hum, and decreased volume are frequent symptoms of open volume controls. Sometimes no reception at all is encountered.

If no reception is encountered, and a volume control of the type described above is suspected, touch aerial to grid of detector, and to the high side

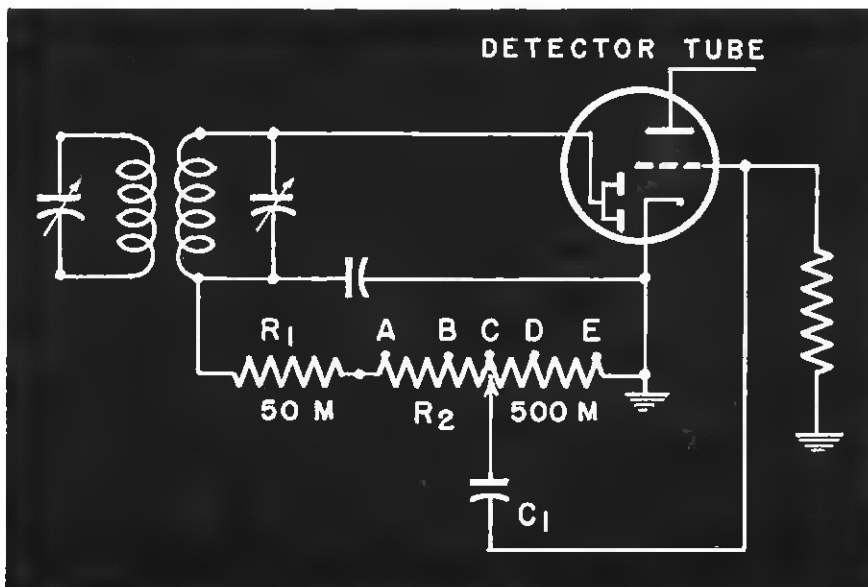

Fig. 1—Conventional half-wave diode detector showing load resistance R_1 and volume control R_2 . Audio voltage developed across R_2 is applied to grid through C_1 .

points A, B, C, D, and E on R_2 . At point A, the AF or signal voltage is, let us say, 4 volts. At point B it is 3 volts. At C it is 2 volts, at D 1 volt, at E, zero volts. When the movable arm is at A, the greatest signal voltage is tapped off and fed to the grid of the detector to be amplified. Therefore, the loudest volume occurs when the movable arm is at A. The least volume, or no volume, will occur when the arm reaches E, where the signal voltage is zero.

It is important for a serviceman to know what symptoms appear when a volume control of the type described is incorrectly connected. Inexperienced mechanics sometimes make such incorrect attachments, and if the serv-

iceman (see Fig. 4). Normally (Fig. 1) the path of the rectified signal is through the 50,000-ohm (common value) IF filter resistance, through the volume control, to the grid of the detector. At A, 1/11 of the signal voltage has been dropped, 10/11 remains. At midpoint C, 6/11 of the signal voltage has been lost, 5/11 remains.

When A and C in Fig. 2 are reversed (Fig. 4), 5/6 of the signal is present at midpoint C, instead of 5/11. 1/3 of this voltage is lost across the second half of the volume control section, C to A. 2/3 of 5/6 remains, or 5/9—about 56%. Compare this with the 5/11 of the signal, or 45%, that is imposed on the de-

Fig. 2—Common terminal arrangement for potentiometer volume control. A, C, and E correspond to Fig. 1.

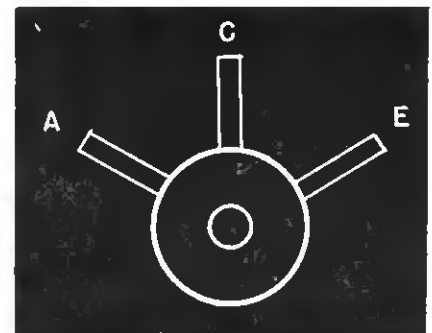

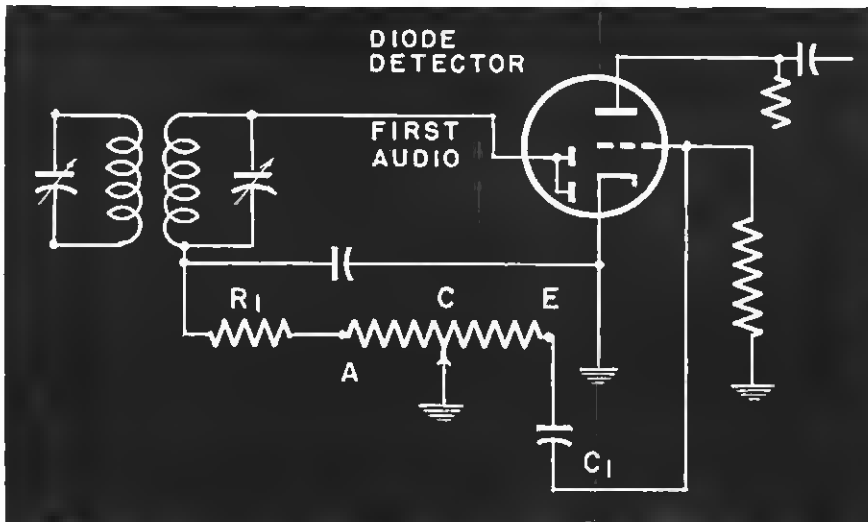

Fig. 3—Effective volume control circuit, when terminals C and E (Fig. 2) are reversed. This connection causes distortion in detector by varying diode load resistance.

(A in Fig. 1) of the volume control. If noise is obtained at grid, but none at volume control, the control is probably open. (The blocking capacitor has been checked and found to be o.k.)

Carbon tetrachloride poured into the openings near the terminals, as the movable arm is being rotated, will clear up most cases of noisy volume controls. For stubborn cases, the washer near the middle of the shaft should be pried away from the metal contact against which it rests, and a piece of copper wire tied in the space between. This resets the position of the movable arm, so that it makes a better contact with the resistance of the control.

For a fast way to clean a noisy volume control, when no time can be spared taking set out of its cabinet:

Take knob off, turn cabinet on its back, pour Carbona with a dropper through the cabinet along the volume control shaft, rotating arm as you do so.

A New High-Speed Circuit Tester.

This "magic eye" type set tester was described by A. Liebscher in the recent issue of the Radio Service News published by RCA. It is repeated here as a help to those who may have missed the above article.

The electronic indicator described in the circuit on p. 72 is not designed to be a cure-all, but it will go a long way in relieving your nerves and conscience by making care-free random probing possible—and what's more,

very practical. With it you can feel free to be quite "trigger-happy" without endangering the life of your meter or causing damage to a bias cell.

Take any radio chassis or electronic control device, turn it upside down and start probing with this "magic" indicator. Yes, probe any point—plate, screen, bias, a.v.c., power line output, oscillator grid, power transformer secondary and all the rest—and your answers will come rolling right along; positive dc, negative dc, ac, motor-boating, negative oscillator grid voltage, audio speech or music, etc.

Shows Relative Voltage

Of course, there are limitations. The indicator will not show actual voltage, but it will differentiate between high, medium and low dc voltage (so you can tell plate or screen from cathode and grid); in fact, you can go a step further and identify the ac filament contacts—all without turning a knob or even changing a pin plug.

The cathode bias resistor (R_c) is set to cause the indicator 6E5 tube to illuminate 2/3 of its normal unbiased shadow angle, with no input signal or external voltage applied. (See figure on p. 72.)

Then the plate resistor (R_p) is adjusted to cause the two edges of the illuminated portion of the indicator to contact each other without overlapping with a 6.3-volt, AC, 60-cycle signal applied to the input.

After these two easy calibrations have been made the interpretation of various light wedges are used to differentiate between AC (a-f) or dc, relative voltage values; continuous audio or interrupted audio.

The application of a negative direct voltage will close the eye within a range of approximately -4 to -1000 volts. Voltages down to a half volt or less will be indicated, although they may not be sufficient actually to close the eye.

Polarity Indication

Positive voltage applications up to 1000 volts will reverse the deflection, causing the eye to open. We see here that a quick, safe and reliable indication of polarity is obtainable even down to the smallest potential which will produce a visible indication.

Studying the circuit, you will note that the resistor (R_t) and the capacitor (C_t), in series, will serve as a means of assuming a charge from an applied direct voltage. This charge

(Continued on page 72)

Fig. 4—Volume control circuit when terminals A and C are reversed. Load on diode detector is variable. Control of volume will not be linear even with linear potentiometer.

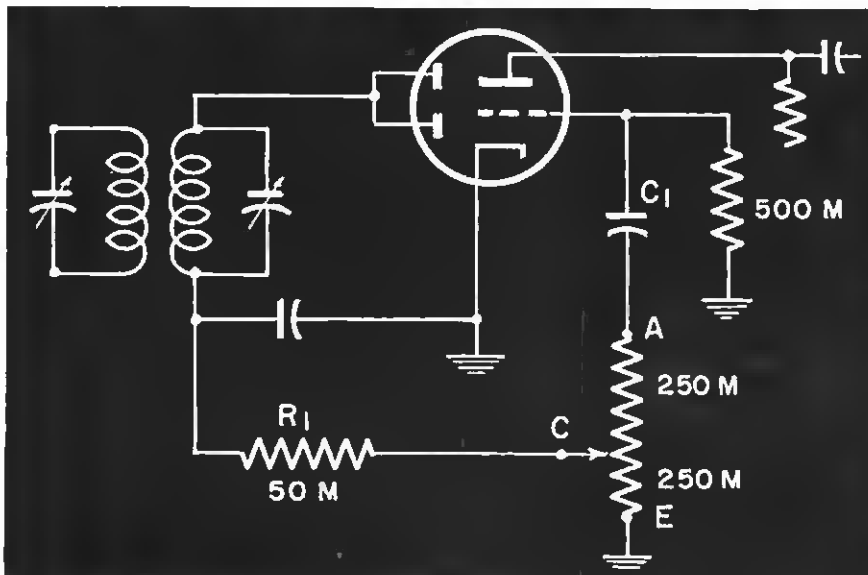

Service Notes

CIRCUIT TESTER

(Continued from page 71)

will slowly leak off due to the high resistance discharging circuit through the 10 megohm input resistor (R_i), which with R_t remains to discharge C_t , once the source of the applied voltage is disconnected. This discharge rate for either positive or negative voltage will be in proportion to the applied voltage, thus showing a slow return to the normal shadow angle when high voltage is applied. The lower the voltage, then, the more rapid the return to normal will be.

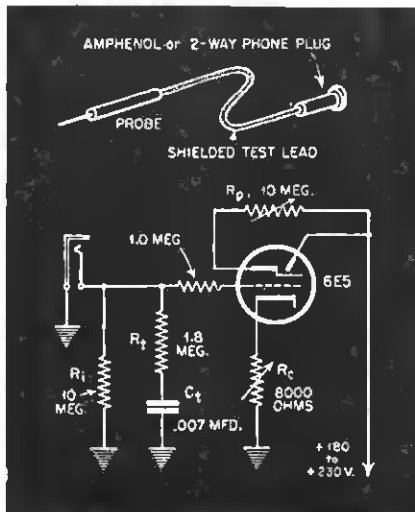

Circuit of electron eye radio tester. Plate voltage can be taken from set under test.

From the foregoing we have found how a negative voltage will cause the eye to close and how a positive voltage will cause it to open more than normal. If we then apply an AC or audio voltage composed of alternate positive and negative peaks the indicator deflection should show a swing in both directions. This is exactly what happens and the eye shows a partial illumination over its entire deflection area with any voltage from approximately 4 volts r.m.s. to 1000 volts, r.m.s. The partial illumination is due to the "on" and "off" time of the a-c voltage swing in either direction. Audio frequencies between zero and 30 cycles will be indicated by their flickering and amplitude repetition.

In practical application it is easy to detect a leaky coupling capacitor with an internal leakage resistance around 1 or 2 megohms by observing polarity indications while probing at the grid side of the capacitor.

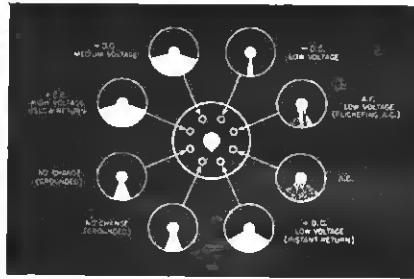

Typical group of patterns around power tube socket.

After the above leakage test has been made, a further check on coupling capacitors is a simple matter. By connecting a small capacitor, say of about .002 mfd. in series with the probe the direct plate voltage will be blocked, permitting only A.C. or audio voltage to influence the indicator. With this adaptation the same a.f. indication should be apparent at both ends of the capacitor; if it is not, the capacitor may be open or grounded and consequently useless.

Should your problem involve intermittent output, the indicator as modified above, can be used as a high impedance monitor to test for the erratic

Effect of various voltages on pattern of eye tube in tester circuit.

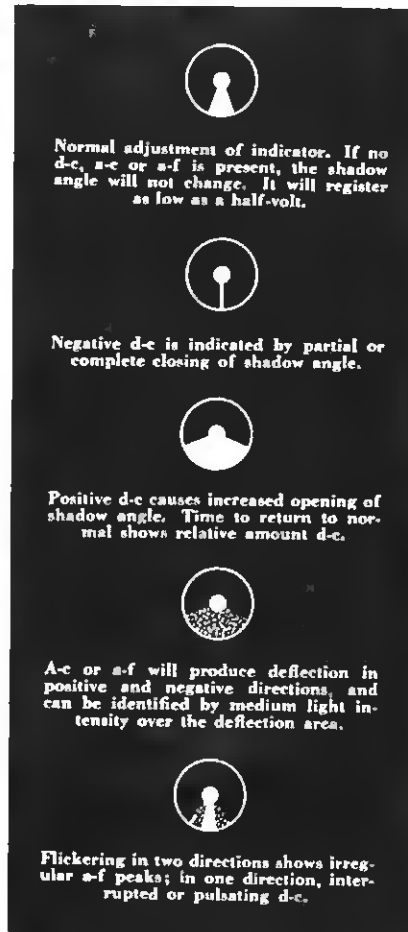

action of a capacitor over a period of time sufficient to produce such behavior. Once connections are made for monitoring the signal through a suspicious part of any defective device it is not necessary to touch anything until the normal course of events has proven or disproven any questionable performance. A typical group of patterns around a socket showing interpretation is given.

Hum Causes

• One of the chief complaints heard by the serviceman is that "the loudspeaker hums and it annoys me so I have to shut the thing off." In the following article some of the causes and cures of the type of internal noise popularly called "hum" are outlined. In a later article other noise sources will be discussed.

In a half-wave rectifier as shown in Fig. 1, the output contains a ripple factor composed of 60 impulses per second (when 60 cycle AC is used as a power source). The function of the "pi" section filter is to remove this ripple factor from the output of the power supply, thus preventing it from reaching the loudspeaker where it would be audible as a 60-cycle tone.

In a full-wave rectifier as in Fig. 2, the output contains a 120 cycle ripple factor, because both sides of the 60-cycle alternating input are utilized. The filter section performs the same function, but this time the filter may be of slightly less capacitance due to the increased frequency being handled.

The "pi" section filter acts to smooth the ripple in the following manner: On the first cycle the capacitors assume a charge, as the cycle decreases the capacitors release their charge into the circuit thereby tending to keep a constant output until the next cycle starts.

The choke, because of its inductance, tends to retard the flow of current, thus adding to the smoothing action. In some filter circuits a resistance is used in place of the choke, with less efficiency, but greater cost economy.

When either of the capacitors in the circuit become open, a ripple voltage will be present in the output of the power supply. This will be evident in the loudspeaker as a hum of 60 or 120 cycles depending on whether a half-wave or a full-wave rectifier is being used. An open input capacitor will also result in materially lowered voltage output. If one or both capacitors become shorted or the choke

(Continued on page 76)



ESMERALDA COPE HAS TWO JOBS . . .

Esmeralda Cope is one of many hundreds of women workers in the Detrola Radio Division who now are building land mine detectors, FM signal generators and other electronic war equipment. This job continues until Victory. But without detracting from this primary task, many of these workers are being acquainted also with their post-war assignments on the same production lines. Thus they will be ready to build hundreds of thousands of fine radio receivers, automatic record changers, television receivers and other products to enrich the life of a world at peace. Yes, Esmeralda Cope has two jobs. And International Detrola's creed of highest quality rules them both.

BUY WAR BONDS TILL VICTORY

DETROLA RADIO

DIVISION OF INTERNATIONAL DETROLA CORPORATION • BEARD AT CHATFIELD, DETROIT 8, MICH.

C. RUSSELL FELDMANN  **PRESIDENT**

**A POSTWAR
HOME RADIO**
with no
**PREWAR
ENTANGLEMENTS**



A line of home radios, new as tomorrow, is coming up.

They are instruments such as you have never known before, un-
hampered by prewar conceptions, designed and built
with full application of war-born discoveries.

LEAR RADIO

Address Inquiries to: **LEAR, INCORPORATED**
Home Radio Division, 230 East Ohio Street, Chicago 11, Ill.



Formerly
Lear Asia, Inc.

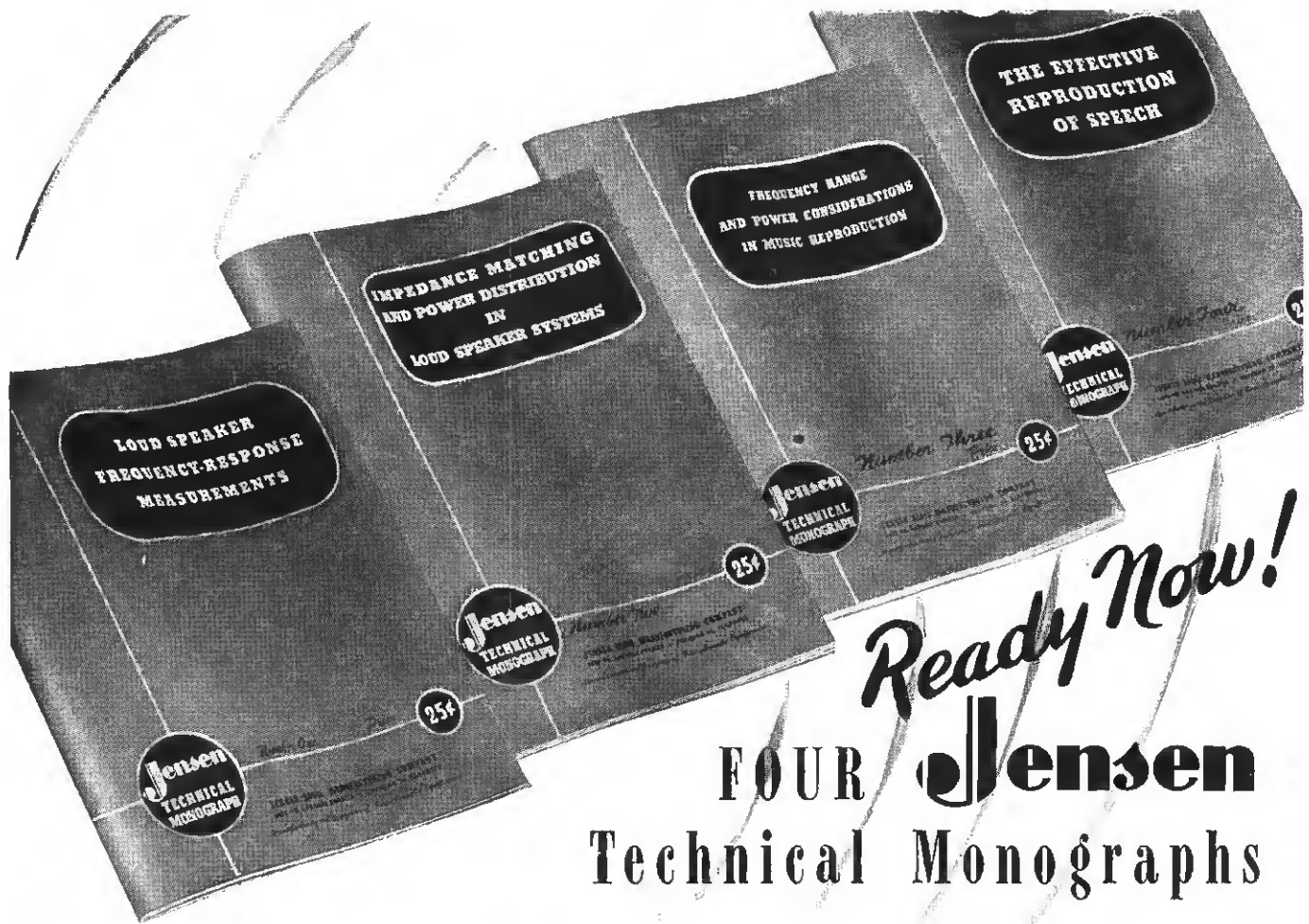

Ready Now!

FOUR Jensen Technical Monographs

EVERYONE interested in the reproduction of sound—engineer, tradesman, instructor, student or layman—should own these four Monographs. Published by the Jensen Technical Service Department in the interest of improved sound reproduction, they are the first four numbers of a series. Up-to-date in factual information, replete with useful charts, graphs and tables, they supply a world of data, heretofore unobtainable, to guide in the selection, installation and operation of loud speakers. You will want *not only these four numbers but the rest of the series* as announced from time to time.

MONOGRAPH No. 1: "Loud Speaker Frequency-Response Measurements." Deals with one of the most interesting and controversial subjects in the field of acoustics. Discusses, among other topics, frequency response of the human ear, the influence of environment on frequency response, the practical aspects of frequency-response measurements. Amply illustrated with charts and graphs.

MONOGRAPH No. 2: "Impedance Matching and Power Distribution." Discusses such subjects as multiple speaker connection, volume control, design of efficient transmission lines, and conversion of volume levels to power and voltage. The text is supported by

twenty-eight drawings and tables. More than a score of questions are described, illustrated and solved, including a comprehensive sound system for a military installation.

MONOGRAPH No. 3: "Frequency Range in Music Reproduction." What frequency range is needed for high fidelity reproduction? What are the maximum, useful audio frequency ranges under actual listening conditions? What are the practical limitations on high fidelity reproduction even if perfect transmission, reception and reproduction were possible? How much change in high frequency cut-off is required to be just noticeable to the listener? All these and many more questions are answered in this Jensen Monograph.

MONOGRAPH No. 4: "The Effective Reproduction of Speech." Explains why faithful speech reproduction requires a frequency band almost as wide as for music, while amplified speech for strictly communication purposes may be reproduced satisfactorily within a narrower band because in this case the principal emphasis is on such things as articulation, loudness, masking, and power requirements. Presents useful conclusions and practical information for everyone interested in speech reproduction.

Get any or all of these Monographs today from your Jensen jobber or dealer. Fill in the coupon and send with it 25c for each copy desired, or clip a dollar bill to the coupon and get all four.

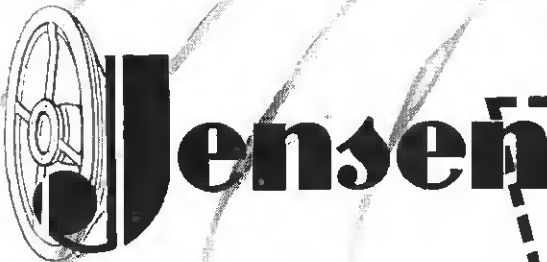

FREE to men in the Armed Services, and to Colleges, Technical Schools and Libraries.

RADIO MANUFACTURING COMPANY

6625 South Laramie Avenue, Chicago 38, Illinois

Send me:

- Loud Speaker Frequency-Response Measurements
 - Impedance Matching and Power Distribution
 - Frequency Range in Music Reproduction
 - The Effective Reproduction of Speech
- (Check one or more. Send 25c for each book ordered.)

NAME _____
 ADDRESS _____
 CITY _____ ZONE _____ STATE _____

Service Notes

(Continued from page 72)

opens, there will be no voltage output from the circuit and the rectifier tube will probably fail due to the increased load placed upon it. Thus, the first and most prolific source of hum is in the power supply itself.

Inductive hum pick-up is also a common source of trouble, especially in high-gain audio systems. Any conductor of AC will have a field surrounding it, and if an unshielded transformer is placed in that field, inductive hum pick-up will result.

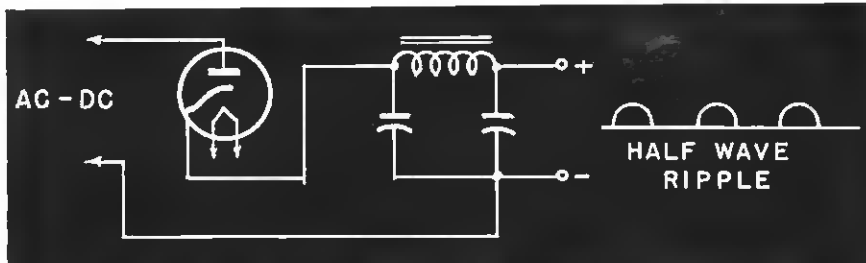

Fig. 1—Typical half-wave rectifier used in AC-DC sets showing output ripple voltage.

Hence, it is well, in servicing, to remember that fact and place all transformers or inductances at right angles to their mutual field patterns. Rotate transformers to find best position. A filament lead carrying AC placed near a high-gain grid circuit will usually cause unwanted hum pick-up. These filament leads should be twisted to prevent radiation of their fields. All high-gain grid circuits in amplifier systems should be shielded and the shield grounded to a common chassis point, even the tubes themselves must be completely shielded to prevent unwanted hum modulation of the signal.

In receivers, another source and type of hum is present in the radio and intermediate frequency portions of the circuit. This appears as a hum on the signal when tuned in and is known as "tunable hum." It is not present in the absence of a carrier. This type of hum is due to several possible factors. Among them are: defective screengrid or cathode bypass capacitors, poor shielding of both tubes and RF or IF transformers and defective grounding of these shields.

Tunable hum may be traced to a high RF impedance of the power transformer, and in some cases, may be eliminated by grounding one side of the primary of the power transformer to the chassis with a 0.01 mf. bypass capacitor. It has even been traced to defective grounds in the electric meters and house wiring cir-

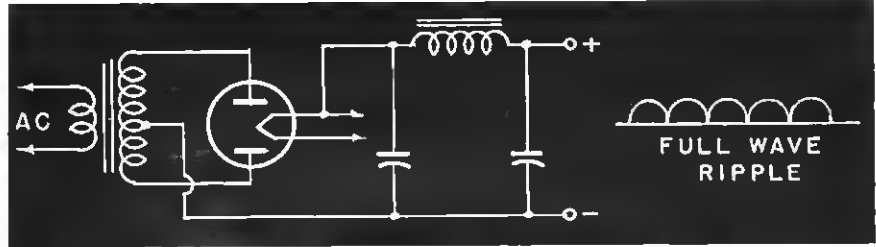

Fig. 2—Full-wave rectifier gives ripple at twice line frequency.

cuits which set up a field, due to system unbalance, that was induced in a nearby antenna.

There are no fixed methods of tracing hum in a receiver. It is well, if

pick-up. These can be located by a process of isolation in the set itself. Emission tube testers will not always show this kind of trouble, hence it is better to locate the defective tube in actual operation, if possible. Cathode to filament shorts are the most common cause of hum, even a high resistance short will be the cause of appreciable noise. A gassy or "soft" tube will also introduce hum into associated circuits. A mismatched pair of push-pull output tubes will be a source of hum (and distortion).

When the audio amplifier has enough gain, an excellent method of hum reduction is realized by the use of negative feedback. In this circuit, Figure 3, a portion of the output voltage is fed back to the input of the amplifier 180 degrees out of phase with the input signal. In this way hum and noise are cancelled out of the part of the amplifier which the feedback loop encompasses. The degree of cancellation depends on the amount of noise voltage fed back. Caution must be observed as the gain of the amplifier will be reduced as the amount of feedback voltage is increased.

Hum from Transformer

When an inefficient filter is used in the power supply of small receivers, and a large hum component is present in the final audio stage, a hum bucking coil is used in the loudspeaker. This consists of a few turns of wire in series with the voice coil inductively coupled to the field coil of the speaker in phase opposition to the hum voltage present in the output

(Continued on page 78)

possible, to isolate it stage by stage. Starting with the final audio amplifier and working back towards the antenna input circuit, the output of each stage should be stopped by grounding the grid with a large capacitor. If a cathode ray oscilloscope is available, the work is much easier. Using the 60 cycle sweep, place the probe on each plate circuit, starting with the final amplifier.

This will not only show where the hum is present but will also show whether it is coming from the power supply or other sources, by its frequency. In testing the RF portions of the receiver, set up an unmodulated carrier on the signal generator and couple it to the antenna circuit. The hum will be present as a modulation of the signal on the screen of the scope. The same procedure is used in testing the IF section.

The tubes themselves in either an audio or a radio frequency amplifier can be a potent cause of AC hum

Fig. 3—Feedback in audio stages will reduce hum and other distortion.

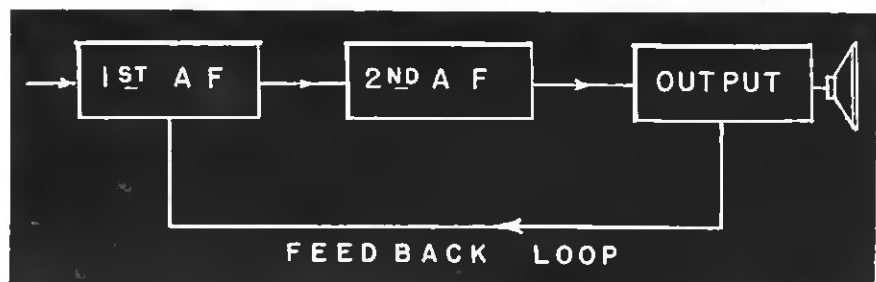

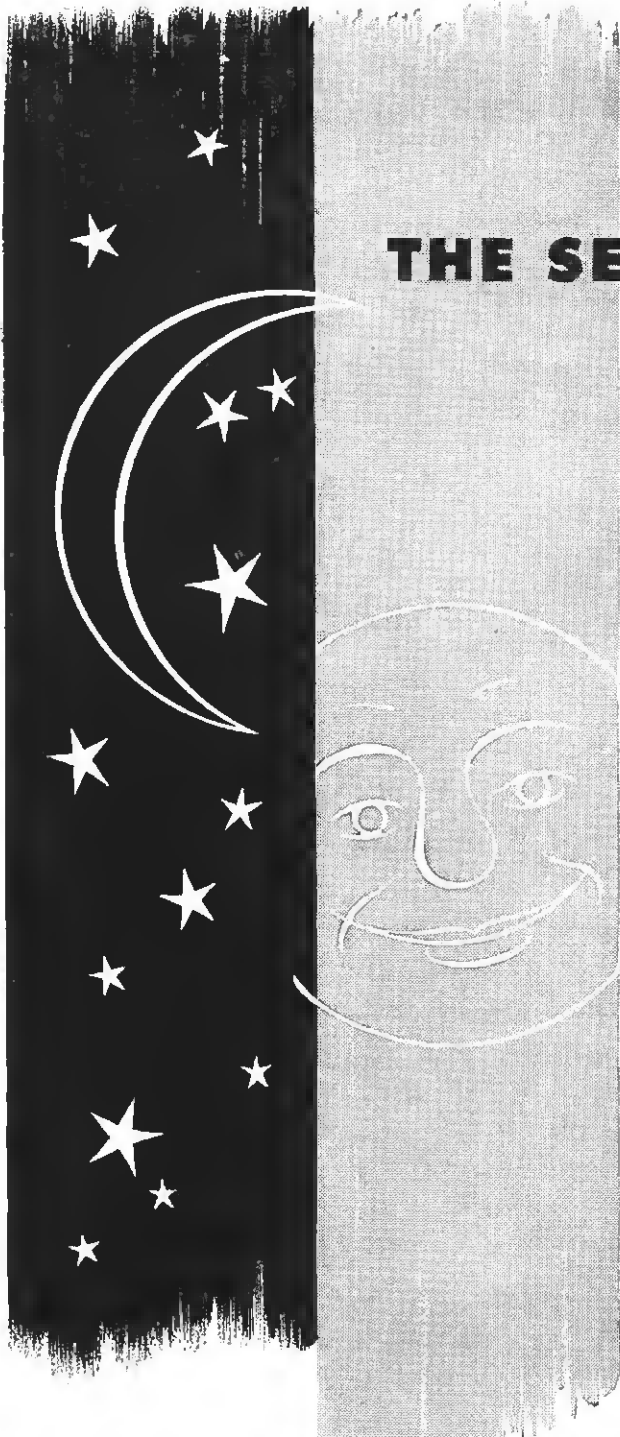

THE SET THAT

never slept

10,800 Continuous Hours

Fifteen months of continual service, 10,800 continuous hours, night and day with the switch never once turned off—and no repairs or replacements needed. That's the record established by a Hallicrafters SX-28 in use testing crystal standards at Scientific Radio Products Co., Council Bluffs, Iowa.

Equal to Five Years' Use

Witness to this amazing performance was Myron C. Jones, resident inspector in charge. Day after day he watched "the set that never slept" in continuous action between January 5, 1943 and April 10, 1944.

Inspector Jones writes:

"This is what I call punishment. It surpasses five years of ordinary use, with no new parts needed. This war plant had many more Hallicrafters receivers, all performing outstandingly. You can't beat Hallicrafters for endurance, sensitivity, selectivity, tone, ease of operation and all around performance."

"The Radio Man's Radio"

This is only one more significant notch in Hallicrafters' record. Men who know radios inside out, men who depend on them when life itself is at stake and when there can be no compromise with quality, specify Hallicrafters, "the radio man's radio."

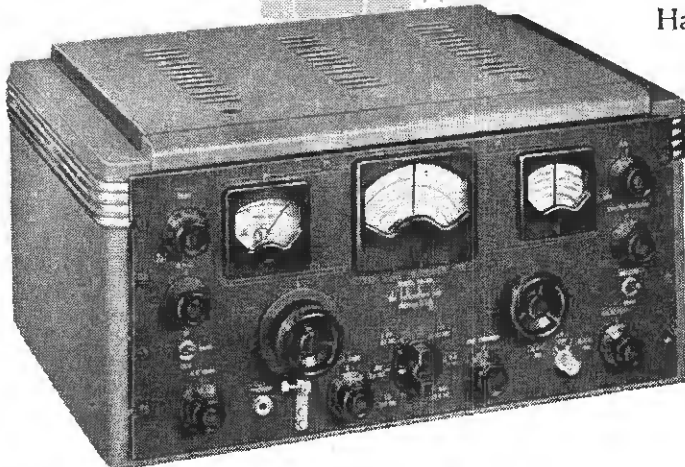

BUY A WAR BOND TODAY!



hallicrafters RADIO

THE HALLICRAFTERS CO., MANUFACTURERS OF RADIO
AND ELECTRONIC EQUIPMENT, CHICAGO 16, U. S. A.

NEW PRODUCTS

VACUUM TUBE VOLTMETER incorporates features to simplify operation. Wide frequency range A.C. voltmeter measures from 50 cps. to 50 megacycles. Six D.C. voltage ranges. Input capacitance of less than 2 mmf and input resistance of 11 megohms all ranges. D.C. current ranges from 50 microamperes to 1 ampere in six ranges. Single zero adjust for all A.C. and D.C. ranges. Voltage regulated supply provides stable operation. Reiner Electronics Co., Inc., 152 W. 25th St., New York —RTR

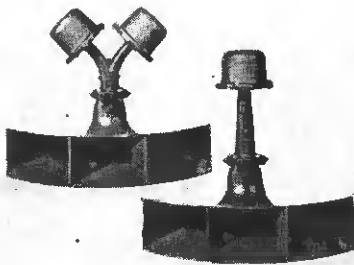

LOUDSPEAKER, Type 26-B, designed to operate with maximum intelligibility through high noise levels and with uniform distribution over horizontal angles of 120 and vertical of 40. Designed for voice reproduction when used by itself or as an excellent high frequency com-

ponent to a wide range system. Unit of cast aluminum, handles power input of 40 watts when equipped with 2 Jensen U-20 drive units. 22" wide, 14½" deep, 20" high. Complete technical bulletin upon request. Langevin Co., 37 W. 65th St., New York 23, N. Y.—RTR

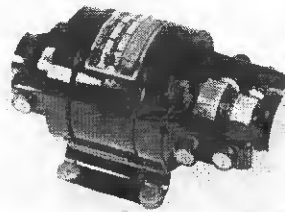

CARTER MICRO-MAGMOTOR series small dynamotors, to be available in quantities after the war. The multi-output micro-magmotor has permanent magnet field (saving about 10-watts necessary to excite the field coils) and furnishes outputs totaling up to 100-watts. A typical unit would be one with a 350-volt, 50 milliampere output, a 250-volt, 25 milliampere output, and a 6.3-volt A.C. (100 cps), 2 ampere output. A proper application would be for mobile transmitter-receiver. Lightweight, only 5 pounds for the average unit. Carter Motor Co., 1608 Milwaukee Ave., Chicago, Ill. —RTR

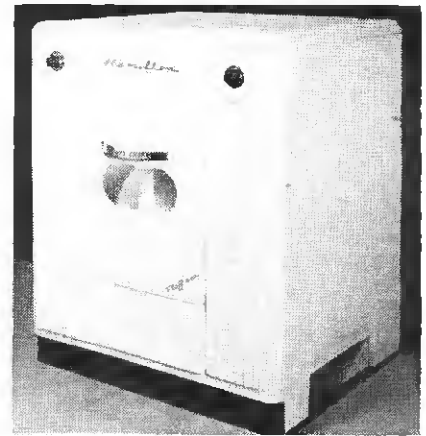

HAMILTON AUTOMATIC DRYER to be sold nationally after the war. Gives speedy drying (15 to 25 min.) of 18 lbs. of clothes (wet). To be available in both gas and electric heated types. Temperature of dryer is automatically controlled. Costs about 9c. per hour to operate at 2c. electric rate. Finish, white dulux enamel. Dimensions, 39" x 31" x 25". Hamilton Manufacturing Co., Two Rivers, Wisc.—RTR

Manufacturers of merchandise in the fields of radio, television, and electrical home appliances are invited to submit brief descriptions of new items, accompanied by clear photos.—Editor.

Service Notes

(Continued from page 76)

of the amplifier. This will result in some cancellation of the audible hum. The connections of the hum bucking coil should be reversed since the hum will be worse for one position.

The power transformer, when mounted on the same chassis as the radio frequency portion of a receiver can cause hum modulation of the signal by mechanical modulation of the oscillator. The vibration of the heavy laminations by the 60 cycle impulses will cause the plates of the oscillator tank capacitor to vibrate, or movement of any of the parts of the oscillator circuit including the tube itself will cause this effect. In some cases the audible hum from the transformer laminations sounds as if it was coming from the loudspeaker of the set, especially in small cabinets. This is easily cured by tightening of the transformer laminations, and the use of shellac in severe cases.

A defective power transformer winding, in which a few turns have become shorted, will electrically displace the center tap and cause unbal-

ance in the output, thus producing another source of hum. This is true in the high voltage windings. Incorrectly tapped filament windings will cause this problem also. A resistor with an adjustable slide tap may be used across these windings to maintain the proper electrical balance.

Set Should Be in Cabinet

It must be remembered when testing for hum of low frequency, such as 60 or 120 cycles "by ear," that a loudspeaker will not provide audible response at this frequency without a suitable baffle. Hence, when a speaker is removed from the cabinet and placed on the bench the hum will become less audible. Therefore a suitable baffle should be provided for the speaker while on the test bench.

To sum up the foregoing: Hum is, in the majority of cases, due to insufficient filtering in the power supply sections of a receiver or amplifier. Ageing electrolytic condensers will be found to be the most frequent offenders. By a process of isolation even the severest cases of hum can be located and remedied.

Changing Tubes in RCA BT42

On model BT42 chassis RC408A originally equipped with "G" tubes, when changing to GT tubes with metal base, disconnect the capacitor C₁₆—a 400 mmf and 1-meg. resistor R₇ in plate circuit of 1H5. These parts use pin No. 1 of the 1N5 as a common mounting terminal and the GT tube with metal base shorts out the plate voltage from the 1H5, resulting in a very dead set.

This service short cut was worked out by W. J. Daugherty, Kincaid, Kans.

Buzzing Noise

A buzzing noise was the complaint on this set. All the tubes were tapped, condensers and resistances wiggled, with no results. When the serviceman placed his hand on the output transformer, however, a sudden decrease in the intensity of the sound occurred. This suggested that the laminations of the output transformer were loose, and their vibration was causing the noise. As a remedy, a small piece of wood was inserted between the core of the transformer.



BECAUSE the company back of Arvin Radios is in a strong position —with many millions of dollars in capital and surplus— with no government loans nor government-owned buildings— with 25 years' experience in manufacturing and merchandising— with 11 modern plants— a company that built more than 500,000 radios the last peacetime year . . . That's part of the background that will make the Arvin Radio dealer franchise so valuable to you in days ahead.

ARVIN MEANS RADIO SALES SUCCESS

Others of the Many Reasons Why You'll Profit With Arvin Top Flight Radios

● **Top Flight SALES OPPORTUNITY**— *Because* the Arvin line has (1) beauty (2) marvelous performance (3) surprisingly low prices— and the broad appeal that provides a well-rounded sales opportunity in itself, or in conjunction with other radios you may sell. The Arvin line includes table models, popular priced floor models with AM and FM, floor and table combinations, portables and rural battery sets.

● **Top Flight ENGINEERING**— *Because* the new Arvins have been developed by an outstanding engineering staff— headed by Duke Silva, one of the foremost radio engineers in the industry. You'll have radios engineered to the highest standards for performance and dependability— attractively priced for the average buyer— designed for wide family appeal that promotes multiple sales— and that means more profit for you— with Arvins.

● **Top Flight DEALER COOPERATION**— *Because* Arvin sales policies are the outgrowth of 25 years of successful experience in providing the fullest support to the dealer. Arvin Radios will be liberally advertised— nationally and at point-of-sale. Attractive prices provide adequate profit margin for the dealer . . . and a competent, energetic promotional organization works with Arvin dealers for maximum sales success.

NOBLITT-SPARKS INDUSTRIES, INC., COLUMBUS, INDIANA

DISTRIBUTOR NEWS

Wholesalers Looking Ahead to Merchandise Resumption

Berk Sees Jobber in Strong Postwar Position

"There is no question in my mind," Sol W. Berk, manager of Concord Radio Corp., 901 W. Jackson Blvd., Chicago, declares, "that the position of the jobber in the postwar era will have changed materially for the better.

"With the war came the problem of obtaining small quantities of radio components fast, and the jobber has been the mainstay of the industry in this situation. Many a manufacturer, faced with virtual stoppage of his experiments, and even his production lines, has turned to



Sol W. Berk

the jobber for items which would take months to obtain through former sources. The larger jobber has been able to make deliveries on these immediately, directly from stock.

"This has led to a gradual education of the manufacturer that the jobber is the logical supplier for these items. As a potential source of what heretofore has been termed, 'Samples,' the jobber bids fair to replace the so-called 'short order' departments of many plants.

Rapid Delivery Factor

"The added cost of doing business with the jobber versus that of buying small orders directly is more than overcome by the speed of delivery.

"Under these circumstances, it is our opinion," Mr. Berk said, "that the experience of the manufacturers during this war will be the basis of an extended 'industrial' business afterwards. There is no question that the position of the jobber as a better source, for small orders has been strengthened by the war."

Van Antwerpen Announces Postwar Wholesaling Plans

Radio Specialty Co., Milwaukee, is setting up its organization to meet the problems of the postwar period.

Says A. Van Antwerpen, president and general manager, "We have never for one minute lost confidence in the future of the specialty distributor. We feel that we can perform a service to both our manufacturers and our dealers that will more than justify a legitimate distributor's profit.

"We believe there is a big difference between a real specialty appliance distributor and the ordinary wholesaler or jobber who acts primarily as a warehouse to supply a demand that must be created and fostered by the manufacturer. We have always maintained a high calibre, well-paid sales force in whom our dealers could have confidence and a sales promotion and advertising department headed by a capable man whose main duty is to help our dealers with this important part of their business.

"Our credit department has always worked closely with dealers, advising them on financial matters and acting as

Jobber-Rancher Olsen

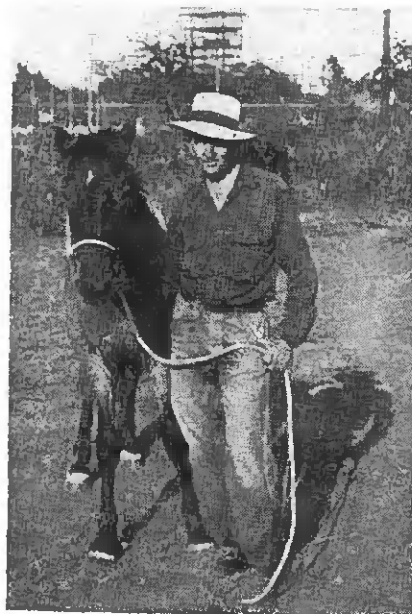

Service dealer friends of Harold Olsen, owner of Olsen Radio Supply, and the Harold Olsen Ranch, San Antonio, Texas, enjoy the pleasure of a cross country gallop mixed with their business dealings when they visit this parts jobber. He is proud of his horse stock as he is of his abundant radio parts stock.

a clearing house for their problems. The same is true of our service department—dealers could always depend on our men having the knowledge necessary to help them.

"We propose to continue and to expand those important functions—to make ourselves a definite part of the dealer's picture and by so doing earn the right to this business. As a part of this expansion we are pleased to announce that H. E. (Gene) Dahl has joined our organization. Mr. Dahl comes to us after 20 years of retail sales experience.

"In the last 9 years Mr. Dahl has become nationally known as the manager of one of the largest and probably the most successful retail appliance departments in the Wisconsin area. We believe we are fortunate in getting a man of Mr. Dahl's ability and experience," continued Mr. Van Antwerpen, "and that his services will be a big help in further cementing our dealer relationship.

New Lines Added

"Working under the direction of V. L. (Vince) Kelly, our vice-president in charge of sales, now serving his 19th year with the company, Mr. Dahl will help organize and coordinate the merchandising of new lines we expect to carry, but eventually his duties will be mainly in the field of building up retail selling organizations and in giving our dealers direct 'on the firing line' sales and merchandising help."

According to Mr. Van Antwerpen, the new lines to be added are: washing machines, ironers, electric ranges, vacuum cleaners, space heaters, kitchen cabinets, sewing machines, and small appliances. The Company is now negotiating for franchises in these fields.

Excellent Quality Only

Present major lines are Philco products, Columbia Records, and Grand Gas Ranges. In discussing new appliances, Mr. Kelly, vice-president in charge of sales, states emphatically that any new lines added must be of a calibre high enough to stand on their own feet. "No loyal Philco dealer," says Mr. Kelly, "will be coerced into believing his Philco franchise is in danger if he does not handle our other lines.

"We will not tolerate that kind of selling by our men. In the long run, merchandise must be sold on its own merit, or it will eventually fall by the wayside.

"We intend to select carefully, and present our dealers with the kind of merchandise they can sell."

RESEARCH

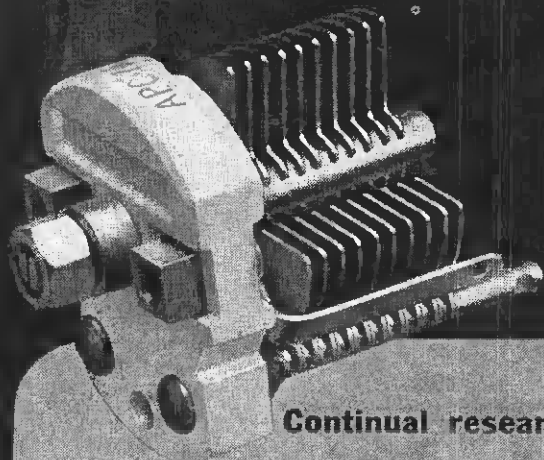

Continual research in chemistry, metallurgy and effects of various atmospheres on different plating finishes assures you that your Hammarlund variable capacitor will stay on the job.

HAMMARLUND

THE HAMMARLUND MFG. CO., INC., 460 W. 34TH ST., N. Y. C.
MANUFACTURERS OF PRECISION COMMUNICATIONS EQUIPMENT

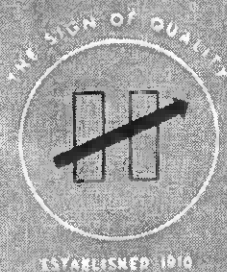

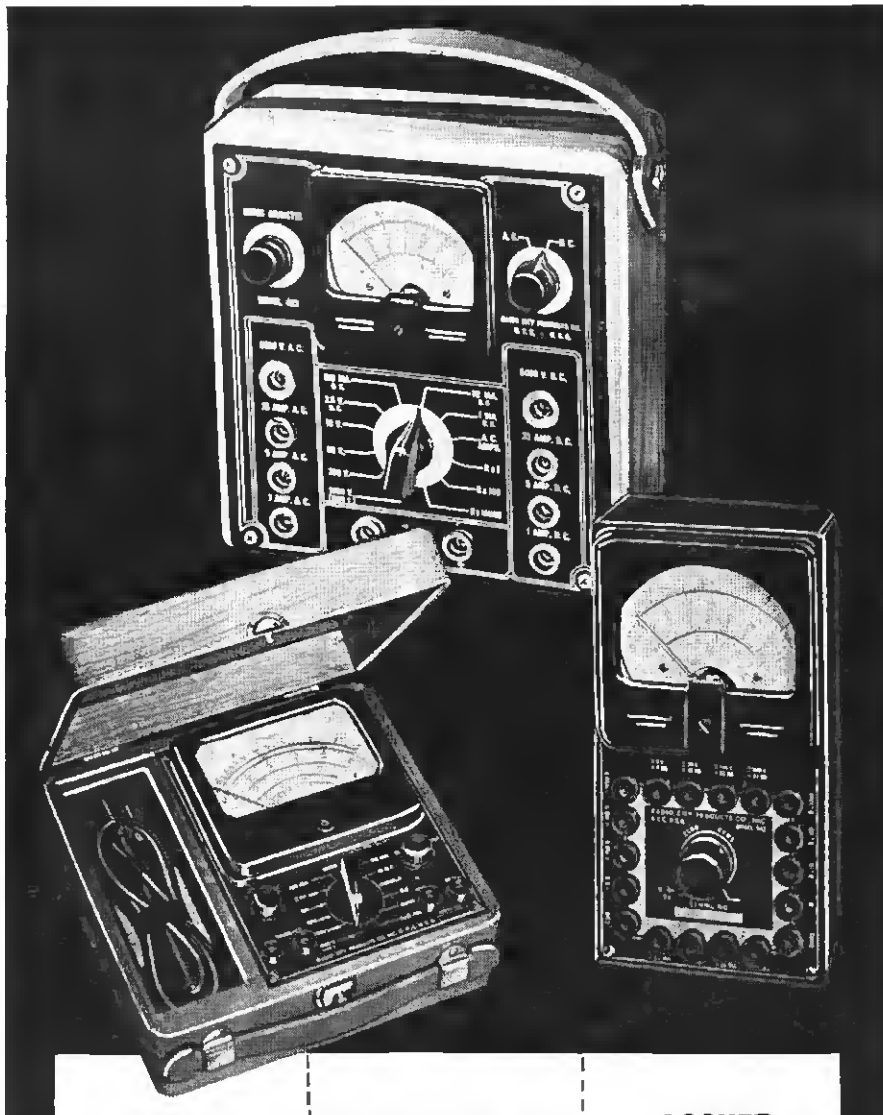

SENSITIVE MULTITESTER

20,000 OHMS PER VOLT
RCP MODEL 461P

For laboratory, field and shop testing of military, naval and radar equipment, here is an instrument with features and range which assure accuracy. Readings as low as 1 microampere on the 100-microampere scale. Model 461P has hinged cover, 8 x 7 $\frac{7}{8}$ x 3 $\frac{1}{2}$ inches (weight 4 pounds) test leads, self-contained batteries, leather handle; ready to operate, net \$38.50. Code: SIMPO. Model 461, open face bench type, no test leads, net \$34.50.

SUPERTESTER

RCP MODEL 422

This compact unit has extremely high and low ranges, and is the equivalent of 27 instruments. Invaluable for television, for amateur, electrician, engineer. Features are AC current measurements and high voltage not applied to selector switch nor to general test circuits. 3-inch square meter with movement of 200 microamperes or 5000 ohms per volt sensitivity on DC voltage measurements. RCP Model 422 complete with batteries, net \$29.50. Code: MERAY. Model 422P, portable with hinged cover and low voltage test leads, net \$31.95. Code: MANER.

POCKET MULTITESTER

RCP MODEL 442

Pocket-sized, 5 $\frac{7}{8}$ x 3 $\frac{1}{4}$ x 2 $\frac{1}{8}$ inches, but a big value in service and price. A highly satisfactory, accurate multitester, combining six essential instruments in a small, compact model. The 3" square meter has a movement of 200 microamperes and sensitivity of 5000 ohms per volt. All scales are easily read. RCP Model 442, in metal case, weight 1 $\frac{3}{4}$ pounds, net \$21.00. Code: LAMOR. Complete, with self-contained batteries, ready to operate in snap spring contact holders, net \$21.00.

RADIO CITY PRODUCTS COMPANY, INC.

127 WEST 26th STREET



NEW YORK 1, N. Y.

MANUFACTURERS OF PRECISION ELECTRONIC LIMIT BRIDGES — VACUUM TUBE VOLTMETERS
VOLT-OHM-MILLIAMMETERS — SIGNAL GENERATORS — ANALYZER UNITS — TUBE TESTERS
MULTI-TESTERS — OSCILLOSCOPES — AND SPECIAL INSTRUMENTS BUILT TO SPECIFICATIONS

Television

(Continued from page 68)

nique which will employ 100,000 salesmen.

Mr. Wagman cited plans of one department store to install a "little theater" seating 100 people around a revolving turntable on which receivers carrying programs will be displayed. He also stated that dealers anticipate the problem of selling receivers during the time that television programs are on the air, which will probably be primarily during evening hours.

Survey Shows What the Telev viewers Prefer

Robert L. Gibson, a director of the Television Broadcasters Assn., and an executive at the General Electric Co., disclosed the results of a program preference survey made by GE at a meeting of the American Marketing Assn. in New York. Mr. Gibson said the survey indicated that 52 per cent of the viewers prefer live talent shows, while 27 per cent preferred films. Audiences prefer full-length films to short and full-length plays were popular, the survey revealed.

Enlarged Video Image Planned by RCA Staff

Principles and methods involved in changing the dimensions of characters and objects in a television image to fit their environment were explained at the opening technical session of the first National Electronics Conference in Chicago, in a paper prepared by Ioury G. Maloff and David W. Epstein of RCA.

Reflective optical systems employing special types of mirrors and lenses, Mr. Maloff explained in presenting the paper, are used to pick up images from the face of the receiving tube and project them onto a screen suited in size to the requirements of the room or auditorium in which the images are to be viewed.

Satisfactory Quality

RCA systems for projection of television images, the authors of the paper stated, consist of a spherical front surface mirror and an aspherical lens.

The gain in illumination on the viewing screen obtained with these new systems is about six or seven to one when compared with a conventional F.2. lens, it was revealed, and the quality of the images obtained is comparable with images produced by conventional projection lenses.

Issues Video Booklet

General Electric's television station WRGB, at Schenectady, New York, has issued a booklet called "Television at WRGB," describing GE's film on television, "Sightseeing at Home." Program preparation, costuming, a brief discussion of transmitting and relaying problems, etc. The past and future of television are discussed in the booklet as well.



Experience Counts

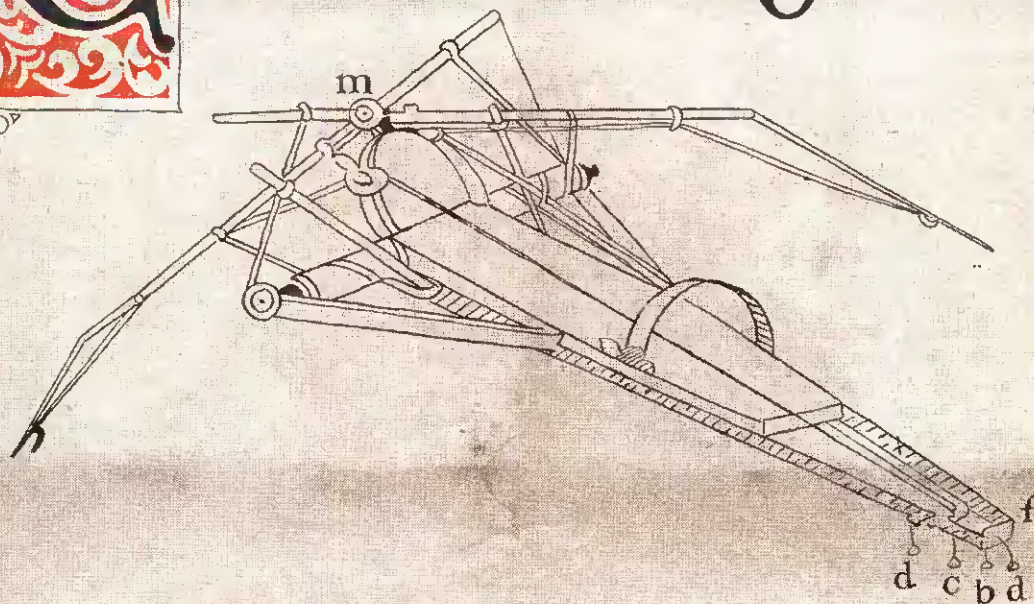

In 1500, Leonardo da Vinci had a fine idea—a flying machine!

His 16th Century Flying Fortrēss had a dandy arrangement of stirrups and pulleys which operated oars supposed to propel the craft through the air. Leonardo's machine didn't work and it didn't work for one simple basic reason . . . There wasn't enough knowledge and experience to develop a flying machine. Had da Vinci the benefits of our experience he could have built a flying flying machine.

There is a very significant moral to that story—Experience Counts!

For years, **WARD PRODUCTS CORPORATION** has been the leader in the design and manufacture of sectional and one-piece antennas. This position was established and maintained because **WARD** has the *Experience that Counts*. **WARD** has pioneered many of the design changes that have become accepted standards in the industry. . . . For the finest sectional and one-piece antennas for automobile and home applications — Look to **WARD**!

Send for our attractive new 1945 calendar.



THE WARD PRODUCTS CORPORATION
1523 EAST 45TH STREET
CLEVELAND 3, OHIO

WARD Antennas



BUY WAR BONDS

Success Plan

(Continued from page 33)

Briefly summarizing the successful program at Rodin's, the front end of the store, in peace-time, will be devoted to displays of major appliances and cabinet radios. Two large display windows also contribute to this phase of silent salesmanship. The repair department is logically placed in the rear, in a space 20 x 30 ft., which is light and well ventilated for fast, efficient work. Customers who want service walk to the rear, past the record department and playing booths, and also see the display of other merchandise in stock in normal peace-time.

Finally, Horrow stresses that handling nationally advertised quality lines minimizes sales resistance. He also advocates employing capable salesmen to sell major appliances, and supporting their efforts with local advertising, such as radio announcements and newspaper space and timely mailing pieces. And to train salesmen to sell up for better consumer satisfaction and more profits for the organization.

Sun in Postwar

(Continued from page 48)

from one to ten thousand dollars.

Sun Radio Co. gives service people priority over civilians. According to M. Louis Belton, in charge of the parts and communication department, "This treatment builds up a safe and sound good-will policy for tomorrow."

Sun Radio through its engineering facilities, has been able to make various substitutions on critical tubes. Although 99 per cent of their customers were grateful for helping them keep their sets in operation, the other 1 per cent were skeptical, and had to be "shown," before authorizing the work.

Peacetime Radio Display

According to Manager Sugar, the peacetime minimum stock is 500 machines on display. Two floors are utilized for radio display solely. The third floor is devoted to the service department. This department, ably handled by William A. Wilson, service director, occupies five rooms.

When the customer takes his radio in to be repaired, novel copyrighted "good-will" signs introduce him to the firm's service and credit policies.

These signs advertise the store's service.

The company is widely known as a radio replacement center and its service calls average an exceptionally large number per day.

Manager Sugar will tell you that the firm is living for the day when peace will turn on the green light for greater retailing in radios. No longer will their display rooms be cluttered with non-essentials, and, postwar, a greater emphasis will be placed on convenience of arrangement of products.

Bands Return For Christmas

(Continued from page 39)

Issued December 8 were Tony Pastor and Orchestra, "One Meatball" and "Robinhood," 20-1607; and Tommy Dorsey, "I Dream of You" and "Opus No. 1," 20-1608. Bluebird offered on that same date Hal McIntyre and Orchestra, "I'm Making Believe" and "I'm In A Jam With Baby," 30-0831. For the immediate future Victor plans from four to five popular releases weekly.

Due to the fact that the Boston Symphony did not join the musicians' union until after the Petrillo ban was imposed, this orchestra has not recorded since early in 1940. Its first pressing since that time will be released by Victor shortly, and includes selections from the works of Beethoven, Tchaikovsky and Debussy. Waxing of important symphony orchestras will follow, including Arturo Toscanini's NBC Symphony; Leopold Stokowski's orchestra; Chicago, San Francisco, Cincinnati, Indianapolis, St. Louis and Los Angeles Symphonies, and the National Symphony Orchestra directed by Hans Kindler.

Encourage Holiday Sales

New storage albums by Victor are gift-worthy and should promote not only holiday profits, but encourage year-round sales in records-for-gifts and record library building.

Decca presents something new in Jascha Heifetz' recording of "White Christmas," 23376, backed by "A La Valse," two popular pieces with wide appeal. Twin-sale suggestion is the Heifetz cutting of "Figaro" from "The Barber of Seville," backed by "Gweedore Brae," 29153.

Another Decca event is their Spanish Language Course on Records. This is first in a series projected by

Decca's new language department. The course is taught through interest held by a thriller-diller about one Robert Martin, U. S. representative for a Mexican firm, while reporting to his employer in Mexico. The set is packaged as a unit and is accompanied by sales aids consisting of information booklet, color counter cards, window display, ad mats, a 6-page dealer mailing piece, and customer envelope stuffer.

More New Releases

Decca has pressed another "Trolley Song," this time recorded by Guy Lombardo and his Royal Canadians, 18634, backed by "Always." Ella Fitzgerald with the Song Spinners and Johnny Long has pressed "And Her Tears Flowed Like Wine" with flipover "Confessin'," 18633. Released December 14 is disc 18636, the Andrews Sisters, "One Meatball" and "Rum and Coca Cola."

More Bing Crosby by Decca on 18635 is "Evelina" and "The Eagle and Me" from "Bloomer Girl," current New York musical success. Highlights of this hit will soon be released by Decca in its "Bloomer Girl Album," recorded by the original cast.

Capitol's Children's Discs

News about Capitol reveals their entrance into the field of children's recordings with a popular album, "Stories for Children," J-1, featuring as story-teller "The Great Gildersleeve," well-known radio character enacted by Hal Peary.

Another innovation for Capitol is their "Christmas Carols" album, A-2, nine hymns by the St. Luke's Choristers, with organ and string ensemble.

Other new releases by Capitol are Johnny Mercer, "Accentuate the Positive," 180; Jo Stafford, "I Promise You," 181; and Billy Butterfield and Orchestra, "There Goes That Song Again," 182.

Musicraft does not bypass the children's market, either, but offers album 65, "Peter and the Wolf for Children." In four ten-inch records they have emphasized the story against the background of Prokofieff's own piano reduction of the orchestral suite. Narrator: Milton Cross.

For the "older children" Musicraft suggests "Hot Fiddle Classics," album 66. Al Duffy is the Hot Fiddler, and the music consists of familiar classics via the boogie woogie route.

So . . . Merry Christmas, Mr. Dealer, and a Happy and Successful New Year of tops in record sales!

PICTURE PAGE of Mt. Carmel's Famed Precision-el



Ever hear the story of how "precision-el" originated? It was coined by a writer who visited the Meissner plant at Mt. Carmel some time ago. He had watched in amazement as hundreds of flying fingers handled intricate and delicate assignments with unerring precision. "This," he was told, "is just a small part of Meissner's personnel . . ."

"Personnel?" he exclaimed. "Well, from what I've seen today, I'd call them 'precision-el'! No wonder Meissner has such a reputation for quality!"

Specialist! Mt. Carmel, Illinois, is said to have more electronic technicians per thousand population than any other city in America. This young lady is one of many experienced workers at Meissner's Mt. Carmel plant.



Time Out! This busy worker pauses for only a fleeting second as the roving photographer snaps his picture. He does his part in making the vital and highly technical products with which Meissner supplies Allied armed forces 'round the world.

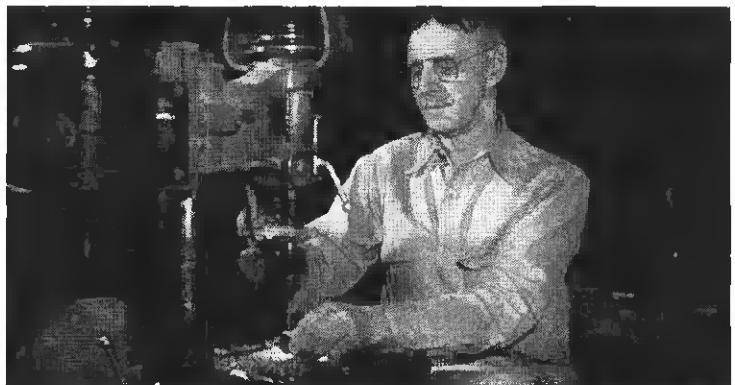

Veteran! Here is another reason for Meissner's top reputation for precision work. Meissner people rightly take pride in their job, in their own personal production.



Precision-el at Work! These young women, like many Mt. Carmel residents, have literally learned the electronic business "from the ground up." They are versatile enough to handle any one of many difficult assignments.



Now! Special 1944 Bulletin

Here's what everyone in the industry needs to know about Meissner's 1944 line of radio parts. Contains complete descriptive matter, with pictures. Now, more than ever, it pays to keep posted on what Meissner offers. Send for your copy today, because the supply is limited. Free! Write to address below.

MEISSNER

MANUFACTURING COMPANY • MT. CARMEL, ILL.

ADVANCED ELECTRONIC RESEARCH AND MANUFACTURE



Model 645 A.C.-D.C. Electronic Multimeter

(Vacuum Tube Voltmeter)

Both A.C. and D.C. volt ranges are **electronic**. This provides the maximum of sensitivity and overload protection for all A.C. ranges as well as D.C. and ohms ranges.

Measures resistance up to one thousand megohms and as low as 2/10 ohm.

Constant input resistance 12 megohms on all D.C. volts ranges.

Input resistance 4.4 megohms on all A.C. ranges. Flat frequency response between 50 cycles and 10,000 cycles.

Meter cannot be damaged by accidental overload on any electronic range. Electronic overload protection on all A.C. and

D.C. volts, and ohms ranges.

Variations in line voltage do not affect accuracy within the range of 100 to 125 volts. The instrument is equipped with ballast control tube and self-compensating circuits.

Meter Ranges—

A.C. Volts: 0-1/4/10/40/100/400/1000

D.C. Volts: 0-4/10/40/100/400/1000

Ohms: 0-1000/10,000/100,000/1 meg/
10 meg/100 meg/1000 meg

M.A.: 0-1/4/10/40/100/400/1000

Decibels: Minus 30 to minus 5/minus
10 to plus 15/10 to 35/30 to 35

Either positive or negative D.C. voltmeter indications instantly by means of reversal switch. Signal tracing type test lead with isolation resistor in probe. Model 645 is an ultra-modern high sensitivity instrument, with all of the famous Jackson features, including exceptional accuracy and simplicity of use.

MODEL 645

Net Price

\$56.50

Available *now* on *rated orders* . . . after war a new regular in the Jackson line . . . a line that shall always live up to a long reputation for **INTEGRITY OF DESIGN**.

BUY WAR BONDS AND STAMPS TODAY

JACKSON

Fine Electrical Testing Instruments

JACKSON ELECTRICAL INSTRUMENT COMPANY, DAYTON, OHIO

Distributor Appointments

Galvin Manufacturing (Motorola Radio) Corp., Chicago, according to William H. Kelley, general sales manager, has appointed Mueller and Selby, 2549 Farnam St., Omaha 2, Nebraska, as distributor for Motorola radio in the Nebraska territory. They will carry Motorola's complete line of postwar products which is to include FM and AM table models, consoles, and automatic phonographs, AC-DC battery portables, and the new Motorola personal portable radio set. ● Also announced was the appointment of the Strickland Distributing Co., 615 Jefferson St., Paducah, Ky. I. H. Strickland is head of the firm. ● The Post & Lester Co. of Hartford has been appointed as distributor for Motorola radios in the Connecticut territory. ● The C & H Supply Co., of Seattle, Wash., has been appointed distributors for Motorola radios in the Seattle and Portland, Ore., territory.

RCA Victor's Cleveland office, Harold M. Winters, manager, announced that the distribution of RCA Victor radio, television and electronic products in southwestern Ohio will be handled by Ohio Appliances, Inc., Mark Lintner, president. ● The West Virginia distributing firm, Van Zandt Supply Co., of Huntington, will handle RCA Victor radio, television, and electronic products in the Huntington, Charleston and Bluefield areas of the state.

Emerson Radio and Phonograph Corp., N. Y., announces the appointment of the Sunset Electric Co., Spokane, Wash., as distributor of Emerson radios and television sets. ● Charles Robbins, vice-president in charge of sales for Emerson also named the Capitol Distributing Co., 111 Westminster St., Providence, as distributor in that territory. ● The addition of the W. G. Walz Co., El Paso, Texas, as distributor for Emerson in southwestern Texas, New Mexico, and Arizona has been announced ● Hughes-Peters, Inc., Columbus, Ohio, is another wholesaler now with the Emerson distributing organization.

Waters Conley Co. of Rochester, Minn., manufacturers of portable phonographs, announce the appointment of six more distributors for their Phonola line. These are: Philco Distributors, Inc., Detroit division, Detroit, Mich. ● Philco Distributors, Inc., Toledo, Ohio ● Strong, Carlisle & Hammond Co., Cleveland, Ohio ● Bennett Radio Co., Inc., Columbus, Ohio ● Electric Appliance Distributors of Kentucky, Inc., Louisville, Ky. ● Rodefeld Co., Indianapolis, Ind.

Westinghouse Electric Supply Co. has named Charles H. Whiteacres stores manager for the New England district with offices in Boston. ● J. R. Bostwick has been appointed manager of the southwestern district stores, headquarters Dallas.

(Continued on page 90)



ILLUSTRATION FROM PHILHARMONIC'S CURRENT NATIONAL ADVERTISING. "THRILLED BY A NEW PERFECTION!"

Earnmarked for many a profitable Christmas!

THE PHILHARMONIC Radio-Phonograph will not be on the Nation's Christmas shopping list this year. But the swift approach of final victory gives us hope that long before next Christmas, the new PHILHARMONIC will bring you added prestige, added volume, and added profits.

For, PHILHARMONIC is earmarked for leadership. And you will recognize this leadership at once.

Its leadership in engineering... Its

leadership in design...Its leadership in the beauty of its cabinets, created by Morris Sanders, noted architect.

Everyone prefers the possession of things which are *known* to be superlatively good.

The social desirability of the new PHILHARMONIC will be recognized by the men and women who are at the forefront of your community in culture, discrimination, and ability to choose only the best.

It is this quality, supported by national advertising, and backed by sound dealer policies, that will make the PHILHARMONIC Radio-Phonograph franchise of such high value.

These are the important reasons why leading radio and music dealers have already caught the ground swell of the greatest opportunity for prestige and profit in our industry!

• PHILHARMONIC RADIO CORPORATION •
524 East Seventy-Second Street, New York, N. Y.

Philharmonic

RADIO - PHONOGRAPH

Radio Trade Activities

Concord Entertains Manufacturer "Reps"



The Atlanta, Ga., Branch of the Concord Radio Corp., playing host to southeastern manufacturers' representatives at the Atlanta Biltmore. Seated left to right: William Hopper, Mallory; Elmer Eades, RCA; E. Hollingsworth, Hollingsworth & Still; Edward Berliant, manager Concord, Atlanta; Mrs. A. Burwell, Henry W. Burwell, Inc., Maitland K. Smith; L. C. Still, Hollingsworth & Still. Standing left to right: Henry Wald, Concord store manager; M. McKinney, AnSCO; Ed. Hulce, manager Concord camera dept.; Paul Witte, industrial sales manager, Concord; V. Hutto, Concord purchasing agent, and James Millar, James Millar Co.

Named by Crosley

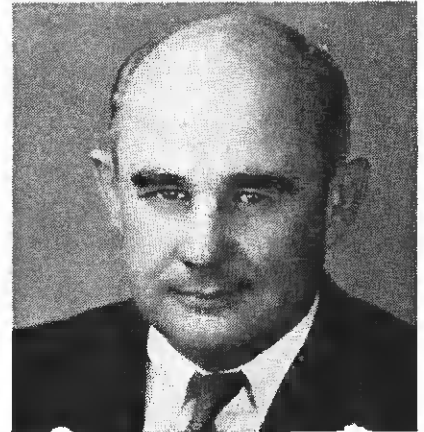

E. C. Brode new manager distribution of the Crosley Corporation, manufacturing division.

Garod Radio Expands



Max Weintraub, above, president Garod Radio Corp., Brooklyn, N. Y., whose firm has taken on additional floor with 30,000 square feet.

Harold D. Conklin

Joins Stromberg-Carlson



Appointed to head electric range division of The Admiral Corp., Chicago.



George W. Crowell named midwest sales representative in Stromberg's radio division.

Promoting Home Freezer Industry



"Frozen Foods" movie in the making at General Electric Consumers Institute. Dr. D. K. Tressler (in dark coat), manager, and technical director of the film, holds script conference while cameras get under way.

John Meek Postwar Model

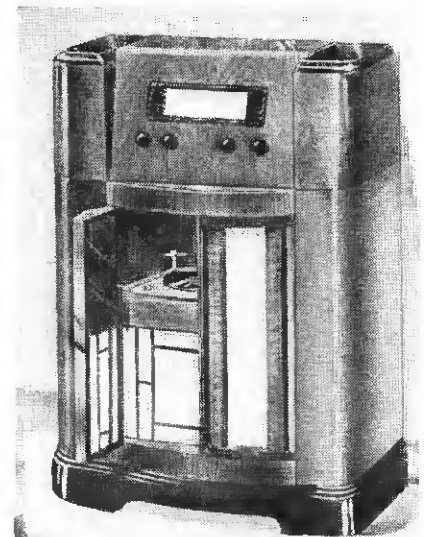

7 tube AM-FM console combination. "Hide-away" phonograph, automatic record changer.

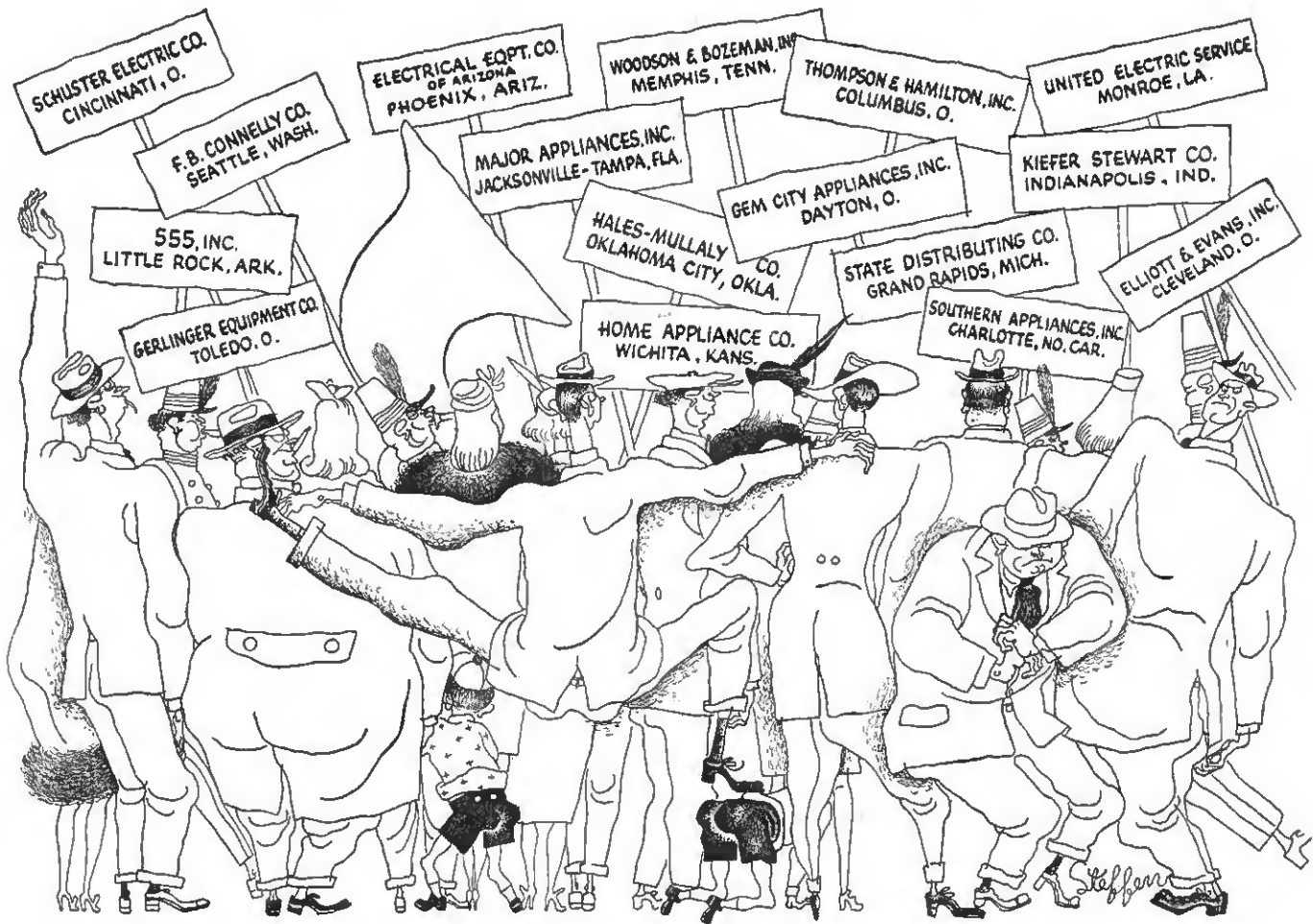

16 More Reasons why Majestic Means Business . . . and lots of it!

Here they are: 16 outstanding distributors appointed to handle the Majestic line—16 more reasons why *Majestic Means Business . . . and lots of it!*

And the appointments shown above are in addition to five other important distributors previously announced:

Ray Thomas Co., Los Angeles, California
 Colen-Gruhn Co. Inc., New York City
 J. J. Pockock, Inc., Philadelphia, Pennsylvania
 Sidles Co., Omaha, Nebraska
 Major Appliance Corp., Watertown, Massachusetts (Boston)

These distributors are leaders in their territories, well-known for their cooperation with dealers. Their association with Majestic is further evidence of the powerful distributing organization through which Majestic will serve its dealers in *all* parts of the country.

But a strong, cooperative distributing organization is only one of the advantages that Majestic Dealers will enjoy. In addition . . .

Majestic has a name: A recent 17-city survey shows 88.2% of all persons interviewed familiar with the name "Majestic"; 24.5% either own or have owned a Majestic radio!

Majestic has a plan, Controlled Distribution, which assures every Majestic dealer a *fair chance for a fair profit on every sale!*

MAJESTIC RADIO & TELEVISION CORPORATION ★ CHICAGO 32, ILL.

RADIO & Television RETAILING • December, 1944

Majestic will have the products—engineered by a staff that knows how to build the best of recent radio and electronic advances into improved peacetime radios and radio-phonographs . . . planned by experienced management that knows what radio-buyers want and how to give it to them so that sales are easy and profitable.

★ ★ ★

Like to learn more about the Majestic Franchise? Write us today!



ALLIANCE "Even-Speed" Phono-motors



Good News!

ALLIANCE RESUMES PRODUCTION on One Standard Model

• We are now able to return to production of one standard variation of Alliance Model 80 Phono-motor, according to the following definite specifications and on the production plan explained below.

STANDARD SPECIFICATION No. 811—Turntable No. Y-278-S2; 110 Volt, 60 cycle, 9" Model 80

Production must be on the following practical basis under present conditions where there are no large volume priority orders—namely, by accumulating a sufficient quantity of small orders with necessary priority and making periodical single production runs at such time as the quantity of accumulated orders is enough to make this practical. Priority orders (currently only orders of AA-3 or higher, with GOVERNMENT CONTRACT NUMBER and MILITARY END USE, or where certified to be used in Sound Systems, Intercommunicating or Paging Systems, as exempted from order M-9-C) must allow delivery time required to obtain a minimum practical production run; to procure material for all orders in hand, and make one production run of the one type standard unit only, for shipment on the various accumulated orders. • Check the above against your requirements, and if you have proper priority, communicate with us.

REMEMBER ALLIANCE—Your Ally in War as in Peace!

AFTER THE WAR IS WON, WE WILL TELL YOU ABOUT SOME NEW AND STARTLING IDEAS IN PHONO-MOTORS

ALLIANCE MANUFACTURING COMPANY
ALLIANCE, OHIO



Sell Talk-A-Phone
the most complete line
of inter-coms



Talk-A-Phone offers America's Most Complete Line of Inter-communication Equipment . . . Units for every application from the smallest office to the largest factory . . . Standard—DeLuxe—Chief and Super Chief Models. TODAY every business needs Talk-A-Phone's time-saving advantages. Get your share of this business now.

Talk-A-Phone is The Ideal Jobber Inter-com Line. Our rigid jobber policy combined with good deliveries make Talk-A-Phone the line that you can make money on NOW as well as in the post-war period. Write or wire for discounts, 8 page colorful catalog and other selling helps. Address Dept. RTR.



Talk-A-Phone Mfg. Co.

1512 So. Pulaski Rd. Chicago 23, Ill.

Distributors

(Continued from page 86)

Sentinel Radio Corp., Evanston, Ill., through Sanford Samuel, eastern territorial sales manager, names following distributors: J. R. Hunt & Co., Calvert & Saratoga Sts., Baltimore, Md. • Excelsior Radio Co., 17th & Derry Sts., Harrisburg, Pa. • Elliott-Lewis Electric Co., Inc., 1017 Race St., Philadelphia, Pa. • Springfield Radio Co., 405 Dwight St., Springfield, Mass. • George Gerber Co., 130 West Exchange St., Providence, R. I. • Joseph Mandell & Co., Inc., Medford & N. Washington Sts., Boston, Mass. • Sanford Electronics Corp., 136 Liberty St., New York, N. Y. • Richmond Hardware Co., 101-107 S. 14th St., Richmond, Va. • Capital Light & Supply Co., Inc., 6-8 Huntley Place, Hartford, Conn. • C. S. Mersick & Co., 278 State St., New Haven, Conn. • Hatry & Young, 203 Ann St., New Haven, Conn. • Grand Light & Supply Co., 633 State St., New Haven, Conn.

Stromberg-Carlson Co., according to Clifford J. Hunt, sales manager of radio division, has appointed the Grand Rapids, Mich., branch of the Radio Distributing Co. of Detroit, as distributor of the company's postwar radio line. • The Louisville, Kentucky, district office of the Graybar Electric Co., has been named area distributor of the Stromberg-Carlson postwar radio, FM and television lines. The area to be embraced by Graybar's Louisville office includes the greatest part of Kentucky and the Evansville, Ind., trading zone. • The company also announces the General Hotel Supply Co., of San Antonio, Texas, as area distributor.

Crosley Corp. announces the appointment of the Dorrance Supply Co., of Youngstown, Ohio, as distributor in the northeastern part of Ohio, and the central western part of Penna.

Stewart-Warner radio division announces the new postwar wholesale distributor in the San Francisco and northern California territory will be the Edward F. Hale Co. of San Francisco. • State Distributing Co., 1234 N. 12th St., Milwaukee, Wis., has been appointed exclusive wholesale distributor for Stewart-Warner postwar radios in Wisconsin and the upper peninsula area of Michigan.

Radio Corp. of America has chosen the Radio and Appliance Distributors, Inc., of Hartford, Conn., as the wholesale distributing agency for RCA Victor products in Connecticut and western Massachusetts.

Baker Goes to Greusel

W. D. (Bill) Baker, has terminated 25 months of service as salvage executive of the War Production Board to become affiliated with the Greusel Distributing Corp., Milwaukee, Wis. Baker has been identified with the appliance industry in the Wisconsin market since 1927, and comes to the Greusel Distributing Corp. in the capacity of sales manager.



Your customers are accepting this invitation

Some mighty good prospects in your neighborhood are interested in FM radio as developed by General Electric. More, they want to see and hear the first G-E models as soon as Victory makes them available.

How do we know? Because they've taken the trouble to tell us so!

The invitation illustrated at the top of this page is enclosed with every copy of the G-E book "Your Coming Radio." This exciting forecast of tomorrow's G-E Radio developments is being mailed to postwar customers all over the country. *More than*

twenty-five per cent of those who received this book have accepted our invitation—a record-breaking consumer response!

It brought us firsthand information of great benefit to G.E. dealers. Information including names, addresses, even types of receivers preferred.

And remember this: "Your Coming Radio" will continue to be advertised. In full-color pages reaching 38,000,000 readers monthly. AND over CBS with an additional weekly audience of 28,500,000! *Electronics Dept., General Electric, Bridgeport, Conn.*

GENERAL  **ELECTRIC**

176-013

GENERAL ELECTRIC IS BUILDING MORE MILITARY RADIO EQUIPMENT THAN ANY OTHER HOME-RADIO MANUFACTURER

Harrison Appoints Wolfe

William E. Harrison, president of Harrison Radio Corp., 12 W. Broadway, N. Y., has announced the appointment of Irving Phillips Wolfe as advertising and assistant sales manager. Mr. Wolfe has been active in the advertising and sales promotion fields for the past 15 years.

Royal Vacuum Distributor

Colen-Gruhn Co., Majestic radio distributor, 387 Fourth Ave., N. Y., has been appointed distributor for the Royal vacuum cleaner line. Colen-Gruhn will cover the metropolitan territory as well as part of the New York state area.

McDonald Brothers Expand

McDonald Brothers, distributors of Philco products, 963 Union Ave., Memphis, Tenn., are opening a super-service parts department. They expect to expand their wholesale parts business further as more merchandise becomes available, according to an announcement.

R. H. St. John Appointed

The appointment of R. H. St. John as manager of the Albany branch has been announced by H. B. Tompkins, Eastern district manager of the Westinghouse Electric Supply Co. Mr. St. John replaces Alger Reilly, who has been transferred to the Newark branch of the company.

G. Albert Rhimer



Appointed sales manager of Trilling & Montague, Philadelphia distributors of Norge and Farnsworth products.

Rutkin Names Affiliate

Myron Rutkin, head of M. Rutkin Electric Supply Co., of Newark, N. J., announced the formation of an affiliate corporation, Appliance Wholesalers, to distribute traffic and major appliances and radios in northern New Jersey. The new concern was organized to more effectively distribute the number of lines offered to them.

100 Distributors on Radio Sales Committee

Organization of a special distributors' radio planning committee to assist in shaping merchandising policies of the newly created radio receiver division of the Westinghouse Electric & Manufacturing Co., was announced by Harold B. Donley, manager of the division. Included on the committee are representatives of approximately 100 distributors throughout the United States, Alaska, and Hawaii.

Mr. Donley is chairman of the new group, and Paul H. Eckstein, assistant sales manager of the division, is secretary.

Members for the current period are: Oscar Ray, vice-president, Times Appliance Co., Inc., New York; Frank E. Fowler, president, Southern Furniture Sales Co., Knoxville, Tenn. Members of the Westinghouse Electric Supply Co. included are: John T. Urban, general appliance manager, New York headquarters; Corwin Savage, radio manager, Boston; and John C. Cox, Jr., midwest district appliance manager, St. Louis.

Walker-Jimieson in Role of Novel Santa Claus

Walker-Jimieson, 311 Southwestern Ave., Chicago, radio and electrical distributors, have a novel substitute for the usual habit of sending gifts to customers at Christmas time. W-J sends a gift to the customers' son, daughter, or some member of the family in service. Customers simply fill out a form letter with the name of the person to whom the gift is to be sent, and Walker-Jimieson does the rest.

KEN-RAD *Metal Tubes*

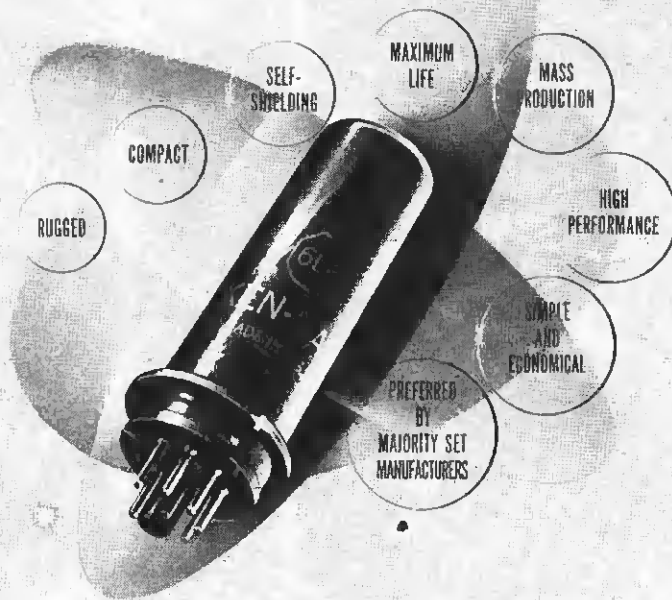

The weight and space saving advantages of Ken-Rad "self-shielding" metal tubes have long been recognized. Their sturdy ruggedness under severe service conditions in fighters and bombers is a matter of record.

Write for your copy of "Essential Characteristics" the most complete digest of tube information available

TRANSMITTING TUBES
CATHODE RAY TUBES
SPECIAL PURPOSE TUBES
RECEIVING TUBES
INCANDESCENT LAMPS
FLUORESCENT LAMPS

KEN-RAD
EXECUTIVE OFFICES
OWENSBORO · KENTUCKY
EXPORTS 13 MOORE STREET NEW YORK

Bickford Announces Business Ethics Code

Bickford Brothers Co., Rochester, N. Y., have issued a statement on their business ethics policy, telling of their opposition to so-called "back door" selling by distributors. The Bickford policy is:

1. Any product which we distribute will be sold *only* through authorized franchised dealers.

An authorized franchised dealer is one who has signed an accepted Bickford franchise covering a particular product and who stocks and displays that product in line with the terms of the franchise.

2. In event an individual, a firm, a dealer, or any member of a dealer's organization desires to purchase for his own use, or for resale, any product distributed by us and for which product such person or firm is not a duly authorized franchised dealer, such party will be respectfully referred to our list of dealers handling that product.
3. No sales will be made by us, even to our own employees, of the products we distribute. This ruling covers our own executive staff.
4. Dealers, friends, and employees are kindly requested not to ask us to violate this code. Such courtesy requests positively cannot be granted. We are wholesale only—strictly, absolutely, and without exceptions!

Bickford Brothers have guaranteed to forfeit \$1,000 if found guilty of violating their code.

W. H. Kelley Lists Galvin Distributor Policies

On assuming his new post as sales manager of the Galvin Manufacturing Corp., William H. Kelley issued a statement on the important position the distributor holds in the merchandising field.

The fundamental functions on which the Motorola distributor organization is based were listed by Kelley. The distributor will introduce, exhibit, and stock a complete line of postwar Motorola products, both of models and of parts. He will help train servicemen and salesmen. He will provide advertising, sales assists, and stand by as a willing troubleshooter.

Philco Super-Markets Adapted to Radio Needs

Philco distributors throughout the country are organizing and using with marked success the self-service super-markets where merchandising principles featured by retail super-markets in the grocery trade are adapted to radio parts distribution operations, according to Charles E. Gerhard, manager of parts sales, Philco Corp. The company's first and largest super-market was started in Philadelphia, and already 100 Philco distributors have their own parts super-markets in operation.

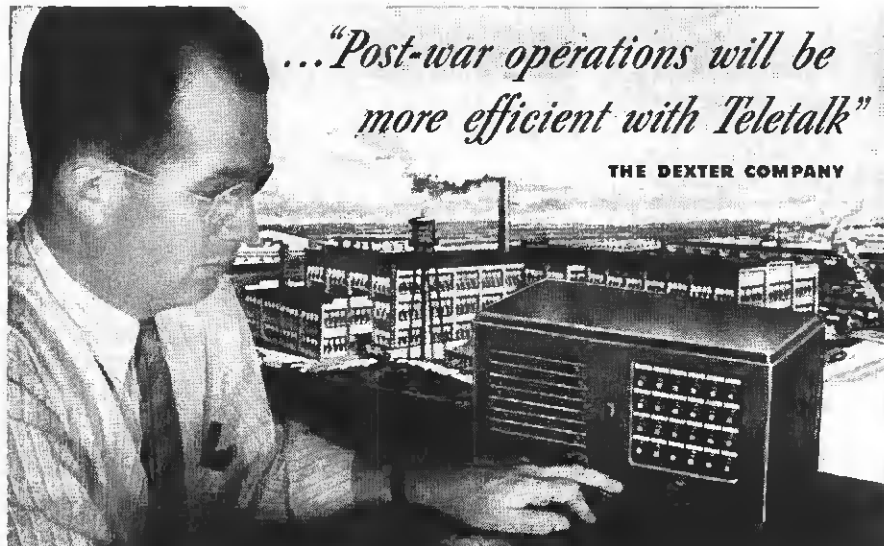

...*"Post-war operations will be more efficient with Teletalk"*

THE DEXTER COMPANY

Time saved by their Teletalk Amplified Intercommunication System during this war period has been most helpful, says the Dexter Company, laundry equipment manufacturers of Fairfield, Iowa. Looking to the future, C. W. Yeager, Treasurer, says: "Teletalk will, we believe, make our plant operations more efficient in the post-war period . . . enable us to give our customers the service they will expect."

Everywhere in your vicinity there are progressive concerns making plans to go into high gear for the years of competitive manufacturing and selling that lie ahead. Few plans are more important than those which insure quick, convenient . . . Teletalk . . . intercommunication between offices, factories and warehouses.

Get ready for tomorrow with Teletalk. Increase your revenue by calling the attention of these concerns to the time and energy-saving advantages of Teletalk. In the two-suite office as well as the large factory, Teletalk's time-saving convenience increases the efficiency of every executive . . . will easily pay for itself in a few months' time.

Teletalk Amplified Intercommunication Systems are easy to install, require almost no service . . . operate from the electric light circuit. In most major cities there is a Teletalk representative near you. Get in touch with him or write to us for full information on the profit-building possibilities that Teletalk offers.

Licensed under U. S. Patents of Western Electric Company, Incorporated, and American Telephone and Telegraph Company

BUY EXTRA WAR BONDS ★ ★

WEBSTER ELECTRIC CO., Racine, Wis., U.S.A.
 Est. 1909. • Export Dept.: 13 East 40th St., New York (16), N.Y. • Cable Address: "ARLAB" N.Y.C.

WEBSTER ELECTRIC

Where Quality is a Responsibility and Fair Dealing an Obligation

In Your Behalf

A dependable OSCILLOGRAPH

R. F. O.-5

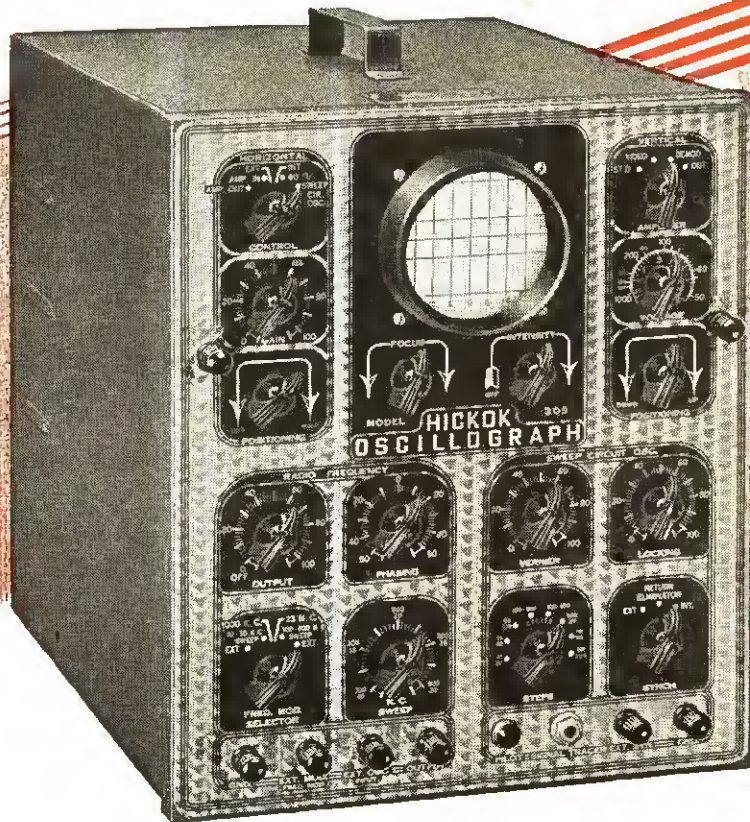

The HICKOK OSCILLOGRAPH R.F.O.-5 is especially designed for frequency modulated, amplitude modulated, and television service. This is your instrument for COMPLETE VISUAL ANALYSIS.

Self-contained Wide Band and Narrow Band F. M. Oscillator, Demodulator, Video Amplifier, Signal Tracer, Visual A.C. Vacuum Tube Voltmeter. It features high sensitivity amplifiers, returns trace eliminator, calibrated screen, variable width frequency modulated oscillator, pilot light and phasing control.

Power supply, 110 to 120 volts, 50-60 cycles. Size, 11"x13"x15¼". Finished in baked crackle lacquer. Shipping weight, 55 lbs. Shipped on WPB authorization 3243. Otherwise, orders must be accepted for shipment after WPB restrictions are removed. Advise whether you wish New METER Catalog or New RADIO SERVICE EQUIPMENT Catalog.

THE HICKOK ELECTRICAL INSTRUMENT COMPANY
10523 DUPONT AVENUE CLEVELAND 8, OHIO

THE STANDARD OF QUALITY
FOR A THIRD OF A CENTURY

HICKOK

New Ansley Model



AM-FM radio phonograph Dynaphone intended for sale only after permission for manufacture has been granted by WPB.

Meyberg Holds Bendix Dealer Sales Meeting

Leo J. Meyberg Co. of San Francisco, recently held the first series of appliance dealer sales meetings since 1941. Subject of the conclaves was the presentation of the advertising and merchandising program soon to be launched by Bendix Home Appliances, Inc. Meetings were held in Fresno, Sacramento and San Francisco under the direction of W. J. Lancaster, vice-president, San Francisco division, and R. C. Christiansen, sales manager, Bendix division. Over two hundred northern California dealers attended.

Florida Firm Ready With Big Postwar Line

The Florida Radio & Appliance Corp., is now actively engaged in the wholesale distributing business, handling gas and electric appliances of all types. John V. D'Albora is president. George B. Gray will direct merchandising and sales. Hal E. Enyeart and L. R. Bickley have backgrounds in the wholesale supply business and dealer relationships. Full scale operations will be carried on in Jacksonville, Tampa and Miami. The main office is located in Miami, P. O. Box 1088.

Purchases Supply Company

Ward J. Hinkle of Amsterdam, New York, has purchased the Adirondack Radio Supply Company parts distributing firm of Gloversville, New York, according to an announcement made by Mrs. Catherine Cross, former owner.

Sees Film Important

"The use of film will be infinitely more important in television broadcasting than the electrical transcription disc is today in radio," said Ralph B. Austrian, executive vice-president of RKO Television Corp., in a talk to the publicity club of New York.

BEFORE YOU SIGN UP...

STOP ♪♪



LOOK ♪♪

LISTEN ♪♪



TO MAGUIRE HOME RADIO ♪♪

It's entirely new and different. It's an excellent feature-filled product. It's exactly what your customers will want. It's backed by a liberal dealer policy. *It's just what you've been looking forward to selling in the post-Victory market!*

Plenty has happened in the field of electronics since the last home radio sets were made. New materials, new devices... new men have forged to the front in answer to the demands of total War. *Emergency sires leadership* that will not falter or cease at the War's end, but rather will welcome Peace as a magnificent opportunity for further advancement... Maguire war-won leadership... in the electronics field; in the small arms field ("Tommy" guns and other small arms); in the food processing

field; in the oil producing industry... will continue with the same full vigor after Victory. **Only the best can produce the best!** This policy has been instrumental in assembling many of the nation's foremost scientists, engineers, designers and technicians at Maguire Industries, Inc. The combined efforts of these men have produced a line of Maguire Home Radio Receivers that establish a new high in *interference-free reception, tonal quality and uninterrupted operation.*

Don't discount new leadership produced by the War. Investigate Maguire Home Radio. For full information, write Maguire Industries, Inc., Electronics Division, 342 West Putnam Avenue, Greenwich, Connecticut... today!



MAGUIRE INDUSTRIES, INC.
ELECTRONICS
division

RIDER VOLUME XIV COVERS 1941-42 RECEIVERS



That's me three years ago. The first program I carried was Frank Sinatra—back in the days when a bobby sock was something worn by a London policeman.

My, how we 1941 models have worked since then. For most of us it's been too much and many of my contemporaries are now piled up in overcrowded service shops.

There is one bright spot however. Rider Manual Volume XIV is now off press. Carrying complete authorized servicing information on 1941-42 sets, we ailing sets are sure of correct diagnosis and quick painless repair.

But please be patient if your jobber's supply of Volume XIV is inadequate. He, and the Rider folks will get you your volume as fast as present WPB limitations permit.

RIDER MANUALS (14 VOLUMES)
Volumes XIV to VII . . . \$11.00 each volume
Volumes VI to III . . . 8.25 each volume
Abridged Manuals I to V
 [1 volume] \$12.50
Automatic Record Changers and Recorders 6.00

OTHER RIDER BOOKS YOU NEED
The Cathode Ray Tube at Work
 Accepted authority on subject \$3.00
Frequency Modulation
 Gives principles of FM radio 1.50
Servicing by Signal Tracing
 Basic Method of radio servicing 3.00

JOHN F. RIDER PUBLISHER, INC.

The Meter at Work
 An elementary text on meters 1.50
The Oscillator at Work
 How to use, test and repair 2.00
Vacuum Tube Voltmeters
 Both theory and practice 2.00
Automatic Frequency Control Systems
 —also automatic tuning systems 1.25
A-C Calculation Charts
 Two to five times as fast as slide rule 7.50
Hour-A-Day-with-Rider Series—
 On "Alternating Currents in Radio Receivers"—
 On "Resonance & Alignment"—
 On "Automatic Volume Control"—
 On "D-C Voltage Distribution" 90c each

404 Fourth Avenue, New York 16, N. Y.
 13 E. 40th Street New York City Cable: ARLAB

RIDER MANUALS *are complete*
IN 14 VOLUMES

The Service Man's Best Friend

WARTIME RADIO SERVICE
\$3.00
SUPPLEMENT NUMBER ONE
\$1.00

About 1,200 tube substitutions and much other important information.

We have IN STOCK, adapters to make more than 100 of these substitutions. Quick, convenient, low priced. Ask for list airmail.

CITY RADIO COMPANY
 504-6 E. WASHINGTON ST.,
 PHOENIX, ARIZONA

Motorola Is Honored



Frank J. O'Brien, vice-president Galvin Mfg. Co., holds "E" flag while Sergeant Jane Perfect, Marine, sews fourth star to flag in honor of Motorola's fifth production award.

Truesdell Goes to Bendix As General Manager

William P. Hilliard, general manager of the Bendix Radio division of Bendix Aviation Corp., has announced the appointment of Leonard C. Truesdell, who has been sales manager of Crosley Corporation's radio and appliance division, as general sales manager for the line of home radios which Bendix plants will manufacture and market as soon as the military situation permits.

Truesdell, a nationally known executive in the radio, phonograph and appliance fields for the past 20 years, will assume immediate direction of the company's nation-wide sales, marketing and promotional organization and will announce appointments of key distributors and dealers.

Prior to his association with Crosley, Truesdell was national manager of the major dealer and dealer development department for the Frigidaire division of General Motors Corp.

Stewart-Warner Ready For Postwar Set Making

Within 60 days after present government restrictions are lifted, Stewart-Warner Corporation will be producing and shipping civilian radios from what is now reputedly the largest privately-owned shell fuse plant in the United States, Frank A. Hiter, senior vice-president of the corporation, has told Stewart-Warner postwar radio distributors and dealers.

"Our postwar engineering board has completed minutely-detailed plans for the reconversion of our South Plant, currently being used for shell fuse production. It is quite probable that these plans will enable Stewart-Warner to be among the first manufacturers with civilian sets on the postwar market," Hiter stated.

General Instrument Names New Division Manager

Richard E. Laux, executive vice-president of General Instrument Corp. of Elizabeth, N. J., has announced the appointment of Leon Golder as manager of its new speaker division, for which plans are now being made for large scale manufacture after the war.



Leon Golder

"Lee" Golder is a veteran of the radio components field, having started his career with the original Sonora Phonograph Co., advancing to the position of Chicago District Manager. In 1924 Mr. Golder left the Sonora Co., to become eastern district manager of Magnavox Co., where he remained until 1927 when he resigned to assist in the organization of Rola's Cleveland operations.

As a pioneer in the manufacture of radio components, it is a logical step for General Instrument to enter the field of speaker production, says a statement by the company.

New Fonda Officials

The Fonda Corp., New York, designers and manufacturers of sound recording equipment, announces the appointment of Irving M. Felt as president, and Edgar Ellinger, Jr., as executive vice-president. Both executives hold similar posts in the Jefferson-Travis Radio Manufacturing Corp. and Union Aircraft Products Corp.

Joins Stewart-Warner

George Johnson has joined the radio division of Stewart-Warner Corp., it was announced by Floyd Masters, division manager. Mr. Johnson will handle sales promotion work, and radio distributor relations.

Inspect for Operadio

Fred D. Wilson, commercial sound division sales manager for the Operadio Manufacturing Co., St. Charles, Ill., and L. A. King, general sales manager, have each completed tours of the East and West respectively. War production plants, and recently installed Operadio plant broadcasting equipment were inspected by the Operadio officials.

MEASUREMENTS AROUND THE WORLD

IN SUNNY OLD MEXICO, THE WORD "PULGADA" IS USED TO SIGNIFY A MEASUREMENT OF 0.916-INCH ...ACCURATE ENOUGH, PERHAPS, FOR MOST PURPOSES But in the case of delicate Radio and Electronics Measurements...wherever accuracy is a fetish...there you will find

MONARCH

Measuring-Testing-Calibrating Equipment furnishing the kind of dependable service specified by all who prefer precision

We're getting "posted" NOW, to fill all post-war needs of our customers.

★ **MONARCH MFG. CO.** ★
2014 N. Major Ave. Chicago, Ill.

FROM THE OFFICE OF THE PRESIDENT
TO ALL EMPLOYEES
IMPORTANT NOTICE!

We take pleasure in announcing completed installation of our AMPLICALL Communications System throughout the plant. This provides instant contact with any individual without loss of valuable time, also immediately locates anyone away from his desk. The loud speakers are utilized for announcements of general interest, public addresses, musical programs, etc. This addition will unquestionably add to our efficiency and afford new opportunities for both social and business progress.

Johnson
PRES.

AMPLICALL

... PREFERRED COMMUNICATIONS

Bulletin board notices like these are going up in more and more plants from coast to coast. Management knows and prefers

AMPLICALL's perfect tonal sound, flexible design and dependable high quality. We invite your inquiry for full information.

THE RAULAND CORPORATION • CHICAGO 41, ILLINOIS
Electroneering is our business

BACK THE ATTACK

BUY MORE WAR BONDS

RADIO • RADAR • SOUND • COMMUNICATIONS • TELEVISION

HOMER G. SNOOPSHAW says:

War batteries really pack a wallop! Fighting men *know* it—and Burgess ads *show* it! When folks read these ads in 31 important magazines and 1,629 weekly newspapers, they'll understand better why batteries are scarce here at home.



HE HAS YOUR BATTERY



Jap pill-boxes and gun emplacements are "knocked out" fast when deadly bazookas go into action! It takes a trained two-man team and battery-power to keep these portable weapons firing. Batteries that once were made for homes and farms are now sent to serve our fighting men. Use your available Burgess Batteries sparingly . . . keep them cool and dry.

Write to Your Serviceman Today!

BURGESS BATTERIES

IN THE NATION'S SERVICE

Free Battery Hints—Write Burgess Battery Co., Freeport, Ill.

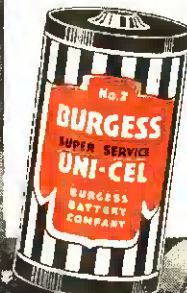

Get **EVERYTHING!**

Standardize on

STANCOR

Transformers

Call your nearest Stancor Jobber...
or write us for his address

STANDARD TRANSFORMER CORPORATION
1500 N. HALSTED STREET • CHICAGO



Sees Tele Reuniting The American Family

In a talk before the American Television Society in New York, Dr. Orestes H. Caldwell, editor of RADIO & Television RETAILING, predicted new trends in home life and even in home decorations as a result of nationwide acceptance of television. Dr. Caldwell's remarks follow:

"The American family will find new occasion for getting together and getting better acquainted again, in the coming age of television. For the evening Television Hour will be a 'must' to every member of the household. Young and old will hurry home to be on hand when the cathode-screen lights up. Family autos will stand idle; gasoline and tires will be saved. Movies (which have taken the young out of the home for so many hours heretofore), best-selling novels, detective stories, prolonged telephone chatter—all will be willingly sacrificed as the family group gathers in its own living-room to watch news, drama, athletic events and travel, unrolled by this new wonder—all with effortless magic.

Full Enjoyment

"Contrasted with the movies, greater freedom and relaxation can be enjoyed in the family living-room, viewing television. Those who wish can smoke, or sip coffee or drinks. Pertinent comments and conversation are there not out of order. And tight shoes and restrictive garments can be eased, for the fullest enjoyment of the television program.

"I have seen such a home revolution take place in my own family circle, as it enjoys the television programs now on the air. And I can predict a tremendous and happy further impact on family life and family customs, as television blooms and television receivers become as widespread as radios and telephones are now.

Changes Foreseen

"Even home decorations will be affected. New furniture will, in the future, be chosen which can be readily rearranged to form a family audience group, facing the television screen. Living-room drapes will be selected with an eye to blocking out daylight during winter-afternoon football games, to give the family a better view of the pigskin tussle a hundred miles away! And, of course, family buying methods will be revolutionized when the household can see articles demonstrated over the air. This may have a significant effect on the cost of living.

"A revolution is ahead for American family life through television. And from personal experience in a television household, I know that television's impact will all be in the direction of a sounder, happier, and more closely-knit family circle."

General Appoints Rogers

Herman R. Rose, president General Television and Radio Corp., Chicago, Ill., announced that John E. Rogers has been appointed director of radio sales. Mr. Rogers has been with Galvin Mfg. Corp.

To Sell Turner "Mikes"



Royal J. Higgins, 600 So. Michigan Ave., Chicago, will represent the Turner Co., Cedar Rapids, Iowa, in the greater Chicago area.

Shartle General Manager

The Cleveland Distributing Co., marketing major home appliances to dealers throughout northern Ohio, has named Howard J. Shartle as general manager. For the past two years, Shartle has served as regional chief of Radio and Radar Division, WPB, with headquarters in Cleveland. The company will market a group of nationally advertised home appliances, including Gibson refrigerators, Blackstone washers, Bendix home radio receivers, Quaker oil-fired space heaters, Grand gas ranges, and several other products to be announced.

Universal "Mike" Plans Ad Series Portfolio

Ful-page advertising illustrations run in RADIO & Television RETAILING during 1944 by the Universal Microphone Co., Inglewood, Cal., will be published in January in portfolio pictorial form and more than a dozen illustrations will show the various stages in communications through the years. "The History of Communications" will caption the booklet.

Los Angeles artist Keith Thomas drew the illustrations which show various stages in communications, including scenes from the Spanish-American War as well as World Wars I and II.

The Signal Corps has included a salon set of the prints in its permanent Chicago depot exhibit of sources of supply and also in its traveling educational display. Radio schools of the services of supply, as well as schools and colleges, are also using the series for study purposes.

The entire series will be ready for free distribution in January on a gratis basis. Each one will carry descriptive notes and the views will be of size to frame for office, store, home or ham shack.

Jones an OPA Official

W. Paul Jones, vice-president in charge of the refrigerator division of Philco Corp., has been elected chairman of the OPA domestic mechanical refrigerator industry advisory committee. Mr. Jones joined Philco in 1938 to head the company's refrigerator division.

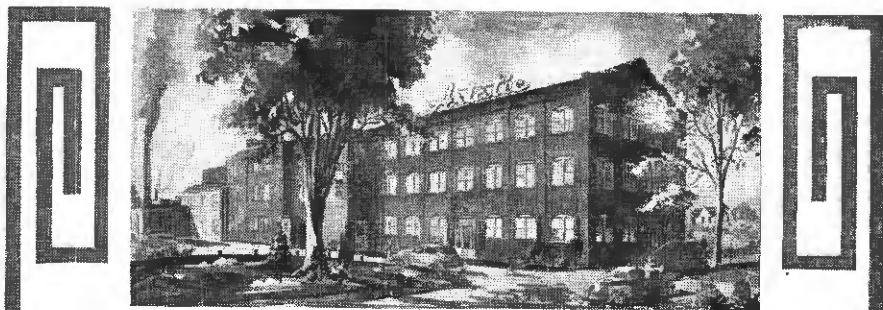

STEPPING UP PRODUCTION TEMPO

At its large, new, modernly equipped plant at Conneaut, Ohio, The Astatic Corporation is today supplying Microphones, Pickups, Cartridges and wartime unmentionables to the armed forces, essential industries and accredited government agencies. With all operations and departments now under one roof, Astatic looks optimistically forward into the new year with greatly increased production facilities and customer accommodations. These advantages will enable Astatic to make a quick transition to meet commercial demands when the reconversion time arrives.

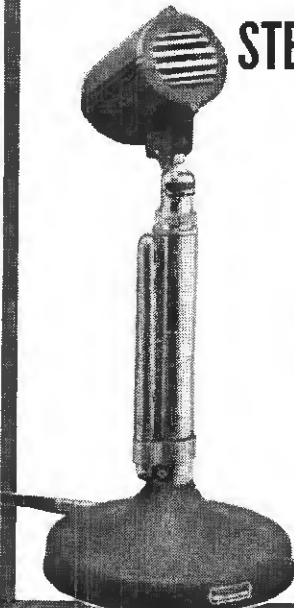

THE
Astatic
ASTATIC CORPORATION
CONNEAUT, OHIO

IN CANADA: CANADIAN ASTATIC LTD., TORONTO, ONTARIO

NOTE: Please change Astatic address in your files to CONNEAUT, OHIO.

VOMAR

Manufacturers of
RADIO, ELECTRICAL AND
ELECTRONIC COMPONENTS

ELECTRONIC PRODUCTS MFG. CORP.
DEXTER, MICHIGAN



***Old Man Centralab**
"Old Man" is right
... for he is a real
"old timer". There
is no substitute for
experience, and
the "Old Man"
now, as in the past
twenty-two years,
is still your best bet.

Still your
best bet for
replacements

Centralab
VOLUME CONTROLS

Centralab

Division of GLOBE-UNION INC., Milwaukee

Ansley Gives His Views On Retailer's Problems

"Without a doubt the radio dealer's worst problem has always been the difficulty of making a legitimate mark-up on his sales . . . a mark-up that would enable him to realize a fair return for his work and his investment," declares Arthur C. Ansley, president of the Ansley Radio Corp., Long Island City, N. Y.

"The blame for this situation rests largely with the manufacturer whose hunger for more and more volume has led them to sell their products without restraint to any gas station, garage, discount house or hole-in-the-wall store that would give them an order. These outlets, without normal retail overhead and with their sales made for them in legitimate dealer's showrooms and by manufacturers' mass advertising, have been able to sell at discounts that would be ruinous to a legitimate store," says Mr. Ansley.

Protests Price Cutting

"The manufacturers' practice of dumping left over sets at the end of each season at prices way below cost, has made matters even worse," the statement points out.

According to Mr. Ansley, "The dealer's only answer to this situation is to feature, as his major line, the products of a manufacturer who operates under a policy of exclusive franchises or some similar type of restricted distribution. To be sure, such a line may sometimes require more salesmanship on the dealer's part, but when a sale is made, the dealer can be pretty sure it is a sale for him and not for the discount house around the corner.

"The values offered by these restricted lines are certainly as good and often better than those of other manufacturers, and the fair price for which they can be sold enables the dealer to give his customers the kind of service that will keep them satisfied and will result in the word-of-mouth advertising that is the soundest basis for a permanent business."

Electronic Labs Expands Line for the Postwar

Electronic Laboratories, Inc., Indianapolis, Ind., manufacturers of light and heavy-duty vibrators and vibrator power supplies has broadened its scope of application. Its inverters and power supplies are now available for the operation of practically every electrical device, and permit the operation of refrigerators and other commercial appliances from non-standard current.

New Motorola Booklet

A beautiful four-color booklet has just been issued by the Galvin Manufacturing Corp., Chicago, entitled "When Motorola Radio Comes Home from War." The bulletin details the role the Motorola Radio distributor will play in the post-war radio market, and the varied types of helpful services he will offer his dealers. Much useful information for radio merchants as to sales and promotion assists are included.

Postwar Planning at Magnavox Factory



Officials and district sales managers of the radio-phonograph division in meeting at The Magnavox Company's plant at Fort Wayne, Ind.: Front Row: O. A. Fiebig, sales department; R. D. Betikofer, Detroit district manager; Frank Freimann, executive vice-president; G. H. Smith, sales manager; J. B. Sharpless, Milwaukee district manager; and V. E. Olson, Buffalo district manager.

Back Row: V. J. Sanborn, Cleveland district manager; L. H. Bushnell, San Francisco district manager; D. F. Doyle, Boston district manager; Chief Warrant Officer Mel Collier, department manager of the Chas. E. Wells Music Company, Denver, Colorado, before entering service; E. P. Bliss, Jr., Philadelphia district manager, R. V. Newbell, advertising manager; J. F. Wirtz, New York City district manager; H. R. Zenker, Los Angeles district manager, and R. E. Cederoth, Kansas City district manager.

Universal Outlines Aims of Postwar Sales Policy

Continuing its policy of keeping its sales personnel tuned to changing events, Landers, Frary & Clark held a five day postwar sales conference at its New Britain, Conn., plants for a review of the wartime period and a preview of postwar models, sales promotion, advertising, etc.

Declaring that aggressive selling would be necessary to insure full employment postwar, A. E. Allen, chairman of the board, opened the five day meeting. R. L. White, president, spoke of the company's general policies. B. C. Neece, vice-president and general sales manager, outlined the future aims and plans of the company. W. J. Cashman, director of promotion and publicity, presented Universal's marketing and advertising plans. H. M. Parsons, vice-president in charge of major appliances, and E. J. Van Buskirk, vice-president in charge of small appliances and housewares, also spoke.

Several days were devoted to a series of clinics on Universal's engineering and designing plans for major and small appliances conducted by W. J. Russell, vice-president in charge of engineering, assisted by H. E. Motz. Leo A. Brown, vice-president in charge of production, continued the meetings with a resume of the changes in manufacturing to meet postwar competition. Marguerette Reinhart, director of Universal's laboratory for modern living, pictured the laboratory's function in the postwar era.

E. L. Farquharson, sales manager of the home laundry division, and Lee Moss, sales manager of the home cleaning division, closed the meetings with a series of conferences on major appliance merchandising policies.

War Bond Sales Boosted

An employee of Lear, Inc., Dale Westfall, suggested the idea of getting the Sixth War Loan off to a flying start in Piqua, O. A Civil Air Patrol plane "bombed" the city with 30,000 leaflets urging the purchase of War Bonds, ten of which were marked for a \$25 War Bond prize for the lucky finders.

With Belden Thirty Years

Whipple Jacobs, president of the Belden Manufacturing Co., Chicago, celebrated his thirtieth anniversary with the organization on November 5. Mr. Jacobs joined the company shortly after his graduation from high school.

NOW AVAILABLE —

NEW CATALOG, DESCRIBING THE COMPLETE LINE OF
Electro-Voice

**COMMUNICATIONS
MICROPHONES**

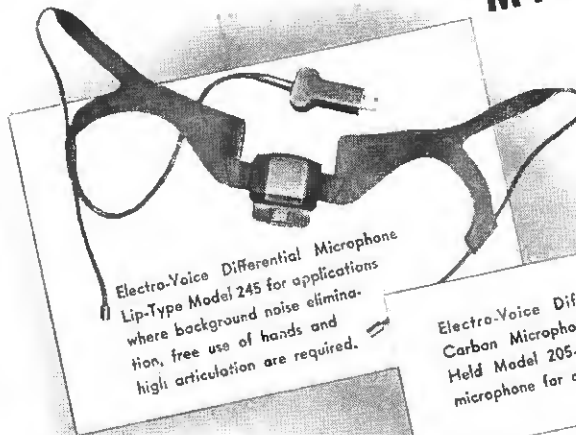

Electro-Voice Differential Microphone Lip-Type Model 245 for applications where background noise elimination, free use of hands and high articulation are required.

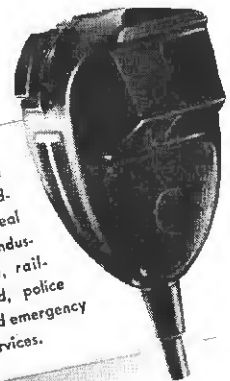

Electro-Voice Differential Carbon Microphone, Hand-Held Model 205-S, an ideal microphone for aircraft, industrial, railroad, police and emergency services.

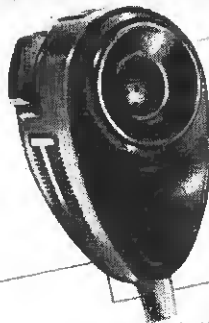

Electro-Voice Carbon Microphone, Model 210-S, a single button microphone which embodies all of the latest developments required for military use.

Electro-Voice Dynamic Microphone, Hand-Held Model 600-D, designed for high fidelity speech pick-up in those locations where the ambient noise does not exceed 100 db.

ELECTRO-VOICE CORPORATION
1239 South Bend Ave., South Bend 24, Ind., Dep RR12
Please send us your new "Electro-Voice Communications Microphones Catalog."

NAME OF COMPANY _____
ADDRESS _____
CITY _____ STATE _____
ATTENTION OF _____

Electro-Voice MICROPHONES

ELECTRO-VOICE CORPORATION • 1239 SOUTH BEND AVENUE • SOUTH BEND 24, INDIANA
Export Division: 15 East 40th Street, New York 16, N. Y., U. S. A. Cables: Avlab

ESICO

U.S. PAT. OFF.

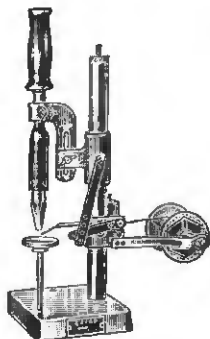

SPOT SOLDERING MACHINE
designed for treadle operation for advancement of iron and solder, leaving operator's hands free for handling of product.



SOLDERING IRONS

are widely used in industrial plants throughout the country. They are designed to withstand the strain of continuous service required of factory tools.

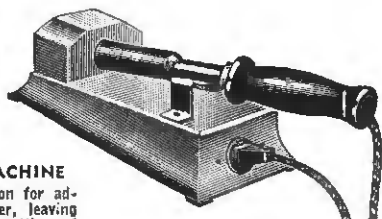

SOLDERING IRON TEMPERATURE CONTROLS

prevent overheating of soldering irons between soldering operations. Irons do not deteriorate when being used. The idle period causes oxidation and shortens life.

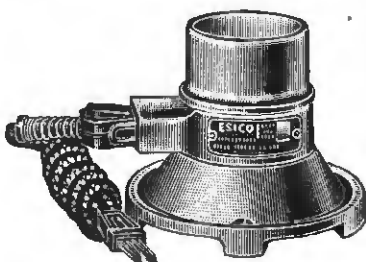

SOLDER POTS

ruggedly constructed pots of various sizes designed for continuous operation and so constructed that they are easily and quickly serviced, should elements have to be replaced.

Write for Catalog

ELECTRIC SOLDERING IRON CO., INC.

2344 WEST ELM STREET, DEEP RIVER, CONN.

SALES ENGINEER FOR TUBES

Eastern division of national electronic manufacturing company has position for sales engineer familiar with use of tubes in various types of electronic apparatus. Man should have merchandising and engineering background, knowledge of industry, and executive ability. He must be able to talk to technicians in factories, work with people and supervise a small staff of salesmen. Good salary and bonus. Write for full details to: Dept. 2T, Box 429, Grand Central Annex, New York 17, N. Y.

Attention Radio Manufacturers!

Manufacturers' agent wants for postwar sales, a popular-priced, trouble-free, modernly-designed, portable radio set with a snappy name that can be merchandised in volume through existing jobbers and dealers. One model—one style—one color—one price, to satisfy the great Northern California market for a "second radio" for the bedroom, kitchen, den, playroom—also apartments, rooming houses, hotel, summer cottages, etc.

Russell & Co. Western Merchandise Mart
SAN FRANCISCO 3, CALIFORNIA

Radiart

Wishes You A



Latest WPB Information is . . . no permission to make auto antennas until Germany surrenders.

Radiart Corporation

3571 W. 62ND ST.

CLEVELAND 2, OHIO

IMMEDIATE DELIVERY FROM STOCK

SPRAGUE - CORNELL DUBILIER AEROVOX CONDENSERS



10 mfd 450v Tubular	50¢
16 mfd 450v Tubular	65¢
20 mfd 450v Tubular	70¢
20 mfd 150v Tubular	44¢
30 mfd 150v Tubular	47¢
40 mfd 150v Tubular	50¢
20-20 mfd 150v Tubular	76¢
40-20 mfd 150v Tubular	82¢
30-30 mfd 150v Tubular	79¢
50-30 mfd 150v Tubular	94¢
10 mfd 50v Tubular	32¢
25 mfd 25v Tubular	35¢

TURNER MICROPHONES

Model	Type	Cord	List	Your Cost
BX	Crystal	7'	\$9.95	\$5.85
22X	Crystal	7'	18.50	10.88
33X	Crystal	20'	22.50	13.23
BD	Dynamic	7'	14.50	8.53
33D	Dynam.	20'	23.50	13.82



PM SPEAKERS

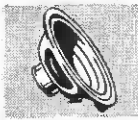

4" Square	\$1.25
5" Round	1.25
6" Round 3.6 oz.	2.10
10" Round 20 oz.	7.20
12" Round 11 oz.	5.19
12" Round 20 oz.	7.33

20% deposit required on all C. O. D. orders. Orders of \$25.00 or more accompanied by payment in full, will be shipped prepaid. DON'T FORGET L-265 or AA-3 certificate.

RADIO SUPPLY & ENGINEERING CO., Inc.
128 SELDEN AVE. DETROIT 1, MICH.

Ken-Rad President Visits Reporter



Phil Hanna, Chicago Daily News reporter, made a trip to Owensboro, Ky., to do a feature article on the outstanding production job being done by the Ken-Rad Tube and Lamp Corp. He ended up in local hospital with a secondary foot infection and Roy Burlew (left), president of Ken-Rad, went to Hanna's bedside in order that the latter could get his story.

Emerson Makes Job Survey

More than 5,900 civilian jobs are waiting for radio technicians now in the Army Signal Corps and Naval Communications, according to a survey of radio dealers made by Emerson Radio and Phonograph Corp., New York. Preliminary results of the survey were based on estimates received from more than 1,300 retailers throughout the country.

Exclusive Territory for Estate Stove Dealers

The first annual convention of the Estate Stove Co., Hamilton, Ohio, wholesale distributors meeting held in Cincinnati, was marked by enthusiasm over the prospects for postwar sales of Estate Heatrola cooking and heating appliances, tempered by a realistic attitude toward present wartime conditions. David F. Kahn, Estate president, expressed the management's enthusiasm for the policy whereby all sales of Estate products will be handled through wholesale distributors on an exclusive territorial basis.

Named Division Manager

Gregory L. Rees has been appointed range and water heater sales division manager, Edison General Electric Appliance Company, according to Ward R. Schafer, general sales manager. Rees has been with the company since 1935 as development engineer and special sales representative on ranges and water heaters.

Prosecute Black Market

Daniel P. Woolley, New York regional OPA administrator, announced that ten criminal informations containing forty-four counts have been filed by the U. S. attorney, John F. X. McGohey, against firms dealing in radios, electric phonograph sets and radio-phonograph combinations. "This is another step taken by the N. Y. office," said Mr. Woolley, "to crush black market practices in the radio industry."

Universal "Mike" Active

Universal Microphone Co., Inglewood, Cal., has distributed a Christmas envelope to its parts jobbers calling attention to its Stroboscope for jobber distribution during the holiday season. Albert D. Leban, of Philadelphia, has been reappointed factory representative for Universal in that area, a position he held previous to Pearl Harbor.

Ne-O-Lite Display Card

A new display card holding 20 Ne-O-Lite units, list price \$20, has been issued by the General Cement Mfg. Co., 919 Taylor Ave., Rockford, Ill. It is ideal for counter display.



Sound equipment promises to go "like hot cakes" in the postwar markets! Business, Industry, Government—all have learned from wartime experience how modern sound aids can speed up operations, save manpower, reduce errors, boost productivity, and cut costs. And they'll be even more "sold" on sound when they can be told about the new developments and applications resulting from wartime needs and experiences. You can stack up more prospects in this vastly expanding market by offering BELL Sound Systems. The complete BELL line gives you the right answer to an unusually wide range of needs, as suggested by the list at right. So get ready now to handle this business "hot off the griddle" as soon as possible after the wartime lid is off—write today for complete details on BELL Sound Systems!

Bell Sound Equipment Includes

- Electronic Sound Devices
- Intercommunicating Systems
- Industrial Voice-Paging and Broadcasting Equipment
- Permanent and Portable Amplifying Systems
- Recording and Disc-Playing Units
- Electronic Controls
- Operating Sequence Recorders
- Other Electronic Devices

BELL SOUND SYSTEMS, INC.

1186 Essex Ave.

Export Office: 4900 Euclid Ave.

Columbus 3, Ohio

Cleveland 3, Ohio



FOR **SPEEDY**
ACCURATE
ALIGNMENT

**Test
Oscillator**



SUPREME MODEL 571

- Simple Operation — all ranges read on two basic scales.
- Dual Tuning Ratio. One for speed—one for vernier adjustments.
- Electron coupled circuit giving greatest stability. Iron core coils.
- Ladder Attenuator.
- Double shielding minimizes leakage.
- Golden Oak carrying case.

SPECIFICATIONS

R.F. RANGES:
65-205 KC; 205-650 KC;
650-2050 KC; 2050-6500 KC;
6.5-20.5 MC, Harmonics to
82 Megacycles.

AUDIO FREQUENCY:
400 cycles available for external
testing.

INTERNAL MODULATION:
R.F. Carrier modulated at approxi-
mately 30% and 70% at 400 cycles.
Modulation level selected by toggle
switch.

EXTERNAL MODULATION:
Jack provided for external audio
modulation.

ACCURACY:
1/2 of 1% on first three bands, 1%
on last two bands.

SIZE:
9-1/2"x8-11/16"x7-3/8"

POWER SUPPLY:
115 volts 60 cycles—Special volt-
age and frequency on request.

SUPREME

SUPREME INSTRUMENTS CORP.
Greenwood, Miss., U. S. A.

NEWA Plans April Meet at Stevens in Chicago

Charles G. Pyle, managing director of the National Electrical Wholesalers Assn., 500 Fifth Ave., New York, announces that the 37th annual convention of the group is planned for the week of April 22, 1945, at The Stevens, Chicago.

Mr. Pyle announces at the same time that the convention will be held only if it appears to be advisable according to the situation at that time with regard to transportation facilities.

Berliant Named by Concord Radio Corp.

The appointment of Ed Berliant as manager of the Atlanta branch of the Concord Radio Corp. of Chicago and Atlanta, formerly the Lafayette Radio Corp., is announced by the corporation.

Irvine Plans on Rapid Conversion for Galvin

Stressing the fact that the enlarged engineering and production facilities of the Galvin Manufacturing Corp. will require a minimum of conversion from war to peace, Victor A. Irvine, advertising and sales promotion manager, stated, "The new thinking which comes out of Washington indicates that civilian production of radios will very likely get under way soon after the war in Europe is ended. It is time therefore that we tell the American public, our distributors and their thousands of dealer customers that Motorola Radio will be ready with new and improved models for home and car."

Mr. Irvine continued, "Our first lines will include FM and AM table models, consoles and automatic phonographs, AC-DC battery portables, and a thrilling Motorola 'Playboy'—the smallest, mightiest little personal portable on the market when war shut down our production. We could never keep up with the demand for this set and we anticipate a tremendous increase in its popularity."

He concluded that, "it will be offered also as a three-way set . . . battery-operated and AC-DC. We will have battery-operated models for farm areas . . . and we'll have surprising new Motorola car radio models. . . ."

Westinghouse Man Explains Selling Aid

In a talk before the Association of National Advertisers, N. Y., R. H. Bolin, manager, appliance advertising and sales promotion of the Westinghouse Electric and Manufacturing Co., Mansfield, Ohio, demonstrated the company's basic plans for carrying product promotion through to the retail salesman. "The sales training program which the distributor uses to train dealers and their salesmen," he said, "is built to teach the retail man how best to present that sales story, also to give him a complete background knowledge of the product."

JUST OUT

NEW FLAT RATE RADIO SERVICE SCHEDULES

for

\$2.50 and \$3.00 per hour

These contain 234 different rates in alphabetical order, 160 cross references, 372 rate quotations, 236 new time ratings, 215 reminders about other charges that might otherwise be overlooked, and 352 detailed instructions.

Also

ENLARGED TUBE SECTION

Contains 1095 substitutions, 3500 socket connection notations, 190 instructions, and 390 references. Data is with each tube.

These two new books are \$1.00 each.

ALSO AVAILABLE

Flat Rate Books without the enlarged tube section based on the following rates per hour for labor.

\$1.00	\$1.75	\$2.50	\$3.25
\$1.25	\$2.00	\$2.75	\$3.50
\$1.50	\$2.25	\$3.00	

These books are 35c each or 3 for \$1.00.

Order from your jobber or us.

RADIO EQUIPMENT CO.

1415 W. FRANKLIN AVE.
MINNEAPOLIS 5, MINN.



WIRES

MADE BY

Engineers FOR
Engineers

VICTORY

concentrating upon
for the duration

cornish

WIRE COMPANY, INC.

15 Park Row, New York City, New York



ELECTRICITY

For Any Job — Anywhere

★ ONAN ELECTRIC GENERATING PLANTS supply reliable, economical electric service for electronics applications, and for scores of general uses.

Driven by Onan-built, 4-cycle gasoline engines, these power plants are of single unit, compact design and sturdy construction. Suitable for mobile, stationary or emergency service, intermittent or continuous.



Models range from 350 to 35,000 watts. A.C. types from 115 to 660 volts; 50, 60, 180 cycles, single or three-phase; 400, 500 and 800 cycle, single phase; also special frequencies. D.C. types range from 6 to 4000 volts. Dual voltage types available. Write for engineering assistance or detailed literature.

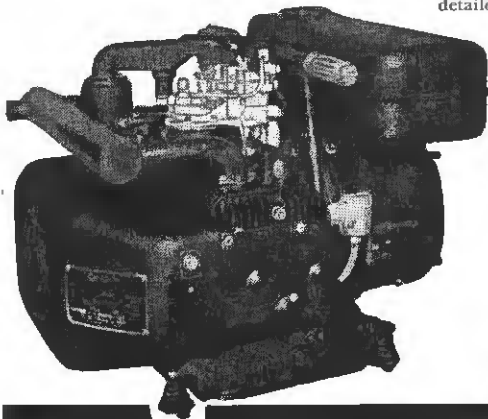

★

Plant shown is from lightweight OTC series; 1500 and 2000 watts, 115-volt, 60-cycle, A.C. and 2000 watts, 115-volt D.C.; Engine is 2-cylinder, 4-cycle, air-cooled.

D. W. ONAN & SONS 2026 Royalston Ave., Minneapolis 5, Minn.

THIS Master Plan

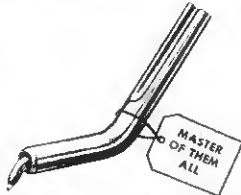

MEANS BIGGER NEEDLE PROFITS

The Master Plan was developed to make Fidelity's Master the best merchandised needle in the country.

Each FM needle is packaged in an attractive and useful record brush... beautiful counter cabinets add prestige at the same time they display and sell... colorful literature for the counter, booth and mails show FM superiority... eye-catching streamers for windows and booths build sales... magazine advertising tells readers about this revolutionary new needle... and a tested co-operative newspaper advertising campaign directs the customers to your store. Get in touch with your Fidelity Distributor now and ask him about the big profitable introductory Fidelity Master Deal.



MASTER SALESMEN
Above: Beautiful FM counter display cabinet. Below: The attractive FM record brush package. Both make sales.



PERMO, Incorporated, Chicago 26, Illinois



GIVES YOU ALL THESE ADVANTAGES:

FINER REPRODUCTION of your favorite records...
LONGER NEEDLE LIFE: Thousands of plays without changing...

INCREASED KINDNESS TO RECORDS... due to:
GREATER FLEXIBILITY which allows free movement of the Permium* needle tip in both vertical and horizontal directions.

FLOATING POINT CONSTRUCTION, an exclusive Fidelity feature...

FILTERS RECORD SCRATCH; Gives more pleasing reproduction.

SELF-LOCKING FEATURE: Exclusive patented principle locks needle in tone arm securely.

* U. S. PAT. REG.

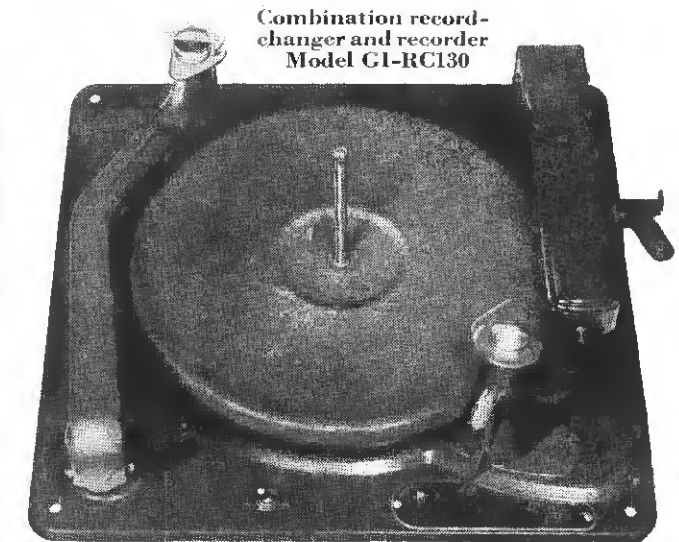

Smooth Power

FOR POSTWAR PRODUCTS

You can get to your profitable postwar markets earlier if you'll discuss with us now your general requirements for recorders, record-changers and turntables.

Driven by our velvety-running Smooth Power motors, these General Industries units can be depended upon for that quick pickup and unvarying speed which are so essential to accurate recording and faithful reproduction. They're designed and built for long-time performance.

If your specific needs cannot be met from our wide line of standard units, our engineers will make adaptations to fit your requirements. We'll be glad to work with you now, so as to speed deliveries when our war commitments have been met.



THE GENERAL INDUSTRIES COMPANY
DEPT. M ELYRIA, OHIO



Stabilized COMPOSITION ELEMENT CONTROLS

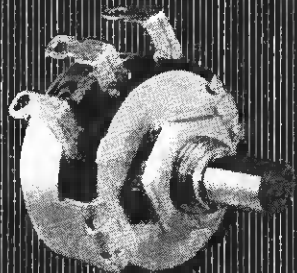

★ Results speak. Servicemen and maintenance workers have promptly spotted something definitely better in non-wire potentiometers and rheostats when using the present Clarostat midget composition-element controls.

The *stabilized* element sets new performance standards. Extreme immunity to humidity, temperature and other climatic variations. Split-finger contact rides smoothly over glass-like surface of resistance element. Positive contact. Minimum wear due to self-lubricated element. Rated at 1 watt. Resistance values of 500 ohms to 5 megohms.



★ Consult Our Jobber . . .

Let him help you with your wartime replacement problems. Ask for latest catalog. Or write us direct.



CLAROSTAT MFG. CO., Inc. - 285-7 N. 6th St., Brooklyn, N. Y.

Lear Promises All-New Set for After the War

Lear, Inc., formerly Lear Avia, will enter the home radio field after the war with an all-new set that will offer many desirable features. A new advertising campaign has been launched serving notice that Lear radio equipment, which has been building an enviable reputation in aircraft and other fields, will be available in home type sets after military needs are concluded.

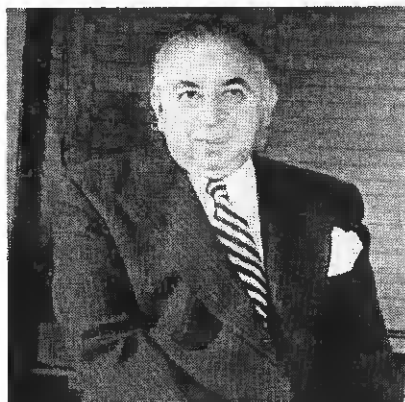

Merchandiser Nate Hast

Fifteen years of experience in the technical field of aircraft radio will stand behind the New Lear line of home radios, which will include portable, table, console, and other style sets, fully equipped with FM, television and other new features.

Nate Hast, newly-appointed merchandising manager, is organizing the Lear sales staff, and drawing plans for the distribution of the new postwar line.

Service Trade Pointers

Leonard C. Truesdell, general sales manager, who will direct marketing of the home radio line to be introduced by the radio division of Bendix Aviation Corp., outlined a four-point program to prepare the nation's radio service business for the strongly competitive postwar situation it will face in common with the radio manufacturing industry.

Speaking at a meeting of the Philadelphia Radio Service Men's Assn., Truesdell recommended starting now to assemble the modern facilities, equipment and personnel needed to keep pace with newest developments; absorbing into the service industry highly trained ex-servicemen; and selling the radio service industry's technical knowledge and services by sound advertising in convenient, attractive places.

Kelvinator Goes on Air

As part of the preparation of Nash-Kelvinator for reconversion to production of Nash motor cars and Kelvinator electric refrigerators, the Nash-Kelvinator Corp. has contracted for the 4:30-5:00 p.m. EWT period Sunday evenings over 190 Blue Network stations. The new show will feature the Andrews Sisters.

El-Menco MOLDED MICA CAPACITORS



IMMEDIATE DELIVERY

ALL SIGNAL CORP. ORDERS BEARING INSPECTION AT SOURCE; INSPECTED ON PREMISES & SHIPPED IMMEDIATELY

All R.M.A. or A.S.A. color coded

A complete stock is ready for immediate shipment of quantities, ranging from 500 to 5,000 of each capacity in regular MICA CAPACITORS in 5%, 10% and 20% tolerance and silvered MICA CAPACITORS in 2%, 5% and 10% tolerances.

Write for price sheets and complete information

Territory open for **JOBBERs**

SEND FOR OUR SPECIAL INITIAL ORDER OFFER



ALBERT ROTHENSTEIN
National Distributor
135 LIBERTY ST. New York 6, N.Y.

OLSON SPECIAL!

The one and only **ELECTRIC SOLDERING IRON**

with all these features priced so low!



Only

\$2.95

Complete With 3 Tips

- ★ LIGHT WEIGHT
- ★ HEATS IN 2 MINUTES
- ★ 3 INTERCHANGEABLE TIPS
- ★ BULB CAN BE INSERTED TO USE AS TROUBLE LIGHT

This Electric Soldering Iron weighs only 3.6 ounces . . . handles easy as a pencil . . . yet it's ruggedly constructed, built to take plenty of punishment. At our low price of \$2.95 you get the Iron, cord, and three removable tips of different sizes. Cork-insulated handle. Overall length, 7 inches. Heats quickly, but draws only 17 watts. A precision tool every technician needs. Immediate delivery!

MAIL THIS ORDER TODAY!



Radio Warehouse

73-C MILL ST., AKRON 8, OHIO

Please send me _____ Electric Soldering Irons with 3 tips at \$2.95 per set. (Add 15c postage.) Total, \$ _____

I enclose check money order.

AA-3-V3

NAME _____

ADDRESS _____

Belgian Radio Shop



Darrell Barte, who was managing editor of this magazine at the time he enlisted in the U. S. Signal Corps, took this picture in a Belgian town. "Depannage" means "repairs." "De Toutes Marques" translates into "all makes", and "A Domicile 20 F", is an offer to repair sets in the home for 20 francs (approximately 46 cents).

Firms Honored With Production "E" Awards

The employees of the Belmont Radio Corp., Chicago, Ill., have won their fifth Army-Navy Production Award. This makes Belmont one of the first of the nation's radio plants to fly the "E" flag with four stars added.

The General Industries Co., Elyria, Ohio, adds the White Star to its Army-Navy Production Award flag, for winning for the second time the award for meritorious services on the production front.

The Amperex Electronic Corp., Brooklyn, N. Y., received for the third time the Army-Navy "E" award for meritorious production, and adds a second white star to the original "E" flag.

The Hallicrafters Co., Chicago, announced that it has received its fifth Army-Navy "E" award, the first exclusive short-wave radio manufacturer to be so honored. The award entitles the company to add a fourth white star to its "E" flag.

Two New Appointments

The newly created radio receiver division of the Westinghouse Electric and Manufacturing Co., has received two additional officials, Harold B. Donley, manager of the division announced. Georges Faurie, formerly with the Delco appliance division of General Motors, has been named manager of advertising and sales promotion, and J. N. Van Deman, was appointed manager of the middle Atlantic district. He will make his headquarters in Philadelphia.

Stellner and Wavering, Appointed by Motorola

Paul V. Galvin, president of Galvin Manufacturing Corp., has announced the appointment of Walter H. Stellner as vice-president in charge of the new home products division. Elmer H. Wavering is to be vice-president in charge of the new automotive division. Stellner was appointed advertising manager for the home radio division in 1937, and Wavering joined Motorola as an engineer in 1930.

Proctor Publicity Head

Mary R. Riedel, service consultant and acting manager in the New York office of the Proctor Electric Co., has been appointed by Robert M. Oliver, vice-president and general sales manager, to establish and direct a new Proctor information center to handle publicity for the company. Headquarters for the information center will be at 480 Lexington Ave., New York 17, N. Y.

Wisconsin Radio Laws

A new section has been added to the ordinance providing for licensing of radio and electronic servicemen at Madison, Wis. Examinations, how to obtain licenses, fees, renewals and revocations of licenses, supervision by an electrical inspector, and the acquiring of permits for loudspeaker and television installations are included. The previous ordinance was repealed, and changed to include electronic servicemen.

Admiral's Postwar Plans Stressed at Conference

The Admiral Corporation held a distributors conference in Chicago to discuss Admiral's postwar plans and the sale of its peacetime products. Ross D. Siragusa, president, gave the opening address, and stressed the importance of knowing at all times what the public wants, and what it will buy. Maurice S. Despres, president of the Dale Distributing Co., New York, discussed several dealer plans, and the opportunities ahead for the Admiral distributor.

Other Speakers

E. S. Brinsley of the Universal C. I. T. Credit Corp. spoke of financing plans designed to help the distributor get the Admiral products into the dealer's store, and then to the purchaser. The advertising and publicity director of Admiral, Seymour Mintz, gave an illustrated talk on the dealer contacts and advertising assists rendered by his department.

L. H. D. Baker, vice-president in charge of major appliances, discussed Admiral's appliance program in regard to refrigerators, home freezers, electric ranges, and the recent purchase of the entire appliance division of Stewart-Warner Corp. R. A. Graver, vice-president and general sales manager spoke on problems of conversion, the postwar line and potential market, and the special features of the new Admiral television-radio-phonograph combination.

DEPENDABLE MUTER PRODUCTS * DEPENDABLE MUTER PRODUCTS

DEPENDABLE **MUTER** PRODUCTS

Manufacturers
of Component parts for
the Radio, Electronic
and Communications
Industries

THE MOTOR CO.
1255 South Michigan Avenue
Chicago, U. S. A.

MUTER PRODUCTS * DEPENDABLE

DEPENDABLE MUTER PRODUCTS * DEPENDABLE

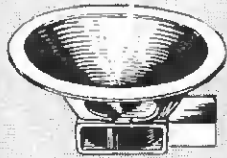

the excellence of your post-war radio engineering

will be faithfully interpreted for your customers by a **QUAM** Speaker

QUAM-NICHOLS CO. 33rd PLACE AT COTTAGE GROVE, CHICAGO

War Bond Prize Awards Increased by Sylvania

December 26 is the closing date in Sylvania's War Bond window display contest; 580 prizes will be awarded to retail radio and service outlets to promote the Sixth War Loan. The bond prizes total \$10,500.

In addition to the prizes offered dealers, Sylvania announces a separate contest for jobbers. Jobbers' salesmen, either by mail or telephone, must "talk up" the window display contest to ten or more of their customers and induce them to participate. Care must be taken that the winning contestant (one of the first five winners) names the jobber who was most helpful in preparing his prize winning display. To each jobber mentioned by the first five retail prize winners will go a \$100 War Bond, awarded by Sylvania Electric Products Inc.

Little Time Remains

There is also a series of prizes for the best jobber windows, stressing the Sixth War Loan drive. First prize, \$250 War Bonds; second, \$100, and third, fourth and fifth are \$50 each.

All photos of windows should be sent to the Sixth War Bond Display Contest, care *Display World*, Cincinnati 1, Ohio. Entries must be postmarked no later than midnight, December 26.

Proctor Official Urges Standard Brand Purchase

Robert M. Oliver, vice-president and general sales manager of the Proctor Electric Co., makers of the "Neverlift" Iron, has urged consumers to "stick to reliable, familiar and nationally advertised products." He urged those who wish to buy reliable brand products now that they need not fear early obsolescence due to introduction of postwar models. He stressed the fact that the new models will become available gradually, and that "a war model made by a reliable manufacturer will be as good, perhaps better, than its pre-war predecessor."

Chicago Reps Elect Irvin Aaron President

At a meeting of the Representatives held at Chicago during the Electronic Parts and Equipment Conference, Irvin I. Aaron, 4028 North 16th St., Milwaukee 9, Wis., was elected president. He succeeds S. K. Macdonald of Philadelphia, who now becomes chairman of the Reps board of governors.

A new committee of the Reps has been assigned to industry relations, with Robert Breuer, 1674 Broadway, New York City, as chairman. Other members of the committee will represent principal geographical areas of the country, each member being an outstanding representative. From time to time the Committee will meet with the other important divisions of the radio parts industry to work for the common interests of better radio distribution.

INDEX To Advertisers

	Page
Aerovox Corp.	58
Alliance Mfg. Co.	90
Astatic Corp.	99
Automatic Radio Mfg. Co., Inc.	65
Bell Sound Systems, Inc.	103
Bendix Radio Div., Bendix Aviation Corp.	50, 51
Burgess Battery Co.	98
Centralab	100
City Radio Co.	96
Clarostat Mfg. Co., Inc.	106
Cornish Wire Co., Inc.	104
Crosley Corp.	61
Delco Radio Div., General Motors.	63
Detroit Radio Div., International Detroit Co.	73
Dumont Electric Co.	99
DuMont Laboratories, Inc., Allen B.	69
Electric Soldering Iron Co., Inc.	102
Electronic Products Mfg. Corp.	100
Electro-Voice Corp.	101
Emerson Radio & Phonograph Corp.	43
Fada Radio & Electric Co., Inc.	11
Farnsworth Television & Radio Corp.	6
Freed Radio Corp.	5
Garod Radio Corp.	1
General Electric Co.	91
General Industries Co.	105
General Instrument Corp.	14
Hallcrafters Co.	77
Hamilton Radio Corp.	49
Hammarlund Mfg. Co., Inc.	81
Hickok Electrical Instrument Co.	94
Howard Radio Co.	9
Hytron Corp.	64
Jackson Electrical Instrument Co.	86
Jensen Radio Mfg. Co.	75
Ken-Rad Tube & Lamp Corp.	92
Lear, Inc.	74
Maguire Industries, Inc., Electronics Div.	95
Majestic Radio & Television Corp.	89
Mallory & Co., Inc., P. R.	Cover 2
Meek Industries, John	44, 45
Meissner Mfg. Co.	85
Merit Coil & Transformer Corp.	4
Monarch Mfg. Co.	97
Muter Co.	107
National Union Radio Corp.	60
Nohlitt-Sparks Industries, Inc.	79
Olson Radio Warehouse	106
Onan & Sons, D. W.	105
Permo, Inc.	105
Philco Corp.	12, 13
Philharmonic Radio Corp.	87
Quam-Nichols Co.	108
Radiart Corp.	102
Radio City Products	82
Radio Corp. of America:	
RCA Victor Division.	53, 54, 55, 56
Radio Equipment Co.	104
Radio Supply & Engineering Co., Inc.	102
Rauland Corp.	97
Raytheon Mfg. Co.	7
Rider Publisher, Inc., John F.	96
Rola Co., Inc.	46
Rotheustein, Albert	106
Russell & Co.	102
Seeburg Corp., J. P.	Cover 3
Sentinel Radio Corp.	17
Sonora Radio & Television Corp.	15
Sprague Products Co.	18
Standard Transformer Corp.	98
Stewart Warner Corp.	19
Stromberg-Carlson Co.	20
Supreme Instruments Corp.	104
Sylvania Electric Products, Inc.	10
Talk-A-Phone Mfg. Co.	90
Templeton Radio Mfg. Corp.	67
Thordarson Electric Mfg. Co.	16
Trav-Ler Karenola Radio & Television Corp.	47
Universal Microphone Co.	8
Utah Radio Products Co.	Cover 4
Ward Products Corp.	83
Waters Conley Co.	59
Webster Electric Co.	93
Westinghouse Electric & Mfg. Co.	2, 3
Wileox-Gay Corp.	41

While every precaution is taken to insure accuracy, we cannot guarantee against the possibility of an occasional change or omission in the preparation of this index.



*The biggest gift that
Santa can deliver... soon!*

J. P. *Seeburg* Corporation

CHICAGO



where brain-children grow up

• Ideas become realities in the model shop of the Utah laboratory. Here is built *the first* of every product made by Utah. This model is thoroughly tested for design and construction. Thus, when the product reaches the production line, it is free from "bugs" and is ready for long, trouble-free service. The majority of the "brain-children" now growing up in Utah's model shop go to war. But these "war-babies" will be just as important tomorrow. With the postwar transition, they will have a deep effect on radio and electronic developments for commercial and consumer needs.

★ ★ ★

Every product made for the trade, by
Utah, is thoroughly tested and approved



Keyed to "tomorrow's" demands: Utah wirewound controls, switches, plugs, jacks, vitreous enamel resistors, transformers, vibrators, speakers.



Utah



UTAH RADIO PRODUCTS COMPANY
810 Orleans Street, Chicago 10, Illinois