

Troubleshooter . . . Mrs. Courtney, Wartime Radio Servicer —  
Releases Man for War Work



SEPTEMBER 1945

# RADIO *Retailing* TODAY

In This Issue ★ RADIO-ELECTRONIC MAINTENANCE—WITH FOUR-COLOR CHART  
Fall Selling, Records, Appliances





# Give Scrap Wisely

## for War Production

**G**ive your scrap metal to help make guns, tanks and planes. Or sell it . . . don't hold old material when it can aid the War effort.

Give—but give wisely. Salvage usable parts—nuts, lock washers, screws, solder lugs, etc. Parts like these are fabricated by automatic screw machines and punch presses and their output is needed for essential War production. Don't discard parts which must be repurchased in the near future.

Your good common sense will tell you what to scrap and what to save. But act now! Don't hold on to an old receiver simply because it has some parts that you may use some day. Salvage the parts which may be used for replacements—and give the rest for scrap.

That will be three-way help for the War effort—salvaging usable parts to “keep 'em listening”, relieving busy machines, and providing scrap to keep War production in high.

*Do your part! Get busy today.*

**P. R. MALLORY & CO., Inc.**  
**INDIANAPOLIS • INDIANA**

**P. R. MALLORY & CO., Inc.**  
**MALLORY**



**Approved Precision Products**

Collier's for August 7, 1943

WIN  
TALK



27

MILLION

Messages to America

FROM

Admiral

## AMERICA'S SMART SET

During the past ten months, the pages of Collier's Magazine have brought over 27 million messages to America from Admiral Radio. Every fourth week you'll find a timely advertisement by Admiral . . . right opposite "Wing Talk," one of the most popular features of Collier's.

. . . And every Sunday at 2:30 P.M., EWT, Admiral broadcasts "World

News Today" over the Columbia Broadcasting System. 42 stations bring this popular news program with its direct short-wave reports from overseas to over 3½ million Americans.

*Before the war . . .* Admiral was generally recognized as the fastest growing, up-and-coming radio company in the industry. *After the war . . .* with the added backing of hundreds of thousands of dollars invested in national advertising . . . *Admiral is determined to make a bid for leadership in the radio industry.* Your Admiral dealer franchise is going to be more valuable than ever before.

Today  
the  
ap  
gu  
as  
la

of war. Any wonder Admiral is proud to  
Continental Radio & Television Corporation, Chicago, U. S. A.

Admiral

Tune in CBS, 2:30 P.M. EWT, Sundays, for Admiral "World News Today."

RADIO  
AMERICA'S SMART SET

Continental Radio & Television Corp.  
3800 W. Cortland St., Chicago, U.S.A.

# THE BLUE NETWORK

is proud to announce a great new radio show

# RCA'S "WHAT'S NEW?"

Something *new* on the air! A new *kind* of show—one full hour of up-to-the-minute entertainment, packed with music...laughter...drama...news—presented by Radio Corporation of America.



Figures who make the news will present the news—in RCA's unique "on-the-spot" interpretations of the latest world events!



From Hollywood to Broadway, RCA will comb the nation for the newest stars, the latest song hits, the most recent stage and screen sensations!



While their names are still in headlines, leading sports-folk of America—from stadium, rink and ballpark—will tell "WHAT'S NEW" in sports, predictions.



While the ink is still wet on the blueprints, leading scientists and designers will present the latest scientific wonder that is helping shape tomorrow's world.



DON AMECHE, star of radio and films, host on "What's New?"

On Saturday, September 4th, a great new radio show came to the Blue Network... to answer the question all America is asking: "WHAT'S NEW?"...what's new in world affairs...in sports...science...Hollywood...music...humor—and a score of other timely and important fields?

Headed by Don Ameche, and supported by the RCA Victor Chorus, the RCA Victor Orchestra, and a distinguished list of guests, "WHAT'S NEW?" is one of the greatest programs ever broadcast...new, distinctive, truly different—a milestone in radio entertainment.

### Looking to tomorrow's markets

With the radio industry "all out" for Victory, "WHAT'S NEW?" emphasizes the vital role that is being played today by American radio equipment on the battle-fronts. The skill and experience now going into this equipment are a promise of the better products that the industry will offer to American consumers in the postwar world. For radio manufacturers and retailers, "WHAT'S NEW?" helps lay the foundation for tomorrow's peacetime markets.



### EVERY SATURDAY

7-8 PM EWT • 6-7 PM CWT • 5-6 PM MWT • 4-5 PM PWT

Nationwide Coast-to-Coast Coverage Over 159 Stations of

# The BLUE Network

BACK THE ATTACK—BUY MORE BONDS



THE **Sonora**  MISSION  
*Clear as a Bell*

1. To help win the war by continuing full speed ahead with all the manufacturing, designing and engineering force at our command. *Then—*
2. To dedicate our full energies to the progress and prosperity of the legitimate jobber and his dealers. *And at all times—*
3. To devote our entire skill, abilities and resources in the cause of the jobber—the backbone of the home front—as a vital channel of distribution under the American system of free enterprise.

*J. M. Hill*  
President,

SONORA RADIO & TELEVISION CORP.

**...but actions speak  
louder than words!**

You retailers know that full pages in full color don't whisper . . . *they shout!* And when those smashing pages appear in Life, Esquire, American Weekly, Time, Red Book, American Magazine, Cosmopolitan, American Home . . . you know they mean *business!*

We are now engaged in such a campaign . . . full pages, full color in America's top magazines, building faith in SONORA; so that SONORA may deserve the faith of the retailers of America . . . who, when all is said and done, add the final chapter of success to all advertising.

When the day comes that the demand now being

rolled up for SONORA can be satisfied at your counters . . . you will find that SONORA fits your selling problems like a glove. For SONORA is as easy to handle as any minor appliance . . . an over-the-counter transaction . . . a "Package" sale in every sense of the word.

Ask your jobber to tell you all about The SONORA "Package" Plan—and more about SONORA's national advertising.

SONORA RADIO & TELEVISION CORPORATION  
325 N. HOYNE AVENUE • CHICAGO



**Sonora**   
*Clear as a Bell*

THE ONLY NATIONALLY ADVERTISED JOBBER-DEALER RADIO



## *Alibis* • THE BACKFIRE OF SECONDHAND ORDERS

Secondhand orders, confused, slow and often garbled, have no place in the routine of a modern business. Too often they explode in alibis and irresponsibility.

A sure safeguard against the hazards of oft repeated "he said" is use of Teletalk Amplified Intercommunication . . . the direct, dignified, 100% accurate answer to inter-office or inter-plant communications.

If you are not now selling Teletalk Amplified Intercommunication Systems to the busy offices and plants in your vicinity, get in touch with us. Let us show you how Teletalk almost sells itself to executives who must save time and energy in these war-burdened days. Teletalk units are beautifully styled, finished like a fine piece of furniture. Available in capacities of from 5 to 24 stations to fit the exact requirements of every business. They are easy to install, operate from the light circuit. War orders almost always give priority.

Write us today. Make Teletalk a profitable addition to your business.

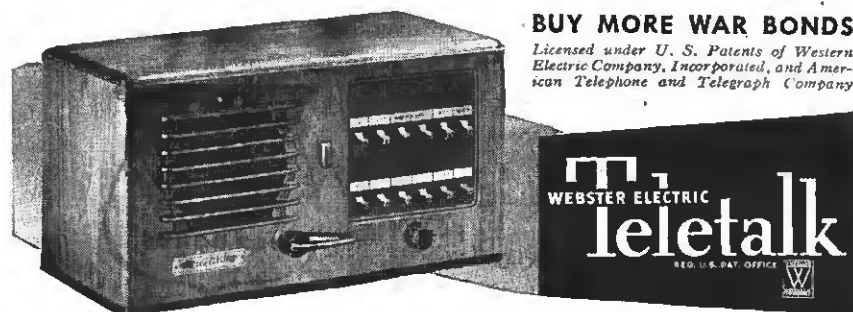

**BUY MORE WAR BONDS**

Licensed under U. S. Patents of Western Electric Company, Incorporated, and American Telephone and Telegraph Company

WEBSTER ELECTRIC COMPANY, Racine, Wis., U.S.A. • Established 1909 • Export Dept: 13 E. 40th St., New York (16), N. Y. • Cable Address: "ARLAB" New York City

**WEBSTER ELECTRIC**

"Where Quality is a Responsibility and Fair Dealing an Obligation"

# RADIO *Retailing* TODAY

SEPTEMBER, 1943

Page

15	EDITORIALS
16	SELL THE "COMBINATIONS"
18	ELECTRONIC MAINTENANCE*
20	SERVICEWOMAN
22	APPLIANCES REPLACE RADIOS
32	SALES IN CLASSIC DISCS
34	TRENDS IN RECORD SALES
38	SERVICEMAN SELLS RECORDS
40	RADIO MEN ADVERTISE
42	ONE-MAN SERVICER
44	FACTORY SOUND USES
46	APPLIANCE FUTURE
48	SUBSTITUTE LINES
52	WASHINGTON REPORT
54	LETTERS TO THE EDITOR
56	PARTS SUPPLY NEWS
59	NEW PRODUCTS
62	SERVICE NOTES

\*SUPPLEMENT: Large 4-Color Chart Showing "Frequency Spectrum of Radio Electronic Maintenance," illustrating article on page 18. Chart is backed by two features—"Radio Today—Across the U.S.A." and "Radio Electronic Distributors."

RADIO Retailing TODAY, September, 1943, Vol. 28, No. 9, 25c a copy. Published monthly by Caldwell-Clements, Inc., 480 Lexington Ave., New York 17, N. Y. M. Clements, president; Orestes H. Caldwell, treasurer. Subscription rates United States and Latin American countries, \$1.00 for one year, \$1.50 for two years, \$2.00 for three years. Canada \$1.50 for one year, \$2.00 for two years, \$3.00 for three years. All other countries \$2.00 for one year, \$3.00 for two years, \$4.00 for three years. Printed in U.S.A. Re-entered as second class matter August 28, 1942, at the Post Office at New York, N. Y., under the act of March 3, 1879. Member of Audit Bureau of Circulations. Copyright by Caldwell-Clements, Inc., 1943.

**ORESTES H. CALDWELL**

Editor

**M. CLEMENTS**

Publisher

H. L. M. Capron, Merchandising Editor  
William E. Moulic, Technical Editor  
Helen Thurman, Associate Editor  
John L. Stoutenburgh, Associate Editor  
Charles F. Dreyer, Art Director  
E. T. Bennett

M. H. Newton  
Lee Robinson  
B. V. Spinetta  
N. McAllister

John A. Sambörn  
O. H. Sutter  
W. W. Swigert  
J. E. Cochran

R. Y. Fitzpatrick, Chicago, 201 N. Wells St.  
Telephone RANdolph 9225

Editorial and Executive Offices ..

Telephone PLaza 3-1340  
480 Lexington Avenue  
NEW YORK



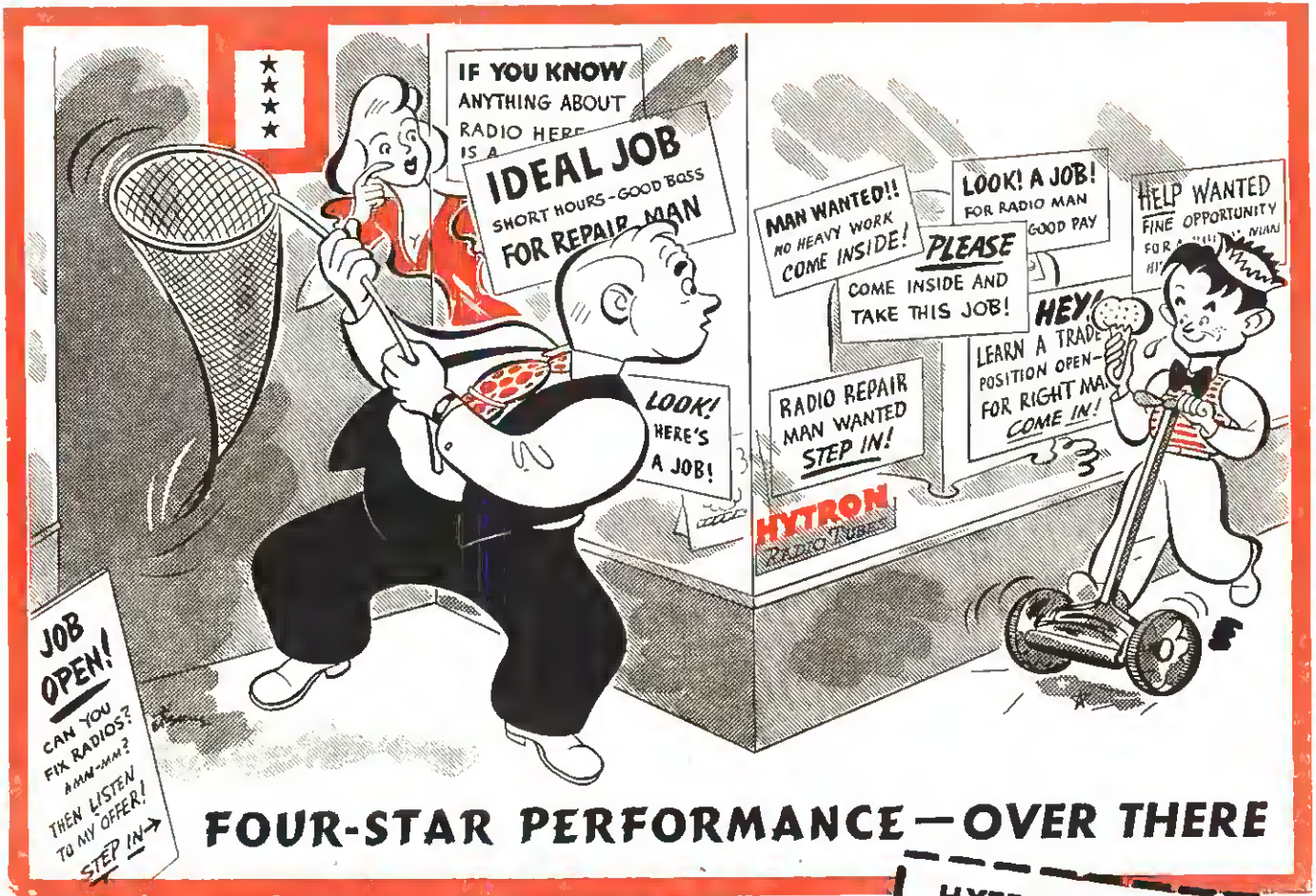

**FOUR-STAR PERFORMANCE — OVER THERE**

**...means little help and few spare parts for dealers and jobbers over here.**

The labor and replacement tube situation is tough!

Yes, even the kids are busy—mowing lawns—delivering papers—pinch-hitting for brothers and dads who are helping to win the war.

Naturally, Uncle Sam must have most of our output now; and your supply of M-R (Maintenance and Repair) tubes must of necessity be limited.

Hytron's war effort is vital. Keep in mind, however, that the more equipment our fighting forces get now, the sooner they, and Hytron, will bring back your peacetime profits and prosperity.

**HYTRON HYLIGHTS**



**NOW IT CAN BE TOLD!**

With a "radio" war demanding more and more Hytron special purpose tubes, Hytron converted 100% to War Production on June 12, 1942. It was the first receiving-tube manufacturer to do so. Rather than wait for new equipment to be procured, Hytron converted its own machines, at its own expense. Consequence: months of productive time were saved; and hundreds of thousands of War tubes reached our fighting men on time.



OLDEST EXCLUSIVE MANUFACTURER OF RADIO RECEIVING TUBES

**HYTRON**

**CORPORATION** ELECTRONIC AND RADIO TUBES

SALEM AND NEWBURYPORT, MASS.

# Voice communications on every front...

*Whether by radio or land wire telephone, a voice command gets the job done with clarity and speed.*

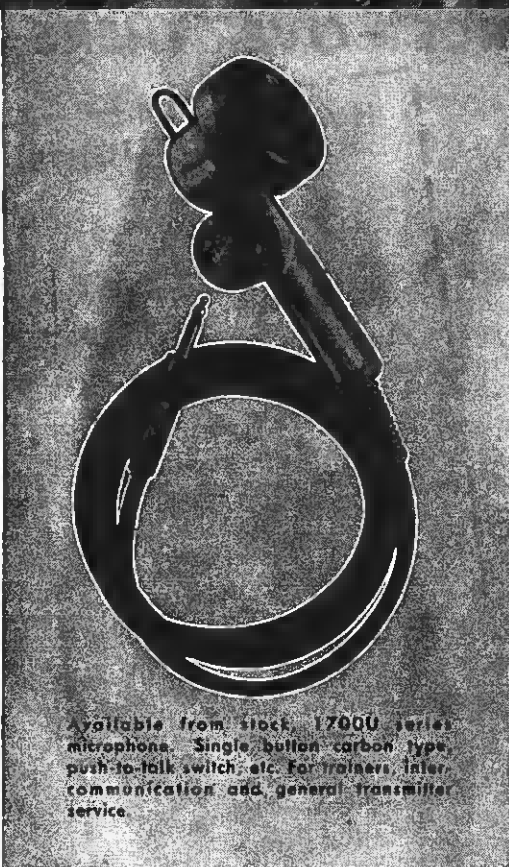

Available from stock, 17000 series microphones. Single button carbon type, push-to-talk switch, etc. For trailers, inter-communication and general transmitter service.

UNIVERSAL microphones are playing a vital part in voice communications of all the Armed Forces . . . being the first instrument through which a command is given. Care must be taken that the electronic patterns of the voice are held true for the many electrical circuits through which they must later pass. UNIVERSAL microphones with their precise workmanship are carrying the message through in all forms of voice communication whether from a tank, ship or aeroplane. UNIVERSAL products meet all U. S. Army Signal Corps Laboratory tests. Standardization of parts, inspection, and workmanship of high order combined with the best of material, make UNIVERSAL'S microphones and accessories outstanding in every application.

*U. S. Army Signal Corps and U. S. Navy plugs and jacks are offered as voice communication components to manufacturers of transmitters and sound equipment for the Armed Forces. Catalog No. 850 contains complete details.*



**UNIVERSAL MICROPHONE CO. LTD.**  
INGLEWOOD, CALIFORNIA

FOREIGN DIVISION, 301 CLAY ST., SAN FRANCISCO 11, CALIF. • CANADIAN DIVISION, 560 KING ST. W., TORONTO 2, ONTARIO



# WARNING

## AGAINST MISUSE OF

### EMERSON RADIO CABINETS

*Installation of other-make chassis in branded cabinets violates the name and trade mark rights of the manufacturer*

In accordance with established policy, limited numbers of cabinets bearing the Emerson name and trade mark have in the past been made available to the trade for servicing Emerson Radio exclusively.

Recently a few instances have been brought to our attention where the purpose of this service has been violated. Other makes of chassis have been installed in the cabinets thus provided and have been represented and sold as complete Emerson units.

However limited or scattered those instances may have been, it will be recognized that such deception constitutes a fraud against the

purchaser who believes he is getting Emerson quality and performance for his money. It is an illegal infringement on name and trade mark rights and, if ignored by us, would work not only against the interests of the Emerson Company but also against Emerson distributors and dealers.

We are confident that Emerson's determination to protect all concerned against such practice will be approved by the trade and we urge that any definite knowledge of further violations be reported to us for proper action.

EMERSON RADIO & PHONOGRAPH CORP., NEW YORK 11, N. Y.

Out of a proving ground wide as the world

there is coming



**Emerson ELECTRONIC RADIO**

and other miracles of electronic research for peacetime use

# How an RCA Electron Tube



# Can Help Dress a Woman



**R**EMEMBER how radio once mystified people? "What? Hear music from 1000 miles away through a bunch of tubes in a wooden box?" Well, you know the rest of that story. You helped write it!

Now it's Electronics—*your* biggest opportunity for tomorrow.

Today, thanks to an RCA electron tube, a device might even be built to stop a cloth-printing press the instant the uniformity of the printed color changed in the slightest. It's been estimated that such a modern "electric eye" can analyze and sort out 2,000,000 separate color variations. Think what that can mean to the woman who insists on perfect color matching—and to the textile industry that has to supply her.

You, Mr. Distributor, may well find yourself one day selling electronic equipment for this and a thousand other uses. And you, Mr. Serviceman, installing and maintaining it.

Just bear in mind two things: First—that its operation will largely depend on circuits, tubes, and parts already familiar to you from your radio days. Second—that *the Magic Brain of All Electronic Equipment Is a Tube and the Fountain-Head of Modern Tube Development Is RCA! RCA Victor Division, Radio Corporation of America, Camden, N. J.*

**TUNE IN "WHAT'S NEW?"**—RCA's great new show, Saturday nights, 7 to 8, E.W.T., Blue Network



This electronic automatic recording spectro-photometer is used at RCA for testing luminescent materials for cathode-ray tubes. In 2 minutes it does accurately what a trained man formerly did, but not as well, in 2 weeks.



# RCA ELECTRON TUBES





## The 'Game Goose' gets home . . . again

● The old girl's done it again. She's laid her eggs where they'll count most—and in spite of hell and high flack, she'll soon be smoothing her ruffled feathers at home. —The capacity of America's fighting men and machines to absorb punishment, as well as dish it out—to come back again, and again, and again—is no accident.

Electronic Laboratories is proud of the *E·L* equipment that is helping the 'Game Goose,' and every American fighting plane, get home again.

On every front where the United Nations are in combat, *E·L* Vibrator Power Supplies are proving themselves as rugged and reliable as the company they keep. At high altitudes, in steaming jungles or blazing deserts, they perform their appointed task with the greater efficiency and freedom from wear, characteristic of *E·L* Vibrator Power Supplies.

Wherever electric current must be changed in voltage, frequency or type, *E·L* Vibrator Power Supplies and Converters offer many definite advantages, for peace, as well as for war.



**For Operating High-Powered Radio Receivers and Transmitters, Coin-Operated Phonographs, Public Address Systems and the Like—** Standard *E·L* Model 264 Power Supply. Input Voltage, 115 V DC; Output Voltage, 115 V AC; Output Current, 5 amperes; Output Power, 500 Volt-Amperes; Output Frequency, 60 cycles; Dimensions, 16" x 9 3/4" x 6 1/2"; Weight, 44 lbs.

*E·L* Standard Vibrator Power Supplies are designed with a wide range of output wattage ratings for input voltages including 6, 12, 32, 115, and 220 volts. Custom-designed and built power supplies can be provided to meet any particular needs.

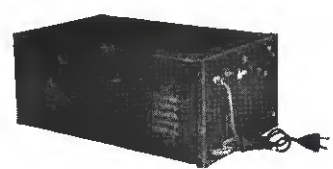

# Electronic

## LABORATORIES, INC.

INDIANAPOLIS

**E·L ELECTRICAL PRODUCTS**—Vibrator Power Supplies for Communications . . . Lighting . . . Electric Motor Operation . . . Electric, Electronic and other Equipment . . . on Land, Sea or in the Air.





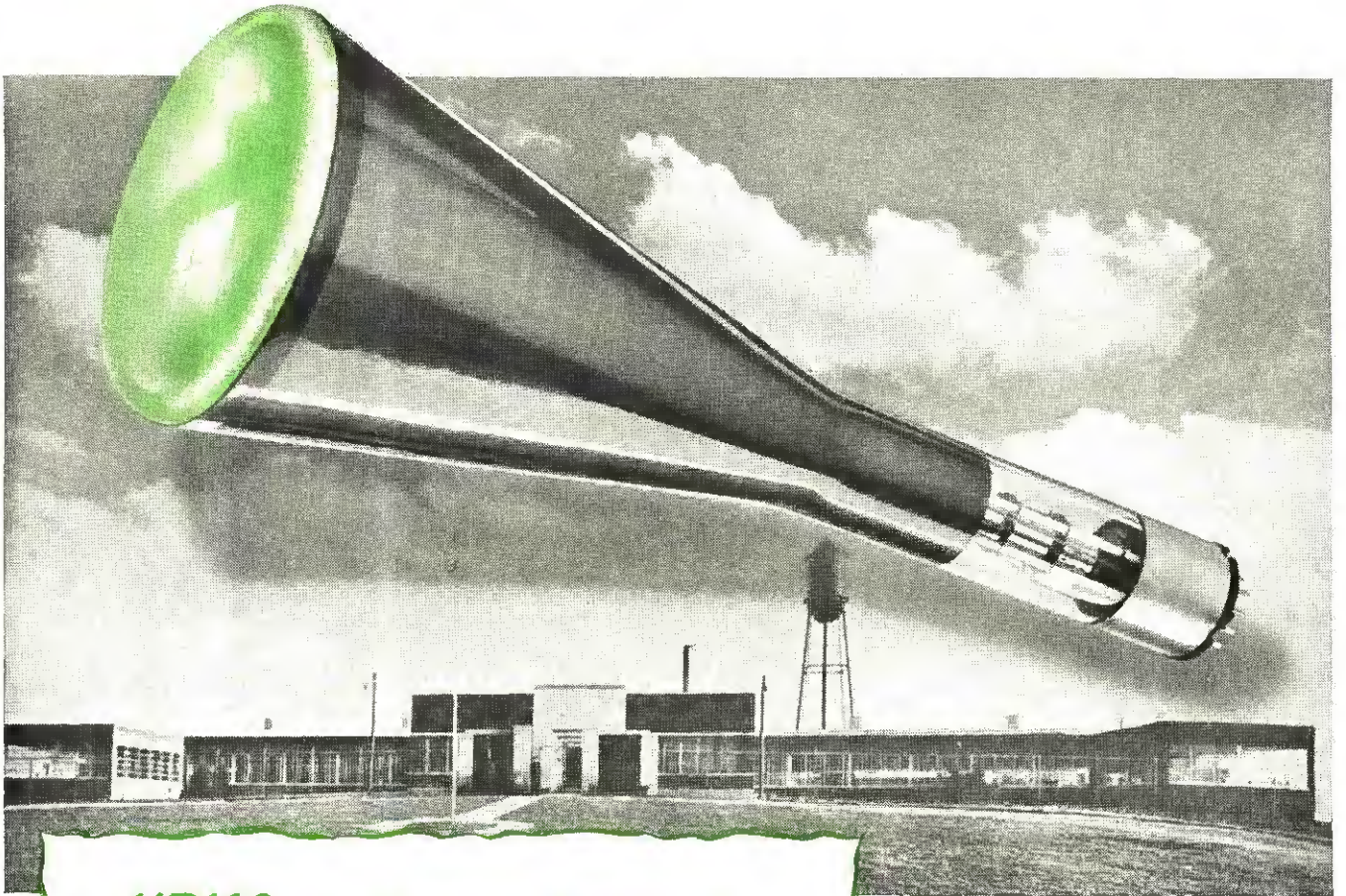

**MEMO** for Post-War Reference:

NATIONAL UNION IS ONE  
OF THE LARGEST PRODUCERS  
OF CATHODE-RAY TUBES

In our cathode-ray tube production record, now climbing upward week by week, we see the working out of plans made long ago. Here are the dreams of our engineers come true. Here is the model factory they planned and equipped especially for cathode-ray tube manufacture—one of the Industry's

largest. Here are the mass production machines they designed—built by this company's own equipment division. Here are the hundreds of skilled workers to whom they taught this special art of tube making that calls for the utmost precision and accuracy. Here are their laboratories with research continuing

at an even greater pace, as though their work had just begun. And here are the results of all this thought and effort—National Union Cathode-Ray Tubes *by the carload*. Today, enroute to those who need them most—our fighting forces! Tomorrow, destined to bring to millions of homes a marvelously improved kind of television with larger images, with greater sharpness, reality, at mass-market prices—and to thousands of factories many new precision testing and measuring devices.

*Count on National Union for the things you'll need—tubes, test equipment, engineering data—to keep your post-war service in step with electronics progress.*

NATIONAL UNION RADIO CORPORATION

NEWARK, N. J.

LANSDALE, PENNA.

**NATIONAL UNION**  
**RADIO AND ELECTRONIC TUBES**





# FADA Radio

## A Message to Our Dealers & Jobbers

FADA RADIO AND ELECTRIC COMPANY, INC.

FADA  
Radio  
MANUFACTURERS OF

Radio and Electrical Apparatus  
30-20 THOMSON AVE.  
LONG ISLAND CITY, N.Y.

CABLE: FADARADIO  
BENTLEY CODE

TELEPHONE  
IRONSIDES 6-5400

J. M. MARKS, PRESIDENT

Gentlemen:

War flings down the gauntlet . . . to our American radio technicians, no less than to our fighting forces. It is a challenge to their native ingenuity to outdo the world in scientific research and development under the severest pressure. This challenge is especially directed to firms like FADA who have pioneered in their respective fields and have been called upon by the Government to meet that challenge.

Long before Pearl Harbor, FADA has been producing for battle-front use an extraordinary variety of new radio apparatus.

FADA is still forging ahead with many more innovations for Army and Navy use.

After the war is won, this added knowledge and experience will be made available to the American public . . . through you. In the interim, FADA is keeping alive public interest and confidence through a concerted advertising program of large scope in newspapers, billboards and radio. Suffice it to say, FADA is still working for you by maintaining public acceptance of its name as a singular mark of merit, and by providing a source of startlingly changed . . . simplified . . . improved radio/electronics . . . for you . . . post war.

Sincerely yours,

FADA RADIO AND ELECTRIC CO., INC.

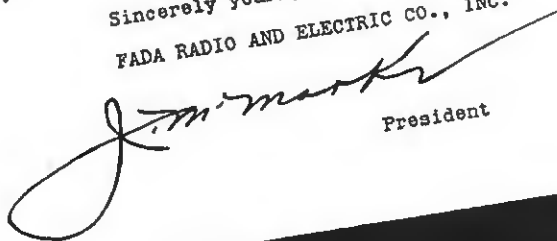

President

# GUNS ON EVERY FRONT NOW ARE FIRED BY THIS MAGNAVOX CONTROL

*Electric Gunfiring Solenoid,  
designed and manufactured by Magnavox, now  
standard with United Nations Armed Forces.*

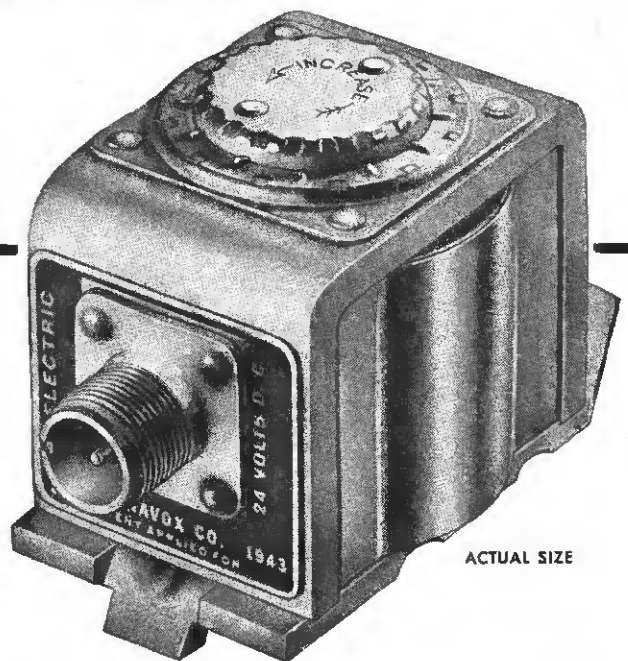

ACTUAL SIZE

COMPARED WITH former gunfiring controls, this Magnavox Solenoid increased firing efficiency 180%, decreased battery drain 50% and cut weight 18%. Cost was cut to a fraction by Magnavox design and mass production methods. These precision devices are now made one hundred times as fast as formerly. Thirty-six models, for various types and sizes of guns, now roll off the Magnavox production lines by the hundreds of thousands.

This is just one example of problems taken in stride by Magnavox engineers, creating and manufacturing military equipment ranging from solenoids to the most intricate types of complete radio communication systems.

Magnavox brings to the war effort the skill and "know how" developed by 32 years of designing, engineering and manufacturing for the radio indus-

try, plus the splendid facilities of the completely modern new six acre plant, finest machine tool equipment and the production economies of efficient management. The Magnavox Company, Fort Wayne 4, Ind.



Magnavox skill and craftsmanship won the Navy "E" in 1941, among the first awarded... now with 3 White Star Renewal Citations.

FOR 32 YEARS **Magnavox** HAS SERVED THE RADIO INDUSTRY

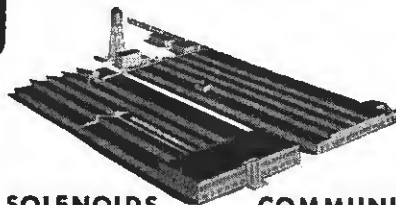

LOUD SPEAKERS • CAPACITORS • SOLENOIDS

COMMUNICATION & ELECTRONIC EQUIPMENT



# 12,000 REASONS FOR RAYTHEON'S REPUTATION!

RAYTHEON tubes are selected as original equipment by America's leading radio manufacturers. Cost is a factor . . . but consistent performance, RAYTHEON performance, outweighs any cost factor. The 12,000 highly skilled RAYTHEON employees are 12,000 reasons why the RAYTHEON tubes you select will give consistent performance . . . they are a quality product and RAYTHEON quality never varies.

**RAYTHEON PRODUCTION CORPORATION**  
Newton, Massachusetts  
Los Angeles . . . New York . . . Chicago . . . Atlanta



DEVOTED TO RESEARCH AND THE MANUFACTURE OF TUBES FOR THE NEW ERA OF ELECTRONICS

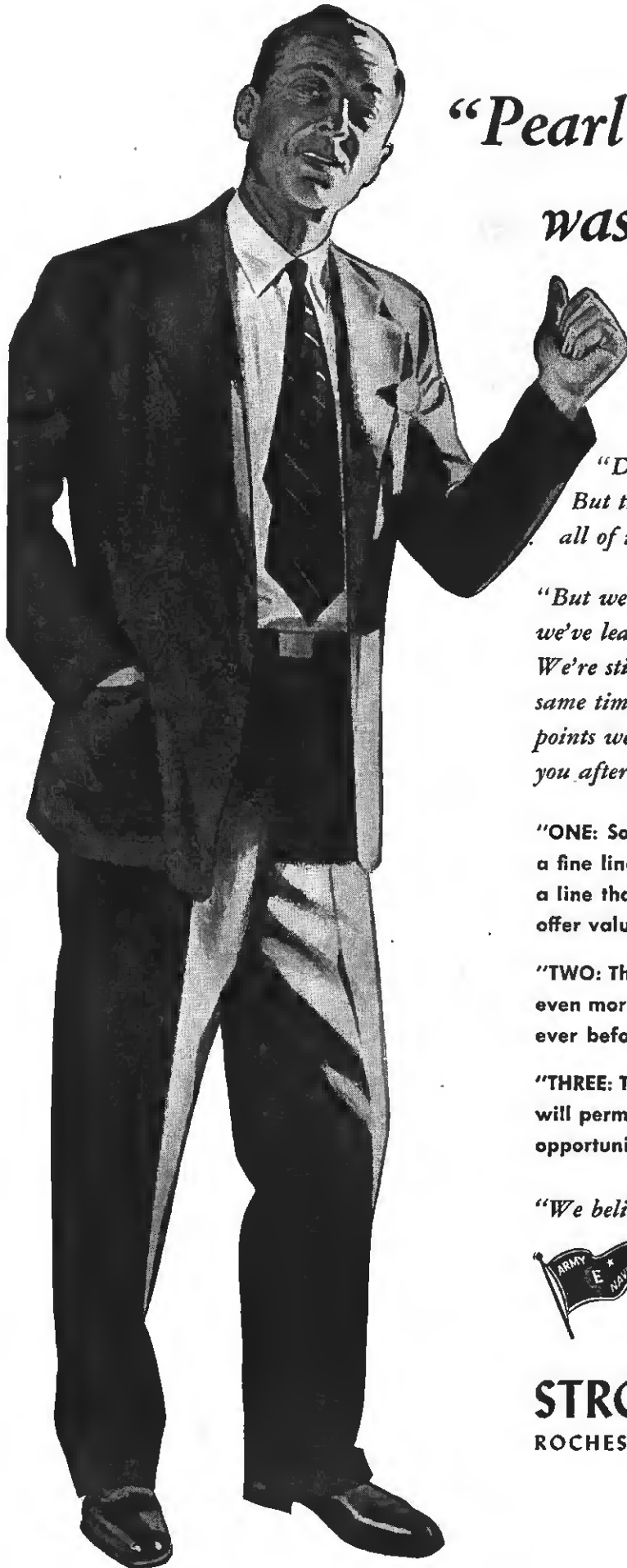

## **“Pearl Harbor was 10 years ago!”**

*“Since Dec. 7, 1941, we’ve learned things about radio and electronics that would have taken ten normal years.*

*“Don’t misunderstand us. We’re not bragging. But the demands of war production have caused all of us to grow and learn something more.*

*“But we do want you to know that part of what we’ve learned in those ‘ten years’ is yours. We’re still busy in war production, sure. At the same time, we’re never forgetting those three points we’ve promised to make ready for you after the war:*

**“ONE:** Soon after this war is won you’ll have a fine line of Stromberg-Carlson radios to sell . . . a line that will win customers . . . a line that will offer value in a wide range of prices.

**“TWO:** The Stromberg-Carlson name in radio will be even more widely and more favorably known than ever before.

**“THREE:** The Stromberg-Carlson policy of distribution will permit every authorized dealer to have a real opportunity for profit on the postwar line.

*“We believe you’ll be glad to know you can count on these things when you do your postwar planning.”*



**STROMBERG-CARLSON**  
ROCHESTER 3 • NEW YORK





O. H. CALDWELL, EDITOR ★ M. CLEMENTS, PUBLISHER ★ 480 LEXINGTON AVE., NEW YORK, N. Y.

### **Radio-Electronic Maintenance**

Rapidly the general public is becoming electronic-conscious. Business and industry recognize that a powerful new force is making itself felt—and are seeking ways to apply these electronic methods in individual corporate activities.

Radio-electronic manufacturing has been expanded twelve-fold since Pearl Harbor. And already hundreds of thousands of young men have been trained in radio and electronic principles.

All these developments mean that electronic applications will be utilized on a tremendous scale in the future peacetime America. Electronic devices will be almost as commonplace in industry, business, agriculture and everyday life, as ordinary electrical devices are today.

But the job of keeping these numerous electronic devices in working order will fall on the men who fit themselves to take on this enlarged and profitable responsibility. Radio-electronic maintenance will be the logical outgrowth of today's radio maintenance.

In this issue, in our large color chart and in articles, we present the first guide-posts along the profitable road of future radio-electronic maintenance.

### **Attacks That Hurt Radio**

Whether circulated intentionally or not, ill-founded reports that home radio listening has been seriously curtailed due to diminishing repair facilities, are damaging the radio industry—our business.

Swivel-chair statisticians, some in newspaper offices, spread their beliefs recklessly. Their pessimistic inaccuracies would lead one to believe that Washington is deliberately withholding needed home-receiver parts, and that the radio maintenance man is either unable to render competent service or is preparing to fold up his business.

*Radio Retailing Today* knows that this attack from radio's competitors is not even a series of half-truths. By actually going into the field and talking with the men who are working night and day to keep the radios playing, the true situation revealed is that while the labor, parts and tube situations are acute and the radio man is behind in his work, he is not stymied in his efforts to keep sets playing.

### **"I'll Fix It," Says Dealer**

"Bring any set old or new, in here and I'll fix it somehow," one dealer declares. His attitude is that of most of his contemporaries today.

If anyone hears that radio-maintenance organizations are going out of business, the best way to find out that this is not true is to visit a few of them. You'll find they're loaded with profitable work, and are only worrying about how to get *all the work done*.

We should not relax our efforts to convince Washington that radio in the home is necessary. We should keep everlastingly busy on the parts and tube problems as they confront us. But we should put down any attempts to discredit the fine job being done to keep up morale in the home, now that radio men have adjusted themselves admirably to the wartime situation.

## Many Dealers Report Having Large Phonograph-Radio Units in Stock. How to Move Them. Arguments to Use and Steps to Take

● Now—after two years of war, and a year-and-a-half of no radio production—stocks of table-model radios are about exhausted.

But in this condition of scarcity, there is an overabundance of phonograph-radio combinations. Large, expensive “combinations” are the only class of home radios of which there are stocks available—in fact, excess stocks. For, large “combinations” (as many dealers report to us) are not selling. And they are tying up a lot of capital, too.

If you will look back over the last decade of radio merchandising you will see the reasons combinations are not selling. Knowing *why* they are not selling, should indicate the *means* of selling them.

Back in the early nineteen-thirties, there was an almost universal effort to make radios smaller and cheaper. And a mighty good job, measured by size and price, was done. Remembering the atrocious cabinetry, the rank design, the abominable taste of the consoles of the period, people flocked to the smaller, less conspicuous “small radios.” And liked them. That was step number one to keep in mind.

### Applying Step No. 1

Present-day combinations are housed in cabinets which are much better designed, in better taste, and really in keeping with the furniture in good homes. So, in merchandising your stock of combinations, lay emphasis on their styling, their cabinetry, their ability to fit into a nice living room, without standing out like

---

DEALERS WHO HAVE BEEN FACED WITH AND HAVE SOLVED THE PROBLEM OF MOVING EXCESS STOCKS OF COMBINATION PHONO-RADIOS ARE INVITED TO REPORT ON THE METHOD THEY HAVE USED MOST SUCCESSFULLY.

---

Harold Lambert photo



## Merchandise "Combi

a sore thumb. “Early Grand Rapids” is a period of the past.

Again looking back you will remember how manufacturers and dealers each year vied with one another to introduce new models.

Loudly you shouted about the fancied improvements, the newest developments, and tried your level best to make the public think you had a revolutionary new discovery. Remember those ads and those sales talks? You taught the public to expect new models at least once a year, and in that particular you did a fine job.

### And Here's No. 2

And so, point number two, in merchandising these big combinations

is to stress the fact that they are really late and fine models—that there have been and will be, no revolutionary developments in this class of merchandise for a long time; that they are not obsolete, and will always give “the music you want, when you want it” with a realism no “midget” set can equal.

Looking back again, remember how you praised the *tone* of the table models, banking on the reputed “tin ear” of the public not to know the difference? And then, again, in “selling down” you sure did a fine job with the tone quality. Point number three, then, in merchandising your “combos,” is *tone*. Don't just say they have better tone, prove it.





## **nations" to Fall Buyers**

Prove it, not only by demonstration, but give technical support to your assertion. Show the power required to reproduce the low tones, show the influence of speaker size, and size of baffle, on tone quality. Factors all, which no midget can have, and which your combinations possess to a high degree.

### **Combine all three factors**

Combine these factors, now, and you are ready to lay some weight on "pride of ownership." Everyone is more or less vulnerable to this "pride of ownership" attack, particularly when it is skillfully and subtly applied.

Remember that our country is at war, and who doesn't. Many a radio-entertainer, musician and singer will go to the Valhalla which awaits us all, before peace comes again. Records will be the only means, soon, of listening to some of our present-day favorites. New songs too, will replace those of today, as today's have replaced those of only a few short years ago. Records are the means of keeping those songs alive, for you and yours. Strong factors, in selling the combinations.

### **Reach Every Prospect**

All of these facts you should present—as strongly as you can—to your

## **In your campaign to clear out your phono-radio combinations—**

- 1. Emphasize their styling and cabinetry**
- 2. Remind prospect they are late models; that**
- 3. No revolutionary developments are in sight**
- 4. Prove their superior tone quality**
- 5. Lay weight on "pride of ownership"**
- 6. Go after old and new prospect lists**
- 7. When all else fails, offer price concessions**

full list of radio customers, and to as many new prospects as possible. Enthusiastically and consistently applied, they should sell some combinations.

But if you have tried your best, and still find your stock heavy and non-moving, look back again to the thirties, for the lesson and the answer.

Remember how your competitors took the business right out of your store, by offering larger discounts, longer trade-in allowances? And how you had to "meet" your competition to stay in business? All of which certainly taught the dear public not to pay list prices, or anywhere near it.

### **It's Still "the" Law!**

That old economic law of supply and demand keeps right on working—notwithstanding government attempts to the contrary. And so, if your best efforts to create a demand for your supply of combinations fails, you have but one course left. And that is to reduce your prices to levels at which people will buy.

In considering price restrictions, be realistic. Remember that the longer you keep merchandise in stock, the more it costs you, and the less it is worth. Remember you can make no profit until your merchandise is sold. And don't forget that if you must take a loss, the sooner you take it, the less it will be. There is a price at which you can sell anything—even dead horses! It's your job to find that price at which you can sell your

*(Continued on page 66)*

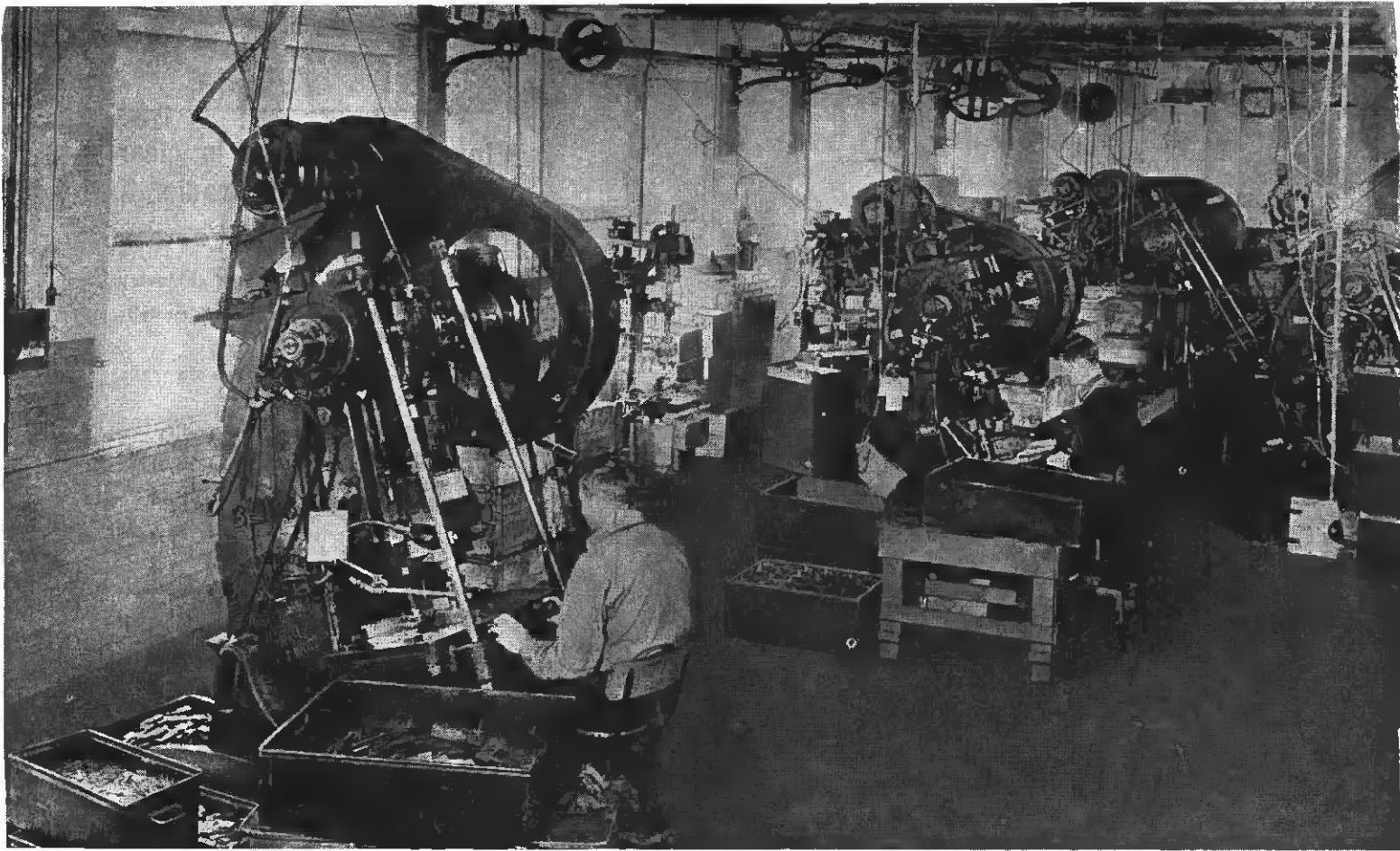

# **Radio-Electronic Maintenance**

**Radiomen Must Prepare Now to Handle Electron-Tube Apparatus. See Large Color Chart with this Issue**

• Early American pioneers forced their way through a great wilderness from the East coast to the West. Today, a corresponding wilderness is part of the frequency spectrum. Radio scientists are filling in the gaps in the unknown "bands" of frequencies.

Today's radio servicemen must form the nucleus of the group responsible for the maintenance of the vast amount of radio-electronic equipment that is making its appearance in industry and will soon be appearing in the home. Radio servicemen, with their experience in vacuum-tube equipment at the lower frequency end of the spectrum, are the logical ones to expand their knowledge and take charge of vacuum-tube apparatus repairs from DC to X-ray frequencies.

Sent as a supplement to this issue is a complete frequency spectrum chart including typical equipment de-

tails and formulas. Along this spectrum lie the opportunities for progressive radio servicemen.

## **Low Frequency Opportunities**

Not all of the new electronic apparatus falls in the ultra-high frequency end of the range. Great new radio-tube controlled equipment is making industrial processes simpler, faster and cheaper. The grid-controlled rectifier tube in the form of the thyatron and similar types is making motor speed control a simple thing. Control of the speed of motors is an important factor in many industries from steel mills to bottling plants.

Old motor-control systems employed mechanical or power-wasting electrical systems for speed control.

The new electronic method is to employ grid-controlled tubes as rectifiers and regulate the speed of a DC motor by the amount of the voltage output from the rectifier system.

The grid-controlled rectifier tubes are gas-filled and the voltage output may be regulated by the period of each cycle that the tube is permitted to conduct. Since the tube is gas-filled, the passage of current cannot be stopped by the grid, but the time which the conduction starts may be controlled. The usual method of regulation is called the grid-shift system. Here, the grid is supplied with a small AC voltage of the same frequency as that being rectified, but this voltage may be shifted in phase with respect to the plate supply voltage. By shifting the phase of the grid voltage, the tube may be prevented from passing current for any part of the positive half-cycle of plate voltage.

The grid-shift system offers a con-



Personnel protection in plants using high-speed punching, shearing, and similar dangerous machinery is an important and growing problem for electronics and the radio-electronic maintenance man. Factory sound systems are also proving to be an important feature of industrial electronic applications.

venient, high efficiency method of controlling DC voltages. Both automatic and manual control by this means are being used.

### Power Current Tubes

The big brother of the grid-controlled rectifier is the mercury-pool ignitron. This tube can be "started" by a voltage applied to an ignitor electrode. Other high current mercury-pool tubes required a slow mechanical rocking of the tube to initiate the arc. The ignitron is a high current capacity tube permitting high speed control of the flow of current and is the tube making rapid welding methods possible.

Other low-frequency tube applications include DC to AC inverters using thyratrons, vibration analyzers,

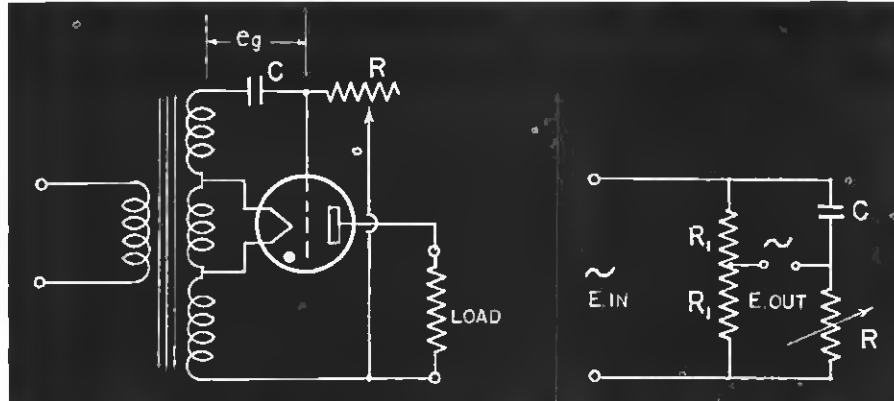

Circuit above is grid controlled rectifier and an additional type of phase shift network. Diagram below shows variation of average voltage as phase of grid voltage is shifted. Note that tube conducts as grid potential rises above striking level.

electro-dynamic vacuum-tube oscillator-driven vibration producers, and hundreds of other devices operating in the power and audio-frequency range. Sound level analyzers and recorders will become more important as campaigns for silencing mechanical equipment get under way. Industrial music, already a success in many war plants, will continue to grow, calling for radio-electronic maintenance men to install and keep in operation.

In the already familiar field of radio communication, many new products will come into more general use and require the services of a skilled repair man. Navigation and direction finding equipment hereto-

## THE FIELDS FOR RADIO-ELECTRONIC MAINTENANCE

- Electronic Motor Speed Control
- Electronic Welding Control
- Electronic Measuring Equipment
- Radio-electronic Communication
- Electronic Heating Equipment
- Photo-electric Tube Apparatus
- Infra-red and Ultra-violet Radiation Equipment
- X-Ray Diagnostic and Inspection Apparatus

fore limited to large commercial installations, will become necessary accessories for the many private planes and boats which the public will own. The important features of direction finding apparatus are the antenna, the electrical balance of the RF input circuit, and the sensitivity of the null indicator. Careful adjustment and compensations are necessary for

reliability. Experts are required.

New television and FM home receivers operating in the vicinity of 100 or more megacycles will employ new methods for preventing circuit drift with temperature and age. More advanced circuits, new tubes and modulation systems will dictate the need for skilled radio-electronic maintenance men in every community.

Industrial and medical electronic heating is growing by leaps and bounds. Vacuum tube apparatus working in the radio frequency range varying in power up to hundreds of kilowatts is making better products from shoe leather to taps and dies.

### Electronic Heating

The apparatus consists of a high-power oscillator, usually employing a push-pull circuit. In many units, the system is self-rectifying since the oscillator tubes also serve as rectifiers. The object to be treated is placed in the electric field between two electrodes or in the magnetic field surrounding a coil. Metal parts are heated in magnetic fields while plywood, leather, etc., are treated in electric fields between condenser-type electrodes.

Maintenance and installations require care in shielding and grounding to prevent RF fields from getting out of bounds, care of insulations and safety methods because of the high voltages employed. Many of the tubes are water-cooled, hence the need for knowledge of circulating

(Continued on page 60)

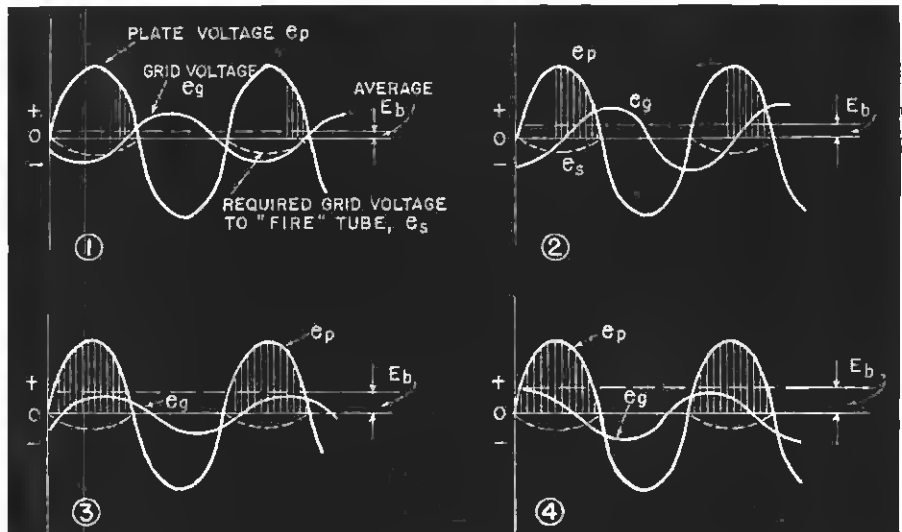

# "By Shifting Secondary

**Mrs. Wallace Courtney (at right) Has a Welcoming Smile for All Customers and Plenty Behind It in Technical Knowledge of Radio Which Enables Her to Bring Sick Receivers Back from Death's Door**



• When we walked into Courtney's Radio Service store in Stratford, Conn., one recent afternoon, we were interested to see a woman in service coat, busily working at the job of servicing a radio. RADIO RETAILING TODAY's representative soon learned that she was Mrs. Courtney and that she is keeping the Courtney service business going during the day while her husband is at work in a nearby plant installing radios in planes for our fighting forces.

Even though parts and help shortages are pressing, Mrs. Courtney admitted that Courtney Radio Service was "doing as well as could be expected," and was moving the sets along as fast as possible.

## **Old Sets Give Trouble**

"We have trouble, especially, repairing the older model radios due to lack of parts," Mrs. Courtney explained. "This set I'm working on now showed the symptom of an intermittently red-hot rectifier tube. I checked the obvious power supply trouble by probing the wiring. The set would play in an inverted position, but a short would develop in the high-voltage circuit when the set was turned upright. Shifting the high-voltage leads around with an insulated probe showed up the broken insulation which permitted grounding to chassis. . . ." finished Mrs. Court-



ney, in response to our further query.

We asked for it—and we got it!

Another tough intermittent handled by Mrs. Courtney was one in an old Grunow. The set would "fade in and out. Voltage and continuity tests when the set was 'out' failed to locate the trouble. By using the 'light tap with a screw-driver handle' method, the second IF can showed promise. Removal of the coil and complete test proved that a fixed trimmer was intermittently open, thus detuning the circuit. . . ."

So now, it's Mrs. Courtney that the customer gets on the telephone. And it's her quiet, pleasant voice that assures the customer that while the shop is restricted in pick-ups and deliveries, if he will bring the set in, she will see that repairs are made satisfactorily, if that is humanly possible. In other words, if the shop has the parts.

## **Capable Servicier**

Tall, lithesome, pleasant and capable, Mrs. Wallace Courtney is typical of a lot of American wives and mothers, who without any fuss or

furor, have stepped calmly into their men's places for the duration in whatever capacities the jobs may call for.

Mother of a young son, a healthy, happy young man of 12, who gets as good marks as any at the top of his class, Mrs. Courtney is now doing an excellent job handling the Courtney Radio Service's repair work during the day, and helping her husband work out repair problems during those evening hours he can spare.

## **Mechanical Background**

Before her marriage, Mrs. Courtney worked in a local wire plant. The factory management hated to lose one of their most competent workers and used every persuasion to induce her to stay. Mrs. Courtney, however, preferred giving her time to homemaking, and no amount of inducement could win her over, so she left. Her natural bent for mechanics, however, plus a woman's natural interest in her husband's work, has led to this couple's working together often on repair and rebuilding of radios, so



# Leads..."

Mrs. Courtney brings a real knowledge to her present war-time job.

## **Mrs. Courtney Takes Over**

Taking over wasn't easy, though. Many a customer arrived on the shop's threshold, set in hand (or on back, according to size), only to display an expression of dismay at the realization he would be "entrusting his radio set to a woman"! Mrs. Courtney's sense of humor generally saved her from this unnecessary but nonetheless prevalent situation. And a little applied stand-your-ground fortitude, plus some gentle kidding, almost always convinced the doubting male. Of course, a quick diagnosis couched in technical terms, backed by good sound knowledge on her part, helped!

## **Good Will Helped**

Then, too, the sound business reputation and backlog of successful service work done at this shop over a number of years stood Mrs. Courtney in good stead. Her customers, after all, were her friends, but even in "the good times" good will had to be backed by satisfactory work performance.

## **Woman War Worker**

There are women in the armed forces, now, and women in the war plants, but there are also women like Mrs. Courtney, who are filling jobs today to release men for battle on the home front as well as on the foreign fighting lines. And these "women war workers" take equal pride in performance in their jobs. They face the public's critical eye, without a Colonel Hobby or a manufacturer's production manager to champion their necessity or ability to fill their jobs.

But Mr. and Mrs. Courtney, along with many other radio retailers, have met that critical public eye before,

usually accompanied by the queries "Why can't you call for my set?" . . . "Why can't I have that new tube next week?" Like most other retailers, Mr. and Mrs. Courtney have had to know more about Washington's war-time business stipulations than Washington itself. And as retailers they have done an excellent job of helping their customers realize their patriotic responsibilities along these lines.

We are sure this radio service-

woman and her co-workers in the field won't find it too hard to set the public right on this current solution to the radio man's help shortage problem.

And, since all good campaign work most always begins at home, radio retailers everywhere can indirectly help themselves by "giving these little girls a big hand!" Your country's War Womanpower Commission will back you up!





## ***He Went "Electrical"***

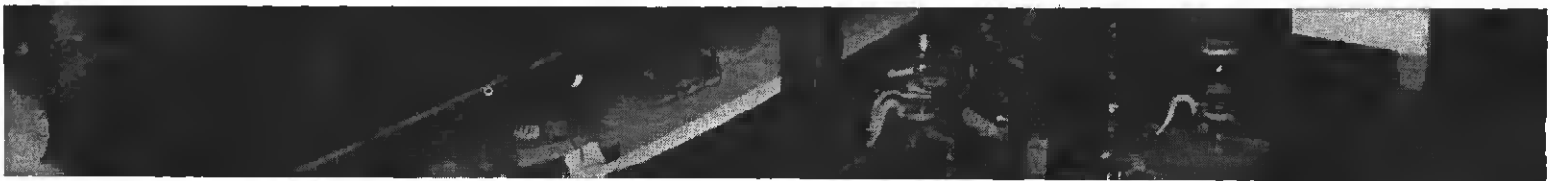

• A big retail sales and service shop, Johnson Electric Supply Co., Main St., Nashua, N. H., is a beehive of activity these days. In normal times the proprietor, Everett E. Johnson, who founded the business in 1912, employed over 20 people. Now there are 14.

When radios became scarce, Johnson immediately stocked hundreds of other items. He is doing a fine job with fruit jars for canning, and has stocked paint, hampers, cutlery, thermos bottles, electric razors, bathroom medicine cabinets, ash trays, penknives, glassware, sun glasses and numerous other small sale items. Because he always bought heavily, Mr. Johnson has big stocks of hard-to-get merchandise. His lighting fixture selection is remarkably complete for these times. Most of the fixtures are Lightoliers, and it is significant that he has been besieged by dealers who want to buy them. Manufactur-

### ***Appliances Replace Small Radios on This New Hampshire Dealer's Shelves***

ers have also sought to buy his entire stock. He sells only to retail customers, however, and home-owners flock into his showroom, glad not only to be able to get *any* fixture, but surprised and pleased to see such a big selection. Mr. Johnson recommends lighting fixtures to any radio retailer. Fixtures only take up ceiling space, he points out, enhance the appearance of the store, and represent a nice profit.

#### ***Long Active in Radio***

This dealer sold many makes of radio; has been active in Bendix, Blackstone and Westinghouse laundry equipment. He did a big job in refrigeration and in electric ranges.

He has some used electric ranges and used radios on hand now. He equipped the first city police cars with Stromberg-Carlson receivers, and put up the Nashua police radio station.

With the help situation so acute and the demand so great, Johnson finds it necessary to farm out some of his radio service work. RADIO RETAILING TODAY's representative saw a huge accumulation of miscellaneous repair work in the two big basement shops here. Electric irons, laundry equipment, toasters, electric clocks, vacuum cleaners, fans, percolators, mixers, refrigerator compressors and many other appliances are neatly arranged and tagged, and are repaired systematically. Though the amount of work is quite far ahead of the repairmen, there is no confusion. Due to delays experienced in seeking factory repairs on steam irons, Johnson now repairs these in his own shop.



Johnson does a lot of large and small electrical contracting work. He services 15 important war plants now, and has two service trucks and two delivery trucks. He makes a practice of servicing hospitals, schools and war plants ahead of the work in the home.

The Johnson showroom is 20 x 60 feet, but this store has such a large stock of new and used appliances that it is necessary to display much of the merchandise, particularly heavy items such as used ranges, large used radios, etc., in the basement and in a series of stalls in the big garage in the rear. Customers are taken to these points from the store, and Johnson makes sure that these display places are kept clean and orderly.

### **Ready for Christmas Rush**

Due to the fact that this dealer has bought heavily, Christmas shoppers are going to have a beautiful time buying here, and Johnson is going

store presents anything but a barren appearance as a result.

The policy here is "no crying to the customer." Mr. Johnson is looking forward to again participating in big radio, refrigerator, laundry equipment and electric range sales, and he believes that a cheerful, optimistic and appreciative attitude toward the customer was never more important than it is today. Repair service, he believes, must be especially good these days and must be rendered economically as possible, and followed through with resourcefulness.

### **Customer Good Will Held**

A customer, seeking repairs, whether to a radio, a refrigerator or other critical appliance nowadays, says Mr. Johnson, is a worried customer before he enters the store. He fears, from what he's read and heard, that it is quite likely that the appliance can't be repaired, or if it can

---

## **VARIETY IN SALES AND SERVICE**

Johnson services any electrical or electronic appliance—large or small. Radios, public address systems, refrigerators, electric clocks, automatic and non-automatic laundry equipment, vacuum cleaners, ventilating and circulating electric fans, electric ranges, household mixing machines, domestic and commercial automatic toasters, hand-irons, electric space heaters and all small electrical table and heating devices.

His showrooms display a great variety of timely sale items, some pre-war, others made of presently available non-critical materials. Situated in a central location, and long established, crowds of shoppers keep his staff on the jump.

Johnson also does commercial and domestic electrical contracting, and finds this fits in well with the sale of appliances and electronic equipment.

---

to do a land-office business. He has a good selection of IES floor and table lamps, pin-up lamps, a big variety of lamp shades, hurricane lamps, door chimes, electric hair dryers, IES reflector bowls, flashlights, glass coffee makers, with electric stoves; electric clocks, and a surprisingly fine selection of high-grade chrome electric table appliances and sets, long since out of production, and today considered virtually unavailable. He also has a few sunlamps and therapeutic baking lamps.

### **Customers Get a Break**

Johnson says that immediately his radio set display shelves became empty, he filled them with other merchandise he was able to get, and his

be repaired, it will cost a lot, and that there will be a great delay. The first thing Mr. Johnson and his clerks do is to put the customer at ease. "Of course we can fix it. We always did repair things for you, didn't we? No reason why we can't do it now," is the attitude. No hackneyed wartime excuses, vague answers or dire hints about how much more the work will cost.

Johnson has a large list of satisfied customers now, and he's obtaining many more by methods involving cheerfulness, efficiency and fair-dealing, and suggests this formula to any dealer as a means of successfully staying in business today, making a profit, and putting himself in a position to participate in peacetime business to come.

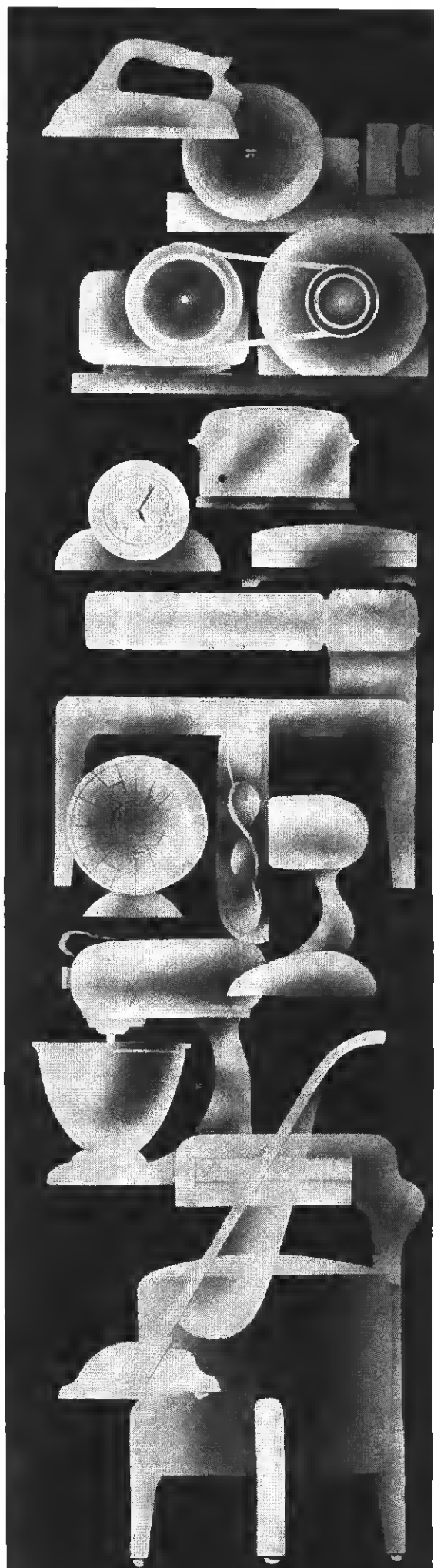

# Radio-Electronic Distributors

**Strive to Keep Radio Maintenance Men Supplied on the Home Front . . . Activities . . . Substitute Lines**

• Radio and appliance dealers and servicemen are doing their utmost nowadays to keep devices operating in the home.

Many manufacturers and distributors are doing an "ambidextrous" job—serving the war effort and doing the best they can for their accounts. Not only have most suppliers been called upon to furnish material for our war plants, but many have been set up as manufacturers.

The supplier in these times needs the patience of Job, the energy of a whirling dervish and the wisdom of Solomon. However, in common with the retailer and serviceman, he's doing his best. In the throes of present-day commercial confusion, the jobber does his utmost to service his accounts.

offer dealers is selling and technical help in sound systems. They make the necessary surveys and render valuable engineering advice. Edwards specializes in Stromberg-Carlson and Webster-Rauland. They also make frequent phone calls to dealers, as it is impossible to have their salesmen visit accounts consistently as they did in the past.

In South Bend, Indiana, Commercial Sound & Radio Co., 528 E. Colfax Ave., distributors, has given the newly formed Radio Servicemen's Club of Northern Indiana and Southern Michigan the latchkey to its front door. Here this club, now having over 45 members, meets to discuss wartime servicing problems.

Olsen Radio Supply, San Antonio, Texas, is doing its bit to keep 'em

its radio accounts supplied, but has been forced to curtail its radio service. In fact, a sign in the building reads: "Due to our inability to secure competent radio service men on account of defense program, we are temporarily discontinuing repair of any radio other than our own sets which come under the guarantee period."

Anchor Radio Distributing Service Co., Ithaca, N. Y., is featuring Aero-vox condensers, tubular type, in various capacities, Wright P-105 P.M. speakers, 5-inch, less outputs. They have been advertising black spaghetti tubing in 30-inch length at 11 cents, and Ken-Rad radio tubes.

## **American Wholesalers Appointed**

Appointment of American wholesalers, Fourth and Channing Sts., Washington, D. C., as exclusive distributors for The Crosley Corporation has just been announced.

American Wholesalers occupies an attractive modern fire-proof structure containing approximately 40,000 square feet. It is about eight minutes from the heart of the city's business district. Two additional floors can be added when required.

David L. Krupsaw, who heads American Wholesalers, has announced that his firm is well-equipped to supply genuine Crosley parts and complete service on household appliances, although new peace-time products will have to wait until the resumption of civilian goods production after the war.

American Wholesalers will display Crosley products in an expansive show-room, 85 by 40 feet, which is flooded on three sides with sun-light.

Many distributors have been cited for valuable contribution to the war effort, and many stories of such activities have been carried in RADIO RETAILING TODAY. One of the latest firms to be honored is the Braid Electric Co., Nashville, Tenn. A congratulatory telegram has been received from Lt. Gen. Brehon Somer-



Commercial Sound & Radio Co., South Bend, Ind., distributors, contribute their store as meeting place for the newly formed Radio Servicemen's Club of Northern Indiana and Southern Michigan. First row, left to right: John Pine, John Lackman, Jim Hester. Second row: G. Richardson, C. S. Wambau, Leo Weiser, Otto Dovenuehle, Elbert Lear, E. B. Dare. Third row: Harvey Gobels, C. Thwaits, C. Kindig, K. Fisher. Behind counter: C. Palmer, H. Feingold, Jim Davis, A. E. Kester, R. P. Tate.

W. H. Edwards Co., 94 Broadway, Providence, R. I., who cover all Rhode Island and southern Massachusetts, have a very large radio stock, and are doing all they can to help the dealer get critically needed supplies. They also maintain an up-to-the-minute repair department for radio men. Another feature they

playing. This supplier is always on the lookout for tubes and parts for the service man.

Sager Electrical Supply Co., 201 Congress St., Boston, one of the largest organizations in New England, finds that about 90 per cent of its business is being done on priorities. This firm is doing its utmost to keep



# Serve

vell, commanding services of supply abroad, addressed to Ben S. Gambill, Braid president.

## 60,000 Names on File

Operating as a separate business, but utilizing a large portion of the building once exclusively occupied by Apollo Service, Inc., 15 Shipman St., Newark, N. J., some of the officials connected with Apollo have set up a war manufacturing plant, where they are serving as sub-contractors to several large manufacturers. The manufacturing business is operated by David Slobodein, Fred Goldberg and Charles Marti. The latter will be remembered as a pioneer radio manufacturer.

Apollo Service reports fair supply of parts on hand. They do service work for the dealer, and keep three girls busy on their filing system which has over 60,000 names of customers of dealers. This business was established in 1922, and normally distributes Crosley radios and refrigerators, Apex laundry equipment, White sewing machines and Royal vacuum cleaners. There are about 38 people employed by this organization. An official of Apollo states that they are bending every effort to keep up efficient service on the many appliances their dealers have sold in the past.

## Offer Non-Critical Items

Preference to electrical, hardware and other appliance distributors on all products now sold by the Tennessee Valley Associates, Nashville, has been announced by Wheless Gambill, Jr., an official of the firm. The purpose of this plan is to hold together the distributor-selling organization which, in the past, has sold such top-line items as Economaster heaters, Ventilair fans and room coolers, Stakool fans and Moist-Aire air conditioners, and which, in the postwar period, will offer a very extensive line of new appliance items, now under intensive study and development.

During the present war period,



Anchor Distributing Co.'s William C. McClelland, recently appointed sales manager for this Pittsburgh firm.

Master Combustors, Stiglitz and Kol-Gas Coal Heaters, and Kimsul insulation. The Kimsul business alone recently approximated 400,000 square feet for one month. This company also distributes toys, games, dolls, housewares, mirrors, pictures, china, glass and giftware. Anchor has just announced the appointment of Wm. C. McClelland as sales manager.

Anchor maintains a large service department for the major appliances it normally distributes, which includes Crosley radios and refrigerators, Apex washers, ironers, vacuum cleaners, White sewing machines and other nationally known lines.

There is considerable dealer activity in the Philadelphia area. Motor Parts Co., 1229 No. Broad St., Zenith radio and Columbia record distributors, have taken on song folios and music albums of the Cole Music Publishing Co., Chicago.

## New Service Dept.

G. E. Reid, for many years manager of the service department of Judson C. Burns Co., G. E. distributors, has been made manager of the new General Electric Appliance Service Center at 31st and Oxford Sts. The new service center, centralizing all G.E. work in the Philadelphia area, employs 35 persons and occupies the entire 42,000 square feet of the four story building.



Distributor Harold Olsen (right) and friends. Owner of Olsen Radio Supply, San Antonio, he occasionally has an opportunity of upholding Texas tradition of "riding the range."

# RADIO TODAY— Across the U. S. A.!

**SAN FRANCISCO, Cal.**— Though this area is gravely affected by critical labor shortage, scarcity of radios, tubes, replacement parts, many alert dealers are coping with the problems successfully. Those who survived the impact of wartime conditions either had sufficient foresight and capital to invest heavily in radios and parts, or were willing to change their merchandising habits; introduce goods fashioned out of non-critical material.

Sherman, Clay & Company, Kearny and Sutter Streets, the West's foremost music house, belongs in the first category. There fine radios and radio-phonograph combinations are still available. But, according to W. J. Lee, merchandise manager, the firm is operating on a voluntary quota basis. Only a certain amount of radios are sold each month. Also, due to the fact that the majority of experienced radio repairmen had been absorbed by the armed forces, Sherman, Clay has discontinued giving citywide radio service except to established customers.

Christophe's, 2338 Mission Street, was among the first to decide on a conversion program. For over 30 years the firm had dealt in radios, electric refrigerators, records, musical instruments, and also conducted a large service department. When last summer the stampede started for radios, Mrs. Christophe, owner of the establishment, looked around for some other type of merchandise to replace her rapidly depleting stock; the choice fell on art objects. The experiment was started on a modest scale. Public reaction was so favorable that the art department is next in importance to the very active record department. Good, reconstructed radios also prove a lucrative side-line. Radios are still accepted for repair but service had been very much streamlined.

Dealer receives his allotment of refrigerators from a recent government release. Happy at the lineup is Earl Grady, before his shop in San Rafael, Calif.

**BIRMINGHAM, Ala.**— Radio dealers in this area are finally and completely out of radios to sell. Phonograph combinations seemed to last the longest, but they are gone now. A very few used sets are on the market, but not many.

Where radios were formerly displayed, Pizitz Department Store of this city is now displaying prefabricated chicken houses. However, that is just one substitute line. Phonograph records, sheet music, musical instruments, kitchen cabinets and ice boxes are also sold.

**WILLIAMSPORT, Pa.**— People with music problems go to Kaseman Music Store, 13 E. 3rd St., and Harry C. Kaseman, the proprietor, who has been selling radios, refrigerators, records, pianos and other musical merchandise, is in a position to advise them, because he has been teaching music for 25 years, and has built up a large following. He founded the business some years ago, and before the war served as the director of a WPA musical project. Mr. Kaseman is associated with all musical activities in his community, and is a member of the National Association of Music Merchants. At present he is doing remodeling work in his store, segregating popular and classical record departments so his customers can make selections with greater ease.

**PROVIDENCE, R. I.**— Anderberg's, 34 Broadway, owned by Arthur Anderberg, who has been in the radio and appliance business in this city for 20 years, is now specializing in repairing laundry equipment for customers, and for resale. This firm does not deliver, yet customers bring in or send via trucking companies, large washers and ironers. Anderberg formerly had 7 service-salesmen. These were all "combination" men. They called on prospects and urged trade-in sales. If unable to sell new equipment, they sold overhaul jobs. Just before the war, Anderberg counted his gross sales \$57,000 for one year in Speed Queen, Bendix and Blackstone laundry equipment. He also has sold GE refrigerators, Maytag and Ironrite appliances and Simplex commercial ironers. He is preparing to engage actively in appliance sales when the war is over. His motto is "service first—sales will follow."

**BOSTON, Mass.**—Berman Radio Co., operating two stores, at 20 and 62 Stuart St., offers non-mechanical iceboxes and Magic-Aire vacuum cleaners, and has about 200 of the latter on hand. There are also a few big radio sets on the floor. Berman's is jammed with service work, and has difficulty getting help. A girl is now employed to help repair the sets. Leo Berman, owner, com-

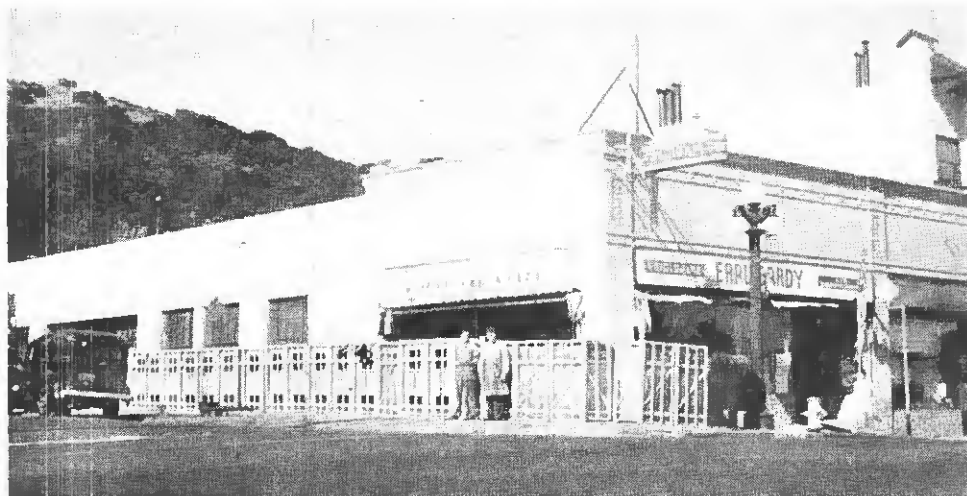



menting on the large sets many dealers have, says people don't want to tie up much money in such receivers now because they feel that the sets will be obsolete in the postwar period. Mr. Berman says, however, that these big radios will sell because diminishing stocks will force those without radios to buy them eventually. Berman's, established in 1918, is now marking time, says the owner, and is primarily interested in maintaining its identity through service, to again become actively engaged in the postwar selling field. Eli Berman, brother of Leo, and former partner, now holds an important teaching position at M.I.T.

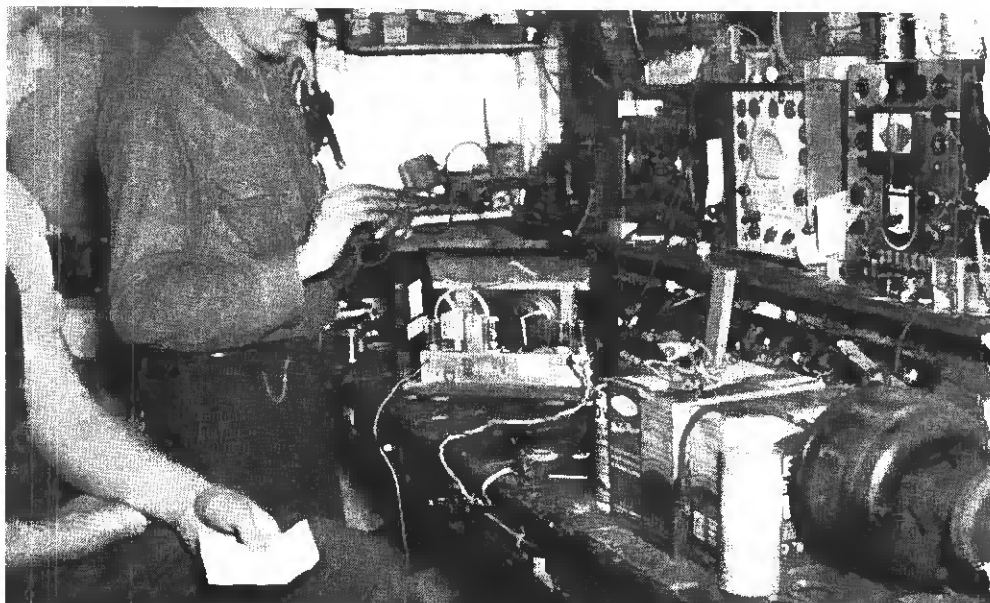

Busy radio bench of N. T. Tidwell, radio service manager for Doss, Hartselle, Ala., shows him supervising one of his schoolboy helpers in foreground.

**MOUNT HOREB, Wis.**—Shortage of help has forced Roy and John Beat, owners of the big Mount Horeb Hardware Co., to do a lot of their own service work on electrical appliances. At the present time, two high school boys are being utilized on some of the service and sales work. New lines at the store include dining room furniture, additional farm hardware, storage cabinets and bulk greases and oils for the farm trade.

E. Gilbertson, Gilbertson Hardware, Mount Horeb, has a fine repair department which is now handling anything from fishing reels, guns, kerosene stoves, and appliances to soldering milk cans. Mr. Gilbertson handles all this work himself, while his wife takes care of the store trade. To fill the former appliance space in the store, the Gilbertsons have added dishes and fancy pottery and gift ware. Sales have gone steadily ahead on these new lines, Mr. Gilbertson reports.

**SYRACUSE, N. Y.**—Roy Stage reports that the best possible new business for a radio dealer to go into is Model Airplane Retailing. Roy has handled both solid and flying models for over a year before the war caused radio production to cease.

Roy says model airplane kits and supplies are plentiful and there will be no rationing on this merchandise because the government wishes to stimulate rather than break down interest in aviation on the part of as many citizens as possible.

**TOLEDO, Ohio**—Mr. and Mrs. Roy L. Randolph, 718 Oak Street, are an excellent example of the kind of team successfully operating a small business profitably in war time. She does the inside or store work and he does the outside work.

In the past Zenith, Philco and Westinghouse appliances were sold. Today, however, floor coverings, Kemtone, glass dishes, Silex coffee makers and furniture are merchandised. Radio and appliance service produces the chief income though. The merchandise pays the rent and the other overhead, Roy Randolph stated. Mrs. Randolph is an outstanding phone sales person, he beamed. On account of limited floor space only a small stock of furniture is on display in the store. Prospects are taken to the local wholesale house to inspect the goods and make their selection. The store still has a few radios, sinks and other short merchandise.

However, a considerable stock of used radios is stored in the Randolph residence near by. Roy plans to recondition these in time for fall and holiday trade. The store is only one-fifth large enough for today's demands, he stated. After the war he expects to expand.

**BALTIMORE, MD.**—In keeping with the growing shortages on merchandise, Hecht Bros. Co. has consolidated its radio-record activities of its branch store, at Franklin and Howard Streets, with that of its main store at Baltimore and Pine Streets, it has been announced by Joseph Hoffman, radio-record activities man-

ager of both stores. He will direct the consolidated operations at the main Baltimore and Pine Streets store.

Hecht Bros. Co. has for years been Baltimore's largest and leading retailer of radios, selling as high as 300 sets a week. But after radio production halted and stocks began growing lower with no chance of replacement, more and more attention was given to records, and today it is centering its activities on records in its radio-record department.

**UTICA, N. Y.**—Rexall Radio Stores believe that one picture is worth a thousand words. In their wartime ads in telephone directories and newspapers, they feature the photographs of Lewis W. Simon, their operator. Simon is the author of a textbook on radio servicing. Rexall stores feel that a picture makes an ad stand out and that it inspires confidence in the minds of newcomers who are seeking radio service. They recommend this practice to other dealers.

**LAKE MILLS, Wis.**—Art Reide-mann, owner of Sacker's Hardware has established his own repair department. He can repair radios, appliances, kerosene and gas stoves, pumps, rifles, etc. This builds his store traffic. Wooden items such as poultry feeders' pails, tubs, coaster wagons, etc., as well as a big china and gift line, have been added to take the place of former appliance volume.

*(Further items on dealer activities appear in the main body of the book.)*

# Radio Retailing Today's FREQUENCY SPECTRUM

of Radio-Electronic Maintenance

Showing representative electronic tubes and devices that operate at the various frequencies

SUPPLEMENT TO RADIO RETAILING TODAY, SEPTEMBER, 1943. COPYRIGHT BY CALDWELL-CLEMENTS, INC.

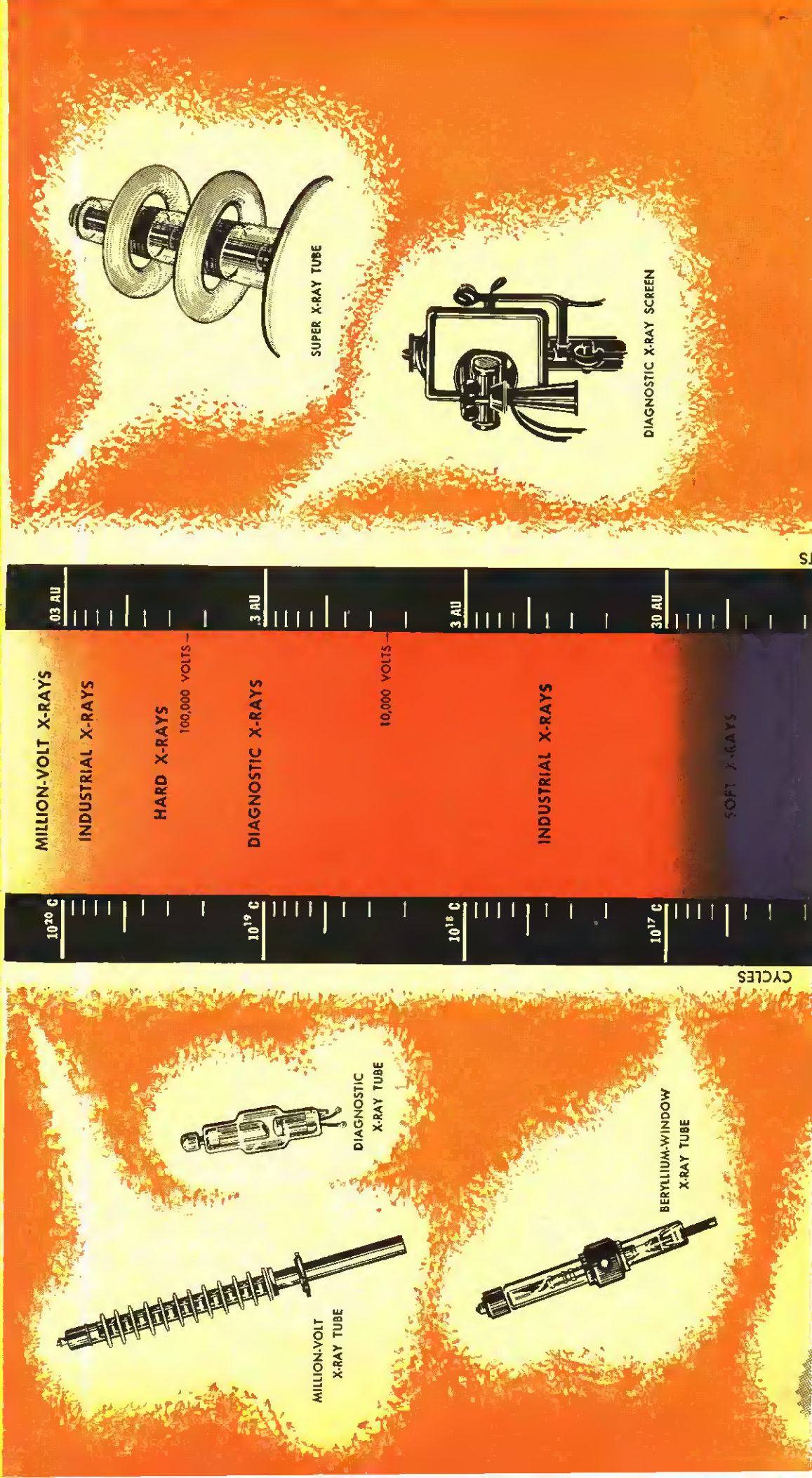



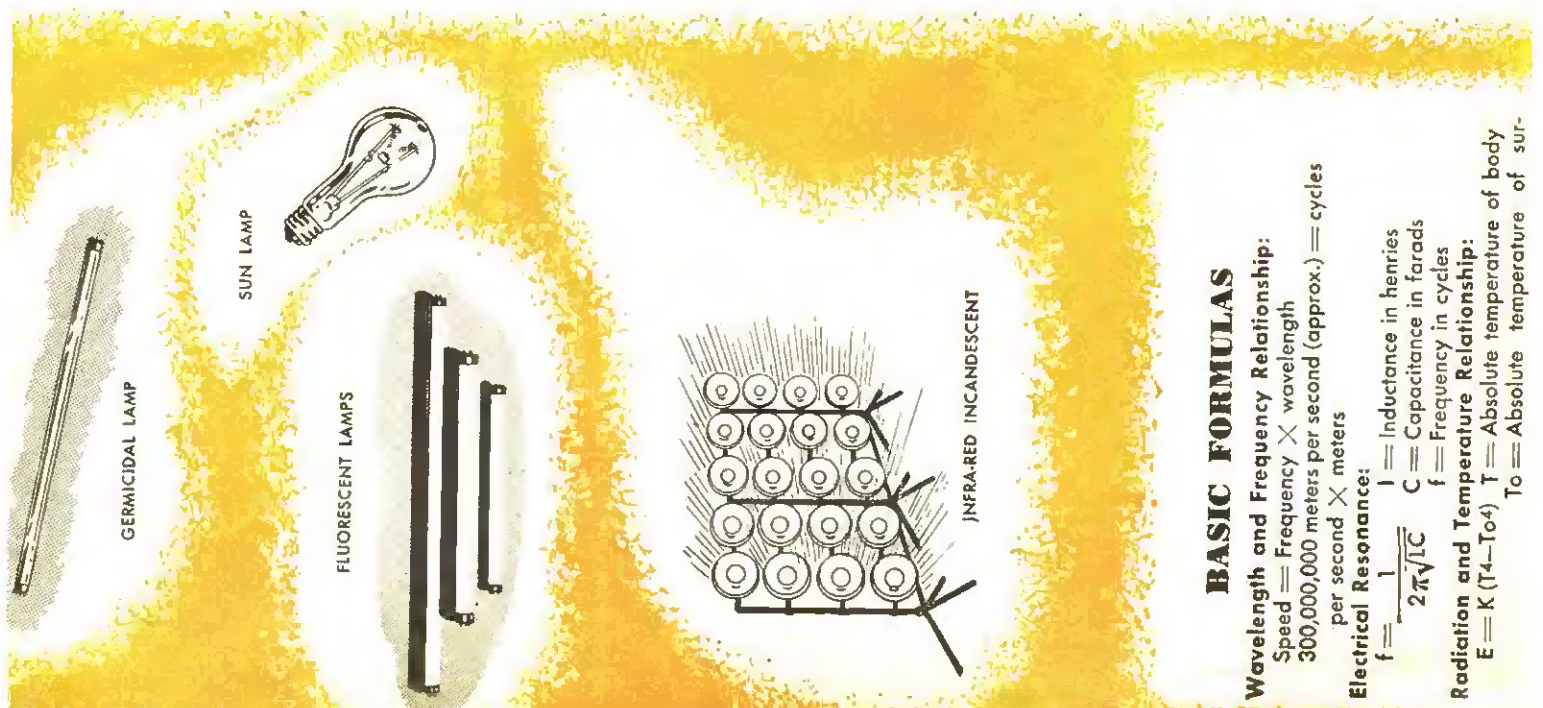

GERMICIDAL LAMP

SUN LAMP

FLUORESCENT LAMPS

INFRA-RED INCANDESCENT

**BASIC FORMULAS**

**Wavelength and Frequency Relationship:**

Speed = Frequency  $\times$  wavelength  
 300,000,000 meters per second (approx.) = cycles per second  $\times$  meters

**Electrical Resonance:**

$$f = \frac{1}{2\pi\sqrt{LC}}$$

f = Frequency in cycles  
 L = Inductance in henries  
 C = Capacitance in farads

**Radiation and Temperature Relationship:**

$$E = K(T_4 - T_0^4)$$

E = Absolute temperature of body  
 T<sub>0</sub> = Absolute temperature of sur-

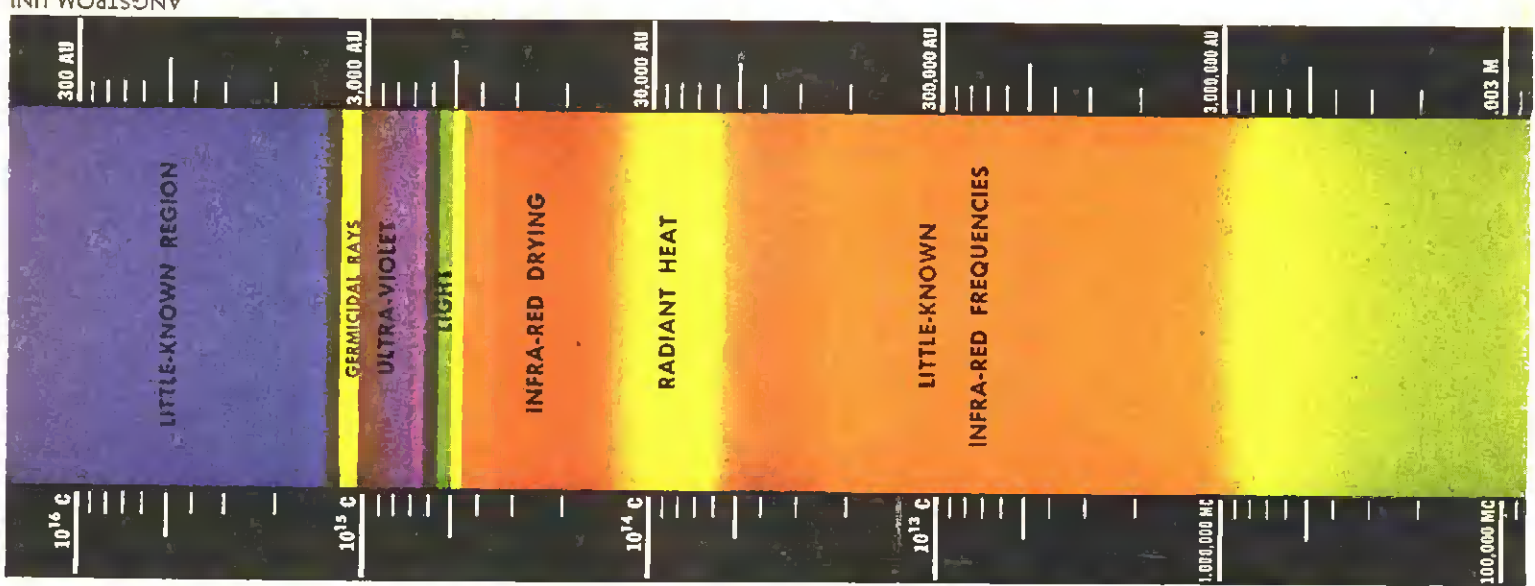

ANGSTROM UNIT

300 AU      3,000 AU      30,000 AU      300,000 AU      3,000,000 AU      903 M

LITTLE-KNOWN REGION

GERMICIDAL RAYS  
 ULTRA-VIOLET

LIGHT

INFRA-RED DRYING

RADIANT HEAT

LITTLE-KNOWN

INFRA-RED FREQUENCIES

$10^{16}$  C       $10^{15}$  C       $10^{14}$  C       $10^{13}$  C      1,000,000 MC      100,000 MC



PHOTOCELL



THERMOCOUPLE BULB



PYROMETER

**REFERENCE CONSTANTS**

**Speed of Electromagnetic Radiations:**  
 299,776 Kilometers per second = approximately  
 186,000 miles per second

**Velocity of Sound in Air at 32°F. and 1 Atm.:**  
 331.1 to 331.8 meters per second  
 1086.3 to 1088.4 feet per second

740.6 to 742.1 miles per hour

**Charge of Electron:**

4.8025  $\times 10^{-10}$  electrostatic units

9.1066  $\times 10^{-28}$ g

**Mass of Hydrogen Atom (1H) (light Hydrogen):**  
 1.6734  $\times 10^{-24}$ g

Planet Earth



rounding walls

- K = Constant depending upon nature of radiating surface
- E = Total energy radiated by body
- Wavelength of an Electron (Fundamental of the Electron Microscope):  

$$\lambda = 12.2 \sqrt{V}$$
- Wien's Law (Wavelength — Temp. Relationship):  

$$\lambda_m T = \text{a constant}$$
- $\lambda_m$  = Wavelength in microns corresponding to the maximum of the energy curve of radiation
- T = Absolute temperature



DISK-TYPE TUBE

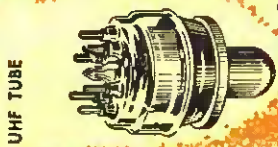

UHF TUBE



INDUCTIVE-OUTPUT TUBE

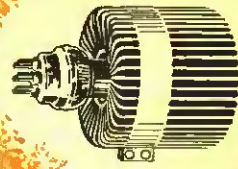

UHF TUBE

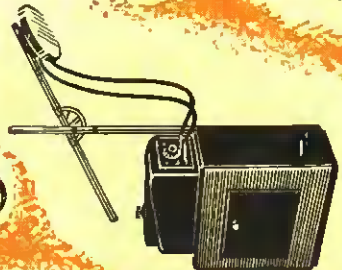

INDUCTOTHERM

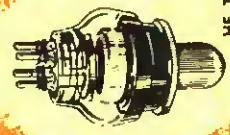

HF TUBE

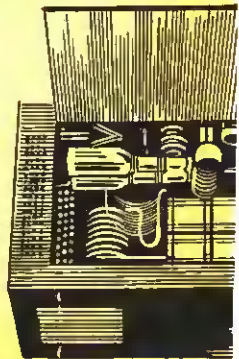

LITTLE-KNOWN

RADIO FREQUENCIES

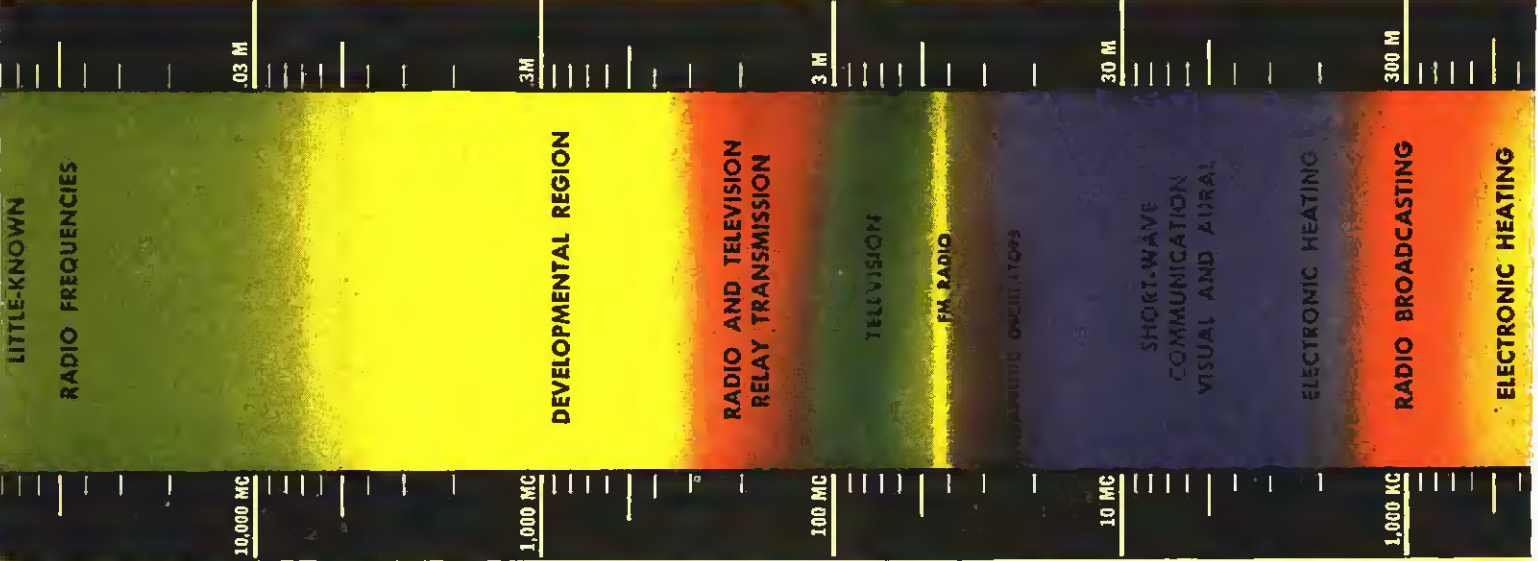

- $6.624 \times 10^{-27} \text{ erg} \times \text{sec.}$
- Wavelength of Red Line of Cadmium:  
6438.4696 Angstroms
- Absolute Zero:  
-459.7° Fahr. = -273.16° Cent.
- Units of Length:  
1 mm = 107 Angstrom = 103 Micron  
1 cm = 108 Angstrom  
1 Micron = 1/10,000 of a cm  
1 Angstrom = 1/100,000,000 of a cm
- Units of Frequency:  
1 Kilocycle = 1000 cycles  
1 Megacycle = 1,000,000 cycles
- Units of Power:  
1 kilowatt = 1.341 horsepower  
1 kilowatt = 3413 Btu per hour  
1 kilowatt = 860 kg-calorie per hour

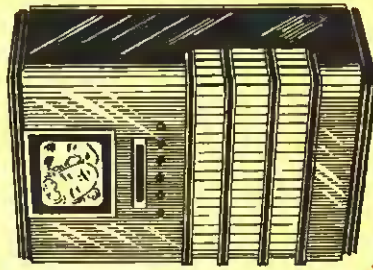

TELEVISION SET



SW RECEIVER

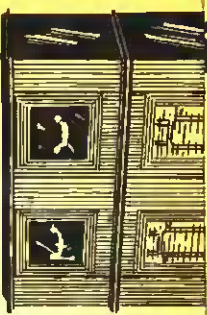

METERS

CPS



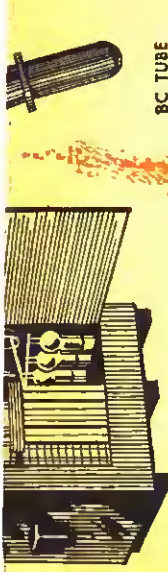

POWER OSCILLATOR

BC TUBE



POWER LINE COMMUNICATION

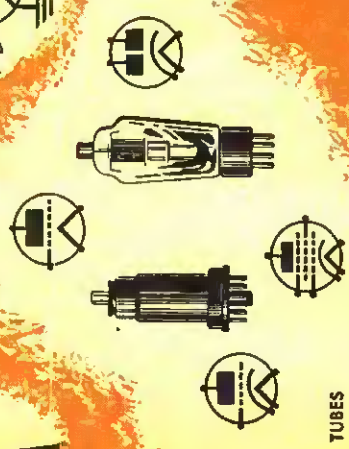

TUBES

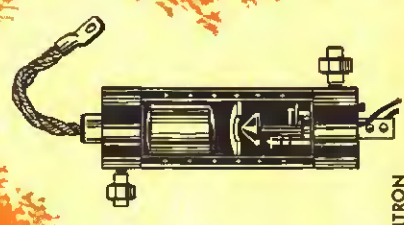

IGNITRON

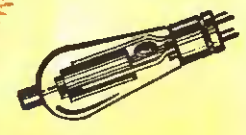

THYRATRON

SEA AND AIR  
NAVIGATIONAL AIDS

SUPERSONICS

POWER-LINE  
CARRIER-CURRENT  
APPLICATIONS

AUDIO FREQUENCIES

POWER TRANSMISSION  
AND DISTRIBUTION

SUBSONIC

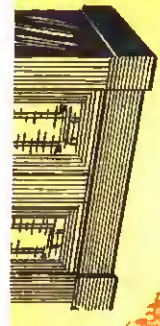
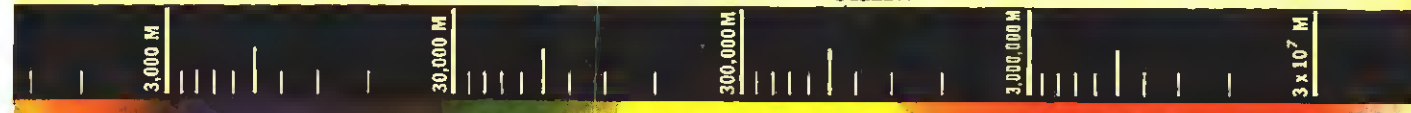
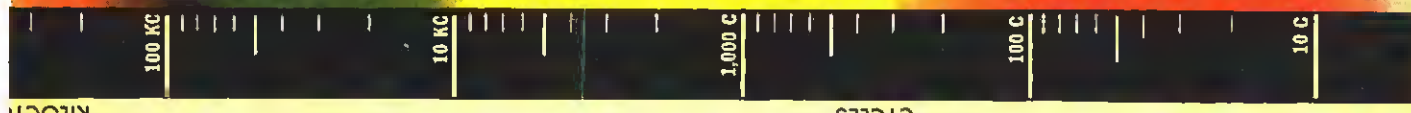

HOME RADIO

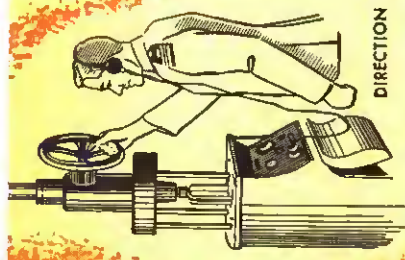

DIRECTION FINDER

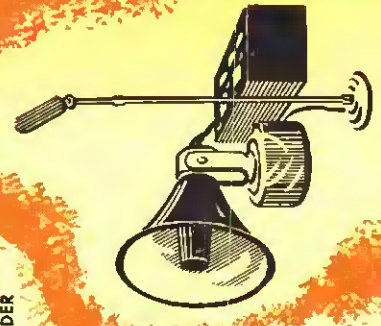

P.A. SYSTEM

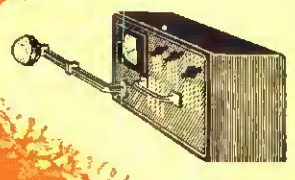

SOUND-LEVEL METER

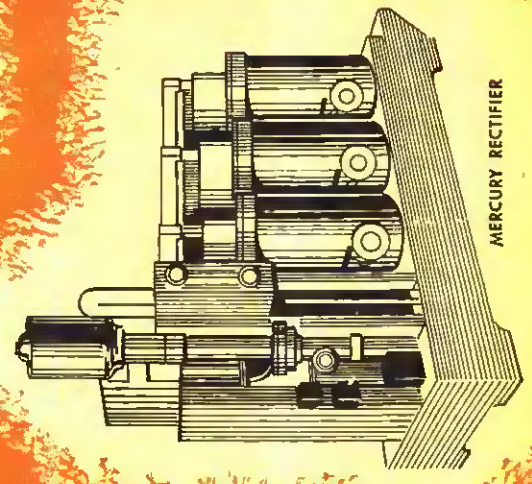

MERCURY RECTIFIER

WAVELENGTH

FREQUENCY





*Gita Rosova,  
sales assistant  
and trained  
musician*

*Madeleine Steele,  
buyer and  
music lover*

*Dorothy Foster  
sales assistant  
and musical  
interpreter*

## **Selling the Classics**

**Wurlitzer's New York store record buyer, Madeleine Steele, and her two sales assistants keep the classic discs whirling from shelf to customer. Turn the city's largest stock of chamber-music recordings into sales**

• While Wurlitzer's New York store carries almost every item in the musical line from the jugarina to grand pianos, our chief interest was their record department. Headed by Miss Madeleine Steele, buyer, who is aided by her two assistants, Miss Gita Rosova and Miss Dorothy Foster, Wurlitzer's record section is a busy one.

Miss Steele, whose home town is Chicago, and who comes from a music-loving family, has been in the merchandising field for several years. Originally selling records, she has also sold radios, until set manufacture for civilians was discontinued, and now is back in record sales once more. Her belief from observation of customers' buying habits is that record sales will continue just as heavy in the postwar period as they are now, and will be just as popular then as in the pre-war period.

### **Stock Variety**

Currently commenting, Miss Steele advocates plenty of variety in the selection of stock. This is carried out at Wurlitzer under her direction. The department contains the means

of satisfying the widest tastes. Stock exhibits a sweeping variety—from several types of children's nursery-rhyme records and "talking books," talks to scouts with accompanying books, young peoples' lessons in languages, boogie-woogie, "classical jazz," popular classics, and all types of classical recordings, right on up to record albums of music for use over public-address systems in funeral establishments.

### **Display Vital**

Display is Miss Steele's next strong point which she stresses in her own department. Attractive self-service racks are arranged between the counter and the listening booths, with stock of the most popular leaders directly behind the counter, and album storage accommodated in two compact, shelved rooms at the end of the section. Arrangement facilitates selling, she claims, and the maintaining of properly filled display spaces is paramount. At the rate record sales move stock, the constant rearrangement of new stock must be carried out without delay, and strict attention to keeping the section in good

order, keeps the entire staff busy.

Frequent arranging also provides a means for knowing just how fast different types of merchandise are moving, and is an aid not only to future buying, but also in keeping entirely familiar with a big "variety" inventory.

### **Know Your Public**

Knowing your public is also vital to keeping record sales moving to the highest degree of profitable turnover in sales. In Wurlitzer's New York store, located on 42nd St. between 6th Ave. and Broadway, this is not an easy task. But these three record saleswomen—even in this changeable traffic area—know their customers and their tastes.

In cases where the sales clerk is not familiar with the purchaser, she is quick to discern the buyer's tastes and from this knowledge can quickly suggest satisfactory substitutions, should the pressing called for be "out of stock."

In these times of shellac shortages, it is a factor in increased sales to be able to intelligently offer to supplement the buyer's request. The Misses



Foster and Rosova, being musicians in their own right as well as good sales persons, can easily suggest similar recordings to the "out-of-stock" disc requested, and be fairly sure of making a "substitute" sale with which the customer will be equally pleased.

#### **"Put-Away" System**

Miss Steele's recommendation "knowing your public" has the further basis of her pre-war record selling days in a smaller city. There it was much easier to know your customers, Miss Steele states, and she often found that this knowledge paid dividends in sales on the "put away" basis. Familiarity with an individual customer's music preferences meant she could phone him on receipt of new merchandise and offer to hold particular recordings until the customer could get to town to make the purchase.

#### **Current Music Trends**

Current trends in music as reflected by the public's buying shows a definite rise in the sale of the classics. "There is a rush on the part of the public to buy the standard classics," Miss Steele declared. "In addition to having an extremely ample stock of this type of music, we also have one of the largest and most complete collections of chamber-music, in

which we have a healthy turnover, but—it has to be 'sold'!"

#### **Selling Chamber-Music**

The average investor in the "standard" classics is not as a rule familiar with nor has as yet developed a taste for chamber-music. Miss Steele starts right here to make the effort to sell through educating this customer from the beginning. Knowledge of his selections in "standard" classics guides her in her recommendation of chamber-music. The next step is to feature the melody, choosing that kind of chamber-music which features melody rather than technique. The artist is also stressed by suggest-

ing to the buyer discs by the more widely known musician. An example of this is the Schubert Trio No. 1 in B Flat Major (Victor Album 923) which features Rubinstein, Heifetz and Feuermann or the Budapest String Quartet's recording of Quartet No. 11 in F minor, Opus 95 (Columbia Set 519).

#### **Popularizing Sonatas and Concertos**

Next in expansion from the symphonic, operatic and chamber-music records is the exploration into the realm of sonatas and piano concertos. The general public's interest in piano concertos is usually stirred most by the current method of popular band leaders' semi-jazz orchestrations of famous Tchaikowsky and Grieg themes, and purchasers' interests can be widened by introduction to the classical recordings of these original renditions, branching out to other records in the same category.

#### **Enlarging the Record Library**

When a customer has established a basic foundation for his record library with the "standards," one of the most frequent questions is: "What next should be added?" Miss Foster has a system in selling this particular customer. Simplification is her motto. A musician, herself, and student of  
(Continued on page 36)

## **WHEN YOU ARE SELLING THE CLASSICS**

**Know Your Inventory**

**Know Your Music**

**Know Your Customer—**

**His Tastes and Education in Music—**

**What He Has Bought—**

**What He Intends to Buy—**

**All These Points Are Important to Help You Make That Sale; and, Through Arousing Your Customer's Interest, to Suggest Future Sales and Insure the Customer's Return**

Interior view of Wurlitzer's Record Department at 120 West 42nd Street, New York City





# What's Ahead in Record Sales

**Leonard W. Schneider, Decca Executive, Answers Queries Now in Many Dealers' Minds**

Based on recent conversations with dealers, and in the interests of its readers, RADIO RETAILING TODAY formulated the following questions which were asked of Decca's Leonard W. Schneider. His answers are given below. In a sales executive position with this large recording firm, Mr. Schneider keeps close contact with its dealer pulse, and graciously consented to give this information we requested as being of interest to record retailers everywhere.

*Q: What is the answer to the statement of some dealers that the current record boom is a war baby—scheduled to fade out with postwar?*

A: So far we have not heard comments of this kind from any of our dealers. The fact that before the United States entered the war we were doing the biggest business in our history seems to weaken the statement

that "the current record boom is a war baby."

*Q: What should dealers do NOW to promote continuance of record sales in postwar on a permanent basis?*

A: Since 1934 Decca has consistently recommended that dealers install self-service fixtures as the most economical way to do the largest amount of record business. There is no reason to believe that postwar conditions will do anything but confirm us in our advocacy of self service.

*Q: How can the average dealer install self-service most advantageously?*

A: Without giving detailed instructions on setting up a record store for self-service, we can say that it is largely a question of adapting the right kind of racks to the available space in the store. The independent retailers helped us pioneer in the development of the proper equipment and placement of units to obtain the greatest amount of visibility by the largest amount of store traffic, and some of the larger department stores have taken it on from there. It is

always our hope that dealers will feel free to call on any Decca salesman for assistance in installing self-service.

*Q: What are record manufacturers doing now to promote the profitable continuance of record sales in post-war?*

A: Naturally we have been aware of the trends in records and recording and continue to make our plans for postwar business. It is too soon to say what these plans are, but we expect to retain our present leadership in the field.

*Q: What are they doing to refute the occasional dealer's comment that juke boxes detract from his record sales?*

A: We have not heard this comment from a dealer since the very earliest days of our existence.

*Q: What does Decca advocate to the average dealer as best store layout to promote the highest record sales?*

A: The best store layout to promote the most sales of records would  
(Continued on page 36)





The ingenuity of Wilcox-Gay craftsmen has been geared to the development and building of weapons which are helping to win a United Nations Victory. Many new ideas that will benefit a peacetime world are being stored for the duration.



**WILCOX-GAY CORPORATION**  
CHARLOTTE, MICHIGAN  
Pioneer Manufacturers of Electronic Equipment

# PIONEERS IN RADIO BROADCASTING



**ORESTES H. CALDWELL, Editor**  
**RADIO Retailing TODAY**  
becomes No. 1 Veteran on Kaltenborn's list

## New Kaltenborn Roster

### Adds 28 Radio Veterans

#### to the Twenty Year Club

• The second roster of the Twenty Year Club has just rolled off the presses with 28 new members now numbered among radio's veterans. H. V. Kaltenborn, NBC's veteran commentator, who is founder of the club, published the work.

In all there are 112 members in the club. The club was founded April 4, 1942, on Kaltenborn's 20th anniversary as a news commentator.

Among the club's members are 17 who have been in radio for 30 years or more and five who have been in the industry for 35 years or more.

Orestes H. Caldwell, editor of *Radio Retailing Today*, replaces David Sarnoff, Radio Corp. of America president, as the mythical "Veteran of Veterans." Caldwell pioneered in radio transmission in 1904, while Sarnoff got his first job as junior telegraph operator with Marconi Wireless in 1907, according to the statement issued by the National Broadcasting Co.

The present occupations of the 109 living members cover the whole field of radio. Fifty-nine are executives; 27 engineers; nine radio editors; six performers; two are in the Royal Canadian Air Force; two are educational directors and one each is a radio psychologist, lawyer and auditor. And there is that one radio news commentator.

## RECORD SALES

(Continued from page 34)

be the one that displays the most records. This seems automatically to refer us back to self-service.

*Q: What is the public going to call for in music trend over the holiday season that dealers can start stocking now?*

*A: As in years gone by, dealers will want Christmas music for the Christmas holidays. This means not only Bing Crosby's "White Christmas" (No. 18429) and "Adeste Fideles" (No. 621 and No. 18510) but also albums such as Fred Waring's "'Twas the Night Before Christmas" (Alb. A-350); Dickens' "A Christmas Carol" (Alb. A-290); Bing Crosby's and Fred Astaire's performances of the hits from Irving Berlin's "Holiday Inn" (Alb. A-306); sets of children's records ("Mother Goose," "Nursery Rhymes," "Superman" and others); and certain "gift" albums such as Herbert Marshall's "The Count of Monte Cristo" (Alb. A-337).*

With production of records at its peak, manufacturers can expect difficulty in filling Christmas orders from dealers unless they have already made

provision for handling Christmas orders in advance. We did this by means of a sample order form and letter to our dealers, explaining the situation to them and suggesting that they devote some of their present quotas to Christmas merchandise beginning in August. We make partial shipments against these orders continuing up through the first week in December. Dealers are thus supplied with records for which they can anticipate holiday season requirements without last-minute confusion and without further taxing already heavily burdened production facilities.

*Q: How can the number of record players in American homes be increased in order to promote the sales of records. (There are 60 million radios in 30 million homes and only 6 million record players distributed in these 30 million homes.)*

*A: This question will have to wait until after the war, when production of record players is resumed, for its answer. We know there is an existing market for new record players to start with; naturally that is the market to supply first. Education of the non-buyers can follow later.*

## SELLING CLASSICS

(Continued from page 33)

the viola, she does not attempt to overburden her quarry with this fact. She uses this knowledge to make it easy for the prospective purchaser to make his own selection under helpful guidance. First, does the customer have a good representation in his collection of the "three B's"—Bach, Beethoven and Brahms? And in this connection does he have the greatest classics in each of these composer's works? Suggestion: (1) "The Victory Symphony" (Beethoven's Fifth Symphony)—Victor Album 640; (2) "Eroica" Symphony (Beethoven's Third Symphony)—Columbia Set 449. Next, in relation to Brahms, has the customer his four symphonies? Has he Schubert's "Unfinished Symphony"; Tchaikowsky's Fourth, Fifth and Sixth Symphonies?

Miss Foster then suggests the moderns. One of the most original, and a good starting point, is Shostakovich. Here the current popularity of the Russians is an evident and subtle selling point. Red Army Songs (Keynote) can be offered in this connection. Miss Foster recommends

(Continued on page 90)

## Radio-Electronic Maintenance Men—

### STUDY THE BIG FOUR-COLOR SPECTRUM CHART

sent as a supplement with this issue!

It shows the various frequency ranges, all the way from commercial alternating current and sound, on up through radio and television short-wave, to heat, light and X-rays, together with the electronic devices operating in each such range. Electronic devices are coming into rapid use in communication, industry, business, and everyday life. Before long you will be called upon to install and maintain some of these electronic devices. Get ready by reading the article on page 18 of this issue, to which the big, four-color chart forms a supplement. Study also future articles to appear in our coming issues on

"Radio-Electronic Maintenance"



# DELCO RADIOS

**"BATTLE-PROVEN" EVEN BEFORE WAR STARTED!**

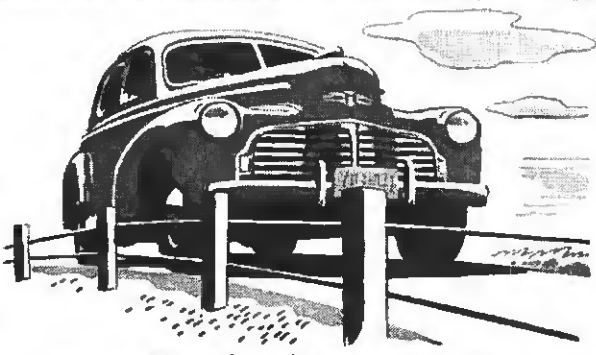

Proved on the highways of peace . . .



to serve on the battlefields of war



**Vibration—shock—intense heat and cold . . . Delco radios have been meeting these "war conditions" for years**

The physical beating dealt out to radio sets used in tanks, tank destroyers and other *mobile* units is old stuff to Delco Radio engineers. For years, Delco Radio has been a leading manufacturer of automotive radios . . . having solved such problems as shock—vibration—heat and humidity—extreme cold—electrical interference. True, such punishment is more intense on vehicles of war . . . but actually they're the same old problems that Delco researchers had to lick to make automotive radio practical.

The important point today is not that Delco Radio pioneered and developed automotive radios to equip America's leading cars. What is significant is that this experience in vehicular radio problems has enabled

Delco Radio, in cooperation with military technicians, to provide efficient inter-vehicle radio communication quickly.

The experience Delco Radio has gained down through the years thus helps speed the day of Victory . . . after which it will help enrich the days of Peace. Delco Radio Division, General Motors Corporation, Kokomo, Indiana.

**Delco Radio**  
DIVISION OF  
**GENERAL MOTORS**

★ ★ ★ ★ **BACK THE ATTACK—WITH WAR BONDS** ★ ★ ★ ★



# All Star Service



Above in "customer's-eye" view of the out-front service counter and repair department of Star Radio Co., Allston, Mass., with (left to right), Sumner E. Shikes and Melvin A. Shikes. Upper right, the owners of "Star" before their show windows.



Star Radio Co. was established 11 years ago, and has been selling records about five years. This business is booming today. There are three listening booths, and a convenient and attractive display setup designed by Shikes Brothers and built to their order.

The use of postcards to a prospect list has built up much record business. Star has cards printed with a blank space in the center. This space is utilized for frequently changed mimeographed messages carrying special items of interest to customers. Each message starts off with the phrase, "From the Desk of Kay Dunne." The latter is Star's efficient young lady who manages the record department.

Radio repair pick-up and delivery is carried out once a week. There are two service charges involved in this work—\$1.00 and \$1.50 depending upon the distance from the shop.

## Ideas Keep Sales Up

Star Radio Co. has a few large new receivers for sale, but they are moving fast because when customers offer the usual objection that \$150, for instance, is too much to put into a set they consider will be out of date if the war ends, Melvin Shikes points out to them that considerable time will be needed by the factories to get into normal civilian production again, and that spread over a period from the present time, to say, a couple of years hence, their investment is not a heavy one.

This firm, despite the fact that it's about ten days behind in repair work, cheerfully accepts more sets; treats the customer with extreme courtesy and consideration, and believes this formula is the best insurance for continued business growth.

• "We don't take advantage of the present acute situation by assuming an independent attitude toward our customers," Melvin A. Shikes, service manager and co-owner with his brother, Sumner E. Shikes, of Star Radio Co., 130 Harvard Ave., Allston, Mass., told a representative of **RADIO RETAILING TODAY**. "We keep our prices as low as is possible, and 'bend over backward' in keeping people so well pleased with our repair work now, that they'll come back to us for sales and service when the war is over and competition becomes keen again."

Star Radio boasts an attractive exterior and interior, and maintains interesting show windows, which are frequently changed.

You won't see any signs designating minimum charges in this shop.

"These signs create a bad impression and make the customer feel ill at ease, and the small amount of revenue derived from charges for testing in the shop, or installing a tube is offset in many instances by the permanent loss of a customer," says Melvin Shikes.

The fair-dealing policies of Star have built an enviable reputation for the Shikes Brothers throughout a wide section of the state. They do service work for a number of radio

dealers, department stores and are official repairers for several large manufacturers.

All of the tubes they have to sell to customers are plainly displayed on shelves in the show room. Tubes used exclusively for their repair work are kept in storage, out of sight. This prevents misunderstandings with customers who might want to buy tubes being reserved for service work. Another policy is to sell batteries only to service people.



Star Radio's booming record department. Chief source of sales revenue, records tie in well with this radio retailing business. Attractive racks shown here were designed by the Shikes Bros.





## Remember radio's first BEAM-A-SCOPE?

Another G-E "first" that helped sell hundreds of thousands of radios . . . and, after the war, General Electric's new and improved Beam-a-scope will be an even greater sales feature for you!

YOU BET you remember General Electric's first built-in Beam-a-scope. It was the talk of the radio world back in 1938.

But you haven't seen — or heard — anything yet! Just you wait — until after the war — and General Electric will bring you an entirely *new* Beam-a-scope.

The post-war Beam-a-scope will give G-E radios top performance . . . will increase pick-up . . . will mean even more satisfied customers.

Sounds good by itself, doesn't it? But there will be *more* important improvements — *more* strong sales features — when General Electric — after the war — brings out the finest new line of home radios you ever sold. *Electronics Department, General Electric, Bridgeport, Conn.*

---

Tune in "THE WORLD TODAY" and hear the news direct from the men who see it happen, every evening except Sunday at 6:45 E.W.T. over CBS. On Sunday listen to "The Hour of Charm" at 10 P.M. E.W.T. over NBC.

# GENERAL ELECTRIC

175-B10

GENERAL ELECTRIC IS BUILDING MORE MILITARY RADIO EQUIPMENT THAN ANY OTHER HOME-RADIO MANUFACTURER

# Keep In The Public Eye!

## What Radio Men Find to Sell and Say About Their Work and Goods Despite War Shortages

• Advertising in wartime has many values in its favor, and the greatest of these is the advantage of keeping before your customers the fact that you are still in business, in spite of existing circumstances which might well argue that you have had to "give up"!

Looking around the country we see—from Pennsylvania to Utah, with stopovers in between—that retailers find bonafide use for advertising in the local newspapers—and plenty of different ways of "saying it."

### "Commentator" Style

A Dodgeville, Wis., dealer has adopted the newspaper "spot" commentator style, which people interested in radio will form the habit of looking for periodically. This dealer's name becomes associated in the reader's mind as a part of the community—specifically his "radio man" in that locality.

United Music Store, Toledo, Ohio, uses ten inches on record advertising in the form of record reviewer's column. Heading it "Listen—Disc-Data by Eulalah Overmeyer," they feature notes on current popular releases by Miss Overmeyer, head of their record section.

Reflection of the choice made by

dealers in alternate lines is seen in ads (which appeared in as widely separated communities as Peoria, Ill., Salt Lake City, Utah, and York, Pa.). Records, and also our old-fashioned friend in modern dress, the non-mechanical icebox, get a big play.

Not the least of present radio-dealer advertising is the use of the want ad sections of the papers. For precise listing of available merchandise, specifically current, this section is a good choice. No "dolling-up" of the ad is needed, as it is in a section where the reader with a special and immediate need is looking for specific information.

### Movie Slides

One Union City, N. J., dealer had great success with the use of slides between features at the local movie houses. Using three theatres located at different points in his community, he found his customer list increased by approximately one-third at the end of a few months' time. Located in the city area, his new customers were from outlying districts, people who made regular "trips to town periodically for shopping and a movie" and found it convenient to bring in their sets for any needed repairs at the same time.

With change of address such a prevalent status in these days of inductions and shifting of commercial centers, it is good business in itself just to let your customers know you're still doing business at the same stand.

**RADIOS  
CAN LIVE  
FOREVER**

---

**OLD AGE**  
Causes Tubes to Lose Their  
Pep.

**TEMPERATURE**  
Changes the Chemical Com-  
position of Parts.

**MOISTURE**  
Causes Corrosion and Parts  
Electrolysis.

**MECHANICAL  
WEAR**  
Distorts Volume and De-  
stroys Good Tone.

---

When your radio needs  
service, phone and let  
us send for it, test it,  
and give you an esti-  
mate—

**WITHOUT COST**  
2 Trucks to Serve You

**RADIO  
HOSPITAL**

516 S 20TH ST.  
DAY 4-0937  
NIGHT 8-6885

**Radio Service  
Engineers**

When we repair  
your radio  
**—IT STAYS  
FIXED!**

**PHONE  
4050**

201 BROADWAY  
FARGO, N. DAK.

**Your Radio Is A  
Morale Builder**

Let us keep it in good  
condition for you.

**DIXIE**  
Radio Supply Co.  
1712-1714 MAIN ST.

Concise statement of a single idea . . . might provide the basis for a series. (Right hand ad is that of a Columbia, S. C., retailer; left, North Dakota is heard from.) Center: This Birmingham, Ala., dealer pictures for his potential customer the need for radio repair. Using large, clear type plus short words and sentence groupings, he insures readership through clarity.



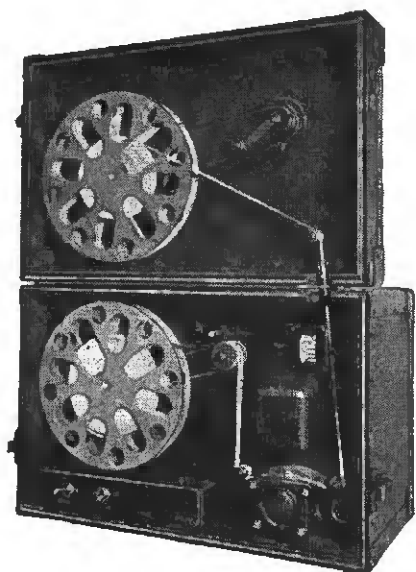

Men in our Armed Forces quickly learn how to receive international code on this Portable Keyer made by Waters Conley. It takes an inked record from paper tape and converts it, by the magic of electronics, into audible code signals.

This companion to the Waters Conley Recorder is another of the war-vital products that take all our time these busy days. But much of the knowledge and experience we are gaining in wartime will help to enrich civilian life when peace comes again... and will open profitable new markets for you.

Phonola

# Waters Conley

COMPANY

WATERS CONLEY COMPANY

*In peacetime, America's oldest and largest manufacturer of portable phonographs*

ROCHESTER, MINNESOTA

17 East 42nd Street, New York

224 South Michigan Avenue, Chicago

• A one-man service shop owner has some valuable tips to offer others in the business. Harold Drew, of Drew the Radio Doctor, 323 Whittle Ave., Olney, Ill., owns and operates the shop alone. Says Mr. Drew:

"Have been in the radio service business here in Olney, Illinois for ten years. I have had service men working for me at different times, but I find that I can make more money by myself. I built the new

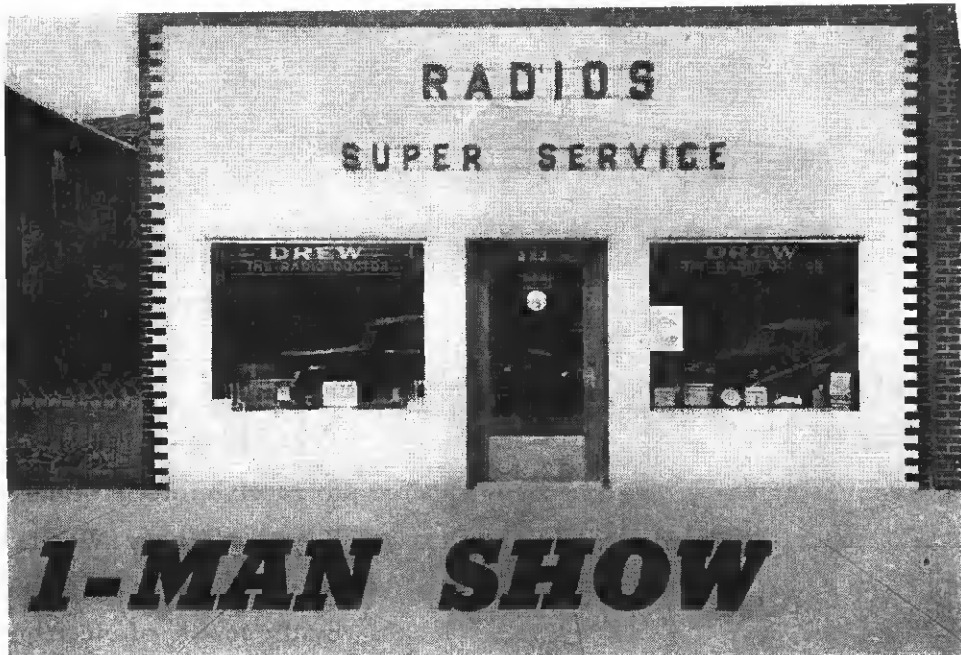

## Service's

## I-MAN SHOW

building two years ago. It is located on one of Olney's Main Streets, a town of approximately 7,000 people. I repair an average of ten to fifteen radios per day. Business has been good the year around. My test equipment consists mainly of the following: Precision 912 Tube Tester, Supreme Vedolyzer, Supreme Model 592 Push Button Set Tester, Supreme 561 Signal Generator, and other equipment which most good radio shops have. I use Rider's Manuals.

"Try to stock at all times parts and tubes sufficient to take care of nearly every radio repair that would be likely. I have always tried to keep my shop clean and attractive; not more than two repair jobs on the service bench at once. Frequently when I have time, test the tubes and suggest a tune up before the customer leaves. The tune up includes cleaning the radio and testing thoroughly to eliminate as far as possible a job

that would bounce. Every radio is put in first class condition, or needed repairs are recommended. My customers are always told what was wrong with their radio, and they get an itemized bill for work done. Then if future trouble develops, there is no argument as to responsibility. I respect my customer. A customer you keep is one you don't have to get another to replace.

"I believe any service man who is fair with himself will be fair and honest with his customer. I consider that there will come a time, maybe not far away, when repair jobs we are doing today may have a lot to do with the new radios we sell tomorrow. I have been able to buy a few small late models in the past months. A little advertising brings them in. They usually can be bought at very reasonable prices, and by reconditioning they sell at a nice profit."

"A postal size card is the most

profitable advertising I have used.

"Have in the past ten years had nearly 50,000 of similar postal card size ads distributed house to house in Olney and surrounding towns. Of course each distribution of cards is a completely new and different ad. Quite frequently I find one or more of these cards on or inside a radio. It is a good sign. Most radio service men are familiar with the tube situation at present, and I believe that with a little effort nearly all jobs that require an unavailable tube can be changed to accommodate another type which may be gathering dust on your shelf. From the beginning, I have sold radios as well as serviced them, and believe the two go hand in hand.

"It is often said that a good radio service man is not a good business man, and it is my opinion that whenever that is the case it is generally that he doesn't try to be.

"From the foregoing you may gather a few ideas I have gained in ten years of repairing and selling radios. The business has given me a lot. Have appreciated the opportunity to build from nothing to the finest radio service shop in my part of the state. To complete the picture, I feel certain that I have just started, because the new merchandise and opportunities to come will really give me, as well as every other serviceman, an opportunity to be part of an industry that as far as I can see has no limits to its possibilities."

Left, Harold Drew, the "radio doctor," owner of the spectacular one-man radio business described on this page. At top, his own building—"just what the doctor ordered."





*Combat is the toughest test*



**In the air, on land or at sea, combat is the toughest test for men and equipment**

Every day potentiometers, resistors, switches, headsets and other Utah-made products by the thousands are passing that test with flying colors. They have proved that the engineering which created them and the manufacturing methods which are turning them out in ever-increasing quantities are worthy of the fighting men who depend on those parts to do their jobs.

It is the same engineering staff and the same manufacturing facilities that will be converted to the development and production of the Utah products to meet "tomorrow's" needs.

UTAH RADIO PRODUCTS COMPANY, 810 Orleans Street, Chicago, Ill. Canadian Office: 560 King St. West, Toronto. In Argentine: UCOA Radio Products Co., SRL, Buenos Aires.

**PARTS FOR RADIO, ELECTRICAL AND ELECTRONIC DEVICES, INCLUDING SPEAKERS, TRANSFORMERS, VIBRATORS, VITREOUS ENAMELED RESISTORS, WIREWOUND CONTROLS, PLUGS, JACKS, SWITCHES, ELECTRIC MOTORS**



**CABLE ADDRESS: UTARADIO, CHICAGO**

Today, Utah Parts are in the thick of the fight. When "tomorrow" comes, they will be ready for the peacetime application of war-born electronic, radio and electrical miracles.



**UTAH RESISTORS** — are available from 5 to 200 watts — either as fixed, tapped or adjustable. Also non-inductive types.

**UTAH WIREWOUND CONTROLS** — rheostats, potentiometers, attenuators. Five sizes — from 3 to 25 watts.

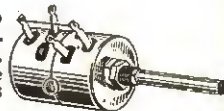

**UTAH JACKS** — Long and short frames and "imp" type jacks to meet your requirements.

**UTAH HEADSETS** — are giving non-failing performance on the fighting fronts.



**UTAH SWITCHES** — A Utah switch for every need — "Imp" Push-Button, Utah-Carter Rotary and Push-Button Jack Switches.



**UTAH PLUGS** — Two and three conductor types designed to meet your requirements, whether they involve application, size or shape.



# Factory "Broadcasting"

**Sound Systems for Radio-Electronic Specialists to Sell in Wartime**

## **What the Workers Hear—**

Brisk marches with good swinging rhythm.  
 Popular music recordings.  
 News events broadcast from local radio station.  
 "Personal news" about factory employees, weddings, new babies, birthday greetings, etc.  
 Letters from employees in the armed forces.

## **When They Hear It—**

6.55—7.05 a.m.—Marches  
 9.30—10.00 a.m.—Popular tunes  
 10.00—10:10 a.m.—News  
 11.30—12 noon—Popular music  
 12.55—1.05 p.m. Marches  
 2.00—2.30 p.m.—National and "Personal" news and music  
 3:35—4:05 p.m.—Marches

## **The Results—**

Basing figures on bonuses earned by workers as equivalent to the total work turned out, company made a test for 10 weeks, the figures following showing the percentages of bonuses achieved:

1st. week — 45.15%	6th. week — 48.41%
2nd. week — 43.66%	7th. week — 49.2%
3rd. week — 48.25%	8th. week — 47.42%
4th. week — 47.8%	9th. week — 49%
5th. week — 49%	10th. week — 51.8%

From figures compiled on actual experience in Operadio's St. Charles, Ill., plant.

At same time, rejects on final inspection dropped from 3% to 2.5% and wiring rejects from 3% to as low as .5%.



# RADIONICS

with its subdivisions of Electronics, Radio, etc.,  
calls for reliable Post War selling policies

**T**HIS IS THE FOURTH in a series of merchandising questions on post-war planning which we are raising for the consideration of the radio dealers of America to assist them in their post-war planning.

The future of the Radionic industry can be just as brilliant or as black as we choose to make it! Everything depends on the intelligence with which *you* and we plan for the post war period.

A good radio line deserves better from its makers than periodical mark-downs and yearly dumps. Yes, it's fun to gamble... we all like to do it... but it's a lot more profitable in the long-run to be a smart, consistent merchandiser and take a full profit the year 'round. Why live on cake and cream for half a year, then go on bread and water the other half? Why sell radio short?

You've all had dumps. You all know whose dumps they were. You've all worried about your overall profits and the standing of your instalment accounts when a dump struck the market like a cyclone! We *know* you don't like dumps—or Zenith wouldn't have grown to leadership as it did!

Zenith has never believed in policies that cause unexpected obsolescence and year end dumps. Zenith's long established selling policy is constructive, consistent, *insistent* on the year 'round profit for all who handle the line.

After the war, it is going to be *all-important* for you to deal with radio manufacturers whose production, selling, merchandising, and promotion policies stand the test of time.



The past is the indicator of the future. Once bitten—twice shy!

In your post war planning, add this check-up to the others Zenith has given you:

## Question:

"During the past decade, which brands of radios forced me to take the biggest end-season mark-downs, sales-pressured me into organized 'dumps', obsoleted my valuable inventory without mercy?"

## Check which:

- \_\_\_\_\_ My bug-a-boo dump line
- \_\_\_\_\_ More or less undependable
- \_\_\_\_\_ Somewhat better
- \_\_\_\_\_ Most stable year 'round policy-protected line.

The answers, put down by yourself, in black and white, should give you plenty of information on which to plan your post war thinking on *this one point alone!*

Zenith policy... in the past... and in the future... the line which maintains value and profit twelve months of the year. Zenith protective policies, backed by good merchandise, have inevitably brought the reward of leadership.

ZENITH RADIO CORPORATION, CHICAGO 39, ILLINOIS

**BETTER THAN CASH**

U. S. War Savings Stamps  
and Bonds

**ZENITH**  
LONG DISTANCE RADIO  
RADIONIC PRODUCTS EXCLUSIVELY—  
WORLD'S LEADING MANUFACTURER

# Electric Appliance Future

**Now Is the Time to Find Out What YOUR Prospective Electric Appliance Customer Will Want After the War**



Note: This sketch of refrigerator, eliminates all sections in order to show clearly the revolving shelves.

• So much has been said about postwar predictions that the dealer must at times feel a trifle dizzy when he tries to put himself in his prospective customer's place.

We find more and more evidence, however, that manufacturers are quietly but continuously trying to solve the problem of what specific improvements will be demanded by the public in postwar electrical appliances.

A recent and intelligent booklet crossed our desk from the General Electric Co., which attempts by the sliderule of hard fact to draft the potential buyer's needs of the future, when peacetimes will release the bottleneck of civilian supply and electrical appliances will blossom forth in new dress for the housewives of America.

Some of the improvements this firm is thinking about along the lines of refrigeration:

Will the prospective buyer desire a unit with revolving or sliding shelves—to kill the old bogie of getting at that jar of leftovers way in the back of the box. . . .

## **Ice-tray capacity**

With the prospect of increased use of frozen foods, will the householder rather pull out two of his ice trays to provide this stor-

age space, temporarily; or will he prefer to leave ice-tray capacity space intact, and have an added area in the top section made available. . . .

Will the postwar consumer be interested in low-temperature cabinets for home storage of frozen foods? This would allow variety of choice in foods, permit price saving via large package purchases, make possible in-season low cost purchase of meats, etc., for future use.

Will the future's farmer want a quick-freezing unit for home-grown foods? This manufacturer suggests a quick-freezing cabinet combined with a frozen food storage section.

Specific point of interest to the farmer—where the problem of daily feeding large groups of hired hands, along with their families, is added to the necessity for food preservation in large quantities for future use and future sale—is the further suggestion for a combination quick-freezing and frozen food storage unit, *incorporated* in a large refrigerator of "walk-in" proportions.

## **Distributed Refrigeration**

Getting back to the average family household of the future, designers have put forth ideas for kitchen-planning where the refrigeration unit is no longer one box, but conveniently distributed about the kitchen in units in the most convenient locations. Further, in this connection, is the most practical suggestion that all kitchen cabinet units have space-saving sliding doors, eliminating the old, awkward, hinge-type door, which steals floor space.

Stoves are also a source of study for possible improvements, and General Electric proposes a "high oven" model—which, while it subtracts from the amount of "table top" space of the stove when not in use, permits enough space for large roasts on special occasions, or the baking of several items at one time.

None of these suggested changes could be classed as utopian dreams, but appear to be along the line of practical help to postwar housekeeping.

## **Customer's Needs Important**

Your customers' opinion is what counts, however, and their reaction to this type of investigation into postwar electrical appliance possibilities is a healthy one.

How does your customer feel about electric blankets? Does she own one? Has she heard or read about them? Does she have friends who own one? Will she buy one when they are again available?

A simpler question and much easier to visualize, is whether or not the housewife of today, who will certainly be the housewife of the "future," prefers the open handled iron to the regular model released just before war restrictions set in.

The answers to these questions may mean the difference to the retailer at a later date between a "shopping inquiry" and a "sale" . . . time wasted in explaining you never heard of such a thing or money in the cash register! Now is the time to talk with your customers about what they would like to be able to buy after the war. Do a little dreaming of your own and try it on the practical housewife! And you'll get answers that may lead future sales successes for you.

---

**RADIO RETAILING TODAY'S EDITORS WILL WELCOME ANY SUGGESTIONS FROM READERS OBTAINED FROM THEIR CUSTOMERS AS TO WHAT THE CUSTOMERS WOULD LIKE IN POSTWAR ELECTRICAL APPLIANCE IMPROVEMENTS THAT DEALERS BELIEVE WILL SELL BEST. THESE SUGGESTIONS WILL BE FORWARDED TO MANUFACTURERS. THE EDITORS IN TURN WILL ENDEAVOR TO PUBLISH FROM TIME TO TIME THE MANUFACTURERS' REACTIONS TO THESE SUGGESTIONS, REPORTING ON WHETHER OR NOT THESE IMPROVEMENTS ARE POSTWAR MANUFACTURING POSSIBILITIES.**

---





**THERE'S A SOURCE . . . AND ONE WELL WORTH INVESTIGATING**

TAKE ONE of the first experiments in telecasting, for instance. A moving picture of smoke was transmitted successfully through space

That tiny puff of smoke started a bonfire. On Sept. 1, 1928,\* in a public showing before critical newspapermen of San Francisco, Farnsworth engineers first demonstrated their magical science. And it was acclaimed.

Dealers and distributors who saw radio sweep the country after World War I, and who have profited greatly from radio, are looking forward to television as the next billion-dollar industry.

Television will be fanned to full heat during the days that will follow Victory. *Today's radio dealers will be tomorrow's television dealers.* Marketing and servicing will be much like radio's.

For 17 years, Farnsworth engineers have pioneered in the development of this amazing new science. After Victory, there will be television equipment for commercial, institutional and industrial jobs. Eventually, there will be television for every home.

Today, naturally, all Farnsworth production is aimed at precision devices that serve as the eyes and ears of our fighting

men. But all Farnsworth *advertising* is directed at *your* post-war market . . . creating demand for television . . . opening a field that will be rich in business possibilities.

Serving this market will be your job!

Look for the current Farnsworth national magazine advertisement in *Time*, Sept. 6; *The New Yorker*, Sept. 11; *Life*, Sept. 20; *Newsweek*, Sept. 20; *Collier's*, Sept. 25; and *The Atlantic*, Oct.

\*No. 2 in a series depicting milestones in the history of Farnsworth Television.

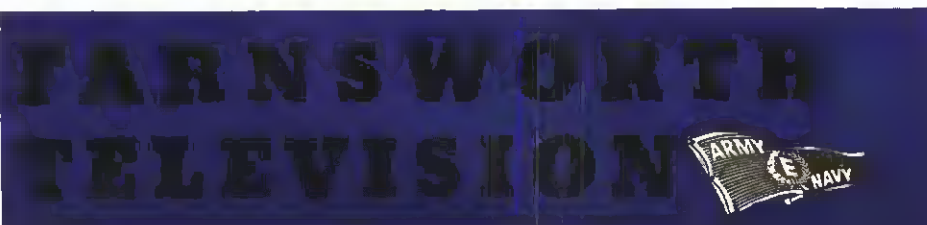

• Farnsworth Television & Radio Corporation, Fort Wayne 1, Indiana. Farnsworth Radio and Television Transmitters and Receivers; Aircraft Radio Equipment; the Farnsworth Dissector Tube; the Capehart, the Capehart-Panamuse; the Farnsworth Phonograph-Radio.

# SUBSTITUTE LINES

**Household and Utility Items . . . Music Books  
and Record Accessories . . . Furniture . . . Toys**

## **Juicers Popular Item**

Juice extractors have been popular alternate selling items. Formerly made of metal, the material situation has forced them to go plastic. They are a good over-the-counter item for a quick turnover. Most of them will last for years and present few come-back angles. Just prior to the war, electric "liquefiers" held much promise. Selling from about \$16.95 up, they possessed great sales appeal, though general public acceptance was rather slow, due chiefly to the fact that people didn't know much about them. One dealer sold a lot of these items through the medium of demonstration. Here was a new article, just beginning to toddle when the materials shortage came.

Manually operated juicers, which had been sold chiefly in department, drug and specialty stores, were introduced to the electrical appliance dealer quite recently through the selling efforts of several large jobber outlets.

Prior to their handling of these juicers, appliance dealers had been selling motor-driven juicers, of several makes, as well as electrical mixing machines, having a juicer attachment.

## **Wartime Utility Products**

Western Fall Market, held recently in San Francisco, reports that a group of wartime utility products interests dealers and buyers. These practical necessities for the home include various tools and patented preparations for home repair, maintenance and decoration, aids for the victory gardener, shopping carts, and other practical utility items for home use.

## **Offers Iceboxes, Furniture, Toys**

I. Feldman Co., 186 Broadway, Providence, R. I., distributors of Motorola, Gibson refrigerators, Thor laundry equipment and Hit records, for all Rhode Island, southeast Mas-

sachusetts and eastern Connecticut, keeps two salesmen on the road. Formerly three were employed. This firm has many alternate selling items to offer radio dealers. Occasional furniture, toys, housewares, non-mechanical iceboxes and glass coffee makers.

One of the things Feldman did to prevent dealers from over-stocking on unfamiliar lines, was to offer them a complete assortment of carefully chosen toys. All of the items were fast-movers. Up until very recently Feldman had Motorola car radios to sell. Mr. Feldman believes that after the war, retailers will find conditions very different. He says that in order to operate successfully, the dealer will have to be able to compete with chain stores and mail order houses that are now clearing their decks for action, and he advises the local merchant to lay his plans carefully by aiming to make his store attractive, and to operate on a large volume basis, on what competition will necessitate, a considerably lowered margin of profit.



"That's funny, I'm sure I put that super, super, super midget set somewhere in this pocket."

## **Washington Firm Takes On Books**

The Walter M. Ballard Co.'s large music store in Washington, D. C., has taken on books, covering a wide variety of musical subjects. "We think musical book selling by music stores is a swell idea," says Dwight Burroughs, Jr., of the Ballard Co.

The main floor showroom at Ballard's is 90 ft. long by 18 ft. wide, and has 18 ft. ceilings. On this floor the company uses a self-service record setup of its own design. In the basement there are seven playing booths.

This store is now doing a lot of remodeling.

## **Alternate Items Offered**

Simon Distributing Co., Washington, D. C., has hundreds of miscellaneous items to offer its dealers. A recent copy of their folder shows toys; a wide variety of household brushes, photo frames, baby strollers, bar accessories, games, cookbooks, featuring "meatless" recipes, ration book covers, potato mashers, coffee brewers and a chemical to remove moisture from the air in closets, basements, etc.

## **Melody Pushes Books**

Melody Record Supply, Inc., New York, is urging dealers to stock books for Christmas, right now, and reports that a number of its dealers are doing a good job. "Music books" may be a little confusing as a term, but what Melody means is a line of general books having to do with music, musicians, composers, etc., for adult and child readers. These books come from the presses of many publishers, and cover a wide variety of subjects, all, however, having to do with music, and heretofore have been sold in book stores almost exclusively.

Melody keeps right on top of the market for its dealers, and is currently suggesting record cabinets, racks, record carrying cases, record brushes, language sets, etc.



# Immediate Delivery on Meissner Iron Core I. F. Transformers

No. 16-5740  
frequency range  
360-600  
(456 kc. input)  
No. 16-5742  
frequency range  
360-600  
(456 kc. output)  
Price \$2.20 each



Designed primarily as original parts in high-gain receivers of superior quality . . . Wide frequency range and greater selectivity permit almost universal application for replacement use . . . all units are double-tuned with ceramic base. Mica-dielectric trimmers, windings are of high grade Litz wire, thoroughly impregnated. Black finish shield  $1\frac{3}{8}$ " square by  $3\frac{1}{2}$ " high.

**Meissner**  
MT. CARMEL, ILLINOIS



PREOLSTON BUILT ELECTRONIC PRODUCTS

Has it got

“IT”?



## Looking Back In Radio Merchandising History

Which distributors and dealers have made the big profits in distributing America's 59,340,000 radio sets? When, in your own history, were your own turnover and your own profits at high tide?

In the answers to these questions, there's a clue to your future course. A study reported by the U. S. Department of Commerce estimates an ANNUAL post-war demand for 25,000,000 radio sets, an ANNUAL sales volume of \$880,000,000 for the radio retailers of the United States. Foresighted distributors and dealers are already making their plans to win their share of this rich prize, and in charting their course, they are re-examining what past experience has taught them.

## Isn't This The Fact?

The distributors and dealers who have made the biggest profits were those who had the good sense or good fortune to tie up with a *wanted* line on its way UP. Your own best turnover and best profit period was likely at the time when the public demand for radios was large AND when YOUR line had that *combination of features, style, appearance and value that appealed to the public*, plus a fair distributor and dealer margin not subject to unfair competitive attack—that combination best described as "IT".



*Majestic*

**Mighty Monarch of the Air**

*In Wartime As In Peacetime*

**MAJESTIC RADIO**

2600 West 50th Street, Chicago



## Why Majestic's Line Will Have "IT"

In the Majestic organization are men who are "old hands" at the job of determining what the public wants and what it will buy—men whom YOU may have seen out on the firing line, handling customers on your own retail floor, developing that sixth sense which comes only from direct contact with the ultimate buyer. At the Majestic factory these men are already sizing up the current public taste, weighing the appeal of new war-born features and electronic developments, measuring the public's post-war purse. The line that can give you and other distributors and dealers an edge in the competition for profitable post-war sales, is already in the making!

## Controlled Distribution Will Protect Your Profits

This line, tempered to the public taste, will come to you backed up by the radio industry's most modern distribution program—a program that does NOT confine the retailer's sales to Majestic alone, but that DOES give him a large measure of PROFIT PROTECTION by confining its sale to selected outlets meeting stern qualifications. Get the picture, Mr. Distributor and Mr. Dealer, and you'll surely want a place in it!

Keep your eyes on Majestic!

# \$ 1000

## PRIZES IN WAR BONDS FOR MOST HELPFUL ANSWERS TO THESE THREE QUESTIONS

1st Prize, \$500 maturity; 2nd Prize, \$250 maturity; 3rd to 13th, \$25 maturity.

Every one is eligible. Contest ends December 31, 1943.

To stimulate YOUR post-war thinking, and to check OUR post-war plans, Majestic offers prizes for the most helpful answers to these questions:

- (1) What types of radios will be in large demand in YOUR locality immediately following victory?
- (2) In what new features or new merchandising policies are you most interested?
- (3) What kind of advertising support do you believe will be most helpful to you?

It's facts and ideas, not rhetoric, that will count. Write YOUR answers to these three questions—mail them to me personally, today!

E. A. TRACEY, President

**& TELEVISION CORPORATION**  
*Builders of the WALKIE-TALKIE, "Radio of the Firing Line"*

# Washington Says—

## Reissues List of Essential Activities

The War Manpower Commission has reissued its list of essential activities, and has included amendments that have been made from time to time. Included under paragraph 31, following are some of the "essential" repair services: radios, refrigerators, sewing machines, clocks, power laundry equipment, electrical appliances and motors, heating equipment, electric, gas and plumbing and heating installations in domestic, commercial and industrial buildings.

The Commission states that "it is intended that consideration be given only to individuals qualified to render all-around repair services on the types of equipment specified herein as required for the minimum essential needs of the community."

## Critical Occupations Listed

The WMC has also released for publication a series of changes in the rules for inducting men. Acting as the nation prepared to induct fathers, Chairman Paul V. McNutt outlined a three-point program planned (a) to hold essential workers on war-useful jobs if they are so employed now; (b) to assure transfer of workers to jobs aiding in the war effort; and (c) to supply men needed for the armed forces without cutting war production.

At the same time Selective Service local boards were instructed to give greater consideration than ever before to occupational deferment.

Included in the list of critical occupations are radio communications technician, radio telegrapher, radio-photo technician; receiver tester, radio; refrigerator equipment repairman, all-around on gas and electric units.

## Work on Plan to Aid Essential Consumer Goods

The Office of Civilian Requirements has handed to the War Production Board a tentative program embracing a policy to maintain radios, automobiles, refrigerators and certain other electrical appliances "essential" to the civilian economy, it has been announced by WPB vice chairman Arthur D. Whiteside.

Stating that because "certain essential articles will be produced does not mean that OCR intends, because of the critical materials required, to re-open substantial manufacture of many items formerly produced for civilians," Mr. Whiteside did point out that the

basic policies announced forecast maintenance of radio and other essential services for the efficient functioning of the civilian economy.

Among the policies announced were: "Adequate repair parts, replacement parts and labor must be made available to maintain existing essential equipment in the hands of civilians in operating condition.

"The distributive and service trades must be maintained to the extent necessary to make essential goods and services available to civilians when and where needed.

"Every effort will be made to economize the use of resources and to conserve the goods now in civilian hands.

"We do not advocate forcing the civilian population down to bare subsistence levels in the present military situation."

## Distribution Problem Acute

The report states frankly that OCR has not solved the complicated problem of distribution to the end that all localities will have "a proportionate share of scarce items," but states that plans in connection with the distribution phase are being rapidly developed.

The report states that the chief problems confronting OCR are: Shortage of manpower, inadequate distribution of scarce goods and lack of some materials, particularly metals, for civilian manufacture.

It is pointed out that many civilian goods which bulked large in 1939 are no longer produced for civilians. The last passenger automobiles for civilians were turned out on January 21, 1942, radios on April 15, 1942, mechanical refrigerators on April 30, 1942, vacuum cleaners on May 1, 1942, washing machines on May 15, 1942; and most electrical appliances were

also stopped in May, 1942. Practically all civilian home construction except that sponsored or approved by the National Housing Agency was prohibited in April, 1942. Hundreds of other metal goods have also been stopped entirely or drastically curtailed.

## Tall Figures on Radio's War Role

What the government thinks about the value of radio listening audiences is stressed in the following statement released by the United States Department of Commerce:

"It's a well-known, accepted fact that radio has been a most potent plugger of Government campaigns designed to shorten the war. But the extent of this plugging over the air waves has been largely an unknown quantity until the Office of War Information recently surveyed the situation and made public the following statistics:

"Under the National Spot Allocation plan, 85 programs sponsored by 70 advertisers broadcast much-needed war messages. These have amounted to 9,000,000 listener impressions per week.

"The Station Announcement plan has been used by 891 stations to the tune of 8,000 messages per day. Over 50 programs have turned over complete shows on war themes. OWI estimates these would have cost over \$13,000,000 for time and talent.

"Of specific campaigns, the following shows the effectiveness of such volunteer promotion:

"A 2-week campaign on glider pilot training filled every glider school in the country. In the nurse recruiting campaign, radio helped persuade 23,972 women to join. It helped increase Signal Corps enlistment 10 times over and Coast Guard 40 per cent. It helped speed buying of coal 70 per cent in the spring of last year. It helped add 30,000,000 people to the war bond pay-roll deduction plan."

## The Shellac Situation

According to War Production Board, essential civilian uses of shellac are allowed 100 per cent, such as electrical insulation, electrical motors and parts, scientific instruments, communication instruments, etc. Shellac was denied for uses such as furniture and floor finishes, miscellaneous polishes, bowling alleys, hair lacquer and certain types of maintenance and repair. Manufacturers of phonograph records were granted for July, August and September, 20 per cent of the amount consumed in the same quarter of 1941.

## LIEUT. E. J. BERMAN



Having completed his course at Signal Corps Officers Candidate School, Lieut. Berman, former sales manager of Shure Bros., makers of microphones and acoustic devices, visits the plant. At right, brother Jack; left, S. N. Shure.



*Let's Bury the Tramps—with Bonds and Stamps!*

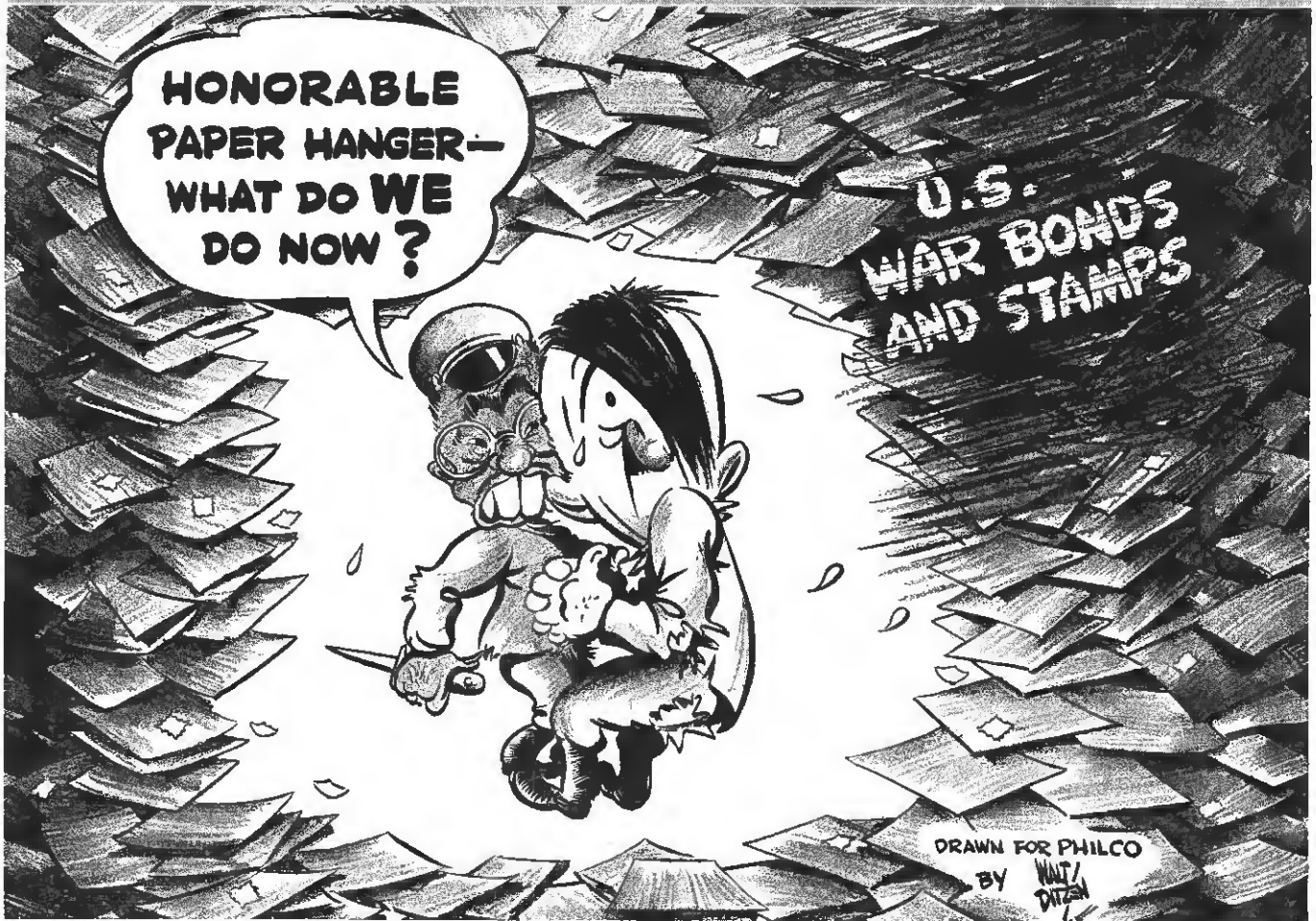

Copyright 1943—Philco Corporation

**B**EGINNING September 9th, the battle cry of America's home front is, "Back the Attack—with War Bonds." The Third War Loan is on. The goal is fifteen billion dollars. To reach it, Uncle Sam is asking every American, *as an individual*, to join the offensive and buy an *extra* War Bond during September.

America is on the move, thanks to the courage and valor of our men on the battle front, the toil and sacrifice of the home front, the might and ingenuity of the industrial front. This is no time to relax . . . it

*In cooperation with the U. S. Treasury Department, the Philco cartoon campaign appearing in the national magazines during September will be devoted to the Third War Loan.*

is the hour to *press the attack!* Our soldiers and sailors are doing it, under the magnificent guidance of their heroic leaders. Industrial America is doing it. The men and women of Philco, today, are producing radio, communications and

electronic equipment, ordnance and storage batteries at an all-time peak. Now we of the home front must do it . . . each one of us . . . during September! Buy an *extra* War Bond to back the attack of our boys at the front. It's a personal investment in victory today . . . and the fruits of victory tomorrow.

# PHILCO CORPORATION

**"BACK THE ATTACK WITH WAR BONDS"**

During the Third War Loan in September Buy an EXTRA War Bond for Victory.

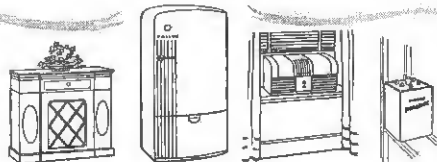

**PHILCO—the Quality Name in Millions of American Homes.**

**LISTEN TO "OUR SECRET WEAPON"**

Hear Rex Stout expose Axis lies and propaganda. Every Friday evening, CBS stations.



# Letters to the Editor

## Tells Outcome of Tax On Rebuilt Sets Problem

*Editor Radio Retailing Today:*

Here is the final outcome of the excise tax controversy we wrote you about in the two letters you published in the August issue.

The law separates a radio into three parts; chassis, cabinet and speaker. If these three parts are acquired from separate sources and assembled for sale, tax is due on the basis of the sale price of the completed article, regardless of taxes paid when they were built, although some credit may be allowed.

As far as direct replacement of bad parts in the chassis on a repair basis, there seems to be no tax, but if used parts were assembled into a completed chassis, it would be taxable. Our tax agent insists that replacing a bad speaker with a new one makes the whole radio taxable, along with replacing a wood cabinet for a plastic, and I guess he must be right because the law includes "adding to or altering the appearance of an article."

We don't mind paying our just taxes, but we would rather know in advance what taxes are to be met, rather than discover that we have been doing shady business and must pay back taxes and penalties. We are offering this publicity on the tax subject to our fellow service men so they won't have to take to the hills and hide from the "Revenooers."

Now we wonder if the WPB men will let us use parts to repair used radios for sale under the L265 limiting order, and re-order the parts on a certificate?

RADIO SERVICER

## How to Get Tires and Gas?

*Editor, Radio Retailing Today:*

Have always been a reader of your magazine, and always look forward to receiving it. I stopped doing radio service work for myself about a year ago, and put my car in storage. I then sold my tires. Then, as the war went on, it took all the radio servicemen in the armed forces, and I started to get calls to do work again. As I am in a war plant, I repair radios for customers four hours a night and Saturday afternoons and Sundays.

I wrote to the OPA and told them my story, and they said they could



"What! You want to charge me 50 cents to test the radio, after my husband has been working on it an hour for nothing?"

give me no gas or tires. Now, what I want to know is why, if radio servicing is considered essential, won't they cooperate with me? My business is registered at State House. If you can give me any hints on how to get gasoline and tires, I'll be very grateful.

NEW HAMPSHIRE READER.

## Where Are Those Long-awaited Tubes?

*Editor, Radio Retailing Today:*

The civilian tube situation is getting very acute. Can we do anything toward obtaining sooner the necessary tubes which were promised in February? Or is this item a "football" like gasoline?

PENNSYLVANIA SUBSCRIBER.

## Asks Manufacturers' Help On Retail Front

*Editor, Radio Retailing Today:*

The manufacturers are doing a splendid job in building war-time radios and associated products, but I think that they should still keep in touch with their dealers and servicemen and help them all they can.

I feel sure that with a little effort from the big radio companies we would have more parts and tubes available and that radio repairing would also be classed as "essential," with more gasoline allotted for service calls, etc.

Many of us radio service-dealers at the present time could very easily close our shops and go into some defense industry, and perhaps make more money.

Only the love of radio and our obligations to maintain the radios we sold in operating condition, keeps most of us going.

We know, whether it's generally realized, or not, that we are keeping up public morale by keeping these radios going. People are using their radios more and more now that gas restrictions have been imposed.

A NEW ENGLAND DEALER

## Offers Suggestion on Series Operated Tubes

*Editor, Radio Retailing Today:*

Some old timers really have to laugh when the fellows at the factory still call themselves engineers; and yet won't admit they can't build satisfactory filaments for series operation. Series operation of any set of filaments requires equal amperage draw for each filament—and it is not possible in average production.

Why not 120 volt filaments in multiple? Why kill a cat the hard way?

W. W. BRACKENRIDGE  
Electric Service Shop

Harrison, Ohio





# Flying blind... but not deaf

**H**IGH over obscuring clouds, through the murk of fog and the black of night, the "blind" pilot speeds to his mission . . . and returns . . . almost completely dependent upon what he hears through his headphones. A tremendous responsibility for any piece of equipment.

Making headphones to the exacting standards of the Army and Navy Air Force is one of the wartime tasks of Rola. A pioneer in Radio and later in Electronics, the technical knowledge

and the manufacturing skill of this seasoned organization now is devoted exclusively to giving our Fighters in the Air the best, most effective equipment of any in the world. THE ROLA COMPANY, INC., 2530 Superior Avenue, Cleveland, Ohio.

1 1 1

*In addition to complete headsets, Rola manufactures transformers and coils of all kinds for aerial communications. If your problem involves Electronics . . . and is important to the war effort . . . why not discuss it with a Rola engineer.*

★ ROLA ★

MAKERS OF THE FINEST IN SOUND REPRODUCING AND ELECTRONIC EQUIPMENT

# PARTS SUPPLY NEWS

## Golenpaul on Postwar Surplus Parts Threat

If manufacturers and jobbers cooperate in maintaining price structures and brand reputations, postwar dumping of surplus radio parts need not be a serious threat to the trade, points out Charley Golenpaul, sales manager of the jobber division of Aerovox Corp., and chairman of the Eastern Group, Sales Managers Club.

Highlights of Golenpaul's article stress the following: Despite the fact that radio parts are being produced in fantastic quantities, such parts are just as rapidly assembled into radio and electronic equipment for the armed forces. Thus completed equipment, much of it of a vital military character, will hardly be dumped into civilian hands. Also, it will hardly pay to break up such discarded military equipment in order to salvage second-hand parts.

Golenpaul declares that distinction can be made between such surplus parts and regular jobber items, because parts made for equipment manufacturers are not usually individually packaged. Manufacturers can play up their packaging to offset "loose" goods purchase. Again, manufacturers parts usually carry an entirely different part number or type designation to the confusion of the jobbing trade, and the guarantee, covering the initial buyer only, will not apply to such goods resold to others as parts.

## Urges "Shopping Around"

One radio retailer from out of town visited *Radio Retailing Today's* office, and offered the suggestion that servicemen take some time off, if they can possibly do so, and "shop around" for badly needed equipment, parts and tubes. This dealer recently sold a PA system to a factory, and states that he was able to buy a new well-known make record player and changer, speakers and other equipment needed, in New York City, without priorities.

## Electronic Equipment Demand Is Growing

According to a statement recently released by the radio division of War Production Board, "electronics equipment requirements in the war program and for maintenance and repair of civilian radio sets are constantly increasing, and the electronics industry

faces a fresh challenge in the task of meeting proposed production schedules."

Stating that the rate of production will have to be stepped up to meet the higher production schedules for the remainder of 1943, the bulletin declares that as a further indication that there is no "levelling off" of electronics production in prospect, the radio division estimates that war production needs to be supplied by the industry will be 30 to 40 per cent greater for 1944 than for the present year.

## New Super Capacitors

The Industrial Condenser Corp., Chicago, is now in production on a new line of heavy duty, high voltage ca-

pacitors for continuous operation up to 150,000 volts working. These units can be used in surge and lightning generators, and are equipped with the famous solder seal terminals for operation at highest altitudes and under the most humid conditions.

## Rents Test Instruments

The Waugh Laboratories, 420 Lexington Avenue, New York, are offering for rent various instruments, including oscilloscopes, tube and circuit testers, Tel-O-Mikes, etc. The Laboratories, a division of the Waugh Equipment Company, has issued a booklet showing the equipment available on a rental basis.

## Solar Moves Offices

Announcement has been made of the removal of general offices of Solar Mfg. Corp., and Solar Capacitor Sales Corp., from Bayonne, N. J., plant to 285 Madison Ave., New York 17. Manufacturing activities continue in the two Bayonne plants as well as in Chicago. The departments occupying the new quarters are accounts, credits, sales and export.

## Latest News About New "Victory" Parts

At the recent meeting of the American Standards Association's war committee on replacement of parts for civilian radio, held in New York, the list of so-called "Victory" standard volume controls was cut down to eleven types. This was done at the urgent request of WPB and OPA members, according to George D. Barbey, president of the National Electronic Distributors Assn. The types follow:

The composition types will be the standard 1 1/8 in. diameter control; the wire-wound, standard 1 1/2 in. According to the NEDA report, there was considerable discussion about the universality of the 11 controls. The engineers claimed that 80 per cent of the sets could be fitted by the control as is, or by cutting the shaft to length. As there were many suggestions for the adapting of the other 20 per cent, the problem was turned over to NEDA for solution. The latter group has named a committee, and President Barbey has urged members to aid in

### Composition Element With Integral Flatted Shaft

Part No.	Resistance in Ohms	Taps at Ohm Points	Taper
VVC-1	10,000	—	Symmetrical
VVC-2	25,000	—	"
VVC-3	250,000	—	Clockwise audio
VVC-4	500,000	—	" "
VVC-5	500,000	150,000	" "
VVC-6	1 megohm	—	" "
VVC-7	1 megohm	300,000	" "
VVC-8	2 megohms	—	" "
VVC-9	2 megohms	15,000 & 500,000	" "
VVC-10	2 megohms	500,000 & 1 megohm	" "

### Wire Wound Element with Integral Flatted Shaft

Part No.	Resistance	Taper
VVC-34	10,000	Linear

Units furnished with switches shall have the applicable suffix listed as follows, added to the part number: S—single pole, single throw; T—double pole, single throw; U—single pole, double throw; V—4 pole, single throw shorting.

the design of a sleeve or other method to fasten an old shaft to the new flatted shaft. Sketches and suggestions should be sent to the National Electronic Distributors Assn., P. O. Box 2, Reading, Pa.





## *Remember when your wife went away?*

**Y**OU knew you had taken her too much for granted, because you missed her in a thousand ways you never expected.

That now applies to your jobber. Because of the war, he can't give you the fine service you took for granted.

But your jobber is doing all he can. He's playing fair with you and his other customers to the best of his ability. At the same time, he is called on to meet sudden and unexpected demands to help along the war.

*For example . . .* A shipment of medium bombers, sorely needed to hit the Jap, was being held up for want of a few hundred feet of test lead wire. The bomber plant, after scouring the country's manufacturers in vain, appealed finally to the local radio jobber. The scarce wire was in stock, and the bombers left on schedule.\*

Often the radio jobber is the only source of supply for a discontinued or restricted item. Sylvania is proud of the wartime record of radio jobbers. You would be, too, if you knew all the facts.

When you look at your depleted shelves, remember the prompt service your jobber gave you when he could. When the war is won, we, as a manufacturer, and you, as a retailer, will need the jobber more than ever to supply an expanded radio and television market.

*\* An actual case from our files, details of which must now be withheld on account of the war.*

••• **SYLVANIA**  
ELECTRIC PRODUCTS INC.



We haven't meant  
to neglect you, but  
Uncle Sam has been  
on our tail

Of course we like Uncle Sam, too. When he says "Turn your plant into a war plant," we're glad to turn it inside-out for him. And when he asks for practically all our output, we're glad to GIVE.

But, to us, the sad thing about all this war work is it means we have to neglect you, temporarily--

--you, who made our business possible in the past...

--you, who'll make our business possible in the future.

There'll be no great profit in this war business, but we don't mind that.

There's no future in it. We're not kidding ourselves. We know that our future lies in resumption of our old peacetime business ... with old friends (you) and with peacetime products, old and new, when the war is over.

We're sorry we've had to neglect you. Many of our representatives have gone into war work; you haven't seen one, maybe, for many a moon. You may think we've forgotten you. But we haven't forgotten you -- and we are itching for the time when we'll be seeing you and serving you often again ... as in the past.

"Keep your mind  
on your  
war  
work"



With the few radio tubes that are available, you want to get your share of the service work they make possible. Ask for the display and booklets with your next order for TUNG-SOL Tubes.

**TUNG-SOL**  
*vibration-tested*  
**RADIO TUBES**

TUNG-SOL LAMP WORKS INC., NEWARK, N. J., Sales Offices: ATLANTA, CHICAGO, DALLAS, DENVER, DETROIT, LOS ANGELES, NEW YORK  
ALSO MANUFACTURERS OF MINIATURE INCANDESCENT LAMPS, ALL-GLASS SEALED BEAM HEADLIGHT LAMPS AND THERMAL SWITCHES



# NEW PRODUCTS

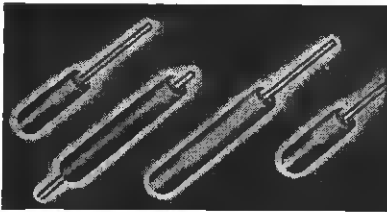

**STACKPOLE INSULATED CORES** for applications calling for iron cores having high unit resistivity. Special core material shows resistance of practically infinity. Recommended for applications where a resistance of 150 megohms or greater is required, and where voltages do not exceed breakdown value. Material used reduces leakage currents and their resultant noise troubles. Also, possibilities of voltage breakdown between coils and cores are reduced. Other Stackpole iron core types are regularly supplied for a wide variety of uses, and for frequencies to 175 megacycles and better. Stackpole Carbon Co., St. Marys, Pa.—RRT

**JFD ADAPTER HARNESSSES** for farm and household battery operated radio sets. Come in a number of different models, and do not require soldering or cutting. Maker states that over 1 million farm and portable battery radios now in

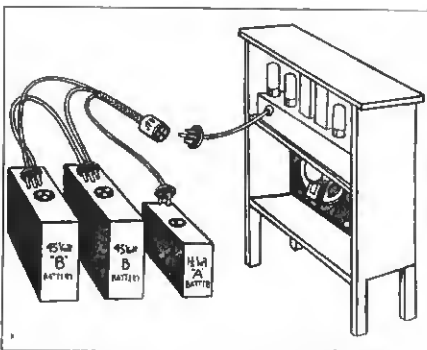

use were designed for combination "AB" battery packs, but that these packs are now war-scarce. JFD harnesses are suggested to be used in connection with separate "A" and "B" batteries, on which the government has allotted materials for manufacture, and which JFD says are now plentiful. To adapt a battery radio which uses "AB" pack, disconnect

worn-out pack from radio, then take the correct JFD harness and plug the battery cable from the radio into the socket on the end of the harness. Then plug other ends of the harness into the "A" and "B" batteries. J.F.D. Mfg. Co., 4111 Ft. Hamilton Parkway, Brooklyn, 19, N. Y.—RRT

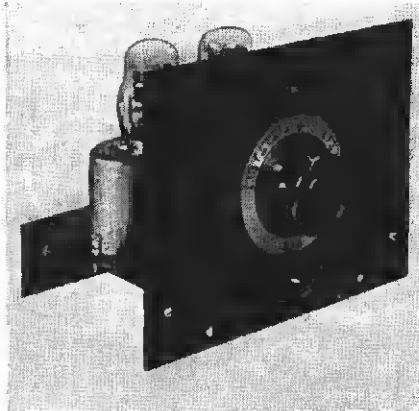

**LAFAYETTE RADIO TRAINING KIT**, now offered in quantity to military and private training programs. The one and two tube regenerative kits (illustrated) are designed to provide complete basis receiver training at low cost. The one tube kit, when assembled, demonstrates grid leak detector operation and the effects of regeneration on a detector circuit. With the addition of a minimum of parts an R. F. stage can be added without redrilling the chassis or moving any component parts of the detector circuit. Alignment procedure can then be demonstrated in its simplest form. These kits may be operated either from power supplies or from batteries when proper tubes are used. Lafayette Radio Corp., Chicago, Ill., Atlanta, Ga.—RRT

**RADIO CITY DUAL-TESTER** — New Model 804, equipped for direct testing of all acorn tubes and old and new types of regular receiving tubes, rectifiers, etc. Contains latest type built in "Rolindex" mechanical roller tube chart. Tester in sturdy oak case, with removable cover.

Size 14½" x 13" x 6"; weighs 12¼ lbs. Radio City Products Co., 127 W. 26th St., New York, N. Y.—RRT

**TELECHRON COMMUNICATIONS CLOCK.** Supplied in 15" dial for wall mounting, and in addition to the conventional minute and sweep second hands, it has a special dial divided into 24 sections instead of the conventional 12 sections, a 24-hour movement and two 24-hour hands. The latter, finished black and red respectively, and with convenient means for setting with regard to each other indicate local time and Greenwich (zero Meridian time) respectively. The 24-hour operating cycle of the hour hands and the dial character lay-out permit direct reading of time, on a 24-hour basis, eliminating the A. M. and P. M. complications. The clocks operate direct from the regulated frequency alternating current supply. Warren Telechron Co., Ashland, Mass.—RRT

**NORELCO FREQUENCY METER,** direct reading with an accuracy of 2% retained over entire range of 50,000 cycles. Has wide applications as a laboratory test instrument, for testing quartz crystals, for use in a Wow meter for phono motors and for experimental work as the base of a frequency modulation indicator. Can be used as a speed indicator, and it drives a recorder without use of auxiliary amplifiers. The maximum frequency is 50,000 cycles with six ranges, 0-100; 0-500; 0-1000; 0-5000; 0-10,000, and 0-50,000. Frequency is indicated directly on front panel of meter or on separate recorder. Meter has input impedance of 100,000 ohms or over. Will measure frequency regardless of input signal voltage variations between 1/2 and 200 volts. Stability is maintained with line voltage variations between 105 and 125 volts. Meter does not use D.C. amplifiers. North American Phillips Co., Inc., Dobbs Ferry, N. Y.—RRT

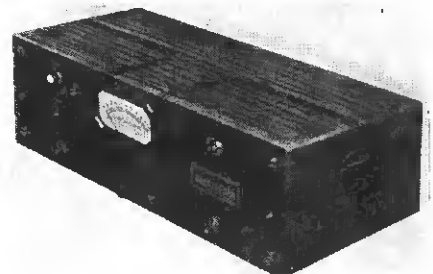





# The SPRAGUE TRADING POST

EXCHANGE BUY SELL

## Your Own Ad Run FREE

The "Trading Post" is Sprague's way of helping radio servicemen obtain the parts and equipment they need, or dispose of the things they do not need during this period of wartime shortages. Send in your own ad today—to appear free of charge in this or one of several other leading radio magazines on our list. Keep it short—WRITE CLEARLY—and confine it to radio items. "Emergency" ads will receive first attention. Address it to:

**SPRAGUE PRODUCTS CO., Dept. RRT-38**  
North Adams, Mass.

**WANTED AT ONCE**—Philco 027 VTVM and circuit tester. Will wire money at once. Must be in good condition, meter undamaged. J. P. Morrison, Jr., Box 4264 Cap. Hill Sta., Oklahoma City, Okla.

**SIGNAL GENERATOR WANTED**—Prefer Hickok model 188X, but will buy any good make. Also need Rider's Manuals. Wm. H. Batcheller, 724 Hollywood Ct., Whiting, Ind.

**WANT PROFESSIONAL RECORDER**—Will pay cash for unit, also blank records. Will swap printed stationery for same. Geo. M. Toney, P.O. Box 125, New Kensington, Pa.

**WANTED**—Tube tester, VOM, signal generator and analyzer to test the latest sets. Harold Radio Service, 1204 Seventh St., Oakland 7, Calif.

**WANTED**—A good condenser bridge analyzer to measure 50 mfd. or more; meter rectifier DC to AC, also an oscilloscope. Will pay cash and postage. W. F. Ouder, RT. 1, Box 389, Kimmswick, Mo.

**EQUIPMENT WANTED**—Need multi-meter, tube tester, and a signal generator. Give full details. Robt. W. Gorseline, 6 Ocean Green S.W., Washington, D.C.

**WANTED**—Precision 832A, 31 range AC-DC tester or similar pocket VOM. J. S. Osterfield, 18 Ridgeway St., Lynn, Mass.

**FOR SALE**—50 radio chassis (electric, battery, auto, 32 volt). Mostly later models with 1/2 parts still mounted. Also 100 used tubes taken from above sets. All types of speakers; micro-tube lab, hearing aid kit type C-1, Acousticon Model A-45 case, chassis with all parts mounted except tubes, battery cable, low impedance ear piece. Plenty of hearing aid parts, crystal mike, midgeet condensers, etc. Edwin T. Larason, Box 46, Martinsburg, Ohio.

**URGENTLY NEEDED**—Sky Buddy receiver. Will pay good price. Louis Seifert, Jr., Mineral Ridge, Ohio.

**RIDER'S MANUALS FOR SALE**—Vols. 1 to 8 incl. in A-1 condition. \$45 C.O.D. John Knop, West Bend, Wisc.

**SALE OR TRADE**—Two M-30 Stancor mobile transmitters complete with dynamotors, tubes, handsets and cables for police car use, Bliley Mo. 2 Xtals for-30580 kc. Can be ground higher. H. B. Reynolds Radio & Ept. Lab., Oneida, N. Y.

**VOM NEEDED**—Pocket volt-ohm-meter. Prefer a Supreme No. 542, or a Triplett 666S, or what have you? Needed for war work. R. H. Turner, 748 Connecticut St., Gary, Ind.

**TUBES WANTED**—One each 25Z6, 1H5, 35Z4, 35L6GT, and two 25Z5 tubes. New or "seconds" as long as they are good. Massett's Radio Repair Shop, 745 Shakespeare Drive, Berea, Ohio.

**SIGNAL GENERATORS WANTED**—RCP model 703 or earlier; Triplett models 1231A, 1232; RCA 153 or earlier. All letters answered. Geo. L. Bell, Jr., RD No. 1, Niles, Ohio.

**TESTER FOR SALE**—Supreme model 89 de luxe tube and volt-ohm tester. A-1 condition. Will take \$20 cash. Val. Obal, 511 "D" St., So. Norfolk 6, Virginia.

**SIGNAL GENERATOR WANTED**—AC or battery-powered unit in good condition. Any make. Macks Electric Shop, McCook, Nebr.

**WANTED**—Signal generator or oscillator in good condition. Supreme 571 or similar std. make preferred. J. F. Mitchell, Yarmouth, Iowa.

**WILL SWAP OR SELL**—Surplus stock, etc. Terms cash. All in good or excellent condition: Webster 15-watt amplifier with matching 12" Jensen speaker, \$25; Majestic 12" speaker with exciter, \$5; Astatic X-tal mike, \$15.75; DB carbon mike with stand, \$10; SB carbon hand mike, \$3.75; floor mike stand, \$2; banquet mike stand \$1.50; Majestic 9" super-dynamic speaker HiW, \$3; Philco starting timer, new, accurate, HiW, \$15; Philco phono motor, new, \$7.50; code-audio oscillator with batteries, \$5; IF (470 adj.) oscillator with batteries, \$7.50; Philco battery tester, new, \$7.50; Philco condenser analyzer, \$10; Under-pillow speaker mag., \$3.75; "Pocket-tracer" sig. gen., \$2, etc. Write for list. 1st come, 1st served. Askin Radio Service, 1107 South Main St., Paris, Illinois.

**WANTED IMMEDIATELY**—National Union Uni-Ballast, Type X. David Wood, RFD No. 2, Bethel, Conn.

**CASH FOR EQUIPMENT**—Need tube tester, ohmmeter, and volt meter, Albert Smith, Green Cone Spring, Florida.

**WANTED AT ONCE**—0-50 DC microammeter (Triplett); 0-3 DC milliammeter (Triplett). Name best price. Wesley MacFarlane, Jr., 1138 Palma Ave., Schenectady, N. Y.

**FOR SALE**—Tubes, speakers, chokes, power transformers, audio transformers, books, 15" jig saw, radios, etc. Write for list. Want late tube tester and signal generator for cash or part trade. Royce Saxton's Radio Shop, Route 1, Pontiac, Illinois.

**FOR SALE OR TRADE**—Aerovox L-C checker, model 95—\$25. Crystal mike, velocity mike, dynamic mike, Rider's manual No. 6. Thiel Radio, Manitowoc, Wisc.

**FOR SALE**—One Radio City Products VOM model 446, \$5; Superior tube tester model 1240, \$12; one Philco dynamic tester, model 030, \$25. All in A-1 condition. Joe Whisnant, 1328 Rozzells Ferry Rd., Charlotte 2, N. C.

**FOR SALE**—Portable phono-recorder, carotone, like new. List \$69, my cash price \$50. Delco 3-band, regular and s-w receiver, 6-tubes, 6-volt in good used condition, \$25 cash. All f.o.b. express. Aaron Watson, Deep Gap, N. C.

**FOR SALE OR TRADE**—One Triplett 3" red dot volt, ohm, milliammeter, AC and DC, 7 1/2 to 1500 V. in 4 steps, current 1.5 mil. to 15 amps, in 4 steps, ohm 1000 to 200,000, Good signal generator all built in on case. Want real good radio or \$30. B. C. Davis, 41 Cauthen St., Rock Hill, S. Carolina.

**COMMUNICATION RECEIVER FOR SALE**—Hallicrafters SX-16 with extra crystal, R.M.E. 70-DB 20" in same cabinet. Both in fine condition, What do you offer? Steve Fertner, 64 W. 82nd St., New York, N. Y.

**RELAYS FOR SALE**—Two AC operating at 115 volts, and one DC operating at 115 V. Write for details. Leo Goldenberg, 2882 West 15th St., Brooklyn, N. Y.

**WANTED**—Auto radio test and demonstration pack, preferably Stancor super model 132. Must be in working shape. Also want Rider's Manuals Vols. 4, 5, 8, 10, 11, 12, 13. Edwin W. Cooper, Peoria, Okla.

**TRADE**—Will swap pair of 20,000 ohm navy-type earphones (list \$10.95) in perfect condition for any type or size phono amplifier or wireless oscillator in working condition, home-made or bought. Milton Kalashian, 7 Warren St., Newburyport, Mass.

**SCOPE FOR SALE**—Dumont model 148 5" cathode ray oscilloscope in A-1 condition. Best cash offer takes it, or will consider a Presto 12" recording turntable as part payment. Jos. A. Gagliardi, 5 Antrim St., E. Boston, Mass.

**FOR SALE**—One Stancor used de luxe auto radio test A pack, \$25. Also one new ditto, \$35. Paul Capite, 637 W. 21st St., Erie, Pa.

**TUBE TESTER FOR SALE**—Supreme model 85. What do you offer? G. R. MacDonald, East Millinocket, Me.

**COMMUNICATION RECEIVER TO TRADE**—practically new Super Defiant SX-25 Hallicrafters com. receiver, factory seal never broken. Will trade for Hickok oscillograph model RFO-5, or Supreme model 560-A veedolyzer, or RCA-Rider chanalyst. Robert B. Wendt, K2-6 Willow Village, Ypsilanti, Mich.

**EQUIPMENT WANTED**—Want a good set tester, tube checker, tubes, record players, or what have you? Describe fully. Al. Becker, 4257 W. Congress, Chicago, Ill.

**WANTED**—Signal generator, tube tester, multimeter, etc. of reliable make and in good condition. W. M. Wheeler, 20 Homestead Ave., Bradford, Pa.

## This Helpful Booklet FREE!

Write today for your free copy of the Sprague "VICTORY LINE" Folder. In addition to listing the exact condenser types now available under wartime restrictions, this contains helpful data on hard-to-make replacements.

It tells you, for instance, how to replace 600 volt capacitors with 450 volt types; how to use dries on wet electrolytic jobs, and much more. It's a folder that will help you in your daily work—and it costs you only the price of a post card to write and ask for your free copy.



# SPRAGUE CONDENSERS AND KOOLOHM RESISTORS

Obviously, Sprague cannot assume any responsibility for, or guarantee goods, etc., which might be sold or exchanged through above classified advertisements

(Continued from page 60)

thousand for "soft" rays to several million for "hard" rays.

The X-ray tubes are both hot and cold cathode types. The high voltage supply requires care in insulation, care in control of corona, as well as fool-proof safety precautions from shocks and exposure to the rays.

Technical preparation is the necessary keynote now for present and future radio-electronic maintenance men. While the types of electronic equipment in use in industry today is large, and the ones mentioned here few, a mastery of all the technical details is difficult. Your own requirements can be best filled by a study of the types of industries in your community. Concentrate on these or a portion of them until you are qualified as a radio-electronic maintenance man.

### **Alabama Dealer Keeps Radios Operating**

It takes all hands, including part-time workers, to get out the business at Bullock's Radio Service, Tuscum-bia, Ala. H. C. Bullock, proprietor,

**H. C. Bullock, owner of Bullock's Radio Service, Tuscum-bia, Ala. gets the sets repaired. Everyone has two or more jobs. . .**

has assumed the responsibility of keeping all radios operating in his city, as there is not another shop left.

He uses a couple of schoolboys who work after hours and during vacation. His office girl works on radios in her spare time, and another mechanic works most time on major appliances but devotes some time to radios. Mr. Bullock also puts in some hours at the bench. Everybody has two or more jobs, but that is the way it has to be in wartime when help is scarce.

Bullock operates on a cash basis and he charges \$1.00 for testing a set, unless he is authorized to do the work. He has quit selling tubes and other parts across the counter with a few exceptions. He said he found that some people bought tubes when something else was wrong with their sets, and that amateur experimenters often burned out tubes needlessly. Besides he needs his stock of tubes in his business, hence the rule.

Bullock keeps a sort of continuous training school for his employees. He has accumulated all the manuals and catalogues possible on the various makes of radios and is using them in his teaching.

The system of having to send in old parts before replacements can be obtained is a big headache to dealers right now, Mr. Bullock said. It is not only the time it takes to pack the

parts, but also keeping track of them and determining which part goes with which radio. However, he has nothing but praise for the radio jobbers, saying they are doing a good job of helping dealers keep all radios going for the duration.

### **Radio Maintenance Details for Admiral Chassis N6 (Late)**

This six tube circuit is a modification of the early N6 chassis (see circuit and details given in RADIO RETAILING TODAY for August). This set uses a 6J5GT second audio in place of the 6SK7 employed in the earlier model.

The rectified oscillator voltage is also used in this set as a minimum AVC bias voltage. The tone control is a variable bass compensation system acting in the volume control circuit. Additional compensation is provided in the form of feedback from the speaker voice coil circuit. The cathode to ground voltage of the first audio and the power audio tube is varied by a portion of the audio voltage developed across the voice coil. The second audio tube cathode circuit is not by-passed, thus there is some additional degeneration in that circuit.

The IF transformers are aligned at





**THE PEACETIME  
MEASURES OF  
REFLECTION AND  
DEFLECTION ....  
WILL BE READ FROM**



# **TRIPLETT**

**ELECTRICAL MEASURING INSTRUMENTS**

**WITH CONFIDENCE  
AND ECONOMY**

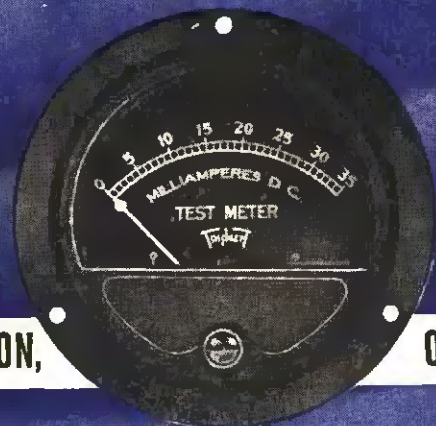

**THE TRIPLETT ELECTRICAL INSTRUMENT CO., BLUFFTON,**

**OHIO**

***BACK UP YOUR BELIEF IN AMERICA...BUY WAR BONDS***

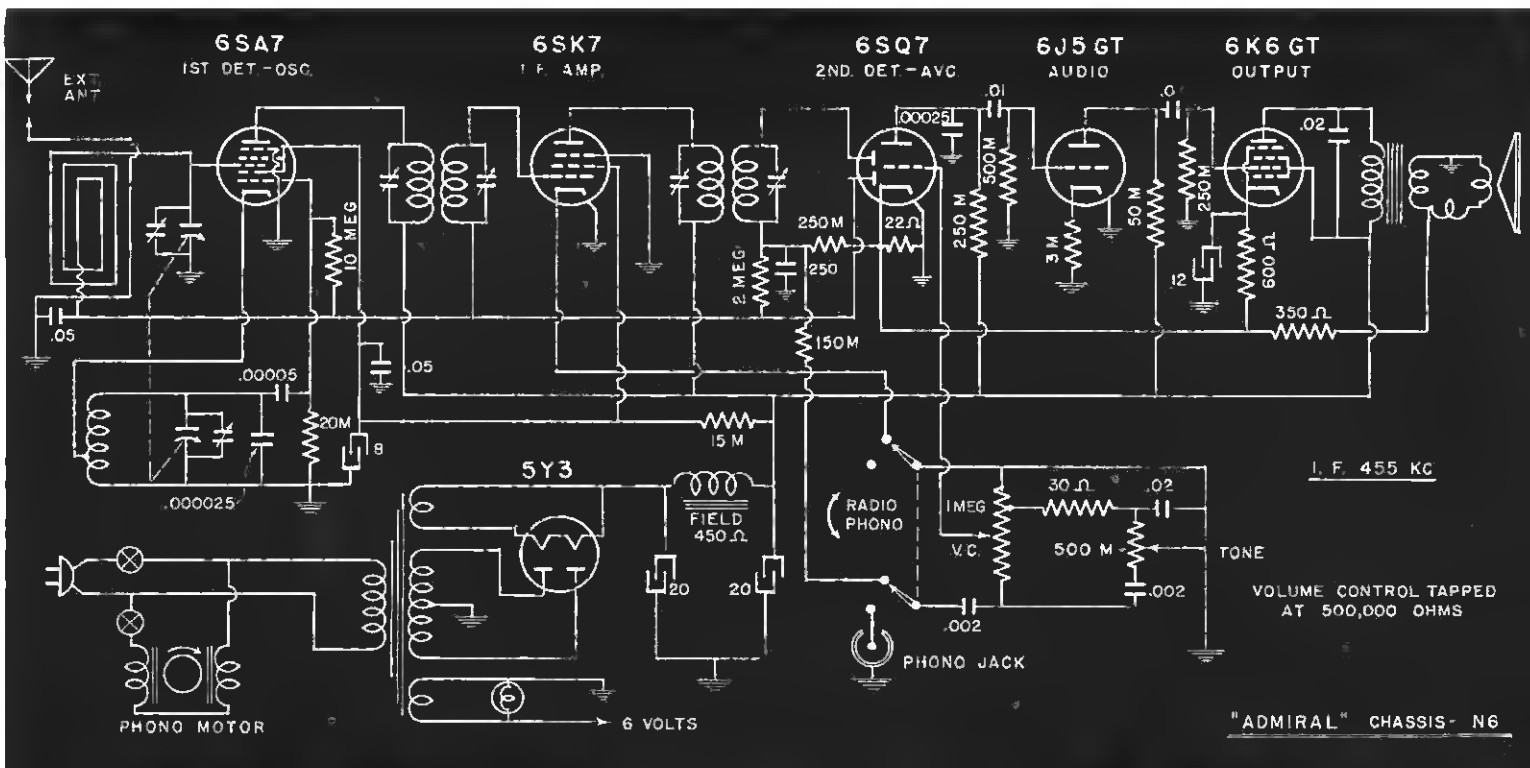

455 kc. Connect the signal generator to the antenna tuning condenser stator through a 0.1 mfd. capacitor. With the set dial at 1630 kc., adjust the IF trimmers starting with the second stage and working back.

With the same connections tune the dial and signal generator to 1630 kc. and adjust the oscillator trimmer located on top of the tuning gang section. Connect a two turn loop radiator to the signal generator and couple it about two feet from the set loop. Tune the dial and generator to 1400 kc. and adjust antenna trimmer which is located on top of tuning gang section. Some sets do not have this trimmer and the small necessary adjustment can be made by moving the leads to the loop slightly.

### Seven-watt P.A. Amplifier Repair Notes

This Silvertone model 12874 and 12875 delivers 7 watts at total gain of approximately 110 db. in the microphone channel and 70 db. in the phono channel.

The two audio channels are connected to alternate grids of the dual 6SC7 triodes. The half of the 6SC7 used with the mike channel is capacity coupled to the second half of the tube to give the extra gain required for the high impedance mike. The input circuit for the microphone does not show a grid return path for the 6SC7. A 0.5 meg or 1 meg resistor should be connected from grid to ground.

The field circuit of the speaker is designed for a 1500 ohm field. The speaker output transformer is not on the amplifier chassis. The 6L6G output tube is designed to work into a 4000 ohm load.

## BOOKLETS

To help the beginner understand the fundamentals of radio, a 68 page primer has been produced by General Electric Electronics Department. The scope of the material is broad, with mathematical and engineering treatment on fundamental theory held to a minimum. The work is prepared from the viewpoint of the practical serviceman rather than that of the advanced engineer. Copies may be obtained by sending 25 cents in coin to Advertising Division, Electronics Department, General Electric Co., Bridgeport, Conn.

Basic facts of the chemistry of washing and approved home laundering methods are contained in a new manual, "Modern Home Laundering," announced by the Westinghouse Home Economics Institute. The booklet also discusses the care and use of washing machines and other laundry equipment in the home. Copies are 5 cents each, and may be obtained by

writing to the Consumer Education Service, Westinghouse Electric & Mfg. Co., Mansfield, Ohio.

"Music and Manpower" is the title of a 24-page booklet, representing an exhaustive and authentic study of the subject to date, just released by Operadio Mfg. Co., St. Charles, Ill.

Describing music as a "mental vitamin," the subject of industrial music as a production factor is treated both historically and currently. The booklet describes what music does, how it is received by workers, types of music used and recommended, case histories, and has one section devoted to voice-paging. There are photographic illustrations as well as drawings. Although only a limited edition has been printed, Operadio says copies are available to any executive requesting same.

A 56 page catalog, describing 16 mm. educational and recreational film, is available free by writing request to DeVry Films and Laboratories, 1111 Armitage Ave., Chicago

Two channel 7-watt amplifier circuit has gain of 110 db. A 1-meg grid return resistor should be used in the mike input circuit.

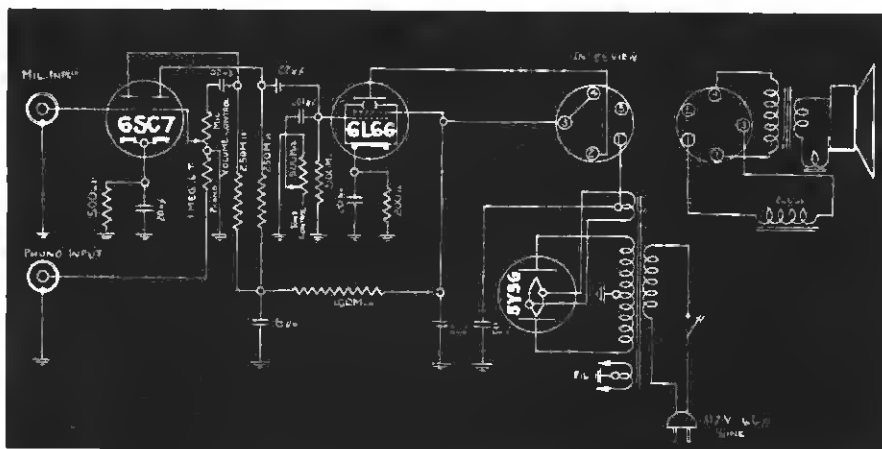



# A NEW TECHNIQUE *that is* SPEEDING VICTORY

LITERALLY a one man army, the paratrooper strikes fast and hard—almost anywhere. He represents a new and deadly technique of modern warfare, one that America is utilizing to the fullest.

Industry, too, has learned new techniques. New short cuts, new refinements in design, new ways to build faster and better the tools and weapons our fighting men need.

Simpson electrical instruments and testing equipment, for example, offer a basically superior type of movement which required a slow and costly method of construction only a few years ago. Today, in the Simpson plant, this greater accuracy and stamina is a matter of mass production.

Tomorrow the many things industry has learned under the impetus of war will build a brighter, happier world. The harder we work on the job at hand, the sooner that tomorrow will come.

**SIMPSON ELECTRIC COMPANY**  
5200-5218 Kinzie Street, Chicago 44, Illinois

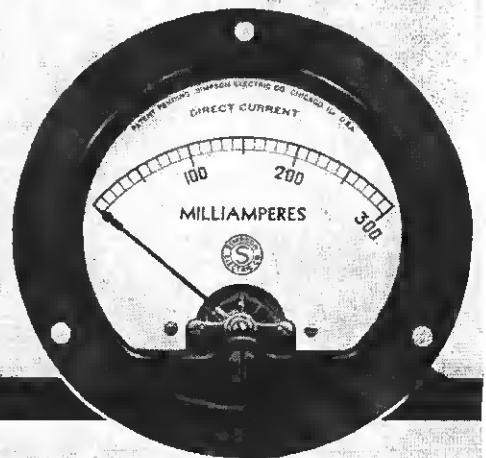
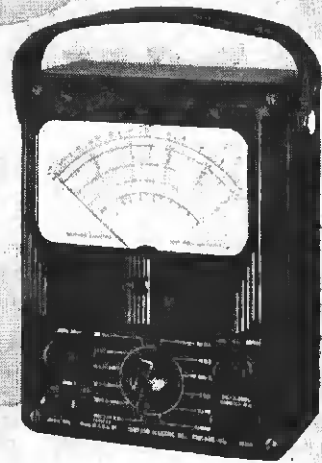

# Simpson

INSTRUMENTS THAT STAY ACCURATE

Buy War Bonds and Stamps for Victory



## "MAGIC!" is their word for it

We damn well know it won't win the war . . . *but* if your boy is in there pitching it's encouraging to know the Hits of Broadway and Main Street are delivered right to his foxhole.

How? With Presto Recordings and Playbacks. Whether he's with MacArthur, Eisenhower, Spaatz, or training on home grounds, Presto Equipment is bringing him the latest from Home—music, news, songs, entertainment . . . recorded while "live" and rebroadcast to him between battles. That goes for the Navy, too!

And when Presto Recordings and Playbacks are not dishing out the "jive" they're drilling in the facts of fighting—training troops, broadcasting orders, recording operational data, and a lot of other things we won't talk about.

"Magic!" is the word the boys have for it. But to you it's just plain Presto! . . . trade name of all that's finest and best in Sound Recording.

**PRESTO**  
RECORDING CORP.  
242 WEST 55th ST. N.Y.

In Other Cities, Phone: . . . ATLANTA, Jack. 4372 • BOSTON, Bel. 4510  
CHICAGO, Har. 4240 • CLEVELAND, Me. 1565 • DALLAS, 37093 • DENVER,  
Ch. 4277 • DETROIT, Univ. 1-0180 • HOLLYWOOD, HL. 9193 • KANSAS  
CITY, Vtz. 4631 • MINNEAPOLIS, Alliantic 4216 • MONTREAL, Mar. 6368  
TORONTO, Hud. 0333 • PHILADELPHIA, Penny. 0342 • ROCHESTER,  
Cul. 5548 • SAN FRANCISCO, So. 8854 • SEATTLE, Sen. 2560  
WASHINGTON, D. C. Shop. 4003—Dist. 1640

World's Largest Manufacturers of Instantaneous Sound Recording Equipment and Discs

## COMBINATIONS

(Continued from page 17)



combinations. A mark-down of somewhere between 30 per cent and 50 per cent from current prices will move your combinations into customers' homes, or clubs, and put some more money in your bank account.

### Buyers Are Realistic

It is not easy for one who has long fought against the evil price-practices of the unscrupulous radio dealer, now to recommend cutting prices on radio. But the facts are plain. The public does not really want large combinations. Manufacturers made, and dealers bought, far too many. Large combinations are in fact, "excess merchandise," "surplus stocks," and they are priced far too high. In the minds of the public they are also *old models*, for which they never would pay full price.

And so—hopes, fancies, and principles to the contrary—realism indicates you will have to mark-down your prices of combinations if you want to move them. And good judgment says "the sooner you mark these down the better."

How much you mark them down is up to you. But the price at which they will move, is up to the public.

And the public is realistic. Believe it, or not.

### Charles A. Verschoor Dead at 55

Charles A. Verschoor, well known to the radio industry as a pioneer manufacturer of midget radios, and for years president of the International Radio Company, Ann Arbor, Mich., died Sept. 2 at the age of 55. Following his radio experience he developed an inexpensive miniature camera for the American market.

His wife, the former Ida Corbett, is the only survivor.



*Just Released!*



9

## NEW BRILLIANT ALBUMS OF SONORA RECORDS!

The recent addition of the 9 Albums of Records listed here, brings new sure-fire favorites to the catalog of SONORA Records.

Every one a masterful creation of feature recording artists. Every one a top hit in counter polls the nation over. Every one an embodiment of the flawless tone technique for which SONORA always has been honored in the world of music.

Here is a rich opportunity to cash in on the biggest Record demand in history.

**M-355 WALTZES OF JOHANN STRAUSS.** Four 10" records. American Concert Orchestra. A brilliant collection of the most famous Strauss Waltzes beautifully played.

**DA-267 DVORAK.** Three 10" records. The Philharmonic Symphony Orchestra plays this music of the people with a simple directness, an enchanting beauty, and perfection of form including lighter themes from Dvorak classics.

**DA-268 SCHUBERT.** Three 10" records. The Philharmonic Symphony Orchestra. A melodic group of instrumental song fests.

**DA-266 BRAHMS.** Four 10" records. The Philharmonic Symphony Orchestra. A splendid interpretation of the rich sonorous beauty that established Brahms among the mighty in music.

**M-269 STRING SERENADE.** Four 10" records. The United Concert Ensemble plays with an artistic richness and admirable vigor.

**M-454 OLD TIME FAVORITE MEDLEYS.** Three 10" records. The Manhattan Concert Orchestra plays 14 memory-awakening tunes.

**M-455 LISTEN AMERICA.** Three 10" records. The Musical Brigadiers play 9 inspiring American war favorites.

**DA-270 TSCHAIKOWSKY.** Four 10" records. The Philharmonic Symphony Orchestra plays a group of liting tempestuous selections acclaimed the greatest of Tschaiikowsky's creative efforts.

**M-456 XMAS CAROLS.** Three 10" records. Choral and Orchestral renditions of your Christmas favorites.

**Sonora**   
*Clear as a Bell*

SONORA RADIO & TELEVISION  
CORPORATION  
325 North Hoyne Avenue • Chicago, Ill.

# CONSIDER CUSTOMER COMFORT

• A customer, who had been contemplating buying a radio-phonograph combination set in a retail store, and was considered by the salesman a first rate "prospect," after several visits had taken place, suddenly did what all "prospects" eventually do—made up his mind to buy right away. So the customer came in the showroom—this time to close the deal. He sat down in front of the instrument, and the salesman switched on the radio.

What happened? Nothing! The receiver just wouldn't operate. Calmly, at first, the salesman checked the electric supply cord; then he operated a few wall switches. Then he pulled the heavy cabinet away from the wall, and peered in the back. A complete black-out. He twisted the supply cord, and finally, his blood-pressure rising, whacked the side of the cabinet a few times with his open palm.

This particular combination set was a slow-mover. The dealer was naturally anxious to sell it. The salesman had been offered a bonus if he disposed of it. The customer had "sold" himself on it, and had come in to buy it. The salesman excused himself from the fidgeting customer, and hurried to the fuse-box. He found the fuses all right.

On the way back, he ran into a service man and told him what was happening.

"Oh, I borrowed a couple of tubes out of that job to use in Mrs. Smith's repair job." That's all. And that's the end.

The customer would not buy the set. He got up and went out—and bought a radio he'd been looking at elsewhere.

The dealer lost a sale amounting to over \$200.

This, then, serves to illustrate the necessity of keeping demonstration sets in perfect condition.

Have a good aerial connection. See that pushbuttons are calibrated perfectly, and that the mechanism works silently and efficiently. Keep the cases polished; keep the knobs tightly fastened to their shafts. See that the sets are plugged into a trouble-free, dependable electrical outlet.

Under no circumstances "service" show models in front of a customer.

It is disconcerting, and it cheapens the radio in the customer's mind. If the set develops unavoidable trouble take it off the floor, and do the work somewhere out of sight.

## Comfort Is Important

There are two very important things to do with a customer. One is to put his mind in a receptive mood, and the other is to put him in a comfortable position. Mrs. Jones had been shopping all day, and toward evening dropped in a radio



store to buy a "second" set. There were no chairs in the store, and Mrs. Jones was extremely weary.

Did she buy? No. She did not, because she just couldn't stand any longer. If she'd been placed in a comfortable chair in front of a good radio, the welcome rest would have been a potent factor in having her make up her mind favorably.

Everyone feels in a more receptive mood when he is comfortable. That's not psychology, but just a common fact. So it is well never to overlook comfort if you want to do a good selling job with radio now, and with radio after the war, when the business is really "going to town."

## A Popular "Isolationist"

It is the experience of most radio salesmen that a "mass" display of demonstrator sets is a Chinese Wall against closing a sale. It gives the customer an out, because it is so difficult to select from such a display. If you are able to sell from such a jumble, it will take longer, and may often result in "come-backs." The

customer is apt to say, "I brought this set back, because I think I like the sound of that other one—let's see which one was it?—better."

So it will be seen that the "isolation" system of showing sets and of demonstrating them is the best. Try to find out what kind of an instrument the customer has in mind. About what he wishes to pay, and then, having correctly separated demonstrator models, try to concentrate on the one you think the customer should have, and you'll be doing the buyer a favor, and the seller—meaning yourself—a favor and getting a dividend as well.

There are plenty of sets left on some dealer shelves today, and even to those who've been cleaned out, a few sales pointers, such as those listed below, point toward a tomorrow—when the war is over—presenting a bright horizon to contemplate. Representing a consensus of opinion amongst floor salesmen the following time-tested conclusions have been reached:

## Showroom Ten Commandments

1. Provide comfortable rest facilities for your patrons.
2. Have sets in perfect working order; and know your programs thoroughly.
3. Keep demonstration sets "isolated."
4. Don't talk to customer while set is being played.
5. Play nothing but music, unless speech is *definitely requested*. You may, just coincidentally, turn on a politician or some sort of speaker whose policies or statements are violently opposed by the prospective customer; or if this is not the case, it still offers the opportunity for the customer to ask *your* opinion on what the speaker is saying. Then you're on a spot.
6. The first thing, find out as much as possible what the customer has in mind to buy. Type, price, etc.
7. Leading up to the close, suggest to customer that the radio be sent up to him for approval, *but* if he

(Continued on page 70)



# Television

## WEAPON ON THE HOME FRONT NOW...



*In the future—*

## THE GREAT NEW INDUSTRY FOR YOU TO SHARE IN

**O**NE PICTURE is worth a thousand words. This is especially true of Air Raid Warden instruction. No wonder the OCD has turned to Television to bring the lessons of civilian defense to Air Raid Wardens in a number of principal cities throughout the country.

For example, the National Broadcasting Company is now televising English films that show the workings of the enemy's newest explosive types of incendiaries and how to deal with them. This telecast goes out twice every Monday on the NBC revised Air Raid Warden's course over Station WNBZ, New York. These televised lectures have been attended by more than 250,000 wardens since February 1942, through television sets installed in eighty-two New York police pre-

cinct stations. And wherever Television is doing this important job, you are sure to find RCA equipment.

After the war Television may spread rapidly to major U. S. cities; you will become a vital part of this great new industry. What better way to speed Television's coming than by helping to win the war? And the best way to do that is to buy more War Bonds, conserve critical materials, and keep America's radios in top condition.

Whatever the future may bring, here is a thought to guide you in building a profitable business: Look to RCA, recognized leaders in the fields of Radio, Television and Electronics, for the finest, most advanced instruments on the market.

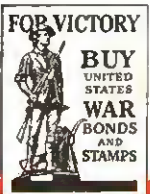

RCA VICTOR DIVISION

# RADIO CORPORATION OF AMERICA

CAMDEN, NEW JERSEY

## CONSIDER CUSTOMER COMFORT

(Continued from page 68)

agrees, be sure to have him sign an order first.

8. When the customer "boosts" the old radio he now owns, don't antagonize him, and hurt his feelings by making any disparaging remarks about the set. Act interested.

9. If customer reacts favorably to reception, etc., from set being operated, ask for the order. That's the right time to do it.

10. Have contracts, pen and ink and blank checks near by. "I like this set all right, but I haven't a check with me," is a remark by a customer you should never have to worry about. Sometimes, of course it's an excuse by the customer who is not ready to buy, but more often it is an honest statement of fact—but if you don't close the sale, via the blank check method, the customer may, and often will, have a change of heart once having left the showroom.

With some "big" sets left today, and a few used radios to sell, dealers and salesmen do well to keep in practice the selling techniques successful in the past—techniques to be applied when competition again becomes "the life of trade."

## DOOR-TO-DOOR SELLING

### Will Future Appliance Canvassers Be Seen "by Appointment"?

• With very little of everything to sell today, and with little or no pressure required to get a customer to purchase almost anything, retail dealers find it good advice to keep themselves "sales-minded" for the battle of wits to come. A retailer has only to look back to the early 1930's to recall vividly just what high-pressure selling was like, and what it always will be like under more or less normal conditions.

When things have settled away in world affairs, and manufacturers, jobbers and retailers go back to John Q. Public for his business, how are they going to get it? Is the door-to-door canvasser going to come back, or is some other, and perhaps better, means of securing "prospects" going to be brought about?

Steps in the sale of a radio receiver are very definite ones. First, the manufacturer makes a set. Then he advertises it through various mediums. Then the manufacturers' salesmen sell it to jobber outlets, whose salesmen in turn sell it to the retailer. The retailer, being the last step

reached in this process must do two things. He must sell the receiver to someone, and second, he must sell it quickly if he wishes to get list price, because the set may be superseded by a later model.

### Two Methods of Sale

The retailer finds, in the final analysis, that he has two methods open to him to dispose of the set. One method is to do some first-class window-dressing, some local advertising, and perhaps some telephone soliciting, and the other is to employ "outside" salesmen to work on "leads" . . . or to go out "cold turkey."

In the past, every large retail outlet in the country depended first upon its door-to-door canvassers for volume business. Even large department stores became consistent users of this type of salesmen, who spent almost their entire time outside, with some, often very little, "floor time."

### Hard-Bolled Job

It was a tough job in those days to hire outside solicitors who could stand the gaff. It took men who were thick-skinned to the n'th degree, yet possessed of colorful enough personality to engage the interest of "prospects." Gone of course, many, many years, is the old-style, ultra-aggressive, foot-in-door high pressurer, who was all right in his day for "knock 'em down" methods. He was supplanted more recently by what were supposed to be highly trained men, and women, too, who used all sorts of excuses to get into a home. "I am making a survey," was a statement driven home to more and more housewives, as business grew steadily worse while we were approaching the Depression.

### Some Harm Done

"Did me a lot of harm," said one dealer, speaking of left-handed approaches used by his salesmen. "A man making thirty calls a day, brought in perhaps one live prospect, and made me a lot of enemies, many of them formerly customers." As the door-to-door salesmen increased, the warmth

(Continued on page 72)



"I told the lady we couldn't get parts to fix her radio until we beat Hitler. But she says how will she know when he's beaten without a radio!"



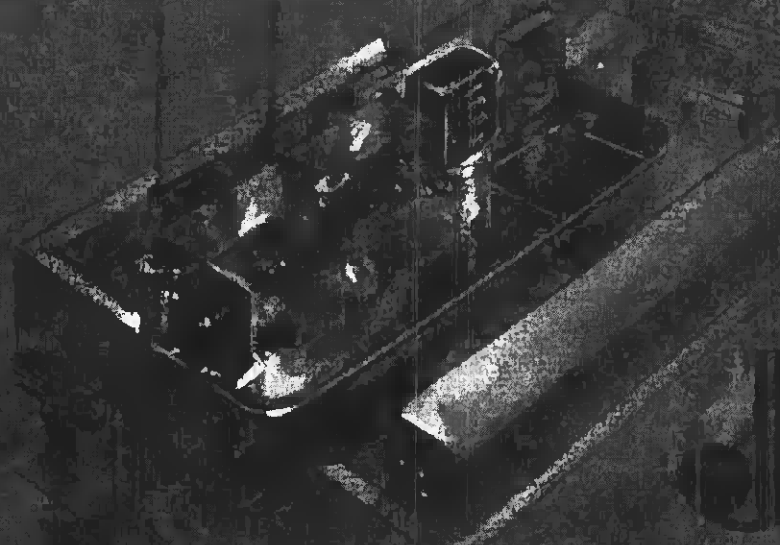

# Jensen REPRODUCERS

AID THE SCR-299

IN *"Winging the Battle of Communications!"*



The latest development in military communications equipment deserves the best in speech reproducers. It is natural, therefore, that Jensen speech reproducers were specified for the famous SCR-299, the high-powered mobile communications unit as built by Hallicrafters. Jensen speech reproducers are serving with equal distinction in all branches of the armed forces.



**Jensen**  
RADIO MANUFACTURING COMPANY

6601 SOUTH LARAMIE AVENUE

CHICAGO, U.S.A.

(Continued from page 70)

of reception upon the part of the badgered housewife cooled rapidly.

The retailer, who plans to stay in one place in a community, is not interested in one-two-three or one-shot sales. On the contrary, he must always be looking ahead to the future, yet, truly enough, he can't be expected to sit idle and see his business being taken away by out of town solicitors, who have been trained in some of the smartest order-getting schools in the country. The local dealer had to put men in the field to protect himself, and then and there he found it difficult to get men able to put pressure on the public, and if he was able to find them, he discovered that they left a lot of sore spots behind them.

"Don't beat about the bush," one local retailer urged his salesmen. "Do two things. First tell them the firm name, and then come right to the point. 'Mrs. Jones, I represent Blank and Co. We are selling such-and-such radios.'" The dealer points out that this is at least a straightforward, honest approach, and one hardly to be resented.

The toughest job of all in the en-

tire picture, however, if you contemplate this method of selling, is, as stated before, the ability to get men who like this type of work. Most salesmen hate it. A few say they like it, but one sales manager says that they are very, very clever fellows, and are only saying they like it to make the sales manager like them.

Hard times threw almost all sorts of men into door-to-door selling. A dealer relates that he discovered that a very sensitive chap he had hired for this type of sales work, religiously and faithfully rang the required number of door bells each day, but confided in a fellow solicitor that as he pushed each bell, he mumbled to himself, "I hope they're out—I hope they're out."

#### Prospects or "Suspects"

In outdoor selling, salesmen naturally follow the lines of least resistance. In any cross-section of a town or city, a salesman ringing door-bells will encounter rough treatment, slammed doors and insults. Cards reading "No salesmen or peddlers," etc. On the other hand, to illustrate the point, he will also encounter the

talkative, receptive type, who'll invite him in and talk his head off—and seldom, if ever, buy anything. The salesman lets himself into this by "selling" himself that this is a prospect and some time should be spent on the call. "Prospect" files are full of records of such calls.

Of course the results achieved in outdoor selling are always measured by the number of solicitors out. If Mrs. Brown has had twelve calls at her front door in one morning, the man who makes the thirteenth is apt to find himself firmly entrenched behind the eight ball.

Right now is a good time to test this out. Go out yourself and ring a few doorbells and see what happens. You'll get an amazingly different welcome, because it's not being overdone now. "I wish sometimes that more salesmen would come to the door," said a woman recently. "They used to be a terrific pest, but now I'd welcome a few. Just a few, though. It would be quite a novelty to see them again."

#### "Visiting Hours" Suggested

Telephone soliciting is good, and often achieves excellent results, but it requires highly skilled persons to do it, and it is always without the personal touch, and allows the "prospect" to get away too quickly to ever take the place of personal solicitation.

Perhaps after this war some other suitable means of selling will be found. Perhaps it will be that there will be less dealer outlets . . . less competition of similar lines, less over-production, more "protected" territory for a dealer and more rigid franchise observance.

At all events, if house-to-house selling is to be continued on a large scale, perhaps communities might get together, and housewives arrange a schedule of times during which door-to-door salesmen would be interviewed. A novel idea, but it works in business—why not in the home?

#### Opens Lending Library

While Tim Lyons, of Lyons Electric Co., Decatur, Ala., works in a war plant, his wife carries on the business which specializes in radio repairs. She has added a lending library, a 5 and 10 cent counter and gifts and novelties to the stock.

This announcement is not to be construed as an offer to sell or as an offer to buy the securities herein mentioned.  
The offering is made only by the prospectus.

175,000 Shares

## Emerson Radio & Phonograph Corporation

Capital Stock

\$5 Par Value

Price \$12 per share

Copies of the prospectus may be obtained from the undersigned only in states in which the undersigned is qualified to act as a dealer in securities and in which the prospectus may legally be distributed.

F. EBERSTADT & CO.

September 7, 1943.



**FOR ELECTRONICS  
MEASUREMENTS, TOO,**

*the Standards are Weston*

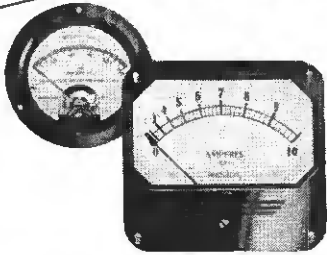

**Panel Meters for Electronic applications**

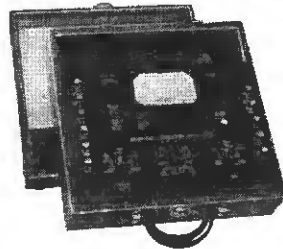

**Electronic Circuit Testers**



**Ultra-Sensitive Laboratory Portables**

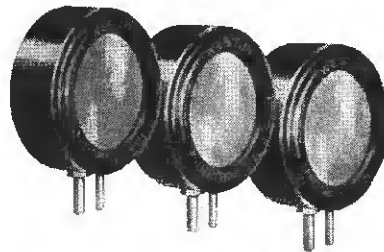

**\*Photronic (photo-electric) Cells**

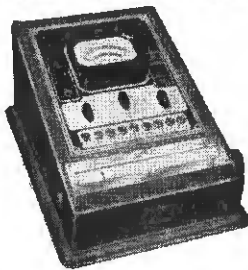

**Electronic Tube Checkers**

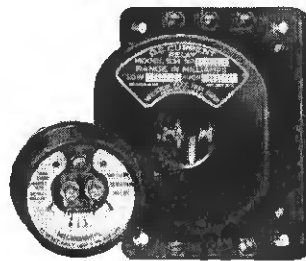

**Sensitive Relays**

In the field of electronics, too, the measurement tools bear the name most familiar to you. For just as WESTON pioneered fundamental electrical measurement, as well as the special measurement needs of radio, so WESTON has provided simple, precise instruments and devices for the problems encountered in electron-

ics research, production and control: Weston Electrical Instrument Corporation, 597 Frelinghuysen Avenue, Newark, New Jersey.

\*PHOTRONIC - A registered trademark designating the photoelectric cells and photoelectric devices manufactured exclusively by the Weston Electrical Instrument Corporation.

Laboratory Standards . . . Precision DC and AC Portables . . . Instrument Transformers . . . Sensitive Relays . . . DC, AC, and Thermo Switchboard and Panel Instruments.

**WESTON**

Specialized Test Equipment . . . Light Measurement and Control Devices . . . Exposure Meters . . . Aircraft Instruments . . . Electric Tachometers . . . Dial Thermometers.

**FOR OVER 54 YEARS LEADERS IN ELECTRICAL MEASURING INSTRUMENTS**

**A LEADER  
can't rest  
on his laurels!**

For real leadership requires constant vigilance...constant research...constant unwillingness to admit that perfection is ever attained!

That explains why Thordarson engineers...in good times or in bad...in peace-time, or in the midst of war, are forever experimenting, investigating, striving in every way to develop transformers that are ready to fill every need...not only AS the need arises, but even BEFORE the need arises.

**THORDARSON**  
ELECTRIC MFG. COMPANY  
500 WEST HURON STREET, CHICAGO, ILL.

*Transformer Specialists Since 1895*  
ORIGINATORS OF TRU-FIDELITY AMPLIFIERS

**TOM THUMB  
IS FIGHTING WITH  
THE BOYS IN THE SOLOMONS!**

Backed up by a hard-hitting, wide-awake factory, TOM THUMB is making life miserable for those "Sons of the Rising Sun" and when the last "Son" has yelled "Unconditional surrender," the wheels will start turning again for the production of this fast-moving line of sets. The TOM THUMB distributor and dealer franchise will again spell year-round volume and handsome profits.

Make your plans NOW to get on the TOM THUMB bandwagon

**Automatic**  
RADIO MANUFACTURING CO., INC.  
122 Brookline Avenue, Boston, Mass.

## Regular Call Letters For FM Broadcasters

About a month ago, FM Broadcasters, Inc., national trade association of FM stations, made a suggestion to the Federal Communications Commission that frequency modulation outlets be permitted to use the same kind of call letters employed by AM broadcast stations.

It has just been announced that this practice will be permitted beginning Nov. 1st. The FCC describes the new arrangement as follows:

"In cases where a licensee of an FM station also operates a standard broadcast station in the same city, he may, if he so desires, retain his standard call letter assignment followed by the suffix 'FM' to designate broadcasting on the FM band. Thus, if the licensee of a standard broadcast station with the call letters 'WAAX' (hypothetical) also operates an FM station in the same location, he will have a choice of using the call 'WAAX-FM' or he may, on the other hand, be assigned a new four-letter call—say, WXRI. Similarly, an FM broadcaster on the West Coast who operates a standard broadcast station 'KQO' may, if he likes, use the call 'KQO-FM' or he may ask for a new four letter call, 'KQOF,' for his FM station. This choice will remain entirely with the FM operator."

## Music Used To Fight Absenteeism

• Music, the newest weapon against absenteeism, is being used more and more by war plants. Not only does it appear that the worker "stays put" on the job more consistently where music is used, but feels better and produces more.

Radio men are noticing that more and more factories are installing sound systems every day. Loudspeakers in factories carry FM programs, recorded music, regular radio programs, "personal" and national news, as well as important messages to the workers.

Miss Amy Lee, staff writer for the National Association of Music Merchants, recently released a story entitled "Music Helps Reduce Absenteeism," the results of a survey she made.

### Music Is Essential

Miss Lee states that "the favorable results from music, used properly, outweigh the unfavorable, and indicate that music is being recognized as an essential, even indispens-



able, part of a plant's completely successful operation."

Weston Electrical Instrument Corp., Newark, N. J., according to Miss Lee, has recently completed the wiring of its second plant for transmission of music. Since Weston's use of music in its plant, absenteeism has been perceptibly reduced.

Some other interesting highlights in the survey follow:

Sylvania Electric Prods. Co., Emporium, Pa., reports, "No doubt, music makes the plant a much pleasanter place to work in and an employee is more likely to report for work, instead of staying home for insignificant reasons, because of this."

#### **In Use Since 1941**

Charles Komar & Sons, South Amboy, N. J., have used music in their plant since 1941. Stating they believe that music here has helped combat absenteeism, even though the rate has increased somewhat, they state: "However, we hesitate to think what that rate would be if we were not furnishing music to our employees. We do know that in comparison with similar plants, we have a better record as far as labor turnover is concerned."

Grumman Aircraft Eng. Corp., Bethpage, N. Y., told Miss Lee: "There is a direct relationship between contentment of the worker on the job and absenteeism. . . . Music, whether through participation in band and other musical groups or through listening, improves the job environment and so improves the attitude of the worker to his job."

Music plays a leading role at the Midwest plant of the Caterpillar Tractor Co., Peoria, Ill., with the management cooperating 100 per cent to keep workers happy.

#### **Absent Rate Cut**

"Most plants employing female help in this sector are complaining of 15 per cent absentees," says a statement from Carlton Lamp Corp., Newark, N. J. "In our case we have 4 to 8 per cent, averaging 5. Some of this reduction is due to music and pleasant surroundings . . . music has been an aid to us in these trying times of labor problems."

Botany Worsted Mills, Passaic, N. J., state their belief that they are

*(Continued on page 76)*

## *Serving on the* **HOME FRONT . . .**

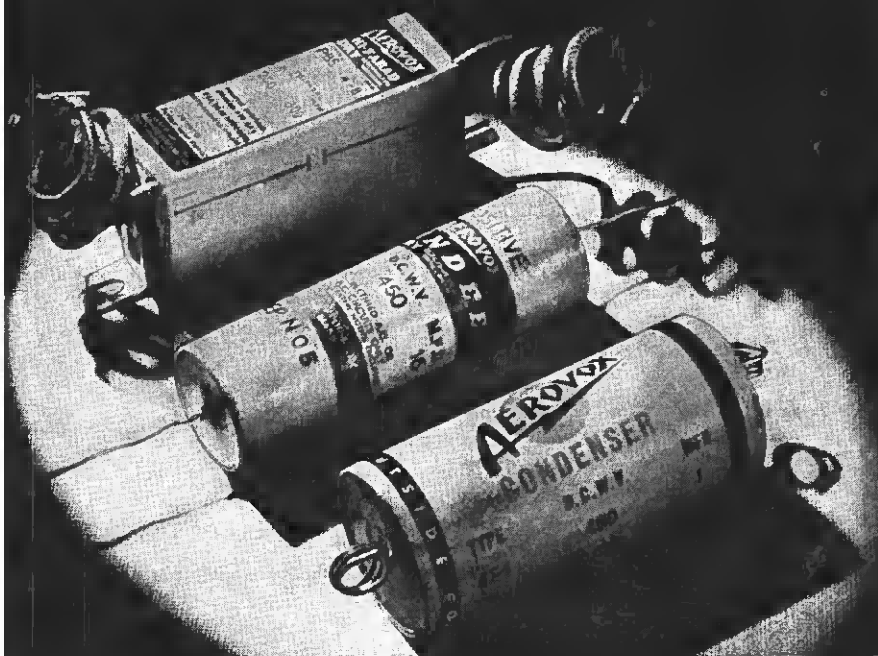

## **GENERAL-PURPOSE REPLACEMENTS**

Type PBS Cardboard-Case Electrolytics in single, dual and triple section units. 25 to 600 v. D.C.W. Wide choice of capacities and combinations. Adjustable mounting metal flanges.

Type PRS-V or wartime Dandees. Single-section units in 25 to 450 v. D.C.W. 4 to 100 mfd. Dual units: PRS-A concentrically-wound, three leads, 25 to 450 v. D.C.W. 8-8 to 20-20 mfd. PRS-B separate sections, four leads, 150 to 450 v. D.C.W. 8-8 to 20-20.

Type '84 Paper Tubulars. In 400 v. .01 to 1.0 mfd.; 600 v. .001 to .5 mfd.; 1000 v. .001 to .1 mfd.; 1600 v. .004 to .05 mfd.

● There's still a satisfactory Aerovox capacitor replacement for servicing most radio sets—regardless of growing shortages, curtailment of critical materials, banning of previous types.

In order to take care of upwards of 90% of usual radio service calls, Aerovox has been offering these three popular capacitors—Type PBS cardboard-case electrolytics, Type PRS-V tubular electrolytics, and Type '84 paper tubulars. These three types have been doing a real wartime job on the home radio front.

#### **Ask Our Jobber . . .**

He can advise you regarding your wartime servicing and maintenance replacement problems. Ask him for our latest catalog—or write us direct

**AEROVOX** *Capacitors*  
INDIVIDUALLY TESTED  
AEROVOX CORPORATION, NEW BEDFORD, MASS., U. S. A. • SALES OFFICES IN ALL PRINCIPAL CITIES  
Export: 100 VARICK ST., N. Y. C. • Cable: 'ARLAB' • In Canada: AEROVOX CANADA LTD., HAMILTON, ONT.

far better than "those we know of that do not have music." "Our absentee problem, while it is a problem, has been of a percentage that is far below the published figures we see for most war industries. . . ."

Sterling Aluminum Products, Inc., St. Louis, Mo., according to Miss Lee's report, is installing sound in all five buildings "with the full confidence that we will find this idea important on solving today's complex personnel problems."

### Utah Appoints Karet to Important Post

O. F. Jester, vice president in charge of sales of the Utah Products Co., Chicago, has announced the appointment of R. M. Karet as sales manager of the wholesale and sound division of the company.

A member of the Utah organization since 1936, Karet has had extensive experience in the radio and sound equipment industries, and is well known to the radio trade throughout the country.

He will assume responsibility for the sale of Utah products distributed through parts jobbers, sound houses



R. M. KARET

and similar organizations. Karet's background especially fits him for his new position. He is at present engaged in the company's war activities—as well as taking an important part in postwar plans.



When the destroyers put out to sea from Honolulu their destiny is in large part guided by electronic tubes many of them Ken-Rad Tubes Every Allied battle craft surface sub-surface or aerial carries such equipment by which the enemy can be detected reported and destroyed

In support of these scientific aids to Victory is the working-power of Ken-Rad which will be at your disposal after our common enemies are disposed of Meantime you may find a few Ken-Rad Radio Tubes at your dealer's or repair shop Ken-Rad Tubes are well-worth having even if you have to wait for them

# KEN-RAD

RADIO TUBES . INCANDESCENT LAMPS . TRANSMITTING TUBES

OWENSBORO - KENTUCKY

### Practical Radio for War Training

by M. N. BEITMAN

Published by Supreme Publications, 328 So. Jefferson St., Chicago, Ill.

This single volume by the prolific writer, Mr. Beitman, attempts to present the student with the needed theory of electricity and radio, and to explain the practical side of radio repair, adjustment, operation and alteration.

It is evident that the author assumes the reader has had no previous knowledge, and for this reason it should prove of considerable value to the learner, while having at the same time, valuable information for the experienced serviceman. Mr. Beitman's concise and easily understood definitions of mathematics as related to radio will doubtless be appreciated by readers who possess no great degree of knowledge of figures. Certainly the explanations are remarkably clear.

The chapters include What Makes Up a Radio Receiver, Mechanics of a Radio, Mathematics of Radio, Circuits Using Resistors, Properties of Coils and Transformers, Properties of Condensers; L, C, and R, Combined Circuits, How Meters Work. Also Vacuum Tubes, Power Supplies, Audio Amplifiers and Accessories, Radio Frequency Voltage Amplifiers, Detection, Receiver Circuits, Oscillators, Radio Transmitter Circuits, Lines, Antennas, and Radiation, Test Equipment Using Meters and Electronic Test Equipment.

The 336-page paper-bound book is profusely illustrated and sells for \$2.95.



## Philco Earnings and Production Increases

The consolidated net income of Philco Corp. for the first six months of 1943 totaled \$1,526,282, or \$1.11 per share of common stock. This was after estimated federal and state income and excess profits taxes and after provision for anticipated voluntary price reductions and renegotiation of war contracts. Of these earnings, \$415,000 or 30 cents per share consists of the post-war refund of excess profits taxes. In the first six months of 1942, adjusted earnings amounted to \$1,152,877 or 84 cents per share of common stock.

The statement was released by John Ballantyne, Philco president, who also commented on the new high levels in production, saying: "Philco's production of radio and electronic equipment for the army and navy continued to increase in the second quarter of the year. Present indications are that further production increases can be looked for in coming months, as additional engineering and development work is completed and manufacture of new equipment is begun."

## Mallory Workers' "Determination & Ability"

P. R. Mallory & Co., Inc., Indianapolis, Ind., have just been awarded a third star for their "E" pennant, which was first won in January, 1942. At the request of the Navy Department, no ceremonies are being held in connection with the star award.

In commenting on the new honor, Admiral C. C. Bloch, Chairman of the Navy Board for Production Awards, wrote:

"The men and women of P. R. Mallory & Company, Incorporated, have achieved a signal honor by continuing their splendid production in such volume as to justify this renewal of their award. In the first instance, it was difficult to win the Army-Navy 'E' and by meriting a third renewal, the management and employees have indicated their solid determination and ability to support our fighting forces by supplying the equipment which is necessary for ultimate victory."

## Dr. Rosenthal Appointed

Dr. A. H. Rosenthal, internationally known physicist and electronic engineer, has been appointed director of research and development of Scophony Corp. of America, according to an announcement made by Arthur Levey, president. Dr. Rosenthal was associated with Scophony, Ltd., of London, for several years, and in his present position will head a group of scientists and engineers engaged in research and development work related to war problems.

Television Productions, Inc. (a Paramount subsidiary) and General Precision Equipment Corp., are associated with Scophony Corp. of America.



- It Does the Job of Several Mikes • You Can Hold It
- You Can Hang It • You Can Mount It on Standard Stands

A truly multi-purpose microphone, which can do the job of two or more units. It fits the hand snugly; is equipped with a suspension hook for hanging mike applications, stage work and call systems; it can be mounted on any standard floor or desk stand. Especially engineered for maximum voice response and smooth, natural response to music pick-ups. Gunmetal or chrome type finish.

The Turner Han-D is equipped with a contact slide switch, for easy on-off operation.

9X Crystal has level of -48 DB, range of 60-7,000 cycles.

9D Dynamic, especially recommended for use under bad climatic conditions, intense heat and rough handling. Level -50 DB. Range 60-7,000 cycles. With 7 ft. removable cable set, available in 200-250 ohms, 500 ohms or hi-impedance.

## TURNER THIRD HAND WITH L-40 MIKE



### Leaves Both Hands Free for Other Jobs

For every spot where both hands are needed on the job, Turner 3-H-L40 is the lightweight unit to use. Defense plants use it for call systems. Police cars need it for better communications. The "Third Hand" holds the mike close to the mouth, giving tremendous volume without feedback.

Equipped with Turner L-40 microphone which has exceptionally high signal level. Gives more intelligible speech reproduction and minimizes feedback. Chest sounds are damped out. Gunmetal or chrome type finish. Level -48 DB.

The Turner Third Hand, 3-H, slips over the neck in a jiffy. Goose neck adjusts mike to any position. Can be used with long lines as traveling mike. Window demonstrators find 3-H indispensable. Can be ordered with mike switch at extra cost.

All Crystals Licensed Under Patents of the Brush Development Co.

Free New Turner Microphone Catalog, showing all available models. Write for yours today.



THE TURNER CO.  
CEDAR RAPIDS, IOWA



## Busy days, these!

Busy is right! RAULAND distributors are plenty busy these days supplying army and navy requirements and war plants in their territories with *AMPLICALL* Intercommunication, Industrial Paging and Sound Equipment, and setting new sales records doing it! RAULAND's program of national advertising is backing up the highly successful RAULAND FB distributing plan, enabling our jobbers to effect many new contacts for present and future business.

THE RAULAND CORPORATION . . . CHICAGO, ILLINOIS

• *Electroneering is our business* •



RADIO . . . SOUND . . . COMMUNICATIONS

## remember ALLIANCE Phono-motors?



*Let's Swing*

Hitler and his gang from a sour apple tree! . . . we're doing our part by putting Alliance dependability and skill into Dynamotors and other types of precision motors for our flying fighters. Alliance is serving on all fighting fronts. After we Win, and when joy again is unconfined, we'll tell you about some new and startling ideas in Phono-motors—Ideas that will help you in Peace as you are now helping in War. Why not put that in your notebook now? . . . under A.

REMEMBER ALLIANCE! . . . *Your Ally in War as in Peace!*

**ALLIANCE MANUFACTURING COMPANY**  
ALLIANCE, OHIO

## L. W. TEEGARDEN



Active in radio and electronic work since 1930, Mr. Teegarden has been appointed assistant general sales manager of RCA-Victor Division, Camden, N. J. The promotion was announced by H. C. Bonfig, general sales manager.

## Sylvania Acquires Its Fifteenth Factory

Sylvania Electric Products, Inc. has recently announced the acquisition of its fifteenth manufacturing plant, a steel and brick building in Warren, Pa. After conversion, the new plant will be used for the production of assembly parts for radio tube, electronic and lighting products.

The newly purchased building, which was formerly a motor sales and service operation, has a floor area of 17,600 square feet. The building will be converted immediately, and production is expected to be underway there soon.

## Many Promotions Made by Bell & Howell

Bell & Howell Co., Chicago, announce among the many promotions, the appointment of John C. Mouser, now general superintendent of the Rockwell plant. He was formerly chief production methods engineer in tool design, toolroom and processing. The company also announces that Carl Henriksen, formerly chief tool engineer, has been advanced to the chief production methods engineer post, and that I. G. Wilcox, recently superintendent of parts manufacture at the Rockwell plant, has been named general superintendent for their Larchmont Ave. plant in Chicago.

## Radio Servicemen Meet

The Philadelphia Radio Service Men's Association, inactive all summer, will hold its first meeting on September 21. Plans will be formulated at that time to try to ease the tube and parts situation.



## What Dealers Are Doing In Wisconsin

**MADISON, Wis.**—Brockman Radio Service gets a couple of radio instructors at Truax Field, Madison, to come to the shop in spare hours to help handle radio volume. E. Brockman travels considerably making sound installations for Uncle Sam. Delivery of radios is arranged for through a local dray company which calls for radios and collects from the customer for dray line and dealer.

Kidder Radio, said to be one of the best arranged shops in the Middle West, no longer calls for or delivers work, says Milton Kidder, one of the owners. Individual work benches, etc. are all on wheels, so radios and benches can be shifted without lifting, which lessens the labor problem. A special drive-in department at the rear for automobile radio owners helps speed up this service.

Capitol Radio Service now makes a charge of 5 cents for testing each tube, because repair time is at a premium. This change has not deterred the public who seem to have plenty of money to pay for any sort of service they want.

**FORT ATKINSON, Wis.**—Jerrold's Hardware not only goes along repairing radios, appliances and farm tools, but it recently added a furnace cleaning service which is netting a real profit. Charges range as high as \$10 per furnace, with some as low as \$4. The furnace vacuum was bought second hand for \$125 and has paid for itself many times over. Many of such units (used) are available in some sections of the nation.

**WATERFORD, Wis.**—When appliance volume fell off, Mrs. John Steinke, whose husband has a fine appliance store, helped out by enlarging a small gift department to take up the space. The result is a boom in gift sales. This new line now accounts for 45 per cent of the store's entire volume. Mr. Steinke devotes his time to the service department which is very busy now with appliance and plumbing repairs.

Some Things are REALLY Scarce Right Now\*



\*(Especially Professional Services)

**T**HE needs of our fighting forces make professional services increasingly scarce on the home front.

Radio servicemen, unable to obtain extra help, must do like other forward-looking professional men—avail themselves of modern, time-saving techniques. Today it is an economic necessity and a patriotic duty to turn out your work—quickly!

To do this you need the facts that are contained in proven text and reference books such as those listed at the right. These books are written for—and to servicemen. They go a long way toward supplying the extra "help" you need to keep the work flowing steadily through your shop. Order today!

#### NOTE ON TAXES:

Remember to deduct the amount of your investment in Rider Books.

#### RIDER MANUALS

Volumes XIII to VII .....\$11.00 each  
Volumes VI to III ..... 8.25 each  
Volumes I to V, Abridged .....\$12.50  
Automatic Record Changers and Recorders 6.00

#### OTHER RIDER BOOKS YOU NEED

The Cathode Ray Tube at Work  
Accepted authority on subject .....\$3.00  
Frequency Modulation  
Gives principles of FM radio ..... 1.50  
Servicing by Signal Tracing  
Basic Method of radio servicing ..... 3.00  
The Meter at Work  
An elementary text on meters ..... 1.50  
The Oscillator at Work  
How to use, test and repair ..... 2.00  
Vacuum Tube Voltmeters  
Both theory and practice ..... 2.00  
Automatic Frequency Control Systems  
—also automatic tuning systems ..... 1.25  
A-C Calculation Charts  
Two to five times as fast as slide rule.  
More fool-proof, 160 pp. 2 colors ..... 7.50  
Hour-A-Day-with-Rider Series—  
On "Alternating Currents in Radio Receivers"—  
On "Resonance & Alignment"—On "Automatic  
Volume Control"—On "D-C Voltage Distribution"  
90c each

#### JOHN F. RIDER PUBLISHER, INC.

404 Fourth Avenue • New York City  
Export Division: Roeca-International Electric Corp.  
100 Varick Street, New York City Cable: ARLAB

# RIDER MANUALS

## SPEED REPAIRS — AND VICTORY

# STANCOR TRANSFORMERS

USED BY MOST SERVICEMEN . . . MOST!



## STANDARD TRANSFORMER

• CORPORATION •

1500 NORTH HALSTED STREET . . . CHICAGO

# WAR-TESTED

FOR SUPERIOR  
*Peace-Time*  
PERFORMANCE

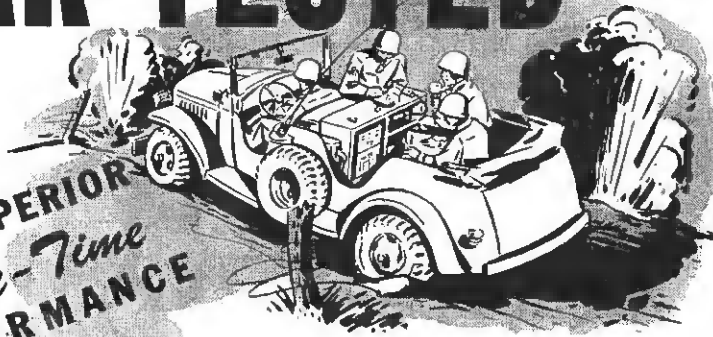

In the middle of battle . . . through the boom of guns and the roar of planes . . . when every man and piece of equipment are extended to the utmost . . . radio provides the vital means of communication for our fighting forces. Under these grueling conditions, Sentinel-built equipment is proving its dependability.

In the post-war battle for sales and profits, this war-tested dependability and performance . . . plus up-to-the-minute design . . . will be powerful merchandising weapons for Sentinel dealers.

**SENTINEL RADIO CORPORATION**  
2020 Ridge Avenue, Evanston, Ill.

Quality  
Since 1920

# Sentinel RADIO



## Parts by Centralab

Div. of Globe-Union Inc., Milwaukee, Wis.

- Steatite Insulators
- Ceramic Trimmers
- High Frequency Circuit Switches
- Volume Controls
- Ceramic Capacitors
- Wire Wound Controls
- Sound Projection Controls

### W. L. Fattig in New Post

W. L. Fattig, who has been in the radio business since 1928, has been appointed acting supervisor of the technical service section of the General Electric receiver division, Bridgeport, Conn., according to an announcement made by I. J. Kaar, division manager. P. R. Butler, former manager of the section, is in the U. S. Navy.

According to an announcement made by O. W. Pike, engineer of the tube division of G. E.'s electronics department at Schenectady, E. F. Peterson has been placed in charge of design engineering of receiving tubes.

### WALKER PRESENTS "OSCAR"



Frank Walker, RCA Victor official, presents Cowboy Elton Britt with gold-plated pressing representing the millionth copy of his Bluebird hit, "There's a Star Spangled Banner Waving Somewhere."

### "E" for Newark Company

In impressive ceremonies, the United Electronics Co., Newark, N. J., was recently awarded the Army-Navy "E" award for outstanding production. Four employees accepted the Army-Navy pins in behalf of the personnel from Lt. Com. J. Douglas Gessford, USNR. C. A. Rice, vice president of United, introduced Col. F. O. Bickelhaupp, U. S. Signal Corps, who presented the award, and the acceptance speech was made by R. H. Amberg, president of the company.

### L. A. Brown Vice President

R. L. White, president of Landers, Frary & Clark, New Britain, Connecticut, has announced the appointment of L. A. Brown to the position of vice president in charge of manufacturing and works manager for all of the Universal plants. Mr. White has been with the organization for 21 years.



## Sarnoff Sees Lower Consumer Prices

Fast-paced expansion of new markets and substantial reductions in consumer prices are the postwar promise of a new way of applying scientific research to the complicated problems of commercial distribution, says the Radio Corporation of America. The statement was issued as a result of two years of experimental study.

Commenting upon RCA's application of the fact-finding methods of science to the problems of distribution, President David Sarnoff said in part: "Industry called in science years ago to solve its technical problems. The constant succession of improved and new products, together with the extraordinary advances in mass production and lower consumer prices over a long period of time, marks the success of the idea." Now, according to RCA, scientific research is going to be applied to the marketing in much the same manner that it was successfully used in solving technical problems.

## Sound Equipment Aids Safe Plant Operation

That the installation of sound equipment throughout war plants sharply reduces industrial accidents and also serves as a means of communication, was stressed by A. R. Royle, Sound Division sales manager of the Stromberg-Carlson Company, to more than 250 safety engineers who recently attended the annual conference of the Wisconsin Council of Safety, held in Milwaukee.

After citing a number of installations where sound systems have proven of great benefit, Mr. Royle, described the experience of an aluminum mill which was having a sound system installed in its blooming mill to facilitate orders from supervisors to furnace operators. At the precise moment that the last connection to the apparatus was made at the rolling mill, one of the heavy white-hot ingots was mis-rolled, a serious mishap that would shut down the mill for an hour. A supervisor yelled the alarm. Suddenly the overhead crane swooped over and picked up the defective ingot from the production line, without the necessity of the mill halting its operation.

Mr. Royle, explaining the incident, said that, unknown to the person who gave the alarm, the newly-installed microphone picked up his voice and relayed the words to the crane operator who, in turn, removed the hot ingot.

"In other words, the stage was set for an accident. The fact that the sound system was installed and functioned perfectly, prevented any accident from occurring, and in addition, saved considerable time and material," Mr. Royle concluded.

*A Profitable way to fill today's order book*

**TALK TO THEM ON THE JOB**



**BELL VOICE PAGING AND BROADCASTING EQUIPMENT**

Keep in direct touch vocally with all your employees . . . get full, immediate attention to all bulletins, announcements, instructions and reports . . . keep workers' morale high with recorded music broadcasts. BELL VOICE Paging Equipment, the first to be specially designed for industrial needs, gives you all these advantages plus many unusual features. Standard, heavy-duty, tamper-proof units combine readily to meet requirements of any extent or capacity, permit easy rearrangement or expansion at any time. Write today for details on BELL VOICE PAGING EQUIPMENT!



**BELL SOUND SYSTEMS, INC.**  
1185 ESSEX AVE., COLUMBUS 3, OHIO  
Export Office: 5716 Euclid Ave., Cleveland, Ohio



**VACO Ambery Drivers Are "Leaders on Every Front"**

For Signal Corps trainees . . . for a host of other activities in the war effort, Vaco is supplying screw drivers and small tools designed for efficiency, and to speed up work in the radio and electronic field. Over 173 sizes and types—shock-proof, break-proof. Write for catalog.

Vaco's ability to create special drivers and small tools is aptly illustrated in the panel at left, showing some of our unusual developments.



**VACO Products Company**  
317 E. ONTARIO ST.  
CHICAGO, ILL.



**BATTERY SHORTAGE TO BE MET**

**SURE WISH WE COULD!**

**"YOUR CUSTOMERS ARE OUR CONCERN, TOO,"** says Homer G. Snoopshaw. "There seems to be enough raw material to make a lot of farm batteries and Uni-Cels, *but* there just isn't enough manpower or equipment. Naturally our Armed Forces come first, but we're also working at top speed to turn out as many civilian batteries as possible. The demand far exceeds our capacity to supply, so we still ask you to continue to distribute them fair and square; and sure appreciate your help!"



**Free CONSERVATION AIDS.** You can help your customers conserve the critical war materials in dry batteries and get maximum service from them. Write for a supply of Burgess "Battery Savers."

**BURGESS BATTERY COMPANY, FREEPORT, ILLINOIS**



**BURGESS BATTERIES**

## Radio Tubes and Parts

★ NO PRIORITY REQUIRED  
★ IMMEDIATE DELIVERY

Write for our latest catalog listing Tubes, Condensers, Speakers, Volume Controls, Vibrators, Resistors, Transformers and hundreds of hard-to-get replacement parts at unbelievably low prices!

**RADIO WAREHOUSE MARKET**  
362-C WOOSTER AVE. AKRON, OHIO

## Texas Sheriff Makes Two-Way Radio Count

Stating he believes that a law enforcement agency cannot function properly unless radio equipped, Sheriff Buckshot Lane of Wharton County, Texas, has some interesting comment about the use he makes of his equipment. Sheriff Lane made the following statement to **RADIO RETAILING TODAY**:

"We maintain two-way radio in this county, and due to this being a coastal area subject to gulf hurricanes, and also as a wartime measure, we have agreed to help out the Rural Electrification Co-op in every way possible so that electric power will get through.

"The Co-op has installed receivers in the service trucks and these cars keep tuned to this radio station. In an emergency I will dispatch a two-way equipped car out to render what aid is necessary, as power supply is of vital importance.

### Owned by Sheriff Department

"Our radio equipment was purchased from Fred M. Link, New York, and we maintain our own radio technician and operator. We consider the Link equipment among the best, and boast of the fact that it is Link equipment. Our station call letters are KWSO. The station is owned and operated by the Wharton County Sheriff Department.

"We feel that any law enforcement agency not radio equipped cannot function properly, and this department would feel entirely lost without the use of it. To keep going properly we must have power. Therefore we intend aiding the power companies as much as possible."

Just how important this Texas officer considers his equipment will be of interest to every radio man whether he is doing police work now or contemplates entering this interesting field.

## Booklet on Care of Electric Appliances

For the purpose of helping homemakers keep their appliances in good working order, a revised wartime edition of the booklet, "The Care and Use of Electric Appliances in the Home," is announced by Westinghouse Electric & Mfg. Co. The new booklet has an 18-page section of "fix it" suggestions, and chapters on the proper care and use of 16 of the most widely used electric home appliances.

The booklet also points out the importance of getting professional service when serious trouble develops in appliances, and urges consumers to take their appliances to the dealer for repairs whenever possible. Copies of the booklet may be procured from Westinghouse at Mansfield, Ohio.



**Brandt and Henyan  
in New GE Posts**



**ARTHUR A. BRANDT**

Arthur A. Brandt, George W. Henyan, and V. M. Lucas have been appointed to new positions in the electronics department, of the General Electric Company, according to an announcement by Dr. W. R. G. Baker, vice-president in charge of the department.

Mr. Brandt has been made general sales manager. In this capacity he will be responsible for the co-ordination of the sales plans and policies of the several divisions, and the operations of the electronics department district offices.

Mr. Henyan has been made assistant to the vice-president of the department, and Mr. Lucas has been appointed manager of the Government division.

**Buy War Bonds!**

The Third War Loan Drive for 15 billion dollars got under way Sept. 9. The retailers of America have pledged themselves to sell one billion dollars in "E" Bonds.

Secretary Henry Morgenthau, Jr., Secretary of the Treasury, has issued the following statement:

"The retailers of America are setting a fine example for other patriotic groups in taking for themselves a billion dollar quota in 'E' Bonds and Stamps during the Third War Loan. All retail organizations have worked with us since the beginning of the War Bond Program, and judging from past experiences, I have no doubt that they will reach their quota. The recommendation of leaders of the retail group that at least 10 per cent of their advertising budgets be spent in behalf of the Third War Loan is another example of how this splendid group is cooperating with the Treasury Department in its War Financing efforts."



**"ALL-OUT"  
TO HELP WIN  
THE WAR**

Today, the 36-years of skill and experience that pioneered and developed the "QUANTITY-plus-QUALITY" manufacture of BRACH products, are directed exclusively toward serving our armed forces on their road to Victory.



**L. S. BRACH MFG. CORP.**

*World's Oldest and Largest Manufacturers of Radio Aerial Systems*

**55-65 DICKERSON STREET • NEWARK, N. J.**

**DON'T LOSE TUBE SALES  
SUBSTITUTE!**

Get complete details in the handy guidebook that features

- Full coverage of popular tube types
- 5 substitutes for 50L6GT
- 3 substitutes for 12SA7
- Over 100 substitutions and change-overs
- Complete socket data and resistor ratings
- Full adaptor data on loctal to octal change-overs

20 pages of non-technical comprehensive data contained in  
**RADIO TUBE SUBSTITUTION AND**

**CHANGE-OVER MANUAL**

by **ROBERT T. OELRICH**

Order your copy now . . . Price \$1.00  
See your Radio Parts Jobber, or write

**OELRICH PUBLICATIONS**

1627 S. Keeler Ave., Chicago 23, Ill.

# OHMITE

10 AND 20 WATT  
**BROWN DEVIL  
RESISTORS**

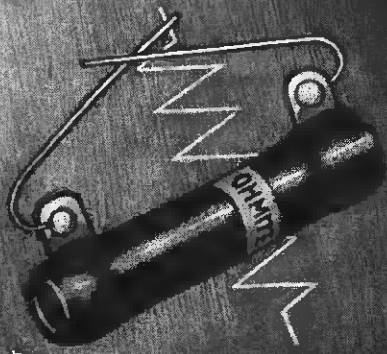

*For Dependable  
Service in Electronic  
Applications*

Long known for their dependable performance—Ohmite Brown Devil Resistors serve today in critical war applications—in radio communications and other electronic equipment. Their extra sturdy, wire wound, vitreous enameled construction insures permanent resistance. These same units will be ready to serve your peacetime needs after Victory is won.

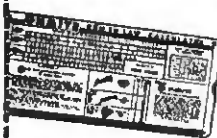

**Ohm's Law Calculator**  
Helps you figure ohms, watts, volts, amperes—quickly, easily. Solves any Ohm's Law problem with one setting of the slide. All values are direct reading. Send only 10c in coin. (Also available in quantities.)

**CATALOG 18**

Gives helpful information on Ohmite stock resistors, rheostats, chokes and tap switches for all types of applications. Free—Write for it.

Authorized Distributors  
Everywhere



Ohmite Manufacturing Co.  
4873 Flournoy, Chicago 44, U.S.A.

**HEADS MUSIC WAR  
COUNCIL**



Max Targ, re-elected president of the Music War Council of America, reported gratifying results of the council at the annual meeting in New York.

**Stromberg-Carlson on Air**

The Stromberg-Carlson Co., of Rochester, N. Y., makers of precision radios, telephone and sound equipment, has acquired time on W59NY, FM affiliate of WQXR, New York City, for the "Treasury of Music," a classical and semi-classical radio program.

A half-hour show, it is heard on Monday, Wednesday and Friday at 7:30 P.M. featuring prominent orchestras and vocalists.

**Emerson Stock Issue  
to Be Offered Public**

A registration statement covering 175,000 shares of Emerson Radio & Phonograph Corp., capital stock has been filed with the Securities and Exchange Commission, and the announcement has been made that the issue will be offered to the public promptly. These shares are part of 400,000 already outstanding and represent no new financing.

Net income of Emerson Radio & Phonograph Corp., for the seven months ended May 31, 1943, totaled \$487,941 compared with \$651,464 for the full fiscal year ended October 31, 1942; \$758,684 for the year ended October 31, 1941, and \$304,480 for the year ended October 31, 1940. According to the prospectus, the board of directors of Emerson intend to initiate a dividend policy involving payment of such regular quarterly dividends, with extras, as the earnings, financial condition and business prospects of the company will justify.

**CUTTING HOLES  
IN RADIO  
CHASSIS?**

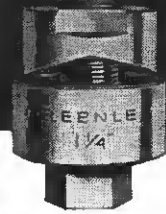

Save Time  
with  
**GREENLEE  
PUNCHES**

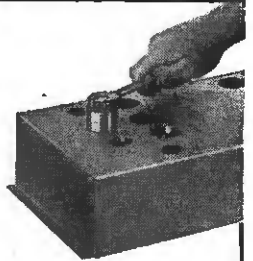

① **No Drilling** — Making small holes larger without drilling is a simple task with Greenlee Punches. Holes as small as 1/8" are enlarged in a jiffy with a few turns on the cap screw.

② **No Reaming** — Range of sizes from 1/8" to 2 1/4" cut accurate holes—eliminate reaming. Knockout Punches up to 3 1/2" size are also available.

③ **No Filing** — Die supports the metal and tool cuts clean, smooth holes fast and easy — leaves no ragged edges.

WRITE FOR CATALOG 33E

Find out how these and other Greenlee Tools can save you time. They are available for essential users. Write for Catalog No. 33E.

**GREENLEE TOOL CO.**  
1909 Columbia Ave., Rockford, Ill.



**BEFORE  
DURING  
AFTER**

**BEFORE** the war SNYDER products satisfied the nation's peacetime Antennae requirements for more than a decade.

**DURING** these war years, use has demonstrated the correctness of design and operation of their products. Their record of accurate and dependable performance is the basis of their war-wide acceptance.

**AFTER** the war is won post-war plans include SNYDER's continued leadership in the field.

ANTENNAE & ASSOCIATED PRODUCTS





## Study Shows Radio Audience Cut But 4%

Contradicting rumors to the effect that from 15 to 40 per cent of U. S. homes are currently without radio reception facilities due to lack of tubes, parts and service, a nationwide study reveals that but 4.3 per cent are without service.

It is said that these rumors have in some cases been promoted by newspaper interests which are being affected by radio advertising competition.

Dr. Frank Stanton, CBS vice president in charge of research, declares that such exaggerated claims of radio audience cuts are untrue, and the study made a few months ago, based on a scientific cross-section of 5,997 personal interviews conducted by Elmo Roper, shows that 95.7 of all U. S. radio homes have one or more receivers in operating condition. Life magazine made a study of the situation in December, 1942, based upon 5,971 cases, showing 95.8 per cent of the homes having one or more working radios.

### "Second Sets" Play Part

Other highlights of the Roper report show that 21.7 per cent of all radio homes reported "second" sets out of order. With about 60 million receivers owned by listeners, the tremendous stock of secondary sets has thus far prevented loss of radio service to the great majority. Over a period of years, on a nationwide basis, from 3 to 6 per cent of all radio homes have been without service. Dr. Stanton adds that the CBS-Starch Quarterly Reports, for urban areas, shows a range of 2.9 to 6.4 per cent between 1934 and 1937. The average for both urban and rural areas, at the end of 1937, was 4.2 per cent of owners with radios out of order. This latter figure was based on the findings of the Joint Committee on Radio Research.

### Tells About Philco's Postwar Plans

"For Philco Corporation, the most important job at the present time is to help win the war," declares T. A. Kennally, vice president in charge of sales, following the receipt of numerous requests from dealers who want to know about Philco's postwar policies.

The Philco executive, however, stated that his company is planning now to be in a position to make the most of postwar opportunities. "All our studies indicate that the market for home and automobile radio receiving sets, radio-phonographs, refrigerators and air-conditioners at the end of the war will be of unprecedented proportions," he said, emphasizing the point that "the public, unable to purchase these products at the present time, will be eager to obtain them as soon as production is resumed."

**WHEN THE LIGHTS COME ON AGAIN**

# AUDIOGRAPH

THE FIRST NAME IN SOUND

When our thoughts turn to praise for blessings instead of prayers for Victory, Audiograph will find its place, as a gratifying acoustical aid. Audiograph is one of our Family of Activities in the field of electronics—a field destined for service to man.

**JOHN MECK INDUSTRIES**  
PLYMOUTH, INDIANA

## HARD TO GET PARTS

<p><b>SPEAKERS</b></p> <p>4" P.M. Less Tran. .... \$ .97</p> <p>5" P.M. Less Tran. .... 1.35</p> <p>5 1/2" P.M. With Tran. .... 1.95</p> <p>5" P.M. With Tran. .... 1.75</p> <p>15" Magnavox Dynamic for Auditorium Use, High Fidelity, 1500 ohm. field, Large 6L6 Push Pull output Tran. 2" Dust Covered Voice Coil ..... 12.50</p> <p><b>PICKUP CARTRIDGES</b>—RCA Victor Magic Tone Cell with Permanent Needle for Replacement in V215, V219, V221. It is also designed and comes complete with Hardware and Instructions for installation in any RCA Victor Combination manufactured from 1938 to 1942 ..... <b>\$4.97</b></p> <p><b>ASTATIC</b> LP6 and LP21 with Permanent Needle ..... <b>\$5.75</b></p>	<p><b>MICA CONDENSERS</b> All brand new &amp; color coded</p> <p>.001, .002, .0025, .003, .005 ..... <b>\$.15</b></p> <p>.0001, .00015, .0002, .00025, .0003, .0005, .00001, .00005 ..... <b>.08</b></p> <p><b>TUNING CONDENSERS</b></p> <p>3 Gang TRF ..... <b>\$.75</b></p> <p>2 Gang Super ..... <b>.39</b></p> <p><b>SWITCHES</b></p> <p>Single Pole Double Throw Rotary Tone Control, <b>\$.15</b></p> <p>Single Pole Single Throw Toggle, 6 Amp. .... <b>.18</b></p> <p>Double Pole Double Throw Slide ..... <b>.18</b></p> <p>Single Pole Single Throw Rotary ..... <b>.12</b></p> <p><b>SOCKETS</b></p> <p>8 Prong Octal Amphenol Type ..... <b>\$.04</b></p> <p>8 Prong Octal Amphenol Type ..... <b>.05</b></p> <p>8 Prong Octal Amphenol Type, Low Loss ..... <b>.05</b></p> <p>Capacities ..... <b>\$.06</b></p> <p><b>TRIMMER CONDENSERS</b>—All</p>
---	---

**MANHATTAN RADIO PARTS CO.**  
72-76 CORTLANDT STREET NEW YORK

★ ★ ★ ★ ★ ★ ★ ★ ★ ★

## All Out for the Duration!

All our facilities—men and equipment—are now working full speed to help win the war—and when we've finished that job, we will again continue to make better

# DEWALD RADIO'S

DeWALD RADIO MFG. CORP.  
440 Lafayette St., New York, N. Y.

★ ★ ★ ★ ★ ★ ★ ★ ★ ★

**PEERLESS  
ALBUM**

## WHEN A RECORD NEEDS A FRIEND

### DESIGN For SELLING

illustrating the  
LIBRARY  
EDITION



with

## PROTECTO FLAP

• A famous architect has said that an unflinching test of a design is the measure of its utility. The Peerless Protecto Flap achieves a high rank judged by that standard. The exclusive crash-proof flap is the perfect method for protection and preservation of more-than-ever precious records. Protecto Flap Albums are designed for sales... get your share.

Peerless  
Album Co., Inc.  
38-44 W. 21st St., New York, N.Y.

## Coogan Sees Big Postwar Foreign Market

Stating that his own company has its postwar export problem well under way, Walter A. Coogan, director of the international division of Sylvania Electric Products Co., who was recently reappointed chairman of the export committee of the Radio Manufacturers Assn., declares that the postwar future in foreign markets shows great promise for RMA members.

Faced with what he terms "unprecedented export complications brought about by the war," the export committee of RMA will set up its operations by forming subcommittees to which specific subjects will be delegated. "It is not difficult to obtain orders today," he explained. "Our most pressing problems are those connected with obtaining licenses from OFW and priority ratings from WPB. The shortage of shipping space has eased up considerably, and is now available to most countries."

In describing the postwar prospects for exporters, Mr. Coogan said: "In Latin America, for example, a postwar electronic era is rapidly growing into a potential market that will far exceed even the most enthusiastic prospects now current."

## Carl M. Snyder Dies

Carl M. Snyder, assistant manager of General Electric Company's appliance and merchandise department at Bridgeport, Conn., died Aug. 14, in the New Haven Hospital, following an illness of several months. Coming with G. E. in 1930, Mr. Snyder was a pioneer in the ensemble selling of equipment for completely electrified homes.

## HARRY D. GRIFFITH



Re-elected president of the National Association of Music Merchants, Mr. Griffith, vice president of the Griffith Plano Co., Newark, N. J., presided over the recent annual meeting in New York.

# READRITE

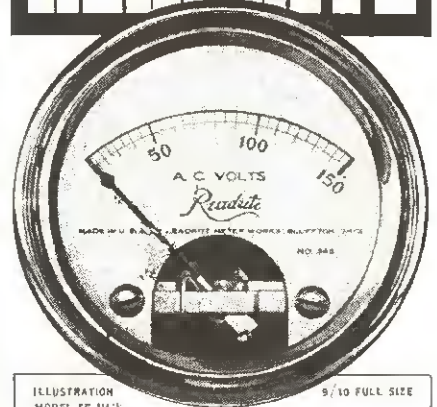

ILLUSTRATION  
MODEL 55 "L"

9/10 FULL SIZE

## A.C. METERS D.C. METERS

Available in all catalogued models and ranges

Scale—80°—11½" on enameled metal plate. *Specify Range A.C. or D.C. Add "L" after catalog model number*

Construction—Full bridge moving iron type with hard steel pivots.

Accuracy—± 5% Full Scale or ± 2% any one point to order.

Mounting—2⅝" diameter hole. ⅞" depth behind flange.



READRITE METER WORKS, Bluffton, Ohio

## ★ MORE HEAT ★ LESS COAL

(1) It is necessary for everyone to save coal—for our war plants and armed forces. (2) Comfortable homes are necessary for maintaining morale and health at home. Our discoveries now make both possible—at the same time.

We are justly proud of the  
**STIGLITZ**  
WARM-AIRE HEATER



Victory Model  
V-618  
with exclusive  
Atr-Jet Carburetion

Saves ⅓  
on coal

One firing lasts  
up to 3 full days

Burns the  
smoke and soot

Proven Satisfactory from Coast to Coast

**STIGLITZ**  
A Generations  
of Manufacturing Heating Equipment  
**FURNACE & FOUNDRY CO.**

"The Oldest Store Factory in America"

2007 PORTLAND AVE., LOUISVILLE, KY.

Marketed Through Leading Distributors—Exclusively





**UNIVERSITY**

**REFLEX SPEAKERS**  
now the accepted **STANDARD** for all **WAR USE**

**EVERY UNIVERSITY REFLEX**  
the result of years of pioneering research and development.

**EVERY HIGH EFFICIENCY SPEAKER**  
in University's extensive line of power speech reproducers has a vital part to play in the WAR program.

**REMEMBER**  
University is now producing many special speakers for the Army, Navy & Signal Corps. Submit your special problem direct to the engineering dept.

**UNIVERSITY LABS., 225 VARICK ST., NYC**

### Quam Is Named Director

The Nichols Steel & Wire Co., manufacturers of steel wire, galvanized sheets, etc., has announced the election of Jim Quam, president and general manager of Quam-Nichols Co., Chicago, as director of that organization.

### Crosley Adds Two New Distributors

Stating that it is not only keeping its distributor personnel intact through the wartime period, but is enlarging and expanding its wholesale outlets, The Crosley Corp., Cincinnati, announces the appointment of two more distributors. They are the O'Keefe Motor Co., Carrier Mills, Ill., and the National-Rose Spring & Mattress Co., Memphis, Tenn.

The O'Keefe Co., headed by Clyde O'Keefe, started in as an automobile dealer in 1923, and since 1939 has been a Crosley retail dealer. The National-Rose Co. now employs about 250 people and is manufacturing large quantities of mattresses for the government, and has a furniture jobbing department.

Announcement of the new appointments was made by J. H. Rasmussen, commercial manager of The Crosley Corp.

### Emerson Features "Electronic Radio"

The forthcoming national advertising campaign of Emerson Radio will illustrate in a distinctly modern style the scope of the company's war production, and will point to the eventual resumption of civilian operations.

The national magazine campaign, which is being supplemented by radio broadcasts, trade journal advertising, direct mail literature and by field representatives, features Emerson "Electronic" radio as a quality and performance advance beyond pre-war standards. According to their announcement, the term "Electronic" derives from the projected applications of techniques, principles and other developments which are accumulating in the company's war-serving laboratories, as well as in other departments.

### Firm's Earnings Climb

Aircraft Accessories Corp., Kansas City, reports net profit of \$741,433 for its fiscal year ending April 30, 1943, according to Randolph C. Walker, president. This is equal, after preferred dividends, to \$1.21 a share on 593,335 shares of common stock outstanding at the close of the period. On the basis of 714,919 shares of common outstanding on July 30, 1943, after conversion of preferred stock, the net profit is equivalent to \$1.04 a share.

### AVAILABLE

for  
**IMMEDIATE DELIVERY**  
**QUALITY MERCHANDISE**  
**AT LOW PRICES**

### STANDARD BRANDS—PAPER CONDENSERS

Size	W.V.	Fa.	Per C
.002, .006	400	.06	\$ 5.00
.01, .02, .03	400	.06	5.00
.05, .1	400	.07	6.00
.2	400	.11	9.00
.25	400	.14	13.00
.5	400	.19	18.00
.006	1600	.09	7.50

### ELECTROLYTIC CONDENSERS

8 Mfd. 450 W.V.	30c ea.
10 Mfd. 25 W.V.	14c ea.
30 x 30 Mfd. Tubular with Mtg. Strap	55c ea.
375 275 W.V. 1 1/4 x 2 3/4 inches	
30 x 30 x 25 Mfd. Tubular with Mtg. Strap	
350 300 25 W.V. 1 1/2 x 2 1/2 inches	69c ea.
20 x 20 Mfd. 1/2 x 2 1/2 inches	
150 W.V.	35c ea.

IF Transformers peaked at 456 k.c. .... 39c ea.

### VOLUME CONTROLS

Exact Replacement Control for General Electric Model No. 665	\$.45		
Switch	Shaft	Make	
3 Meg. S.P.S.T.	3"	Centralab	.35
2 Meg. D.P.D.T.	3"	Stackpole	.35
CRL Universal Controls 5M, 10M, 25M, 250M, 500M, 1 Meg. with Switch	.45		
500M, No Switch	.35		
1 Meg. Tapped, No Switch	.35		

### SWITCHES

Combination S.P.S.T. } Slide Switch	
D.P.D.T. } Momentary or Fixed	\$.15
S.P.S.T. Toggle Switch with leads	.25

### COILS

Antenna R F Coil—Set of 2	39c per set
Antenna Oscillator Coils—Set of 2	39c per set

### CARBON RESISTOR KITS

100 Assorted 1/2 Watt All Popular Sizes	\$.150 per C
100 Assorted 1/4-1/2-1 Watt All Popular Sizes	1.75 per C

### SOCKETS

8 Prong Wafer Sockets (Octal) 1-5/16 Mtg.	\$.250 C
Insulated Bakelite Dial Lamp Sockets, Bayonet Type with leads	3c ea.

### SPEAKERS

1" P M 1 1/2 oz. Magnet	\$.125
5" P M 3 1/2 oz. Magnet, no Transformer	1.50
Transformer Single 50L6	.49
Combination	1.95
4" 3000 Ohms, no Transformer	1.45
5" Magnetic	1.35
3" 450 Ohms with Transformer, Single 50L6	1.85
8" 450 Ohms with Transformer, Single 25L6	2.95
12" 600 Ohms Rola	3.75
12" 1600 Ohms Magnovox	3.75

### MAIL ORDER TODAY — DON'T DELAY

F.O.B. N.Y.C. No order shipped less than \$5.00  
Terms Net—C.O.D.

L-265 Certification must accompany all orders

**ART RADIO CORP.**  
115 LIBERTY ST., NEW YORK, N. Y.



**MUELLER**

**CLIPS**  
FOR MAKING QUICK TEMPORARY CONNECTIONS

- Made in 10 sizes—from the tiny wee-pee-wee to the 300 ampere Big Brute.
- Offered in both steel and solid copper.
- Red and black rubber insulators to fit each size.
- A complete line with

**A CLIP FOR EVERY PURPOSE**  
Immediate deliveries on practically all items  
Send for free samples and catalog 701

**Mueller Electric Co.**  
1584 E. 31st St. Cleveland, Ohio

# RADIO SERVICE MEN

**HOLDING UP JOBS FOR TUBES?  
WE REPAIR MANY WITH OPEN FILAMENTS**

Send us your burned out, but not shorted 150 mil filament tubes carefully packed. Those we are able to repair will be returned to you C.O.D. for 25c per tube, transportation paid on fifty or more.

## WARTIME SUBSTITUTIONS

We have worked out in our shop a large number of substitutions for almost all the hard to get types and put detailed instructions for making changes into booklet form.

### TRY THIS ONE

Use 12K7 to replace 12SA7—Remove wires, etc., from number 5 and extend to grid cap, move connections from 8 to 5 short 8 to 6. First job pays for the booklet. You can't afford to figure it out for yourself.

### ONLY \$3 POSTPAID

We furnish adapters to use 1LA6 or 1LC6 in place of 1A7—12K7 for 12SA7—12K7 or 12J7 for 12SK7 or 12SJ7, also any other substitutions in our booklet. Just plug the substitute tube into the adapter and plug it into the radio, no need to change the wiring.

### \$2 EACH, NET

**CITY RADIO COMPANY**  
THE RADIO CITY OF PHOENIX, ARIZONA  
504-6 E. Washington Street

## RMA Group Is Studying Postwar Radio Problems

Scheduled meetings September 15th and 16th of the Radio Manufacturers Assn., in New York, for the purpose of organizing the new Radio Technical Planning Board made up of two organizations, RMA and the Institute of Radio Engineers, stress immediate war production as well as postwar plans. The meetings were called by President Paul V. Galvin. The executive committee of the RMA parts division, of which Ray F. Sparrow is chairman, was also scheduled, as well as a meeting the following week of the transmitter division, headed by chairman G. W. Henyan.

It is expected that as a result of the meetings, many war production problems will be ironed out, as well as solving postwar policies.

### R. C. Cosgrove, Chairman

R. C. Cosgrove, vice president and general manager, manufacturing division of the Crosley Corp., who was named by Paul V. Galvin, president of the Radio Manufacturers Assn., is serving as chairman of a special committee of the RMA to undertake studies of the postwar problems of the radio manufacturing industry.

The studies are to be undertaken on a broad scale, and the committee expects to cooperate fully with government and industry agencies and organizations. Mr. Cosgrove said that the work on economic problems of the industry would be correlated with that of the technical planning agency now being organized by RMA and the Institute of Radio Engineers.

### Other Committee Members

Other members of the RMA committee on postwar planning include: W. R. G. Baker, vice president, General Electric Co., Bridgeport, Conn.; M. F. Balcom, vice president, Sylvania Electric Products Co., Inc., Emporium, Pa.; John Ballantyne, president, Philco Corp., Philadelphia, Pa.; H. C. Bonfig, vice president, RCA Victor Division, Camden, N. J.; Walter Evans, vice president, Westinghouse Electric & Manufacturing Co., Baltimore, Md.; A. H. Gardner, president, Colonial Radio Corp., Buffalo, N. Y.; Leslie F. Muter, president, The Muter Co., Chicago; J. J. Nance, vice president, Zenith Radio Corp., Chicago; E. A. Nicholas, president, Farnsworth Television and Radio Corp., Ft. Wayne, Ind.; Ross D. Siragusa, president, Continental Radio and Television Corp., Chicago; Ray F. Sparrow, vice president, P. R. Mallory & Co., Indianapolis; and A. S. Wells, president, Wells-Gardner & Co., Chicago.

Mr. Cosgrove is also serving as chairman of the set division of the RMA, and was named a vice president of the association at the annual meeting.

HERE'S

## The ANSWER TO THE RESISTANCE LINE CORD PROBLEM!

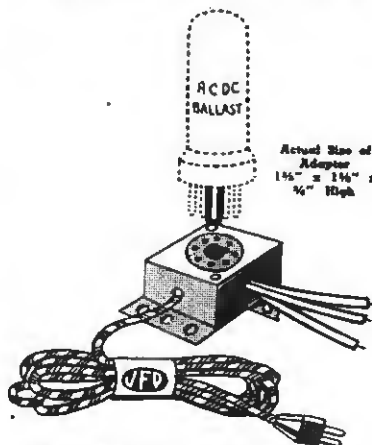

### JFD RESISTANCE CORD REPLACEMENT ADAPTERS

Resistance line cords, for replacement in AC-DC Radio sets, are now practically impossible to get. New JFD Adapters permit easy substitution of standard ballast tubes FROM YOUR OWN STOCK. Only 4 different numbers of Adapters take place of all types of resistance line cords.

Write for Literature

**JFD Mfg. Co.**

4111 Ft. Hamilton Pkwy. Bklyn. 19, N. Y.

## CLAROSTAT

ROLLING ON TO

# Victory

\* Clarostat continues to be engaged 100% in the most important job of all—winning the war—on land, sea and in the air.

But after victory has been won, Clarostat promises the trade—servicemen, jobbers and others—that Clarostat products for initial and replacement uses alike, will once more be generally available for peacetime pursuits. Meanwhile, let's keep 'em rolling!



CLAROSTAT

Controls and Resistors

CLAROSTAT MFG CO INC 283 J N 68 St Bklyn N Y



# ESICO

U.S. PAT. OFF.

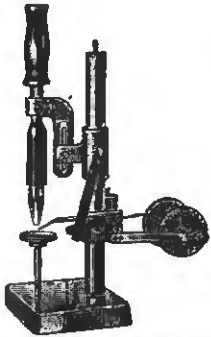

**SPOT SOLDERING MACHINE**  
designed for treadle operation for advancement of iron and solder, leaving operator's hands free for handling of product.



**SOLDERING IRONS**

are widely used in industrial plants throughout the country. They are designed to withstand the strain of continuous service required of factory tools.

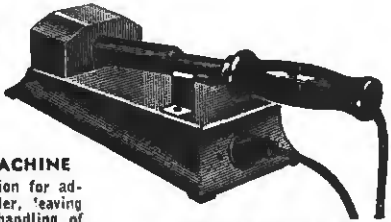

**SOLDERING IRON TEMPERATURE CONTROLS**

prevent overheating of soldering irons between soldering operations. Irons do not deteriorate when being used. The idle period causes oxidation and shortens life.

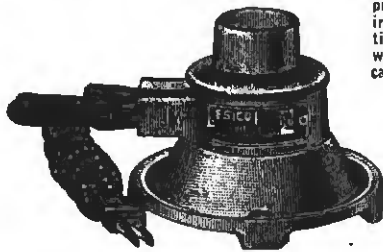

**SOLDER POTS**

ruggedly constructed pots of various sizes designed for continuous operation and so constructed that they are easily and quickly serviced, should elements have to be replaced.

*Write for Catalog*

**ELECTRIC SOLDERING IRON CO., INC.**  
239 WEST ELM STREET, DEEP RIVER, CONN.

Another reason why *Fidelitone De Luxe*  
*Floating Point* Needles are **EASY TO SELL** \*

**KIND... TO RECORDS**

Dealers and clerks from coast to coast tell us that customers buy *Fidelitone De Luxe Floating Point* Phonograph Needles because the precious Permo metal tip is kind to records... helps to give more enjoyment for a longer time.

\* Information based on actual statistics from recent *Fidelitone National Quiz Contest*.

PERMO, Incorporated  
6415 Ravenswood Ave., Chicago, Ill.

5000 plays  
**#1**  
everywhere

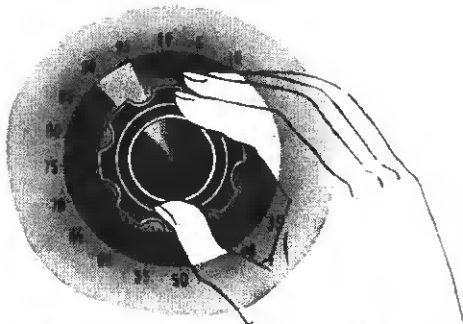

## MONARCH Testing-Measuring Instruments . . .

for the laboratory and for the production line, are speeding production now, as never before, due to their exceptional accuracy and dependability.

Our testing instruments are regularly specified by many manufacturers for shipment with other equipment as government contracts require. If you need assistance along any of the lines mentioned we invite you to consult us without any obligation.

**MONARCH MFG. CO.**  
2014 N. Major Ave. Chicago, Ill.

# ONAN

ELECTRIC PLANTS

*Electricity for Any Job Anywhere*

★ ONAN GASOLINE DRIVEN ELECTRIC PLANTS provide electricity in locations where it is not otherwise available, and for emergency and standby service for all communications work.

Thousands of these reliable, sturdy Plants are doing a winning job on all the fighting fronts by providing electricity for Communication and other war tasks. Ratings from 350 to 35,000 watts. A.C. 50 to 800 cycles, 110 to 660 volts. D.C. 6 to 4000 volts. Also dual A.C. and D.C. output models. Air or water cooled.



Details gladly furnished on your present or post-war need for Electric Plants.

**D. W. ONAN & SONS**  
2011 ROYALSTON AVE. • MINNEAPOLIS, MINN.



Our General Manager who is somewhere in the South Pacific has just been made a captain in the U. S. Army. We're very proud of him, especially since his background is entirely with us,—we practically "raised him from a pup."

Not so very long ago he came to work for us on his summer vacation from college. His job was sweeping floors, and while he did them well, it was apparent he was wasted on that job. The following summer he came to us permanently and landed a job in the stock room. Eventually he became purchasing agent and when he left for the army he was General Manager.

Now for the point in this story. The great American way of life has always been to work hard, use your head, your initiative, not pay too much attention to the time clock and eventually you'll get somewhere, both in the way of worldly goods and recognition.

But it seems that the tendency these past few years has been away from this practice. Under some of our laws now, an executive is not an executive if he spends more than 20% of his time at "noodle" work.

This has its good points, but on the other hand it seems to me, that if you are trying to be a success you can't spend too much time figuring out the percentage of your "allowable" leadership. Suppose when this man was climbing the ladder he had said, "I can't do certain non-executive work this week because I've already used up my 20% so the company will have to wait until next week."

Well, somehow I don't think he would have become a captain in industry or in the army? Do you?

*Kelley Stanciland*  
**QUAM-NICHOLS CO.**  
 33rd Place & Cottage Grove, Chicago



## SELLING THE CLASSICS

(Continued from page 36)

Kolodin's "Guide To Recorded Music" (Doubleday Doran, \$4.00) for any dealer wishing a good quick classic reference, as an aid to handy review of classic recordings and their group-ing.

### Classics a Fundamental

Another of Miss Steele's assistants is Miss Rosova, also a trained musician and a student of the violin. While her knowledge of and training in music is a factor in intelligent selling of records, Miss Rosova does not rely upon it alone to "sell" effectively. Her interest in the buying public is a keen one, and like both Miss Steele and Miss Foster, her first thought is to catch the keynote of her prospective customer's musical bent, and in what record he may be interested if the one called for is "out of stock." Under Miss Steele's direction, both Miss Foster and Miss Rosova follow through on the procedure of making the sale of what they have in stock, rather than take an order for a "special" disc, to be obtained direct for this one customer. Although a devotee of all classical music, Miss Rosova is quick to sense a customer's preference for the "popular" classic, significant of another trend in current record-buying. The biggest demand for this type of music is for albums such as those of Pine Top Smith (Decca), Duke Ellington (Victor), and the Tommy Dorsey and Artie Shaw albums. Single discs of old time populars made by Benny Goodman, Lionel Hampton, Harry James and certain collector's items such as Victor's "I Can't Get Started" by Bunny Berrigan, Bluebird's Glenn Miller recording of "Little Brown Jug," Decca's album "Gems of Jazz," Columbia's "James Session" album.

"However, even the fans of the 'hottest' music invariably show an interest in the Victor Kostelanetz album of Strauss Waltzes, and some of these even wind up with Victor's album of Chopin's 'Les Sylphides Ballet Music'" Miss Rosova smiled.

Is it that "music hath charms"? Or, is it, after all, just plain, good old-fashioned salesmanship?

## INDEX To Advertisers

	Page
AEROVOX CORP.	75
ALLIANCE MFG. CO.	78
ART RADIO CORP.	87
AUTOMATIC RADIO MFG. CO., INC.	74
BELL SOUND SYSTEMS, INC.	81
BLUE NETWORK CO.	2
BRACH MFG. CORP., L. S.	83
BURGESS BATTERY CO.	82
CENTRALAB	80
CITY RADIO CO.	88
CLAROSTAT MFG. CO., INC.	88
CONTINENTAL RADIO & TELEVISION CORP.	1
DELCO RADIO DIV., GENERAL MOTORS CORP.	37
DE WALD RADIO MFG. CORP.	86
EBERSTADT & CO., F.	72
ELECTRIC SOLDERING IRON CO., INC.	89
ELECTRONIC LABORATORIES, INC.	9
EMERSON RADIO CORP.	7
FADA RADIO & ELECTRIC CO., INC.	11
FARNSWORTH RADIO & TELEVISION CORP.	47
GALVIN MFG. CORP.	Cover 4
GENERAL ELECTRIC CO.	39
GREENLEE TOOL CO.	84
HYTRON CORP.	5
JENSEN RADIO MFG. CO.	71
JFD MFG. CO.	88
KEN-RAD TUBE & LAMP CORP.	76
MAGNAVOX CO.	12
MAJESTIC RADIO & TELEVISION CORP.	50
MALLORY & CO., INC., P. R.	Cover 2
MANHATTAN RADIO PARTS CO.	85
MECK INDUSTRIES, JOHN	85
MEISSNER MFG. CO.	49
MONARCH MFG. CO.	89
MUELLER ELECTRIC CO.	87
NATIONAL UNION RADIO CORP.	10
DELTRIC PUBLICATIONS	83
OHMITE MFG. CO.	84
ONAN & SONS, D. W.	89
PEERLESS ALBUM CO., INC.	86
PERMO, INC.	89
PHILCO CORP.	53
PRESTO RECORDING CORP.	66
QUAM-NICHOLS CO.	90
RADIO WAREHOUSE MARKET	82
RAULAND CORP.	78
RAYTHEON PRODUCTION CORP.	13
RCA VICTOR DIV., RADIO CORPORATION OF AMERICA	8
READRITE METER WORKS	86
RIDER PUBLISHER, INC., JOHN F.	79
ROLA CO., INC.	55
SEEBURG CORP., J. P.	Cover 3
SENTINEL RADIO CORP.	80
SIMPSON ELECTRIC CO.	65
SNYDER MFG. CO.	84
SONORA RADIO & TELEVISION CORP.	3, 67
SPRAGUE PRODUCTS CO.	61
STANDARD TRANSFORMER CORP.	79
STIGLITZ FURNACE & FOUNDRY CO.	86
STROMBERG-CARLSON CO.	14
SYLVANIA ELECTRIC PRODUCTS, INC.	57
THORDARSON ELECTRIC MFG. CO.	74
TRIPLETT ELECTRICAL INSTRUMENT CORP.	63
TUNG-SOL LAMP WORKS, INC.	58
TURNER CO.	77
UNIVERSAL MICROPHONE CO., LTD.	6
UNIVERSITY LABS.	87
UTAH RADIO PRODUCTS CO.	43
VACO PRODUCTS CO.	81
WATERS CONLEY CO.	41
WEBSTER ELECTRIC CO.	4
WESTON ELECTRICAL INSTRUMENT CORP.	73
WILCOX GAY CORP.	35
ZENITH RADIO CORP.	45

While every precaution is taken to insure accuracy, we cannot guarantee against the possibility of an occasional change or omission in the preparation of this index.



● SEEBURG'S PROGRAM OF PLANNED PROGRESS LOOKS AHEAD...

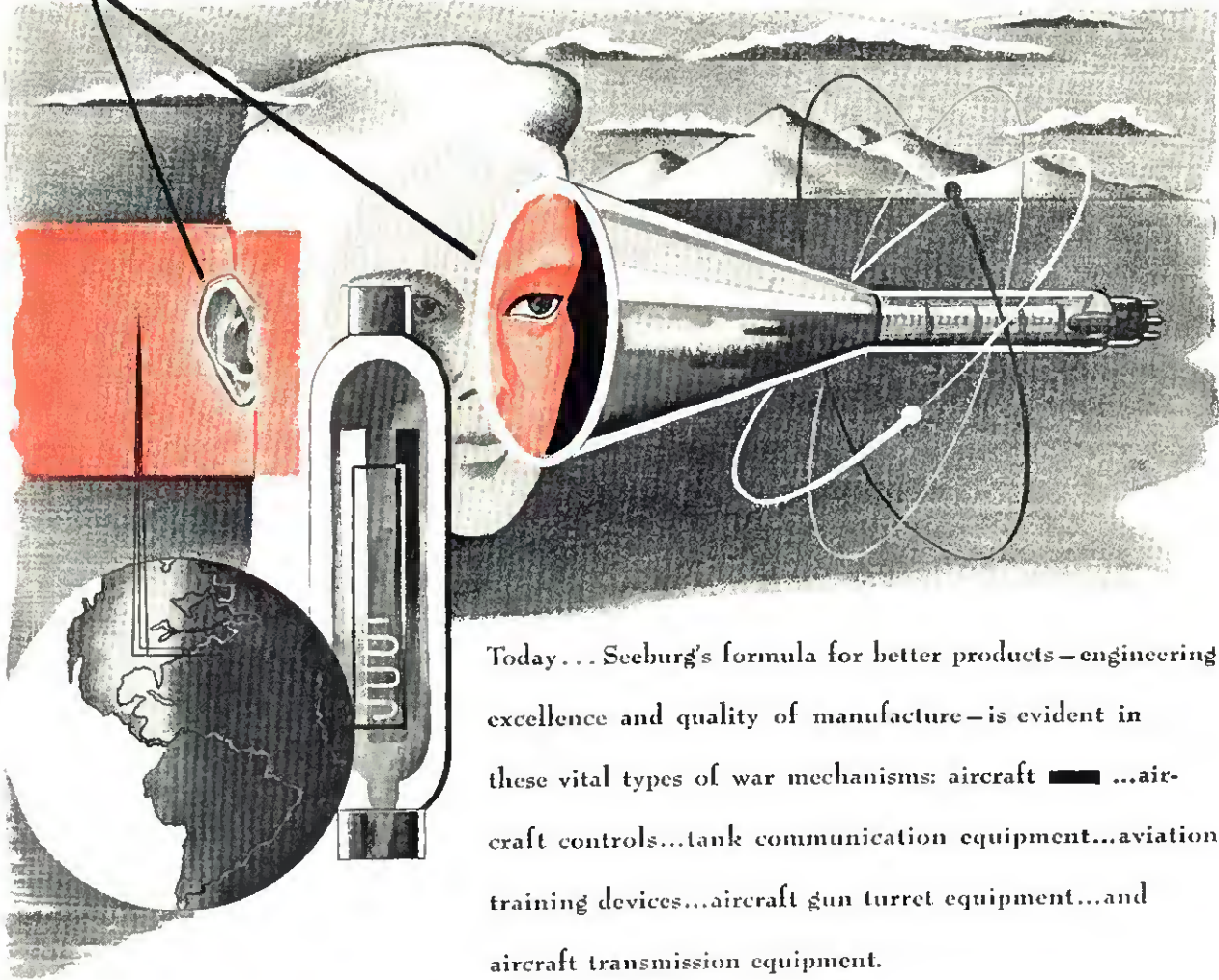

Today... Seeburg's formula for better products—engineering excellence and quality of manufacture—is evident in these vital types of war mechanisms: aircraft — ...aircraft controls...tank communication equipment...aviation training devices...aircraft gun turret equipment...and aircraft transmission equipment.

Tomorrow...after victory is ours...this formula will be manifested—as part of Seeburg's program of planned progress—in new products—for bigger and broader markets.



Awarded to the J. P. Seeburg Corporation  
for Outstanding Production of War Materials  
in each of Its Four Plants.

MAKERS OF FINE MUSICAL INSTRUMENTS SINCE 1902

*Seeburg*

J. P. SEEBURG CORPORATION • 1500 DAYTON STREET • CHICAGO, ILL.





## **It's there... We just don't have Time to Talk about it...**

Not long ago the "experts" spoke of a long war . . . five years . . . some said ten. After our smashing victory in North Africa, plus our devastating round-the-clock bombing of German war factories, these same "experts" saw Victory . . . just around the corner. Chances are they were wrong both times. The war will probably end neither as early nor as late as they predict, but somewhere in between.

There is nothing to be gained by dropping our knitting now and indulging in giddy star-gazing. Our number one job is the production of Radio Communications Equipment and Radar for our armed forces. War has taught us many new things about Electronics, but we're not going to be able to crowd all we've learned into the first models we release after the war. We can't tell you what our first post-war radios and phonographs will look like, but you can depend on it . . . *they'll sound swell . . . and they'll sell well!* The post-war radio market is going to be one whale of a market!

**You May Expect Big Things from Motorola . . . We Can't Say When, but We Can Say . . . NO ONE WILL BE READY SOONER!**



*For the development and production of Radio Communications Equipment for our armed forces, the Motorola organization was awarded the Army-Navy "E" with added Star for continued excellence of performance.*

**Motorola** RADIO  
**GALVIN** FOR HOME & CAR  
 MFG. CORPORATION • CHICAGO, ILLINOIS