

RADIO RETAILING

COMBINED WITH

RADIO TODAY



RADIO IS A NECESSITY! To every American...in the home, factory, office, and car...RADIOS ARE VITAL. KEEP'EM WORKING!



JANUARY
IN TWO PARTS — PART ONE

42

SERVICE
ENGINEER

DISTRIBUTOR

MALLORY



We Three...

No use kidding ourselves. We three—you, your Mallory Distributor and the Mallory Company—face a real problem.

It is the problem thrust upon us by the conscription of raw materials, vital for wartime production. Shortages of materials have interrupted, slowed down, sometimes cut off the production of many radio repair parts. Yes, it is a problem, sometimes a tough problem, to repair broken down radio receivers and "keep 'em listening."

But we three, working together, can lick that problem. Here is how:—

1. Order your repair parts according to your normal requirements. **DO NOT HOARD.**
2. Specify the replacements that you require, according to the recommendations of your Mallory Radio Service Encyclopedia.
3. Your Mallory Distributor will do his level best to fill your order promptly. If the repair part is not available, your Mallory Distributor will recommend an alternative. Your Mallory Distributor wants to help you—he works closely with the Factory—and you can depend on any suggested alternate to give satisfactory service.
4. Should you encounter any difficulty either in procurement, installation, or operation, do not hesitate to contact the Factory. Tell us the name of your Distributor and give full technical information—we will help you.

Let us work together, we three—and we will always find a way to lick the problem.

P. R. MALLORY & CO., Inc.
INDIANAPOLIS INDIANA

Cable "Pelmallo"

P. R. MALLORY & CO. Inc.

MALLORY

Approved Precision Products

**NO LID TO LIFT
NO "HIDE-AWAY,"
JUST OPEN THE DOORS
WITH Slide-A-Way**

That's how simple it is with an Admiral! No lid to lift . . . no dark, clumsy phonograph "hide-away" . . . just open the doors and out slides Admiral's exclusive "Slide-A-Way" phonograph with automatic record changer. Enjoy your favorite recordings . . . played as you've never heard them before. Thrill to flawless radio reception . . . achieved through such Admiral engineering triumphs as the super-sensitive triple-tuned RF converter circuit, Magna-Band S-P-R-E-A-D, treble-bass compensation, etc. A glorious musical instrument . . . smart, convenient. See it . . . hear it . . . at your Admiral dealer (look for his name in your classified telephone book). Continental Radio & Television Corp., 3800 Cortland St., Chicago, Ill., U.S.A.

SWIFT, SAFE AUTOMATIC RECORD CHANGING

NO NEEDLES TO CHANGE

NO NEEDLE SCRATCH

RECORDS LAST LONGER

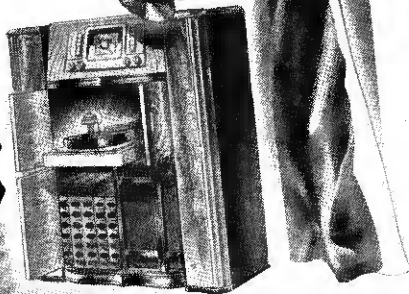

*World's largest manufacturers of automatic record changers. Originators of Slide-A-Way . . . Aeroscope . . . AC-DC-Battery Bantam . . . Tilt-Tuning . . . Touch-O-Matic



4207-A10 AM Reception
4207-B12 FM-AM Reception

Admiral Radios are especially designed for use with F.M.

Admiral
AMERICA'S SMART SET

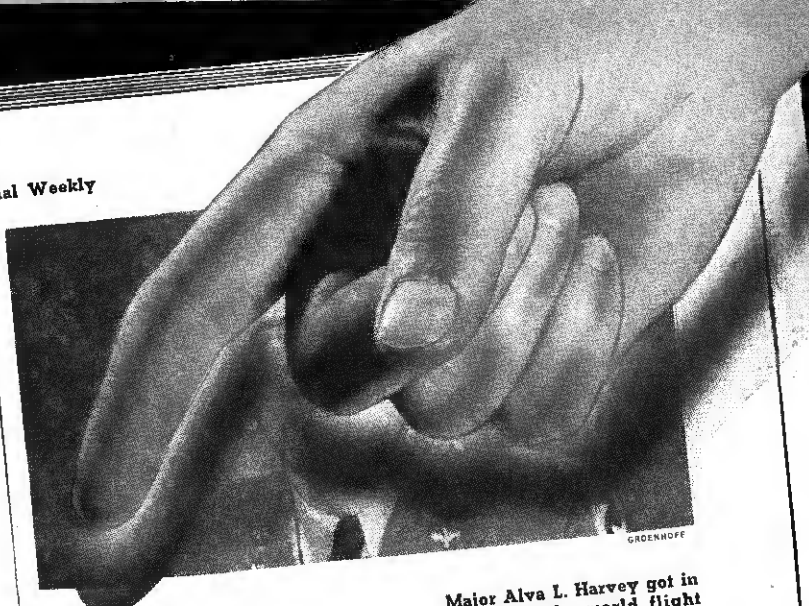

GREENHOFF

Major Alva L. Harvey got in his round-the-world flight seventeen years after making his first start. He was in the Army World Flight plane that crashed in Alaska in 1924

Wing Talk

*We'll be here
13 times in '42!*

WE'VE just signed the biggest advertising contract in Admiral history! It calls for a series of thirteen half page advertisements to appear opposite "Wing Talk," one of the most widely read features in Collier's, the National Weekly with over 3,000,000 circulation.

First advertisement . . . reprinted at the left . . . will appear in the January 24th issue. Look for it! Others will follow at four week intervals . . . a total of over 36 million messages during 1942 in Collier's alone! What an opportunity for profit-minded retailers!

Spectacular new features . . . values that challenge comparison . . . sales-making merchandising promotions . . . aggressive national and local advertising . . . promise to make Admiral the sensation of the industry. Get in touch with your Admiral distributor for further details.

CONTINENTAL RADIO & TELEVISION CORP.
3800 Cortland Street, Chicago, U. S. A. • Export Office: 116 Broad Street, N. Y.

Originators of Tilt-Tuning, Touch-O-Matic, Aeroscope, Slide-A-Way, AC-DC-Battery Bantam

World's Largest Manufacturers of Automatic Record Changers

pilot in gun firing button on the commander's wrist. He was the first to be shot down. Best proof that the wing commander had brought down another Nazi plane would be a photograph of the enemy descending to earth. So he flipped the

wanted to private. who have to be their defense counsel. they ever get in trouble.

F. R. N.

"THE OUTSTANDING SUCCESS FM DEMONSTRATION

A SOUND-MOVIE IN FULL COLOR

In simple, easily understood language, this talking picture answers the very common question—"What is radio?"

It also describes, by means of familiar analogies and colorful animation, the difference between conventional AM radio and the new FM system.

The four advantages of the Armstrong System of FM:

- (1) Static reduced to the vanishing point
- (2) Life-like reproduction
- (3) Elimination of station interference
- (4) Elimination of fading

are all convincingly explained and demonstrated.

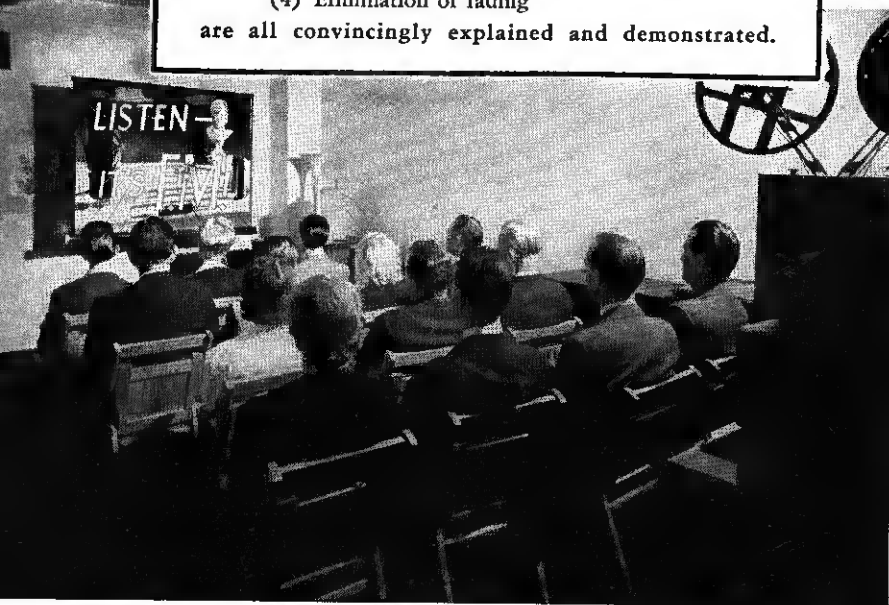

The G-E sound-movie "Listen It's FM" was shown to over 1800 customers during G-E FM promotion week at Barker Brothers.

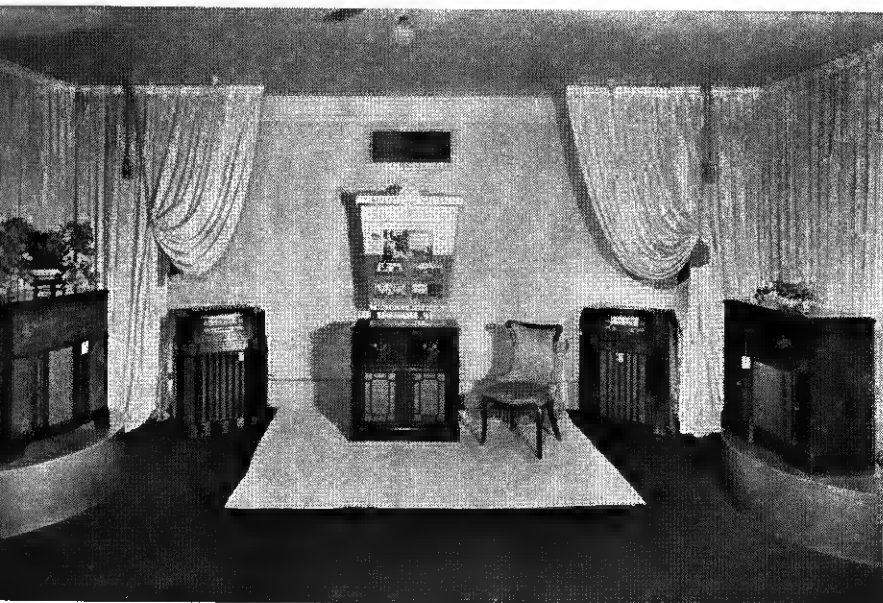

Barker Brothers dramatically feature G-E FM radios in this eye-arresting display room. Note the G-E static-maker display serving as the background in the center of the display.

CAUGHT

THOSE are the words of O. R. Coblentz, Manager, Radio Department, Barker Brothers, one of the world's largest furniture stores. This alert merchandising organization is whole-heartedly behind FM, the new art in radio.

During the week of November 10 through November 15, a special FM promotion was planned with the cooperation of the General Electric Company and its Los Angeles distributor. The entire week was devoted to giving the public complete information on Frequency Modulation and its many advantages over the conventional system of AM broadcasting and reception.

Visitors to Barker Brothers radio department were greeted by enthusiastic salespeople who staged a MINIATURE STATION FM DEMONSTRATION. The visitors were then shown the sound-movie "LISTEN IT'S FM" in a projection room conveniently located to the radio department.

Following these special promotions, visitors were invited to see and hear the General Electric FM radio models in our most attractive display room featuring G-E radios exclusively. Station K45LA, the new FM transmitter in Los Angeles, broadcast a series of special programs. Over 5,000 copies of the G-E PRIMER on FM were distributed to interested customers and prospects.

The instantaneous and complete success of Barker Brothers special FM promotion is proof that FM is one of those radio business opportunities that every radio dealer will want to grasp.

HERE'S HOW THIS FM PROMOTION SUCCEEDED AT BARKER BROTHERS IN LOS ANGELES

"The outstanding success of the General Electric FM demonstration week in Barker Bros. caught us napping. We, of course, expected a good response to our promotion, having used the combined pulling power of radio, complete metropolitan Los Angeles newspaper coverage, and store promotion, but we certainly did not expect the crowds of people that thronged into our



O. R. COBLENTZ

department. The sales force are most enthusiastic over the results. It is unusual to stage an educational demonstration of this kind with such a large volume of direct and immediate sales."

O. R. Coblentz, Mgr.
Radio Dept. Barker Bros.

OF THE GENERAL ELECTRIC AT BARKER BROTHERS "IS NAPPING"



MINIATURE-STATION FM DEMONSTRATOR

This portable demonstration unit consists of two miniature radio stations which actually broadcast the program—a high fidelity music-recording. One station broadcasts the program over ordinary radio, AM, and the other over FM.

The program can be picked up by a modern FM receiver by switch-back and forth from AM to the FM band, your customers can hear themselves the amazing superiority of FM over AM.

In addition a violet-ray noise-maker, an electric razor, and a house bell are each used to demonstrate how FM rejects static while interference from these devices ruins reception of conventional radio.

The G-E Miniature-station FM Demonstrator was in use continuously during store hours at Barker Brothers FM promotion.



CALL ON THESE G-E RADIO FIELD MEN TO HELP YOU PUT YOUR FM PROMOTION ACROSS

G. S. PETERSON
General Electric Company,
Box 5970-A, Van Buren
St. Post Office, Chicago,
Ill. *Regional Radio Sales
Manager for Midwest and
Southwest States.*

H. A. CROSSLAND
General Electric Company,
235 Montgomery St., San
Francisco, Calif. *Regional
Radio Sales Manager for
Pacific Coast and Rocky
Mountain States.*

D. W. MAY
Metropolitan Distributing
Branch, General Electric
Company, 570 Lexington
Ave., New York, N. Y.
*Metropolitan New York
and Northern New Jersey.*

L. W. YULE
General Electric Company,
140 Federal Street, Boston,
Mass. *New England
States.*

T. P. BEGY
115 Frontenac Ave., Buffalo,
N. Y. *New York
(excluding Metropolitan
District), Western Vermont.*

R. J. MEIGS
General Electric Co., 1405
Locust St., Philadelphia,
Pa. *Southern New Jersey,
Eastern Pennsylvania,
Delaware, Maryland, Virginia,
North Carolina.*

R. P. VAN ZILE
General Electric Company,
609 Red Rock Bldg., Atlanta,
Ga. *South Carolina,
Georgia, Florida, Alabama,
Mississippi, Louisiana,
Tennessee.*

R. A. BUESCHER
General Electric Company,
4966 Woodland Avenue,
Cleveland, Ohio. *Western
Pennsylvania, West Virginia,
Kentucky, Ohio,
Michigan, Indiana.*

H. J. MANDERNACH
General Electric Company,
Box 5970-A, Van Buren
St. Post Office, Chicago,
Ill. *Indiana, Illinois,
Eastern Missouri, Eastern
Wisconsin, Arkansas.*

E. P. TOAL
General Electric Company,
12 South 6th St., Minneapolis,
Minn. *Western
Wisconsin, Minnesota,
North and South Dakota,
Nebraska, Iowa.*

C. T. WANDRES
General Electric Company,
1801 North Lamar Street,
Dallas, Texas. *Western
Missouri, Kansas, Oklahoma,
Texas, Southern
New Mexico.*

B. S. WELLS
General Electric Company,
200 South Main St., Salt
Lake City, Utah. *Eastern
Nevada, Utah, Colorado,
Northern New Mexico,
Wyoming, Southern
Idaho, Montana.*

T. F. HALL
General Electric Company,
212 No. Vignes St., Los
Angeles, Calif. *California,
Arizona, Western Nevada.*

JOHN KLENKE
3871 50th Ave., N.E.,
Seattle, Washington,
Washington, Oregon,
Northern Idaho.

OR SEE YOUR G-E RADIO DISTRIBUTOR



THE LIGHT THAT MUST NOT FAIL

RADIO BROADCASTING can be the tool of tyranny or the defender of democracy . . . it all depends on who uses it, and how.

Under European dictatorship, broadcasting is a slave of the dictator . . . sowing seeds of hatred and deception. The listener must take what the State chooses to give him—or nothing. To listen to a foreign broadcast is high treason, punishable by the concentration camp, torture, and even death! Freedom of broadcasting and freedom of listening, alike, have been blacked out.

Here in America, a Free Radio makes us strong. Uncensored, unchained, broadcasting shares

in that "Freedom of Speech" which is written into the American Bill of Rights. The news you hear is undistorted by propagandists. The views you hear are the honest views of commentators who speak without fear of persecution. And *you* are free to tune your radio to whatever you wish to hear.

Union and strength are America's rewards for this freedom. In 48 states, listeners to 50 million radio receivers *believe* the news they hear on the air. They know their radios can be trusted. And this faith is a valuable thing.

Since the beginning of the year, for example (up to October 11)

the National Broadcasting Company has winged 979 defense programs into American homes—in cooperation with the Government Administration, the War Department, the Navy, the Treasury Department, Service Groups and Special Organizations. These broadcasts were received by Americans everywhere with enthusiasm and understanding.

Through public service such as this, the National Broadcasting Company continues now as in the past to serve America as only a Free Radio can serve it . . . continues to affirm that here in America, Radio's light of truth must never fail us!

NATIONAL BROADCASTING COMPANY

A Radio Corporation of America Service

ANOTHER DRAMATIC **FIRST** IN ZENITH HISTORY

TRANS-OCEAN STANDARD and SHORT WAVE CLIPPER

For Blackouts and Power Shut-offs

ONLY ZENITH HAS THIS!

★ U. S. PAT. NOS. 2164251 and 2200674 WAVEMAGNET and SHORTWAVE MAGNET

BUILT-IN MOVABLE
FOR STANDARD AND SHORT
WAVE RECEPTION IN TRAINS,
PLANES AND SHIPS

No Power Blackouts with this Emergency Portable

In local radio broadcasting blackouts and electric power shut-offs, this new portable radio enables you to listen direct on its own battery power to America's powerful short wave stations, which may be your only source of instruction and information during emergencies. All this and foreign short wave too! An attractive home and traveling radio plus beautiful tone on all broadcasts.

A POWERFUL NEW SELLER FOR 1942

The newest most dramatic seller in the radio industry today. An emergency DeLuxe portable that a war time public will demand—introduced when interest in a super portable is at white heat!

Again, Zenith is ahead of the entire field—Again, Zenith gives you an exclusive portable designed especially for war time selling. A new selling slant for a new selling season.

EXCLUSIVE FEATURES OF THE DELUXE PORTABLE

Tested By MacMillan In The Arctic

Going back to the old short wave testing grounds used since 1923 by Zenith Radio Corporation for perfection of short wave equipment, the DeLuxe Portable was rigorously tested in the Arctic by Commander Donald B. MacMillan, noted explorer, who says, "In all my Arctic experiences I have never heard anything like it."

FIRST TIME! Personal short wave radio reception from our own or foreign continents—while you ride in planes, trains or ships!

FIRST TIME! A portable radio that gives domestic short wave reception in locations where broadcast does not penetrate in the daytime.

FIRST TIME! Miraculous time and band buttons. Pre-set the pointer—"Press a button... there's Europe!"

FIRST TIME! On conveyances, on land, sea, air, choice of portable radio reception with built-in movable Broadcast Wavemagnet and Shortwave Magnet.

FIRST TIME! Band Spread makes foreign station tuning on this portable radio like ordinary radio broadcast tuning.

FIRST TIME! Logged at the factory on short wave broadcasts... A convenient logging chart on inside lid of cover is pre-logged by factory experts. Shows exactly what stations are found on each wave band and at what number on the dial.

FIRST TIME! Zenith famous Radiorgan Tone Device on a portable radio.

POWER—from self-contained battery and standard lighting current interchangeable at a second's notice. Also, Telescope Whip Aerial for use in getting extra distance.

EARPHONES for privacy, special low impedance ear phones for sporting events, traveling and the hard of hearing (extra equipment).

BACKED BY A POWERFUL
NATIONAL MAGAZINE CAMPAIGN
SEE YOUR ZENITH DISTRIBUTOR
FOR ALL DETAILS



ZENITH
TRANS-OCEAN CLIPPER
DELUXE PORTABLE RADIO

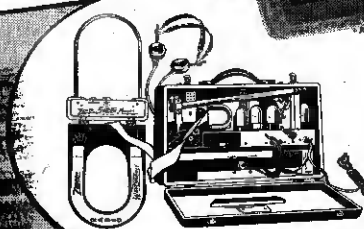

GUARANTEE

THE FIRST AND ONLY PORTABLE RADIO
GUARANTEED TO RECEIVE EUROPE,
SOUTH AMERICA OR THE ORIENT EVERY
DAY—OR YOUR MONEY BACK. IT ALSO
BRINGS IN FOREIGN SHORTWAVE RECEPTION
ON TRAINS, PLANES AND SHIPS.



Specialists under the Skin!

THESE girls, whose flying fingers assemble the 300,000,000 precision parts used in Sylvania radio tubes every year, are all specialists in their craft.

And they are so expert at it, because it is the one and only job they have to do.

That's also true of the organization that employs them. For Sylvania's mastery of tube making is largely due to the fact that this is Sylvania's one and only job in radio.

It takes the full time attention of electronic engineers who have nothing but radio tubes to

think about — to provide the pace-making developments that keep Sylvania tubes the very tops in performance.

It takes a highly specialized sales organization, as well, to enable us to offer retailers the clean, uncompromising franchise Sylvania gives you.

So you can see why it is to your profit that Sylvania has earnestly worked to

be a master maker of radio tubes. And how great a master is evident in the fact that Sylvania is the second largest radio tube manufacturer in America today.



HYGRADE SYLVANIA CORPORATION

New York City

EMPORIUM, PA.

Salem, Mass.

Also makers of HYGRADE Incandescent Lamps, Fluorescent Lamps and Fixtures.

68% INCREASE!

THAT'S THE ENVIABLE RECORD OF
CROSLLEY RADIO IN A HIGHLY COMPETITIVE YEAR!

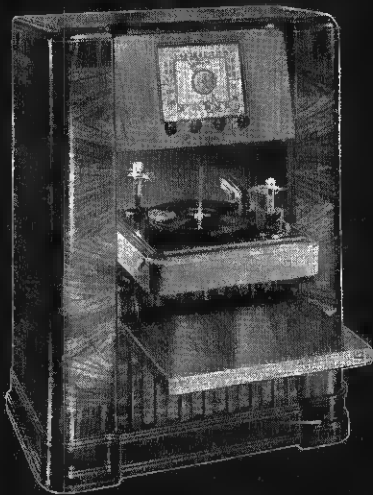

MODEL 72-CP . . . 7-tube* AC superheterodyne radio-phonograph with 10-tube performance. Two bands, American and International short wave, Floating Jewel Tone System, 10" concert speaker. The latest in automatic record changers and many other features.

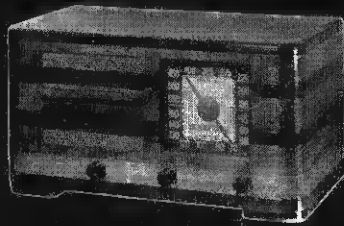

MODEL 52-FC . . . A powerful 4-tube* superheterodyne. This is a 5-tube when used on AC-DC. It is equipped with a long life Crosley battery pack. Cabinet of sliced walnut veneer banded with fiddle mahogany.

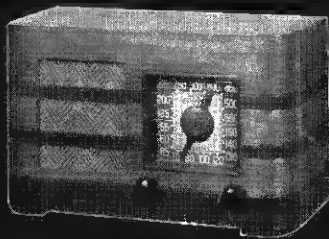

MODEL 52-TA . . . 5-tube* AC-DC superheterodyne with 7-tube performance. Super field electro-dynamic speaker . . . built-in Crosley Magna Loop antenna . . . all wood cabinet with solid walnut dial frame.

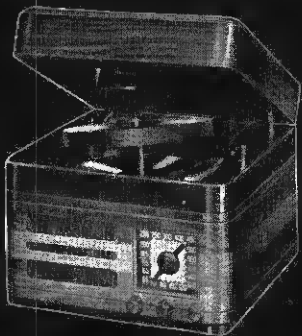

MODEL 52-TQ . . . A 5-tube AC radio-phonograph combination. Plays 12-inch records with the lid down. The newest in automatic record players and the patented Floating Jewel Tone System make this a most saleable and profitable set.

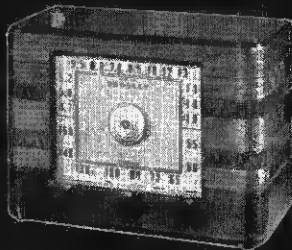

MODEL 52-TL . . . The famous Crosley "Fiver" . . . the super 5-tube* AC superheterodyne with 7-tube performance. Two band reception . . . American and International Short Wave.

*Including rectifier.

A FAMILY sits listening to a Crosley Radio. There is a sudden click, a hurried announcement. It's a broadcast blackout on the air.

That's when the long reach of a Crosley, its selectivity on distant stations, is appreciated. That's when the solid merit and quality built into Crosley Radios will prove itself . . . when Crosley short wave performance will be a necessity!

That's the kind of merchandise you can sell in wartime—when nearby stations may go off the air—when news may have to come from a long distance.

That's when the dealer selling Crosley will appreciate the advanced engineering and precision of manufacturing that Crosley now offers.

Crosley has radios that are standouts in the industry—write, wire or phone today for further details on the Crosley wartime selling program.

FM grows more important daily. Even in areas where FM stations are not yet operating shrewd buyers want this feature in the sets they buy so that their investment of today will still be valuable tomorrow. Excellence of Crosley FM with 14 exclusive firsts offers a real opportunity. Be sure you have Crosley FM sets.

Buying just another refrigerator may be something which women will feel they can postpone. But buying a Crosley with the added convenience and economy of the Super-Shelvador puts this purchase in the class with necessities. Crosley had the greatest sales gains in the industry in 1941—follow the trend towards Crosley and profit from the exclusive features only Crosley offers. Crosley Washers and Ranges represent another real opportunity to aggressive merchants. Investigate today. See the complete Crosley Line in Space 541-B and 542-B American Furniture Mart, Chicago, Illinois, during the Winter Market, Jan 5 to 17.

THE CROSLLEY CORPORATION
POWEL CROSLLEY, Jr., Pres. CINCINNATI, OHIO
HOME OF WLW—"THE NATIONS STATION"
—70 ON YOUR DIAL

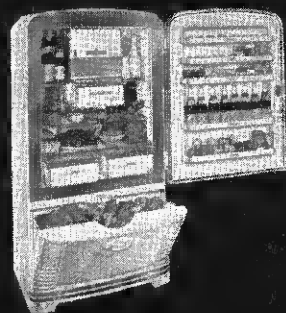

MODEL SE-742 . . . Typical of the Crosley line is this quality built refrigerator. Giant meat chest holds 14 lbs. of meat . . . twin clear-vision vegetable crispers with plate glass covers . . . removable shelf in Freezorcold for bulky frozen foods . . . 7 cu. ft. of convenient storage space. Many deluxe features.

CROSLLEY

AND DEFENSE

Crosley Research Engineering and Manufacturing facilities are contributing largely to the Government's victory program—Crosley is manufacturing Special Equipment for the U. S. Signal Corps, U. S. Air Corps, U. S. Army Ordnance Department, U. S. Navy, the Quartermaster Corps and Coast Guard Service.



"Times change, and we change with them"



Never was that old Latin saying more completely confirmed than during this past year.

They were difficult times, for you and for us. They caused delays in our production which we greatly regretted. But we could not avoid these delays, and still maintain Farnsworth standards of manufacturing.

For, in addition to making much of our capacity available for defense work, we kept our promise

to provide you with a completely re-engineered line of Farnsworth radios and phonograph-radios, and to produce merchandise which would continue Farnsworth's outstanding reputation for trouble-free performance.

Please accept our sincere thanks for the understanding, support and co-operation you gave us.

What of the future? We have one supreme obligation . . . to make everything required of us by the armed forces and to utilize any remaining capacity for production of the finest radios and phonograph-radios we are able to build.

And we consider this latter an important contribution to the morale of our country. For every radio receiver, today, is a source of information and inspiration contributing to the effectiveness of the national war effort.

The new year is one in which there is much to be done. Let us all face it with confidence and determination.

President

FARNSWORTH Makers of Radio and Television Transmitters and Receivers, the Capehart, the Capehart-Panamuse and Farnsworth Phonograph-Radio Combinations.



Tubes That Are Interchangeable

IN TWO PARTS
PART TWO
JANUARY, 1942

RADIO RETAILING
COMBINED WITH **RADIO TODAY**

GT TYPES	GLASS	METAL	METAL/ GLASS
1A5GT	1A5G
1A7-GT ²	1A7-G
1B7-GT ²	1B7-G
1C5-GT	1C5-G
1G4-GT	1G4-G
1G6-GT	1G6-G
1H5-GT ²	1H5-G
1N5-GT ²	1N5-G
1P5-GT ²	1P5-G
1Q5-GT	1Q5-G
<hr/>			
2W3-GT	2W3
3Q5GT	3Q5G
5W4-GT	5W4-G	5W4 ¹
5Z4GT	5Z4-G	5Z4 ¹	5Z4MG ¹
6A8-GT ²	6A8-G	6A8 ¹	6A8MG ¹
6AC5GT	6AC5-G
6AE5-GT	6AE5-G
6B8GT ²	6B8-G
6C5-GT ²	6C5-G	6B8 ¹	6C5MG ¹
6F5-GT	6F5-G	6C5 ¹	6F5MG ¹
6F6-GT	6F6-G	6F5 ¹
6H6-GT ²	6H6-G	6F6 ¹	6H6MG ¹
6J5-GT ²	6J5-G	6H6 ¹	6J5MG ¹
6J7-GT ²	6J7-G	6J5 ¹	6J7MG ¹
6K5-GT	6K5-G	6J7 ¹
6K6-GT	6K6-G
6K7-GT ²	6K7-G	6K5 ¹	6K7MG ¹
6K8-GT ²	6K8-G	6K7 ¹
.....	6L6-G	6L6 ¹
.....	6L7-G	6L7 ¹
.....	6N6-G	6N6MG ¹
.....	6N7-G	6N7 ¹
.....	6P5-G
6P7-GT	6Q7-G	6Q7 ¹	6Q7MG ¹
6Q7-GT	6R7-G	6R7 ¹	6R7MG ¹
6R7-GT	6S7-G	6S7 ¹
.....	6SA7-G	6SA7 ¹
6SF5-GT	6SF5 ¹
6SJ7-GT ²	6SJ7 ¹
6SK7-GT ²	6SK7-G	6SK7 ¹
6SQ7-GT ²	6SQ7-G	6SQ7 ¹
6V6-GT	6V6-G	6V6 ¹
6X5-GT	6X5-G	6X5 ¹	6X5MG ¹
6Y6-GT	6Y6-G
<hr/>			
12A8-GT ²	12A8-G
12K7-GT ²	12K7-G
12K8-GT ²	12K8 ¹
12Q7-GT	12Q7-G
12SA7-GT ²	12SA7-G	12SA7 ¹
12SF5-GT	12SF5 ¹
12SJ7-GT ²	12SJ7 ¹
12SK7-GT ² /G	12SK7 ¹
12SQ7-GT ² /G	12SQ7 ¹
25A6-GT	25A6-G	25A6 ¹	43MG/25A6MG ¹
25A7-GT	25A7-G
25AC5-GT	25AC5-G
25L6-GT	25L6-G	25L6 ¹
.....
25Z6-GT	25Z6-G	25Z6 ¹	25Z6MG ¹
35L6-GT	35L6-G
35Z5-GT	35Z5-G
50Y6-GT	50Y6-G
117Z6-GT	117Z6-G

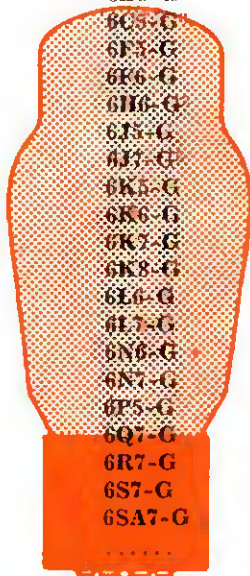

See Note
..A

See Note
..A

Copyright, 1942,
Caldwell-Clements, Inc.
480 Lexington Ave.
New York

3 War-Time Helps for

1 - TO GET YOU NEW CUSTOMERS

This is too much for me! I'm going to call:
(YOUR NAME HERE)
Address and Phone

I PAID \$60 FOR THAT RADIO AND NOW IT SOUNDS LIKE \$10!

RADIOS ARE HUMAN, TOO

ALL IT NEEDS IS A COUPLE OF NEW TUBES

IT'S TOO DEEP FOR ME! I'M GOING TO CALL MY RADIO SERVICE EXPERT

ALL THAT IMPROVEMENT FOR SO LITTLE MONEY!

I PAID \$60 FOR THAT RADIO, and now it sounds like \$10

Let us bring back the PAR-formance of your set with
TUNG-SOL RADIO TUBES

WAR IS ON RADIOS

Don't let IT SLIP!

There's a lot of radio service business to be had now. Radios are being used more, both for war news and for entertainment. Set owners want better reception, and are spending money for set improvement.

Tung-Sol has prepared the cleverest barrage of direct-mail and other business-getting helps ever built to aid the radio service man to bring in **NEW** customers.

2 - TO K OLD

Here's a great little book increasing the friendship and how to bring back customers how to increase service sales how to reach customers right where.

Don Herold, famous business writer, shows how to make **EVERY CUSTOMER A FRIEND** and **EVERY FRIEND A CUSTOMER**. It reads funny—but it makes horse sense.

WRITE FOR THIS
FREE 16 PAGE
BOOKLET WRITTEN
ESPECIALLY FOR
RADIO SERVICEMEN

TUNG-SOL LAMP WORK

You in 1942

from Tung-Sol

KEEP YOUR CUSTOMERS

to help you learn the art of confidence of old customers, who have strayed away, to your regular customers, by yours but now going else-

cartoonist and humorous

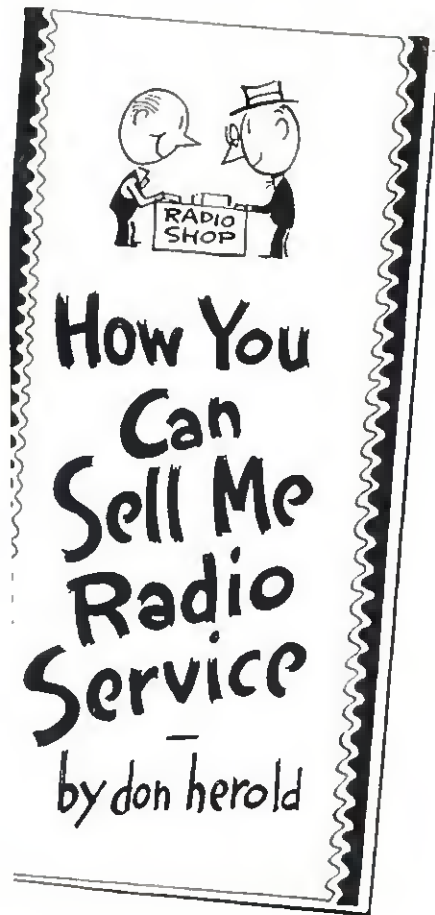

3 - TO SIMPLIFY YOUR WAR-TIME STOCK

Why carry two or three types of tubes for the same radio set socket when ONE will do the job?

TUNG-SOL will help you to operate with a smaller, simpler war-time inventory in 1942. Tung-Sol has concentrated production on the most popular types and has discontinued overlapping or duplicating types wherever possible.

Tune in on this Tung-Sol war-time stock simplification plan, get your stock on a sensible basis, and reduce the number of types which you have to handle, stock, inventory and report every month.

Ask for large Stock Guide Card for your wall. Also vest pocket edition.

Increases your profit through better use of stock.

TUNG-SOL RADIO TUBE STOCK SIMPLIFICATION GUIDE			
Old Stock Number	Old Price	New Stock Number	
1A5GT	\$1.25	1A5GT G	\$1.25
1C5GT	1.25	1C5GT G	1.25
1G4GT	1.25	1G4GT G	1.25
1G6GT	1.25	1G6GT G	1.25
1Q5GT	1.25	1Q5GT G	1.25
1Q6GT	1.25	1Q6GT G	1.25
205GT	1.25	205GT G	1.25
5W4GT	1.25	5W4GT G	1.25
6A5GT	1.25	6A5GT G	1.25
6AC5GT	1.25	6AC5GT G	1.25
6B5GT	1.25	6B5GT G	1.25
6C5GT	1.25	6C5GT G	1.25
6F5GT	1.25	6F5GT G	1.25
6H5GT	1.25	6H5GT G	1.25
6I5GT	1.25	6I5GT G	1.25
6J5GT	1.25	6J5GT G	1.25
6K5GT	1.25	6K5GT G	1.25
6L5GT	1.25	6L5GT G	1.25
6M5GT	1.25	6M5GT G	1.25
6N5GT	1.25	6N5GT G	1.25
6O5GT	1.25	6O5GT G	1.25
6P5GT	1.25	6P5GT G	1.25
6Q5GT	1.25	6Q5GT G	1.25
6R5GT	1.25	6R5GT G	1.25
6S5GT	1.25	6S5GT G	1.25
6T5GT	1.25	6T5GT G	1.25
6U5GT	1.25	6U5GT G	1.25
6V5GT	1.25	6V5GT G	1.25
6W5GT	1.25	6W5GT G	1.25
6X5GT	1.25	6X5GT G	1.25
6Y5GT	1.25	6Y5GT G	1.25
6Z5GT	1.25	6Z5GT G	1.25
125F3GT	1.25	125F3GT G	1.25
125P3GT	1.25	125P3GT G	1.25
125Q3GT	1.25	125Q3GT G	1.25
25A5GT	1.25	25A5GT G	1.25
25A7GT	1.25	25A7GT G	1.25
25A9GT	1.25	25A9GT G	1.25
35L5GT	1.25	35L5GT G	1.25
35Z5GT	1.25	35Z5GT G	1.25
11726GT	1.25	11726GT G	1.25

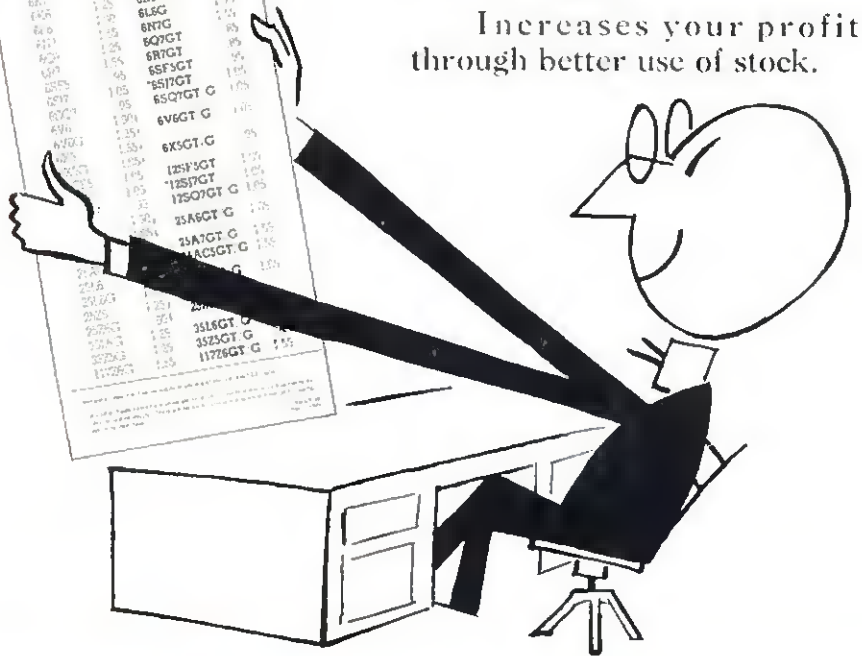

KS INC.

RADIO TUBES DIVISION NEWARK, N. J.

Sales Offices: Atlanta, Detroit, Dallas, Denver, Los Angeles, Chicago, New York

Authoritative Listings of Equivalent Tube Types

NOTES ON INTERCHANGEABLE TUBES

In the general interchangeable list at the right, tubes on the same horizontal line are interchangeable if the following conditions are observed:

Superscripts: 1, 2, 3—

The numbers beside certain tube types refer to the connections to the number 1 pin of an octal base. Superscript 1 means that the external metal shell is connected to pin 1. A 2 means that the external metal ring shield is connected to pin 1. A 3 means that the internal shield is connected to pin 1.

When interchanging tubes with connections to pin 1 with those not having a connection to this pin, check the tube socket to see that socket lug 1 is not connected to the circuit other than the chassis or common negative circuit. This #1 lug is often used as an anchor terminal when the set is designed for glass tubes not having connection to pin 1.

The note A refers to the suppressor grid connection in metal and GT types. Metal tubes have this grid in the

'SA7 types connected to the #1 pin and shell. GT tubes of the same type have the suppressor connected internally to the cathode. A metal tube may not function when replacing a GT in some AC/DC sets since the suppressor will be without a DC return path. See circuit diagram.

Use of an interchangeable tube in RF, oscillator, or IF circuits may require realignment due to variations in element capacities.

Extremely critical circuits may not perform with an interchanged type due to slight capacity differences.

Many tubes are also branded GT/G and are interchangeable with GT and G types and with metal type if so shown on chart.

Interchangeability of tubes is limited to physical sizes of the various types of construction in a very few models of sets.

INTERCHANGEABLE RECTIFIERS

GT TYPES	GLASS	METAL	METAL/ GLASS
5W4GT ⁶	5W4G ⁶	5W4 ⁶
.....	5U4G ⁴
.....	5V4G ⁵
.....	5Y3G ⁷
.....	5Z4 ⁷	5Z4MG ⁷
.....	5T4

5X4G⁴
5Y4G⁷

6X5GT⁸ 6X5G⁸ 6X5⁸
..... 6ZY5G⁹

50Y6GT¹⁰ 50Z7G

5Z3⁴
80⁷

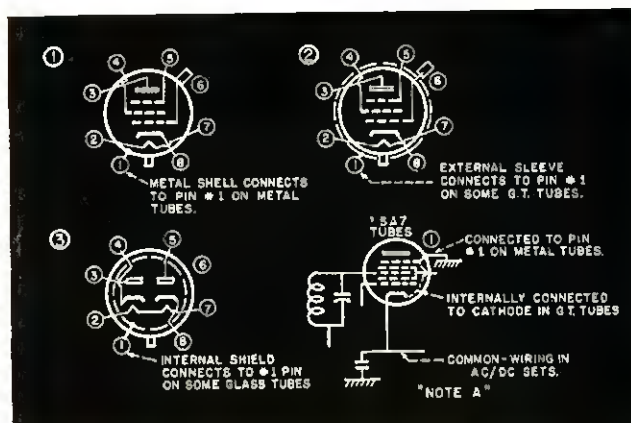

Interchangeable Rectifier Notes

Any tubes within the same box may be interchanged under following conditions: Metal tubes should not be used if #1 socket lug is connected to circuit other than ground or chassis.

Superscript conditions:

- 4—if transformer will supply 3 amps. filament current.
- 5—if max. output current is not over 175 ma.
- 6—if max. output current is not over 100 ma.
- 7—if max. output current is not over 125 ma.
- 8—if supply will deliver 0.6 amp. filament current.
- 9—if max. output current is not over 40 ma.
- 10—if tapped filament is not required.

LOCKTAL TUBES AND SIMILAR TYPES

LOCKTALS	SIMILAR TO	LOCKTALS	SIMILAR TO	LOCKTALS	SIMILAR TO
1LC5	1N5G	7B7	6SK7	12B7/14A7	12K7-GT
1LC6	1A7G	7B8	6A8G	14A4	12J5-GT
1LD5	1H5	7C5	6V6	14A5	6V6
1LE3	1E4G	7C6	75	14B6	12SQ7-GT
1LA4	1A5G	7C7	6J7G	14B8	12A8GT
1LA6	1A7G	7E6	6R7G	14C5	6V6G
1LB4	1T5GT	7E7	6B8G	14C7	12J7-GT
1LH4	1H5G	7F7	6C8-G	14E6	12SR7
1LN5	1N5G	7G7/1232	6AC7/1852	14F7	12C8
3LE4	3S4	7H7	6AB7/1853	14H7	6AB7/1853
7A4	6J5G	7J7	6J8G	14J7	6J8G
7A5	35L6-GT	7L7	6AC7/1852	14N7	6F8G
7A6	6H6	7N7	6F8G	14Q7	12SA7
7A7	6K7G	7Q7	6SA7	14Y4	6X5/84
7A8	6A7	7V7	6AC7/1852	35A5	35L6G
7B4	6F5G	7Y4	6X5-84	35Y4	35Z5-G
7B5	6K6G	XXD	7F7-6F8G	35Z3	35Z4GT
7B6	6SQ7	XXL	7A4-6J5G	50A5	35L6-G



over **3,000 hours**
Constant

RAYTHEON *tube Service*
IN EL PASO TRAFFIC CONTROL SYSTEM

Traffic control systems require constant operation . . . an excellent test of tube filament endurance . . . the City of El Paso, Texas chose dependable RAYTHEON TUBES for their traffic control system . . . these RAYTHEONS have served for over 3,000 operating hours without a single interruption in service.

This is an old, old story for RAYTHEON TUBE endurance . . . wherever there is a tough tube job to do you will usually find RAYTHEONS doing more than their share of the work.

While RAYTHEON'S large production facilities are turning out millions of tubes for military use, their requirements for original equipment to set manufacturers and for civilian replacement purposes, through service channels, remains an ever important patriotic duty for the RAYTHEON organization. Radio servicemen can continue to look to RAYTHEON for their best tube protection.

See your RAYTHEON TUBE Distributor Today!



Raytheon Production Corp.

NEWTON, MASS. • NEW YORK • CHICAGO • LOS ANGELES • ATLANTA

WORLD'S LARGEST EXCLUSIVE RADIO TUBE MANUFACTURERS

A Timely Statement

STROMBERG-CARLSON
TELEPHONE MANUFACTURING COMPANY

ROCHESTER, NEW YORK

OFFICE OF THE VICE PRESIDENT
AND GENERAL MANAGER

TO ALL STROMBERG-CARLSON
RADIO DEALERS IN
THE UNITED STATES

I am told that the Government's defense program calls for several hundred million dollars of radio equipment. This is several times the volume of factory billings for all radio receivers produced by the Industry last year!

Obviously a shortage looms. We think it is just a matter of weeks before the merchandise on your floor will be worth more than money in the bank.

This, therefore, is no time for "loss leaders", or for giving free premiums to force traffic. Nor is it a time to cheat yourself on your cost of doing business. We urge you, as never before, to take a reasonable profit. Trade-in allowances that are too liberal, and cut prices hurt you just as much as they hurt your competitor--from both of you they take dollars in profit and margin for overhead.

We cannot recommend too strongly (1) that you know your costs, and (2) that you insist on a reasonable profit on every sale. And as an anchor to windward, we suggest you expand your radio-service department. Use genuine parts and employ careful workmen to keep existing radio sets in trouble-free operation.

Our production plans for 1942 favor FM phonograph combinations. We expect the great FM growth of 1941 to continue as more FM stations go on the air.

No one knows whether or not there will be enough radios in September to support the "usual radio season". Hence we are spreading our national advertising more evenly through the year, doing a much heavier job than ever before this spring. We urge you to do likewise.

In closing, let me point out that the high unit-of-sale of a Stromberg-Carlson avoids the need for many sales and terrific turnover to keep your doors open. This high dollar volume, with relatively low unit sales, can be a major factor in supporting your business in the critical times just ahead. I hope you will make the most of it.

Cordially yours,

Ray H. Manson

Ray H. Manson

There's Nothing Finer than a Stromberg-Carlson Radio

STROMBERG-CARLSON

A Finer Radio For Standard Programs • The Only Radio For FM At Its Best

RADIO RETAILING Combined with RADIO TODAY, January, 1942

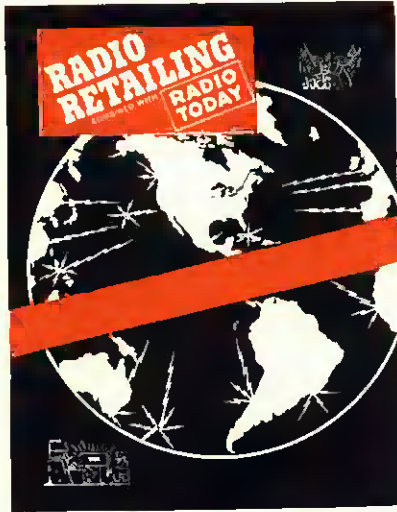

O. H. CALDWELL, EDITOR. M. CLEMENTS, PUBLISHER
480 LEXINGTON AVE., NEW YORK, N. Y.

Radio a Necessity!

The essential service which radio is rendering the civilian population is now being recognized by the Government.

There is no more vital consumer article in the home, the office or the automobile, than the radio set.

It brings news. It stimulates morale. And it becomes the instrument of instant mass-communication in emergency or air-raid alarm.

Radio is a necessity. And being such, the supply of replenishment and replacement sets should be continued throughout 1942 at a rate at least equal to the 75 per cent quota already indicated for the first quarter.

Repair and Rebuild!

Three-quarters as many radio sets will be manufactured during January, February, and March of 1942, as during the same period a year ago.

This situation will call upon the aggressiveness and ingenuity of local servicemen and repair organizations to fix over old radios. This is the time to go over all dusty but eligible carcasses in the radio shop's back-room and cellar "graveyards."

Check 'em over, supply the necessary tubes, parts and repairs, and "get 'em going again." The same applies to radio relics in the customer's own home.

Dig them up, check them over, make 'em work, and—keep 'em working!

Auto-Radio Belongs to You in '42

With new-automobile production soon at a standstill, the 1942 market for automobile radios shapes itself as a matter for local installations in the millions of cars yet un-equipped. This gives the local serviceman an opportunity he never enjoyed before.

About one-third of the autos in any community are already radio equipped. Another one-third are jalopies be-

yond prospect of radio outfitting. But the remainder—one-third of all the cars on the road—or as many cars as are already with radios—are first-class prospects for auto-radio sales.

Auto radio belongs to the local radioman, in 1942!

People Want Portables

With war upon us, the portable radio set should come into its own.

Business men need the little personal "3- to 4-pounders" to keep in hourly touch with the news—at their offices, in trains, at lunch, and in hotels.

And the larger portables have their many uses—for families during blackouts, for travellers, for production executives, and for boys in camp. With its alternate power supply from either electricity outlet or battery, the portable is the ideal set. During blackouts or air-raids, when electricity supply is cut off, the battery radio is essential. In threatened areas, portable radios belong on the "must" list, along with first-aid kits, protective helmets and gas masks.

Make Every Sale a Combination

Music has its great value in wartime. It serves as a builder of spirit and as a relief of overstrained emotions. Music for such purposes must be chosen and timed appropriately to the listener's moods.

It is not surprising that sales of phonograph records in '41 have leapt 50 per cent ahead of the year before. People are buying records and want to play them when they feel in the mood.

So the dealer will be doing his customer a real service if he presses hard to sell a phonograph-radio combination wherever possible, in place of a straight radio receiver. In being thus able to play both radio and records, the customer will be getting a greater value for his outlay, which will be appreciated in the days ahead.

Enemy-Alien Short-Wave Radios

With a million and a half enemy aliens registered in the United States, it is evident that the Attorney General's order that short-wave radios be altered or turned in to the local police, is going to mean a lot of service jobs for radio men before finally complied with.

Unnaturalized Italians now in our midst number 700,000; Germans 300,000; Hungarians 400,000, and Japs 100,000.

It is apparent then that the few hundreds of sets turned in so far are but a drop in the bucket, in comparison with the vast number of sets held by enemy aliens, and which must eventually be modified or turned in. Here's a field of service work where the radio man can be useful to his country, his aliens, and his police.

O. H. Caldwell

EDITOR



PA Photo

RADIO i

Leaders Pay Tribute to Essential Service Being Rendered by Broadcast Stations and

Radio has an increasing obligation to keep the public fully informed. A free radio is just as essential as a free press.

Franklin Delano Roosevelt

Radio Is Indispensable to Democracy

*By James Lawrence Fly,
Chairman Federal Communications Commission
Chairman Defense Communications Board*

I take this opportunity to express my gratification for the splendid way in which American radio has gone to war. The industry is united in the national march to victory. Such patriotic cooperation is reflected in every type of radio service, extending from manufacture to maintenance. This should be a matter of pride and satisfaction to every radio man, whether operating a broadcast station or providing the day-to-day repairs that are keeping the radio sets on the alert in 30 million American homes.

This unselfish patriotic response of radio is due, in large measure, to preliminary planning in which industry and Government exchanged ideas and, as a result, came to agreement on unified procedure *before* hostilities began. And this mutual planning and study is a continuing thing, enabling us to meet and solve problems in the communications field long before they could become acute.

Radio has become indispensable to the preservation of democracy. For its cornerstone is the existence of a wide-spread and well-informed public opinion, requiring

that the channels for the dissemination of news be open and free. Consequently, every person in the industry—from broadcaster to technician—is engaged in mutual, coordinated effort. They are meeting war-time problems with efficiency and understanding.

Orchids to Radio Trade Which Provides Homes with Sets and Keeps Them Working

*By Frank E. Mullen,
Exec. Vp. and Gen'l Mgr. National Broadcasting Co.*

Radio's great job of reporting the world war reached a peak of accomplishment with descriptions by eye-witnesses of the bombing of Hawaii and Manila, and we go into 1942 conscious of part of our task well done, but a still greater undertaking ahead. For radio has been assigned a major part in the United States war effort, and we are pledged to follow through to the finish.

Our war broadcasts, our public service programs, and the many hours of time which we are giving to the government for aiding the sale of defense bonds, giving information on Civil Defense programs, and a host of other necessary governmental activities, have built up listening audiences to unprecedented figures.

But much of this would be wasted effort if our radio receiving sets didn't work; if a family circle prepared to listen to air raid instructions, for instance, couldn't hear the announcements. We hear a lot about "keeping 'em



U.S. Army Photo

NECESSITY!

Local Radio Men Who Supply and Maintain Radio for Nation's 30,000,000 Homes

flying" but how about those boys who are "keeping them hearing"?

Three cheers for the radio repair men of the country, who keep millions of sets in operating condition and thereby do their bit in the morale-building efforts of radio.

And there is every evidence that the radio repair man will get to be more and more important as the war goes on and radio materials get less and less. Already there is fear that "priorities" will curtail radio set building. In which case, more power to the repair man!

Dealers and Servicemen Have Final Responsibility for Radio's Usefulness

*By William S. Paley,
President Columbia Broadcasting System*

Radio has been an important factor in American life for many years. It now may be called an indispensable factor.

There is hardly an aspect of the war effort that radio is not assisting. And in the fields of civilian defense and civilian morale, it is hard to see how the nation could do without radio.

We of the broadcasting industry realize that our efforts would be of little avail if the nation's homes were not equipped with the sets to receive our broadcasts. In the final analysis, the success of radio's attempts to serve in this crisis will depend on the skill and loyalty of the men

who supply the nation with radio sets and keep those sets in working order.

I am sure that the American radio retailer and repairman will rise to his responsibility.

Radio Can Be Only As Good As Its Home Outlets and Maintenance

*By Alfred J. McCosker,
President WOR, Chairman Mutual Broadcasting System*

Today we are engaged in winning a war. The words national defense have resolved themselves into all-out offense to maintain the life we value so dearly. At a time such as this the function of radio becomes daily more important both in maintaining national morale and in broadcasting information and instruction.

A tank corps is only as good as its maintenance, and supply of fresh parts. The same is true of radio broadcasting, which is as effective as the sets over which our efforts are heard.

It is of vital importance today that the radio sets of the American public be cared for at a point of peak efficiency and that such a service be prompt and efficient. Readers of RADIO RETAILING TODAY are the men who have been doing the job and doing it well. On you will fall an ever-increasing responsibility—a responsibility which we broadcasters fully recognize. To the work you are doing we give our heartiest encouragement with the realization that through cooperation between the broadcaster and the serviceman, we can successfully serve our country.



Below, the U. S. Army uses its new command, car, in which radio provides communication for "roving" officers.



RADIO "ALERTS THE NATION

At the left is the popular star Dinah Shore, who sings requests for men in the Service, NBC, Sunday Nights.

Below are aliens in Los Angeles, turning in radios and cameras in response to Govt. order. Servicemen may help by removing shortwave. See Service Section.





Above, radio devices guide U. S. Army planes (Signal Corps photo), and below, a radio-equipped soldier dog.

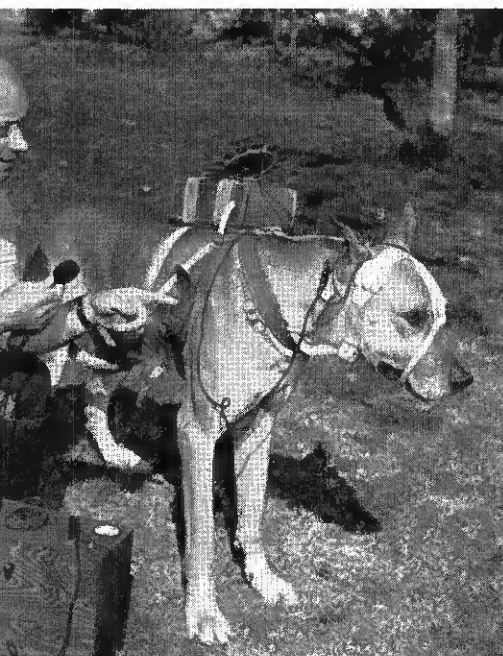

Bomb shelter rooms like this one above are now being planned throughout the U. S. First essentials include a good radio.

At left, the CBS news flasher Elmer Davis shown with part of studio equipment which helps keep the public informed.

Below, they're working to rhythm and getting more done in Portsmouth, Va., shipyards. Music via Atlas Sound Speakers.



Radio's BILLION-DOLLAR Business

ROLL CALL OF RADIO INDUSTRY, JAN. 1, 1942

Manufacturers of radio receivers	82	Radio-set and parts distributors	2,100
Manufacturers of radio tubes	7	Manufacturers' agents	297
Manufacturers of radio parts	734	Retail outlets selling radios	59,000
Manufacturers of test equipment	51	Servicemen, including dealers' servicemen	40,000
Manufacturers of broadcast and amateur equipment	105	Radio amateurs and experimenters	95,000
Manufacturers of sound equipment	95	Broadcasting stations	915

RADIO EQUIPMENT SALES, 1941

	Number	Retail Value
Total sets sold during 1941	13,800,000	\$520,000,000
Radio sets exported	700,000	
Automobile radios	2,000,000	80,000,000
Home radios sold in U. S.	11,100,000	420,000,000
Consoles	1,500,000	100,000,000
Table models	6,300,000	130,000,000
Combinations	1,700,000	150,000,000
Portables, battery	1,600,000	35,000,000
Farm radios, battery	1,000,000	25,000,000
Home sets sold as replacements	3,300,000	160,000,000
Home sets sold to homes previously without radios	2,200,000	100,000,000
Home radios sold as extra sets	5,600,000	168,000,000
Tube replacements	33,000,000	35,000,000
Tubes, initial equipment	92,500,000	102,000,000
Total tubes sold 1941, including 5,500,000 exported	137,000,000	146,000,000
Parts, supplies		63,000,000
Phonograph records	117,000,000	51,000,000

RADIO SETS IN USE

	January 1, 1941	January 1, 1942
U. S. Homes with Radios	29,400,000	30,300,000
"Secondary" sets in above homes	11,000,000	14,600,000
Battery portables	1,800,000	3,000,000
Auto-radios	8,000,000	9,500,000
Total sets in use, U. S.	50,200,000	57,400,000
Sets with shortwave reception	35,000,000	
Sets with FM	200,000	
Phonograph player units, including combination	6,500,000	
Television receivers in use	10,000	

Twenty-two years of radio-set sales. Annual output of receivers 1920 to 1942.

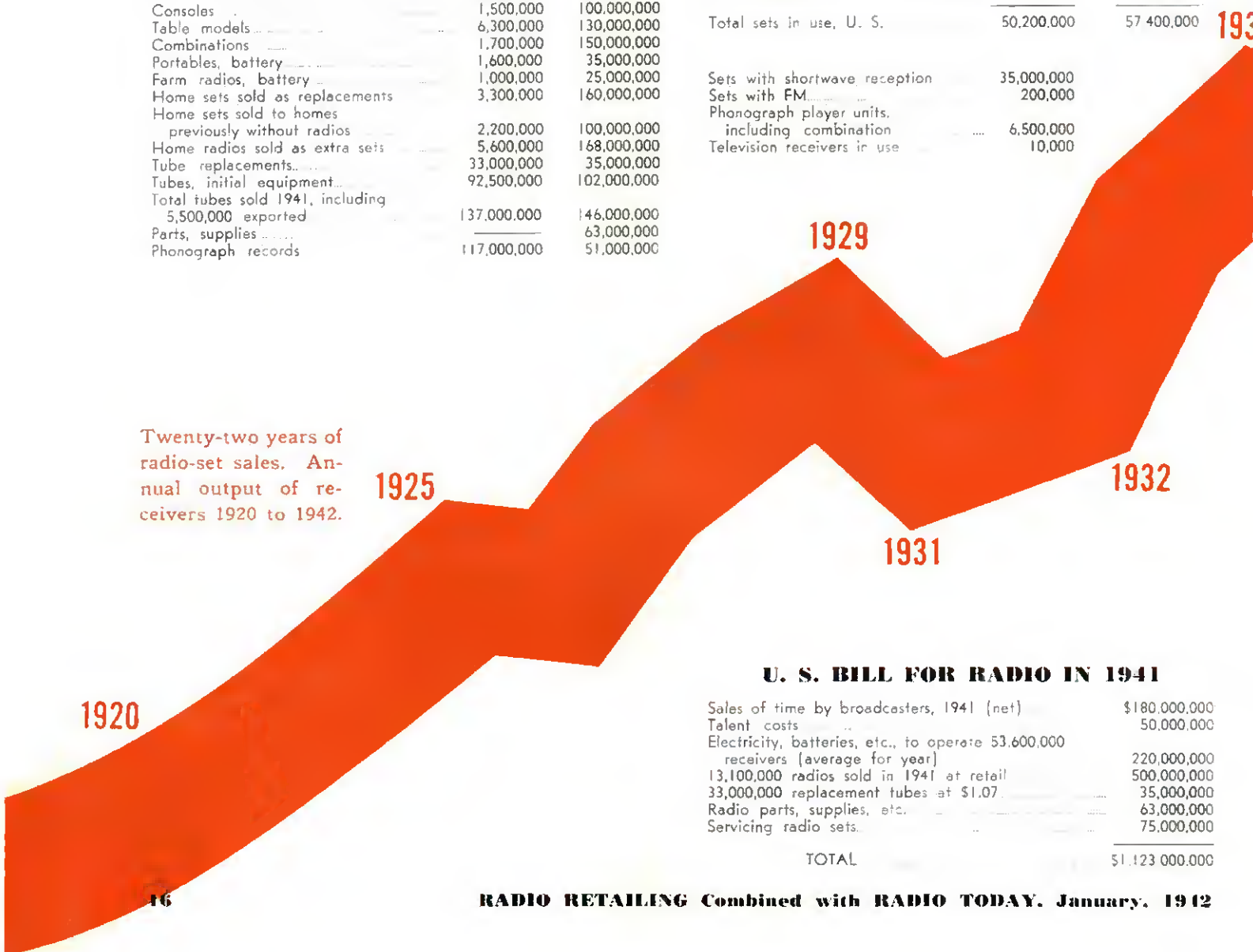

U. S. BILL FOR RADIO IN 1941

Sales of time by broadcasters, 1941 (net)	\$180,000,000
Talent costs	50,000,000
Electricity, batteries, etc., to operate 53,600,000 receivers (average for year)	220,000,000
13,100,000 radios sold in 1941 at retail	500,000,000
33,000,000 replacement tubes at \$1.07	35,000,000
Radio parts, supplies, etc.	63,000,000
Servicing radio sets	75,000,000
TOTAL	\$1,123,000,000

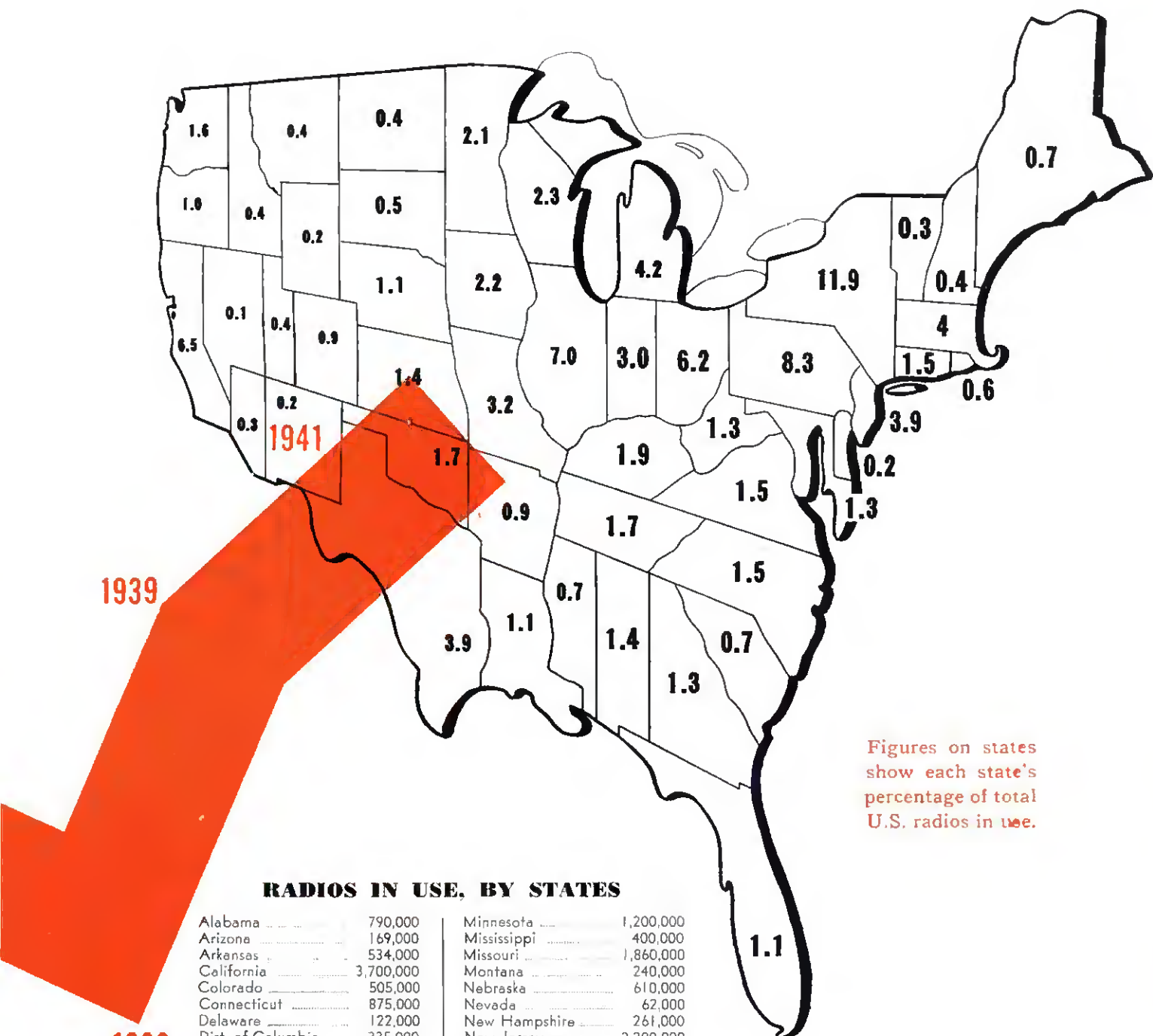

Figures on states show each state's percentage of total U.S. radios in use.

RADIOS IN USE, BY STATES

Alabama	790,000	Minnesota	1,200,000	Utah	235,000
Arizona	169,000	Mississippi	400,000	Vermont	188,000
Arkansas	534,000	Missouri	1,860,000	Virginia	850,000
California	3,700,000	Montana	240,000	Washington	940,000
Colorado	505,000	Nebraska	610,000	West Virginia	738,000
Connecticut	875,000	Nevada	62,000	Wisconsin	1,320,000
Delaware	122,000	New Hampshire	261,000	Wyoming	105,000
Dist. of Columbia	335,000	New Jersey	2,200,000	Total, U. S.	57,400,000
Florida	640,000	New Mexico	132,000		
Georgia	780,000	New York	6,750,000		
Idaho	208,000	North Carolina	878,000		
Illinois	4,000,000	North Dakota	252,000		
Indiana	1,750,000	Ohio	3,560,000		
Iowa	1,240,000	Oklahoma	960,000		
Kansas	790,000	Oregon	601,000		
Kentucky	1,070,000	Pennsylvania	4,740,000		
Louisiana	640,000	Rhode Island	330,000		
Maine	439,000	South Carolina	420,000		
Maryland	762,000	South Dakota	278,000		
Massachusetts	2,300,000	Tennessee	975,000		
Michigan	2,440,000	Texas	2,226,000		

THE RADIO BUSINESS TODAY—ITS MAGNITUDE JAN. 1, 1942

	Total Investment	Annual Gross Revenue	Number of Employees	Annual Payroll
Radio manufacturers (1,074)	\$ 50,000,000	\$300,000,000	75,000	\$ 80,000,000
Radio distributors, dealers, etc.....	\$ 350,000,000	\$600,000,000	150,000	\$225,000,000
Broadcasting stations (915).....	\$ 80,000,000	\$180,000,000	20,000*	\$ 50,000,000
Commercial communication stations.....	\$ 35,000,000	\$ 20,000,000	10,000	\$ 4,000,000
Listeners' sets (57,400,000).....	\$3,500,000,000			\$220,000,000†

*Regular staff—not including part-time employees, artists, etc., who number at least 25,000 more.

†Annual operating expense for listeners' sets, for tube replacements, electricity, batteries, servicing, etc.

• Everybody knows that we are finally committed to a "total" war.

But just what a "total" war means in the operation and management of a business, it is apparent few realize.

Never before in this country have we experienced anything like it.

On every business, large or small, the war will have a profound effect; so it will too, on most individuals.

Business men in general and radio men in particular, must study the situation carefully—think seriously, and act accordingly.

First on the list of things to think about, is merchandise. Radio is composed of "defense-precious" metals,

vital to war needs. Radio production facilities are vital to military communications. It is highly probable that 1942 will see production of radio for broadcast use cut from the whopping 14 million of 1941 to a reduced output.

As this is being written, the word has just gone forth that private automobiles will no longer be manufactured or sold. If production of radio is seriously curtailed, most manufacturers will concentrate their production on the "better" units—the combinations and other "top-of-the-line" models. With demand equal to, or greater than supply, and with buying power on the increase, there should be no incentive to stock the "low-priced" models, and no obstacle in the selling of the higher-priced models.

The answer, to smart dealers, is obvious.

Though production is certain to be curtailed, there is no reason to "load" your stock with anything you can buy. Definitely your buying should be in balance with sales. Models which are selling, and which can be sold, you may buy in any reasonable quantity, without fear. But models which are not selling, should be shunned, even though the discounts are made very attractive. Remember that every "cut-priced" bargain you sell is *one less* full profit set you can sell.

Balance in Buying

Many dealers are increasing their diversification—with appliances, sporting goods, music, and kindred lines as well as "sound."

Other war time factors that can be overlooked only at your serious peril, are the fast-rising cost-of-doing-business and taxation. It costs money to

WAR'S IMPACT





n your business

fight a war, and this money must come from you and from me. Taxes of the past will seem puny compared with the taxes soon to be levied.

You should, and will, pay willingly any taxes imposed to defend our country and our way of life. But you must also think about how you are going to pay them.—And what paying them means to your business.

Taxes mean “cash-on-the-barrel-head.” You must have more “cash on hand” to meet larger tax payments. You must have more working capital in order that these larger cash payments and probably increased stocks, may not “break your back” at the bank.

Translated into terms of your own business, it means you must maintain a higher gross margin—earn a larger profit.

At left, a part of the diversified stock in a finely styled radio salesroom at Washington, D. C.

And that is just another way of pointing out that the time has come when you can no longer sell a radio for a ten-spot more than your cost—and stay in business. “Discounts” to purchasers must be skinned down—or eliminated. Prices must be maintained if you are going to survive the effects of “total-war”—on your business.

Watch the Margin

And “trade-in allowances” are the same kind of explosive as “discounts”—will blast you just as far. So watch out for both, all the time, no matter what the “other fellow” does.

Then too, comes the matter of personnel—how to get them, and keep them.

War takes men—lots of men—to fight. And for every man with a gun, 15 to 20 men or more are required—“behind the man behind the gun.”

Modern war is a contest of produc-

tion even more than it is of men under arms.

Twenty million men and women are now engaged in production, or transportation, or service, in our war effort.

Soon thirty or forty or even fifty millions will be required. Wages are high. These extra men and women must find their way to war-time work from the ranks of those who serve the domestic consumer. Many of them will come from the ranks of retailers

and distributors. The Army and the Navy will claim a few millions more from all ranks.

And so the problem of procuring people to carry on your radio business becomes a current and a pressing problem from which you cannot hide.

There will be less slack for poor judgment, less room for mistakes in guiding your business too—as a direct result of the new wartime demands—both direct and indirect.

Careful Figuring

More than ever before the “facts and figures” of your business must be current, complete and accurate. You must study them closer—read the story they tell you more accurately, and act on them quicker than has been your custom in the past. Your stock, your accounts receivable, and your accounts payable must be main-

(Continued on page 38)

Should Output of LARG

Pros and Cons of War Economy Issue Presented

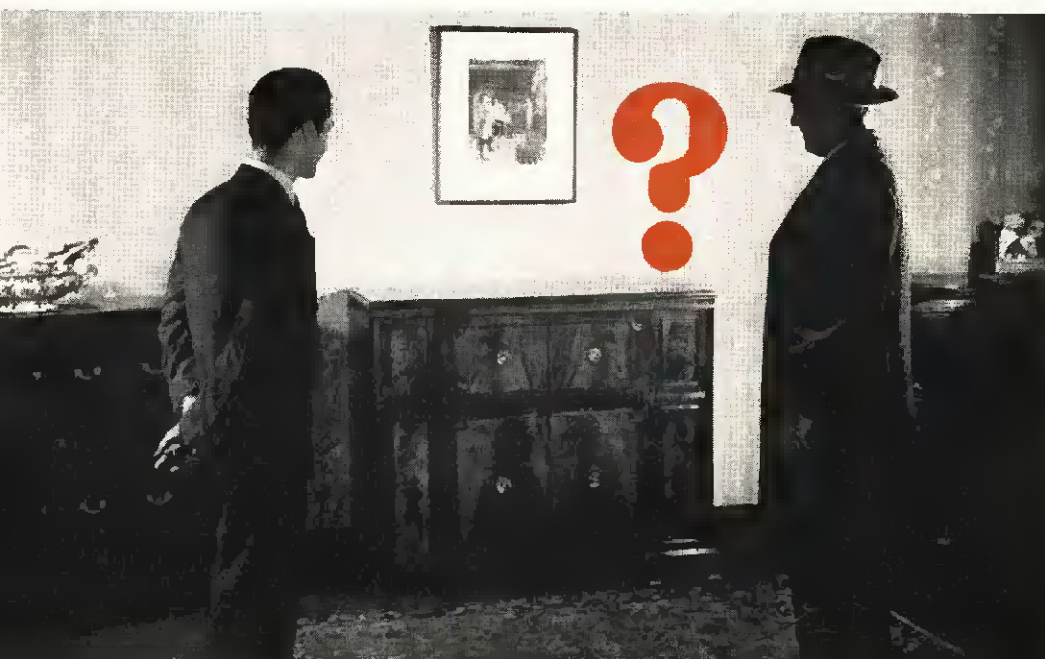

Limit Production to Table Models and Portables!

Here are the arguments presented by those who would limit radio-set manufacture to the smaller sets, as compiled from various statements championing this cause:

If there are not sufficient materials to manufacture all the radios the public will buy, we must cut down or eliminate production where the greatest amount of materials will be saved; yet we must get into the hands of the public as many radios as possible, forgetting which may be the most profitable for our industry.

In 1941, the industry produced about 8,000,000 table model and portable sets. By limiting production to only these two types, our industry can cut production by 30 per cent or 35 per cent—and 8,000,000 homes would have new radios, in good condition.

Another point to consider is that

the table models and portables are “the average man’s radios”—that consoles and combinations are actually in the luxury class, and hence are not as fundamentally important.

It is imperative, therefore, that our production be keyed to today’s needs—that we produce as many radios as possible, without taking more than a reasonable share of the materials available; that those radios be of the type best suited to the financial means of 75 per cent of the public.

Curtailing Better Sets a Catastrophic Blow to Trade

By Ross D. Siragusa, President
Continental Radio & Television Corp.

The proposed move to partially or totally wipe out the higher priced brackets will be a catastrophic blow to the radio dealer and distributor of this nation—merchants that we must keep in business if we expect to re-

turn to the making and distribution of peace-time goods.

As you know most talk in the newspapers and various weekly forecast publications has dealt with the ill effects that the manufacturer is faced with when raw material for civilian needs is curtailed. Little or no mention is made of the far-reaching effects upon that manufacturer’s distributors and their salesmen, retailers and their sales force.

The pattern as cut by Washington today takes excellent care of the manufacturer and its employees because of the manufacturers’ ability to swing over to war work—but the merchant is left high and dry without any visible means of support.

In view of the slight additional critical material required to raise the unit of sale appreciably, I feel that all arguments possible should be submitted to the authorities before any such drastic action is enforced upon the industry.

Higher Unit Values Consistent With Materials Available

By J. M. Marks, President
Fada Radio and Electric Company, Inc.

The general restriction that Washington will impose on radio sets, while definite in its contemplated curtailment, is not yet clarified nor specific as to the effect this will have in limiting production of radio sets in the higher-priced brackets.

It is only natural that every effort will be made to maintain production in the higher brackets but I think this is more or less a question of materials that will be available and the manner in which individual manufacturers will allocate such materials. The “yard stick” that will be the determining factor is, after all, the material

radios be **RESTRICTED**

Industry Faces Curtailments and Materials Shortages

that will be available. This, in itself, will restrict production, and the type of production as to break-down in the different price brackets is a question, I believe, each manufacturer will have to consider very carefully in order to achieve as high a unit of sales as possible.

Some manufacturers may feel that they may obtain more radio sets and a higher dollar volume by distribution of materials in the lower-priced brackets. The term "higher-brackets" does not of necessity mean building a multi-tube radio set. To illustrate: There is nothing to prevent a manufacturer from putting out a five-tube radio set at a \$30 list instead of \$14.95 by adding a band or a tone control and a more expensive cabinet, or by even conceivably employing the same bill of material with a slightly larger pan in a floor model.

Frankly, I believe that 1942 will result in a much higher unit of sale in the industry, since it will be impossible for many factories to operate on the curtailed program contemplated unless the utmost use of materials available are employed to attain the highest possible dollar volume.

Place of Large Radios in America's War Economy

By Lee McCanne,

Ass't General Manager

Stromberg-Carlson Telephone Mfg. Co.

Even in war time, large radio sets have a real raison d'être in America's war economy.

1. To hold together those organizations of skilled workers who will be needed to produce the more complicated defense communications equipment.

Some defense radios can be turned out by the average workmen in radio

factories, but other defense apparatus under development or in production requires skilled craftsmen and precision testing equipment. Shortages and delays are bound to occur in producing this type of equipment, as must be expected in anything else, and factories undertaking these skilled operations needs a backlog of production of large sets for stock as a fill-in to keep their skilled working force intact and busy.

2. For public places and large gatherings where small sets simply cannot do the job.

It is perhaps more important that

groups be reached and kept alert than individuals—groups such as are found in Cleveland's school auditoriums, in the University of North Carolina gymnasium, in the Lord Baltimore hotel lobby, on Burlington Zephyr trains, in Camp Lee, Va., mess halls or in the E. J. Heinz packing factory—to name only a few examples of where, in addition to numerous clubs and assembly halls, large home type sets are serving the public.

3. There is a steady market for large sets, indicating a more basically stable demand than has been the case

(Continued on page 32)



NEW STANDARDS in S

Material-Shortage Challenge Met by Radio Industry with Part-Standardization, Substitutes, and New Designs for Civilian Sets



Active heads of the RMA Materiel Bureau, conducting standardization program and search for materials for civilian sets. Center, Dr. W. R. G. Baker, director of RMA Engineering Division; left, Virgil M. Graham, assistant director; right, L. C. F. Horle, supervising the Materiel Bureau under RMA Engineering Division.

• The one important material of which there is no shortage in the radio field is Flexibility in Thinking—an asset which permits the progress of radio design and production even though serious material shortages exist.

Designers and engineers are finding many new ways of building radio sets—fine radio sets—by the judicious use of available materials and by their open-mindedness in considering other methods and materials heretofore thought completely impractical.

The critical metals in radio have shifted their relative degree of unavailability in the past few months. In the summer of 1941 the first talk of material shortages hovered around aluminum—the magic metal of radio. Airplanes were eating up existing production and crying for more. It appeared that radio would be stymied for lack of this important element which is absolutely essential to electrolytic condensers and permanent magnet speakers. There was talk of using copper foil capacitors insulated with paper, and of using the older type of electro-magnetic dynamic speaker in place of the permanent magnet speaker. Now the situation has reversed and copper is the scarce item—more so than aluminum.

Shifting Shortages

The result of this shift in shortage has created new problems. These shortage problems are being licked by several means. Substitute materials is part of the answer, of course, but less romantic and far more important, is standardization of parts and tubes.

America's entry into the actual fighting has not yet materially changed the shortage conditions which existed

prior to December 7. However, just as the situation reversed itself on copper and aluminum as the defense production progressed, it may certainly be expected that similar shifts in critical materials will put in an appearance as the United States develops its war plans.

Developments Ready

The newest shortage affecting the radio set field is rubber. The place where this strikes is the power line cord. Insignificant as this part may seem, it is still essential. New developments may be expected to solve this rubber problem either through the use of substitute insulations or reduced volumes of rubber in the cord. One other substitute already in use in power cords is steel for the plug prongs, in place of brass.

The new materials which were suggested some months ago as substitutes for aluminum, steel, nickel, etc., are still being studied and held in readiness for use when the situation warrants.

Steel chassis pans were thought to be doomed and metal-coated cardboard and porcelain were suggested. However, steel sheets of the proper gauge are still available for this purpose.

How Standardization Will Help

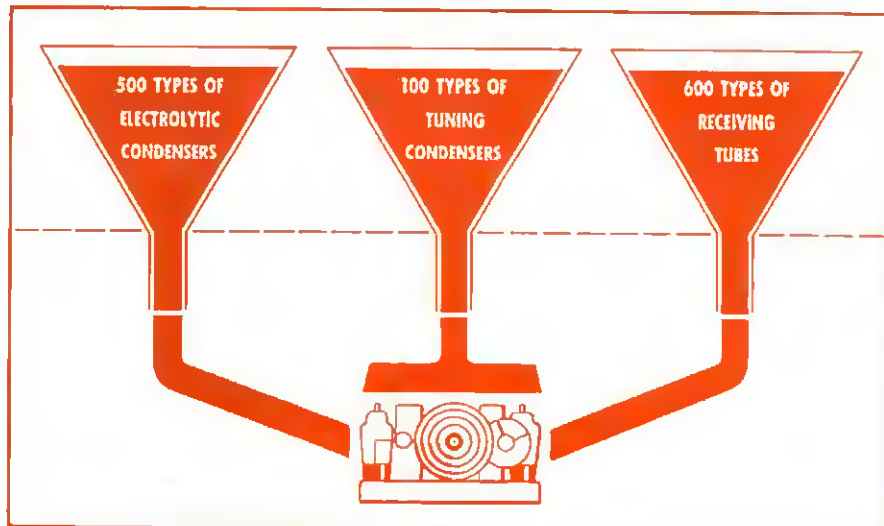

Reduction of the hundreds of sizes, shapes, and values of radio parts to an essential minimum will save material, and production facilities.

What Goes Into the 5-Tube Set

The cadmium plating commonly used on these steel chassis pans may have to give way in the near future to other rust-preventive coatings such as lead, or some form of paint. The scarcity of zinc in the domestic market has caused other industries to use lead-coated iron and steel sheets rather than the common galvanized product.

Tubes are now using plated steel grids and plates. These parts formerly made from pure nickel are now formed from steel wire and strip and being plated with nickel. Extremely thin coatings of nickel are all that are necessary for the acceptable performance of the tube. The important cathode sleeve is still being made of pure nickel tubing.

Wood Cabinet Problems

The use of steel parts in receiving tubes makes an interesting new assembly method possible. The delicate parts are now being handled by small permanent magnets taped to the finger tips of the assembly line operators. Parts can be kept cleaner and deformations through handling are less.

Should nickel become more scarce, although the radio tube industry is now using only a small fraction of its former needs through the plating technique, the use of gold may become a reality. Gold has been suggested for grids since it has desirable characteristics with regard to secondary emission.

Cabinets are another thing which aggressive cooperation of manufacturers through the RMA Materiel Bureau helped to get off the problem list.

The shortage of phenol plastics which constitute most of the plastic radio cases, pointed toward the use of wood exclusively. On the surface of the problem, wood seemed to be the answer. However, the same shortage of chemicals used in the plastic industry, affects the paint, lacquer, and wood finish makers. Wooden radio cabinets have been finished with various types of synthetic lacquers and Oriental gum finishes. Shortages in both of these products will be met by

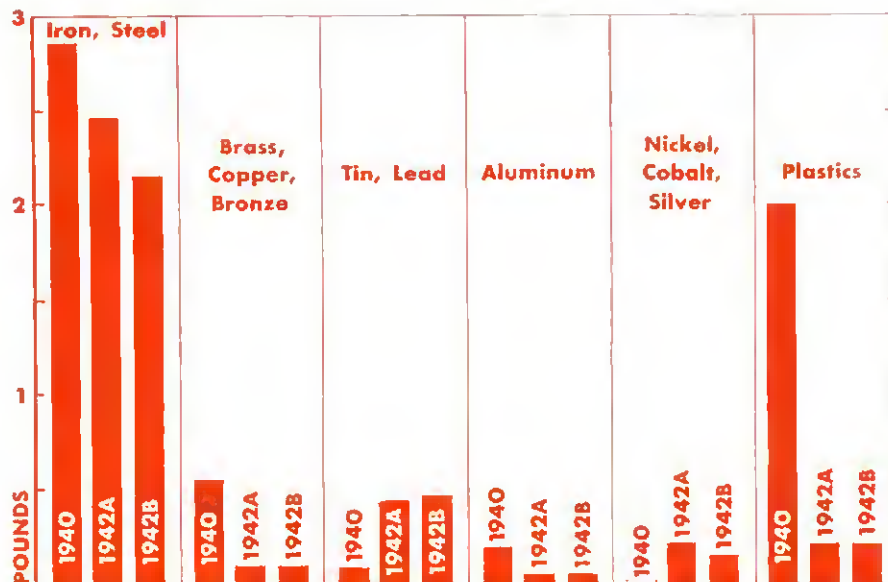

The average 5-tube AC-DC "pre-shortage" set of 1940 was made of the amounts of critical materials indicated above. Two proposed set designs for 1942, A and B, would use substitutes and less critical materials to replace those not available.

a return to the linseed oil-resin combination which was one of the first types of finishes used. Cabinets will look a lot different than those first ones, however, because of the many new tricks learned in the use of these basic materials.

One molding company has a process of producing large one-piece plastic cabinets from sheets of plastic materials. Less expensive molds can be used with the new process.

Circuit designs of 1942 receivers are likely to undergo some changes. Permeability tuning is gaining in popularity and new developments in this field make it quite practical. Savings in aluminum and copper are an important feature of variable permeability systems. Recent reports from makers of the powdered iron cores state that the United States is now self-sufficient so far as materials for these cores are concerned. They also report efficiencies higher than the best European product, where powdered iron cores were first introduced.

Standardizing Parts

Set design may move toward the AC-DC type of circuit if the copper and synthetic enamel shortage makes the use of power transformers out of the question.

Circuits may also become more complicated rather than simpler. This apparently strange course of events may result from the standardization of electrical sizes of parts.

Most sets built in the past few years have taken care of the filtering problem by using a very large block of capacity in the power supply circuit. Equally good and in many cases better filtering can result from less total capacity if it is distributed through the circuit at the proper points.

To encourage designs more saving in capacity, the RMA Materiel Bureau has, with the cooperation of set manufacturers, laid ground work for substituting for the three or four hundred types and sizes of dry electrolytic capacitors only a few dozen. These few are adequate to cover all types of domestic set circuits and good design practice will make these tens do the work of the former hundreds.

Scrap Now Used

Another important contribution to the saving of aluminum, steel and other materials is the standardization of variable tuning condensers. The four major manufacturers of air tuning condensers have made and stocked a tremendous range of sizes and styles. Slight variations in dimensions, plate shapes, etc., made a huge overlapping of stock, materials, tools and dies by the manufacturers. These many types are now consolidated into a few basic frame sizes, with a limited number of gangs and plates.

The loudspeaker problem seems to be fairly well in hand. The development of Alnico No. 5, a magnetic ma-

(Continued on page 80)



Another group greatly interested in FM is the farm folks. More than 50,000 of them were attracted to this demonstration staged by W47NV, Nashville, Tenn., on tours among country fairs in the South.

value as an educational medium is indicated by several applications filed in past weeks by educational groups seeking licenses for non-commercial FM stations.

Educational Channels

Commenting on advantages to be gained through construction of FM transmitters by school and college groups, John W. Studebaker, United States Commissioner of Education, says: "I should like once more to call attention to the growing interest among school administrators in the establishment of their own radio stations in the ultra-high frequency (FM) bands reserved for educational use.

"The fact that costs have been radically reduced should serve as an added inducement to school administrators everywhere to give consideration to making budgetary provisions for installing their own radio stations. I am told that an average school station can now be installed at the price of one classroom. High frequency (FM) stations can be used for intra-school system programs, for community wide educational programs (as more FM sets are purchased), and as laboratory equipment for vocational courses for radio technicians."

The educational channels extend from 42.1 to 42.9 megacycles in the standard FM broadcast band, and have been set aside by FCC for non-commercial, educational transmitters.

FM Set Sales Climb

Figures on sales of FM sets during the month of November, compiled for FM Broadcasters, Inc., the national trade association of FM, indicate that more than 40,000 new receivers were sold in that period. Incomplete returns on December sales point to a distribution of an additional 50,000 to 60,000 sets in pre-Christmas weeks. This raises the national total on January 1, 1942 to approximately 240,000 units. New York City, New England and Chicago are still the three leading areas.

FM in 'Forty-Two

Unusual Opportunities Seen in Many Fields as New Service Faces Most Promising Year

• FM came far in the year just closed. A quarter million sets were estimated to be in use on January first!

Taking its first commercial steps towards sale of program time during the past twelve months, FM also impressed itself on the general public as a vastly desirable new service which every listener would want to have.

FM today means something very definite to radio men and to people in general, whether they yet have FM sets or not. FM has arrived.

And now the question is—

What new triumphs are ahead for FM in 1942?

What are the next steps in FM's growth? How will FM's further acceptance by the public be marked during the coming months?

Several high spots stand out as promising particular value and interest, during the year ahead.

Warm-weather High Spots

1. As summer weather rolls around and natural static returns, the public will find FM especially useful to get its vital news bulletins of the war, free of interference from lightning and natural or manmade interference. There were many nights last summer when broadcast listening on the regular channels was simply impossible owing to the ear-shattering static. And now that the public is everywhere demanding frequent news

bulletins of the progress of the war, it will find that on such nights it can turn confidently to FM and get clear and undisturbed news broadcasts just as free of static as on the nights of best winter reception.

And in event that air-raid warnings become a factor in civilian life in the United States, listeners on FM will have a dependable service undisturbed by interference of any kind.

2. Extensive relaying of FM programs will be a feature of 1942's development. By picking up programs from a station supplying an adjoining territory, FM programs will be carried as a sort of network supplying widely extended territories.

FM Sets Stabilized

3. Quality of transmission will improve with FM, and high fidelity performance will no longer be limited to line-wire restrictions, as FM station relay programs by wide-range transmission.

4. FM receivers are now pretty well stabilized in design and manufacture, and a purchaser can now buy an FM set with confidence, knowing that the set he purchases in 1942 will continue to give good value in future years.

5. FM will extend its services to other fields and other applications. Automobile FM receivers will undoubtedly appear during 1942, enabling drivers to listen to FM programs as they motor along.

Increasing recognition of FM's



WILCOX-GAY CORPORATION

Radio Manufacturers

CHARLOTTE, MICHIGAN, U. S. A.

YOU WANT TO KNOW ABOUT 1942

During the early part of 1941, Wilcox-Gay announced its "H.U.S." (higher unit sale) sales policy in view of the impending government defense program. This policy was:

1. To produce a smaller quantity of units of better quality correctly priced.
2. To limit the number of dealers in every community so that each would receive a sufficient quantity of merchandise for a profitable operation at factory-recommended prices.
3. To promote close factory cooperation to assist dealers in their program to "sell up" at full profit for themselves.

The problems of our loyal distributors and dealers are of great concern to us. That is why we inaugurated the "H.U.S." policy. The success of this policy during 1941 has prompted us to continue it. The extent to which this policy can operate will, of course, depend on the requirements of our government, which at the present are an unknown factor.

Wilcox-Gay factories are now pressed into government service on many fronts. We believe this to be our primary task. However, engineering and research are already busy with the development of new products for the future. These developments will be in stride with Wilcox-Gay tradition.

Wilcox-Gay is "on-the-job" and we are pledged to protect our fine dealer organization to the best of our ability. In the future, as in the past, you can depend on us to deal with this situation on a fair and equitable basis.

WILCOX-GAY CORPORATION

Chester M. Wilcox

Chester M. Wilcox
President

Q U A L I T Y R A D I O S S I N C E 1 9 1 9

Manufacturers of the Famous Wilcox-Gay Recordio



IT TAKES A LOT *THE NATION'S*

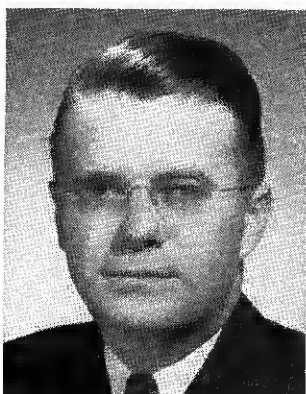

G. Hamilton Beasley
President

HUNGRY for news—the nation depends on radio to keep it informed.

It is the responsibility of the radio industry to keep the receivers in American homes and automobiles in first-class condition. This is your responsibility and your contribution to the defense of the nation.

So that resources and materials important to Victory can be conserved, it is necessary to select radio parts carefully. Utah's part in the task of keeping communication at top efficiency is attested to by the fact that more than 7,000,000 Utah parts were used last year—many of them in national defense for the Army, Navy, Air Corps and important civilian

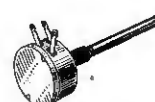

IN 1941, 7,014,701 UTAH PARTS WERE FURNISHED FOR



J. W. Caswell
Vice-President



W. Dumke
V.-P., Charge of Prod.



H. S. Neyman
V.-P. & Treasurer

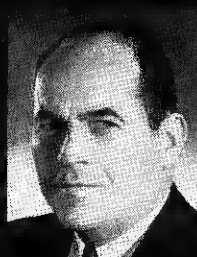

O. F. Jester
General Sales Manager



W. A. Ellmore
Chief Engineer



C. L. Walker
Asst. Chief Engineer

UTAH RADIO PRO SPEAKERS • TRANSFORMERS 820 ORLEANS STREET

OF PARTS TO KEEP WARS OPEN



communications.

This year, again, Utah engineering will keep abreast of industry developments. Again, Utah's policy of aggressive research and product development will be maintained.

To the trade, Utah products again will offer the same high quality and exceptional value. They will continue to be distributed through recognized channels only. Requirements of Utah customers will be met as promptly and as quickly as possible. Utah Radio Products Co., 810 Orleans Street, Chicago, Illinois. Canadian Office: 560 King Street, West, Toronto. In Argentina: Ucoa Radio Products Co., S. R. L., Buenos Aires. Cable Address: Utaradio, Chicago.

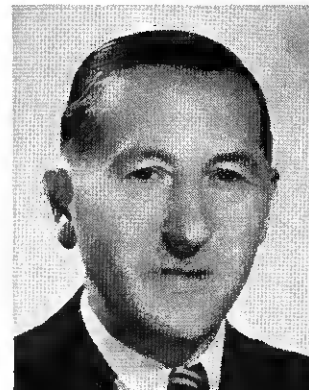

Peter L. Jensen
Vice-President



USE IN DEFENSE AND CIVILIAN COMMUNICATIONS



J. M. Hume
Sales Engineering



W. H. Edwards
Sales Engineering



R. M. Karet
Sales

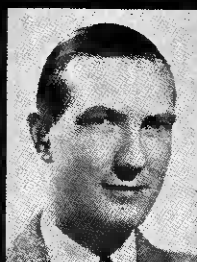

R. R. Hutmacher
Sales



P. H. Heckendorn
Sales



F. E. Ellithorpe
Sales

DUCTS COMPANY

VIBRATORS • UTAH-CARTER PARTS

CHICAGO, ILLINOIS

Wartime Parts Jobbing

Pennsylvania Distributor Takes Steps to Meet New Conditions

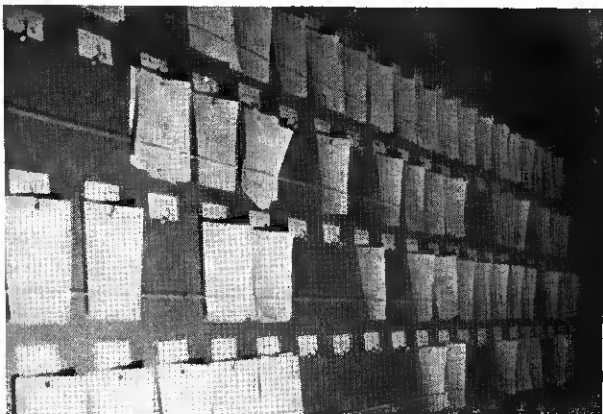

Here's the Back Order "signal" board, devised by the prominent Reading, Pa., jobber, and described herewith.

• There's a parts jobber in Pennsylvania who owes this reporter a day's pay.

We waited on his customers, we ordered merchandise for him, we answered phone calls, and we froze to death while we unloaded 40 cartons of tubes.

George D. Barbey of Reading, Pa., would get a bill for this, and fast, but for the fact that we learned plenty. We learned (the hard way) about priorities, back orders, staff vacancies, etc., and we got a good look at how a resourceful distributor runs his business in war time.

This jobber has been a business man for 25 years. In radio parts, he has a solid following among servicemen in his area. Today's problems are being met in a fast, practical and hard-boiled way.

His methods for handling back orders, "defense sales," staff vacancies, and counter sales during this war period may be immediately helpful as highlighted tips. Here they come.

On Back Orders

Work yourself out a definite system for back orders before your shortage of stock gets you out on a limb. In my case I've put the orders on hooks on the wall, outside the office of the man who does my ordering. Here's how this works.

We keep order books marked with a big "BO" on the counter. When

a customer requests something we haven't got, we use these books, and make out the slips in duplicate. These are left in the books till the end of the day, when they are taken out and put on the hooks—there are 80 of these placed in rows alphabetically by manufacturers' names. The man who does the ordering keeps an eye on them, and when he orders, he removes the white slips and files them in a 3x5 customer file. Thus we can always tell how we stand on BO's with any individual customer. The yellow slip is then stamped plainly, with a mark that means "ordered."

A glance at this wall anytime will give you an idea of how things are going. You get an overall idea of how much stuff has been ordered that you haven't got. You can tell from the number of hooks without white slips how much of the stuff has been ordered from the supplier. You can also tell how far the suppliers are behind in filling your orders, by the number of yellow slips present.

As stock comes in, the yellow slips are removed from the board, the orders filled and shipped. When there are none of these under a manufacturer's name, it means of course that he is able to fill his orders promptly.



Mr. Barbey makes a close study of priority and war supply conditions, for his parts headquarters at Reading, Pa., and his branch store at Lancaster. He is also president of National Radio Parts Distributors Ass'n., from whose get-togethers comes timely guidance for parts distributors.

You'll need some cord stretched across the bottom of the slips to keep them from blowing away.

Also on the matter of keeping up your stocks these days is this: Be sure that your "standard stocks" are adjusted to the new conditions. If you have entered the figure "18" under a certain make of condenser, it means of course that according to your turnover on the item, you should have 18 of them regularly in stock. If this item shows up on the back order board you'd better hike the standard stock figure, so that you'll be ordering more each time. If condenser deliveries are slow, you have to put extra pressure on them.

On Priorities

Get yourself at least two rubber stamps for your counter, with the "P-100 Amended" notice on it, and a couple of stamps carrying the notations as to how an order is divided, defense or non-defense.

If you're cooperating with the Priorities Committee of the Radio Parts & Associated Industries, and want to encourage all your suppliers to do so, too, you might adopt our system of attaching a special postcard to all orders sent to suppliers. This will save you a lot of time, in filling out forms and accounting for your defense percentages to each supplier. The form of the card used by us is as follows:

"TO OUR SUPPLIERS: We are reporting our National Defense Sales, and our sales under 'Preference Rating Order P-100 Amended' to the PRIORITIES COMMITTEE OF THE RADIO PARTS & ASSOCIATED INDUSTRIES. For our percentage figures since Oct. 1, 1941, please write direct to the above committee at Room 1457, 53 West Jackson Blvd., Chicago, Ill."

When a serviceman comes to your place with a large order, and you find that you are able to fill it to the last item (due to some forethought in your

(Continued on page 32)

*Push a Button... this new RCA Victrola
does everything else*

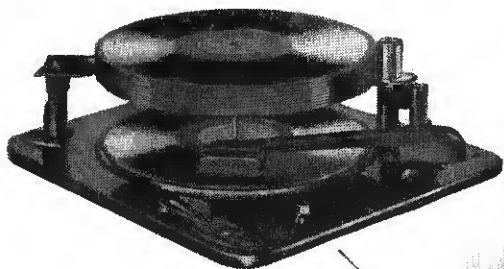

**IN FACT, THE V-215
PRACTICALLY SELLS ITSELF**

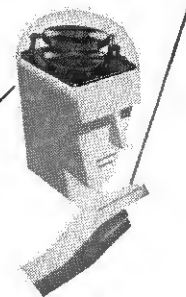

YOU CAN CERTAINLY give your customers entertainment-convenience with the new RCA Victrola Model V-215. Its superb and exclusive features make it a sensation wherever shown. It enables you to give one of the most dramatic demonstrations your customers have ever witnessed. For all its features add up to conveniences which radio listeners and music lovers *want*. If your customers want radio reception and record reproduction at their finest, show them the V-215 *first*.

These Exclusive Radio and Phonograph features make the V-215 a self-seller

- 1—Roll-Out Record Changer.** Glides out automatically. No ornaments to move—no lid to lift!
- 2—Magic Tone Cell, Jewel-Lite Scanner and light-weight Flexible Tone Bridge** give brilliant tone fidelity — eliminate objectionable mechanical noise.
- 3—No Needles.** The tiny sapphire point of the Jewel-Lite Scanner gives faithful reproduction for countless playings, eliminates old-fashioned needles entirely.
- 4—Records Last Indefinitely.** By exerting feather-light pressure on records, the Magic Tone Cell increases record life.
- 5—Completely Automatic Record Changer.** At the push of a button the Magic Brain plays, stops and changes records—even shuts off motor when record program is over.
- 6—Teletube Radio.** Standard, shortwave and foreign reception with 9-tube push-button set containing Teletube and new audio system for finer reception.



RCA VICTROLA
with the Magic Brain

New Radios

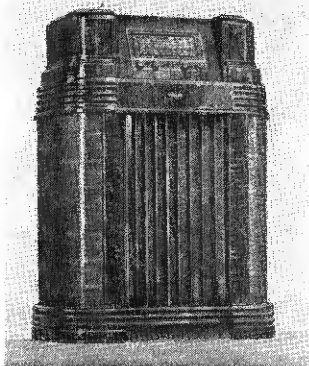

PHILCO 380X, an 8-tube console radio with built-in aerial system. Electric push button operation—9 buttons. Concert Grand balanced field electro-dynamic speaker. A.V.C. Covers standard American broadcasts, day and night American and foreign shortwave, state and city police calls, aircraft, ship and amateur stations. Walnut cabinet. Philco Corp., Tioga & C Sts., Philadelphia, Pa.—RRT.

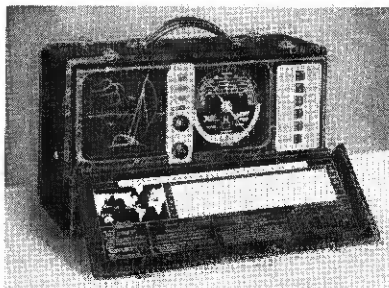

ZENITH SHORTWAVE PORTABLE radio which operates on self-contained battery pack or 110 v. AC-DC, is equipped with coupled movable Wavemagnets, one for standard reception and the second to pick up shortwave signals. There are 6 bands, standard and 16, 19, 25, 31 and 49 meters. Automatic time band buttons clearly identified show the band they put into operation and the best period of the day for use. Contains a logging chart on the front cover lid. Radiorgan tone feature. Zenith Radio Corp., 6001 Dickens Ave., Chicago, Ill.—RRT.

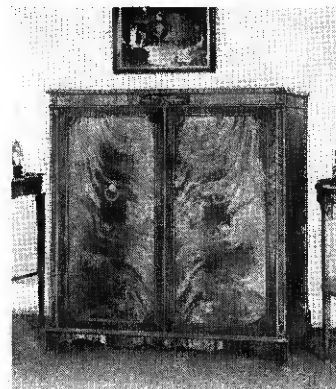

STROMBERG-CARLSON ENGLISH REGENCY NO. 935-PR, in genuine mahogany, has 3 bands, standard, shortwave and FM. Full-floating labyrinth speaker system with carpinchoe leather speaker. Tuning eye, built-in loop. Built-in shortwave and FM antenna. Permanent point pickup, automatic record changer plays and shifts 10 and 12 in. records. Generous album space. Stromberg-Carlson Tel. Mfg. Co., 100 Carlson Rd., Rochester, N. Y.—RRT.



RCA VICTOR MODEL 36X is similar to the Super Six instrument in a wood cabinet. It has 6 tubes, AC-DC, 2-point high-frequency tone control and extra large built-in Magic Loop antenna. Spread-vision dial. RCA Mfg. Co., Front & Cooper Sts., Camden, N. J.—RRT.

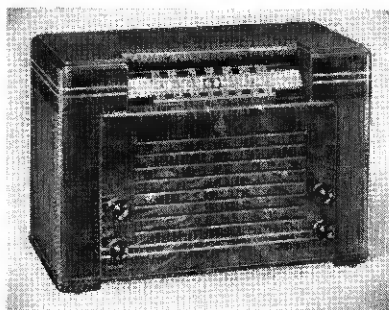

EMERSON TABLE RADIO, an AC short-wave radio set, model 459. It is a 6-tube superhet with 3 bands—daytime and nighttime foreign and American short-wave bands. Tuning range from 13 to 555 meters. Lighted full-vision slide rule dial in 3-dimensional calibrations. R.F. amplifier, 4 tuning controls, large electro-dynamic speaker. "Sta-Bent" Ingraham cabinet of walnut. Emerson Radio & Phono. Corp., 111 8th Ave., New York, N. Y.—RRT.

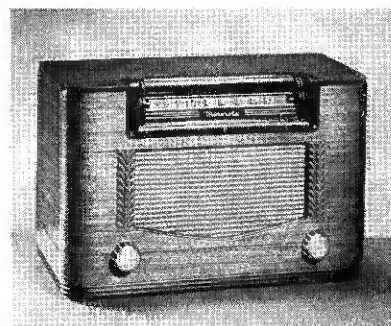

MOTOROLA VITA-TONE 6-tube AC-DC superhet with broad band RF amplifier stage. Self-contained "Aero-Vane" loop aerial. Features 3-dimension Vita-Tone. Cabinet is walnut veneer of "Dial-over-Speaker" design. Simulated carving overlays on each side of the speaker grille. Galvin Mfg. Corp., 4545 Augusta Blvd., Chicago, Ill.—RRT.

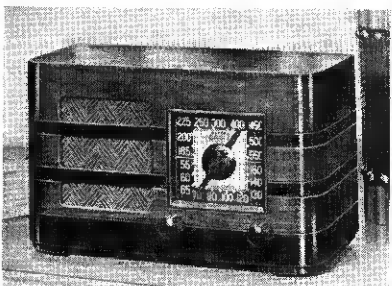

CROSLY MODEL 52TA, 5-tube AC-DC superhet table radio features super-field electro dynamic speaker and beam power output. Has a Magna Loop antenna. Large full-view dial. Tunes 550 to 1600 kc. Walnut cabinet. Crosley Corp., 1329 Arlington St., Cincinnati, Ohio.—RRT.



FADA TABLE COMBO, model PT-208 radio-phono with Fa-da-scope built-in loop antenna, plays 10 or 12 in. records fully enclosed. Deluxe walnut wood cabinet houses the 5 tube superheterodyne

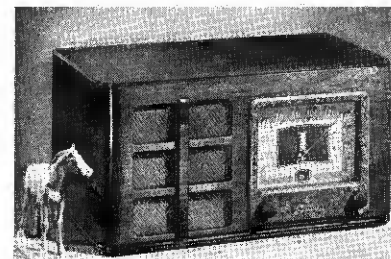

SONORA FARM RADIO, a 4-tube, 1.4 volt superhet table model, tunes 535-1720 kc. to cover the standard broadcast band and 1712 kc. police channel. Clock-type dial, 6 in. speaker, A.V.C. Walnut cabinet. Sonora Radio & Telev. Corp., 325 N. Hayne Ave., Chicago, Ill.—RRT.

Joins America's Mightiest Movement in Behalf of Good
Starting Saturday!

MUSIC APPRECIATION RECORDS

DISTINGUISHED INTERPRETERS
OF THE WORLD'S MOST BEAUTIFUL
Immortal Masterpieces of

BACH - BEETHOVEN - TSCHAIKOWSKY
STRAUSS - CHOPIN - MOZART - GRIEG

23
SYMPHONIES
12
OPERAS
5
SPECIAL SYMPHONIC
ALBUMS

All the world's greatest music.
Bach, Beethoven, Wagner,
Schubert, and many others in
classics.



These are the world's greatest...
The world's most beautiful...
The world's most beautiful...
The world's most beautiful...

These are the world's greatest...
The world's most beautiful...
The world's most beautiful...
The world's most beautiful...

These are the world's greatest...
The world's most beautiful...
The world's most beautiful...
The world's most beautiful...

THE NEW THRILLING OPPORTUNITY FOR MUSIC LOVERS
The Romance of Music Appreciation Records

Here is the world's greatest music...
The world's most beautiful...
The world's most beautiful...
The world's most beautiful...

POPULAR CLASSICS	34¢
COMPLETE SYMPHONIES	\$1.99
GRAND OPERAS	\$1.99

HERE YOU CAN BUY MUSIC APPRECIATION RECORDS

NOW Selling Through Record Stores at Standard Dealer Mark-Up!

HERE is the world's greatest music — symphonic, operatic and classic treasures — superbly recorded by celebrated vocal artists, America's leading orchestras and their renowned conductors.

Made to sell at a low price unheard of before. Cooperation of artists, conductors and orchestras, who agree to waive all royalties, largely make this possible. This is their contribution to the movement to make the world's greatest music available to everybody.

More than two million sets of the world's greatest symphonies and operas sold in two years—the greatest record selling achievement of its kind. This tremendous response by American music lovers of all classes is the

ultimate and final endorsement of this great new line of phonograph records.

Now offered to the record dealer at standard dealer mark-up. Now, for the first time, dealers can stock this complete line of best selling records at customary dealer profits. Here at last is a Record line combining outstanding quality of product with low selling price,—essentials of *volume business*; plus that important third dimension, standard dealer margin.

If the Continental representative doesn't reach you within the next few days, write direct for complete details of this famous Record Franchise, now for the first time available to the record dealer, exclusively, through Continental.

New Complete Symphony Record Sets
The Nation's Favorite Classics, superb recordings by the finest symphony orchestras. 2, 3, 4 and 5 record sets. 3 record sets (6 sides) **\$1.99** Prices include Excise Tax
sell for . . .

Favorite Opera Record Sets
The big sellers, Carmen, Faust, Rigoleito, Lohengrin, Pagliacci, and many others. 3 and 4 record sets. 3 record sets (6 sides) **\$1.99** Prices include Excise Tax
sell for . . .

Symphonic and Opera Record Sets in De Luxe Albums
Record Sets of Famous Symphonies and Operas are also supplied in attractive Albums. 3 record sets (6 sides) **\$2.69** Prices include Excise Tax
sell for . . .

CONTINENTAL MUSIC CO., INC.

Dept. 1354
630 S. Wabash Avenue, Chicago, Ill.
251 Fourth Avenue, New York, N. Y.

Exclusive National Distributors

569 Mission Street, San Francisco, Calif.
150 Marietta Street, N. W., Atlanta, Ga.



H. L. M. CAPRON,
Merchandising Editor

CAP SAYS:—

“TIME IS WHAT YOU DO WITH IT”

● A lot of people have more of *nothing* than *time*. And do nothing *with* their time.

● Time is precious, more precious now than ever before in the history of our country.

● Time should be made to count.

● With time you can think—and plan.

● And prepare to meet the changing conditions surely.

● And act to help yourself and help others.

● Train yourself to protect your homes and your lives. To serve your Nation, your community, as well as your business and yourself.

● If you want to evaluate a single hour, pause a moment and *think*. How valuable do *you* think a single hour is? The hour before the Japs struck at Pearl Harbor? Few can say just what the value of *that* hour was, to the U. S., to the Japs, and perhaps to you and me.

● No need now to pick a *single* hour.

● Every hour is important—perhaps vital—to you—to your business—perhaps to your country.

● Everyone of us must be on the alert every hour, ever ready to do our best.

● And that goes for radio dealers, business men, workers, the same as it does for the officers and men of our Army and Navy.

● These are not times when things will take care of themselves.

● We have *no* time—to lose—or to idle away.

● And *your* time is measured by what *you* do with it.

● REMEMBER PEARL HARBOR.

model disclosed 241 items—including tubes—which might conceivably need attention. The same manufacturer's \$40 table model included 116 of these items, assembled together in about one-third the space.

6. By a reasonable process of elimination, increased relative production of large radios is indicated.

As against recent relative proportions, decreased auto radio production is indicated by sharply curtailed automobile production; less need for farm sets through R.E.A.'s electrification of 35 per cent of the farms in recent years; shortage of plastics has increased the cost and reduced the demand for small low priced sets, while the ability of battery manufacturers to supply defense needs for portable battery sets, and batteries for A.R.P. flashlights, puts the produceable quantity of battery radios in question.

(Continued on page 51)

Wartime Parts Jobbing

(Continued from page 28)

ordering system) you might explain to him something about how you do it. Then he'll give you credit for exceptional service in a difficult time.

If you have the time, take a personal interest in the serviceman and his problems. He will appreciate your giving him the benefit of your experience with *many* servicemen, over a number of years. And an extra spirit of friendliness will be helpful, if merchandise shortages get more serious and you have to disappoint some of your customers. They should realize, though, that they are lucky to get anything these days, and they should relax some of their ideas regarding specifications of the items they ask for.

On Staff Vacancies

If you see yourself losing part of your staff to the draft or to defense jobs (and you probably will) get your head counterman and your sales manager to help you. Keep your eyes open among your servicemen customers, and the hams. Also keep an eye peeled in the direction of your friends in other businesses—sometimes they will fit in.

In filling non-technical jobs such as shippers, etc., it is a good idea to contact the industries affected by material shortages. There you can often find intelligent help above draft age.

Should Output of Large Radios Be Restricted?

(Continued from page 21)

over the years for any other class of radios.

4. Small set production figures have been over-weighted in recent years by innovations forcing multiple-radio ownership per family.

Large radios have had more time to settle down to a basically stable market, whereas the introduction of plastic midgets, auto radios, portable sets and the new personal portables has swelled relative production figures from year to year.

It is important that every home in America have at least one good functioning radio, but many recent surveys show multiple-radio ownership of

from five to twelve or more radios per family, including auto sets and all other types. It can be questioned whether a family should be entitled to more than one radio per individual in times like these.

5. Today's radio production should be built to last, and to be serviced readily.

Looking Forward

What is the sense in putting today's critical materials into sets whose service life may be measured by the failure of its first tube? Every service man knows it is more difficult to make adjustments in the crowded space and multiple-purpose tube circuits of the typical small set than it is to keep a large set in operation. A recent investigation of one manufacturer's \$200

NEW

Butter Conditioner

IN HOTPOINT REFRIGERATORS

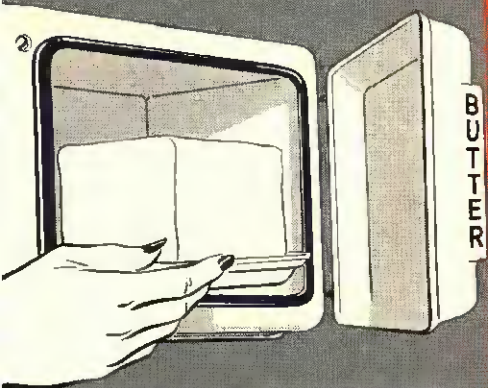

Hotpoint's New Butter Conditioner is recessed in side-wall to provide additional storage space for tall bottles.

*Not just a Gadget...
IT A GREAT NEW FEATURE!*



DELUXE DORIC—7 cu. ft. capacity, one of Hotpoint's many new 1942 refrigerators.



... A GREAT Plus CONVENIENCE

LEADING the list of Hotpoint's Great New Refrigerator features for 1942 is the Butter Conditioner. But there are many more outstanding features. The slogan 7 + 7 which dominates Hotpoint's new program is more than a mere advertising theme. It typifies the big capacity—7 cu. ft. plus the flexibility of food storage provided—7 zones of food preservation:

- 1. Easy-Clean Speed Freezer.
- 2. Six-way Cold Storage Zone.
- 3. Butter Conditioner.
- 4. Beverage and Big Bottle Zone.
- 5. General Food Storage.
- 6. Measured Humidity for fruits and vegetables.
- 7. Dry Storage for canned goods.

Below are illustrated a few of the basic design essentials to adequate refrigeration. They are found in Hotpoint's new 1942 deluxe models. See your Hotpoint Distributor today for complete details. Edison General Electric Appliance Co., Inc., 5680 West Taylor Street, Chicago, Illinois.



FREEZER—Ice cubes, desserts are frozen in this glistening porcelain, Easy-Clean freezer. Also ample for fast-frozen foods.

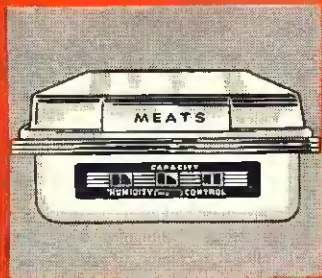

6-WAY COLD STORAGE—Meat storage pan and chiller tray may be arranged in 6 different combinations for preserving meats, desserts, surplus ice cubes, beverages.

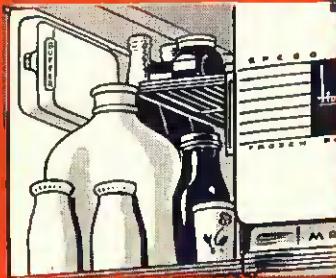

GIANT BOTTLE ZONE—Space for bottles, even full gallon size is provided in the cold zone next to Speed Freezer. Adjustable part-shelf for small-size packaged foods.

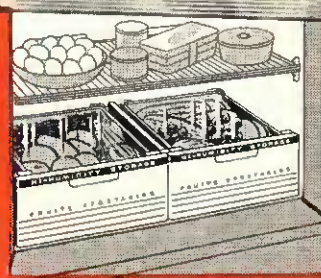

HI-HUMIDITY COMPARTMENT—Provides the proper degree of cold and moisture in proper balance to keep vegetables crisply fresh. Fitted with glass tops, food is always visible.

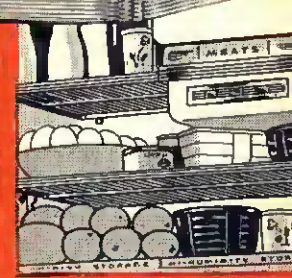

GENERAL FOOD STORAGE—Plenty of shelf space and proper temperature is provided for family left-overs. Sliding shelves with guard rail provide accessibility.

Hotpoint

ELECTRIC REFRIGERATORS

By Every Yardstick—A Great Refrigerator Buy

RANGES • WATER HEATERS • WASHERS AND IRONERS • CLOTHES DRYERS • DISHWASHERS • ELECTRASINK • STEEL KITCHEN CABINETS

Appliance Sales

Wisconsin Dealer Finds a Way to Meet New Credit Regulations



Here's the nifty store where Mr. Johnson does an exceptional business for a town of 500. This photo is used on a snappy postcard, as one of the mailing pieces used to keep his prospects aware of the Johnson stock of new appliances.

• "See us even if you cannot make a down payment," advertises Walter Johnson of the Walter Johnson Co., located at Siren, Wisconsin, a small town of 500 population.

Mr. Johnson, who has a handsome store well stocked with refrigerators and radios, has long had arrangements with local banks whereby the people who lack the necessary down payment for their purchases of appliances, etc., can get the necessary loans on other personal property in order to make a deal. This is a plan that rarely causes any hardship on the purchaser.

Timely Offer

Recently, Mr. Johnson got out a direct mail piece to his customers, which stressed the new government credit regulations. Part of the copy said, "Governmental credit regulations affect only a few items and only require substantial down payments.

You may buy from us, not only on the most liberal payment, but, if necessary, you can obtain cash in the same deal. . . ."

Avenue to Sales

"Almost everyone wants to buy appliances and allied merchandise," says Mr. Johnson, "so I worked out a way whereby the down payment could be arranged, if necessary, through personal property loans. Of course, much business is done for cash and then again some folks have the down payment without a personal property loan needed. However, the easier we can make it for them to buy, and still comply with federal regulations, the more business we'll do. We have still a good stock of merchandise, but may have difficulty later on in getting more appliances."

Sales at this store run about \$55,000 per year says Mr. Johnson. His goal is \$1,000 per week. His staff

consists of a bookkeeper stenographer, a radio service man and one outside man, besides himself.

Mr. Johnson's establishment would do credit to a big city store. It is modern and flashy with fine window display space. It measures 26 by 40 and has a full basement. It also has a radio tower which is used to get better reception for demonstrating radios. Small town or not, Mr. Johnson has shown that a dealer can do a good appliance business in a limited area, provided he has good merchandising ideas to back up good products.

THIS MONTH

in refrigerators

Eight new lines now ready.

Three big appliance shows in Chicago; one in San Francisco.

Service assumes new importance.

Production curtailed 30 to 52%.



Hit War Stride



Crosley's Super-Shelvador DM-942 is an 8.8 cu. ft. job, extra Moist Kold space, cream shelf, 2 freezing shelves.

The Gibson Freezer Shelf F662 model is a 6.73 cu. ft. unit with Strata-Zone food conditioning, etc., priced at \$174.95.

Leader of the Westinghouse line of 6 True-Temps, the Dolly Madison Seven, blue-trimmed.

New Values for 1942... See also next page

Refrigerator execs show two sizes new line of 6 models. There's Moist Master in each size.

Philco's new RH-7 has side-mounted freezer, extra frozen-food space, cold shelf, etc.

The Deluxe Dorie is Hotpoint 7 cu. footer, with butter conditioner, 16-point temperature control.

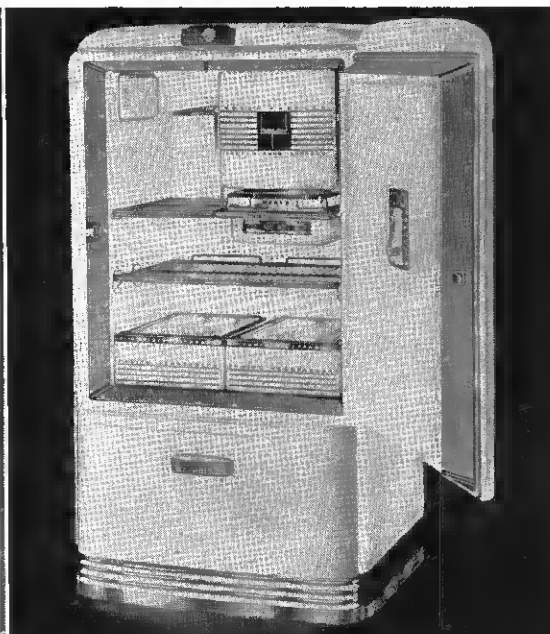
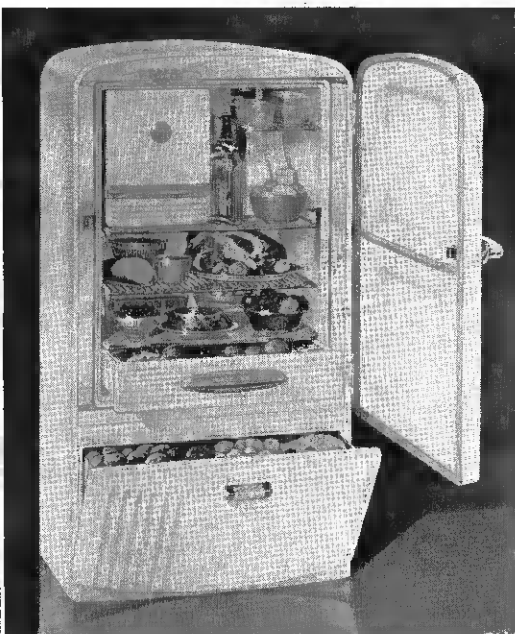
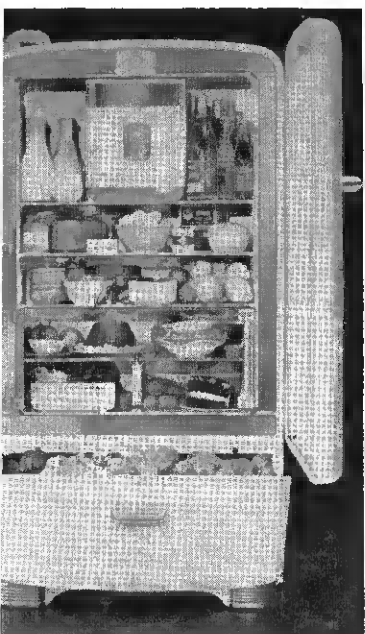

GE Refrigerator Prospects

In a statement on the prospects for refrigerator production this year, A. M. Sweeney, refrigerator section manager for General Electric Co., said that "there never was a time in our refrigerator history when we could look to so many opportunities for new types of refrigeration, new applications, lower costs of operation, and a generally healthy outlook because of our continued research and engineering developments. True enough, these must lay dormant for the duration, but they will be immediately available for a tremendous surge in our business when 'this thing' is over."

Mr. Sweeney advised that "if every distributor and retail outlet will adopt a wise policy of proper consideration of organization and operation in 1942, we feel that even with a seriously curtailed sales volume all can survive and come through this period stronger and better able to meet the sales opportunities of the years before us."

Kelvinator Stars Six New Units

Just introduced by Kelvinator is a 1942 line of six models in price from \$149.95 to \$259.95—four are 7 and two are 9 cu. ft. capacity. The extra size of the units was emphasized by the Kelvinator vice president in charge of sales, Frank R. Pierce, who said that new features and new all-around values were being offered in spite of production restrictions and increased cost.

The company's general sales manager, Charles T. Lawson, pointed out that the big new models have many

"sell-up" features which Kelvinator has consistently emphasized, and that the fewer units in the line will helpfully reduce the dealer's investment. He said that "health protection and safeguard from food losses is more important today than ever before because, with war raging, it is the patriotic duty of Americans to guard and improve their health . . . and to conserve the national food supply."

Kelvinator features five different storage conditions in the two "Moist Master" models and many other refinements; for fundamental features of all models, the firm lists 18 big points. Extra features include a "5-way Magic Shelf" for special convenience in storing awkward items.

Refrigerators to Production Limit

In a statement to RADIO RETAILING TODAY, J. F. Crossin, manager of the refrigeration division for Crosley Corp., says that "up to the allocation made to us by Federal agencies, we are maintaining production and deliveries of 1942 Crosley refrigerators on schedule."

Mr. Crossin declared that "unless prohibited by executive order, we see no reason why we should not maintain both production and delivery constantly up to the limit permitted by the government."

Crosley has brought out a 1942 line of refrigerators, consisting of seven models—one 6-ft. unit, four 7-ft. jobs and two 9-ft. models—all with the Shelvador feature and accenting "Twice as Much Food to the Front Within Easy Reach."



Egmont Arens

FAMOUS DESIGNER

Stylist for
Radio Retailing
Today

The new typographical layout evident in this issue of RADIO RETAILING combined with RADIO TODAY was designed by Egmont Arens, a leading industrial designer. Mr. Arens has had a hand in redesigning many magazines. Among periodicals he has restyled may be mentioned *Creative Art*, Conde Nast's *Vanity Fair* and *Liberty* magazine.

Mr. Arens is design consultant to firms in the food and industrial field, such as Reynolds Metals Company, Hobart Manufacturing Company, Dayton Scales, The Great A&P Tea Company, etc.

Westinghouse Ready With '42 Refrigerators

Emphasizing "new design and engineering techniques" to make thrifty use of vital materials, Westinghouse has announced its 1942 line of refrigerators—a total of six models all with the True-Temp feature. The firm's manager of the household refrigeration department, T. J. Newcomb, declared that in some cases the changes actually provided improved performance.

Four of the units are 7 cu. ft. size, and two are 9 cu. ft. Features include full-size evaporators, new storage bins, re-styled doors, shelves capable of 16 different arrangements, interior trims in color, etc.

Westinghouse informative labels will continue as a feature of the new line.

Two New V.P.'s for Stewart-Warner

Stewart-Warner directors have elected two new vice presidents, Joseph C. Elliff and George L. Meyer. Mr. Elliff came to Stewart-Warner in 1939, after working for 16 years with the Curtis Publishing Co., 11 years as Western manager for *Saturday Evening Post*. As executive vice president, he will continue to serve as assistant general sales manager, at the same time assuming new duties.

Mr. Meyer, a Stewart-Warner employee since the company was founded, has since 1939 been manager of the Stewart Die Casting Co., a subsidiary.

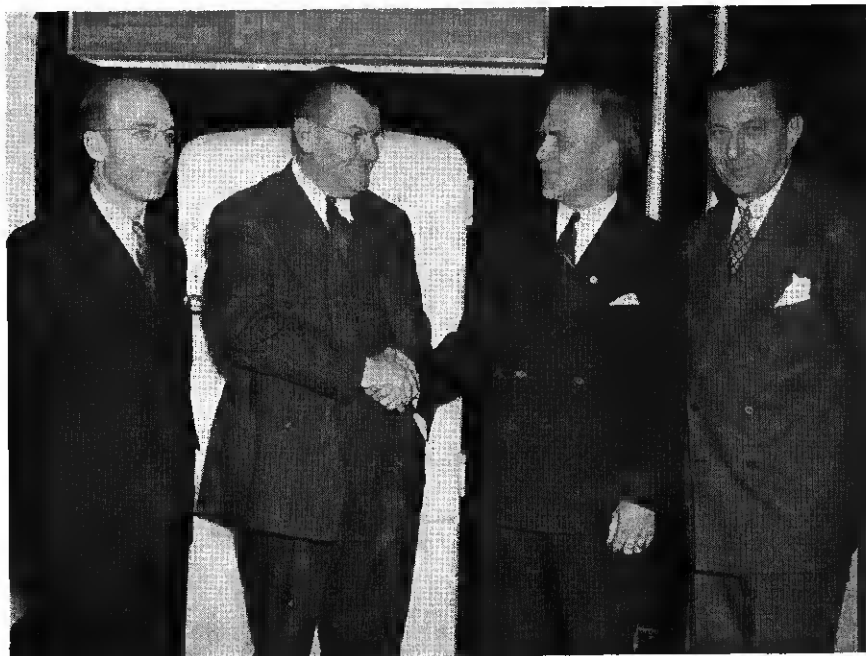

With new lines in background, Philco officials celebrate opening of new quarters of Philco Distributors, Inc., Philadelphia. T. A. Kennally, center left, congratulates Fred Ogilby, head of the jobbing firm; others are James H. Carmine, left, and Hal Sheer.

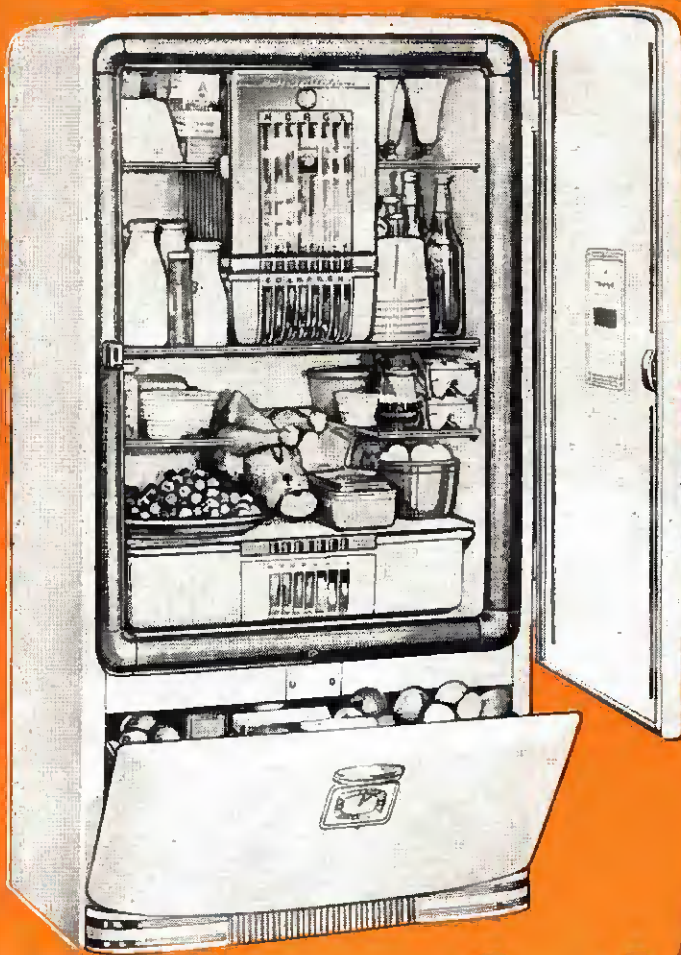

As promised..

NORGE comes through for '42

SALE-MAKER FEATURES

- *Famous Night-Watch Automatic Defrosting
- New Base Leveller Adjusts to Uneven Floors
- New Deeper Coldpack Never Used for Defrosting
- New Deeper Hydrovoirs Fully Glass Covered
- New Use of Plastics Lovelier Interiors
- *Norge has all the other Big Features, too—but only Norge has the Night-Watch

SEE NORGE BEFORE YOU BUY

In recent months Norgé has published a series of advertisements promising to dealers every co-operation and consideration within its power. Swift to back up promise with performance, Norgé now presents the new 1942 version of Norgé Rollator Refrigeration.

Keyed to the market from the dealer's point of view, the new Norgé line presents seven models that cover the demand—planned in a powerful and logical step-up sequence that fits the requirements of modern retail merchandising.

Keyed to the consumer's point of view, this new Norgé line shows brilliant styling, consistently maintained quality, new convenience features, and all the ruggedness, dependability and economy for which Norgé has long been noted. Make no mistake about it—you can depend on Norgé for '42.

NORGE DIVISION • BORG-WARNER CORP. DETROIT

Something Solid to tie to—NORGE

ROLLATOR REFRIGERATION • GAS RANGES • WASHERS
ELECTRIC RANGES • HOME HEATERS • COMMERCIAL REFRIGERATION





DR. O. H. CALDWELL
Editor, Radio Retailing Today

“RADIO MAGIC”

FRIDAYS, 7:15 EST

• This week, Radio Magic's 109th program, Jan. 16, will discuss "Radio's Expanding Role," reporting the IRE convention at New York City, with convention chairman I. S. Coggeshall as guest commentator.

Jan. 23—"Radio Static, Its Cause and Cure."

Jan. 23—"Radio Tube Devices in Army Camps."

Feb. 6—"Music Speeds the National Effort."

Feb. 13—"Automobile Radio in '42."

Feb. 20—"Little-Known Radio Inventors."

Feb. 27—"Radio-tube Devices and Health."

These Radio Magic programs, designed to inform the public about radio and their own radio sets, are conducted by Editor Caldwell of RADIO RETAILING TODAY over WJZ and the Blue network of NBC every Friday evening at 7:15 p.m. EST (6:15 CST). Through recordings, Pacific Coast stations fit Radio Magic into their own evening programs.

During each program, Editor Caldwell explains how listeners can get best reception from their own sets, by simple precautions relating to antennas, tubes, and repairs with the assistance of local radio servicemen.

War's Impact on Biz

(Continued from page 19)

tained in motion, and in balance as to proper ratio. Your "liquid" position must be maintained and your "cash" situation should be improved if possible—certainly should not be allowed to deteriorate.

And "expense" must be watched like a hawk—to make sure that a series of minor increases does not add up to a total greater than your margin will allow.

By the same token, gross margin must be watched—and maintained in certain ratio to rising expense if your business is to be kept solvent—and going.

The service or repair department is taking on a new and greater importance, too, as new-set sales fall off.

Many dealers are already using young women in their sales force, but the service department requires men—and trained men, too. Such trained men as you may now have, though exempt from Army service under pre-

vious rulings, may soon be required to render a service to their country of more importance than fixing a broadcast listener's radio. Servicemen—that is good servicemen—are soon going to be hard to find, and hard to keep. Already many dealers are using part-time servicemen. Trained men who are engaged in a war industry, on an 8-hour shift—and are willing to work another 4 or 6 hours day for the larger income involved. It's a good idea to know of several such men, for the time may not be so far away when few, if any, servicemen will be available to the radio dealer on a full time basis.

Those Extra Lines

Many dealers are now giving more attention to other lines of radio than home broadcast receivers, and are finding conditions a little different than they are accustomed to.

Sound installations for industry—to provide music for the workers and a means of giving instructions to everyone at once, are profitable jobs.

Many a dealer who has long turned his back on "sound" is now doing a fine job on these industrial installations.

Phonograph records are being "taken on" by more and more of the smart dealers.

Many such dealers who have added records during the last year now report they are "paying the rent" with record sales.

Why every radio-dealer who sells phonographs—and combinations—does not sell records too, is a question no merchandiser has ever satisfactorily answered. They go together like "ham and eggs" and properly so. You're overlooking something to your real interest if you do not take on records to complement your combinations, and "pay the rent."

When you're wondering where your sales force is going to come from, when John and Bill are in uniform, give real thought to the use of young women, or even married women on a part-time basis, as many dealers are doing. Some dealers report find results—some only fair to good—but that's true of men, too, probably is true of your own crew, and may be due as much to the "boss" as to the salespeople, too.

Keep 'Em Selling

Viewpoint—your own viewpoint—is now more important than you think. To a large degree, your associates will reflect your views, your actions, your leadership. Only to a lesser degree, will your customers be affected by your enthusiasm, and your optimism.

These are not times to complain. Rather these are times when we must all give our best thought, and our best effort to our work. The work of the radio dealers is to keep this business running profitably—serving his customers well, in spite of any "war-born" problems.

This must and can be done—if each of us looks our own problems squarely in the eye—and thinks clearly and hard, about it.

And then has the courage to put his thoughts into action.

But make no mistake about it, dealers who drift, who will "wait and see" are going to be terribly surprised when the problems they refused to think about, catch up with them. These war-time problems are present all over the country.

PHILCO

For the Service of Our Armed Forces

THE one driving force behind the heart, mind and sinews of America today is . . . *Victory!*

Victory for what? For freedom . . . for the happiness, security and safety of our families . . . for the American way of life.

To that happy end, the facilities of Philco, with all its laboratories, equipment and skilled personnel, are at the disposal of the government in as great a portion as the nation may require. ★ ★ ★

Another pledge we make to the far-flung Philco family . . . the distributors, dealers and salesmen who have lived and prospered through the products of Philco manufacture.

We started together and moved on to radio leadership . . . *in a depression!* Philco looked at hard times as a *problem in merchandising*. With the ingenuity of its engineers and the energy of its sales organization, it gave you merchandise and promotion that matched the spirit of the times and brought you the means of profit in the midst of adversity. That's when you learned that it is vital to be with Philco when the going is rough!

Good times came. And with them you shared in the full flowering of Philco leadership. With in-

genious engineering, alert merchandising and aggressive advertising you saw Philco branch out into new fields . . . you witnessed the birth and growth of "*Philco All Year 'Round*" with radio, refrigeration, air-conditioning, auto radio, tubes, batteries, parts and accessories . . . the most valuable all year 'round franchise in the appliance field! In these years, you learned that in smooth going, too, the Philco pace is fast . . . and profitable!

And now, WAR has come. Life goes on, though its very meaning and purpose have changed . . . each of us is united in an all out effort that our armed forces may "win through to victory." We have confidence in that victory and faith in the survival of the American Way.

While we are consumed at Philco in how we may help to implement our armed forces, we do not forget that life must go on at home to make America strong in battle . . . we do not forget our obligation to the thousands over the years who have depended upon Philco for their livelihoods. So in these days, again, you may look to the strength, stability and ingenuity of Philco to bring you, within the limits of the nation's war effort, the means to carry on.

This our pledge: *Our country first!* And, with constant vigilance for the obligations of leadership, we will be ready for the peaceful days of the future.

*For the Service of our Philco Dealers,
"the means to carry on, within the
limits of the nation's war effort..."*

Philco All Year 'Round

Dealers of America in Every

PHILCO All Year 'Round brings to the appliance dealer a *diversified* merchandising program that serves the buying needs of the public in every selling season of the year.

For Fall, Winter, Spring and Summer it brings you the merchandise, sales plans, advertising and promotion you need to flatten out the peaks and valleys and to make your business a year 'round source of profit.

This All Year 'Round activity in manufacturing and merchandising carries with it a responsibility and obligation which Philco does not fail to recognize. Hundreds, yes, thousands of appliance dealers now look to Philco products and Philco promotion for the major part of their yearly selling plans.

Today, Philco's engineering and productive capacity is available first to the service of our armed forces. But in the war economy of the nation, civilian life goes on. Eighteen men work at home, so the estimates say, to equip a single man in the field. While the government plans for the strength of our fighting forces, it plans as well for the welfare of those eighteen men and their families.

In so far as the nation's all out war effort continues to provide for the production of civilian goods, the appliance dealers of America may look to Philco again, in its diversified All Year 'Round program, as the greatest single source of supply, the greatest hope for "the means to carry on."

Now, for the spring of 1942, Philco offers you merchandise you can sell and promote today, tomorrow, next week and next month in all divisions of the Philco All Year 'Round program.

RADIO-PHONOGRAPHS



Music on a Beam of Light . . . the new Philco Automatic Record-Changer . . . Stroboscope Pitch and Tempo Control . . . the Tilt Front Cabinet . . . perfected Home Recording . . . these great inventions from the Philco laboratories have *revolutionized* the radio-phonograph. They have made Philco the overwhelming leader in radio-phonograph sales. They are an important part of the all year 'round program your Philco distributor has ready for you *now*.

RADIOS

Philco brings you, for the Spring, a complete selection of radio models to sell . . . consoles, table models and portables. Outstanding values in every price bracket and a complete line to meet the needs and purse of every buyer . . . giving you the merchandise you need to make your Spring selling and promotion *productive*. Your Philco distributor is ready now with new selling plans and promotions, ready to help you apply the power of the Philco All Year 'Round Program to your sales campaign for the Spring.

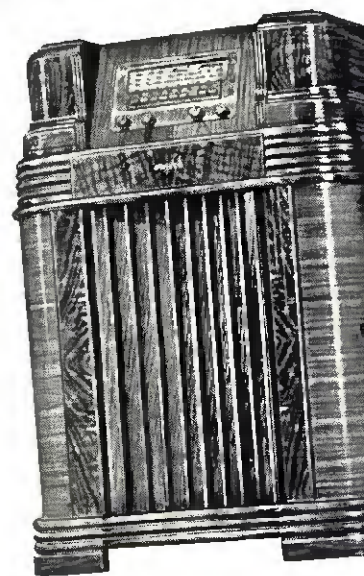

... and gives you the means to carry on

Philco serves the Appliance Selling Season of the Year

REFRIGERATORS

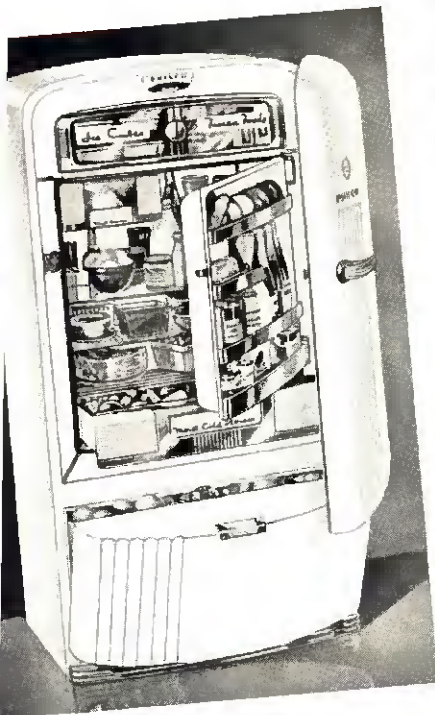

Your Philco distributor has the new Philco Refrigerators on hand for Spring selling. They bring you new beauty and the new features of Advanced Design that have brought Philco to the forefront of the industry. And they bring you that quality and dependability in manufacture that is the guarantee of years of reliable service and satisfaction. These new Philco Refrigerators are an important part of the Philco All Year 'Round program that your Philco distributor has ready to discuss with you for Spring selling.

AIR CONDITIONERS

With Philco-York single room air conditioners, Philco leadership in appliance merchandising has taken the lead again in developing an important new industry. Last year, Philco sales of air conditioners exceeded those of all other makes combined. For the selling season of 1942, Philco offers new models of the Philco-York Air Conditioner as part of its All Year 'Round plans.



AUTO RADIOS



With the growing importance of radio as a means of information and defense as well as entertainment, the public realizes today that a radio in the car is as important as a radio in the home. Philco offers for 1942 a complete line of automobile radios for any car and at prices for every purse. As the world's leading manufacturer of automobile radios, Philco offers you in this line the utmost in tone, performance and value at every price.

REPLACEMENT TUBES

To keep the nation's radios playing, Philco Replacement Tubes occupy a place of ever increasing importance. Move your tube department "up front" . . . and feature Philco Tubes! They fit any make of radio and positively improve performance.



BATTERIES, PARTS AND ACCESSORIES

"Keep them playing!" The 55 million radio sets of the country must be kept in repair. Your Philco distributor is ready to equip your service department for this bigger, more important job. Parts, accessories, batteries, equipment, made by Philco with the quality that enables you to do every job with an unqualified guarantee of satisfaction.

Philco in Advertising and Promotion --

Today, more than ever, PHILCO offers you the most valuable franchise in the appliance field!

**PHILCO
ADVERTISING
AND PROMOTION
CONTINUES
ALL YEAR 'ROUND**

The Philco advertising campaign, which has backed the sales efforts of Philco dealers month after month and year after year, continues without interruption.

Featured by full color pages in the leading weekly publications, the Philco national advertising campaign is appearing on regular schedule in the following magazines:

SATURDAY EVENING POST
COLLIER'S
LIFE
LIBERTY
TIME
NEWSWEEK
AMERICAN MAGAZINE
LADIES' HOME JOURNAL
WOMAN'S HOME COMPANION
BETTER HOMES AND GARDENS
TRUE STORY
RED BOOK
COSMOPOLITAN
NATIONAL GEOGRAPHIC
NEW YORKER
MOVIE-RADIO GUIDE

And in addition, Philco advertising continues in local newspapers and over the air on more than 225 broadcasting stations.



Each year, each new set of circumstances has demonstrated the strength and the value of the Philco All Year 'Round franchise. Today, with an overall reduction in manufacture for civilian use, its value is clearer than ever.

A variety of quality products, today, share the public acceptance of the Philco name. Together they form a year 'round sales program that enables Philco to continue to offer you merchandise and to continue its advertising and promotion. New evidence, for today and for the future, that Philco All Year 'Round is the most valuable franchise in the appliance field.

See your Philco distributor and make your plans now for the Spring. He is ready to discuss merchandising sales plans and promotional activities that will enable you to *buy more Defense Bonds in 1942!*

PHILCO
All Year 'Round

New Products



WELTRONIC "TRANS-CEIVER" a 4-pound radio telephone receiver and transmitter having the appearance of a large "French" telephone. Built-in battery power supply. Provided with on and off switches and finger operated selector to change from transmitting to receiving and vice versa. Designed for operation on a single wavelength it is adjustable, however, from 112-300 mc. through screw adjustment. Detachable, adjustable short fishpole aerial. Weltronic Corp., E. Outer Drive, Detroit, Mich.—RRT.



IRC POSITIVE CONTACT BAND now supplied on wire wound resistors of 25 watts and up. Consists of a silver contact button on stainless steel spring. Bands are available separately in 9/16 in., 3/4 in. and 1 1/8 in. diameters. International Resistance Company, 401 N. Broad St., Philadelphia, Pa.

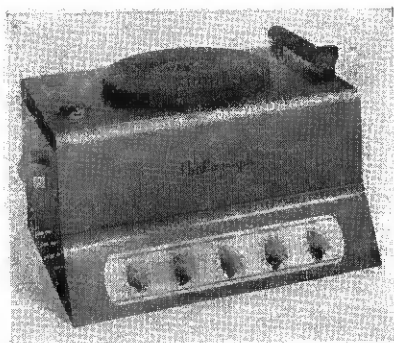

AUDIOGRAPH 35-WATT AMPLIFIER, model B-35C, may be installed as part of permanent p.a. system or with 2 speakers mounted in portable carrying case. Full 35-w. with less than 5 per cent harmonic distortion. Flat response within 1.5 db. from 50 to 8000 cycles. Output impedances—2, 4, 8, 166, 250 and 500 ohms available at convenient terminal board. John Meck Industries, 1313 W. Randolph St., Chicago, Ill.—RRT.



SHURE BROADCAST MIKE, a "Super-Cardioid" unidirectional dynamic microphone "556," has a wide-angle front pick-up. Wide range frequency response from 40 to 10,000 cycles. Patented Shure "Uni-phase" single unit construction. Available in 3 models—556A for 35-50 ohm circuits, 556B for 200-250 ohms; 556C, high impedance. \$75. Shure Bros., 225 W. Huron St., Chicago, Ill.—RRT.

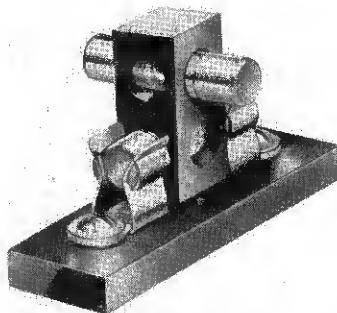

LITTELFUSE SPARE FUSE HOLDER & PULLER applicable to all 4 AG and 5 AG fuses. The fuse in circuit goes through one end of the soft rubber rectangular holder, above is an opening for the spare fuse. One end of the holder is red, and indicates that a fuse has blown and another spare is required. Littelfuse, Inc., 4997 Ravenswood Ave., Chicago, Ill.—RRT.

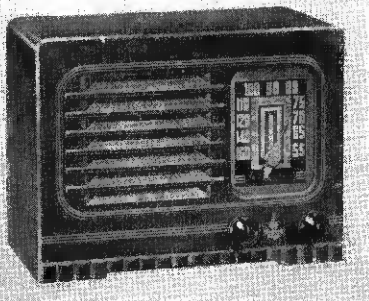

EMERSON MODEL 461, a simulated leather cabinet houses the 5-tube superheterodyne ac-dc table set. It features built-in super loop, connection for external antenna, automatic volume control, beam power output and large electro dynamic speaker. Emerson Radio & Phono. Corp., 111 Eighth Avenue, New York, N.Y.—RRT.



STROMBERG-CARLSON HOME RECORDING KIT may be installed on six of company's 900 series and with slight adaptations on six of the 500 series. Kit includes microphone, control box and cable assembly, cutting head complete with drive mechanism, cutting arm rest and mounting screw, recording needle and installation and operating instructions. Eastern price, \$47.50; southeast and western price, \$51.50. Stromberg-Carlson Tel. Mfg. Co., Rochester, N. Y.—RRT.

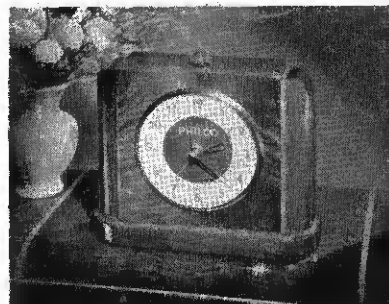

PHILCO AUTOMATIC RADIO-CLOCK which switches on a radio set automatically. All that's necessary is to tune the radio to the station wanted and set the clock. This timepiece is self-starting electric clock in a walnut case with polished gold finish bead. Philco Corp., Tioga & C Sts., Philadelphia, Pa.—RRT.

KNIGHT "JIFFY" P.A. SYSTEM includes a 30-watt amplifier with phono top and tubes, two 12 inch Safused dynamic speakers, one Shure "Uniplex" low-feedback mike, 1 takedown stand 2 tripod stands, and a compact portable case. Allied Radio Corp., 833 W. Jackson Blvd., Chicago, Ill.—RRT.

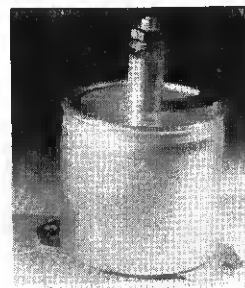

AEROVOX TRANSMITTING CAPACITOR for fixed tuning, by-passing, blocking, coupling and neutralizing. Losses are extremely low. Case is grounded and single high-tension terminal is used. Available in .00001 and .000025 mfd. at 10,000 volts and .00005 mfd. in 5,000 volts. Aerovox Corp., New Bedford, Mass.—RRT.

Each small Sapphire Point used in the cartridge assembly for Astatic's Low Pressure Crystal Pickups, is subjected to microscopic examination to assure its suitability to meet Astatic's exacting standards. Only those parts that "measure up" are ever used in Astatic products.



Good IS NOT ENOUGH!

● The high operating efficiency and long dependable service of Astatic Crystal Microphones, Pickups, Cartridges and Recording Heads are a result of the exacting care and precision exercised in their manufacture. Astatic employees, long experienced in assembling the many small and often fragile parts entering into these products, show amazing skill and accuracy in these operations. Constant supervision and testing provide an additional safeguard. No crystal microphone, pickup or other product ever leaves Astatic's shipping rooms before it has been tested and approved to meet established laboratory standards of operating efficiency. Good is not enough. Astatic constantly strives for perfection.

ASTATIC

THE ASTATIC CORPORATION

YOUNGSTOWN, OHIO

Licensed Under Brush
Development Co. Patents

In Canada:
Canadian Astatic Ltd.
Toronto, Ontario



The kind of record business they do in Kentucky, at Louisville Radio & Refrig. Sales Co.

RECORD RUSH this year

***"Make Every Sale a Combination" Is Continuing Slogan for '42,
as Record Sales Hit New Peaks***

• The importance of phonograph records got the spotlight again when the year closed and it was found that the total sales for 1941 amounted to 117,000,000 discs. The year before, the industry had celebrated a total of 75,000,000.

Apparently the public interest in recorded music continues to sweep ahead with a wallop big enough to change the profit status of many a radio dealer. A lot of the retailers do not know the national total on records, and they may not greatly care; they do know that the folks in their community are buying the discs in exceptionally strong volume.

A Sound Proposition

And as they take stock at the beginning of the new year, they are made to realize that here is a flourishing year 'round business in which the suppliers are filling orders in war time. A business, as one dealer puts it, "with no service headaches, no time-payment problems, and no price-cutting to speak of." And best of all, the public seems to have a sustained appetite for the merchandise. To this extent: records sold in '41 were worth \$51,000,000.

Accompanying the brisk business in "private music" is an impressive increase in the number of combinations sold during the last year. These units added up to 1,700,000, which doesn't lack much of being double the 900,000 total for 1940. There's a trend to remember.

Plenty of Players

Noting this new figure on annual sales of phonograph-radios, it can be estimated that the total number of record-playing instruments in use is now up to 6,500,000, including the combos. Six and a half million instruments into which the record retailers must aggressively start to feed new discs!

This job is a big and profitable one, and it is the belief of this magazine that all the helpful ideas and methods in selling records in 1942 should be more fully offered to the dealers. For that reason this new section of the magazine is launched, to gather and to interpret national trends among retailers of all brands of records, and to make exclusive reports on the real profit factors this year.

Mail Job on Records

Tips on How to Improve the Promotion Pieces You Send Out

• The woods are full of record retailers who, when they think of extra sales production on records, instantly think of new direct mail pieces for their prospects. It is one of the eminently favorite methods for getting more business.

Herewith are a number of suggestions on how to make the mailings more effective. Obviously a retailer cannot adopt all of them. The list is made up of tips supplied by a num-

ber of dealers, and will serve as a reminder of the *many* ways that mail programs may be improved.

1. Stuff in an occasional flyer on the subject of record-playing accessories (needles, pick-ups, racks, etc.)
2. Try a *series* of mailers, in a style that will make the prospect learn to watch for the next one.
3. Don't be afraid to send serious musical literature to the right people, even if the material looks dull and long-winded to you.
4. Write to your prospects occasionally when you have nothing at all to sell, except good will.
5. Try a mailer which reports on the sales of certain records in your area. Most folks are interested in local hits.
6. Combine your record announcements with news on new record-playing instruments, whenever it's appropriate.
7. Send out announcements of exceptional hits as a matter of information.
8. Tie up some of your mailers with news events.
9. Once in a while, get clear off the beaten track—send out telegrams, trial records, store-recorded excerpts, etc.

Sales Hypo

10. Work with your local theatre manager on mailing ideas to use during showing of musical pictures.
11. Maintain a bulletin service which ties in with broadcasts of special musical significance.
12. Keep careful tab on which of your mailings are a success; don't repeat the devices that don't seem to work in your area.
13. Be sure to let all your old customers know about any special offer, or new prices coming up.
14. Shift the emphasis, at times, from *what* records to buy, to *how* all discs can be comfortably and conveniently heard in your store.
15. Be sure to include some pieces which encourage people to start or maintain record libraries.
16. Make use of some mailers which indicate that the prospect should re-

ply to the store, either by answering a question, or by indicating musical preferences.

17. Personalize your material by using the names of your record salesmen whenever you can.
18. Establish the custom of using some trade mark or photo which may help people to visualize your address or your service.
19. Get a line of what *other* record advertising your customers are getting in their mail, so that you can gear your pieces accordingly.
20. Keep a schedule of national ads on records, currently running, before you when you shape your direct mail plans.

"Keep 'Em Flying!"

To help the U.S. Army Recruiting Service in its drive to enlist 30,000 men for service as bombardiers, navigators and pilots in the U.S. Army Air Corps, Columbia Recording Corp. has released a special record of the song, "Keep 'Em Flying!" by Gene Krupa and his orchestra. The song, written by William Coleman of the War Department, and recorded on the Okeh

(Continued on page 48)

Best Selling Records

Popular

CHATTANOOGA CHOO CHOO—Glenn Miller on Bluebird 11230.

PIANO CONCERTO—Freddie Martin on Bluebird 11211.

ELMER'S TUNE—Glenn Miller on Bluebird 11274.

THIS IS NO LAUGHING MATTER—Charlie Spivak on Okeh 6458.

THIS LOVE OF MINE—Tommy Dorsey on Victor 27508.

TONITE WE LOVE—Tony Martin on Decca 3988.

SHEPHERD SERENADE—Bing Crosby on Decca 4065 and Horace Heidt on Columbia 36370.

WHISTLER'S MOTHER IN LAW—Bing Crosby on Decca 3971.

JIM—Dinah Shore on Bluebird 11204 and Jimmy Dorsey on Decca 3963.

YOU MADE ME LOVE YOU—Harry James on Columbia 36296.

SHRINE OF ST. CECILIA—Vaughn Monroe on Bluebird 11344.

HUMPTY DUMPTY HEART—Glenn Miller on Bluebird 11369 and Bing Crosby on Decca 4064.

LET'S GO HOME—Charlie Spivak on Okeh 6366.

I DON'T WANT TO SET THE WORLD ON FIRE—Tommy Tucker on Okeh 6320 and Horace Heidt on Columbia 36295.

CLEMENTINE—Bing Crosby on Decca 4033.

Coming up

REMEMBER PEARL HARBOR—Sammy Kaye on Victor 27738.

WHITE CLIFFS OF DOVER—Glenn Miller on Bluebird 11307.

I SAID NO—Alvino Rey on Bluebird 11391.

STRING OF PEARLS—Glenn Miller on Bluebird 11382.

ROSE O'DAY—Freddie Martin on Bluebird 11286.

EVERYTHING I LOVE—Glenn Miller on Bluebird 11365.

ON THE STREET OF REGRET—Vaughn Monroe on Bluebird 11411.

DEAR MOM—Kate Smith on Columbia 36489.

BLUES IN THE NIGHT—Woody Herman on Decca 4030.

STARDREAMS (Theme Song)—Charlie Spivak on Okeh 6546.

(These lists specially prepared for RADIO RETAILING TODAY by Alex A. Gettlin, publisher of "Recordaid")

Disc Display



Above, a smart string of 10 record rooms at Frederick & Nelson's, Seattle. Below, new "combination" room with collapsible partition, Hockett-Cowan Music Co., Fresno.



Directly below, a close-up of sound-proofing and style in Castellanos-Mollan Corp.'s booths, NYC. Lower left, counter self-service at Whittles Music Co., Dallas.



Above you see an important element of record showrooms—the newest in combinations. This is Victor's V-215, with "Roll-Out" feature, Magic Tone Cell, Jewel-Lite scanner, etc. Below, a "Record Bar" out front invites customers at Mass Bros., Inc., Tampa, Fla.



Replace
with the
Best!

ALLIANCE "EVEN-SPEED" PHONO-MOTORS

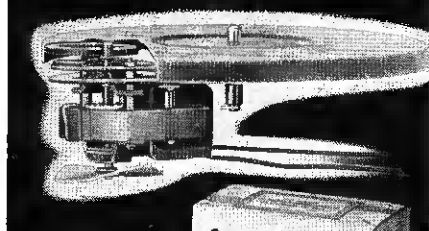

INDIVIDUALLY
PACKAGED



EASY TO INSTALL... Fit 95% of all makes

● The low cost and quick, easy installation of "Even-Speed" Motors make it more practical and profitable to replace the entire unit when trouble occurs than to attempt what may prove to be a difficult repair job. The "Even-Speed" line of only four phono-motors provides a unit for 95% of all replacement requirements. Carry a few in stock for every month will bring a greater demand for replacements.

Each motor and turntable comes in an attractive carton for your greater convenience.

Ask your jobber or mail a postcard today for complete information and low prices on the "Even-Speed" line of phono-motors.

Export Dept.: 377-379 Broadway, New York City

ALLIANCE MFG. CO.
ALLIANCE, OHIO

Research in Phonograph Mechanisms

In reviewing Philco's progress during the past year, Thomas A. Kennally, vice president of Philco Corporation, credited engineering and research as being two of the most important factors.

"Philco made its first real bid for radio-combination business in 1939. The following year our engineering department brought out a revolutionary development—the photo-electric tone arm. 'Music on a Beam of Light' offered tremendous advantages over the then standard steel needle, and the public was quick in its appreciation of the vastly improved tone, the long record life and elimination of the needle nuisance, made possible by this sensational innovation.

"In 1941 Philco engineers followed up the photo-electric tone arm with an entirely new automatic record changer that not only handled records more gently and surely but incorporated a stroboscope for absolute control of pitch and tempo."

Philco maintains one of the world's largest research laboratories for the development of the radio, phonograph, and television arts. Many of the company's scientists are now engaged in research work for the Government.

Colorful Slav Records by Sonart

A group of recordings of "Southern Slav" songs and dances, recorded by well known artists, are being marketed by Sonart Record Co., 251 W. 42nd St., New York City. This music is Serbian, Croatian and Slovenian, and features an instrument called the "tamburitza," a favorite stringed instrument of the Yugoslavs.

There's an album of three records made by the Duquesne University Tamburitza Orchestra (M-2), and other single records by baritone stars, choral groups and guitarists. The album is \$2.75 and the 10-inch single discs are 75 cents each.

The Sonart records have a lot of spirit, color and interest. They will come as a genuinely pleasant surprise to many record fans.

"Keep 'Em Flying!"

(Continued from page 46)

label, has been sent to 1,500 radio stations throughout the U.S. Records also went to the Red, White and Blue Radio Network, composed of radio stations located adjacent to army encampments.

Working with the War Department Columbia has launched a drive among retail record shops and coin phonograph operators to promote the tune. Special mailings to thousands of dealers and operators are being sent out by the War Department, urging them to feature the recording.

"Naturals" FOR 1942

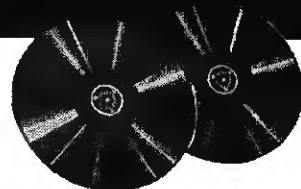

NEW, LOW-PRICED audiodiscs IN BIG DEMAND

NOW—push Blue Label Audiodiscs for faster turnover and profits! Here is America's stand-out line for schools, home recordists and others seeking the best possible disc at lowest cost. Audio plus-features give you a tremendous selling edge. Push the whole Audio line—and fill those sales gaps in 1942!

Blue Label Audiodiscs have Audio's professional coating on both sides of a steel base. These high quality blanks are 6", 8" and 10" in diameter—at low list prices of 30c, 40c and 55c!

Yellow Label Audiodiscs, famous 4-hole glass base type, are increasingly popular too. Amazing durability, and a flawless surface make them the favorite of recordists everywhere. Coated on both sides, these easy-to-use blanks are 10", 12" and 16" diameter with glass base; 6", 8", 10" and 12" with steel base. List prices range from 40c to \$2.00.

AUDIODISCS in attractive, easy-to-merchant-disc packages, are front-counter "naturals" with a multitude of talking points. Audio's exclusive coating formula and process guarantee uniformity—mean better thread action, lower surface noise, longer playback life, and complete freedom from deterioration.

This Complete Handbook Boosts Audiodisc Sales



"How to Make Good Recordings", 128 pages of practical and enjoyable instruction, covers all phases of recording equipment, materials and technique. Profusely illustrated, it is written in non-technical language that anyone can understand. Feature this authoritative handbook—and boost the demand for Audiodiscs and Audiopoints. Now in its third printing, list price... only \$1.25.

audiopoints for recording and playback excellence

Sell Audiopoints for every recording and playback need. Precision manufactured—scientifically tested under actual operating conditions—these quality Audiopoints insure better-satisfied customers and constant repeat business. Attractive packaging is an important self-selling feature. Display the complete line of Sapphire, Stellite and Steel Audiopoints and Audio Reproducing Needles for faster turnover, greater profit. List prices range all the way from 75 for 10c to \$7 each.

★ ★ ★ Audio's in khaki too, supplying the United States Army, Navy and F.B.I. However, facilities have been expanded to maintain normal trade deliveries. So don't delay! Check Audio's triple-profit line with your jobber, or write us direct, TODAY.

AUDIO DEVICES

INCORPORATED
1600 BROADWAY NEW YORK CITY

Self Service Display for Your Albums

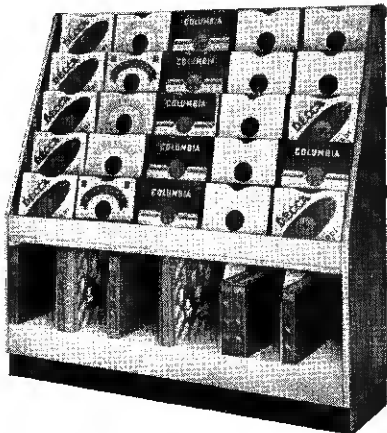

A new display unit for record albums, streamlined for center-aisle or wall use, has been announced by the A. Bitter Construction Corp., 27-01 Bridge Plaza, N., Long Island City, makers of the patented "Record Bar" and other record selling equipment. This "Self Service" job has room for some 300 records displayed on slanting surfaces, and 16 albums on the upright part; storage space takes care of 500 records or 75 albums.

Compactness is featured here—the unit occupies 5 ft. of floor space, and is 58 inches tall (low enough to be looked over when used in center aisle). There's space on top and sides for display material.

Classic and Imperial Record Firms Merge

A merger of two record companies, the Classic Record Co. and the Imperial Record Co., has been announced. The new firm will take the name of the former and will have national distribution through some 70 jobbers, with headquarters in Pittsburgh, Scranton, Pa., and New York City.

Classic will now feature popular records at 35c, with the "Elite" label and such well known orchestras as Vincent Lopez, Bunny Berigan and Blue Barron. A classical line of discs will be called "Concertone," also starting with a number of leading artists.

Eli E. Oberstein, widely known record sales executive, will head the N.Y. office at 2 W. 46th St., and will direct all recording activities; A. E. Middleman will manage sales from the Pittsburgh office at 524 Penn Ave.

Record Catalog Out

The second edition of Victor's popular record catalog is now ready. Following the sell-out of the first edition, the book was revised to include the newest record releases, and is now off the press. It is a convenient and streamlined listing of only the Victor and Bluebird popular numbers.

PRESTO RECORDERS SPEED DEFENSE PRODUCTION

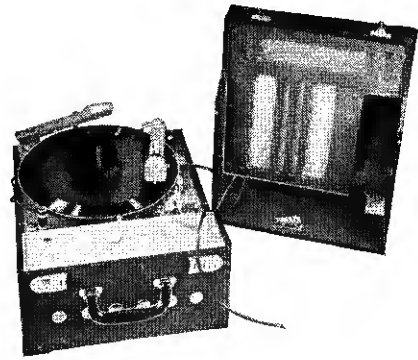

Presto recorders are now being used to help lick the toughest problem in any factory today... breaking-in new men. Recordings explaining new processes, new assembly and testing methods multiply the efficiency of instructors a hundred-fold. Presto recordings of mechanical noises in motors and machinery are used to teach workers quickly to identify faulty parts or adjustments. Recordings of orders, instructions, reports, sent over private wires from offices to plants speed the use of vital telephone facilities, help eliminate costly errors.

Presto recordings reproduce speaking voices so naturally that they identify each speaker beyond question, give a lifelike re-enactment of conferences and interviews.

These are but a few uses made of the Presto recorder by such companies as United Aircraft Corp., General Motors Co., Mack Truck Co., Armstrong Cork Co., as well as various government departments. For the complete story send for booklet entitled "Industrial Uses of the Presto Recorder." Mailed free on request.

PRESTO RECORDING CORP. 242 WEST 55th ST. N.Y.

In Other Cities, Phone... ATLANTA, Jack. 4372 • BOSTON, Bel. 4510
CHICAGO, Har. 4240 • CLEVELAND, Mo. 1565 • DALLAS, 37093 • DENVER, Ch. 4277 • DETROIT, Univ. 1-0180 • HOLLYWOOD, Hil. 9133 • KANSAS CITY, Vic. 4631 • MINNEAPOLIS, Atlantic 4216 • MONTREAL, Wel. 4218
PHILADELPHIA, Penny. 0542 • ROCHESTER, Col. 5548 • SAN FRANCISCO, Yu. 0231 • SEATTLE, Sen. 2560 • WASHINGTON, D. C., Shep. 4007

World's Largest Manufacturers of Instantaneous Sound Recording Equipment and Discs

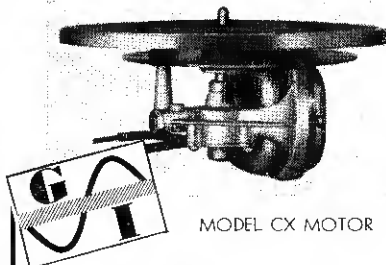

MODEL CX MOTOR

"Smooth Power"
PHONOGRAPH MOTORS
AUTOMATIC RECORD CHANGERS
RECORDING ASSEMBLIES

The GENERAL INDUSTRIES CO.
DEPT. 15, ELYRIA, OHIO

G. I. "Smooth Power" Keeps Them Playing

BUILT for service—famous for it—General Industries "Smooth Power" phonograph equipment is America's stand-by make to "keep them playing" for the duration. Made in the world's largest phonograph motor plant. Backed by 40 years of General Industries leadership in the development and production of electrical equipment. Wherever called on, if it's G. I. it will give service.

Write Today for Latest Catalog

Order Cutting and Play-back Needles from our affiliate, General Phonograph Mfg. Co., Inc., Putnam, Conn.



As Advertised in . . .
the Ladies Home Journal and 10 other magazines



NEW YEAR'S WISHES
for the **WHOLE YEAR.**

No matter how you dress it up . . . no matter how simple . . . it's the spirit behind the wish that counts . . . so we extend, from way down deep our best 1942 wishes to you. And too, we make this resolution "to continue to serve you at our best", and plentifully with your Recoton Phoneneedle requirements.

RECOTON CORPORATION, LONG ISLAND CITY, N. Y.

RECOTON
phoneneedles



BUY U. S. DEFENSE BONDS APLENTY

Upswing in Columbia Record Sales

Sales of Columbia Masterworks, Columbia popular, Okeh popular, and Country Dance records were up 70% for the year 1941, over 1940, it was revealed by the Columbia Recording Corp. president Edward Wallerstein, in a recent statement. The firm now has the greatest volume of orders in its history, Mr. Wallerstein reported, with CRC plants in Bridgeport and Hollywood working around the clock to fill consumer demands.

The increase was noted in all types of records, but notably in Masterworks. In accounting for the rise, the Columbia head cited many factors in the company's policies, such as dramatic reductions in prices, improvement in recording quality, the consistent presentation of orchestras and artists who represent real quality, and the development of younger bands and bandleaders along with the established top artists in the popular field.

Cash Prizes for Jobber Salesmen

Jobber salesmen for RCA Victor now have a chance to suggest ideas for the series of humorous cartoon ads now running in the *New Yorker* and other magazines. Successful ideas get an award of \$10 plus a \$25 Defense Bond, and the best-in-contest gets an extra \$50 bond.

This series of ads is the highly successful one which features the work of famed cartoonists such as Robert Taylor, Barbara Shermund, etc., and is built around the Magic Brain which plays both sides of a record without turning it over.

Needle Deliveries OK

Reports from Recoton Corp., 21-10 49th Ave., Long Island City, N. Y., are that war-time conditions are not expected to interrupt deliveries of the company's Phoneneedles. Officials say that they anticipated requirements of the emergency period and warehoused large quantities of the needles, so that regular deliveries may be made now. Also, shipments of Recoton's supplies are coming through regularly.

Catalog Contest Winners

The 512 merchandise prizes offered by RCA Victor in its "I Like the Victor Record Catalog Because . . ." are now being awarded to those who wrote the best 50-word completions. Three grand prize winners were Mrs. Benjamin F. Shaver, Los Angeles; Miss Virginia J. Wooden, College Park, Maryland; and Miss Eleanor Paterson, Denver, Colo.

If you want **SOMETHING BETTER demand**

DEWALD

A FAMOUS NAME IN RADIO SINCE 1921



DeWALD Model 566

Unusual value in a 5 tube AC-DC Superhet, 2-band receiver that brings in standard broadcasts and short wave. Streamlined, hand-rubbed Walnut veneer cabinet with Mahogany finish grille.

Write today for illustrated literature in the New 1942 DeWALD Radio Line.

JOBBERS: Choice territories still open. Write or wire for details.

DeWALD RADIO MFG. CORP.
436 - 440 Lafayette St., N. Y. C.

Listen

The GUIDE TO GOOD MUSIC

Boosts your RECORD Sales!



It's your own monthly magazine designed to sell **MORE RECORDS** for you!

LISTEN Magazine gives your customers authoritative **UNBIASED** reviews of all new recordings released by all companies. Also feature articles by David Hall, author of "The Record Book," Artur Schnabel, Joseph Szigeti; Barry Ulanov, Editor.

LISTEN sells records! sells them to old and new customers and makes "firm" friends for you. **LISTEN Magazine** is the reader's strongest incentive to buy albums, which means extra sales for you. **LISTEN** keeps all record catalogues alive!

LISTEN'S Special Service enables you to plan your record stocks in advance, resulting in extra profits for you.

GET YOUR SHARE OF EXTRA BUSINESS and PROFITS!
Write **TO-DAY** for full details!

Listen 1123 BROADWAY NEW YORK, N. Y.

University

AIR RAID ALARM SOUND SYSTEMS

are required for **NATIONAL DEFENSE**



High Efficiency Reflex Speaker Siren Systems for air raid alarms are now being installed in many cities throughout the entire country. These Reflex Speaker Siren Systems serve not only to sound the "Alarm" and "All Clear" signals; but also to give oral instructions and prevent panic in times of crisis.

More and more large communities, etc., are becoming "Air Raid Alarm" conscious, and are asking for sound installations from the parts jobber in the territory.

★ **AIR RAID ALARM SPEAKER SYSTEMS FOR NATIONAL DEFENSE**

Write for Details

UNIVERSITY LABS, 195 Chrystie St., NYC

NOW

a really high-powered

RADIO ENGINEERING LIBRARY

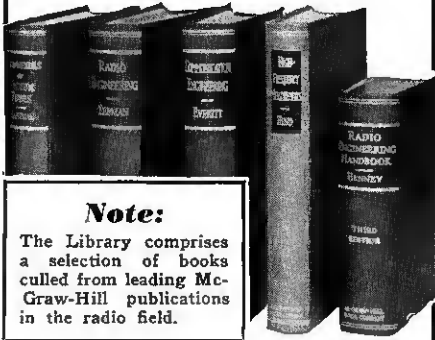

Note:

The Library comprises a selection of books culled from leading McGraw-Hill publications in the radio field.

- ▶ especially selected by radio specialists of McGraw-Hill publications
- ▶ to give most complete, dependable coverage of facts needed by all whose fields are grounded on radio fundamentals
- ▶ available at a special price and terms

These books cover circuit phenomena, tube theory, networks, measurements, and other subjects—give specialized treatments of all fields of practical design and application. They are books of recognized position in the literature—books you will refer to and be referred to often. If you are a practical designer, researcher or engineer in any field based on radio, you want these books for the help they give in hundreds of problems throughout the whole field of radio engineering.

5 volumes, 3559 pages, 2558 illustrations

Eastman's *Fundamentals of Vacuum Tubes*, 2nd edition

Terman's *Radio Engineering*, 2nd edition

Everitt's *Communication Engineering*, 2nd edition

Hund's *High Frequency Measurements*

Henney's *Radio Engineering Handbook*, 3rd edition

Special Low Price, Easy Terms

Special price under this offer less than cost of books bought separately. In addition, you have the privilege of paying in easy installments beginning with \$3.00 in 10 days after receipt of books, and \$3.00 monthly thereafter. Already these books are recognized as standard works that you are bound to require sooner or later. Take advantage of these convenient terms to add them to your library now.

FOR 10 DAYS EXAMINATION SEND THIS

---ON-APPROVAL COUPON---

McGraw-Hill Book Co., 330 W. 42 St., N. Y.

Send me Radio Engineering Library for 10 days' examination on approval. In 10 days I will send \$3.00 plus few cents postage, and \$3.00 monthly till \$24 is paid, or return books postpaid. (We pay postage on orders accompanied by remittance of first installment.)

Name

Address

City and State.....

Position

CompanyRR-1-42
(Books sent on approval in U.S. and Canada only)

Should Large Sets Be Restricted?

(Continued from page 32)

7. A majority of large home set buyers is not in the luxury class.

Investigation after investigation, survey after survey has convinced us that fully half the home owners buying console radios and large phonograph combinations are factory workers, garage mechanics, firemen, policemen and others who love music, but may or may not be in the so-called "white collar" class.

Some of these radio owners work on night shifts, even in peace time, and lead a life which makes it difficult to attend movies or ball games or concerts available to many of us. Some of them are unable to take long vacations; no trips to Florida in the winter or abroad in the summer. Radio is thus their chief relaxation and "escape" or emotional outlet, ever ready to provide music, new knowledge and entertainment in their spare time, whenever that may be. Thus, their radio is a major purchase, and they prefer to buy a good one, one which gives them natural tone.

With more and more people working long hours and night shifts on America's 168-hour war time work-week, surely this one means of relaxation should be provided them, with best possible reception.

8. Soaring sales of phonograph records stimulate a demand for large radio-phonograph combinations.

In the last war there was no radio broadcasting. The phonograph, alone, had to provide relaxation for the soldiers and workers. This time radio is here to share the burden, and to supplement music and entertainment with direct news flashes, but who will say that war jitters have not had some influence in the mounting sales of phonograph records, which climbed from around 10,000,000 records in pre-war 1937 to 108,000,000 records this year.

The extra amount of critical materials required in highly perfected modern automatic record changers is negligible, as compared to the material required to play single records. The cost of an automatic record changer, however, makes it desirable and good economy to use it in a large radio-phonograph, one which can do full justice to the music picked off the record.

9. The price is not proportional to the quantity of critical materials involved. Other factors, such as skill, careful workmanship and thorough testing make a quality set worth more dollars to the consumer, dealer, distributor and factory.

Rubber is now one of the most critical materials, yet the same rubber covered plug and power cord is required for a \$10 radio set as for a \$50 radio-phonograph combination.

In this same way, the electrolytic condenser (aluminum), the gang condenser (aluminum, brass, steel) and the power transformer (copper, iron, steel) can be allocated to a large set or a small set, without a proportionate change in the weight of materials used.

Much of the weight of large sets is

CLEAR AS A BELL

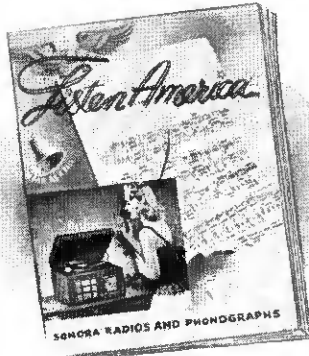

LISTEN AMERICA

These two words are the theme of every presentation of a new SONORA Radio Line . . . two words that have come to possess an unusual significance and importance to SONORA's trade.

This year, the "Listen America" presentation brochure introduces an unusual line of 1942 post-season SONORA models . . . a line that is keyed right to these unusual times . . . trimmed for action, yet a vital and Complete Home Entertainment line, planned with a fundamental foresight, packed with that certain SONORA ability to create the right merchandise at the right time.

SONORA Jobbers and Dealers will carry on in '42 . . .

The "Listen America" Brochure will be mailed on request to interested Jobbers. Write for it, using your firm letterhead.



Sonora
Clear as a Bell

**RADIO & TELEVISION CORP.
CHICAGO**

due to a large wood cabinet, and wood is not a critical material.

Much as it is desired to keep the parts factories busy, they, too, need their quality parts volume, on which they obtain better prices for better workmanship, more dollars per pound of material.

10. To support the national economy.

Wars must be financed by taxes, and preserving a broad tax base requires jobs and steady employment.

Radio, as we know it in America, has been the most outstanding example in all the world of giving so much for so little. The merchandising of small sets has been streamlined to the extent that a store can hardly exist on small-

set radio sales alone; there must be other lines of business to carry the overhead, with small-set radios on display for over the counter plus sales.

With necessary curtailment in home appliances which use large amounts of metal and are not necessary—as radios are—in a war time economy, the radio dealer finds his sources of overhead carrying merchandise cut off, leaving him in the position of selling small radios at a loss, unless he can have large radios to carry the store.

This does not mean that any dealer, distributor or factory makes an excess profit on large radios. Percentage wise, the profit can be exactly the same. The fact remains that, in selling one \$100 set, he would take in ten

Fly-Weight Goes Aboard



Irving Sarnoff, of Bruno-New York, metropolitan distributor for RCA Victor, delivers the RCA "Pick Me Up" portable to American Airlines stewardess for shipment. This unit is called the lightest of its size and type ever developed.

A Statement by E. A. TRACEY

GENERAL MANAGER

Majestic



RADIO AND TELEVISION CORPORATION

2600 WEST FIFTIETH STREET, CHICAGO, ILLINOIS

CONTROLLED DISTRIBUTION

EARNS NEW PROFITS FOR MAJESTIC DEALERS

The Majestic "Controlled Distribution" is a brand new idea in radio merchandising.

It's new--unusual--AND IT GIVES TO RETAIL PROFITS EQUAL IMPORTANCE WITH THE FACTORY DESIRE FOR VOLUME.

In this day of rapidly changing merchandising policies, the retail profit has become increasingly important.

The Majestic "Controlled Distribution" plan assures this full retail profit.

Alert retailers are adding new lines to maintain their sales volume--they're considering not only the merchandise--they are considering the manufacturer--his policies--his sales and most important, his assurance of full dealer profit.

Those dealers have found that the Majestic "Controlled Distribution" plan provides the answer in every instance--the assurance of a profitable retail operation.

Write for full details.

Yours very truly,

MAJESTIC RADIO & TELEVISION CORP.

E. A. Tracey
E. A. Tracey,
General Manager.

EAT:sl

MAJESTIC RADIO & TELEVISION CORPORATION

2600 W. Fiftieth St., Chicago, Illinois

times the gross profit that he could take in in selling ten \$10 sets, yet have only one delivery to make, one transaction for paper work, one customer to collect from, fewer and less frequent service calls and less space required on his floor.

In the same way, in selling a \$300 set, he may make no more profit percentage wise over a \$100 set, yet have more net profit left after all his overhead costs are paid.

Thus, large radio sets are necessary, if we are to maintain jobs for radio salesmen and dealers, and keep open the channels of distribution which are also needed for service and parts and expert attention to the existing radio receivers.

Radios are necessary to America at war. Wars may be won or lost on communications. Domestic radios are important for maintaining public morale, to keep the public informed, to recruit skilled aid, to call an assembly, to train defense workers or to spread an alarm.

Yet personal radios for individual bedrooms are not enough. Powerful sets are needed for school auditoriums, hotels, factories, railroad trains and stations, public buildings and shelters—wherever people gather together. These larger more powerful sets require a disproportionately small amount of extra critical materials. They can be built to last for the duration, however long that may be, with reasonable demands for tube replacements and attention.

Admiral Appointment

Announced by Continental Radio & Television Corp., Chicago, as a new Admiral distributor is United Electric Service, Inc., 306 N. 3rd St., Monroe, La.

• Our defense work comes first but we will deliver civilian requirements as best we can

ESPEY FM CHASSIS

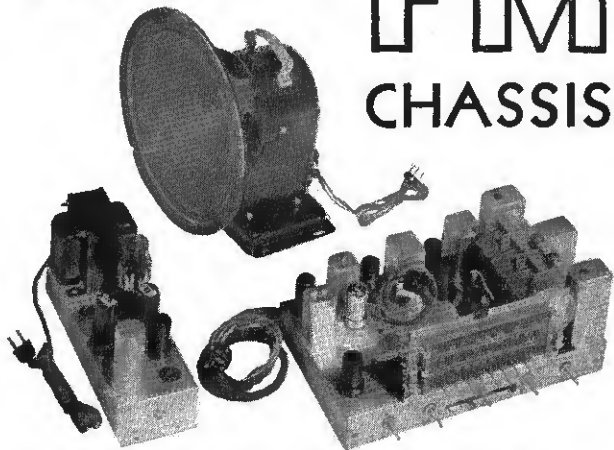

—for PRIVATE BRAND MERCHANTISERS
—to ELIMINATE PRICE COMPETITION
UNSURPASSED PERFORMANCE AT A PRICE

MODEL 2143—14 tubes—3 bands, broadcast, short-wave, and FM—bass and treble tone control—push-button tuning control—auditorium type electro-dynamic speaker—12 watts output.

Armstrong Licensed—Hazeltime Licensed—R. C. A. Licensed

ESPEY MANUFACTURING CO. INC.

Manufacturer of Phonographs and Radios

305 E. 63rd St.

New York

HOWARD *Extra Value* Means More 1942 Profits!

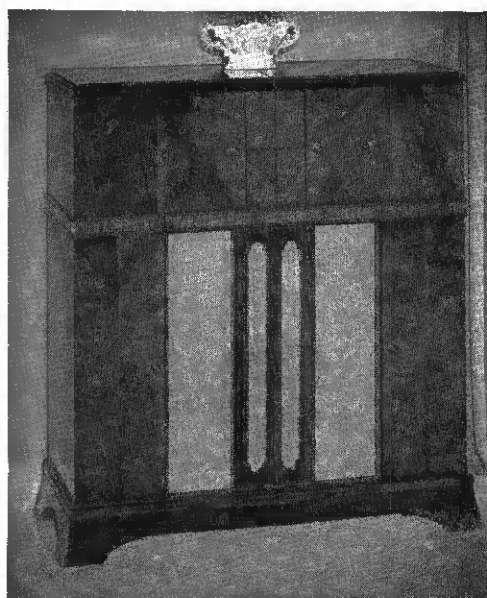

FM - AM

14 TUBES

4 BANDS

TUNED RF ON ALL BANDS

AUTOMATIC CHANGER

BASS BOOST AMPLIFIER

"Sheraton" Model 718X-FM-A Automatic Radio - Phonograph

Unsurpassed for beauty, performance and tone realism. Provides brilliant record reproduction with the finest in radio reception. Brings in FM, Standard Broadcast and Short Wave programs. Has electric push-button tuning, 12 inch speaker, convenient divided-top cabinet and compartment for storing record albums. Light-weight phonograph pick-up keeps surface noise at a minimum and reduces record wear. Armstrong FM licensed. Custom cabinet available in Walnut, Mahogany or Blonde Mahogany. A supreme triumph of Howard master craftsmanship.

STANDARD BROADCAST
SHORTWAVE BAND-SPREAD
3 BANDS
8 TUBES
RF STAGE
AUTOMATIC CHANGER
PUSH-PULL OUTPUT
12" SPEAKER



"Chairside" 808-CH Automatic Combination

Places full-toned radio reception and record entertainment within comfortable chairside reach. The ideal combination for the small apartment or living room. A natural choice for den or library of larger homes. Automatic record changer is of newest design with lightweight high fidelity pick-up and long life needle. Has space for record albums. Available in three finishes—Walnut, Mahogany or Blonde Mahogany.

WRITE TODAY FOR FULL DETAILS!

America's Oldest Radio Manufacturer

HOWARD RADIO COMPANY

1731-35 Belmont Av., Chicago, Ill. - Cable Address: HOWARDCO, USA

Another BITTER Sales-Building

MAKERS OF THE Famous RECORD BAR*

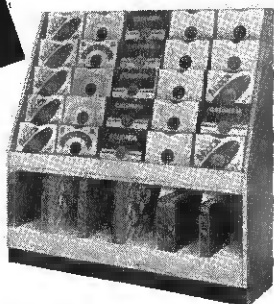

MOVES popular priced stock—eliminates clerk.
DISPLAYS about 300 records, 16 albums.
STOCKS 500 records or 75 albums.

Suitable for aisle or wall position, occupies only 5 feet of floor space, only 58 inches high. Provision on top and sides for display material.

Self-Service RECORD-ALBUM UNIT

FREE—Informative Booklet on Record Selling and Merchandising
*Reg. & Copy. U.S. Pat. Off. 1940

A. BITTER CONSTRUCTION CORP.

Brewster Bldg., 27-01 Bridge Plaza N., Long Island City, N. Y.

Radio Production Rate for First Quarter is 75%

The OPM has just framed its first "limitation" order for production of radios in 1942, following a recent meeting with industry leaders in Washington. The order cuts production to 75% of that for the first three months of last year, so that for this year about 670,000 receivers can be produced monthly for the first quarter of this year. The proposed quota leaves the radio trade executives optimistic for 1942, as the 75% rate is only 10% under the rate requested by the RMA Priorities Committee itself.

The order would not restrict sup-

plies of tubes and parts for sets already sold. Also, manufacturers may build either large or small sets, within the quota. OPM is due, however, to request the "freezing" of all current set designs, and the reduction of the number of models in a line.

The set and tube conferences were conducted by Jesse L. Maury, presiding officer of the OPM Radio Industry Committee, and his assistant, Myron E. Whitney, respectively. The meetings were called to arrange special allocations of nickel for tubes, both replacement and initial equipment, along with wire wound resistors for the first quarter of 1942.

Arrangements also were made by the

RMA Priorities Committee, of which Fred D. Williams of Philadelphia is chairman, to secure special allocations of copper and alloys and also plastics, both for initial equipment and replacement parts, for the first three months of this year.

Down Payments Required on Small Sales

Most dealers know that beginning Jan. 1 the credit regulations of the Federal Reserve Board required a down payment of 20% on installment sales of radio and other articles costing less than \$50. These small sales had been exempt from the requirement up to Dec. 31, and RMA requested the board to extend the exemption, to facilitate sales of smaller radios this year.

The Board has replied that, "although requests that the exemption be continued . . . have been received from various sources and for various reasons, and have been carefully considered, they have not seemed to the Board to justify such action."

The reply also said that the restrictive effect of the regulation, on sales of radios, was fully recognized by the Board, but added that this effect was intended "particularly in view of the fact that the supply of such sets, in the present emergency, is restricted for reasons of national defense."

Wartime Demand for Portables

The new market for portable radios, under wartime conditions, is being emphasized by Zenith Radio Corp., who calls attention to "a vast expansion of public demand" for these sets. The firm points out that (1) everyone wants to keep posted on news, (2) there's a shortage of table models, (3) millions of men in the armed forces choose portables first, as gifts, and (4) portable owners don't have to worry about power supply during air raids.

Zenith spotlights its "Universal" portable as the set that fills the bill, and its distributors are ready with merchandising helps and displays on the unit. Dealers are urged to include the set in any ads that they're running currently.

Pioneers' Party

The annual Hi-Jinks banquet of the Radio Pioneers of Southern California, held last month at the Mayfair Hotel in Los Angeles, was a lively success and drew 142 radio men, according to news from the Pioneers' secretary, Jack Perlmuth. A charter member, Dave Marshank, was master of ceremonies for the entertainment, and the club president, George Tivy, presided.

Here's New Business!



*** With the New Meissner FM Converter

Follow up both your new and old set sales with the Meissner FM Converter . . . you can make second set sales right now!! This compact converter is easily demonstrated and easy to install . . . there are no complicated attachments . . . just connect it to any quality radio for FM reception. This is your opportunity to sell a fast moving unit, one that the public wants to buy.

The FM Converter is shipped complete with tubes, ready to operate. List price \$44.95. See your distributor today.

Write for New 1942 Catalog—Address Dept. R. T.

Meissner

MT. CARMEL, ILLINOIS

"PRECISION-BUILT PRODUCTS"

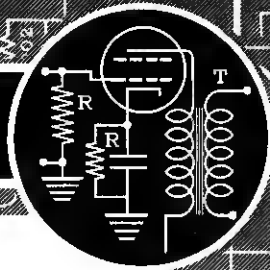

Parts and Service to the Front!

Exactly what is the radio serviceman offering to the American people today? What has he got, for people who are totally preoccupied with war and wild rumors of attack?

Repairs? Alignments? Replacements?

Yes. But these words are too bloodless for the times.

The voice of a patient President, a broadcast from a beleaguered fortress, the crash of patriotic music, the calm confidence of a military leader—these are more like it. Because **these** are the vital things that are delivered by the loudspeakers of the nation. The radio man is the expert who gives these matters a wider distribution than any other technician on the American scene.

And what does the parts jobber have on his shelves today? Condensers? Volume controls? Tubes?

“On the Spot” Responsibility

Sure. But there are truer labels for them.

The last word on the deadly blitz, the needs of national unity, the newest call to arms. These are the things that are latent in the distributor's merchandise. It is the parts man's job to supply **large** areas with the keys that unlock the air.

The serviceman and parts jobber thus come to the front, charged with the task of keeping 57,000,000 radios active in the national welfare. This is their biggest job in its simplest terms, although they are contributing in other ways to the emergency effort. It is particularly important while new receivers must be produced on a shorter scale.

These men and their products have the **local** “on-the-spot” responsibility for immediate radio reception. They are the nearest to the individual citizen and therefore vital to the alertness of a country where each man is free.



This distinctive page, and the pages that follow, mark an enlarged section of RADIO RETAILING TODAY, designed to be of practical and money-making value to the men who service America's 57 million radios, and sell parts and technical skill for the installation and repair of radio-tube devices.

Beginning with this issue, additional pages are being devoted to service problems because of the increased importance of servicing resulting from the curtailment of set production, and because many of our dealer readers are now adding service departments.

Tracing Hum Voltages

Useful Methods for Finding Causes of Hum in Receivers and Audio Amplifiers. How to Identify Hum Patterns.

• Hum, both intermittent and continuous is a complaint often experienced by servicemen. Many times, the job of finding what is causing the hum is long and tedious. The simplest procedure is to try increasing the filter capacity. This may or may not help the situation and if it does, it may be a wasteful use of capacity. Additional filter capacity may not be necessary if the actual cause of the trouble is found and corrected.

Since hum is a signal, it can be traced in a manner similar to the regular signals present in the set. Hum originates from many causes. It may be present only when a station carrier is tuned in, whether a station is present or not, or a combination of both at which time the hum may increase or decrease depending upon the phase between the two sources.

Hum appearing when any h.c. carrier is tuned in is being introduced in the RF-IF section of the set and modulating the carrier. Hum in this section of the set is usually due to a cathode-filament leakage in one of the RF-IF tubes. It may also be due to a faulty screen, cathode or plate circuit by-pass capacitor.

AC Hum Introduced

If the hum is being introduced through cathode-filament leakage, it will have the characteristic sound of the supply frequency. If it is due to open by-pass condensers in the RF end of the set, the hum will have the characteristic sound of the supply frequency if the set has a half-wave power supply, and a sound twice the supply frequency if a full-wave circuit is used. The AC ripple, which causes the hum, in a half-wave circuit has the frequency of the supply since only the positive wave is rectified each cycle. In full-wave circuits, both positive and negative waves are rectified and the ripple frequency is twice the supply frequency.

The magnitude of the hum in a half-wave circuit is usually worse than in a full-wave circuit since the ripple voltage is higher in the former. A higher frequency ripple is more easily filtered since the condensers do not have to supply the power for the set over as long a period of time. In the case of a 60-cycle half-wave circuit, the capacitors supply the current for

the set over one-half a cycle or 1/120 of a second.

Hum in the Audio End

If the hum is present at all times (whether a station is tuned in or not) it is usually being introduced in the

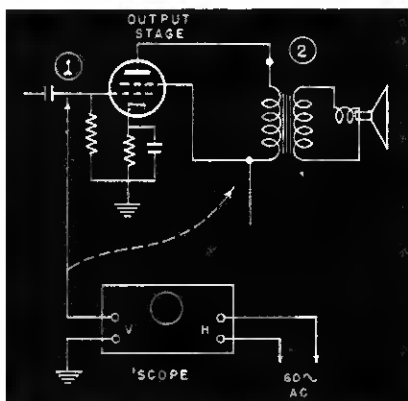

Fig. 1—First two points of test are output grid and plate. If hum pattern is obtained at 1, the source is identified by removing tubes one at a time until pattern disappears. See text.

audio end of the set. The most common cause is power supply hum.

The first AF stage is usually a voltage amplifier with considerable gain. Hum voltage may be easily picked up by this stage and amplified to annoying proportions. It may be introduced if the grid lead is misplaced with respect to power and filament wiring, or through open cathode by-pass capacity. Heater-cathode leakage and low or open cathode by-pass capacity will cause a bad hum voltage to be developed across the cathode resistor.

Hum is often introduced in the output tube circuit through cathode leakage. Unbalanced tubes in a push-pull circuit may also cause a hum through the output transformer. The unbalanced tubes draw different values of plate current and if a ripple voltage is present in power supply output, the AC ripple components across the two halves of the output transformer will not cancel and the hum may be heard through the speaker. Balanced tubes and better filtering will solve this type of hum. Push-pull amplifiers are usually provided with adjustable cathode resistors so that the plate currents can be balanced.

The various conditions of hum can be traced through the circuit by several means. One method using the oscilloscope is convenient and offers a visible means of checking the frequency and magnitude of the hum voltage.

Isolating the Trouble

The set-up for hum tracing with the 'scope is simple and requires only the oscilloscope itself. In place of the output of the internal sweep oscillator, an external voltage of the same frequency and wave shape as that supplying the set is applied to the horizontal input. This voltage need only be 4 or 5 volts and is easily obtained from the filament circuit of the 'scope or similar step-down source. This voltage is amplified by the horizontal amplifier and the gain is adjusted to give a horizontal line about the width of the screen.

The "high" side of the vertical input is the movable test probe while the ground or "low" side of the 'scope goes to the chassis or common ground wiring in the set in the case of an AC/DC circuit.

Check AF Grid First

The first point to check is the grid circuit of the audio output stage. Put the test lead from the vertical input circuit to the point in the set corresponding to 1 in Fig. 1. With hum present some form of circle or ellipse will appear on the screen. The shape of the pattern (circle or ellipse) is not important. The shape of this pattern depends upon the phase and magnitude relation between the hum voltage and AC on the horizontal input to the 'scope. If the voltages are

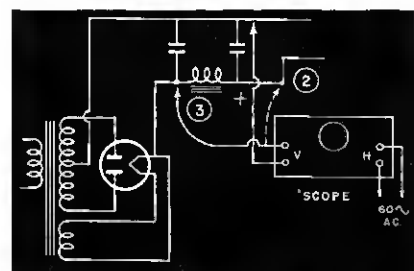

Fig. 2—Faulty filtering in power supplies can be traced to individual filter sections by observing wave shapes.



equal and the phase relation is exactly 90° or 1/4 cycle the pattern will be a circle.

In a typical test, the 'scope pattern for test point 1 was as shown in Fig. 4a. The scope remained connected to the output grid while tubes were removed and replaced one at a time working back from the output stage toward the antenna. When the intermediate tube was removed, the hum pattern disappeared. An intermittent heater to cathode leakage in this tube was causing the trouble.

The tube was replaced and the 'scope test prod moved to point 2 in Fig. 1 giving the pattern shown in

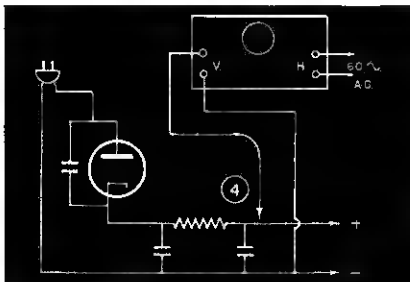
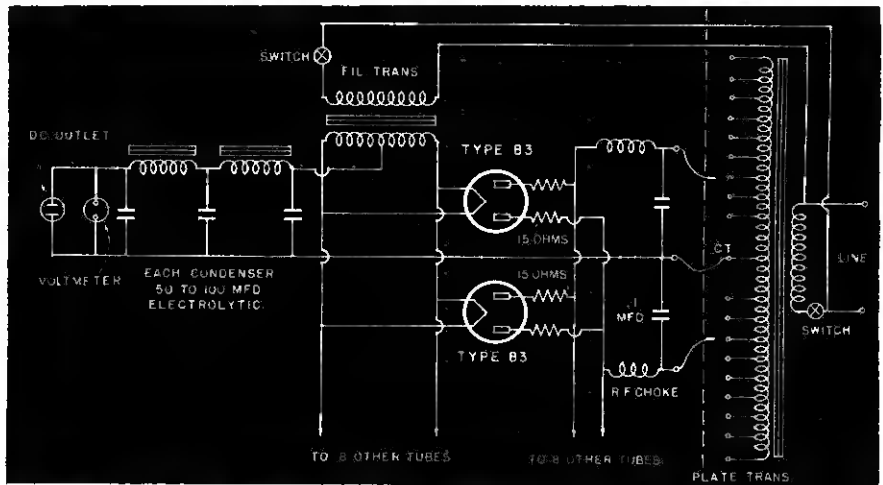

Fig. 3—Half-wave power supplies have characteristic hum patterns. Hum due to power supply will be found in output plate circuit.

Fig. 4b. The two small peak marks on this second pattern indicates a presence of 120-cycle ripple which was coming from the full-wave power supply. The hum was below the audible level and the small hum shown by the 'scope in the plate circuit was normal. When observing small hum signals, be sure that the lead to the 'scope is not picking up the hum from the power circuit. The input lead should be short and away from AC circuits.

Open Filter Pattern

An example of open or insufficient filter capacity is shown in Fig. 4c. This is a 120-cycle ripple voltage of considerable magnitude and it will be



This DC power supply delivers from 40 to 130 volts at sufficient power to operate farm sets. Built by serviceman, Bob Schlosser. See details in story below.

found in the B+ wiring of the set. The test prod was at point 2 on Fig. 2. A filter capacitor can be shunted across various sections of the power supply filter until the pattern begins to look like Fig. 4b. If the scope is connected to the input of the filter such as point 3, Fig. 2, the pattern will be similar to Fig. 4c but will have sharper peaks. By working through the filter system from input to output, the experienced serviceman will be able to tell whether each section is doing its job.

AC/DC half-wave circuits usually have more hum than the straight AC supplies. A typical pattern obtained from the B+ circuit (point 4, Fig. 3) is shown in Fig. 4d. Since the ripple is the same frequency as the horizontal sweep, only one peak appears.

In general, a hum pattern which has loops or lines that appear to cross one another such as Fig. 4c and d, the cause is ripple in the power supply. Twin loops in full-wave circuits, and one loop in half-wave power units.

Intermittent hums and other noise in the set can be localized by connecting the 'scope somewhere in the middle of the set, the second detector for example, and with the intensity turned

clear off let the set run until the speaker gives an indication of the noise. The intensity is then increased and the type of noise observed. If the 'scope shows nothing, the noise is somewhere in the audio end.

DC Power Supply Helps Test Farm Receivers

A complete variable voltage power supply, built by Robert Schlosser, Schlosser Radio Service, Pontiac, Ill., helps to test the many farm radios in that Corn Belt.

The equipment is built in two units. The one unit houses the plate transformer with tip jacks on the panel connected to taps on the secondary winding. These taps are arranged to give equal voltage on either side of the center tap. As the current requirements are rather large, the primary is wound with No. 17 wire. The secondary is wound with No. 18 wire. The taps vary logarithmically from 43.5 to 137.5 volts on either side of the center tap. Taps around 55 to 65 volts are usually used on 32 volt ra-



Fig. 4— A B C D Actual hum patterns due to different causes referred to in text. Pattern A is 60-cycle hum due to faulty tube cathode. B is the 120-cycle hum of about normal intensity. A bad case of 120-cycle hum is shown in C. D is the one-loop 60-cycle hum of half-wave power supplies.

dios. This unit is shielded. See accompanying diagram.

The other unit houses ten type 83 tubes, filament supply, filters, and voltmeter. The fifteen ohm resistors in series with each plate are needed to even up the current to each tube. The RF chokes were home made, but did not seem to be critical. The filter chokes were obtained from an old Balkeit "A" power unit. The filter condensers should have at least a 200 volt rating. The filament transformer has a secondary of No. 8 wire. This unit is also shielded.

On 32 volt radios using a vibrator power system there is practically no hum or hash. On the direct type of radio there is some hum, but not too much to satisfactorily test the set. In operating the equipment the filament switch should be turned on for a few seconds before applying plate voltage.

The transformers, RF chokes, and the sheet metal cases were all home made. Details of these of course will vary with the materials available. Both transformers are quite large.

Unique Circuit Features in Crosley FM Receivers

Novel discriminator and audio circuits are used in the Crosley FM/AM models 22CA and 22CB. These sets use a total of 12 tubes for AM, FM, and shortwave reception. Separate oscillator tubes are used for FM and AM. One of the IF tubes, a 6SK7 serves as an amplifier for both AM and FM signals when the proper transformers are switched into the plate and grid circuit.

The signal from the FM antenna is capacity coupled to the grid of the

6AC7 mixer. The signal from the FM oscillator is also coupled to this grid through the capacity of a piece of insulated wire between the grid of the oscillator and the grid of the mixer. This capacity is shown on the diagram as Cx. The intermediate frequency is 13.7 mc.

The last IF amplifier on FM is a sharp cut-off 6SJ7 with a parallel resonant circuit in the plate load. Another parallel resonant circuit is capacity coupled to the plate of the 6SJ7. These two 13.7 mc. resonant circuits, which normally would be inductively coupled, are separately shielded in this circuit. The resonant circuit across the diode plates regulates the phase of the FM voltage applied to the right hand plate. Discriminator action is obtained by the change in phase which takes place between the voltages on each plate of the diode as the frequency is varied by the modulation.

Two FM Bandwidths

A "broad" and a "sharp" FM service is offered in this circuit by the addition of a second tuned circuit which can be connected across the discriminator resonant combination. The frequency-voltage characteristic of the combination becomes steeper in the "sharp" position and less steep in the "broad" range. The purpose of this feature is to permit reception of stations that are adjacent on the band and may have side bands that cause interference.

The audio voltage is taken from the divided load resistors in the diode circuit just as in other FM circuits. This FM audio signal is switched to the volume control and grid circuit of the first AF amplifier. The output of this amplifier goes through a tone control

circuit of the push-button controlled bass-boost feedback type. The audio signal is connected to the grid of twin triode which serves as second AF amplifier and driver. The second half of this tube is cathode loaded with a center tapped choke. The grid of the push-pull output tubes are connected across the choke to obtain audio voltage in the correct phase relation.

The AM section of the set is conventional, using a mixer-oscillator, IF stage, detector-audio stage, and the same power audio equipment.

New Rider Book on Record Changers

"Automatic Record Changers and Recorders," a 744-page volume published by John Rider, 404 4th Ave., New York, outlines a plan of analysis that applies to any type of changer so that its functioning is quickly understood. To illustrate this idea, a step-by-step analysis of a simple drop-type record changer was made in the author's laboratory, each step being photographed and explained.

The latter portion of the book is devoted to the manufacturers' service data, which covers practically all the automatic record changers and recorders on the market, according to the publishers.

Not only is the text section indexed, but an extensive cross-reference index indicates which record changer or recorder is used with any particular radio-phonograph combination and where the data covering the changer or recorder can be found in the book. Also the record changers and recorders are listed under their own maker's name.

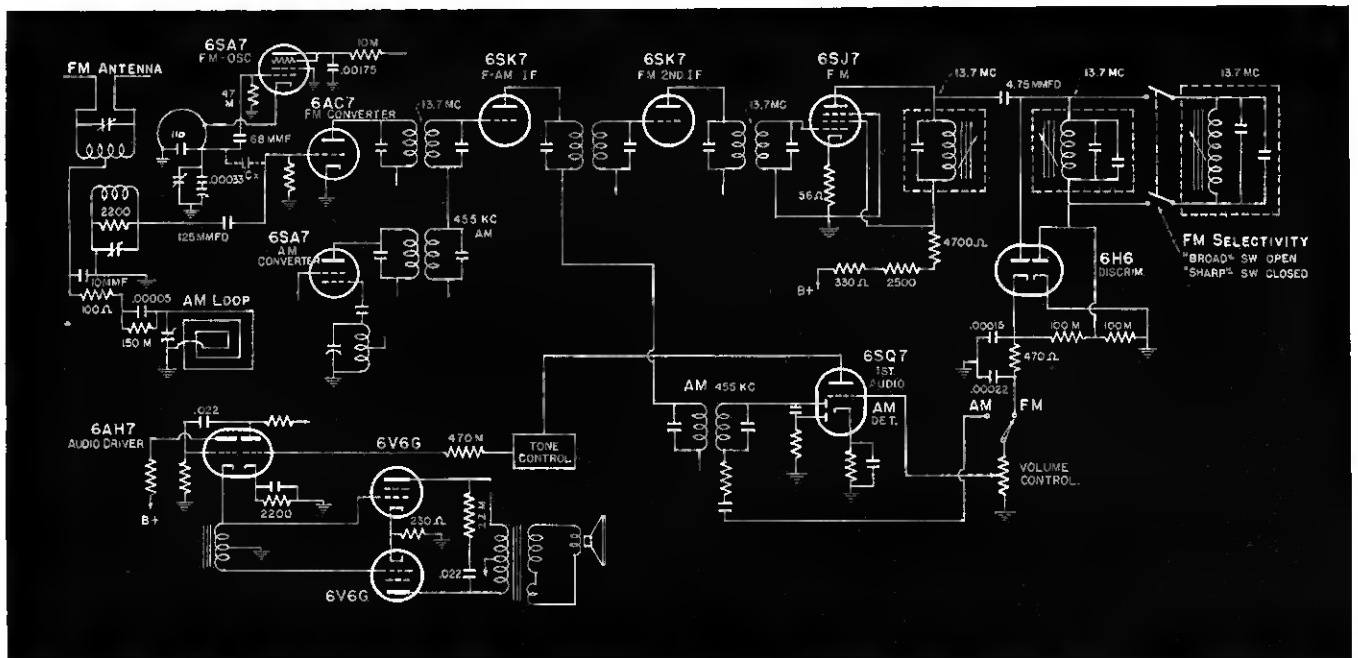

Combination FM/AM receiver by Crosley uses new type discriminator circuit and cathode coupled audio driver stage. See details in story above.



A Factory Engineer for Your Shop

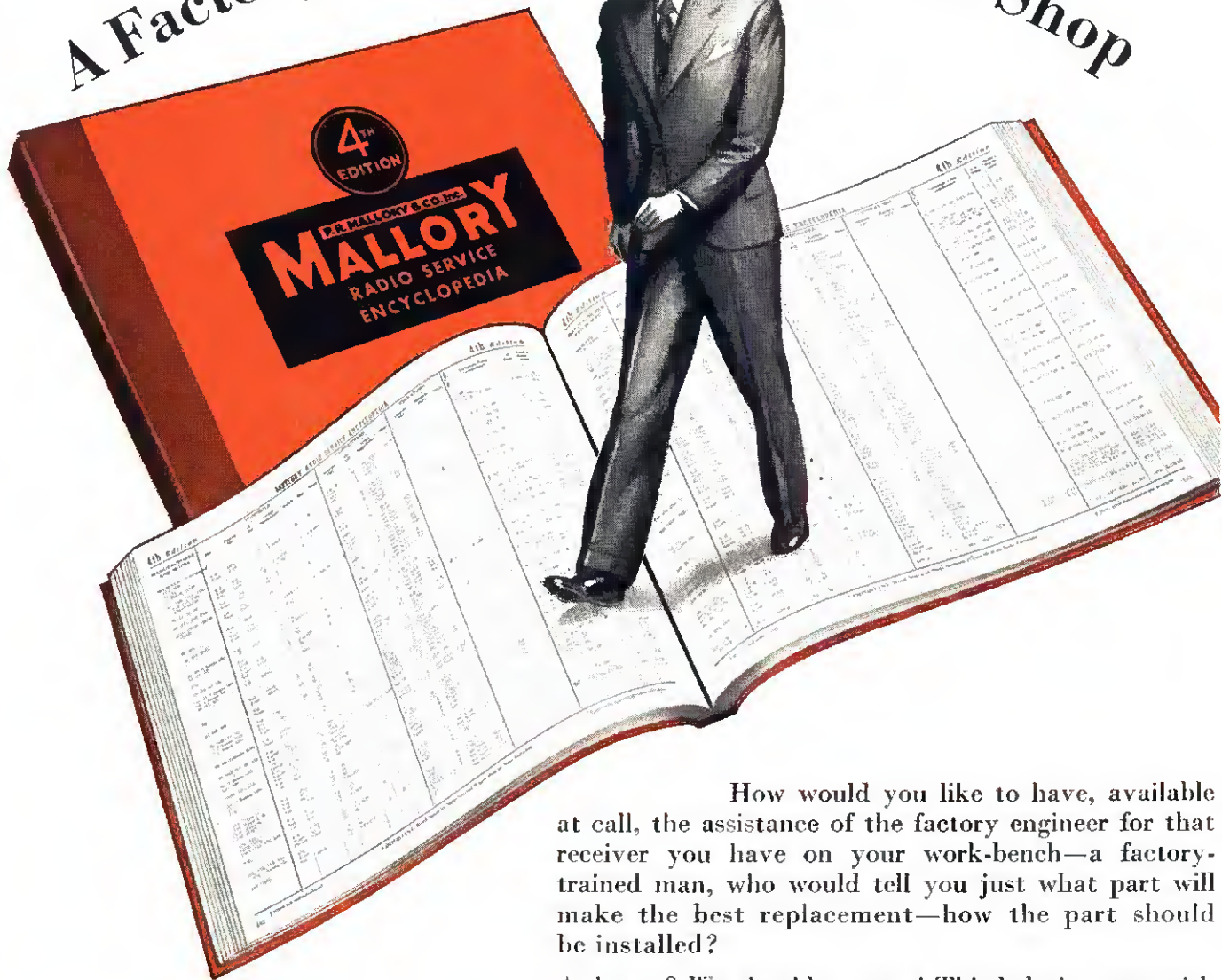

How would you like to have, available at call, the assistance of the factory engineer for that receiver you have on your work-bench—a factory-trained man, who would tell you just what part will make the best replacement—how the part should be installed?

A dream? We should say not! This help is yours with the Fourth Edition "MYE"—the Mallory Radio Service Encyclopedia. Here in one book, in one compact listing, on one page, is the essential information necessary to make a speedy, satisfactory repair for any model of any receiver—circuits, original part numbers, recommended replacements for volume controls, condensers, vibrators.

In addition, the "MYE" gives you the tube complement, the I.F. peak and the Rider's Reference, if detailed inspection of the entire schematic is required. Ask the chap who has bought one. He will tell you the Fourth Edition "MYE" is the most used book in his library.

Don't postpone action, see your Mallory Distributor today for the most helpful investment you can make.

P. R. MALLORY & CO., Inc.

MALLORY

Approved Precision Products

P. R. MALLORY & CO., Inc.
 INDIANAPOLIS INDIANA
 Cable Address—PELMALLO

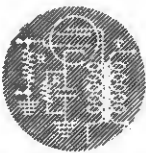

Let CLAROSTAT
Solve
YOUR RESISTANCE PROBLEM

- ★ From special wire-wound controls such as this multiple-unit tandem assembly, down to standard Series M midget controls for better radio servicing, you can count on CLAROSTAT for the widest range of work.
- ★ And that's especially significant these days, when you may go from set servicing to sound systems, on to electronic gadgeteering and industrial equipment, and on to wartime radio activities. Regardless, always remember that CLAROSTAT offers that wider choice of resistors, controls, resistance devices.
- ★ Consult your local CLAROSTAT jobber about your standard or special requirements. Ask for latest data. Or write direct—

CLAROSTAT MFG. CO., Inc.
281 N. 6th St., Brooklyn, N. Y.



Tricks of the Trade

CROSLY 616

Low B+; about 100 v. at 5Z4 output. Caused by shorted 0.002 mfd. capacitor at 6N6 socket.

CHRYSLER-PHILCO 1708

Weak or no reception. Check 0.01 mfd. from plate of 7B6 to grid of 7B5 for leakage. No reception beyond 900 kc., look for bad oscillator coil.

EMERSON MD331

Wire from 110 line burned off at connection to rectifier. Replace 0.05 line by-pass with 600 volt unit. Look for ballast break in case of intermittent reception or blinking dial light.

RCA 3M1

Poor reception—The overall gain of this model may be increased by decreasing the 680 mmfd. antenna series condenser. The higher the capacity of the antenna, the lower the value of this condenser should be.

RCA 45X1

Intermittent-check output transformer for partial short in primary windings.

RCA R-89

Distorts at high volume-decrease value of 10 meg. grid resistor of 6F5 tube to 5 meg.

RCA Q-14

Weak and distorted-check 330 mmfd. mica condenser, which by passes the plate of the 6SQ7 tube, for leakage.

RCA 9K3

Dead on short wave band-check 33,000 ohm grid leak of the 6J7 oscillator tube for increase in resistance.

RCA 6T5

Distorts and chokes on strong signal—check 220,000 ohm AVC resistor in can of 2nd IF transformer for open.

AC-DC MODELS

Open or intermittent filament . . . a quick test can be accomplished by connecting the set to the line and checking voltage between the filament legs of each tube. The open filament will show almost the same value as the line voltage. Intermittent filaments will read normal voltage and then suddenly jump to the line voltage reading.

A "LAB" to fit your pocket

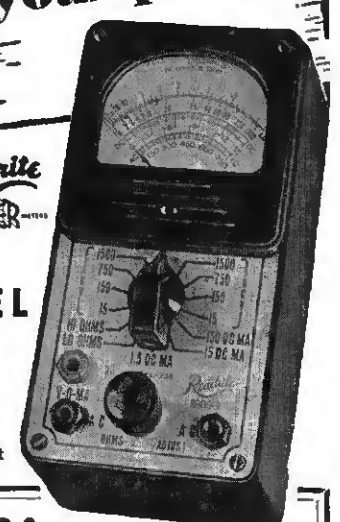

MODEL 739
\$10.89
Dealer Net Price

A.C. D.C. VOLT-OHM-MILLIAMMETER
Pocket Volt - Ohm - Milliammeter with Selector Switch Molded Case. Precision 3-Inch Meter with 2 Genuine Sapphire Jewel Bearings. AC and DC Volts 0-15-150-750-1500; DC MA. 0-1, 15-150; High and Low Ohm Scales.
Dealer Net Price, including all accessories, \$10.89
MODEL 739 . . . DC Pocket Volt-Ohm-Milliammeter. Dealer Net Price . . . \$8.25
WRITE FOR CATALOG
SECTION 1120 COLLEGE DRIVE
READRITE METER WORKS, Bluffton, Ohio

THE EASY WAY TO CUT HOLES IN RADIO CHASSIS

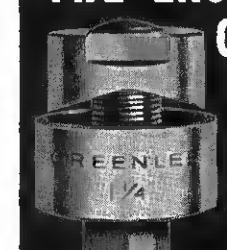

Here's a handy tool to help the radio worker save many hours of work when cutting holes for sockets, plugs, connectors, and meter holes in radio chassis. No tedious drilling, reaming, or filing is necessary. A cap screw is inserted in a small drilled hole, and the punch is easily forced into the die by a few turns of the cap screw with an ordinary wrench. Ten punches are available for cutting 3/4, 7/8, 1, 1 1/8, 1 1/2, 1 3/8, 1 1/4, 1 3/8, 1 1/2 and 2 1/4-inch holes. Write for more information.
GREENLEE TOOL CO.
1901 Columbia Ave., Rockford, Ill.

GREENLEE TOOL CO.
1901 Columbia Ave., Rockford, Ill.
Please Send Information On Greenlee Radio Punches.
NAME.....
ADDRESS.....
CITY..... STATE.....



INSTRUMENTS *for the Long Pull!*



Weston Model 669 Vacuum Tube Voltmeter

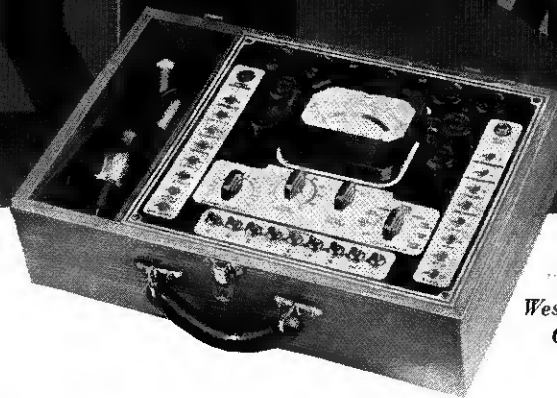

Weston Model 774 Checkmaster

Weston Model 772 Super-Sensitive Analyzer

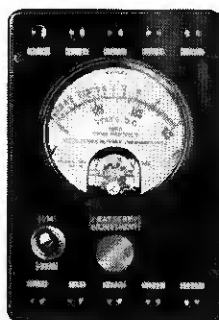
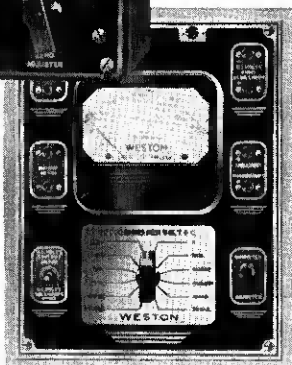

Weston Pocket-Size Test Instruments

To the serviceman who owns WESTON test equipment, *that name on each instrument panel has real meaning* these days. Normally, it means long, uninterrupted service and substantial savings in instrument replacement costs. It means *all this and more* today. It means that he has tools that will give him dependable service . . . *work and earn for him without interruption . . . all during the uncertain period ahead.* Weston Electrical Instrument Corporation, 581 Frelinghuysen Ave., Newark, New Jersey.

Laboratory Standards . . . Precision DC and AC Portables . . . Instrument Transformers . . . Sensitive Relays . . . DC, AC, and Thermo Switchboard and Panel Instruments.

WESTON

Specialized Test Equipment . . . Light Measurement and Control Devices . . . Exposure Meters . . . Aircraft Instruments . . . Electric Tachometers . . . Dial Thermometers.

FOR OVER 53 YEARS LEADERS IN ELECTRICAL MEASURING INSTRUMENTS

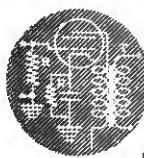

MR. GEO. BRUZEE
Geneva, New York

National Union Products have been one of the bases on which I have built the most successful service business in this trading area. I have sold National Union with full confidence for more than ten years and the results have fully justified my faith in the merchandise and the company. Naturally I have taken every advantage of National Union deals, but of equal importance to my mind is the fact that N. U. has kept the market clean and enabled me to make a sales profit.

WHERE YOU FIND
NATIONAL UNION
YOU FIND BETTER
RADIO SERVICE

PREMIUM
Quality
TUBES



BATTERIES



CONDENSERS

also Sound X/tra tubes, panel lamps, cathode ray tubes, exciter lamps, sound equipment, photo electric cells, sound accessories, dry batteries, flash light bulbs.

NATIONAL UNION invites . . .

All radio service dealers to enjoy the benefits of the N. U. Shop Equipment Plan. The latest in tube testers and test equipment are available to you . . . prompt delivery. More than 60,000 completed deals prove the success of this plan. Investigate now.

Ask Your N. U. Distributor or Write



NATIONAL UNION
RADIO Corp.
57 STATE ST., NEWARK, N. J.

Auto Receiver Combines Noise Limiter and Detector

A diode type peak clipping noise limiter is combined with the second detector of the several Philco auto radios such as the Studebaker S-1926 model.

The detector circuit uses the upper diode section of the tube (see accompanying diagram) in a delayed AVC circuit. The cathode of this section of the tube is biased from a voltage divided to about +2 volts. This prevents AVC action from starting until the carrier level exceeds this value. The AVC voltage is obtained from the load resistor string through a 1 meg resistor and 0.1 mfd. filter network.

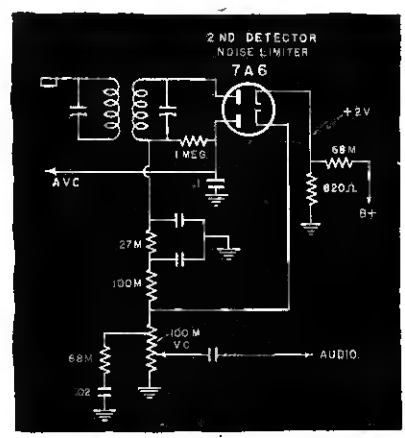

The plate of the second diode section is connected to the AVC system and thus is biased negatively according to the strength of the carrier. The cathode for this second diode is tapped on the load resistor string at a point which makes it about half as negative as its plate. Since the plate is usually more negative than its cathode, rectification in the second diode circuit does not normally take place. Should a burst of noise come through the receiver, of sufficient level to overcome the difference in voltage between the AVC potential and the instantaneous audio level, the second diode section will rectify the noise and increase the AVC voltage applied to the RF tubes. Because of the short time constant in the noise rectifying circuit, short bursts of interference can be applied as an AVC voltage and "kill" the set for that interval. Further limiting effect is obtained when the second diode is conducting as it then connects the 0.1 AVC filter capacitor across the volume control through the internal impedance of the diode, about 4000 ohms.

Note the tapped volume control bass boosting circuit with a 68M—0.02 mfd. high pass network.

New Sylvania Tube Sheet

A 12-page booklet just released by Hygrade Sylvania Corp. contains the average characteristics of receiving tubes, base diagrams, and panel lamp characteristics.

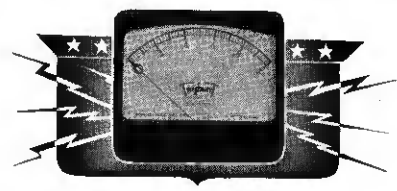

For Triplett Customers Only

Long before the state of emergency was proclaimed, the Triplett Company was getting ready to do its part in building our national security. We knew that we must meet important new responsibilities. At the same time, we felt keenly our continuing obligations to our customers—old friends with whom we have had happy business relations through many years.

We doubled—then tripled—our output to fill the needs of our old accounts. We added to our production facilities . . . hired many more men . . . are working extra shifts at time-and-a-half.

All this has not been enough. We have been called on to produce more and more for national defense. We are proud of the job we are doing to help meet the emergency, but it is difficult not to be able to serve our old friends equally as well. In the face of these conditions, the Triplett Company has adopted these policies "for the duration."

FIRST: We will continue to serve you by our service to our mutual responsibility—the national emergency.

SECOND: We will continue to do everything we can to fill orders from our regular customers, even though some deliveries may be temporarily delayed. No business from new accounts has been nor will be accepted until after our old friends have been served, except where priorities make it impossible to do so.

THIRD: Our engineering and research departments will continue to work on the development of superior equipment and improved methods to serve you still better when we can resume normal operations.

The present emergency is incidental and as we work towards the future, we will do our best to continue to merit your confidence and loyalty.

Ch. Triplett
President

The Triplett Electrical Instrument Company
Manufacturers of Precision Electrical Instruments



EXTRA QUALITY COUNTS MORE THAN EVER THESE DAYS...

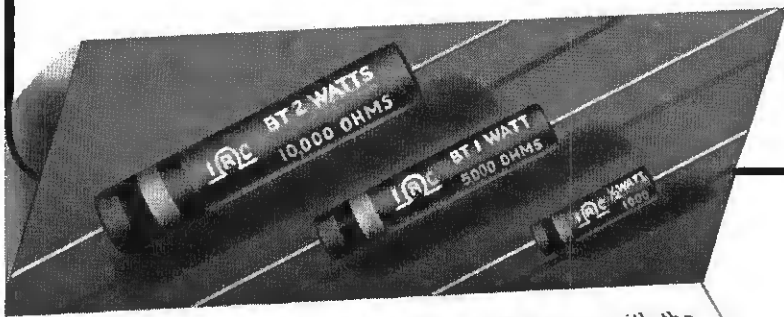

INSULATED METALLIZED—The only resistors with the famous Metallized-type element (except IRC "F" type and high-power and high-voltage types produced for industrial use). Completely sealed and insulated from end to end. Moisture-proof and vibration-proof. 1/2, 1- and 2-watt sizes.

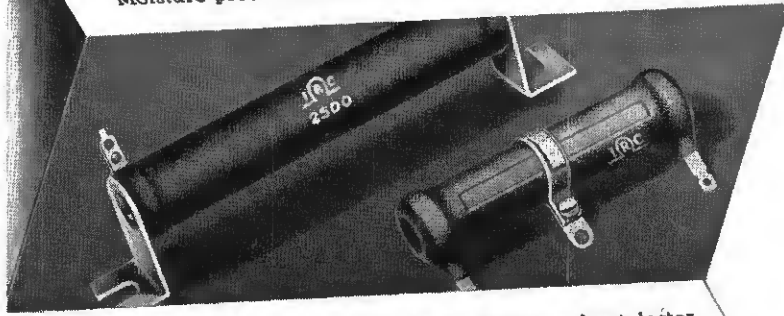

POWER WIRE WOUNDS—They dissipate heat faster—stand overloads better—are protected against moisture by an exclusive Climate-Proofed Cement Coating. 53 standard sizes and shapes, also many special types, from 5- to 200-watts, fixed or adjustable, inductive or non-inductive.

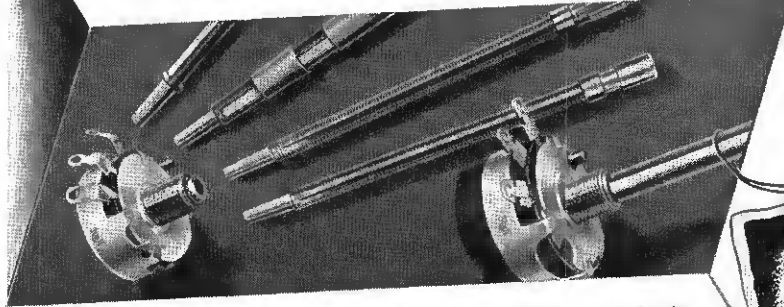

CONTROLS—POTENTIOMETERS—Quiet—and built to stay quiet. The only Controls with the noise-eliminating features of Metallized-type element bonded to a moisture-proof base; 5-finger "knee-action" contactor; and spiral connector which eliminates metal-to-metal wiping contact.

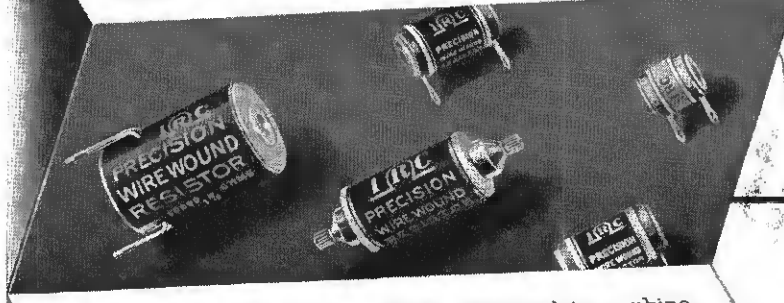

PRECISION WIRE WOUNDS—Designed to combine a high degree of accuracy with real dependability and modest cost. Made in 14 types. Inductive or non-inductive windings. Standard accuracy is 1%, or to as low as 1/10 of 1% on special order. Impregnated against atmospheric conditions.

IRC Resistors and Controls represent the greatest values for your money—not that they cost less, but because they are built to perform better and last longer.

Quality and dependability are now more important than ever in keeping the nation's radios in good working order when almost every day brings War news and other broadcasts of utmost significance, no radio owner will want to miss.

BUILDING BUSINESS—FOR YOU!

This little tag, packed with all IRC Volume Controls sold through the jobbing trade, is designed to hang on the control knob whenever you make a replacement. No customer will fail to see it. None will fail to be impressed with the fact that you have used a replacement of the highest quality. The reverse side has space for your name, address and phone number and suggests that satisfied customers recommend your services to friends.



INTERNATIONAL RESISTANCE CO.

401 N. BROAD ST., PHILA., PENNA.

Radio Tubes in Industry

Photoelectric units have been given many important jobs in which they supervise or record production output.

Typical of the photo-tube counting jobs is one recently installed in a St. Louis brewery. This installation was designed to count the filled cases leaving the plant and the empty cases returned by the drivers.

The eight photoelectric counting assemblies were made by the Worner Products Corp. of Chicago.

Four conveyors deliver filled cases from the bottling machines to the shipping room. Each delivers, on an average, 300 cases per hour. This count is of great importance since it provides a record of the brewery's output.

Four other conveyors equipped with photoelectric counting units are those in the receiving room. All empty cases returned for credit come in over these conveyors. Counters are reset to zero after each batch of empties counted so that no errors can occur in keeping accurate tally of the cases returned by each customer. Before the installation of photoelectric counting equip-

ment, errors were apt to cause arguments, resulting in ill-will. Now all possibilities for disagreement have been eliminated.

Four of the conveyors are equipped with ready-made portable counting assemblies. These comprise a frame which clamps on the conveyor and supports the photoelectric light source and receiver on adjustable standards. The frame also supports the photoelectric control box containing amplifiers and relays. Light source and photocell are each housed in a small cast-iron case. The bottom of the casting is flanged and threaded to receive a 1/2 in. pipe which serves as a support. These supports are adjustable for height.

The other four counting units are composed of the same parts but instead of being portable are permanently attached to the conveyor.

When desired, installations of this kind may be made so that the control box and counter are at some distance from the conveyor, making it possible to have all counters at a central location.

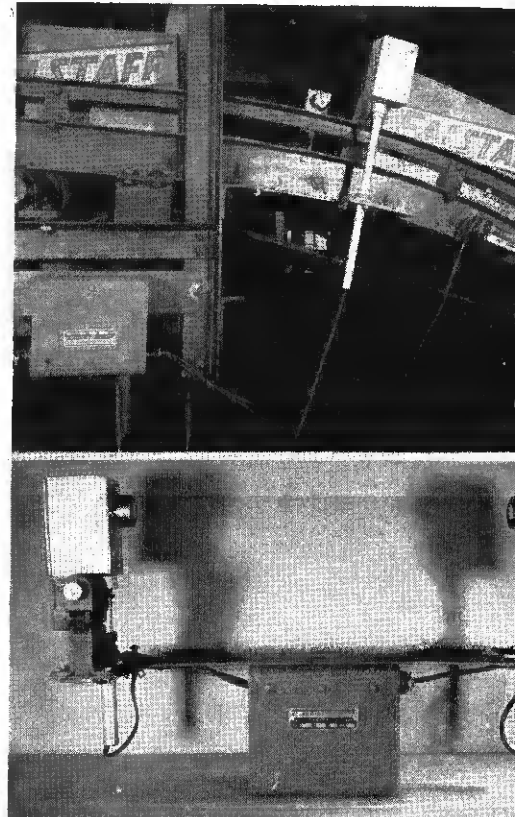

Automatic case counter keeps track of production and returned cases for refunds to purchaser.

If your need for instruments is essential enough to give you the right to buy, it is essential enough to rate the best.

To those who have searched out the facts, best means *Simpson!*

SIMPSON ELECTRIC CO.
5208-18 Kinzie St., Chicago, Ill.

Simpson
INSTRUMENTS THAT STAY ACCURATE

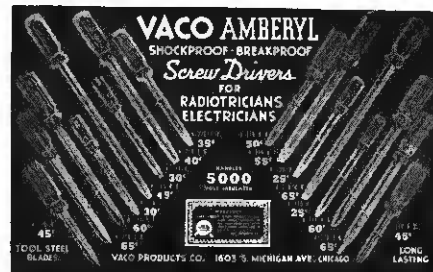
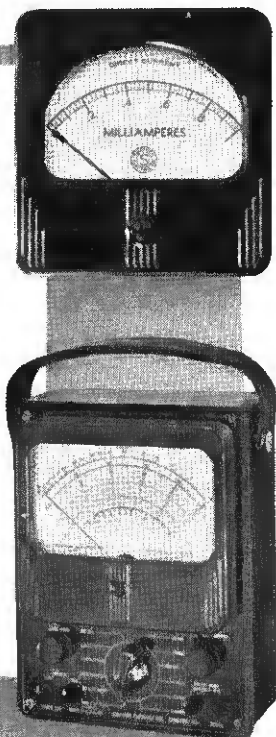

VACO RADIO DISPLAY UNIT IS

an example of our leadership in producing "the right driver for the right job." Mechanics and servicemen everywhere say: "Vaco's best!" 157 different types of screw drivers in the Vaco line covering every need and suited for every purpose. Handles of break-proof and shock-proof Amberyl. Inquiries invited.

VACO Products Co. 1603 S. Michigan Ave. CHICAGO, ILL.

**ALWAYS
IN LINE**



DEPENDABLE

KEN-RAD Radio Tubes



They keep right on rolling off the lines . . . the Radiohms, Resistors, Capacitors and Switches under the eagle-eye of Old Man Centralab.

The present emergency has neither stopped (nor slowed) the steady flow of deliveries nor has it impaired the priceless perfection that has made the name CENTRALAB a synonym for Quality.

Constant research in our laboratories by Centralab engineers, chemists and metallurgists assure you that the resources of Centralab are "forever yours".

Keep on using CENTRALAB parts for every replacement job . . . now as in the past.

CENTRALAB • Div. of Globe-Union, Inc., Milwaukee, Wis.

Centralab



*"Keep 'em Rolling
Keep 'em Flying..."*

**RIDER RADIO BOOKS
ARE DOING THEIR SHARE!**

- IN ARMY
- NAVY
- COAST GUARD
- SIGNAL CORPS
- INDUSTRIAL TRAINING

★ On land—on sea—in the air—communication is a vital factor dependent upon skilled men to design, operate and maintain the complicated equipment. That is why we are proud of the many branches of the various services that employ Rider Radio Books in the training of radio technicians. As a serviceman, you can contribute your share to National Security by repairing defective radios *quickly*. You can increase the speed of your production and the amount of your profits by knowing more about the sets on which you are working and the instruments you are using. You will find a Rider Book listed below that you should read today. Check the listings and order **RIGHT NOW!**

Automatic Frequency Control Systems

From the simple type of A. F. C. circuit to the most complicated push-pull control circuit . . . you will find them all clearly explained in this book. A rare combination of theory and practice. 143 pages. \$1.25.

Cathode Ray Tube

A universally used testing device in radio and electrical fields, the cathode-ray tube—giving accurate information about electrical wave forms—is invaluable in radio maintenance operations, laboratories and electrical research. A classic, written in clear, easily understood style, this book is now in its 8th printing. More than 25,000 copies have been sold. 338 pages. \$3.00.

Servicing by Signal Tracing

A new idea!—An exposition of the theory of operation of all radio type receivers, amplifiers, television, etc., in terms of what happens to the signal. This is the most fundamental system of analyzing defects in communication systems.—It has been embraced by thousands of professional radio repairmen in all parts of the world. Written by the creator of that system—in a style that is easy to understand. 360 pages. \$3.00.

Vacuum-Tube Voltmeters

The subject of this new book is one of the favorite tools of radio engineers and other laboratory workers. Vacuum-Tube voltmeters are explained here from the theoretical as well as the practical angles. 179 pages. \$2.00.

An-Hour-A-Day-With-Rider Series

Fundamental books every radio beginner should read to provide a solid foundation for further study on Alternating Currents in Radio Receivers on Resonance and Alignment on Automatic Volume Control on D-C Voltage Distribution. Each book contains 96 pages and is bound in hard covers. Price 90c each.

★ ★ ★ ★ ★ ★ ★ ★ ★ ★

And for the Maintenance of Radio Receivers in the Homes of America, Radio Servicemen Use

RIDER MANUALS

A well informed public is as essential to civilian morale as a well informed military command is to the morale of an army. Thus the professional serviceman serves his country well by *quickly* repairing a defective home radio.

To increase the speed of locating troubles, all wide-awake servicemen use all twelve Rider Manuals.

Abridged Rider Manuals I to V—2000 pages—\$12.50.

Rider Manuals, Volumes III to VI—covering sets issued each year between 1932 and 1935—\$8.25 each.

Rider Manuals, Volumes VI to XII—covering sets issued between 1935 and 1941—\$11.00 each.

OFF PRESS JAN. 22nd

"AUTOMATIC RECORD CHANGERS AND RECORDERS"

Complete servicing information. Explanatory text, diagrams and drawings. 744 pages. \$6.00.

Frequency Modulation
Explains FM. Introduces the principles underlying this important new type of radio transmission that has become an important factor. This book also goes into the maintenance of FM receivers. Instantly popular when published a year ago, its sales have consistently mounted. 138 pages. \$1.50.

The Meter at Work
Elementary treatise covering theoretical as well as practical aspects of all kinds of "small" electric meters. The unusual construction of this book—separating text and illustrations—makes it easy for you to read and get the facts quickly. Read this book to be sure you get the meters best suited to your needs. 152 pages. \$1.50.

Oscillator at Work
This book explains how to get maximum utility from your present oscillator and how to test and repair all kinds of oscillators. A practical book for the man who uses oscillators. 243 pages. \$2.00.

Bias Network in Motorola Auto Sets

A voltage dividing network in series with the center tap of the power transformer in many Motorola models is used to supply the bias for the audio tubes and also a delay voltage for the AVC system. See accompanying circuit. The total current drain of the set flows through the divider resistors

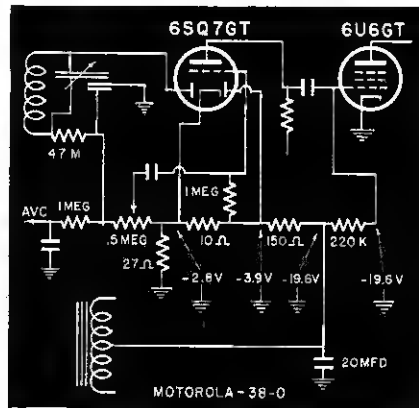

Proper audio bias and delay AVC voltage is obtained from a divided network in the power supply. Total drop about 20 volts.

to ground. The grid of the output tube is connected to the most negative point, which is about -19.6 volts. The cathode of this tube is grounded. The grid of the 6SQ7GT is -3.9 volts below ground while its cathode is -2.8 volts below ground, therefore, the grid bias is -1.1 volts.

The AVC network is connected to the -2.8-volt point in the bias circuit and thus has a delay potential. The three RF tubes thus have a minimum bias of -2.8 volts.

Notice, also that the RF by-pass across the second detector diode load resistor is built into the output IF transformer trimmer.

Universal Names Wells

A newcomer to the staff of Universal Microphone Co., Inglewood, Calif., is William W. Wells, who has been for the past 3 years in the research labs of Colonial Radio Corp., Buffalo, N. Y. He will head production of Universal's defense orders. The firm has finished its initial Army contract for aircraft mikes, and has started to work in its new annex building on special jobs for tanks and planes.

Dealer Winner

Louis E. Dean, radio and record retailer of Hyannis, Mass., has been awarded a prize piece of luggage as the winner of a Fidelitone Floating Point phonograph needle guessing contest sponsored by the Fidelitone makers, Permo Products Corp., Chicago.

JOHN F. RIDER PUBLISHER, Inc.

404 FOURTH AVENUE, NEW YORK CITY

Export Division: Rocke-International Elec. Corp., 100 Varick St., N. Y. C. Cable: ARLAB



BOOK REVIEWS

1941 RADIO DIAGRAMS

Compiled by M. N. Beitman
 Supreme Publications
 3727 W. 13th St., Chicago.

The "most often needed 1941 radio diagrams and servicing information" is the phrase used by the publisher in describing this 8½ x 11-inch manual of 192 pages. Included in this book are the diagrams and service notes of the 1941 models which were popular and sold in large numbers. The diagrams are large and clearly reproduced. An index of models covered is a convenient reference to the correct page.

The book has a flexible cover and is priced at \$1.

Practical Radio Mathematics

N. N. Beitman
 Supreme Publications, 328 S. Jefferson St., Chicago

This new booklet is a simplified home study course in the mathematics of radio circuits. Relationships between voltage, current, and power in pure resistive, inductive, capacitive circuits are made clear. The calculations for determining the impedance of circuits containing combinations of these three units are also presented. A chapter on vacuum tubes and how to use the characteristic curves will prove helpful to the serviceman.

The price of the booklet is twenty-five cents.

Cartridge Replacement Manual from Astatic

A phonograph pick-up cartridge replacement manual is being prepared by the Astatic Corporation, Youngstown, Ohio, for the convenience of jobbers, dealers, and servicemen. The use of the manual will enable distributors to select the correct Astatic cartridge for use in the various phonographs and radio phone combinations in use.

The manual is expected to be ready for distribution after January 15.

Gibson Jobbers

Gibson Electric Refrigerator Corp., Greenville, Mich., has announced the appointment of Stratton Warren Sales Co., Memphis, Tenn., and Radio City Distributing Co., Dallas, Texas, to handle Gibson Freez'r Shelf refrigerators and Kookall electric ranges.

Aircraft Radio Folder

"Eyes, Ears, Voice for the Pilot" is the title of a new Learadio folder on its 3-way systems—transmitters, receivers, direction finders. Another new folder describes their new 3-band portable. Lear Avia, Inc., Dayton, Ohio.

KEEP AHEAD WITH G-E TEST EQUIPMENT



NEW TUBE CHECKER
Model TC-2

The model TC-2 offers greatest possible protection against obsolescence — includes all existing American tube sockets with two unwired spares. Complete filament voltage coverage from 1½ volts to 117 volts with five spare taps. Short Test — standard RMA with rejection at .25 megohm, Two color panel — beige and maroon. Weight — 16 lbs.

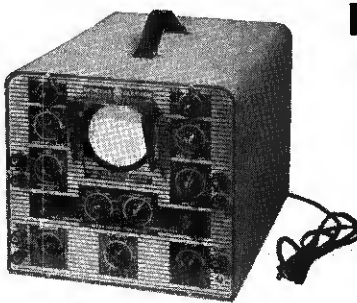

NEW OSCILLOGRAPH AND FREQUENCY MODULATOR
Model OFM-2

A precision instrument that stands alone among combination instruments for accurate and rapid service work. Unique in that it delivers only the wanted signal due to exclusive circuit arrangement in which unwanted harmonics are entirely suppressed. Weight — 31 pounds.

GENERAL ELECTRIC PRE-TESTED RADIO TUBES

All types for replacement and renewal

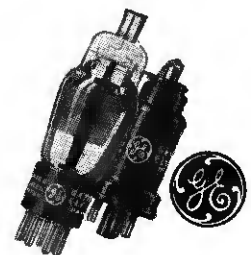

Mail the Coupon

FREE!
VALUABLE TECHNICAL TUBE MANUAL

General Electric Company, Tube Sales Section, Radio and Television Department, Bridgeport, Conn.

Please send me, without cost or obligation, new G-E Manual of Radio Tube Specifications.

Name

Address

GENERAL ELECTRIC



Individually Tested
PAPER TUBULARS

• Yes indeed, even these inexpensive Aerovox Paper Tubulars are *individually* tested. That's true of *every* Aerovox condenser—the ten-cent paper tubular and the ten-dollar oil-filled capacitor, alike. Each and every Aerovox condenser is factory-tested for your convenience, assurance, ultimate pocketbook. • Furthermore, these paper tubulars, with their extra-heavy-waxing and neatly milled ends, with pigtails that won't loosen or pull out, are now dressed up in vivid yellow-black-and-red label jackets. They look as good as they really are. • Ask your jobber for Aerovox tubulars. Always have some on hand for your rush jobs. • Ask for latest catalog—or write us direct.

AEROVOX CORPORATION

NEW BEDFORD, MASS., U. S. A.
Sales Offices in All Principal Cities

In Canada
AEROVOX CANADA LTD.
Hamilton, Ont.
EXPORT: 100 Varick St., N. Y.
Cable "ARLAB"

A short message from **BOGEN!**

AMERICA IS IN ACTION! New problems are daily being faced—new adjustments and solutions daily made. Materials and production for Victory take precedence over everything else—and hundreds of Bogen Paging and Communication systems are speeding the efforts of our Army, Navy and Air Forces. We want to thank our many old customers and good friends for the patience they have demonstrated in the matter of deliveries. Their willingness to wait is the strongest possible tribute to Bogen.

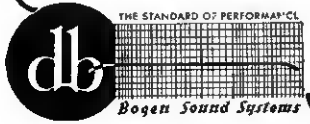

DAVID BOGEN CO., Inc.
663 Broadway, New York City

Alter Shortwave Sets for Aliens

The Attorney General of the United States, Francis Biddle, has just issued a circular letter to local and state police authorities, ordering that all enemy aliens in the United States turn in to the nearest police station all short-wave sets and cameras in their possession.

Any radio set in the hands of an enemy alien, which is capable of receiving radio signals other than those of the standard broadcast band, must by this order be immediately surrendered to the police, "unless the set is so altered or modified" that such signals cannot be received. Police are further instructed by the Attorney General to use every consideration to make this regulation impose as little hardship or inconvenience on well-intentioned aliens as possible.

The Department of Justice order thus seems to open the way for radio servicemen to render a useful service of eliminating shortwave reception from aliens' sets—and get paid for it. In this way, the alien may keep his set for regular broadcast listening to U. S. stations, while the police authorities are spared the storage of hundreds of radio sets which they are poorly equipped to handle. And the radio man collects \$1 to \$2 per radio set altered.

Be Sure of Changes

Radio men who perform this service of altering aliens' receivers, should make sure that the changes they make are completely effective, so that under no circumstances can short-wave reception be restored without the addition of new parts, or additional wiring. Vital circuits or parts should be completely removed if possible and retained by the serviceman with his complete record of the job. Where short-wave coils cannot be removed, they should be shorted and the leads to the bandswitch removed.

In addition, the serviceman undertaking such alteration work on short-wave sets of enemy aliens, should keep a log book or record of all sets so altered. In this log book he should enter:

Name and address of owner of set (verifying identification carefully).
Date alteration was made. Number of persons in owner's family or household. Other radios in use in that household.

Name and model of set altered.
Year. Circuit employed.

What changes made to make set comply with regulations.

Does serviceman suspect alien owner of possessing or using another short-wave set which has not been altered.

Such a record of facts in connection with the alteration is necessary if the serviceman is afterwards approached



by government agents and asked to make a statement concerning the work he performed, and the circumstances surrounding the alteration.

With over a million enemy aliens now in the United States, and with nearly two-thirds of all home radios equipped for short-wave reception, it is apparent that a tremendous number of radio receivers are involved under the Attorney General's order.

By setting himself up to make alterations completely and effectively, meanwhile keeping a complete record of all such work done, the radio craftsman will be doing a job in the public interest, and helping both the alien and the police.

Servicemen Say Thanks for Ads

A group of 200 servicemen in the Chicago area recently got together and signed a testimonial addressed to L. W. Teegarden, manager of RCA's radio and tube divisions. It was a vigorous vote of thanks to RCA for the series of radio service ads run in *Collier's* magazine, which the Chicago radio men said they greatly appreciated because of the timeliness and because "it stresses our constant desire to service the public honestly in a manner that will always merit the confidence and good will of radio owners."

The Walker-Jamieson Co., RCA jobbers in the area, report that servicemen in the area are practically unanimous in applauding the ad series.

Pennsylvania Servicemen Tackle War Jobs

The position of the radio serviceman during war times was the chief topic for discussion when RSA members at Wilkes-Barre, Pa., met for regular session Jan. 6. One matter decided on was that the method for removing the short wave band from radios owned by aliens should be standardized.

Members at the meeting were Spencer Eddy, Austin Renville, John Kennedy, Ralph Brown, Pat Maneval, Edward Buckman, Stanley Dudek, Michael Kulka, Ralph Fitzgerald, Frank Gross, Paul Biniek, Edward Nowicki, and the secretary, C. F. Bogdan.

Rep Moves to Boston

The Henry P. Segel Co., formerly located at 235 Pine St., Gardner, Mass., has moved to 221 Columbus Ave., Boston, Mass. Mr. Segel cites "our increased business and our desire to improve our service to customers and manufacturers" as reasons for the move. Among the lines now handled here are Kato generating plants (on display); Supreme Instruments; Bud Radio; Turner mikes and vibrators; and Masco amplifiers.

HAVE YOU EVER SEEN ALL THE CLIPS THAT MUELLER OFFERS?

Special Clips
for
Every Use



Solid Copper Clips



Insulated Clips



Send for Free Samples and Catalog 980
MUELLER ELECTRIC CO., 1573 East 31st St., CLEVELAND, O.

CUT RADIO REPAIR TIME AND INCREASE SERVICING PROFIT

This new handbook shows you how!

RADIO Troubleshooter's HANDBOOK

A. A. GHIRARDI
Author

\$3.50
only

COMPLETE IN ONE BIG VOLUME



710 PAGES!

New revised and enlarged

NEVER before in radio servicing have minutes meant money the way they do now! To speed up troubleshooting, cut repair time on every service job . . . to make your working day pay you the biggest profit, send at once for Ghirardi's revised, enlarged on-the-job **RADIO TROUBLESHOOTER'S HANDBOOK**.

Here, boiled down to essentials for you, skillfully tabulated and indexed for split-second reference, is everything you need on hand for 1942 servicing. Imagine having in one handy volume such working service data as: trouble and remedy Case Histories for 4,607 models of 196 makes of receivers and record changers . . . alignment instructions for more than 20,173 superhets . . . noise elimination charts for auto radios installed in all car models . . . complete servicing information with charts and tables—66 BIG SECTIONS IN ALL, each one as easy to refer to as a name in your phone book.

710 pages of "shirt sleeve" working data to help you save time and make more money at service work. Over 400 pages of vital new information never before published. And all of it factory-checked; none of it duplicating any data in existing servicing manuals. It's the quickest, surest, most economical way to increase your efficiency and earn a greater share of the profits in radio today! Get your copy at once. This revised and enlarged edition of the **RADIO TROUBLESHOOTER'S HANDBOOK**, complete, is still only \$3.50.

OTHER GHIRARDI BOOKS TO HELP YOU

RADIO PHYSICS COURSE
A complete home-study radio course so head-and-shoulders above anything in the field that it is used as the basic text by thousands of students and schools. World's greatest collection of radio knowledge gathered together in one huge 972-page volume. Everything is explained clearly, and illustrated, and easy to understand for quick study and reference. Complete in one volume, \$5.00.

MODERN RADIO SERVICING
A practical How-to-Do-It home-study course in radio service work. Easy to understand. Teaches you step by step all about test instruments, troubleshooting, testing and repair. Trains you at home in spare time for profitable radio servicing. By the expert, A. A. Ghirardi, who packs a lifetime of remarkable radio experience into its 1300 pages, for only \$5.00.

SPECIAL "COMBINATION" OFFER brings you two great books—**MODERN RADIO SERVICING** and the **RADIO TROUBLESHOOTER'S HANDBOOK** at the special money-saving price of \$8.00.

YOUR LOCAL DISTRIBUTOR should be able to supply you with **RADIO TROUBLESHOOTER'S HANDBOOK** and the other books in Ghirardi's modern radio "library". If he is out of stock, use this coupon to order direct.

FREE COLOR CODE CHART!
Send for your copy of Ghirardi's new Capacitor & Resistor Color Code Wall Chart. Easy-to-read, it gives you all RMA coding arrangements at a glance. Check the coupon to get your FREE copy.

SEE YOUR DISTRIBUTOR OR MAIL THIS COUPON NOW!

RADIO & TECHNICAL PUBLISHING CO. Dept. RRT-12
45 Astor Place, New York, N. Y.

Enclosed find payment for books I have checked (on 5-days' trial). I understand that if I am not fully satisfied, I may return the book(s) at the end of the trial period and receive my money back.

(1) Radio Troubleshooter's Handbook \$3.50 (\$4 foreign)
(2) Radio Physics Course \$5.00 (\$5.50 foreign)
(3) Modern Radio Servicing \$5.00 (\$5.50 foreign)

(1) and (3) combined in your special offer \$8 (\$9 foreign)

Rush my FREE Color Code Chart
 Send FREE literature on book (1), (2), (3)

NAME

ADDRESS

CITY..... STATE.....

Prepare

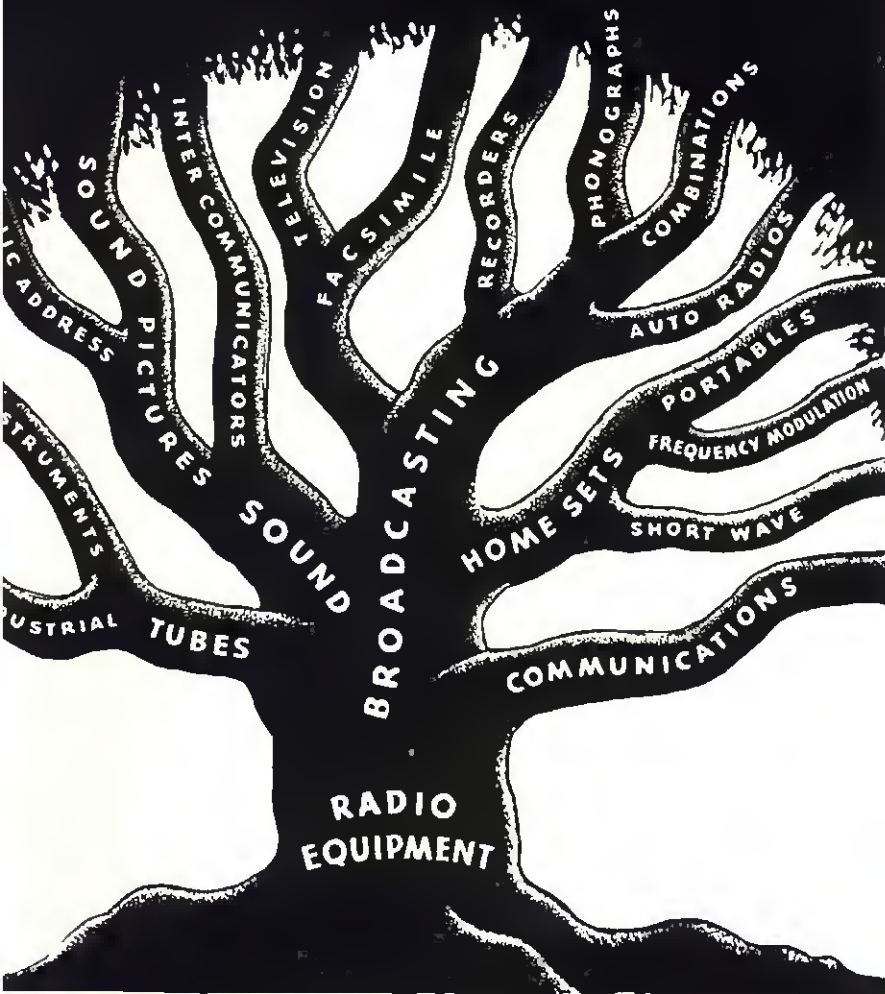

NOW for

RAD

Includin

PUBLISHED AS AN
INTEGRAL SECTION OF
RADIO RETAILING TODAY

in March

Note these Features!

- ✓ Classified lists of manufacturers of all sets, sound equipment, transmitters, record players, combinations, recorders, intercommunicators, testing instruments, etc.
- ✓ Classified lists of manufacturers of tubes, parts, accessories, equipment, phonograph records, recording blanks, needles, batteries and raw materials.
- ✓ Charts, diagrams and tables of year-round reference value.
- ✓ The only radio trade directory that lists all classes of products for both manufacturing and distribution.

SPECIAL ADVERTISING FEATURES

- ✓ Immediate nationwide coverage of radio buying power—industry and trade.
- ✓ Advertisements placed alongside or adjacent to the manufacturer's listing, if immediate reservation is made.
- ✓ Striking visibility due to special position and makeup.
- ✓ Maximum prominence as a source of supply all year long.
- ✓ No other publication, trade or technical, can match the engineering, purchasing and executive coverage of the RADIO YEAR BOOK & TRADE DIRECTORY in the manufacturing and broadcasting fields, or its coverage of buying power in the merchandising and servicing fields.

1942-1943

RADIO YEAR BOOK

Including
RADIO TRADE DIRECTORY



CALDWELL-CLEMENTS, INC., 480 Lexington Avenue, NEW YORK

the 1942-43

RADIO YEAR BOOK

RADIO TRADE DIRECTORY

With the radio industries on a total-war footing, do you know where to get the products you need for Distribution or Defense?

UPPERMOST in the minds of responsible radio men today is the problem of getting the products and materials they need.

Whether they are manufacturers, jobbers, dealers or servicemen—whether engineers or technicians in Sound, Communications, Broadcasting or Recording—they have a common problem varying only in degree and detail.

Today, as we begin to compile the new edition of the RADIO YEAR BOOK & TRADE DIRECTORY, it is quite obvious that *product availability* is the neck of the radio bottle. Hence the directory section of the RADIO YEAR BOOK, with its usual thoroughness, will have radio's most comprehensive listing of manufacturers; complete in one issue—all classified by types of products, firm names, brand names and addresses.

The importance of these listings, and the opportunity for adjacent advertising, should not be underestimated by any manufacturer even though he is engaged in defense work. Under present conditions, the loss of markets is too easy and too costly to permit of any indifference to the trade.

No manufacturer is alone in having shortages—either commercial or defense. Nor should any manufacturer, through lack of merchandise and lack of advertising jeopardize the trade's interest in his company or his product.

The year-round selling power or prestige-value of a listing in the RADIO YEAR BOOK & TRADE DIRECTORY, is greatly amplified when the manufacturer uses advertising space to supplement the information in his listing.

Product copy or prestige copy—and sometimes a combination of both—is an excellent *anchor* for a brand that is likely to suffer from the sharp shifting of distribution now in progress.

During periods when merchandise cannot be furnished, the important thing is to assure the trade that no permanent withdrawal from the field is contemplated. Furthermore, when the manufacturer keeps his foot in the door, through suitable advertising, he protects his market against competition, new or old.

Manufacturers-

MAIL THIS COUPON FOR FURTHER DETAILS OF DIRECTORY LISTINGS AND ADVERTISING SPACE



CALDWELL-CLEMENTS, Inc.
480 Lexington Ave.
New York N. Y.

Send details of free directory listings in the new edition of the RADIO YEAR BOOK & TRADE DIRECTORY, to appear in March as a section of RADIO RETAILING TODAY.

Without obligation, send details of advertising space in the new edition of the RADIO YEAR BOOK & TRADE DIRECTORY to appear in March as a section of RADIO RETAILING TODAY.

Name
Address
Products



CALDWELL-CLEMENTS, Inc.
480 Lexington Avenue, New York, N. Y.

★ ★ ★ ★ ★
FOR SERVICE
 This New Broadcast Model
 at LOW COST
 Offering Full Profits

New
TURNER
211 Dynamic
 Styled and Engineered
 to Sell and Stay Sold!

A quality mike that outperforms many units selling at twice the price! Utilizes new type magnet structure and acoustic network; unique diaphragm structure results in low harmonic and phase distortion, without sacrificing high output level. Frequency range widely extended. It's the mike for critical P.A. use, commercial broadcasting, extra intelligibility in sound systems for military areas, defense plants and paging systems. Rich brushed chrome finish, tilting head. 200,500 ohm and hi-impedance. List.....\$45.00 (Price subject to change without notice.)

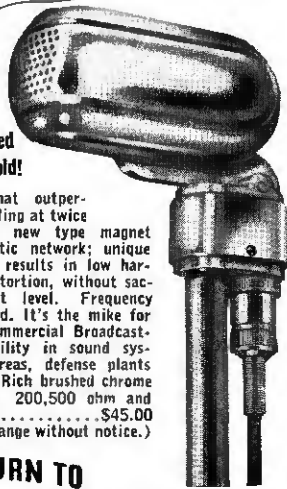

WRITE NOW for Complete Catalog
The Turner Co.
 915 17th St., NE.
 Cedar Rapids, Iowa

LIMITED SET PRODUCTION = INCREASED SERVICE

Be ready for it with a
DEPENDABLE DRAKE SOLDERING IRON

You're always sure of being ready with this extra hot 125 watt DRAKE iron with 3/8 in. tip. Check up today on DRAKE Radio Soldering Irons.



No. 325 SPECIAL List\$5.00



SEE YOUR RADIO PARTS JOBBER

DRAKE ELECTRIC WORKS, INC.
 3656 LINCOLN AVE. CHICAGO, ILL.

Navy Enlists Radio Men

The U.S. Navy now needs radio men for special training and duty in connection with its new "radio locators" which are used in detecting planes and other aircraft. Those with practical radio experience are being enlisted as "Radioman Second Class," Naval Reserve—a rating that pays \$72 monthly and all expenses.

Applicants must (a) be male citizens between the ages of 17 and 50, (b) be a high school graduate, (c) hold or have held an Amateur Class A or B license, or, if no amateur experience, be actively engaged in radio repair or service work or have had experience with transmitting or receiving equipment.

Men selected will be sent to a Naval Training School for an intensive 8 months' course in mathematics and radio theory and its application to the locator devices.

Students who successfully complete the course may be recommended by the Officer-in-Charge of the School for advancement in rating up to and including "Chief Radioman" (at \$99 monthly, plus allowances). This work with the new and secret radio locators will prove especially attractive to many professional radio men, since it embraces a branch of the radio science which will have many post-war commercial applications.

All Navy Recruiting Stations are prepared to provide additional details.

Refrigerator Trade-In Problems?

A new 1942 guide to refrigerator trade-ins—a complete handbook and manual for dealers—is now offered by Standard Refrigerator Trade-In Manual Co., 41 Union Square, New York, N. Y. The book covers the field since 1928, and has over 700 illustrations, with detailed specifications and an analysis of present market conditions.

The introductory price is \$1.75 and early orders get a supplement showing 1942 refrigerator models, free.

Six Jobbers for Crosley

Six new distributors for Crosley products have been announced. They are J. & N. Ceazan Co., Los Angeles; Wichita Wholesale Furniture Co., Wichita, Kansas; Dealer's Appliance Co., Kansas City, Missouri; Electric Fixture & Supply Co., Omaha, Nebraska; Major Appliance Co., Jacksonville, Florida; and the Tracy-Wells Co., Columbus, Ohio.

Auster to Govt. Post

Milton Auster, radio pioneer, the New York distributor, Dale Radio Co., has been appointed as a business specialist on radio parts in the Emergency Management Office of the Office of Price Administration, Washington.

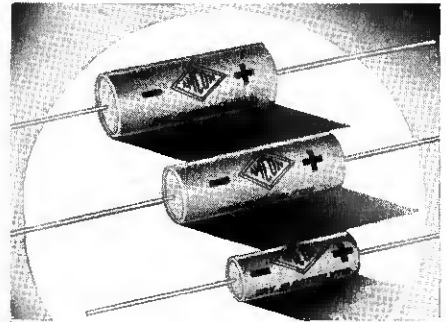

EXTRA PROFITS FOR SERVICEMEN WHO REPLACE WITH FAMOUS Little Americans

MODERN ELECTROLYTIC AND BY-PASS CAPACITORS

Smaller and more dependable with stepped-up quality and a performance ability that leaves an endless chain of satisfied customers. Available in all standard capacities and voltages.

EASY REPLACEMENTS
 Readily wires into the most inaccessible spots. Firmly anchored tinned leads take to the solder like a duck takes to water. Use them on all your replacements.

DEPENDABLE QUALITY
 When you replace with Little Americans you assure customer satisfaction . . . improved set performance—and you can bank with confidence on their dependability and long service life.

Order from your **JOBBER**
AMERICAN CONDENSER CORP.
 2508 S. Michigan Ave. Chicago, Ill.



LITTELFUSE
 Instantly and Automatically Insured by
Midget Mercury Switch



Has wide and increasing range of use: For auto glove and trunk compartments, thermostat circuits, refrigerators, radio door lights, sliding panel light, indicator circuits, safes, etc. Baffle on end of electrode prevents light flicking (as when car is on rough road). Central position of electrode makes it operative in any position. For circuits to 25 volts AC or DC, non-inductive, and currents up to 10 amps., at 6 volts, and 3 amps. at 25 volts. Whatever your application write us. Can be designed in several different types. Let us show you how it fits.

No. 1303 High Voltage Fuse Mounting

For 1000 volt fuses. 1" wide, 3 3/4" long, 3/8" thick. Overall height 1 3/16. Dependable. Send for catalog.

LITTELFUSE INC.
 4791 Ravenswood Ave., Chicago, Illinois

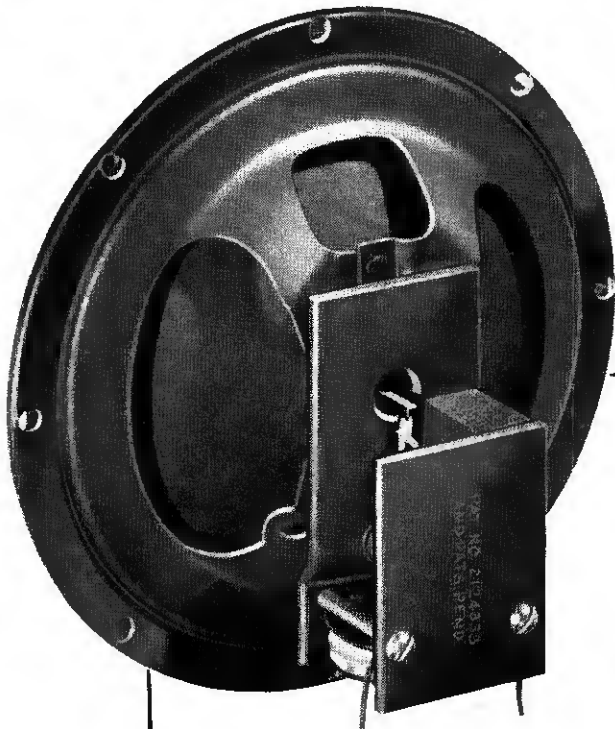

An Open Letter to the Radio Industry!

Today every industry has its headaches — some more than others. The Radio Industry is no exception.

On the one hand, we recognize, and our Government recognizes, the important part civilian radio will play in driving this war to a victorious conclusion. It is imperative that our people are not deprived of radio facilities.

On the other hand we find some of the materials needed to manufacture radio receivers are now most vitally needed in the construction of armament. To an honest American there is no question as to which demand receives precedence.

Here is a problem — and a challenge. But the radio industry has successfully met many such a challenge — and will meet this one!

No more striking example of the response of the radio industry to such a problem can be presented than the QUAM PERMANIC SPEAKER for Battery Radio. Here is a speaker, departing radically from conventional design, that offers better performance and

depth of tone, better sensitivity and bass response and output comparable to a dynamic of similar size.

It is no "ersatz" speaker — but a very definite improvement in speaker design and performance. Even in days of normal supply and demand it would be revolutionary.

And, incredible as it seems, the QUAM PERMANIC requires only ONE THIRD OF THE VITAL DEFENSE MATERIALS used in a speaker of conventional design! Furthermore, and in spite of its vastly improved performance, the QUAM PERMANIC can be offered at but approximately 70% of the cost of a Dynamic Speaker of good quality and similar size. This, remember, in the face of substantially improved performance!

This is the spirit in which the radio industry will meet its present problems — as it has accepted every challenge in the past — not merely by overcoming an obstacle, but at the same time carrying its standards a little higher. It is the spirit of an ingenious America, a victorious America!

THE QUAM-NICHOLS COMPANY
Cottage Grove at 33rd Place Chicago 1674 Broadway New York City

THE QUAM PERMANIC SPEAKER
FOR BATTERY RADIO

Sound Helps America

Nation's Industries Profit from Coordination and Morale-Building Features of Public-Address Systems

• America at war is taking advantage of every scientific aid to guarantee that we will win. Sound systems for amplified music, selective and mass intercommunication, are doing a great job to speed our country's efforts.

One of the newest uses of sound in this country is the "ear-conditioning" of civilians and civil defense groups to the terrific noise of air raids. Recordings of actual bombings complete with air raid sirens, anti-aircraft barges, and thunderous concussion of exploding bombs are amplified to sound levels near the actual ones. After the most peaceful minded house-

holder has sat through five or ten minutes of this ear-splitting excitement, he is usually seized with a new understanding of the terrors of an air attack, and is ready to play an active part in organizing his own community to protect itself against any such attack.

Morale Building with Recordings

Recordings are being used to build morale among industrial workers and so to speed up war material production. And now amplified melodies are even accelerating the building of battleships in the same way that whole brass bands were enlisted to stimulate ship building during World War I. It is therefore no surprise to radio men to learn that the 35,000-ton battleship *Alabama*, under construction at a navy yard, is being built to music. The program comprises six concerts daily, from records played through an amplifying system—four during the shifts and two at lunch-time. The music is described as "sweet and swing," "classic and corny" and its effect upon the workers is found to be stimulating and to promote increased spirit and effort.

In fact, the record-breaking total of a hundred major sound amplifying and reproducing systems were installed during a recent 30-day period, including a number of unusual installations.

The huge new munition plant built by the government in Indiana takes full advantage of sound systems to handle the great number of workmen. At left is the observation tower with its announcement speakers. Below is partial view of the 99 time-clock alleys.

These sound jobs reveal the constantly widening field for "sound" in business and industry, during the present critical period.

Sound on Railroads

For example, twelve 100-watt loudspeakers are doing yeoman duty in the Roanoke classifying yards of the Norfolk and Western railroad, handling war-time traffic—constituting one of the most powerful systems of its type in the world. Since the installation, operations in the switching yard have been carried on with a notable increase in efficiency. Orders are now communicated verbally over large areas, doing away with the need for time-consuming signaling by lights and flags.

Another unique sound installation has been completed at the Des Moines Ordnance Plant by the Technical Service Corp. of Des Moines. This system includes a master control station in the Administration Building where microphone, radio and phonograph facilities have been provided. Remote microphones are provided as well at the telephone switchboard, for paging, at several other points in the plant. Four groups of loudspeakers are employed powered by amplifiers installed on the poles which support the horns. Signals from the control station are transmitted to the remote amplifiers over telephone cables.

Munition Factories

A powerful sound system designed for permanent use in a new U.S. munitions depot at New Brighton, Minn., was installed ahead of time so that it could also be used by the building contractor for expediting and paging. The apparatus consists of a central control cabinet with microphone and phonograph facilities feeding 64 power amplifiers which, in turn, drive 32 100-watt loudspeakers. The system is so arranged that any of the 10 groups of speakers covering various parts of the plant can be used individually for paging in selected areas, or the whole system may be used for plant-wide coverage.

Another sound system has been installed in a big brewery at Albany, N. Y. A number of powerful re-entrant loudspeakers are placed at intervals throughout the warehouse and on the loading platforms. To acknowledge the call, the person being



paged goes to the nearest of a number of communicator stations located throughout the plant.

Making Ships with Music

The Oregon Shipbuilding Corp. has installed an extensive industrial sound system which provides recorded music programs for the plant, in addition to paging and announcing facilities. Nine large speaker-trumpets are driven by 150 watts of power. The system is also used to provide music during the lunch and supper hours for the workers.

During the same month, sound systems were installed in 21 schools and colleges, 12 industrial plants, eight churches, seven U.S. Government projects, 11 hotels, hospitals and institutions, and in such miscellaneous locations as a race track, several funeral homes, auditoriums, department stores, lodges, restaurants, a roller rink, a bowling alley and a night club. In addition, one city in Kansas purchased a mobile sound system, so that the police cars cruising around town can issue stentorian traffic commands to infractors of local rules of the road.

Safety Messages

When modern sound installations are made in industrial plants, the purpose is above all to stimulate morale and to promote general good feeling between workers and management, by the introduction of pleasing music during working hours.

Even though the noise conditions in such plants may reach such high intensities as 65 to 100 decibels, it has been found possible to use individual loudspeakers at each machine so that the music being played is heard clearly above the factory roar.

The loudspeaker system can also be used for local plant broadcasts of safety instructions and for possible air-raid warnings.

The musical programs are started 5 minutes before the time work is to

War Jobs for Sound

Building morale and reducing fatigue of factory workers.

Serving as air-raid warning systems in plants and cities.

Directing and instructing large numbers of industry employees.

Conditioning civilian defense workers to sounds of bombing and raid noises.

Testing parts subject to vibration with powerful amplifying equipment.

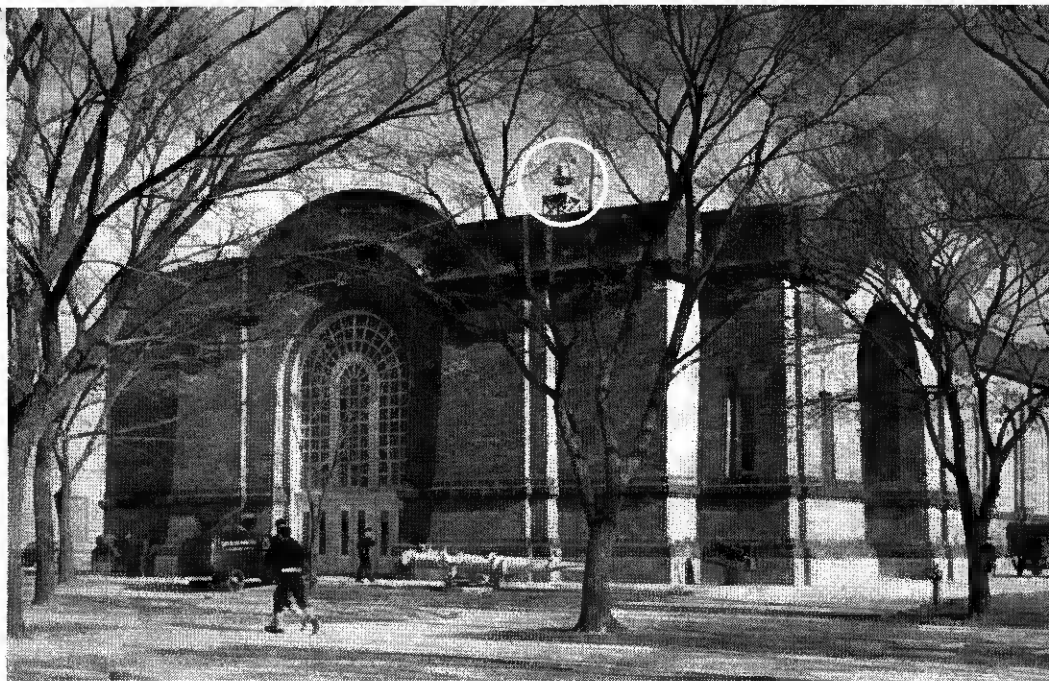

Sailors at the Great Lakes Naval Training Station have all the music they want from the complete sound system which delivers the latest in recordings and Bernardian Chimes throughout the area. Note speaker atop the building.

begin and thus have the effect of getting employes in and ready to begin work promptly.

Sound Relieves Fatigue

Industrial tests have shown that in factory work there is a peak of fatigue occurring about 11 a.m. To offset this, music is begun at 10:55 a.m. and continued 24 minutes until 11:19 a.m.

Then at the noon hour, news is given while the employes eat lunch in the cafeteria or alongside their machines. At 12:30 a "request" program of musical selections follows.

Other fatigue peaks occur at 2:30 and about 4 p.m. and these are again periods for quarter-hour musical selections. At closing time, music is again heard. The noon-hour "request" musical programs which follow the noon news periods, are made up of selections chosen by the employes themselves, and thus they feel that they have a hand in arranging the noon music. Wedding marches and "happy-birthday" greetings are often included on appropriate occasions.

The usual practice for the supply of the necessary musical recordings, is to furnish an initial plant "library" of 500 records, and then to furnish 100 new records a month, on an exchange basis. This accomplishes the elimination of old records, and continuously keeps the local industrial-music collection both up-to-date and in good operating condition.

In some of the workrooms where the new industrial music has been installed, high noise levels prevail but the new music system successfully meets this difficulty, particularly with the aid of small local speakers in-

stalled at each machine in rooms where the noise is great. In general women like the music to be distinctly audible, so they can follow the melodies. Men at work, on the other hand, prefer music only as a "background" and so for male workers the music levels need be relatively low and the sound sources can be large centralized speakers.

In contrast with workrooms of high noise intensity are certain departments in textile plants, such as the burling or mending rooms, where the hand workers are surrounded by mountains of cloth material which maintain a depressing pall of silence all day long. In these hitherto "silent-as-the-tomb" departments, the coming of amplified music has been a great relief to the workers, tremendously stimulating their interest in their work and their sense of well-being.

The effect of such music in industry has been to increase production from 6 to 11 per cent. But the great benefit to be accomplished is the stimulation of employe morale, reduction of fatigue, and the building of a splendid spirit of friendly cooperation between workers and management.

Battleships are built to music and launched with the aid of sound systems. Shipyard men working overtime do their jobs more efficiently if they can listen to their favorite tunes. University Labs. speakers were used in the ceremony shown at right.

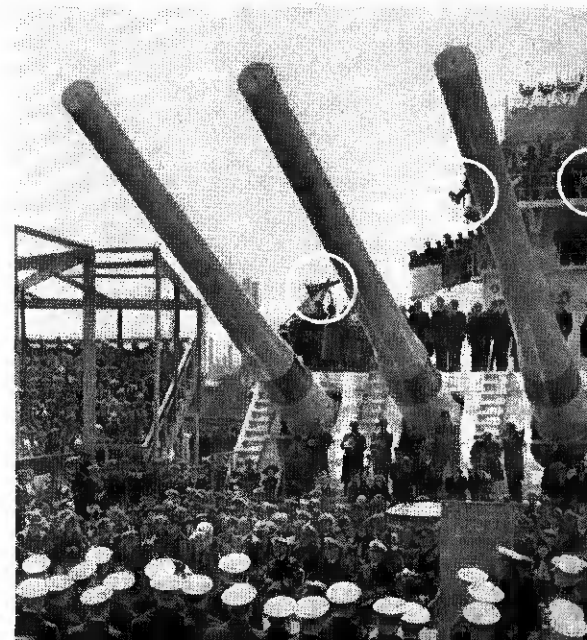



THE STRANGE CASE OF SERVICEMAN WALDO MUDD

Dear Miss Barefacts:
 I know that your column is entitled "Advice to the Loveless" and I am not loveless. As a matter of fact, I have more love than I know what to do with. That's why I am writing to you.
 You see, Miss Barefacts, I am a radio service man. I make good money and I'm very happy. I mean I was happy until I met Arabella Blouts. She is one of my customers. In fact, she is my very best customer. That's the trouble.



Arabella has a very nice apartment with about eight radios in it. The first time she called me, I went over and fixed two of the radios in about half an hour. Then Arabella asked me to sit down and have a drink with her.
 The correspondence course I took in radio servicing didn't say anything about what to do in a case like this. Besides, I don't drink anything but ginger ale. However, Arabella insisted, so I asked for ginger ale. It was very funny tasting ginger ale and I even felt funny after I drank it.
 Then Arabella sat down beside me. She is a very big girl. Also, she is very determined. Every time I moved away from her, she shoved over closer to me. Finally, I was at the end of the davenport and couldn't move any farther. Also, I was at the end of my wits.
 When I got back to my shop, I remembered she hadn't paid me for fixing the radio. Also, I was dizzy and didn't feel like working any more that day.
 The next day, Arabella called and said both of the radios I had fixed were broken again and would I please come right over. Well, there wasn't anything to do but go over and fix them. So I did.

Then the same thing happened again, the very next day.
 However, Miss Barefacts, I will not bore you by telling you any more of this sort of thing. Suffice to say, it was six months ago that Arabella first called me. Since then, she has called me almost every day. I have fixed all of her radios at least a half dozen times each and she still hasn't paid me for a single job. What's more, I am afraid to send her a bill. Arabella is funny that way. She might get mad and not call me any more. After all, she is the best customer I have.
 What shall I do?

Very truly yours,
WALDO MUDD,
Radio Service Man.

★ ★ ★
Dear Mr. Mudd:
 Don't worry. Your problem should be an easy one to solve. My first suggestion is that you marry Arabella Blouts. Evidently that would please her. Then you can repair her radios in your spare time and spend the rest of your time at work for which you will be paid. My second suggestion is that, in the future, you use Sprague Condensers and Koolohm Resistors for every replacement. Once you install them you can forget them—and so can your customer. Then, the next time you meet a girl like Arabella, she will have to be more original in finding an excuse to invite you back again.
 Sincerely yours,
GERTRUDE BAREFACTS,
 Editor, "Advice to the Loveless Column."

SALES HELPS

Donald Duck in Tube Display



Now being distributed by jobbers of Hygrade Sylvania Corp. is a brand new tube display for dealers and servicemen, with Donald Duck doing a lively tube-selling job in eight colors. The new job comes in two sizes, 36" high and 12" high, and is thus adaptable to available space in windows or on counters. Both have easels. Art work for these was done by Walt Disney studios.
 It is recommended by Sylvania's director of advertising, Paul S. Ellison, that radio men get together with local movie houses, to help publicize local showings of Donald Duck cartoons and thus get extra notice for the popular Duck's tube connections.

• ATOMS are made in five different types, thus making them practically universal for any replacement job whether it calls for a single-section or multi-capacity unit, lug mounting, or a condenser with separate positive and negative leads.

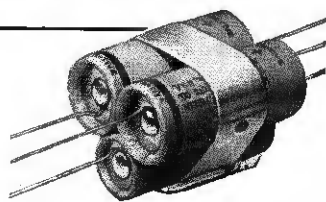

Make up hard-to-get replacements by strapping individual Atoms together with ST Mounting Straps—supplied free! You'll find the combined Atoms actually smaller, often cheaper, and fully as reliable. You save time—money—space.

SPRAGUE PRODUCTS CO.

North Adams, Mass.

GOOD CONDENSERS—EXPERTLY ENGINEERED—COMPETENTLY PRODUCED

AMERICAN RADIO TUBE CO.

Manufacturers of

BALLAST TUBES

• • •

**RADIO TUBES DIAL LIGHTS
VOLUME CONTROLS
CONDENSERS**

Distributed by

ART RADIO CORP.

115 LIBERTY ST. NEW YORK

Quality at Lowest Prices . . .

Send for Price List . . .

ART RADIO CORP.,
115 Liberty St., N. Y. C.

Gentlemen: As per "ad" in RADIO TODAY please send Price List.

NAME

ADDRESS

CITY..... STATE.....

Please Indicate SERV. MAN DEALER

Serv. Man or Dealer

Blue and Gold



Philco dealers can get striking effect with this new floor display, in 3 shades of blue, with gold base and pillars. Two wings are also available.

Sparton Radios in Big Promotion

A vigorous promotion campaign on Sparton radios, highlighted by double-page ads in the magazine *Life*, is now under way. Scale of the drive exceeds all efforts of recent years, according

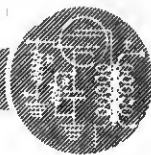

Accessory Manager

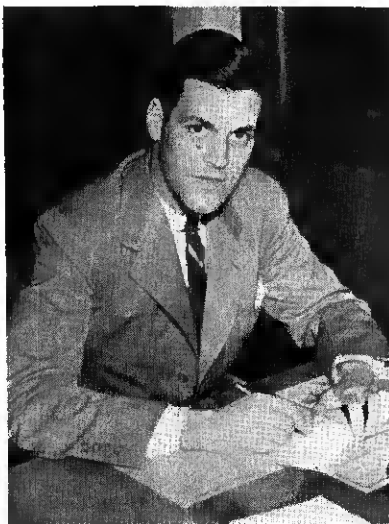

James M. Skinner, Jr., the new manager of Philco's Accessory Division, outlined complete new sales plans for auto sets, tubes, batteries and parts, at Philadelphia meeting of company officials and district reps.

to F. T. Sterritt, advertising manager for Sparks-Withington Co., Jackson, Mich. Current ads feature combinations and include a "Partial list of exclusive dealers in cities over 50,000."

The new program includes complete merchandising helps which come directly from Jackson, Mich., headquarters—pre-proofs of ads, new catalog, elaborate full-line folders, etc.

NEW BOOKLETS

An illustrated catalog, P-1, on Wernco Plastiktrim, an extruded plastic decorative trim, is available from R. D. Werner Co., Inc., 380 2nd Avenue, New York City.

A copy of the new folder describing the complete line of Gripmaster Strain Reliefs and the adaptability of same to cord and cable applications, will be sent on request from the George Walker Co., 118 Amsterdam Ave., Pasaic, N. J.

A limited number of copies of the FM Bibliography compiled by Miss Elizabeth Kelsey engineer of Zenith Radio Corp., 6001 Dickens Ave., Chicago, Ill., is available free for those who request them.

Ghirardi's newly revised and expanded "Radio Troubleshooter's Handbook" is described and a detailed listing of its 66 chapter titles is given in an attractive circular just issued by Radio & Technical Publ. Co., 45 Astor Place, New York, N. Y.

Vertrod Mfg. Co., 132 Nassau St., New York City, has published a folder on their FM, shortwave, television and broadcast antennas. Besides these specifications it gives directions on how to select the proper antenna and what you should know about radio receiving antennas.

Radio Sales Sharply Up

First reports on the results of Crosley's war-time radio sales campaign among the firm's distributors show that the jobbers delivered to their dealers 48.8 per cent as many radios in one week as during the entire previous four weeks. The report covers the first week of the drive launched by J. H. Rasmussen, shortly after war was declared.

R. I. Petrie, vice president and general sales manager of the company, says that "our distributors and dealers have been capitalizing profitably on the tremendous impetus given to radio receiver sales since America's

entry into the war opened up a vast new market."

Leader among the jobbers for this first period of the drive was Interstate Electric Co., New Orleans, La., whose week-long sales totalled 300.5 per cent of the sales for the previous four weeks.

Angle Honored

Wesley M. Angle, president, Stromberg-Carlson Tel. Mfg. Co., has been re-elected a director of the National Association of Manufacturers for 1942. Mr. Angle has been a member of the N.A.M.'s committee on employment relations.

NEW Quick-Reference Catalog 18 on Rheostats • Resistors • Tap Switches

FREE

OHMITE
RHEOSTATS • RESISTORS • TAP SWITCHES • CHOKES • ATTENUATORS

For Radio, Television, Sound, Electronic and Industrial Uses
CATALOG NUMBER 18

Especially useful today! Gives complete up-to-date information on the wide range of Ohmite stock resistors, rheostats, chokes and switches used in all types of applications—Lists over a thousand stock items, including new developments—Gives descriptions, ratings and prices—Helps you select the right units for each job, easily, quickly. Get your copy of this handy new Catalog 18 now! It's FREE.

Be Right with OHMITE

OHMITE MANUFACTURING COMPANY
4871 Flournoy St., Chicago, U. S. A.

Send Free Catalog 18.
 10c enclosed—Send Ohm's Law Calculator.

Name _____
Address _____
City _____ State _____
Rad. Ret.—Jan. '42.

Handy, Useful Ohm's Law Calculator

Figures, ohms, watts, volts, amperes—quickly, easily. Solves any Ohm's Law Problem with one setting of the slide. All values are direct reading. Does not require any slide rule knowledge. Size 4 1/8" x 9". Yours for only 10c to cover handling cost.

Be Right with OHMITE RHEOSTATS • RESISTORS • TAP SWITCHES



RADIART AERIAL for 1942

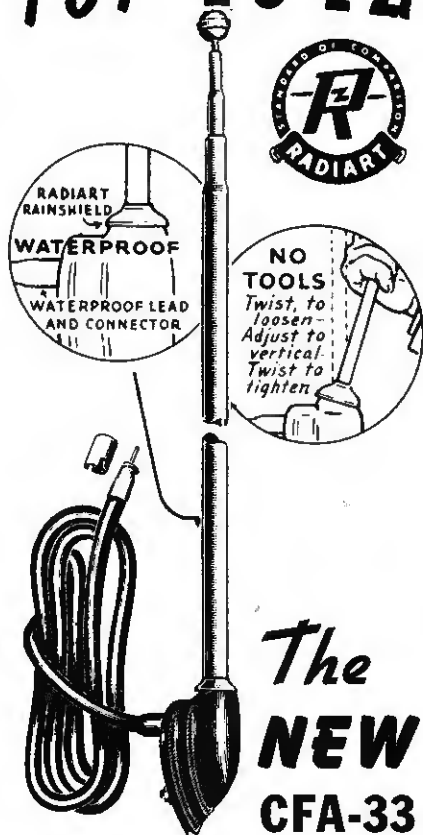

The
NEW
CFA-33

ALL-ANGLE

NO TOOLS
needed to adjust
"ALL-ANGLE"

WATERPROOF
AERIAL

WATERPROOF
LEAD

AND THE ROD IS
THEFTPROOF

Now Ready for Delivery

THE RADIART CORP
CLEVELAND, OHIO

Radio Engineers Tackle War Problems

The Institute of Radio Engineers, holding a three-day convention at the Commodore Hotel, New York City, January 12-14, witnessed a demonstration of the latest threat to any hit-and-run wireless transmitter which, in the hands of enemy agents, attempts to send a message to its home base and get off the air before being caught. This latest adjunct to radio listening posts was described by Dr. Marcel Wallace of the Panoramic Radio Corporation, as an electronic eye which spreads a picture of the broadcasting spectrum before the operator and aids his ear in detecting and locating a spurious transmission.

To the radio engineers assembled in the technical session, it represented one more instance of current engineering attack on possible enemy subterfuges involving communications.

Dr. F. B. Jewett, President of the National Academy of Sciences, told the convention that \$25,000,000 was being spent by American scientists mobilized in universities and commercial laboratories throughout the country, to wage a technological war on Germany and Nazi-inspired countries.

Noran E. Kersta, of National Broadcasting Company, recounted half a year's experience with commercial television and predicted that the system would before long, be geared to civilian defense, both to instruct and to warn populations in the metropolitan area.

In Dead Man's Guleh

Burton Browne, the Chicago advertising man, reports a shocking discovery made while he was vacationing on a ranch near Wickenburg, Ariz. Mr.

Browne spent a good deal of time in the saddle; one day he was riding along a canyon when he came upon the body of a young man, protruding from a cave. He found that the head and right hand of the man had been blown off by a dynamite blast which apparently had gone off while the charge was being fixed. The victim was unidentified.

Television as War Weapon

Television appeared as a defense weapon of national importance this month when a television class in instruction for air raid wardens was broadcast by NBC in New York City, and relayed to the General Electric Company's receiver in the Helderberg Mountains near Schenectady, 129 miles northwest of New York.

Air raid wardens, police chiefs, fire chiefs, etc., expressed the opinion that the television class was the most practical method of instruction yet devised. They stated that they had "learned more through this one show than through all the literature read and all other courses of instruction combined."

GE officials believe that television relay receivers installed at strategic points throughout New York State would be a most efficient means of assuring proper and complete instruction of air raid wardens and other war work volunteers on the farm and small communities.

A Thousand Parts

A 16-page catalog, No. 18, listing over a thousand stock items in rheostats, resistors, tap switches, chokes and attenuators has been issued by Ohmite Mfg. Co., 4835 W. Flournoy St., Chicago, Ill. A free copy may be had by writing to the company

Chicago Manufacturer Broadcasts Defense Report



As guests on "Chicago at Work" program, executives of Belden Mfg. Co., tell how Belden wires and cables figure in wartime production. Left to right, H. W. Clough, Henry Dorf (WHIP announcer), Whipple Jacobs, and C. S. Craigmile.



INDEX

To Advertisers

	Page
AEROVOX CORP.	68
ALLIANCE MFG. CO.	48
AMERICAN CONDENSER CORP.	72
ART RADIO CORP.	76
ASTATIC CORPORATION	44
AUDIO DEVICES, INC.	48
BITTER CONSTRUCTION CORP., A.	53
BOGEN CO., INC., DAVID	68
CENTRALAB	65
CLAROSTAT MFG. CO., INC.	60
CONTINENTAL MUSIC CO., INC.	31
CONTINENTAL RADIO & TELEV. CORP.	1
CROSLEY CORPORATION	7
DeWALD RADIO MFG. CORP.	50
DRAKE ELECTRIC WORKS, INC.	72
EDISON G. E. APPLIANCE CO., INC.	33
ESPEY MFG. CO., INC.	53
FARNSWORTH TELEV. & RADIO CORP.	8
GENERAL ELECTRIC CO.	2, 3, 67
GENERAL INDUSTRIES CO.	49
GREENLEE TOOL CO.	60
HOWARD RADIO CO.	53
HYGRADE SYLVANIA CORP.	6
INTERNATIONAL RESISTANCE CO.	63
KEN-RAD TUBE & LAMP CORP.	64
LISTEN	50
LITTELFUSE, INC.	72
MAJESTIC RADIO & TELEV. CORP.	52
MALLORY & CO., INC., P. R.	Cover 2, 59
McGRAW-HILL BOOK CO.	51
MEISSNER MFG. CO.	54
MUELLER ELECTRIC CO.	69
NATIONAL BROADCASTING CO.	4
NATIONAL UNION RADIO CORP.	62
NORGE DIV., BORG-WARNER CORP.	37
OHMITE MFG. CO.	77
PERMO PRODUCTS CORP.	49
PHILCO RADIO & TELEV. CORP.	39, 40, 41, 42
PRESTO RECORDING CORP.	49
QUAM-NICHOLS CO.	73
RADIART CORP.	78, 79
RADIO CITY PRODUCTS CO., INC.	80
RADIO CORPORATION OF AMERICA	Cover 3
RADIO & TECH. PUBLISHING CO.	69
RAYTHEON PRODUCTION CORP.	9
RCA MFG. CO., INC.	29, Cover 4
READRITE METER WORKS	60
RECOTON CORPORATION	50
RIDER, JOHN F.	66
SIMPSON ELECTRIC CO.	64
SONORA RADIO & TELEVISION CORP.	51
SPRAGUE PRODUCTS CO.	76
STROMBERG-CARLSON TELE. MFG. CO.	10
THORDARSON ELEC. MFG. CO.	80
TRIPLETT ELEC. INSTRUMENT CO.	62
TUNG-SOL LAMP WORKS, INC.	2, 3-Part II
TURNER CO.	72
UNIVERSITY LABORATORIES	50
UTAH RADIO PRODUCTS CO.	26, 27
VACO PRODUCTS CO.	64
WESTON ELEC. INSTRUMENT CORP.	61
WILCOX-GAY CORPORATION	25
ZENITH RADIO CORP.	5

While every precaution is taken to insure accuracy, we cannot guarantee against the possibility of an occasional change or omission in the preparation of this index.

AMATEURS

planning to play your part in

CIVILIAN DEFENSE

Get the story of
RADIART
VIPOWER for
 Mobile and Portable Amateur
 Emergency Stations . . .

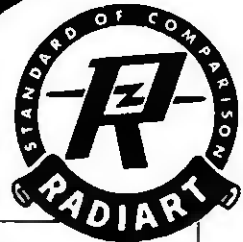

Check especially on

RADIART VIPOWER 4200-D or 4200-DF

—a compact unit delivering 300 volts at 100 m. a. Also tapped for other voltages. (4200-DF has built-in audio filter).

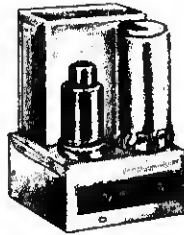

RADIART VIPOWER

4203-D. Same characteristics as Model 4200-D, except that the use of Radiart 4255 reversible synchronous vibrator eliminates the need for a rectifier tube.

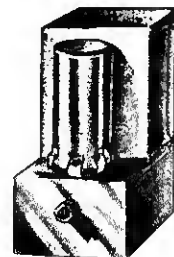

YOUR RADIART JOBBER
 will supply you with Bulletin 840 or
 keep in touch with the Radiart Engineer-
 ing Department for latest developments

THE RADIART CORP

CLEVELAND, OHIO

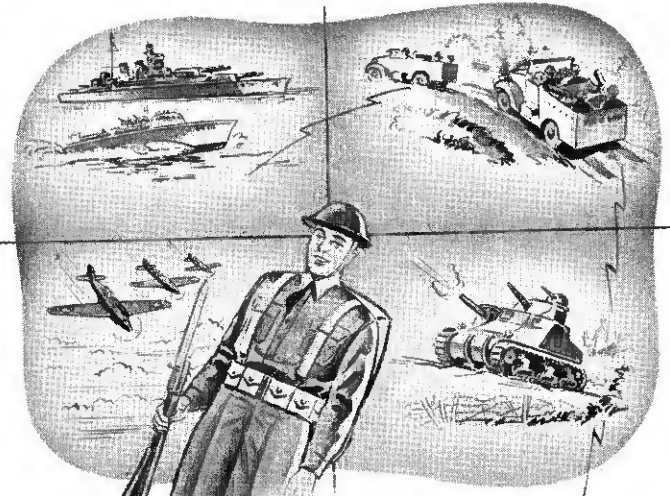

Communication established - but not without transformers - dependable transformers!

THORDARSON
Transformers

THORDARSON ELECTRIC MFG. CO., CHICAGO, ILL.

Transformer Specialists Since 1895



New Standards in Set Design

(Continued from page 23)

terial which gives the same magnetic force as previous Ahico magnets three times as large, points toward a 60 per cent savings of aluminum and nickel. As previously mentioned, electromagnetic speakers will probably not be used due to copper shortage.

Another important development in permanent magnet manufacturing is the use of scrap metal. Formerly, virgin metals were required, but this new process gives a larger available supply of material.

Radio Sets in 1942

To answer the question of whether this intensified search for materials for civilian radios is a necessary undertaking, one need only make a few estimates and observations.

The propaganda value of radio has never been questioned by any government, and the maintenance of a full strength listening public is highly desirable for a unified public opinion, and a mass emergency communication system.

For adequate coverage of the population we must have a receiving set in each of the approximately 30 million homes in this country, about 10 million sets for portable and office use, and about 10 million auto sets—one in every third car. Thus to maintain the desired audience size, about 50 million sets are needed. These sets have an average life of 4 to 6 years, and with intensified servicing this life could be extended to 8 or 10 years. Simple arithmetic shows that at least 5 to 6 million new sets must be built each year to keep the 50 million necessary sets in the hands of the American public.

Chart on Page 23

The chart, "What Goes Into the Average 5-Tube Set" has been drawn from data compiled by Dorman D. Israel, chief engineer of Emerson Radio Corp. The data is part of a paper, Civilian Receiver Design in 1942, presented by Mr. Israel at the IRE Fall Meeting.

The chart shows weights of materials for a typical 5-tube AC-DC broadcast band home receiver of three different designs, a 1940 model and two possible 1942-built sets.

WE CALL A Spade A Spade!
THAT'S WHY
Servicemen are buying
RCP TESTERS



You get what you pay for in RCP Test Equipment—quality, performance, dependability—all the wanted features, at lowest possible cost. Every dollar you invest in RCP is sound economy. Buy Radio City Products.

RCP 309 Dynoptimum TEST CIRCUIT

Tests new miniature and Bantam, Jr., tubes and all other new and old receiving tubes as well as all ballast tubes. Provides for tubes up to full line voltage. Tests at BMA specified plate voltages and leads. Hot interelement short and leakage tests between all individual elements. Hot cathode leakage test. Noise test—indicates noisy tubes that would otherwise test "good". Spare socket for future tubes with new base arrangements. Adjustable for all line voltages 105-135 with line voltage indication directly on meter. Direct reading. Simple and speedy to operate.



Only \$1895

RCP 446 AC-DC MULTITESTER

This instrument's been purchased by the hundreds for Defense Training. RCP Model 446 combines precision engineering with remarkably low price. Added to traditional RCP dependability, this RCP multitester becomes an unusual buy. Only... \$1195

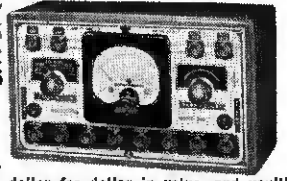

- DC Voltmeter 0/5/50/250/500/2500
- AC Milliammeter 0/1/10/100/1000
- DC Ammeter 0/10
- AC Voltmeter 0/10/100/500/1000
- Ohmmeter 0/500/100,000/1 Meg.

Compare it in appearance, compare it dollar for dollar in value, and you'll find Multitester Model 446 ranks with testers selling at far higher prices.

SEND FOR FREE CATALOG TODAY!



RADIO CITY
PRODUCTS CO. INC.
88 PARK PLACE, N. Y. C.

From the Earth to the Moon—that's the distance that the 80,000,000 metal tubes manufactured since 1935 would reach, placed fifteen feet apart!



Proved by ACCEPTANCE... Proved by PERFORMANCE!
"METAL" means MODERN!

ACCEPTANCE! In a little over six years, more than 80,000,000—yes, 80 million—RCA Metal Receiving Tubes have been used by the Industry in over 300 electronic applications. And today, RCA is turning out *more metal tubes than ever before*—for 1941 production outstripped all previous records!

ACCEPTANCE! Of the six largest-selling receiving tube types throughout the entire Industry... four are metal types—

two-thirds of the total!

PERFORMANCE—and performance alone—is the cause of such leadership. Metal tubes permit the designer to turn out better equipment... more efficient, more dependable! For six years, the majority of important receiving-tube improvements has appeared *first* in metal types—and many advantages still appear *only* in metal types!



"DESIGNED FOR METAL TUBES"
Means Better Equipment!

Look for metal-envelope tubes in the equipment you buy and sell. Remember that metal tubes give the highest efficiency... the highest performance standards... the highest reliability. And that means... lasting customer-satisfaction... extra good-will for you!



METAL TUBES

RCA Manufacturing Company, Inc., Camden, New Jersey
 A Service of the Radio Corporation of America • In Canada: RCA Victor Company, Ltd., Montreal



Radio...all out for Victory

Research and invention have placed radio in the first line of battle

COMMUNICATION—rapid communication—is a vital necessity, on land, at sea and in the air. RCA research and engineering developments in both radio and electronics are strengthening—and will further fortify—the bulwarks of our communications system. At Princeton, New Jersey, the new RCA Laboratories—the foremost center of radio research in the world—are under construction.

★ ★ ★

International circuits, operating on short and long waves, have made the United States the communication center of the world. Today, R.C.A. Communications, Inc., conducts direct radiotelegraph service with 49 countries.

★ ★ ★

Production of radio equipment is essential for news and timely information, for military and naval communications, for dissemination of news among foreign countries. The “arsenal of democracy” has a radio voice unsurpassed in range and efficiency. In the RCA Manufacturing Company’s plants, workers have pledged themselves to “beat the promise,” in production and delivery dates of radio equipment needed for war and civilian defense.

★ ★ ★

American life and property at sea are being safeguarded by ship-and-shore stations.

The Radiomarine Corporation of America has equipped more than 1500 American vessels with radio apparatus and is completely engaged in an all-out war effort.

★ ★ ★

Radio broadcasting is keeping the American people informed accurately and up-to-the-minute. It is a life-line of communication reaching 55,000,000 radio sets in homes and automobiles. It stands as the very symbol of democracy and is one of the essential freedoms for which America fights. The National Broadcasting Company—a service of RCA—and its associated stations, are fully organized for the coordination of war-time broadcasting.

★ ★ ★

New radio operators and technicians must be trained for wartime posts. RCA Institutes, the pioneer radio school of its kind in the United States, has more than 1,200 students enrolled and studying in its New York and Chicago classrooms.

★ ★ ★

When war came and America took its place on the widespread fighting front, radio was At the Ready . . . with radio men and radio facilities prepared to answer the call to duty “in the most tremendous undertaking of our national history.”

David Sarnoff
PRESIDENT



Radio Corporation of America

RADIO CITY, NEW YORK

The Services of RCA: RCA Manufacturing Co., Inc. • RCA Laboratories • R.C.A. Communications, Inc. National Broadcasting Company, Inc. • Radiomarine Corporation of America • RCA Institutes, Inc.