

RADIO RETAILING

25 CENTS PER COPY

McGraw-Hill Publishing Company, Inc.

"Clean Slate"

JANUARY 1939

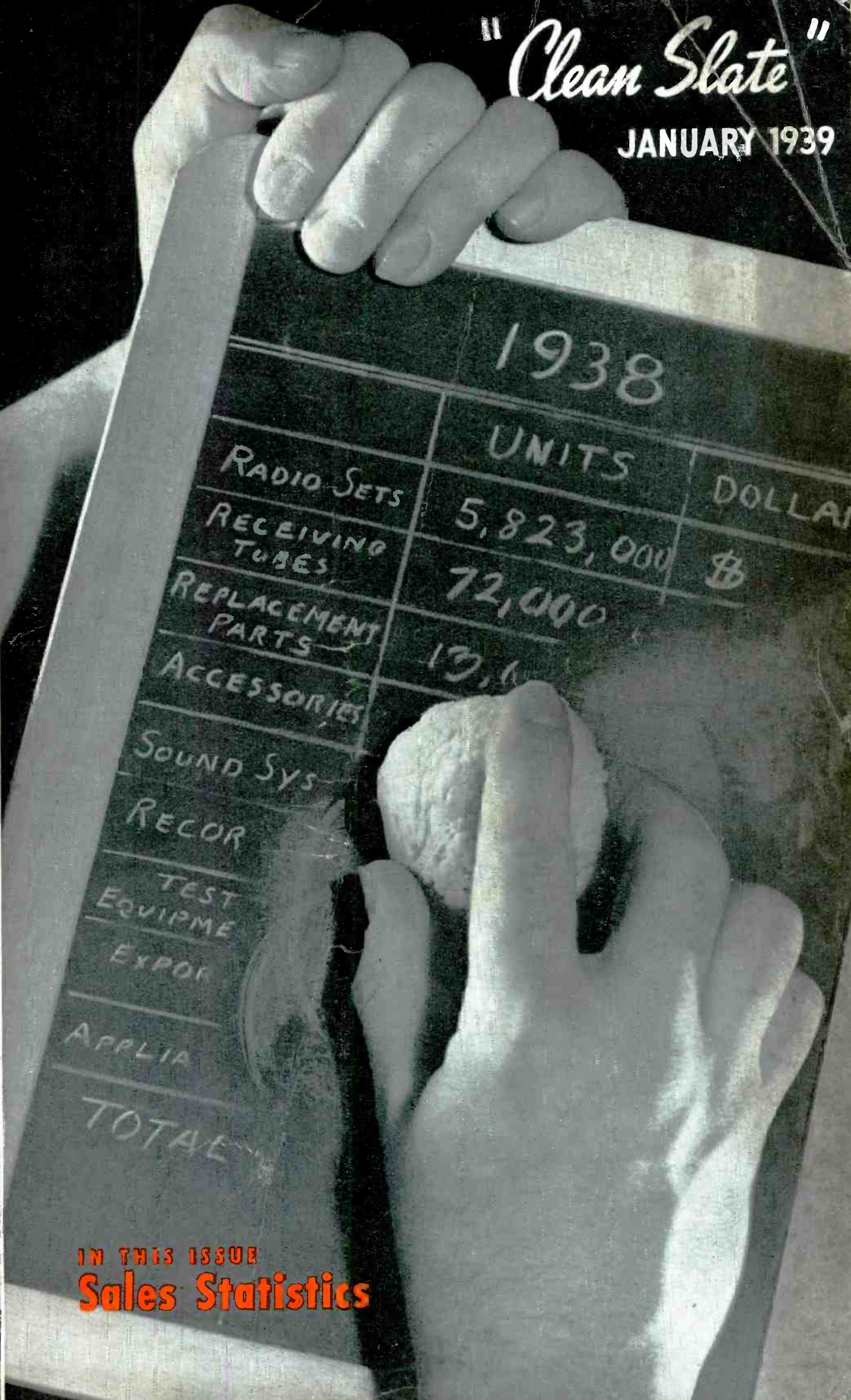

IN THIS ISSUE
Sales Statistics

For Exact Duplicates... Save Time... Improve Service

Insist on MALLORY
Special Replacement
"SR" CONDENSERS

P. R. MALLORY & CO., Inc.

Mallory "SR" Special Replacement Condensers incorporate latest condenser engineering developments.

Each "SR" Special Replacement Condenser is mechanically identical to the original for easy mounting and connecting.

Where standard shapes and capacities may be employed, Mallory UNIVERSAL "CS" - "CN" - "CM" - "RS" - "RN" - "RM" and "UR" Condensers can be used.

Regardless of the make or model of radio you have to service, there is the right type, easily installed Mallory Replacement Condenser.

Whatever your condenser requirements are, insist on Mallory for complete satisfaction and safety. Refer to the Second Edition of the Mallory-Yaxley Radio Service Encyclopedia for complete recommendations and listings by make of set and model number. See your Distributor.

P. R. MALLORY & CO., Inc.
 INDIANAPOLIS INDIANA
 Cable Address — PELMALLO

Use **MALLORY**
 REPLACEMENT
 CONDENSERS... VIBRATORS

Use **YAXLEY**
 REPLACEMENT
 VOLUME CONTROLS



SR-601



SR-604



SR-609



SR-610



SR-615



SR-616



SR-634



SR-619



SR-620



SR-617



SR-630



SR-614



UR-188



SR-628

Mallory
 Condensers
 cost no more

RADIO RETAILING

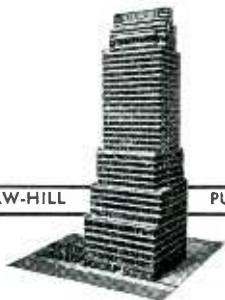

A McGRAW-HILL

PUBLICATION

JANUARY 1939

O. FRED. ROST..... Editor
W. MacDONALD.. Managing Editor
C. A. NUEBLING.. Technical Editor
J. H. AVELING.... Assistant Editor
HARRY PHILLIPS..... Art Director

Tom Blackburn
Chicago

George Tenney
San Francisco

H. S. Knowlton
Boston

H. W. MATEER
Manager

LEE ROBINSON
Sales Manager

McGraw-Hill Publishing Company, Inc.

JAMES H. MCGRAW
Founder and Honorary Chairman

Publication Office
 99-129 North Broadway, Albany, N. Y.
 Editorial and Executive Offices
 330 West 42nd Street, New York, N. Y.

Cable Address: MCGRAWHILL, New York
 Member A.B.P. Member A.B.C.

James H. McGraw, Jr...... President
Howard Ehrlich..... Executive Vice-President
Mason Britton..... Vice Chairman
B. R. Putnam..... Treasurer
D. C. McGraw..... Secretary
J. E. Blackburn, Jr...... Circulation Manager

RADIO RETAILING, January, 1939, Vol. 24, No. 1. Published monthly, price 25c copy. Subscription rates—United States and possessions, Canada, Mexico and Central American countries, \$1. All other countries \$2 a year or eight shillings. Printed in U. S. A. Entered as Second Class Matter, September 8, 1936, at Post Office, Albany, N. Y., under the Act of March 3, 1879. Cable address "McGrawhill, New York." Member of A.B.P. Member of A.R.C. Copyright 1939 by McGraw-Hill Publishing Co., Inc., 330 West 42d Street, New York, N. Y.

Branch Offices: 520 North Michigan Ave., Chicago; 883 Mission St., San Francisco; Aldwych House, Aldwych, London, W. C. 2; Washington; Philadelphia; Cleveland; Detroit; St. Louis; Boston; Atlanta, Ga.

RADIO MONTH.....	By O. Fred. Rost	9
YEAR-END FIGURES		11
1938 RADIO BUSINESS AT A GLANCE.....		12
SALES PHOTOSHORTS		16
SELLING THE BOX ITSELF.....	By Caswell Oden	20
EDUCATIONAL MARKETS		23
HOW TO SELL SCHOOLS.....		24
MODERN AIDS TO EDUCATION.....		31
IN THE MODERN CLASSROOM.....	By R. R. Lowdermilk	32
HOW TYPICAL INSTITUTIONS USE EQUIPMENT.....		36
RADIO IN SCHOOLS.....	By Whitney Connelly	38
RECORDS AS A TEACHING AID.....	By Richard Gilbert	45
INSTRUCTION BY INSTANTANEOUS RECORDING.....	By Ralph Powell	47
TEACHING WITH TALKING PICTURES.....	By Alfred Weiss	48
NEWS OF THE MONTH.....		55
NEW PRODUCTS		62
HOW TO FIGURE SERVICE COSTS.....	By Joe Marty	68
NEW CIRCUITS		70
SOCKET TOPS AND BOTTOMS.....		74
TRICKS OF THE TRADE.....		78
AUDIO FREQUENCY		84

SALES STATIC... "It doesn't work—I think the screws need to be tightened!"



STROMBERG-CARLSON
BEAT THE INDUSTRY
AVERAGE IN SALES
AGAIN!



THE LABYRINTH
AND AUTHENTIC
DESIGNS
ARE THE
ANSWER!



AND A
PROFIT
ON EVERY
SALE!

Now NEW STROMBERG-CARLSONS
THAT WILL LEAD THE TREND

Still Higher!



No. 350-S

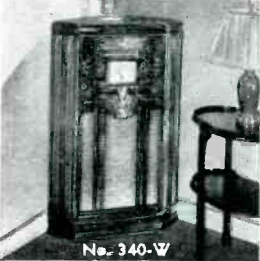

No. 340-W



No. 340-Y



No. 325-H

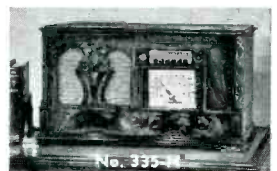

No. 335-L

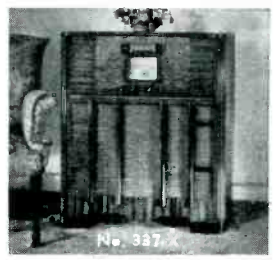

No. 337-X

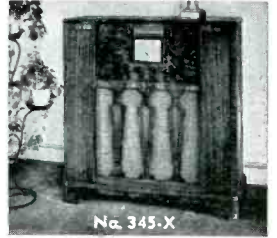

No. 345-X

Radios that "clicked" was the reason Stromberg-Carlson sales jumped ahead with a gain of 250% in November while the Radio Industry as a whole was staging its slow come-back. And just see what you have to sell to start the New Year: New Authentic Corner Cabinets—one in mahogany, one in walnut—a Table Model alluring in its Authentic Chippendale motif; a new streamlined High Fidelity Console with ultra modern touch; two Slanting Panel Console Grands that open up a brand new market. The famous Labyrinth, biggest sales feature in radio.

These additions, to the line that "clicked," will carry the trend more strongly to Stromberg-Carlson—and to profits.

Stromberg-Carlson Telephone Mfg. Co., Rochester, N. Y.

There Is Nothing Finer than a
Stromberg-Carlson

Here is Your 1939 Auto Radio Department

2 UNIT
PUSH-BUTTON
SET *at*
\$24⁹⁵



PUSH-BUTTON
CONTROL HEADS
TO MATCH THE
INSTRUMENT PANELS
OF ALL 1939 CARS

Be first to profit with Motorola!
SEE YOUR DISTRIBUTOR NOW!

Motorola
AMERICA'S FINEST AUTO RADIO

GALVIN MANUFACTURING CORPORATION • CHICAGO

NEW!
AND THE BIGGEST
DOLLAR VALUES
IN RADIO...

From this massive
 8-Tube console at

\$69.95*

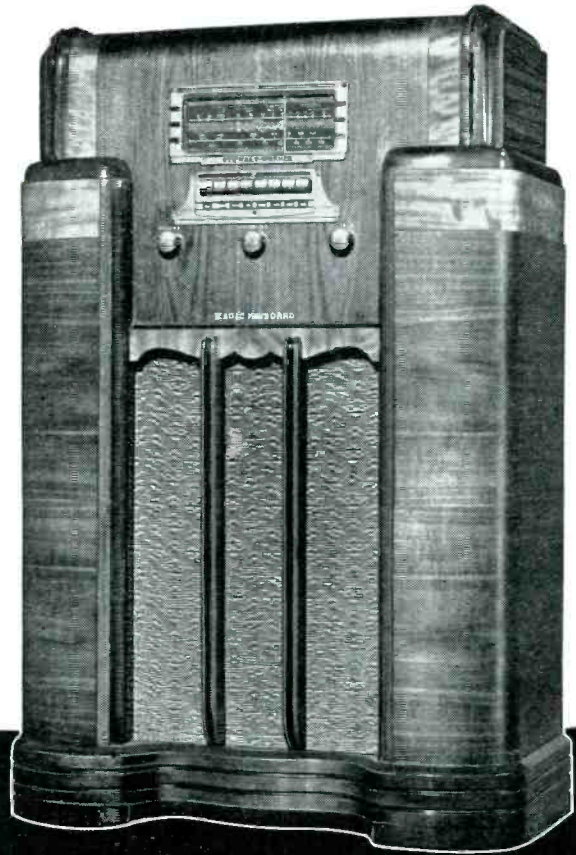

5-tube AC Superhet
 5-station Keyboard

5-tube AC Superhet
 AVC—4-button tuner

6-tube 2-band AC
 —Magic Keyboard

5-tube 2-band model
 covers new "C" band

"Senior Varsity" 5-tube
 AC-DC in all school colors

6-tube 1-band AC
 Radio-Phonograph

"Campus" Model
 in Ivory or Walnut

—to an amazing AC-DC superhet
 with 5 working tubes at

\$9.95*

in walnut bakelite
 \$12.95* in ivory as shown

**Covers Every "HOT" Price Bracket With
 A Value That the Industry Can't Match!**

MATCH them tube for tube, feature for feature and dollar for dollar *against the whole field* . . . and you'll be amazed at the extra value of these new Stewart-Warners!

They're completely new . . . engineered for 1939 in 1939! Every one is a genuine superhet. Every one has AVC. Every tube is a working tube. All but the Campus model at \$9.95 have Magic Keyboard tuning. And 2-band models include the "C" band.

From the amazing 7-tube performance, 5-tube AC-DC Campus model, in ivory or walnut molded cabinet with Magic Lighted-Tip Dial, to the massive 41-inch, 8-tube, 2-band console with 3-gang condenser and oversize console-type speaker, there's a model for *every hot price bracket*. An ideal step-up line . . . and a record value for every step!

**All prices factory list*

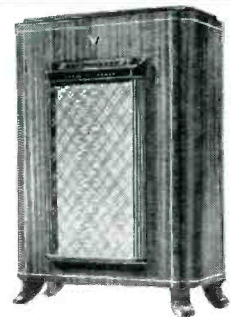

Another supreme value — the Stewart-Warner Concert Grand built throughout for superb tone on nearby stations. No dial — 8-station Magic Keyboard.

STEWART-WARNER
MAGIC KEYBOARD AND VARSITY RADIOS

**BLOCKADE THE WEST ROAD!
TWO MEN AND A WOMAN!
BE CAREFUL! THEY'RE KILLERS!**

**WITH THE AID OF
RAYTHEON TUBES**

Illinois Police Radio Blockade Cuts Crime Careers Short!

The "radio blockades" of the Illinois State Police and police of many other states have become famous throughout the country. In Cook County, Illinois, the blockade begins in the well-equipped police station WQPC pictured below. Once the alarm is sounded, every road is blockaded immediately—cutting off all escape channels for fugitives.

Fighting crime is no game for "panty-waists." Police must be tough and efficient. Squad cars must be swift and sturdy. And radio tubes must be dependable—and ready for emergency flashes.

That's why RAYTHEONS are used by so many State Police organizations. Why RAYTHEONS are used, too, in millions of homes, in leading auto set radios, by leading Commercial Airlines, the U. S. Forestry Service, Coast Guard, Weather Bureau, etc.

Anywhere sturdiness and long life under adverse conditions are required—you will find RAYTHEONS. Yet they cost no more than the second-best tube.

RAYTHEON is your guarantee of the best turnover of any tube investment!

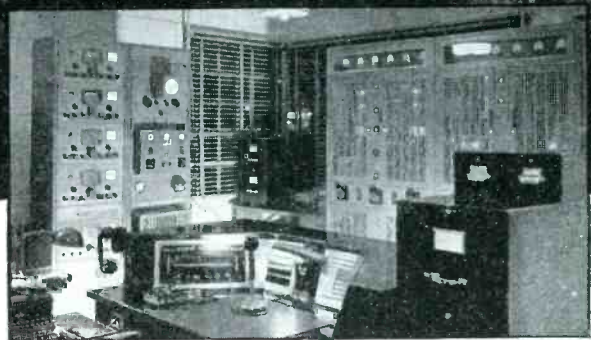

RAYTHEON

NEWTON, MASS. • NEW YORK • CHICAGO • SAN FRANCISCO • ATLANTA

"WORLD'S LARGEST EXCLUSIVE RADIO TUBE MANUFACTURERS"

**IMPROVED DESIGN
PROVIDES 20%
EXTRA SPACE**

New, Streamlined 6 cu. ft. Gale requires no more kitchen space than conventional 5 cu. ft. model!

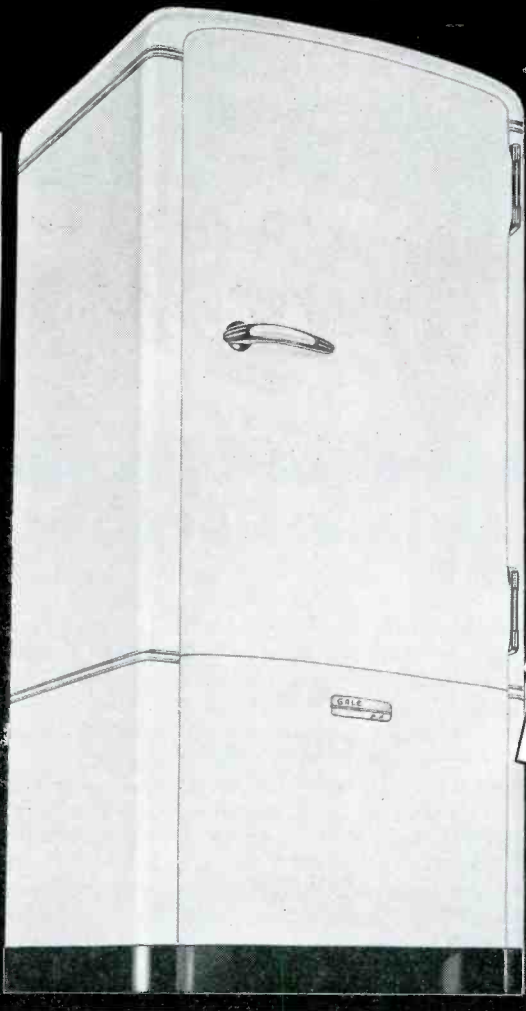

Look to the new Gale
(formerly Briggs)
for the answer to to-
day's biggest refriger-
ator problem — a truly
FINE product to sell at
a competitive price!

GALE PRODUCTS

OUTBOARD, Marine & Manufacturing Company—builders of Johnson Sea-Horses, Evinrude and Elto Outboard Motors, Iron Horse Generators, announce a *separate* division for Gale Electric Refrigerators (formerly Briggs) and Gale Space Coolers (formerly Johnson).

Increased plant facilities and personnel, necessary to meet the growing demand for these quality appliances, have been provided at Galesburg.

The development of this Division is another step in the

parent Company's long range program to make GALE PRODUCTS a great factor in refrigeration.

UNUSUAL DEALER OPPORTUNITY

Seven years successful operation in refrigeration have proved the soundness of the Company's policy of building *high grade* products and marketing them through channels that permit *moderate* resale prices, with *big volume* for dealers. Write for full details. Dealer territories open.

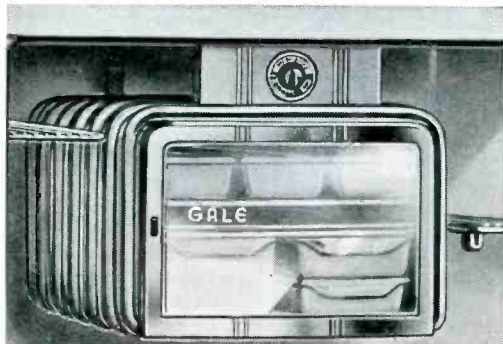

FEATURING A GREAT NEW DEVELOPMENT

GALE PRODUCTS presents an entirely new line for '39. New beauty throughout! New "streamlined" design for *extra* capacity! And featuring the new Sealed Evaporator! This remarkable development (exclusive with Gale) seals the ice compartment from food odors, makes for utmost sanitation, prevents sticking of trays, induces freer circulation with proper food temperature, while *preserving lower temperature* within the freezing compartment. This lower temperature is so effectively maintained that ice does not melt away when coils are defrosted! . . . Porcelain enamel housing, with glass door and chromium trim have great eye appeal, while actual demonstration has powerful sales appeal!

GALE PRODUCTS, 700 MONMOUTH BLVD., GALESBURG, ILLINOIS

3 NEW Meissner ADAPTER KITS!

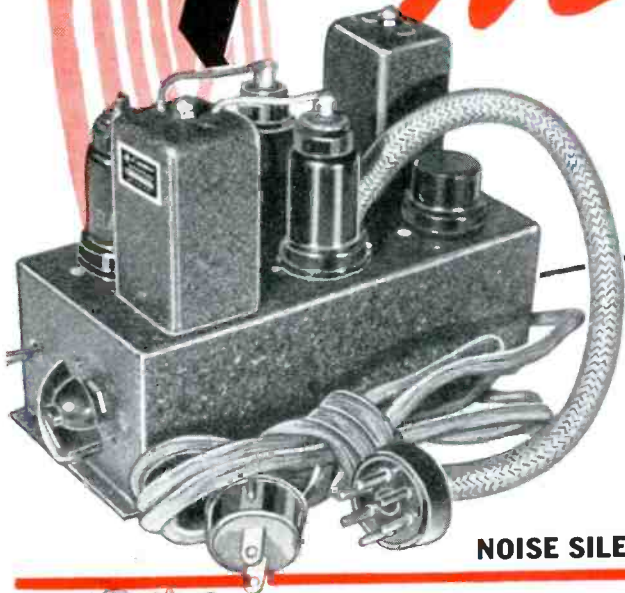

More NEW Profitable Business for YOU!!

MANY of your present and prospective customers have a real need for at least one of these 4 new Meissner Adapter Kits! So, go after this business—now—before someone else gets it! Priced to give you a real profit! See these kits at your Parts Jobber today. Or write for further information to Dept. R-1 at the factory.

NOISE SILENCER

A real noise silencer designed to reduce static, man-made interference, and improve short wave reception. Based on the famous Lamb circuit. Operates with any superheterodyne receiver without regard to the number of I.F. stages; an additional stage of I.F. within the Silencer, making a four-tube unit, compensates for losses.

A complete kit—self-powered—takes but a few milliamperes from the receiver. Requires only a few minutes to assemble and wire. For receivers having an intermediate frequency of 450 to 470 KC. Equipped with a six-point adapter for plugging into receiver. Operates on 110 volts, AC or DC.

Dealer's Net Price — \$6.90



PHONOGRAPH OSCILLATOR

A complete self-contained unit. Connects a phonograph pick-up without affecting performance of radio. Acts as a miniature broadcast station. Just tune radio to its frequency same as you would a broadcast program.

Has its own power supply. Hook-up consists of making two connections—one to antenna post, the other to ground post of receiver. As it can be turned off and on by a switch, you may listen as you wish—to famous recordings—on regular broadcast programs. Operates on 110 volts AC or DC.

Dealer's Net Price — \$6.90

BEAT

FREQUENCY OSCILLATOR

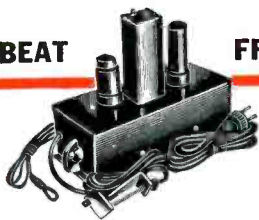

With this unit even the inexperienced DX hunter now can locate quickly the desired station by the turn of a switch. Self-powered—completely self-contained—operates on 110 volts AC or DC. One connection to the radio and one to your AC outlet is all that is necessary. May be used with any set having 456 to 465 KC I.F. Battery-operated unit also available. **110 Volt Unit**

Dealer's Net Price — \$6.90

Battery-operated Unit — Dealer's Net Price — \$3.60

Complete Receiver Kits
I. F. Transformers
Service Parts
Dials • Switches
Tuning Units

Meissner

MT. CARMEL, ILLINOIS

"A FAMOUS NAME FOR TWO DECADES"

Just Out! The Year's Hottest Radio-Phonograph Line!

THE SENSATIONAL NEW "100 SERIES"

PHONOGRAPH *WITH* PHILCO

Three New Models with Greater Value—Lower Prices!

Here are the three models that will bring you radio-phonograph sales this spring! Sensational value! Exquisite cabinets! Exclusive selling features! And performance on both radio and phonograph you never dreamed possible except at many dollars more!



Automatic Record Changer Model 107

A BIG instrument . . . with automatic record changer and PHILCO Instant Electric Push-Button Tuning radio! Priced so that you can sell it under \$100!* Both radio and phonograph controls are concealed under top lid.

PRICED SO YOU CAN SELL IT FOR LESS THAN \$100!*

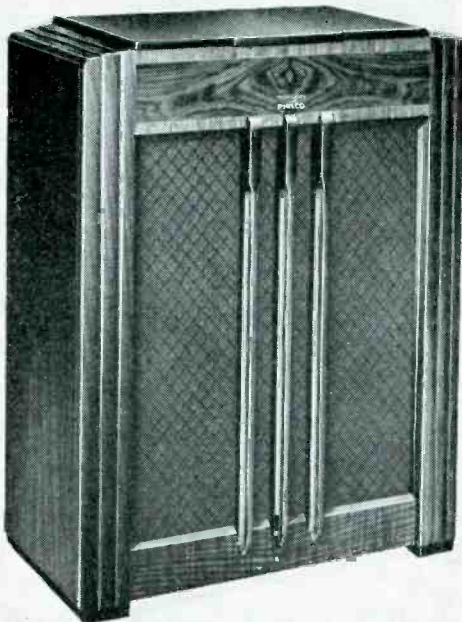

PHONOGRAPH *WITH* PHILCO Console Model 105

\$69⁹⁵*

A full-sized console model radio-phonograph combination for less than your customers expect to pay for a radio alone! Exclusive PHONOGRAPH *WITH* PHILCO Semi-Automatic Reproducer—close the lid and the record starts or repeats automatically! PHILCO Instant Electric Push-Button Tuning radio.

*Prices slightly higher in the West



Table Model 101 · 5 Tubes!

\$29⁹⁵

Five-tube superheterodyne circuit . . . all five tubes work! Underwriter's Laboratory approval! Crystal Pick-Up . . . self-starting electric motor.

SEE YOUR PHILCO DISTRIBUTOR

The RADIO MONTH

JANUARY

1939

Fair Weather The new year promises to give the radio industry much good going and fair weather of the same type that the old year mustered during its closing months—perhaps to sweeten our memory.

No factories are idle. No warehouses are bulging with staggering surplus of finished sets. No dealers' floors are groaning under unsold overstocks. No credit lines are stretched to the breaking point. As a matter of fact, all along the radio front conditions are almost the exact reverse of what they were a year ago.

And what a difference in the outlook!

Already general business conditions have bounced back 40% above the sad low point of last June. Each month sees hundreds of thousands of workers back on industry's payroll, sure of that pay envelope which helps them boost all retail sales, including set sales. All available data points to continued improvement through the whole of 1939 with no serious setbacks in sight.

Radio's only fly in the ointment is the low price level of current models, and that should fade out of the picture as the public's inherent desire for the best that it can afford once more asserts itself under the stimulus of restored confidence in the efficacy of the current trend toward recovery.

Barring only unpredictable events, there is fair weather and good going ahead, and the smart retailer will set his sails to cash in to the fullest possible extent.

New Models Radio set makers are fast thinking, fast moving, hard hitting go-getters

who watch closely what is selling fastest and lose little or no time in supplying their dealers with what the public wants.

Thus, when the popularity of the \$9.95 midgets, brought out a year ago, continued despite recent improvement in business, this demonstrated such undeniable public acceptance that no important manufacturer could afford to disregard the newly created price bracket.

And none have disregarded it. In fact, some of the midgets offered today present a paradox that challenges our reputation for veracity—when we are asked to explain how the parts and set makers can live when they are selling midgets complete at no more than the list price of the tubes used.

Bright spot in the situation is: New mid-season lines now being introduced include models at higher than sub-basement prices that will make it easy for dealers to do some concentrated trading-up and thereby raise the average value of sales, and what is equally important, increase profit margins.

There are plenty of valuable features present in those new models that provide excellent talking points in pushing the customer's desire into a higher price bracket and no wide-awake retailer can afford to miss the opportunity.

December Sales Originally our retail sales barometer and monthly review of sales was omitted (for this month only) due to the changes in production schedules necessitated by publication of annual statistics.

BUT—this being the last page to go to press we just can't hold back the good news that December finally

piled up such totals of sales (in units) that even if we wanted to, we could not publish the barometer itself, because the sales indicator would be pushed right through the top of it, and that would mean new drawings and a whole new set-up, for which time is lacking.

Believe it or not, when all the reports are in that barometer will stand somewhere around 125 or even 130, just 25 to 30 per cent ABOVE December, 1937.

That, of course, is for the country at large, while in some state dealers experienced increases of 50% or more. Also, many dealers actually increased their dollar volume, being located where large consoles and combinations could be sold. Only six states found December unit sales below 1937.

Our study of those hundreds of reports also has confirmed the previously expressed opinion that inventories are now below normal and, of course, far below what they were a year ago.



EDITOR

Radio Dealers: this is **THE BIG WINTER MONEY-MAKING PACKAGE**

ZENITH

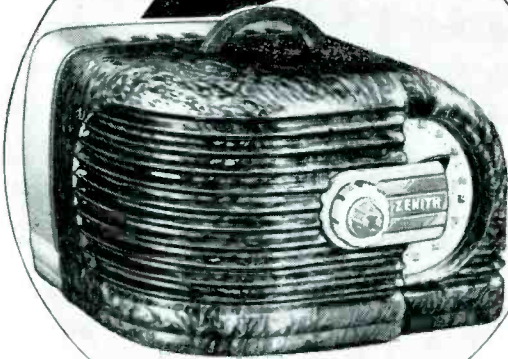

**NEW STARTLING
RADIO WITH THE
WAVE MAGNET**
in the little gold box!

**NO ANTENNA • NO GROUND
NO NOISE • NO INSTALLATION
NO BATTERIES • JUST PLUG IN
AND PLAY ANYWHERE**

AND THE NEW

BIG 8

CONSOLE

- ① RADIORGAN TONE COLOR RECEPTION
- ② TRANSCONTINENTAL AUTOMATIC TUNING
- ③ 12-INCH FULL TONE ELECTRO DYNAMIC SPEAKER
- ④ 8 POWERFUL METAGLASS TUBES
- ⑤ REGULAR BROADCAST & 3 BAND SHORT WAVE RECEPTION
- ⑥ LARGE BEAUTIFULLY FIGURED CHOICE WALNUT FINISH CABINET
- ⑦ OVERSIZE RUBBER FLOATED CHASSIS

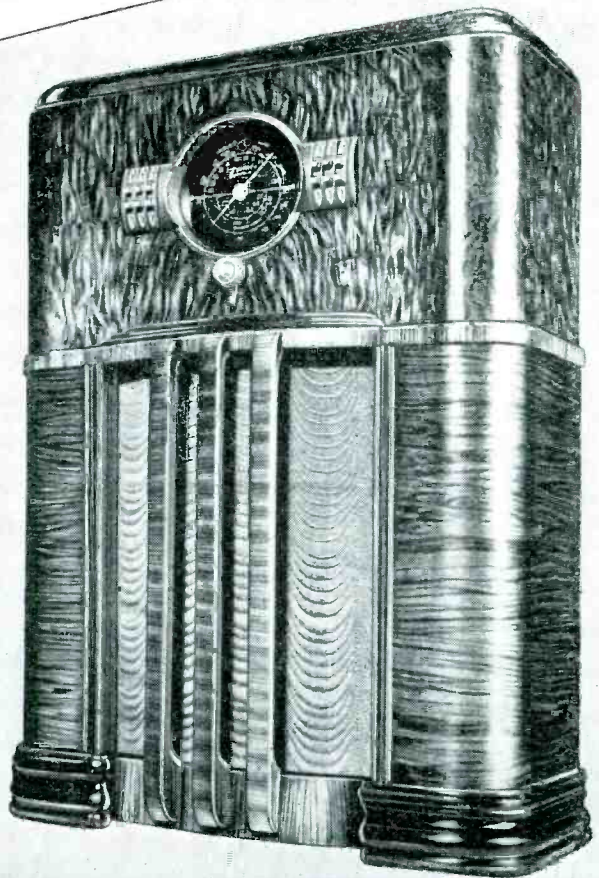

*Phone Your Zenith Distributor
for Details and Climb Aboard!*

RADIO RETAILING

JANUARY, 1939

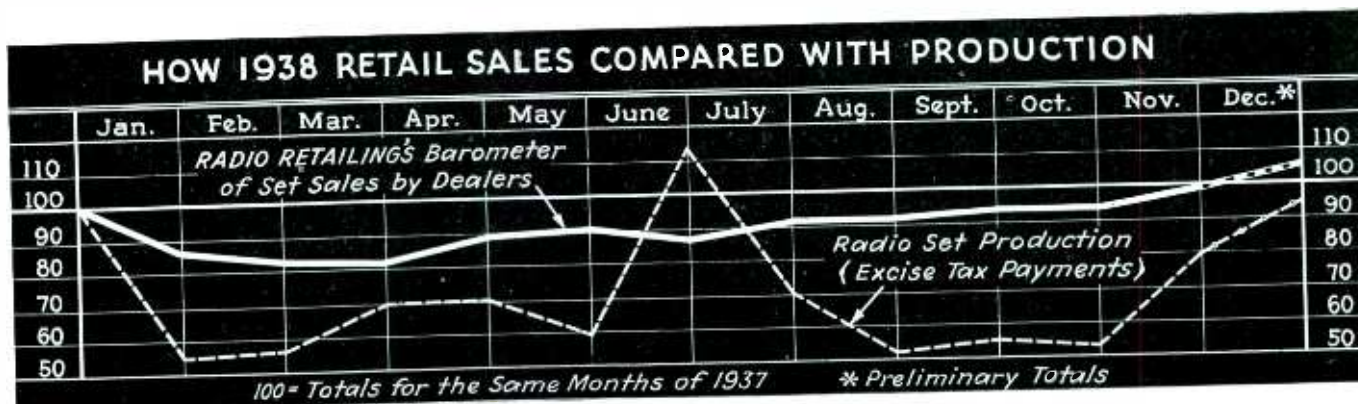

Year End Figures

OUTSTANDING accomplishment of the radio industry in the year just ended is: *Having successfully dug its way out of that almost hopeless looking inventory situation of a year ago, without recording any significant business failures or leaving the path strewn with wrecked concerns.*

Set and parts manufacturers, distributors and retailers, collectively and individually, took a terrific beating during the first half of the year, but they gave proof of a magnificent vitality in the comeback that the industry has staged since then.

Every available resource of research, engineering, design, production and merchandising talent was used in the process. Old conceptions of values, price brackets and profit margins were cast overboard so that a sufficient number of units might be sold to support production, if necessary, on a dollar-swapping basis.

Unfortunately, the struggle for unit volume created a competitive quicksand which pulled dollar values down to such deplorably low levels that the whole economic structure of the distributing branch of radio shuddered.

Neither distributors nor dealers can be expected to support the necessary promotional advertising, sales and service activities on the gross margins that they can earn on microbe models when their rent, other fixed overhead, sales and service salaries demand sales that average more per unit.

Thus, at the threshold to a new season, the manufacturing branch of the radio industry faces the problem of finding a quick and sure-fire method of stopping the further collapse of price levels, launching a concerted effort to raise the average dollar value per sale to a point where the present highly efficient system of distribution can be maintained.

A quick survey of general business conditions shows

that the time for such a rebuilding program is at hand.

Already a well-defined upswing in business is under way. The steel, automobile, building and other major industries are steadily increasing their output, which means more men on payrolls and more pay envelopes.

That means that *now is the time* for the radio industry to wean the public away from the idea that a microbe marvel gives them all that comes over the air. *Now is the time* to push the trend of public buying into higher price brackets and thereby pave the way for a new prosperity in which manufacturers, distributors and dealers may share alike.

It is also the time for tube and parts manufacturers to mop up some of the emergency-born tactics and policies which are keeping that branch of the business in a mire of low prices.

Sets . . . For a year such as 1938 turned out to be, figures on total production cannot be impressive, nor is it safe, in this instance, to use them as a measure of retail sales. Allowance must be made for the fact that the market was called upon to absorb in 1938 a towering bulk of goods that was expected to be sold in 1937 so that, if true overall figures were available, the actual sales totals *in units* would look quite satisfactory.

Thus, for instance, the combined *excess* carry-over of radio sets from 1937 into 1938 by manufacturers, distributors and dealers was conservatively estimated to total one and three-quarter million sets. Since then most of those have been sold and over five million more sets have been produced so that actually the market absorbed nearly seven million sets.

That they have been absorbed cannot be doubted, because inventories everywhere appear to be actually sub-normal. In fact, some manufacturers and distributors

(Continued on page 14)

1938

RADIO

SETS (domestic)

1937		1938
7,631,267	UNITS	5,823,000
2,636,872	Console	1,107,300
3,578,612	Table	3,573,400
62,783	Phono-Comb.	352,300
1,353,000	Auto	790,000

TUBES (receiving — domestic and export)

1937*		1938
92,000,000	UNITS	72,000,000
43,000,000	Initial	35,500,000
49,000,000	Replacement	36,500,000

TESTERS

	1937*		1938
Tube Checkers	\$800,000	dealer net	\$760,000
Analyzers	\$540,000	dealer net	\$430,000
Multimeters	\$410,000	dealer net	\$400,000
Oscillators	\$400,000	dealer net	\$390,000
Oscillographs	\$325,000	dealer net	\$305,000
Miscellaneous†	\$500,000	dealer net	\$575,000

(†Complete instruments only, exclusive of individual meters)

RECORDS

1938
37,000,000 UNITS

PEOPLE

American lives touched by radio daily... 72,865,000

Employed by 500 makers of sets and parts...	91,000
Employed by 700 broadcast stations	23,000
Employed by 2,500 radio wholesalers	25,000
Employed by retail radio merchants	56,000
Radio salesmen and servicemen.....	150,000
Estimated radio listeners daily.....	72,520,000

RADIO RETAILING

BUSINESS AT A GLANCE

PARTS (replacement)

	1937*		1938
Condensers†	\$ 1,600,000	mfgrs. s.p.	\$1,400,000
Controls	\$ 755,000	mfgrs. s.p.	\$ 690,000
Resistors	\$ 450,000	mfgrs. s.p.	\$ 425,000
Transformers	\$ 1,700,000	mfgrs. s.p.	\$1,450,000
Vibrators	\$ 700,000	mfgrs. s.p.	\$ 650,000

(† Fixed, including motor-starting)

ACCESSORIES

	1937*		1938
6-Volt Wind Chargers	200,000	UNITS	130,000
32-Volt Wind Chargers	1,650	UNITS	1,980
6-Volt Gas Chargers	24,300	UNITS	18,500

EXPORTS

1937*		1938
652,028	SETS	472,000

SOUND

	1937*		1938
Complete Portable Systems	\$3,000,000	retail s.p.	\$2,600,000
Complete Permanent Systems#	\$1,400,000	retail s.p.	\$1,680,000
Inter-Communicators	\$ 900,000	retail s.p.	\$ 625,000
Instantaneous Recorders*		mfgrs. s.p.	\$ 580,000
Instantaneous Recorder Discs*		mfgrs. s.p.	\$ 450,000
Microphones	40,000	units	35,000

(# Includes much "contract" business.
* Includes broadcast station purchases)

COMPARISON

Country	Population	Radios in Use	Ratio
UNITED STATES	130,000,000	38,500,000	1—3½
Sweden	6,233,000	1,026,000	1—6
Denmark	3,706,000	673,000	1—6
Germany	66,000,000	8,000,000	1—8
France	41,834,000	3,916,000	1—10½
Argentina	12,561,000	1,000,000	1—12½
Japan	70,000,000	2,593,000	1—28
United Kingdom	486,726,000	10,000,000	1—48
Italy	42,527,000	800,000	1—53
Mexico	16,552,000	250,000	1—64
Brazil	45,000,000	400,000	1—100
Russia	165,000,000	350,000	1—470

were without stocks of some of the "hot" models long before the peak of the holiday rush. Furthermore, dealers, reporting regularly for *Radio Retailing's* sales barometer, show their own inventories down from 30 to 60% below a year ago.

Tubes . . . Like the set manufacturer, the average tube maker took something of a beating in the early months of 1938, perhaps to a lesser extent because replacement orders held up fairly well but severe, nevertheless, because of initial equipment declines. All this sluggishness changed materially for the tube plants later, however, as set manufacturers started pouring in orders to fill sockets of holiday models, and toward the end of 1938 most tube makers fell seriously behind in production, catching up just before *Radio Retailing* went to press.

One effect of the first six month's leanness was to emphasize the relative stability of replacement as against initial tube business. From examination of the figures appearing in these pages it will be apparent that while replacement tube sales fell short of 1937 they more nearly split total volume with initial business.

Parts . . . Again, in the replacement parts field, the relative stability of jobber business as against initial equipment shipments to manufacturers showed up. All radio replacement parts were off as against 1937 but to a relatively slight degree, as examination of tables elsewhere in this report will show.

Fixed condenser sales, we understand, definitely showed an increase insofar as units were concerned, but lower prices, particularly on midget etched-foil electrolytics, dropped dollar volume slightly. Condensers for motor-starting showed a substantial replacement gain. With prices about the same as in the previous year, controls lost slightly in units, tendency being to improve such parts and hold prices up as the new year began. Fixed resistors, on which prices have long been hammered down to rock-bottom, held near the 1937 level. Transformer replacements dropped little. Vibrators were off slightly but not enough to cause serious crying in manufacturing circles.

Testers . . . Radio test equipment finished the year with a total nearly as imposing as that of 1937 but there was considerable juggling of total dollar volume between the different types of instruments.

As near as close study of the market permits us to judge, instruments hitherto not included in our Tube Checker, Analyzer, Multimeter, Oscillator, Oscillograph breakdown registered nice gains. This would include such things as condenser analyzers and other specialties. Analyzers appeared to be the hardest hit items in the field, with oscillographs and associated equipment not quite measuring up to expected gains but totalling a nice figure just the same. Tube checker sales held up near 1937 totals, and multimeters, in the case of several individual companies, clicked off definitely better totals, winding up the year off less than general business declines.

Records . . . Phonograph records were a particularly bright spot. Not only did they register surprising gains over 1937 but at the close of the year there were definite indications that they would play an even more important part in total volume for the radio business hereafter.

One hope for increased dollar volume in the set field, in fact, definitely lies here.

Sound . . . Statistics gathered show without question that the "permanent" variety of sound equipment, both large and small systems, made a good showing in this field during the year just past, with sales for educational use definitely a major factor. Much of this business was obtained on a contract basis, large jobs by-passing small soundmen to a certain extent, but an influx of small, compact and more flexible items late in the year reflected to the benefit of the general trade.

Portable systems, still the dollar volume mainstay of the business, declined slightly in favor of permanent jobs. And inter-communicators, estimated too high for 1937 in several earlier stabs, failed to produce expected 1938 volume. Compensating for this loss to a certain extent was a substantial increase on instantaneous recorders, now apparently just starting into their real stride.

Accessories . . . Reflecting general business weakness rather than any individual weakness of their own. 6-volt wind driven and 6-volt gas driven chargers dropped a little business in 1938, which will probably be more than made up in the new year if conditions in rural areas continue in the upward direction now indicated. Thirty-two-volt wind driven units, coming into an almost completely unsaturated market just a short time ago, naturally showed an increase.

Battery and other accessory figures were not available as *Radio Retailing* went to press, will be published when and if the Editors can obtain and verify them.

Appliances . . . Just how well the radio business maintained its position in the light of declines elsewhere, will be readily seen upon examination of major electrical appliance figures appearing on this page. And most appliance manufacturers feel, justifiably, that they too were fortunate by comparison with still other fields.

All-in-all, radio equipment sales were just "in the stretch" as the year closed, struggling to make up in the final quarter ground lost in the first six months and finding the time too short despite a lengthened stride. If the last quarter could have been rubber-banded out a few more weeks there is no telling how close final 1938 totals might have come to those of 1937. Certain it is, however, that gathered momentum will give 1939 a flying start which would have come in very handy last year.

* Final estimate.

ELECTRICAL APPLIANCE SALES*			
	1937		1938
Refrigerators	2,310,000	UNITS	1,240,000
Washers	1,465,405	UNITS	1,032,956
Cleaners	1,706,337	UNITS	1,220,100
Ironers	178,858	UNITS	107,196
Ranges	405,000	UNITS	250,000

© "Electrical Merchandising"

"THESE THREE THINGS YOU MUST REMEMBER"



*An important message to radio tube retailers
from Mr. Paul S. Ellison, Renewal Tube Sales
Manager, Hygrade Sylvania Corporation*

TO MY MIND there is no sleight-of-hand, no mystery or black magic concerned with building a successful radio retail sales or service business. Granted that the owner is honest, industrious, and reasonably well-trained in the fundamentals of his business, he should succeed. There are, however, three simple considerations which cannot be ignored in the selection of the merchandise to be sold:

A. COMPANY DEPENDABILITY. Buy only from companies whose reputation and general standards indicate successful and aggressive management.

B. PRODUCT DEPENDABILITY. Original research, scientific developments, and quality control in production, as well as performance in the field are absolutely essential. There are no substitutes.

C. PROFIT DEPENDABILITY. Policies over a period of years tending to establish a freedom from price cutting. Promotional and display helps that *sell*. A product that stays sold. All of these factors you must obtain, if profits are to be insured.

Test your merchandise by these three important standards and your business *will* succeed.

Paul S. Ellison
Renewal Tube Sales Manager

HYGRADE SYLVANIA CORPORATION

NAME YOUR PROGRAM, MISTER

Rubber heels skidded to a full stop, necks craned toward a doorway Philco when Ann Grass, with a Mystery Control in her lap out on the sidewalk before Glaser's of Chicago, spun the dial and pointed. Eyes looked first at the blonde, then at the set . . . then at the blonde



CLEVER BUSINESS

WITH BRAILLE

Blind, Cecil Minard of Sandusky, Michigan, has replaced the regular roll chart of his Supreme 506 with one done in Braille, determines condition of tubes by listening to the unit's transformer hum. Lifsey Distributing will soon supply a hinged meter case so that he can feel the needle

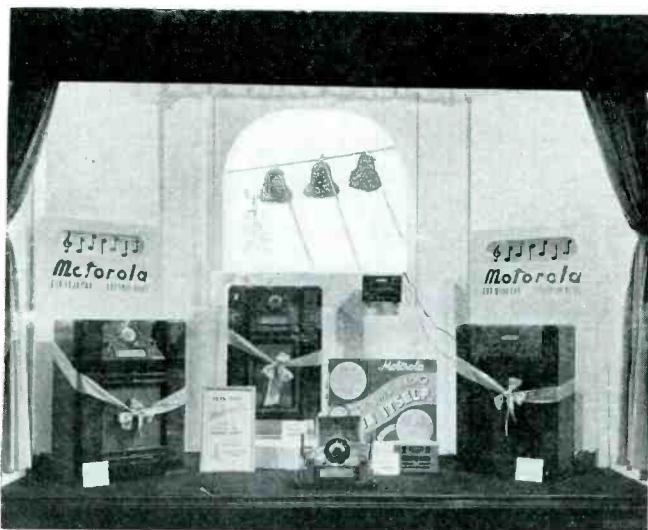

WINDOW OF THE MONTH

Involving as it does simple silhouette backgrounds, bows, paper-covered pedestals and Motorola display material this current window by Elder and Johnson of Dayton is effective yet inexpensive. Keynote is irregular but artistically good placing of merchandise.

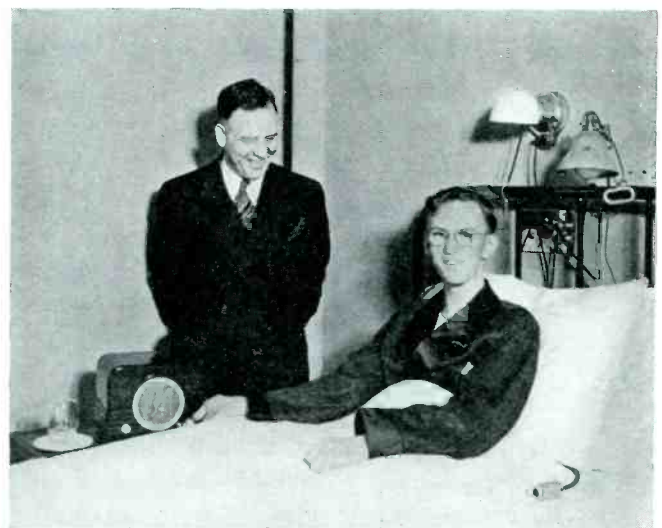

CARRIES HIS BED ON HIS BACK

The old-fashioned salesman carried a pack on his back. For 18 months Edward J. Wintering, Jr. of Cleveland has practically carried his bed. Confined to a hospital, he has sold nine G-E radios, a refrigerator and a washer on one floor. He simply plays his own set whenever rules permit and makes sure that he has plenty of circulars

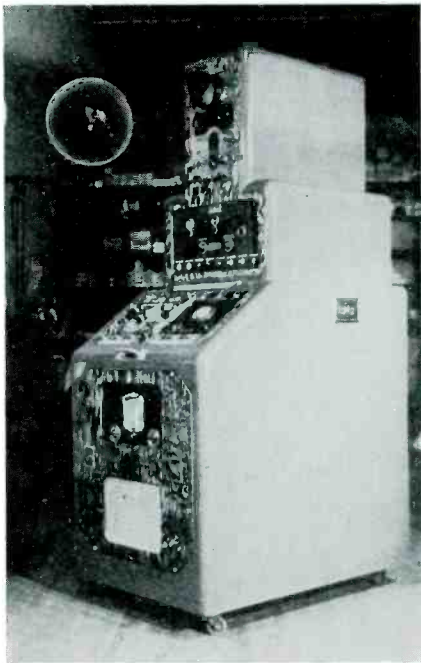

**BY EARNEST MOORE
OF CHICKASHA**

Here's one serviceman's idea of a test instrument layout at once technically convenient and a merchandising aid. Clough-Brengle instruments are mounted skyscraper style. Rollers permit the unit to be wheeled to the bench or up to the window

STARTED SOMETHING FOR INDEPENDENTS

To Detroit servicemen well-wisher B. F. Fitzner pointed out that few people, when asked, could quickly give either the name or 'phone number of a radio serviceman. They took the hint, got together and spent \$7 apiece for 13-weeks of cooperative advertising in a daily newspaper



SUPER SANDWICH-MEN

During the Kansas State Corn Husking Contest at Belle Plaine R. L. Wood of the S. A. Long Company secured spot news broadcasting rights from KFH, plastered the announcers with apronlike signs advertising Zenith farm and city radios. Thus he hit both air and on-the-ground audiences

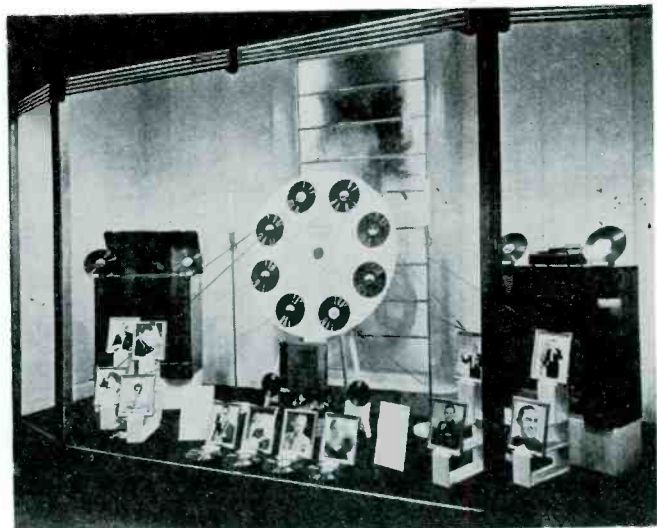

ONE MAN HOBBY LOBBY

Collector of personally autographed Victor records is H. C. Block, Jr. of an Indianapolis department store, who follows visiting dance-band leaders and vocalists all over the State for their signatures. Tied in with photos of the stars themselves his initialled discs recently made this unusually effective window display

Proudly Presenting the **SILVER JUBILEE**

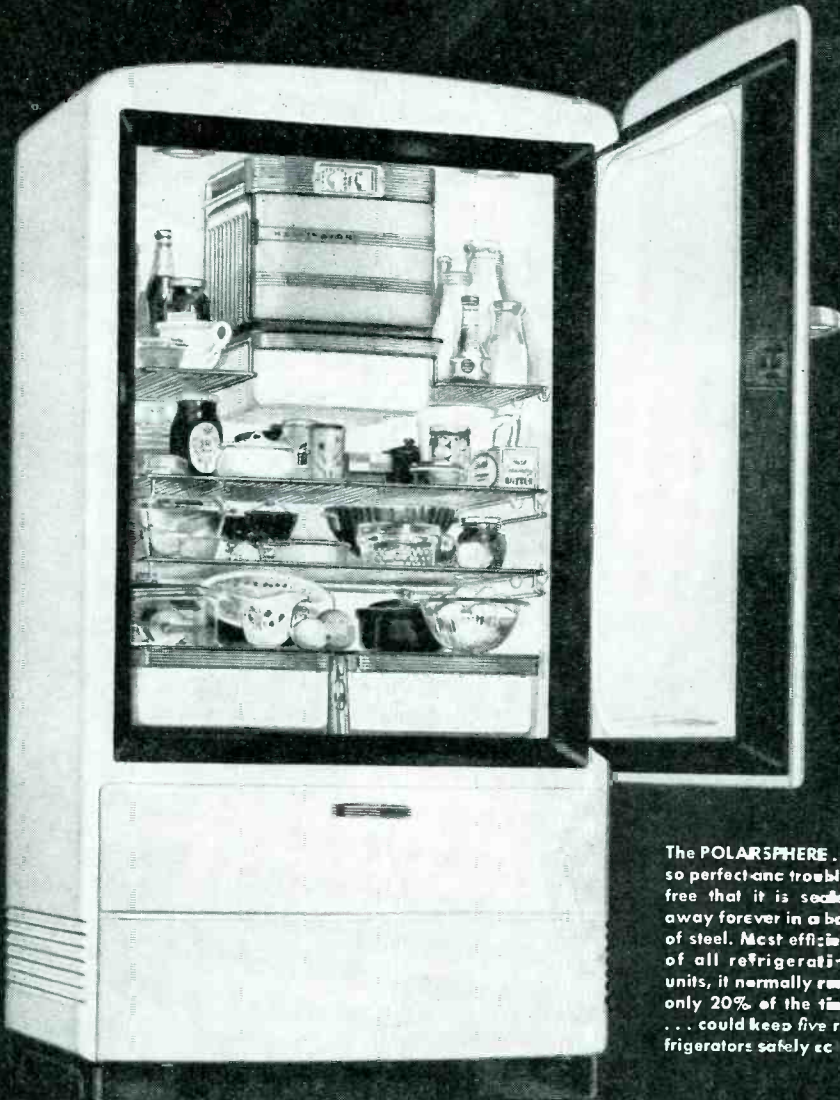

New! Glass-top Cold Chest... big enough to hold 14 pounds of meat... keeps it fresh and flavorful for days.

New Location for Thermometer... quick, easy-reading... you know exactly how cold the interior is.

The POLAR SPHERE... so perfect and trouble-free that it is sealed away forever in a ball of steel. Most efficient of all refrigerating units, it normally runs only 20% of the time... could keep five refrigerators safely etc. d.



TODAY YOU'LL SEE 25 years of pioneering and progress!

Here they are... twelve beautiful Silver Jubilee models, priced from \$118... absolutely new from flat top to streamlined pedestal. Complete price coverage... with values that stand out head and shoulders against any kind of competition!

You can talk beauty... and we leave it to you if the Silver Jubilee models aren't the most eye-appealing refrigerators ever created.

You can talk features... and those given

KELVINATOR

Cool-making power equal to 1050 pounds of ice a week! Only Kelvinator has the sensational "Polar-sphere".

New, Modern Design . . . Wider front, more storage space . . . ends stretching and fumbling about.

Spacey-Cube Release in trays of Magic Metal. New pull-out tabs—easily free tray from sleeve.

New! Vegetable Bin—amazingly roomy! Convenient, dry storage. Tillsoul Chromium-type band.

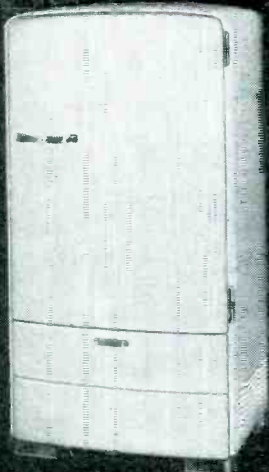

above are just the highlights!

You can talk economy . . . and here's where Kelvinator shines! Get the full story on the new Polarsphere, and see why last year's record-breaking performance is being surpassed for 1939.

Here, in our estimation, is the hottest-selling line that ever graced a salesroom. But don't take our word for it—see your distributor and see for yourself!

KELVINATOR, Division of Nash-Kelvinator Corporation, Detroit, Michigan.

ANOTHER SILVER JUBILEE ANNOUNCEMENT

Vital to Appliance Dealers and Retail Salesmen



KELVINATOR Starts Celebration of 25th Anniversary with Founding of NATIONAL SALESMEN'S INSTITUTE

● You would expect this announcement from Kelvinator—the originator of the "Sales Mean Jobs" crusade that swiftly grew into a nation-wide prosperity movement.

George W. Mason, president of Nash-Kelvinator Corporation, believes the greatest need today is better salesmanship. From that belief comes this statement of H. W. Burritt, vice-president in charge of sales of the Kelvinator Division:

"I am privileged to announce the founding of the Kelvinator National Salesmen's Institute, with Sidney Edlund as its president, and known nationally as sales manager, author, teacher, and co-founder of the 'Man Marketing Clinic'.

"The Institute bids fair to have an immediate influence on increased earning power for the salesman. Dealers, too,

will benefit by solving such problems as securing the best sales manpower, keeping that manpower increasingly productive, reducing employment turnover, and reducing sales expense.

"The Institute courses will be open to any dealer, any salesman handling any Kelvinator appliance.

"Dedicated to the growth and betterment of the appliance industry, the Institute is an earned recognition of the part that has been played—and will always be played—by dealers and retail salesmen in this industry."

H. W. Burritt
Vice-Pres. in Charge of Sales,
Kelvinator Division.

Come in and Join

KELVINATOR'S 25TH BIRTHDAY PARTY

SELLING *the* BOX ITSELF

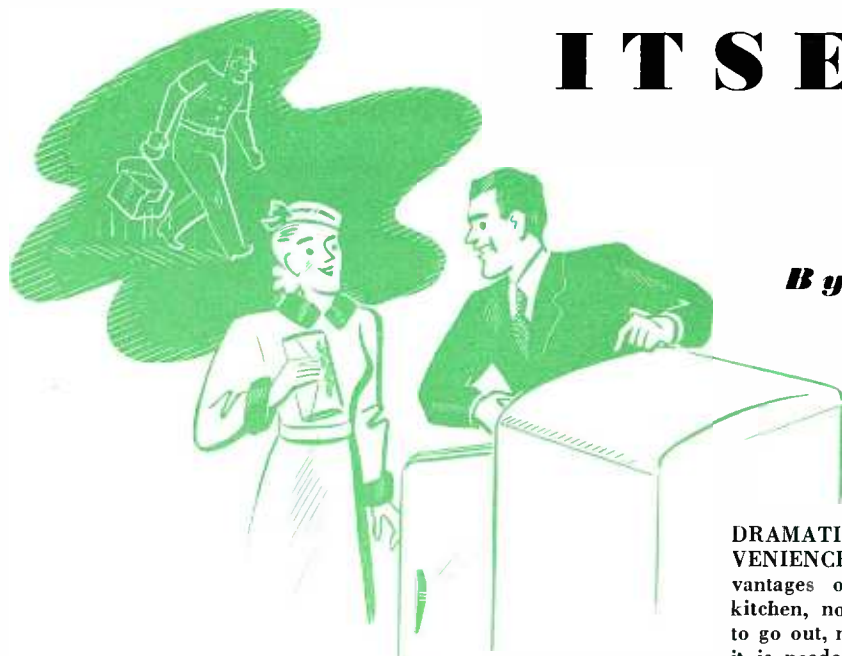

By CASWELL ODEN

DRAMATIZE ELECTRIC REFRIGERATION CONVENIENCE—Paint a vivid verbal picture of the advantages of having no ice man tracking up the kitchen, no waiting for ice when the woman wants to go out, no messy chopping of ice with a pick when it is needed for drinks

LAST month we finally got into Mrs. Jones' home, without exhausting ourselves at the door, and this month we're going to sell her an electric refrigerator, or know the reason why not.

We sell her the box in this way: The Box Itself, along with its Convenience—then the Economy, our trump card, our irresistible sales argument. We may mix up all three in our summary, when we're closing, but we don't do that at first. Too much of a good thing, all at one time, is too much for the lady to grasp.

The dealer we work for carries only one make, but we have with us catalogues on practically every box on the market. We sell them all, we tell Mrs. Jones, but we want to recommend the "Coldfood" box because it holds such records for customer satisfaction, as far as our own experience is concerned. "And whether you know it or not, Mrs. Jones, you can't last long in this business without the goodwill of your users. Why, half the boxes I sell are to leads given me by my users—and this certainly wouldn't be the case if those users weren't completely satisfied.

"Don't misunderstand me, now. If you have your heart set on any particular box, I certainly don't want to sell you something you don't

want. But I do want to give you the benefit of my experience. After all, Mrs. Jones, the average electric refrigerator salesman has only one box to sell. And it is only natural that he should paint a very beautiful picture of the box he's selling. But I am in a different position. I don't *have* to do that. I can sell you any box you want. And when I tell you that I think you'll be better satisfied with the 'Coldfood' than any other box, it is only because I honestly believe you will."

How to Sell the Make You Have

It is easy for Mrs. Jones to see, now, that if she buys a box this is the man to buy it from. She'd been thinking about a "Squeedunk" box, because her sister has one, but the "Coldfood" is probably better. This man sells them all—so he should know. He's a nice man, too; he's not trying to shove off something on her that she doesn't want.

So we show Mrs. Jones the "Coldfood." I can't do it here, because if I do the manufacturers of the "Squeedunk" box, and all the other boxes, won't like it. But I want to tell you that my "Coldfood" box is *any* box, any standard (and preferably leading) box.

The refrigerator salesman can usually convince the average prospect that his particular box is the

one she should buy. The only point I want to emphasize here is that he can do it *better* by *not* speaking disparagingly of any other box. And that there is no *occasion* for him to do so when he makes believe he sells them all. (It isn't necessary for him to be as familiar with all these boxes as he is with the one he wants to sell. A casual reading of the catalogue, or even a folder, will usually suffice. Even then they will know about a hundred times more about it than the prospect does. And if she sticks him with a question, it doesn't matter. In fact, it even helps them. He just looks in the catalogue. "Just



PLAY UP THE THINGS SHE CAN SEE

—Talk to women about visual features such as the cabinet, its finish, hardware, the cold control, interior light, ice trays and shelving. Reserve technicalities for their husbands, and avoid them even here if possible

a minute, I'll see. We sell so few of them that . . .")

Don't Go On 'Till You're Sure

Anyway, we show Mrs. Jones the "Coldfood." We even compare it with one or two other boxes and, by subtle innuendo wherever possible, show her where it is, in our opinion, her best buy.

We must cover the "Coldfood" thoroughly, no matter how many times we're interrupted, no matter what. But just *how* thoroughly we cover it depends upon Mrs. Jones. We may convince her in a hurry. We may not. But even if we *do* convince her in a hurry, we mustn't let her off with a half-baked solicitation. And on the other hand, we mustn't bore the lady to death, especially about things she doesn't understand.

When I speak of a thorough solicitation, I don't mean that we must tell the lady what makes the box get cold. She doesn't know and she doesn't want to know. But we must point out the advantages of those pretty things she can *see*, and *all* of them. Mr. Jones may want to know something about the unit, later on, but Mrs. Jones won't.

Mrs. Jones should be told about such things as the beauty of the cabinet, the insulation, the finish, the hardware, the cold control, the interior light, the ice trays, the ice cubes, the shelving, how to defrost, perhaps just a little about the unit, then the guarantee, and finally—the cost of operation.

"Canned" Economy Story

She may give us an argument about the cost of operation. And if she does, *now* is the time to settle *that* argument. Because it is very annoying, after we have gone into our irresistible sales talk (the Economy), to have to take time out and argue about the cost of operation.

So when we tell her the cost of operation will be about 75¢ a month, and she says oh, no, it will be at least \$1.50, we just smile.

"It's a funny thing, Mrs. Jones, this cost of operation. Some people just cannot believe it is so low, today—on a good box. I can tell a

person, within a few cents, just how much current any model Coldfood will use, with ordinary use. We don't guess at these things. We know. These figures have been established by laboratory tests, hot room tests. But I go further than that. I take the word of my users.

"It reminds me of a case I had a couple of weeks ago. That is, I sold the box about two months ago, but I was in the neighborhood a couple of weeks ago and I dropped



MAGNIFY YOUR STOCK WITH CATALOGS—The prospect will take it for granted you sell all the makes pictured, listening more readily to praise about the particular one you really want to sell because she thinks she's getting an inside tip about the best

in to see how it was operating."

(This is fiction. But truth, aside from being stranger than fiction is also harder to believe, so we'll give the lady fiction.)

"It's over on McDade Boulevard, and when I sold Mr. Krump (always pick out a fairly unusual name; it sounds better) the box, I told him it would cost him about 75 cents a month for current. It's a size larger than yours, Mr. Jones. Well, he said I was crazy. He knew too many people with electric refrigerators to believe a story like that. And he did, Mrs. Jones, because there are a lot of people with

LAST MONTH:
"A-B-C of Refrigeration Salesmanship"

NEXT MONTH:
"The Irresistible Sales Talk"

boxes several years old—and \$1.50 for *those* boxes is cheap. But today is not several years ago. In the last few years the cost of operation has been cut in half.

"Anyway, Mr. Krump bought the box. He didn't believe what I told him about the cost of operation but he bought it anyway, because he wanted it.

"Well, when I went in the other evening, I asked how the box was operating, and he said fine. Then I asked him how much it had added to his electric bill. 'Listen,' he says, 'I owe you an apology. You know how much this box has cost me for current? Just about 55 or 60 cents a month. I had no *idea* it would be so cheap, but that's what it runs me. I was looking at my electric bills the other night.'

"And do you know what I told him, Mrs. Jones? I told him I was certainly glad to hear it but that the box, really, had cost him a little more than that. That he had simply cut down a little on something else — without knowing it.

"Well, he looks at me, a little surprised, then pokes me in the ribs and grins. 'Man,' he says 'you stick to your story *either* way, don't you?'

"And I do, Mrs. Jones. I don't want to be too low, and I don't want to be too high. I want to be *right*. And I *am* right, when I tell you that this box, with average usage, will cost you approximately 75 cents a month for current."

And if you don't believe that *that* story, sincerely told, puts an end to the cost of operation controversy, then you try it some time.

Stress Convenience Here

While we're selling Mrs. Jones on the Box Itself we naturally sell her on the Convenience too. All refrigerator men know how to do this. Briefly, we simply explain, as fetchingly as we can, how nice it will be when she has no ice pan to empty. No ice man tracking up her clean kitchen floor. No waiting for the ice man when she wants to go out. No worrying about the ice pan running over, when she *is* out. No sloppy chopping of ice

(Continued on page 67)

IF YOU ARE A
Better than Average
DEALER

The so-called average dealer and service man meets some of our requirements, but he seldom meets them all. The very things which make the Tung-Sol Consignment Plan so valuable depend on selected distribution.

READ THEM CAREFULLY

- Have you an established radio service business? ✓
- Is your location free from interference with already established Tung-Sol agents? ✓
- Have you the necessary technical knowledge and equipment to service radio? ✓
- Is three months' supply a sufficient tube stock? ✓
- Will you agree to make a monthly stock report on standard forms provided by the wholesaler? ✓
- Will you regularly use display and advertising material furnished by us? ✓
- Will you maintain Tung-Sol established retail prices? ✓
- Have you sufficient capital to meet your obligations promptly when due? ✓

If you operate your business on these principles, you are a "better than average dealer."
Write today

We want you!

TUNG-SOL LAMP WORKS Inc., (Radio Tube Division)
Dept. B

- SALES OFFICES: ATLANTA
- CHICAGO • DALLAS
- DENVER • KANSAS CITY
- DETROIT • LOS ANGELES
- NEW YORK • GENERAL
- OFFICES, NEWARK, N. J.



NOW Sell More PORTABLES

**Improved
With New
CX Motors
Constant Speed
Light Weight**

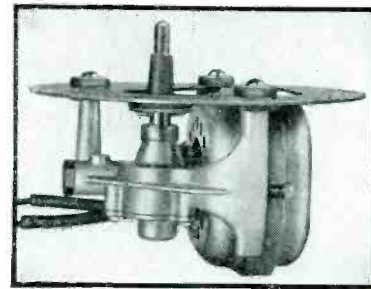

Model CX. An 8", 9", 10" or 12" turntable is supplied.

THIS is the new, lighter-built General Industries development—Model CX. For portables and table models. Constant speed. Self-starting induction type. Fan cooled. Ample oil reserve in sealed chamber. Noiseless, helical-cut gears and long over-size bearings. Patented drive insulates turntable.

TEST MODEL CX NOW

Order a sample Model CX Flyer for testing. Remember to mention frequency of current you use, and size of turntable required.



The GENERAL INDUSTRIES CO.

3937 Taylor Street

Elyria, Ohio

**For 1939 . . . It's ATR Vibrators!!
FULLY GUARANTEED FOR 1 YEAR**

There is No Better Vibrator Made than ATR—Produced by the World's largest Vibrator Manufacturer.

A Complete Line of Replacement Vibrators For Auto and Farm Radios Featuring:—

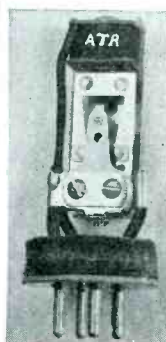

- Large Oversized 3/16" Diameter Tungsten Contacts having Full Wiping Action—for greater reliability and Longer Life.
- Perforated Reed of Highest Quality Swedish Spring Steel—for uniform flexibility and prevention of reed breakage.
- Highly Efficient Magnetic Circuit with Formed Base—for greater accuracy and more uniform operation on both high and low voltages.
- Mica and Metal Stack Spacers with Two-Bolt Stack Construction—for adjustment permanency under any operation condition.
- Extra Flexible Leads with Tinned Clamp Supports for good low resistance connections and freedom from lead breakage.
- Highest Precision Construction and Workmanship—Practically all parts used are held to within a tolerance of 0.0005 of an inch.

FREE

To win new customers and friends, ATR will give absolutely free one #1240 Vibrator (competitive 4-prong non-synchronous type listing at \$1.75) to every dealer or serviceman purchasing any 6 Vibrators shown on the ATR Vibrator Guide. Merely send to the factory six "order reminders" taken from ATR vibrator cartons (there is one on each) with your jobber's name written or stamped on and date of purchase. For each group of six ATR vibrator "order reminders", one #1240 ATR vibrator will be given free, postpaid. All purchases must be 1939. This offer good until May 1, 1939. Act now! Remember, Insist on ATR Vibrators; there is none better!!

ATR Vibrators are VALUE PLUS—and Prices, 25% Lower!!

Write for your **FREE** Copy of the ATR Vibrator Guide and Equivalent Chart. Your ATR Vibrator Distributor will be Happy to Serve You.

AMERICAN TELEVISION & RADIO CO.

Manufacturers of Auto and Farm Radio Vibrators, Inverter Vibrators, DC-AC Inverters, "A" Eliminators, and Battery Chargers.

St. Paul, Minnesota, U.S.A. Cable address: "LIKEX" New York

EDUCATIONAL MARKETS

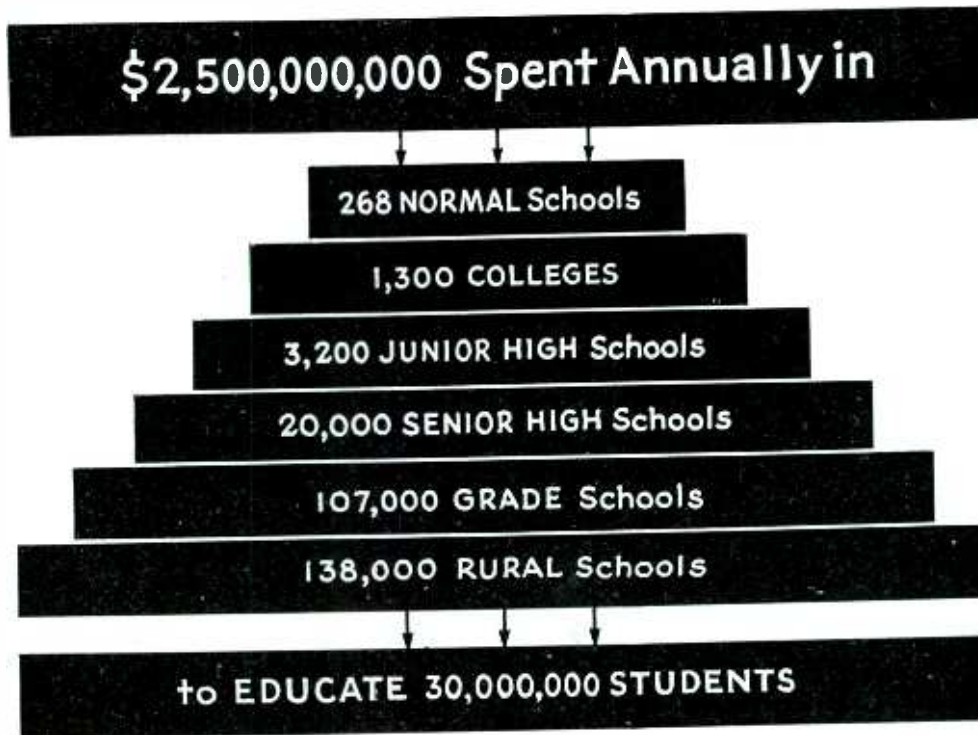

UN SOLD S C H O O L S

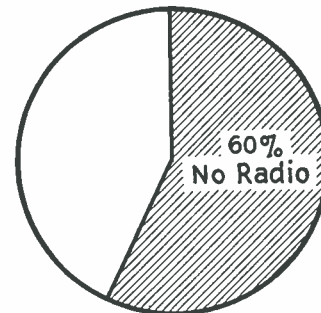
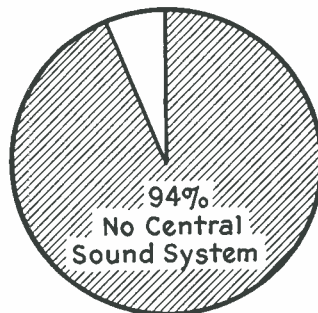
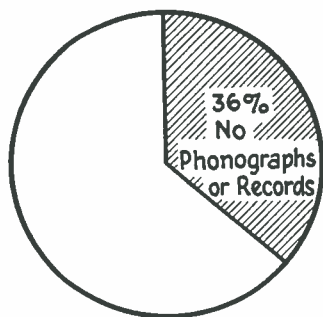

NOTE: These three pie-charts, showing schools without phonographs or records, central sound systems or radio, are based on figures obtained from a

survey of 8,806 school systems, made by the American Council of Education. The systems included in the survey control a total of 82,297 buildings.

DOUBLE-BARRELLED SALES HELP

Immediately following this tabulation are pages in which *Radio Retailing* passes along to dealers, servicemen and distributors effective methods of promoting the sale of SOUND, RADIO, PHONOGRAPHS, RECORDERS and FILM among schools. Here we "talk shop."

Then comes a special paper insert entitled "Modern Aids to Edu-

cation", designed for reading by educators themselves and intended as a sales tool to help the trade "button up" such profitable business. Here we talk to the ultimate user.

Much of the insert is written by schoolmen who are boosters for our products, hence all or any of the material in the insert may be freely shown to the prospect.

Don't Neglect Small Jobs

By LEE McCANNE

Stromberg-Carlson Telephone Mfg. Co.

● Many soundmen keep in touch with schools through construction reports, State Bureaus and local Boards of Education and so develop large sound jobs. But there are wealthy private schools which have seldom, if ever, been solicited.

Do you realize that wiring a private school for simple bells to announce the beginning and ending of each class period is an outlay which would go a long way toward the installation of a system which would not only serve this purpose through voice or chime announcements but could also distribute radio and recorded programs as well?

Small schools seldom have such a large auditorium as to require amplification from the stage. Close-talking microphones and a power output equivalent to that of a good radio-phonograph combination would fill the need for a gymnasium, music room and several class rooms. Most of the manufacturers of sound system equipment have at one time or another developed such systems, adaptations if you will, of home type, powerful phonograph-combinations equipped with microphones, speaker impedance matching and speaker line keys or controls. Exclusive of the extension speakers, such an outfit may list for less than \$300.

There is no denying that elaborate, high quality equipment is highly desirable in many instances but, by keeping one's feet on the ground and selling the simple jobs first, almost any radio dealer can uncover opportunities in his own neighborhood readily.

Demonstration Now Practical

By W. L. ROTHENBERGER
RCA Manufacturing Co., Inc.

● The year 1939 promises to be a banner one for the sound business, especially in the school market. There is an exceptional opportunity for radio dealers to establish themselves in their communities in this rapidly expanding field.

The increasing importance of school sound systems for administrative and educational use has created a great demand for simple, flexible, modern-styled equipment at

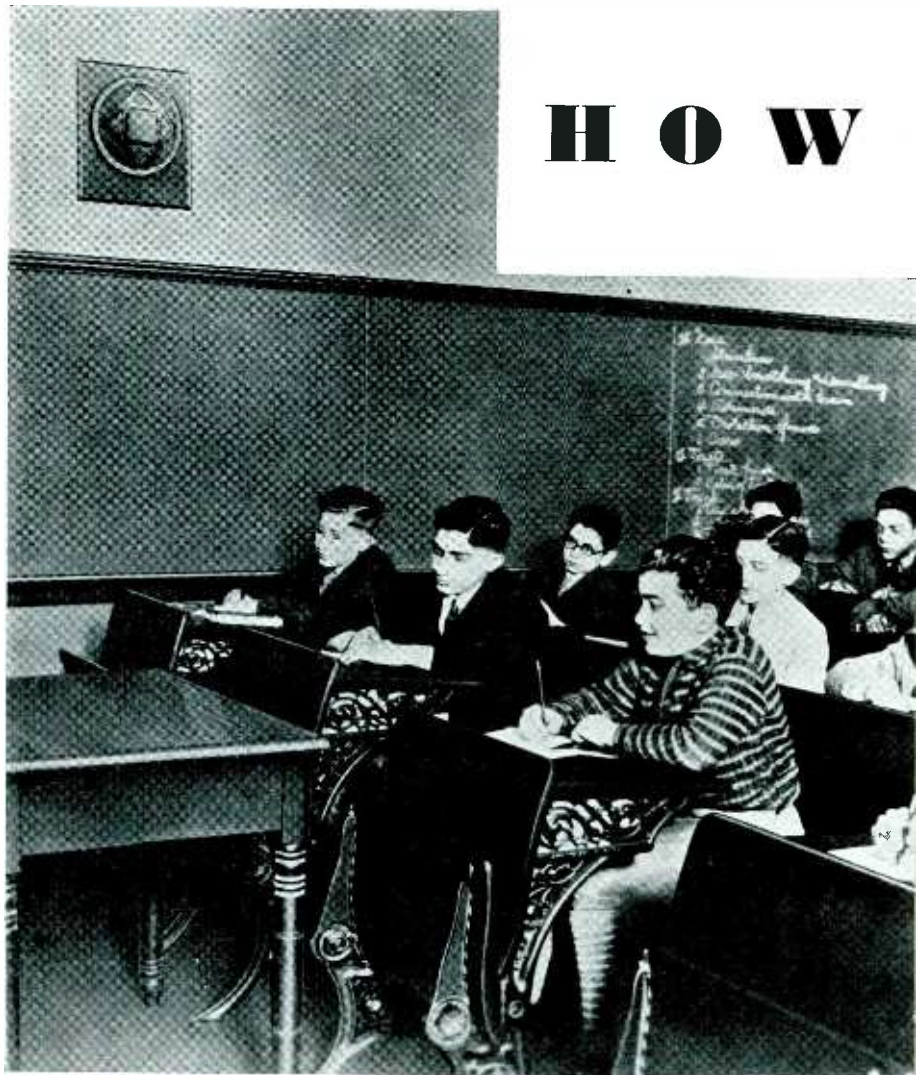

JOBS MUST BE RIGHT—Equipment installed in schools must be of high quality as these purchasers are necessarily critical. Sale of sub-standard merchandise at a price does not pay in this field. Picture shows typical flush wall design speaker in a classroom

(Photo courtesy Western Electric)

a reasonable price. We have designed a table model and a console unit to meet this demand, offering distributors and dealers something new in school system merchandise. The opportunity to demonstrate such equipment easily in the prospective school is now offered, as the table model is as simple to transport and install as a radio receiver, and the console unit not much more difficult to handle.

Improvements in instantaneous recorders are also seen as being important in the educational field. School principals and other executives may now readily prepare special educational material on records which may be played back to classrooms on regular schedules.

Spread Word About New Talking Movies

By PHILIP S. MALICKSON
Sentry Safety Control Corp.

● Too many radio merchants have concentrated entirely on merchandising to the home only. Comparatively little attempt has yet been made to expand in other markets closely allied with present day activities.

How many have seriously thought how important the matter of education in schools is today? How many have considered the genuine and widespread need for talking motion pictures in this field? Some institutions already use this method of supplementing teaching, but the surface has not been scratched.

t o S E L L S C H O O L S

To the trade, manufacturers of sound, radio, phonographs, recorders and film pass along practical tips



MUST BE CERTAIN, SAFE—School equipment must not only be easy to use and foolproof in operation but it must also be safe. Here's the workmanlike film storage room in a big mid-western institution

(Photo courtesy Electro-Acoustic Products)

Familiarize yourself with the many improvements that have been made in projectors for this purpose, particularly with the new 16 mm. devices. Familiarize yourself, too, with the many new film subjects that have just recently been made available. Tell school executives about this improved equipment.

Remember, too, in your selling, that more and more important educators are "with you" every day in suggesting talking movies in schools.

Delayed Reception Useful

By R. H. LASCHE
Fairchild Aerial Camera Corp.

● In a great number of schools, entire classes in speech and modern

languages are recorded periodically during the school year, each student recording on a separate disc, so that progress, or lack of it, can readily be noted. By this method the students can hear their errors when the recording is played and are much more apt to correct these errors of pronunciation, grammar, voice quality and inflection. Since the perfection of the first sound recorder these instruments have been used for this type of instruction.

The same idea is carried out in music departments by recording the individual voices and instruments as well as large choirs, orchestras, bands and smaller ensembles. Here, if a student's voice or instrument is off pitch or the quality does not blend with others of the group, the student himself, to say nothing of his associates, notices the fault at once. As a result, the performance is greatly benefited by frequent recordings and playback.

Delayed reception is an extremely important use for recording equip-

ment in schools. It is not always practical or possible for an entire class in music, history, speech or dramatics to listen to the finer radio programs because these programs are sometimes broadcast at a time of day when the class is not in session. If these broadcasts occur in the evening a permanent recording can be made and played back the following day to the entire class when it meets. These recordings can also be kept as a permanent library for class room use.

Start Small, Work Up

By HASKEL A. BLAIR
David Bogen Company, Inc.

● Most of the small schools have their school boards decide the particular type of equipment desirable for their installation. In some cases schools have equipment financed by the Parent-Teachers Association. These school boards or PTA groups

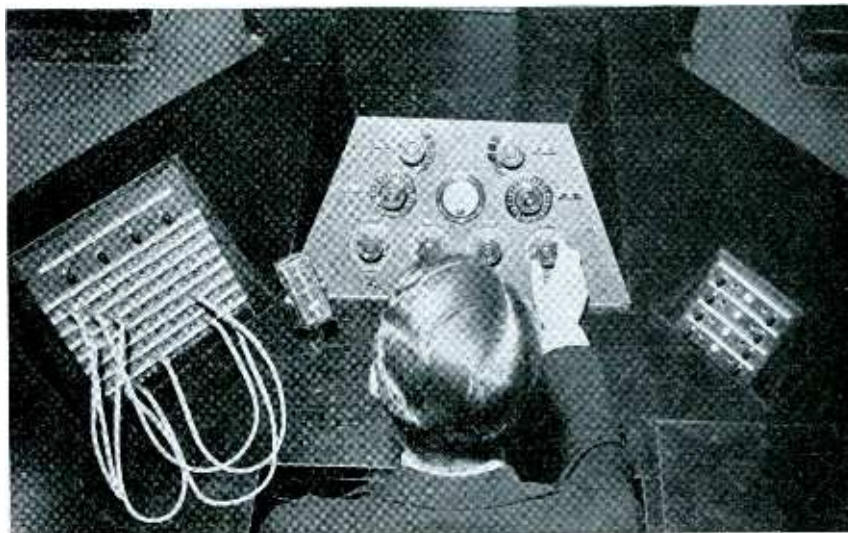

INGENUITY ESSENTIAL—Adapting equipment to the building, and simultaneously to its budget, requires thought on the part of the dealer. Here's a method of modifying an ordinary desk for convenient inclusion of control panels

(Photo courtesy Amperite)

ARE YOU JUST A

THAT'S NOT THE LEONARD WAY OF DOING BUSINESS



Leonard Dealers are Treated as Individuals, with Problems of Their Own. They Get Help Instead of "High Pressure." They Get Plenty of Territory to Grow in, instead of Being Over-Crowded



YOU'RE NOT in business for your health. No one is.

You are looking for that very useful "net" at the end of the year. But there is more than one way of arriving at this "net." Some of the ways are painful — some pleasant.

Leonard believes that half the headaches in this business aren't necessary . . . that high-pressure selling, over-crowded territories, and over-loading, are chickens that come home to roost.

It seems that a lot of other business men agree with us . . . judging by the list of Leonard distributors shown at the right.

Run your eye down the list. You'll recognize most of them. It reads like the Blue Book of this industry.

They've been in business a long, long time. They know what it's all about.

They know that one dealer, loyal throughout the years, is a bigger asset than half a dozen who pass out of the picture.

They know that dealers must make a profit from the franchise if they are to stay in business.

They know that an electric refrigerator is different from a pack of chewing gum that can be franchised to anyone. They know that dealers need "growing room."

So the process of placing a Leonard dealer franchise isn't one of "shooting tacks at a map." They go slow and easy . . . which results in fewer dealers, but explains why Leonard dealers keep on being Leonard dealers.

We have deliberately not said a word yet about the Leonard line of '39.

The features shown at the right are simply some of the highlights. We would prefer that you see the line yourself and meet the man who stands behind it in your locality.

We bet you're going to like him.

If you believe in individual initiative and freedom of action . . . if you like "elbow room" . . . we believe you'll like the Leonard way of doing business.

At least, why not find out? LEONARD, 14250 Plymouth Road, Detroit, Michigan.

ASK ANY LEONARD DEALER
ABOUT THE

LEONARD WAY

TACK ON A MAP?

Fast Selling High Spots for 1939!

*Leonard Travels in
Good Company*

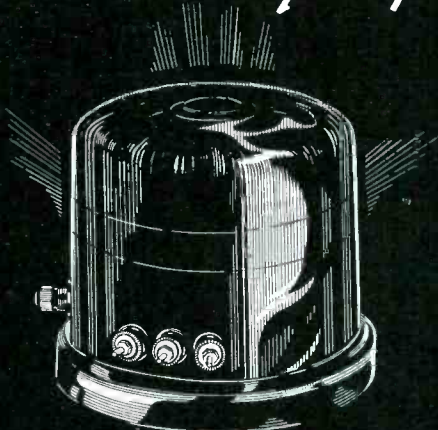

The quiet, sealed unit that gives your salesmen a sales-clinching economy story, and you a new idea of "service freedom".

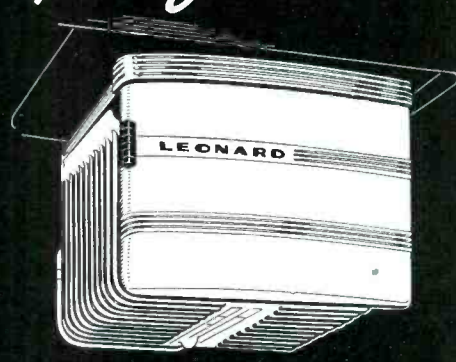

New evaporator does its bit in helping to freeze cubes faster—also provides storage space for "fast-frozen" foods.

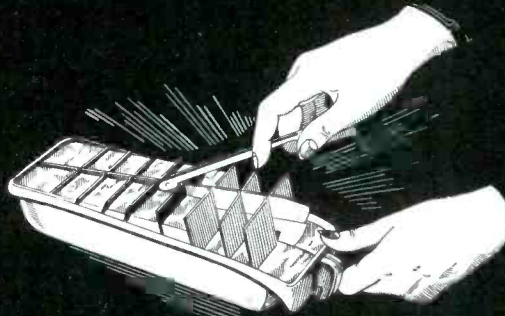

All trays in standard models furnished with the time- and toil-saving Ice Popper Cube Release.

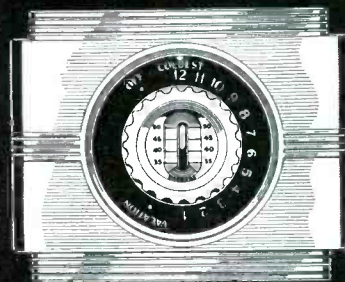

... The Master Dial ... tunes in the temperature you want inside.

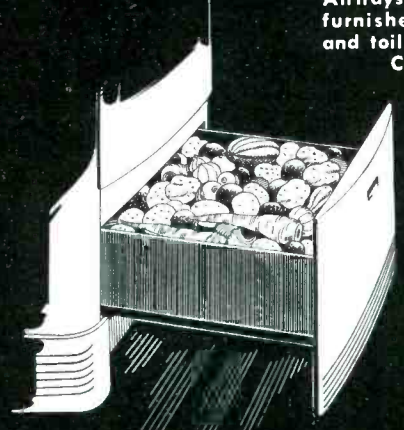

Nearly two bushels of vegetables go into this extra-capacity dry storage bin.



Here's where ... and how ... meats and fish are properly kept.

Albany, N. Y.	E. S. & E. Co., Inc.
Altoona, Pa.	Electric Appliance Distributors
Amarillo, Tex.	Nunn Electric Co.
Atlanta, Ga.	Lamar-Rankin Co.
Birmingham, N. Y.	Broome Distributing Co.
Birmingham, Ala.	Watts-Newsome Co.
Boise, Idaho	Bertram Motor Supply Co.
Boston, Mass.	J. H. Burke Co.
Buffalo, N. Y.	Joseph Strauss Co.
Burlington, Vt.	Vermont Hardware Co.
Charleston, W. Va.	Eskew, Smith & Cannon
Chicago, Ill.	L. C. Wiswell Co.
Cincinnati, Ohio	Schuster Electric Co.
Cleveland, Ohio	Arnold Wholesale Corp.
Columbus, Ohio	Appliance Distributing Co.
Dallas, Texas	Peaslee-Gaulbert Corp.
Dayton, Ohio	York Supply Co.
Decatur, Ill.	Linn & Scruggs
Denver, Colo.	Hendrie & Bolthoff Co.
Des Moines, Iowa	A. A. Schneiderhahn Co.
Detroit, Mich.	Buhl Sons Co.
Dodge City, Kans.	Mullin Furniture Co.
Escanaba, Mich.	Delta Hardware Co.
Grand Rapids, Mich.	J. A. White Distributing Co.
Harrisburg, Pa.	Knerr, Inc.
Indianapolis, Ind.	United Distributing Corp.
Kansas City, Mo.	Federal Distributing Co.
Knoxville, Tenn.	Maytag Appliance Co.
Los Angeles, Cal.	Graybar Electric Co.
Louisville, Ky.	Stratton-Tersteppe Co.
Memphis, Tenn.	Harry T. Wilson Co.
Miami, Florida	Major Appliances, Inc.
Milwaukee, Wisc.	Taylor Electric Co.
Montgomery, Ala.	Mathews Furniture Co.
Nashville, Tenn.	McWhorter, Weaver Co.
Newark, N. J.	E. B. Latham Co.
Newburgh, N. Y.	Shapiro Sporting Goods Co.
New Haven, Conn.	H. M. Tower Corp.
New Orleans, La.	Radio Specialty Corp.
New York, N. Y.	E. B. Latham Co.
Oklahoma City, Okla.	Otaseo Supply Co.
Omaha, Nebr.	Paramount Radio Shop, Inc.
Paducah, Ky.	Gleaves & Son
Peoria, Ill.	Cohen Furniture Co.
Philadelphia, Pa.	Motor Parts Co.
Phoenix, Ariz.	Graybar Electric Co.
Pittsburgh, Pa.	J. A. Williams Co.
Portland, Maine	Cressey & Allen
Portland, Ore.	Electrical Distributing, Inc.
Providence, R. I.	Ballou, Johnson & Nichols Co.
Richmond, Va.	Graybar Electric Co.
Rochester, N. Y.	Beaucaire, Inc.
St. Louis, Mo.	Electric Lamp & Supply Co.
Salt Lake City, Utah	United Electric Supply Co.
San Francisco, Cal.	Graybar Electric Co.
Scranton, Pa.	Household Appliance Dist.
Seattle, Wash.	Seattle Hardware Co.
South Bend, Ind.	Cloud Bros.
Syracuse, N. Y.	Morris Distributing Co.
Toledo, Ohio	Electric Range & Equip. Co.
Washington, D. C.	Southern Wholesalers, Inc.
Wichita, Kans.	McKelvey's
Williamson, W. Va.	Persinger Supply Co.

of Doing Business



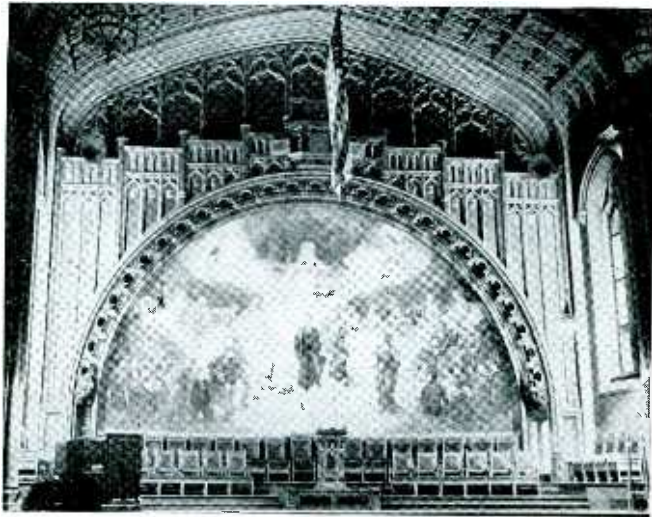

HIGH FIDELITY, HIGH UP — Six speakers are used in the Great Hall of City College in New York, four just behind the flag and two more left and right. A 70-watt amplifier of the Bi-Natural type, with a special crossover filter network and volume expansion, drives them

(Photo courtesy Bogen)

are laymen, nontechnical and so, very often, their study involves a lot of discussion and many general inquiries on their part.

We have recommended that our distributors, in contacting schools, lay particular stress on actual demonstrations of small "Junior" type specialized school systems. The investment involved for this new type of equipment is no more than a high quality portable sound system and it is therefore possible for the distributor to stock one of them and, when contacting the school, arrange to make an actual demonstration on the premises.

Such an actual demonstration crystallizes the school's ideas; permits officials actually to see the equipment in operation, hear its effectiveness and obtain a first-hand explanation of the features and operating details. Such a demonstration very often eliminates a good deal of general discussion and quotations that often prolong such transactions. This has proved to be of considerable assistance to the trade and, of course, it leads to additional sales for auditorium sound installations and other types of sound equipment, for school needs.

Amplification Reduces Strain

By C. P. CUSHWAY
Thordarson Electric Mfg. Co.

● Amplifier systems have developed rapidly in the past few years and today are considered indispensable in certain fields. For example, in educational work amplifying sys-

tems play an important part in oral instruction. They eliminate much strain and effort in speaking on the part of the teacher and permit the student to hear the instructions without danger of missing a word. They reduce the acts of instructive talking and listening to their natural or subconscious qualities and permit concentration of thought on the subject itself.

Excellent quality of reproduction is essential in schools. Audio amplification is not in itself sufficient.

Get Department Heads Together

By RALPH POWELL
Presto Recording Corp.

● To sell recording equipment to schools, the dealer must bear in mind the following facts. Each school has numerous departments, all battling for their share of the

school budget. Get the heads of the speech, music and dramatic departments to band together in their request for a recorder. It will be equally valuable in each department.

After you have sold the department heads, furnish them with ammunition to back their request to the school manager for the necessary funds. To do this get the support of the parents whose children attend the school. If possible, arrange a demonstration of the recorder at a meeting of the Parent-Teachers Association. Record the voices of the parents to let them see how little they know about their own voices. Show them how they compare with trained speakers. Record a concert by the school band or glee-club or even individual students. Record a scene or two from a school play and offer records of the leading players to their families.

You will find that fathers and mothers are vitally interested in hearing records of themselves and their children. They will want to know how recorders are used by leading musicians, actors and public speakers. And their enthusiasm will help tremendously in getting the department head the equipment he wants. In fact, there are quite a few cases on record where a student's family has presented a recorder to the school as a graduation present.

Prices Today Fit Budgets

By H. A. WILSON
Operadio Manufacturing Co.

● Radio dealers, soundmen and servicemen are neglecting in the

FLEXIBILITY DESIRABLE—Here's a 100-watt amplifier used by a high school in Benton Harbor, Michigan, to flood its outdoor stadium with sound. A 15-watt unit is used in the auditorium
(Photo courtesy Electro-Voice)



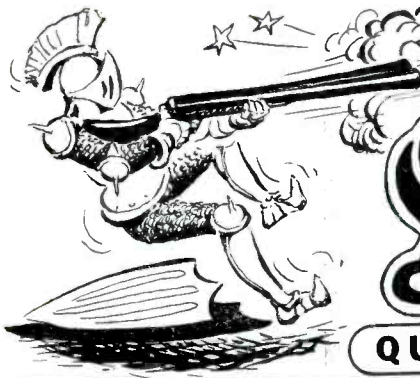

A DOUBLE SHOT AT THAT PROFIT DOLLAR
WITH *Sentinel* DOUBLE-BARRELLED LINE!

Sentinel

QUALITY RADIO SINCE 1920

AC
MODELS
FARM
MODELS

A
COMPLETE
LINE
SENSIBLY
PRICED

Sentinel Radio Corporation • Dept. RR • 2222 Diversey Pkwy., Chicago

A GOOD NAME
GOES A LONG WAY



Ken-Rad Tubes have a good name because of their long-time dependability and high standards of quality and performance.

Ken-Rad Tube & Lamp Corp.
Owensboro, Ky.

KEN-RAD

DEPENDABLE RADIO TUBES

A World of Service
in *OHMITE Resistors*

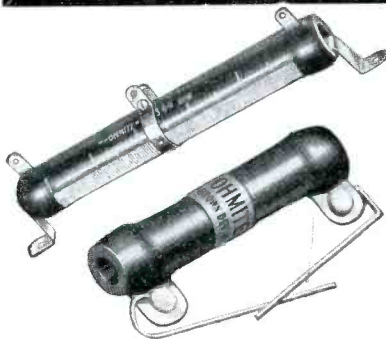

Like "tried and true veterans", these Ohmite Vitreous-Enamelled Resistors insure continuous, trouble-free service day-in and day-out. That's why they are so widely used for replacements by Servicemen the world over, as well as for original equipment by leading manufacturers.

BROWN DEVILS — Dependable, economical resistors for voltage dropping, bias units, bleeders, and other uses. 10 and 20 watt sizes.

10 WATT DIVIDOMS — Handy Adjustable Resistors for quick, accurate change of resistance value or simple replacement. Also available in other ratings up to 200 watts.

Ask for Them at Your Jobber.

Ohmite Manufacturing Co.
4845 West Flournoy Street
Chicago, Illinois, U.S.A.

Free Catalog 17
Send for Your Copy Today

Ohmite Manufacturing Company
4845 West Flournoy St., Chicago, Ill.
Send me Free Catalog 17.

Name
Address
City
Occupation

Be Right with **OHMITE**
RHEOSTATS • RESISTORS • TAP SWITCHES

Janette Rotary Converters

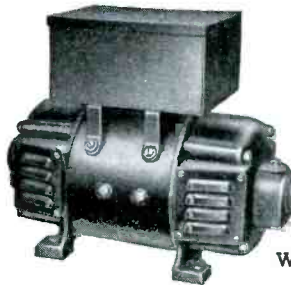

For Converting D.C. to A.C.

Built for radio and sound apparatus — capacities 110 to 3250 volt amperes — with or without all wave filters. Dynamotor construction — economical to operate — ruggedly built for years of trouble-free service — used or recommended by the largest manufacturers of radio and sound apparatus — in use all over the world.

Why Experiment — Insist on a Janette

Ask for Bulletin 13-25

Janette Manufacturing Company
556-558 West Monroe Street Chicago, Ill. U.S.A.

"PINCOR"



LONG
LIFE

SMOOTH

SILENT

**DYNAMOTORS
and CONVERTERS**

A Complete Line
for Every Purpose

Radio engineers have learned from experience that Pioneer Gen-E-Motor Corporation's dynamotors, gen-e-motors and converters provide the last word in dependable power supply units for air craft, police, marine and auto radios and public address systems. They are available in a wide range of capacities for every requirement. Designed and constructed to give maximum long life and service. Light weight and compact. For complete information fill out and mail coupon below.

PIONEER GEN-E-MOTOR CORPORATION
Dept. R-1A, 466 W. Superior Street, Chicago, Illinois
Please send me "Pincor" Silver Band Dynamotor Catalog and Data Sheets.
Name
Address
City State



RUGGED, BUSINESSLIKE—All devices in schools are subject to relatively rough usage so they must not only be precision-built but must also be built to "take it". This instantaneous recorder is a good example
(Photo courtesy RCA)

most part a highly profitable field in their communities. Schools, regardless of their size, are buying centralized sound distribution systems in order to take advantage of the educational aids and broadcasts by Government Bureaus, Broadcast Chains and the various Universities.

Schools which heretofore have refrained from purchasing equipment of this kind because of the equipment or the price no longer hesitate, as school sound is now available to fit the actual needs of the particular school, priced well within that school's budget.

Schools Break the Ice

By S. N. SHURE
Shure Brothers

● The use of sound is definitely on the up-swing in schools and educational institutions. Educators are beginning to realize the many advantages of sound equipment for instruction and entertainment in both student and community activities.

A sound-equipment sale to a school means much more to the dealer than the mere profit of one individual transaction. Students,

teachers and parents become sound-conscious from the use of such equipment and the goodwill and publicity accruing to the dealer in this way is enormously beneficial.

Sound equipment should be fool-proof and flexible. It has been our experience that uni-directional microphones solve many hitherto difficult educational problems.

Good Technicians Essential

By A. R. KAHN
Electro-Voice Mfg. Co.

● School sound installations provide excellent engineering opportunities for able technicians. They really place the installation man in the position of "Sound Architect" who thinks in terms of customer benefit.

It is he who makes suggestions, analyzes problems and makes recommendations. He does not sell equipment in the usual sense but, rather, works in close cooperation with the school officials to determine their needs. Sales follow, in their natural course.

Survey, Plus Calls

By R. E. POTTS
Bell Sound Systems, Inc.

● Every progressive educator realizes that some type of radio distribution is needed in his school. Actual steps should be taken now so that your local schools will understand that you are in an excellent position to supply their needs on this equipment.

In 1939 let's all buckle down and make a systematic search for prospects. Keep a card file of every interested person who in the near future will actually buy sound equipment. Checking back by telephone or by personal calls is essential.

Study Broadcast Programs

By P. S. LUCAS
Remler Company, Ltd.

● Schools are rapidly installing the wire for school systems and it is natural to assume that they expect to buy such systems just as soon as they know for certain what they

want. Their present problem is what to buy and how to use it.

The dealer should study the many possible uses for sound systems in schools and pass on this information to the principals and school boards. The best way to begin a study of this type is to become acquainted with the educational and semi-educational programs now on the air. When you see such titles as: "Americans At Work," "Exploring Space," "Living History," "Essays in Music," "New Horizons," "Adventures in Science," "Exploring Music," "Peoples Platform," etc. these should be brought to the attention of educators.

It doesn't take much imagination to see how an alert school teacher can employ such programs to dramatize his or her subject.

Keep An Eye On Repeat Business

By JAMES R. FOUCH
Universal Microphone Co.

● Many authorities to the contrary, the customer does not go to the retailer when it comes to sound equipment for schools. The dealer must go out and get his own leads, make his own contacts, give his own demonstrations and make the final close. Good equipment, of course, goes a long way toward making a sale. But it takes more than just a good line of merchandise.

Selling to schools requires a specialized form of specialty selling. Personally canvass the school field and make a card index based primarily upon the time of year at which schools make up their annual purchasing budget. Make it a practice to follow news in Teachers Institutes, PTA groups and other similar gatherings. Try the "free trial to responsible buyers" angle. Carefully analyze local school needs. Make personal calls upon faculty members most interested.

Naturally, the original sale to a school is but an entering wedge to still more business. The busy dealer will continue to service his installations and to install more equipment. There are many products to be sold. Once upon a time, for instance, a single microphone sale would go with almost any sound installation. Nowadays few sales call for less than three or four and as time goes on the number increases.

Modern Aids To EDUCATION

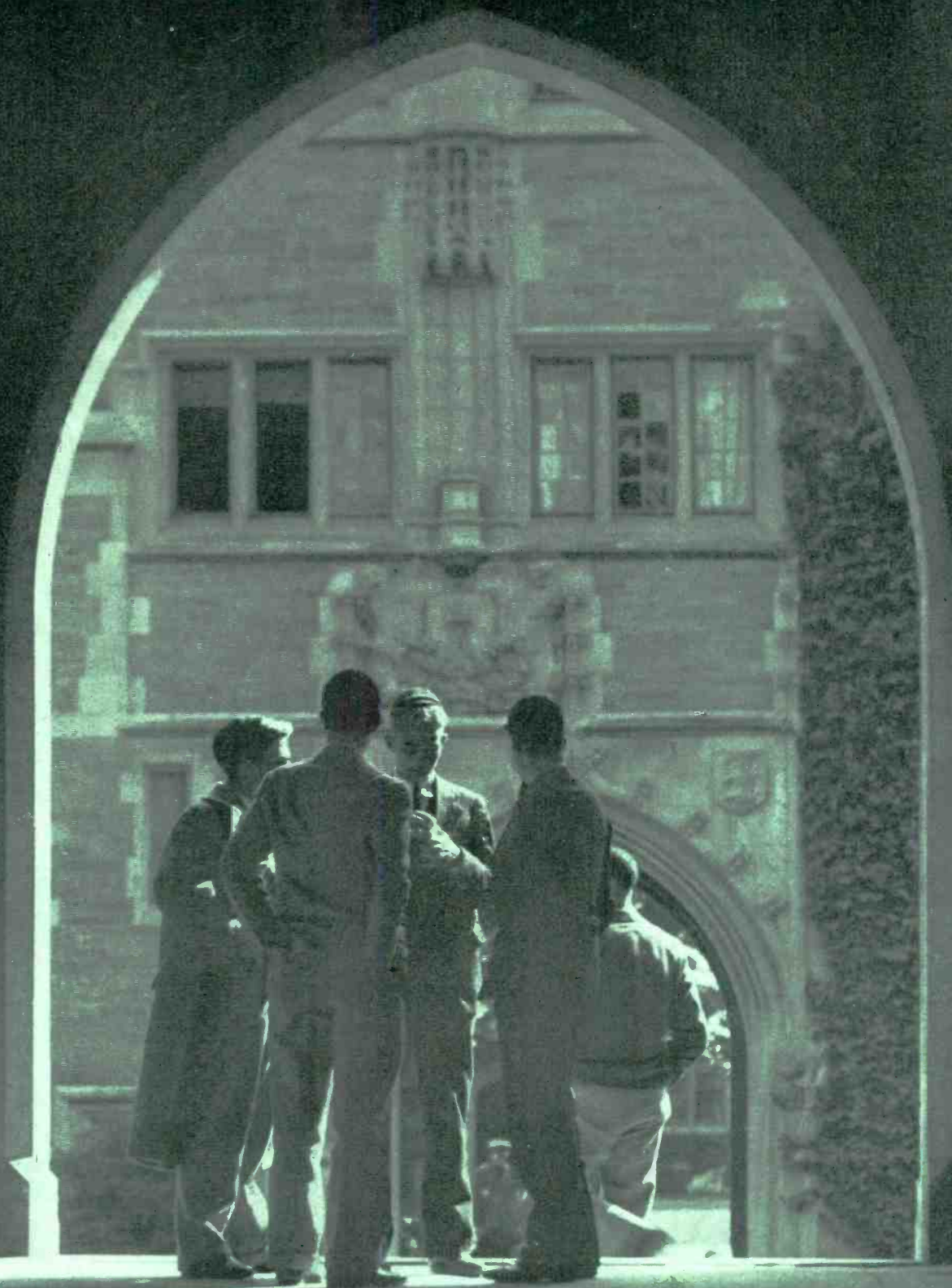

Radio Retailing

McGRAW-HILL PUBLISHING CO., INC., 330 W. 42nd St., New York

AN EVEN dozen years ago, the use of radio in education was still just another of those "fads and frills" in education which the village fathers attack, during periodic waves of budgetary retrenchment, as "non-essentials." Even within the ranks of teachers and administrators, there were those who held that school radio-listening lacked academic respectability, and actually feared that radio might, some day, replace the classroom teacher. However, since radio broadcasts offer a wealth of instructional materials not readily available from other sources, it was inevitable that the use of radio as an instrumentality for supplementing classroom instruction should continue to grow.

Today many school systems in the United States are known to be using radio, and the number of radio-equipped schools is constantly increasing. In fact, equipment for broadcast-reception and program-distribution has come to be regarded as an essential fixture of the modern school plant, and, even though unable to purchase equipment of this type at the present time, many school systems are having new buildings wired for radio, at the time of their construction, to facilitate its installation as soon as funds for this purpose are available.

Contrary to the direful predictions of those who, at first, had opposed it, school radio-program listening has taken over none of the functions of the classroom teacher. Quite the opposite of this, it has put a premium on the critical acumen of the teacher in helping pupils to analyze social trends and purposes. Instead of encouraging dependence on so-called "soft pedagogies," it has stimulated teachers to envisage the broader responsibilities of the school to the society which supports it. Instead of discouraging pupil initiative, school radio-listening appears to have aided materially in hastening the acceptance of instructional techniques which provide an opportunity for pupil initiative and inventiveness to develop. In short, the school use of radio has probably helped to dissolve the artificial barriers which ever since the period of medieval scholasticism, have tended to isolate the thinking of both teachers and pupils from the actualities of contemporary life.

Although a few schools began soon after the advent of radio broadcasting, to supplement class-

**SOUND
RADIO
PHONOGRAPHS
RECORDERS
FILMS**



In The MODERN

By **R. R. LOWDERMILK**

*Bureau of Educational Research,
The Ohio State University*

room instruction with radio-program listening, it was not until the power amplifier and the dynamic loud-speaker emerged from the laboratory to give radio a voice that could make itself heard under normal classroom listening conditions that schools, generally, began to consider the educational potentialities of radio.

Very shortly afterward, the power amplifier, in combination with loud-speakers and the microphone, appeared on the market in the form of the public-address system, and a few far-sighted manufacturers, in anticipation of a possible school market, made the further additions of a radio tuner, an electric-phonograph unit, and individual loud-speaker switches, and offered this new product to the public as the centralized program-distribution system. However, since the educational function of radio was conceived, at that time, wholly in terms of using broadcasts of recognizable educational significance to supplement other instructional materials, the type of receiving-set that had already been developed for home use was considered equally appropriate for school use.

The fact, however, that it was seldom found financially possible to provide each classroom with its own

receiving set led to inevitable difficulties. Daily moving of sets from room to room resulted in the need for frequent repairs, while the inconvenience that resulted from having to change classes for program reception discouraged some teachers from using radio at all. Faulty reception resulted frequently from such causes as power-line interference, inadequate antenna and ground facilities, off-station tuning, and injudicious use of the tone control. Not infrequently, classes missed a part of the program because the set was not turned on in time.

Centralized Programs Cheaper

In consequence of difficulties of these kinds, schools began gradually to turn to the centralized program-distribution system as the logical solution to their equipment problems. Although the initial investment sometimes taxed the school budget to its very limit, schools found, to their surprise, that the centralized radio-sound system provided listening facilities for the entire school at a cost which was actually less than which would be involved if each room were provided with its own receiving-set, together with interference-filtered power supply, and adequate antenna and ground facilities. In addition, the

phonograph unit provided for the reproduction of recorded programs for music appreciation or for entertainment and recreational activities and the office microphone facilitated the performance of routine administrative functions.

However, the school administrator did not long remain the sole user of the office microphone. From the very beginning, pupils were intrigued with the novelty of broadcasting, and longed for an opportunity to share in this challenging experience. Teachers, quick to capitalize this newly-awakened interest as a device for motivating class work, found that promising that the writer of the best composition or

school systems, where radio is being widely used, are now including this as one of their specific curriculum objectives.

Selecting Suitable Equipment

One of the greatest single obstacles to the even more wide-spread utilization of the manifold potentialities of radio in the schools is the occasional dissatisfaction arising from equipment inadequacies. In order fully to understand how this can possibly be so, it is necessary only to examine a few of the uses schools are trying to make of the centralized radio-sound system.

When this new product first appeared on the market it seemed that

Thus, telephones and inter-communication provisions, class-program bells, fire alarms, and other similar features have been added on to the centralized radio-sound system, while essential improvements have in some cases been neglected. In consequence, many an administrator, overwhelmed with the multitude of auxiliary features of such equipment, has diverted school funds from other needed items of supplies and equipment in order to get a centralized radio-sound unit that "matches the grain of the office furniture," only to find, later, that it is not sufficiently flexible to provide for uses that are most frequently desired!

Yet the manufacturers are not in a conspiracy to "dump" inadequate equipment on the schools. The manufacturer is genuinely interested in providing precision-engineered equipment that will provide for such school uses as he can foresee. It is really the responsibility of the school administrator to make his needs known.

In selecting radio-sound equipment, the school administrator should first familiarize himself with the ways in which other schools are using such equipment. Then, he should consider the specific kinds of educational experiences that might be made more realistic or more effective in his own school by using equipment similarly. His next step is to find out what characteristics of design and operation his equipment should possess in order to provide for these uses. Other schools and equipment salesmen will probably be able to offer helpful suggestions. Competent engineers should be consulted. Costs of including various features should also be considered.

The administrator should then list the specifications for his equipment in terms of operational characteristics and general design, being careful to mention any additional features that are to be provided at some future time. Copies of these specifications should then be sent to responsible concerns, known to be marketing this type of equipment, with the request that they submit bids, together with complete technical specifications.

When these technical specifications and bids are returned, they should be checked, if possible, by an independent expert, in order to make certain that the equipment de-

(Continued on page 49)

CLASSROOM . . .

the best report might broadcast it over the school microphone stimulated pupils to put forth unprecedented effort in their work, and to strive for more-effective written and oral expression. By the time this artificial motivation had begun to lose some of its appeal, it was discovered that the radio-sound system offered a more-appropriate outlet for simple dramatizations growing out of regular class work than the already-overworked auditorium stage. Moreover, pupils began to develop radio-program discrimination through trying to find ways to improve their own productions. Soon radio dramatization was recognized to be a distinct type of creative expression in its own right, and, eventually, the use of this type of radio equipment came to be accepted as a legitimate secondary function of school radio.

Today the reception of radio programs for classroom listening is generally acknowledged to be the primary function of radio in the school, and, although their number is constantly diminishing, a few schools still hold this to be its only function. However, a far greater proportion of today's leading figures in the school use of radio take the position that pupils probably derive certain experience values and aesthetic satisfaction from participating in radio-program production that they would not be likely to get in any other way, and a number of

the manufacturer had anticipated all the necessary requirements of program-distribution within the school. Either radio programs or programs of recorded music could be distributed to listening class groups or the school administrator could save time and unnecessary steps by making routine announcements over the loud-speaker system. What was not at first foreseen was that conditions might arise when two or more of these three types of inputs would be desired simultaneously! For example, in using music-appreciation broadcasts, schools soon realized that a distinct advantage would be gained if the equipment were designed in such a way that the broadcast might be faded down to permit the music supervisor to interpolate program explanations. Likewise, in directing physical-training exercises by radio, the simultaneous use of phonograph and microphone inputs was desired, while a similar need was experienced with respect to the use of recorded music as a background for choric speaking. The need for replacing the input-selector switch with an input mixer was further accentuated with the advent of pupil radio-drama production.

On the other hand, many of the later improvements in program-distribution equipment have consisted of provisions for the central control of other services which have little relation to program-distribution.

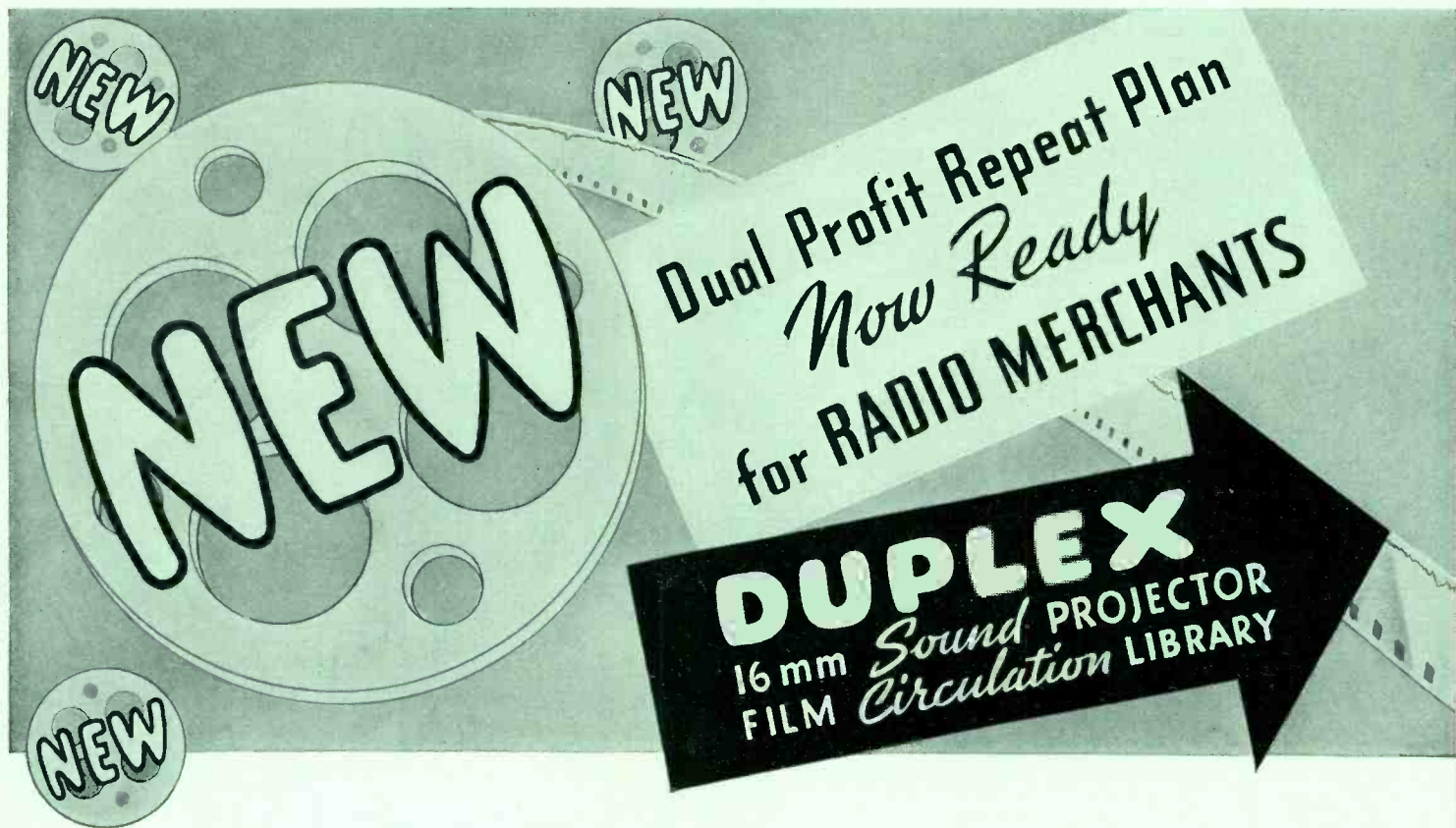

Sell Sound Projectors, Rent Sound Films

NOW FOR THE FIRST TIME *...we supply both*

THIS NEW MARKET • Schools, Churches, Clubs, Industry, Entertainment — Here is a New Market and an immediate growing demand for 16 MM. Sound Projectors and Sound Films. The Duplex Sound Projector is designed to provide Picture and Sound same as in the professional theatre. The Films cover a full range of subjects suitable for Education, Religion, Entertainment, and Industry.

EASY SUBSTANTIAL PROFITS with a restricted franchise in this New important market carrying selling rights for the Duplex Sound Projector and exclusive renting rights to the Film Circulation Library of 16 MM. Sound Films.

HERE'S A 2-WAY REPEAT Merchandising Plan and Franchise offered for the First Time to Radio, Music and Electrical Merchants.

TALKING MOTION

PICTURE SOUND FILMS • Subjects are available for Education, Religion, Industry, Welfare, Entertainment.

For This Huge Market

Grammar Schools	250,000
Churches	232,000
Government	12,000
High Schools	26,000
Colleges	1,700
Better Class Homes	75,000
Hotels	25,000
Industrial	15,000
Fraternal	28,000
Political	6,000
Ships	25,000
Welfare	3,500

FILM CIRCULATION CORPORATION

Alfred Weiss, Pres.

1600 BROADWAY

NEW YORK, N. Y., U. S. A.

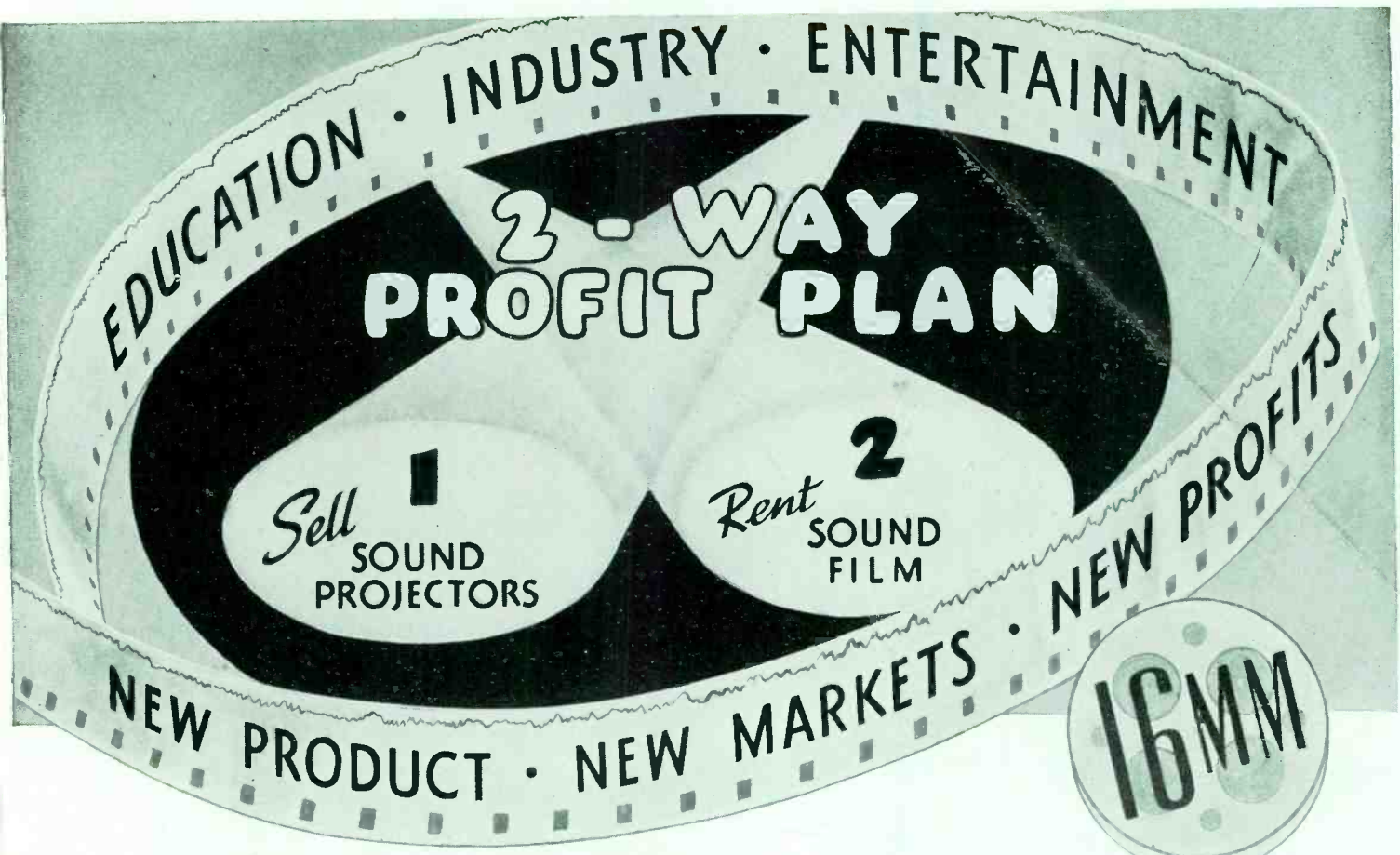

Check ✓ **These Important Merchandising and Profit-Making Features**

AHEAD OF RADIO • The Duplex 16 MM Sound Projector with its rental Library of Sound Films affords you a 2-Way Profit Plan — Selling Projectors — Renting Films.

MARKET • Consider in your own territory the great number of Schools, Churches, Colleges, Clubs, Industrial Organizations, etc. This immediate market makes this Dual Franchise unusually attractive.

IMMEDIATE DEMAND • Important Educators have already endorsed the up-to-date method of teaching with Sound Pictures — the CLERGY have endorsed it for Religious Teaching and Entertainment in the Church — INDUSTRIAL ORGANIZATIONS are already using Talking Pictures in their various sales and demonstrating activities.

PRICED LOW • The Duplex 16 MM Sound Projector is priced so low and the Films rent at such reasonably attractive price that even small Schools, Churches, Colleges, Clubs, Business Organizations, Community Centers, Lodges, etc., can afford the use of Talking Pictures for either Education or Entertainment.

AUTOMATIC REPEAT BUSINESS • The renting of Sound Films is profitable. You rent not only to purchasers of Duplex Sound Projectors but to many who already in your territory have sound projectors.

NO INVENTORY • Carry only a projector needed for demonstration purposes and an extra one or two for immediate delivery.

NO OBSOLESCENCE • Duplex Sound Projectors are standard. They do not go through changes of styles.

NO ADDITIONAL OVERHEAD • Duplex Sound Projectors and the Film Library require very little space — no extra sales help — no specialized service. NO INSTALLATION necessary.

FITS YOUR PRESENT LINE • This dual franchise for the sale of Duplex Sound Projectors and renting of Sound Films are "NATURALS" for your present lines.

GOOD SALES VOLUME • The Unit sale is much larger than in radio and the profits are liberal and substantial.

EXCLUSIVE FRANCHISE • You get an exclusive franchise — No price cutting — No chiseling competition.

• Exclusive Franchise — Write Today

Choice territory is still open on Exclusive Franchise to wide-awake radio, music and electrical merchants. This Franchise is based on the principle that you must have exclusive distribution in your territory so that cut-price competition and other interference is entirely eliminated.

Write or wire today for exclusive franchise details.

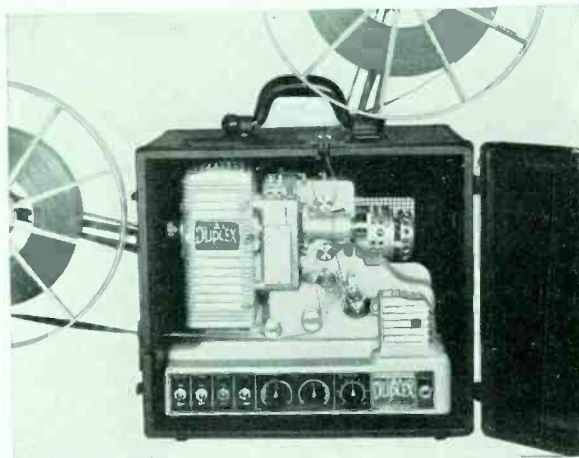

Manufactured Under Licenses From Electrical Research Products, Inc., under U. S. Patents of American Telephone & Telegraph Co. and Western Electric Co., Inc.

BRILLIANT PICTURES • The Duplex 16 MM Sound Projector with its 750 or 1000 Watt Projector Lamp affords sharp brilliant pictures in sizes up to 9' x 12' and over — Standard Lens Equipment 2" f 1.6 — Can be used for Sound or Silent Films — Accommodates all size reels — Simple operation, plugs in and operates like radio — Heavy Duty, Construction — Central Oiling — Forced Ventilation.

TRUETONE QUALITY • The Amplification is full A.C. The Auditorium Type Speaker is 12" — Finger Tip Control — Amplifier accommodates Crystal Microphone for use in public address — also accommodates Phono Pickup for record reproduction.

THE EQUIPMENT • The Duplex 16 MM Sound Projector is a complete Talking Motion Picture Equipment — Includes Sound Projector, Amplification sufficient for large and small audiences.



How Typical INSTITUTIONS Use EQUIPMENT

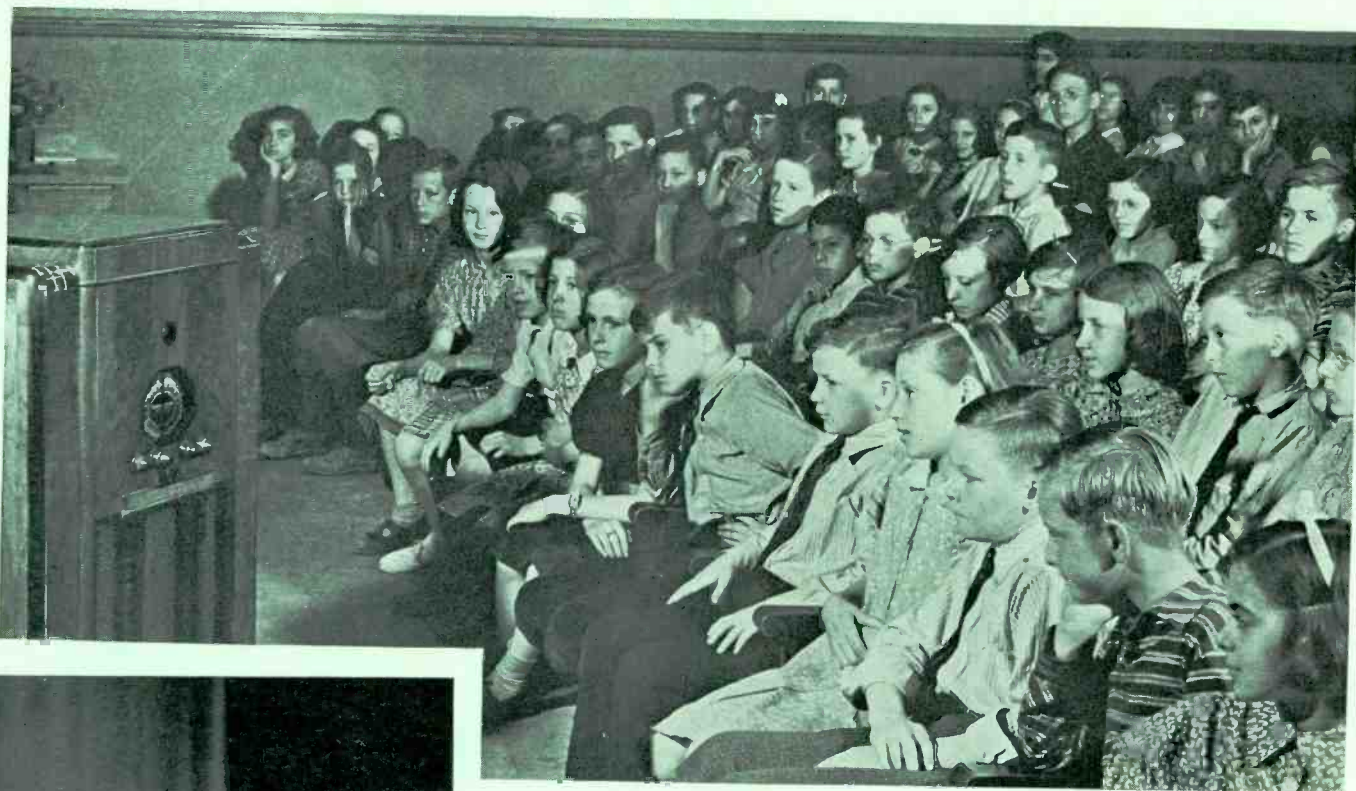

MASS RADIO LISTENING—Individual radio receivers (*above*) are in some instance used in schools with excellent effect. Here is a typical class listening in the middle West



DOES DOUBLE DUTY—In a Niles, Michigan, high school pupils (*left*) may be instructed from this central control point. The equipment also saves much time for institution executives when important announcements to both teachers and pupils are necessary

FOR TYPING—From the speaker on the wall over the blackboard (*below*) amplified recordings deliver to student typists rhythm so frequently desirable in developing a uniform touch



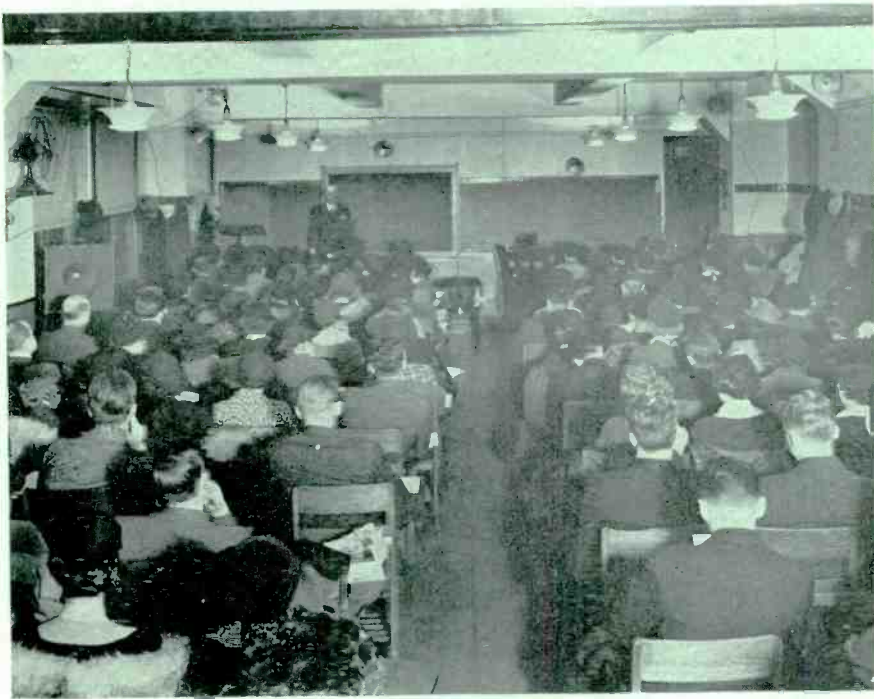

FITS NEW SCHOOLS—Here (*above*) is one of many school sound system control units designed to permit easy operation by teachers and at the same time styled to flatter any principal's office

SPEED DICTATION—At Pace Institute (*left*) in New York, advanced shorthand students write as an instructor dictates into a lapel microphone feeding a portable amplifier which carries his voice clearly to all parts of the room



FOR DEFICIENT LITTLE EARS—Story hour, during which a teacher in one of Detroit's schools (*above*) for hard-of-hearing pupils reads from a sound reinforcing unit, benefits these lower grade children



STUDENT BROADCAST — A Detroit school stimulates students (*above*) to greater effort in composition by permitting those who write the best to read them to the entire student body over the institution's sound system

PUBLIC SPEAKING — Older students gain valuable practical experience (*left*) in public speaking when permitted an opportunity to talk over amplifying equipment to their fellow students



WHEN CHAMBERLAIN SPOKE—
To these Arcadia, Louisiana students came the tired voice of England's Neville Chamberlain via radio immediately following the Munich agreement. This high school, already providing a daily routine of planned programs, suspended classes so that both pupils and teaching staff might listen to a broadcast of major importance



Radio in Schools

By **WHITNEY CONNELLY**

FROM the modest schoolhouses of our most remote rural districts to the impressive structures of our top-flight universities, radio is forging rapidly to the front as an accessory as vital and necessary to the classroom as the textbook. From kindergarten-tot to sedate candidate for a higher degree, students today are distinctly radio-conscious.

This is no theory. It is an existing fact that is recognized by the Government, by broadcasters, by undisputed authorities on educational methods and by teachers. It is most forcibly emphasized by the students themselves. Born with the radio, they tolerantly accept the marvels of its development and subconsciously absorb a surprising store of valuable information. By the inexplicable law of averages, they also absorb—and particularly is this true of high school students—a certain percentage of knowledge that in some instances has fostered naive sophistication.

It is this last mentioned undesirable feature that has done as much, perhaps, to spur the more progressive of our educators into

action. Sponsored by the Federal Radio Education Committee of the Federal Communications Commission, representatives of the University of Wisconsin, George Peabody College for Teachers, Stanford, Columbia, Harvard, Northwestern, New York University, Ohio State, University of Chicago and other outstanding educational institutions have banded themselves in a Committee for the Evaluation of School Broadcasts.

Their active staff, directed by Dr. I. Keith Tyler of Ohio State and ably assisted by six associate directors, is centrally located at the Ohio State University in Columbus.

Student Influence Number One!

Intensive research work has been conducted by these acknowledged authorities in their specialized branches of science, music, English, history, social studies, etc. After their reports were classified and tabulated, the information gleaned from careful interviews with thousands of students and teachers in elementary grade schools, high schools and colleges, was startling.

Over sixty percent of the high

school students included in the survey named the radio as their first source of information on contemporary happenings. Likes and dislikes for foods, for music, for legislation and for realistic novels were all influenced by the radio.

In Wisconsin and Missouri, according to survey, high school students were spending more than two hours each day listening to the radio. In the same area, over 50 percent of elementary grade school children were permitted to choose their own programs.

An alarming twist that leered ironically from the tabulated figures and added complication to the problem, was that most adults were, by comparison, radio illiterates! Few could name a half-dozen significantly constructive programs on the air.

Lacking that peculiar psychological relationship that the student, growing into adolescence, acquired during the development of radio to its present-day efficiency and low cost, the more mature minds of parents frequently accepted radio only as an entertainment medium. A mere recreation to be indulged in after a tiresome day's work; a diversion for a weary brain whirling with tomorrow's plans. A flick of the hand and there was music, or what have you.

Teachers Should Guide Listening

The Committee quickly decided that all educational institutions

(Continued on page 50)

REMLER



ANNOUNCING NEW 1939 REMLER JUNIOR SOUND SYSTEM for SCHOOLS

Combination "broadcasting", public address, two-way inter-communication and paging system. Single centralized control. Push button switches distribute talks, announcements, music, etc., to any or all Speakers. Single switch for fire and emergencies. Enables Schools to make systematic use of national education broadcasts. Foreign and domestic reception 550 to 17,800 kilocycles. Phonograph plays 10" or 12" records. Fidelity crystal pick-up. Two amplifiers in control cabinet permit simultaneous use of program and inter-communication channels. Moderate prices . . . a profit-builder backed by the Remler reputation for reliability. Send for new catalogue.

REMLER COMPANY, Ltd. 19th at Bryant, San Francisco

Centralized SOUND FOR SCHOOLS

- This New Bogen Centralized System meets the most exacting requirements of educators. It is extremely simple to operate, requiring no technical knowledge. It is flexible in its application, being suitable for every type of school or educational institution. We invite correspondence regarding your particular problem.
- Provision for Remote Control
- Visual Volume Indicator
- Talk-Back Operation
- Selective or group calling
- Master emergency switch
- Frequency equalizer for tone
- Expansion Capacity up to 32 rooms



Model S-32

These units are furnished with a steel door and fool-proof lock not shown in illustration. Speakers housed in beautiful walnut baffles designed for tilt-angle wall mounting to assure correct acoustics. Bogen school systems have the approval of leading educational institutions throughout the country. Write today, and we will supply you with complete details at no obligation. Dept. RR-1.

DAVID BOGEN CO. 663 BROADWAY INC. NEW YORK, N. Y.

NEW MIKE





No feedback from rear of room

gives new Pick-up Control

IT'S the Western Electric 639A Cardioid Directional Mike — combining dynamic and ribbon units in one mike — giving you clarity, fidelity and control unmatched by either type alone! With both units in operation, its pick-up is equally good through 120°. By turning the 3-way switch, you make it either a dynamic or a ribbon mike. In addition to its recognized superiority for studio pick-up, it is also particularly good for Public Address work because it reduces feedback. Send for full details.

Western Electric CARDIOID DIRECTIONAL MIKE

GRAYBAR ELECTRIC CO., Graybar Building, New York, N. Y. R.R.-1-39
Please send booklet describing Western Electric's New 639A Mike.

NAME _____
 ADDRESS _____
 CITY _____ STATE _____

Only RCA Makes
and Does Everything
in Radio and
Sound

IT PAYS TO GO

RCA All the Way!

Because public
acceptance
means bigger
profits

RCA Victor begins the New Year with a **BANG!**

...with this great
new **ELECTRIC** \$ **49⁹⁵***
TUNING VALUE...

Here's the splendid new radio with
which you can really "go to town"!
In features, in price, it's the radio
buy of the New Year!

**LOOK AT ALL THE FEATURES
THIS FINE NEW RCA VICTOR
RADIO ENABLES YOU TO OFFER
AT AMAZINGLY LOW COST!**

RCA Victor Console Model 96K5. This instrument has Electric Tuning for six stations, Victrola Button, 3-band Super-Sight Straight-Line Dial, Plug-in for Victrola Attachment, Continuously Variable Tone Control, Automatic Tone Compensation, Automatic Volume Control, Magnete Frequency-Locking Transformers, and a tuning range from 540 to 22,000 kcs., providing domestic and foreign short wave reception on 49, 31, 25, 19, 16 and 13 meter bands plus amateur calls. There are many other features too—all of which will prove of great sales advantage to you.



PUSH A BUTTON
*there's your
Station!*

RCA presents the "Magic Key" every Sunday,
2 to 3 P. M., E. S. T., on the NBC Blue Network
*f.o.b. Camden, N. J., subject to change without notice



RCA Victor

RCA Manufacturing Co., Inc., Camden, N. J. A Service of the Radio Corporation of America

Only RCA Makes
and Does Everything
in Radio and
Sound

IT PAYS TO GO

RCA All the Way!

Because public
acceptance
means bigger
profits

RCA Victor Radio Tubes offer you the
**BEST KNOWN NAME and
OLDEST TRADEMARK**

in the business!



THERE IS NO DOUBT about the public acceptance of RCA Victor Radio Tubes. Millions of dollars have been spent to popularize and create public acceptance for products bearing the RCA Victor Trademark.

That's why there is a tremendous market for RCA Victor Radio Tubes—a market which is constantly growing—a market which is conscious of the quality that has been built into products bearing the RCA Victor Trademark. Because of this it will pay you to keep on hand an adequate stock of these tubes at all times. See your RCA Victor Distributor.

• • •
RCA presents the Magic Key every Sunday, 2 to 3 P.M., E.S.T., on the NBC Blue Network.



RCA Victor RADIO TUBES

RCA Manufacturing Co., Inc., Camden, N. J. • A Service of the Radio Corp. of America

7 of the 47 RCA Victor You Can Sell



That's no exaggeration. The widespread use of Victor Records in schools may surprise you—but it very definitely can mean lots of business to you! Remember—these schools are buying new Victor Records all the time—and if they buy their Victor Records from YOU the door is wide open for you to make profitable sales of the many other RCA Victor products they can use!

● Here is RCA Victor's new low priced School Sound System—a system so attractive that *one advertisement* has brought inquiries from 527 schools—representing a potential business of more than \$250,000. The administrative and educational uses of this equipment are almost countless. Its price is low. The profit to you is high. Are you selling it to the schools in your neighborhood?

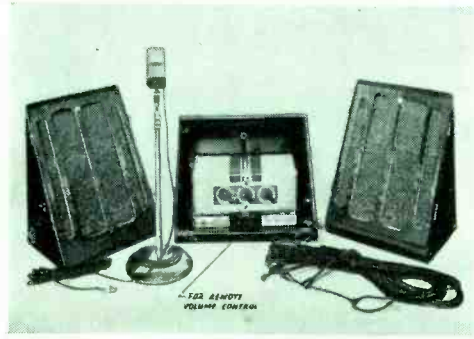

● For use in auditoriums, gymnasiums and on athletic fields, RCA Victor portable public address systems are extremely popular with schools. Here's another big profit item for which there is actually a widespread demand. If you contact the various schools in your neighborhood—really get behind this equipment and sell it—you'll make large profits. Are you doing it?



● This new RCA Victor's portable recorder—has created a great and heretofore unfilled demand among schools. It enables teachers to make accurate records *right on the spot*, of voice training, public speaking, choral and orchestra work, dramatic presentations, radio programs, and notable school events. Are you selling this instrument to the schools in your neighborhood?



● You've probably never thought of it before—but schools make wholesale use of RCA test and measuring equipment. The RCA Oscillograph illustrated above is just one of the products in this category. It's an instrument that returns a nice profit to you—is one you can sell to the schools in your neighborhood. But have you done it?

Victor School Products

—Profitably!

Selling to schools makes money for you. It brings you repeat business. It's a priceless advertisement that builds additional business for you in the future!

HERE are seven of the RCA Victor radio and sound products that are used by schools from coast to coast. Besides these, there are many others your RCA Victor distributor will be glad to tell you about.

Selling these products means profits for you. Not only on the original sale—but on the repeat business it brings you from every school. Moreover, it means that the children in each of these schools will be talking about the things you have to sell—at home. They'll create extra business for you.

Here's a big *business!* A powerful advertising campaign in school magazines—the largest ever undertaken by a radio and sound manufacturer—creates new demand for RCA Victor products each month. Every moment you're out of this business you're losing money. Don't miss another penny of the profits it offers you. Find out about it today from your RCA Victor distributor.



● Illustrated above is RCA Victrola Model U-123—a model that will be used extensively in schools. Modern Victrolas are a necessity in modern schools—not only to play Victor educational records—but also for the reception of the many educational radio programs which teachers want their students to hear. Are you selling this instrument to the schools in your neighborhood?



● Even RCA amateur radio receivers are being used extensively in modern schools. There are many reasons why all modern schools should have these instruments. If you contact your neighborhood schools... tell them how valuable amateur receivers can be... you'll sell them... at a good profit. Are you doing this?

Listen to the Magic Key every Sunday, 2 to 3 p. m., E. S. T., on the NBC Blue Network.

Modern schools stay modern with RCA tubes in their sound equipment.



RCA Victor

SOUND SERVICE FOR SCHOOLS

Educational Dept., RCA Manufacturing Co., Inc., Camden, N. J.
A Service of the Radio Corporation of America



RADIO HAS CREATED something *new* in education, and the Radio Corporation of America is proud to be a pioneer in this highly important service.

For 12 years, RCA, through the National Broadcasting Company, has been aiding educators reach students from coast to coast. Such programs as the Farm & Home Hour, Walter Damrosch's NBC Music Appreciation Hour and America's Town Meeting of the Air have become national institutions. Each year more and more schools are becoming radio conscious — are bringing their students the benefits of such NBC programs.

Radio gives such subjects as science, literature, history, music, and many others, a dramatic treatment that attracts and holds

students' attention. Because these programs have been so effective, they increase in number each year. Such programs account for 25 per cent of NBC's full schedule.

Tomorrow's world leaders—in business, in finance, in politics, in international affairs—all are today's students. And radio, which has done so much to make life fuller and brighter in the home, is contributing to their education—is paving the way to greater education for all!

No wonder it will pay you to take an active part in the sale of RCA educational equipment to the schools in your neighborhood!

Listen to the Magic Key every Sunday, 2 to 3 P.M., E. S. T., on the NBC Blue Network.

RADIO JOINS HANDS WITH EDUCATORS TO MAKE LESSONS LIVE!



Radio Corporation of America

Radio City, New York

RCA Manufacturing Co., Inc. • RCA Institutes, Inc. • R.C.A. Communications, Inc.
Radiomarine Corporation of America • National Broadcasting Company

THE phonograph's place in the classroom needs no argument at this late date. Most music supervisors are familiar with at least a portion of the really enormous repertory of recorded music, embracing all periods and styles of the art. Through records musical appreciation may be taught, by steps, from the singing games and simple folk dances of the kindergarten to the scientific and esthetic approach to symphonies and tone poems in university lecture halls. As a famous educator remarked, "One can teach more of the correct interpretation of music with a phonograph in ten minutes than he can by talking about it for a week."

But how many educators in other branches of their field have investigated the possibilities of the phonograph and records as aids in the teaching of subjects such as literature, languages, dramatics, public speaking, history, current events, geography, physics, biology, physical education, and shorthand speed dictation? Here, too, the phonograph may be applied in a manner guaranteed to vitalize these subjects, clarifying their comprehension and accelerating their mastery.

Not Just Music

Language courses are available in more than twenty-five tongues, including Latin and classical Greek. While these singularly effective methods have been prepared primarily for use at home, an increasing number of schools and colleges throughout the country are prescribing their use in classrooms. Such records, noted for their authoritative correctness, the eminence of their speakers, and their perfect reproductive qualities, are invaluable in secondary schools, especially where languages are not taught by native instructors.

There are also hundreds of records of speeches, recitations, and readings in many languages. Vivid interpretations of scenes from Shakespeare by great actors of the past and present, such as Sir Johnston Forbes-Robertson, Dame Ellen Terry, Maurice Evans, John Gielgud, and Orson Welles, stimulate students' interest in the Elizabethan drama tremendously.

The study of modern poetry may be enhanced with readings of their own works by John Drinkwater, T. S. Eliot, Robert Frost, Walter de

RECORDS

as a

Teaching Aid



By

**RICHARD
GILBERT**

derson, and Verhaeren. Two cantos from Dante's *Inferno* are read in classic Italian by Harvard's Grandgent.

There is a splendid group of "Speech Training and Choral Speaking Records" by members of London's Speech Institute which any large record dealer can easily import.

Even History

The history class can make use of the phonograph in a particularly vivid manner. Progressive educators will applaud the provision of authentic illustrations of music from Greek and Jewish antiquity, chants from the fifteenth century chapel of Henry VI of England, and vocal and instrumental music produced exactly as it sounded during the Renaissance. There are records of music written by Frederick the Great, and a reconstruction of *An Evening at Sans Souci*, in the recording of which authentic eighteenth century instruments were used.

Unfortunately, there are no records by Washington, Lincoln, Napoleon, Gladstone, or Queen Victoria. But from Roosevelt I to Roosevelt II the voices of American presidents may be brought to the classroom. Some of these addresses commemorate great occasions in the life and progress of the world. Pupils of today and tomorrow can hear President Coolidge welcoming Charles A. Lindbergh after his epochal New York

(Continued on page 51)

la Mare, Virginia Sackville-West, Gertrude Stein, and other writers. Teachers, no less than pupils, can become acquainted with the "real" George Bernard Shaw—and some remarkable axioms for verbal behavior—in the playwright's own recorded "Spoken English and Broken English." Prof. Skinner of the University of Wisconsin gives authentic pronunciation of several thousand words on seven records.

The foremost artists of the Comédie-Française provide whole scenes from the plays of Racine, Molière, Hugo, de Musset, and other French immortals. Advanced French classes can listen to purest Gallic in records of poetry and prose, constituting a veritable anthology of the literature. And they can adjust the speaking rate to their ability to interpret.

The famous actor, Alexander Moissi, has recorded excerpts from the works of Goethe, Schiller, An-

SPECIALISTS IN RADIO AIDS TO LEARNING

We are pioneers in the field of radio and specialists in the application of radio equipment to educational activities. In cooperation with leading educators, councils and research bureaus, we have developed high-grade budget-minful equipment to meet the specialized requirements of schools. A few of our products are described below. We offer the extensive experience and valuable cooperation of our Education Division to educators everywhere, without obligation.

PUBLIC ADDRESS SYSTEMS and ACCESSORIES



Leading schools and colleges are daily using KNIGHT Sound Equipment to great advantage as effective aids to learning. Among the KNIGHT sound products available are Centralized Sound Systems, Systems for classroom, auditorium and stadium use, etc. Available also is a complete variety of accessories including speakers, microphones, pickups, etc.

SCHOOL RECORDERS



We are distributors for every leading recorder line—Presto, Universal, Knight and Allied—ideal for use by diction and language classes, for dramatic training, musical instruction, for off-the-air recording, etc. We carry the country's largest stock of fresh recording discs in all sizes and are exclusive distributors for the new "Flex Discs" which are inexpensive, non-inflammable and ideal for school recording work.

RECORD PLAYERS



We have a complete variety available—including a new unit recently developed especially for school use in cooperation with leading educators. The new Knight Player will handle recordings up to 16" in size; has dual-speed control; operates on AC-DC; has crystal pickup. 10" Jensen speaker; 16" turntable; master volume control; remote control (optional); has large 5 watts output to cover practically all school needs. Write for complete details.

PHONO-RADIOS



Our Knight line of radios and radio-phonograph combination is popular with schools throughout the country. Quality is exceptional; prices are low. Models are available for AC, AC-DC or battery operation. Powerful reception on radio and excellent tone on both radio and phonograph are emphasized in the line. Record player attachments for use with any radio set are also available.

**FREE TO
EDUCATORS**

Send for free valuable literature prepared by ALLIED'S Educational Division. Write for "Bulletin on Recording Technique"; chart showing "How to Use Radio-Sound Equipment in the Schools"; also ask for the complete ALLIED Catalog.

ALLIED RADIO CORP.
833 W. JACKSON BLVD. CHICAGO

To The Reader:

This presentation is intended to focus attention on the large number and wide variety of devices that are produced by the radio and allied industries and are now used to a varying degree in education.

Its preparation was decided upon when we found that there were not available through ordinary channels either an authoritative and impartial summary of obtainable products, nor any case studies that would prove the effectiveness of those products as aids in gaining specific curriculum objectives.

As a case-in-point, we were astonished to discover that less than 40% of all elementary and secondary schools now own a radio set, and that despite the fact that the national radio networks and many local stations devote a definite and in some cases considerable period of their broadcasting time during the school year to programs that either are expressly prepared for listeners in the class room or have high educational value.

It is hoped that the material presented herein will stimulate interest in and the wider use of the modern aids to education that are mentioned. Certainly our editorial staff welcomes inquiries from educators or others, who have questions or specific problems concerning products in this field.

O. Fred Rost
EDITOR

Please address inquiries to
O. FRED ROST, Editor
RADIO RETAILING
330 West 42nd Street
New York, N. Y.

STRANGELY enough, we are all partially deaf to the sounds we ourselves produce. We cannot hear our own speaking voices as they actually sound. When we sing or play a musical instrument our ears play tricks on us. Some of us become discouraged about our musical ability when actually we are displaying the beginnings of real musicianship. Most of us believe that we have some hidden dramatic talent, yet we are reluctant to make use of it because our limited attempts at dramatic expression have never found a responsive audience. We know that something is not quite right about our music, our voices, our attempts at dramatic expression, but we never quite understand what is wrong until we hear ourselves on a phonograph record.

A sound recorder removes, we might say, the veil from our ears and permits us to concentrate our complete critical faculties upon ourselves. Then, having found out what is wrong with the sounds we

Instruction by INSTANTANEOUS RECORDING

By **RALPH C. POWELL**



PROFESSOR AND PUPIL—John M. Regan of Bayonne, N. J., makes a record of his voice while Professor David P. Powers handles the controls. The machine has proven itself an invaluable accessory for improving student speech

THEN THEY'LL HEAR THEMSELVES—D. R. Gebhart of Peabody College, Nashville, instructs a singing group, simultaneously records for immediate playback

make, we are in a position to be taught how to correct our faults.

Can you imagine how difficult it would be to teach geography without maps? Can you imagine teaching a blind person how to repair an automobile?

Teachers of speech, music, dramatics, foreign languages, had almost as difficult a problem before the advent of sound recorders. It has been possible for them to teach us to make sounds properly but it has required endless time and patience both on the part of the teacher and ourselves. And the hardest part

of the teaching job has been to give the students an understanding of their own faults. Until they know why they are being criticised, and until they can hear themselves in the third person and give to themselves the same impression they give to the teacher, they cannot readily begin to correct themselves.

Recording instruments make an accurate record of the voice, then reproduce the record a moment later. Recording machines won't teach anyone to speak properly, nor to become a musician, but they give students a complete picture of their

faults. They give students an incentive to improve themselves and they pave the way for rapid and intelligent progress.

The ability of teachers is judged by the amount they are able to accomplish with their students in a given space of time. Is it any wonder, therefore, that thousands of teachers in the speech, music, dramatic and foreign language departments of our schools are clamoring for the aid of sound recording equipment? A sound recorder gives them a three to twelve-month head start

(Continued on page 53)

SHURE MICROPHONES MAKE A DIFFERENCE!

Sound begins at the microphone. The choice of a microphone may mean the difference between a good, bad, or indifferent sound system.

Shure Engineers, specialists in microphones, have played a significant part in the development of better microphones at low cost... microphones which have added much to the quality, convenience and flexibility of sound systems. That's why Shure microphones today enjoy such wide popularity in more than 55 countries throughout the world.

Specify Shure microphones for replacement and new installations. Choose from the most beautiful, the most modern styles and types available today—including new directional models which simplify microphone placement and eliminate "feedback" and audience noise.

Write today for Catalog 150R.

Shure Patents Pending. Licensed under patents of the Brush Development Co.



SHURE "UNIPLEX"

This New Model 730A "Uniplex" Uni-Directional Crystal Microphone gives excellent high quality response at the front—yet is dead at the rear! Solves feedback, reverberation and background noise. Satin Chrome Finish. Complete with built-in Cable Connector and 25 ft. of special Super-Shielded cable.

List Price \$29.50

"Sound Systems Sound Better With Shure Microphones"



A LOW-COST SYSTEM Every School Will Want

BELL'S new Panel Radio and talk-back system is filling a real need in the school, hospital and hotel field. It's a top-quality desk-type unit at a very attractive price! Look at these valuable features!

- High quality radio with wide tuning range
- 6 watt talk-back amplifier for inter-communication
- 24 watt amplifier with bass and treble compensation
- Heavy steel cabinet with baked-on silver gray crackle finish
- Provision for phonograph attachment
- Audible monitor
- Master switch for each ten-switch panel
- One to three ten-room switches can be used.

Write for details today

BELL Sound Systems

1185 Essex Ave., Columbus, Ohio
Export Office: 308 W. Washington Ave.
Chicago, Illinois, U.S.A.

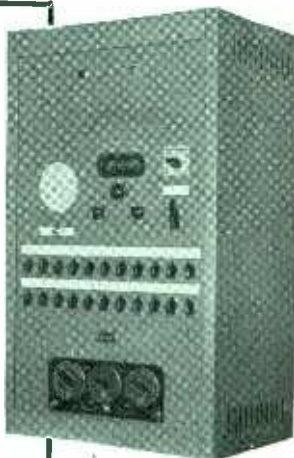

Electro-Voice "620"

DYNAMIC MICROPHONE

Designed for the ultimate in P.A. and recording work. The unusually flexible mounting allows either directional or non-directional pick-up with a minimum of feedback. The Wide Range response gives naturalness and definition to speech. Music has depth, fullness and brilliance. Impervious to salt air, rough handling, barometric and temperature changes, heat and humidity. It is a permanent asset to any installation.

ELECTRO-VOICE MFG. CO., INC.
328 E. Colfax Ave. South Bend, Ind.
Export Office: 100 Varick St., New York, N. Y.



Teaching with TALKING PICTURES

By ALFRED WEISS

PROGRESSIVE educators have for years used silent motion pictures as an adjunct to personal instruction. Some have been able to show "talking" films, despite the fact that until recently combined sight and sound equipment was prohibitively expensive to all but the largest institutions, and suitable features difficult to obtain.

Today efficient, reliable and relatively inexpensive talking motion picture equipment is available for educational purposes and many schools are availing themselves of this new equipment. For it is a recognized fact that long before the younger children can absorb knowledge through reading or verbal instruction, due to their technical deficiency in the first case and their tendency to be easily distracted by externals impinging upon their eyes in the second, they readily learn when taught with combined sight and sound. While students in upper grades, in high school and in college do not to the same extent need such combination of sight and sound because their more mature minds are schooled to study, it is known that upon them also knowledge conveyed simultaneously by both pictures and words makes a vivid impression. Particularly valuable in this latter instance are technical films.

One instance illustrating the effectiveness of sound film in education comes immediately to my mind. The other day I viewed a picture about plant life. It followed the entire growth and life of a flower and on the screen I saw sap actually flowing through the stems and leaves, while at the same time hearing an explanation.

I also recently saw an important history lesson in 10 minutes on the screen and heard the important facts relative to the episode while the picture was going on. There are also subjects on animal life, geography, musical appreciation and other topics of interest to educators.

It is of interest that the Government actively sponsors visual education and has made available a number of films. Important industrial concerns have produced sound films about the history and process of making products which vitally influence the conduct of our life. These are often available without cost to schools.

Then, too, there are many new films prepared by Foundations, regular film producing companies and even other schools and colleges which have directed production of special features.

There is another aspect of sound film equipment in schools which is of considerable interest.

Schools using such equipment for educational purposes may at the same time permit the machines to be operated by the Parent-Teacher Association. In many cases entertainment provided under such auspices can provide funds for the financing of other school activities. Use of sound equipment in schools, therefore, is not strictly limited to education alone, although this is, of course, its primary function.

IN THE MODERN CLASSROOM

(Continued from page 33)

sign will provide for the desired uses.

The final choice, then, will probably be based on (1) adequacy of the provisions for the desired uses, (2) operating simplicity and convenience, (3) ability of the school to pay the price quoted, and (4) assurance that continuous service will be available locally.

If this procedure is followed, it is believed that the principal causes for present dissatisfactions will be removed.

Recent Trends

The modern school is making an even wider use of radio and associated equipment. Separate speech-input units are being used in connection with radio-drama production, and for picking up occasional programs that are originated from the auditorium stage. Instantaneous recording is gaining increasing recognition for use in the analysis and correction of speech defects, and for the analysis and improvement of various types of pupil performance. The phonograph has been revived in the form of the sound wagon, for use in the studio of the radio-drama workshop, and in the form of the portable transcription reproducer, for use in playing 16-inch program transcriptions for classroom listening. Some transcribed programs are already being made available for school use, and it is known that still more material of this type is to be released in the near future.

Sound Film Too

Sound film is coming into increased use. While it is generally conceded that television, though no longer just a future possibility, cannot be expected to become practicable for school use for perhaps another half-dozen years, a number of educators have already begun seriously to consider the use of facsimile reception. One school system has already started broadcasting programs for classroom listening over its own ultra-high frequency transmitter, and several others are known to be making similar plans.

Schools have found radio, in its various aspects, an indispensable ally in amplifying educational effectiveness, and, in the light of present trends, an even greater movement in this direction may be expected in the future.

NOW- AT A PRICE SCHOOLS CAN AFFORD -THE FEDERAL RECORDER



• The new simplified Federal records anything spoken, sung, or played into the microphone. Records may be played back immediately without lifting from the turntable.

• Portable model PR-12 combines four distinct units in one—perfect recorder, electric phonograph, licensed radio, and public address system.



No Rehearsal Room Complete without this Modern Music Teacher!

Most effective and progressive method of teaching school music today is by self-correction, made possible with the use of the recorder. Now Federal brings this important equipment comfortably within the budget limitations of your school. With a Federal in your rehearsal room, your band, orchestra, ensembles, soloists, all may hear their own performances as concert audiences or contest judges will hear them. Individual faults in pitch, tempo, volume, and expression may thus be corrected, in advance.

No technical knowledge required. Anyone can operate a Federal. Operates anywhere. Simplified control desk makes it as easy as running a phonograph or tuning a radio. Made in both portable and console models, with recorder, electric phonograph, radio, and public address features.

Portable model P-12 with 12-inch turntable, Wright-De Costa dynamic speaker, \$25 crystal microphone, is a sensational success in school work and is being adopted by hundreds of schools of all classes throughout the country. Priced at only \$179 complete.

Almost every subject in modern curricula, where the speaking voice is heard, is also taught more effectively with the use of this modern Federal Recorder. School addresses, educational radio programs, concerts, recitals, all become permanent records. Sound and music are given to school movies. Thus the low cost of the Federal Recorder is spread over the entire teaching system.

Write for fully descriptive and illustrated catalog of Federal Recorders; tells the whole story of this enormous advancement in simplified recording; explains how you can adopt this modern method of music instruction; shows benefits to be derived. Send for copy of this informative book now.

CONTINENTAL MUSIC COMPANY, INC.

Dept. 1753

630 South Wabash Avenue

Chicago, Illinois



MORE SOUND RECORDING EQUIPMENT is sold during February, March and April than in any other period, mainly because schools and universities are buying for the coming year. Inquiries received during the last few months indicate that hundreds of schools are now ready to buy Presto recording equipment for their speech and music departments.

NOW is the time to show them the new Presto Model K recorder. This instrument, placed on the market only three months ago, is now out-selling every other model in the field. Lightweight, inexpensive, simple to operate, the model K fills every school requirement for a high grade sound recorder, playback and portable public address system.

Send for these booklets today.

1. HOW TO SELL THE PRESTO RECORDER
2. HOW SCHOOLS USE THE PRESTO RECORDER
3. CATALOG DESCRIBING COMPLETE LINE

PRESTO RECORDING CORP.
135 W. 19 St., N. Y. C.

RADIO IN SCHOOLS

(Continued from page 38)

have definite major responsibilities with regard to radio.

More planned programs must be prepared sufficiently in advance to permit rearrangement of study periods and for the assignment of out-of-school broadcasts. The radio must be utilized directly in the classrooms. Through the national, state and district teacher-organizations, by personal contact, by direct mail and by addresses at educational conventions, the progressive movement grew. State departments of Education lent their aid. Parent-teacher organizations gave their support. Broadcasting systems co-operated.

Throughout the entire country, in smaller communities, in large cities, in public schools, in private schools, the powerful new ally of modern educational methods is welcomed with enthusiasm and gradually the new order takes form.

Prominent Educators Approve

In a recent message to educators, Dr. I. Keith Tyler is definite in his stand.

"Teachers of youth," he writes, "must seize upon the radio as an important educational tool. It enables them to bring into the classroom new and more vital materials of instruction. It extends the range of learning experiences to include those which have not previously been possible within the school. Drama, a potent educational technique, can be put to use; great music can stir the souls of adolescents; living authorities can speak directly to learners; many-sided issues can be discussed effectively by experts; excursions can be undertaken without leaving the school-house. All of this is made possible at a trifling expense by putting broadcasting to work in education."

How Typical Schools Use Radio

At the Sequoia Union High School in Redwood City, California, classroom use of the radio is an integral part of the core course, Social Living. A weekly advance program bulletin is prepared that includes broadcasts of history, geography, English, music, current events, vocational guidance and discussion of current legislation.

At St. Vincent's Academy and College for girls, in Shreveport, La., a complete educational institution from kindergarten through

Now You Can Tackle THE BIGGER JOBS

You can now get more than your share of the "higher-priced" intercommunication market—HOTELS, HOSPITALS, DEPT. STORES, FACTORIES, OFFICES—because we have kept this high quality 2-way system priced low for quick sales to this market. Model 143—2-way system—provision for up to 10 additional substations and up to 4 speakers on each substation. No other system offers these features!



MASTER STATION

Demonstrate Model 143 to your "higher-priced" prospects—let them realize the money they save without sacrifice of quality. There's extra profit for you by selling additional substations, priced with 50 ft. of wire at only \$10.00.

REMOTE STATION

AS ILLUSTRATED

\$47.50

Complete With Wire Ready for Installation



Write for catalogue showing all new models
REGAL AMPLIFIER MFG. CORP.
14-16 West 17th St., New York, N. Y.

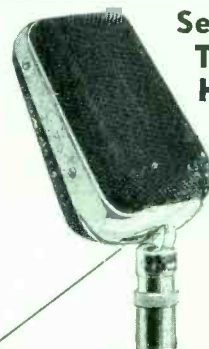

Self-Locking TILTING HEAD

★
Cannot be Acoustically Overloaded

NEW MULTI-UNIT Dual Diaphragm Crystal Microphone

An outstanding achievement in microphone construction for auditorium, lecture hall, students assemblies, athletic events and public address installations. Maximum amplification with reduced feedback. Cannot be acoustically overloaded. Made in two models. MU-2 constructed with two dual diaphragm crystal units using four diaphragms. MU-4 uses four dual diaphragm crystal units and eight diaphragms. Black and chrome. Complete with three-prong interchangeable locking connector and 25-ft. cable.

List Prices

MU-2 \$29.50 : MU-4 \$39.50



Astatic Microphone Laboratory, Inc.

Youngstown, Ohio

Licensed Under Brush Development Co. Patents
Astatic Patents Pending

four years of college, a high school instructor smiled at the query:

"Radio in the class room? It was a necessity! Too many pupils in current events discussion had later information than I could secure from morning newspapers."

A member of St. Vincent's College says:

"We are well pleased at the excellent results secured from a series of dramatic broadcasts during an out-of-school period. In advance of the date, the student receives a preparatory pamphlet. After the broadcast, she is required to submit a written brief of her analysis."

In the elementary grades at St. Vincent's Academy, planned advance program schedules are prepared on history, geography and nature studies. After broadcast periods, written reports are required.

In the high schools of Knoxville, Tennessee and Jefferson, Indiana, students conduct broadcasts by direct wire from the schools to local stations, the broadcasts featuring science, journalism and commercial work alternated with glee club and band activities.

At Teachers College, Indiana, Pennsylvania, a college radio club sponsored by faculty members from the physics and English departments is cooperating in a program of using radio in the classroom.

The Radio Council of the Chicago public schools has inaugurated a weekly program bulletin which lists outstanding educational broadcasts for classroom and home assignment.

The Menlo School and Junior College, Menlo Park, California, has been conducting debates via short-wave radio with high school students at Palo Alto, California and Aberdeen, Washington, with Glendale Junior College, California and Stephens College, Missouri.

The Arcadia, Louisiana high school offers a splendid example of the constructive use made of radio in the classroom today. The daily routine of planned advance programs is observed but when events of national interest (as the recent European crisis), are broadcast then classes are suspended while the entire school listens in.

Here are but a few examples of the many methods by which radio can be put to work in schools, furthering education *along desirable, planned lines.*

RECORDS AS A TEACHING AID

(Continued from page 45)

to Paris flight. A "Messaggio al Popolo Nord Americano" of some years back by Benito Mussolini will have a dramatic effect in the classroom even though students of history and current events cannot understand the language of Il Duce. Prime Minister Neville Chamberlain's historic "Peace in our time . . ." and his broadcast speech from Heston Airport on his return from Munich, September 30, 1938, will undoubtedly become a prize exhibit

in the classrooms of the future.

The late King George V's voice is perpetuated in his "Silver Jubilee Message to the Empire," and other important speeches. "The Message to the Empire of March 1, 1936," by King Edward VIII is preserved, as is also his Abdication Speech of some months later.

And Geography

Geography can be made much more interesting through the use of a phonographic magic carpet that whisks you off to unseen but palpable places, and sets before

Fairchild Sets the Standard For Precision-Built Sound Recording Equipment

Guided by the principle that "there can be no compromise with quality," Fairchild engineers have perfected sound recording equipment which paces the industry. Fairchild tone fidelity, distortion-free range, dependability and simplicity have literally amazed radio and recording experts.

Fairchild Maintains a Corps of School Experts to Help You

Fairchild school specialists understand thoroughly the use of sound equipment in speech, dramatics, music, language and physics classes, and in recording educational radio programs. They will be glad to survey your needs and recommend proper equipment. Their job is not done until you get maximum results.

Send for literature describing school equipment.

"... it had to satisfy Fairchild first"

FAIRCHILD EQUIPPED!
EASTMAN SCHOOL OF MUSIC
CARNEGIE TECH.
COLUMBIA UNIVERSITY
SYRACUSE UNIVERSITY
YALE UNIVERSITY
SAMUEL TILDEN H. S.
and dozens more—as modern...



FAIRCHILD
Sound Equipment Division
AERIAL CAMERA CORPORATION
88-06 Van Wyck Boulevard, Jamaica, L. I., N. Y.

PLANNED EDUCATION



In planning your Educational program for the coming year we believe you should acquaint yourself with the great possibilities which the recording field offers.

In the instruction and pronunciation of various languages the recorder plays an important part in actually showing the student his or her progress. In the takeoff from national radio hookups, Political or Economic data for class-room debate, the recorder renders a valuable service. In the instruction and teaching of elocution, students have been known to speed their progress by having their mistakes recorded and played back to them.

We believe you should investigate the tremendous possibilities of this new method of Education. Your attention is drawn to our new 1939 catalog which describes in complete detail our new and most scientific recording machines. A copy will be mailed to those addressing Dept. RR-1.

The Allied Model 'A' illustrated above has been designed especially for Educational purposes. We invite your investigation.

ALLIED
RECORDING PRODUCTS CO.
126 W. 46th St. • New York, N. Y.
Cable: ALLRECORD

you an assembly of yellow and brown musicians performing in Japanese and Chinese theatres, at the royal court in Jogjakarta, and to streets and coffee houses on the other side of the world. Balinese music and the sounds of six African savages attacking the eighteen hardwood bars of the giant xylophone at Lubero in the equatorial forest, or the beating of the Royal Watusi drums, all these strange sounds conjure up pictures even more appealing to youthful imaginations than the photographic illustrations in school geographies. Such records are easily obtained, and at modest prices.

Technical Too

Technical purpose records, frequency records, and records of music and speech with certain frequencies eliminated are indispensable for demonstrating the phenomena of sound in the study of physics.

Records of bird calls are available for biology work.

Specialists in physical education will appreciate the large number of folk tunes and dances recorded. These examples cover a wide range. They will be found as useful in geography classes as in the accompaniment of the quaint games and dances of other lands which have become part of our school and playground work.

For the fullest appreciation of the immense scope of recorded sound and its diverse application to educational purposes, acquaintance with the following catalogs and books is suggested:

Some Data Sources

The general *Catalog of Victor Records; Victor Records for Elementary Schools; What We Hear in Music; Music and Romance; Victor Book of the Opera; A Lecture-Laboratory Course in Music Appreciation and History of Music; Sound Service for Schools* (all published by the RCA Manufacturing Co., Inc., Camden, N. J.) *The Victor Book of the Symphony* is published by Simon & Schuster, New York.

The standard *Catalog of Columbia Records* (Columbia Phonograph Co., Inc., New York). The booklets for *The Columbia History of Music by Ear and Eye* are published by the Oxford University Press, New York.

The *Catalog of Decca Classical*

The
AMPERITE
ACOUSTIC
COMPENSATOR
gives you
HIGH OR LOW PITCH
WITH THE SAME MICROPHONE

With the flip of a finger you can now (1) lower or raise the response of the microphone. . . (2) adjust the microphone for most desirable response for close talking or distant pickup. . . (3) adjust the system to any "taste", room condition, or equipment.

MODELS RBHk, RBMk, with Acoustic Compensator, frequency range 40 to 11000 cps, output -65 db., complete with switch, cable connector and 25' of cable. \$42.00 LIST

NEW! MODEL RSHk (hi-imp); RBSk (200 ohms) Frequency range 60 to 8000 C.P.S. Output -68db. . . Chrome or Gunmetal \$32.00 LIST

NEW LOW PRICE CONTACT "MIKE"
Model SKH (hi-imp); SKL (200 ohms) \$12.00 LIST

MODELS RAH-RAL, excellent for speech and music. Reduce feedback. \$22.00 LIST

Write for Complete Illustrated Bulletins and Valuable Sales Helps.

AMPERITE Co. 561 BROADWAY, N. Y.
Cable Address: Alkem, New York

AMPERITE Velocity **MICROPHONE**

VIBRALOC
DIMENSIONAL SYSTEM

"Enchanter" Model—Dealers
Net \$84.75

Dual Microphone Inputs . . . Radio-Phono Input . . . Inver-ratio tone control . . . seven output . . . 25 watt output . . . Uni-Matic output impedance selector . . . Fuse . . . Ruby Lite, Vibraloc Reproducers . . . 15 Watts each, size 15"x15"x8" . . . Studio Velocity or Dynamic Microphone . . . Chrome Floor Stand. . . .

(Complete 12 watt system—similar to above but with crystal microphone . . . dealers net, \$49.95.)

We are complete sound equipment suppliers. Have our own plant and engineering dept. Shipment same day.

Amplifiers . . . Phonographs . . . Microphones . . . Reproducers . . . Complete Systems for Schools or Industrials.

Manufactured under ERPI license.
Catalog Upon Request

VIBRALOC
MANUFACTURING CO.
SAN FRANCISCO, CALIF.
1273 MISSION ST.

Records—includes Prof. Curt Sachs' anthology *20000 Years of Music* and Dr. von Hornbostel's *Music of the Orient* sets (Decca Records Inc., New York).

The Gramophone Shop Encyclopedia of Recorded Music (The Gramophone Shop, Inc., New York). A valuable compilation by composers of classical recordings from every important record catalog in the world—up to September, 1936. Supplements are issued monthly. This firm also distributes *L'Anthologie Sonore* records, a synthesis of the musical arts from before the year 1000 to the eighteenth century. Analytical and historical notes for Volumes I, II, III, and IV are available.

Linguaphone Language Records and Books (Linguaphone Institute, New York).

Music on Records, by B. H. Haggin (Oxford University Press, New York). A critical survey of recordings of outstanding musical masterworks.

The Arts, by Hendrik Willem van Loon (Simon & Schuster). This huge guidebook contains an excellent list of recordings selected from the catalogs of the major companies.

Equipment to Fit the Need

A large variety of reproducing instruments are available, from hand-wound acoustic portables to automatic record-changing radio-phonograph combinations.

Where schools are already equipped with radios, and appropriations are not available for self-contained phonographs, record players of the better type are suggested. These may be handily operated from the teacher's desk, the connecting wire running from there to the radio.

Where schools are without electric current, or the use of a phonograph out-of-doors is desired, portable hand-winders can be used. Another method is to obtain a battery radio and a record player with a spring motor.

The ideal installation is one that combines radio and phonograph reproduction and an instantaneous recorder. The latter can be used to tremendous advantage in the recording of radio programs. Equipment of this sort is available in a variety of sizes. Good tone and adequate volume are highly desirable in a school installation.

INSTANTANEOUS RECORDING

(Continued from page 47)

over the teacher who has no recording equipment available. Sound recorders have made it possible for teachers to improve the speech of students so rapidly as to be a source of amazement to parents. This gratifying progress has been the means of increasing the interest of parents in speech and music training and, as a consequence, the importance of these departments in the school.

A list of musicians using sound recorders would embrace the majority of well known radio artists, concert artists, band leaders, conductors and coaches. Music teachers are installing recorders in their studios. Their reputations are based on the results they produce, and they have invariably found that recordings provide a short cut to results.

Recording is even more important in school training where teachers are working with "raw material". In the beginners' speech classes in over 1000 schools the student makes a short record of his voice during the first week. He is allowed to listen to his record and discuss it with the teacher. He then receives

AMPLIFIERS

By THORDARSON

Built to Meet Need—Not Price



Model No. T-20W60

Peer of a
Distinguished Line
The 60 WATT

Tone control permits attenuation and accentuation at both high and low frequencies by separate controls. • Expander-Compressor circuit with two separate channels. • Three high impedance, high gain microphone channels. • High impedance phono channel (two may be arranged by almost instantaneous conversion of one microphone channel.) • "Magic eye" volume indicator. • Control panel positioned for maximum convenience and illuminated for easy readability in dark installations. • Uses four 6L6's with inverse feedback. • Extreme flexibility makes it choice amplifier for large installations using a large number of loud speakers and microphones. See your jobber or write factory for catalog No. 600.

THORDARSON ELECTRIC MFG. CO.
Amplifier Division
500 W. HURON ST., CHICAGO, ILL.



... WITH THE
**ARCTURUS
 EQUIPMENT DEAL**

A quality tube line . . . a Company that backs you up with powerful sales helps . . . a new and finer Equipment Deal that gives you EXTRA PROFITS—that's the Arcturus Plan. It's the easy, modern way to more profitable business in 1939!

NEW EQUIPMENT . . . practically FREE!

Almost any needed type of store or test equipment is available through the Arcturus Equipment Deal. You buy Arcturus Tubes at Standard Prices . . . you have your choice of quality instruments . . . Down Payments are amazingly low . . . you get Immediate Delivery of the equipment . . . Tube Requirements are the lowest yet!



CASH IN ON "MIDGETS"

A complete line of Arcturus tube replacements for the midget sets is now ready! You know how tremendously popular these small sets have become . . . over a million Arcturus "GT's" now being used as original equipment are creating a huge replacement market. They're practical, too, as replacements for metal tube types. Arcturus GT MIDGETS offer more proof of the completeness of the Arcturus line.

MAIL THE COUPON!

ARCTURUS

ARCTURUS RADIO TUBE CO., Newark, N. J. R15
 Without cost or obligation on my part, send details of your new equipment deal.
 Name _____
 Street _____
 City _____ State _____
 I am a dealer I am a serviceman
 My jobber is _____
 For your convenience this coupon can be pasted on a penny postcard

instructions for correcting his faults in timing, expression, pronunciation. The record is laid aside. A month later he records the same passages, plays the original recording and compares it with his second attempt to note his improvement. This is followed by a recording of a more difficult piece which will show additional faults. And the same process of comparison is repeated throughout the course.

Students in advanced speech classes become candidates for the debating teams, dramatic societies, etc. At this stage the common faults have been eliminated and entire debates and plays are recorded so that the participants can listen to themselves in retrospect and thus become familiar with their work as a whole.

The same technique is applied in the music department where individual students, as well as choral groups, school bands and orchestras are recorded both as a means for educating the student musicians and as a permanent record for the department head who wishes to compare the results of various methods of teaching.

The recording equipment now used in schools ranges from the small portable recorders costing a few hundred dollars to the more elaborate permanent equipment used for recording educational radio broadcasts, school plays, debates, etc. The latter equipment will make records for several hours continuously, if required, and costs from one to three thousand dollars.

**WHAT ENGINEERS LIKE ABOUT
 CINAUDAGRAPH SPEAKERS**

What engineers like about Cinaudagraph Speakers is the even, high quality of tone and dependability of construction. Furthermore Cinaudagraph offers this fine quality in a complete line of permanent magnet and electro-dynamic speakers from 5" to 18". Investigate the new profit possibilities of comparatively priced Cinaudagraph speakers used extensively by the country's foremost manufacturers of radio and Public Address equipment.

Write to Cinaudagraph Corp.,
 Stamford, Conn., for new
 descriptive catalog today.



CINAUDAGRAPH CORPORATION
 STAMFORD, CONNECTICUT

INDEX TO ADVERTISERS

Allied Radio Corp.	46	Film Circulation Corp.	34, 35
Allied Recording Products	52	Presto Recording Corp.	50
Amperite Mfg. Co.	52	Radio Corporation of America	44
Arcturus Radio Tube Co.	54	RCA Manufacturing Co.	40, 41, 42, 43
Astatic Microphone Labs.	52	Regal Amplifier Mfg. Corp.	53
Bell Sound Systems	48	Remler Co., Ltd.	39
Bogen Co., David	39	Shure Brothers	48
Cinaudagraph Corp.	54	Thordarson Mfg. Corp.	53
Continental Music Co.	47	Vibracloc Mfg. Co.	52
Electro-Voice Mfg. Co.	43	Western Electric Co.	37
Fairchild Aerial Camera Corp.	51		

Parts Show Already $\frac{1}{3}$ Sold

Booth contracts going fast following initial offer

CHICAGO—Preparation for the 1939 National Radio Parts Trade Show being held at the Stevens Hotel June 14-17 went into full swing when, during the last part of December, the announcements and contracts for space were sent to manufacturers of radio parts and accessories.

Response was immediate and as the New Year began more than a third of the total space occupied in last year's Show had already been absorbed. The following exhibits had been scheduled:

Amperex Electronic Products, Inc.
American Radio Hardware Co., Inc.
Arcturus Radio Tube Co.

Bud Radio, Inc.

Centralab, Inc.
Continental Carbon, Inc.
Cornell-Dubilier Electric Corp.
Clarostat Mfg. Co., Inc.

The Hallcrafters, Inc.
Hygrade-Sylvania Corp.

International Resistance Co.

Jefferson Electric Co.
Jensen Radio Mfg. Co.

P. R. Mallory & Co., Inc.
Meissner Mfg. Co.
The Muter Co.

National Union Radio Corp.

Oxford-Tartak Radio Corp.

Presto Recording Corp.

Quam-Nichols Co.

Radio Mfg. Engineers, Inc.
Raytheon Production Corp.
Readrite Meter Works

Simpson Electric Co.
Sprague Products Co.
Standard Transformer Corp.
Shure Bros., Inc.
Solar Mfg. Corp.

Thordarson Electric Mfg. Co.
Triplett Electric Instrument Co.

United Catalog Publishers, Inc.

Ward Products Corp.
Ward Leonard Electric Co.

International Changes Name

ANN ARBOR—International Industries, Inc., is the new name of the former International Radio Corporation, the change voted by directors to more adequately cover the variety of products now made by the firm.

Officers elected for 1939 include Charles A. Verschoor as chairman of the board, John Bradfield as president, Gustave A. Fassin as vice president, Robert T. Herkner as secretary and treasurer, L. C. Gillespie as assistant secretary, John Bradfield, C. Stanley Porter and Wm. E. Brown, Jr. as members of the board's executive committee.

Brunswick Sticks to Policy

NEW YORK—Convinced that radios retailing for more than \$100 will have to be in fine furniture cabinets is H. L. Weisburgh of the Mersman Bros. Corporation's Brunswick radio division, who has opened up over 1500 department, furniture and music houses to this line since July of last year.

Brunswick will continue to sell direct to retailers in 1939.



STEWART-WARNER'S KELSEY — Introducing L. L. Kelsey, Stewart-Warner's radio sales manager

Stewart-Warner's Three-R's

Radios feature built-in antennas, refrigerators use ultra-violet, ranges boast special features. In water heater business

CHICAGO—Busy were the 500 distributors and their men who crowded Chicago's Edgewater Beach Hotel January 5, 6 and 7. For Stewart-Warner Corporation was shooting the works on its 1939 lines and had a lot to show and explain.

L. L. Kelsey, new radio sales manager, introduced his new regional men: H. P. Dunkly, Boston; B. R. Peacock, Buffalo to Cincinnati; Sid Rogovin, Atlanta and thereabouts; Dean A. Lewis, Chicago, Duluth and St. Louis; DeB. Gaines, Dallas, Kansas City, New Orleans; Spence Reese, Denver and points west.

Stewart-Warner is manufacturing radio of the type that is most saleable under present conditions, Mr. Kelsey declared. Nine models were shown.

Built-in antenna is a feature on this years table models. Magic Keyboard appears on all except a \$9.95 set. All have automatic volume control.



REGIONAL REPS—Grouped around L. L. Kelsey here are Stewart-Warnermen H. P. Dunkly, B. R. Peacock, Sid Rogovin, Dean A. Lewis, DeB. Gaines, Spence Reese

In the refrigerator line, John F. Ditzell, electrical appliance sales manager, offered ultra-violet light as a bacteria and mold destroyer. Three price levels, "Challenger," "Deluxe" and "Super-Deluxe" were offered.

Frances Weedman, famed home economist, introduced the new Stewart-Warner range. An illuminated dial which is lit when current is flowing is a 1939 feature. A clock which will control oven, plugged-in appliance or the "Econ-o-Way" cooker is another. Ranges have 5-speed heat controls on surface, six in oven, plus thermostatic heat control.

Electric water heaters wound up the Stewart-Warner line, which marks the greatest step taken so far by that corporation into the appliance field. The greatest advertising campaign in the firm's history will back it up, advertising man Cliff C. DeWees told the crowd.

Reps Plan National Campaign

NEW YORK—"The Representatives" plan a national publicity campaign to begin shortly, have appointed C. B. Cooper of New York's Cooper-DiBlasi chairman of a special committee.

Newly elected sectional vice-presidents of the organization include Rus Hines of San Francisco, Earl Smith of Dallas, E. Ralph Haines of Oak Park, Brower Murphy of Atlanta, Arthur H. Baier of Cleveland, Martin Friedman of Philadelphia and Ernest K. Seyd of Hartford.

Addressing the December 13th meeting was Charley Golenpaul of Aerovox. H. A. Roes of Kansas City announced that he has moved to 2015 Grand Avenue. Ray Perron of Taunton, Mass., advised that he is starting his third season of lecture and demonstration meetings with servicemen in the New England district.

Hoyt Celebrates 35th

PENACOOK, N. H.—January 1939 marks the thirty-fifth birthday of the Hoyt Electrical Instrument Works of this city, maker of radio meters.

CBS To Make Records

Broadcast chain buys American Record Corp., gets Columbia, Brunswick, Vocalion labels

NEW YORK—The Columbia Broadcasting System has purchased the American Record Corporation from Consolidated Film Industries, Inc., will take over the manufacture and distribution of Columbia, Brunswick, Vocalion and other associated disc brands.

Subsidiaries of the purchased American Record Corporation simultaneously acquired by CBS include the Columbia Phonograph Company, Inc., Brunswick Record Corporation, American Record Corporation of California and Master Records, Inc. Pressing plants are owned in Bridgeport, Connecticut and Hollywood, California. Foreign exchange agreements include Columbia Graphophone, Ltd., and Electrical Musical Industries of London.

Interesting sidelight on the CBS-CFI deal is the fact that the purchased American Record Corporation's subsidiary Columbia Phonograph Company at one time owned the Columbia Broadcasting System.

Frigidaire Conventions Under Way

DAYTON—Three separate crews of Frigidaire executives left here January 13, travelling in three different directions to stage conventions and show new products to more than 20,000 dealers and salesmen throughout the nation. Heading the delegations were Lee A. Clark, H. J. Walker, Jr. and Ellsworth Gilbert. With them went other officials bringing the traveling total to 39.

Thirty-three cities are included in the itinerary, with the program to be given twice in New York, Boston, Los Angeles. An innovation in food preservation is promised.



UP GOES SHANNON—*Robert Shannon*, former RCA Manufacturing Company v.p. and general manager who has just been elected executive vice president. In April 1938 he was elected to the firm's Board of Directors



NEW CBS RECORD HEAD—*Edward Wallerstein*, former record department sales manager for RCA-Victor, who has just been made president of the American Record Corporation, Columbia Broadcasting System subsidiary. With him will be associated Frank K. White, named treasurer, C. C. Boydston, assistant treasurer and Ralph F. Colin, secretary.

Loveless Wins S-C Honors

ROCHESTER — Stromberg-Carlson's Larry Loveless took top honors for smashing the year's sales quota, earning himself a neat 250 per cent of quota instead of a mere 100 per cent. Loveless is sales rep for the New York southern tier.

Next two top men with record-breaking sales proclivities that helped 1938 Stromberg-Carlson unit sales soar above those for 1937 were Donald E. Lee and James S. Gibson.

Hadley Goes National

NEWARK, DELAWARE—The Robert M. Hadley Company, well known in west coast radio and moving picture circles for the past six years as a maker of quality transformers, has just established a plant here.

A full line of radio transformers for the jobbing field is to be produced at Newark as well as at the older factory in Los Angeles to permit national distribution of equipment for use by amateurs, servicemen and others.

President Robert M. Hadley, who has moved east to superintend activities in that area, advises that a comprehensive catalog of Hadley transformers is now ready for distribution to the trade on request.

Stromberg's 5th Drive

ROCHESTER—In the midst of its 5th Better Salesmanship Campaign is Stromberg-Carlson, offering retail radio salesmen valuable awards made on a straight point basis rather than competitively. Begun December 12, the drive will carry through until February 28, is designed not only to stimulate retail salesmen but also to improve their technique in the movement of larger units.

Radio sales manager Lee McCanne is directing the activity.

Crosley Shows Facsimile

Low-priced "Reado" radio printer shares convention honors with new home and auto radios, ranges, washers, et al.

CINCINNATI—Human interest highlight of the Crosley Corporation two-day distributor convention held here January 6 and 7 was the new "Reado" facsimile recorder designed for use in homes in conjunction with a radio receiver. Priced extremely low, the device turns out pictures or text about two standard newspaper columns wide, on a continuous paper roll.

Shown to distributors simultaneously were new home radios, auto radios, ranges, washers and other Crosley products, now ready for the 1939 season.

Optimism regarding business prospects for the year were expressed by president Powel Crosley, Jr., who said the company was spending much money in anticipation of the business it confidently expected to get. Other speakers were Powel Crosley, III; C. R. D'Olive, Thomas W. Berger and John S. Garceau.

RCA Distributors Drive

CAMDEN—Heads of RCA Victor distributing companies all over the country have just concluded a "testimonial sales campaign" in honor of David Sarnoff, president of the Radio Corporation of America, and George K. Throckmorton, president of RCA Victor. They pledged to break all previous sales records for the months of November and December.

To those who fulfill pledges (not yet announced) a gala week end of entertainment will be tendered in Camden during January.



WITH WEBSTER-CHICAGO—*Donald MacGregor*, one of the original organizers of the RMA and until recently with a Pennsylvania cabinet maker, has just been appointed general manager and treasurer for the Webster Company of Chicago

RMA Fights 5 Per Cent Tax

Will automatically be removed
June 30 unless renewed by
Congress

WASHINGTON—Continuing its campaign to remove the 5 per cent excise "nuisance" tax on radio, the Radio Manufacturers Association has asked the treasury department to recommend complete repeal of the tax. Unless continued by Congress it would expire June 30.

A special RMA committee appointed by president A. S. Wells held a lengthy conference with treasury officials, presenting reasons for discontinuance of the tax. Representing the group at the conference were A. S. Wells, A. H. Gardner, James M. Skinner, John R. Howland, J. McWilliams Stone, Robert R. Kane and Bond Geddes.

Bruno In Facsimile

NEW YORK—William A. Bruno of the Bruno Laboratories, Inc., 30 West 15th St., has taken out a license under Finch Facsimile patents, will shortly manufacture inexpensive facsimile receivers in kit form.

At present making microphones, pickups and turntables, Bruno has just completed plans for an aggressive merchandising campaign in behalf of these products during 1939.

Aerovox Goes Yankee

NEW BEDFORD, MASS.—To its new 433,000 sq.ft. plant here, from Brooklyn, N. Y., moves the Aerovox Corporation as we go to press. Six city blocks long by two wide, the New Bedford buildings which will house both condenser-making machinery and the concern's general offices provide four times the room formerly available to Aerovox, one of the largest manufacturers in the business.

The New England plant is scheduled

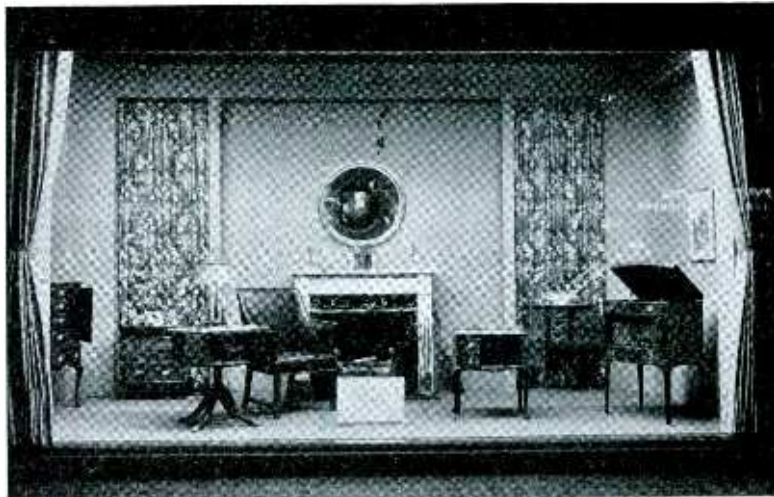

STATE STREET SPECIAL—Featured for three weeks by Chicago's Carson, Pirie & Scott was this exclusive Brunswick radio window

to be in full operation by February 1. Meanwhile, according to president S. I. Cole, no difficulties will be experienced filling jobber condenser orders due to



SOUND MAN—Just completing one of the swankiest jobs he's ever built for a school is David Bogen, who looks forward to increased amplifier business in 1939

the fore-warned accumulation of stocks in the Brooklyn plant and the production of additional merchandise for several weeks by departments already established at New Bedford. Aerovox is, in fact, already in a better position to meet stock demands than during strike conditions which applied throughout much of 1938.

Elbow-Room For Fada

LONG ISLAND CITY—Just completing its biggest radio year, Fada Radio and Electric of this city has added 30,000 additional square feet of floor space to its factory.

General manager Jack Marks reports that while demand has been heaviest in table models Fada consoles and, particularly, radio phonograph combinations have been moving well.

DuMont Reports Sales

PASSAIC, N. J.—Reported by Allen B. DuMont of the Allen B. DuMont Labs., Inc., is the sale of many television receivers to stores initially interested in the use of such equipment for display despite infrequent transmissions in the New York area.

Stores are using the equipment effectively to build store traffic, according to DuMont, occasionally pull large crowds when test programs are transmitted, will start moving the merchandise to the consumer when regular programs become available.

Magnavox Improves Position

FORT WAYNE—From Stanley Sondles, general sales manager for The Magnavox Company, Inc., comes word that this well-known firm has completed reorganization under 77-B. During the reorganization, according to Sondles, Magnavox has steadily improved its working position, further modernizing plant facilities, introducing important new products and strengthening personnel.



MEET VAN SICKLE'S GANG—All of Van Sickle Radio, St. Louis amateur and serviceman equipment jobber, left to right: Walter Bappret, O. H. (Grij) Griffiths, Gus (Red) Mohr, Jules (Aerovox) Beneke, Geo. (Curlie) Koehler, Chas. (Speedy) McCauly and Phil Ham

Kelvinator Silver Jubilee

Introduces broad new line of refrigerators with 1939 features

DETROIT—Celebrating the Silver Jubilee of the household electric refrigerator, Kelvinator has just introduced a new line of "5th Anniversary Models," developed in commemoration of the event which will be dramatized throughout the entire year.

Four series and a total of twelve models make up the line, ranging in capacity from three cubic feet to 8 cubic feet. Despite many new developments included in these new models the average retail prices will be lower than in 1938, according to H. W. Burritt, vice president in charge of sales.

High point of the 1939 Kelvinator presentation is the announcement of the "Polarsphere," mechanical unit of the hermetically sealed type so small and light that a housewife can easily hold it in her hands, yet so powerful that it could furnish sufficient cold to refrigerate five of the new Kelvinator cabinets.

Majestic Sales Up

CHICAGO—Majestic Radio & Television Corporation reports that sales for the six months ending November 30 were up 200 per cent as against the same period in 1937. The factory was at that time running extra shifts to maintain deliveries.

Coming shortly are new table model Majestics and several new consoles designed to stimulate Spring business.

Campbell Joins Ansley

NEW YORK—Robert H. Campbell has just joined the Ansley Radio Corporation in the capacity of sales manager, predicts that 1939 should find the market on a gradual up-turn for receivers in the higher price brackets.

New Building for Eby

PHILADELPHIA—Into a newly purchased building late last month moved H. Eby, Inc., hereafter to be addressed at 4700 Stenton Avenue. Greatly increased facilities are provided for production of Eby radio parts and electrical accessories.

"Nude" Mike Line

INGLEWOOD, CALIF.—Universal Microphone Company's entire microphone line will henceforth be available in manufacturers' models dispensing with such refinements as extra fittings, switches, cases, cables, etc., as well as in the firm's present highly stylized and elaborately packaged forms. Manufacturers' models will bear the letters "MT" before their model numbers and these stripped-down types are to be made available to Universal jobbers who wish to incorporate them in custom-built jobs.



NEW DRIVE BY NEW MEN—Planning an intensive campaign for Nash-Kelvinator's Leonard Division are, left to right: *Walter Jeffrey, Ray Legg, Truman Steinko and R. R. Ludington*



TEN, TEN, TEN AGAIN—On the tenth of the tenth month of production at 10 a. m. Arcturus turned out its millionth GT Midget tube. Left to right: Final test-rack lady, *J. A. Stobbe, Abbott Feindel, A. E. Lyle and Jack Geartner*



FACSIMILE SPECIALIST—Proud of his firm's newest recorder is *Ehlert of Finch Facsimile*, who predicts big doings in the field shortly

Walker Upped By RCA

CAMDEN—Frank Walker has been appointed manager of the RCA Manufacturing Company's Victor and Bluebird Record Department, will continue also as manager of the firm's broadcast transcription activities.

Walker has been in the record business since 1919. In 1924 he was general manager and director of the Columbia Phonograph Company. In 1933 he joined the RCA Victor organization.

Six More For RSA

CHICAGO—Following approval by the executive committee of the RSA, six additional chapters will soon be operative, in St. Joseph, Mo., Scranton, Penna., Ft. Wayne, Ind., Springfield, Ill., Williamsport, Penna. and Allentown, Penna. Chapters are in process of formation in still other cities.

From the Newark Chapter of RSA comes word that pressure has been brought to bear on certain servicing organizations using misleading advertising, with the result that standards have been raised for the entire group.

Mir-O-Ray

NEWARK—Developed by Arcturus Radio Tube Company is a new product known as "Mir-O-Ray," a reflecting material for signs to be marketed by the firm's Mir-O-Ray Division. H. A. Yerkes is in charge.

Distribution News

TUNG-SOL—*Supplies, Inc.*, of Toledo has just taken on this tube line. Execs include Clarence Kamm, Russell F. Kehr and Russell F. Teall. A new jobbing house, the firm will also handle parts, cameras, projectors and other accessories. *Sound Systems, Inc.*, Huntington, W. Va., another Tung-Sol distributor, has just opened a branch at Charleston.

STROMBERG-CARLSON — *Union Supply* of Burlington, Iowa now has this line in a limited section in the southeastern portion of the state. C. E. Anderson heads the firm.

COLUMBIA, BRUNSWICK, VOCALION—*The Roycraft Company* of Minneapolis has been appointed to distribute these record lines in Minnesota, Iowa, North and South Dakota and western Wisconsin. E. T. Christman is manager of the firm's new record department.

STANCOR—C. L. Pugh of the Standard Transformer Corp's jobber sales division announces the following personnel changes: *Gerard McL. Cole* is Stancor direct sales representative for the State of Illinois including metropolitan Chicago. Two old associates of the Forrest C. Valentine Company, former Stancor rep in industrial fields, have been appointed direct Stancor representatives; they are William McFadden, serving Ohio, Indiana and Kentucky, and *Wally Swank*, covering Michigan.



REPORTS GAIN—Doing a nice job is *Mentzer* of Precision Apparatus, who reports substantial gains in the test equipment market for 1938. He'd move to larger quarters if it wasn't for a lease



OPTIMISTIC—Solar's *Art Moss*, who predicts that the June parts show will achieve a complete booth sell-out. He ought to know. He's secretary-treasurer of the Show Corporation



NO HURRY—Not anxious to stock the trade heavily with television until real program service is available to the consumer is American Television, according to exec *Sterenfeld*

DEALER HELPS

ARTIFICIAL CORNER — Unique hinged "wings" permit *Stromberg-Carlson* corner cabinet radios to be properly displayed where there is no available corner. New folder simultaneously announced shows entire S-C set line.

BALLAST BUGABOO—New characteristic chart by *Arcturus* helps servicemen by listing 179 types made by the company, indicating proper replacement for odd units. Indispensable for the serviceman's wall or file.

CONDENSER CATALOG—No. 165A is the latest by *Cornell-Dubilier*. Gives complete details about most used types.

CAT-RAYS ET.AL.—*Allen B. DuMont Laboratories* of 2 Main Ave., Passaic, N. J., offers a 1939 catalog about cathode-ray tubes and allied products. Interesting wall chart released simultaneously shows clearly the principles of cathode-ray tube operation. 2½ by 3½ ft. over all, it will be particularly useful in explaining the unit which is the heart of television to customers and should therefore go fast. Sells for 50 cents but supply is limited.

Own a PRECISION 815A TUBE SELLER!

Your National Union Jobber Will Give You One If You Buy 34 N.U. Tubes and or Condensers Per Month



TESTS NEW LOKTALS and SINGLE END TUBES

The necessity for high efficiency modern tube testing equipment is fully appreciated by aggressive radio merchants who keep their shops up to the minute. They can handle more work, build customer good will and increase profit. This new Precision 815A Tube Seller incorporates the latest scientific advancement in instrument design combined with highest degree of eye value to impress customers. It comes to you ready to do a thorough going job on testing all tube types including the new Loktal and single ended tubes, ballast units, gas rectifiers and magic eyes. The tests are strictly in accord with standardized RMA specifications and all electrodes are individually tested. A load selector applies properly rated loads to the tube under test. Each electrode can be neon short checked while tube is hot. Noise test pin jacks provide for ear phone or

amplifier connection. Of particular merchandising value is the big nine inch D'Aronsonval type meter with a scale in three colored English reading sectors one inch wide. A calibrated percentage scale enables tube matching. A scientific test device which you will be proud to own.

HERE'S HOW YOU GET ONE!

Your National Union jobber will give you one of these fine new Precision model 815A Tube Sellers if you will contract with him to purchase 25 National Union tubes and/or electrolytic condensers now, 34 each month for twenty-two months and 27 in the twenty-fourth month which concludes your two year contract. You place a small deposit when you sign the contract and get it back as a merchandise credit as soon as the total number of tube and/or condenser points have been earned. Why not get one right away, see your jobber, sign up and the instrument is shipped to you immediately—you have full use of it all during the time you are fulfilling your purchasing agreement. If you don't know who your nearest N.U. jobber is, send a coupon today!

BUILT BY PRECISION—APPROVED BY N.U. THESE TESTERS ARE QUALITY INSTRUMENTS



Come On!
Build Customer
Confidence with
NATIONAL UNION
TUBES and
CONDENSERS

NATIONAL UNION RADIO CORP.
NEWARK, NEW JERSEY
Send me name of nearest N. U. jobber.
Name.....
Street.....
City.....State.....



SPINET SWEEPSTAKES—Cliff Bettinger of Philco, at a meeting staged by Thompson & Holmes, awards prizes to West Coast dealers, giving Miss Radacher of Stockton's Peffer Music first, William Sanders of San Francisco's Martin Piano second

CONSUMER PIECE—The *Ansley Radio Corp.*, of 240 West 23rd St., New York, has a swanky new folder on impressive paper describing its revolutionary piano-phonograph-radio-harpsichord instrument named "Dynamtone". Pictures reproduce especially well.

AMPLIFIER GUIDE—For 15 cents readers may obtain from *Thordarson Electric Mfg. Co.* of 500 W. Huron, Chicago, Sound Amplifier Guide No. 346-D just off the presses. Incorporates circuit diagrams, chassis layout charts and parts lists for amplifiers ranging from 8 to 120 watts

output. One interesting item is a high quality phono-radio amplifier with volume expansion and unusually flexible tone controls. Distributors have these guides.

TECHNI-TALKS—This is the name of a house-organ about to be brought out by *Oxford-Tartak Radio Corp.* of 915 W. Van Buren St., Chicago, devoting itself to the technicalities of sound and replacement radio speakers. Write on business letterhead, say you saw this note in *Radio Retailing* and ask to have your name put on the list to receive the first and subsequent issues.

CARDIOID—Western Electric's catalog 639A tells all there is to know about the new Cardioid Directional microphone.

SOUND DISPLAY RACK—A steel rack wide enough to hold four amplifiers made by the firm, stacked one above the other, is offered by the *David Bogen Company* of 663 Broadway, New York. Phonograph motor and switching panel is built-in, insulated clips permit connection of all units and instant comparison. Also has an illuminated top sign. Offered at reasonable price.

FOR SCHOOLS—Third edition of *RCA Victor's* "Sound Service for Schools" catalog is just off the presses, more complete and exhaustive than ever before and available to interested teachers and school execs through company distributors or the Educational Department at the Camden factory under the direction of Ellsworth Dent.

Another knockout dealer help by the same company this month is a lighted display card which switches the firm's 40th Anniversary Victrola on when touched. Called "Magic Demonstrator" and a human interest natural.

Just-released catalogs about records include a complete one on the entire Victor and Red Seal line, a ballet music brochure for which a special treatise was written by Richard Gilbert, a "connoisseur's record list."

"HOW TO" BOOK—"How to Design Your Own Tube Checker." This is the title of a booklet offered free to servicemen by John Meck Instruments, 164 N. May St., Chicago. Mention *Radio Retailing* when writing.

CATALOG—Hot off the presses is the 1939 "Radio Profit Guide" by the *Radolek Company*, of 601 W. Randolph St., Chicago. Covers everything in radio from "soup to nuts", 164 pages overall.

WITH CONFIDENCE—This is the title of a new folder by *The Knaphurst Company*, of 501 S. Jefferson St., Chicago, describing its appliance-radio book-keeping system. Just off the presses and ready for mailing to the trade on request.

The Aerial you Need for VOLUME SALES is COL-MAR



It's selling fast wherever displayed. Buyers are enthusiastic and sending their friends in for more. Now is standard radio equipment on several expensive cars. Yet this aerial sells at a reasonable price and is being installed on cars of all prices.

Truly the Aerial of TODAY and TOMORROW. Controlled from the dash—neat and handsome in appearance—practical in operation—most efficient in receptivity. Simple installation. Free from ignition interference, wheel and tire static.

For poor radio areas and long distance reception, the Col-Mar Vacuum Auto-Radio Aerial is the best antenna available. Expertly engineered to match the finest car design. Materials and workmanship guaranteed. Write us for distribution proposition.



PIONEER SPECIALTY COMPANY
521 ST. JEAN AVE.
DETROIT, MICH.



Attend the National Radio Parts Trade Show

1939 JUNE 1939

WED	THU	FRI	SAT
14	15	16	17

OPEN ONLY to Jobbers, Manufacturers, Manufacturers' Agents, and Engineers.

OPEN to Servicemen, Amateurs, Retailers, Students and others.

Stevens Hotel, Chicago

Readrite
RANGER

Always UP-TO-DATE
KEPT

COMPACT

NEW MODEL 432

ATTRACTIVE
TUBE TESTER

Checks All Types Radio Receiving Tubes

only \$21.60
COMPLETE IN QUARTERED-OAK CASE

Including the New 1.5 and 50-Volt Series: Loctal Base Types and the OZ4 and other Gaseous Rectifiers.

- Separate Plate Tests on Diodes and Rectifiers
- Uses Attractive Triplett Direct Reading Instrument 3" Size, (GOOD-BAD) Scale, (GOOD-BAD) Scale.
- Neon Short and Leakage Tests
- Line Voltage Adjustment
- Ballast Tube Continuity Test
- New Improved Low Loss Switch

Suitable for counter or portable use. Sloping etched panel of silver and black. Model 431.....\$15.90

Checks all receiving tubes. (No ballast test.) Tester uses dependable Readrite Meter. Quartered-Oak case same as for Model 432. Write for Catalog—Section 120 Colgate Dr.

READRITE METER WORKS Bluffton, Ohio

"DYNAMIC CONDUCTANCE" TUBE TESTER



• Consolidated is proud to offer the new Model 9000 "Dynamic Conductance" Tube Tester. Engineered to give top performance. Assured against obsolescence. Built to take full advantage of greater accuracy afforded by dynamic mutual conductance circuit. Sells for only \$37.50. See your jobber today!

CONSOLIDATED WIRE AND ASSOCIATED CORPORATIONS

514 S. Peoria St. Chicago, Ill.

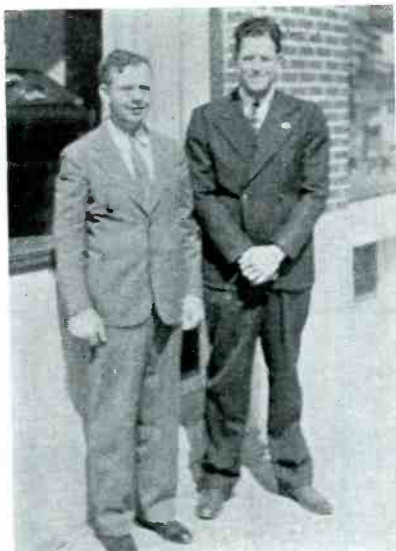

SAN ANTOINE PARTSMEN—Two well known men at San Antonio's Strauss-Frank. Left to right: J. B. Reeves and Albert Rose

DIAL DOPE—American Emblem Company, Inc. of Utica, N. Y. has just made available a four-sheet folder completely describing, picturing and pricing its line of dials, universal scales and escutcheons.

CAMERAS, SUPPLIES—The Mottow Co., wholesale distributor in the Merchandise Mart, Chicago, has just announced a new 30-page catalog describing, picturing and pricing its line of cameras, projectors, photo supplies.



NO WONDER IT INCREASED—Since Helen Staniland, vice-president of Quam-Nichols, took over the firm's jobbing division sales have shown a substantial increase. She's treasurer of the western branch of the sales managers club. And we betcha she's been making some personal calls on jobbers

THE CONDENSER Sensation OF 1938...

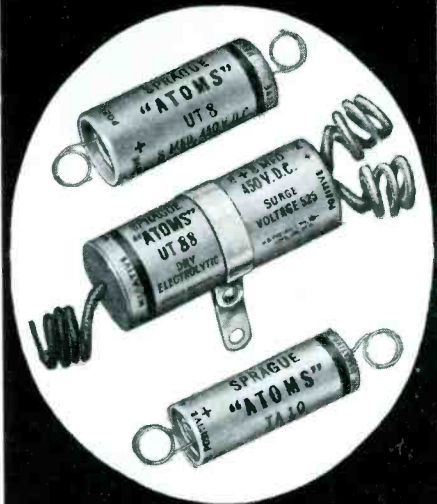

THE MIDGET Standard OF 1939!

No wonder Sprague ATOMS—the sensational new midget dry electrolytics—broke all previous sales records in 1938!

For here are the smallest midgets on the market—the most complete line of midgets in both duals and singles and in all working voltages—the midgets that are **UNCONDITIONALLY GUARANTEED** against blow-ups—and unquestionably the most reliable, even for replacing much larger old style condensers.

In brief, Sprague ATOMS sold so amazingly well because they are so amazingly good. They save time, space, money. A couple of Kits of Atoms equip you for almost any ordinary condenser replacement . . . especially where space is limited or where you need an honest-to-goodness, fool-proof condenser at an absolute rock-bottom price.

Ask your jobber today! Get next to the biggest little condenser sensation in years.

SPRAGUE PRODUCTS CO.
North Adams, Mass.

SPRAGUE ATOMS
"Mightiest Midgets of All"



EMERSON — Model CE - 259 — 5 - tube superhet portable battery model.

Preview of New

EMERSON

MODEL 238—Five tube a.c.-d.c. superhet for standard American broadcasts and police calls features Emerson "Miracle Tone Chamber". Equipped with electro dynamic speaker, automatic volume control, built-in antenna. Staybent construction of the 5½ by 10 by 5½ in. cabinet allows use of continuous veneers on front and sides. Opening and closing of lid starts and stops receiver. List \$24.95.

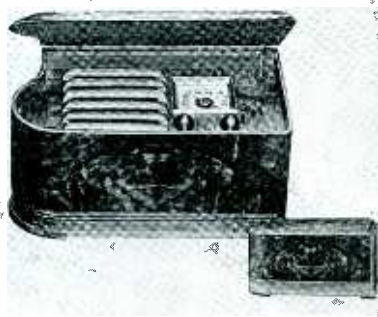

Emerson Radio and Phonograph Corp.
111 Eighth Ave., New York, N. Y.

STEWART-WARNER

Stewart-Warner Corp.,
1826 Diversey Parkway, Chicago, Ill.



MODEL 01-611—Superhet table model with illuminated dial, automatic volume control, Magic Keyboard. Ballast or dummy tubes have been eliminated—every tube is a working tube.

STROMBERG-CARLSON

Stromberg Carlson Tel. Mfg. Co.
100 Carlson Road, Rochester, N. Y.



MODEL 345-X — Slanting panel console grand with selective 10 tube chassis, Acoustical Labyrinth and Carpinchoe Leather Speaker. Authentic English 18th Century design. Electric flash tuning.

MODEL 01-817—Effective use of wood grain make this an attractive console, a superhet which has automatic volume control and Magic Keyboard tuning. Illuminated dial, all-working tubes.



MODEL 335-H fills a new table model price bracket. The idea for its walnut cabinet was taken from a Chippendale clock case, grille was taken from a Chippendale chair back motif. Electric flash tuning.



MISSION BELL

Mission Bell Radio Mfg. Co., Inc.
833 Venice Blvd., Los Angeles, Calif.

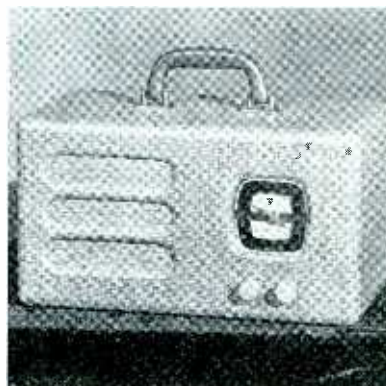

PORTABLE—Model 400 complete battery operated portable radio, self-contained in weather-proof, airplane cloth covered cabinet with carrying handle. Has automatic volume control, employs low drain tubes, needs no aerial or ground connection.

Radio Merchandise



ARVIN—Model 89, six push button, six tube a.c. superhet. List \$44.95.

SENTINEL

Sentinel Radio Corp.
2222 Diversey Parkway, Chicago, Ill.

COMBINATION — Radio Phono Model 125AC-CB in console grand cabinet. Seven button permeability tuning, 6 tubes, 2 bands, tuning from 540 to 18,300 kc. Self-starting a.c. phono motor, 12 in. turntable for 10 in. and 12 in. records, automatic stop, crystal pickup, separate radio-phono switch, volume control on both radio and phono. List \$79.95.



ARVIN

Noblitt-Sparks Industries, Inc.
Columbus, Ind.

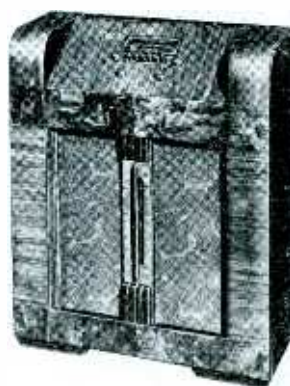

Priced from \$16.95 to \$99.95, the nine new models of the 1939 line include model 91, illustrated. Six tube superhet circuit, 10 in. dynamic speaker, skip band coverage provides American and foreign reception, 6 station push button and dial tuning, electric eye tuning indicator, beam power output, walnut. List \$64.95.



MODEL 177 UT—Streamlined bakelite cabinet in selection of six colors, 5 tubes, a.c.-d.c. superhet, tunes 540 to 1730 kc. New illuminated finger dial. List \$9.95.

G-E

General Electric Co.
1285 Boston Ave., Bridgeport, Conn.

MODEL G-86 — Built-in beam-a-scope, phonograph key, 8 tubes, 3 bands—540-18,000 kc., 5 watts output, keyboard touch tuning, multivision louvre dial, visual 4-pt. tone fidelity control, automatic band indicator, automatic power switch, cathode-ray tuning indicator, oscillator stabilization circuit, 12 in. dynamic speaker, automatic volume control.



HOWARD

Howard Radio Company
1731 Belmont Ave., Chicago, Ill.

MODEL 4BT battery operated superhet using the new low drain 1.4 volt tubes. May be powered with A-B packs, standard Aircell or A and B batteries. The drain is .25 amp. from the A battery. Economizer provides low "B" drain of 7.5 ma. for ordinary reception, 12.5 ma. drain at maximum power output. Five in. permanent dynamic speaker



WIRELESS RECORD PLAYER — Plays 10 or 12 in. records from any location in the room through radio loudspeaker without wired connection. Plugs into any a.c. electrical outlet. Crystal pick-up, self-starting motor.

PREVIEW OF NEW RADIO MERCHANDISE

R C A VICTOR



R C A Manufacturing Co.,
Camden, N. J.

MODEL 96K-5—A 6 tube console housed in modern-type cabinet of matched walnut veneers. Utilizes Super-Sight dial, plug-in for Victrola attachment, continuously variable tone control, automatic tone compensation, automatic volume control, temperature-compensated circuits. Tuning range of 540-1720, 2300-7000, 7000-22,000 kc. List \$49.95

MODEL 97T-2—Table model with 7 tubes, electric tuning to 6 stations, Victrola push-button switch, 3-band super-sight streamlined dial, Ultra-Continental cabinet, plug-in for Victrola attachment. List \$49.95



PHILCO

Philco Radio and Television Corp.,
Philadelphia, Pa.



COMBINATION—Model 108, six tube console model with new Philco streamline dial, disc controls and instant electric push-button tuning. Semi-automatic reproducer phonograph plays both 10 in. and 12 in. records. List \$129.50 less trade-in allowance.

RADOLEK

The Radolek Co.,
601 W. Randolph St., Chicago, Ill.

RECORD PLAYER—Portable transcription record player with built-in amplifier and speaker. Plays 10 in. or 12 in. 78 r.p.m. phonograph records. High fidelity, crystal pickup, self-starting constant speed phono motor, 3 watt power amplifier, 6 in. electro dynamic speaker, volume control, tone control, brown leatherette covered case.



DUPLEX

Film Circulation Corp.,
1600 Broadway, New York, N. Y.

SOUND PROJECTOR—Sixteen mm. sound projector is a complete a.c. talking motion picture equipment with amplification sufficient for large and small audiences. The 750 or 1000 watt projector lamp gives sharp brilliant pictures in sizes up to 9 ft. by 12 ft. or more. Can be used for sound or silent films, accommodates all size reels, 12 in. auditorium type speaker, amplifier accommodates crystal mike for P.A. and phono pickup for records.



REGAL

Regal Amplifier Mfg. Corp.,
14 W. 17th St., New York, N. Y.



RECORD PLAYER—Model B47 wireless record player features arm rest, crystal pickup, self-starting motor, volume control and switch. Operates on a.c. 110 volt current, weighs 12 lbs.

STEWART-WARNER

Stewart-Warner Corp.,
1826 Diversey Parkway, Chicago, Ill.

ELECTRIC RANGE—Model 9059, illustrated, is one of a line of 6 models marking the entry of the company into the electric range field. All models have welded steel frames; one-piece, acid-resisting porcelain steel tops; porcelain finish throughout, including ovens and storage compartments. Surface units use new, fast-heating rod type element.



THORDARSON

Thordarson Electric Mfg. Co.,
500 W. Huron St., Chicago, Ill.



AMPLIFIER—Model T-20W08 eight watt amplifier is furnished in metal screen cover or handy portable combination speaker and carrying case. Speaker case is of base reflex type, unusual in small portable amplifiers. Four tube beam power amplifier, individual control of mike or Phono, 6 watts of power for field excitation. Priced at \$39.50 for amplifier only.

PREVIEW OF NEW RADIO MERCHANDISE

TUBEMASTER

TESTER—Pattern 20-A employs the three-in-one test for indicating mutual conductance, power output and emission quality in a single test. Meter dial is direct reading in "good" and "bad" scales. Equipped to test every new 35-volt and octal base tubes. Guaranteed against obsolescence for two years after date of purchase. Dealer price \$34.50.



John Meck Instruments
164 N. May St., Chicago, Ill.

KELVINATOR

Division of Nash-Kelvinator Corp.
14250 Plymouth Road, Detroit, Mich.



REFRIGERATORS—The midget and the giant of the Silver Jubilee Kelvinator line for 1939. Four-cubic-foot model at left and 8-cubic-foot model at right. New line features the "Polar-sphere" cooling unit, greater accessibility and visibility for food shelves, "open throat" cabinet which allows full use of sliding shelf space.

OPERADIO

Operadio Manufacturing Company
St. Charles, Ill.



REMOTE SOUND AMPLIFIER CONTROLOR—Small enough to fit in the palm of the hand, with it volume can be controlled from any point in the audience. Volume can be raised, lowered or shut off completely. Operates by setting volume controls at pre-determined maximum, plugging in remote controlor, then reducing volume to desired level.

VOCAGRAPH

Vocagraph Sound Systems
164 N. May St., Chicago, Ill.

SOUND SYSTEM—Centralized amplifier for school or industrial plants, provides coverage for 30 usual sized class-rooms and may be extended to cover larger units. Separate controls for each room allow program distribution or conversation with any desired room. System of load balancing employed keeps volume constant despite changes in number of rooms served.



FINCH

Finch Telecommunications Laboratories, Inc.
37 W. 57th St., New York, N. Y.

FACSIMILE RECORDER—Type FC, 100 scanning lines per minute, total length of stroke 9 in., 100 lines per in., paper on recorder 8.5 in. wide, continuous feed possibilities of 200 feet, maximum width of useful copy 8.5 in., 5 ft. per hour. If 10 point type is used this would imply recording speed of approximately 130 words per minute.



REMLER

Remler Co., Ltd.
19th and Bryant St., San Francisco, Cal.

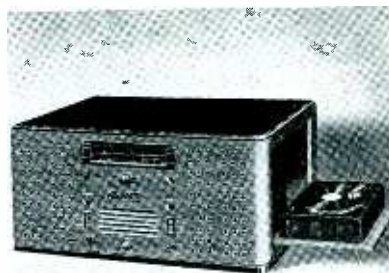

SOUND SYSTEM—Remler, Junior, for schools. Will handle up to 40 rooms. Has one program channel and one independent inter-communication channel.

WESTERN ELECTRIC

Western Electric Co.
195 Broadway, New York, N. Y.



MICROPHONE—Cardiod directional mike picks up equally all sounds reaching it from the front. Performance was obtained by combining outputs of non-directional pressure unit with bi-directional ribbon with unit of new design. Since pressure and pressure-gradient elements are separated mechanically, selection of either unit is possible by simple switch.

R C A VICTOR

R C A Manufacturing Co.
Camden, N. J.

SCHOOL SOUND SYSTEM—Designed for schools of medium size. Offers two-way communication between principal and any teacher. Music, speech, radio and record programs may be transmitted from central table model control cabinet. Twelve-tube, high fidelity, electric tuning radio receiver, Victrola with feather-touch crystal pickup, constant-speed motor.



PREVIEW OF NEW RADIO MERCHANDISE

TRIUMPH

OSCILLOGRAPH-WOBBULATOR—Model 830, a 3 in. oscillograph with built-in frequency - modulated 1000 kc. oscillator. Single or double trace alignment curves. May be used to show overall response of an audio amplifier directly on the screen. Input sensitivity .4 volt per in., frequency modulated band - width calibration on panel; list price \$69.95.

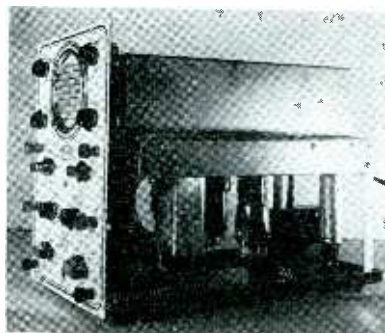

Triumph Mfg. Co.
4017 W. Lake St., Chicago, Ill.

SPRAGUE



CONDENSERS

—Sprague Atom Midget Tubular Dry Electrolytic Condensers are small condensers of dual capacities having common negative leads and are offered in a full line of dual combinations. Type UT-88 is 450 volt 8-8 mfd. unit. Other capacities are 10-10 mfd., 50 volt; 12-12, 200 volt; 16-16, 200 volt; 8-16, 200 volt; 8-16, 250 volt; 8-16, 450 volt.

Sprague Products Co.
North Adams, Mass.

ELECTRO PRODUCTS

A-B ELIMINATOR—Changes 110-volt a.c. current to pure d.c., is suitable for use with 1½ and 2-volt farm or battery operated receivers, power supply is sufficient for any size set. Low voltage adjuster includes switch and potentiometer, "A" output may be increased or diminished.

Electro Products Labs.
549 W. Randolph St., Chicago, Ill.



THE Eyes HAVE IT!

Solar
Capacitor Analyzer

Your eyes and the MAGIC TUBE... see all, know all, quick as a wink!

Write for Descriptive Literature

SOLAR

SOLAR MFG. CORP. 190-461 Broadway New York, N. Y.

BARTON—Controla-Speed washers by The Barton Corp., West Bend, Wis., have three-speed control for washing and wringing. This variation in speed of washing and wringing makes it possible to suit washing process to kind of material. Changes in speed are accomplished by finger-touch control. Full agitator stroke is maintained at all speeds. The 1939 Barton line includes four Controla-Speed models and four lower priced models.

BENDIX—Oscillograph model No. 160 is a precision instrument with swivel adjustable cathode-ray tube mounting. Visually shows exactly what is going on in any electrical circuit. For diagnosis of performance of avc, afc, oscillator, i.f.-r.f. circuits, audio amplifiers, power supply circuits and automatic tuners. Cathode-ray tube calibrated to show selectivity of receiver under test. Bendix Radio Corp., General Motors Building, Detroit, Mich.

BITTER—Record Stock Cabinet Model No. 100 made by A. Bitter Construction Co., 27-01 Bridge Plaza North, Long Island City, N. Y., may be used independently or as a unit. Outside facings of walnut finish, dustproof construction, capacity 500 of 10 in. records, 500 20 in., 75 album sets. Price \$40 f.o.b. factory.

CARDWELL—Band spread condenser by Allen D. Cardwell Manufacturing Corp., 81 Prospect St., Brooklyn, types EU-25-100-AF and EU-50-100-AF combine low capacity condenser for "band-spread" with high capacity for "band-set". Both units are in one compact Trim-air midget frame. High capacity tank section may be locked at any desired capacity, allowing tuning section to spread over a narrow band of frequencies on the entire dial.

C-D—Cornell Dubilier Electric Corp. of South Plainfield, N. J., introduces "Quietone" filter units which are designed to promote quiet radio reproduction. The i.f. series is intended for use with any type of a.c. or d.c. operated set for use in clearing broadcast and short wave bands of annoying interference. Prices list from \$1.00 to \$7.50 depending upon application.

CENTRALAB—Low capacity, low voltage, lever action switch for use in broadcasting, radio receiving, public address, test instruments and industrial uses. Each switch takes up to 12 contacts that can be used in shorting or non-shorting sequences. Furnished with either two or three positions. Index action can be positive in all positions, or spring return to center from either side. Centralab, 900 E. Keefe Ave., Milwaukee, Wis.

EICOR—Model C20, with filter, dynamotor just announced by Eicor, Inc., 515 S. Laflin St., Chicago, Ill. The brush holder accommodates a brush of longer length and greater cross-section area, locks brush caps, incorporates a device to stop end play in the armature shaft. Substantial reduction of ripple voltage is claimed.

MICAMOLD—Ballastons, types X, Y, Z are universal ballast units with simple means of adjustment on the base by Micamold Radio Corporation, 1087 Flushing Ave., Brooklyn, N. Y. Replacements for most ballast units now in use. X and Y ballastons replace both standard and special octal base types, while Z ballastons replace types having four-prong or UX base.

MUELLER—"Alligator" tip clip used on pair of test leads allows the user to obtain ordinary, temporary clip connection, semi-permanent connection to fixed binding post by means of standard phone tip soldered to end of Alligator clip. Especially designed for use on laboratory test leads. May also be used as small test prod.

UNIVERSAL—A portable amplifier having three inputs, two for microphones and one for crystal pickup is a new product of the Universal Microphone Co., Inglewood, Calif. Each input has independently operated gain controls that can be used as mixers. Controls for bass and treble accentuators, the low and peaking at 100 cycles and high end at 7,000. Volume indicating meter provided has illuminated dial calibrated directly in decibels. Leatherette carrying case.

RCP Presents
TEST INSTRUMENTS
with a future!

ALL RCP INSTRUMENTS ARE COMPLETELY
 EQUIPPED FOR TESTING LOCTAL TUBES
 COMBINATION TUBE & SET TESTER

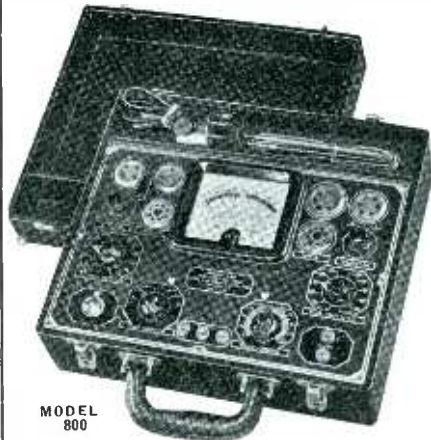

MODEL 800

Two great RCP instruments—the Tube Tester and Universal Multitester—are combined in Model 800. Tests all type tubes; makes all tests at RMA specified voltages and loads; $4\frac{1}{2}$ " square meter; individual hot interelement short and leakage tests; meter line voltage indicator; 8 A.C. & D.C. voltage ranges 0/5/50/500/1000; D.C. milliamps 0/10/100/1000; D.C. ammeter 0—10. Ohmmeter 4 ranges from 0 to 10 meg; low ohm measurements below 0.1 ohm; D.B. meter—8 to 55 db. in 4 stages; condenser leakage check and many other features that make this instrument the outstanding "buy" of the season.

Model 800 combination tube and set tester..... \$27.95

AC-DC MULTITESTER MODEL 444

A
 MONEY-
 SAVING
 CHAMPION



D'Arsonval meter accurate within 2%. Four range AC voltmeter 0/5/50/500/1000 volts. Three range ohmmeter 0/500/50,000/500,000 ohms. Four range D. C. voltmeter 0/5/50/-500/1000 at sensitivity of 1000 ohms per volt. Four decibel ranges—12 to—8/8-28/28-48/34-54 db. Four output ranges. Three current ranges 0/1/10/100 milliamperes. A real value-buy at \$9.95.

Ask your jobber today for full details on the complete RCP line, or write direct.

MODEL 411 UNIVERSAL SUPER TESTER

The most comprehensive tester ever produced—will be ready next month. It's a sensational buy at \$16.50. Write for complete details.

RADIO CITY Products Co.
 88 PARK PLACE NEW YORK CITY

SELLING THE BOX ITSELF

(Continued from page 21)

with a pick, first getting a piece too big, then too small; never getting the size we want but always getting the floor wet, our clothes wet, and the box hot; to say nothing of getting thirstier and getting ourselves in a bad humor. (Just how facetious we can be depends, of course, on Mrs. Jones.) And we also tell Mrs. Jones about the Convenience (but not the Economy: that comes later) of being able to buy food in any quantity desired, and at any time desired, with the assurance that it will be kept fresh because she'll have a box in which the temperature will be the same at all times.

Avoid Price At First

While we're selling the Box Itself and the Convenience, Mrs. Jones is very apt to start asking us questions about the cost of the box and the monthly payments, and if she does this means that we've practically got her sold; but "practically" is a long way from "completely" so we ignore these questions, politely, to the best of our ability. Right now we're selling her the box (with the Convenience), and we want her to be thoroughly sold on this box, and to want it, before we start showing her, positively astounding her, with the actual change in her budget that its purchase will effect.

The first time she asks us, we don't hear her. The second time she asks us, we mumble something about coming to that later. The third time, we stop and stroke our chin thoughtfully. "Well, at 15¢ a day for ice, you'll just about break even; maybe it'll cost you about a dollar a month." (We're thinking about net cost—and we have a perfect right to!)

But if Mrs. Jones insists upon knowing . . . then, confound her, we tell her. We do not, however, make an issue of this—while selling the box.

By the time we finally finish selling Mrs. Jones the Box Itself and the Convenience, she may want it so much that she has decided that, after all, maybe she can afford the six or seven dollars a month she thinks it will cost. If so, fine. But whether she has or not, we are now ready to give her our irresistible reason why she should buy it—and that is what we'll give her next month.

The NEW
IRC
GUIDE
Is Here!



IT'S FREE!

Right now is the time to ask your jobber (or write to us) for the new IRC Guide to All Standard and Special Volume Control Replacements. The finest, most complete Guide yet! Just off the press—just waiting to go to work for you. Get yours today!

SAVE MONEY THIS YEAR

The new IRC Guide tells exactly what replacement to use on practically any radio receiver. Best of all, it saves you real money by showing how to use less costly IRC standard controls on many so-called "special" jobs. Exact duplicate replacements are listed for use where standard controls will not answer the requirements. Time and again, however, a standard control will fill the bill merely by cutting the shaft, grounding a terminal or adding grid bias. IRC tells you how to do it—saves you time and money. Other Guide features include complete listings of the new IRC Midget Controls (available March 1); new Universal Plug-in Shafts having adjustable flat location; new Wire Wound Controls; new Control accessories, etc. Get your copy at once!

ANNOUNCING

Wire Wound CONTROLS



Just out . . . for low power volume control and rheostat use. Equipped with famous IRC Silent Spiral Connector. Complete listings included in the new IRC Guide.

INTERNATIONAL RESISTANCE CO.
 401 N. Broad Street • Philadelphia, Pa.

How To Figure

Survey reveals what picks the pocket of the radio repairman

By **JOE MARTY**

Executive Secretary,

Radio Servicemen of America, Inc.

WITH 26,428,797 radios in the United States—easily 1,733 per serviceman and the number constantly growing—it is amazing to discover so many repairmen going broke. Going broke in the face of an increasing amount of business coming their way, as radios take more care than any other home appliance.

It was to check up on why servicemen were going broke that the Radio Servicemen of America, Inc., has been doing a little detective work on the books of some 500 widely scattered members.

Philanthropists of the industry! That's what servicemen turned out to be—working at an average loss of 30 cents an hour, or \$3 for a 10 hour day.

Busy, For Nothing

Of course it's nothing new. Never will I forget a chap—let us call him Joe Blow—who was operating back in the dear dead days when servicemen were at a premium. He had a basement store, lived in back. All of his tubes and parts were on consignment. When I called there were holes in the panel of his test bench where he had sold stuff. He was down to working with pocket tools. I discovered that Joe was three months back in his rent, was about to have his telephone cut off. He was driving a 1928 car with no roof. All because he didn't observe the most fundamental business principles. If his wife needed \$2 for groceries, the next job cost the customer \$2.

Believe it or not, he was as busy as a one-armed paper hanger with the hives, and yet he was ruined by three invisible factors which wreck so many servicemen:

- (1) He didn't value his time.
- (2) He didn't value his knowledge.
- (3) He tried to be satisfied with a profit on parts alone.

From 500 questionnaires filled out by radio servicemen of America, all over the country, I have learned that this situation is a common one. It is a tip-off as to why so many servicemen do not make a profit. It is the reason fellows go out of business so much more quietly these days.

First let us consider this idle-time

business. If you are like other fellows, you are only getting paid right now for 49 per cent of your time. The rest of it may be spent sweeping, dusting, fixing up stock—but it represents hours you put in your business for which nothing is coming into the till.

I was in an Ohio town the other day and had to wait 30 minutes while a serviceman talked to a salesman. He didn't get any dough for that amount of time. When he went out on a call that took him 45 minutes to get to, and 45 minutes to get back from, that was time that he wasn't

getting paid for. Now on the other hand, he had rent to pay, a car to keep up, an office girl's salary and a lot of other expenses that went on whether he was working or not.

Let me ask you to perform an experiment: Jot down all your fixed expenses each month, add them up and divide them into the number of hours of working time put in. That will give you an idea of how much you have to average every hour before you make a profit. Can't you see how silly it is to hand a customer a bill which reads as follows:

Condenser\$6.50
Labor50

Total\$7.00

Radio service men—the big philanthropists of the industry! Why a labor charge like that will not pay

Table 1
Average Monthly Expenses

Item	Your Figures	Average All Reports	Lowest Reported	Highest Reported
Rent	\$ _____	\$ 23.90	\$ 10.00	\$ 35.00
Electricity	_____	6.10	3.00	10.00
Telephone	_____	7.75	5.00	15.00
Heat	_____	3.10	None	7.50
Car Storage	_____	2.00	None	6.00
Gasoline	_____	18.25	6.00	50.00
Tires	_____	2.05	.50	5.00
Car Repairs	_____	2.15	.50	5.00
License Plates	_____	1.50	.35	2.35
Car Depreciation*	_____	13.70	4.00	25.00
Car Insurance	_____	1.05	None	4.50
Advertising	_____	12.15	1.70	25.00
Printing	_____	.85	None	4.25
Postage	_____	1.20	None	1.51
Workmen's Compensation Insurance	_____	.65	None	5.83
Fire Insurance	_____	1.75	None	3.83
Social Security Tax	_____	1.10	None	7.22
Other Taxes	_____	4.35	None	18.65
Depreciation Test Equipment*	_____	8.15	5.40	13.00
Uncollectible Accounts	_____	5.80	1.40	25.00
Books and Magazines	_____	1.35	.30	3.00
Organization Dues	_____	.40	.17	12.00
Shop Supplies	_____	1.10	None	1.88
Small Tools	_____	1.55	.25	3.33
Wages, Office Girl	_____	1.20	None	25.00
Interest on Investment	_____	.65	None	3.50
Miscellaneous	_____	.65	None	2.08
Total Expenses (Except idle time expense)	\$ _____	\$124.45	\$ 63.04	\$ 246.66

*An approximate monthly car and test equipment depreciation figure can be obtained by dividing their cost by fifty.

SERVICE COSTS

Table 2
Computation of Idle Time Expense

Item	Your Figures	Average All Reports*	Lowest Reported*	Highest Reported*
(1) Gross Labor Sales	\$ _____	\$ 199.00	\$ 82.00	\$ 320.00
(2) Price Charged Customers for One Hour of Time	\$ _____	\$ 1.68	\$ 1.00	\$ 2.50
(3) Pay Hours per Month: (1) divided by (2)	_____	119	65	173
(4) Total Hours Worked per Month	_____	243	208	303
(5) Idle Time Rate: (4) minus (3) divided by (4)	_____ %	51%	42%	69%
(6) Salary (or Salaries) per Month	\$ _____	\$ 111.00	\$ 75.00	\$ 150.00
(7) Idle Time Expense: (6) times (5)	\$ _____	\$ 56.50	\$ 31.16	\$ 97.50
(8) Pay Time Cost: (6) minus (7)	\$ _____	\$ 54.50	\$ 23.25	\$ 87.00

* These figures from the questionnaires were reduced to a "per man" basis. However, if your business is a two or three serviceman business, fill in your actual total figures for all men.

you for the time you spend coming or going.

Why Kid Yourself?

Why shouldn't a radio serviceman get paid for his knowledge? It takes two years of study at the very least to become a competent serviceman. Say your time is only worth \$15 a week, you have at that rate \$1,560 invested in that noodle of yours. Then, you have to keep up with the field. Our questionnaire revealed that men invested at least \$1.35 a month for data and did at least two hours a day of reading. That has to be paid for. You deserve to get paid for your test equipment investment. We found that test equipment depreciated at the average rate of \$8.15 a month. You know that you have to replace your tube checker at least every two years and other stuff sometimes goes out just as quickly.

What about the car you drive? The depreciation on that jalopy averages \$13.70 a month. Why you can't go over a mile and give service for \$1.50. And yet how many of your customers will holler after you make such a trip, do 15 minutes work, and send them a bill for \$3.

I know that I am going to get some beefing from fellows who say that the serviceman has to compete with the chain store. Nuts, I reply. Chain stores are selling bait, spread their cost over a lot of merchandise. How many radio owners trust a drug clerk to take care of their sets? When the

public calls you in to repair its radio it is in the capacity of an expert. I maintain that servicemen are not selling their talents as experts. One of the money makers in the RSA reported the highest monthly expense. Here is how he operates.

1. He always sells the good points of the old set. That is flattering because it boosts the customer's original confidence in his judgment, encourages him to get a real repair job.

2. He concentrates on fewer cus-

tomers and sells them more service. For example, he finds out what the customer really wants on his set—Europe or two or three favorite stations. He delivers a job that does this to a queen's taste.

3. He calls back after 30 days to find out how it is working.

4. He takes time to teach the customer how to tune a radio set properly. You would be amazed at how many women can't do it.

5. He checks over the antenna installation. That's important. Why the other day in an Illinois town a serviceman was bragging about the number of customers he serviced. I was out with him and four out of 21 had bad antenna systems, either down or flopping against the house. He had never thought of calling them to get these jobs.

6. This deluxe serviceman contacts his customers once a year, especially in March, the deadest time of the year.

Avoid "Hand-to-Mouth" Error

What makes all the data gathered by the radio servicemen survey red hot is the fact that the pressure of competition is increasing. These young engineers out of college who can't get into the radio factories are coming into the game. The old time screwdriver mechanic is on his way out. You ask, "How can a fellow

(Continued on page 84)

Table 3
Computation of Correct Selling Price

Item	Your Figures	Average All Reports	Lowest Reported	Highest Reported
(1) Total Monthly Expenses: Table 1	\$ _____	\$ 124.45	\$ 63.04	\$ 246.66
(2) Idle Time Expense: (7) Table 2	_____	56.50	31.16	97.50
(3) Pay Time Cost: (8) Table 2	_____	54.50	23.25	87.00
(4) Total Cost: (1) plus (2) plus (3)	_____	235.45	213.04	483.05
(5) Pay Hours per Month: (3) Table 2	_____	119	65	173
(6) Average Actual Cost of Each Pay Hour: (4) divided by (5)	\$ _____	\$ 1.90	\$ 1.32	\$ 2.37
(7) Business Profit: 25% of (6)	_____	.50	.33	.59
(8) Correct Selling Price of One Hour of Time: (6) plus (7)	\$ _____	\$ 2.48	1.65	2.96
(9) Present Selling Price of One Hour of Time: (2) Table 2	\$ _____	\$ 1.68	1.00	2.50

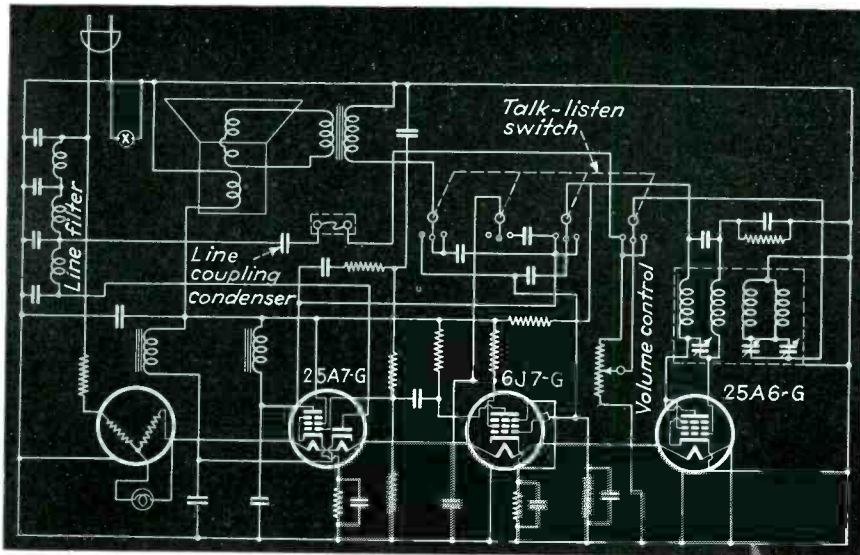

Wireless Chattabox

The circuit of the Chattabox, a wireless intercommunicator by Crosley is shown herewith. Operation of the unit is as follows:

With the talk-listen switch in the "listen" position, the signal carried by the power line enters the unit through the line filter at the left. This is composed of inductances and their associated capacity network. From here it passes through the line coupling condenser to the right hand gang of the function switch. This switch section cuts the volume control in and out for receive and transmit. The signal then feeds through the triple tuned transformer at the right to the 25A6G which acts as a grid leak detector. Audio voltage developed in the detector is amplified by the 6J7G and pentode section of the 25A7G, finally reaching the speaker.

When the switch is thrown to "talk", the 25A6G becomes a power oscillator, generating a 90 kc. signal. The speaker connects across the input of the 6J7G to serve as a moving coil microphone. The audio signal is further amplified by the pentode section of the 25A7, the output of which modulates the oscillator signal.

With the switch in "call" position, the unit still functions as a transmitter. However, the left section of the function switch ties the screen of the 6J7G through a condenser to the 25A7G plate, causing the audio amplifier to oscillate, thus modulating the oscillator with a call tone.

Application of the 6SA7

As shown in Fig. 2, the 6SA7 consists of a heater, cathode, a grid (G_1) for the oscillator function, a screen

(G_2 and G_3), a pair of collector plates mounted on the side rods of G_3 , a signal grid (G_4), a suppressor (G_5), and a plate. The suppressor is connected to the shell, and the two grids forming the screen are connected together inside the tube. The presence of the suppressor increases the tube's plate resistance and, therefore, increases conversion gain. This action of the suppressor is especially important when the tube is operated with a plate-supply voltage as low as the screen voltage, as in an ac-dc receiver. An important function of the screen and collector plates is to minimize the effect of signal-grid voltage on the space charge near the cathode. The negative voltage on the signal grid repels electrons traveling toward the plate and turns some of these electrons

back toward the cathode. Any of these electrons which reach the region near the cathode affect space-charge conditions in this region. It can be seen from Fig. 2 that, because of the position of the signal-grid side rods with respect to the collector plates, the collector plates intercept most of the returning electrons. The electrons returned by the signal grid, therefore, have little effect on the space charge near the cathode. Because of the shielding effect of the screen, the electrostatic field of the signal grid also has little effect on the space charge. Thus, the collector plates and the screen serve to isolate the cathode space charge from the signal grid.

The result is that a change in signal-grid voltage produces little change in cathode current. Although

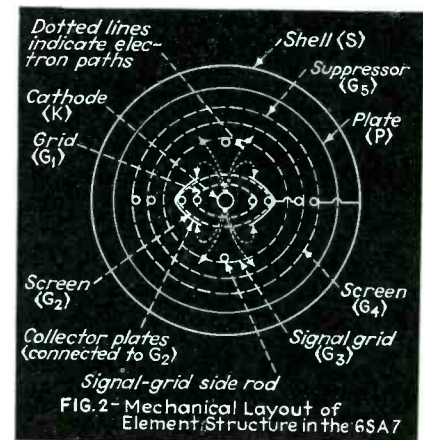
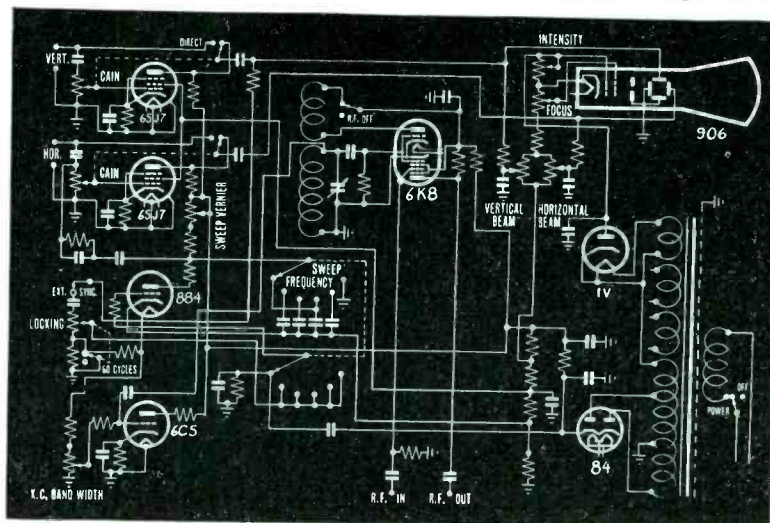

FIG. 2—Mechanical Layout of Element Structure in the 6SA7

a change in signal-grid voltage produces a change in plate current, this change is accompanied by an opposite and almost equal change in screen



OSCILLOGRAPH-WOBBULATOR—Complete self-contained instrument by Triumph. Horizontal and vertical amplifiers shown at upper left, sweep oscillator directly below. A 6C5 wobbulator shown at lower left, has its control calibrated in kc; this frequency-modulates the 6K8, a 1000 kc. oscillator-mixer to a band-width up to 50 kc. Single or double trace alignment available. By setting the wobbulator band-width at 10 kc. and feeding an unmodulated 1000 kc. signal at the "R.F. IN" posts, the overall audio curve of a receiver may be viewed on the screen when "R.F. OUT" voltage is rectified and applied to the audio input. Vertical posts connect to output of set.

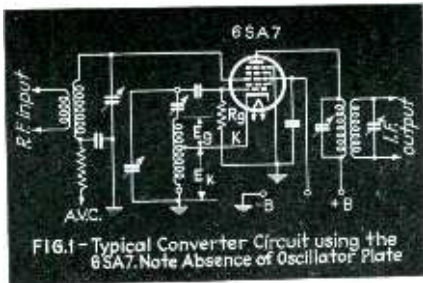

FIG. 1—Typical Converter Circuit using the 6SA7. Note Absence of Oscillator Plate

current. An r-f voltage on the signal grid, therefore, produces little modulation of the electron current flowing in the cathode circuit. This feature is important because it is desirable that the impedance in the cathode circuit should produce little degeneration or regeneration of the signal-frequency input and intermediate-frequency output. Another important feature is that, because signal-grid voltage has little effect on the space charge near the cathode, changes in avc bias produce little change in oscillator transconductance and in the input capacitance of the No. 1 grid. There is, therefore, little detuning of the oscillator by avc bias.

In the circuit of Fig. 2, as outlined by RCA the oscillator circuit provides peak plate current at the time when the oscillating voltage (E_k) on the cathode (with respect to ground) and the oscillating voltage (E_e) on the No. 1 grid are at their peak positive values. For maximum conversion transconductance, this peak value of plate current should be as large as possible. The effect on plate current of the positive voltage on the cathode is approximately the same as would be produced by an equal voltage, of negative sign, applied to the signal grid. Hence, the amplitude of oscillating voltage on the cathode limits the peak plate current. This amplitude should, therefore, be small.

During the negative portion of an oscillation cycle, the cathode may swing more negative than the signal grid. If this occurs, the signal grid will draw current unless the oscillator grid is sufficiently negative to cut off cathode current. This signal-grid current will develop a negative bias on the signal grid and may also cause a negative bias to be applied to the r-f and i-f stages through the avc system. As a result, sensitivity will be decreased. In order that signal-grid current should be prevented, the d-c bias developed on the oscillator grid should be not less than its cut-off value.

Because the peak plate current depends on how far positive the oscillator grid swings with respect to cathode, it is desirable that this positive swing be as large as possible. It follows that the oscillator grid-leak resistance should be low. This re-

(Continued on page 72)

Stop

Don't Buy Any Instrument until you know all about the CHANALYST

Actual size 8½ by 11 inches HEAVILY ILLUSTRATED

Get This 80-Page Book Tells Everything About True Dynamic Testing

Ordinarily when you buy a piece of test equipment you use it for months before you know what it will do for you. This means you must first make the investment BEFORE you find out if it is profitable. But not so with the Rider Chanalyst! We want you to know exactly what this instrument can do for you and how you operate it. We want you to be sure it's a good investment—BEFORE you buy it. So, we have prepared an 80-page (8½" x 11") book, loaded it with illustrations and written it so you can understand ALL about the Rider Chanalyst and true dynamic and functional testing the first time you read it. This book with hard covers would ordinarily sell for \$2.50. We will mail it to you for 25 cents in stamps or coin—a fraction of its preparation cost. We do this for we believe a serviceman should have the real facts on what he can expect of an instrument BEFORE he buys it. We know you will want a Chanalyst after you read this book. Send for it today!

MAIL NOW!
ONLY **25¢** in stamps or coin

You Don't Need An Expert to demonstrate this easy-to-operate, trouble-shooting instrument. Read this book—go to your jobbers and **Demonstrate It to Yourself**

The RIDER Chanalyst

Service Instruments, Inc. 404 Fourth Ave., New York City

Enclosed find 25 cents (in stamps or coin) for the 80-page book completely explaining the Rider Chanalyst and True Dynamic Testing.

Name _____

Address _____

sistance, however, should not be so low as to cause excessive damping of the tank circuit. It has been found, for operation in frequency bands lower than approximately 6 megacycles, that all these requirements are generally best satisfied when the oscillator circuit is adjusted to provide, with recommended values of plate and screen voltage, a value of E_k of approximately 2 volts peak, and an oscillator-grid current of 0.5 milli-ampere through a grid-leak resistance (R_g) of 20000 ohms.

The 6SA7 may be used with a separate oscillator. With separate excitation, there is no oscillating voltage on the cathode. The amplitude of oscillation, therefore, can well be made higher than the amplitude used in self-excitation. As a result, somewhat higher conversion transconductance can be obtained with separate excitation than with self-excitation. When separate excitation is used, it may be desirable to neutralize the effects of space-charge coupling by connecting a small capacitance between the No. 1 grid and No. 3 grid.

New Tubes

906-P4—Three inch electrostatic-deflection type cathode ray tube by RCA with white phosphor screen. Primarily intended for television with a maximum anode voltage of 1500 volts.

1803-P4—Twelve inch electromagnetic deflector type cathode ray tube by RCA for television use. Produces a picture about 7½ by 10 inches in black and white. Maximum anode voltage 7000 volts.

Attend the National Radio Parts Trade Show

1939 JUNE 1939

WED	THU	FRI	SAT
14	15	16	17

OPEN ONLY to Jobbers, Manufacturers, Manufacturers' Agents, and Manufacturers' Engineers.

OPEN to Servicemen, Amateurs, Retailers, Student and others.

Stevens Hotel, Chicago

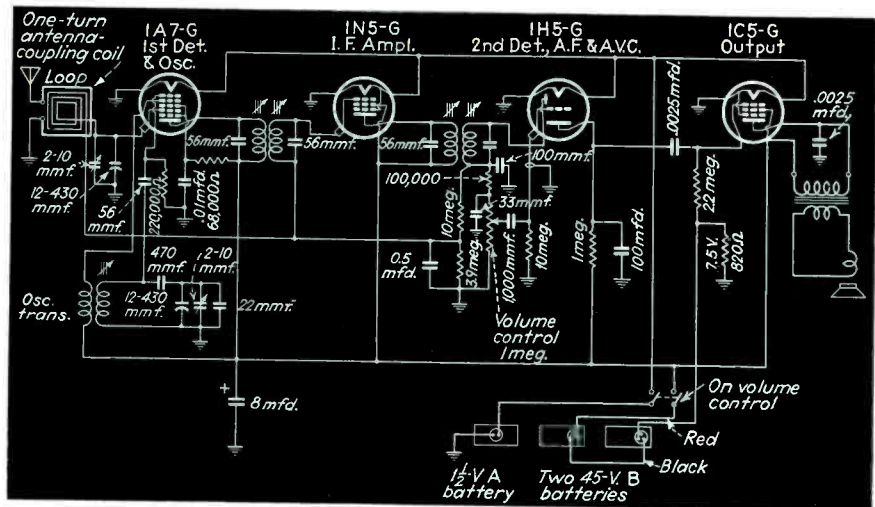

BATTERY PORTABLE—New 14 volt self contained portable by RCA. Built-in loop antenna used for local reception, for greater sensitivity a separate antenna may be connected. Two 45 volt blocks supply plate voltage, one dry cell powers filament. Maximum power output .21 watt; "A" battery drain .24 ampere; total plate current 9 milliamperes.

1804-P4—Nine inch electromagnetic deflection type cathode ray tube for television use. Anode voltage 7000 volts.

2V3-G—Tungsten filament type high vacuum half wave rectifier. Characteristics are:

Filament voltage.....	2.5 volts
Filament Current.....	.5 amps.
Peak Inverse Voltage.....	16500 volts
Peak Plate Current.....	12 ma.
Average Plate Current.....	.2 ma.

957—A 1.25 volt acorn triode by RCA having a moderately high amplification factor. May be used as a detector, amplifier or oscillator; filament power is only .063 watt; plate power, .27 watt. Any of these types may be operated directly from a single dry cell without series resistance. Characteristics are:

Filament Voltage.....	1.25 volts
Filament Current.....	.05 amp.
Plate Voltage.....	135 volts
Grid Voltage.....	-5 volts
Plate Current.....	.2 ma.
Plate Resistance.....	24600 ohms
Amplification Factor.....	16
Transconductance.....	650 mmhos

958—A 1.25 volt acorn power triode especially designed for transmitting service as an oscillator or r.f. amplifier. It may also be used as an audio power output tube. Filament power is .125 watt; plate power .27 watt. Characteristics are:

Filament Voltage.....	1.25 volts
Filament Current.....	.10 amp.
Plate Voltage.....	135 volts
Grid Voltage.....	-7.5 volts
Plate Current.....	.3 ma.
Plate Resistance.....	10000 ohms
Amplification Factor.....	12
Transconductance.....	1200 mmhos

959—A sharp cut-off acorn pentode intended for r.f. amplifier and detector service. It may also be used as a resistance-coupled a-f. amplifier. Filament power is .063 watt plate and screen power .26 watt.

Filament Voltage.....	1.25 volts
Filament Current.....	.05 amp.
Plate Voltage.....	135 volts
Suppressor.....	connected to neg. filament
Screen Voltage.....	.67.5 volts
Grid Voltage.....	-3 volts
Plate Current.....	1.7 ma.
Screen Current.....	.4 ma.
Plate Resistance.....	800,000 ohms
Amplification Factor.....	480
Transconductance.....	600 mmhos

2A4G—A hot cathode, argon filled, single grid, thyratron by Raytheon particularly useful in applications where constancy of characteristics is necessary even with large variations in ambient temperature; octal base.

Filament voltage.....	2.5 volts
Filament current.....	2.5 amp.
Maximum anode voltage (forward).....	200 volts
Maximum anode voltage (inverse).....	200 volts
Maximum voltage between any two electrodes.....	250 volts
Maximum anode current (peak).....	1.25 amp.
Maximum anode current (average).....	0.10 amp.
Maximum averaging time.....	45 sec.
Tube voltage drop.....	15 volts
Cold starting time.....	2 sec.

RK-56 A heater type beam power amplifier by Raytheon with isolantite base. Similar to the RK-39 with lower plate dissipation; comparable to a 6V6 with increased shielding. Plate lead brought out to cap. Suitable for Class B or C r.f. use.

7000—A high gain amplifier by Ken-Rad which can be used in applications where elimination of hum and microphonics is important. Similar in characteristics to the 6J7; has octal base.

WHAT THIS BUSINESS NEEDS

By C. N. Hewlett

WHAT THIS BUSINESS NEEDS . . . is a method for marking small resistances so that this value won't be lost when the unit burns up.

If the resistance value was stamped or painted on one end, rather than the body, end, and dot; heating would not usually destroy the marking.

Radio Retailing will pay \$1 for every published "What This Business Needs". Submitted items must be technical and constructive.

Operation of Battery Tubes

Among the important design prerequisites for the various battery tube types is the requirement that good performance be attainable over a comparatively wide range of A and B battery supply voltages. It is well known that the terminal voltages of batteries, particularly those of the dry type, decrease as the batteries are discharged. For best tube performance and battery power conservation as outlined by Sylvania, it is desirable that the discharge characteristic curve be as flat as possible, for a given current drain, over the range of terminal voltages for which the tubes are designed to operate.

The most useful range of 1.5 volt dry batteries, suitable for filament

supply voltage for these tubes, extends down to approximately 1.2 volts. Beyond this value the voltage falls off rapidly as the battery is discharged and the duration of reasonable set performance obtainable thereafter represents only a very small percentage of the battery life. These figures are based upon a total battery drain of 250 milliamperes and daily discharge periods of 4 hours, since these values are representative of the operation of current battery receivers which employ the new tubes.

A corresponding percentage reduction in voltage of a 90 volt B battery

would give an approximate value of 68 volts. Since it is highly desirable that the voltages of the A and B batteries decrease at the same rate (this being governed primarily by the ampere hour capacity and discharge characteristics of the batteries) it is recommended that 68 volts be considered as the approximate end of life B battery voltage. Care should be taken in the receiver circuit design to provide for ample tolerances so that reasonable set performance is obtainable when the receiver is subjected to tests at 68 volts B supply and 1.2 volts on the filament.

5 FEATURES OF THE Lifetime TUBE TESTER



You need them all for Safeguards Against . . . **Obsolescence**

MODEL 1610

\$39.00*

complete in carrying case

MODEL 1610 uses the approved emission circuit constructed to

1. Sockets will accommodate all receiving tubes including the new local type.
2. Chart scroll listings can be added to for new types—new up-to-date scrolls can be obtained at any time on nominal exchange cost basis, easily installed.
3. In chassis construction only standard parts of highest quality used—no seconds, no job lots, no "specials."
4. Push button controls are so arranged as to provide the right connections for any type of receiving tube, 50-Volt tubes included. Note complete absence of a selector switch . . . push button control provides remarkable flexibility in checking between elements.
5. Strong, sturdy metal case; protection for the tester, convenience for carrying and operating. Beautiful black satin finish.

RMA load requirements; separate plate tests on diodes and rectifiers; ballast tube continuity test; gaseous rectifier test; neon short test; illuminated dial and BAD-GOOD scale.

Incorporates all the features for maximum protection against obsolescence. Has attractive metal case with black satin finish and chrome fittings. It catches the eye of everyone and creates an atmosphere of distinction and ultra-modernness whether used in the home or in the shop.

Model 1611. . . . Combines push-button Volt-Ohm-Milliammeter with Tube Tester of Model 1610, in same type case. Uses plug-in type copper oxide rectifier. Dealer Net Price \$49.50.

*All Triplett Testers Selling for Over \$25.00 Are Available on Attractive Time Payment Plans . . . See Your Jobber or Write for Details.



The Triplett Electrical Instrument Co.
202 Harmon Ave., Bluffton, Ohio

Please send me more information on
 Model 1610; Model 1611; I am also interested in . . .

Name
 Address
 City State

J. F. D. ADJUSTABLE AC-DC BALLASTS
The Most Precise A, B and C ballasts to replace 99% of the AC-DC Ballasts now in use

INSTRUCTIONS

A	B C	D	E	E
F	H	AJ	BJ CJ	DJ
Y	Y-B C	Y-D	Z-A	Z-B C
S	S	R X A	L R X B C	X-D

SPECIAL MANUFACTURER'S TYPES

BALLAST RESISTOR CHART—Serving 99 per cent of modern receivers, three types of ballast resistors by J. F. D. are completely indexed in their new wall chart shown above. In addition special resistor types are listed and their equivalents given in the new types. Available by writing J. F. D. Manufacturing Co. or Radio Retailing, 4111 Ft. Hamilton Pk'way, Brooklyn, N. Y.

SOCKET TOPS and BOTTOMS

TYPE	SOCKET	TYPE	SOCKET	TYPE	SOCKET	TYPE	SOCKET
OOA	4D	6B4	5S	12A5	7F	79	6H
OIA	4D	6B5	6D	12A7	7K	80	4C
OA4G	4V	6B6	77	12Z3	4G	80M	4C
OZ3	5N	6B7	7D	12Z5	7L	81	4B
OZ4	4R	6B8	8E	12Z5-6Z5	6K	81M	4B
I	4G	6C5	6Q	14	5E	82	4C
IA4	4K	6C6	6F	14Z3	4G	83	4C
IA4P	4K	6C7	7G	15	5F	83V	4L
IA4T	4K	6C8	8G	17	5A	84	5D
IA5	6X	6D5	6Q	18	6B	85	6G
IA6	6L	6D6	6F	19	6C	88	4C
IA7	7Z	6D7	7H	20	4D	89	6F
IB4	4K	6D8	8A	22	4K	90	6N
IB4P	4K	6E5	8B	24A	5E	92	6N
IB4T	4K	6E6	7B	24S	5E	95	6B
IB5-255	6M	6E7	7H	25A6	7S	96	4G
IC5	6X	6F5	5M	25A7	8F	181	4D
IC6	6L	6F6	7S	25B5	6D	182	4D
IC7	7Z	6F7	7E	25B6	7S	183	4D
ID5	5R	6F8	8G	25L6	7AC	213	4C
ID5P	5Y	6G5	6R	25N6	7W	216	4B
ID5T	5R	6G6	7S	25S	6M	257	5B
ID7	7Z	6H5	6R	25Y5	6E	264	4D
IE5	5R	6H6	7Q	25Z3	4G	291	5G
IESP	5Y	6J5	6Q	25Z5	6E	293	5G
IE5T	5R	6J7	7R	25Z6	7Q	295	5G
IE7	8C	6J8	8H	26	4D	401	4D
IF4	5K	6K5	5U	27	5A	402-403	4D
IFS	6X	6K6	7S	27HM	5A	450	4D
IF6	6W	6K7	7R	27S	5A	482	4D
IF7	7AD	6K8	8K	29	6N	483	4D
IG5	6X	6L5	6Q	30	4D	484	5A
IH4	5S	6L6	7AC	31	4D	485	5A
IH5	5Z	6L7	7T	32	4K	486	5S
IH6	7AA	6N5	6R	33	5K	585	4D
IJ5	6X	6N6	7W	34	4M	586	4D
IJ6	7AB	6N7	8B	35	5E	801	4D
IN5	5Y	6P5	6Q	35A5	8-8	840	5J
IV	4G	6P7	7U	35Z3	8-9	841	4D
2A3	4D	6Q6	5Z	36	5E	842	4D
2A3H	4Q	6Q7	7V	37	5A	843	4D
2A4G	5S	6R7	7V	38	5	864	4D
2A5	6B	6S7	7R	39/44	5F	866	4P
2A6	6G	6SA7	8-4	40	4D	950	5B
2A7	7C	6SF5	8P	41	6B	951	4K
2B6	7J	6SJ7	8-2	42	6B	985	5D
2B7	7D	6SK7	8-2	43	6B	986	4C
2E5	6R	6SQ7	8Q	44	5F	1221	6F
2G5	6R	6T5	6R	45	4D	1223	7R
2W3	4X	6T7	7V	46	5C	1231	8-5
2Z-G84	4B	6U5	6R	47	5B	1851	8-3
4A6	8L	6U7	7R	48	6A	1852	8-2
5T4	5T	6V6	7A	49	5C	1853	8-2
5U4	5T	6V7	7V	50	4D	AD	4G
5V4	5L	6W5	6S	50Z6	7Q	AF	4C
5W4	5T	6W7	7R	51	5E	AG	4C
5X4	5O	6X5	6S	52	5C	AX	4D
5Y3	5T	6Y5	6J	53	7B	B	4E
5Y4	5Q	6Y6	7AC	55	6G	BA	4J
5Z3	4C	6Y7	8B	56	5A	BH	4J
5Z4	5L	6Z3	4G	57	6F	BR	4H
6A3	4D	6Z4	5D	58	6F	DI _{1/2}	4B
6A4-LA	5B	6Z5	6K	59	7A	DI	4C
6A5	6T	6Z6	7Q	64	5E	DEI	5A
6AB5	6R	6Z7	8B	65	5E	E	4D
6ACS	4Q	6ZY5	6S	67	5A	G	4D
6A6	7B	7A6	8-1	68	5E	GA	5B
6AB6	7W	7A7	8-5	69	6N	H	4D
6AC6	7W	7A8	8M	70	6N	LA	5B
6AD6	7AG	7B7	8-5	71	4D	PZ	5B
6AE6	7AH	7C6	8-6	75	6G	PZH	6B
6AF6	7AC	7Y4	8-7	76	5A	Wunderlich A	6N
6A7	7C	10	4D	77	6F	Wunderlich B	6P
6A8	8A	12A	4D	78	6F		

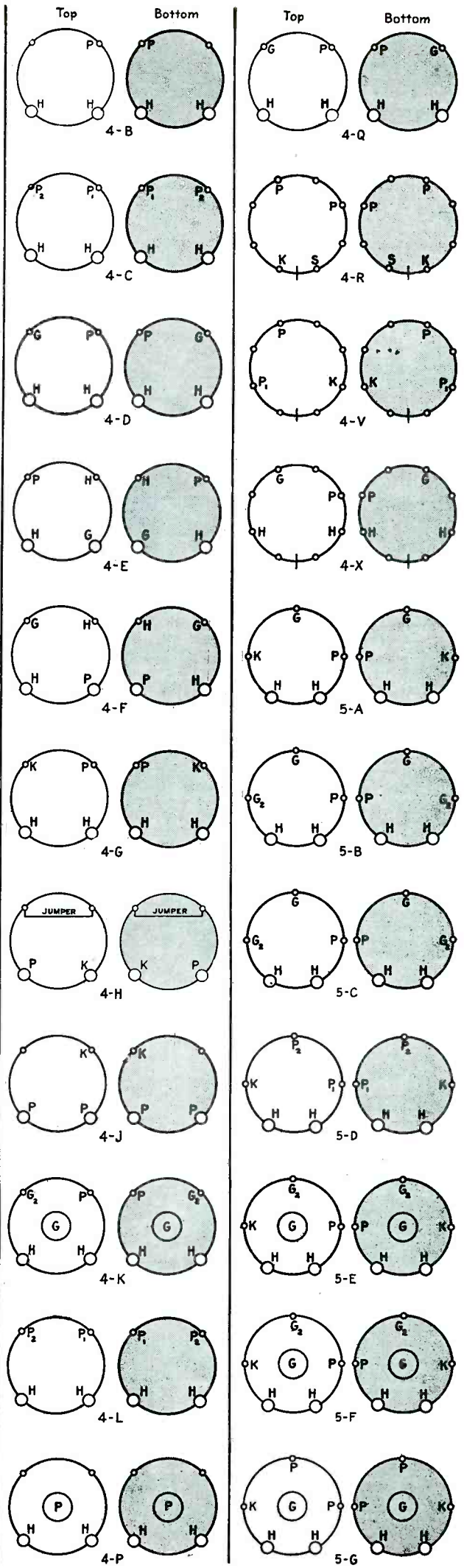

WANTED!



Model 440 "Test Master"

An all service tube and set tester. Double-filament switching; screen fluorescence and angle test; hot cathode leakage test; high sensitivity neon short-check; noise test; percentage scales; "good" and "bad" scales. As set tester has six A.C. and D.C. voltage ranges; resistance ranges from 1 ohm to 100 megohms; four milliamp ranges; six decibel ranges; 0-15 amp scale; neon leakage test, noise test, etc. Your price.... **\$59⁰⁰**

Model 220 "Roto-Ranger"

A finer tube and set tester with convenient Simpson Roto-Ranger feature. Your price.... **\$62⁷⁵**



the critical inspection of the hard-to-please serviceman

• Are you the kind of man who makes the air blue when equipment is not built right? If so, you are the kind of a man who will appreciate Simpson quality.

One inspection is all we ask. In any Simpson Testing Instrument you will see that added touch you have been looking for—in design, in workmanship, in sturdiness, in finish, in practical consideration of your on-the-job needs.

The Simpson line includes instruments covering every requirement, but from the simplest to the most elaborate you will find that every detail expresses the practical insight and engineering background of Ray R. Simpson and a group of associates who have devoted their entire engineering careers to instrument development.

Some of the many types are illustrated here. Ask for bulletins describing types in which you are interested. See them at your jobber's.

SIMPSON

INSTRUMENTS THAT STAY ACCURATE

SIMPSON ELECTRIC CO., 5204 Kinzie St., Chicago



Model 333

Tube Tester. Small (only 7½ x 10½"). Light in weight (only 7 lbs.) . . . at a remarkably low price. Tests all tubes, including new Loctal and other recently developed types. Has double filament switching. Your price..... **\$26⁵⁰**



Model 230

The smallest A.C.—D.C. instrument on the market, yet it contains a sufficient number of ranges for the experienced man to do a complete servicing job. Your price.... **\$14²⁵**



TRIPLE TESTED!

1 Accurate resistance reading taken of each carbon element—total and at different settings.

2 Thorough test (above) of assembled unit without cover—resistance, noises, grounds, defects.

3 Completed unit, capped, critically examined and tested, including power switch if included.

• Thorough inspection and production tests account for uniformity and quality of CLAROSTAT Midget Controls. 100% inspected parts. Triple tests on every control.

• Just try one—and learn how good a control can be. • Ask jobber for 208-page service manual—or write us direct. (5c per copy).

CLAROSTAT



MANUFACTURING CO.
Incorporated
285 North Sixth St.
Brooklyn, N. Y.

Is Service Profitable?



Servicemen find they do make money with Ward Leonard replacement parts. They are dependable. Remember, making good job failures is what eats into profits. Send for service circular 507.

WARD LEONARD ELECTRIC CO.

35 South Street, Mount Vernon, N. Y.

Please send me Bulletin 507

Name
Street
City State
Jobber

S O C K E T T O P S A N D B O T T O M S

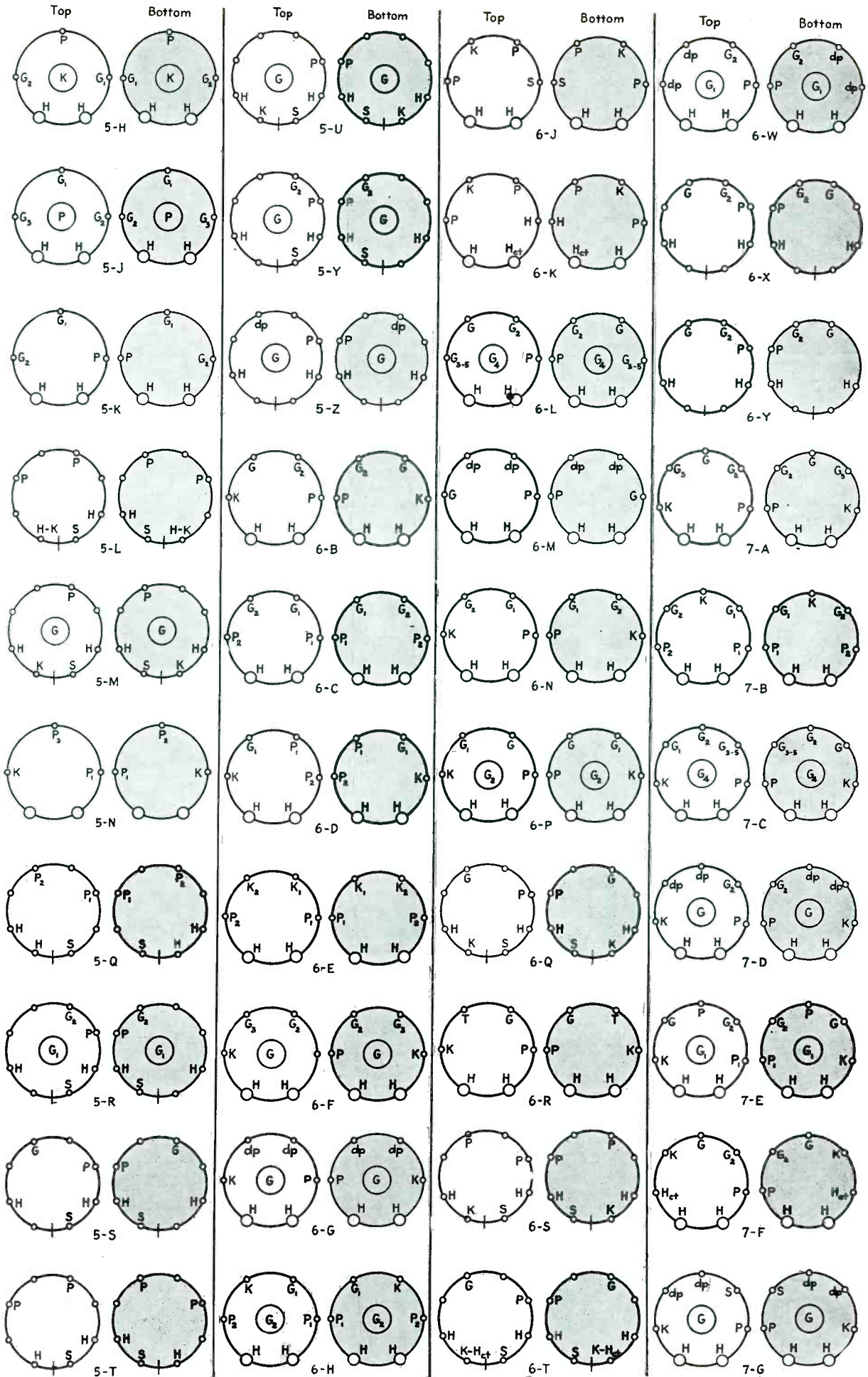

© Radio Retailing

SOCKET TOPS AND BOTTOMS

© Radio Retailing

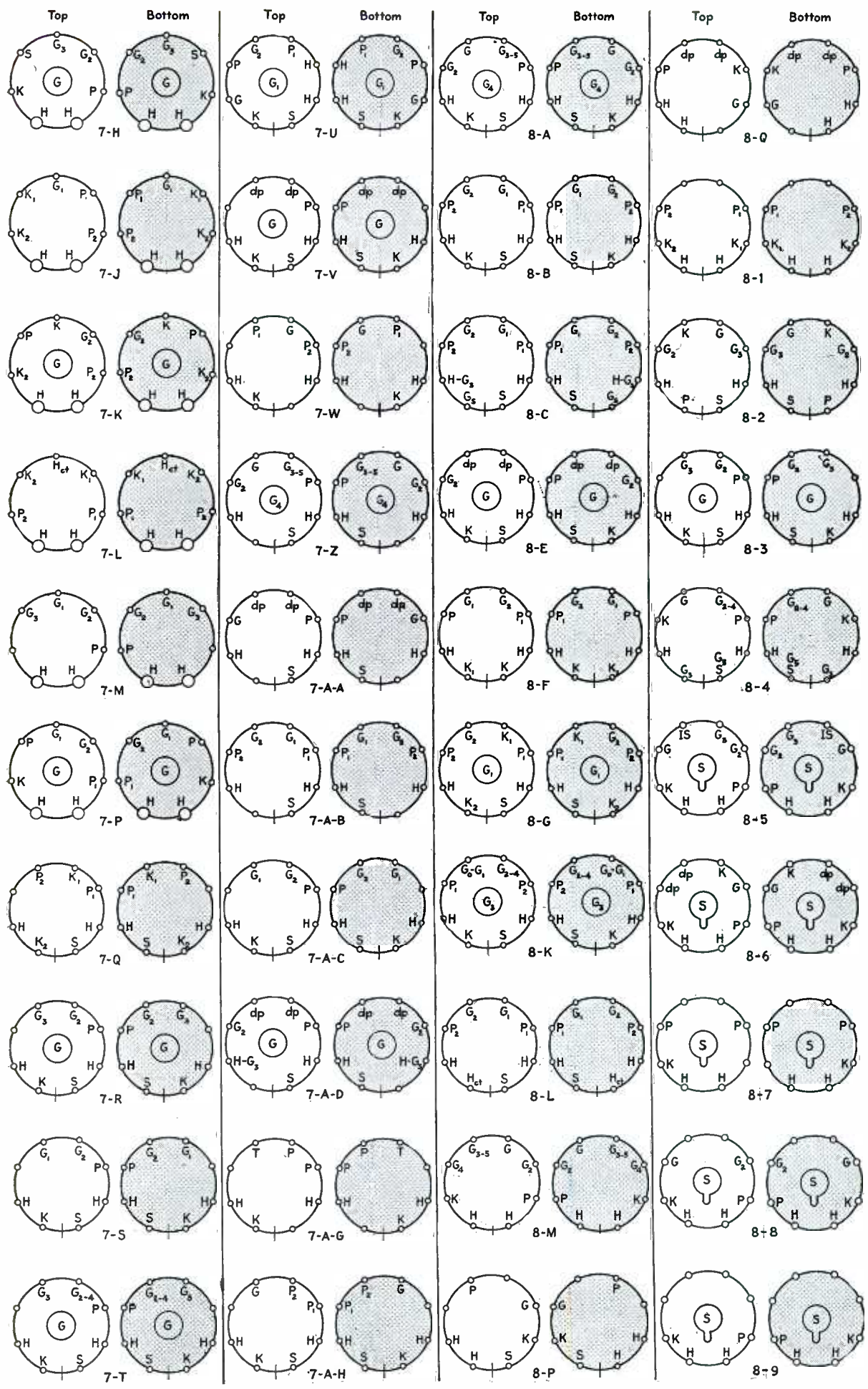

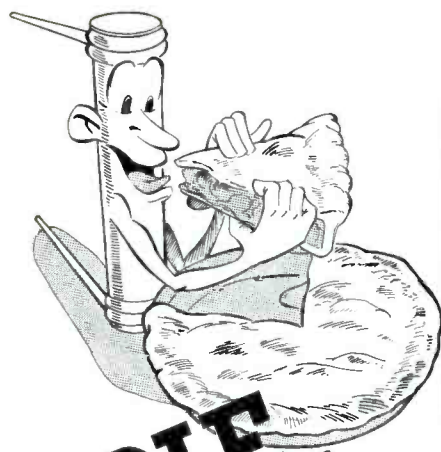

IT'S "PIE" FOR CENTRALAB

If we were to show the replacement business of the serviceman as a pie, the failure of the average Fixed Resistor would account for a slice that is more than a quarter of the whole pie. That means, of course, that Old Man Centralab plays an important part in the replacement business.

And with a resistor, hard-as-stone, impervious to moisture, shocks, excessive temperatures and vibration, the wise serviceman finds it "easy as eatin' pie" to completely satisfy that resistor need with CENTRALAB.

Always specify, nay, insist on Centralab at your jobber.

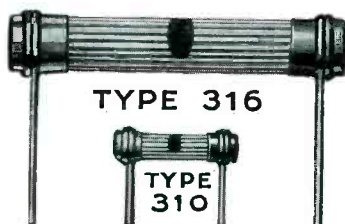

Baptized in fire at 2500 degrees . . . hard as stone. Center core and ceramic jacket fired together to form a single shock-proof unit. Pure copper covers resistor and for wire lead contact.

Division of Globe Union Inc.

Centralab

Milwaukee, Wis.

TRICKS

BOSCH 5A

Dead . . . look for burned out 500,000 ohm $\frac{1}{2}$ watt resistor in screen of 24 detector. Replace with 1 watt unit.

BOSCH 20

Several of these sets have been found with the oscillator plate dropping resistor shorted out. This is important to the circuit and should be replaced with a 40,000 ohm 5 watt unit.

CORONADO 650

Intermittent . . . one or both of the two switches mounted on back of volume control is defective.

CROSLY 173

Weak reception . . . usually can be traced to open speaker field. Also check 8 mfd 25 volt electrolytic connected from first a.f. 78 suppressor grid to tuning condenser.

CROSLY 635

Bad oscillation from 700 kc to 800 kc, whistles on other stations . . . look for leaky .02 mfd condenser from screen to cathode of 6A7.

DELCO AUTO SETS

Most of these receivers have a 1,500 ohm resistor in series with one of the 6D6 cathode leads. Sensitivity can be increased by substituting a 300 to 500 ohm unit.

Dead . . . check tone condenser for short.

Vibrator hash . . . defective 42 output tube. Also try 8 mfd. electrolytic from one side of the heater to ground.

GE A65

Hum and distortion . . . insert 50,000 ohm resistor in series with 6C5 plate resistor at the B plus end. Bypass junction of these resistors with .1 mfd. or larger 600 volt condenser. Distortion is sometimes caused by defective 50,000 ohm plate load resistor.

EMERSON AX211

Intermittent or weak . . . Check antenna coil (large black coil at rear of chassis). Ground end of coil is soldered to a large lug which is in turn soldered to chassis. This lead breaks and makes only partial contact.

Follow Your Interference

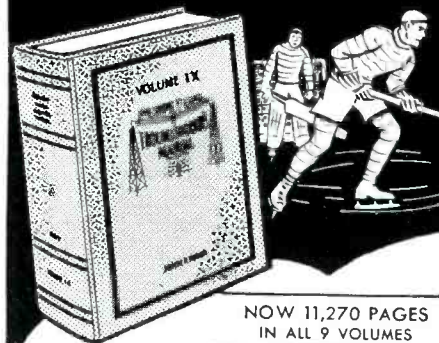

NOW 11,270 PAGES
IN ALL 9 VOLUMES

Follow Rider Manuals For Speedy-Profitable SERVICING

Rider Manuals "take out" the stiff opposition of today's complicated circuits. Stop tussling with baffling service problems! Push-button tuning, 24-hour time clock tuning, motor driven mechanisms, remote control units and other new and complicated features of the 1939 sets make it vital that you have the information provided by Volume IX. No profiting service technician can afford to be without all nine Rider Manuals.

YOU NEED THIS! RIDER MANUAL VOL. IX

New — 1650 pages of time-saving facts on 1938-39 receivers.

New — 64-page 'How it Works' section. Time saving hints on complicated sets.

New — 140-pages indexing and cross-indexing all nine Rider volumes.

Volume IX, priced at \$10.00, contains the most authentic and comprehensive compilation of service data available in the industry — facts you need when servicing the newer, more complicated sets. You will eventually buy Vol. IX. Why wait! Get it today and start benefiting from this vast storehouse of essential circuit data.

JOHN F. RIDER, Publisher
404 Fourth Ave.,
New York City



GE F 63, 65, 66

A squeal rising in pitch as volume control is advanced often results when primary leads are reversed on a replacement transformer.

GE K 43

RCA 100, 101 Modulation hum . . . Connect 50,000 ohm non-inductive resistor from antenna post to ground.

GLORITONE 27

Weak . . . to increase sensitivity and volume remove the wire on the candohm resistor from the terminal next to B plus and solder to the extreme end. This increases plate voltage.

GREBE SK4

Fading . . . clean contacts on rectifier tube socket.

KADETTE 1019

Takes too long to warm up, poor tone. . . . Condenser pack leaking to chassis, replace whole pack.

LYRIC 90

Noise . . . look to two components for this trouble. 1. Examine terminal caps on 1,000-ohm (carbon type) bias resistor of 45 tubes for loose

connections. (Wattage rating: 10 watts.) 2. Check push-pull input transformer for leakage or short between primary and secondary windings. No reception . . . in addition to above components, test condenser bypassing plate supply of rf and 2nd a.f. tubes. This is component of dual 0.5 mfd. unit in metal case. Can is common negative.

MARQUETTE 51 (HERBERT HORN)

Signals accompanied by hissing noise . . . open .01 mfd. plate bypass on 42.

Tube Testing

By W. C. Cherry

When a receiver is operating but in an abnormal manner, it is generally good procedure, after testing the tubes in a reliable checker, to further diagnose those that tested "good" by placing new tubes in all the sockets. Static-like noises, hum and intermittent reception have been consistently traced in this manner to tubes that tested "good" in his checker. The relation of this is not a veiled attempt to discourage the use of tube testers. Rather, the point to stress is this: there are two steps to thorough tube testing: first, a check in a good tester; second, check by performance. If one method doesn't show up trouble, the other will.

Speaker Test

By N. A. Johns

Dynamic speakers can be tested in many cases without removing them from the receiver cabinets. When an off-center cone is suspected of causing noise and distortion, apply an ohmmeter between one of the voice-coil leads and a clean unpainted point of the frame. Since an off-center voice-coil often shorts to the pole piece (which is screwed or riveted to the frame), a ready d.c. current path is provided between the two components; and an ohmmeter, connected in the manner stated, will indicate a reading if the condition exists. The best way to make the test is to tune the receiver to a loud signal with the meter in position.



PATRONS in Paramount's Balaban & Katz Theaters do not suffer the exasperating interruptions from sound outage. Every show is a perfect show—especially from the standpoint of sound. That's because B & K sound engineers avoid sound track emergencies by practicing a "preventive maintenance" plan—which consists of frequent periodic sound system check-ups with Supreme instruments.

THE stability of the Signal obtained from the new Supreme Model 571 Signal Generator (shown at left) enables them to make the most accurate check on the amplifier. And with the Supreme Model 546 3" Oscilloscope (shown at right) on the output, the slightest variation from normal in the amplifier is faithfully recorded.

SUPREME Instruments are fast winning favor in the theater sound field—just as they have in the radio service field. Which accounts for the fact that **more radios are tested each day with Supreme Instruments than with any other kind!**

See your Parts Jobber now. He sells Supreme Instruments on the lowest terms in radio history! Or mail the coupon for full information.

SUPREME

SUPREME INSTRUMENTS CORP.
GREENWOOD, MISSISSIPPI, U. S. A.

EXPORT DEPT. Associated Exporters Co., 145 W. 45th Street, New York
Cable Address: LOPREM, N. Y.

MAIL COUPON TODAY!

SUPREME INSTRUMENTS CORP., Dept. R-2,
Greenwood, Miss.
Please RUSH me your newest information on SUPREME
Instruments:

Name: _____
Address: _____
City: _____ State: _____

YOUR



EMBLEM, Mr. Serviceman!

—AND WHAT IT MEANS TO YOU

MAIL THIS COUPON!

RADIO SERVICEMEN OF AMERICA, INC.
304 South Dearborn St., Chicago, Ill.

Gentlemen:

I hereby make application for membership in the Radio Servicemen of America.

Name

Mailing Address

City

State

I am enclosing \$4.00 for Dues and Initiation. (Does not include Local Chapter Dues where Local Chapters are organized.)

It identifies you with the only national independent organization of Servicemen in the industry. It links you with fellow-members in every State and in most foreign countries in a cooperative organization run by and for the members, uncontrolled by any outside interests. You elect your representatives. (All responsible officers are bonded.)

And here is what the RSA does for you: ★ Supplies Advanced Circuit Notes to Members each month. ★ Gives Technical Help on Service Problems. ★ Maintains a National Speakers Bureau. ★ Offers Advanced Service Courses to Members at slight cost. ★ Issues a Monthly RSA Publication. ★ Provides for Annual Convention. ★ Besides many other benefits now being planned.

Don't be on the outside looking in. Join Now. Send the Coupon Today.

Let's Grow Together in 1939

National Yearly Dues \$3.00 **RADIO SERVICEMEN OF AMERICA, INC.**
Initiation Fee \$1.00 **Joe Marty, Jr., Executive Secretary** **304 S. Dearborn St., Chicago**

SILVERTONE 1821, 1827

No reception . . . short in 0.1 mfd., 300 volt tubular condenser bypassing plate supply of 78 tube in second i.f. stage. Use 400 or 600 volt replacement. 1,000 ohm (1/2 watt) resistor in same circuit likely damaged also by overload due to condenser breakdown.

SILVERTONE 1850

Poor control of volume . . . over-sensitive 951 tube. This condition can be eliminated in most cases by increasing the normal 1 1/2 volt bias to 3 volts.

SILVERTONE 4720

Dead . . . remove control grid lead from 1C7G mixer; grasp lead clip in one hand and place index finger on grid cap of tube. If set plays look for short between primary and secondary of antenna coil.

SILVERTONE 4786

Large 140 ohm flexible resistor located at 6V6G socket gets hot to smoking point . . . look for trouble in the .003 mfd condensers from plate to cathode of 6V7G tubes.

SPARTON 57 A.C., D.C.

Dead, no plate voltage on all tubes

. . . open 1000 ohm molded resistor located between filter unit and plate of 6D6.

SPARTON 74

Dead, plate and screen voltages okeh . . . look for open 200 ohm bias resistor feeding cathodes of i.f. and r.f.

SPARTON 517, 557, 567

Distortion, disappears when finger is placed on grid cap of 75 tube . . . check for leaky bypass at junction of 220,000 and 100,000 ohm resistor in plate circuit of 75.

STROMBERG-CARLSON 37

Dead . . . test for short in 0.3 mfd., 400-volt condenser bypassing plate-supply of 58 i.f. amplifier tube. Unit is section of by-pass capacitor assembly, part No. 22,702. 15,000-ohm resistor will be noted connected to defective component.

Rasping at room volume . . . speaker cone off center and scraping against pole piece. Re-center.

TRUETONE D726

Static but no reception . . . check first i.f. coil in plate circuit of 6A7.

MOTOROLA 89K1 (CLOCK TUNING)

Failure to turn on . . . relay spring too stiff. Turns on, but intermittently fails to tune when buttons are pushed, relay contacts dirty or contact springs not stiff enough.

Drying Out Coils

W. V. Henderson

A novel method of driving out the moisture from R.F., I.F. and oscillator coils is to simply connect them across the 110 volt A.C. line for a moment. The current should be allowed to flow only long enough to warm the coils—5 or 10 seconds is plenty. This method also has the advantage that the heat is applied from the inside, driving out the moisture; baking in an oven often seals moisture inside the windings. Of course, care must be exercised in order not to permit the wire to become hot enough to damage the insulation. This kink should not be applied to short wave coils since the inductance is too small to limit current flow to a safe value.

JIM QUAM Says



It's amazing how many different things contribute to the quality and value of a product. Take a Quam Speaker for example. First, there's engineering and design staff — I wouldn't trade our laboratory personnel for any of them.

There's production economy and the careful precision of hand craftsmanship.

Inspection is important—Quam Speakers are inspected all down the line, every part as well as the final thorough test.

We make our own tools and our own speaker by doing so.

The purchase of materials is more advantageous in the quantities we use.

In other words, speaker manufacturing is a complex business requiring an experienced versatile organization that takes years to build—and we have that kind of organization.

QUAM-NICHOLS CO.
33rd Place & Cottage Grove CHICAGO 1674 Broadway NEW YORK



TRUETONE S719

Oscillation, especially at high frequency. . . . The 57 tube shield base rivets corroded and practically insulating shields from chassis. Drill out rivets and replace with bolts after thoroughly cleaning rust or corrosion around holes.

WESTINGHOUSE WR-203, WR-303

No reception . . . look for short in 0.1 mfd., 400 volt tubular condenser bypassing plate supply of 6A8 and 6K7 i.f. stage. Use 600 volt replacement.

ZENITH 7

Intermittent reception . . . look for faulty voice coil. The clearance of the coil is very small and care must be used when replacing.

ZENITH 5528

Dead or weak on automatic tuning . . . check C2, a 50 mmf. condenser for open (part No. 22-289)



Stop those RADIO NOISES!

● Be a radio noise doctor. Cash in on today's major problem—background noises due to increased use of electrical appliances, and greater sensitivity of all-wave sets.

AEROVOX comes to the rescue with six different types of line-noise filters to take care of any kind of noise source, and the AEROVOX Interference Analyzer which tells what type to use and how to apply it.

Handy silent salesman display card, holding four most popular types, sells line over the counter. Carrying a few units in the service bag, preferably along with analyzer, sells the line on service calls. Simply irresistible, because . . .

Handy units plug in between appliance and line. Or at set.

Analyzer (left) indicates right type and installation.

Units range from \$0.50 to \$4.75 list. analyzer, \$7.50 dealer's net price.



Ask your local AEROVOX jobber to show you this line of radio noise eliminators and the analyzer. Ask for literature on curing radio noises. Or write us direct.



WARD AERIALS ARE EASY TO SELL - EASY TO INSTALL FREE!

Write for new catalog of Ward's complete line of low-priced manufacturers - approved aerials for car and home - also get on mailing list for free magazine packed with selling and service tips.

WARD PRODUCTS CORP.
WARD BLDG. CLEVELAND, O.

Third-Degree Tester

By J. M. Thompson

Often standard trouble-shooting practice leads the serviceman to the defective stage but the actual culprit must be found by other methods. Most men prefer to tap and probe around with the insulated end of a screwdriver. This is bulky and often results in damage to parts that are not defective. The drawing herewith shows a simple hammer, that will be useful to any serviceman.

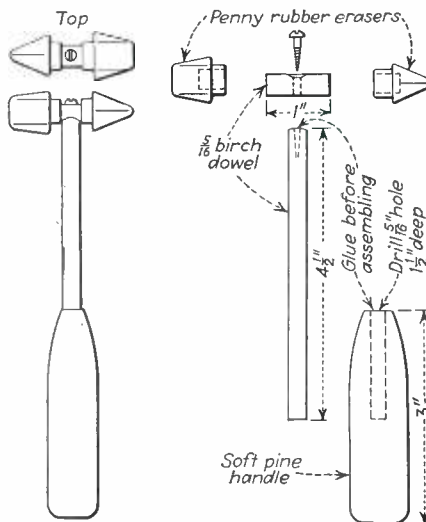

New 3 Inch OSCILLOGRAPH WOBBULATOR



Model 830

A combined 3" Oscillograph and frequency modulated Wobbulator at the lowest price ever offered, \$69.95!

Operates as a single or double trace Wobbulator and as a qualitative audio analyser, giving the contour of an audio response curve from 0 to 10,000 cycles for any audio or p.a. amplifier or coupling device without an audio oscillator! A typical 0-10,000-0 cycles audio curve is illustrated in the second pattern.

Model 830 performs all the regular functions of a 3" cathode ray oscillograph and indicates defective condensers, incorrect bias, overload and modulation—these latter patterns are illustrated on the left.

The sensitivity through the vertical amplifier is 0.4 volts rms per inch—the most sensitive 3" oscillograph! The thyatron sweep range is from 7 to 30,000 cycles! Perfect locking at all frequencies—a characteristic of Triumph "no drift" sweep circuits.

Send for your free copy of the Model 830 circuit and characteristics sheet with illustrations of the fully shielded interior design. Immediate deliveries—available from your radio parts distributor.

TRIUMPH MFG. CO.

4013 W. Lake St., Chicago, Ill.

Send Model 830 circuit and data FREE!

Name

Address

City State

INDEX TO ADVERTISERS

January 1939

	Page
Aerovox Corp.	81
Allied Radio Corp.	46
Allied Recording Corp.	52
American Television Radio Corp.	22
Amperite Co.	52
Arcturus Radio Tube Co.	54
Astatic Microphone Labs.	50
Bell Sound Systems, Inc.	48
Bogen Co., David	39
Brach & Co., L. S.	82
Centralab	78
Cinaudagraph Corp.	54
Clarostat Mfg. Co.	75
Consolidated Wire & Assoc. Corps.	61
Continental Music Co., Inc.	49
Cornell-Dubilier Elec. Corp.	82
Crosley Corporation	Inside Back Cover
Electro-Voice Mfg. Co.	48
Fairchild Aerial Camera Corp.	51
Film Circulation Corporation	34, 35
Gale Products	6
Galvin Mfg. Corp.	3
General Electric Co.	Back Cover
General Industries Corp.	22
Hygrade-Sylvania Corp.	15
International Resistance Corp.	67
Janette Manufacturing Co.	29
Kelvinator, Div. of Nash-Kelvinator	18-19
Ken-Rad Corp.	29
Leonard	26, 27
Mallory & Co., Inc., P. R.	Inside Front Cover
Meissner Mfg. Co.	7
National Union Radio Corp.	59
Ohmite Manufacturing Co.	29
Pioneer Gen-E-Motor Corp.	29
Pioneer Specialties Co.	60
Presto Recording Co.	50
Quam-Nichols Co.	81
Philco Radio & Television Corp., Phonograph Div.	8
Radio City Products, Inc.	67
Radio Corporation of America	44
Raytheon Production Corp.	5
RCA Manufacturing Co., Commercial Sound	42, 43
RCA Manufacturing Co., Set Division	40
RCA Manufacturing Co., Tube Division	41
Readrite Meter Works	61
Regal Amplifier Corp.	50
Remler Co., Ltd.	39
Rider, John F.	78
Sentinel Radio Corp.	29
Service Instruments, Inc.	71
Shure Brothers	48
Simpson Electric Co.	75
Solar Manufacturing Co.	66
Sprague Products Co.	61
Stewart-Warner Corp.	4
Stromberg Carlson Tele. Mfg. Co.	2
Supreme Instruments Co.	79
Thordarson Elec. Mfg. Co.	53
Triplett Electrical Instrument Co.	73
Triumph Manufacturing Co.	82
Tung-Sol Radio Tubes, Inc.	22
Vibratloc Mfg. Co.	52
Ward Leonard Electric Co.	75
Ward Products Co.	81
Western Electric Co.	39
Zenith Radio Corp.	10

SEARCHLIGHT SECTION (Classified Advertising)

Classification	Page
BOOKKEEPING SYSTEM	83
CATALOGS	83
EMPLOYMENT	83
RADIO STOCKS	
Allied Radio Corp.	83
Burststein-Applebee Co.	83
Chicago Appliance Co.	83
Midwest Appliance Parts Co.	83
Mostow Company	83
New York Radio Supply Co.	83
Sonoret Radio	83
Williams Philco, Inc.	83

Although Radio Retailing takes every precaution to insure accuracy, we cannot assume responsibility for an occasional change or omission in the above index.

McGRAW-HILL PUBLISHING COMPANY, INC. Publication Office: 99-129 North Broadway, Albany, N. Y. Editorial and Executive Offices: 330 West 42d Street, New York, N. Y.

More Business for you

WITH THE C-D LINE OF

Quietone RADIO INTERFERENCE FILTERS



Here's a new profit opportunity for you! C-D offers a complete line of practical, efficient interference filters to eliminate radio and electrical disturbances. Wherever there's an electrical appliance or outside power lines to interfere with radio reception, there's a need for Quietone.

Designed in attractive colors to match room interiors. Ask your C-D jobber about Quietone. Talk Quietone to your customers. Show it—sell it. Retail prices from fifty cents up.

A Product of
the World's Largest Manufacturer of Capacitors



Now... Get REAL RESULTS with New 1939

BRACH Antennas

Scientifically Designed
to Insure—

- ✓ BETTER RECEPTION
- ✓ EASY INSTALLATION
- ✓ PERMANENCE
- ✓ SATISFIED CUSTOMERS
- ✓ GOOD PROFITS
- ✓ MORE SALES



The BRACH line is a complete line and every item is priced right. Large stocks on hand at all times insure prompt deliveries. Send for new catalog today!

World's Largest Makers of Antenna Systems

L. S. BRACH Mfg. Corp.

55-67 Dickerson Street

Newark, N. J.



Established 1906

SEARCHLIGHT SECTION

EMPLOYMENT and BUSINESS OPPORTUNITIES—SURPLUS STOCKS—RESALE MERCHANDISE

UNDISPLAYED RATE:
15 cents a word, minimum charge \$3.00
Positions Wanted (full or part-time salaried employment only) $\frac{1}{2}$ the above rates, payable in advance.
(See ¶ on Box Numbers.)
Proposals, 50 cents a line an insertion.

INFORMATION:
Box Numbers in care of our New York, Chicago and San Francisco offices count 10 words additional in undisplayed ads. Replies forwarded without extra charge.
Discount of 10% if one payment is made in advance for four consecutive insertions of undisplayed ads (not including proposals).
(New advertisements must be received by February 6th for the February issue)

DISPLAYED—RATE PER INCH:
The advertising rate is \$8.75 per inch for all advertising appearing on other than a contract basis. Contract rates quoted on request.
An advertising inch is measured $\frac{7}{8}$ " vertically on one column, 3 columns—30 inches—to a page. Radio Retailing

WANTED Men who can sell

direct to City, County and State Governments, high quality Police and Fire Radio Communication Equipment—No investment necessary—Commission basis—This may be your opportunity to step ahead in a fully protected territory—What are your qualifications?

SW-123, Radio Retailing
330 W. 42nd St., New York City

WRITE FOR OUR NEW 116 PAGE CATALOG

of WASHING MACHINE AND VACUUM CLEANER PARTS

The Only Complete Catalog of Its Kind in the Country, That Can Be Used Profitably as a Service and Counter Guide With Retail Prices.

Dealers net prices on back pages
Established 10 Years. Reputation for Quality and Service.

MIDWEST APPLIANCE PARTS CO.
2722 W. Division St. Chicago, Ill.

FREE! Allied's 1939 RADIO CATALOG

Ready Now—Send For It!

Every Radio Dealer, every Service Dept. needs this big guide to Everything in Radio at lowest prices! Over 14,000 exact duplicate and replacement parts; all leading lines of Test Equipment, including new Push-Button Testers; newest Sound Systems, Kits, Amateur Gear, books, tools, etc.—and 62 amazing 1939 KNIGHT Radios—sets for every purpose—ideal price-leaders as low as \$6.95! 180 pages of values—write today for ALLIED's new 1939 Catalog. It's first choice wherever high-grade, low-cost radio equipment is required!

NEW SETS



NEW P. A.



NEW TESTERS



FREE
Send Coupon!

Allied Radio Corporation
Dept. 18-A-9.

833 W. Jackson Blvd., Chicago, Ill.

Send me your 1939 Catalog—FREE

Name

Address

High Value! Low Prices!

ALL GUARANTEED FOR THREE MONTHS SEALED CARTONS



1C7G	..\$.45	4230
1H4G	.. .35	5520
1V	.. .30	6A835
6A7	.. .35	6C535
6F7	.. .40	6F5G35
2525	.. .35	6K7G35
41	.. .30	6Q7G35
	.. .45			

We have a complete line of Tubes. Write for Prices

**NEW YORK
RADIO SUPPLY CO.**
152 W. 42 ST. R. R. N. Y. C.

... they said It Couldn't Be Done!

BAGS—Finest quality @ \$.29
BRUSH REBRISTLING29
ARMATURE REWINDING99
100 Carbon brushes in metal hopper 1.39
Attachment sets—5 pc., less coupling 1.98

We Never Sacrifice Quality to Meet Price!

CHICAGO APPLIANCE CO.
812-14 N. Wells St., CHICAGO, ILL.
"AMERICA'S LARGEST"

Send for New 32 Page Catalog on CAMERAS — PROJECTORS PHOTO SUPPLIES

"100% Wholesale—We Protect the Dealer"
The MOSTOW Co.
Merchandise Mart, CHICAGO, ILL.

PHILCO PARTS

For Dealers and Servicemen
FAST SHIPMENTS made anywhere.
Genuine Philco Parts and Tubes. Send 10c postage for Philco Replacement Parts Book. Catalog sent FREE.

WILLIAMS PHILCO INC.
800 S. Adams St. Peoria, Ill.

EVERYTHING IN RADIO!
Our immense stock of radio sets, parts and supplies enables you to purchase your entire needs on one order! You will find all your Neat locally known favorites in this big book which is FREE for the asking. Practically every order is shipped the same day it is received. Write for Catalog

BURSTEIN-APPLEBEE CO.
1017 1/2 McGee St. Kansas City, Mo.

QUALITY PARTS

Several Well-Known Lines
AT PROFIT PRODUCING PRICES
Request Our "Specialized Bulletin"
SONORET RADIO

36 Woodbury St., WILKES-BARRE, PA.



BOOKKEEPING SYSTEM Especially Designed for APPLIANCE-RADIO DEALERS

A direct, easy-to-understand system, devised by an expert accountant in your line of business. It is in practical use by many dealers everywhere.

Provides for cost of sales, operating expenses, inventory to date, cost of repossessions, cost of rebuilding, loss on trade-ins and every conceivable situation of your very own business.

Also system for smaller store.
Write today for descriptive folder.
THE KNAPHURST COMPANY
501 S. Jefferson Street Chicago, Illinois

YOU ARE ONE

of more than 25,000 readers of RADIO RETAILING.

Your problems of selling radio sets, accessories and other home merchandise—whether business or individual—are duplicated with other readers, but—

Still OTHER readers can provide the solution of your problem IF THEY KNOW WHAT IT IS!

Tell them! Here!

Through classified advertising in the Searchlight Section of RADIO RETAILING—your business paper and theirs.

Audio Frequency...

Young Ben Franklin

There is a story about Benjamin Franklin's youth.

Young Ben, it seems, once said to his father: "Dad, why don't you say grace once a week over the whole barrel of food instead of at every meal?"

This little story beautifully fits what I have to say about the number of people who think that just because a tube lights it is good.

Why don't tube manufacturers tell the consumer that it takes more than a lighted filament to make a good tube? Then maybe the serviceman would not have to tell every customer separately.

PATERSON, N. J.

JOSEPH DAVIS

My Radio

My radio is the smartest thing you ever saw;

It's versed in science, medicine and law.
No subject is too deep, or none too gay.
No song too difficult, for it to play.
Each night it tells the whole worlds news to me;

Condensed, so I can understand and see.
In politics, it argues pro and con,
And you can never tell which side it's on.
It has a cure for all my aches and ills;
A famous water or old Buncombe's pills.
But it will guarantee beyond a doubt
To cure you so you will be nothing out.
A dozen remedies it has for falling hair,
And how old age is changed to maiden fair.
Or of a simple remedy at 40 cents a tube,
That made a gay Beau Brummel of a
homely rube.

In ages past the miracles were few
Compared with what my radio can do.
I sometimes wonder if it tells the truth,
About transforming my old age to youth.
But even though I caught it in a lie
I'd miss the thing, if it should up and die.
WILMETTE, ILL.

A. J. WOODCOCK

Misfire?

Your page in the December issue entitled: "Four Reasons Why the Dealer Who Takes a Used Set in Trade Rarely Disposes of it Without Loss" was very interesting but the statement on the bottom somehow missed fire.

How about the very prevalent dealers who consistently take in used radios at much, much more than they are worth? Or the dealers who get rid of overstock with high trade-in allowances?

You do have a swell magazine, though.

BOULDER, COLO.

DAMON ARDOUREL

Works Both Ways

"How Far Away Does Business Pay?" Your recent article heading is words of

wisdom and this is being realized daily by all wise executives in every part of the world. Certainly service in the metropolitan area here at a greater distance than three miles cannot often be effected economically but I would rather you suggested that large stores keep out of suburban areas than the reverse.

I must protest most strongly that upon reading your article it appears you are sitting in judgment upon the advertising of the suburban retailer. I think you are not sufficiently farsighted to realize that a suburban retailer must necessarily be known throughout the length and breadth of his metropolis to receive the calls to which he (as the man on the spot) is justly entitled.

CREMORNE, N.S.W.

EDWARD D. HUCKELL

Huckell Radio

On The Button

I would like to see a really good article on radio costs and how to charge for services, both on repair, installation, and tube replacement as well as trade-ins. Something useful. My compliments on your magazine. There is no better.

NEW RICHMOND, WISC.

WARREN PRASHL

Take a good close look at author Joe Marty's yarn in this issue.

Stop Thief

We are very much enthused with the *Radio Retailing* magazine. In fact we have a hard time keeping it from being stolen.

ROCHESTER

EDW. G. MASLINE, JR.

Masline Radio Parts

Says We're Consistent

Your magazine *Radio Retailing* is very good. After reading it for 2 years it is amazing that no one issue has been outstanding but all consistently good. Each one contains some feature that makes that issue well worth keeping.

AMERICAN FORK, UTAH

JOHN ABEL

Oh! Fred

Radio manufacturers have fallen down in the construction of higher priced units. Imagine a \$100 set using only a two-gang condenser. Selectivity is no better than some of the old models.

How are we going to sell new sets in spite of improved tuning devices if the customer finds that he gets code interference, heterodyne whistles and catcalls due to the cutting of corners and the leaving out of r.f. stages?

Last week I placed a 9 tube 1939 set in a customer's home when the customer said

he would trade in a 1930 job if the new one eliminated these trick noises. He later called me up and told me he would not swap even, much less pay me for the new one.

Oh! Fred!

ROCKLAND, MAINE HOUSE-SHERMAN, INC.

Y-e-a-a-y Team!

To date I have received two copies of *Radio Retailing*. I have read them from cover to cover and I can truthfully say in no two magazines have I ever acquired more useful information.

Radio Retailing is one of the best, if not THE best.

INDIANOLA, IOWA

CHAS. R. HUTCHCROFT

May I take this opportunity to congratulate you on a fine job. I mean *Radio Retailing*, because you are giving servicemen a variety of fine, helpful information. I am sure that all who read it are benefiting in dollars and cents as well as in knowledge the same as myself.

BALTIMORE

FRED G. BUCKHAULT

Eureka Radio & Refrigeration Service

SERVICE COSTS

(Continued from page 69)

make more money when there is more competition?" I reply, "The public will pay good money for good service work, and not a dime for bum jobs. The thing to do is to work yourself into a position that permits you to make a profit. Take another look at the figures gleaned from our survey.

The average charge per hour is \$1.68 the average cost of doing service for a man is \$1.98.

That means a loss per hour of 30 cents.

I suggest again that you jot down all of your monthly expenses. Divide these by the total number of hours you work per month. That will give you your cost per hour. Add 20 per cent to your cost per hour for profit.

Now you are going to say, "The folks out where I work are poor. They can't stand any such charges." You know you've got to get your cost. Possibly you can cut it some by restricting calls to a certain radius around your shop. Maybe you would be better if you did not have some of these people for customers.

Sit down with a pencil and have a heart to heart talk with yourself. Fill in the blanks on the side of the tables presented with this story with your own picture.

“CROSLEY is the line for '39”

... that's the echo from Cincinnati. That's the echo of the most enthusiastic distributors' meeting in Crosley history, when new merchandising plans for the Shelvadors, appliances and radios were disclosed. Full cause for cheers are found in:

- 1** Carefully planned merchandise to entice and enthruse the 1939 prospect.
- 2** Three separate lines of Shelvadors to cover every price bracket and win every competitive situation!
- 3** Promotion ideas that promise better profits and great volume to all classes of dealers.
- 4** Disclosure of where plenty of prospects for 1939 Shelvadors can be found.
- 5** Information about *new* Crosley products which greatly enhance the value of a Crosley franchise.

Distributors cannot reach all dealers at once. Don't wait. Go to them. Write the factory. Hear the 1939 story now. Get an early start. Now is the time to get going, for
CROSLEY'S THE LINE FOR '39.

THE CROSLEY CORPORATION

Home of "the Nation's Station"—WLW—70 on your dial
ROWE CROSLEY, Jr., President CINCINNATI

Just Out! Spectacular New Series!



RADIOS

They've Got What It Takes!



GD-600

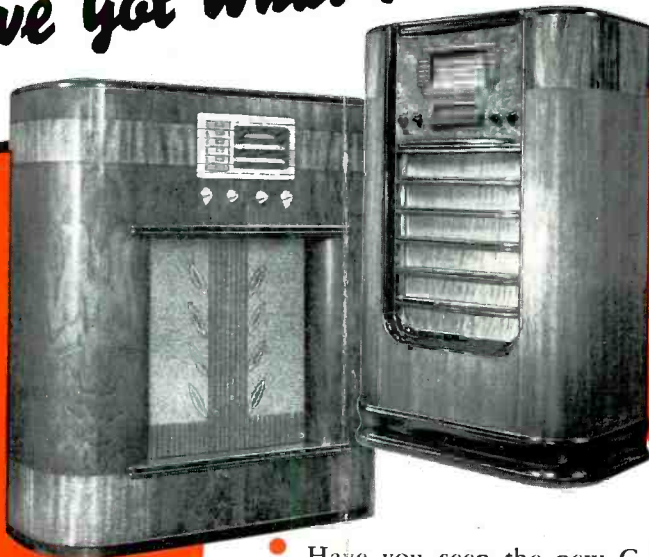

G-655



G-78

G-86



GD-500



GD-63

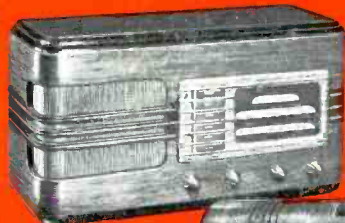

G-64



GD-610

• Have you seen the new G-E Radios? Just Out! They're hotter than hot! They're smarter than smart! They've got what it takes—in features—in design—in performance! And in price they're tagged for fast and furious action.

G-E broke their all-time sales record in 1938. It's a safe bet that 1939 will see G-E Radio sales hit another new high. Because this new G-E series offers more sheer value in every price bracket than has ever been offered in G-E history. Better phone your G-E Radio distributor NOW!

NEW G-E WIRELESS RECORD PLAYER

No Wires • No Connections to Radio



Reproduces recorded music through the loudspeaker of any radio—electrically. Operates from any location—within hearing distance of radio set. No wires—no connections to radio. Turns any radio into a modern-type radio-phonograph combination. Priced to sell in big volume.

GENERAL  ELECTRIC