

# RADIO RETAINING

McGraw-Hill Publishing Company, Inc.

25 CENTS PER COPY

AUGUST 1938



**GOOD RECEPTION BEGINS WITH A GOOD ANTENNA... Recommend modern systems before winter weather... Test tubes and sets for plus business while in the customer's home**





## A Nine Point Star to Solve Your **CONDENSER PROBLEMS**

This entirely new Mallory development brings you all the advantages you've ever had in condensers, plus new improvements of tremendous significance to you.

## 9 Star Points Feature the New P. R. MALLORY & CO. Inc. **MALLORY Type BB Condensers**

- 1** Positive, non-corroding connections.
- 2** Positive acting gas seal... condensers cannot explode.
- 3** One piece drawn aluminum can.
- 4** Heavy leads... no thin foil tabs.
- 5** New separator material... impervious to surge voltage.
- 6** Extremely low power factor and series resistance.
- 7** Uniformly low RF impedance.
- 8** Uses new Mallory fabricated plate. Much shorter than other types of plate for given capacity. No acid etching. No squeezing to fit can. Plenty of room for separator and electrolyte.
- 9** No temperature limitations due to small size.

## Another Star of the First Magnitude the 2nd Edition Mallory-Yaxley Radio Service Encyclopedia . . .

You'll agree with thousands of other service men that the 2nd Edition "MYE" is the greatest help a service man ever had. Covers every phase of automatic tuning... every system. Nearly twice the information given in the 1st Edition. Second printing just off the press. Be sure to have your distributor reserve a copy for you now.



USE  
P. R. MALLORY & CO. Inc.  
**MALLORY**  
REPLACEMENT  
CONDENSERS . . . VIBRATORS

**P. R. MALLORY & CO., Inc.**  
INDIANAPOLIS, INDIANA  
Cable Address—PELMALLO

USE  
**YAXLEY**  
REPLACEMENT  
VOLUME CONTROLS

# RADIO RETAILING

A McGRAW-HILL

PUBLICATION

AUGUST, 1938

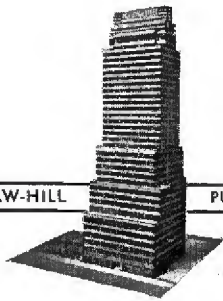

O. FRED. ROST . . . . . Editor  
 W. MacDONALD. . . . . Managing Editor  
 C. A. NUEBLING. . . . . Technical Editor  
 HARRY PHILLIPS. . . . . Art Director

Tom Blackburn  
 Chicago

George Tenney  
 San Francisco

H. S. Knowlton  
 Boston

H. W. MATEER  
 Manager

LEE ROBINSON  
 Sales Manager

## McGRAW-HILL PUBLISHING COMPANY, INC.

JAMES H. MCGRAW  
 Founder and Honorary Chairman

Publication Office  
 99-129 North Broadway, Albany, N. Y.  
 Editorial and Executive Offices  
 330 West 42nd Street, New York, N. Y.

Cable Address: MCGRAWHILL, New York  
 Member A.B.P., Member A.B.C.

James H. McGraw, Jr. . . . . President  
 Howard Ehrlich . . . . . Executive Vice-President  
 Mason Britton . . . . . Vice-Chairman  
 B. R. Fulnam . . . . . Treasurer  
 D. C. McGraw . . . . . Secretary  
 A. W. Morrison . . . . . Circulation Manager

RADIO RETAILING, August, 1938, Vol. 23, No. 8. Published monthly, price 25c copy. Subscription rates—United States and possessions, Canada, Mexico and Central American countries \$1. All other countries \$2 a year or eight shillings. Printed in U. S. A. Entered as Second Class Matter, September 8, 1936, at Post Office, Albany, N. Y., under the Act of March 3, 1879. Cable address "McGrawhill, New York." Member of A.B.P., Member of A.B.C. Copyright 1938 by McGraw-Hill Publishing Co., Inc., 330 West 42d Street, New York, N. Y.

Branch Offices: 520 North Michigan Ave., Chicago; 833 Mission St., San Francisco; Aldwych House, Aldwych, London, W.C. 2; Washington; Philadelphia; Cleveland; Detroit; St. Louis; Boston; Atlanta, Ga.

RADIO MONTH . . . . .	7
BUSINESS BAROMETER . . . . .	9
PHOTOSHORTS . . . . .	11
TRAINING GREEN SALESMEN . . . . . By Caswell Oden	14
PARTS JOBBERS STOCKS . . . . .	16
CREDIT FOR THE LOW INCOME BUYER. . . . .	18
TUBE SALES IDEAS . . . . .	20
DES MOINES DISTRIBUTORS . . . . .	21
HOW TO DEMONSTRATE SOUND. . . . .	22
PREVIEW OF NEW PRODUCTS . . . . .	24
NEW ELECTRICAL APPLIANCES . . . . .	31
AUGUST NEWS . . . . .	32
TECHNICAL TOPICS . . . . .	43
CIRCUITS . . . . .	44
AN AUTOMATIC ANALYZER . . . . . By Allen Beers	49
TRICKS OF THE TRADE . . . . .	51
AUDIO FREQUENCY . . . . .	56

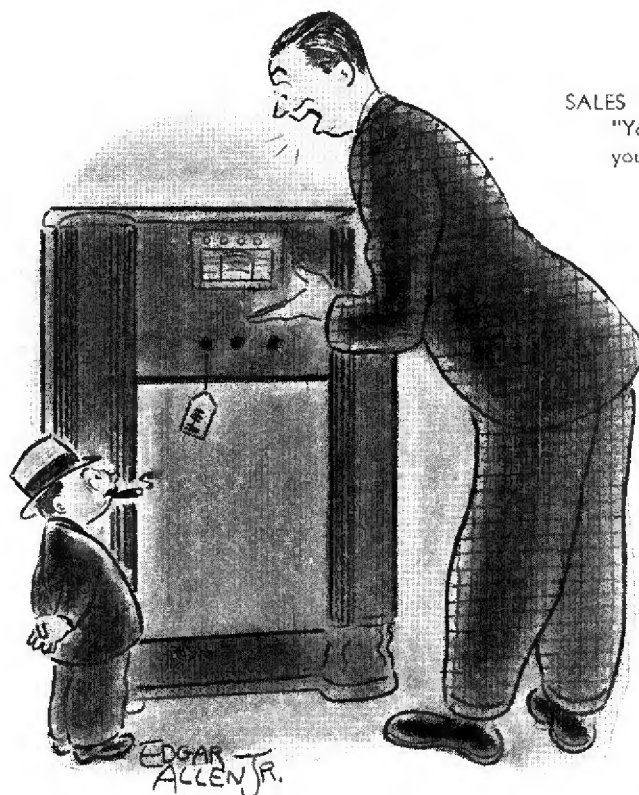

SALES STATIC . . .  
 "You're certainly getting  
 your money's worth, Sir!"





MORE WORTHWHILE  
SELLING FEATURES  
THAN ANY LINE  
I'VE EVER SEEN!

AM I GLAD  
I'M WITH  
STROMBERG-  
CARLSON!

IT'S GOING TO  
BE A BIG YEAR  
FOR ME AND  
MY DEALERS!

THEY'VE SEEN...THEY'VE BOUGHT...THEY AGREE

## *It's Radio's Hottest Line!*

Distributors and Dealers who have seen the new Stromberg-Carlsons say, "It is the radio line of the year." Every dealer owes it to himself to see this great line at once. Have your distributor give you radio's real profit story.

PORTLAND, MAINE  
Farrar-Brown Co.  
BOSTON, MASS.  
Gross Sales, Inc.  
NEW YORK, N. Y.  
Gross Sales, Inc.  
ALBANY, N. Y.  
Hudson Valley Asbestos Corp.  
ELMIRA, N. Y.  
Barker, Rose & Kimball  
ROCHESTER, N. Y.  
Stromberg-Carlson Tel. Mfg. Co.  
BUFFALO, N. Y.  
Graybar Electric Co.  
PHILADELPHIA, PA.  
Motor Parts Co.  
SCRANTON, PA.  
Charles B. Scott Co.  
ALTOONA, PA.  
Electric Appliance Distributors  
PITTSBURGH, PA.  
Graybar Electric Co.  
CLARKSBURG, W. VA.  
Williams Distributing Co.  
RICHMOND, VA.  
Graybar Electric Co.  
AKRON, OHIO  
Hamburg Bros. Co.

COLUMBUS, OHIO  
Pixley Electrical Supply Co.  
CINCINNATI, OHIO  
Graybar Electric Co.  
LOUISVILLE, KY.  
Stratton & Terstegge Co.  
NASHVILLE, TENN.  
Tennessee Valley App., Inc.  
DETROIT, MICH.  
Specialties Distributing Co.  
SOUTH BEND, IND.  
Cloud Bros. Co.  
CHICAGO, ILL.  
Stromberg-Carlson Tel. Mfg. Co.  
MOLINE, ILL.  
Rogers Maytag Co.  
MILWAUKEE, WISC.  
Lappin Electric Co.  
DUBUQUE, IOWA  
Renier Radio & Television Co.  
MINNEAPOLIS, MINN.  
Graybar Electric Co.  
SIOUX CITY, IOWA  
Warren Electric Co.  
ST. LOUIS, MO.  
Brown Supply Co.  
KANSAS CITY, MO.  
Jenkins Music Co.

OKLAHOMA CITY, OKLA.  
Jenkins Music Co.  
WICHITA, KANSAS  
Jenkins Music Co.  
EL PASO, TEXAS  
Peterson Lumber & Paint Co.  
DENVER, COLO.  
Robert F. Clark Co.  
ALBUQUERQUE, N. M.  
Raabe & Mauger Hdware Co.  
PHOENIX, ARIZ.  
Penrod & Siegmund  
SALT LAKE CITY  
Radio Studios, Inc.  
SPOKANE, WASH.  
Hughes & Co.  
SEATTLE, WASH.  
Graybar Electric Co.  
PORTLAND, OREGON  
Graybar Electric Co.  
SAN FRANCISCO, CALIF.  
Graybar Electric Co.  
LOS ANGELES, CALIF.  
Stromberg-Carlson Tel. Mfg. Co.  
SAN DIEGO, CALIF.  
Electric Supplies Dist'g. Co.

## HERE IS WHY THEY BOUGHT..

### LABYRINTH MODELS from \$119.50\*

Radio's greatest selling feature. Invention for improving tone quality—now available at prices anyone can afford.

### AUTHENTIC DESIGNS—Style New to Radio—from \$99.50\*

Just what everyone has been wanting for years. The cabinet-making art of the 18th Century combined with the radio skill of the 20th.

### TABLE MODELS priced from \$39.95\*

The most attractive sets of this type to be found in radio. Cabinets in walnut and in rosewood—a size for every table radio need.

### CORNER CABINET RADIO and EAR- LEVEL PROJECTION—New Develop- ments Made Possible by the Labyrinth

A style that makes every prospect say, "Why didn't someone do it before?" A feature that improves tone quality in any room.

\* All Prices F. O. B. Factory

Get in touch with your nearest distributor or write direct to the

Stromberg-Carlson Telephone Mfg. Company  
178 Carlson Road, Rochester, N. Y.

Please send me complete information  
on Radio's Hottest Line.

Name \_\_\_\_\_  
Address \_\_\_\_\_

*There is nothing finer than a*  
**Stromberg-Carlson**



**RESCUED!**  
**FROM A WATERY GRAVE**  
**BY THE EVER-ALERT**  
**U. S. COAST GUARD!**

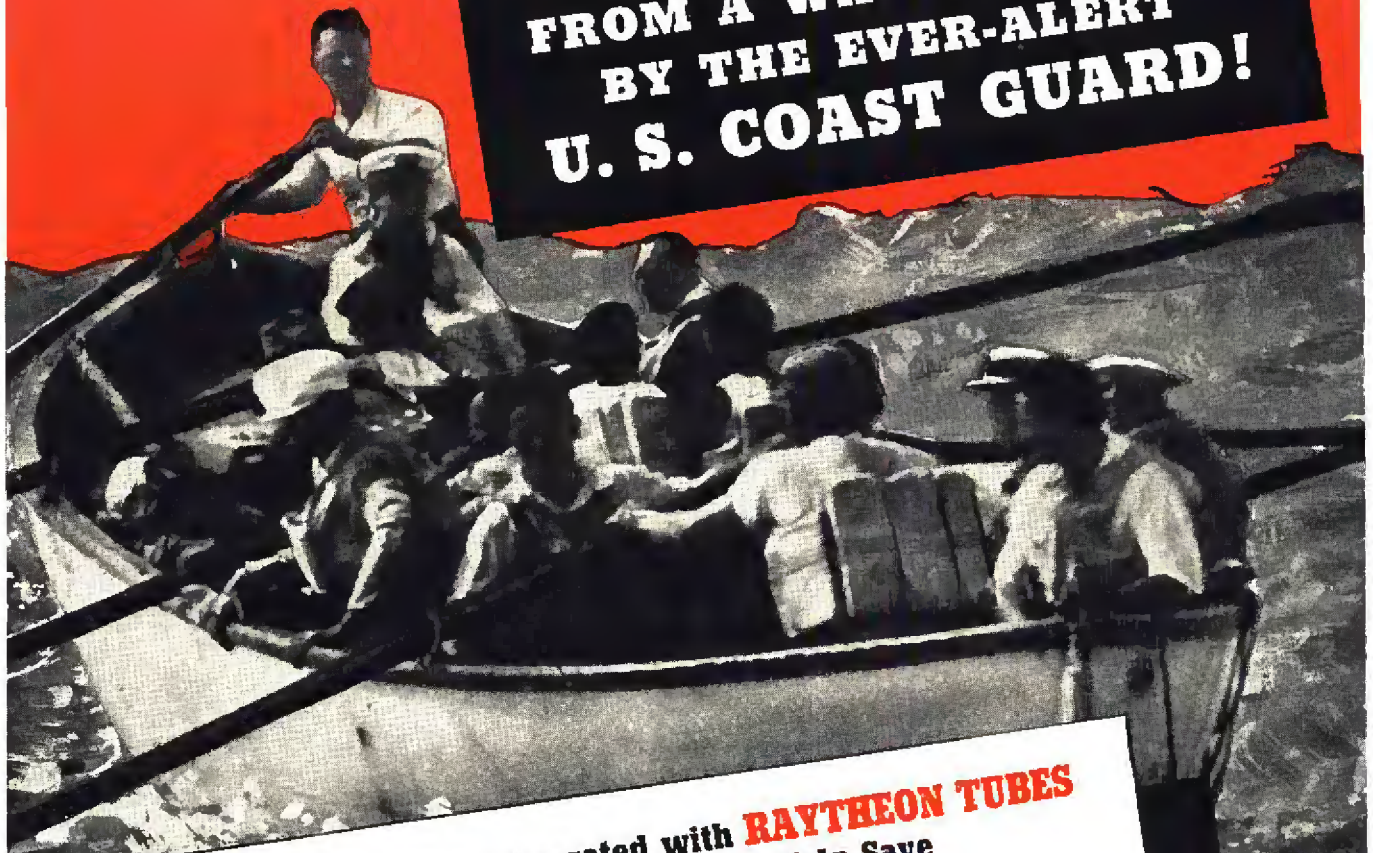

**Communications Equipment Operated with RAYTHEON TUBES**  
**Receive and Flash Messages Which Help Save**  
**Thousands of Lives Yearly!**

Weary, but happy survivors from what might have been another tragedy at sea!

But what an entirely different story newspaper headlines might have flashed to the world had not Raytheon tubes functioned in their usual dependable manner!

Other vital U. S. government communications depend on Raytheons, too. The Army, the Navy, Weather Bureau, Air Corps.

There may be no lives risked on your choice of replacement tubes, but why don't you, too, use RAYTHEONS—they cost no more! And you can always sell RAYTHEON tubes at your full profit.

**RAYTHEON**

NEWTON, MASS. • NEW YORK • CHICAGO • SAN FRANCISCO • ATLANTA



**"WORLD'S LARGEST EXCLUSIVE RADIO TUBE MANUFACTURERS"**



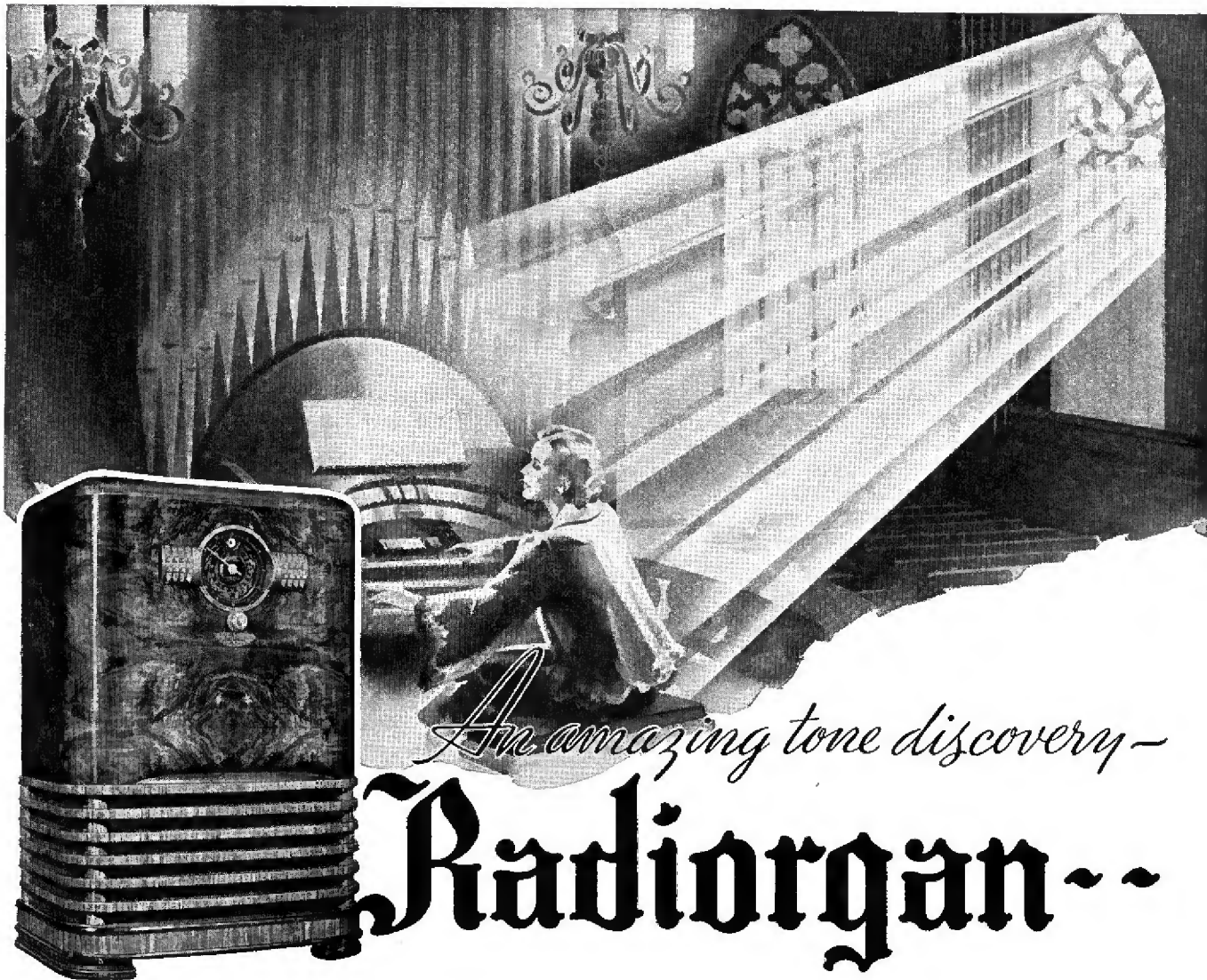

*An amazing tone discovery -*

# Radiorgan

With this 1939 Super-feature Zenith Radio tone performance BEGINS . . . where radio . . . even Zenith radio up to now has stopped. And you can prove this to yourself and your customers, incontestably.

Do not fail to operate RADIORGAN for *yourself* at your Zenith Distributor's. You will positively HEAR Zenith tone go SIX BIG DEFINITE STEPS BEYOND *conventional* radio tone.

You can take the customer into NEW REALMS OF TONE which means you can take yourself into NEW REALMS OF SALES. Not a luxury feature. You'll find RADIORGAN begins on a popular-price Zenith. 1939 Zenith compact, table, console, chairside and combination models from \$14.95 to \$350.

## ZENITH

1939 Zenith is ten years ahead with RADIORGAN as it was in 1928 with the first automatic tuning ever put on a home radio.

CELEBRATES 1939 LEADERSHIP  
WITH GIANT VALUES

ZENITH RADIO CORPORATION, CHICAGO, ILL., U. S. A. · CABLE ADDRESS "ZENITHRAD"



**NEW ARVIN  
PUSH BUTTON**

**AC Model 68 . . . \$24.95 list**

Powerful 5-tube AC superheterodyne with 6 push button automatic tuning. Has special Arvin "station variator" which increases tuning range to 18 or 24 stations. Electro-dynamic speaker. Modern walnut plastic cabinet 11½" high, 8" wide, 6¼" deep.



**TWO STREAMLINED  
PLASTIC RADIOS  
in a choice of colors**

Full sized table radios 11½" wide, 8" high, 6¼" deep. Powerful superheterodynes using 5 tubes, plus ballast tube. Operate on AC or DC current. Electro-dynamic speaker.

**Model 58A in Ivory**  
at left . . . . . \$19.95 list  
**Model 58 in ebony black**  
below . . . . . \$16.95 list



SEE THESE NEW ADDITIONS  
TO THE COMPLETE LINE OF  
**ARVIN**  
RADIO S

**MODERN STYLING  
ATTRACTIVE PRICES  
BEAUTIFUL RECEPTION**

Right—New Arvin Model 88 with lid raised to show phonograph turn table.



**NEW ARVIN Radio-Phonograph  
AC Model 88 . . . \$39.95 list**

You can cash in on the popularity of radio-phonograph with this table model. Improved pick-up reproduces voice and musical recordings beautifully through the Arvin circuit. Plays 10" and 12" records. Has 6-tube superheterodyne circuit with 6" electro-dynamic speaker. Provides fine selectivity and splendid tonal range.

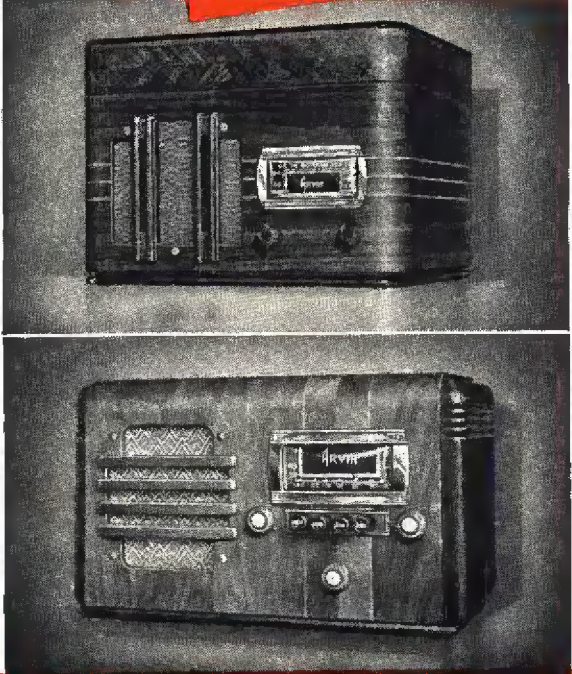

**NEW ARVIN Push Button  
AND DIAL TUNING**

**AC Model 78 . . . \$29.95 list**  
A powerful broadcast and short wave superheterodyne receiver with full electro-dynamic speaker, covering 540-1750 kc. and 5.75-18.0 mc. Combines the convenience of 4-station push button tuning for a few preferred national chain stations and the flexibility of dial tuning for general station coverage. Cabinet 9" high, 14¼" wide, 6¼" deep.

● These new Arvins are fine radios—quality sets in every detail of appearance and performance. They are not to be confused with the many midget radios on the market today.

Five models, including the radio-phonograph, meet the demand of thousands of users—giving you the sales appeal of push button tuning, dial tuning or a combination of both in table radios. You can sell these new Arvins in volume—they're so reasonably priced.

The modernistic gold foil display, shown above, with the new plastic Arvins is a honey of a merchandiser. This window-counter display catches the eye—and really glorifies the new streamlined sets. The display is free with an order for any three table radios. Ask your jobber. Noblitt-Sparks Industries, Inc., Columbus, Indiana.

Prices slightly higher in extreme South and West.

**ASK FOR CATALOG** showing complete line of table models, consoles, chairside radios and battery radios.





HARRY BOYD BROWN  
National Merchandising  
Manager of Philco

# All Owners of Old Sets Must Now Admit Their Radios Are Obsolete

**P**HILCO Mystery Control revives the demand for quality radio—removes the emphasis on price—sharply reverses the trend toward cheaper sets. Yes, thanks to Philco Mystery Control, this

Fall season will see the greatest sales and profit opportunity for Philco Dealers since the introduction of the AC Tube 10 years ago.

A thrilling, dramatic, exciting radio invention! A traffic-getter without parallel! A demonstration that you can scarcely believe even after you have seen it. But—most important of all—a radio invention that brings a new comfort—a new convenience and pleasure to radio operation and enjoyment. A revolutionary radio development that is appreciated by everybody the instant it is seen.

Philco Mystery Control makes possible a newspaper advertising story that will pull like a house afire—and better still—that will bring buyers *not* looking for bargains, *but buyers that are willing to pay the price for something fundamentally and vitally new—something tremendously desirable.*

Philco Mystery Control will bring hundreds of thousands of new radio buyers into the market. Buyers whom mere price appeal could not touch—buyers who will now realize that their old radio is truly obsolete—because they see in Mystery Control the one thing they will want more than the old radio they have been satisfied with for years.

Yes—hundreds of thousands of people—you and I have met many of them—own radios for which they paid \$300 or more a few years ago. You have heard them say, “My old radio sounds just as good as any of these late models”. Nothing short of actual failure to operate has been able to lure these people into the market.

But Mystery Control will shatter that resistance. Overnight, every radio relic will lose its lustre! Every time its owner rises from a chair to change a program, every time he leaves his soup at the dinner table to tune in a station, every time he wishes for music from his porch or bedroom, that old set will whisper to him, “I’m all done! I’m obsolete! What you need is Philco Mystery Control!”

There is no substitute for Philco Mystery Control. And remember—it is an exclusive Philco invention. Only Philco has it. Only Philco dealers will cash-in on it.

*Harry Boyd Brown*

# PHILCO



# The RADIO MONTH

AUGUST

1938

**Siamese Twins** You can't sell radio sets or service unless programs are being broadcast, and broadcasting would be futile if no radio sets were available for reception. Obviously, therefore, broadcasting and manufacturing are wholly interdependent branches of the same industry. One must fail without the other. Neither can prosper alone.

Already 82% of all American homes have at least one set. Demands of the remaining 18% cannot alone sustain the future of the industry, so that replacement business must be depended upon to support its growth and perpetuation.

Two factors within the control of the industry will affect the volume of replacement buying that is developed from year to year, viz: (1) The extent to which broadcasters succeed in not merely retaining present public interest in radio but how much they can increase such interest, with resulting more frequent and longer use of, and greater wear and tear on receiving sets; (2) The degree to which manufacturers, through improvements in performance, styling and merchandising of receiving sets, can create greater obsolescence-consciousness in the minds of the public with resulting greater desire for modern equipment.

Putting it another way—to sell radio sets and service, we must keep the public sold on radio and—to keep them sold on radio we must keep them sold on broadcasting. No two branches of any industry ever were more inseparably tied together than is radio broadcasting and manufacturing. What then, is more logical than that those two branches should work together for the common good?

The National Association of Broadcasters is organizing its full strength in a campaign to sell the public, the government, its own members, more completely on radio. Self-preservation alone dictates that the Radio Manu-

facturers Association, the Radio Servicemen of America and all other organized interests of the industry should support such type of effort, but instead of each branch of the industry doing an isolated job, let there be a united industry, which through a joint or liaison committee can sponsor a united effort to strengthen and broaden public desire for our products.

Already the Motion Picture Industry has appropriated *one million dollars* to induce more people to attend the "movies". That effort alone may lure hundreds and perhaps thousands away from their radios, unless the radio industry does a better selling job. Within the last few years, night baseball, other night sporting events, more good roads, many new attractions have entered into active competition with radio.

A united effort, sponsored by the whole industry can do much to offset the external influences that threaten future growth and prosperity. Such effort might take the form of a general promotion through broadcasts, and publications, with every dealer tied into the schedule or a more prolonged campaign might be ushered in with a NATIONAL RADIO FESTIVAL, staged at some large auditorium, lasting a week, featuring broadcasts of famous programs, dramatizing the accomplishments of radio through suitable exhibits.

In any event a constructive job of selling radio to the public needs doing, and to such effort *Radio Retailing* pledges its support.

**45 States** The monthly sales reports from radio dealers, which form the basis for our Sales Barometer always provide a welcome and refreshing interlude, in that we gain a sense of personal contact with each cooperating dealer, as his report is opened and studied. We have come

to look upon the period of the first to the seventh day of each month as one of special interest, as with each mail delivery those reports pile in on us.

However, last month we had the thrill of a lifetime. Due to the extra long July Fourth week-end the mail on the morning of the fifth almost snowed us under. When finally sorted and counted, that single delivery was found to have contained sales reports from *over four hundred dealers*, located in 45 states and the District of Columbia. That's a record with us. *Thanks fellows and keep up the good work.*

**Cash On The Line** The Jamestown Association of Radio Service Engineers and Dealers has given notice that henceforth radio parts and service charges are on a cash basis.

That's good work. Dealers and service men everywhere should adopt the same plan—take the cash and let the credit go when it comes to parts and service work.

Service, particularly, is as much a professional function as that of a lawyer and—did anyone ever hear of a lawyer who did not make sure of getting his fee *in advance*?

That every dealer may have some customers who justify exception does not alter the fact that cash-on-the-line is a good rule.



EDITOR



# "1939 RCA Victor Line 25% Better Values than 1938" SAYS STORE OFFICIAL

Dealer enthusiasm from coast to coast confirms wisdom of RCA Victor's decision to offer

## ELECTRIC TUNING for All!

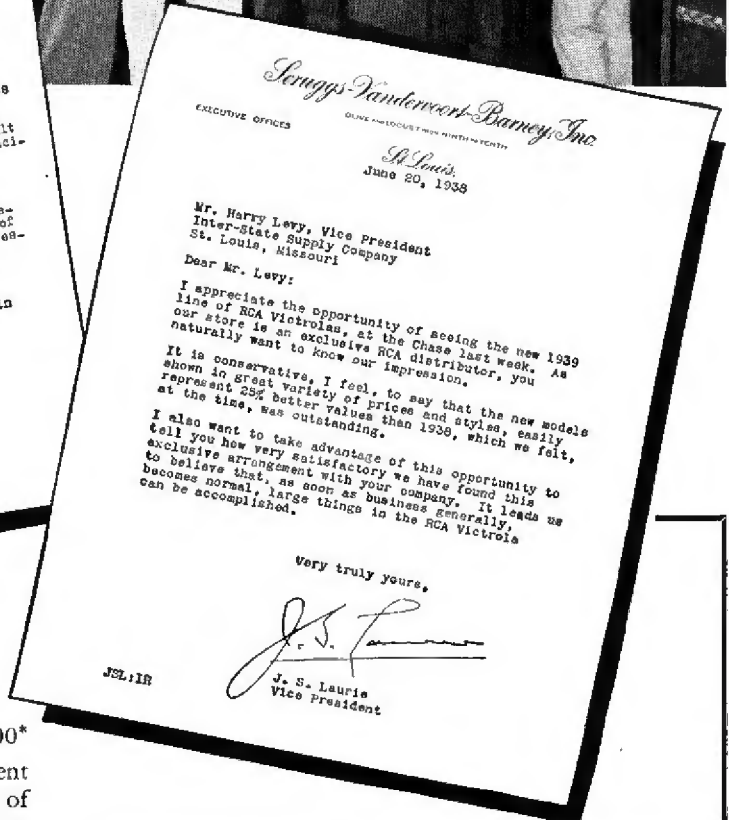
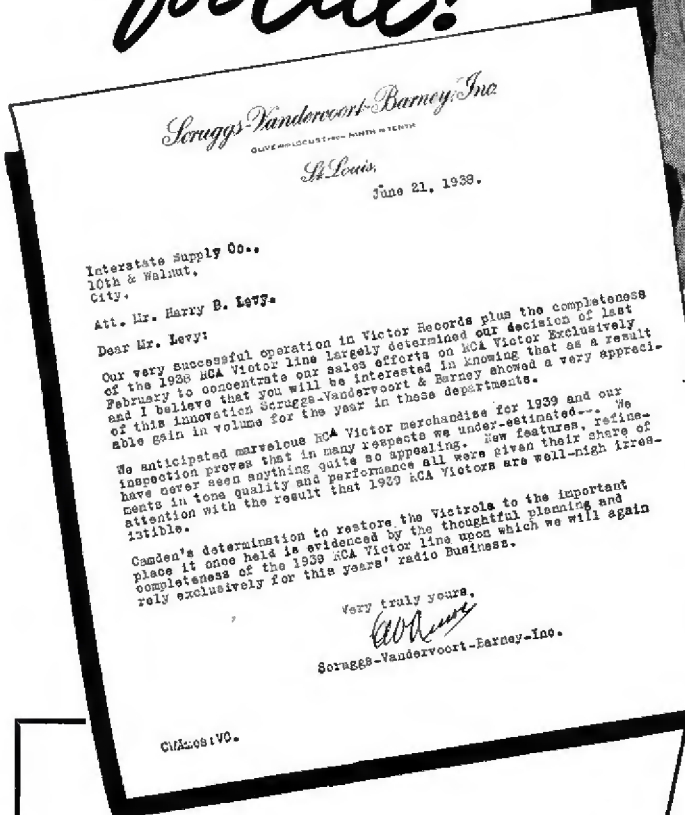
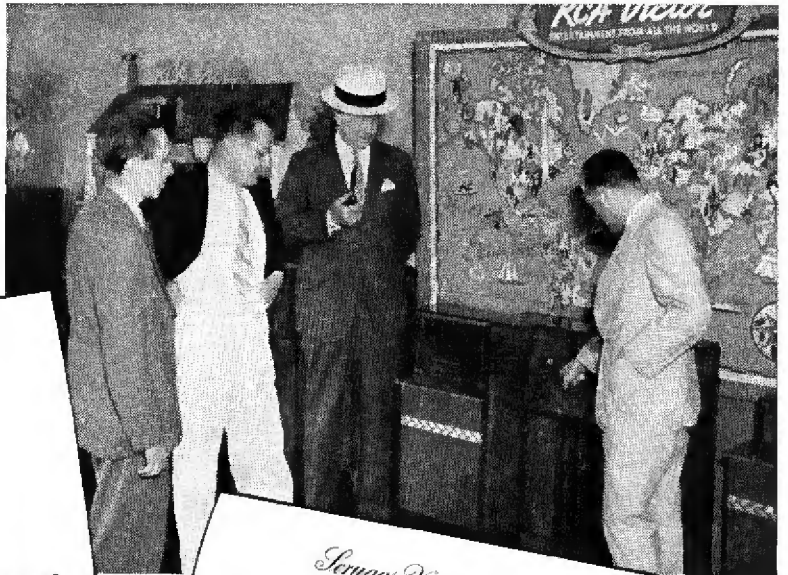

### Two of many enthusiastic dealer letters

Dealers admire new console grand model 97KG. Price \$85.00\*

... this photograph was taken in the Radio Department of Scroggs-Vandervoort-Barney, St. Louis, Mo.—one of the leading department stores in the country. Harry Levy, RCA Victor distributor, is shown demonstrating RCA Victor Model 97KG to Clarence W. Amos, manager of the Scroggs-Vandervoort-Barney Radio Department, Joseph Cantoni, an owner of the Southside Radio Service Co. of St. Louis, and J. S. Laurie, vice-president of Scroggs-Vandervoort-Barney. Letters from Messrs. Laurie and Amos are reproduced on this page. They mirror the enthusiasm dealers from coast to coast hold for the new line. Model 97KG is just one of 32 sensational new RCA Victor radios with Electric Tuning—each one of which is a sure-fire profit item—backed with features to help you sell. Some of the outstanding features of Model 97KG are its

new distinctive Console Grand Cabinet, Electric Tuning for 6 stations, Victrola Button, "Plug-In" for Victrola Attachment, Straight-Line Dial and RCA Victor Metal Tubes. \*Price f.o.b. Camden, N. J., subject to change without notice.

FOR FINER RADIO PERFORMANCE—RCA VICTOR RADIO TUBES  
RCA presents the Magic Key every Sunday, 2 to 3 p. m., E. D. S. T., on the NBC Blue Network



# RCA Victor

RCA Manufacturing Co., Inc., Camden, N. J.  
A SERVICE OF THE RADIO CORPORATION OF AMERICA



# BUSINESS BAROMETER

**S**TUDY of the nation's July radio business indicates that flood tide has started—as far as retail set sales are concerned—and may be expected to run with increasing force to reach its crest in December, unless some unforeseen circumstances should check its flow.

To understand fully the significance of the *Radio Retailing* barometer's climb to the 91 mark in July, it is necessary to remember that our 100% level represents retail set sales for the same month of a most unusual year—1937. In that year the normal cycle of sales was turned upside down, the first half continuing the fast pace set by 1936, (which broke all records in set production and retail sales) the second half seeing the beginning of a widespread depression and violent decline in sales.

Thus, where set sales for the first six months of 1938 had to stand comparison with the high-level sales of what started out to be a banner year in 1937, our barometer figures for the last six months of 1938 are stacked up for comparison against those months of 1937 when sales were definitely on the toboggan. Therefore, if current signs of a real business revival do not prove false, it can be expected that our barometer, which for July has moved encouraging toward the 100% mark, will continue to move in that direction during the remaining months of the year—Flood tide has started.

Now for a few observations that serve to reinforce the soundness of our deduction.

Broken down into Federal Reserve Bank districts, our dealers' sales reports reflect a general narrowing of the gap between 1937 and 1938, even in those districts where sales had dropped most drastically. In some territories where dumping and other abnormal high pressure operations had kept unit set sales near or even ahead of 1937 levels for some months of the first half of 1938, the July sales reports reflect a healthier condition in that comparative percentages are more nearly in line with the country at large. From many quarters, however, comes the comment that unit sales are high because table models and extreme midjets are easily sold but keep dollars down.

Inventories of new sets are reported higher by 75% of all dealers, chiefly because deliveries of 1939 models are under way. Many dealers credit their better July showing to the impetus of the new lines. Increases in the number of store shoppers, and wider interest in new models are reported. In states where intensive political campaigns have been in progress, set sales and service

business benefited noticeably.

While sales in rural territories have lagged because crops, although big and in some cases "bumpers," have not moved to market as rapidly as was hoped, August, and particularly September, are expected to bring a loosening of the jam and cause greatly accelerated buying.

That prices for farm products are moving in the right direction to promote bigger sales to farmers is indicated by the fact that the *Farm Journal's* index of farm buying power as of August 15th had moved upward to 95.2, which is within less than 5% of the normal, based on averages of the years 1924 to 1929.

Many of the 1,000 cooperating retailers whose reports form the basis of the above analysis will have said, "How come," when they read that opening paragraph predicting a steady upswing because many still are showing substantial, and in some cases drastic, declines of sales. Then we remind that this summary deals with the nation as a whole, because space would not permit detailed comment on each state or territory, and we remind them also that we shall be glad to answer inquiries regarding specific territories.

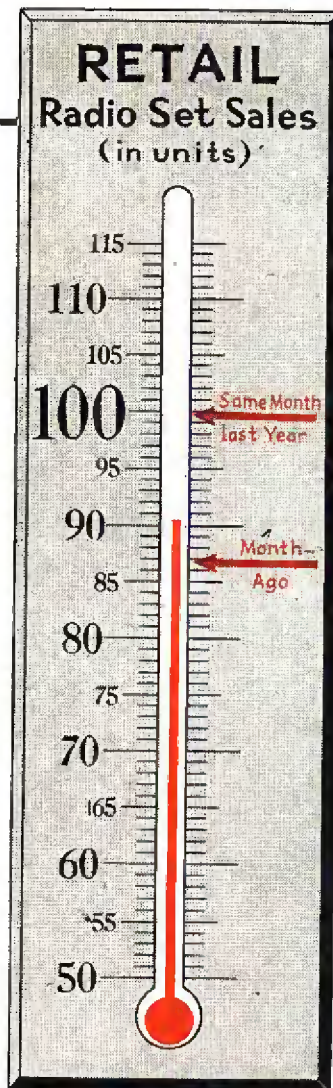

**JULY**





## PERMEABILITY-TUNED *Push-Button* CONVERTER

It is a complete push-button tuning unit ready to be installed in any AC Superheterodyne with a 456 or 465 kc. I. F. system—regardless of the number of sections in the variable condenser! It is a simple installation job. A cable and plug (which comes with the converter) does the trick.

This Meissner converter modernizes any receiver—giving it a push-button choice of 7 stations plus manual tuning; and does not disturb alignment or

tracking of the receiver in the least! The whole unit measures only 6¼" x 7" x 2½". Its dull gold escutcheon harmonizes with the front panel of any receiver.

Servicemen everywhere are doing a nice sideline business installing them. Ask your Parts Jobber for No. 9-1004 at \$11.10 net. Other Meissner Push-Button units as low as \$4.50 net complete.

SERVICE PARTS

VIBRATORS

ADAPTER KITS

TUNING UNITS

COMPLETE RECEIVER KITS



# Meissner

"A FAMOUS NAME FOR TWO DECADES"

MT. CARMEL,  
ILLINOIS



# RADIO RETAILING

AUGUST 1938

**F**EW price-drop headaches coruscate the brow of quarter-Cherokee Earl V. Parker, big chief of the Home Appliance and Service Company, Ada (Pop. 11,261), Oklahoma. Holding up his radio-appliance volume despite widely advertised price-cutting in distant Oklahoma City is a small town merchandising method carefully calculated to impress level-headed farmers and stockmen.

Mainspring of the plan is a distinctive service car. It travels an advertised route, on regular schedule, rolling 100 miles each week. To people who flash clippings illustrating dumped "bargains" Parker insidiously says: "That's a swell price, isn't it. Are those folks going to come down here and keep it running for you?"

Other important cogs are: Parker's policy of maintaining a small stock, turning it over often and so keeping himself in a position to "sweeten" when make and model price-cutting hammers down values despite his service guarantee; his refusal to permit expansion of such fixed expenses as rent, despite continually rising sales.

Reversing the usual formula, service almost invariably precedes sales. Napoleon contended it was better to be a live drummer boy than a dead Emperor. Parker thinks it is better for a family to have a midget radio in perfect condition than a magnificent console out of whack. "Fix their old sets first, sell them new ones later, with less effort, on the strength of your service." This is the Parker policy.

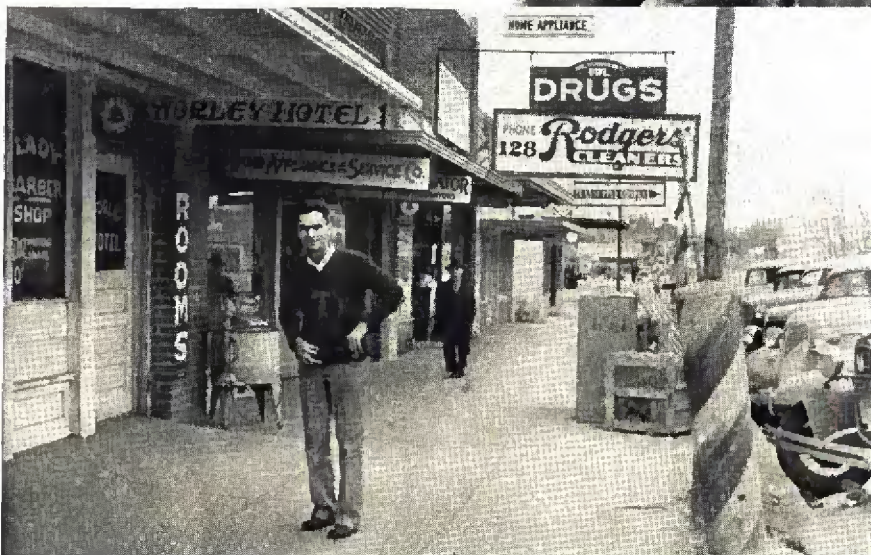

**RED** Blood  
**BLACK** Ink



### DEMONSTRATES RADIO BY RADIO

From a studio within his store (note microphone over set) by remote control to a local broadcast station actual demonstrations of current receiver models are staged by Noel Ray, Gadsden, Alabama. An employee serves as a "prospect," asks questions enabling Ray to bring out fine points. Refrigerators, washers, are demonstrated the same way, produce interesting sound effects

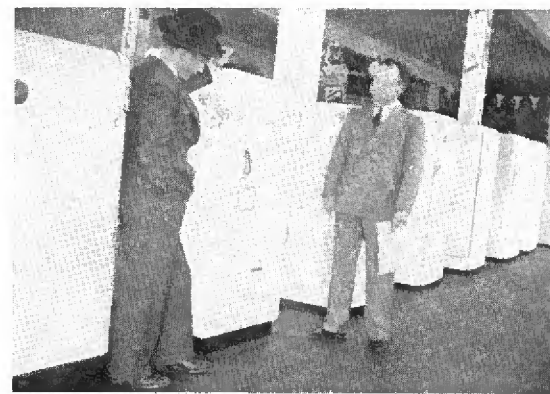
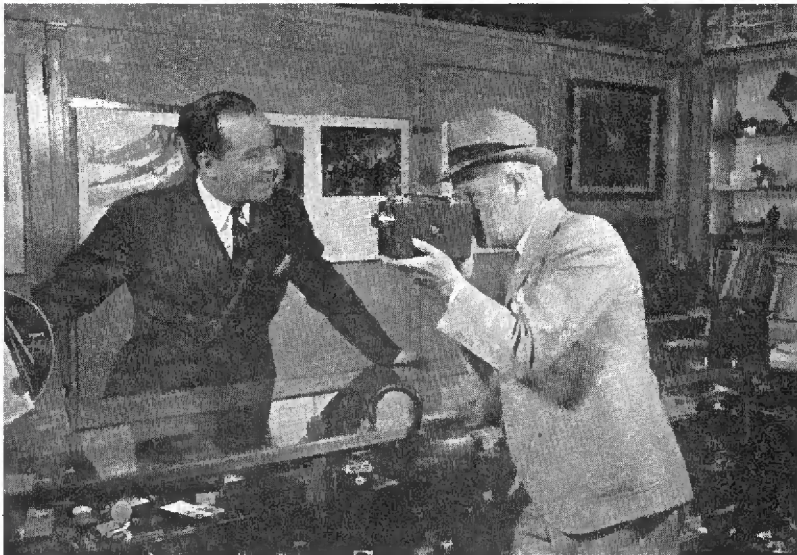

### GET CAMERAS IN THEIR HANDS

The way to sell cameras is to get them into the hands of the prospect. So attractive are new models that the average man, once he has had the opportunity of demonstrating ease of operation to himself, hates to pass them back across the counter (*Dale Carnegie in a GE sales film*)

### EAST SIDE, WEST SIDE

Down one side of the Meyer Lubotsky store, Milwaukee, is a radio display. Down the other are refrigerators. In the "alley" between customers can be quickly conducted to any model of either item



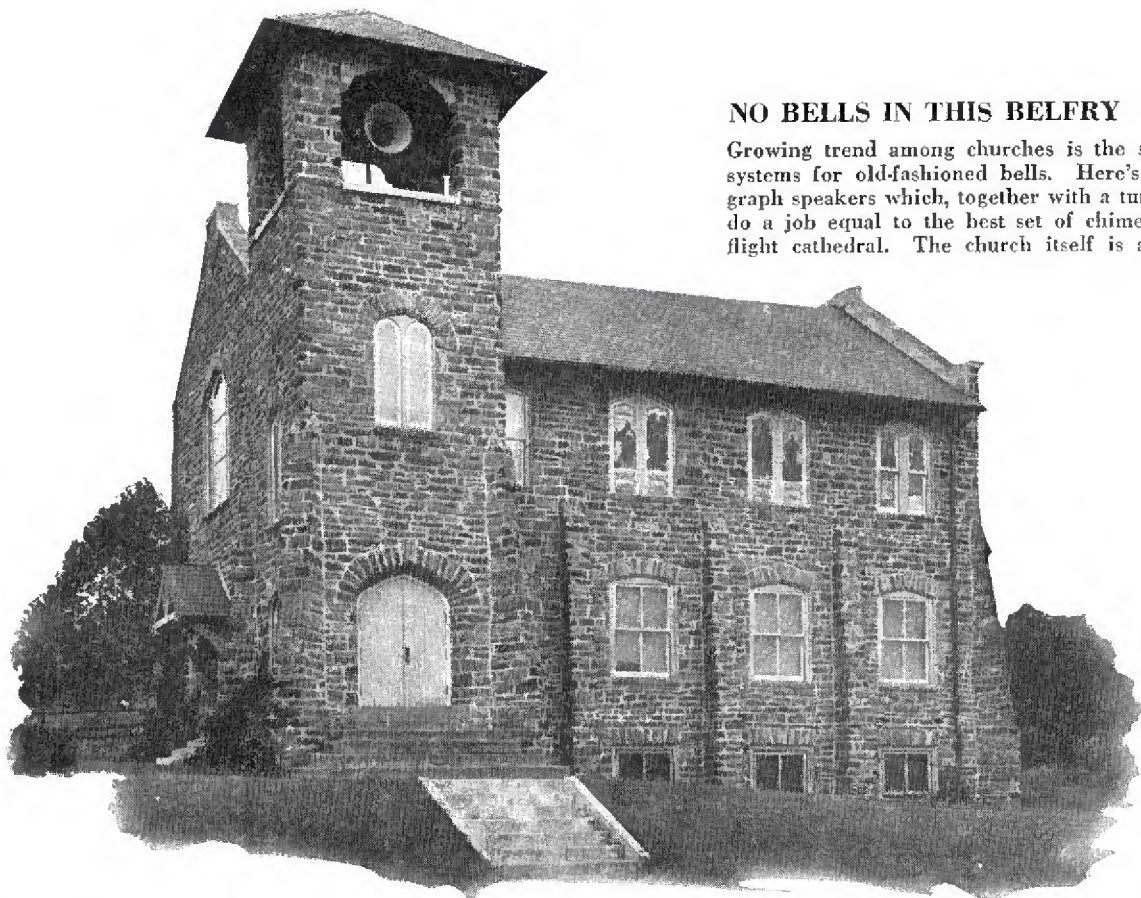

### NO BELLS IN THIS BELFRY

Growing trend among churches is the substitution of sound systems for old-fashioned bells. Here's a bank of Cinaudagraph speakers which, together with a turntable and amplifier, do a job equal to the best set of chimes owned by any top-flight cathedral. The church itself is also wired for sound

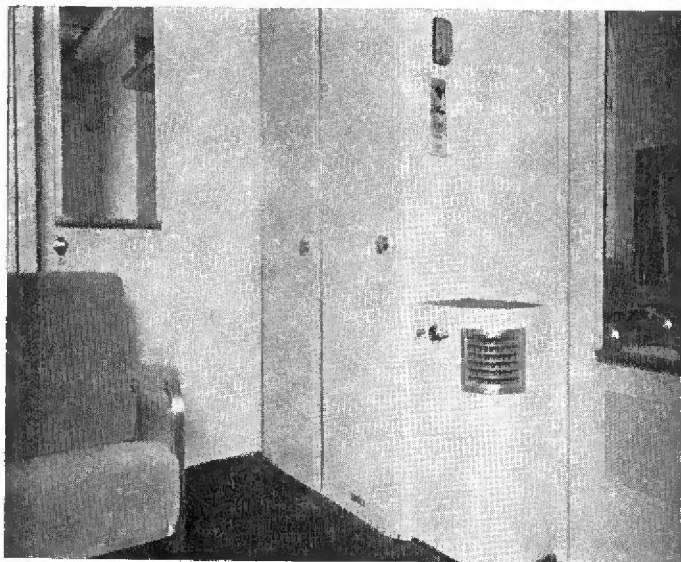

### NOW IT'S WORKING ON A RAILROAD

Built into the deluxe compartments on the re-styled "Broadway Limited" are RCA Victor radios that fit the scheme of things to perfection. At home, in a car, on a railroad, radio is always ready

### AND LESS HAGGLING ABOUT TRADES

Joseph L. David of Passaic, New Jersey, concentrates on the men, despite his knowledge that women influence 80 per cent of all retail sales. Why? Because his records show sales to men average \$140, to women, \$75!

RADIO RETAILING, AUGUST, 1938



### EIGHT OUT OF TEN FALL

Just as each old customer completes his radio payments Royal Radio of Milwaukee sends a man to make sure the set is still satisfactory . . . and to talk refrigerators, washers





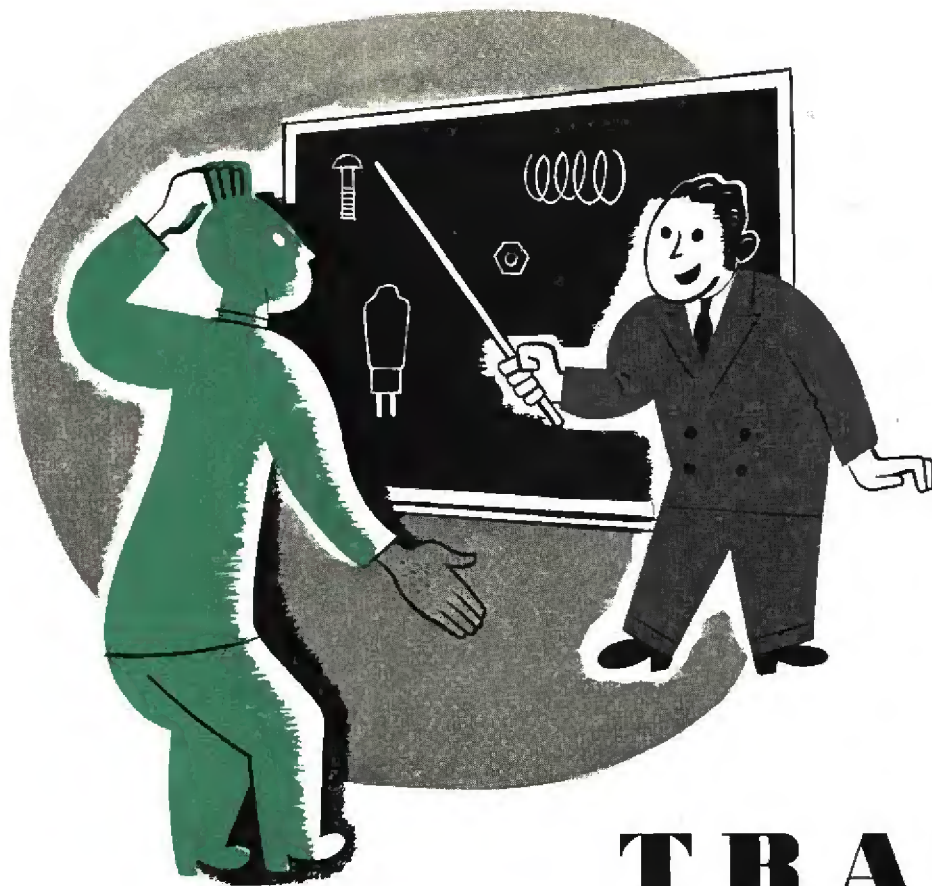

1

Moisture behind the tyro's ears dries up rapidly if you pump him full of dope about competitive makes as well as facts concerning the stuff he is to sell

# TRAINING

**T**HE proper training of inexperienced men in the outside selling of radio and electrical appliances is really a three-fold undertaking: (1) teaching them the selling points of the merchandise, (2) teaching them to canvass, (3) teaching them to sell.

Training an inexperienced man to sell well enough to earn a living is something which cannot be done in a day, or a week, or a month. It involves (a) a knowledge of his own mental and physical equipment, (b) a knowledge of competitive makes, (c) selling ability in general.

If we take even a man who is already a good salesman (c), give him four days of intensive training in his product (a), he is still at a disadvantage: he is not familiar enough with competitive makes (b) to hold his own with an experienced salesman—all else being equal. I'm not saying that he won't survive; but he will reach his peak only through experience.

Consequently, I do not recommend the impossible. I advocate the teaching of a man gradually, letting him earn while he learns, which

2

That ogre-like look about women who answer hesitantly pressed doorbells bothers beginners less when they learn to anticipate a turn-down and how out in advance



is not only better for him but less expensive for his employer.

It is necessary, with our set-up, that the men become self-supporting very quickly; and they can, as merely canvassers (2), be very val-

uable men. A certain knowledge of his product (1) is necessary for the canvasser, naturally, but this training need not cover a short space of time. He can learn his equipment



gradually (and consequently more thoroughly); instruction along these lines should be given him at later sales meetings, and at odd moments by the supervisor.

It is *very* essential, however, that the new man learn a great deal about the proper way to canvass—and right away. Much of this an intelligent man would learn for himself, in time, but he will learn much faster, and is much less likely to become discouraged, if his supervisor gives him quite a little coaching during his first week or so.

#### Canvassing

It may be amusing to some of you when I include such subjects as *pace* and *stoicism* along with *approach* and *pressure*. But if you ever taught an inexperienced man,

If he does not seem to be in a hurry there is less chance of the housewife (power of suggestion) being in a hurry to close the door. Further, five hours of canvassing every day is the height of monotony, and the sooner he learns to settle down to a slow (but steady) grind, the sooner it will become less boring to him. He can even reach the point where he doesn't mind it at all.

There are two ways to have a door slammed on you—in your face, and get mad about it; or at your back while you are already on your way to the next house. In the latter case, you are busy looking at some of your papers, and the lady gets the idea that her uncivil manner has not even been *noticed*. The more artistic canvasser sometimes even conveys (and politely) the impression that

comes ruffled; and while this is due partly to a sort of practiced stoicism, it is more because he has learned to anticipate a rebuff and circumvent it.

#### "Suction"

I am going to go far out on a limb and tell you that the most effective canvassing can be done with the least degree of pressure.

It is very true that a certain degree of pressure must be brought to bear upon the prospect by the canvasser, and at the right time. But too much pressure is worse than none at all. We must remember that a man at the door is at a disadvantage in the applying of pressure. A man with an appointment inside the home, or calling back after a radio has been placed on demonstration,

## GREEN SALESMEN



especially a sensitive man, to canvass with the most effect and the least embarrassment or humiliation to himself, you will not be among those amused.

The new man should be told to take his time when he is canvassing,

he is glad to get rid of her. The supervisor can demonstrate this better than he can explain it! Constant practice enables a man to detect these door slammers instantly, and avoid their fury.

The good canvasser seldom be-

**3**  
"Suction" is the clever business of agreeing that one ancient appliance is not so bad in order to gain a sympathetic ear for another. You later replace the first one anyway

is in a much more favorable position in this respect. A better name for the type of pressure I have in mind for the canvasser is *persuasion* and it should be, and can be, not only courteous but camouflaged, veiled, and practically unnoticed, as pressure, by the prospect.

There are four members of this pressure family, and each one is effective when used at the proper time. These are high-pressure, low-pressure, no-pressure, and, what may be a new one to you, "suction."

The only time that high-pressure can be used effectively, by the *canvasser*, is when he has his product with him. A man carrying a vacuum cleaner in his hand, for instance, can in a great many cases, to make a long story short and get back to radios, "ossify" the lady and have the thing demonstrated and sold before she fully realizes what has happened.

At the other extreme is the man canvassing for refrigerators. It is selling from beginning to end.

Between the two is the radio. A man canvassing for radio demonstrations, even if he has the radio on a trailer in front of the house, is in

(Please turn to page 54)



# Parts Jobber Stocks

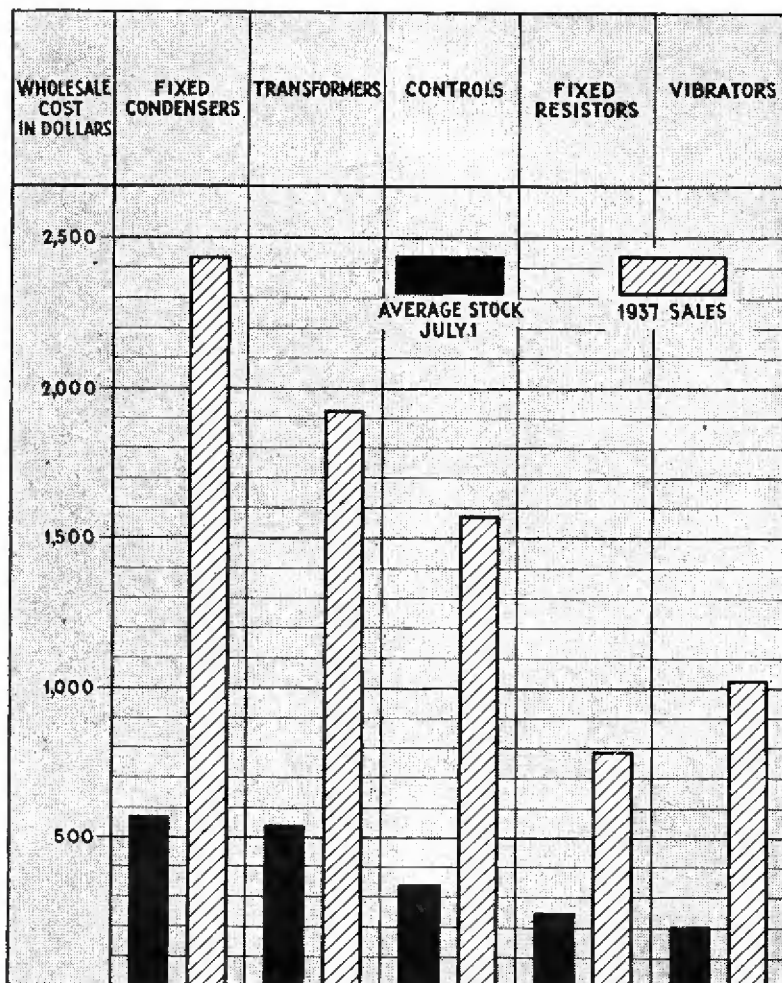

**July 1 survey covering condensers, transformers, controls, resistors, vibrators, indicates trade is in flexible position**

**J**UST as the "Business Barometer," appearing as a regular feature of *Radio Retailing* since April, permits more reliable projection of probable new season set sales totals, enables the trade to guard more intelligently against overproduction, so would similar figures relative to replacement and experimental parts in retail stocks facilitate closer control of this important segment of the business.

Readers have urged us to expand in this direction.

The Editors have closely investigated the possibilities of this suggestion and are forced to the con-

clusion that a month-by-month retail parts sales summary is not at the moment practicable owing to the vast number of small items encountered and the inability of the trade to estimate closely inventories at other than widely separated intervals. Next best thing is a periodic checkup of parts stocks on hand among jobbers. This we can occasionally attempt, as in the present instance.

On hand July 1 in the average parts jobber's stock was an investment of \$579 in fixed condensers, \$545 in transformers, \$320 in controls, \$250 in fixed resistors and \$201 in

vibrators. Average stock investment in these five major items totalled \$1,895.

In 1937 the average radio parts jobber sold \$2,436 worth of fixed condensers (wholesale cost value), \$1,925 worth of transformers, \$1,575 worth of controls, \$1,020 worth of vibrators and \$794 worth of fixed resistors. Average sales, these five major items together, totalled \$7,750.

Surveyed to obtain this data not hitherto available, were twelve states: California, Connecticut, Florida, Illinois, Maryland, Nebraska, New Jersey, New York, North Carolina, Ohio, Pennsylvania and Wisconsin. Smallest parts jobber reporting sold \$555 (wholesale cost value) worth of the five items covered during 1937; largest \$21,600. Smallest stock investment encountered, these five items together, totalled \$270; largest \$3,800.

Further detailing reports to show the wide difference in parts jobber calibre covered by this survey and so guard against possible misinterpretation of the figures, we find that the smallest fixed condenser stock encountered July 1 involved a \$45 investment, the smallest fixed resistor stock a \$21 investment, the smallest transformer stock an \$82 investment, the smallest control stock a \$50 investment and the smallest vibrator stock a \$25 investment. At the other end of the scale, largest jobbers reporting had \$2,000 in fixed condensers, \$400 in fixed resistors, \$2,700 in transformers, \$700 in controls and \$500 in vibrators.

Smallest jobber sales in 1937 were: \$150 in fixed condensers, \$50 in fixed resistors, \$100 in transformers, \$30 in controls and \$75 in vibrators. Largest sales reported for the year showed: \$6,000 in fixed condensers, \$2,400 in fixed resistors, \$7,500 in transformers, \$4,800 in controls and \$4,800 in vibrators.

While there are obviously parts jobbers larger than the biggest included in this report, if not smaller than the littlest, it is felt that the variety on hand for tabulation presents a satisfactorily accurate average for most practical purposes of study.





IT'S got all the smashing sales wallop of a 16-inch gun—this Double Barreled 1939 Sentinel Line.

A revolutionary new Farm Radio with the lowest operating cost in battery radio history—City Radio with an amazing new and exclusive Front-Adjusted Electric Push-Button Tuning System—both at the lowest prices ever offered for quality receivers—and each model built to Sentinel's highest standard of quality—with every new and modern radio feature—irresistible values—merchandise that's packed with sales appeal.

Get your 1939 Radio Profits with the Double-Barreled Sentinel Line—Mail the coupon today.

### City Radio

- Amazing New ELECTRIC Push-Button Tuning System.
- Smart Molded Bakelite Cabinets.
- RAD-O-FONE, the private telephone for the home.
- Novel Thermometer Type Dial.

### Farm Radio

- Battery Drain slashed 60%—with the lowest operating cost in history.
- RAD-O-FONE, the private telephone for the farm.
- Distinctive Cabinets.
- 1½ Volt, 6 Volt, 32 Volt, 6-110 Volt and Hi-Line Models.

**SENTINEL QUALITY**



**AT LOWEST PRICES EVER OFFERED!**

# Sentinel

**MAIL THIS COUPON**

SENTINEL RADIO CORPORATION  
 Dept. R. R. 8 2222 Diversey Parkway, Chicago, U. S. A.  
 Please rush me complete details of 1939 Sentinel Line.  
 Farm Radio     City Radio

Name .....

Address .....

City.....

**QUALITY RADIO SINCE 1920**

H. A. 8



## How refrigeration can be safely sold by radio retailers to "poor people" who were passed over when the cream was skimmed

**A** STORY, a jest, sums up an age—and the market which has absorbed America's electric refrigerators up to now may be summed up by a story. It seems a wealthy woman was telling how she cleaned her rubies with port wine; her diamonds with bourbon; her pearls with buttermilk. "And you, my dear," she languidly asked her friend, "What do you clean your jewelry with?"

"When my jewelry gets dirty," replied the friend, "I don't clean it—I just throw it away!"

Such people, in varying degrees of affluence have been a heaven for refrigeration salesmen in the last ten years. Fresh in funds, these citizens could make their wants elastic—could be sold "up" or if not pleased could "throw it away." They looked, they liked electric refrigeration—and today 11,221,000 wired homes—49.4 per cent of the total, to be exact, enjoy it.

And now we have come to a turn in the road. Aside from replacements, we are starting to sell refrigeration to the poorer portion of the public, and there is a difference in such a market. There are new angles to face when one goes after the \$2,000 or less income group.

Poor people and what makes them tick has been a lifelong study of Burr Blackburn, director of research, Household Finance Corporation. His is a firm which makes loans to people too poor to enjoy bank accounts. Its job is to guess right on both credit risks and collection policies. Worth listening to are Blackburn's views on the market which radio dealers are exploring.

Sales to the poor are amazingly easy to make, he points out. Credit is the catch in the picture. Returns and collections are the trouble makers. There has been a change in outlook, since 1929, which makes low income groups increasingly reckless in obligations.

Perhaps it was the bank failures, possibly the way American leaders

# CREDIT

## *for the*

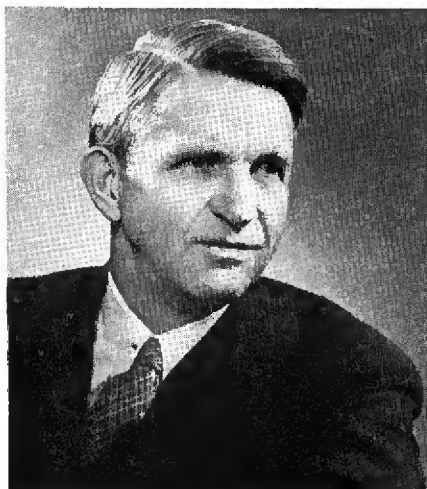

**BURR BLACKBURN**—His lifework has been the devising of plans which permit the average American to pay

lost prestige, maybe government spending—but the philosophy of poor people today is largely to take anything they can get—and let tomorrow take care of itself. As an example of how credit sense has disintegrated, in 1929 Household Finance Corporation made loans to 70 per cent of its applicants, today it dars take only 30 per cent.

"From 20 to 30 per cent of the families in any community are on the brink of insolvency," says Blackburn. "Consequently it behooves any dealer doing business with low income classes to be exceedingly careful. For insolvency is a disease which is spreading. The coming job of credit bureaus, of chambers of commerce, and mer-

chants in general, is to coach people to live within their paychecks. There is no profit in doing business with families who cannot pay their bills."

"What can a radio dealer do about this when he is selling refrigerators?" Blackburn was asked.

"Generally speaking, families are on the brink of insolvency because they have not been educated in family economics. The city man with a salary has little co-operative sense. His wife and children get what they can wheedle out of him. Not knowing how to spend money, the whole family gets itself into trouble by reckless buying, by pyramiding debt. With one out of every five department stores selling all types of merchandise on deferred payments, according to the National Retail Credit Association, with 72.4 per cent selling other than durable goods on this basis, it becomes obvious how keen the competition is for the poor family's dollar, and how carefully the dealer selling electric appliances must proceed.

Of utmost importance, is the obtaining of a complete history of the customer. What he earns, and what he is already obligated to pay on other deals is a prime matter of record. With knowledge of the rent he pays, and other details, it is easy for a dealer to figure out





## LOW INCOME Buyer . .

whether the man can pay out on his purchase. Names of relatives are needed, and should be checked before credit is passed. Willingness to pay cannot be judged altogether by records of other accounts, but by time on the job, length of time in a neighborhood, etc. Here are some good rules to follow:

1. A customer's total installment indebtedness should not exceed more than two months' income.
2. His monthly payments on loans and installments should not exceed 10 per cent of his monthly income.
3. He should never obligate himself to make installment payments which will force him to sacrifice the necessities of life.
4. He should know the true interest rate which is being charged.
5. He should be encouraged to get credit at the lowest cost.

Most of the trouble and expense in selling poor families is due to failure to use good judgment in passing on the risk. Note the experience table of the Quackenbush Company.

40% of repossessions were due to errors in credit extensions—poor moral risks on which the firm was unable to get information on past credit experience.

30% of repossessions were due to loss or reduction in income—this figure greatly affected by increasing the time of the contract.

10% of repossessions were due to not thoroughly selling the customer on the goods.

10% were due to unsatisfactory merchandise and racketeering of competitive salesmen.

10% were due to domestic troubles.

100%

Failure to keep customers paying on their contracts causes loss of trade to a dealer. In an analysis made of those 30 days slow, 17

per cent were not buying in the current month; of those 90 days behind, 70 per cent were doing their buying elsewhere.

"The trouble with the credit bureau is that it doesn't prevent the pyramiding of debt among poor people who are already bogged down," declares Blackburn.

Brightest ray of sunshine in the scene, he thinks, is the opportunity for the radio dealer to cash in on a consumer trend. For a quarter of a century, the movement, which started in college home economics departments, has been gathering momentum. Today the popularity of agencies and booklets on the subject has made a radio joke out of "tattle tale gray," sex appeal created by soap, gargling with special toiletries. The public is laughing at such sales stories.

"The American public is much more ripe for unemotional economic education than advertisers realize," says Blackburn. "They are fed up on ballyhoo and evasive statements. I saw a cartoon the other day of two little girls before a movie sign which said 'gigantic, stupendous, colossal'. One little girl was remarking, 'Is it any good?'"

"What can the average radio deal-

(Please turn to page 56)

### YOU HAVE TO KNOW HOW

In Atlantic, Iowa, the Young Furniture Company sold refrigerators for 15¢ a day, got too many returns when the weather turned cool.

Yet in Little Rock, Arkansas, the Keller Radio and Refrigeration Company sold much the same deal, kept a boy on a bicycle busy collecting, found the plan profitable.



# TUBE SALES IDEA CONTEST

IN PRIZES **\$150.** IN PRIZES

RADIO DEALERS, SERVICEMEN, DISTRIBUTORS

For the Best Letters on the Subject

## *“How to Build Bigger Tube Sales”*

RADIO RETAILING will award the following four prizes, subject to contest rules here published.

**CLASS A** For radio dealers, servicemen and those employed by them  
1ST PRIZE.....\$50.00  
2ND PRIZE.....\$25.00

**CLASS B** For regularly established tube distributors and their employees  
1ST PRIZE.....\$50.00  
2ND PRIZE.....\$25.00

### CONTEST RULES

1. The prizes as above announced will be awarded by three impartial judges for the four letters of 500 words or less which contain the most simple, practical and widely usable sales plan or sales idea through which *radio dealers or servicemen* can increase the sale of replacement tubes without engaging in unethical, unbusinesslike or loss-producing practices.

2. Letters submitted will be judged strictly *on the merits of the ideas* they contain and *not* on the manner of presentation or literary style. They should be written on business stationery.

3. All letters submitted become the property of *Radio Retailing*. None can be returned.

4. Eligible to enter this contest are all regularly established radio retailers, servicemen, tube distributors and any regular employees or sales persons in such establishments. Before the final awards are made the judges will require satisfactory evidence from nominated winners that they are eligible under this rule.

5. Letters must specify whether entered for Class A Dealers' prize or Class B Distributors' prize. Remember, there are two classes of prizes, but *all* sales ideas submitted *should be suitable for use by dealers and servicemen only*.

6. **NOT ELIGIBLE** are officials or employees of the McGraw-Hill Publishing Co., or of any manufacturer, or of any advertising agency, or any individual not strictly within the classification of Rule No. 4.

7. This contest closes at midnight, September 30, 1938. All letters entered must be addressed to the *Tube Contest Editor, Radio Retailing, 330 West 42nd St., New York, N. Y.*, and must bear postal cancellation stamp of September 30, 1938, or a prior date.

8. Each entry will be judged by the following board of judges, whose decision is final:

BOND GEDDES, Executive Vice President,  
Radio Manufacturers Association  
JOE MARTY, Executive Secretary,  
Radio Servicemen of America, Inc.  
O. FRED. ROST, Editor,  
Radio Retailing

9. Duplicate prizes will be awarded in case of ties.

10. A Complete list of winners will be published in the October, 1938 issue of *Radio Retailing*.



# BIOGRAPHIES IN MINUTE



**A. A. SCHNEIDERHAHN** (A. A. Schneiderhahn Co.) Des Moines calls him lucky. Born in St. Louis, formed Midwest Auto of Dubuque with G. J. Timmermann. Later manufactured through-the-windshield spotlights, sold one by mail to Prince of Wales. Next got distributorship for Atwater Kent in Sioux City. Opened branch in Des Moines, eventually moved there. Now distributes Zenith



**D. H. LIPSEY** (Roycroft-Iowa Co.)—Still better known in Chicago, from which he came in 1937. Optimistic about business this season, says independent dealers can compete with any catalog house by properly advertising trade-ins and then doing their stuff on new lines when people come in. Now pushing in the territory for Philco

**D. D. GIFFORD** (Gifford-Brown-Holliday)—One of the many auto supply distributors that took a hop, skip and jump into radio. At time we shot his picture seemed much concerned about non-uniformity of discounts in radio business. Does a nice job of distribution for Motorola



**W. R. CANTRELL** (Luthe Hardware Co.)—Born in Springfield, Missouri. Grew up in tradition of hardware business with his folks in Nashville, where relatives still operate a family store. Played football at Iowa U under coach Biff Jones in pre-war days. His firm's been distributing Stewart-Warner since 1935



**G. C. MERRITT** (Westinghouse Electric Supply)—In charge of Westinghouse radio sales in Des Moines, directing sales of other equipment as well. Started in town in 1907 as a collector for an electrical contractor. Progressed through stock room, purchasing department, to present job



**H. R. LINEBAUGH** (Sidles Co.)—When he isn't selling RCA, he's keeping a sharp lookout for rare coins, his hobby. Owns Flying Eagle 1856 quarter, penny worth \$15. Got into business through theatre orchestra work, playing a trumpet. Knows music from the ground up and likes to talk about it

**JOHN J. HEIB** (Heib Equipment Co.)—Thinks facsimile would sell especially well in farm areas. Says people working on farms need news flashes, especially weather reports and market quotations, but don't have time to sit around waiting for them. Covers the area like a blanket with a staff rooting for Crosley





**DISTRIBUTOR SPEAKS HIS MIND**—John H. Brown of H. C. Noll's, Omaha, thinks the average sound retailer fails to show off his wares to best advantage, makes some practical suggestions



## *How to Demonstrate* **SOUND**

**A**n alarm clock stood on a pedestal beside a microphone. Back in the recesses of the auditorium the gray heads of the school board bobbed about as they awaited a demonstration on sound equipment.

"Z-z-z-i-i-n-n-g!" went the alarm clock, concentrating attention. Then to the microphone stepped John H. Brown of the H. C. Noll Company, Omaha distributor. "Gentlemen," began Brown, "the kind of material that you will want to go through this microphone is as variegated as a bill-of-fare in a restaurant. Sounds as widely different from one another as chop suey is from spumoni ice cream will be amplified. I will demonstrate to you how well our equipment handles variety."

Then Brown shook the rafters with the stirring strains of the "Stars and Stripes Forever." After that he put on a record of a soprano

singing voice, a basso profundo. Next came sound effects, frequency records, every type of sound he could produce. His demonstration was interesting, convincing. He got the order.

### **Demonstration the Thing**

"Sound equipment today is as different from homemade products as the home-rolled radio was from the factory assembled product," Brown later told *Radio Retailing*. "These factory assembled jobs will do a lot more than the average outfit put together by some serviceman. The trouble is, we have not yet perfected ways and means of putting this type of equipment through its paces. We do not show off what it will do. Therefore, I suggest that the first thing necessary to sell sound equipment is:

*Records.* Records that carry everything from a whisper to a brass

band, that in one little package offer a performance which permits a man to show off his wares to the fullest. I also think the man selling sound equipment should carry a portable record player which will permit prospective buyers to listen to the record alone and then hear it through the amplifier.

In Omaha, says Brown, virtually every piece of business practically originates itself. Somebody gets an idea he wants something done, calls in some radio men. Many of them attempt to build it. The customer has no idea of what the job should cost, sets up an arbitrary figure and the bidders immediately get busy and try to build to that figure. Only one out of five such homemade outfits works properly.

### **Business Needs Imagination**

Down at Borsheim's jewelry store they got an idea that clock chimes out in front would attract trade. The firm was thinking of spending around \$1,000 for a chime clock. The difficulty lay in where to put it. Someone thought possibly the clock could be kept inside and a

*(Please turn to page 56)*

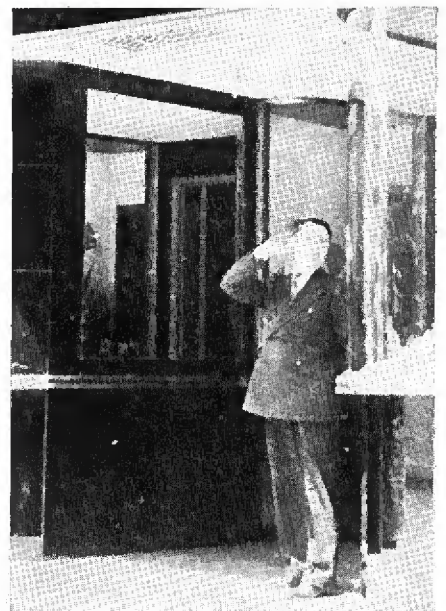

**HE WAS FROM MISSOURI**—Contemplating purchase of a \$1,000 chime clock was this jewelryman when Brown heard about him, demonstrated and installed a sound system to do the job at lower cost



YOUR EAR WILL TELL THE DIFFERENCE



9-Tube Console Grand illustrated, No. 9CG



THE NEW

## FAIRBANKS-MORSE RADIOS

### Features of the NEW F-M Line

which includes table, console,  
and console-grand models  
with 7-, 9-, and 12-tube chassis

- Instant Electric Tuning • Acousti-Sealed Tone Chamber • Monitor Panel • Complete Permeability Tuning • Cabinetry of highest quality with interlocking construction • Clearer and stronger short-wave reception • Plus the most startlingly realistic tone you have ever heard in a radio.

If you want a radio line that is built for those who insist that their radios be truly fine *musical instruments*—that takes you miles away from price competition, novelty cabinets, trick dials, and gadgets—that gives a new thrill to listening—

If you want to fill every demand of

the *profitable* type of buyer from a small number of models and put your profit in the bank instead of into stock—

Write or wire for details. Fairbanks, Morse & Co., Home Appliance Division, 2060 Northwestern Ave., Indianapolis, Indiana.

# FAIRBANKS-MORSE RADIO

A TRULY *fine* RADIO



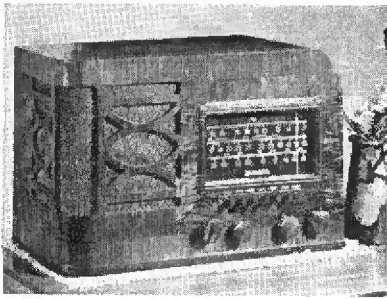

**HOWARD** Howard Radio Corp.  
1731 Belmont Ave.

Features Howard's Bass Boost over three bands from 22,000 to 540 kc. Beam power output, one stage preselection, electronic tuning eye.

# Preview of New

## ZENITH

Zenith Radio Corp.  
6001 Dickens Ave., Chicago, Ill.

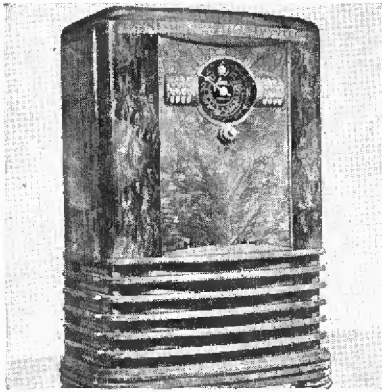

**MODEL 95367**—A 9 tube superhet with Transcontinental Automatic Tip-Touch Tuning; receives American, foreign broadcasts, police, amateur, aviation, ships; 12 in. speaker; big black "Robot" dial; spinner tuning.

## STROMBERG

Stromberg Carlson Tel. Mfg. Co.  
100 Carlson Rd., Rochester, N. Y.



**MODEL 340-V**—Styled from a Pennsylvania corner cabinet shown in Wallace Nutting's "Furniture Treasury" the corner console shown is said to conquer acoustic difficulties by use of the Stromberg-Carlson Labyrinth.

## DETROLA

Detrola Radio Corp.  
1501 Beard Ave., Detroit, Mich.

**COMBINATION** — Radio-phonograph which accommodates 10" and 12" records. Self-starting a.c. motor. Receiver covers broadcast band from 540 to 1720 kc. Crystal pickup, reduction drive, aeroplane dial, 5" dynamic speaker, beam power output.



## MOTOROLA

Galvin Manufacturing Corp.  
4545 Augusta Blvd., Chicago, Ill.

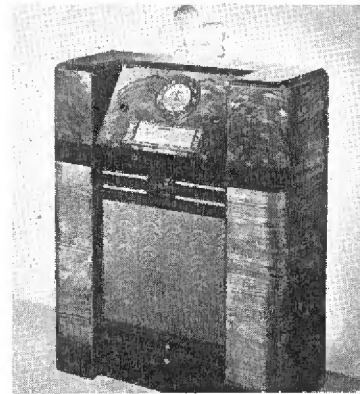

**MODEL 89K-1** — Eight tube a. c. superhet equipped with "Time Tuning" will tune in any one of six stations automatically during the day. "Feather touch" motor driven 6-station automatic tuning, straight line dial slanted for easy tuning, 10 inch electro dynamic speaker.

## WILCOX-GAY

Wilcox Gay Corp.  
Charlotte, Mich.

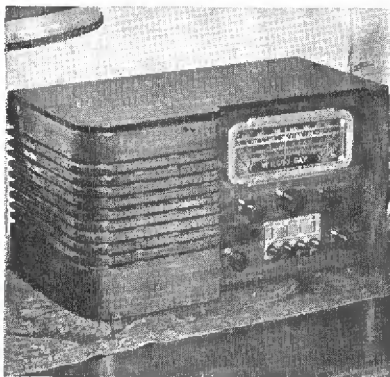

**MODEL A-54**—Seven tube superhet, push-pull amplification, two speed manual tuning and 4 station pushbutton automatic tuning, two wave bands, 3 gang condenser, walnut cabinet. List \$34.95

## CROSLEY

Crosley Radio Corp.  
Cincinnati, Ohio

**MODEL 438M** — Combination Radio and phonograph. Electrodynamic speaker, Crosley mechanical system of push button tuning. The radio's volume control regulates output of both radio and phonograph. Tuning range of 540 to 1725 kc. Self-starting phono-motor with automatic cut-in of the high impedance pickup.

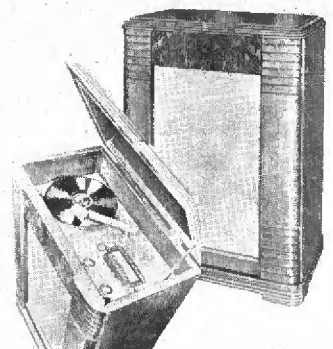



# Radio Merchandise

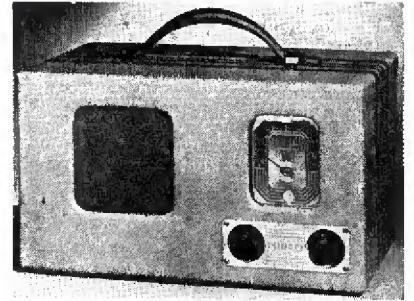

## PHILCO

3701 N. Broad St.  
Philadelphia, Pa.

For sportsman, vacationer, traveler; eighteen pound self-powered portable receiver offers 250 playing hours before battery replenishment.

## RADIO-LAMP

Radio Lamp Co.  
1227 W. Washington Blvd., Chicago, Ill.

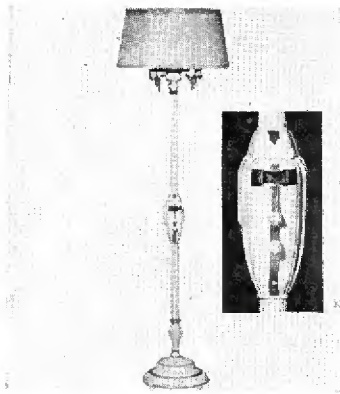

A full 63 in. six-way lamp and reflector houses 4 tube radio receiver in lamp base and speaker at the top. The set's volume control and illuminated dial are located in the center break of the lamp. Finished in antique ivory and gold or old English bronze.

## PIERSON-DELANE

Pierson-DeLane, Inc.  
2345 Washington Blvd., Los Angeles, Calif.

RECEIVER—Model PD-88 gives wide range reproduction coupled with simplicity of control. 12 in. speaker, acoustic frequency range from 30 to 8000 cycles with less than 2% distortion at normal output; 20 push button tuning; individual bass and treble controls; triple tuned band pass filter; infinite impedance detector. \$155 list

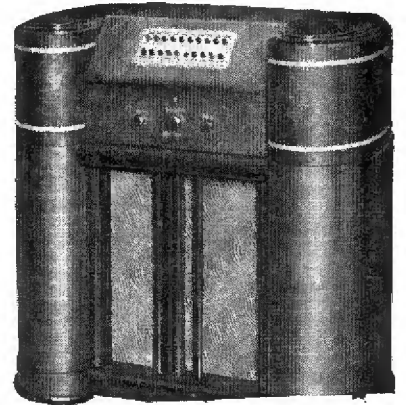

## FAIRBANKS, MORSE

Fairbanks, Morse and Co.  
2060 Northwestern, Indianapolis, Ind.

Model 7AT — Table model a.c. receiver covering a range of 535-1725, 2200-7200, 7000-23000. Pushbutton and dial tuning. List. \$69.95



## ARVIN

Nobilitt Sparks Industries, Inc.  
Columbus, Ind.



MODEL 58A — Streamlined, ivory, radio, a.c., d.c., superhet. Five tubes plus ballast tube, edge-lighted dial.

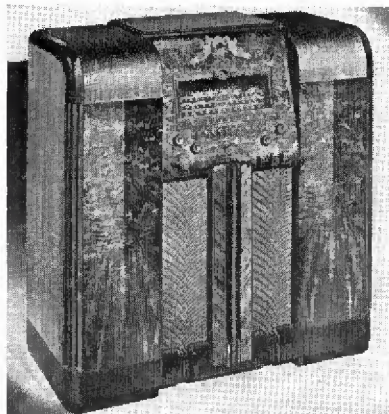

Model 9CG — Console grand with pushbutton tuning and band coverage from 535 to 1725, 2200 to 7200, 7000 to 23,000. List \$129.95

MODEL 78—Walnut 5 tube superhet table radio with 4 station push button automatic tuning and visual dial tuning. American and foreign reception, electro-dynamic speaker, edge lighted dial. \$29.95.

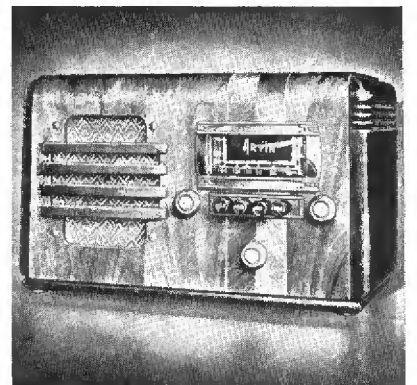



# PREVIEW OF NEW RADIO MERCHANDISE

## FADA

Fada Radio and Electric Corp.  
Long Island City, N. Y.

MODEL 6A65C—Six button automatic tuning, American broadcast, state police, foreign to 16 meters. Six tube a.c., superhet, 10 in. speaker.

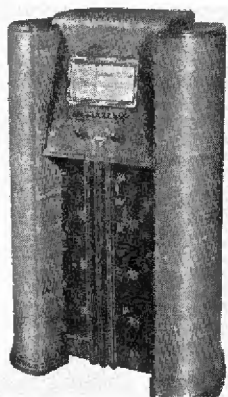

## WEBSTER-CHICAGO

The Webster Co.  
5622 Bloomingdale Ave., Chicago, Ill.

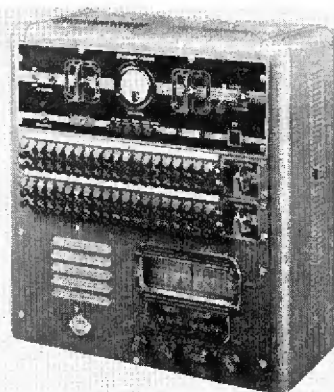

SOUND SYSTEM — Model S-40 designed to answer the demand for a popularly priced sound system for schools. Compact, centralized, completely self-contained, provides two-way communication system in addition to picking programs from any room for audition in any one or all other rooms.

## ALLIANCE

Alliance Manufacturing Co.  
Alliance, Ohio.

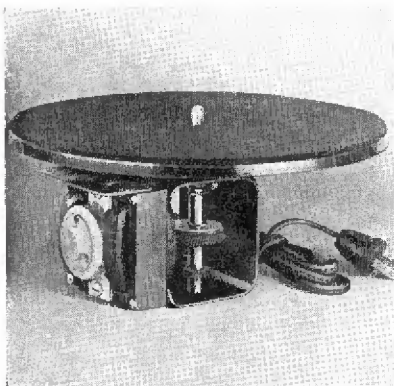

TURN TABLE—"Even Speed" motor drive is said to maintain uniform speed through all variations of record drag and variations in line voltage or operating temperature. Large bearings with ample oil reserves and laminated Bakelite helical cut gears for silent operation.

## TORPEDO

The Turner Co.  
Cedar Rapids, Ia.



MICROPHONE — Low priced streamlined, semi-directional, the "Torpedo" is designed for use with any amplifier which calls for crystal or other high impedance microphones. Output level rated at —60 db. Eight feet of low capacity cable is furnished. List \$14.95

## PORTAPACK

Electronic Laboratories, Inc.  
122 W. New York St., Indianapolis, Ind.

A self-contained a.c. power supply for use where a.c. power is not available. Designed to deliver 110 volts a.c. at 60 cycles at a wattage of 75 watts for a period between 7 and 10 hours depending upon condition of battery used. Six and 110 volt terminals. Rechargeable by connection with an a.c. line.

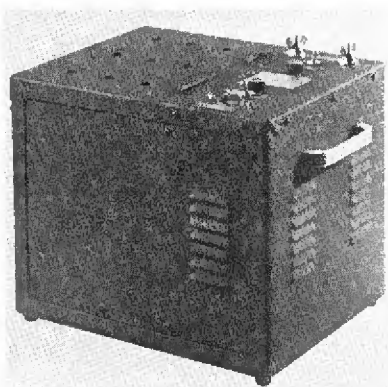

## POWER-FLOOD

Product Development Laboratories  
Charlotte, Mich.

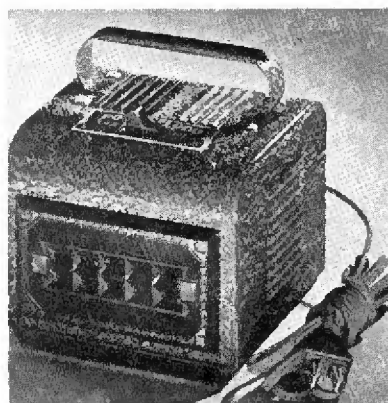

LIGHT CONTROL — Hi-lo intensity switches provide economy in lamp life to the photographer during focusing, without distortion of lighting balance when exposure is made at "hi" intensity. Provides five-socket outlet capable of handling as many as five 100 watt bulbs; 5/8 x 5/4 in overall in size. Can be similarly adapted to light control in the photographic enlarger.

## FALCON

Utility Mfg. Co., Inc.  
261 Fifth Ave., New York, N. Y.

CAMERA — Candid type uses standard Kodak 127 or Agfa A8 film to make 16 pictures. Wollensak Minivar 50 mm. lens. Fixed focus, time exposure and snapshot shutter speeds, spyglass eye-level view finder.

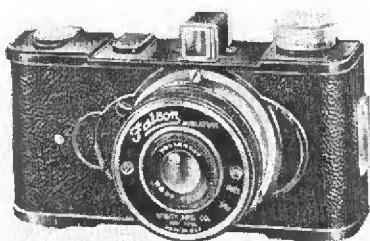

## OPERADIO

Operadio Mfg. Co.  
St. Charles, Ill.

SOUND SYSTEM—For schools with 20 rooms or less, system includes master control, amplifiers, ten loud speakers, ten speaker cabinets, microphone and stand. Radio set and high impedance phonograph unit can be used with the system. Each room can be talked to singly, or all rooms simultaneously

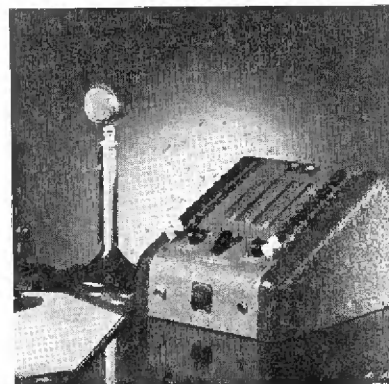





**CHECK** THESE RADIO  
VALUES AND YOU'LL  
**✓✓ DOUBLE CHECK**  
THE PROFIT POSSIBILITIES

*Unprecedented radio values!*  
That's the story in a nutshell of  
the new 1939 Westinghouse Pre-  
cision Radios.

Never before have so many out-  
standing features been offered to  
the radio buying public at prices  
as low as Westinghouse has set  
this year.

The line is complete, from pre-  
cision built table models to a  
phonograph combination and  
deluxe consoles. Every cabinet  
styled by America's foremost de-  
signers. Every set provides per-  
formance that backs up every-  
thing you say about it.

Here is a line that you can sell  
in volume at substantial profit.

Furthermore—Westinghouse  
offers you a completely new and  
resultful merchandising pro-  
gram for your local use. Hard-  
hitting cooperative newspaper  
advertising . . . colorful floor and  
window displays . . . consumer  
folders and other helps with  
PROVED sales-getting features.

It will pay you to get complete  
details of this remarkable line  
and merchandising program.  
Call your local Westinghouse  
Representative today!

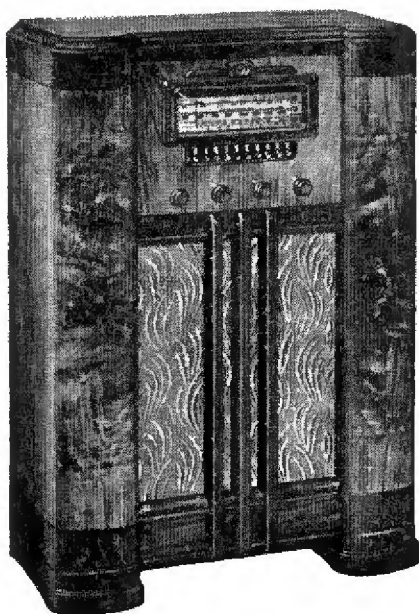

MODEL WR-368

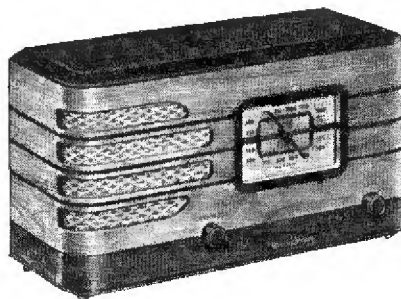

MODEL WR-256

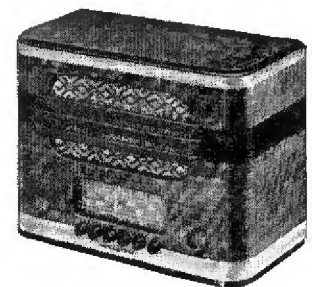

MODEL WR-258

*Merchandise Headquarters — Westinghouse Radio — 150 Varick Street — New York City*

**Westinghouse** Precision  
**RADIO**



# PREVUE OF NEW RADIO MERCHANDISE

## UNIVERSITY

University Laboratories  
191 Canal St., New York, N. Y.

**WIDE ANGLE SPEAKER**—Model WR. Especially suited for temporary or permanent sound truck use, the speakers mount easily, are stormproof. Said to give high efficiency sound coverage with uniform response over an angle of 180 degrees.

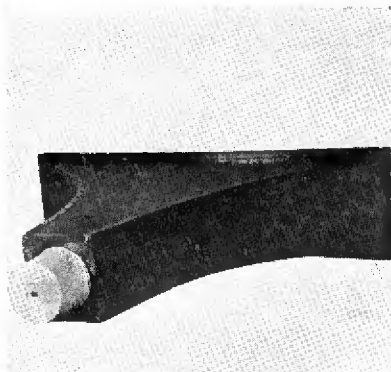

## MALLORY

P. R. Mallory and Co., Inc.  
Indianapolis, Ind.

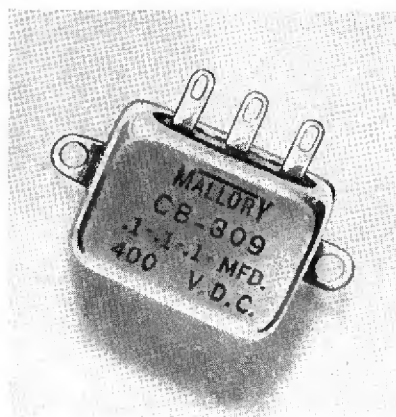

**CASED BY-PASS CONDENSERS**—Type CB are supplied in two working voltages of 400 and 600, a variety of capacities, and single and multiple section types. The 400 volt size has retained the size of the 200 volt type.

## OHMITE

Ohmite Mfg. Co.  
4835 W. Flournoy St., Chicago, Ill.

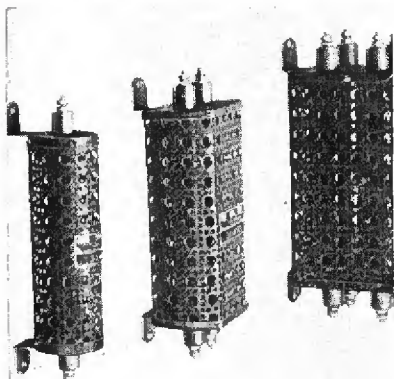

**CAGE TYPE RESISTORS**—For use where wattages up to several hundred watts are to be dissipated, prevents accidental contact with the resistor. Perforated metal finished with black wrinkle Japan

## LENZ

Lenz Electric Mfg. Co.  
Chicago, Ill.

**AUTO RADIO CABLE**—Offers stability under varying weather conditions, new type insulation with high "Q" and low capacity, weather-proof braid. Any number of conductors may be used, including r.f. and control leads.

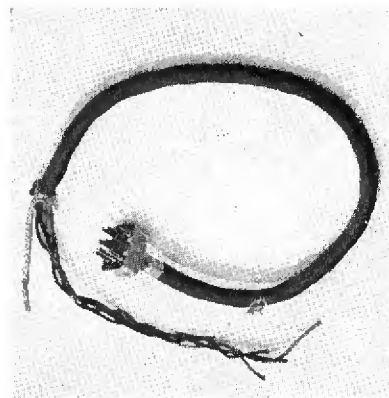

## IRC

International Resistance Co.  
401 N. Broad St., Philadelphia, Pa.

**ATTENUATOR** — Type A-21 distinguished by use of a molded motor commutator with conducting segments of copper molded in phenolic. Multi-finger beryllium copper contact and flat spiral spring connector. Standard terminal impedances of 50, 200, 250 and 500 ohms.

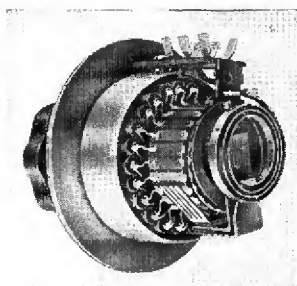

## JAMES

Pauley James Corp.  
4619 Ravenswood Ave., Chicago, Ill.

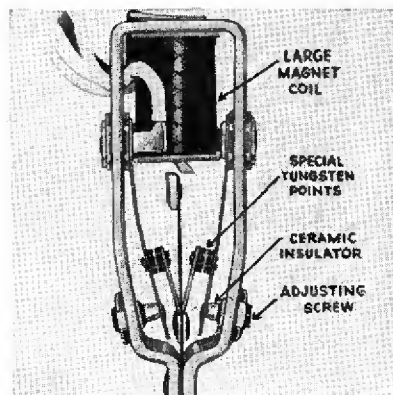

**PUSH-PULL VIBRATOR**—Reduces usual vibrator r.f. interference. New two-way drive of the reed is claimed to result in steadier operation of the unit, lessen high voltage peaks and give higher amplitude.

## AEROVOX

Aerovox Corp.  
70 Washington St., Brooklyn, N. Y.

**CONDENSER** — Hermetically sealed B type dry electrolytic in a can of 1 in. diameter is designed for ring mounting upright or inverted. Low etch ratio is said to allow use of increased amount of foil and improved heat dissipating qualities when in use.

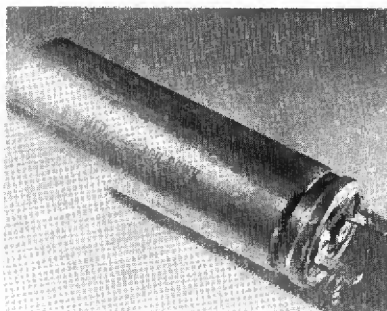

## BELDEN

Belden Mfg. Co.  
4647 W. Van Buren St., Chicago, Ill.

**ANTENNA KIT**—Clear Channel easily installed antenna systems use low loss transmission lines and maximum coupling features to give clear channel reception in frequencies from 400 to 22,000 kc. Equipped with new Belden iron core transformer couplers. Surge impedance of the line 37 ohms.

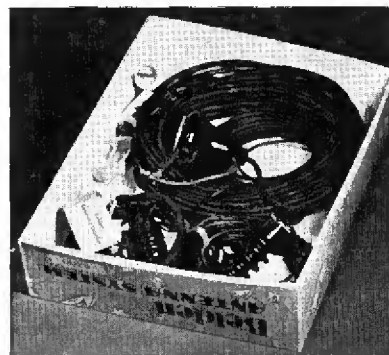



**METERETTE**

Pocket switch-type volt-ohm-milliammeter. Has two controls. Black d.c. scale reads from 0 to 10, 50, 250, 500, 2,500 volts at 5,000 ohms per volt; red a.c. scale reads from 0 to 10, 100, 1,000 volts at 1,200 ohms per volt. Low and high resistance — to 2,000,000 ohms. Measures 0 to 10, 100, 1,000 milliamperes and 0-200 microamperes.

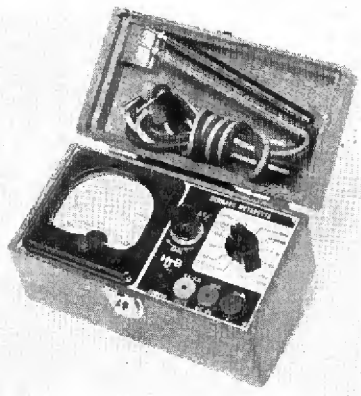

H. J. Bernard  
319 Third Ave., Brooklyn, N. Y.

**HICKOK**

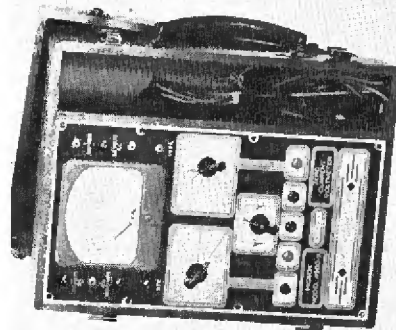

Hickok Electrical Instrument Co.  
Cleveland, Ohio

**ZERO CURRENT VOLT-METER** — Coverage in the following ranges 0-10, 50, 250 volts at infinite resistance per volt. 0-10, 50, 250, 500, 2,500 a.c. and d.c. volts at 1,000 ohms per volt; 0-1, 5, 50, 500 d.c. milliamperes; 0.1 a.c. milliamperes. Five resistance ranges from .05 ohms to 10 megohms, five capacity ranges from .0001 mfd. to 200 mfd. 0-500 d.c. microamperes.

**PHILCO**



Philco Radio & Television Corp.  
3071 No. Broad St., Philadelphia, Pa.

**TESTER** — Combination vacuum tube voltmeter and circuit tester. Automatic push-button selection of type of test and range. Provides extreme accuracy on such low range voltages as grid voltages, automatic volume control circuits, etc. Tests for usual voltages, current, resistance, capacity and output.

**DAYCO**

**TUBE TESTER**—A series of Bakelite "cards" provide automatic adjustment of tester for designated tubes. In making test, proper card is selected and inserted. Depression of one control gives shorts test. The card is released and changed in position. A second control gives quality test. Emission type tester.

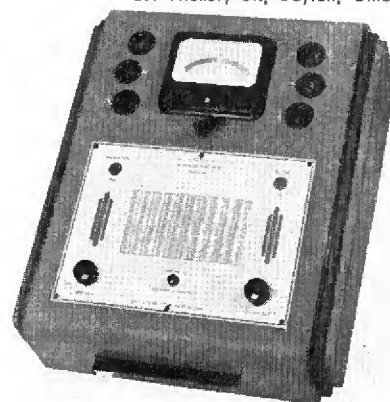

Dayco Radio Corp.  
201 Hickory St., Dayton, Ohio

**GE**

**OSCILLOGRAPH AND FREQUENCY MODULATOR**—Model OFM-1 is a combination instrument. Modulator has sweep width of zero to 50 kc., input to vertical cathode ray plates is 0.26 rms volts per inch with amplifier, 25 without. Horizontal plate input is 6.8 with amplifier and 20 without. Amplifier output useful to 100,000 cycles. Modulator harmonics are suppressed.

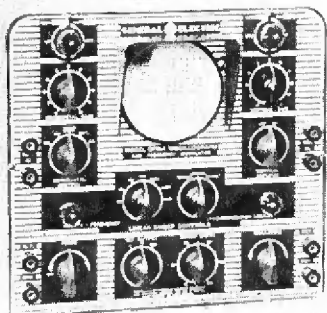

General Electric Co.  
Bridgeport, Conn.

**CLOUGH-BRENGLE**

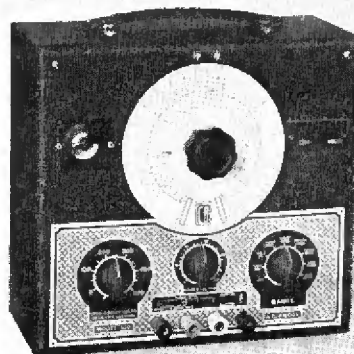

The Clough Brengle Co.  
2815 W. Nineteenth St., Chicago, Ill.

**A.C. BRIDGE**—No. 130, measures paper and mica condenser resistance, leakage, and capacity, electrolytic power factor and transformer ratios. Electrolytic leakage check.

**RCA**

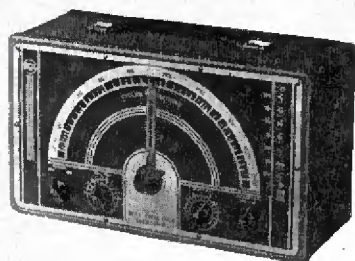

R C A Manufacturing Co.  
Camden, N. J.

**AUDIO OSCILLATOR** —No. 154 claims overall distortion of less than 5 per cent over the entire range from 30 to 15,000 cycles, complete a.c. operation. Metal tubes, high output, with an output frequency of plus or minus 1 db. from 30 to 10,000 cycles.

**A T C**

Sentinel on and off time-control for electric appliances. Self-starting synchronous motor, moulded Bakelite case in white ivory, black or walnut. \$9.95.

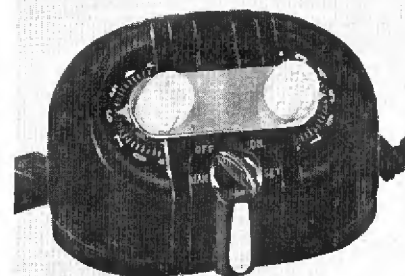

American Timer Corp.  
Geneva, Ill.



# PREVIEW OF NEW RADIO MERCHANDISE

## KNIGHT

Allied Radio Corp.  
833 W. Jackson Blvd., Chicago, Ill.

**RECORD PLAYER**—  
For use with any ac set, reproduces records through radio amplifying system; has self-starting synchronous type motor, heavy 8-in. felt-covered turntable, high-fidelity magnetic pickup; accommodates 8, 10 or 12-inch records; operated on 110-120 volts, 50/60 cycles ac.



## DYNAPHONE

Ansley Radio Corporation  
240 W. 23rd St., New York, N. Y.

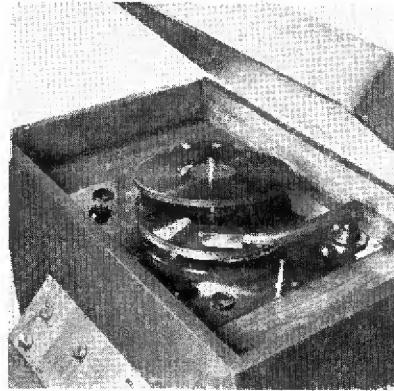

**RECORD CHANGER**—  
Model R-2, variable speed control, handles 8, 12 or 10 inch records. Single knob control for starting, stopping or rejecting record

## SUNDT

Sundt Engineering Co.  
4248 Lincoln Ave., Chicago, Ill.



**MICROPHONE**—  
"Round - the - Neck" model mounts crystal directly beneath speaking horn similar to that used in telephone work, a construction which is said to obtain relatively high output. Breastplate and neckband hold the horn near the speaker's mouth, leaving hands free. Directiveness of the horn reduces feedback.

## BELL

Bell Sound Systems, Inc.  
Columbus, Ohio

**AMPLIFIER** — Model 460 reduces feedback by use of bass and treble compensators and automatic volume compressor. 60 watt unit with five channel input, beam power tubes, master gain control

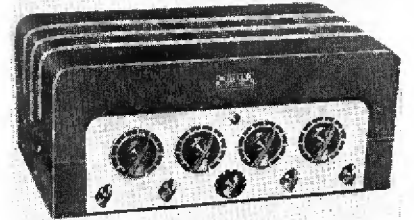

## CLARION

Transformer Corp. of America  
69 Wooster St., New York, N. Y.

**SOUND SYSTEM**—  
Model C-159 with beam power tubes, inverse feedback, stand-by switch, mixing and fading facilities, two self-contained power supplies, 12" heavy duty P. M. speakers, parabolic reflectors, military hand mike.



## LAFAYETTE

Wholesale Radio Service Co., Inc.  
100 Sixth Ave., New York, N. Y.

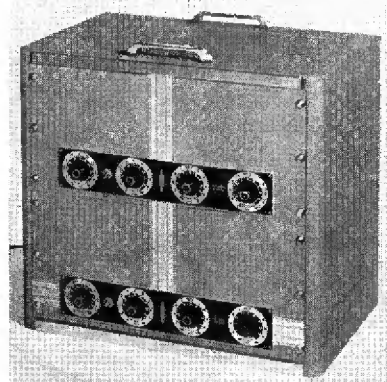

**"BINAURAL" SOUND SYSTEM**—To achieve amplification which is directional in effect, Models 380-T, 382-T 384-T utilize two complete sound systems, each amplifier having its own microphone and pair of high fidelity speakers. For use in theatres, concert halls, audition studios, etc. where especially accurate reproduction is desired

## SHURE

Shure Bros.  
225 W. Huron St., Chicago, Ill.



**MICROPHONE**—  
"Super Level" model 70H incorporates new improvements into the 70H. Rated by the manufacturer at 46 db. below 1 volt per bar (26 db. below 1 volt for 10 bar signal). Grafoil Bimorph crystal triple moisture sealed.

## HAMMARLUND

Hammarlund Mfg. Co., Inc.  
424 W. 33rd St., New York, N. Y.

**FOUNDATION KIT**—  
'BD-40' designed to simplify design and construction of amateur transmitters. Employs 807 or RK-39 beam tetrode. Can be used as a 40 watt output stage in a low power compact transmitter or as a driver for a higher powered stage

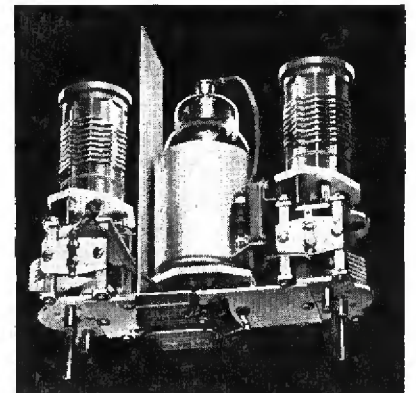



**NEW! SENSATION! TALK!**

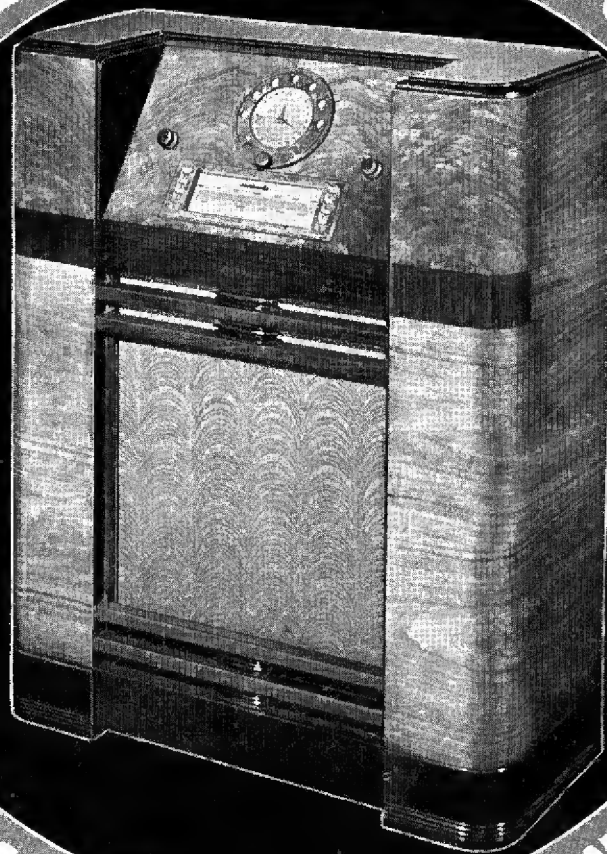

★ ★ THE MOST STARTLING IMPROVEMENT IN RADIO ★ ★

# Motorola TIME-TUNING

## THE RADIO THAT TUNES ITSELF!

TUNES FAVORITE PROGRAMS BY ITSELF... ALL DAY

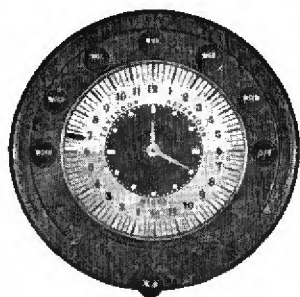

"SET" STATIONS ALL AT ONE TIME...  
THEY'LL TUNE IN ONE AFTER ANOTHER  
WITHOUT ANY FURTHER ATTENTION

COMBINED WITH

"Feather-Touch" ELECTRIC TUNING

This year's biggest demonstrating feature. Nothing you ever saw compares with Time-Tuning in radio convenience and luxury. Automatically tunes favorite programs all through the day and night. Changes stations on the hour, half-hour or quarter hour . . . or the same station can be left on for several hours if desired. Turns itself ON and OFF. Simple and easy to "set" as a clock. It's electric—nothing to get out of order.

### The HOTTEST HOT LINE FOR 1939

Setting the pace for the industry with something *really new* that your customers can afford to buy. Motorola gives you demonstrable worthwhile features that appeal to women buyers . . . a quick "turn-over" line of hot values . . . newest cabinet styling . . . and discounts that allow you a decent profit.

### "ALL-IN-ONE" REMOTE CONTROL

Perfection in Remote Control. Tunes six favorite stations, turns set ON and OFF, and raises and lowers volume either at the radio set or remote control without turning any knobs or switches.



**GALVIN MFG. CORPORATION • CHICAGO**



## PREVIEW OF NEW RADIO MERCHANDISE

### WARD

Ward Leonard Electric Co.  
Mount Vernon, N. Y.

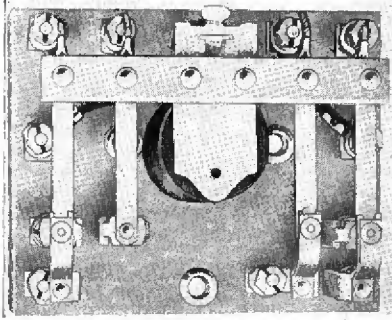

**BREAK-IN RELAY** — Heavy duty and midget sizes, Micalox insulated break-in or push-to-talk relays, are especially suitable on phone transmitters where operator presses or releases a button to change from transmitting to receiving.

### GOLD CROWN

Pioneer Gen-E-Motor Corp.  
466 W. Superior St., Chicago, Ill.

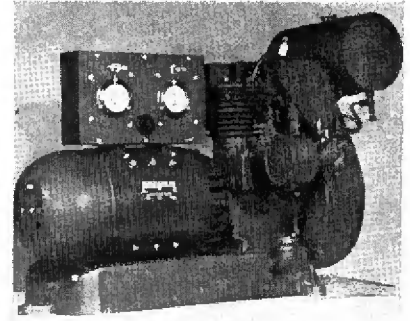

**HEAVY DUTY POWER PLANTS** — Gas-electric power plants answer heavy duty requirements of farm, homes, resorts, construction work, boats, etc. Thirty-two and 110 volt d.c. plants and 110 volt a.c. plants available in 600, 1000, and 1500 watts capacity.

### BLUE BEAVER

Cornell-Dubilier Electric Co.  
South Plainfield, N. J.

**ELECTROLYTIC CONDENSER**—Special vents in type BR permit normal dissipation of electrolytic vapor. Patented hi-formation process affords higher voltage breakdown

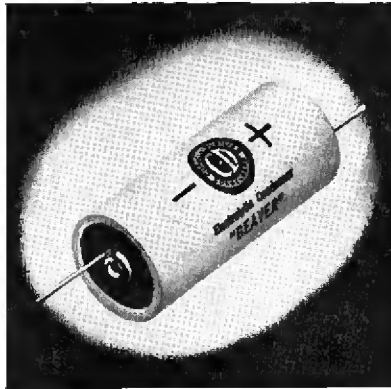

### WILLARD

Willard Storage Battery Co.  
246 E. 131st St., Cleveland, Ohio

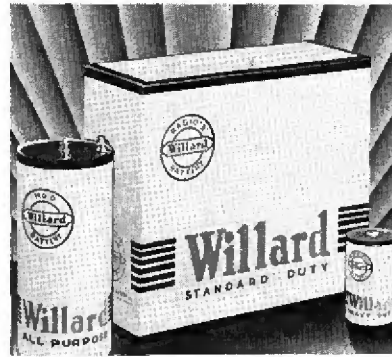

**DRY BATTERIES**—A new line of dry batteries introduced by this company includes standard radio B's and C's, 1 1/2 volt filament and general purpose types and flashlight cells. Distinctive labels are red, gray and black. Included also in the line is a B and C battery adaptor for sets designed to operate from combination packs.

# PACKARD ROTO-SHAVER

★ *Biggest News of the Electric Shaver Year* ★

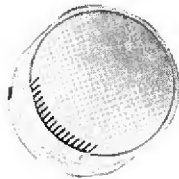

**WITH 2 HEADS**  
Instantly Interchangeable  
A Shaving Head for Him  
A Depilator Head for Her



The new Packard Roto-Shaver is a product perfectly priced, produced and policed for the fine radio retailer. It's the finest shaver on the market. It delivers a shave as close as a fine blade razor the *first time used*—no training period. It's completely guaranteed for one year. It's sold only through jobbers—although retailers get all sorts of cooperation. And its price—which includes two heads as shown—is rigidly maintained. Last, but most important; every sale brings you a *long, protected profit* of \$6.25 to \$7.50 each. Order today, being sure to mention your jobber's name. (Discounts: on less than 6, 33 1/3%; more than 6, 40%)

**WITH 2 HEADS**  
**\$18<sup>75</sup>** LIST

**PROGRESS LEKTRO SHAVE CORP.**  
521 Fifth Ave., New York, N. Y.

CANADIAN DISTRIBUTORS  
Progress Corp. (Canada) Ltd. 54 York St., Toronto, Canada



# You Ought to Know WHAT'S IN THIS



## New Clear Channel Antenna System

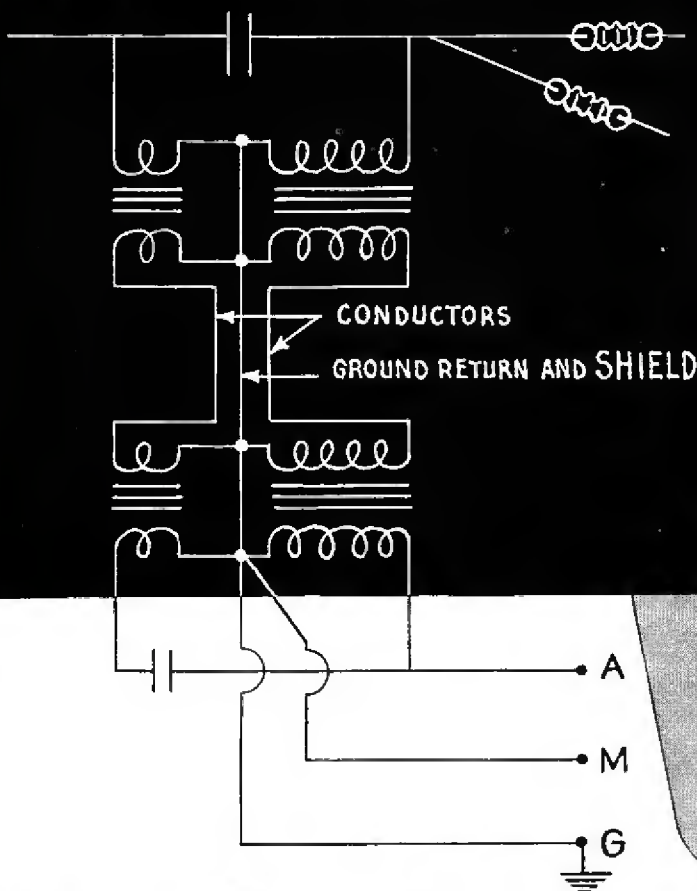

**UNIQUE NEW DESIGN**—Result of long, careful research. The new Belden Clear Channel Antenna System provides ALL the following features:

- 1—A clear channel and uniform performance over the entire wave band from 400 to 22,000 kc. No dead spots.
- 2—A shielded transmission line which reduces noise and makes possible a convenient ground connection for the antenna coupler.
- 3—A shield on the transmission line which functions as a lightning arrester because it grounds any accumulated electrostatic charges.
- 4—A system that transfers greater radio power from the antenna to the receiver because of the iron core couplers and the clear channel transmission line.
- 5—An antenna that is very easy to erect and once erected, it retains a neat appearance longer with minimum risk of breakage due to wind or ice.
- 6—Elimination of man-made electrical interferences.

**BELDEN QUALITY**—has been built into this Clear Channel System. Beldenamel aerial—shielded low loss, 2-channel transmission line—special Belden Iron Core Transformers in the coupling system—these provide the finest antenna system ever produced.

**EXTRA SALES AND PROFITS**—Sell the new Belden Power Line Filter when you sell a new antenna. Eliminate the “Back Door” noises and complete your job of cutting out man-made interference.

*Ask your jobber or write*

**BELDEN MANUFACTURING COMPANY**  
4697 W. Van Buren St., CHICAGO, ILL.

Get Behind  
*National* **ANTENNA**  
**CHECK-UP WEEK**  
Sponsored by Belden

A big national advertising campaign in Saturday Evening Post and Collier's will boost your antenna system sales and increase your service business. Be sure to tie in.

**Watch for Your Announcement**

# Belden

**The Radio Wiring Line**



# FIRM FOUNDATIONS

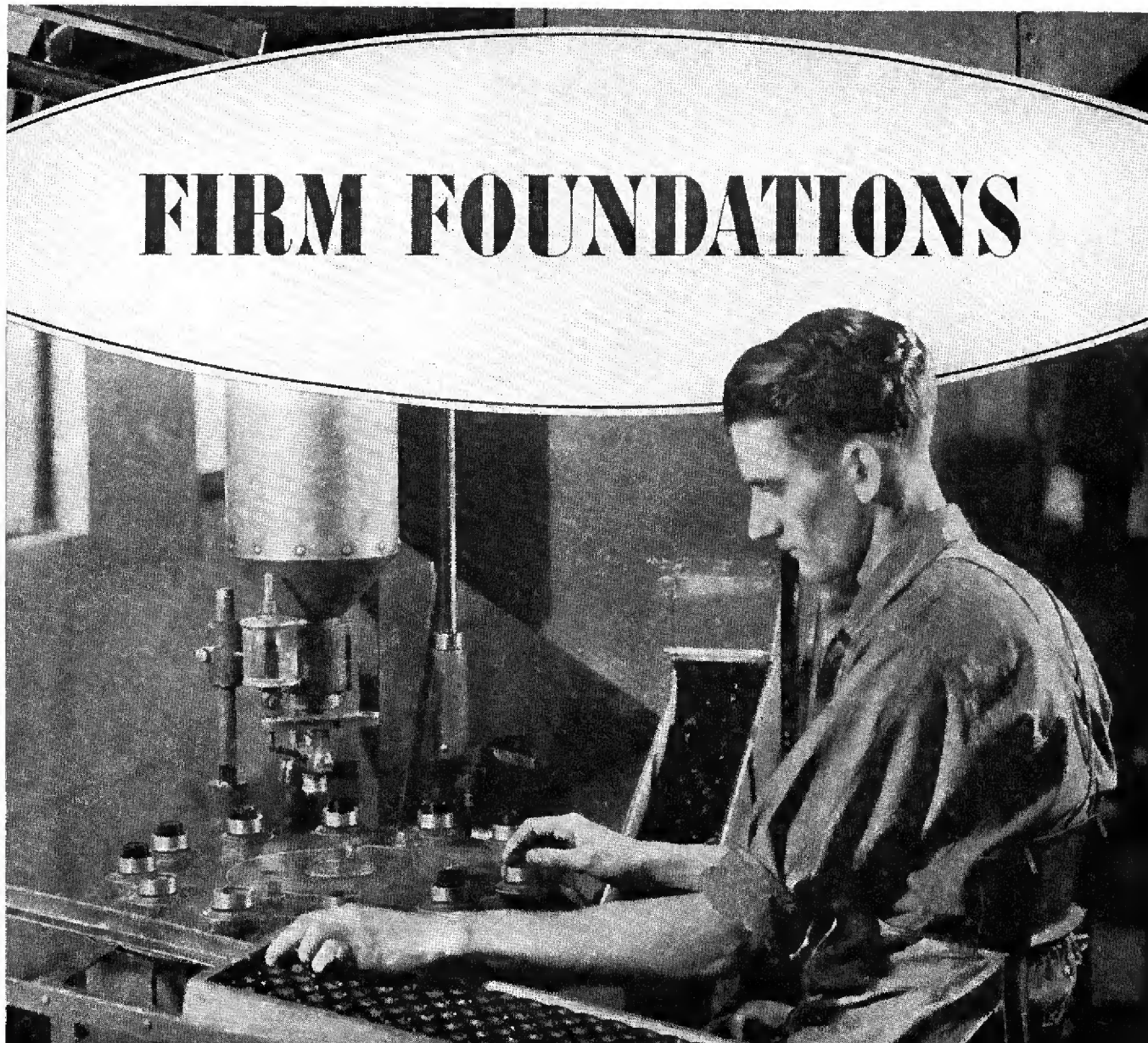

**E**VERY Sylvania tube is built on a "firm foundation"—you may be sure of that. For in the basing process—as in every other step of manufacture—Sylvania insures perfection by accepting only the finest in materials and workmanship.

To begin with, a special grade of basing cement is used, the best obtainable—and Sylvania's base shells undergo exacting tests before acceptance. Then the bases are "loaded" with cement as shown above

. . . the glass bulbs are carefully attached—and finally, the complete units are slowly baked in temperature-controlled ovens to secure perfect adhesion.

At the Sylvania factory, it's "quality in everything"—from the very beginning of production until the tubes are packed and shipped. That's why you can recommend Sylvania's with confidence . . . and sell them with profit! Hygrade Sylvania Corp., Emporium, Pa. Cable HYSYLVANIA, N. Y.

*Hygrade Sylvania Corporation Also Manufactures The Famous Hygrade Lamp Bulbs.*

## SYLVANIA

SET-TESTED RADIO TUBES





# APPLIANCES TURN ONE SALE INTO SEVERAL

## GIBSON

Gibson Electric Refrigerator Corp.  
Greenville, Mich.

MODEL MS-688 — Freez'r shelf, hermetically sealed Scotch yoke mechanism, Defrostajar, 6 cu. ft. capacity, 11.3 sq. ft. of shelf space, ice cube capacity of 63 cubes, 9 pounds



## JOHNSON

Johnson Motors  
Galesburg, Ill.

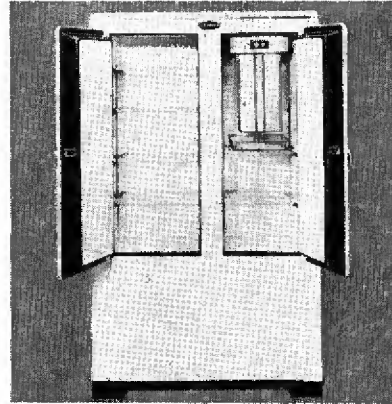

REFRIGERATOR — Model J-135. For larger homes, restaurants, clubs, taverns, stores, schools, camps, two door refrigerator offers 22.3 square feet of shelf area and 13.5 cu. ft. net capacity

## SHELVADOR

Crosley Radio Corp.  
Cincinnati, Ohio

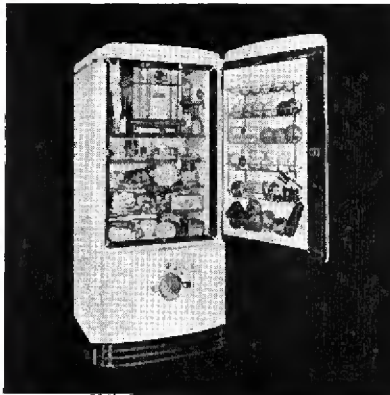

REFRIGERATOR — Capacities range from 3.16 to 6.5 cu. ft. with price variation from \$99.50 to \$149.95. Eighteen point temperature control, cold storage tray, automatic interior light, removable and hinged shelves. Built-in radio optional in most of the models.

## HORTON

Horton Mfg. Co.  
Ft. Wayne, Ind.

The Economizer, a new development in home laundering said to save from 50 to 90% in soap and  $\frac{1}{8}$  washing and rinsing time, may be attached as optional equipment to any Horton washer, provides filtered, zero-soft water.



## KELVINATOR

Kelvinator Div. Nash-Kelvinator Corp.  
Detroit, Mich.

REFRIGERATOR — Model PK6-38 is distinguished by illuminated thermometer and dial, colorful baffle door, sliding and adjustable shelves, and redesigned food files with porcelain fronts and chrome handles



## HOTPOINT

Edison General Electric Co.  
5600 W. Taylor St., Chicago, Ill.

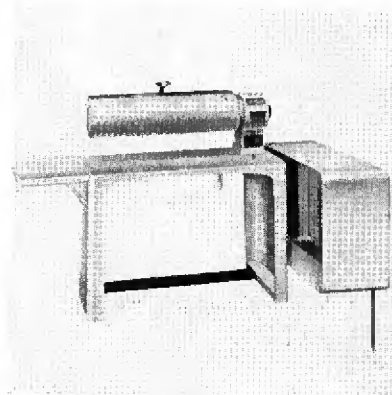

IRONER — Priscilla Imperial console type ironer has folding cover which acts as extra shelves for finished ironing. Dual knee and finger control, chromium plated shoe

## STEWART WARNER

Stewart-Warner Corp.  
1826 Diversey Parkway, Chicago, Ill

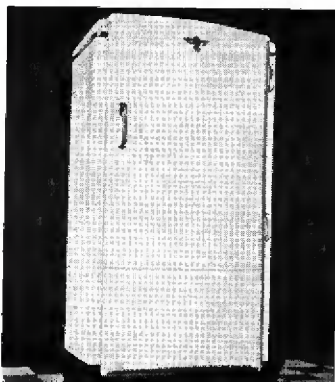

REFRIGERATOR — Features Sav-A-Step removable compartment in which are kept things used frequently in preparation of a meal, and the Tilt-A-Shelf which pulls out and tilts downward.

## NORGE

Norge Div., Borg-Warner Corp.  
670 E. Woodbridge St., Detroit, Mich.

Powered with Rollator-compressing unit, completely sealed, odor-proof evaporator, metal trays with rubber grids and ice tray release, 9 point cold control, automatic flood light





# NEWS

## Music Men Talk Shop

Radio tubes do Chameleon act at NAMM's 37th annual convention

CHICAGO—Many long-haired musicians were forced to admit, at the thirty-seventh annual convention of the National Association of Music Merchants held here in the Hotel Stevens August 1 to 4, that the radio tube as an adjunct to musical instruments is here to stay. Visitors beheld instruments which defied them to tell whether the notes were produced by the usual mechanical means, partly or wholly by tubes.

In the piano field, electronic instruments were exhibited by Hardman, Peck & Company, Krakauer Brothers and Jannsen, several of them sounding like full sized grands despite vest pocket dimensions. One provided, at the touch of a button, tones similar to those of an organ, or a banjo. The swing, *Radio Retailing* noted, appeared to be away from conventional grand piano shapes and toward more petite instruments.

The Vega Company exhibited an electronic guitar which opens up new vistas. Tops in the accordion field was a \$1500 affair with 18 switches.

On deck with the latest recording instruments were Presto Recording and Federal Recorder, blazing trails which should lead to much business among music teachers who find it desirable to show pupils how their output sounds.

On hand also with interesting exhibits were Capehart, Hammond, McMurdo Silver, Sound Products Company, Wur-

litzer, RCA, Ansley Radio Corporation and Electro-Acoustic Products.

Items attracting much attention included "swing" drums. You can run the scale on these drums. There were also "cocoanuts" on which tunes may be played with drumsticks. Chicago newspapers publicized widely a chromatic stroboscope which registers true tone quality more accurately than devices hitherto used by piano tuners.

Highspots of a survey by the Lawrence H. Selz Company indicated that of 4,800 people recently surveyed 46.6 per cent did not own pianos. Nearly one-third of these non-owners did own at one time, dispensed with the instruments because (a) They did not fit in with modern furnishings, (b) were too expensive to move, (3) no one in the home played the instrument. Of instruments found in use 73.5 per cent were found to be uprights, 24.7 per cent grands. Most pianos in use were between 11 and 20 years old.

Chief topic of discussion heard in hotel corridors was the problem of inducing school teachers to stop scalping profits by supplying school bands with instruments.

## Supreme Ups Perkins

GREENWOOD, MISS.—E. G. Perkins of the engineering department is now in charge of the Supreme Instruments Corporation's high-frequency test instrument design. Floyd Fausett, former chief engineer, is no longer with the company.



**NEW HONOR**—Paul S. Ellison of Hygrade-Sylvania, who has just been named chairman of the radio sales executives group, Sales Managers' Club, eastern division. A. O. Berard of Ward-Leonard relinquishes the post in September

## Facsimile For Sparton

JACKSON, MICH.—The Sparks-Withington Company of this city, manufacturer of Sparton products, has just taken out a facsimile license under Finch patents.

## Brittain Buys Into Lansing

LOS ANGELES—L. B. Brittain, formerly with Herbert H. Horn and for some time a local radio dealer, has purchased an interest in the Lansing Manufacturing Company, maker of loudspeakers. Brittain will direct sales, according to president J. B. Lansing.

## New Address For Federal

NEW YORK—To 50 West 57th Street moved the Federal Recorder Company late in July.



**NEARING COMPLETION**—The National Broadcasting Company's two-million dollar Hollywood studios, as they looked August 1



## Salesmen Startle Milwaukee

Unionize, "shop" stores to weed out unsound outlets, set up own trade-in schedules

MILWAUKEE—At a conference between representatives of the unique Retail Electrical Appliance Salesman's Union of this city and local electrical household appliance distributors early last month unionmen Koerner and Burbach announced that they were proceeding immediately with their plan to eliminate unsound Milwaukee retail outlets and so improve the picture for "legitimate" dealers. Retail outlets were being "shopped" to unearth detrimental practices such as violation of trade-in allowance schedules, according to Messrs. Koerner and Burbach, who stated that there would be no attempt to ban stores merely because Union salesmen were not employed.

During the meeting, the Union representatives requested that distributors clarify the policies with respect to refrigeration and other major appliance sales by Milwaukee outlets for delivery outside the normal trading area. Obvious interest of the Union was the securing of commissions for its members on such sales.

Another subject opened was the establishment of a trade-in schedule for old electric ranges. The Union, apparently, will attempt to set up a schedule, induce dealers to 'phone for approval of proposed allowances before granting them. It was also stated that the Union would shortly ask retail appliance dealers to open further negotiations on existing labor agreements relative to salesmen's wages and commissions. It would, according to Koerner and Burbach, probably ask for some kind of minimum weekly salary.

## Six New F,M Models

Prices range from \$69.95 for 7-tube table model to \$159.95 for console grand

INDIANAPOLIS—Six new models have just been added to the Fairbanks, Morse & Company radio line. All are superbets with a 455 kc. intermediate frequency, work on a.c., tune from 535 to 1725 kc., from 2200 to 7200 kc., and from 7000 to 23000 kc., in three bands.

Model 7AT is a table type, at \$69.95 list, has seven tubes. 7AC is a console at \$89.95, has seven tubes. 7AG is a console grande at \$99.95, has seven tubes. 9CC is a console at \$114.95, has nine tubes. 9CG is a console grande at \$129.95, has nine tubes. And model 12BG is a console grande at \$159.95, has twelve tubes.

All models use several metal and several "G" type tubes.



**HIMBER HUMBLLED**—Richard Himber, well-known orchestra leader and amateur magician of note, admits to members of the firm's New York sales staff that Philco's Mystery Control has him stumped



**PITCHING FOR TRIUMPH**—Last aboard a Chicago-to-Detroit 'plane is J. D. Van der Meer, Triumph Manufacturing's new assistant chief engineer. Van der Meer used to be assistant radio engineer with the Bureau of Air Commerce, was at one time with the Bureau of Lighthouses in Detroit

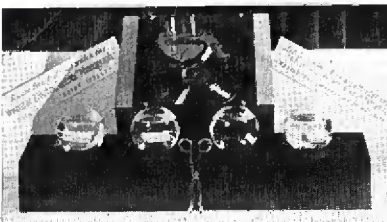

**DUNKED, THEN PLAYED**—Novel display making the rounds of exhibits is the setup pictured. Webster Electric of Racine submerges X-76C crystal pickup cartridges in bowls of water, invites technicians to fish them out and play them in the accompanying amplifier to demonstrate protection against moisture

## Antenna Check-up Week Announced

Belden sponsors October 15-22 campaign, offering dealers, servicemen and wholesalers promotional aids

CHICAGO—The first annual antenna check-up week is to be sponsored by the Belden Manufacturing Company during the week of October 15-22. Patterned after automotive campaigns with slogans such as "Prepare Your Car for Winter Driving" and "Change to Summer Oil," the drive is intended to benefit all branches of the industry, has as its primary objects:

1. Benefitting of the radio receiver owner by improving reception.
2. Increasing the sale of antennas and parts.
3. Selling more labor in essential service operations.

Supported by consumer advertising in the "Saturday Evening Post" and in "Colliers Weekly," the trade will be invited to obtain from Belden promotional material including: (a) A window-banner featuring National Antenna Check-Up Week. (b) Lapel buttons for store clerks and servicemen to be worn during the campaign. (c) A booklet explaining how to sell better antenna installations and, (d) Reprints of the ads in the "Post" and "Colliers" to be displayed during the drive.

Radio wholesalers will similarly be furnished with stickers for use on correspondence, upon request.

National Antenna Check-Up Week should do for the radio trade what similar campaigns have done for gas station attendants and mechanics in the automotive industry, thinks Belden. Over 26,000,000 receivers are in American homes and a campaign of this kind, coming as it does just before the resumption of important fall broadcast programs, should swell all business by providing easy access for repairmen profiting not only on recommended antenna installations but also on other business obtained while on the premises.

## GE Tester Deal

BRIDGEPORT—A new line of service and testing equipment to be made available to General Electric radio tube dealers through distributors under special terms has been announced here. In the line, officials advise, an oscillograph and frequency modulator, tube and set checker, signal generator, tube checker and multimeter are to be included.

## Williamson New Westinghouse V.P.

EAST PITTSBURGH—Walter Williamson, manager of apparatus and supply sales, has been elected vice-president of the Westinghouse Electric Supply Company.



## Shop Modernization Awards Due

Hygrade Sylvania to pay total of \$100 for best use of plans

EMPORIUM, PENNA.—The Hygrade Sylvania Corporation has announced a service shop modernization competition for radio servicemen, will award a total of \$100 to the three operators who make the best use of plans furnished by the factory to improve appearance and efficiency. Ingenuity in utilizing available space is to be considered when making the awards, the competition closing September 30.

Necessary to permit proper judging of entries are photographs showing a shop modernized along lines suggested in a booklet containing architect's drawings, furnished without charge by the factory. Suggested are "before and after" photos but it is pointed out that men who might have started revamping their shops following exhibit of Hygrade-Sylvania's modern shop at the Chicago Parts Show may submit pictures of their remodeled shop and be eligible in the competition even though photos of the original layout are not available.

### Wholesale Cameraman

CHICAGO—Carl Charlesworth has joined the staff of the Wholesale Radio Service Company's branch here, will manage the local camera sales.



**RAH, RAH RADIOS**—Available from Stewart-Warner are new "Varsity" model sets, furnished in college colors, school letters going on the speaker grilles when ordered. Display by Chicago's Lyon & Healy

## Excise Tax Collections Off

Receipts down 13.4 per cent, 31.5 per cent in last half of fiscal year

WASHINGTON—Radio and phonograph 5 per cent excise taxes (exclusive of auto-radio and accessories not classified)

collected by the U. S. Internal Revenue Bureau during the fiscal year ending June 30, 1938, were 13.4 per cent under those of the preceding fiscal year. In the period from January through June receipts fell 31.5 per cent below those recorded in the first six months of 1937.

Month by month tax receipts reported are as follows:

1937-38	
July (1937)	\$433,243.61
August	761,882.97
September	632,593.30
October	885,862.70
November	711,146.04
December	669,545.35
January (1938)	367,742.97
February	260,580.34
March	249,256.68
April	231,055.49
May	197,050.28
June	448,882.61
<b>TOTAL</b>	<b>\$5,848,841.64</b>

1936-37	
July (1936)	\$595,713.31
August	495,792.96
September	682,952.35
October	869,136.57
November	639,630.11
December	906,358.41
January (1938)	683,578.06
February	464,853.41
March	360,922.38
April	331,618.50
May	329,074.51
June	394,641.50
<b>TOTAL</b>	<b>\$6,754,272.07</b>

Tax receipts in the fiscal year just recorded were nearly \$1,000,000 below treasury estimates last winter when Congress considered proposed removal of radio and other excise taxes as more injurious to business than the probable revenue was worth.

**LET ME TUNE YOU IN  
ON P-R-O-F-I-T**  
*and we'll*  
**MOW 'EM DOWN!**

**NOT A NOVELTY—BUT A  
REAL RADIO!**  
**A 6 TUBE AC-DC SUPERHETERODYNE**



**Majestic**  
MIGHTY MONARCH  
OF THE AIR!

*This startling full  
color display piece,  
to hold radio, avail-  
able to dealers.*



**—CHARLIE McCARTHY**

Tie up your store with this great nationwide promotional idea! 7800 theatres from coast to coast displaying Majestic-Charlie McCarthy Radio in lobbies during run of Charlie's Universal picture, "A Letter of Introduction"—"Letter of Introduction" Contests with Majestic-Charlie McCarthy Radios as prizes! Tie up now and clean up!

**MAJESTIC RADIO & TELEVISION CORP.**  
2600 W. 50th St., Chicago

Export Sales: 330 S. Wells St., Chicago, Ill., U.S.A. Cable: "Majestic-Chicago"



TOO BAD THERE AREN'T  
METERS TO CHECK *profits*

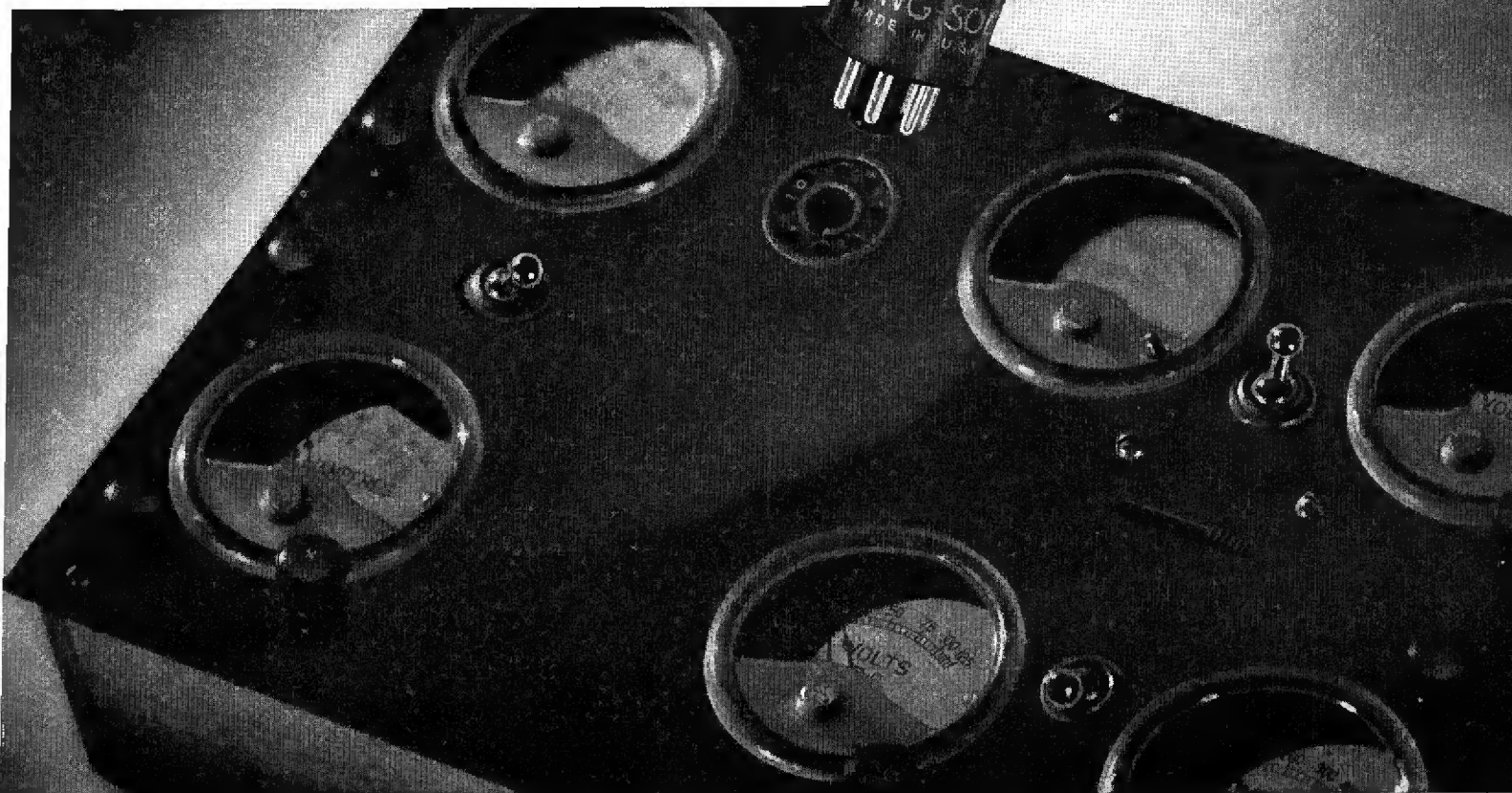

**S**UPPOSE your tube checker  
*did* have a profit and loss dial.

Which way would the needle swing?

Would it indicate that investment losses due to slow turnover, obsolete stock and cut-price competition are cutting into your profits?

Under the Tung-Sol Consignment Plan, the needle *always* reads plus. Your profits are guaranteed, because you pay only for the tubes you sell *after* you sell them.

Thousands of dealers who could qualify have found this plan the means to profitable radio tube sales. Our nearest office will be glad to furnish you with details.

TUNG-SOL LAMP WORKS, INC.  
Dept. B Radio Tube Division

**TUNG-SOL**  
Flow Radio Tubes

Sales Offices: Atlanta, Boston, Chicago, Dallas, Kansas City, Los Angeles, Detroit, New York • General Offices: Newark, N. J.



## New Jensen Lab

CHICAGO—A new laboratory addition is being constructed by the Jensen Radio Manufacturing Company, will add 6,000 sq. ft. of floor space to the concern's plant. Interesting feature of the addition is a large, windowless room with a 40-ft. ceiling. Rigging from the ceiling will permit acoustic experiments indoors with a minimum of reflection error.

## ARA Speakers Announced

CHICAGO—From Marcus W. Hinson, secretary of the American Radio Association, comes word that the following men will lecture during the group's convention September 30 to October 2 inclusive, in the LaSalle Hotel: John Meck, president, Electronic Design Corporation, topic: "Will the radio business ever become a man's business?" J. P. Kennedy, sales manager, Triumph Manufacturing Company, topic: "Using photography to sell radio service." Frank Ewing, vice president, The Fensholt Company, topic: "Utilizing manufacturers' window and store display material to produce profits". T. L. Osborn, manager, Inland Marine Department of Kemper Insurance, topic: "The value of insurance in the radio service business." Marcus W. Hinson, topic: "Fundamentals involved in the successful promotion of a radio service business." Morris A. Lieberman, associate of the law firm of MacChesney,



C.D.'s ADELMAN—Active in promoting the recently inaugurated "Sales Means Jobs" campaign among parts jobbers is Cornell-Dublier's Leon L. Adelman who, some time ago attracted much attention by sponsoring a restricted territory plan among his own jobbers.

Becker & Wells, topic: "Law and the radio service business."

Lorin C. Collins of Lorin Collins and Associates speaks on "Selling the Prospect," J. S. Older of Buckley Dement & Co., discusses the mechanics of direct-mail advertising.

## New Shields Coming

BROOKLYN—Working on a line of tube shields, for release the middle of this month, is Goat Radio Tube Parts, Inc.,

nearing production with items to fit new 1.4 volt, 50 ma. battery types and "bantams."

## Tilton To Distribute Transducer

NEW YORK—The Transducer Corporation has just announced that the Tilton Electric Corporation of 15 East 26 Street has been appointed exclusive distributor for its Bullet microphones, with world distribution rights.

## Frigidaire Branch

ROANOKE—The Frigidaire Division of General Motors Sales Corporation has established a distributing branch here at 22 Franklin Road. J. C. Holmes, a former Roanoke resident, is in charge, moves over from Norfolk. H. C. Baker Company, Inc., former local distributor, is retiring from business.

## Cruise By Detrola

DETROIT—Warren Brennan of Detrola Michigan Sales donned yachting cap July 19, took salesmen of this city's Good Housekeeping shops cruising aboard president Ross' yacht. Scheduled are similar trips to permit complete study of the firm's new line under ideal conditions for personnel of J. L. Hudson's, Peoples Outfitting, Marks Brothers and other prominent stores.



**★ THE PRODUCT...**  
**★ THE PROFIT...**  
**★ THE POLICY...**

**OK**



**\$15.00**  
LIST

*Push the Packard*  
**LEKTRO-SHAVER**

● The new Packard Lektro-Shavers are being made to new precision standards. Thousands are being sold by radio dealers who make \$5 to \$6 on every one. A fortune has been invested in advertising Packard Lektro-Shaver's smooth round head and four-way shearing action—more is being spent as you read this. Lektro-Shaver advertisements will appear in increasing numbers from now on—demand will be greater and greater. Get your share of these sales! Order today through your jobber at these discounts: for five or less, 33 1/3%; for six or more in one order, 40%.

**PROGRESS LEKTRO-SHAVE CORPORATION**  
521 Fifth Avenue, New York, N. Y.  
Canadian Distributors  
PROGRESS CORP. (Canada) Limited  
55 York St., Toronto, Canada



Now—  
a high-powered—

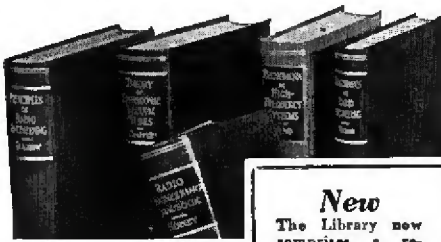

**New**  
The Library now comprises a revised selection of books culled from latest McGraw-Hill publications in the radio field.

## RADIO ENGINEERING LIBRARY

—especially selected by radio specialists of McGraw-Hill publications

—to give most complete, dependable coverage of facts needed by all whose fields are grounded on radio fundamentals

—available at a special price and terms

These books cover circuit phenomena, tube theory, networks, measurements, and other subjects—give specialized treatment of all fields of practical design and application. They are books of recognized position in the literature—books you will refer to and be referred to often. If you are a researcher or experimenter—if your interest in radio is deep-set and based on a real desire to go further in this field—you want these books for the help they give in hundreds of problems throughout the whole field of radio engineering.

5 volumes 3064 pages, 2000 illustrations

1. GLASGOW'S PRINCIPLES OF RADIO ENGINEERING
2. Terman's MEASUREMENTS IN RADIO ENGINEERING
3. Chaffee's THEORY OF THERMIONIC VACUUM TUBES
4. Hund's PHENOMENA IN HIGH-FREQUENCY MEASUREMENTS
5. Henney's RADIO ENGINEERING HANDBOOK

Special Low Price and Easy Terms

Bought singly, the five volumes comprising this library would cost you \$26.00. Under this offer you save \$2.50 and, in addition, have the privilege of paying in easy installments beginning with \$2.50, 10 days after receipt of the books, and \$3.00 monthly thereafter. Already these books are recognized as standard works that you are bound to require sooner or later. Take advantage of these convenient terms to add them to your library now.

SEND THIS ON-APPROVAL COUPON  
McGraw-Hill Book Co., Inc.  
330 W. 42nd St., New York, N. Y.

Send me Radio Engineering Library 5 vols., for 10 days' examination on approval. In 10 days I will send \$2.50, plus few cents postage, and \$3.00 monthly (till \$23.50 is paid, or return books postpaid. (We pay postage on orders accompanied by remittance of first installment.)

Name .....

Address .....

City and State .....

Position .....

Company ..... L-6-38

(Books sent on approval in U. S. and Canada only.)

# LOOK, MR. SERVICEMAN!

- ★ CHAPTERS in 45 CITIES
  - ★ MEMBERS in EVERY STATE
  - ★ and in ALL PARTS of the WORLD
- - That's the Record of the RSA  
in only 7 Months!

More and more, Servicemen have come to realize that it pays to belong—that the RSA is the one big constructive and progressive organization of Servicemen for Servicemen—that it is genuinely and actively helping every member.

## YOU GET ALL THIS

(Material and Service that's Worth \$75 and More)

YOU become eligible for participation in the Advanced Extension Course for Professional Servicemen—available to RSA Members only. ★ YOU GET monthly Advertising and Business Promotion ideas to increase your business and make it more profitable. ★ YOU GET a subscription to "The Radio Serviceman"—the Association's monthly magazine. ★ YOU GET the benefits of being included as a "REGISTERED AND QUALIFIED SERVICEMAN" on record at National Headquarters for reference. ★ YOU GET a Certificate of Merit to hang in your shop. ★ YOU GET a pocket card of credentials. ★ YOU GET the assistance of our big expert technical staff as a department in your service business. We will give you the *right* answer to your "impossible" service problems. ★ YOU GET (if you belong to a local servicemen's group) access to our National Speakers' Bureau—famous speakers for your meetings. ★ YOU GET advance technical information on new circuits.

It's as important to you as your job or your business! JOIN NOW and get in on all its benefits.

## RADIO SERVICEMEN OF AMERICA, INC.

Joe Marty, Jr., Executive Sec'y, 304 S. Dearborn St., Chicago

MAIL THIS COUPON

RADIO SERVICEMEN OF AMERICA, INC.  
304 South Dearborn St., Chicago, Ill.

Gentlemen:

I hereby make application for membership in the Radio Servicemen of America.

Name .....

Home Address .....

City ..... State .....

Firm Name .....

Address .....

..... I am enclosing \$2.00 National Yearly Dues.  
(Plus Nominal Local Chapter Dues)

..... Bill me \$2.00 National Yearly Dues.



## Six New RSA Chapters

Servicemen's group expanding rapidly throughout country

CHICAGO—From the headquarters of the RSA there comes word that the following chapters have voted to affiliate: Green Bay (Wisconsin), Danville (Illinois), Decatur (Illinois), Pittsburgh, Fargo, (North Dakota) and Minneapolis.

Officers of the Green Bay chapter include: George Thelen, chairman; Harold Dole, secretary and Fred Olsen, treasurer.

Officers at Danbury are: Lyal Cummings, chairman; Harry Longer, vice president and Calvin Stapp, secretary-treasurer. Gay Stevens heads the membership committee, George McKinney is examiner, service bench procedure is under direction of Owen McArdle, and Eward Welch is chairman of the advertising committee.

Decatur's chapter is chaired by Gene M. Payton, with Maurice L. Alexander, secretary, and Raymond Shaw treasurer.

William Irlam is secretary-treasurer of the Pittsburgh group.

At Minneapolis the executive secretary is Harry Cory.

An election of new officers has been held by the Johnstown (Pennsylvania) chapter. Ralph Calasso is the newly elected president; D. L. Kaufman, vice president; George Martin, treasurer, and Ken Vaughn, secretary.

New officers have also been elected at

Oklahoma City. Roy Allen is president; W. S. Jones, vice president; and L. G. Dearing, secretary-treasurer.

## C-B To Demonstrate Dynamic Testing

CHICAGO—Cooperating with the speaker's bureau of the Radio Servicemen of America, Inc., is the Clough-Brengle Company, aided by its territorial representatives. Planned are meetings in which a series of demonstrations of dynamic testing are to be given. President and chief engineer Ken Clough's booklet: "Complete Dynamic Testing, Step-By-Step, with Time Saving Cathode-Ray" will be used as a printed outline.

## University to Move

NEW YORK—University Laboratories, now at 191 Canal, moves September 1 to 195 Chrystie Street. The firm makes internally folded air-column trumpets and permanent magnet units.

## Ericksen Leaves F-M

DES MOINES—Parker H. Ericksen, for the past ten years radio sales manager, home appliance division, Fairbanks, Morse, has resigned to associate with Fairall & Company of this city.

## Handbooks, Catalogs, Guides

**TUBE CHART**—*Arcturus* has a new, revised edition of its tube data chart, including complete technical dope on 166 types of glass, "G", Midget and Coronet types. Available through company jobbers or direct request to factory at Newark, New Jersey. No charge. Suitable for wall mounting.

**REPLACEMENT RESISTORS**—A wall chart comprising seven pages of detailed data about tube-type resistors is available from the *Clarostat Manufacturing Company* of 285 N. Sixth St., Brooklyn, N. Y., or any of its jobbers. Factory charges 25 cents for the chart.

**CAMERA COUNTER CARD**—*Universal Camera Corporation* of 32 West 23, New York, offers a camera counter card permitting insertion of an actual "Iris Candid Camera" model. Display is 11½ by 19, in four colors. Dummy cameras are obtainable.

**TESTER DATA**—The complete line of radio test equipment made by *Precision Apparatus* of 821 East New York Avenue, Brooklyn, New York, is illustrated, described, priced in this company's new catalog form 39.

# MEISSNER VIBRATORS

CHECKED and DOUBLE CHECKED  
for DEPENDABILITY

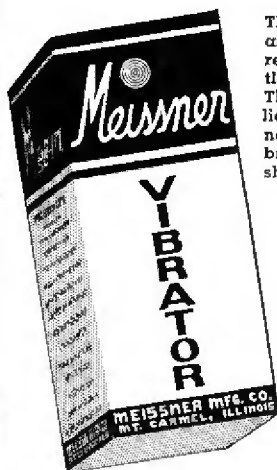

They're tested, not once, but twice, and aged between tests—that's the reason why servicemen have so little trouble with Meissner Vibrators. The secret of Meissner dependability lies in the aging given every Meissner Vibrator. Where ordinary vibrators are manufactured, tested and shipped, Meissner Vibrators are aged so that the slight metallurgical changes that sometimes affect the operation of any vibrator, are discovered in the second test that's given every Meissner Vibrator.

Your not gambling when you install a Meissner Vibrator—you know that it has received every possible test and will give your customer the long and dependable service that makes friends—for you and for us.

See Your Parts Jobber

*Meissner*

Meissner Mfg. Co.  
Mt. Carmel, Ill.

"A FAMOUS NAME FOR TWO DECADES"

## Janette Rotary Converters

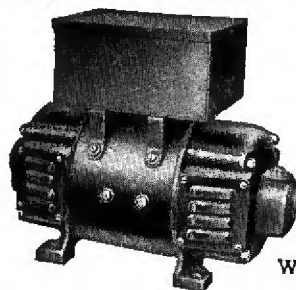

For Converting D.C. to A.C.

Built for radio and sound apparatus—capacities 110 to 3250 volt amperes—without or with all wave filters. Dynamotor construction—economical to operate—ruggedly built for years of trouble-free service—used or recommended by the largest manufacturers of radio and sound apparatus—in use all over the world.

Why Experiment—Insist on a Janette

Ask for Bulletin 13-25

Janette Manufacturing Company  
556-558 West Monroe Street Chicago, Ill. U. S. A.

Boost PROFITS with this  
New WARD AERIAL

Here's the aerial you've wanted! WARD'S new Model CO, a 2-section, telescopic, hinge-type aerial sells for only \$1.95 complete with 40" approved Low Loss Shielded Lead Cable! Made of Admiralty metal Easy-Tilt mounting bracket. Easily installed.

**FREE!**

See what's new for Fall in WARD'S complete line of car aeriels. Write today for free catalog.



The WARD PRODUCTS Corp.  
WARD BUILDING CLEVELAND, OHIO



# "PINCOR" POWER SUPPLY UNITS

# DYNAMOTORS GEN-E-MOTORS CONVERTERS

"PINCOR" dynamotors, gen-e-motors and rotary converters provide the last word in power supply units for air craft, police, marine and auto radios; also for public address systems. Now widely used by leading air lines and municipal and federal agencies throughout the world. Available in a wide range of capacities for every requirement. Compact, light-weight. Sturdily constructed to assure long dependable service. Write for catalog and complete information.

**PIONEER GEN-E-MOTOR CORP.**  
Manufacturer of "PINCOR" Products  
Dept. R-1H  
466 W. Superior Street, Chicago, Illinois

### OTHER "PINCOR" PRODUCTS

**BLUE DIAMOND** and  
**GOLD CROWN** gas-engine  
driven electric light and  
power plants, up to 5000  
watts; alternating or direct  
current; air or water cooled;  
remote control. Send for  
literature.

# HORTON. *first every time*

FOR 67 years specializing in the production of laundry equipment for American homes . . . developing exclusive features for better sanitation and greater usefulness . . . KleenZONING, Kleenette, EconoMIZER . . . that's Horton.

Write now for information about the complete Horton line of Washers and Ironers —no obligation.

*finest every way.* **HORTON**  
HORTON MANUFACTURING CO., FORT WAYNE, INDIANA

# FREE!

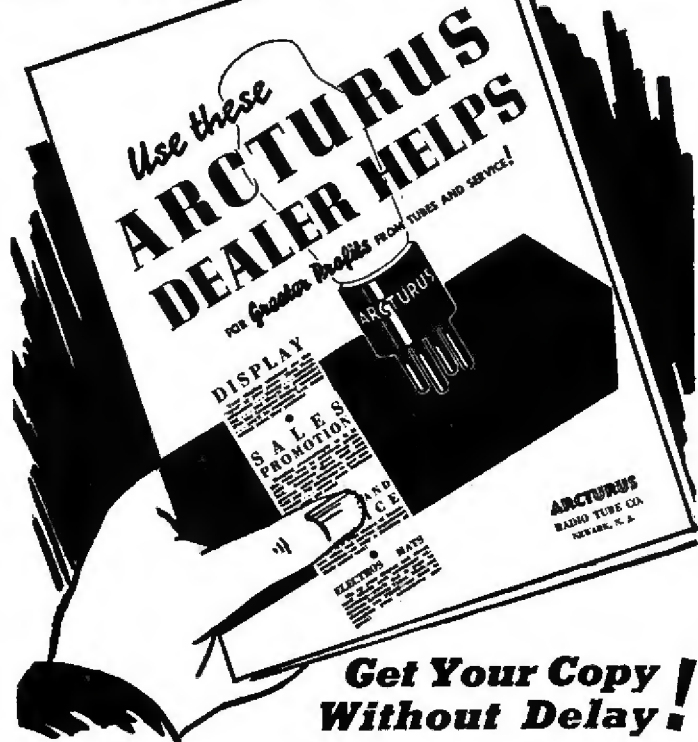

**Get Your Copy!  
Without Delay!**

Here you are . . . a complete array of potent, effective sales, dealer and service helps—many of them available without one cent of cost to you. New, eye-catching display materials; new, up-to-the-minute sales promotion items; new office and service department necessities; new electros and mats. Just the things you need to build better business, more substantial profits.

In short, Arcturus brings you practically everything you need for the business side of your business. New ways of building new business from new customers—new helps to enable you to keep old ones coming to you again and again! Send the coupon at once for your copy of the ARCTURUS DEALER HELPS folder—just off the press. Cash in on this opportunity. Modernize your business-getting efforts as well as your shop!

**Mail the Coupon!**

### THE ARCTURUS EQUIPMENT DEAL!

Lowest Down Payments . . . tubes at Standard Prices . . . Low Tube Requirements . . . Immediate Delivery—the fairest, easiest and finest Equipment Deal ever offered! Cash in on it! Let your purchases of Radio's finest tubes keep your shop equipment up-to-the-minute.

# ARCTURUS

ARCTURUS RADIO TUBE CO., NEWARK, N. J. R-10

- RUSH my copy of the new Arcturus Dealer Helps Folder without cost or obligation on my part,
- Also send full details of your new equipment deal.

Name \_\_\_\_\_

Street \_\_\_\_\_

City \_\_\_\_\_ State \_\_\_\_\_

I am a dealer.  I am a serviceman. My jobber is \_\_\_\_\_

For your convenience this coupon can be pasted on a penny postcard



**MASTER ANTENNAS** — *Technical Appliance Corporation* has two new booklets. One gives all pertinent facts about installation of the Taco Community Master Antenna System in apartment houses, hospitals, hotels and private dwellings. The other describes the entire Taco line of antenna equipment, accessories. 17 E. 16th, New York.

**SETS IN REVIEW**—A new folder by the *Pilot Radio Corporation* of Long Island City, New York, describes and pictures this firm's entire 1939 line.

**RECEIVER KIT**—*Browning Laboratories, Inc.* of Winchester Massachusetts, has a new brochure completely describing the Browning 83 kit, giving circuit details, prices, parts lists. Available to readers of *Radio Retailing* without charge, on request.

**BACKGROUNDS**—A special, folding display screen designed to supply a flattering background for its new corner cabinet radios is obtainable at a slight charge from *Stromberg-Carlson* or its distributors. "Wings" on each side make a good backdrop for conventional consoles too.

**TWO DECADES**—*Frank A. D. Andrea* has a new and elaborate booklet describing his firm's extensive radio manufacturing background, telling in word and picture all about the new Andrea line. Edition is limited and it can therefore be definitely offered only distributors but any available overflow will go to dealers who request it.

## With the JOBBERS and REPS

**SENTINEL**—*Herbert H. Horn*, with headquarters in Los Angeles, is this firm's new rep for the State of California. *Morrow-Thomas Hardware* of Amarillo will distribute Sentinel's farm and city radio line in this Texas area.

**PHILCO**—*Columbian Electrical* of Kansas City now covers western Missouri and eastern Kansas. The organization of the former Kansas City Philco Company has been taken over. J. C. Clinkenbeard manages the new Columbian division.

**GALVIN**—*W. J. B. Kennedy* has been appointed Motorola home radio set representative in the New England area, working out of Melrose, Mass. Adolph Ullman of Boston remains Motorola's auto radio representative in this territory.

**COLUMBIA, BRUNSWICK, VOCALION**—*Stern & Company* of Hartford, Connecticut, Emerson set jobber, has just been appointed to distribute these records.

**WARD-LEONARD**—This company's resistors, rheostats and relays are now represented in South Carolina, Georgia, Florida and Alabama by *Maitland Smith* of Atlanta.

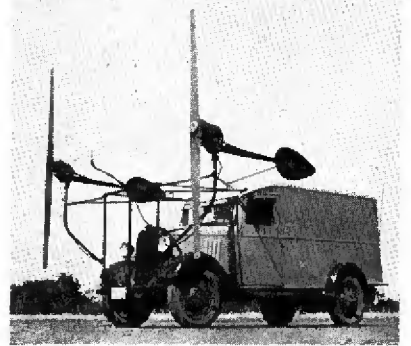

**WIND-ELECTRIC COMPARISON**—Folded back against the sides of this 1½ ton Parris-Dunn experimental truck, standards holding chargers comply with highway laws. Swung out, as in the lower photo, they permit comparative tests between units. Goose-neck appurtenance between chargers measures wind velocity

**NEW!**  
Model CC

**SOLAR**

**CAPACITOR ANALYZER**

This advanced new model has all the good features of our famous CB model . . . PLUS high capacity scale, high test voltage, simplified scales and sloping panel. A.C. operated. Illustrated model, No. CC-1-60, for 110 volts, 60 cycles operation, less tubes, costs \$24.90 Net . . . through your jobber.

**SOLAR MFG. CORP.** 599 Broadway, New York

**COMPLETE ELECTRIC PLANTS**

**MANY NEW MODELS**

**OPERATE A.C. RADIO, PUBLIC ADDRESS, SOUND CAR, MOTION PICTURE EQUIPMENT AND RADIO TRANSMITTERS.**

Also furnish power for Lights, Water Systems, all Household Appliances, for Camps, Farms, Lake Homes, or Standby Service. For use anywhere power is not available.

350 to 5000 Watts

110 volt A.C., 6, 12, 32 and 110 volt D.C. and Combination AC-DC Units. Anyone can Operate. Complete, ready to run.

Write for Details and Territory  
**D. W. ONAN & SONS**  
442 Royalston Ave. Minneapolis, Minn.

**A GOOD NAME GOES A LONG WAY**

Ken-Rad Tubes bring customers into your store. Ken-Rads have a good reputation, give perfect performance and make money for you.

Ken-Rad Tube & Lamp Corp.  
Owensboro, Ky.

**KEN-RAD**  
DEPENDABLE RADIO TUBES



## Majestic's '39 Line Seen

Includes petit models with wide color choice, consoles and special furniture types

CHICAGO—Ready for the trade is the new radio receiver line of the Majestic Radio & Television Corporation, now in production.

Model 42, an ac-dc Petit type with a tri circuit, covering 535 to 1750 kc., is available in mahogany and blue, mahogany and red, ivory and blue or ivory and red. Similar in appearance, but a five-tube ac-dc superheterodyne, is model 52, available in the same colors.

Model 511 is a five-tube ac superhet tuning from 535 to 1750 kc., using a distinctive two-tone, plastic table type cabinet. Model 551, a similar receiver with respect to circuit, has a well-styled modernistic plastic case. In the plastic line is found, also, the widely publicized "Charlie McCarthy" radio.

Model 62A is a solid walnut table type receiver, 6 tube superhet for ac, covering 538 to 1750 kc. and 5.8 to 18.6 mc. 519P is a table type phono combination with a 5-tube superhet circuit to work on ac, covering 535 to 1750 kc.

Model 639 is a 6-tube ac superhet console covering 538 to 18600 kc, in three bands. Console 739 is a 7 tube ac superhet tuning from 538 to 1750, 2300 to 22,000 in three bands. The 939 is a 9 tube ac super with the same coverage. Model 1056 is a 10 tube ac superhet covering 538 to 1750 kc., 1.77 to 18 mc., in three bands. Model 1058 is similar but in a different cabinet Model 1356 is a 13 tube super, tuning from 140 to 325, 538 to 1750 kc. and from 1770 kc. to 18 mc., in four bands. Model 1656 is a deluxe superheterodyne console with the same coverage using 16 tubes.

Included also in the line is table "lay-down" type 58, chairside model 560, upright table model 56, deluxe laydown type 68, upright table model 67, console model 675, chairside model 674, combination radio-phonograph model 673, console model 775, console model 875 and battery types 69 and 690. The first of these last mentioned models is a table type and the latter a console. Both operate from a 6-volt storage battery or from 110 volts ac at the flip of a switch.

## Philco Experts Sail

PHILADELPHIA—John de Tarr Hicks and G. H. Gilbert, foreign service engineers of American Steel Export Company, export division of Philco, have just sailed for their respective territories following three weeks of intensive study of new models in the plant here.

Gilbert, on the *Normandie*, is enroute to Morocco, Algiers, Tunis, Egypt and the Far East. Hicks is on his way to Central and South America and the West Indies.

The men will instruct foreign distributors in the latest methods of servicing.

# NATIONAL UNION

## QUALITY PRODUCTS

### RADIO RECEIVING and TELEVISION TUBES

### CONDENSERS

**Profitable to Use . . . Profitable to Sell because National Union Products are well made, trouble free . . . Radio Service Engineers have proven it! For prices and sales information write NATIONAL UNION RADIO CORP., NEWARK, N. J.**

## HIGH\* EFFICIENCY STORMPROOF# MAGNET LOUD SPEAKERS FOR EVERY P. A. USE.

side angle coverage

double standard acoustic efficiency

highest acoustic output

no resonant peaks

"Front" sound projection

unbreakable horn

smooth spun tone arm

vertical adjustment

standard bronze thread mounting flange

lock type binding posts

oversize alnico permanent magnet

reinforced diaphragm

micrometer voice coil centering

chrome aluminum acoustic top

dust cover

100% shock and vibration proof

no "rear" sound projection

no microphone howl

Available in 30, 42, 56 and 72 inch air-column lengths. For 15 and 25 watt continuous operating capacity. A quality line at competitive prices.

\*Guaranteed highest efficiency and power handling capacity for any speaker of comparative size and weight.

#Resists total immersion in water.

Distributors, sound specialists, dealers and servicemen write for complete descriptive literature with prices and discounts.

**UNIVERSITY LABORATORIES**

**195 Chrystie St., New York City**



# Utah VIBRATORS



## Help Guide

### THE SWEDISH FISHING FLEETS

Even the little fishing villages of far off Sweden know Utah Vibrator dependability. Scouting boats with Utah-equipped radios cruise the seas hunting for the catch. Once found, word is flashed to the waiting fishing fleet in the harbor and out it goes. Gone are the days of fruitless searching,—the radio equipped scout boats make every hour at sea profitable.

Weather reports flashed by radio to the busy fishing boats minimize the danger of sudden storms. The very lives and livelihood of this sturdy people are dependant on the uninterrupted operation of their radios. Utah Vibrators were selected for this important job because of their dependability, long life and precision performance under the handicap of highly unfavorable operating conditions.

In America, too, you'll find Utah vibrators selected for the same reasons;—you can rely on Utah quality. Insist on Utah when purchasing replacement vibrators—your customers will appreciate their long life and dependable service.



SPEAKERS



VIBRATORS



AMATEUR TRANSMITTER KITS

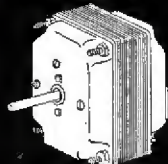

MIDGET MOTORS

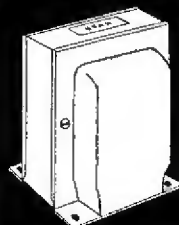

TRANSFORMERS AND CHOKES

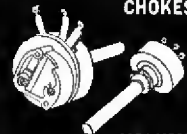

VOLUME AND TONE CONTROLS



PLUGS AND JACKS



VITREOUS RESISTORS



SWITCHES

# Utah

U T A H RADIO PRODUCTS CO.  
CHICAGO, U.S.A. CABLE: UTARADIO, CHICAGO

DEPENDABLE SINCE 1922



# TECHNICAL TOPICS

SERVICE • SOUND • CIRCUITS • INSTALLATION • PARTS

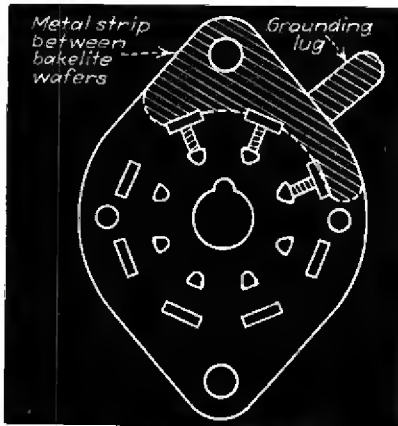

## Grounded Socket Prongs

When tracing the wiring of the new Stewart Warner models it may appear that certain socket terminals are not connected to ground, even though the circuit diagrams show a ground connection. Actually such terminals are connected to the common grounding lug located between the two bakelite wafers of the socket. These sockets can always be identified from a normal socket by the protruding ground lug which is always connected to chassis.

The illustration shows the construction of the socket. Cathode shield and one heater are grounded.

## Wide-Angle Double-Range Tuning Eye

A novel type of cathode-ray tuning indicator has recently been introduced by National Union. Known as the 6AD6G, it has two ray control electrodes instead of the usual one. Thus it is possible to close one side of the eye separately from the other. It is also possible with this "winking" principle to indicate resonance of strong or weak signals.

Especially designed for use with the tuning eye is the 6AE6G control tube. This tube has two triodes in one envelope, the grid connection is however common to both. Grid structure is such that one triode is of the remote cutoff type. This is accomplished by making one triode grid of unevenly

spaced grid wires. The other triode grid consists of evenly spaced wires.

Referring to the circuit, when a low a.c. voltage is applied to the grid of the 6AE6G, one triode section immediately begins to close one side of the 6AD6G. This section is useful for tuning weak signals.

Just as the weak signal shadow angle closes the other section of the shadow angle begins to operate. This section of the eye is most useful for indicating resonance on strong sig-

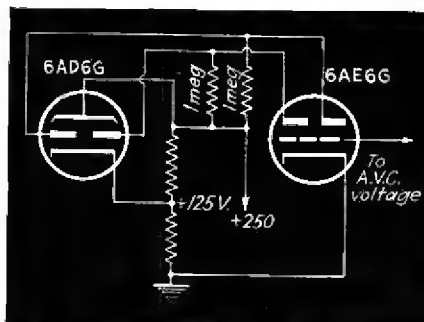

nals. A strong signal will blanket a sensitive tuning eye whereas an insensitive eye will not work on strong signals. Thus the above circuit overcomes this difficulty.

As an indication of comparative

sensitivity between the two sections of the eye; approximately 7 volts of a.c. voltage will just close the weak signal shadow angle. The strong signal shadow angle requires 27 volts before it will close.

## Lab Oscillograph

The circuit shown herewith is the Supreme 2 inch oscillograph designed for laboratory and amateur use. The unit is built around two tubes, an 80 and a 2002 cathode ray tube.

Operating controls are: intensity, for adjusting the brilliance of the spot; focus, and sweep. Provision is made for either internal or external sweep voltages. When switched to internal, a special winding on the power transformer supplies the necessary voltage for a 60 cycle sweep.

No voltage amplifiers are built-in; however, sensitivity is sufficient for normal voltage measurements, frequency and phase measurements and percentage of modulation tests.

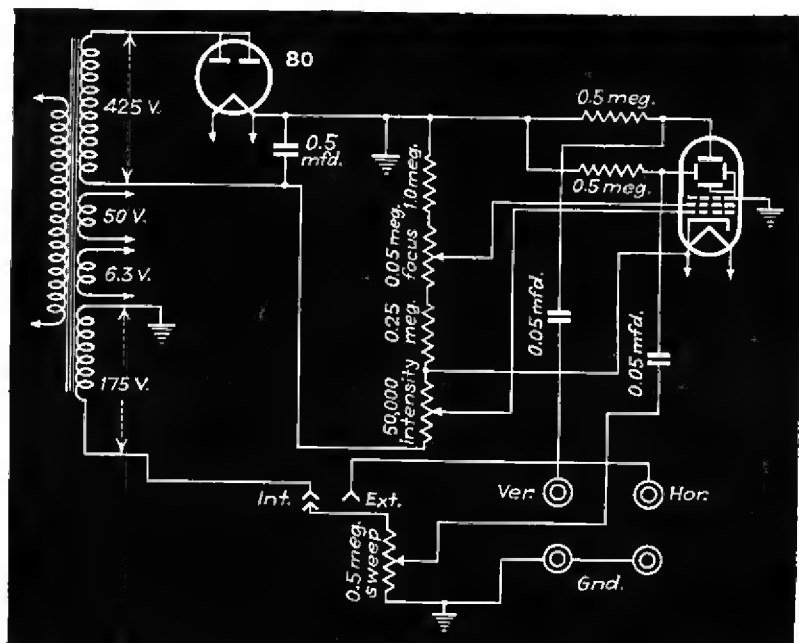



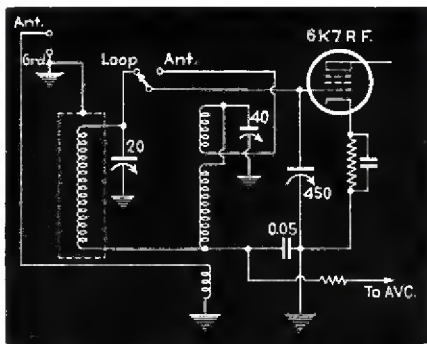

The schematic of the G.E. Beam-a-Scope described last month was incorrect. The corrected circuit is shown above. The Beam-a-Scope is tuned by one section of the 450 m.m.f. gang condenser giving good selectivity by virtue of the high Q inherent in the Beam-a-Scope coil. With regard to sensitivity, good results are obtained with a signal as low as 50 microvolts.

## Two Channel Antenna

Separate signal paths to the receiver are provided in a novel all wave antenna by Belden.

The antenna proper is composed of a flat top or "L" type broadcast section 60 feet long, and an additional half doublet which responds most efficiently to the 31 meter band. This combination of the two types of antenna provides good signals over the band from 400 to 22,000 kc.

The transmission line is a dual type, comprising two conductors and a shield. The shield is common to both channels and also encloses the other two rubber covered wires. This shield or third conductor is the common ground wire of the antenna circuit. This is shown in the illustration.

This method of transmission line coupling makes the surge impedance between the individual conductors and the shield more important than the impedance between the conductors. The surge impedance between the conductors and shield is approximately 37 ohms, or about one half the impedance between conductors.

Connection to the antenna coupler is made from the junction point of the two antenna legs to the condenser and long wave primary winding. The opposite side of condenser connects to short wave primary. The other ends of both short and long wave primaries are connected to the shield of the transmission line, making the shield the common conductor for the ground of the antenna circuit. Because of this the antenna is a grounded

affair, making a lightning arrester unnecessary.

In construction, the antenna coupler consists of two impedance matching transformers, one of which is the short wave and the other the long wave unit. Both transformers are built on iron oxide cores which provide a coupling between windings which is at least 60 per cent greater than can be had with air core couplers. The receiver coupler is similar.

The antenna coupler steps down the impedance of the antenna to match the lower impedance of the transmission line. The receiver or set coupler performs an opposite function. It steps up the impedance of the line to the higher impedance of the receiver input circuit.

The entire circuit has an efficiency of 93 per cent. The increased coupling created by the iron cores transformers also reduces freak resonance and anti-

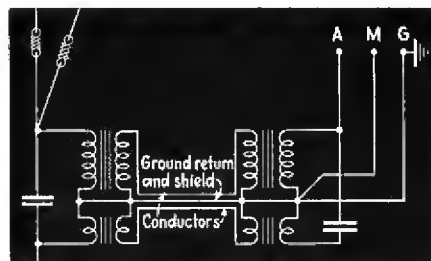

resonance conditions. Thus a uniform receiving condition highly desirable for broadcast receivers is produced.

## Push-Button Tube Tester

Push-buttons have simplified the radio listeners task in the past and are now entering the service field. A tube tester by Supreme selects the proper

voltages and conditions by pressing buttons. This simplifies the process of testing tubes and increases customer interest in testing tubes.

The circuit shown herewith is equipped with six sockets, any pins may be thrown into the meter circuit by closing respective push-button switches. The 601A tube on the left serves as rectifier, supplying plate voltage for testing. Switches are also provided for selecting the correct line voltage for proper operation.

To the right center can be seen two switch contacts for testing eye tubes. A neon bulb serves as leakage indicator.

## Tubular Compensator Condensers

A new type of thermal condenser has been introduced by Sprague which decreases capacity with increase in temperature. This is due to the action of a special dielectric, the construction of which at this time has not been released. There are no loose electrodes, the condenser is stable mechanically, and if left to itself will always return to its given value of capacity at a given temperature.

The condenser consists of two concentric cylinders with appropriate spacers at either end. The outside can is one of these cylinders. Between the two is the special dielectric referred to above.

Two types are available in capacity ranges from 5 to 9.5 mmf. One type has a negative drift from .04 to .6 mmf. for a 30 degree Centigrade rise. The other has a range from .55 to 1.6 mmf. for the same temperature rise.

The condensers are designed, not to

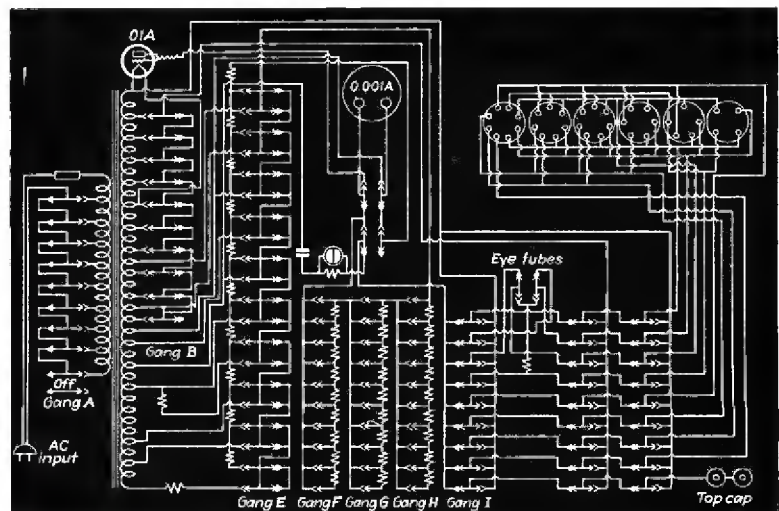



be used independently in a circuit, but mainly in conjunction with another capacity. In an oscillator circuit they should be shunted across the padder condenser to compensate for normal oscillator drift. They will find application also in other tuned circuits.

The breakdown voltage rating is 70 volts r.f.; at 2 mc the ratio of capacity to Q is .04 and .05 for the two types mentioned. At 10 mc the ratio is .06 and .10 respectively.

## Compensated Electronic Mixer

The circuit shown herewith is Jefferson's 3 channel mixer. Low distortion is claimed by the novel output volume control circuits. This resistance network operates in such a manner so as to keep the load resistance acting on each individual tube never lower than required.

In a standard electronic mixer circuit, the grids are connected to individual circuits and the plates in parallel. If only one or two channels are operating, they are, at the same time, shunted by the inoperative tubes. This means that the load resistance of the tubes operating is never lower than the inoperative tubes. Naturally this gives rise to serious distortion since the load resistance is only a part of what it should be.

In the new circuit, when a channel is inoperative it is automatically cut out of the circuit. The only load caused by that channel is the 70,000 ohm resistor in the arm of each gain control. If only one channel was operating, the maximum load caused by the two inoperative stages would be 35,000 ohms, which is a sufficient plate

load for a 6C5.

High impedance input is used on all channels. It is recommended that the high impedance output works into a grid circuit with an input resistance of .2 to .5 meg.

All stages are resistance coupled and are supplied with 230 volts from the power supply. The input and output resistance networks of each stage are identical.

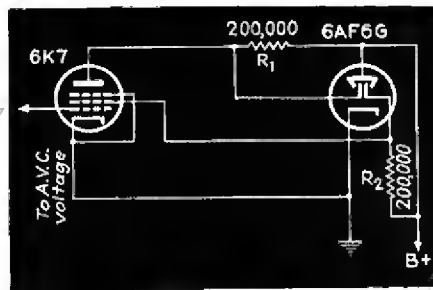

## Twin Tuning Circuit

The twin tuning eye announced last month may be used to full advantage in the circuit by RCA shown herewith. The purpose of the tube is to provide a resonance indication on strong or weak signals. This action may be obtained by use of a 6K7 d.c. amplifier. The screen serves as the sharp cut-off device giving indication on weak signals, while the plate operates as a remote cut-off amplifier for control of the strong signal.

Voltage from the a.v.c. circuit feeds the grid of the 6K7 causing plate and screen current to flow. Since the screen is nearer the filament, screen current reaches a maximum before much plate current flows.

As screen current increases, the screen voltage flowing through  $R_2$  drops, so that at a certain value of

screen current the screen may be considered saturated. The voltage drop in  $R_2$  controls the "weak signal" indicator elements.

At this point plate voltage begins to flow at a greater rate since the plate is more positive than the screen. This causes a similar voltage drop in  $R_1$  controlling the "strong signal" elements.

## New Tubes

**906**—A 3 inch electrostatic deflection type cathode ray picture tube by Sylvania. Screen may be had in either green or yellow. Ideal for television or other high definition uses. Heater voltage is 2.5 volts at 2.1 amps; plate voltage 1500 volts maximum. If a sharply defined spot is not required, 400 volts may be used on the second anode with proportional reduction in first anode voltage.

**1231**—A triple grid amplifier of new construction and appearance. Suitable for video amplifiers and similar applications. Constructed entirely of glass with metal shield. Base pins through bulb support elements. Characteristics are:

	Pentode	Tetrode
Heater voltage....	6.3	6.3 volts
Heater current....	.45	.45 amp.
Input capacity....	8.6	8.6 mmf.
Output capacity....	6.5	6.5 mmf.
Plate voltage.....	300	300 volts
Screen voltage.....	150	150 volts
Cathode Bias Resistor .....	200	200 ohms
Suppressor .....	(to cathode)	(to screen)
Plate current.....	10	12 ma.
Screen current....	2.5	.5 ma.
Plate resistance...	700,000	540,000 ohms
Mutual conductance	5,500	6,500 umhos
Amplification factor	3,850	3,500

**1853**—A high gain pentode amplifier by RCA similar to the 1851 and 1852. Because of its extended cut-off characteristic it is recommended for use in r.f. and i.f. picture amplifiers, particularly those employing automatic gain control. Grid lead is brought out through the base pin. Characteristics are:

Heater Voltage	6.3	6.3 volts
Heater Current	.45	.45 amp
Plate Voltage	300	300 volts
Suppressor Voltage	0	0 volts
Screen Voltage	200	300 volts
Screen Series Resistor	...	30,000 ohms
Amplification Factor	3500	3500
Plate Resistance	.7	.7 megohm
Transconductance	5000	5000 micromhos
Grid Bin	-15	-22.5 volts
Plate Current	12.5	12.5 ma.
Screen Current	3.2	3.2 ma.

**1619**—A 2.5 volt 2 amp. filament type beam pentode similar to the 6L6

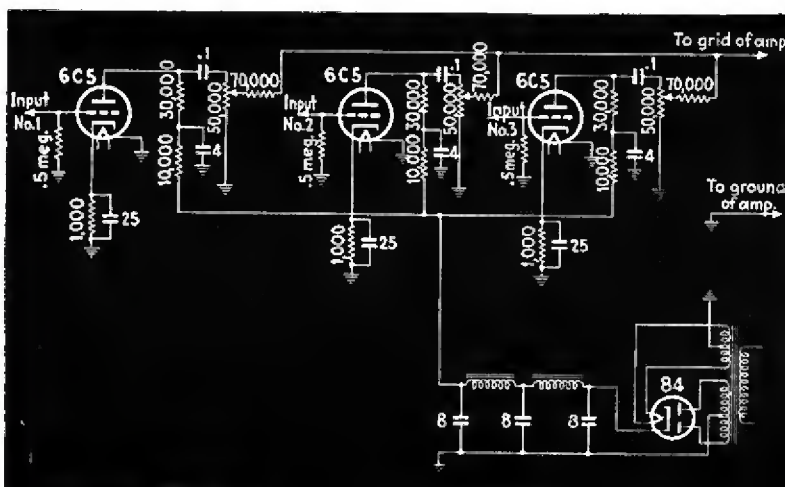



# CIRCUITS

with the added advantage of the quick-heating feature. May be used as audio amplifier or in any r.f. service up to 45 megacycles. Neutralization is generally unnecessary in adequately shielded circuits. In push pull class AB2 amplifier service over 35 watts of low distortion audio may be obtained. Characteristics as Class AB2 amplifier are: (two tubes)

Heater Voltage	2.5 volts
Heater Current	2 amps.
Plate Voltage	400 volts
Plate Current (max.)	150 ma.
Screen Voltage	300 volts
Screen Current	11.5 ma.
Grid Voltage	-16.5 volts
Load Resistance (plate to plate)	6000 ohms
Total Harmonic distortion	2.5 Per Cent
Power Output	36 watts

## 4A6G

A 2-volt twin triode power amplifier by Raytheon for Class B output service. The filament midtap is connected to base pin number 8, allowing operation of the filaments in series at 4 volts or in parallel at 2 volts. Class B characteristics are:

Filament Voltage, each section	2 volts
Filament Current, each section	.06 amp.
Plate Voltage	90 volts
Grid Bias	0 volts
Load Resistance (plate to plate)	8000 ohms
Power Output	1.0 watt
Plate Current (no signal)	2.3 ma.
Plate Current (max. signal)	10.8 ma.
Total Distortion	8.5 per cent

**RK-59** A twin triode power amplifier by Raytheon with an isolantite base. May be used in Class A, Class B or Class C service. Class B characteristics are:

Filament Voltage	6.3 volts
Filament Current	1 amp.
Plate Voltage	500 volts
Plate Current (no signal)	16 ma.
Plate Current (max. signal)	90 ma.
Grid Voltage	-17 volts
Grid Current	18 ma.
A. F. Driving Power	.9 watt
Load Resistance (Plate to Plate)	15,000 ohms
Power Output	30 watts

**RK-60** A twin diode high vacuum rectifier by Raytheon. Designed as an intermediate rectifier, rated to deliver up to 600 volts d.c. Characteristics are:

Filament Voltage	5 volts
Filament Current	3 amps.
A. C. Voltage (per plate)	750 volts
Peak Inverse Voltage	2120 volts
D.C. Putput Current	250 ma.
Average Voltage Drop (at 250 ma.)	61 volts

**1A7G** A 1.4 volt filament type convertor by Sylvania mentioned last month. A new set of operating conditions and characteristics have been derived since then:

Filament Voltage	1.4 volts
Filament Current	.05 amp.
Grid Voltage	0 volts
Screen Voltage	45 volts
Anode Grid Voltage	90 volts
Oscillator Grid Resistor	200,000 ohms
Plate Current	.55 ma.
Screen Current	.60 ma.
Anode Grid Current	1.2 ma.
Oscillator Grid Current	.35 amp.
Total Cathode Current	2.4 ma.
Plate Resistance	.6 meg.
Conversion Conductance	250 umhos
Conversion Conductance at -2 volts	50 umhos

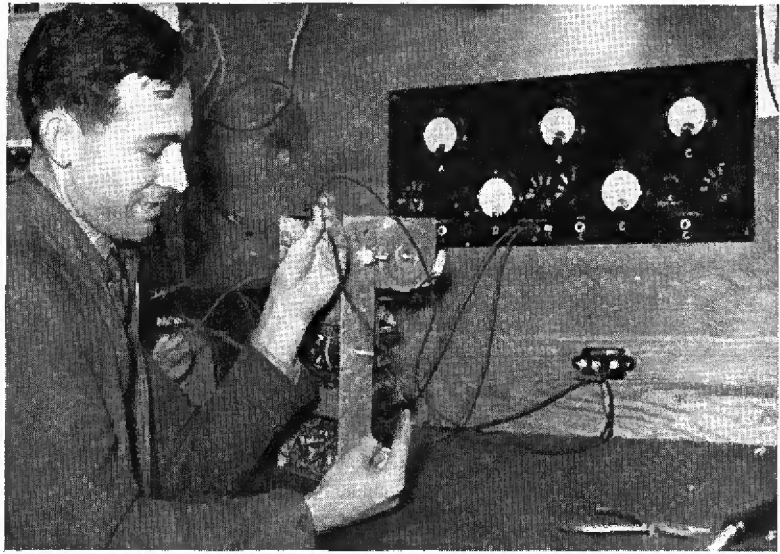

**DUST BITES MAN**—With the open season for dust storms approaching, service men in the Southwest frequently encounter a phenomena which gives them a mighty kick in the pants when least expected.

Says R. B. Cherry, Cherry's Radio Service, Oklahoma City: Dust storms cause static voltages to collect on the antenna. In the shop we keep the transposed feeder "cold" by connecting 100,000 ohms from each side to ground.

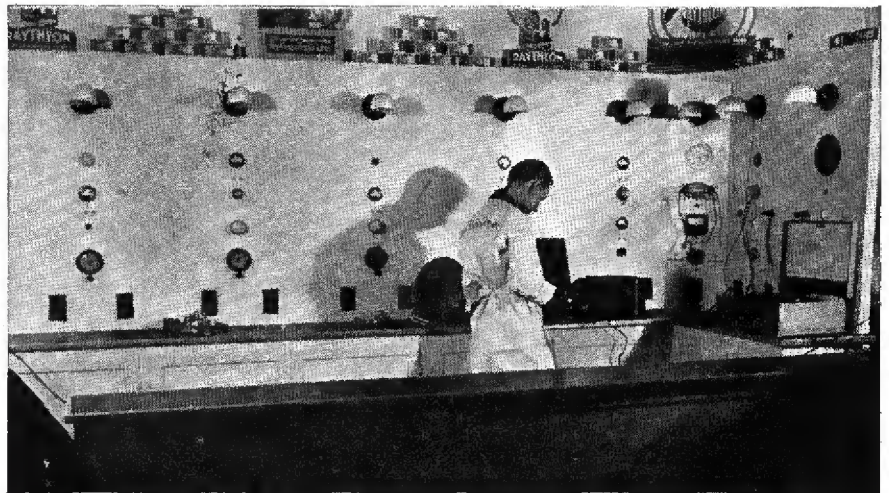

**SERVICEMAN'S PARADISE**—Carl and Clay Madsen, United Radio Service, Hayward, Calif. built this 84 square feet of test panel. Nine separate test units speed up servicing. Units include: magnetic and dynamic speaker tester, signal generator, ohmmeter-voltmeter, neon condenser checker, tube checker and analyzer

**RK-57** A thoriated tungsten filament, carbon plate power triode by Raytheon for high power Class B or C service. Plate terminal on top of envelope. Class B characteristics are:

Filament Voltage	10 volts
Filament Current	3.25 amps.
Plate Voltage	1350 1500 volts
Grid Voltage	0 -16 volts
Plate Current (no signal)	148 84 ma.

Plate Current (max. signal)	400 400 ma.
Grid Current	43 50 ma.
A. F. Driving Power	6 7 watts
Load Resistance	6700 8200 ohms
Power Output	300 370 watts

**RK-58** Same as the RK-57 with exception of top plate connection. Slightly lower output due to decreased insulation of the plate lead. Maximum plate voltage is 1250 volts.





# ADD PROFIT THIS EASY WAY

## COMPLETE DYNAMIC TESTING With CATHODE RAY

QUALITY STANDARD  
OF THE RADIO  
INDUSTRY

By **KENDALL CLOUGH**, *Pres. and Chief Eng.*

**I**T'S the expert who attracts trade and commands a good price for his work, in any business or profession.

Stamping the expert in radio service is the ability quickly and surely to identify and localize *any* trouble in *any* receiver, through speedy, modern dynamic analysis, performed with impressive, time-saving cathode ray.

Best of all, this fast, expert method takes no college degree to learn, but can be put to work by anyone who can read a receiver diagram, in quick time.

Short, to the point, easily understood directions for complete dynamic check of *any* receiver from end to end through quickly obtained, plain-as-the-nose-on-your-face cathode ray patterns are given in a new, condensed booklet, "Complete Dynamic Testing, Step-by-Step, With Time-Saving Cathode Ray."

Here's the easy, swift and sure road to practical mastery of your profession, to public respect and confidence, earned through impressive, out-in-the-open demonstration of expert skill.

Rate tops in your community, and command top return for your work! There's no satisfaction or money either in being a second-rater at any game.

"Complete Dynamic Testing" is mailed anywhere for 50c, or supplied free to the purchaser of any C-B instrument. Sold also by leading jobbers.

To registered C-B instrument owners, now numbering more than 8000, there is available in addition a 45" business-boosting wall chart in black and green of the 14-Point Dynamic Check-Up Chart below. Join the progressive C-B customer family, and use it to increase the size of your average service check by \$3.50 or more.

Dynamic Testing With Time-Saving Cathode Ray is your best and cheapest road to increased income, higher professional standing, and better rates of pay. Don't delay! Act today! The Clough-Brengle Co., 2819 W. 19th St., Chicago, Ill., U. S. A.

**CUT OUT AND MAIL TODAY!**

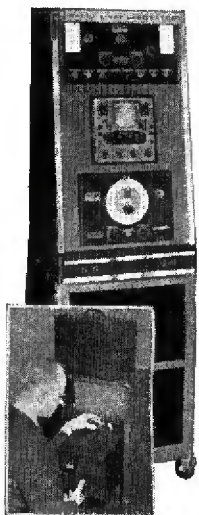

### RADIO X-RAY LABORATORY

Slant-Front Rack, with three panels and reflector, \$29.50. Rolling Dolly, \$14.50. Top: OMA Signal Generator, \$64.50; Middle, Graphoscope, \$64.50; Bottom, 79-C Audio Oscillator, \$59.50.



**"There's NO RECESSION IN COMPLICATED CIRCUITS"**

**RIDER BOOKS**

**ALIGNING PHILCO RECEIVERS—New!** Authentic instructions for aligning ANY of the 8,000,000 Philcos. Over 160 pp. Only \$1.00

**CATHODE-RAY TUBE AT WORK**—Complete, practical, written for servicemen. Information on Oscillograph, etc. \$2.50 335 pp. 450 ill.

**SERVICING RECEIVERS BY MEANS OF RESISTANCE MEASUREMENT** Easy servicing with an \$1.00 ohmmeter 203 p., 93 ill.

**SERVICING SUPERHETS** Revised edition just published shows how to make superheterodyne repairs quickly. 288 pp., \$1.00

**JOHN F. RIDER**  
 Publisher  
 404-4th Ave.  
 New York City

Business may be tough—but not as tough as the complicated circuits in modern receivers. Right now, with conditions as they are, you can't afford to lose a job or a customer. Rider Manuals give you the circuit data you need for the most complicated of today's sets. Be sure you have all 8 volumes—you need them now more than ever before.

**RIDER MANUAL VOLUME VIII**

gives you the servicing data you need—simplified and standardized.

Included with Volume VIII is a special EXTRA section entitled, "How It Works." Covering operations peculiar to the

more complicated 1938 receivers. This is in addition to the complete information on the sets of over 100 manufacturers—1650 pages of indispensable facts—and the price is the same as last year.

**YOU NEED ALL 8**  
*Rider*  
**MANUALS**

**Profit from Elections!**

**SELL OR RENT THIS BELL MOBILE COMBINATION PHONO AND P. A. SYSTEM TO POLITICIANS . . . And Make Money**

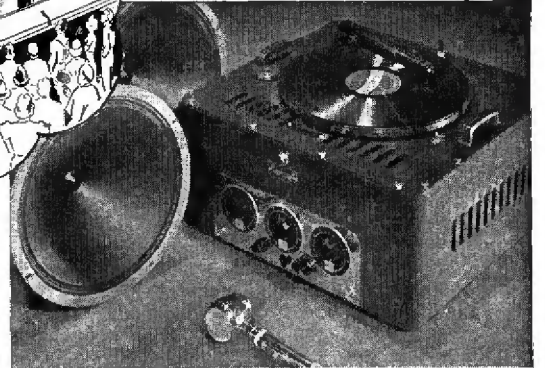
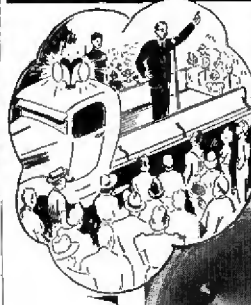

Manufactured Under License Arrangement With E. R. P. I.

**24 WATT SYSTEM for A.C. or D.C. USE**

This is a big year for you to clean up! Politicians and public speakers everywhere are priming themselves for strenuous campaigns . . . they need P. A. equipment. And they prefer Bell! There is a model that will fill the bill for every need. For instance, illustrated is model M-24, a 24 watt 6 volt D.C. or 110 volt A.C. convertible system. It has no power packs to interchange and consumes very little D.C. current. Features include: two 12" permanent magnet dynamic speakers, plug-in type crystal microphone, base and treble compensating controls, three input channels—one for phono and two for microphones, scientific design, quality construction and modern appearance. Easily portable and easy to service. Write for complete details on this and other money-making Bell Sound Equipment.

**BELL SOUND SYSTEMS, INC.**

1185 Essex Ave. Columbus, Ohio  
 Export Office: 308 W. Washington St., Chicago, Ill.

**PH MEN**

self the big-volume radio-raph combination business, sure-fire, money-making, modern-eral Industries record changer-

ependable, they meet the insis-d for a popular-priced record-aying unit that is there with service, without limit. Teamed with equal-ly good values in radio and cabinet. that

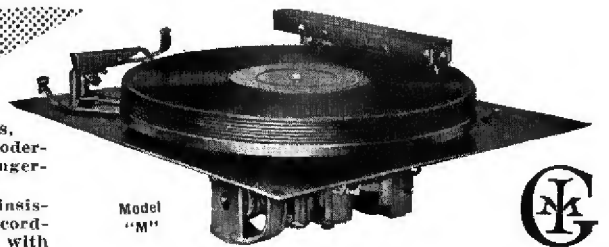



# Building An Automatic Analyzer

By ALLEN BEERS

**T**O operate a profitable service business, speed-up methods are essential. Any device which rids the serviceman's only two hands of routine procedure should not be overlooked. Such is the automatic analyzer.

Noting the schematic of Fig. 1, it will be seen that the unit consists of a power supply, capacity operated relay, motor, and motor switch. These are arranged so that switching to various elements of a tube is done automatically. The capacity operated relay provides the delay action so that meter readings may be taken with ease.

The 45 control tube circuit controls the motor starting timing and stopping. The relay in the plate circuit is set to close at 8 milliamperes. Plate voltage on the 45 should be adjusted by sliding the 250 volt tap along the divider until the plate current reads 45 milliamperes.

Condensers C1, C2, C3 are connected between the 45 grid and ground controlling relay timing. When these are discharged the 45 is biased to cutoff, causing the relay to open. As the condenser charge increases, plate current begins to flow again. At 8 milliamperes the relay closes, energizing the motor. Switch 3, the timing switch regulates the amount of time desired for each test. When set to "S", it shorts the 45 grid to ground, holding the relay open indefinitely.

## Horn Motor Used

The motor controlling the selector switch was taken from a model S Klaxon horn. It turns counter clockwise, drawing 14 amps at 6 volts d.c. To run the motor from a.c., a filament

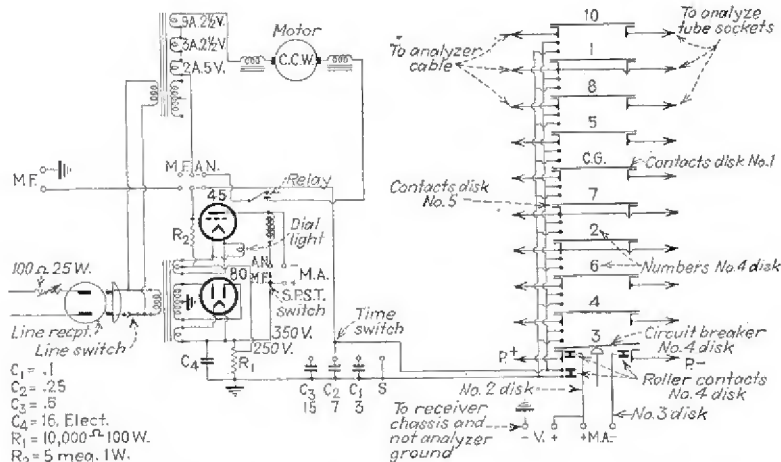

Fig. 1. Schematic of the analyzer showing power supply and switching system

transformer is used with a 5 and 2½ volt winding in series.

On the end of the motor shaft will be found a ratchet washer and nut; remove these. The thread is ¼ inch No. 28 S.A.E., to which is screwed a shaft extension to accommodate the switch rotor. When finished, the shaft should be ⅜ inch in diameter and 2½ inches long. It is very important that the shaft runs true, any wobble means complete failure of the switch since it would jam at some point of the revolution, causing the motor to stall.

The motor switch is clearly shown

in Figs. 2 and 3. A template for the discs is given in Fig. 4. Care should be used to get the dimensions correct or timing will be off. Brass rings around discs 2 and 3 are the meter contacts to the various circuits. These were cut from 2" brass pipe and pressed on the bakelite discs so that a snug fit is obtained. The roller contacts and holder, also the springs, were obtained from old graphite volume controls.

On disc 4 is fastened a small bakelite shoe shaped to size as shown in Fig. 4. This is held in place by a few drops of cement. Around the periphery of disc 3 a ¼ by 12½ inch strip of paper is cemented. On this is printed the octal base numbers in the order shown in Fig. 1. These numbers are visible through a window 1¼ long by ⅝ inches wide cut in the front of the panel.

Connection between each contact on disc 1 to each corresponding contact on disc 5 is made by a strip of .015 phosphor bronze. A special washer is used to give clearance over disc 4. These contacts are normally closed but open one at a time as the motor switch stops at that position. This opens the circuit for milliamperes. A tension spring, as shown in Fig. 3, is also cut from .015 phosphor bronze. It is necessary to adjust the tension of this strip so as to act as a brake, preventing the motor from coasting any distance.

The assembled switch is held together by 3½ inch brass rods threaded on both ends. These are spaced 120 degrees apart and allow proper dis-

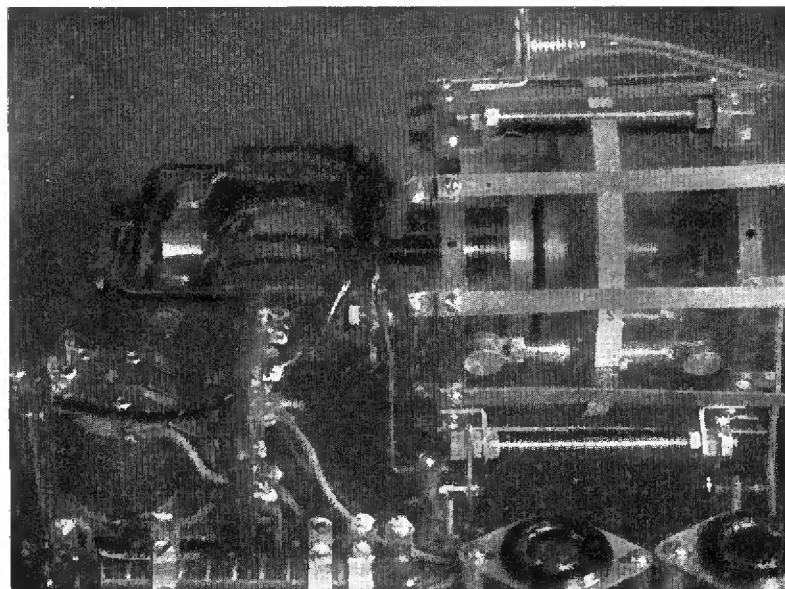
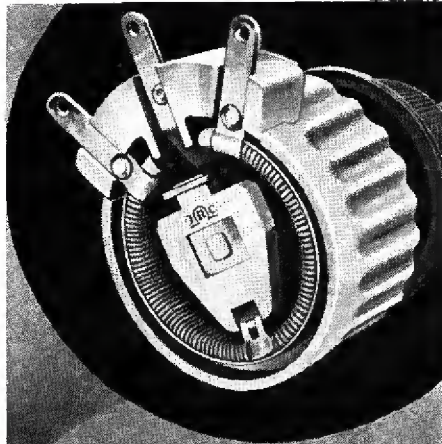

Fig. 2. Assembly details of the motor and motor switch.





# MORE WATTS PER DOLLAR

Through efficient utilization of the unique heat dissipating qualities of aluminum, IRC has engineered a 25-watt ALL METAL Rheostat (Type PR-25) no larger in size than conventional types, yet with approximately one half the temperature rise at full load.

Actual temperature rise for full rotation is only 140° C. measured at the hottest spot.

In addition, due to highly efficient conduction, the full 25 watts may be applied across 1/4 of the winding area with only 160° C. rise at the hottest spot.

Write for Section VI of IRC Engineering Data for full details—or send complete information regarding your proposed application for our recommendation and sample unit.



## ALL METAL RHEOSTATS

**INTERNATIONAL RESISTANCE COMPANY**

401 N. Broad Street, Philadelphia, Pa.  
In Canada: 187 Duchess Street, Toronto, Ontario

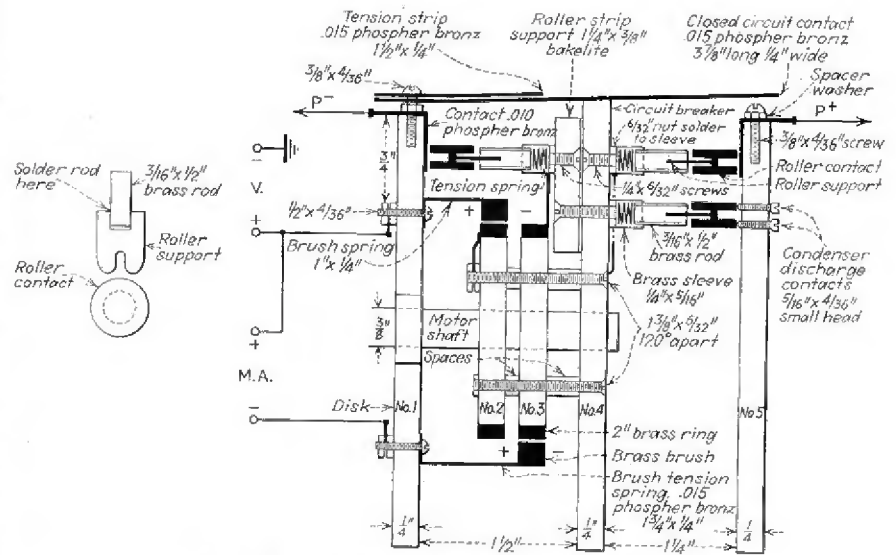

Fig. 3. Dimensions and layout of the motor switch

tance between discs and tension of roller contacts.

In operation, the best procedure is to make a voltage and current test first, and follow this immediately by a socket to chassis resistance test. It is done as follows: In checking a 6A8 tube socket, the timing switch of the analyzer is left in the S position, this is the starting point.

Flip analyzer line switch to "on" position and look in panel window to see which element is to be tested. If set on No. 3 prong, the plate, set voltmeter on 500 volt range; milliammeter on 10 ma. range. Insert analyzer plug in receiver socket and tube in analyzer. Connect negative lead from voltmeter to chassis.

Turn on receiver, and voltmeter will

read plate volts; millimeter, plate current. Now set timing switch for 7 seconds. This connects C2 between the 45 grid and ground.

At the end of 7 seconds C2 is charged, the plate current relay closes and motor begins to turn. As the condenser discharge roller contacts pass over condenser discharge points of position 4, C2 discharges, kicking out the relay; the motor coasts to a stop on the screen grid contact; the the bakelite shoe circuit breaker also slides under the closed circuit contact of position 4 opening the circuit for milliamperes. This is repeated for all other elements; however, be sure to switch meter to a.c. when measuring filaments; also reverse milliammeter on oscillator grid.

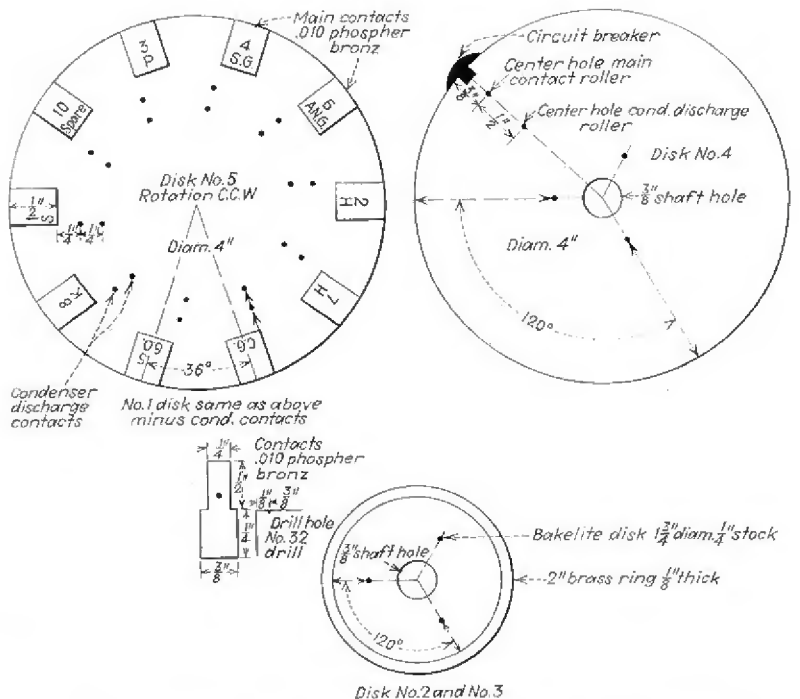

Fig. 4. Motor switch discs are constructed of 1/4 inch bakelite



# TRICKS

## APEX 26

No r.f. screen volts. . . . Check black wire at speaker for voltage; no voltage indicates open tap on speaker field. To repair: tap screen voltage through a 1 watt resistor from the red lead that feeds the r.f. transformer. Screen voltage should read about 80 volts after repair.

## BRUNSWICK 15-22

Signals only at high frequency end of dial . . . open primary in second r.f. transformer.

## CLARION 80

Inoperative, 260 ohm resistor heating . . . test red lead to bypass condenser block for short.

## DELCO R-1129

Distortion and hum when signals are tuned in, 6E5 not operating . . . replace 6E5.

## DETROLA MIDGETS

Distortion . . . replace .5 meg plate resistor of 6C6 detector with .25 meg.



**THE SPEAKER OF THE HOUSE**

● Cinaudagraph permanent magnet speakers need no special introduction. America's foremost engineers in radio and sound long recognized the precision engineering and superior workmanship of these speakers. Now YOU can enjoy Cinaudagraph's famed true-fidelity performance at no extra cost. For today, these speakers are competitively priced. Complete details on request.

**CINAUDAGRAPH CORPORATION**  
Speaker Division  
**STAMFORD CONNECTICUT**  
EXPORT DEPT., 100 VARICK ST., N. Y. C.

## Complete Details on The Instrument Everyone is Talking About

Hold everything until you've read this 16-page booklet on the Rider Chanalyst! It's written by John F. Rider, and is yours for the asking. It tells the how and why of the Rider Chanalyst—What it is . . . What it does . . . How it works . . . How it enables you to speed-test your service jobs — everything you want to know about this revolutionary new instrument. As you read through its pages you will learn how the Chanalyst enables you to trace the passage of the signal from the antenna to the loudspeaker in r-f, a-f or i-f stages, and localize troubles in each stage . . . How to check operating voltages at any point in the receiver without loading the circuit, no matter how complicated the circuit . . . How to check actual control voltages developed by the signal and present at the tube elements—a.v.c. and a.f.c. characteristics . . . How to check bad padders and

coils in oscillator section in a super-heterodyne . . . How to instantly check wattage consumption of the receiver during actual operation . . . How to quickly spot and localize troubles in intermittent receivers.

These are only a few of the multitude of tests which the Chanalyst makes possible. Send for your free booklet today on this remarkable, essential basic new instrument.

**"THERE'S ONLY ONE  
RIDER CHANALYST"**

**SERVICE INSTRUMENTS, Inc.**  
410 FOURTH AVE., NEW YORK CITY

**SEND FOR BOOKLET  
See Your Jobber  
for Demonstration**

SERVICE INSTRUMENTS, INC.  
410 Fourth Avenue, New York City  
Please send descriptive booklet on  
the Rider Chanalyst.

Name.....  
Address.....  
.....



# TRICKS

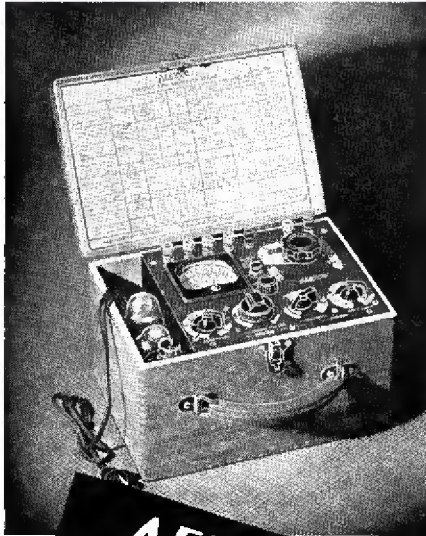

**AEROVOX**  
CAPACITY and  
RESISTANCE  
*Bridge*

● Users of condensers are now offered a more critical and conclusive yardstick of condenser quality, in the AEROVOX Capacity and Resistance Bridge. Combines, in a single, portable instrument, the following:

#### CAPACITY BRIDGE

Measures capacity 100 mmfd. (.0001)—100 mfd. in 6 ranges; leakage; power factor to 50%, etc. of condensers under actual working conditions.

#### RESISTANCE BRIDGE

Measures resistance values of resistors and electrical equipment and circuits. 10 ohms to 1 megohm in 5 ranges.

#### INSULATION RESISTANCE

Measures this important factor in condensers and other devices. Meter calibrated directly in megohms. Reads up to 10,000 megohms.

#### VACUUM-TUBE VOLTMETER

Consists of amplifier stage and gridleak detector. Measures minute values 0—2 volts.

#### PRECISION METERS

Voltmeter, also for external uses, provides 0—60, 0—300 and 0—600 v. meter at 1000 ohms per volt. Also a 60 mv. at 60 ohms milli-voltmeter; and milliammeter 0—6 ma., 0—60 ma.

#### VARIABLE POWER SUPPLY

Available directly at terminals. 15 to 600 volts continuously variable over entire range.

**Ask to See It...**

Your local AEROVOX jobber can show you this indispensable instrument. Or write us direct for descriptive literature.



#### PHILCO 96

Poor sensitivity after bypass condensers, tubes have been checked, especially at 550 end of dial. . . . Suspect antenna coil which is composed of approximately 250 turns of resistance wire at approximately 10 ohms per foot. Rewind with 100 turns of No. 26 or No. 28 copper wire.

#### PHILCO 610

Distortion and low voltage on 75 plate. Check .1 mfd condenser No. 47 at intersection of two 100,000 ohm resistors in second det. plate circuit. Re-align all circuits.

#### PHILCOPHONE 901

Bad hum . . . insulating washers, on pilot light allowing light socket to short to ground.

#### PHILCO 84B

Intermittent reception. . . check .0014 mfd condenser connected to oscillator coil. This is part No. 7. Tone and volume can be improved by connecting an 8 mfd condenser from the green terminal of electrolytic filter to ground.

#### PHILCO FT6

Loud buzz when set is turned on, disappears when cathodes of 75 or 42 are grounded . . . replace double 10 mfd. cathode bypass. This condenser is in the tube compartment of the receiver.



**MAN AT WORK**—P. W. Kidd of Supreme Radio Service has his own method of adapting his six-foot-two to some of the two-by-four corners encountered in auto radio installation. Says service work keeps him limber.

**JIM QUAM**  
*Says*



You know, I get a lot of fun out of amusing my friends with magic tricks. Presti-digitating it's called. I've studied with a lot of top-notch professionals and learned their way of doing things. And, by golly, it wouldn't do some manufacturers any harm to study magicians' ethics! When an expert spends his time and talent developing a trick, he is the one who benefits from his efforts. Any competitor who steals it is drummed out of the Society! You can buy the trick from him, but you must not lift it.

**QUAM-NICHOLS CO.**

33rd Place & Cottage Grove 1674 Broadway  
CHICAGO NEW YORK



**EXTRA · EXTRA ·**  
SEPARATE PLATE TESTS ON DIODES  
AND  
RECTIFIERS...  
BALLAST  
TUBE TEST



Positively Checks Radio Receiving Tubes According to Latest Recommendations of Tube Engineers.

**NEW MODEL 432 Only \$21.60**

- Uses Triplett Direct Reading Instrument (GOOD-BAD) Scale
- Line Voltage Adjustment
- Neon Short and Leakage Tests
- Separate Plate Tests on Diodes and Rectifiers

Complete in attractive, sturdy quartered-oak case; suitable for counter or portable use. Sloping etched panel of silver and black.

Other Readrite Tube Testers Also Are Available

**Readrite**  
WITH RANGER

READRITE METER WORKS  
720 College Drive, Bluffton, Ohio



# AMPERITE offers "ADJUSTABLE RESPONSE"

...made possible by  
**THE ACOUSTIC  
COMPENSATOR**

(pat. pend.)

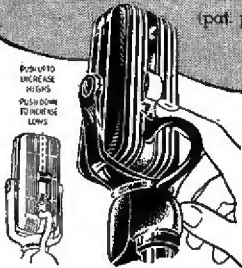

\*Higher or lower pitch with the same microphone.

With the flip of a finger you can now (1) lower or raise the response of the microphone. . . (2) adjust the microphone for most desirable response for close talking or distant pickup. . . (3) adjust the system to any "taste", room condition, or equipment.

MODELS RBHK, RBMK, with Acoustic Compensator, frequency range 40 to 11000 cps, output, -65 db., complete with switch, cable connector and 25' of cable. . . . . \$42.00 LIST

**NEW LOW-PRICED CONTACT "MIKE"**

Model SKH (hi-imp); SKL (200 ohms) \$12.00 LIST

MODELS RAH-RAL, excellent for speech and music. Reduce feedback. . . . \$22.00 LIST

Write for Complete Illustrated Bulletins and Valuable Sales Helps.

**AMPERITE Co.** 561 BROADWAY, N. Y.  
Cable Address: Alkem, New York

**AMPERITE** *velocity* **MICROPHONE**

# New Steel VERTICAL ANTENNA

**PREMAX**

**First to Sense the Trend  
—Now the Accepted Type**

In introducing the only single unit collapsible Vertical Steel Mast, **PREMAX** gives to radio fans the aerial of perfect world-wide reception. Jobbers and dealers hail it as an entirely new profit maker—fans like it because it is

**Straight Up and Down—Easy To Erect in Small Space**

No overhead or unsightly guy wires—a single unit all steel collapsible mast which can be used in any height from 6 to 24 feet. Comes ready to install—in ground or roof type mounting (ground type illustrated). Send for special bulletin and dealer prices today.

**ANOTHER BIG SELLER**

Get the Premax Bulletin on 10 and 20 meter Vertical Radiators—the sensation of the amateur world.

**Premax Products**

Division of Chisholm-Ryder Co., Inc.

3842 Highland Ave., Niagara Falls, N. Y.

# TRICKS

## RADIOLA 66

Dead, loud hum . . . shorted bypass condenser across plate and cathode lugs underneath socket of second detector tube. Replace with a .0024 mfd.

## RADIOLA R21

Motorboating . . . Check 1 mfd condenser (C14 in diagram) which bypasses the screens of r.f., first detector and i.f.

## RCA 128

Weak, distorted . . . 4 mfd cathode bypass on 6B7 leaking or shorted.

## RCA R-78

Loud hiss with tone control in high position. . . . Replace 10,000 ohm resistor (R25) in series with (C35) .005 mfd condenser in plate circuit of 46 output tube.

## RCA VICTOR—8BT6

Noisy, intermittent . . . air dielectric trimmers shorted intermittently by metallic fuzz. Flash with high voltage to burn off fuzz. Condenser across secondary of antenna coil may be flashed without disconnecting if wave band switch is turned to right setting.

## RCA VICTOR 9K

This receiver has a five band dial but only four positions of the band switch. A stop is provided to eliminate the dead position. This should always be in place when the set leaves the shop otherwise a complaint of one dead band might be received.

## RCA M-30

No control of volume . . . replace green wire in cable that runs from set to control unit.

## RCA VICTOR R4

Oscillation . . . open 8 mfd (C-16) in a can with several others. Replace with 8 mfd, 500 volt unit.

## RCA R-28P

Noisy . . . defective r.f. coil mounted in shield on top of chassis.

## REMLER 46

Unable to control volume . . . shorted .1 mfd (No. 7039) condenser on 6K7 and 6Ak cathode. If set is noisy replace 15,000 ohm screen grid dropping resistor.

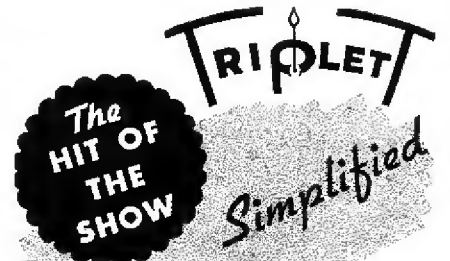

## PUSH-BUTTON TESTING



• Mutual Conductance Per Cent Scale

Rotating Chart Shows Correct Buttons to Push

MODEL 1616 ONLY \$73.34

**DYNAMIC MUTUAL CONDUCTANCE**

## Tube Tester and Volt-Ohm-Milliammeter

Many Claim Dynamic Mutual Conductance . . . Triplet Positively Has It.

The hit of the Radio Parts Trade Show was this precision setting push-button tester by Triplet, with its revolutionary advancements. After rotating chart to the tube to be tested, the button to push is clearly marked under each row. What could be simpler?

And the Dynamic Mutual Conductance test for amplifiers and power tubes not only shows if the tube is GOOD or BAD, but the percentage of mu to the 100% Good Condition also is indicated. In critical sets this permits the dealer to pick his tubes with confidence. . . . Diodes and rectifiers are tested for emission according to the latest approved engineering standards. Gas and Ballast tube continuity test included.

Filament location switch permits application of filament voltages to any prongs of the tube. The same is true for plate location, screen location, c.g. location, etc. This selective feature, together with a spare socket, is an anti-obsolescence factor.

Rotate chart to Volt-Ohm-Milliammeter settings—push button for D.C. scales: 0-10-50-250-500-1000 Volts at 1000 Ohms per Volt; 0-10-50-250 M.A.; .2 Ohms to 500 Ohms—300,000 Ohms—1½ Megohms—3 Megohms; 0-10-50-250-500-1000 A.C. Volts at 400 Ohms per Volt; decibel chart furnished to 42 db's. (Ohmmeter is line powered and provision is made for using batteries if desired). Uses two inter-changeable plug-in type rectifiers, simplifying replacement in case of unintentional damage. One is in the tube tester circuit, the other for the Volt-Ohm-Milliammeter. Furnished in attractive, all-metal case with lustrous finish. Removable cover for portable or counter use . . . sloping panel.

Model 1615—Dynamic Mutual Conductance Tube Tester only with Push-Button testing. DEALER PRICE. . . . \$63.34

Model 1610—True Emission Type Tube Tester with Push-Button Testing. DEALER PRICE. . . . \$39.00

Model 1611—True Emission Type Tube Tester with Push-Button Testing and Volt-Ohm-Milliammeter. DEALER PRICE. . . . \$49.50

SEE THEM AT YOUR JOBBERS—OR WRITE

**FREE**—8 pp. two-color catalog listing today's most complete line of test equipment.

The Triplet Electrical Instrument Co.  
208 Harmon Dr., Bluffton, Ohio

Please send me more information on

Model 1615  Model 1616  
 Model 1610  Model 1611

Name .....

Address .....

City ..... State .....



## TRAINING GREEN SALESMEN

(Continued from page 15)

no position to "ossify" the lady. He must at least go back to the trailer to get the radio, and this gives the lady an opportunity to close the door.

I do not advocate this "ossification" of any prospect; I am merely pointing out the difference between a vacuum cleaner approach and a radio approach, as far as pressure is concerned. A lady who takes in a radio on demonstration may not, and quite often is not, ready to buy it; but she must at least be sold the idea of taking it in—and sufficiently well that she will not "cool off" before the radio goes in. Selling her that idea requires pressure, actually high but apparently low; but most of all it requires a good cock-and-bull story. You'll find that story in the April issue of *Radio Retailing*, under the title of "You Can't Sell Radios at the Door."

No-pressure is used mostly in actually selling, and has very little to do with canvassing.

But the canvasser, as well as the salesman, can make excellent use of this "suction" at times. I suppose I'll have to give you an illustration, in this case, to show you what I mean.

A canvasser is trying to force a radio demonstration. He's got the lady listening and is not afraid of losing her, so the conversation, guided by the canvasser, turns to electric refrigerators.

"Not for me!" says the lady very emphatically. "Don't try to tell me they're cheaper than ice. My sister has one! and my sister-in-law has one and my mother has one. Oh, yes, I know. As far as the actual *electricity* is concerned, they may be all right—but look at the monthly payments! You know how much I spend for refrigeration—Ten cents a day. And that's only during the hot weather. In the winter, I have a nice window box."

Now let's assume, for a moment, that the canvasser is an experienced man. He's heard that story so often that it doesn't make him mad any more. He knows very well that if he started talking to her some evening *in* her home, and really shoved a good sales talk down her throat, he'd have her singing a different song.

But here he stands at the door.

He's not interested in winning an argument about refrigeration *now*. It's the wrong time to talk about the box—to *sell* it. He's trying to place a radio in her home on demonstration.

"Is that right?" he says in slight amazement, gushing interest. "You must have a very good ice box, Mrs. Smith." He listens intently while she bores him with the ice-keeping qualities of her ice box. "Of course," he goes on in feeble defense of electric refrigeration, "an electric refrigerator is a nice thing to have—it must be, or there wouldn't be so many of them sold. But in your case, I'll have to admit your ice bill isn't very high. Now this radio here I was telling you about . . ."

Suction? Suction on the box, but not on the radio!

And the result. Well, thinks the lady (perhaps consciously, but at least subconsciously), here is a man who is a refrigerator *salesman* . . . and yet, he didn't even give her an argument on the box. In fact, he practically agreed with her. She not only feels proud of herself, but decides *this* man is indeed an unusual salesman. He probably tells the *truth* about *everything*, whether he makes the sale or not. He's probably telling the truth about this radio. . . . (She'll hear plenty about the box *later*—when the proper time arrives!)

### Approach

I will discuss only the radio approach here.

The canvasser should stand far enough away from the door to let the lady know, right off the bat, that he is not another one of those high-pressure men. When she opens the door, he smiles, says "Good morning" or "How do you do?" and extends his business card *so the lady will take it*.

Speaking very slowly and distinctly and without excessive enthusiasm, to show the lady he's not going to smother her with words, so smoothly and confidently, in fact, that she sometimes gets the idea (at first, when it's most important) that he's not a salesman at all, he says:

"I represent the Wonder Value Furniture Co. The distributors of . . . . . radios are running an advertising campaign, and our store is making free home demonstrations in this neighborhood. No doubt

you have a good radio now, but could I get you to use one of their new ones for a few days?"

Instead of blustering right on with "no obligation" and all that he pauses for a moment, deliberately, waiting for her answer. He knows what she is going to say, anyway, so he simply lets her say it. She's going to misunderstand him, think he's a salesman, and say "no." Then he is ready to explain that she didn't quite get the idea.

"I don't believe you quite understood me," he smiles. "You mean you don't want to *buy* a radio, don't you?"

She nods her head.

"Well, now we understand each other," he says, still slightly amused at her getting the wrong impression. "Of course," he goes on as if honest confession is good for the soul, "if you wanted to buy a radio—I'd be the first one to try to sell it to you! But this is something different. You see . . ." And from there on he goes into "Bill Brown's" sales talk.

While the approach is a radio approach, this does not mean that it is the only thing he should mention at the door. If he sees there is no chance for a sale, no sense in making a demonstration (she bought a new radio last week), he mentions other equipment.

Would she be interested in an electric refrigerator, or a washer, or furniture of some sort? He shouldn't mention these things one right after the other, in rapid fire order, though. After mentioning one or two other items, he smiles and says, "Well, I don't want to bore you by mentioning everything we have in the store! But, seriously, is there anything at *all*, in the way of house furnishings, that you expect to buy in the near future?"

He should do this, however, only with the ladies who give him a chance to talk. He should *not* even *try* to get out the whole story where he's got to indulge in hypnotic glances and perform vocal contortions in order to keep the door open.

All these things and many more the supervisor should explain or demonstrate to the new man during his first week or two. And if the man listens and learns from experience, too, he'll be a pretty fair canvasser at the end of two weeks.



## INDEX TO ADVERTISERS, AUGUST, 1938

Page	Page
AEROVOX CORP. .... 52	MALLORY & CO., INC., P. R. .... 48
AMPERITE CORP. .... 53	Inside Front Cover
ARCTURUS RADIO TUBE CO. .... 39	MEISSNER MANUFACTURING CO. .... 10, 38
BELL SOUND SYSTEMS, INC. .... 48	MILLION RADIO & TELEVISION CORP. .... 48
BELDEN MFG. CO. .... 35	NATIONAL UNION RADIO CORP. .... 41
CINAUDAGRAPH CORP. .... 51	NOBLITT-SPARKS INDUSTRIES .... 5
CLOUGH-BREngle CO. .... 47	ONAN & SON, D. W. .... 40
CONSOLIDATED WIRE & ASSOC. CORPS. .... 48	PHILCO RADIO & TELEVISION CORP. .... 6
CROSLEY RADIO CORP. Inside Back Cover	PIONEER GEN-E-MOTOR CORP. .... 39
FAIRBANKS, MORSE & CO. .... 23	PROGRESS LECTRO-SHAVE CORP. .... 36
GALVIN MANUFACTURING CO. .... 28C	PROGRESS ROTO-SHAVE CORP. .... 28D
GENERAL ELECTRIC CO. .... Back Cover	QUAM-NICHOLS CO. .... 52
GENERAL INDUSTRIES CORP. .... 48	RAYTHEON PRODUCTION CORP. .... 3
HORTON MFG. CO. .... 38	RCA MANUFACTURING CO., SET DIVISION .... 8
HYGRADE-SYLVANIA CORP. .... 30	READRITE METER WORKS .... 52
INTERNATIONAL RESISTANCE CORP. .... 50	RIDER, JOHN F. .... 48
JANETTE MANUFACTURING CO. .... 38	SENTINEL RADIO CORP. .... 17
KEN-RAD CORP. .... 40	SERVICE INSTRUMENTS, INC. .... 51
MAJESTIC RADIO & TELEVISION CORP. .... 34	SOLAR MANUFACTURING CO. .... 40
	STROMBERG CARLSON TELE. MFG. CO. .... 2
	TRIPLETT ELECTRICAL INSTRUMENT CO. .... 53
	TUNGSOL RADIO TUBES, INC. .... 37
	UNIVERSITY LABORATORIES, INC. .... 41
	UTAH RADIO PRODUCTS CO. .... 42
	WARD PRODUCTS CO. .... 38
	WESTINGHOUSE RADIO .... 27
	ZENITH RADIO CORP. .... 4

### SEARCHLIGHT SECTION (Classified Advertising)

Classification	Page
CATALOGS	55
EMPLOYMENT	55
RADIO STOCKS	
Burnstein-Applebee Co. ....	55
Midwest Appliance Parts Co. ....	55
Radolek Co. ....	55
Regel Mfg. Co., Inc. ....	55

Although Radio Retailing takes every precaution to insure accuracy, we cannot assume responsibility for an occasional change or omission in the above index

## SEARCHLIGHT SECTION

### SEARCHLIGHT SECTION

EMPLOYMENT AND BUSINESS  
"OPPORTUNITIES"

PARTS—DISCONTINUED MODELS  
SURPLUS STOCK

See last issue for advertising rates

#### POSITION WANTED

RADIO MANUFACTURERS And Radio Suppliers Attention. Position desired as buyer—have five years experience as Assistant Purchasing Agent for one of largest Radio Manufacturers; excellent references. PW-122, Radio Retailing, 330 West 42nd Street, New York City.

## WANTED!

### Radio Parts Salesmanager

One of America's fastest growing radio parts manufacturers, thoroughly established, has an opening for a salesmanager experienced in the radio parts field. Must know the jobbing trade and the manufacturing trade. This position requires traveling in addition to home office work. Salary commensurate with ability will be paid. If you can qualify—and that means "Sell"—this opportunity may prove the one in your lifetime. Application by letter only. Write fully, stating age, education, experience and salary desired. Inquiries treated confidentially.

Address: P-121, Radio Retailing,  
330 W. 42nd St., New York City

NOTE: The sales executives associated with this advertiser know of this advertisement.

### OVER 10,000 PARTS FOR VACUUM CLEANERS AND WASHING MACHINES

24-HOUR SERVICE!  
Attach this "Ad" to Your Inquiry and Receive  
"Special Inventory Reduction Price Sheet"  
Manufacturers' Factory Representatives  
**MIDWEST APPLIANCE PARTS CO.**  
2722 W. Division St. CHICAGO, ILL.

#### RADIO IN IT'S ENTIRETY!

"B-A" serves the trade with every need in radio—complete 160-page catalog of nationally known radio receivers, public address, parts, supplies and equipment. Orders shipped same day received.

**COMPLETE CATALOG AVAILABLE**

**BURSTEIN-APPLEBEE CO.** 2012-14 MCGEE ST., KANSAS CITY, MO.

#### FOR SALE

One Ferris Microvolter, model #10B, serial #528, brand new, used only once for 15 minutes. Will sell for \$200.00 cash.

**REGEL MFG. CO., INC.**  
14-16 W. 17th St. New York, N. Y.



# STOP!

Here is the Most Complete  
Radio BUYING GUIDE!



- The new 1939 Radolek Radio Profit Guide contains complete showings of Radio Repair Parts, Radio Receivers, Public Address Amplifiers, Speakers, Microphones, Service Test Instruments, Radio Technical Books, Special Radio Tools, Leading Standard Brands! Everything you will ever need in the Radio Business all at Lowest Prices. You save money at Radolek!
- Every item you get from Radolek is guaranteed. It must be right or we make it right. Standard merchandise produced by leading Manufacturers with Radolek's guarantee added!
- Everything in Radio promptly when you want it—and exactly what you want. Radolek's efficient organization backed by a huge stock of standard guaranteed quality merchandise insures you the fastest service in the Radio business. Twenty-five Thousand Servicemen customers depend on Radolek service and benefit by Radolek's **LOWEST PRICES**. Send Now for your copy of the Radolek Radio Profit Guide. It will help you make more money.

## Send for Your FREE Copy Now!

## RADOLEK

601 W. Randolph St., Dept., A-22, CHICAGO

Name \_\_\_\_\_

Address \_\_\_\_\_

Serviceman?  Dealer?  Experimenter?



# Audio Frequency...

## Price Protection

Every thinking person connected with our entire economic system must realize that the retail business is its backbone.

If this economic system of ours is ever to regain its health, retailers will have to help it. For so long as men are forced to put up with conditions caused by wholesalers selling at retail prices in direct competition with dealers they profess to serve there will be trouble.

Why can't the radio industry organize and remove this evil?

Certain wholesalers selling at retail are powerful and have lots of money. They still can be licked if legitimate radio retailers and servicemen organize and put up a united fight for mutual protection and the right to make a living without having to submit to the scorn and humiliation of their former customers who have since found it possible to buy at wholesale from some distant house.

*Radio Retailing* can put this problem up to its readers. Perhaps by some miracle or other you can wake them.

VINTONDALE, PA. WILBERT L. MISNER

## One Man's Meat, etc.

Caswell Oden's series about outside selling has been mighty interesting. Why not a similar series about *inside* selling for the man who has to stay, or likes to stay, behind the radio store counter?

CHICAGO RALPH L. CHAMBERS

Oden's outside selling series terminates with an article buttoning the subject up in September. We're planning to tackle *inside* selling methods with a series beginning shortly.

I am going to give Caswell Oden a piece of my mind. The setup he recommends is just as cheap as the paper boy delivering at the door. He should go to China where people live on rice. I say his plan is not fair to workers.

DETROIT JOSEPH SHARBA

## Coming Up

What ever happened to the excellent series of "Sales Ammunition" pages like "Why Good Service Can't Be Cheap" that you ran regularly last year? These were very practical, most of them, and the white-on-black style in which they were printed was very effective.

BOSTON G. B. SHEARN

To be perfectly frank, these pages are tougher to think up and work out than our front covers . . . and these are tough enough. There'll be one in September, however, and we're working on it now. Any suggestions for future issues?

## CREDIT FOR THE BUYER

(Continued from page 19)

er do about cashing in on the consumer trend?" was asked.

"He can present all the facts about all refrigerators," he replied. "I don't mean perverted facts, or half facts, but a frank setting forth of statistics about all refrigerators told in understandable language. The prospect wants to know about current consumption, about the capacity of the box, the insulation, and operating features. An honest side-by-side presentation, with all the facts laid on the line, will go far toward convincing the prospect that the dealer is actually acting as a purchasing agent for his trade. In the long run any business succeeds that does the most for its customers—and here is a golden opportunity for the radio dealer today."

## HOW TO DEMONSTRATE SOUND

(Continued from page 22)

loud speaker used out front under a grill. So, having sold themselves on the idea of sound equipment, the trade was called in. Brown saved Borsheim the price of a big chime clock. He took a little fellow with Westminster chimes, attached a contact microphone to it, led his wires outside to a loudspeaker in a grill. The set has been on continuously for about eight months. In addition to being cheaper, it has one advantage an outside chime clock does not have; its tones can be softened or made louder to suit the neighborhood.

### Suggestions for the Trade

For three years H. C. Noll has been carrying sound equipment, and the firm's experience with servicemen leads him to point out three weak spots in the sound equipment sales methods of such outlets:

(A) Servicemen too frequently give away all their discount to the customer in order to get the work.

(B) Servicemen too often call in

the sound equipment distributor to help sell or install and then expect a full margin of profit.

(C) Servicemen sometimes borrow sound equipment from the distributor for demonstrating, rent it and pocket the proceeds, killing the market not only for themselves but for everybody concerned.

### Tips for Factories

It is essential that more substantial dealers be interested in carrying a stock of sound equipment, says Brown. For this reason he suggests to manufacturers that they establish separate discounts to servicemen who don't and to retailers who do stock equipment.

For firms carrying a stock of sound equipment, he recommends a 40 and 10 per cent discount. For servicemen who do all the work 40 is enough. For bird dogs, 20 per cent. This gives the servicemen plenty of profit for operating either on the job or on a bird dog basis, but does not permit them to cut under other outlets.

It may be necessary for some jobbers to organize a retail department on sound, thinks Brown—to develop salesmen and prove that there is a profit in sound equipment before more dealers can be induced to carry stock. Later, they can supply dealers with trained salesmen and gradually drop out of the retail picture themselves.

Manufacturers will find that they can profitably conduct more meetings. It will do the sound business good to get together all the servicemen and salesmen and to show them exactly what sound equipment will do, show them how to meet mail-order competition and give them feedback dope on why a factory assembled unit is better than a homemade one. The value of all sound equipment to the customer is dependent upon the time it saves and the work it does, not on the construction cost. Many men in the retailing end have no concept of this and a "flying circus," demonstrating half-a-dozen items if necessary would be a good thing to bring understanding of sound up-to-date and to point up the thinking of the boys who are doing the selling.



# Don't follow the old curves!

Your Sales Curves won't follow old curves if you follow Crosley!

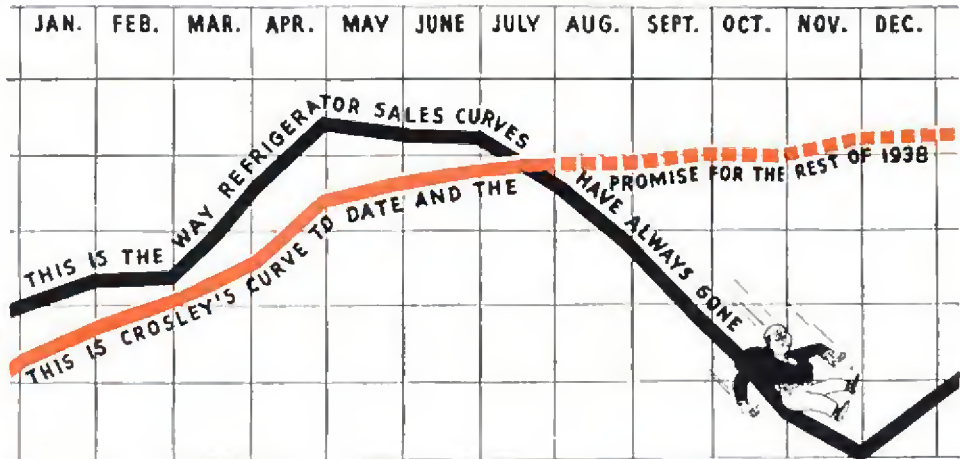

Crosley Follows **NO** Precedent.

Don't play "dead dog" just because the refrigeration business does from now until January 1st. New automobiles stimulated car sales in the fall. Crosley applies the same idea to Shelvadors, presenting brand new startlingly low priced, completely re-engineered refrigerators.

Get the most of the refrigeration business between now and Christmas!

You can get up a lot of momentum between now and January 1st and meet the new year with a running start.

With the new Crosley line of Shelvadors and energetic sales effort this fall you can leave your competition way behind!

**NEW  
"REGULAR"  
SHELVADORS  
PRICED TO  
MEET 1938  
CONDITIONS**

**6  
cu. ft.  
R.F.D.  
SPECIAL  
\$99.95**



*Radio is not standard equipment but may be had in above models at additional cost.*

The public always responds when prices are low and values are evident.

If you are not stocking and showing the new Crosley 1939 models including the RFD Special rush to the nearest Crosley distributor and get going right away.

*Prices slightly higher in South and West.*

**THE CROSELY RADIO CORPORATION**  
 POWEL CROSELY, Jr., President  
 CINCINNATI  
 Home of "The Nation's Station"—WLW—70 on your dial

**CROSELY SHELVADOR**



# "HERE'S THE GREATEST RADIO SCOOP OF THE PAST TEN YEARS" ..

AMAZING G-E BEAM-A-SCOPE ENDS NEED FOR AERIALS AND GROUND WIRES. NEW G-E RADIO OPERATES IN ANY SPOT IN ANY ROOM. JUST PLUG IT IN LIKE A FLOOR LAMP.



GET YOUR **FREE** COPY OF  
THIS VALUABLE BOOK ... NOW!  
THE GENERAL ELECTRIC  
**KEYBOARD SELLING PLAN**

(SPECIAL  
DEALERS'  
EDITION)



A tested selling  
plan for increas-  
ing your radio  
sales through  
**HOME SELLING**  
—based upon the  
actual experience  
of 550 of the

most successful radio dealers in 216 cities  
throughout the nation.

A real working manual and guide to successful  
home selling. A smart merchandising campaign  
for your local promotion. Get your copy  
today from your G-E Radio Distributor.

Again General Electric leads the parade with the most brilliant radio development of the past ten years—the amazing Beam-a-scope. This new scientific built-in mechanism does away entirely with the need for unsightly aerial and ground wires. It makes the new G-E the one radio that does not need to be “anchored” in one fixed location in the room. It operates in any spot—in any room. Just plug it in like a floor lamp—anywhere you choose. Also, the Beam-a-scope reduces local static interference—gives you finer, quieter reception—especially in noisy areas.

Think what a tremendous advantage the Beam-a-scope gives you in closing demonstration sales—in the home—or on the sales floor. It's this year's greatest radio sales feature.

Every radio in the new 1939 G-E line is designed and engineered for sales action. This year, more than ever, it's easier to sell the new G-E Radios than to sell *against* them.



# RADIO

GENERAL  ELECTRIC