

RADIO REPAIRING

25 CENTS PER COPY

McGraw-Hill Publishing Co.

SHOW NUMBER

New SETS

Specifications

New SOUND

Prices

New ACCESSORIES

Directory

New TESTERS

Pictures

New PARTS

Addresses

New CIRCUITS

Service

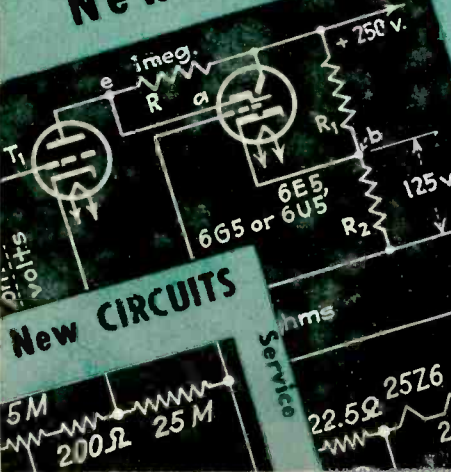

JUNE, 1938

1938 Brings New Stars into the MALLORY-YAXLEY Family

Radio service engineers depend on Mallory . . . for the finest and most efficient replacement parts . . . and for the pioneering that keeps radio service abreast of radio manufacturing.



New! **Small-Sized Metal-Cased Tubulars, Type BB.** These condensers represent the result of over ten years of research. They embody every possible safety factor. They are completely dependable.

New! **Midget Replacement Controls with Plug-In Shafts . . .** 10 new Mallory-Yaxley Midget Volume Controls plus 17 Plug-In Shafts give you the servicing range of 170 ordinary Exact Replacement Controls with fixed shafts.



New!

The 2nd Edition Mallory-Yaxley Radio Service Encyclopedia.

Contains twice as much information as the first edition MYE. 17,000 receivers analyzed. All the dope on every system of automatic tuning . . . alignment . . . audio degeneration. Complete tube charts. You wouldn't believe that such a book could be possible. It will pay for itself in the time you save on one job.

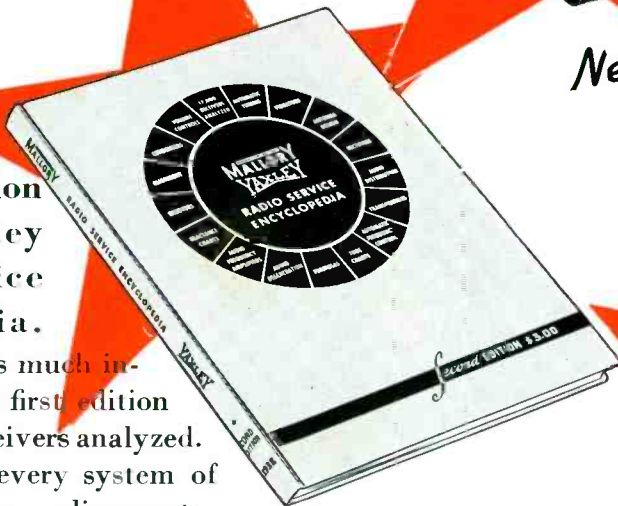

New!

Long-Life Vibrators, priced right. Mallory Replacement Vibrators assure lowest cost per "use hour" and trouble free long life.

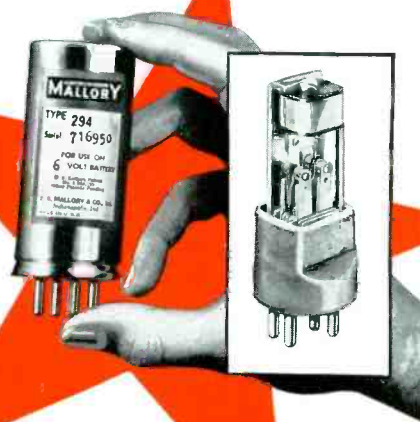

Always insist on Mallory . . . the Quality Product that Costs No More Than Ordinary Products

P. R. MALLORY & CO., Inc.
INDIANAPOLIS INDIANA
Cable Address—PELMALLO

Use
MALLORY
PR MALLORY & CO Inc
REPLACEMENT
CONDENSERS . . . VIBRATORS

Use
YAXLEY
REPLACEMENT
VOLUME CONTROLS

RADIO RETAILING

JUNE, 1938

SHOW NUMBER

O. FRED. ROST Editor
 W. MacDONALD... Managing Editor
 C. A. NUEBLING... Technical Editor
 HARRY PHILLIPS..... Art Director

Tom Blackburn Chicago George Tenney San Francisco

H. S. Knowlton Boston

H. W. MATEER Manager

LEE ROBINSON Sales Manager

RADIO MONTH	9
PHOTOSHORTS	11
NEW SEASON SALES OUTLOOK..... By O. Fred. Rost	14
THERE IS NO DEPRESSION IN THE COUNTRY.. By Tom Blackburn	16
MEN MUST HAVE MONEY..... By Caswell Oden	18
SELLING SUPER SERVICE IN THE EVENING..... By E. F. Staunton	20

SEASON'S NEW PRODUCTS		SPECIFICATIONS, DIRECTORY	
SETS	23	TUBES	55
SOUND	31	SETS	57
ACCESSORIES	39	SOUND	65
TESTERS	47	ACCESSORIES	69
PARTS	49	TESTERS	73
(Numbered Card For Inquiries..... 42A)		PARTS	75
JUNE NEWS	79		
(News Extra	90A)		

TECHNICAL TOPICS

CIRCUITS	91
MICROPHONES, PICKUPS AND SOUND..... By Robert S. Nash	95
SERVICING COMMUNICATION RECEIVERS.... By H. D. Hooton	98
CARRIER TYPE REMOTE CONTROL..... By L. C. Waller	103
SHOP SHORTCUTS	107
TRICKS OF THE TRADE.....	108
AUDIO FREQUENCY	116

SALES STATIC . . . Can you put a coupla more tubes in it so I should hear the Philharmonic's bull-fiddles?

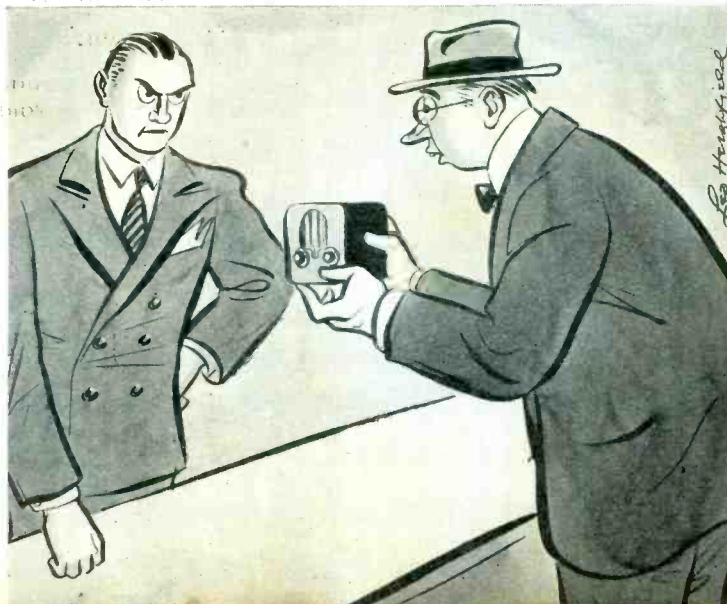

McGraw-Hill Publishing Company, Inc.

JAMES H. McGraw
 Founder and Honorary Chairman

Publication Office
 99-129 North Broadway, Albany, N. Y.
 Editorial and Executive Offices
 330 West 42nd Street, New York, N. Y.

Cable Address: MCGRAWHILL, New York
 Member A.B.P. Member A.B.C.

James H. McGraw, Jr. President
 Howard Ehrlich..... Executive Vice-President
 Mason Britton..... Vice-Chairman
 B. R. Putnam..... Treasurer
 D. C. McGraw..... Secretary
 A. W. Morrison..... Circulation Manager

RADIO RETAILING, June, 1938, Vol. 23, No. 6.
 Published monthly, price 25c copy. Subscription rates—United States and possessions, Canada, Mexico and Central American countries \$1. All other countries \$2 a year or eight shillings. Printed in U. S. A. Entered as Second Class Matter, September 8, 1936, at Post Office, Albany, N. Y., under the Act of March 3, 1879. Cable address "McGrawhill, New York." Member of A.P.P. Member of A.B.C. Copyright 1938 by McGraw-Hill Publishing Co., Inc., 330 West 42d Street, New York, N. Y.

Branch Offices: 520 North Michigan Ave., Chicago; 883 Mission St., San Francisco; Aldwych House, Aldwych, London, W.C. 2; Washington; Philadelphia; Cleveland; Detroit; St. Louis; Boston; Atlanta, Ga.

HOLD THE PHONE! —



JUST HOW LOW IS THE NEW LOW PRICED LABYRINTH MODEL?

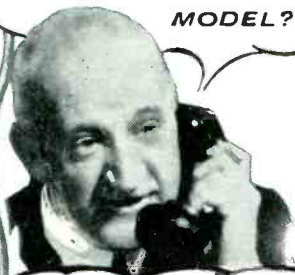

WHEN CAN I SEE THE NEW FURNITURE DESIGNS THE LABYRINTH MAKES POSSIBLE?



RUSH THAT NEW TABLE MODEL WITH THE LOWEST PRICE IN STROMBERG-CARLSON HISTORY!



CAN I GET A STROMBERG-CARLSON FRANCHISE? I'M SICK OF BEING KICKED AROUND!



RUSH THOSE NEW MODELS! — I'M CLEAN OUT OF STROMBERG CARLSONS.

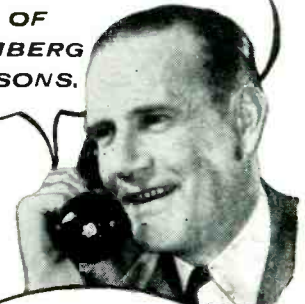

I WANT STROMBERG-CARLSON! I NEED PROFIT!



There's going to be a stampede to Stromberg-Carlson. And why not? A line of Stromberg-Carlsons is coming with *new engineering features . . . new styling and a new range of prices.* Soon Stromberg-Carlson representatives will be ready to give you complete information of the season's *surprise* radio line . . . a line which will put dealers back to making money in their radio business. Be ready for the big news!

STROMBERG-CARLSON TELEPHONE MFG. CO.
ROCHESTER, NEW YORK

There Is Nothing Finer than a
Stromberg-Carlson



17 MILES UP...

IN THE STRATOSPHERE

RAYTHEON TUBES

Forecast for the

U. S. Weather Bureau

EVERY dawn the U. S. Weather Bureau at Boston sends a RAYTHEON tube seventeen miles up into outer space, through all the layers of earthly atmosphere—faithfully reporting pressure and temperature all the way up!

The data supplied by that RAYTHEON tube warns ships at sea of impending storms, governs the operations of the great airlines—and tells your wife that it will rain at her picnic!

RAYTHEONS were chosen by the Government for this exacting work for the same reasons that so many of the Navies of the world use them—their uniformity, ruggedness and dependability!

And those are the same reasons why thousands of servicemen use RAYTHEON tubes for replacements in quality radio receivers—to enjoy greater permanent tube profits!

RAYTHEON

CHICAGO • NEW YORK • ATLANTA
NEWTON, MASS. • SAN FRANCISCO



"WORLD'S LARGEST EXCLUSIVE RADIO TUBE MANUFACTURERS"

Announcing a **NEW CROSLLEY**

REFRIGERATORS TO FIT TODAY'S PURSES!

at startling low prices



**DELIVERED
and INSTALLED
3.1 cu. ft.**

99.50*

Crosley makes it in the great new million dollar plant at Richmond, Indiana, where low costs of manufacture give America the greatest refrigerator value of all time!

Crosley makes it sturdy—makes it efficient, makes it a thing of beauty and an article of service!

Crosley makes it with the famous SHELVADOR so that the easy, handy storage of small food items on the convenient shelves-in-the-door makes more usable room for foods than in ordinary refrigerators.

This new line gives Crosley dealers a powerful weapon for mail order house competition—for obsolete model competition and for chiselling tactics that creep into selling in these times.

Crosley tools up for a new line in the middle of the season—the first manufacturer to do so. New factory efficiency and economies make this possible!

Crosley dealers now have their distinct Shelvador selling advantage further strengthened and its lead lengthened by this NEW line at its LOW PRICE.

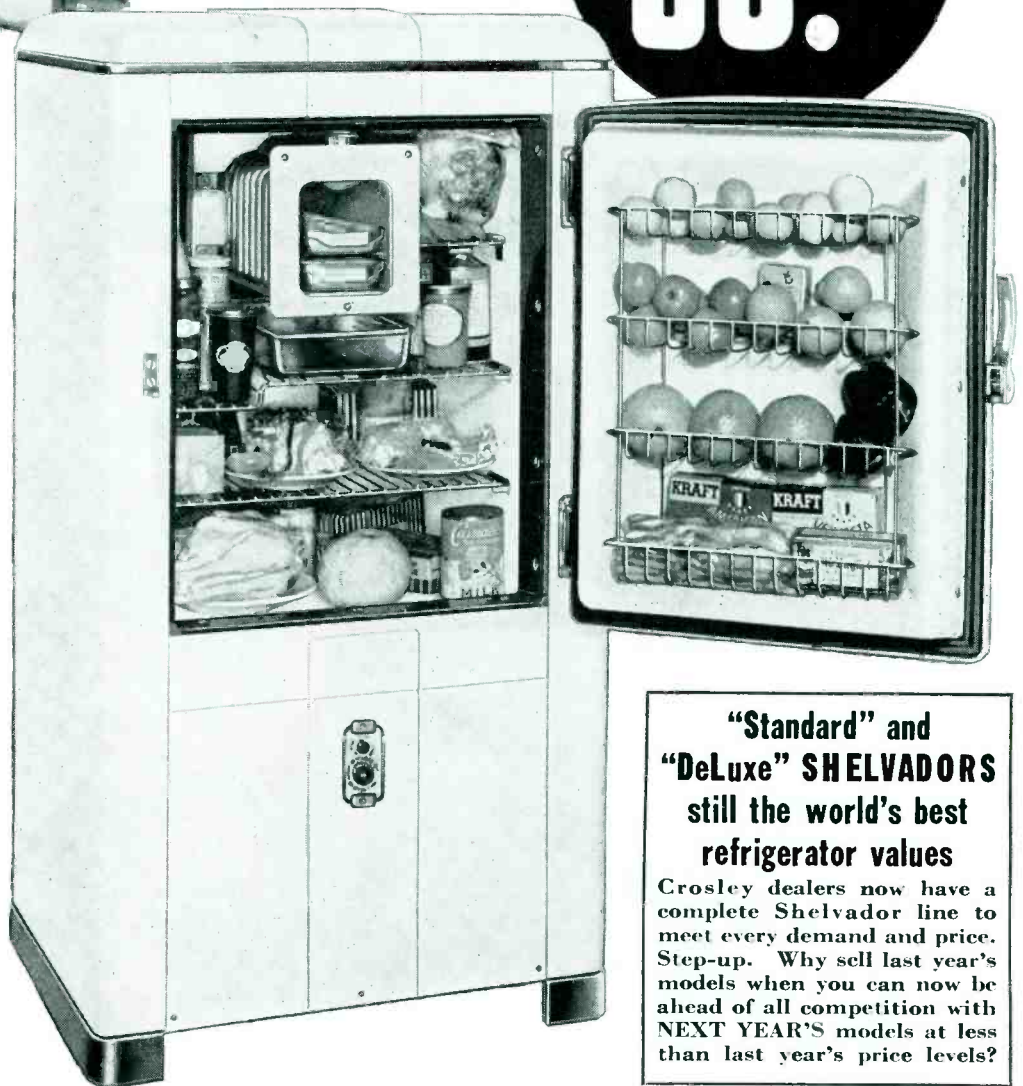

**"Standard" and
"DeLuxe" SHELVADORS
still the world's best
refrigerator values**

Crosley dealers now have a complete Shelvador line to meet every demand and price. Step-up. Why sell last year's models when you can now be ahead of all competition with NEXT YEAR'S models at less than last year's price levels?

THE CROSLLEY RADIO CORPORATION

1939 "Regular Line" SHELVADORS



- with matchless economy of operation,
- with new savings in electric current,
- with heretofore unattained efficiency!



A TRIUMPH OF

CROSLY engineering; CROSLY economies; CROSLY new factory; CROSLY determination to give the world the most refrigerator for its money!

New Sealed Electrosaver

It saves you money BECAUSE IT RUNS INFREQUENTLY AND USES LITTLE ELECTRICITY WHEN IT DOES.

Even greater savings are now developed in the famous Electrosaver sealed refrigerating unit which reduces operating costs to a new and welcomed low. Sealed in oil for a lifetime of performance it's powered to deliver plenty of ice and sufficient refrigeration regardless of weather. Silent as a cat—as constant in its duty as a strong heart! It's quality all the way—at prices folks can pay.

SAVE MONEY IN OPERATION

SAVE FOOD and STEPS and CASH with the SHELVADOR!

This is the refrigerator EASIEST to sell to women. Because it is the handiest. The SHELVADOR saves you steps and enables you to store food so much easier and conveniently. Little things like fruit and eggs and cheese go on the shelves in this door to leave free the space on regular shelves for bulky items, big bowls and such. This clever shelf planning enables you to actually get more food into the Shelvador. Leftovers won't get lost in the Shelvador Refrigerator. You keep them right in sight on the handy shelves. You don't keep the door open for long because there's no need to do a trunk-packing act after each meal—nor must you explore and search for things hiding on backs of shelves. That saves money by saving electric power.

Crosley freezing control enables you to get exactly the right degree of cold you need to preserve food properly, without waste of electricity. Foods are not frozen and ruined in cold weather—nor spoiled from insufficient refrigeration on hot days. Meats stay fresh for days. Milk stays sweet hours longer.

Music while you work

Women miss no more favorite programs because culinary duties keep them in the kitchen. Radio built into the new "Regular" Shelvador—same quality and performance as available in the standard and deluxe lines. In the new "Regular" line the radio—a five-tube superheterodyne—is built at the bottom.

Women like the feature of radio in their refrigerator because it is always handy—adds a smart note to their kitchen—and adds a note of cheer to household drudgery.

*Delivered and installed. 5-year protection plan \$5 extra.



CINCINNATI ★ POWEL CROSLY, Jr., President

Home of "the Nation's Station"—WLW—70 on your dial

Quality

B E G I N S H E R E

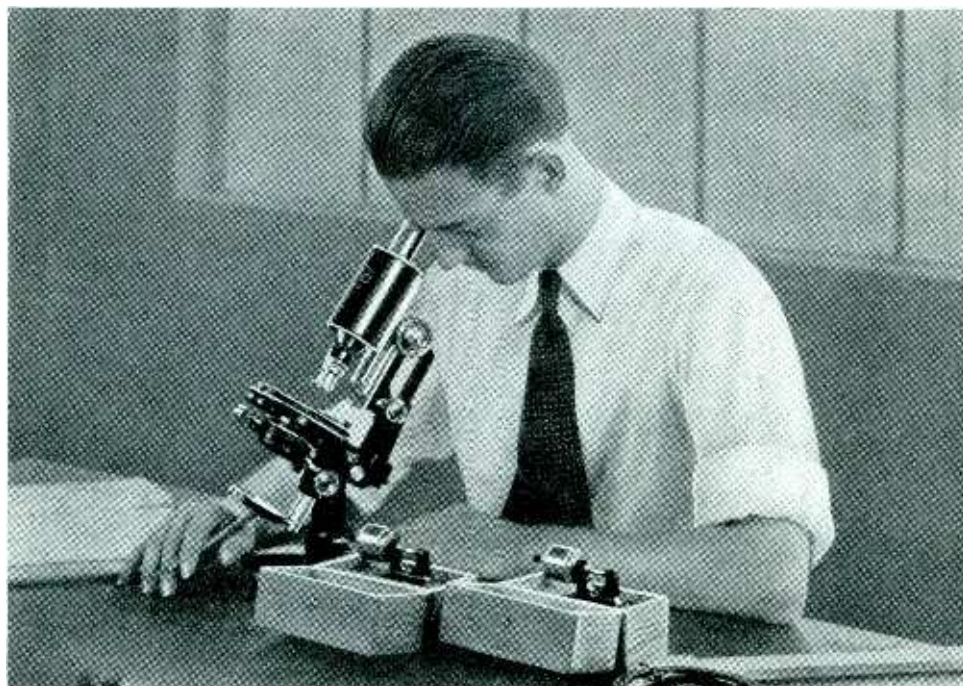

It is Sylvania's firm belief that a radio tube can be only as good as the materials put into it.

That is why, at the Sylvania factory, quality begins here—under this inspector's microscope. Every element to be used in making Sylvania tubes is subjected to rigid examination . . . must be tested and pronounced "okay" before acceptance from sources of supply.

Quality counts—so sell Sylvania's. They'll build customer goodwill and bigger, steadier profits for your business. Hygrade Sylvania Corp., Emporium, Pa. Cable HYSYLVANIA, N. Y. Also makers of famous Hygrade Lamp Bulbs.

SYLVANIA

SET-TESTED RADIO TUBES



SEE US AT 204-06 AMPERE AVENUE, NATIONAL RADIO TRADE SHOW, HOTEL STEVENS, CHICAGO

"LITTLE"

Admiral

5 TUBE "SUPER"

WORLD'S SMALLEST SUPERHETERODYNE



THE MIDGET of them all! Modern bakelite cabinet measures only 7 1/8" wide by 4 3/8" high by 4 1/4" deep. Shipping weight only 5 1/2 lbs. A full 5-tube super with two bands. Range 535 to 1730 KC. and 1800 to 4500 KC. Has 4" dynamic speaker, iron core antenna coil, 1 1/2-watts output.

\$15.00 LIST

IN RED, BLACK,
IVORY & WALNUT
BAKELITE
CABINETS

Model 123-5E Black
Model 125-5E Ivory

Model 124-5E Walnut
Model 126-5E Red

5 TUBE AC SUPERHET \$16.95

AUTOMATIC PUSH-BUTTON TUNING AND UP

In Genuine Bakelite Cabinets
113-5A Black \$16.95. 115-5A Walnut \$17.95.
115-5A Ivory \$19.95.

5-Tube A.C. superheterodyne table model with tuning range from 535 to 1735 KC. Push-button tuning. Exclusive "Magnascope" dial, full A.V.C., two stages R.F., and 5" dynamic speaker. Cabinet measures 11" wide by 6 3/4" high by 7" deep.

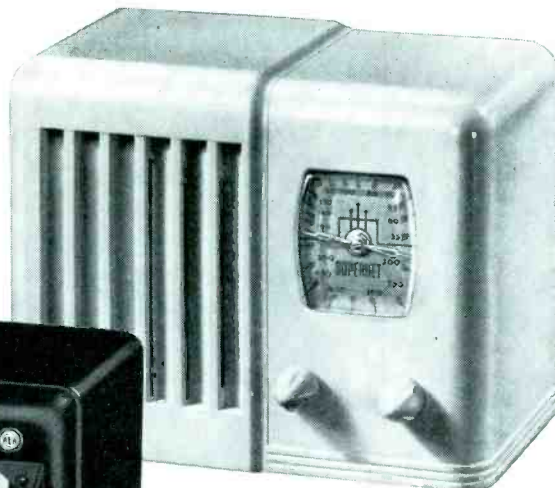

5 TUBE AC SUPER \$12.95

Model 516-5G—In walnut bakelite cabinet 8 3/4" wide by 6 3/4" high by 4 3/4" deep. A full 5-tube A.C. super at an amazingly low price. Tuning range 535 to 1735 KC. Has illuminated pillow shaped dial and 5" dynamic speaker. Unusually high selectivity and sensitivity. Underwriters approved.

517-5G Ivory Bakelite \$15.95



ADMIRAL RADIO-PHONOGRAPH COMBINATION

MODEL 521 5C 5-tube A.C.-D.C. radio with tuning range 535 to 1735 kilocycles. Has pillow shaped airplane dial, manual tuning, 5" dynamic speaker. One stage R.F., 1 1/2-watts undistorted output, 2-watts max. Phonograph has RCA motor and RCA crystal pick-up. Plays up to and including 12" records (with lid closed). Cabinet measures 12" wide by 12" high by 11 1/2" deep. Never before at such a sensational price!

\$29.95

LIST

CONTINENTAL RADIO & TELEVISION CORP.

3800 W. CORTLAND STREET, CHICAGO, ILLINOIS

Be sure to visit our display of 1938-39 Admiral Radios at the Blackstone Hotel when in Chicago for the Radio Parts Show



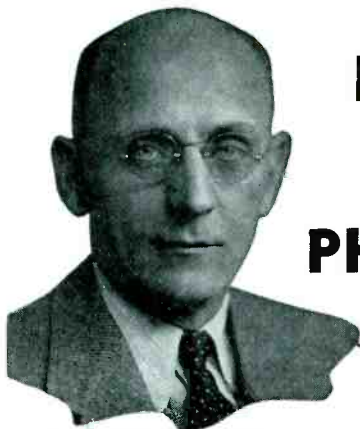

HARRY BOYD BROWN
National Merchandising
Manager of Philco

NO DEALER CAN AFFORD TO BE WITHOUT IT—BUT ONLY PHILCO DEALERS MAY HAVE IT!

MYSTERY CONTROL—the greatest radio discovery since radio itself—an amazing invention that means unparalleled retail sales for Philco radio dealers.

Think of it! No wires—no cords—no plug-in connections of any kind! So small—so light—so compact that you can carry it anywhere and place it anywhere. And then—with one flick of the finger—tune in any one of 8 different stations from *any place in the home within enjoyable hearing distance of the radio.*

Furthermore—the volume can be regulated—increased or decreased as you wish it—and the radio can also be turned off from this same Mystery Control. And each Mystery Control Unit is “in tune” *only with its own companion receiver*—no chance of any confusion—no chance of any effect on the neighbor’s Mystery Control receiver.

No radio dealer can afford to be without this thrilling, fascinating, phenomenal radio invention—and yet only Philco dealers may have it—*only Philco dealers can “cash in” on the vast new market it opens up.*

Mystery Control comes in 2 magnificent Philco models—the Philco 116RX and the Philco 55RX—both in superb new styling—a new beauty in cabinet design plus a new high standard of radio performance. Radios so new—so different—so sensational that they will sell in volume in spite of business conditions—anywhere.

Yes, and these 2 Stars of the radio world—these Philco models with Mystery Control—*will also sell hundreds of thousands of other Philco models*—because the mystery, magic and fascination of Mystery Control will fill your store with people—with interested prospects. And it is prospects—and plenty of them—that makes it possible for you to sell radios in volume.

And what a magnificent array of other Philco models in every price bracket. A wide variety of perfected instant Push-Button Tuning radios—furniture models—table models—compacts. Merchandise of irresistible appeal—*priced to meet conditions—priced to fit the purchasing power of millions of pocketbooks*—merchandise that is bound to sell—depression or no depression—good times or bad.

In other words, business prosperity—real selling activity is here again for the radio dealer, if he gets the Philco franchise. Therefore, by all means, get in touch with the Philco distributor in your territory right away. Be ready to sell and deliver the very day that Philco’s amazing radio values are offered to the American buying public.

Harry Boyd Brown

PHILCO

The RADIO MONTH

JUNE

1938

NEW MODELS Only a few of the 1939 lines have been shown but those we have seen contained the most outstanding and, in fact, stupendous values that have ever been shown in any of the various accepted price brackets.

That fact is of inestimable importance! It means that the manufacturers have found ways and means for producing sets that are so extraordinary in appearance, features and performance that they will be sure to catch the consumer dollars *at list price*.

It means also that dealers who still have overstocks of 1938 models had better step on the gas, stage a sales drive and turn those last year's sets into cash, because it will be tougher to unload, after the public gets a glimpse of the new lines.

UPS AND DOWNS Dealers have complained to us that sets brought out since January 1st are "too cheap", that there isn't enough money in selling them, that they are just trading dollars when selling low-priced sets, etc., etc., ad infinitum.

These complaints would be justified if most of the dealers in the past *had kept the long margins and large dollar profits* that the manufacturers' price schedules provided for them. Instead most of them have given much of their potential profits away.

In the automobile field there is no dealers franchise more valuable than one on FORD cars, and dealers can and are making good NET profits on FORD cars that have a *LOW* list price and carry a decidedly *LOW* discount BECAUSE the product has great public acceptance, represents big value and is backed up by the firm policy of an honest company.

There are many Ford-type of companies in the radio business. Their products have great public acceptance and represent big values. They have

met the demand of the times by producing outstanding values at low list prices. Through them the sales opportunities of every dealer will be broadened while selling costs per set will be decidedly lower, and—the smart dealer will make a fair net profit.

This is not the time to cry over the spilt milk of big margins. Sell what the public is willing to buy and learn how to keep a profit. The merchandise offered by manufacturers *is good*. It *is timely* in design, performance and price. The market *is there*. If you are a good merchant you will know how to cash in on the opportunities *as you find them TODAY*.

TELEVISION Once more the newspapers are carrying much publicity on television. Most of what they reprint is re-hash of old items because fact of the matter is that there is no real news on television.

We ourselves have a big stake in television (and so has every radio dealer). Because of that stake we are watching technical advances very closely and are in intimate contact with all the commercial development of the art. We propose to keep our readers continuously and fully posted on all important news in this new field.

Meanwhile we think this a good time to reiterate what we have said previously, namely: Current experimental broadcasting can be of interest only to those living within a radius of 40-50 miles of the station. The art has not advanced to a point where programs can be broadcast to the whole nation without the investment of staggering sums. No one knows where the money is to come from for financing stations and the tremendous cost of programs. ALL DEALERS EVERYWHERE should advise their customers that they cannot expect to receive television programs unless a television broadcasting

station HAS BEEN ERECTED and is operating WITHIN 40-50 MILES OF THE POINT where the set is to be used.

Until then the public will have to depend on *radio sets*.

FAIR TRADE At present the decisions in various cases involving the selling of radio sets under fair trade contracts leave no clear cut indication of what may eventually evolve as the sound and practical procedure for proper enforcement of the price-stabilizing provisions of Fair Trade contracts when there is a trade-in problem.

Certain it is that on radio sets the use of fair trade contracts demands clear cut provisions that will specify fixed allowances for each different model so that any proven departure from the prescribed formula for trade-ins may be more easily detected.

We urge our readers to extend their utmost in cooperation to the manufacturers and distributors who are attempting to sell lines of merchandise under fair-trade contracts, as we are certain that such experience will lead eventually to a practical plan that can be accepted as the basis for a National policy.



EDITOR

YOU HAVE A RIGHT TO
EXPECT SENSATIONAL NEWS
CONCERNING

Emerson

for 1939

... and You Won't Be Disappointed!
— It's On the Way!

Here . . . in a single all-inclusive line . . . geared as Emerson always is . . . for instant volume sales . . . is an array of models, styles, prices and values that shatter all precedent . . . that meet every possible consumer demand. Here is new beauty—new eye appeal—new, even more amazing, performance. Here are values that will amaze you—that will have the industry talking for months. New developments—new harder hitting advertising and promotion—new selling aids—new and even more effective merchandising! These are the new reasons why Emerson is—and will continue to be—“the World's Biggest Selling Little Radio”.

1st Distributor Showing . . . Hotel New Yorker . . . June 20-21

1st Dealer Showing . . . Hotel New Yorker . . . June 22-23-24

Don't miss it. Complete details of the 1939 Emerson Line available to the trade at the Distributor Showings in June and July.



EMERSON RADIO & PHONOGRAPH CORPORATION

111 Eighth Avenue, New York, N. Y.

Cable Address: Emphonoco, New York

RADIO RETAILING

JUNE

1938

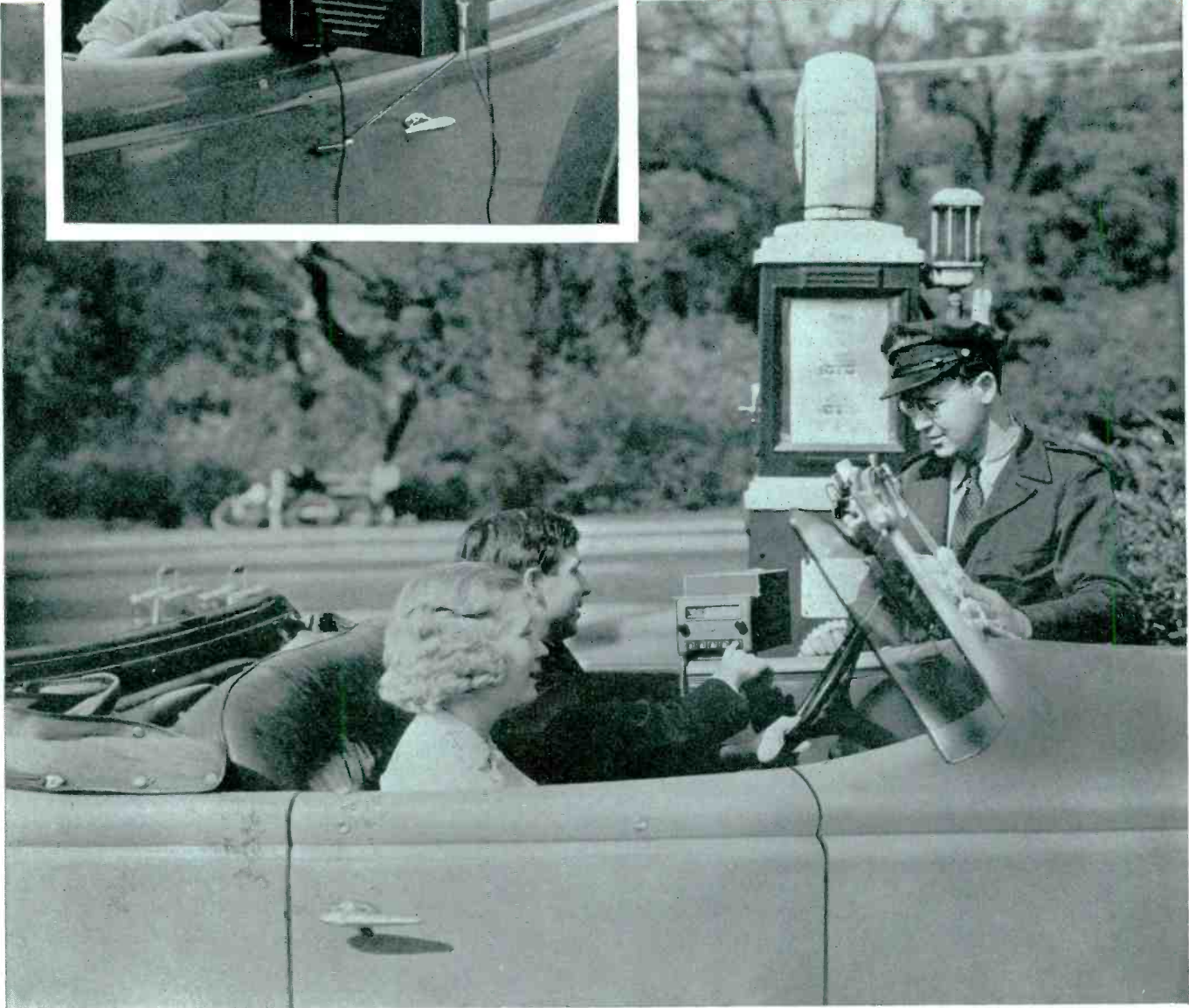

It Just HOOKS ON

MOTORISTS who like to swing into a wayside lunch stand, have their hamburgers, soda-pop and ice-cream brought out to them on trays will appreciate the novel service rendered by this enterprising gas station.

While cars are having their gas-tanks filled, oil changed, tires pumped, minor adjustments and repairs made . . . anything that takes appreciable time . . . an attendant

hooks a Crosley auto-radio over the door, turns it on, tells the driver to push the tuning buttons.

Customers are entertained. Demonstrating a modern car receiver for themselves, many become prospects, want to buy.

Two simple wire brackets covered with rubber where they touch the car finish make quick temporary installations possible. Battery and antenna are provided externally.



LAYOUT FOR A LOCAL SHOW

Here (above) is the way to lay out a co-operative radio exhibit, according to Pacific Power and Light, who believe plenty of center-space for dancing, entertainment is desirable, aids selling in the border-booths. Note raised, illuminated stage at far end

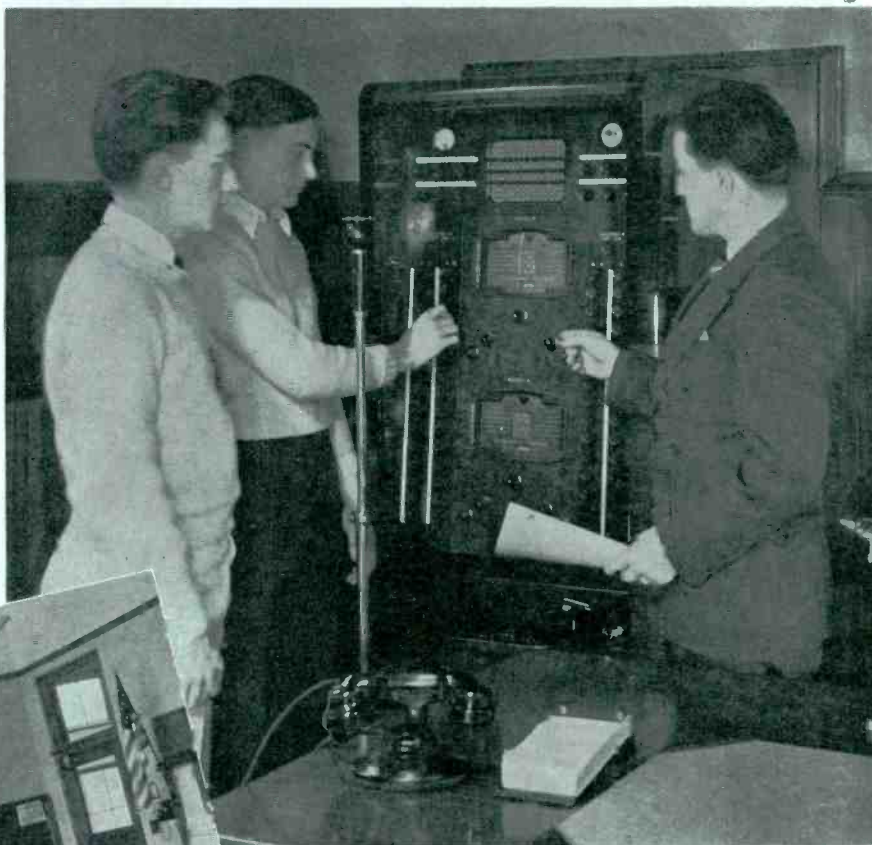

SOUND GOES TO SCHOOL

Even students are taught to operate the new Stromberg-Carlson sound system installed (above) at Marion New York's Central High School, speeding up administration. In the classrooms (left) speakers broadcast programs supplementing studies



TWIN TESTBOARDS SAVE TIME

Two instrument boards are maintained by Radio City Service of Greenville, Mississippi. One set (upper photo) is arranged for quick estimating, includes testers purchased years ago. The other (lower photo) is new, delicate, more accurate for actual repairs

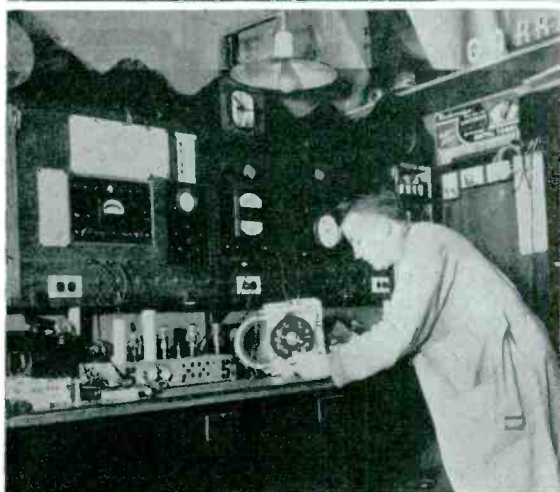
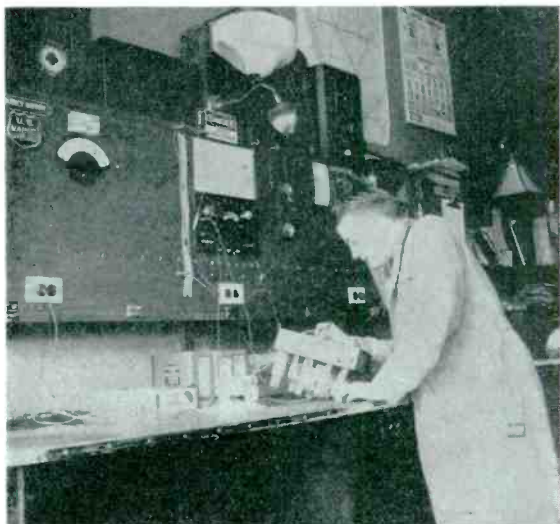

DIFFERENT, YET NOT COSTLY

Windows of Deason's Radio, San Antonio, have small, tiered shelves, wide enough to handle table models, consoles or small accessories. Painted white, they make merchandise stand out, day or night (above)

TIP FOR SUMMER FAIRS

From this tent at the Madison County Fair last year (right) Bill Townsend of London, Ohio sold 28 sets. Note wind charger staked out up front. Naturally, it remained right out in the weather all the time



New SEASON Sales

SET sales will go up! That's a bold assertion to make at a time when most of the radio dealers in the country are looking ahead to the new season with considerable doubt and some trepidation.

Immediately there arise the questions such as: "Why should sales go up?" and—"From where will they go up?" and, lest it be forgotten—up pops that ever intriguing puzzle of "How high is 'Up'?"—

We do not pretend to be in a class with that famous but highly mythical Oracle of Delphi and its priestess Pythia. We are not among the devotees of crystal-gazing nor do we lay even the smallest atom of claim to any talents as a soothsayer. But we *have* spent many years in studying the phenomena of cause and effect or,—to put it in plainest possible language—we believe that if 2 plus 2 really make 4, then the present conditions in the radio industry plus what appears to be ahead, should bring about the result already predicted, viz:

Set sales will go up!

* * *

First there is needed an answer to the question of "From where will set sales go up?"—We must identify the starter's gun, as it were, we must recognize the starting line of the race, we must know where we stand right now,—*We*—the radio manufacturers, distributors, and dealers, *now*—this month, at the threshold to the new selling year.

For individual manufacturers of radio sets only each individual executive can speak but—for the manufacturers as a class we will go on record without fear of contradiction that *never in the history of the radio industry* have the set manufacturers entered a new selling season with so great a consciousness of the need

for careful planning of models, the need for giving value until it hurts, the need for sober and conservative quotas and—last but not least—the need for closely gearing production to the current rate of consumption so as to avoid surplus stocks.

Most important of all—the set manufacturers not only have recognized those needs but—they have made tremendous progress toward satisfying them, and that will become readily apparent as the 1939 season advances.

To recognize the starting line of the 1939 season demands also an appraisal of the inventory situation.

Those who have felt that the prospects of the new season will be blighted by huge stocks of carry-over models may well cast their fears aside because apparently such is not the case.

We personally have surveyed the inventory situation of many manufacturers, distributors, and dealers, and we are convinced that *if future sales potentials are taken into consideration*, there are no alarming overstocks except in certain territories where specific and easily recognizable conditions are responsible.

To the average distributor this means that he can survey the field of new lines and attractive offers with greatest possible freedom and make his selections with greatest consideration to the present needs of his particular trade.

To the retailers that freedom from excessive overstocks, which most of them are enjoying at this writing, places them in a trading position par excellence. Their 1936-37-38 experiences with specific lines are fresh in their minds. Few of them have on hand such heavy stocks of any one brand that in self preservation they must strive to retain any particular franchise. Many have found out through bitter experience that sales efforts scattered over many lines does

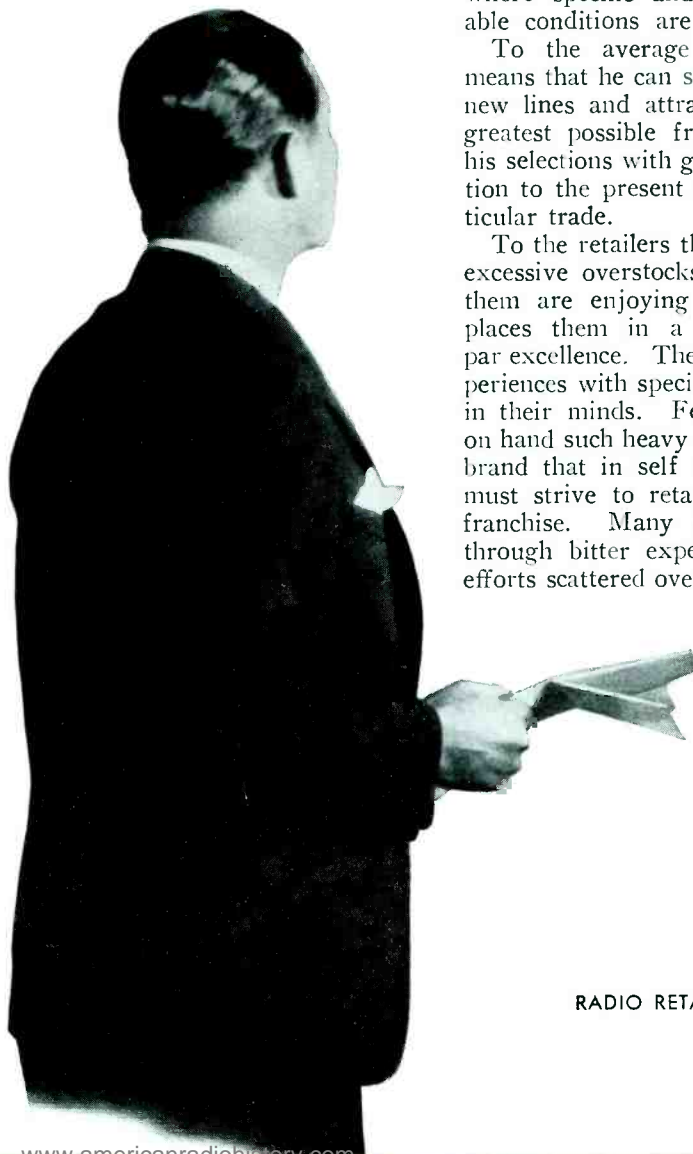

OUTLOOK

By O. FRED. ROST

Study of trade in important manufacturing, distributing and selling centers indicates high values, low prices of new lines, healthier inventory conditions than in other fields will make radio leader in general business advance

not make profits such as can be gained through concentration of effort. More than ever before dealers will choose their lines carefully and determine their commitments soberly.

Thus the starting line of the 1939 race finds all elements of the industry trained down to racing weight; ready to run, but wary of false starts; eager to get going but not willing to carry any blind weight;—all indications of a healthy state and auguring well for the future.

* * *

Comes the question: "Why should sales go up?"—First factor that prompted the prediction that set sales will go up was: The new products—

We have seen enough of the new 1939 models to state that practically without exception *they represent the*

biggest values that the industry has ever offered in its history. In fact those 1939 models of the various manufacturers so literally bulge with sales features and consumer appeal that it will not need super salesmen to book orders.

Knowing that the radio industry is about to launch its finest lines of superior values there remains a second important factor to be determined, namely: "Will the public have the money with which to buy new sets?" In other words—remembering that we have been in the most depression-like "recession" one could imagine—are business conditions going to improve so that set sales will go up?

At this point we must again remind that we are not attempting to parade as a prognosticator of future events.

We are merely prescribing factors that indicate a trend to improvement in business which by September should be clearly noticeable so that the last 4 months of 1938 may be expected to produce a volume of retail sales that would compare favorably with the same period of 1937.

For instance, if such an all-inclusive index of business activity as that of *Business Week* has any value, it is important to note that for the last 4 months it has hovered around or near the same levels that it held in 1932—during the depth of the depression—(from which it subsequently dropped materially only during the banking crisis of 1933 and then began its upward climb). This means that business has been dragging bottom at lowest ebb and practically has no other way to go but up, and in its broadest sense that "going up" would carry with it more employment, more payroll money, more money in circulation, *more retail sales*.

Those who feel that better business can come only if the farmers make more money find lots of good cheer in current news and crop reports. In most of the farm states weather conditions have been so favorable that good and even bumper crops are expected.

Proof that this expectancy of good crops is quickly translated into retail sales may be taken from the fact that April sales of department stores showed declines from 1937 only in the industrial areas of the East and Central West, while in the chief agricultural district sales were *equal or up to 10% higher than last year*.

Furthermore, the rural sales of mail order and chain stores have held up to or exceeded last year's levels in most territories. Therefore, it seems reasonable to assume that if mere crop expectancy can hold retail sales to last year's highly satisfactory levels, the actual harvesting of big

(Continued on page 116)

ONE-MAN BROADCAST—A party-line telephone is the best sales promotion medium for rural radio business, according to Frank B. Woodworth of Bromide, Oklahoma. A few calls practically blanket the trading area

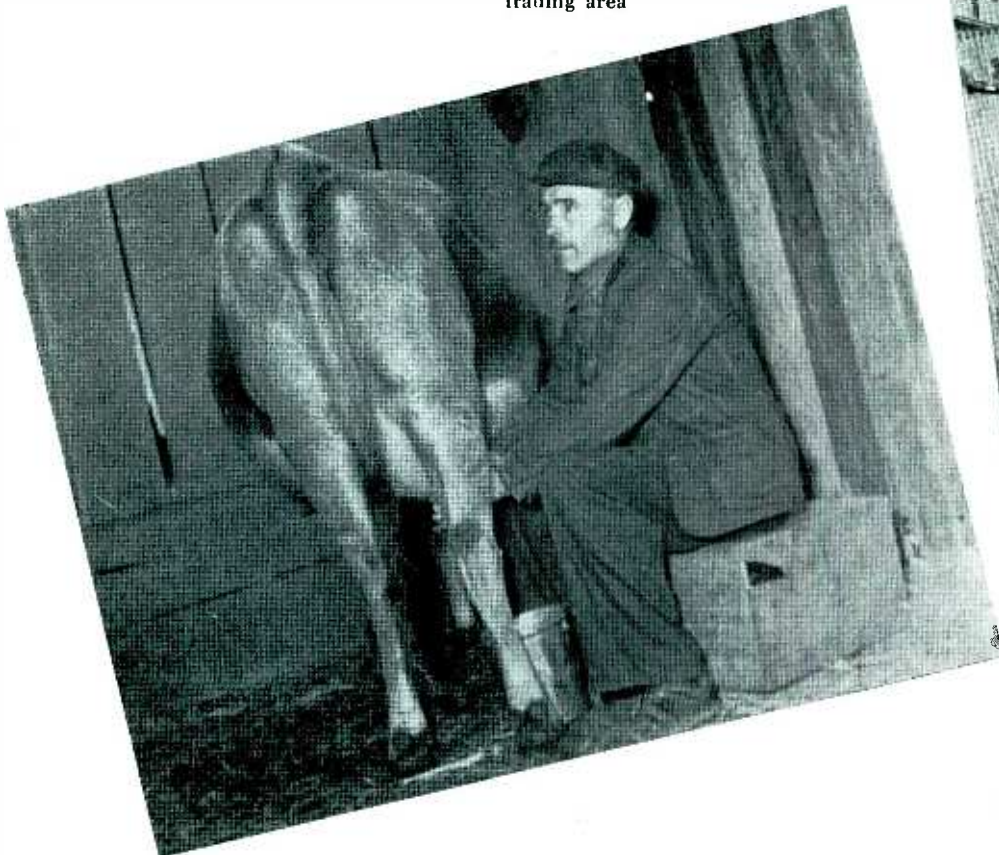

PROSPECT AT WORK—An inter-communicator between here and the house saves time and can scarcely be considered a luxury. Does a radio in the barn reduce fatigue, speed up chores? If it does, it too is a good business investment

ACROSS thirty miles of the ruttiest road on record, over creaking wood bridges that groaned under a car's weight, went your correspondent recently, to feel the pulse of rural America.

The town of Bromide, Oklahoma, boasts no railroad. It is miles from a cement highway and ladies clip-clop up to the postoffice astraddle broad-hipped nags. Here sits the hardware store of F. B. Woodworth, in business for 22 years and a purveyor of radios and washers to the farmers thereabouts.

"The farmer has a desire for the things he reads about," said Woodworth, Sr. "The difficulty lies in finding the money to pay for them. Out on the farm a man may seem to be stony broke, yet his family will have plenty of good food to eat and a warm house to live in. It's because he raises things on his farm which

do not represent any cash outlay. The farmer has to get his cash-money out of things he sells, and very often the amount is relatively small.

Farm business is sweet business, nevertheless according to Woodworth, Sr. Out in his part of Oklahoma there are no trade-ins to consider and he sells for \$10 down, \$10 per month. When anything goes wrong the average farmer loads his appliance on a truck or wagon and brings it in to be repaired. Where the farmer has no wind or gas charger for his battery, he usually lugs it in to be charged.

A party line telephone makes it easy to give sales talks to the entire neighborhood. The one important job is to show the farmer why he can afford his appliance. If this can be done, just as they found money to pay for telephones, they will eventually find money to pay for the other comforts of life.

TO MANY the idea of selling inter-communicating systems and other twentieth-century streamlined

gadgets to farmers seems "wacky".

But when one studies the report made by Glen Walker of Nebraska Power Company, who discovered that farmers dropped their old lanterns with a hurrah, and took to yard-lighting like ducks to water, the step to radio in the cowshed is perfectly natural. Walker, who had a chance to glance over the electrical preferences of 2,362 rural service customers in Iowa and Nebraska, found that they liked these things best:

PERCENTAGE OF SATURATION ON FARM LINES OF NEBRASKA POWER COMPANY

Appliance	Nebraska	Iowa	Total
Brooders	18.1%	7.3%	15.6%
Henhouse Lights...	44.0	20.5	40.4
Hot Plates.....	24.1	19.0	22.9
Ironers	2.3	5.3	3.0
Milk Coolers.....	.9	.4	.8
Milkers	4.6	4.2	4.5
Mills	5.3	.4	4.1
Radio	89.3	77.7	86.6
Ranges	16.9	13.3	16.0
Refrigerators	56.2	51.1	55.8
Washers	81.8	70.4	79.1
Water Heaters.....	4.0	3.1	3.8
Water Pumps.....	45.0	25.7	41.4
Yard Lights.....	83.7	70.1	80.6

There Is *NO*



NO FRILLS NECESSARY—A modern radio cabinet looks very attractive to farmers who have long contented themselves with less. The time to sell sets and chargers and accessories is when they bring in dead batteries

By TOM BLACKBURN

DEPRESSION In The Country

Farmers *can* and *will* buy if you show them how to *save* money by *spending* it

The job of selling farmers, according to Roy E. Hayman of the Oklahoma Gas & Electric Company, is to teach them to use electrical devices to replace present devices—not to expect farmers to add to their present costs.

“Not many farmers can afford the luxury of electricity as such, but practically all farm families who enjoy a good standard of living can replace certain expenses they now have with an electrical bill that will not exceed, and in many cases will be less than present expenses. A study of some of the operations for a general farm was made with the assistance of a number of farmers near Okarche, Oklahoma, in January and February of 1936. The cost on these farms is estimated as follows in the next column tabulation:

Operation	Present Cost Per Month		
	Low	High	Average
Cooking	\$1.50	\$6.00	\$3.00
Feed Grinding.....	2.50	10.00	5.00
Laundry	1.00	2.50	1.50
Lighting	1.00	7.50*	2.00
Radio	1.25	4.00	2.00
Refrigeration**	1.25	4.00	2.00
Water pumping....	.50	3.00	1.00
Totals.....	\$9.00	\$37.00	\$16.50

*Operation of individual plant.
**Refrigeration part of year only.

A good guide to present sales possibilities, says Hayman, is the value of the buildings on the farm you expect to sell. For example, of 214,000 farms in Oklahoma, only 17 counties have buildings worth \$800 and over on the average.

Get the data on your county to learn how easy your market prospects are in your own territory.



FARM MARKET EXPERT—Roy E. Hayman of Oklahoma Gas & Electric says selling farmers is a matter of replacing old costs rather than adding new ones

MEN *must have*

LAST month we decided that a two-man outside sales force is better than a one-man sales force. The two-man force, you may recall, is one composed of canvassers and supervisors working in crews. And the one-man force is the type where each man is a complete salesman and does everything for himself.

In this installment I shall deal with the set-up for our two-man sales force. But before we tell the men about their own particular set-up we have to get them, and we get them by advertising for them.

Advertising For The Men

When advertising for canvassers or salesmen today, you have got to offer a salary if you want any response.

Now I fully realize that anything which smacks of additional fixed overhead expended for problematical gain is not very refreshing to some dealers—but bear with me. This salary can be very small, one dollar or two dollars a day, depending upon how the ad pulls, and a small commission. If you don't offer it, you might as well save the money you would give to the newspaper.

Although you must start the men on a salary and commission basis (or you won't start them at all), those who do not drop out of the running, voluntarily or by request, will soon discover, to their astonishment, that they earn more money on a strictly commission basis (their set-up must see to this!) and ask for such an arrangement.

Set-up

This necessary payment of salaries to the men brings up the question of your own set-up with your sales manager. So before we continue with the men's set-up in detail, we will touch, very lightly, upon that.

It is necessary to be rather vague on this subject. You may be an electrical appliance dealer who finances everything. You may be a furniture dealer who carries his own radios. In that event, you have to pay an additional ten per cent for collections.

You may not, at that. Maybe

Offer a small *salary* in addition to commissions when advertising for a crew or you won't get one today. They'll later find out for themselves that they can earn more on a straight percentage basis

one of your collectors is a salaried man upon whom you can heap all the radio sales brought in by your outside sales force. But, even so, if your outside force does much skipping around, it will run your poor salaried collector ragged.

If you do have to pay ten per cent collection commission on your radios, you still have the partly offsetting advantage (over the dealer who finances his radios) that comes from the opening up of new accounts to which your collectors will add on other furniture, at a small add-on sales commission. That advantage, however, does not compensate you sufficiently to allow you to pay as high a sales commission on radios as can be paid by your brother dealer who finances his radios.

I stress this difference between the two dealers, here, because special emphasis will be placed upon the retailing of radios. And yet, at the same time, we must not lose sight of the fact that the alert man in this business, although his canvassing approach may vary with the seasons, never tosses the sale of any kind—or make—of major appliance over his shoulder.

In any event, you can pay enough total sales commission on your merchandise as a whole, to interest a sales manager—and on a strictly commission basis, too, if you want it that way. His men won't have any reason to complain. If you are a furniture dealer, they may get a little less on radios, but you can pay them as much on refrigerators, and when they run across a prospect for a liv-

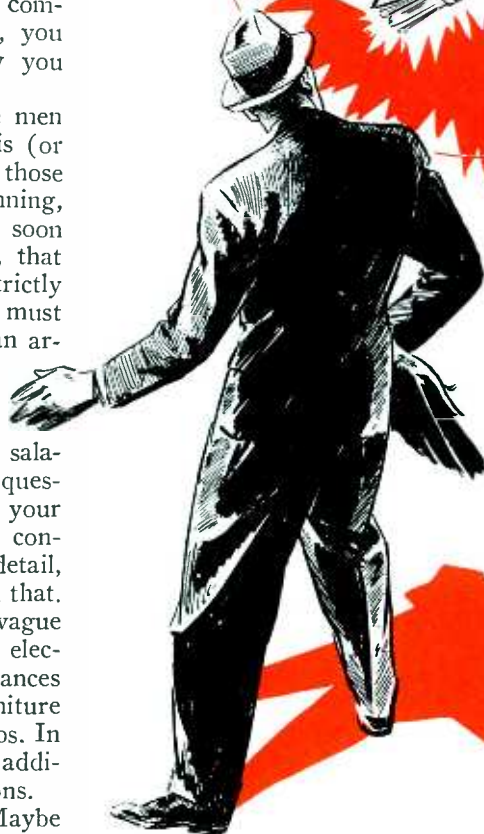

MONEY

By

CASWELL ODEN



ing room suite or dining room suite—they know what to do with it.

Not knowing what type of dealer you are, I cannot give you a set-up involving commissions for your sales manager (assuming you'd like a set-up where you pay the sales manager a certain commission out of which he pays the supervisors and men), but one can easily be worked out between the two of you. The essential thing, of course, is that you, the dealer, net an adequate percentage of profit on each item sold; that your total profit exceeds your expenditure, including salaries when they are in effect.

The Salesmanager

It is the sales manager's job—not the dealer's—to see to this. You have the store and the money and the merchandise. He's got the job. And that job is not only to get business; that job is to get business at a profit to you.

It is your job to fire the whole lot, quickly, if you start to lose money. But it is likewise your job to invest a modest amount of money in temporary salaries to the men—if you are reasonably sure that you have the

sales executive who can make the most of the manpower.

He must, of course, be an exceptional man. The success or failure of your sales force will depend upon him. It will depend, to a smaller extent, upon your supervisors—but it is up to the sales manager to see to it that he has the right men for supervisors. It will depend *not at all* upon the men.

Obviously, your sales manager must be familiar with the business and all its many angles. He must know your own equipment well enough to sell it and have at least a nodding acquaintance with competitive makes.

He must know something about credit and how credit companies operate. He doesn't take all his rejections lying down. When he has a good sale rejected (I said a *good* sale) due to some misunderstanding or because the applicant's credit references or ability to pay have been misrepresented or shown to poor advantage, he investigates the matter and proceeds to get the sale accepted. And all the time he is doing this he is looking at the issue from the point of view of the dealer as well as his

own and that of the questionable sale.

He must be an exceptionally good salesman. Most important of all, he must be a diplomat, be able to handle men, and gain and hold the respect of his men. Last but not least, he must be strictly honest.

The Supervisors

He's going to need several supervisors, of his own general type. He can't train these men himself because it would take too long. He may get them by advertising, but it is quite a job to give to a man you don't know much about. The sales manager, however, will probably know of several good, experienced salesmen he can entice away from their jobs. Men who can really sell and are therefore sick of canvassing for their prospects; men who will rejoice in having a flock of fresh leads handed to them each day. Until he has these men his sales force will necessarily be very small.

These supervisors will work for a three or four per cent over-ride and, whether you believe it or not, they will make money. Each one will have such a fistful of prospects, *fresh* prospects—or, in the case of radios, demonstrations—to call on all the time that he won't know where to go first. All these calls, furthermore, will usually be within a radius of three or four blocks, and, having so cock-eyed many calls to make, he just naturally won't be able to help getting business.

It's the law of averages. If you make enough calls, you are sure to get a sale—no matter *who* you are. And *these* men . . . they'll be the type who know how to bear down every time they get a nibble.

COMING: "Selecting and Hiring Salesmen"

Second of a Series about
OUTSIDE
SELLING

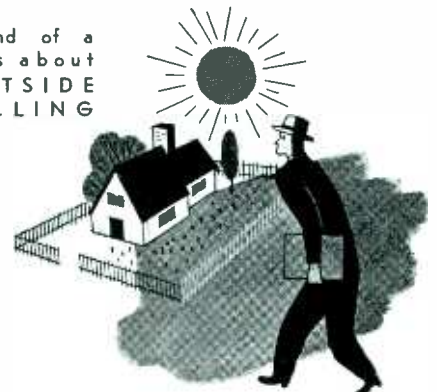

LYONS RADIO SERVICE
8135 - 44TH STREET
LYONS, ILLINOIS

SOUND SERVICE
FOR ALL OCCASIONS
November 30, 1937

Mr. R. V. Dudley
8247 42nd Street
Lyons, Illinois

Dear Mr Dudley:

Your radio can be twice as good as it is! As your radio came from the factory, it was shipped by freight to a warehouse, carted by truck to the dealer who sold it to you. Adjustments more delicate than those of a Swiss watch were subjected to innumerable jars and shocks. It was delivered to you and hastily installed. It sounded good enough for you to buy it.

You've never really heard your own radio! It is capable of playing better than you have ever heard it. It has good parts. It is well designed. All it needs is the final adjustments by an engineer equipped with instruments similar to those employed in the laboratory where it was designed.

This final tuning up can only be done in your home. If the radio is taken to a shop, handling it will likely change the critical adjustments which I wish to make and which will bring you the full pleasure of rich tone, sharp tuning and the distant programs to which you are entitled.

Let me spend an evening in your home. First we'll listen to your favorite station. Then I will go over your radio with my portable laboratory of instruments. From the time I start until I finish, you will not hear a sound from the set. When my cathode ray oscillograph indicates that it is perfect, I'll tune in your favorite station. You be the judge of the results. If, as I claim, it sounds twice as good as it did before, my fee will be \$5.00 plus any spare tubes or accessories you wish to buy. If I haven't made a big improvement, don't pay me a cent. You'll be under no obligation; I won't argue about your decision.

You paid a good price for your radio; it is surely worth \$5.00 more to have a perfect instrument which will give you the full value of your investment. If I didn't think you had a good set to start with, I wouldn't make this offer. Call me anytime for your appointment. Right now is the best time. My phone is Lyons 6826.

Sincerely yours
W. Radke
William Radke, R. E.

December 9, 1937

LYONS
8135 -
LYONS, ILL.

Mr. R. V. Dudley
8247 42nd Street
Lyons, Illinois

Dear Mr. Dudley:

You haven't called me. In justice to the fine radio you have, you should hear its finest performance. Even a Stradivarius violin must be in tune before it can be appreciated by music lovers. I know you have never heard your radio at its best because not one radio in a million could take the mechanical punishment your radio has taken in shipment and still be in perfect tune.

I'm willing to gamble an evening's time that you have never heard the true quality of your radio. I'll bring my laboratory instruments to your home. You can watch every test I make. I'll gladly tell you about each step in tuning up your radio and show you on my instruments visual proof that I am correcting the adjustments which have been jarred out of place. I'll prove every statement I make. Such service as this has never been offered before to radio set owners. The results are incredible.

Call me now and plan on spending an evening with me in your own home. If the results aren't worth my fee of \$5, you don't have to pay a cent. I won't argue about your decision. My phone is Lyons 6826.

Sincerely yours,
W. Radke
William Radke, R. E.

December 18, 1937

LYONS
8135 -
LYONS, ILL.

Mr. R. V. Dudley
8247 42nd Street
Lyons, Illinois

Dear Mr. Dudley:

Would you have paid \$5 more for a radio which was twice as good as the one you bought? For this small fee, I guarantee to vastly improve your radio reception or you don't have to pay me. Experience on thousands of radios makes me certain that I can do what I claim -- make your radio twice as good as it is by proper adjustments of its circuits.

I'll bring into your home a portable tube tester; a sensitive meter which will measure as little as 5 millionth of an ampere and as high as 600 volts; a portable signal generator equivalent to a miniature broadcasting station and a cathode ray oscillograph-wobbulator, the latest type of instrument made for accurately adjusting a radio circuit. You can watch these instruments in use and ask all the questions you wish. I'll tell you exactly what I am doing and why I am doing it. You've never had radio service of the type I offer you. Servicemen who offer to fix any set for a dollar can't afford the type of equipment I use. Furthermore they can't know what they are doing without such equipment.

Know the pleasure of perfect radio reception. If you can't afford the \$5.00 now, call me when you can, but the sooner you call the more value you'll get out of your radio in the added enjoyment of the finest programs of the year. My phone is Lyons 6826.

Sincerely yours,
W. Radke
William Radke, R. E.

Selling SUPER-

By E. F. STAUNTON

IN a Chicago suburb, William Radke gets \$5 for unique radio service calls! And his customers like it. The story of this enterprising young businessman is an example of modern business ingenuity. Radke has an evening sales system which can be duplicated by any advanced radio service engineer.

A series of three sales letters, reproduced here, is his method of advertising. He solicits customers who have radios *less than two years old*. His best clients are the lawyers, doctors, school teachers, politicians, and industrial executives of his community. While he offers his services free if he does not produce the results he claims, he has never failed to collect for his work.

Calls are always made in the evening. He carries on each call a portable laboratory consisting of a sensitive volt-ohm-milliammeter, a signal generator, a tube tester and a combination oscillograph-wobbulator. In addition he has a spare 10-inch p. m. speaker in a baffle with a universal output transformer, aerial kits, tubes and a few essential tools. These items remain in his car until the tests are completed on the radio. His sales of extras and accessories often amount to \$10 or \$15 an a call.

Quoting Mr. Radke: "My first step is to listen to the radio as it is. Most of the people who call me doubt my statement that I can make their set twice as good as it was. I next turn off the radio and test the tubes. Usually I take the chassis out to do this. I also check all voltages but with the volume control down to the point where there is no sound from the set. The mysterious silence with which the tests are conducted has a psychological effect on the customers which builds their confidence in my ability. If everything is all right, I connect my portable oscillograph-wobbulator to the diode load resistor, and with the signal generator,

SERVICE In The EVENING

I align each i.f. stage, paying particular attention to the band expansion circuit with which many sets are wired. Then the oscillator padding adjustment is made, usually at 600 k.c. and the tuning trimmers are peaked at 1400 k.c. Short wave chan-

nel are then aligned for sensitivity. check the mechanical features of the dial for slippage of cables or obvious wear that might soon cause trouble. If the set has a small speaker I connect my 10-inch p. m.; otherwise, I check the set's speaker to make certain the voice coil is accurately cen-

tered and solder the voice coil lead back in place. I remount the chassis taking care that it floats on the soft rubber grommets and that the chassis bolts are just in far enough not to rattle. If the set lacks a good aerial I display an elaborate, ready-assem-



FIRST STEP—Radke has the customer tune in a good station, listen carefully to the quality . . .



SECOND STEP—Next, tubes are tested, the chassis is removed and circuits aligned "right on the nose" . . .



THIRD STEP—Sets requiring extensive adjustments, replacement of parts, are taken to the shop . . .

nels are then aligned for sensitivity.

"Before checking the audio portion of the set, I cut the voice coil circuit and substitute a small 30 ohm rheostat. With the ohmmeter this rheostat is adjusted to $1\frac{1}{2}$ times the resistance of the voice coil which is approximately the impedance of the voice coil at 400 cycles. The vertical plates of the oscillograph are connected across this rheostat and I feed the 400 cycle sine wave from my generator into the audio circuit. I know the pattern of my generator output so well it is easy to spot any distortion, hum or regeneration in the audio circuit of the set. This often presents the opportunity to sell a few bypass or filter condensers where their need is evident by the oscillograph pattern.

"When the tests are complete, I



FOURTH STEP—Finally, the customer is again asked to tune and note the difference, told about accessories such as antennas . . .

bled aerial kit and endeavor to sell the idea of a new aerial.

"Then I tune in on the same station the customer originally selected. The difference is usually astounding. I pack up my instruments and ask for my service fee of \$5 plus any extras used. My customers have always paid. They know they have received good value. They are impressed by my instruments and my thorough methods. Furthermore, I have made friends with them and their recommendations go far to secure new prospects and more \$5 calls."

During the day Mr. Radke conducts a regular service business in his shop, or rents out amplifiers for special events. His evenings are dated up for two or three weeks in advance. His is a system worth trying.

Motorola HOME Radio

Will Feature

SOMETHING MORE THAN PUSH-BUTTONS SOMETHING MORE THAN REMOTE CONTROL

The 1939 Motorola Home Radio line incorporates many new, practical features that will capture the imagination of Mr. & Mrs. John Q. Public. Buyers will be intrigued with Motorola's new conveniences and delighted with its honest values. Motorola "has what it takes" to close sales *this year*—especially in the brackets *under one hundred dollars*.

SELL THE NEWEST

Your customers will really "go for" the new Motorola which tunes itself—a unique instrument with no auxiliary apparatus—positive, accurate and fool-proof in operation.

BEAUTIFULLY STYLED

Motorola's cabinets will be truly beautiful pieces of furniture. Your women customers will appreciate their "good taste" adaptability to any room setting.

TABLE MODELS READY

New lower priced 1939 Motorola Table Models will be in your hands shortly. Look for performance that ought to cost \$10.00 more.

MOTOROLA CONSOLES WHEN YOU NEED THEM

Wise dealers who adopt a sound buying policy will profit by waiting for the July showing of 1939 Motorola Consoles. Out in plenty of time to stock up for Fall selling.

DON'T TIE UP YOUR CREDIT

Motorola's policy of supplying exciting *NEW* merchandise when your retail selling actually starts permits you to *buy what you need when you need it* without tying up your credit. It's better to take your profit out of fast moving items that insure a quick "turnover."

Don't Buy in June What You Won't Sell Until September

GALVIN MFG. CORPORATION • CHICAGO

New PRODUCTS for the New SEASON

Additional items will be pictured in subsequent issues, as released

New SETS

101 STROMBERG

Stromberg-Carlson Tel. Mfg. Co.
100 Carlson Rd., Rochester, N. Y.

MODEL 231F—Cocktail model for easy tuning. Novel tray top popular with people who entertain. Modern pleasing cabinet with full width speaker grill



102 DYNAPHONE

Ansley Radio Corp.
240 W. 23 St., New York

MODEL D-9 — Portable combination constantly improved since 1932. Seven tube radio covers broadcast and foreign shortwave bands. Crystal pickup. Cases come in black, grey or tan, or in genuine cowhide. Operates on ac and dc and can be equipped for both 110 and 220 volts



MODEL 245M — Triple range; high fidelity; acoustical labyrinth; 10 $\frac{1}{4}$ inch speaker; electric flash tuning; automatic frequency control; automatic antenna switch; bass compensated volume control; 11 tubes

MODEL D-21—A thirteen tube combination for local and moderate distance reception and finest tone. Crystal pickup, large high fidelity speaker, cabinets available in variety of finishes on walnut, maple, mahogany

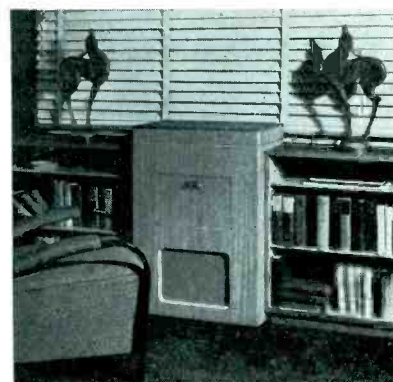

Numbered card in this issue brings you additional details

103 ZENITH

Zenith Radio Corp.
6001 Dickens Ave., Chicago

MODEL 6D311—6 tubes including ballast type, superheterodyne. Standard broadcasts. 5-inch electro dynamic speaker. In brown Bakelite, \$14.95. In ebony or ivory, \$17.95



MODEL 6D317—6 tubes including ballast type, superheterodyne. Transcontinental, automatic, tip-touch tuning. Standard broadcasts. 5-inch electro-dynamic speaker. 14½ inches wide. Wood, walnut finish, with glass column grille. \$29.95

105 RCA VICTOR

RCA Manufacturing Co., Inc.
Camden, N. J.



MODEL HF4 — 12-tube radio in 18th-century period cabinet. Two hinged doors conceal instrument panel and dial. High fidelity instrument with 5-band dial, electrical magic voice, improved electric tuning, master noise-eliminator, RCA Victor tubes



MODEL 97KG—7-tube, 3-band radio housed in console grand cabinet especially designed to fit room as naturally as sofa or easy-chair. Lower and wider. Designed by John Vassos. Has improved electric tuning, many other new features, plus RCA Victor tubes

104 MAJESTIC

Majestic Radio & Television Corp.
2600 W. 50 St., Chicago

MODEL 511—Five tube ac superheterodyne. Two-toned Plaskon ivory cabinet with royal blue speaker grille, illuminated full vision dial. Electro dynamic speaker 5½ inches in size. Avc., 3½ watts output. Size: 8½ x 8½ by 6 inches

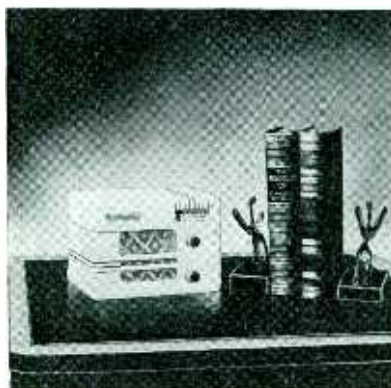
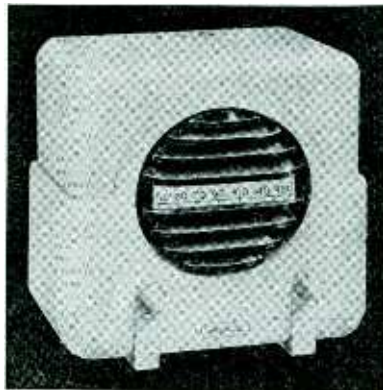

MODEL 52—Five tube ac-dc superheterodyne. Petit Majestic type. Modernistic cabinet natural mahogany or ivory, trimmed in red or blue. Avc., illuminated full vision slide rule dial, 1½ watt beam power output, dynamic speaker. Tuned broadcast and police calls

106 SONORA

Sonora Radio & Television Corp.
Merchandise Mart, Chicago



MODEL D-12 — Two-band, ac-dc superhet. Tunes from 1720 to 535, 2200 to 70000 kc. 2 watts output, beam power tube, tone control, a.v.c., six inch slide rule vernier dial, six inch dynamic speaker. Louvre grille. Size, 16 by 7½ by 9¾ inches



MODEL C-22 — AC model. Plastic moulded design. Tunes from 1720 to 535 kc. Features dyna-boost circuit, 2 watts output. Full dynamic speaker. Slide-rule vernier dial. Available in ivory, mottled walnut, black, ivory face with black body

Numbered card in this issue brings you additional details

107 TOM THUMB

Automatic Radio Mfg. Co., Inc.
122 Brookline Ave., Boston

MODEL 933 — Ultra miniature receiver of extreme modern design. Chinese red, green, blue, orchid, grey or ivory. Standard type finished in crystalline lacquer. DeLuxe type in lustrous Catalin. Full vision illuminated dial. Dynamic speaker



MODEL M60 — Single unit dash mount automobile receiver with giant non-glare dial for safe tuning while driving. Six tubes, sensitivity control for country or city operation

109 G.E.

General Electric Co.
1285 Boston Ave., Bridgeport, Conn.



MODEL G-106 — Keyboard touch tuning (14 keys). Built-in Beam-a-scope does away with outside aerial and ground connection. Automatic program pre-selector selects programs in advance for entire 24 hour period. Visual 5-point tone fidelity control. 10 tubes, 12 watts output

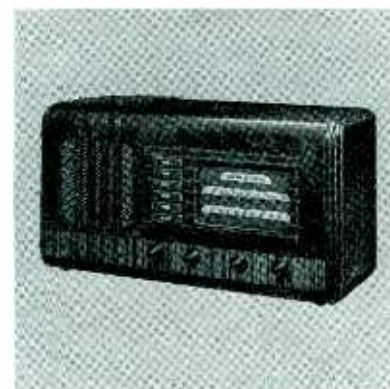

MODEL G-53 — Keyboard touch tuning (6 keys). Oscillator stabilization circuit. Automatic bass compensation. 5 tubes, 2 bands, multi-vision louvre dial, 2-point tone fidelity control, 6 1/2 -inch speaker

108 WILCOX-GAY

Wilcox-Gay Corp.
Charlotte, Mich.

MODEL A-52 — Superheterodyne. Walnut cabinet 7 1/2 x 14 1/2 x 7 inches. Continuously variable tone control and 6 1/2 inch heavy duty dynamic speaker. New, straight line refracting dial and gold finished escutcheon. Avc.

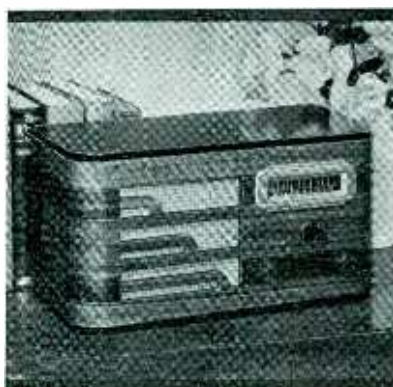

110 FADA

Fada Radio and Electric Co.
30-20 Thompson Ave., Long Island City, N. Y.



MODEL 20T — 6 tube ac-dc superheterodyne; large illuminated dial; walnut cabinet; automatic overload control and beam power output system. Dial calibrations in meters and kilocycles



MODEL A-51 — Iron core coils. Four working tubes. Illuminated dial. Attached aerial. Ac or dc. Four inch dynamic speaker. Available in black, ivory, mahogany and canary plastic. Shipping weight, 5 1/2 lbs.

MODEL 454V — Modernistic ivory plastic cabinet with two-tone illuminated "Golden Glo" dial. Features inverse feedback network to reduce distortion, tonal impurities, undesirable harmonics to give smoother tone at all volumes



Numbered card in this issue brings you additional details

111 REMLER

Remler Company, Ltd.
2101 Bryant St., San Francisco

MODEL 61 — Push buttons tune six network stations. Ruler type dial for manual operation. 6 tubes, superheterodyne circuit and other new features



113 LAFAYETTE

Wholesale Radio Service Co.
100 Sixth Ave., New York

MODEL D-68—A seven tube ac-dc, two band superhet, push-button tuning. Full vision dial; tuning eye; table model



MODEL 54 — Modernistic molded cabinet with venetian blind louvre grille. Size, 6¼ by 10 by 5½ inches. Kc. range is 540 to 1715. 5-tube superheterodyne circuit. Dial tunes stations by name

12 TUBE—Four band, ac or ac-dc superhet with tuning range from 13 to 41 meters; 40 to 130 meters; 173 to 555 meters and 835 to 2,050 meters. Beam output tubes, cathode ray tuning eye

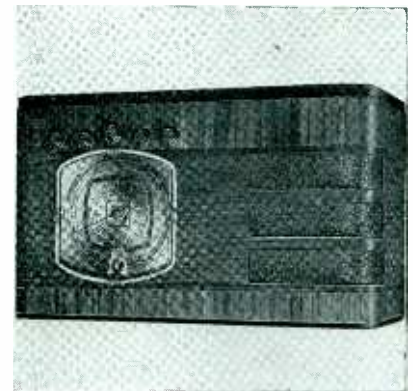

112 EMERSON

Emerson Radio and Phonograph Corp.
111 Eighth Ave., New York, N. Y.

MODEL AX-212—Standard American broadcast and police calls; a.c.-d.c. operation 5 tubes; miracle tone chamber; full vision gemloid dial; available in either walnut or figured maple \$19.95



114 NATIONAL

National Co., Inc.
Malden, Mass.

NC-101X — Amateur band spread receiver. Coils shifted from front panel. Multi-revolution type dial, "S" meter; and crystal filter; crackle cabinet

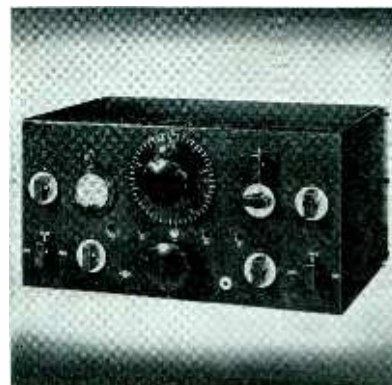

MODEL AX-219—Five tube a.c.-d.c. superhet with turntable and pickup built-in. Turntable a.c. operated; crystal pickup; tangential tone arm; tone control. Plays 10 and 12 inch records. Price \$29.95

NC-80X-81X — Available either with general coverage or strictly amateur band coverage. For use on either ac or dc power source. Crystal filter with continuous selectivity from 200 cycles to 8 kilocycles



Numbered card in this issue brings you additional details

**NOW! THE KIND OF LINE
YOU DEALERS ASKED FOR..**

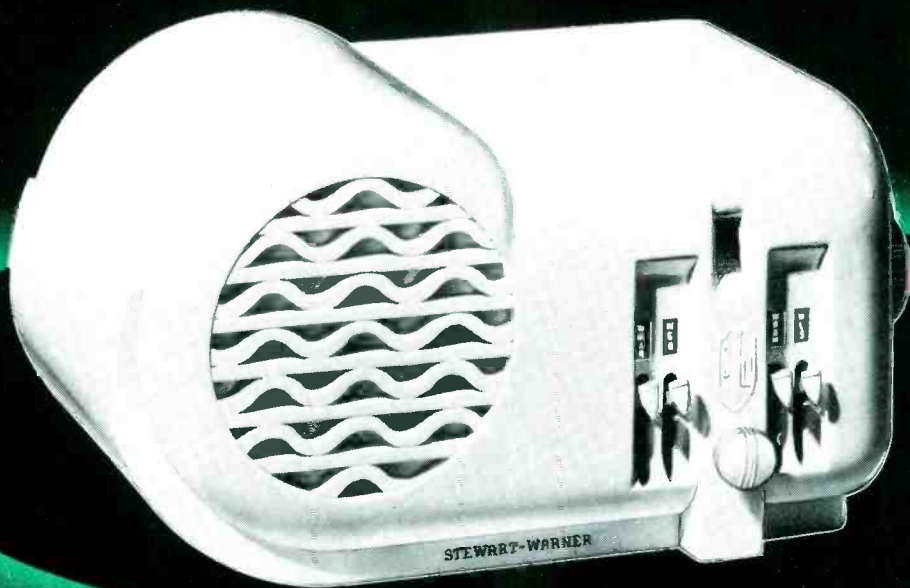

**THE Value Line
FOR '39**

**COMPLETELY NEW!
READY RIGHT NOW!**

STEWART-WARNER

MAGIC KEYBOARD

RADIOS

STEWART-WARNER

A "LEADER" THAT'S REALLY HOT IN PRICE AND VALUE!

Model 97-562—This beautifully styled AC-DC model, in moulded cabinet of ivory Plaskon sets the value keynote for the entire Stewart-Warner 1939 line. Lighted and calibrated dial covers 540-1720 kc. For its size and price it's an amazing performer.

Model 97-561, same as above in Walnut Bakelite.

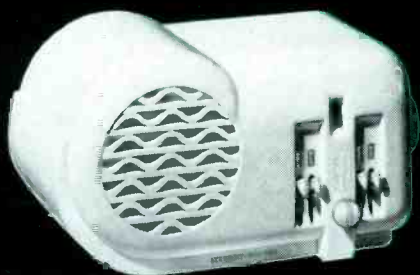

★ Genuine Superheterodyne AC-DC

★ 5 latest Tubes Incl. Ballast

★ 4-Station Magic Keyboard

★ Electron Beam Audio Output

★ Full 5-inch Dynamic Speaker

\$14.95

F. O. B. CHICAGO

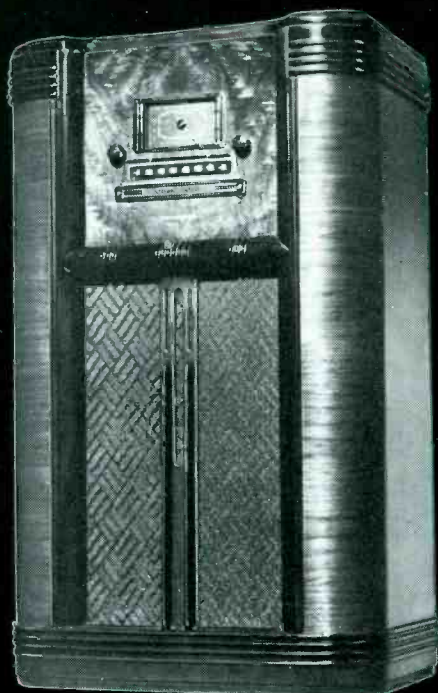

Model 91-537—A really sensational value! A big, full-size console, not a dwarf! Recessed control panel of beautifully figured cabinet wood, and 5-tube 2-band chassis, 540-1725 kc. and 5400-15,400 kc., with 5-station Magic Keyboard tuner, Herculooy Duo-tuning Unit, code-rejection filter, A.V.C., push-button tone control and band switch, and 8-inch dynamic speaker.

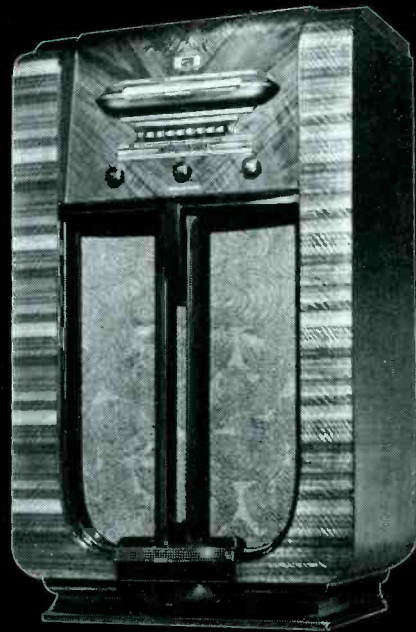

Model 91-817—A style-and-value sensation anywhere! Inclined control panel of matched figured walnut and unusual ripple-stripped vertical panels. 8-tube chassis, 3 wave bands, shadow beam tuner, 12 tuned circuits, new roller-type Magic Dial, separate bass and treble tone controls, code filter, A.V.C., and 6-station Magic Keyboard with Herculooy Duo-tuning Units, full 12-inch dynamic speaker.

Really New! No Hold-Overs—
No "Dressed Up" '38 Models—No Skimping!

It took a new kind of thinking to give you this completely and genuinely new "Value Line for '39." We carried over absolutely nothing but experience. We set just one objective—and stuck to it. And the result is a Stewart-Warner radio line built new from the ground up—not to introduce another annual crop of gadgets—but to pack more of what prospects really want into every model, and give more real radio value at the thriftiest prices in Stewart-Warner history. It's a new kind of radio for a new day—to give the maximum in tone—the easiest, fastest tuning—the most in real entertainment—for the least possible money. A line of big, full-size radios, not dwarf models—brand new, not old models dressed up. It's easier to sell because it is what prospects want—because it is the "Value Line for '39"—and because

Every Model is the Pick of its Price Class

NO PADDED "LISTS"—EVERY MODEL HONESTLY PRICED!

Magic Keyboard RADIOS

THE VALUE LINE FOR '39

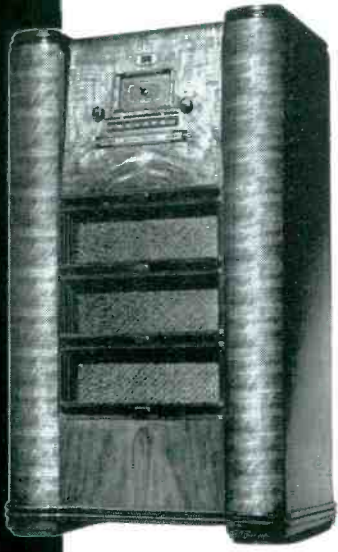

Model 91-627—A full-size console housing 6-tube chassis with 5-station Magic Keyboard with Herculoy Duo-tuning Units, code rejection filter, A.V.C., button-type tone control and range switch, shadow beam tuner. Covers 540-1725 kc. and 540-15,400 kc. 8-inch dynamic speaker.



Model 91-536—The powerful long-and-short-wave 5-tube chassis used in this beautiful half-oval armchair radio, covers 540-1725 kc. and 5400-15,400 kc. 9 tuned circuits, A.V.C., 5-station Magic Keyboard with Herculoy Duo-tuning Units, push-button tone control and band switch. Full 8-inch dynamic speaker. A value you can put against the whole field!



Model 91-512—5-tube superheterodyne, with lighted dial, tone control, A.V.C., and new 4-station Magic Keyboard. Lighted dial covers 540-1720 kc. A really outstanding value.



Model 91-617—Another brand new value leader in the hottest price bracket! A 6-tube superheterodyne with 11 tuned circuits and 3 wavebands, shadow beam tuner, 6-station Magic Keyboard with Herculoy Duo-tuning Units, A.V.C., tone control, and 8-inch dynamic speaker.

The Kind of Line You've Asked For! FEWER MODELS, BIGGER VALUES, MORE TO DEMONSTRATE AND SELL!

In the past few months, literally thousands of you dealers have asked for—demanded—a line like this. A line with fewer models—complete yet small enough to stock! A line that's stripped of needless gadgets and packed with honest performance! A line that's priced so amazingly that even the very top model falls in the "hot" price bracket where it will move! A line with more of what people really want—that you can demonstrate and sell! That's why every new Stewart-Warner model has tone you'd expect in much higher price brackets. Why every Stewart-Warner is new—completely new. Why every one has new and simplified Magic Keyboard tuning that brings in stations instantly and accurately every time—that is utterly simple and dependable—and that can be set and set right, by any owner in a few seconds. From top to bottom, inside and out, these new Stewart-Warner aren't just radics—they're record radio values. When you see them—learn their prices—you'll agree they're the "Value Line of '39"!

No Dwarf Models! All Big, New, Full-Size Radios

EVERY MODEL WITH MAGIC KEYBOARD TUNING



Model 91-1117—Here, at the price of many 7 or 8-tube consoles, is one with 11 latest tubes and no dummies, motor-driven 8-station Magic Keyboard tuner, with automatic band-spread, new roller-type 3-band Magic Dial, push-pull electron beam power amplifier, 11 tuned circuits, code filter, shadow beam tuner, A.V.C., 4-position tone control, full 12-inch dynamic speaker. Available with remote control. The outstanding value in radio today.



Model 91-511 and 97-521—Attractive, richly grained walnut veneer cabinet, rounded end and louver-type grill, supplied either with 5-tube AC superheterodyne or superheterodyne chassis for AC-DC, using 6 tubes including ballast, with tonecontrol, automatic volume control and 4-station Magic Keyboard tuner.

"The Herculoy Duo-tuning Unit, developed by Stewart-Warner, provides the most precise nation-wide automatic station selection in radio today!"

MAGIC

Form No. 41-112 PRINTED IN U.S.A.



Model 91-531—This upright design with wrap-over top curve, in costly ripple-grained walnut veneer, houses a 5-tube, 2-band chassis covering 540-1725 kc. and 5400-15,400 kc. 9 tuned circuits, illuminated Magic Dial, A.V.C., push-button tone control and band switch, and 5-station Magic Keyboard tuner.

Model 91-514 and 97-524—This decidedly modern cabinet in black and rippled ivory is available with choice of two chassis—5-tube AC or AC-DC with 6 tubes including ballast, A.V.C., tone control, and 4-station Magic Keyboard tuner. Full 5-inch dynamic speaker.

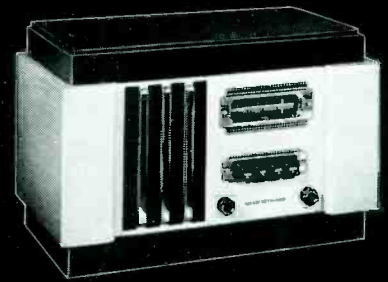

Model 91-513—An absolutely new idea in cabinets, the first table radio designed for a place in the middle of the room. Beautifully finished on all sides—and houses high-quality superheterodyne 5-tube chassis with A.V.C., tone control, dynamic speaker and 4-station Magic Keyboard tuner.

Model 91-621—A real go-getter for those who want more than the minimum—but yet want to save. A beautifully made cabinet with tone-diffusing louvres, housing a 6-tube chassis with shadow beam tuner, 5-station Magic Keyboard, with Herculoy Duo-tuning Units, push-button tone and band switch, built-in code filter, A.V.C., Magic Dial covering 540-1725 and 540-15,400 kc., full 6-inch dynamic speaker.



STEWART-WARNER KEYBOARD RADIOS

115 DETROLA

Detrola Corp.
1501 Beard Ave., Detroit, Mich.

CONVERTER — Ultra high frequency converter for attaching to any standard receiver; range 25 to 63 mc., three tubes, a.c.-d.c., modern moulded cabinet; vernier type dial

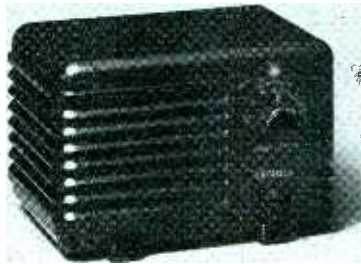

MODEL 219 — Super Pee Wee; ideal for boudoir, travel, kitchen or office. Available in various color cabinet; short waves; five tubes

116 AIR KING

Air King Products, Inc.
19-35 Hooper St., Brooklyn, N. Y.

MODEL 222 — Table compact tunes from 1740 to 540 kc. Works on 110 to 125 volts, ac or dc. Is 5 3/8 by 7 by 4 1/2 inches overall. Shipping weight, 5 lbs. Has four tubes



MODEL 911 — Automatic tuning table type. Tunes from 1740 to 540 kc. 110 to 125 volts ac or dc. Is 10 by 15 3/8 by 7 inches overall. Shipping weight 15 lbs. Uses six tubes

Numbered card in this issue brings you additional details

117

STEWART-WARNER

Stewart-Warner Corp.
1821 Diversey Pkwy., Chicago



MODEL 91-1117 — Eleven tubes; magic keyboard; automatic tuning; ten pushbuttons; 3 band tuning from 530 to 22,500 kc.; shadow beam tuning; four position tone control; automatic bass compensation; automatic antenna system; 12 inch dynamic speaker

MODEL 97-562 — Five tubes; magic keyboard automatic tuning; 540 to 1720 kc; illuminated dial, accurate station selector, pentode audio system; 5 inch dynamic speaker. Cabinet of Plaskon

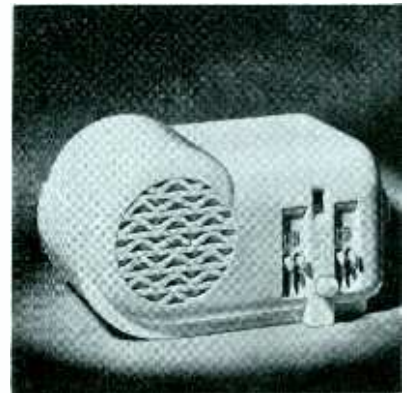

118 ESPEY

Espey Mfg. Co., Inc.
67 Irving Place, New York

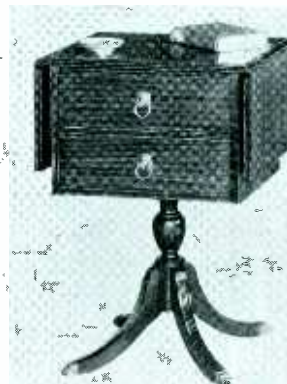

MODEL 7-861 — Duncan Phyfe period style, incidental furniture design with 6-tube radio chassis. American and European reception, mahogany or walnut

MODEL 861B — Traveling companion style plays on any type 110 volt current. Cover may be removed when at home. Six tubes, American broadcast and police calls and shortwave band. Also several amateur bands

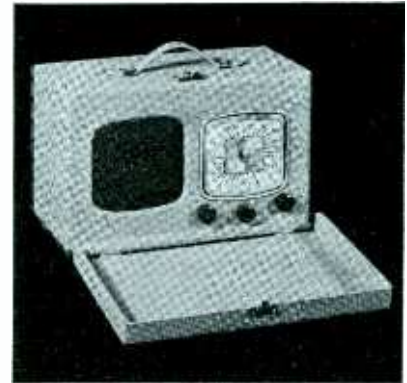

119 ADMIRAL

Continental Radio and Television Corp.
3800 Cortland St., Chicago, Ill.

MODEL 125-5E—Mid-
get superhet with mod-
ern bakelite cabinet
available in black, ivory,
walnut and red; 4 inch
dynamic speaker; iron
core antenna coil; 535
to 1735 kc.; 1½ watts
output

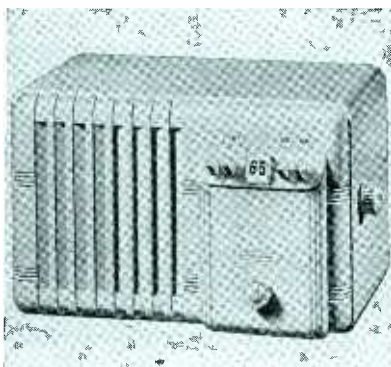
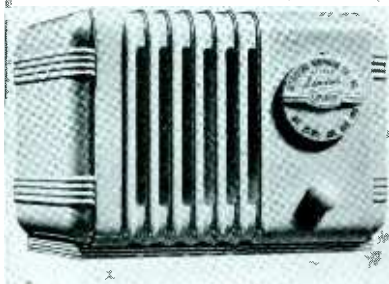

MODEL 115-5A — Five
tube a.c. superhet with
tuning range from 535
to 1735 kc.; manual
pushbutton tuning; drum
type dial with magnify-
ing lens; 5 inch dyna-
mic speaker; two
stages r.f.; in ivory,
black or walnut; \$16.95
to \$19.95

121 HALLICRAFTERS

Hallicrafters
2611 S. Indiana Ave., Chicago

MODEL SX17 — Com-
munications type super-
heterodyne with crystal
filter, electrical band-
spread, band switch-
ing from the five-meter
amateur band through
and including the
broadcast band. Beam
power output. Noise
limiting circuit. Broad-
sharp if switch. Super-
Skyrider model

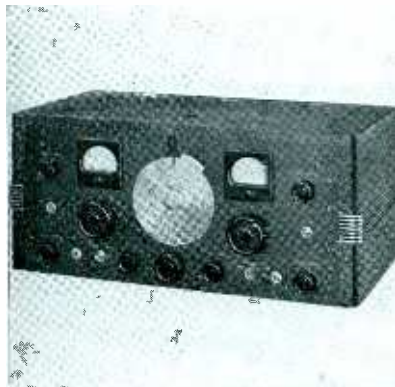

MODEL S20 — Com-
munications type re-
ceiver with extremely
wide band coverage.
Electrical bandspread,
image rejection cir-
cuit. Many modern
features useful to ama-
teur and shortwave lis-
tenser alike at reason-
able price



120 AUTOCRAT

Autocrat Radio Co.
3855 N. Hamilton Ave., Chicago

MODEL 101 — Four
tubes. Full floating dyna-
mic speaker. Iron
core coils. Broadcast
and police calls. Moulded cabinet in
black, green or ivory.
For ac-dc operation on
110 or 120 volts

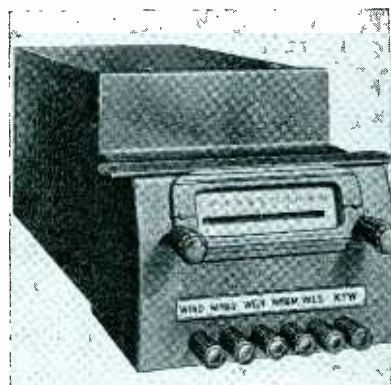
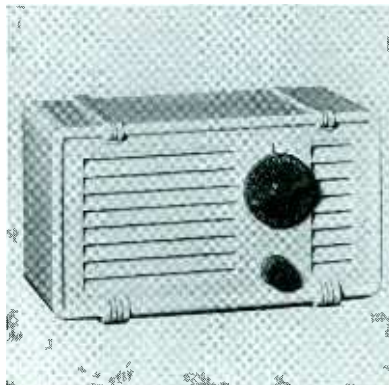

MODEL 359—Five tube
superhet automobile
type. Six push buttons
for automatic tuning.
Slide rule, full vision
dial. Avc. Single unit,
under dash mounting.
Electro-dynamic speak-
er. Size: 6 x 6 x 12
inches. Range: 535 to
1530 kc.

122 McMURDO SILVER

McMurdo Silver Corp.
2900 Michigan Blvd., Chicago, Ill.

ORPHEON — A new
idea in radio for high
quality from local sta-
tions only; no short
wave bands. Speaker
may be had in 15 or
18 inch size; complete
remote control; auto-
matic record changer

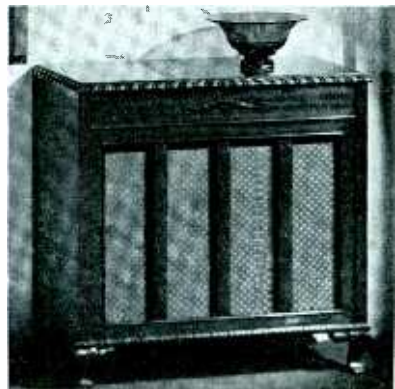

123 BELMONT

Belmont Radio Corp.
1257 Fullerton Ave., Chicago

MODEL 526—Five tube
ac superheterodyne with
automatic Bel-Monitor
tuning. In ebony, wal-
nut and ivory Bakelite
cabinet

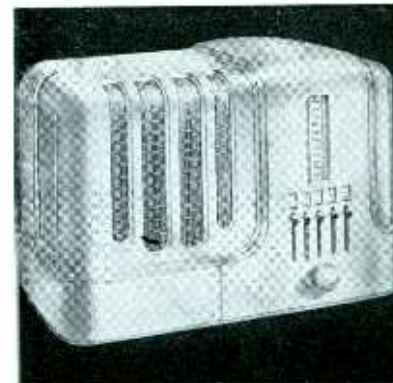

Numbered card in this issue
brings you additional details

A NEW Sentinel LINE!

For the
**BIG CITY
MARKET**

WITH A
VASTLY SUPERIOR
**AUTOMATIC
TUNING SYSTEM**

Plus

Every new and modern feature — a
Line with sensational sales and
profit possibilities offered at

PRICES THAT SELL!

For the
**GREAT FARM
MARKET**

WITH
25% LESS
BATTERY DRAIN,
AUTOMATIC TUNING

Plus

All the features, quality and per-
formance that has made Sentinel
the leading Farm Radio and at
AMAZINGLY LOW PRICES!

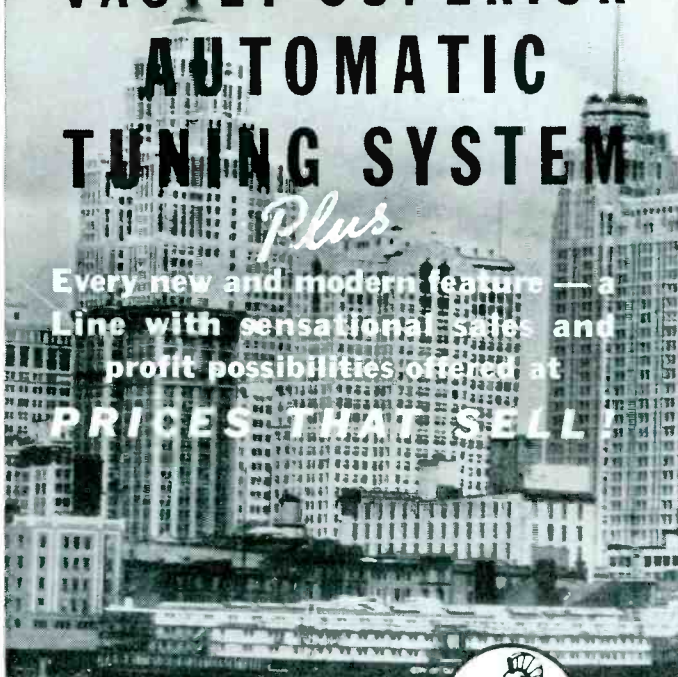

Sentinel

MAIL THIS COUPON!

"SENTINEL RADIO CORPORATION"

Dept. RR, 2222 Diversey Parkway, Chicago

Please rush me complete information on
—Sentinel AC Line—Sentinel Battery Line

Name _____

Address _____

NO QUOTAS, NO HIGH PRESSURE, NO DUMPING

*The
Ultimate in Design
Quality and Tone
Fidelity . . .*

**This means Sales . . .
Repeat Sales . . . and
Profits for the Dealer
and Sound Specialist**

● If you are going to be in the Sound Equipment and Inter-Communicating business on the right basis . . . if you are going to get the better jobs . . . if you are going to get the price that better jobs bring . . . and if you are going to get the better profits that come from doing business on a legitimate basis, then you need the *best* products—Webster Electric products . . . They embody all the characteristics that make for salability, repeat business and maximum profit.



6-Volt D. C., 110-Volt A. C. Mobile System

This Mobile System is typical of the fine design, superior quality and fidelity of tone which is inherent in all units of Webster Electric Sound Equipment. There is a full range of sizes—from 5 to 50 watts. Each unit possesses outstanding eye appeal, being finished in three tones—silver, red and black. Technically, this sound equipment is the finest money can buy. You can sell it with full assurance of a satisfactory profit and a satisfied customer.



Model 212-AM Annunciator DeLuxe Type Teletalk

This is the latest development in Teletalk—the finest and most efficient and most adaptable inter-communicating system on the market. Available in master systems from 5 to 24 stations and permits up to 100 combinations which on certain series are interchangeable. It meets practically any inter-communicating requirement from a simple two-station system and up—either selective or master control. The price is competitive but the tone and performance are above competition.

Licensed by Electrical Research Products Inc. under U. S. Patents of American Telephone and Telegraph Company and Western Electric Company, Incorporated.

The New Webster Electric Mellotone Crystal Pick-up

Here is a new Pick-up unlike anything now on the market. The arm is hand-rubbed walnut of beautiful design. The special cartridge is fully enclosed in moulded rubber and is immune to atmospheric conditions. There is nothing else like it. Write for details.

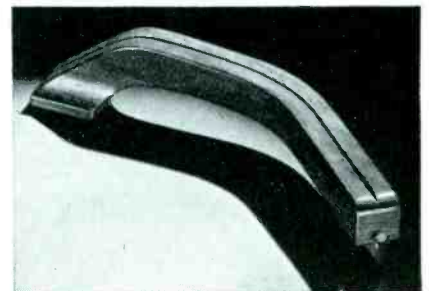

WEBSTER ELECTRIC COMPANY, RACINE, WISCONSIN, U. S. A.

ESTABLISHED 1909

Export Dept.: 100 Varick Street, New York City • Cable Address "ARLAB" New York

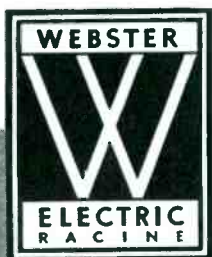

Webster Electric

**PORTABLE AND SEMI-PORTABLE SOUND SYSTEMS • ELECTRONIC
INTER-COMMUNICATING SYSTEMS • ELECTRIC PHONOGRAPH PICK-
UPS • TRANSFORMERS AND FUEL UNITS FOR OIL BURNERS**

200 WEBSTER ELECTRIC

The Webster Elec. Co.
Racine, Wisc.

CRYSTAL PICKUP — Model X-76 phono pickup incorporates new design principles; rectangular crystal element, torque type; thoroughly moisture - proofed, sealed in flexible moulded rubber mounting; electro - statically shielded. High capacity, low reactance crystal. New tone arm reduces tracking errors to 3 to 4 per cent



201 VOCAGRAPH

Vocagraph Sound Systems Div.,
Electronic Design Corp.
164 N. May St., Chicago

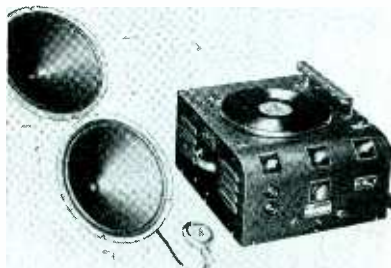

MOBILE AMPLIFIER— Model 30-M30C combination 6 volt d.c. and 110 volt a.c. amplifier, 30 watts output. Single switch throws from genemotor to built in a.c. powerpack. Complete, self-contained. With or without crystal pickup phono top. 135 db. gain. Complete compliment of controls

204 PRESTO

Presto Recording Corp.
139 W. 19 St., New York

RECORDER—A portable unit complete with microphone that makes records up to 12 inch size. Plays any standard phonograph record. Records from microphone or connects to any radio set to make recording off the air



202 OPERADIO

Operadio Mfg. Co.
St. Charles, Ill.

SOUND SYSTEM — Model 414 portable 14 watt unit features remote volume control, P.M. type speaker; recessed illuminated controls; three channel input; provision for paging switch; in attractive two-tone gray carrying cases

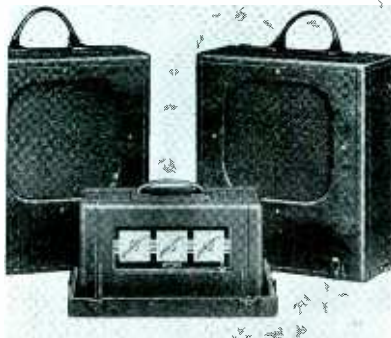

205 SHURE

Shure Brothers
225 W. Huron St., Chicago, Ill.



UNI-DIRECTIONAL MICROPHONE— Model 730A crystal microphone is essentially responsive only to sound approaching toward the front of the unit. May be used horizontally for non-directional characteristics; price complete with 25 foot detachable cable \$29.50 list

203 BOGEN

David Bogen Co.
663 Broadway, New York, N. Y.



CENTRALIZED SOUND SYSTEM — Model S-32 includes built-in tuner, monitor speaker, master and emergency announcement switch, visual level indicator, tone compensator, Class A amplifier, tone compensator, provision for 32 classroom switches. Eight 8-inch speakers included

206 QUAM-NICHOLS

Quam-Nichols Co.
33rd Place & Cottage Grove Ave., Chicago, Ill.

P.M. DYNAMIC — Designed for high power work; capacity 30 watts; maximum frequency range 70-7500 cps; voice coil impedance 6 ohms; ideal for mobile or portable units where vibration is a factor

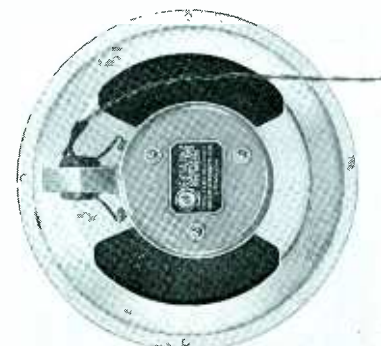

Numbered card in this issue
brings you additional details

207 BELL

Bell Sound Systems, Inc.
Columbus, Ohio

MOBILE SYSTEM—Model M-24 sound system may be used on 6 volts d.c. or 110 volts a.c. by proper connecting of cables supplied. P.M. speakers; separate power switches for turntable, plate supply, and filaments; three input channels, two for microphone mixing and one for phono



211 MILES

Miles Reproducer Co., Inc.
812 Broadway, New York, N. Y.



FILMOGRAPH — For recording sound on film. Records 36 feet per minute; 28 sound tracks on one 16 mm. film; instantaneous playback, no processing. One hundred foot roll film will give 80 minutes of recording

208 CLARION

Transformer Corp. of America
69 Wooster St., New York, N. Y.



AMPLIFIER — Model C-12-R streamline amplifier; 12-16 watts output, beam power tubes, built-in mixer, tone control; full range of output impedances; attractive case with carrying handle; price amplifier only \$32.00 list

212 RCA VICTOR

RCA Mfg. Co.
Camden, N. J.

SCHOOL SOUND SYSTEM — Two complete radio chassis and phonograph for sending broadcast programs or records into classrooms. Microphone break-in to any or all rooms. Monitor speakers for testing any program before delivery



209 LIFETIME

The Lifetime Corp.
1010-1012 Madison Ave., Toledo, Ohio

P.M. UNIT—Model 65 PM deluxe weather-proof high fidelity trumpet unit. Detachable cartridge head shielded by brass chrome head. Twenty-five watts conversion efficiency; price \$65.00 list



213 PHILCO

Philco Radio and Television Corp.
3701 N. Broad St., Philadelphia, Pa.

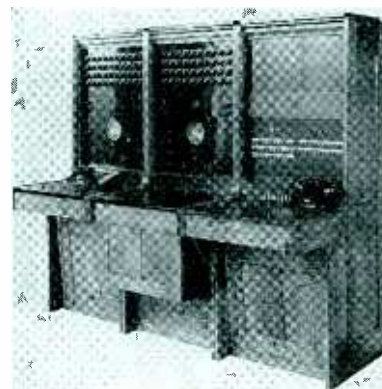

CENTRALIZED SOUND — Combined radio, phonograph, chime, sound and intercommunication system designed principally for school distribution. Provision to 80 outlets individually controlled. A total of 90 watts of audio is available

210 WEBSTER-CHICAGO The Webster Co.
5622 Bloomingdale Ave., Chicago



MOBILE SOUND SYSTEM—Model M-928; 28 watts; operates from either 110 a.c. or 6 volts d.c. Changeover requires simple flip of selector switch, changing of power connection. Motor for turntable operates from main power pack regardless of supply type

Numbered card in this issue brings you additional details

214 CINAUDAGRAPH

Cinaudagraph Corp.
Stamford, Conn.

ELECTRO - DYNAMIC SPEAKERS — New line, sizes 5 to 10 inches, compliments existing complete permanent magnet dynamic types. Feature wide frequency range, simple, rugged construction, low cost



215 VAC-O-GRIP

Vac-O-Grip Co.
2023 Detroit Ave., Toledo, O.

SPEAKER - SIGN CARRIER—Provides two sign panels 96 by 16-in. with 36-in. space between for mounting speakers. Held in place by vacuum cups actuated by suction from car motor to maintain differential pressure



219 STROMBERG

Stromberg-Carlson Tel. Mfg. Co.
100 Carlson Rd., Rochester, N. Y.

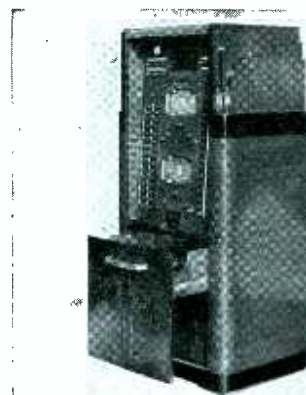

SCHOOL SOUND SYSTEM — Model 702 system incorporates 2 radio channels, phonograph panel and direct address service. Panel knobs control distribution up to 60 points. Two programs may be sent simultaneously; monitor speaker may be used as talk-back microphone

216 KNIGHT

Allied Radio Corp
833 Jackson Blvd., Chicago

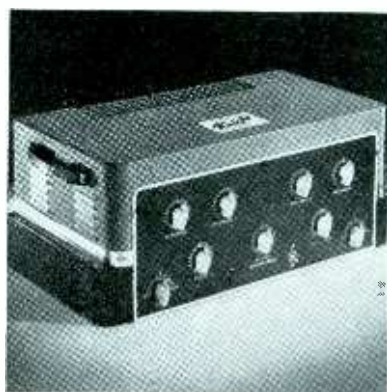

60-WATT AMPLIFIER—Input for four high impedance mikes and two pickups. 6-high gain stages, 130 db. on mikes, 85 db. on pickups; octal glass tubes; master mike control; universal output; speaker selector switch; a.v.c. and a.v.e.; dual tone compensation; inverse feedback; head-phone jack; power stage tap

220

GIBBS

Thos. B. Gibbs & Co.
900-910 W. Lake St., Chicago

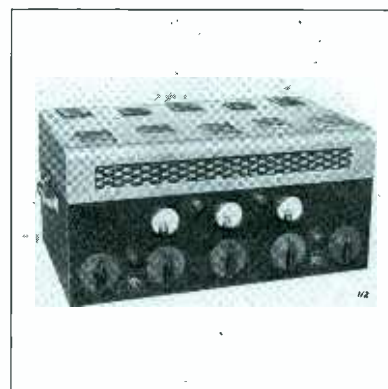

POWER AMPLIFIER — Model 85-XX0; plus or minus 1/2 db, 40-10,000 c.p.s.; 85-150 watts, less than 5 per cent total harmonic distortion at 85 watts. Three input channels; output 500 ohms plus external universal matching transformer; built-in output watt meter, plate current meter, tapped line transformer

217 ATLAS

Atlas Sound Corp.
1451 39th St., Brooklyn, N. Y.

STORM-PROOF HORN —Exponential type made of heavy steel and aluminum spinings, gray weatherproof enamel finish. Provides mounting for cone speaker in inverted reflex position, has half-inch of hair felt to absorb back pressure. Two sizes: for 8-inch cone, less speaker and mounting bracket, \$17.50, for 12-inch \$30



221

JENSEN

Jensen Radio Mfg. Co.
6601 So. Laramie Ave., Chicago



PERI-DYNAMIC REPRODUCERS — Bass-reflex principle in a complete loudspeaker. No baffle required. Offered in knock-down kits for use with 8, 10, 12, 15, 18-inch and auditorium speakers

218 SUNDT

Sundt Eng. Co.
4238 Lincoln Ave., Chicago, Ill.



PHONO - SOUND - MASTER — Model 179 portable sound system is complete with speaker that may be detached. Rated output is 16 watts, 20 watts peak; gain 126 dc.; measures 13 1/4 x 13 1/4 x 6 1/4 in.; two high gain inputs and one phonograph input

222

MIRROR

Mirror Record Corp.
58 W. 25th St., New York

COATED RECORD BLANK — Available in sizes ranging from 6 to 17 1/4 in. Complete stock of lubricated aluminum blanks also available in same sizes

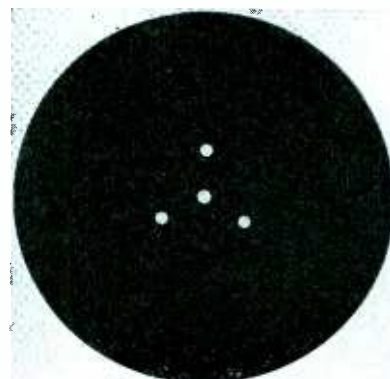

Numbered card in this issue brings you additional details

223 LAFAYETTE

Wholesale Radio Service Co., Inc.
100 Sixth Ave., New York

PHONO-AMPLIFIER—Universal 6 volt dc-110 volt ac type for mobile amplifier or fixed use. Instantly convertible. Stand-by switch, tone control, fader-mixer for mikes. Streamlined, has its own powerpack



227 UNIVERSITY

University Laboratories
191 Canal St., New York, N. Y.



REPRODUCER—Model L.R. high efficiency speech and music reproducer is completely waterproof; uses internal reflexing to include an acoustic length of 4½ ft. in 25 inches. Continuous power handling ability of 25 watts, 50 watts peak. Balanced swivel mounting bracket requires only one bolt for permanent or temporary mounting

224 DYNAPHONE

Ansley Radio Corp.
240 W. 23 St., New York

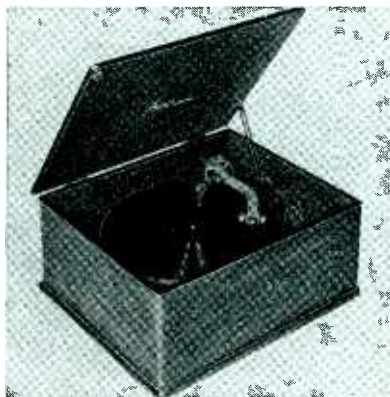

RECORD PLAYER—Model DA, ac or dc, without radio. In cabinet 7 by 17 by 14 inches overall when closed. Weighs 25 lbs. Lists at \$34.50

228 TURNER

The Turner Co.
Cedar Rapids, Iowa

CRYSTAL MIKE—Model 77, head adjustable to semi directional or non-directional position. Built in filter eliminates wind effects and prevents blasting. Absence of peaks reduces feedback. Range 30-10,000 cycles; level -4 db. Price complete with 8 ft. cable less stand \$27.50 list; with stand \$30.00 list



225 OXFORD TARTAK

Oxford Tartak Radio Corp.
915 W. Van Buren St., Chicago

REPLACEMENT SPEAKERS—New line of speakers for service replacement, public address and intercommunicators. Available in p. m. and electro dynamic types

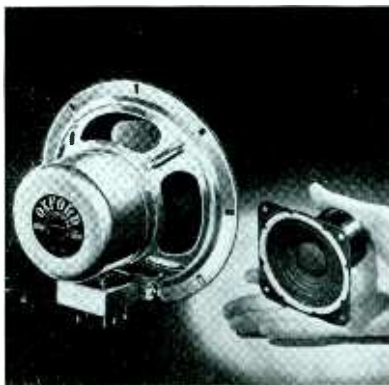

229 AMPERITE

Amperite Co.
561 Broadway, New York, N. Y.



VELOCITY MIKE—Built-in acoustic compensator immediately adjustable to any sound conditions. Response may be varied from high pitched to low with single movement of finger. Complete with switch, cable connector and 25 ft. cable. \$42.00 list

226 REMLER

Remler Co., Ltd.
2101 Bryant St., San Francisco



INTER - COMMUNICATOR, PAGER—Permits two-way conversation between master and any individual station or any group of outlying stations. Also paging of up to 24 stations simultaneously. Phonograph, radio and microphone inputs provided, adding additional versatility for institutional installations

Numbered card in this issue brings you additional details

230 AMPLIFIER CO.

Amplifier Co. of America
37-45 W. 20 St., New York, N. Y.

AUDIO SPECTRUM CONTROL — Provides individual and even accentuation or attenuation of audio range within the following bands: 10 to 300 cycles; 300 to 3000 cycles; 3000 to 20,000 cycles. Employs two 6N7s for electronic type control and one 6 x 5 rectifier. May be added to any amplifier, adds 21 db gain

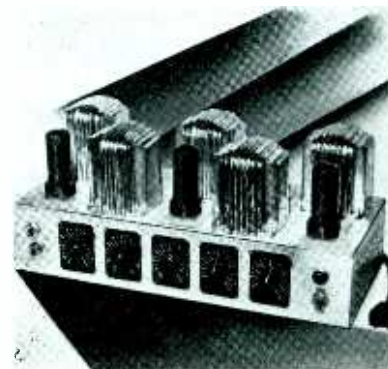

WHAT P.A. POWER RANGE DO YOU WANT ?

YOU CAN GET THE ENTIRE RANGE FROM OPERADIO

MODEL 425 WITH REMOTE MIXTROLOR

Now, the 30 Watt Portable Sound Unit you have been wanting is here. It has a Remote Mixtrolor . . . which gives all the advantages of the Remote Control, but in addition mixes two microphones. Model 425GG features: bass and treble tone compensators to bring out true tonal qualities of voices and music at various output levels; new bullet-type crystal microphone—other types available. Two Operadio extra-heavy-duty permanent magnet dynamic speakers are set in infinite baffle twin speaker enclosures.

BUY ONLY TROUBLE-PROOF UNIT MATCHED EQUIPMENT

Operadio pioneered the idea of UNIT MATCHED P. A. EQUIPMENT. The component parts of each unit are matched perfectly. That means the user gets perfect pre-engineered performance. Buy only Unit Matched Operadio Equipment and you will show a greater profit on every sale.

Keep This Power Chart Handy 8 to 70 WATTS POWER and UP

Operadio has the P. A. system with the exact wattage you need for every portable or permanent sound installation job. This complete chart is your record of Operadio equipment power output. Keep it ready for *instant* use.

When at the Paris Show, your time will be well spent visiting Demonstration Room 550A and Booth No. 218, Hertz Avenue.

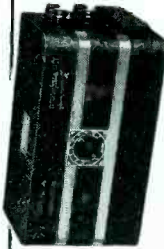

MODEL 870. A booster amplifier to be used with Model 835, and designed for base, wall, or rack mounting. Volume control is inbuilt. Furnishes field for as many as 4 electrodynamic speakers; may be used with AC type dynamic or permanent magnet speakers. Has an unique volume control for variable output independent of a.c. supply.

MODEL 108. The "Little Giant" of store front and show window advertising. Has more power than you need. Microphone can be electrically muted with phonograph input. Complete with a fold-down microphone stand. Amplifier is removed from case during operation.

8 WATTS

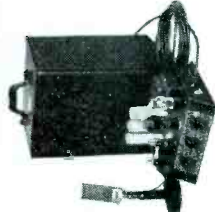

MODEL 414. This flexible unit, electrically mixing two microphones or two microphones and a high impedance phonograph, gives perfect operating results. Provision for new Remote Control. Includes "No-Volt" Velotron microphone and Operadio Heavy Duty two 12" permanent magnet dynamic speakers.

14 WATTS



MODEL 172. Sound truck men especially welcome this combined AC-DC unit in 1 case with full controls on 1 dynamic microphone and 1 crystal microphone. Provision for phonograph. "Econometer" Remote Control, head-phones, and meter monitoring. "Economizer Control" conserves battery supply. Special speakers for sound car jobs.

25 WATTS

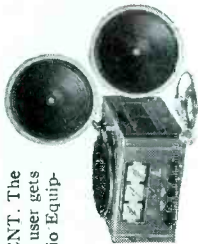

MODEL 425GG. Addition of *Mixtrolor*—adding an auxiliary speaker monitoring 3 channels into your other Booster Amplifiers you obtain up to 420 Watts additional power. 3 input channels electrically mix two microphones or two microphones and two microphones. Non-resonant equalizer, new balancer for both high and low frequencies. Underwriters' Laboratory Listed.

30 WATTS



MODEL 835U. A 35 Watt amplifier that is a "package of dynamite." For any permanent installation, it can be mounted almost anywhere. Used with the new 70 Watt Booster Amplifier you obtain up to 420 Watts additional power. 3 input channels electrically mix two microphones or two microphones and two microphones. Non-resonant equalizer, new balancer for both high and low frequencies. Underwriters' Laboratory Listed.

35 WATTS



MODEL 855R. The aristocrat of P. A. amplifiers of the base or semi-portable type. Provides electronic visual overload indicator; electronic output level indicator; compression to minimize microphone feedback; 4 channel input electronically mixes 3 microphones simultaneously. Includes Phonograph Remote Control. Provision for

55 WATTS



70 WATTS

Operadio Manufacturing Company, Dept. RR6, St. Charles, Illinois (RR6)
() Please send me complete data on Models (List Model Numbers Here)
() Also send your new illustrated catalog.

NAME.....
STREET ADDRESS.....
CITY.....STATE.....

OPERADIO
MANUFACTURING COMPANY
ST. CHARLES, ILLINOIS
EXPORT DIVISION: 145 W. 45TH STREET NEW YORK CITY

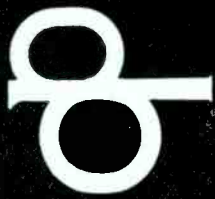

231 TRANSDUCER

Transducer Corp.
30 Rockefeller Plaza, New York

MICROPHONE — Dynamic type, spherical case. Flat frequency response between 25 and 1,000 cycles. Sensitivity minus 52 db. Impedance, 200 or 50,000 ohms, as ordered

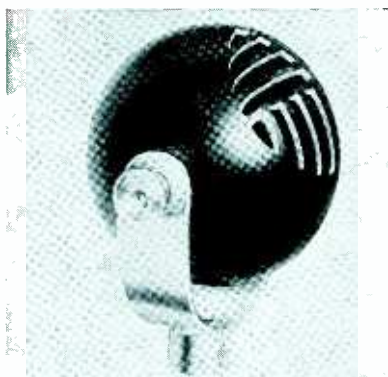

235 SCHLOSS

Schloss Brothers Corp.
801 E. 135 St., New York, N. Y.



PHONO CABINET — Large attractive cabinet designed to house the RCA Victor R93B reproducer. Easily installed with screws. Two needle cups built in; full length hinged top. Price cabinet less reproducer, \$7.00 list

232 PORT-O-VOX

Sound Apparatus Co.
150 W. 46 St., New York, N. Y.



RECORDER — Quality recordings are possible on this new design. Turntable and motor are connected by special coupling system to reduce wows. Motor speed 78 r.p.m.; 12 inch turntable; 110 v, 60 cycle operation; list price \$135.00

236 VIBRALOC

Vibraloc Mfg. Co.
3691 Misson St., San Francisco, Calif.

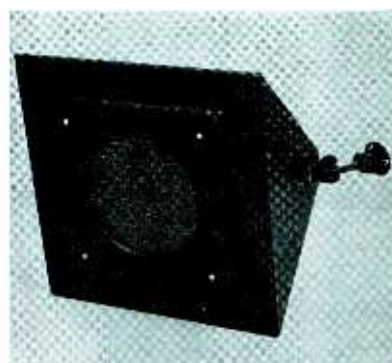

REPRODUCER — High fidelity reproducer rated at 15 watts normal; price \$15. Novel cabinet design aid in proper sound distribution

233 WRIGHT DECOSTER

Wright DeCoster, Inc.
St. Paul, Minn.

NOKOIL SPEAKER — High efficiency 12 inch p. m. speaker furnished in three types. Low frequency type covers from 50 to 3500 cps., standard type from 60 to 5000 cps., wide range type from 60 to 7500 cps; 20 watts power rating



237 ELECTRO-VOICE

Electro-Voice Mfg. Co.
324 E. Colfax Ave., South Bend, Ind.



DYNAMIC MICROPHONE — Response stated as particularly flat from 40 to 10,000 cycles. Output, minus 55 db. Can be furnished to run direct to grid, to 500, 200 or 50 ohms. Can be tilted through 180 arc, operated vertically for non-directional pickup or at angle. With 20 ft. of cable, cable and stand connector. Chromium or gunmetal

234 VELOTRON

Bruno Labs.
30 W. 15 St., New York



MICROPHONE — "No Voltage" type, requiring no polarizing potential. Connects to grid and ground like crystal, ribbon or dynamic. Will operate even when wet. Output minus 50 db., full frequency range well covered. Stable, up to 1000 feet of cable. \$22.50

238 AUTOCRAT

Autocrat Radio Co.
3855 N. Hamilton Ave., Chicago, Ill.

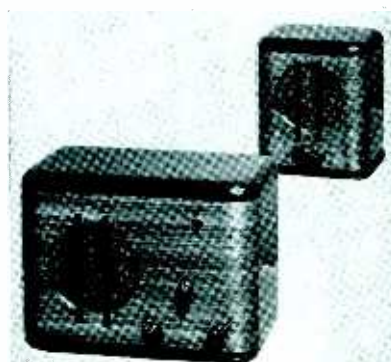

AUTOCRAT PHONE — Intercommunication system for office, factory, restaurant, school and home use. Available in several models from 2 to 11 stations. Confidential earphone; talk listen knob; 110v ac-dc operation

Numbered card in this issue brings you additional details

239 CONVERSAPHONE Conversaphone, Inc.
17-23 W. 60 St., New York, N. Y.

INTERCOMMUNICATOR — Two-way equipment consisting of master and remote station with or without cut-out switch to prevent back noise. Also available in selective type models; easy to install, attractive in appearance and design

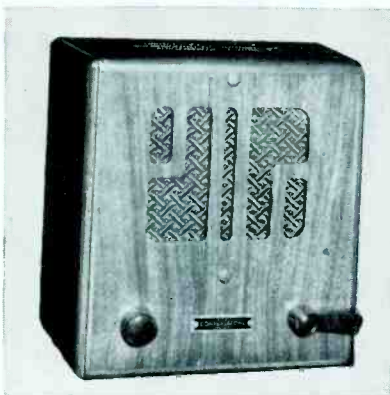

243 THORDARSON Thordarson Elec. Mfg. Co.
500 W. Huron St., Chicago, Ill.

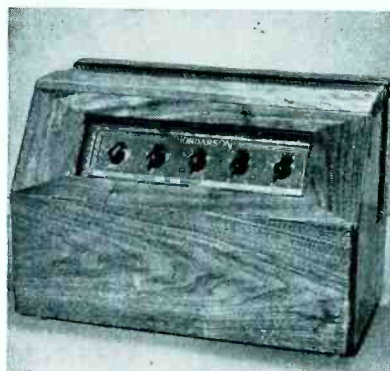

AMPLIFIERS—New line of modernly styled amplifiers in sizes from 8 to 60 watts. Solid walnut cabinets, illuminated dials; protected controls; dual tone controls; low distortion at all audible frequencies

240 COMUN-A-PHONE Comun-a-phone Systems, Inc.
1175 Broad St., Newark, N. J.

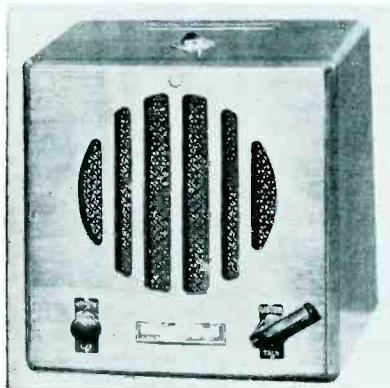

MAGIC PHONE — Two-way intercommunicator system; one master and remote station; ac-dc operation; talk-listen switch; remote station equipped with privacy switch for eliminating background at master end also

244 UPCO Upco Eng. Laboratories
254 Canal St., New York, N. Y.

PICKUP — Lightweight model M-1 pickup for high fidelity. Low needle scratch; output 1 volt; ball bearing arm; adjustable pivot; low record wear; full bass response; price \$7.25 list



241 MEISSNER Meissner Mfg. Co.
Mt. Carmel, Ill.

SOUND TUNER KIT— A trf. tuner using 4 tuned stages with Ferrocart r.f. transformers to provide superhet performance with trf. tone quality. Complete with instructions, schematic and pictorial wiring diagram

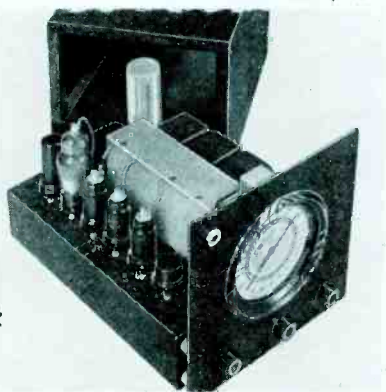

245 SPEEDAFONE Electronic Development Co.
Des Moines, Iowa

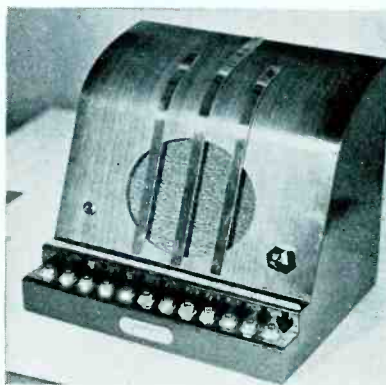

INTERCOMMUNICATOR — Model MS-13 allows up to 13 master stations in one system. Six different conversations may be had at one time. Modernistic walnut cabinet. Each button individually marked

242 MAJOR BOWES Pilgrim Electric Corp.
21 W. 19 St., New York



MICROPHONE —Single-button carbon type especially designed for connection to radio receiver for "home broadcasting". Shockproof, finished in black and gold lacquer, complete with 20 ft. rubber covered connecting cord, \$2.75

246 UNIVERSAL Universal Microphone Co., Ltd.
Inglewood, Calif.

AIRCRAFT MIKE — Small compact microphone not affected by heat, humidity, or position of operation. Complete with push-to-talk switch, holder bracket, cord and plug; duralumin case; 200 ohms impedance, weight 8 oz.



Numbered card in this issue brings you additional details

SONORA

CLEAR AS A BELL

A GREAT NAME IN RADIO
 A GREAT LINE FOR 1939
 A GREAT DISTRIBUTOR OPPORTUNITY

34 GREAT MODELS

Now—for 1939, SONORA offers a new opportunity—an unparalleled opportunity for profitable distributor operation. SONORA presents a complete quality line of 1939 radios with a powerful sales "punch"—a line of 34 magnificent models with "eye" appeal and "Clear-as-a-Bell" tone appeal—priced right for today's market—with distributor net prices that mean exceptional profits. SONORA fits the big, waiting market that only a quality-built, richly-toned, intelligently-priced line of radios can command—and the twenty-five year old SONORA reputation backs this new line of sets—a great line ranging from a hand-sized "Teeny-Weeny" to a luxurious 12-Tube all-wave console. In engineering, in styling, in beauty of tone and of cabinet artistry, SONORA is a logical distributor choice. In price-range, in national policy, too, SONORA brings you the outstanding radio opportunity for 1939!



6 TUBE MODEL DDA-14. A two-band A.C.-D.C. Superhet with Automatic Push-Button Tuning. Tunes 1720-535 K.C. and 5650-18100 K.C. Features: 2 Watts Output; Beam Power Tube; A.V.C.; Push-Button Tuning of any 4 desired stations; 6" Slide-Rule Dial; 6" Dynamic Speaker; Built-in Aerial. Size: 15½" x 8½" x 7". The brilliantly styled table cabinet has the exclusive new SONORA louvre-grille. Provides superb "Clear-as-a-Bell" tone.



9 TUBE MODEL GA-66. Brilliant three-band A.C. Superhet in outstanding deluxe cabinet. Tunes 535-18100 K.C. Features: Automatic Push-Button Tuning; 6" Slide-Rule Dial; Tone Control; A.V.C.; 9 Watts Output; 8" Dynamic Speaker; Pre-selector, etc. Size: 22" x 12" x 11". A brilliant SONORA presentation.



7 TUBE MODEL FA-55. A three-band A.C. Superhet presented in a smartly-styled 1939 cabinet. Tunes 535-18100 K.C. Includes: SONORA Automatic Push-Button Tuning; 6" Slide-Rule Dial; Tone Control; A.V.C.; Wave Trap; 5 Watts Output; 6" Dynamic Speaker; Dyna-Boost Circuit, etc. Size: 18" x 10" x 8".

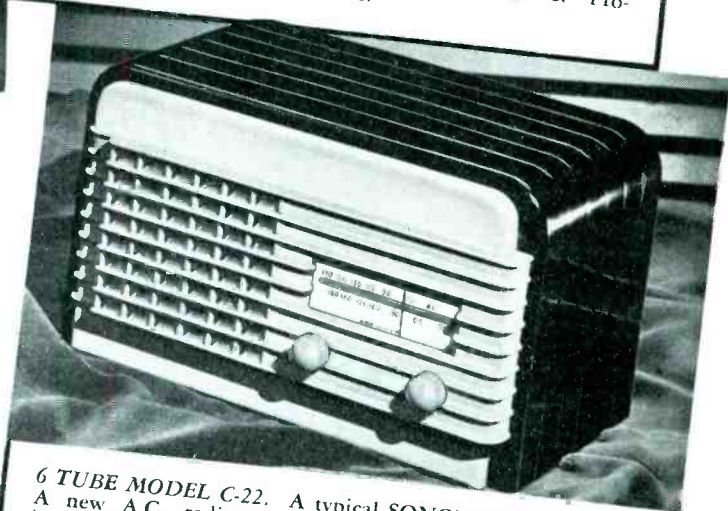

6 TUBE MODEL C-22. A typical SONORA value for 1939. A new A.C. radio in a brilliant plastic-molded cabinet. Tunes 1720 to 535 K.C. Features: exclusive SONORA Dyna-Boost Circuit; 2 Watts Output; Slide-Rule Vernier Dial; Full Dynamic Speaker. Available in ivory, mottled walnut, black, ivory face with black body. The sensational distributor's net price will amaze you! Mottled walnut model lists at only... **\$22.95**

SONORA is open for qualified distributors for territories not yet adequately represented. Write, 'phone or wire for complete details.

Sonora
 Clear as a Bell
RADIO & TELEVISION CORP.
 MERCHANDISE MART • CHICAGO

SINCE 1914 — THE LEADING NAME IN THE MUSIC REPRODUCING WORLD

300 STROMBERG

Stromberg-Carlson Tel. Mfg. Co.
100 Carlson Rd., Rochester, N. Y.

ANTENNA KIT—Number 5 kit gives high sensitivity and effective noise reduction on all standard and short wave bands. Automatically adjusts itself to tuning range in use. Includes lightning arrester, transmission line, and coupling transformer



301 TOBE

Tobe Deutschmann Corp.
Canton, Mass.



FILTERETTE — A radio interference eliminator for electric razors, provides 50 decibels attenuation of radio noise produced by these devices. Suitable for use with any make of electric razor. Plugs in between electric line outlet and shaver

304 RCA VICTOR

RCA Mfg. Co.
Camden, N. J.



MASTER ANTENNA — Covers frequencies from 540 to 23,000 kc., providing high signal strength and high noise reduction on all bands. Kit complete with insulators, wire and instructions

302 AEROVOX

Aerovox Corp.
Brooklyn, N. Y.



NOISE ELIMINATOR — Type 1N-29 line filter is especially adapted for use with electric razors and similar appliances. Plugs in between wall socket and razor. Also available in six other types for various noise conditions

305 ATR

American Television and Radio Co.
300 E. Fourth St., St. Paul, Minn.



ELIMINATOR — Specially designed "A" eliminator for demonstrating and testing auto radios on 110 volt 60 cycle line. Complete with switch, pilot light indicator, 6 ft. rubber cord and plug, heavy gauge metal cabinet

303 STANDARD ELEC.

Standard Elec. Products Co.
St. Paul, Minn.



ADJUST - A - VOLT TRANSFORMER — Smooth continuous control of line voltage. Adjustable from 0-140 volts in 5 volt steps. Type SA5 rated at 860 watts maximum. Complete with etched dial plate and modernistic bar knob; block wrinkle-finish case; net price \$10.80

306 KNIGHT

Allied Radio Corp.
833 Jackson Blvd., Chicago

ALLWAVE ANTENNA KIT—Doublet principle, special transmission cable to reduce noise pickup, two-position coupling transformer for connection between cable and set for impedance match. Sixty feet of flat-top, in two rolls of wire, 60 feet of transmission cable plus other necessary parts



Numbered card in this issue brings you additional details

307 WILLARD

Willard Storage Battery Co.
246-286 E. 131 St., Cleveland, Ohio

STORAGE BATTERIES
—Model 190-6 high power radio battery; 190 ampere hour at radio rate of discharge. Also other sizes of 6 and 2 volt batteries with bail type and special handles. Special tight fitting noiseless radio terminals



311 AMERICAN

American Communicators Corp.
1650 Broadway, New York, N. Y.

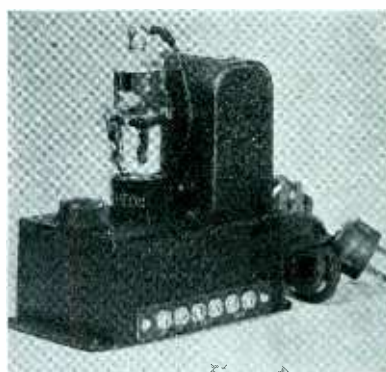

OSCILLATOR — Code practice oscillator gives loud speaker operation. May be used to modulate a transmitter for l.c.w., has many other uses; price \$6.00 list

308 STROMBERG

Stromberg-Carlson Tel. Mfg. Co.
100 Carlson Rd., Rochester, N. Y.

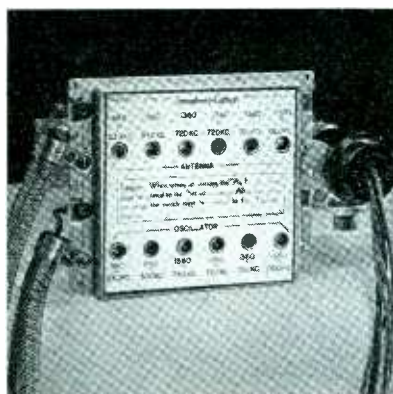

ELECTRIC TUNING UNIT—Provides instant push-button tuning of 6 favorite stations. Labels under buttons illuminated; connects to chassis by 2 shielded wires; self-cleaning silver-plated contacts; mica, bakelite and isolantite insulation; station is set by turning only 2 screws.

312 ELECTRO PRODUCTS

Electro Products Labs.
166 E. Erie St., Chicago



A-B ELIMINATOR — Operates from 110 ac. Employs elaborate filter system. Ample power output to supply correct voltages when lines varies as much as 15 per cent. Potentiometer and voltmeter built in for "A" output adjustment. Efficient design to minimize current drained from line

309 MILLER

J. W. Miller Co.
5917 S. Main St., Los Angeles, Calif.

LINE FILTER — Equally effective for use with receiver on small appliance having current consumption less than 2 amps. Plugs in between appliance and wall socket. Filter unit has provision for ground connection

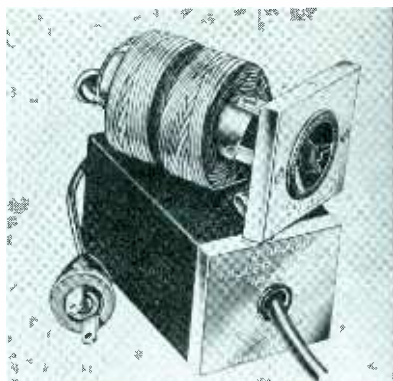

313 UTAH

Utah Radio Products Co.
820 Orleans St., Chicago, Ill.



TUNING UNIT—New automatic push-button tuning device; motor driven; extreme compact construction; electrical circuit is controlled by a single set of contacts using one wire; 180 degrees rotation in 1 second

310 BURGESS

Burgess Battery Co.
Freeport, Ill.



MODEL 10308—Heavy duty size, popular for reliable service and economy on plate drains of 15 to 20 ma. Chrome protected against shelf deterioration

Numbered card in this issue brings you additional details

314 JANETTE

Janette Mfg. Co.
556 W. Monroe St., Chicago

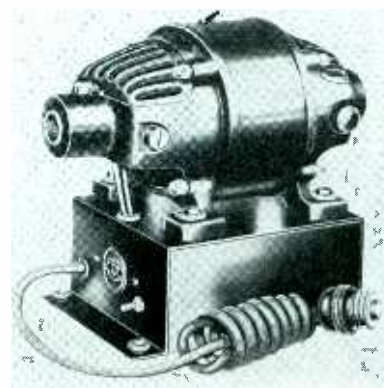

CONVERTER — DC to ac, with wave filters, designed exclusively for radio and sound apparatus. Capacities from 110 to 3250 volt-amperes

315 WARD

Ward Products Corp.
Ward Bldg., Cleveland, O.

AUTO AERIAL—Quinlan model. Streamlined, telescopic side-cowl type with guaranteed rust-proof finish. Easily installed. One of many models in complete line



319 RURALITE

The Ruralite Co.
Sioux City, Iowa

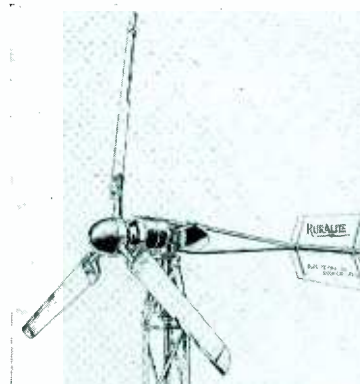

CHARGER — Wind-driven farm power plant. Novel three blade propeller with metal-protected leading edges. Available with fused control panel and charge indicator; metal tower. Capacity 30 amperes

316 FILTERNOYS

Continental Carbon, Inc.
13900 Lorain Ave., Cleveland



NOISE FILTER—Model F18 is a fixed capacitor in a Bakelite plug for insertion between appliance and line. Especially practical for floor and table lamps. Larger sizes available for more severe types of interference. Lists at 35c

320 TACO

Technical Appliance Corp.
17 E. 16 St., New York, N. Y.

BEAM ANTENNA — Two doublets on horizontal plane spaced 90 degrees apart provide four selector legs. Selector chooses any of nine combinations to tune in desired direction. Kit ready for installation



317 IRON HORSE

Johnson Motors
Waukegan, Ill.

GAS GENERATOR — New, larger, more powerful 32 volt, 800 watt type. Model EG-800. Engine is heavy duty, single-cylinder, air cooled unit. Develops 2 horsepower at nominal speed. 2-gallon tank. Governor control. Push button starter, other modern features

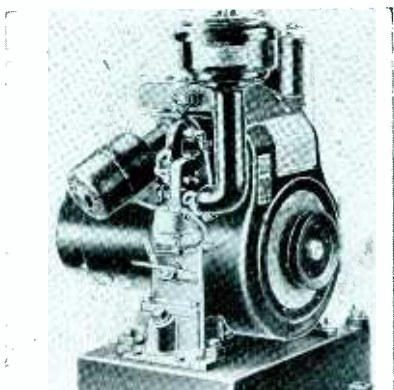

321 OAK

Oak Mfg. Co.
711 W. Lake St., Chicago, Ill.

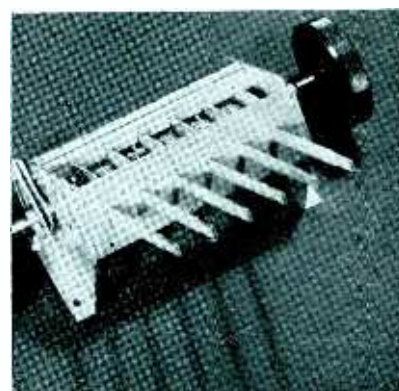

MECHANICAL TUNER — Model 90 tuner available with or without latch bar. Plunger arm protrusion angle available at 0, 45 or 90 degrees; 4 to 8 buttons; 1/2 or 5/8 inch spacing between buttons; front locking or end locking

318 VASCO

Vasco Elec. Mfg. Co.
4116 Avalon Blvd., Los Angeles, Calif.



SOLDERING IRON — Full line of irons for all electric and radio uses; heat dissipating stands prevent irons from overheating. Tip and elements available

322 MEISSNER

Meissner Mfg. Co.
Mt. Carmel, Ill.

REMOTE CONTROL— May be used on any receiver. Push button selection of seven favorite stations and volume control from any convenient location. Walnut veneer cabinet. Available for 110 v, 220 v or ac-dc operation

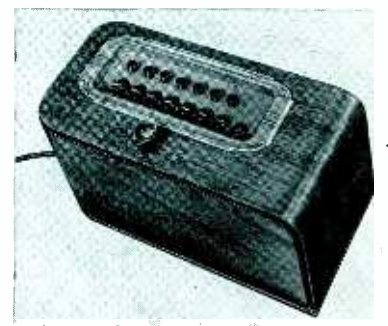

Numbered card in this issue brings you additional details

323 RADI-O-LITE Speak-O-Phone Recording & Equipment Co.
23 W. 60th St., New York

RADIO AND LAMP—Novelty 4-tube ac-dc radio and lamp combination working independently of each other. Incorporates infinite baffle principle. Hand-polished solid walnut cabinet, or colors. Size, 6¾ by 5½ by 5¼



327 COR-NEX

Cornish Wire Co.
30 Church St., New York

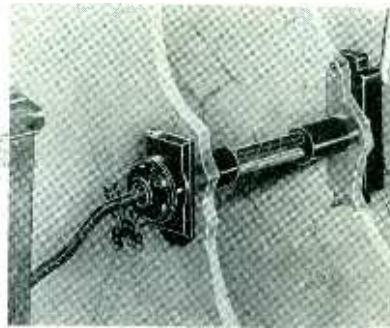

ANTENNA - RECEIVER CONNECTOR — Consists of a lightning arrester, inside plate with leads and polarized plug with cord. Does away with awkward window strips and impromptu wires for lead-in

324 SILVER BAND Pioneer Gen-E-Motor Corp.
466 W. Superior St., Chicago



DYNAMOTORS—Types for aircraft, police, portable radio equipment, sound, other similar purposes. Type E for general use. Type RA for heavy duty. Type DA similar to RA but lower in price. Type PS extremely compact and light in weight. Types for 6 and 12 volt d.c. inputs

328 ALADDIN Aladdin Radio Industries, Inc.
466 W. Superior St., Chicago

AUTOMATIC PUSH - BUTTON TUNER—Designed for stability and elimination of frequency drift. Permeability tuned. For sets with i.f. frequencies between 456 and 465 kc. Two circuits, antenna and oscillator both adjusted from the front. Six buttons. Two cover from 1630 to 945 kc. Four cover 1070 to 540 kc. \$15



325 REMIND-O-CLOCK Remind-O-Clock Corp.
111 Sutter St., San Francisco

TIME CLOCK—A time clock to remind business people of important appointments. May be set for as many as 48 appointments for 12 hours. Valuable in any business organization, hospitals, travel offices



329 NATIONAL National Co., Inc.
Malden, Mass.



"S" METER — Mounted in case and furnished with leads for connection to same company's type NC-80X and NC-81X receivers. Gives visual relative signal strength indication

326 ONAN D. W. Onan & Sons
440 Royalston Ave., Minneapolis, Minn.



PORTABLE AC GENERATOR—For receivers or transmitters or other equipment where weight of 74 lbs., 350 watt output, 110 volts ac, 60-cycle is desirable. Four-cycle engine, governor controlled. Occupies one cubic foot of space complete. Accurate voltage generator

Numbered card in this issue brings you additional details

330 EXIDE The Electric Storage Battery Co.
Allegheny Ave., and 19th St., Phila., Pa.

TWO VOLT BATTERY —Of special design this 2 volt, 230 amp. hour radio battery gives maximum voltage throughout the discharge. Plainly marked terminals; moulded container with carrying handle



**THIS CARD
WILL
HELP YOU
Sell!**

● If you were to put your finger on the chief reason for the success of the established radio retailer, salesman or serviceman it would be this: **HE KNOWS WHAT HE IS TALKING ABOUT!**

There is nothing the customer or prospect can ask him about re- tailing, because he keeps abreast of the times! He knows prices and specifications right down to the last detail.

receivers, parts, accessories—everything that goes into the radio set, or that is sold or serv- iced under the name **RADIO**—that he can't answer quickly—intelligently. He knows the latest products—"who makes what" . . . how they are used. . . where they differ from similar products. He knows prices and specifications right down to the last detail. He knows, because he keeps abreast of the times! He keeps posted by keeping up with radio retailing. He is a "cover-to-cover" reader of *Radio Retailing*.

THIS JUNE "RADIO INDUSTRY TRADE SHOW IN PRINT ISSUE" IS HIS OPPOR- TUNITY—AND YOURS!

Condensed in this issue is the vital information upon which successful radio distributors, re- tailers, salesmen and servicemen depend in order to "know what they are talking about" . . . scores of "New Product" items . . . products of old line companies, and newcomers in the field of radio. . . everything from sets to accessories and 'gadgets.'

These brief items help, but they can't tell you the *complete story* of each product. The only way to get that entire story is from the manufacturer. And *Radio Retailing* makes it easy and convenient for you to do this.

All you have to do is to pick out the product items about which you want more data—then circle the numbers of those items *on the prepaid return postcard at the bottom of this page*. . . *Radio Retailing* will pass on your requests to the respective manufacturers and you'll get that information you desire to enable you to "know what you are talking about."

GAIN KNOWLEDGE

YOUR OPPORTUNITY TO

This perforated postcard is your oppor- tunity to gain valuable information that may mean many sales to you. You don't even have to pay the postage. Simply circle the numbers of the items about which you want additional facts—sign—and drop in the mail, and *Radio Retailing* will do the rest.

THIS OFFER IS GOOD TO SEPT. 1, 1938

Postage Will Be Paid by Addressee

No Postage Stamp Necessary If Mailed in the United States

BUSINESS REPLY CARD
FIRST CLASS PERMIT NO. 64, SEC. 510 P. L. & R. NEW YORK, N. Y.

RADIO RETAILING

330 West 42nd Street

New York, N. Y.

30th Floor

Use RADIO RETAILING

AS YOUR "CLEARING HOUSE" FOR WHAT'S NEW AND NEWS IN RADIO PRODUCTS AND PROMOTIONS

● There never was a time when it was so imperative to know all about everything in radio as right now. With a new selling season just ahead, with new products, new prices, new selling policies being announced every month, you can't afford to pass up any opportunities to absorb the fundamental facts that lead to profitable sales and more satisfied customers.

Thousands of radio dealers, salesmen and servicemen make use of *Radio Retailing's* free "Clearing House Service." You can—and should do the same.

Radio Retailing was the first to inaugurate this free service. Inquiries for information on new products, and other details of the radio business pour in at the rate of over 100,000 annually. Every one receives the personal, prompt attention that only the largest trade and business publishing house in the world—*McGraw-Hill*—can give.

HERE'S THE POSTCARD (prepaid) THAT BRINGS YOU DETAILED INFORMATION ON PRODUCTS MENTIONED IN THIS JUNE ISSUE.

Circle the numbers on the card corresponding with the numbers opposite each "New Product" Item in this book in which you are interested. Then sign and send at once. If you desire special information on products *not* mentioned in this issue, state your needs on the card, or by special letter.

CIRCLE NUMBERS, SIGN AND MAIL



FILL IN . . . SIGN
SEND TODAY!

There is a number on this card for each "New Product" Item described in this book. To secure complete details on any and all items in which you are interested, circle the numbers on this card to tally with the numbers on the editorial pages. *Radio Retailing* will do the rest. No postage is required unless you are outside the United States. In this case use a postage stamp. THIS OFFER IS GOOD TO SEPTEMBER 1st, 1938

RADIO RETAILING

SETS	100	101	102	103	104	105	106	107	108	109	110	111	112	113	114	115	116	117																				
	118	119	120	121	122	123	124	125	126	127	128	129	130	131	132	133	134	135	136	137																		
	138	139	140	141	142	143	144	145	146	147	148	149	150	SOUND	200	201	202	203																				
	204	205	206	207	208	209	210	211	212	213	214	215	216	217	218	219	220	221	222	223																		
	224	225	226	227	228	229	230	231	232	233	234	235	236	237	238	239	240	241	242	243																		
	244	245	246	247	248	249	250	ACCESSORIES	300	301	302	303	304	305	306	307																						
	308	309	310	311	312	313	314	315	316	317	318	319	320	321	322	323	324	325	326	327																		
	328	329	330	331	332	333	334	335	336	337	338	339	340	341	342	343	344	345	346	347																		
	348	349	350	TESTERS	400	401	402	403	404	405	406	407	408	409	410	411	412	413																				
	414	415	416	417	418	419	420	421	422	423	424	425	426	427	428	429	430	431	432	433																		
	434	435	436	437	438	439	440	441	442	443	444	445	446	447	448	449	450	PARTS	500	501	502	503	504	505	506	507	508	509	510	511	512	513	514	515	516	517	518	519
	520	521	522	523	524	525	526	527	528	529	530	531	532	533	534	535	536	537	538	539																		
	540	541	542	543	544	545	546	547	548	549	550																											

PERSON TITLE

COMPANY

STREET CITY STATE

SALES AND PROFITS SOAR WHEN YOU SELL *Servel Electrolux Silence!*

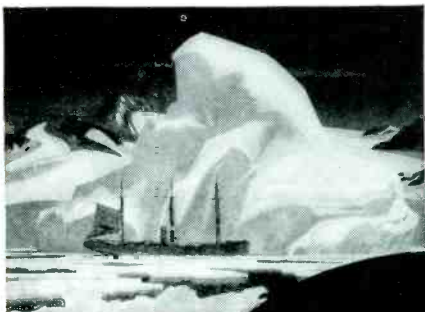

Freezes silently
as nature

Permanent Silence is Only 1 of the Exclusive Sales Advantages that Help Dealers Make More Money with this Different Refrigerator

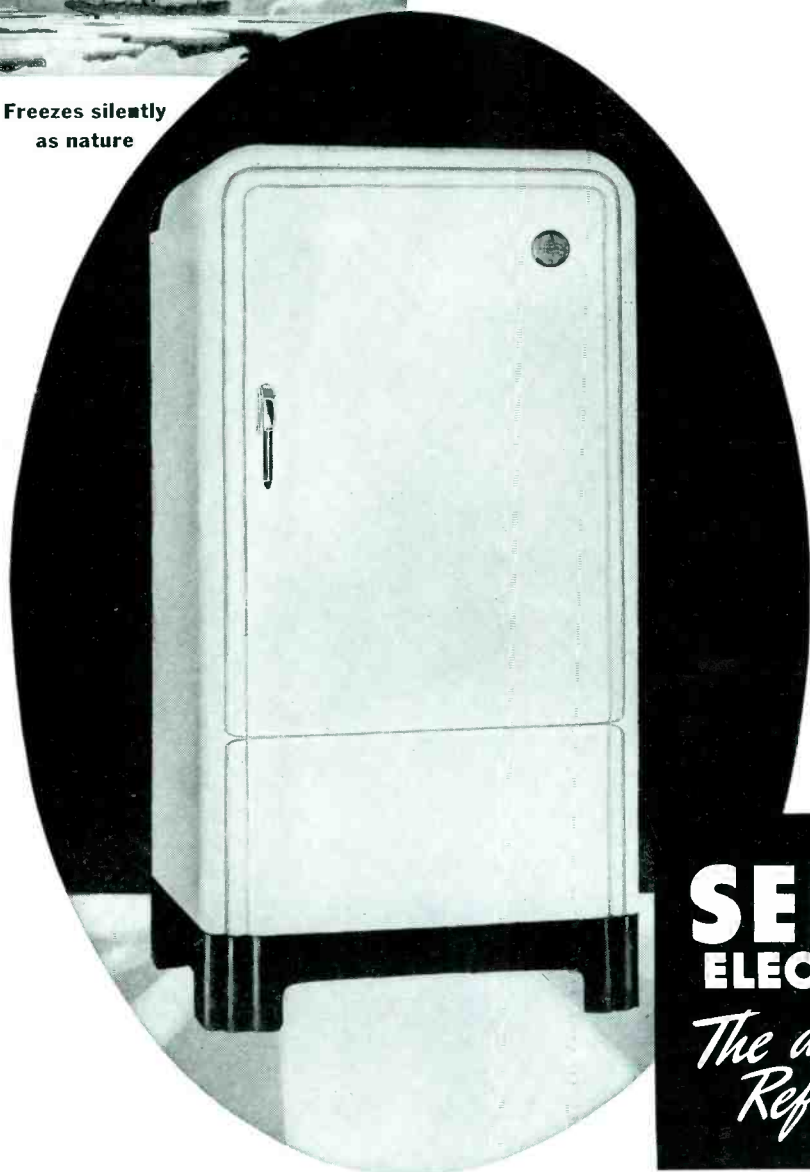

PEOPLE BUY Servel Electrolux because it gives them outstanding and exclusive operating advantages.

No Moving Parts in its freezing system . . . Permanent Silence . . . Continued Low Operating Cost . . . More Years of Satisfactory Service . . . Savings that Pay for It . . . these points *everybody* considers nowadays when selecting an automatic refrigerator.

The reasons why people buy Servel Electrolux are also reasons why dealers and salesmen can enjoy more steady, profitable sales . . . year in and year out.

These major selling advantages which make Servel Electrolux "different from all others" mean better business for you when you sell "the refrigerator you hear about—but never hear."

Servel, Inc., Servel Electrolux Sales Division, Evansville, Indiana.

**SERVEL
ELECTROLUX**
*The different
Refrigerator*

20,000,000 or more listeners every week hear the outstanding hit of the air . . . "The March of Time" . . . flashing to a breathless nationwide audience thrilling dramatizations of news events. And Servel Electrolux is "news" too, to your prospects, who can profitably be told only the *gas* refrigerator can give them the most refrigeration for their money because they "save more for more years."

Sell the Refrigerator **THEY HEAR ABOUT
BUT NEVER HEAR**

331 MARK TIME M. H. Rhodes, Inc.
30 Bartholomew Ave., Hartford, Conn.

TIME SWITCH—Model 4505, will turn radios or other electrical devices on or off automatically at any time up to five hours. Comes in 10 or in 15 ampere capacity. Complete with cord, plug. 10 amp. size \$5.70. 15 amp. \$5.90



335 KATO Kato Engineering Co.
530 N. Front St., Mankato, Minn.

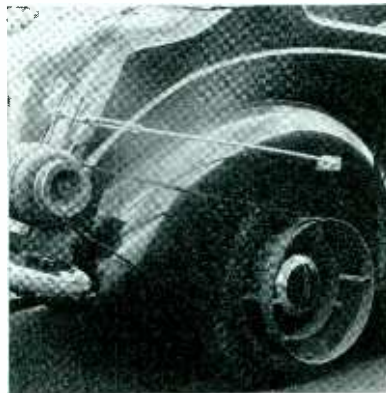

GENERATOR ATTACHMENT — Permits attaching 300 to 2,000 watts ac generator to any car. Easy assembly, may be attached in a few minutes. Also 6, 12, or 32 volts at approximately 20 per cent of ac capacity available

332 HAYNES Haynes Radio Log
161 W. Harrison St., Chicago, Ill.



RADIO LOG — Round the world radio log lists U. S. broadcast stations by call letters, frequency and city; short wave listing; network station; 1938 major league baseball schedules; logs may be obtained localized to any community

336 WEBER COSTELLO Weber Costello Co.
Chicago Heights, Ill.

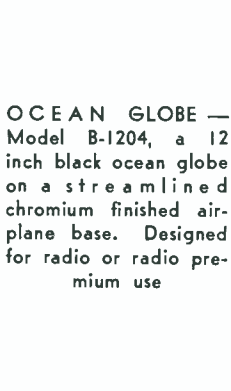

OCEAN GLOBE — Model B-1204, a 12 inch black ocean globe on a streamlined chromium finished airplane base. Designed for radio or radio premium use



333 AUTOCRAT Autocrat Radio Co.
3855 N. Hamilton Ave., Chicago

PUSH - A - BUTTON TUNERS — For any superheterodyne, 6 or 8-button types for top and side installation (type A) or for front and side (type B) installation. Five wires connect from isolantite insulated trimmers to set's variable condenser gang. Adjustable without removing chassis. Six buttons, \$7.50. Eight, \$9.50

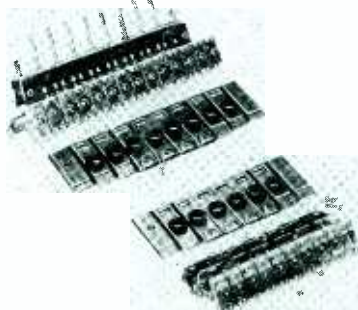

337 SOLAR Solar Mfg. Corp.
599-601 Broadway, New York, N. Y.



ELIM-O-STAT — Designed especially to eliminate interference caused by electric type shavers. Capacitive and inductive type effective on both short and broadcast bands

334 HY-TOWER Parris-Dunn Corp.
Clarinda, Iowa



CHARGER — All basic features of original design plus third brush generator, back of center pivot, double action shock absorber governor spring, electrically welded all steel main frame and new lifetime collector ring

338 FRANKLIN A. W. Franklin Corp.
137 Varick St., New York, N. Y.

PUSH BUTTON MECHANISM—A mechanical automatic tuning system; six or more selector buttons; pulley and cable drive; connects to variable condenser shaft. Button moves 5/8 inch to maximum 60 degree motion of shaft

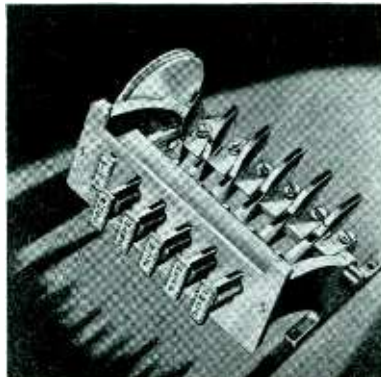

Numbered card in this issue brings you additional details

339 HI-FI

American Injector Co.
Detroit, Mich.

AUTO ANTENNA— Novel chrome plated streamlined car antenna; four sizes fit all cars; specially designed lead in cable; not affected by rain, snow, sleet; free from rattles and whistles at high speed

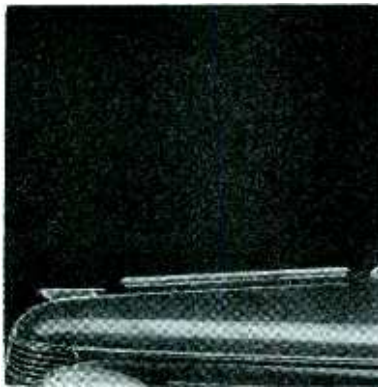

343 ELECTRONIC

Electronic Laboratories, Inc.
122 W. New York St., Indianapolis, Ind.

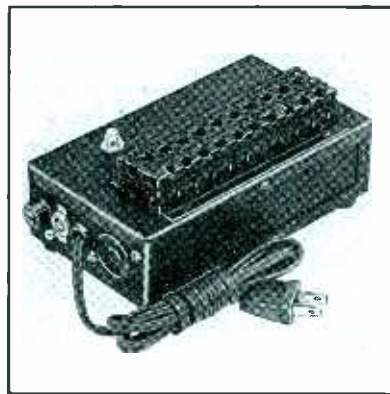

POLARITY CHANGERS—For dc to ac conversion. Vibrating element of device is essentially a double pole, double throw switch. No transformer required. 115 volts dc to 105 volts ac. Capacities of various models: 300 50 watts. Can be provided with adjustable frequency control

340 TELECHRON

Warren Telechron Co.
Ashland, Mass.

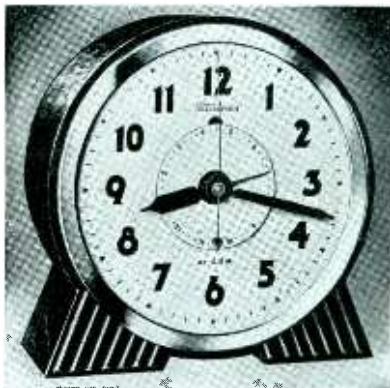

ALARM CLOCK— Electric, self-starting clock model 7H85 may be obtained in mottled brown or ivory plastic. Price \$2.95 to \$3.50

344 ABC

ABC Radio Laboratories
3334 N. New Jersey St., Indianapolis, Ind.



CONVERTER— Long-wave converter for auto radios; two metal tubes, one for r.f. amplifier, the other a converter. Useful in boats, cars, etc. Attaches to any broadcast set; price \$24.95 list

341 WINCHARGER

The Wincharger Corp.
Sioux City, Iowa



DE LUXE WINCHARGER— 1939 model either 6 volt or 2 volt. Furnished in 5 or 10 foot tower models with complete instrument panel. Propellers 15 to 25 per cent more efficient; 30 to 50 per cent output; weather protected collect ring with double carbon brushes

345 CARTER

Carter Motor Co.
1608 Milwaukee Ave., Chicago, Ill.



GENEMOTOR— New heavy duty small size genemotor delivering up to 500 volts at 200 ma.; 6 volts input. Double enamel and silk insulation on all windings

342 DRAKE

Drake Elec. Works, Inc.
3654-56 Lincoln Ave., Chicago, Ill.



HEAT CONTROL—For use with any soldering iron up to 150 watts; increases iron life; keeps tip properly finned. Single switch changes circuit from "warm" to "hot"; 115 volts ac or dc; list price \$3.00

346 J.F.D.

J.F.D. Mfg. Co.
4111 Ft. Hamilton Pk'way, Brooklyn, N. Y.



DIAL BELTS— Woven dial belts for every purpose. Contains a complete assortment of 100 exact replacement belts. List price \$25.00

Numbered card in this issue brings you additional details

FREE TO FRANCHISED DEALERS

**This 12 Foot
5 Color**

**Sparton Action
Display**



**Tied With
A COMPLETE NEW
ADVERTISING AND
MERCHANDISING PLAN
BY AN HONORED NAME
IN RADIO
Take Action!**

Get all the profit-making details—Sparton Advertising plans—Sparton selling plans—Sparton prices lowest in history.

Ask your distributor for full information.

The Sparks-Withington Co., Jackson, Michigan



Model 8618

A new trend in cabinet design and utility.

Mfgs. - Radios - Electric Refrigerators - Auto Horns

400

WESTON

Weston Elec. Inst. Corp.
Newark, N. J.

SERVISET — Model 775 tester combines 2 units, a model 772 analyzer and model 773 tube checker. Complete in spacious carrying case with plenty of room for small tools, sockets, etc. Size overall 5 7/8 x 14 1/4 - 17 1/4; weight 17 lb.; price \$139.00 list

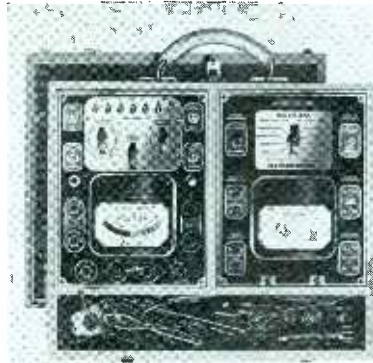

New TESTERS

401

SUPREME

Supreme Instruments Corp.
Greenwood, Miss.

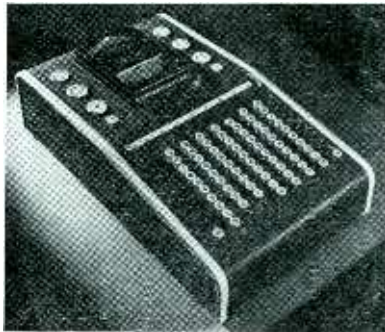

ZEPHYR PUSH-BUTTON TUBE TESTER — To operate, numerical chart is rotated until tube type number appears. Corresponding button, similar to those of a cash-register, is punched and the meter reads "Good" or "Bad" without other operations. Large, double-scale meter easily read from both sides of store's counter

404

RCA

RCA Mfg. Co.
Camden, N. J.



TEST OSCILLATOR— Model 153 has a tuning range from 100 to 30,000 kc. Harmonics from last bond may be used for ultra-high frequency testing. One volt output; large air-plane 6 1/2 in. diam. calibration 2 per cent; list price \$29.95 complete

402

HICKOK

Hickok Elec. Inst. Co.
10514 Dupont Ave., Cleveland, Ohio

OSCILLOGRAPH—Self contained oscillograph with built-in demodulator, and electronic frequency modulator. Variable sweep width 0-30 kc. Permits visual alignment at 665 kc or any harmonic thereof to 5 mc without external oscillator. Sensitivity 0.2 volt per inch; calibrated screen; list price \$165.00



405

CLOUGH-BREngle

Clough-Brengle Co.
2815 W. 19 St., Chicago



RADIO X-RAY LAB—In two sections, finished in green and grey crystalac with chrome trim. Contains: Models 110 rf signal generator, 127 Graphoscope and universal electronic frequency modulator, 79C audio oscillator, 131 universal speaker, 135 tube checker and set analyzer, 132 battery voltage regulator and current indicator

403

TRIPLETT

Triplet Electrical Instrument Co.
Bluffton, Ohio



PUSH-BUTTON TESTERS—Two new lines. Illustrated is model 1616 multi-purpose model incorporating dynamic mutual conductance tube tester, plus complete volt-ohm-milliammeter

406

TRIUMPH

Triumph Mfg. Co.
4017 W. Lake St., Chicago, Ill.

TUBE TESTER — Push-button selector switches and roller type tube chart are outstanding features of model 430. Circuit provides RMA tests of shorts, conductance, leakage and open circuits. Size is 7 1/4 x 9 1/4 x 3 1/2 in.

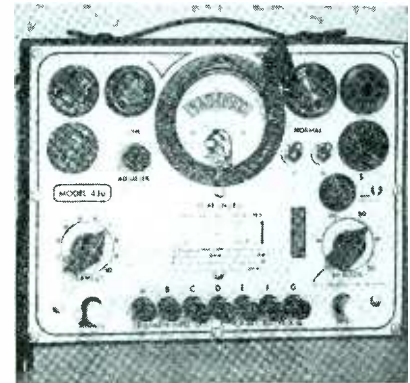

Numbered card in this issue brings you additional details

TESTERS

New PRODUCTS for the New SEASON

407 TOBE

Tobe Deutschmann Corp.
Canton, Mass.

CONDENSER ANALYZER—Permits complete test of electrolytic, paper dielectric and mica condensers. Uniformly graduated, linear control provides maximum speed and accuracy of balance adjustment. Electronic eye; direct reading; no charts or calculation required for any type of measurement



408 SOLAR

Solar Mfg. Corp.
599-601 Broadway, New York, N. Y.



CAPACITOR ANALYZER — Direct reading bridge shows balance by use of 6E5 cathode ray tube; measure capacity, power factor, leakage resistance of condensers and resistors directly on panel

409 OHMITE

Ohmite Mfg. Co.
4835 W. Flournoy St., Chicago, Ill.

DETERM OHM—A calibrated resistance box used to determine the proper circuit resistance by substitution. Resistance range 100 to 999,900. One watt may be dissipated per tap. May be used in voltmeter multiplier circuits, ohmmeters and bridges



410 ALDEN

Alden Products Co.
715 Center St., Brockton, Mass.



OCTAL ADAPTER—Brings old style tube tester up to date. Provides test for all octal tubes; plugs into type 25 socket of tester. Adapter comes complete with chart indicating socket position for tube under test

Numbered card in this issue brings you additional details

411 DUMONT

Allen B. DuMont Labs., Inc.
2 Main Ave., Passaic, N. J.

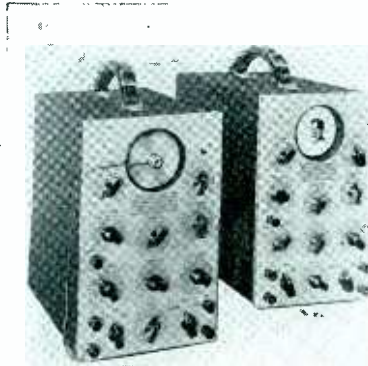

PHASMAJECTOR DEMONSTRATOR — Provides for constant source of video signal and practical television reception. Units are modified 3" oscillographs with minor circuit changers and phasmajector tube inserted

412 SIMPSON

Simpson Electric Co.
Chicago

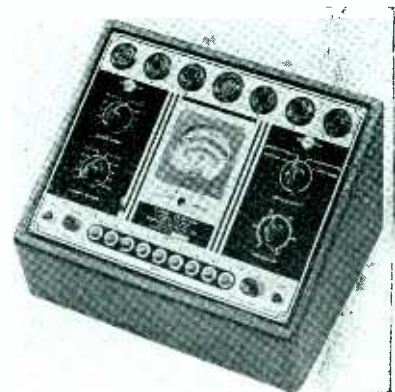

TUBE TESTER — Model 222. Easily read bad, good meter scale. Inclined panel. Sockets for all existing tube types encountered in retail stores. Etched metal panel with clear markings. All modern features

413 MARION

Marion Elec. Inst. Co.
Manchester, N. H.



METERS — D'Arsonval movement meters with 2 per cent accuracy; large clear-reading scale; sapphire jewel-pivots; one milliampere movement regularly supplied with 50 millivolt drop within 2 per cent; bakelite case dimensions $4\frac{3}{8}$ x 4-3/16 inches

414 RADIO CITY

Radio City Products Co.
88 Park Place, New York, N. Y.

TUBE TESTER — Model 307 accurately tests all latest tubes and older types including ballast tubes. Improved circuit design with R.M.A. specified voltages and loads. Hot individual interelement short and leakage tests; line voltage indication and control; \$16.95 net

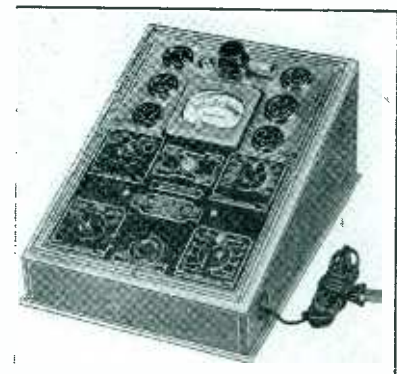

500

VIBRAPOWR

Pauley-James Corp.
4619 Ravenswood Ave., Chicago, Ill.

VIBRATOR — Non synchronous, 4 contact vibrator for auto and home receiver use. Points adjustable for long life; large magnet coil; starts from 2 to 9 volts; twenty types available; housed in tin and zinc container

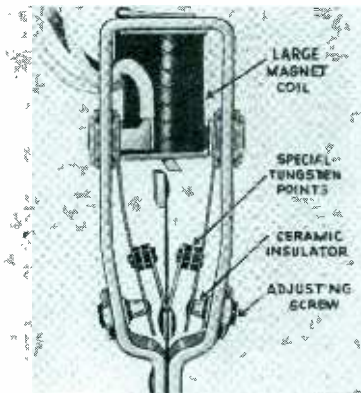

501

CO-X

Transducer Corp.
30 Rockefeller Plaza, New York

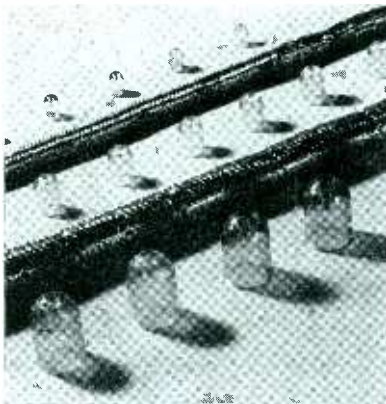

FLEXIBLE COAXIAL CABLE — Designed for use as transmission line having low loss. Low impedance. Insulating "beads" fill outer conductor without skipped spaces, carry inner conductor through center. Capacity as little as 5 mmf. per foot. Variety of types

502

CLAROSTAT

Clarostat Mfg. Co., Inc.
285-287 N. 6 St., Brooklyn, N. Y.

METAL CLAD RESISTORS—Series MPT, Bakelite core wirewound. Improved heat dissipation and low loss. Values from 10 to 10,000 ohms, rating 3 watts. Pigtailed



503

EBY

Hugh H. Eby, Inc.
2066 Hunting Park Ave., Philadelphia

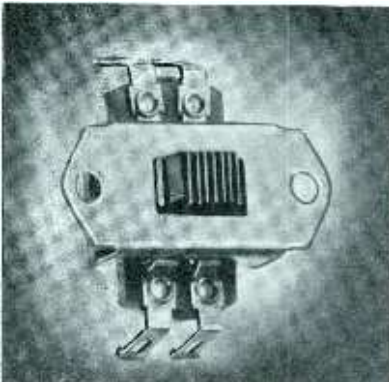

SLIDE SWITCH — Designed for small space requirements. Especially useful for tone control and change over circuits. Can be obtained in single pole single throw, single pole double throw or double pole single throw

Numbered card in this issue brings you additional details

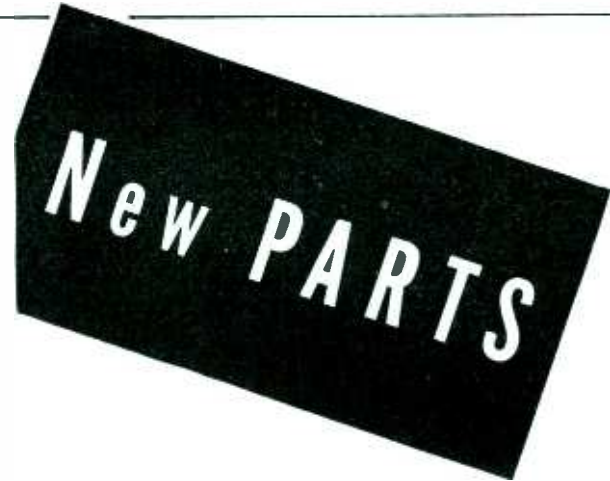

504

CORNELL-DUBILIER

Cornell-Dubilier Electric Corp.
South Plainfield, N. J.

MOTOR STARTING CONDENSER — Designed for this and other a.c. applications. Hermetically sealed in small aluminum can, externally insulated with impregnated fibre sleeve. Low power factor, freedom from internal corrosion. For operation involving maximum of 20 starts per hour, each of 3 seconds' duration



505

SOLAR

Solar Mfg. Corp.
599-601 Broadway, New York, N. Y.

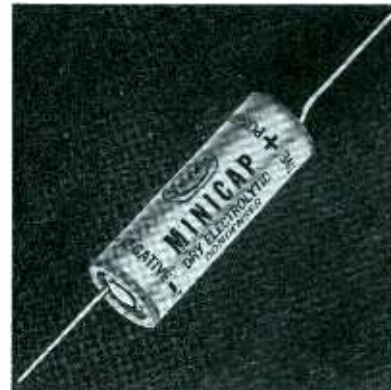

MINICAP — New ultra compact dry electrolytic in small size hermetically sealed metal tube. Full capacity range for general replacement purposes; wire leads; cardboard insulated tube

506

STAR

Star Machine Manufacturers, Inc.
1371-1379 East Bay Ave., Bronx, N. Y.

AUTO-RADIO CONTROLS—Illustrated is typical device in complete line, a control for the 1938 Oldsmobile. Custom-matched. All ratios self-contained. Complete with switch, \$6.75. Escutcheon kits for all cars, 1938, 37, 36, 35, 34 are \$2.25 list

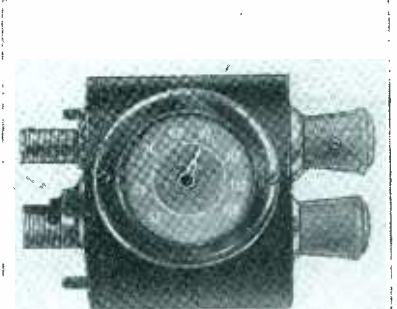

507 MAGNAVOX

The Magnavox Co.
Fort Wayne, Ind.

MOLANDE CAPACITORS — Standardized line of polarized electrolytic capacitors for filter and by-pass service. Only six container sizes for all standard capacities and combination of capacities. Novel mounting lugs allow quick assembly, give positive grip.

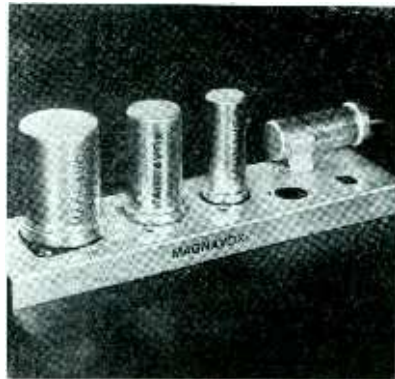

508 IRC

International Resistance Co.
401 N. Broad St., Phila., Pa.

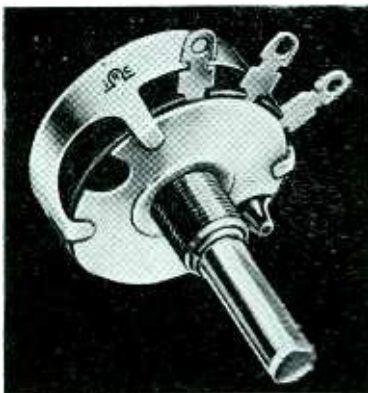

REPLACEMENT CONTROL—Type CS control has silent spiral connector, does away with noise. Five point knee action fingers provides positive contact with metallized resistance element; enclosed in dust-proof case; provision for slip on switches

509 AEROVOX

Aerovox Corp.
70 Washington St., Brooklyn, N. Y.

GENERATOR CONDENSER—A metal-can paper condenser for auto generator noise suppression. Grounded bottom bracket, top terminal lug; intended for mounting and connection directly to generator; standard capacity is .5 mfd; voltage 100 volts; type number 1122; price \$.40 list

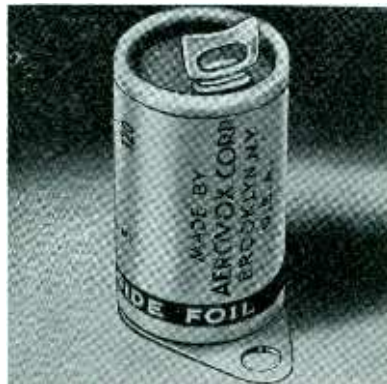

510 TOBE

Tobe Deutschmann Corp.
Canton, Mass.



FILTER-MITE—A compact, paper dielectric, oil processed capacitor having high safety factor. Available in capacities of .05 to 4 mfd at working voltages of 600 and 1000 volts d.c. Metal cased, sturdy lug contacts

Numbered card in this issue brings you additional details

511 CENTRALAB

Centralab
900 E. Keefe Ave., Milwaukee, Wisc.

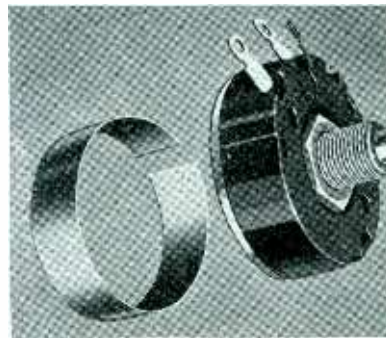

RADIOHM — Carbon composition type variable resistor. Used in radio receiver volume, tone, sensitivity circuits. Also suitable for other high resistance, low power applications in laboratory and industrial instruments. Picture illustrates wall type resistor coiled around inner circumference of Bakelite case

512 STANCOR

Standard Transformer Corp.
1500 N. Halsted St., Chicago

UNIVERSAL POWER TRANSFORMER—Complete line includes 14 sizes; designed for compactness without sacrifice in efficiency; have electro-static shields, RMA colored-coded flexible leads, universal mounting brackets furnished but not used when unit is mounted in half-shell position

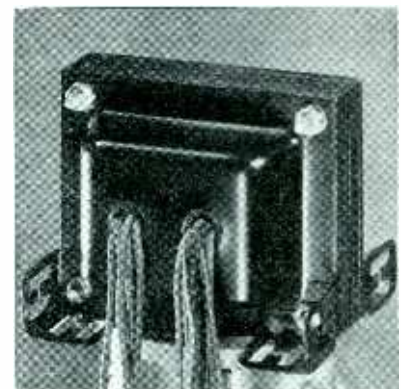

513 HALLDORSON

Halldorson Co.
4500 Ravenswood Ave., Chicago



LINE TO MULTI-SPEAKER TRANSFORMER — For use in matching impedance of a 250 or 500 ohm line to any number of 500 ohm speaker transformer primaries up to six. Two of these transformers will take care of 12 speakers, etc.

514 ATR

American Television and Radio Co.
300 E. Fourth St., St. Paul, Minn.

VIBRATORS — Replacement vibrators for all uses and receivers. New design using 3/16 inch contacts gives long life and reliability. Fully shielded in metal plug-in container; insulated against vibration



They're **SETTING NEW STANDARDS** **FOR MIDGET CONDENSER**

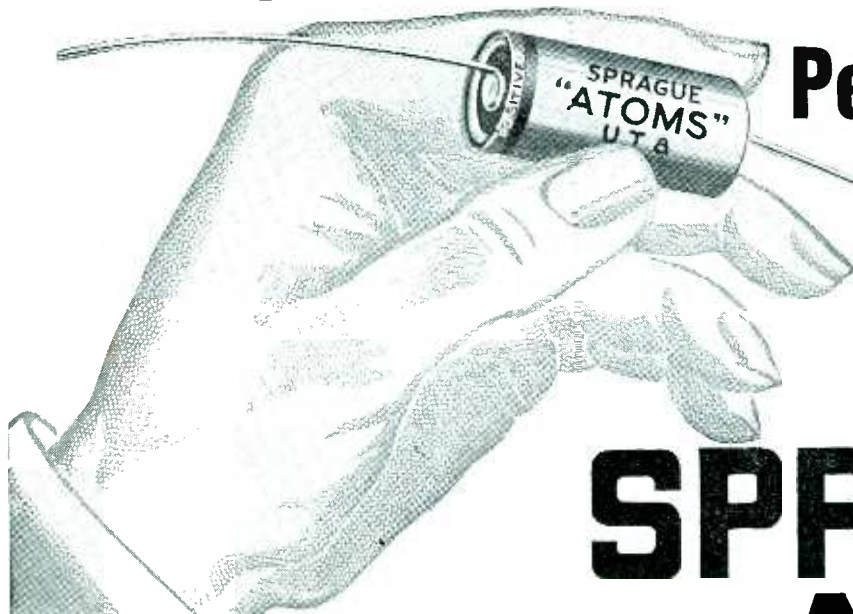

Performance!

SPRAGUE ATOMS

(ETCHED FOIL DRY ELECTROLYTICS)

Low leakage — Ability to stand high surge voltages—Exceptionally long shelf life **UNCONDITIONALLY GUARANTEED.**

Hermetically sealed against moisture — yet absolutely protected against “blow-ups.”

The finest, most reliable midget dries on the market, bar none!

A WHALE of a lot better than you ever thought a small condenser could possibly be made—that, in brief, is the Sprague ATOM! They're better, in fact, than lots of other makes of condensers two or three times their size. You owe it to yourself to try 'em. They're going like hot cakes, *not* because we say they're good, but because servicemen themselves have learned they're good.

Sprague ATOMS are small enough to fit in anywhere—and believe us, they'll stand the gaff. They're made by an exclusive Sprague etched foil process that puts more real, honest-to-goodness quality per inch into a condenser than has ever been put there before. And don't worry about “blow-ups.” There's not a “firecracker” in a carload. Another exclusive Sprague feature of design sees to that.

Note the listing of ATOM Dual Combination Units. Just the thing for hundreds of inexpensive duplicate replacements!

These **HANDY KITS** Will Help You Avoid Plenty of Headaches

Your Sprague jobber can supply you with convenient kits containing 6 or 12 ATOMS. Choose your own assortment of capacities if desired. One or two kits equip you for almost any condenser replacement job.



HERE'S WHERE YOU SAVE YOURSELF SOME MONEY!

Cat. No.	Cap. Mfd.	Working Voltage	List Price	Metal Tube Diameter	Tube Length
TA-10	10	25	\$0.40	9/16"	1-5/8"
TA-25	25	25	0.50	9/16"	1-5/8"
TA-525	25	50	0.55	5/8"	1-5/8"
UT-41	4	150	0.40	5/8"	1-5/8"
UT-81	8	150	0.45	5/8"	1-5/8"
UT-121	12	150	0.50	5/8"	1-5/8"
UT-161	16	150	0.55	11/16"	1-5/8"
UT-201	20	150	0.60	3/4"	1-5/8"
UT-401	40	150	0.65	7/8"	1-5/8"
UT-42	4	250	0.45	9/16"	1-5/8"
UT-82	8	250	0.50	5/8"	1-5/8"
UT-122	12	250	0.65	11/16"	1-5/8"
UT-162	16	250	0.75	3/4"	1-5/8"
UT-43	4	350	0.50	5/8"	1-5/8"
UT-83	8	350	0.55	11/16"	1-5/8"
UT-123	12	350	0.70	3/4"	1-5/8"
UT-4	4	450	0.55	5/8"	1-5/8"
UT-8	8	450	0.60	3/4"	1-5/8"
UT-12	12	450	0.75	7/8"	1-5/8"
UT-16	16	450	0.90	13/16"	2-1/8"
UT-20	20	450	1.00	7/8"	2-1/8"

DUAL CARDBOARD TUBULARS, TOO!

TA-100	10-10	50	\$0.65	5/8"	2-3/8"
TA-212	12-12	200	0.95	13/16"	2-3/8"
TA-216	16-16	200	1.05	7/8"	2-3/8"
TA-816	8-16	200	0.95	13/16"	2-3/8"
UT-88	8-8	450	1.00	15/16"	2-3/8"



SPRAGUE PRODUCTS CO.
NORTH ADAMS, MASS.

For quick, easy replacements "You Can Get At 'Em With **SPRAGUE ATOMS**"

515 OHMITE

Ohmite Mfg. Co.
4835 W. Flournoy St., Chicago, Ill.

RESISTOR — Accurate vitreous enameled wire wound resistor in 10 and 20 watt sizes. Suitable for all replacement work using wire wound types. Available in all standard resistance ranges

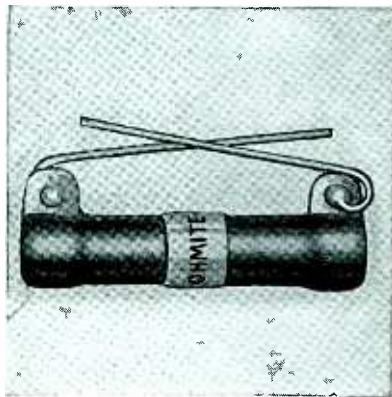

519 MALLORY

P. R. Mallory and Co., Inc.
Indianapolis, Ind.

METAL - CASED CONDENSER — Small size tubular condenser enclosed in metal case. Positive gas seal; 1/3 smaller size for given capacity; one piece aluminum can; low power factor and series resistance; uniform low r.f. impedance; no temperature limitations due to small size

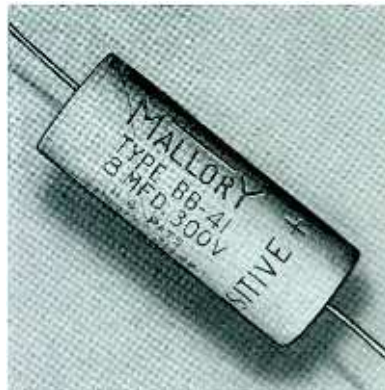

516 INTERNATIONAL

International Transformer Co.
41 W. 20 St., New York, N. Y.

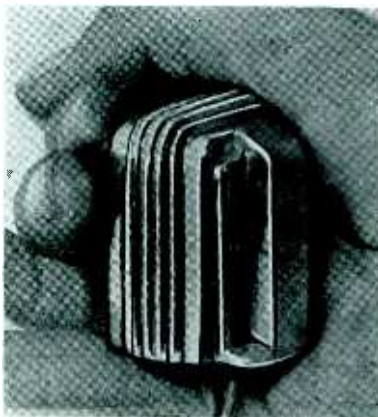

AEROLINE TRANSFORMERS—New light-weight compact high fidelity series of electrostatic and magnetic shielded transformers. Available in 50 models; frequency range 18-20,000 cycles; operating level -90 to +23 db. Models include choke, input, output interstage, mixing, line to line, bridging and frequency equalizers

520 LECTROHM

Lectrohm, Inc.
5133 W. 25th Place, Chicago, Ill.

WIRE SPACE-WOUND RESISTORS—Complete line, vitreous enameled, from 5 to 200 watts. Wound on ceramic cores, available in either fixed, tapped or adjustable types with terminals of either flexible pig-tail or soldering lug, with brackets if so specified. Commercial tolerances 5 per cent. Can be held to 1 per cent



517 G.T.C.

General Transformer Corp.
1250 W. VanBuren St., Chicago, Ill.

PEE WEE TRANSMITTER—Low power transmitter kit for the amateur. Complete with all parts, tubes, crystal and coil form. Both power and r.f. units are mounted on a single battleship gray chassis; 25 watts input; 3 bands on one crystal; 5 bands from 160 to 10 meters with 2 crystals; \$19.95 net price

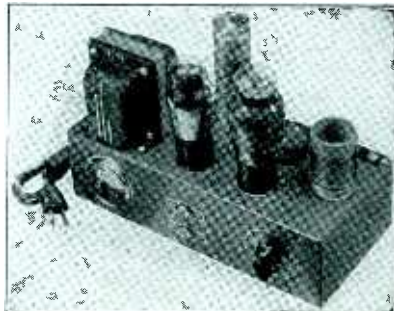

521 STANDARD ELEC.

Standard Elec. Products Co.
St. Paul, Minn.

RELAY—Sensitive "telephone type" relays designed for operation on dc. or full or half wave rectified current. Available for operation on voltages from a fraction of a volt to 220 volts and higher. Standard types list at \$3.25 to \$4.50

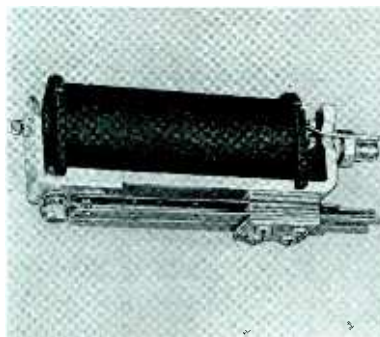

518 ALDEN

Alden Products Co.
715 Center St., Brockton, Mass.

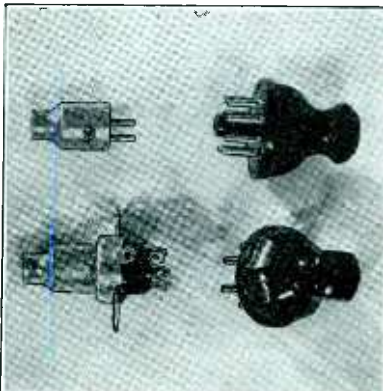

PLUGS — SOCKETS — Shielded and unshielded type plug. Shielded type plug into special socket making contact with shield. New type prong permits 14 wire to be inserted easily, current capacity of prong up to 20 amps.

522 NATIONAL

National Co., Inc.
Malden, Mass.

MIDGET COIL FORM — Isolantite form and base; combination for receivers, midget transmitters, crystal or doubler stages of larger transmitters

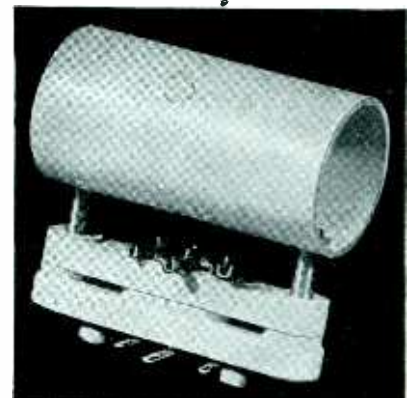

Numbered card in this issue brings you additional details

523 G.H.

Girard-Hopkins
1437 23 Ave., Oakland, Calif.

CERAMIC CASED CONDENSERS—New type ceramic cased paper condenser, non inductive wound; 600 volt dc rating; capacities from .00025 to 1 mfd; high external insulation



527 MILLER

J. W. Miller Co.
5917 S. Main St., Los Angeles, Calif.

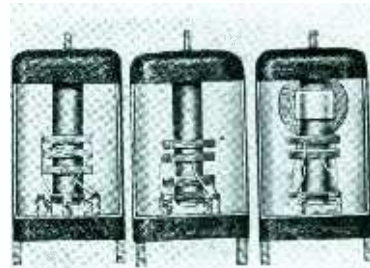

REPLACEMENT COILS—Universal type; model 73; for all replacement work. Available in antenna, r.f. and oscillator type; fully shielded in 1 3/8 x 2 1/2 inch shield

524 FREED

Freed Transformer Co.
72 Spring St., New York

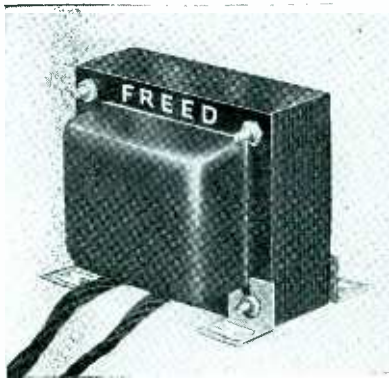

UNIVERSAL REPLACEMENT TRANSFORMERS—Eighteen models provide exact electrical specifications for most existing radios. Shape and removable angles permits mounting of any transformer in many different positions, greatly facilitating installation under difficult chassis conditions

528 CENTRALAB

Centralab
900 E. Keefe Ave., Milwaukee, Wisc.

P.A. CONTROLS—Series II, available in all conventional values for high impedance electronic mixers and low impedance constant resistance line mixers. Line includes attenuators, faders, gain controls. All units furnished with dial calibrated in decibels loss. Maximum attenuation 45 db. to infinity, no insertion loss at 0 db.



525 DUMONT ELEC.

Dumont Elec. Co., Inc.
514-516 Broadway, New York, N. Y.

ELECTROLYTIC CONDENSER—High voltage dry electrolytic good for surge voltages up to 700 volts; continuous operation at 550 volts. Available in standard capacities and capacity combinations

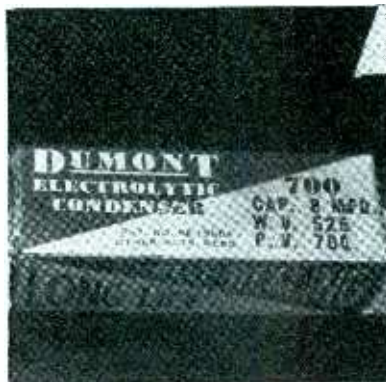

529 MORRILL

Morrill and Morrill
30 Church St., New York



SHIELDED SHELL CORE—Effective permeability, 3.1. Winding cross-section mm², 225. mH. maximum, 20 x .05 strand, .45. mH. maximum 3 x .07 strand, 5.50. Q, 500 kc., 300. 1000 kc., 330. 1500 kc., 300

526 AMPHENOL

American Phenolic Corp.
1250 W. Van Buren St., Chicago, Ill.

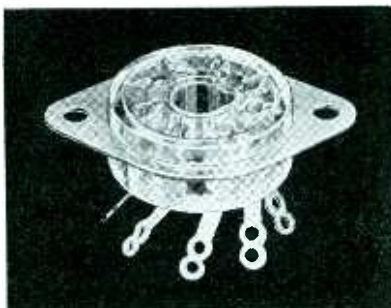

SUPER-MIP—Ultra low-loss socket especially designed for high frequency use. Constructed of new transparent insulating material with a power factor of .0001 to .0002; dielectric constant 2.6; loss factor .00026 to .00053; moisture absorption nil

530 HAMMARLUND

Hammarlund Mfg. Co., Inc.
424-438 W. 33 St., New York, N. Y.

R.F. AMPLIFIER—New unit construction r.f. power amplifier for tubes from 100 to 300 watts output per pair. Complete kit with mounting brackets, condensers, plugs, coil and coil form. Overall dimensions 13x8/2x8 inches

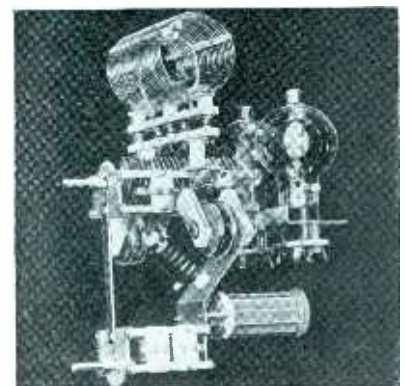

Numbered card in this issue brings you additional details

531 MUELLER

Mueller Elec. Co.
1583 E. 31st St., Cleveland, Ohio

WEE PEE WEE—Tiny thin-nosed clip made of spring-tempered phosphor bronze; entirely non-ferrous; will not heat up in high frequency circuits through hysteresis. Novel snug-fitting rubber insulator

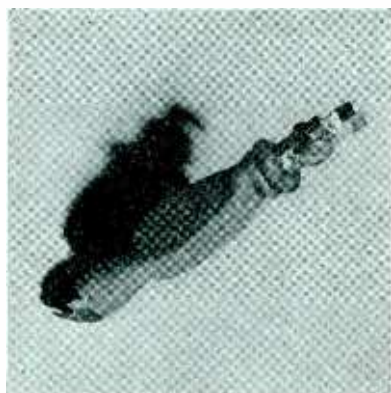

535 SPRAGUE

Sprague Products Co.
North Adams, Mass.

600 LINE—Complete line of electrolytic condensers for every purpose; high surge voltage type. Also extremely small units for use where space is a factor; multiple units for replacement work



532 DIALCO

Dial Light Co.
136 Liberty St., New York



PANEL LIGHTS—Flasher display board for new one inch pilot light assemblies. Complete with pilot lights, cable and plug. Finished in black crackle with yellow lettering

536 KENYON

Kenyon Transformer Co., Inc.
840 Barry St., New York, N. Y.

DEFLECTING YOKE—Television deflecting coils for use with magnetic deflection tubes. Coils designed to reduce distortion to minimum. Suitable for television or measurement purposes



533 WIRT

Wirt Co.
5221-27 Greene St., Philadelphia, Pa.

WIRE RESISTORS—Wire wound type protected by Phenocote, a non-hygroscopic insulating material. All sizes and values available. Novel case for storing units shown above



537 ERIE

Erie Resistor Corp
Erie, Pa.

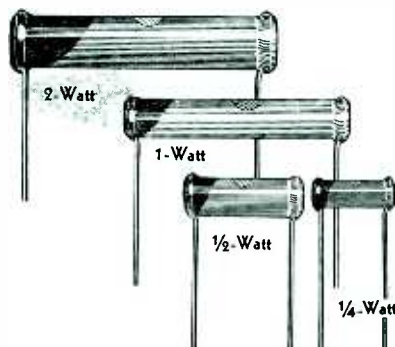

RESISTORS—Made in standard ranges from a few ohms to several megohms; non-insulated; in 2, 1, 1/2 and 1/4 watt sizes

534 SANGAMO

Sangamo Elec. Co.
Springfield, Ill.



MICA CONDENSERS—Complete line of capacity and voltages for every need. Mounted in low-loss bakelite; low temperature coefficient; sturdy lugs; conservative voltage ratings

538 JEFFERSON

Jefferson Electric Co.
Bellwood, Ill.

PLATE TRANSFORMER—Combination 110 v a.c. and 6 v d.c. transformer for use on power line or in conjunction with vibrator; 6 volt primary topped to supply rectifier filament voltage when used on a.c.. Output 300 volts 100 ma.



Numbered card in this issue brings you additional details

DIRECTORY and

SPECIFICATIONS

Information relative to merchandise listed may be obtained by writing direct or, in the case of products pictured in preceding editorial pages, by using the numbered card

TUBES

MANUFACTURERS	TRADENAME	Receiving Tubes	Ballast Units*	Cathode Ray Tubes	Photo Tubes	Control, Thyatron, etc.	Transmitting Tubes	Special Tubes to Order
Amperex Electronics Products Corp., 79 Washington St., Brooklyn, N. Y.	Amperex	•					•	•
Amperite Co., 561 Broadway, New York, N. Y.	Amperite		••					
Arcturus Radio Tube Co., 720 Frelinghuysen Ave., Newark, N. J.	Arcturus	•	••	••				••
Cathode Ray & Television Tube Co., Brockton, Mass.								
Clarostat Mfg. Co., 285 N. 6th St., Brooklyn, N. Y.	Clarostat		••					
Continental Electric Co., Geneva, Illinois	Continental-Tru Vac		••					
Champion Radio Works, 88 Holten St., Danvers, Mass.	Champion	•						
Allen B. Dumont Laboratories, Inc., 532 Valley Rd., Upper Montclair, N. J.	Dumont		••	••				
Duresite Laboratories, 52 Courtland St., Paterson, N. J.	Duresite		••					
Eitel-McCullough, Inc., 789 San Mateo Ave., San Bruno, Calif.	Eimac		••					
Electronic Products Co., 5356 E. Ninth St., St. Charles, Ill.	Air Rex		••		••			
Federal Electric Company, 200 Mt. Pleasant Ave., Newark, N. J.	Federal		••			••		
General Electric Company, 1285 Boston Ave., Bridgeport, Conn.	G. E.	•						
G-M Laboratories, Inc., 1735 Belmont Ave., Chicago, Ill.								
Heintz & Kaufman, Ltd., South San Francisco, Calif.								
Hygrade Sylvania Corp., Emporium, Pa.	Gammatron		••					
Hytron Corp., 23 New Derby St., Salem, Mass.	Sylvania	••	••					
International Radio Corp., 535 William St., Ann Arbor, Mich.	Hytron		••					
J. F. D. Mfg. Co., 4111 Ft. Hamilton Pkwy., Brooklyn, N. Y.	Kadette-International		••					
Ken-Rad Tube & Lamp Corp., Inc., Owensboro, Ky.	JFD		••					
Fred M. Link, 125 W. 17th St., New York, N. Y.	Ken-Rad		••					
F. Lowenberg, 10 East 40th St., New York, N. Y.	Link		••					
Muter Company, The, 1255 S. Michigan Ave., Chicago, Ill.	Electrocell		••					
National Radio Tube Co., Inc., 3420 — 18th St., San Francisco, Calif.	National		••					
National Union Radio Corp. of N. Y., 57 State St., Newark, N. J.	National Union		••					
Philco Radio & Television Corp., Tioga & C St., Philadelphia, Pa.	Philco		••					
Raytheon Production Corp., 420 Lexington Ave., New York, N. Y.	Raytheon		••					
RCA Mfg. Co., Front & Cooper Sts., Camden, N. J.	RCA, Victor		••					
Sparks-Withington Co., E. Ganson Ave., Jackson, Mich.	Sparton		••					
Taylor Tubes, Inc., 2341 Wabansia Ave., Chicago, Ill.	Taylor		••					
Triad Mfg. Co., Inc., Blackstone & Fountain Sts., Pawtucket, R. I.	Triad		••					
Tung-Sol Lamp Works, Inc., Radio Tube Div., 95 — 8th Ave., Newark, N. J.	Tung-Sol		••					
United Electronics Co., 42 Spring St., Newark, N. J.	United		••					
Western Electric Co., 195 Broadway, New York, N. Y.	Western Electric		••					
Westinghouse Electric & Mfg. Co., Lamp Div., Bloomfield, N. J.	Westinghouse		••					
Western Electrical Instrument Corp., 614 Frelinghuysen Ave., Newark, N. J.	Photonic		••					
Wholesale Radio Service Co., Inc., 100 Sixth Ave., New York, N. Y.	Lafayette		••					
World Bestos Corp., 52 Courtland St., Paterson, N. J.	Duresite		••					

* Tube Type Bases (See "Parts" for Resistors)

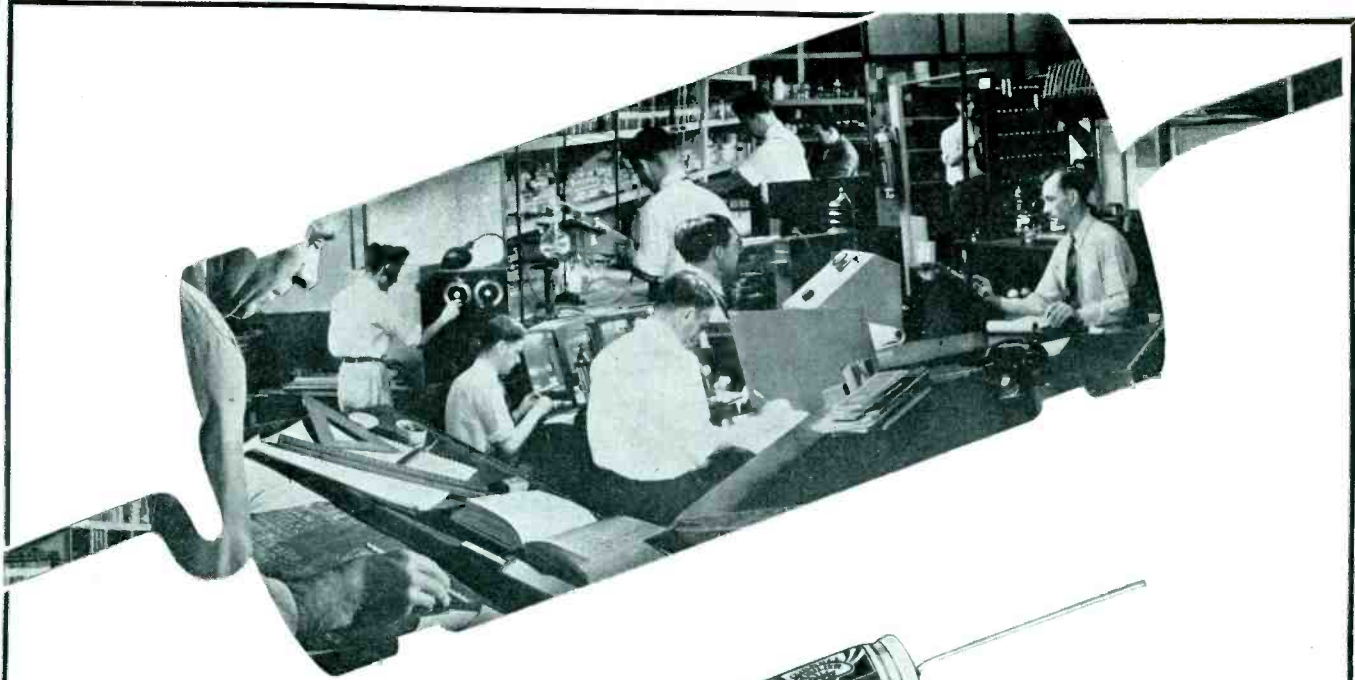

NOT A FIRECRACKER
IN A CARLOAD OF
THESE NEW BR'S!

**Type
BR
FEATURES**

- * Special vent: allows for normal dissipation of harmless, odorless electrolytic vapor; safety under all operating conditions
- * Hi-formation process: affords higher voltage breakdown
- * Super-purity cellulose separator: extra long life
- * Hi-purity aluminum foil: better D.C. leakage recovery
- * Rigid chemical control: uniform performance
- * Tubular, compact construction: ease of wiring into circuit
- * New, varnished protective sleeve spun-over: prevents short-circuit to container

FREE! Our new, big catalog No. 161 is off the press! Write for your copy TODAY! Cable Address: CORDU.



behind the condenser you buy . . .

BEHIND the Cornell-Dubilier capacitor you buy are "shadowed" the vast resources of the largest organization in the world of its kind—the Cornell-Dubilier Electric Corporation. Its engineering experience, skill and ingenuity are concentrated on the building of dependable capacitors—and capacitors alone.

Typical of C-D's superiority are the new type BR "Blue Beavers." They're "over-size" in quality, but "under-size" in physical dimension—designed to give the kind of service you'd expect from larger, more bulky units. C-D type BR "Blue Beavers" are ideal replacement filters—attractively priced.

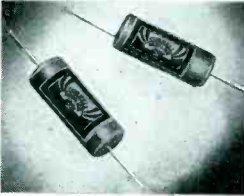

Type D.T. "Dwarf - Tiger" Tubular Paper Capacitors. Compact, moisture-proof, non-inductive condensers that are the finest and most universally used tubulars available.



Type TLA. NEW high voltage filter capacitors impregnated and filled with Dykanol (Chlorinated-diphenyl) a stable chemical compound that will not give off free chlorine regardless of voltage stress or temperature.

Products of the World's Largest and Oldest Exclusive Manufacturer of Capacitors



CORNELL-DUBILIER ELECTRIC CORPORATION

1019 Hamilton Boulevard, South Plainfield, New Jersey

SETS

(Lines not ready for this issue will be listed in July)

Specifications

MODEL	TYPE	LIST PRICE	RANGE IN KILOCYCLES	SUPPLY VOLTAGE	ARE "B" BATT. REQUIRED	DIMENSIONS (H-W-D) (INCHES)	SHIPPING WEIGHT (LB.)	TUBES	INTER-MEDIATE FREQUENCY (KC.)
ABC Radio Labs., 3334 N. New Jersey St., Indianapolis, Ind.									
*800	Police	\$15.95	1500-3500	6 DC	No	5 1/2 x 3 1/2 x 2 1/2	3	6K7, 6K8	456
*600	Foreign	\$24.95	6000-20000	6 DC	No	4 1/2 x 3 1/2 x 7 1/2	5	6K7, 6K8	456
†Short Wave Converter for Auto Radios.									
Air King Products, Inc., 19-35 Hooper St., Brooklyn, N. Y. (Air King)									
222	Table Compact		1740-540	AC-DC	No	5 1/2 x 7 x 4 1/2	5	6D6, 6C6, 25L6G, 25Z5	456
911	*Table		1740-540	AC-DC	No	10 x 15 1/2 x 7	15	6A7, 6D6, 75, 25L6G, 25Z5, M49HG	456
810	Table		1740-540; 2200-7200	AC	No	9 x 14 1/2 x 8	14	6A7, 6D6, 75, 25L6G, 25Z5, M49HG	456
2207	*Table Compact		1740-540	AC-DC	No	8 1/2 x 6	9	6D6, 6C6, 25L6G, 25Z5, M55HG	456
255	*Table		1700-540; 6000-18000	AC-DC	No	8 1/2 x 12 1/2 x 6 1/2	11	6A7, 6D6, 75, 25L6G, 25Z5, M42HG	456
915	*Table		1700-540	AC-DC	No	11 x 16 1/2 x 7 1/2	15	6D6, 6C6, 25L6G, 25Z5, M55HG	456
777	*Table		1700-540	AC-DC	No	7 1/2 x 11 1/2 x 5	8	6D6, 6C6, 25L6G, 25Z5, M49HG	456
251	Table		1700-540	AC-DC	No	8 1/2 x 12 1/2 x 6 1/2	10	6A7, 6D6, 75, 25L6G, 25Z5, M42HG	456
820	Table		1700-540; 2200-7200	AC-DC	No	10 1/2 x 18 1/2 x 8 1/2	20	6A7, 6D6, 75, 25L6G, 25Z5, M42HG	456
815	Table		1700-540; 2200-7200	AC-DC	No	9 1/2 x 14 1/2 x 8	14	6A7, 6D6, 75, 25L6G, 25Z5, M49HG	456
*Automatic Tuning.									
Autocrat Radio Co., 3855 N. Hamilton Ave., Chicago, Ill. (Autocrat)									
101	Table Compact	\$15.00	1700-540	AC-DC	No	4 1/2 x 7 1/2 x 3 1/2	10	6P5, 6K7, 25L6, 25Z6	T.R.F.
359	Auto-Radio	\$24.00	1500-355	6 DC	No	6 1/2 x 12	15	6A8G, 6K7, 6Q7G, 6K6G, 6X5G	456
29	Table Compact		1080-340	2 DC	Yes	13 x 8 1/2		1D7G, 1D5G, 146G, 1G5	456
31	Table Compact		1750-540	6 DC	No	8 1/2 x 13 x 7		6D8G, 677G, 677G, 1F5G	456
Automatic Radio Mfg. Co., Inc., 122 Brookline Ave., Boston, Mass. (Automatic, Tom Thumb)									
M-10	Auto Radio		545-1600	6 DC	No	12 x 7 1/2 x 4 1/2	15 1/2	6A7, 6D6, 6Q7G, 41, 84	456
M-60	Auto Radio		545-1600	6 DC	No	12 x 7 1/2 x 4 1/2	16 1/2	75, 6A7, 6Q7G, 6D6, 41, 84	456
P-70	Auto Radio		545-1600	6 DC	No	9 1/2 x 8 1/2 x 7 1/2	19	75, 6A7, 6Q7G, 6D6, 41, 84	456
M-80	Auto Radio		545-1600	6 DC	No	9 1/2 x 8 1/2 x 7 1/2	20	2-6D6, 6A7, 6Q7G, 2-41, 0Z4, 76	T.R.F.
40	Table Compact		545-1750	AC-DC	No	9 1/2 x 7 x 6	5 1/2	6D6, 6C6, 25A7G, BM80B	T.R.F.
50	Table Compact		545-1750	AC-DC	No	9 1/2 x 7 x 6	6	6D6, 6C6, 43, 25Z5, BM55B	T.R.F.
325	Table Compact		545-1750	AC-DC	No	1 1/2 x 8 1/2 x 6 1/2	8	6D6, 6C6, 43, 25Z5, BM55B	T.R.F.
933	Table Compact		545-1750	AC-DC	No	7 x 4 1/2 x 3 1/2	4 1/2	6K7G-T, 6I7G-T, 25A6G-T, 25Z6G-T	456
915	Table Compact		545-1650; 2400-7000	AC-DC	No	12 1/2 x 8 1/2 x 6 1/2	9	6A7, 6D6, 6Q7G, 25L6G, 25Z5, BM49B	456
911	Table Compact		545-1750	AC-DC	No	14 x 9 x 6 1/2	10	6D6, 6C6, 76, 25Z5, 43, BM55B	T.R.F.
816-818	Table Compact		545-1750	AC-DC	No	11 x 6 x 5 1/2	8	6D6, 6C6, 43, 25Z5, BM55B	T.R.F.
920	Table Compact		540-1700	AC-DC	No	13 x 8 x 6	8 1/2	6D6, 6C6, 43, 25Z5, BM55B	456
840	Table Compact		540-1700	AC-DC	No	14 1/2 x 9 x 7	9 1/2	6D6, 6C6, 43, 25Z5, BM55B	456
850	Table Compact		540-1650; 5500-17000	AC-DC	No	14 1/2 x 9 x 7	10 1/2	6A7, 6D6, 6Q7G, 25L6G, 6G5, 25Z5, BM42B	456
855	Table Compact		540-1650; 6000-17000	AC-DC	No	14 1/2 x 9 x 7	15 1/2	6A7, 6D6, 6Q7G, 25L6G, 25Z5, 76, BM42B	456
892	Console		545-1600; 2200-6400; 5600-17000	AC-DC	No	38 x 24 x 12	57	6A7, 6D6, 2-76, 6C6, 6G5, 2-25L6G, 2-25Z5, BM49A, BM49G	456
Analey Radio Corp., 240 W. 23 St., New York, N. Y. (Analey Dynaphone)									
D-1	*Port. Phono.	\$69.50	No Radio	AC or AC-DC	No	9 1/2 x 14 x 20	33	2-25L6, 2-25Z5, 2-6C6	456
D-1-A	*Table Phono.	\$69.50	No Radio	AC or AC-DC	No	11 1/2 x 16 1/2 x 13 1/2	45	2-25L6, 2-25Z5, 2-6C6	456
D-3	*Port. Comb.	\$84.50	550-1600; 6000-18000	AC-DC	No	14 1/2 x 13 x 8 1/2	27	2-25Z6, 6A8, 6K7, 6Q7, 25L6, BK23B	456
D-10	*Table Comb.	\$84.50	550-1600; 6000-18000	AC or AC-DC	No	11 1/2 x 16 1/2 x 13 1/2	50	2-25Z6, 6A8, 6K7, 6Q7, 25L6, BK23B	456
D-12	*Table Phono. for 16" Records	\$115.00	No Radio	AC-DC	No	18 1/2 x 10 1/2	75	2-25L6, 2-25Z5, 6C6, 76	456
D-12	*Console Phono.	\$115.00	No Radio	AC-DC	No	33 x 22 1/2 x 14 1/2	110	2-25L6, 2-25Z5, 2-6C6	456
D-17	*Console Comb.	\$140.00	550-1600; 6000-18000	AC or AC-DC	No	33 x 22 1/2 x 14 1/2	125	2-25Z6, 6A8, 6K7, 6Q7, 25L6, BK23B	456
D-18	*Auto. Comb.	\$165.00	550-1600; 6000-18000	AC or AC-DC	No	33 x 22 1/2 x 14 1/2	144	2-25Z6, 6A8, 6K7, 6Q7, 25L6, BK23B	456
D-20	*Auto. Phono.	\$170.00	No Radio	AC or AC-DC	No	33 x 22 1/2 x 14 1/2	144	2-25Z6, 6A8, 6K7, 6Q7, 25L6, BK23B	456
D-21	*Console Comb.	\$220.00	550-1600; 6000-18000	AC or AC-DC	No	33 x 22 1/2 x 14 1/2	130	4-25Z6, 4-25L6, 6A8, 6K7, 6Q7, 6C5, BK23B	456
D-22	*Auto. Comb.	\$220.00	550-1600; 6000-18000	AC or AC-DC	No	33 x 22 1/2 x 14 1/2	150	4-25Z6, 4-25L6, 6A8, 6K7, 6Q7, 6C5, BK23B	456
D-23	*Arm Chair Comb.	\$255.00	550-1600; 6000-18000	AC or AC-DC	No	24 x 23 1/2 x 14 1/2	80	25Z6, 25L6, 6A8, 6K7, 6Q7, BK23B	456
D-24	*Auto. Comb.	\$255.00	550-1800; 1800-6000; 6000-18000	AC or AC-DC	No	35 x 27 x 18	155	4-25L6, 4-25Z6, 6A8, 6K7, 6Q7, 6C5, 6L7, BK23B	456
D-25	*Console Comb.	\$205.00	550-1800; 1800-6000; 6000-18000	AC or AC-DC	No	35 x 23 x 15	130	4-25L6, 4-25Z6, 6A8, 6Q7, 6C5, 6L7, 6G5, BK23B	456
D-26	*Port. Phono.	\$144.50	No Radio	AC or AC-DC	No	7 1/2 x 11 1/2 x 18	27	25L6, 25Z6, 6C5	456

Specifications

SETS (continued)

Specifications

MODEL	TYPE	LIST PRICE	RANGE IN KILOCYCLES	SUPPLY VOLTAGE	ARE "B" BATT. REQUIRED	DIMENSIONS (H-W-D) (INCHES)	SHIPPING WEIGHT (LB.)	TUBES	INTER-MEDIATE FREQUENCY (KC.)
<i>(An Ivy Cont.)</i>									
DA	Record Player	\$34.50	No Radio	AC or AC-DC	No	7x17x14	25	25L6-2-25z6, 6A8, 6K7, 6Q7, BK23B	456
U-10	Table Compact	44.50		AC-DC	No	8x13x7	35	25L6-2-25z6, 6A8, 6K7, 6Q7, BK23B	456
U-11	Port. Radio	49.50		AC-DC	No	9x13x8	35		
*Cabinets available in a variety of woods and finishes. †AC-DC \$3.00 extra.									
Belmont Radio Corp., 1257 Fullerton Ave., Chicago, Ill. (Belmont, Freshman Masterpiece)									
526	Table Compact		535-1720	AC	No	7x11x6 1/2	12	6A8G, 6K7, 6Q7G, 6K6G, 5Y3G	465
531	Table Compact		530-1720	AC	No			6A8G, 6K7, 6Q7G, 25L6G, 25Z6G	470
582	Table		535-1720; 2000-7000	AC	No	10x16 1/2 x 7 1/2	16	6A8G, 6K7, 6Q7G, 6K6G, 5Y3G	465
761	Table		540-1750; 1730-5800; 5500-18100	AC	No	11x19 1/2 x 9 1/4	26	6A8, 6K7, 6Q7G, 6J5G, 2-6F6G, 5Y3G	465
860	Console		540-1750; 1730-5800; 5500-18100	AC	No	39x23x11	64	6A8, 6K7, 6Q7G, 6C5, 2-6F6G, 5Y3G, 6U5	465
1175	Console		540-1750; 1730-5800; 5500-18100	AC	No	41x24 1/2 x 12 1/2	70	2-6K7, 6J7, 6C5, 6H6, 6F5, 6J5, 6F6, 5U4, 6U5	465
523	Table		535-1720	2 DC	Yes	11x19 1/2 x 10 1/2	18	1A6, 2-1A4, 30, 950	465
489	Table		535-1720; 5500-18100	2 DC	No	9 1/2 x 16 x 8	18	6D8G, 6S7G, 6I7G, 6K6G	465
577	Auto		530-1550	6 DC	No		13 1/2	6A8G, 6K7, 6Q7G, 6K6G, 6X5G	465
677	Auto		535-1560	6 DC	No		22	2-6K7, 6A8G, 6Q7G, 6V6G, 0Z4	465
Continental Radio & Television Corp., 3800 Cortland St., Chicago, Ill. (Admiral)									
113-5A	Bakelite Compact	\$16.95	535-1730	AC	No	7x10 1/2 x 5 1/2	10	6A8G, 6U7G, 6Q7G, 6K6G, 5Y3G	456
114-5A	Bakelite Compact	17.95	535-1730	AC	No	7x10 1/2 x 5 1/2	10	6A8G, 6U7G, 6Q7G, 6K6G, 5Y3G	456
115-5A	Bakelite Compact	19.95	535-1730	AC	No	7x10 1/2 x 5 1/2	10	6A8G, 6U7G, 6Q7G, 6K6G, 5Y3G	456
516-5C	Bakelite Compact	9.95	535-1730	AC	No	7x8 1/2 x 4 1/2	6	6C6, 25L6G, 25Z6G, 6U7G, L55BG	456
517-5C	Bakelite Compact	12.95	535-1730	AC	No	7x8 1/2 x 4 1/2	6	6C6, 25L6G, 25Z6G, 6U7G, L55BG	456
516-5G	Bakelite Compact	12.95	535-1730	AC	No	7x8 1/2 x 4 1/2	7 1/2	6D6, 76, 6C6, 41, 80	456
517-5G	Bakelite Compact	15.95	535-1730	AC	No	7x8 1/2 x 4 1/2	7 1/2	6D6, 76, 6C6, 41, 80	456
123-5E	Bakelite Compact	15.00	535-1730	AC	No	5x7 1/2 x 4 1/2	5	55A, 25Z6, 6K8, 25L6, 6J7	456
124-5E	Bakelite Compact	15.00	535-1730	AC	No	5x7 1/2 x 4 1/2	5	55A, 25Z6, 6K8, 25L6, 6J7	456
125-5E	Bakelite Compact	15.00	535-1730	AC	No	5x7 1/2 x 4 1/2	5	55A, 25Z6, 6K8, 25L6, 6J7	456
126-5E	Bakelite Compact	15.00	535-1730	AC	No	5x7 1/2 x 4 1/2	5	55A, 25Z6, 6K8, 25L6, 6J7	456
527-5X	Table Compact	19.95	535-1730; 5650-18100	AC	No	11x10 1/2 x 7 1/2	15	75, 41, 6A7, 6D6, 80	456
102-6B	Table Compact	29.95	535-1730; 5650-18100	AC	No	10 1/2 x 18 x 9	19	6A7, 75, 76, 41, 6D6, 80	456
103-6B	Table Compact	39.95	535-1730; 5650-18100	AC	No	13 1/2 x 19 1/2 x 13 1/2	20	6A7, 75, 76, 41, 6D6, 80	456
521-5C	Phono. Comb.	29.95	535-1730	AC	No	12x14 1/2 x 11 1/2	16	6C6, 25L6G, 25Z6G, 6U7G, L55BG	456
521-5C	Phono. Comb.	29.95	535-1730	AC	No	12x14 1/2 x 11 1/2	16	6C6, 25L6G, 25Z6G, 6U7G, L55BG	456
521-5C	Phono. Comb.	34.95	535-1730	AC	No	12x14 1/2 x 11 1/2	17 1/2	6D6, 76, 6C6, 41, 80	456
512-6D	Table Compact	34.95	535-1730; 5650-18100	DC	No	9 1/2 x 16 x 9	16	6A8G, 6U7G, 6Q7G, 6G6G, 6ZV5G, 6J5G	456
965-6A	Table Compact	52.50	535-1730; 5650-18100	6 DC-115 AC	No	11 1/2 x 18 1/2 x 10	23 1/2	6L5G, 6D8G, 6I7G, 6G6G, 6S7G, 6ZL5G	456
950-6A	Console	74.95	535-1750; 5650-18100	6 DC-115 AC	No	41x23 1/2 x 12 1/2	60	6L5G, 6D8G, 6I7G, 6G6G, 6S7G, 6ZL5G	456
915-9G	Console	89.95	535-1730; 1715-5650; 5650-18100	AC	No	41x23 1/2 x 12 1/2	70	6A8G, 6U7G, 6I7G, 3-6I5G, 6Q7G, 2-6F6G, 5Y3G	456
940-11S	Console	89.95	535-1730; 1715-5650; 5650-18100	AC	No	42x27 1/2 x 13	86	6A8G, 2-6K7G, 6I7G, 4-6J5G, 2-6F6G, 5Z3	456
935-11S	Console	109.50	535-1730; 1715-5650; 5650-18100	AC	No	40x23 1/2 x 13 1/2	80	6A8G, 2-6K7G, 6I7G, 4-6J5G, 2-6F6G, 5Z3	456
925-16R	Console	159.50	535-1730; 1715-5650; 5650-18100	AC	No	42 1/2 x 25 x 13 1/2	110	4-6K7G, 6L7G, 4-6J5G, 6J7G, 2-5Z3, 2-6H6G, 2-6L6G	456
930-16R	Console	169.50	535-1730; 1715-5650; 5650-18100	AC	No	42 1/2 x 25 x 13 1/2	110	4-6K7G, 6L7G, 4-6J5G, 6J7G, 2-5Z3, 2-6H6G, 2-6L6G	456
Detroit Corp., 1501 Beard Ave., Detroit, Mich. (Detroit, Pee Wee)									
208	Table	\$9.95	540-1720	AC-DC	No				TRF
211	Table	16.95	540-1720; 2300-6300	AC-DC	No				
212	Table	19.95	540-1720; 2300-6300	AC-DC	No				
197-PI*	Table	15.00	540-1720	AC-DC	No				
199-SI†	Table	20.00		AC-DC	No				
207	Converter	12.00	25000-63000	AC-DC	No				
*Ivory Cabinet: also available in black, gray, walnut, red, blue. †Ivory Cabinet: also available in black, gray, walnut, blue, black deluxee, red deluxee, blue deluxee.									
Espey Mfg. Company, Inc., 67 Irving Place, New York, N. Y. (Espey)									
L-861	Night Stand	\$39.50	550-1700; 5800-18000	AC-DC	No	28x16x10	40	6A8G, 6K7, 6Q7G, 25L6G, 25Z6, K49B	456
L-891	Chairside	42.50	550-1700; 5800-18000	AC-DC	No	24x21x14	40	6A8G, 6K7, 6Q7G, 25L6G, 25Z6, K49B	456
(Continued)									



RCA VICTOR

*Electric
Tuning
for All!*

**32 New Ways for you
To Make PROFITS!**

THE CLIMAX TO FORTY

RCA

OFFERS AMAZING VALUES...



**RCA
VICTOR
RADIOS**

**ELECTRIC TUNING
FOR ALL**

**VICTROLA PUSH-
BUTTON CONTROL**

**VICTROLA ATTACH-
MENT "PLUG-IN"**

**MASTER NOISE
ELIMINATOR**

**RCA VICTOR
MASTER ANTENNA**

RCA VICTOR TUBES

HIGH FIDELITY

**NEW STYLE CONTI-
NENTAL, CONSOLE
GRAND, AND 18th
CENTURY CABINETS**

**ELECTRICAL
MAGIC VOICE**

**TRIPLE-CONE
SPEAKER**

NEW FULL-VISION DIAL



RCA Victor Model 97KG

Electric Tuning for 6 stations, Victrola Push-Button Control, Victrola Attachment "Plug-In", Console Grand Cabinet, Magic Eye, RCA Victor Metal Tubes. \$85.00*



RCA Victor Table Model 96T1

Electric Tuning for 5 stations, RCA Victor Metal Tubes, Standard Broadcasts and Police Calls, Magnetite "frequency-locking" Transformers, Electro-dynamic Speaker, Continental Style Cabinet, and many other features. \$34.95*

RCA Victor Table Model 9X

Cabinet available in walnut and four distinctive colors—onyx brown, Brazilian onyx green, Arizona onyx green, onyx black. AC-DC operation. Built-in Antenna. The price—see your distributor. →

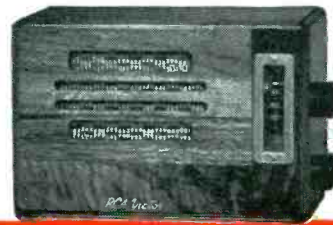

*Prices f.o.b. Camden, N. J., subject to change without notice.

**Now—More Than Ever Before...
The Road to PROFITS is Marked**

YEARS OF LEADERSHIP

Victor

BRILLIANT NEW STYLES for 1939



RCA Victrola Model U-128

Has new gentle action, automatic Record Changer for 10" and 12" records, Crystal Pick-up with top needle loading, Electric Tuning for 8 stations, 12" Dynamic Speaker, 10 RCA Victor Tubes. \$185.00* including RCA Victor Master Antenna and \$9.00 worth of Victor Records.

RCA Victrola Model U-111

Instrument has Feather-touch Crystal Pick-up, True-Tracking Tone-Arm, Synchronous Electric Motor, Tone Control. The radio gets Domestic Broadcasts and Police Calls. \$39.95*

RCA Victrola Model R-89

(Phonograph only.) Plays 10" and 12" records, has Feather-touch Crystal Pick-up, True-Tracking Tone-Arm, Cushion-mounted Constant Speed Motor RCA Victor Tubes and other fine sales features. \$24.50*

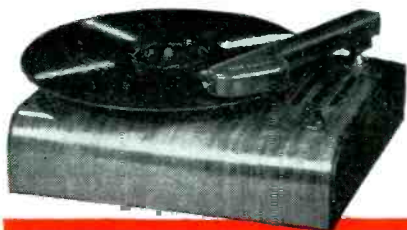

**NEW GENTLE-ACTION
AUTOMATIC RECORD
CHANGER**

**TOP-LOADING
CRYSTAL PICK-UP
TRUE-TRACKING
TONE-ARM**

**HIGH FIDELITY
TRIPLE-CONE
SPEAKER**

**RCA VICTOR
ELECTRIC TUNING
CABINETS OF NEW AND
UNUSUAL BEAUTY**

**Victor Record Society Steps
Up Victor Record Sales!**

The Victor Record Society, which has sent record sales soaring to new peaks, will continue to make money for dealers, not only from the standpoint of record sales, but Victrola sales as well! For the Society's benefits are now included in the price of the 1939 RCA Victrolas.



RCA All The Way



INCREASED ADVERTISING

One of the most gigantic advertising campaigns ever placed by RCA Victor will create customers for you this year!

A Weekly Radio Message to 3,000,000 Homes!

The RCA Magic Key program, broadcast every Sunday on an NBC network of 107 stations—and Victor Record programs, broadcast 6 times weekly on 9 stations—will feature the new radios and Victrolas in strong commercial announcements.

An Audience of 17,988,000 Magazine Readers!

Printed advertising on radios and Victrolas will do a mighty selling job for you! Some of the many publications RCA Victor will use to pound home its sales story on radios and Victrolas include frequent, consistent, 4-color pages in the Saturday Evening Post and Collier's, four pages per advertisement in the "Listen" supplement of Life, Radio Guide, American Home, American Magazine, Cosmopolitan, Time, New Yorker, Scribner's, Esquire, National Geographic, Nation and American Mercury.

For your own use, RCA Victor has prepared a large and widely varied series of cooperative advertisements which advertising experts pronounce the most forceful and effective they've ever seen.

FOR FINER RADIO PERFORMANCE . . . RCA VICTOR RADIO TUBES

RCA presents the Magic Key every Sunday, 2 to 3 P. M., E. D. S. T., on the NBC Blue Network.

**New
Sales-Producing
Promotional Material**

For you, too, RCA Victor has prepared a splendid array of promotional material including some of the most ingenious window and floor displays you've ever seen. The first display of the 1938-39 window service is shown above. Your RCA Victor distributor will be glad to give you full details about the new window displays. They'll combine with the advertising to bring you more calls than ever before—and when people call—they buy!

**FOR
MORE
PROFITS**

RCA Victor

RCA Manufacturing Company, Inc., Camden, N. J. • A Service of the Radio Corporation of America

MODEL	TYPE	LIST PRICE	RANGE IN KILOCYCLES	SUPPLY VOLTAGE	ARE "B" BATT. REQUIRED	DIMENSIONS (H-W-D) (INCHES)	SHIPPING WEIGHT (LB.)	TUBES	INTER-MEDIATE FREQUENCY (KC.)
<i>(Espey Mfg. Co., Inc. Cont.)</i>									
3-861	End Table	\$47.50	550-1700; 5800-18000	AC-DC	No	28x20x12	40	6A8G, 6K7, 6Q7G, 25L6G, 25Z5, K49B	456
13-861	End Table	49.50	550-1700; 5800-18000	AC-DC	No	27x16x16	40	6A8G, 6K7, 6Q7G, 25L6G, 25Z5, K49B	456
7-861	End Table	59.50	550-1700; 5800-18000	AC-DC	No	27x10x14	40	6A8G, 6K7, 6Q7G, 25L6G, 25Z5, K49B	456
10-891	Console	115.00	550-22000	AC-DC	No	41x23x14	70	6A8G, 6K7, 6Q7, 6C5, 2-25L6, 2-25Z6G, 6U5	456
11-1751	Console	155.00	550-350; 550-60000	AC-DC	No	36x23x17	80	3-6K7, 6L7, 6A7G, 6C5, 4-25L6, 4-25Z6G, 6U5	456
861A	Table Compact	25.00	550-1700; 5800-18000	AC-DC	No	8x12x7	8	6A8G, 6K7, 6A7G, 25L6G, 25Z5, K49B	456
861B	Portable	25.00	550-1700; 5800-18000	AC-DC	No	8x12x7	8	6A8G, 6K7, 6A7G, 25L6G, 25Z5, K49B	456
861C	Portable	32.50	550-1700; 5800-18000	AC-DC	No	8x12x7	8	6A8G, 6K7, 6A7G, 25L6G, 25Z5, K49B	456
861D	Portable	27.50	550-1700; 5800-18000	AC-DC	No	8x12x7	8	6A8G, 6K7, 6A7G, 25L6G, 25Z5, K49B	456
771C	Table Compact	75.00	550-1600; 5800-18000	AC-DC	No	9x13x9	15	6A7G, 6K7, 6Q7G, 25L6, BK23B, 2-25Z6G	456
771H	Table Compact	75.00	550-1600; 5800-18000	AC-DC	No	9x13x9	15	6A7G, 6K7, 6Q7G, 25L6, BK23B, 2-25Z6G	456
Fada Radio & Electric Co., 30-20 Thomson Ave., Long Island City, N. Y. (F.A.D.A. Radio)									
434G	Table	\$25.95	535-1720	AC	No	10 1/2 x 7 1/2 x 5 1/2	12 1/2	6A8G, 6K7, 6Q7G, 6Y6G, 80	456
460G	Table	24.95	535-1720	AC-DC	No	10 1/2 x 7 1/2 x 5 1/2	11	6A8G, 6K7, 6Q7G, 25L6G, 25Z5, 115.41	456
434V	Table	23.95	535-1720	AC	No	10 1/2 x 7 1/2 x 5 1/2	12 1/2	6A8G, 6K7, 6Q7G, 6Y6G, 80	456
460V	Table	22.95	535-1720	AC-DC	No	10 1/2 x 7 1/2 x 5 1/2	11	6A8G, 6K7, 6Q7G, 25L6G, 25Z5, 115.41	456
20C	Table	22.50	535-1720	AC-DC	No	10 1/2 x 7 1/2 x 5 1/2	11	6A7, 6D6, 76, 25L6G, 25Z5, 115.41	456
434T	Table	21.95	535-1720	AC	No	12x8 1/2 x 6	12	6A8G, 6K7, 6Q7G, 6Y6G, 80	456
460T	Table	20.95	535-1720	AC-DC	No	12x8 1/2 x 6	12	6A8G, 6K7, 6Q7G, 25L6G, 25Z5, 115.41	456
434W	Table	20.50	535-1720	AC	No	10 1/2 x 7 1/2 x 5 1/2	10	6A7, 6D6, 76, 25L6G, 25Z5, 115.41	456
20V	Table	19.95	535-1720	AC-DC	No	14 1/2 x 9 1/2 x 6 1/2	11	6A8G, 6K7, 6Q7G, 25L6G, 25Z5, 115.41	456
20T	Table	19.95	535-1720	AC-DC	No	10 1/2 x 7 1/2 x 5 1/2	11	6A8G, 6K7, 6Q7G, 25L6G, 25Z5, 115.41	456
460W	Table	17.95	535-1720	AC-DC	No	10 1/2 x 7 1/2 x 5 1/2	10	6A7, 6D6, 76, 25L6G, 25Z5, 115.41	TRF
20W	Table	17.95	535-1720	AC-DC	No	10 1/2 x 7 1/2 x 5 1/2	8	6D6, 6C6, 25L6G, 25Z5, 115.33	TRF
430V	Table	15.95	535-1720	AC-DC	No	10 1/2 x 7 1/2 x 5 1/2	8	6D6, 6C6, 25L6G, 25Z5, 115.33	TRF
430T	Table	14.95	535-1720	AC-DC	No	12x7 1/2 x 6	8	6D6, 6C6, 25L6G, 25Z5, 115.33	TRF
450T	Table	12.95	535-1720	AC-DC	No	10 1/2 x 7 1/2 x 6	8	6D6, 6C6, 25L6G, 25Z5, 115.33	TRF
Garod Radio Corp., 115 Fourth Ave., New York, N. Y. (Garod)									
5	Compact	535-1750	535-1750	AC-DC	No	7x10 1/2 x 5 1/2	10	6D6, 6C6, 25L6G, 25Z5, L55BG	456
5LW	Compact	536-1576; 141-336	536-1576; 141-336	AC-DC	No	7x10 1/2 x 5 1/2	10	6D6, 6C6, 25L6G, 25Z5, L55BG	456
4	Compact	549-1720; 2150-7700	549-1720; 2150-7700	AC-DC	No	7x10 1/2 x 5 1/2	10	6A7, 6D6, 6Q7G, 25L6G, 25Z5, L55BG	456
3	*Compact	535-1750	535-1750	AC-DC	No	7x10 1/2 x 5 1/2	10	6A7, 6D6, 6Q7G, 25L6G, 25Z5, L55BG	456
762	*Table	\$49.70	540-1720; 5770-18700	AC-DC	No	10 1/2 x 16 1/2 x 8 1/2	19	6A7, 6D6, 76, 6P5, 25L6G, 25Z5	456
782-L	*Table	59.00	540-1720; 5770-18700	AC-DC	No	11 1/2 x 21 1/2 x 9 1/2	22	6A7, 6D6, 6Q7G, 25L6G, 2-25Z5	456
782-T	*Table	59.00	540-1720; 5770-18700	AC-DC	No	19 1/2 x 15 1/2 x 9 1/2	23	6A7, 6D6, 6Q7G, 25L6G, 2-25Z5	456
8A4-L	*Console	75.00	540-1720; 5770-18700	AC-DC	No	40x24x13 1/2	52	6A7, 6D6, 6Q7G, 25L6G, 2-25Z5	456
8A4-L	Table	59.95	138-375; 540-1720; 2340-7400; 7100-23000	AC-DC	No	11 1/2 x 21 1/2 x 9 1/2	20	2-6D6, 6K8, 6Q7G, 25L6G, 2-25Z5	456
8A4-T	Table	59.95	138-375; 540-1720; 2340-7400; 7100-23000	AC-DC	No	19 1/2 x 15 1/2 x 9 1/2	21	2-6D6, 6K8, 6Q7G, 25L6G, 2-25Z5	456
408-L	Table	79.50	138-375; 540-1720; 2340-7400; 7100-23000	AC-DC	No	11 1/2 x 21 1/2 x 9 1/2	22	2-6D6, 6K8, 76, 6P5G, 42, 80, 6U5	456
408-T	Table	72.50	138-375; 540-1720; 2340-7400; 7100-23000	AC	No	11 1/2 x 21 1/2 x 9 1/2	22	2-6D6, 6K8, 76, 6P5G, 42, 80, 6U5	456
8A3-P4	Phono. Comb.	139.50	540-1720; 2340-7400; 7100-23000	AC-DC	No	19 1/2 x 15 1/2 x 9 1/2	23	2-6D6, 6A7, 6Q7G, 25L6G, 2-25Z5	456
903-3	Table	83.50	540-1570; 1450-3650; 5650-19000	AC-DC	No	42 1/2 x 27 1/2 x 17 1/2	100	6K7, 6A8, 6B8G, 6Q7G, 2-25L6, 2-25Z6G, 6U5	456
903-P8	Console	109.50	540-1570; 1450-3650; 5650-19000	AC-DC	No	13x25x13	28	6K7, 6A8, 6B8G, 6Q7G, 2-25L6, 2-25Z6G, 6U5	456
309-L	Phono. Comb.	169.50	540-1570; 1450-3650; 5650-19000	AC-DC	No	42x24x13	80	6K7, 6A8G, 6B8G, 6Q7G, 2-25L6G, 2-25Z6G, 6U5	456
309-P8	Table	169.50	540-1570; 1450-3650; 5650-19000	AC-DC	No	43x27x17 1/2	111	6K7, 6A8G, 6B8G, 6Q7G, 2-25L6G, 2-25Z6G, 6U5	456
309-3	Table	83.50	540-1570; 1450-3650; 5650-19000	AC	No	13x25x13	35	3-6K7, 6A8G, 6H6, 6P5, 80, 6V6G, 6U5	456
309-P8	Console	109.50	540-1570; 1450-3650; 5650-19000	AC	No	42x24x13	87 1/2	3-6K7, 6A8G, 6H6, 6P5, 80, 6V6G, 6U5	456
3012-L	Table	169.50	540-1570; 1450-3650; 5650-19000	AC	No	43x27x17 1/2	116	3-6K7, 6A8G, 6H6, 6P5, 80, 6V6G, 6U5	456
3012-P8	Table	99.75	540-1735; 2300-7500; 7300-22000	AC	No	13x25x13	38	3-6K7, 6A8G, 6H6, 3-6J5G, 80, 2-6V6G, 6U5	456
3012-4	Table	183.50	540-1735; 2300-7500; 7300-22000	AC	No	45x28x16 1/2	121	3-6K7, 6A8G, 6H6, 3-6J5G, 80, 2-6V6G, 6U5	456
1203-L	Phono. Comb.	134.50	540-1735; 2300-7500; 7300-22000	AC-DC	No	43x27x17 1/2	110	3-6K7, 6A8G, 6H6, 3-6J5G, 80, 2-6V6G, 6U5	456
1203-P8	Table	99.75	540-1735; 2300-7500; 7300-22000	AC-DC	No	13x25x13	35	3-25Z6G, 4-25L6, 6K7, 6A8G, 6B8G, 6Q7G, 6U5	456
1203-4	Table	133.50	540-1735; 2300-7500; 7300-22000	AC-DC	No	45x28x16 1/2	105	3-25Z6G, 4-25L6, 6K7, 6A8G, 6B8G, 6Q7G, 6U5	456
1203-P8	Table	184.50	540-1735; 2300-7500; 7300-22000	AC-DC	No	43x27x17 1/2	115	3-25Z6G, 4-25L6, 6K7, 6A8G, 6B8G, 6Q7G, 6U5	456
<i>*Automatic tuning.</i>									
General Electric Co., Bridgeport, Conn. (General Electric)									
GD-41	Table	540-1750	540-1750	AC-DC	No	7 1/2 x 10 1/2 x 6 1/2	8	6D6, 6C6, 25L6G, 25Z5	455
GD-52	Table	540-1800	540-1800	AC-DC	No	10 1/2 x 14 1/2 x 7 1/2	10	6A7, 6D6, 75, 41, 80	455
G-50	Table	540-1600	540-1600	AC	No	10 1/2 x 18 1/2 x 7 1/2	10	6A8G, 6K7, 6Q7G, 6K6G, 5Y3G	455
G-61	Table	540-1750; 5700-18300	540-1750; 5700-18300	AC	No	11x21 1/2 x 10 1/2	10	6A8G, 6K7, 75, 76, 6A8G, 5Y3G	455
GD-62	Table	540-1600; 1580-5800; 5600-18300	540-1600; 1580-5800; 5600-18300	AC-DC	No	10 1/2 x 14 1/2 x 7 1/2	10	6A7, 6D6, 75, 25L6G, 25Z6G	455
G-55	Console	540-1800	540-1800	AC	No	38x24x10 1/2	8	6A7, 6D6, 75, 41, 80	545
G-56	Console	540-1750; 5700-18300	540-1750; 5700-18300	AC	No	38 1/2 x 26 1/2 x 10 1/2	8	6A8G, 6K7, 6Q7G, 6K6G, 5Y3G	545

Specifications

SETS (continued)

MODEL	TYPE	LIST PRICE	RANGE IN KILOCYCLES	SUPPLY VOLTAGE	ARE "B" BATT. REQUIRED	DIMENSIONS (H-W-D) (INCHES)	SHIPPING WEIGHT (LB.)	TUBES	INTER-MEDIATE FREQUENCY (KC.)
<i>(General Electric Co., Cont.)</i>									
G-66	Console		540-1600; 1580-5800; 5600-18300	AC	No	39 1/2 x 25 1/2 x 11 1/2		6A8G, 6K7, 75, 76, 6AC5G, 5Y3G	455
GD-67	Console		540-1800	AC-DC	No	38 1/2 x 10 1/2		6A7, 6D6, 75, 25L6G, 25Z6G	455
G-68	Phono, Comb.		540-1600; 1580-5800; 5600-18300	AC	No	37 1/2 x 9 1/2 x 16 1/2		6A8G, 6K7, 75, 76, 6AC5G, 5Y3G	455
G-85	Console		540-1640; 1610-5700; 5600-18300	AC	No	41 1/2 x 26 1/2 x 11 1/2		2-6K7, 6A8G, 6H6, 6F5, 6O7G, 2-6V6G, 5U4G	455
G-97	Console		540-1575	AC	No	36 x 38 1/2 x 16 1/2		3-6K7, 6A8G, 6I5G, 6H6, 6F5, 42, 5Y3G	455
G-105	Console		540-1660; 1630-5700; 5600-18300	AC	No	41 1/2 x 28 1/2 x 14 1/2		2-6K7, 6A8G, 6H6, 6F5, 6I5G, 2-6V6G, 5U4G, 6U5	455
G-106	Console		540-1575; 1575-5700; 5700-18200	AC	No	43 x 28 1/2 x 11 1/2		2-6K7, 6A8G, 6H6, 6F5, 6O7G, 2-6V6G, 5U4G, 6U5	455
The Hallcrafters, Inc., 2611 Indiana Ave., Chicago, Ill. (Sky Rider)									
DD1	*Diversity Superhet		545-62000	AC	No			4-1851, 2-6L7, 4-6K7, 2-6H6, 4-6J5, 6C5, 6J7, 4-6F6, 5Z5	455
SX17	*Crystal Filter Super	\$149.50	545-62000	AC	No	9 1/2 x 21 1/2 x 12 1/2	60	4-6K7, 6L7, 6R7, 2-6V6G, 2-6J5, 2-6J7, 5Z3	455
S20	*Superhet	49.50	540-44000	AC	No	8 1/2 x 18 1/2 x 9 1/2	30	2-6K7, 6L7, 6Q7, 6F6, 2-6J5, 80	455
<i>*Communication type.</i>									
Herbert H. Horn, 1701 South Olive St., Los Angeles, Calif. (Tiffany Tone)									
4T	Table Compact	\$14.95	540-1720	AC	No	7 1/2 x 12 x 6	11	6D6, 6C6, 80, 41	465
4W	Table Compact	15.95	540-1740	AC	No	7 1/2 x 12 x 6	11	6D6, 6C6, 80, 41	465
4A	Table Compact	19.95	540-1720	AC	No	7 1/2 x 14 1/2 x 6	12	6A7, 6D6, 75, 42, 80	465
501	Table Compact	20.95	540-1720	AC	No	6 1/2 x 10 1/2 x 6	11	6A7, 6D6, 75, 42, 80	465
50g	Table Compact	26.95	540-1720	AC	No	7 x 11 1/2 x 6	13	6A7, 6D6, 75, 42, 80	465
517	Table Compact	24.95	540-1720	AC	No	9 x 14 1/2 x 7	14	6A7, 6D6, 75, 42, 80	465
517WE	Table Compact	29.95	540-1720	AC	No	9 x 14 1/2 x 7	14	6A7, 6D6, 75, 42, 80	465
518A	Table Compact	30.95	540-1720	AC	No	8 x 17 x 1 1/2	14	6A7, 6D6, 75, 42, 80	465
518WE	Table Compact	32.95	540-1720	AC	No	8 x 17 x 1 1/2	14	6A7, 6D6, 75, 42, 80	465
67	Table Compact	46.95	540-18000	AC	No	9 1/2 x 16 x 8	19	6K7, 6J5, 6A8, 6U5, 5Y3G, 75, 6V6G	465
87B	Table Compact	49.95	540-18000	AC	No	11 x 19 x 5 1/2	23	2-6C5G, 5Y3G, 6U5, 6A8, 6K7, 6O7G, 6F6	465
97	Table Compact	64.95	540-18000	AC	No	38 1/2 x 25 1/2 x 13 1/2	67	6A8, 2-6K7, 75, 6U6G, 5Y3G, 6U5	465
87A	Console	69.95	540-18000	AC	No	42 x 26 1/2 x 14 1/2	30	6A8, 6K7, 6O7G, 6F6, 2-6C5G, 5Y3G, 6U5	465
97C	Console	69.95	540-18000	AC	No	43 1/2 x 28 1/2 x 13 1/2	95	2-6K7, 6A8, 5Y3, 2-6F6G, 4-6J5G, 6J7	465
11A	Console	119.95	540-18000	AC	No	43 1/2 x 28 1/2 x 13 1/2	95	2-6K7, 6A8, 5Y3, 2-6F6G, 4-6J5G, 6J7	465
4TPR	*Radio-Phono.	29.95	540-1720	AC	No	11 x 14 x 9 1/2	25	6D6, 6A7, 75, 42, 80	465
<i>*Table type.</i>									
McMurdo Silver Corp., 2900 S. Michigan Ave., Chicago, Ill. (Masterpiece)									
Masterpiece VI Home \$350.00 150-70000									
15-16	Home	195.00	540-32000	AC	No		100	2-6L7, 4-6K7, 6G5, 2-6F8, 2-6L6, 2-5Z3, 2-6J7, 2-6H6, 6J5	465
Orpheon	Home	89.00	540-1650*	AC	No		60	6L7, 6J7, 6R7, 6H6, 6G5, 3-6J5, 2-6L6, 2-5Z3	472
<i>Local reception only.</i>									
Mission Bell Radio Mfg. Co., Inc., 833 Venice Blvd., Los Angeles, Calif. (Mission Belt)									
392	Table Compact	\$15.95	540-1750	AC-DC	No	6 1/2 x 10 x 6	10	25Z5, 25L6G, 76, 78, L55B	TRF
383	Table Compact	17.95		AC	No	7 1/2 x 12 x 6	10	6A7, 78, 6O7G, 41, 80	465
393	Table Compact	17.95		AC	No	7 1/2 x 12 x 6	11	6A7, 78, 6O7G, 41, 80	465
387	Table Compact	19.95		AC-DC	No	7 1/2 x 10 1/2 x 6	10	25Z5, 25L6G, 6F7, 6A7, L55B	465
384	Table Compact	27.50	540-1650; 5500-16500	AC	No	8 1/2 x 15 x 8	16	6A7, 6D6, 75, 41, 80, 80	465
386	Table Compact	37.50	540-16500	AC	No	8 1/2 x 15 x 7	15	6A7, 6D6, 75, 41, 80, 80	465
388	Table Compact	37.50	540-1650; 5500-16500	AC	No	10 x 18 x 8	17	6A7, 6D6, 75, 41, 80, 80	465
389	Table Compact	44.95	540-16500	AC	No	10 x 18 x 8	17	6A7, 6D6, 75, 41, 80, 80	465
390	Table Compact	27.95	540-1750	AC	No	8 1/2 x 15 x 7	15	6A7, 6D6, 6O7G, 41, 80	465
391	Table Compact	32.50	540-1750	AC	No	8 1/2 x 15 x 7	15	6A7, 6D6, 6O7G, 41, 80	467
638	Auto	39.95	540-1520	6 DC	No	9 1/2 x 6	15	6A7, 6K7, 75, 6H6, 41, 84	2674
638A	Auto	49.95	540-1520	6 DC	No	9 1/2 x 6	15	6A7, 6K7, 75, 6H6, 41, 84	2674
National Co., Inc., 61 Sherman St., Malden, Mass. (National)									
Table \$35.00 100-33000*									
Table \$5.00 100-33000*									
<i>(Continued)</i>									

Specifications

SETS (continued)

MODEL	TYPE	LIST PRICE	RANGE IN KILOCYCLES	SUPPLY VOLTAGE	ARE "B" BATT. REQUIRED	DIMENSIONS (H-W-D) (INCHES)	SHIPPING WEIGHT (LB.)	TUBES	INTER-MEDIATE FREQUENCY (KC.)
<i>(National Co., Inc., Cont.)</i>									
SW3	Table	35.00	100-33000*	AC	No		17	56, 2-58	TRF
NC80X	Table	165.00	550-1500; 1700-30000	AC-DC†	No			3-6J7, 3-6K7, 6C5, 6B8, 25L6, 25Z5	1560
NC81X	Table	165.00	1700-2000; 3500-4000; 7000-7500; 14000-14000; 28000-30000	AC-DC†	No			3-6J7, 3-6K7, 6C5, 6B8, 25L6, 25Z5	1560
NC100X	Table	237.50	550-30000	AC	No			4-6J7, 3-6K7, 6C5, 2-6F6, 6B5 (optional) 80	456
NC10FX	Table	215.00	1700-2000; 3500-4000; 7000-7300; 14000-14400; 28000-30000	AC	No			4-6J7, 3-6K7, 6C5, 2-6F6, 6B5 (optional) 80	456
HRO Jr	Table	180.00	50-400; 500-30000*	AC	No			3-57, 4-58, 2B7, 2A5, 80	456
HRO Jr	Table	180.00	50-400; 500-30000*	AC	No			3-6C6, 4-6D6, 6B7, 42	456
HRO (Standard)	Table	299.50	50-400; 500-30000*	6 DC	Yes		62	3-57, 4-58, 2B7, 2A5, 80	456
HRO (Standard)	Table	299.50	50-400; 500-30000*	6 DC	Yes		16	3-6C6, 4-6D6, 6B7, 42	456
1-10	Table	85.00	28000-300000*	AC	No			954, 955, 6C5, 6F6	TRF
* Plug-in coils † Also available in 6dc. models.									
<i>(Pierce Airo, Inc., 440 Lafayette St., New York, N. Y. (De Wald))</i>									
527	Auto Radio		540-1720	6 DC	No	4 & 6½x11x11½	14½	6A7, 6D6, 75, 41, 84	456
530	Table Compact		540-1720	AC-DC	No	6½x9x5½	7	6D6, 6C6, 25L6G, 25Z5, M55F	
531	Phono-Comb.		540-1720	AC	No	9x13x8½	14½	6D6, 6C6, 25L6G, 25Z5, M55F	
532	Phono-Comb.		540-1720	AC	No	9x13x8½	16	6D6, 6C6, 3-25L6G, 25Z5, M55F, 885B	
635-S	Table Compact		540-1700	AC-DC	No	8x13x6	9	6A7, 6D6, 6Q7G, 25L6G, 25Z5, M49B	456
639	Table Compact		520-1725; 5620-18000	AC-DC	No	10x17x7½	18½	6A7, 6D6, 6Q7G, 6Y6G, 6X5G, 6U5	456
637	Table Compact		520-1725; 5620-18000	AC-DC	No	10x17x7½	18½	6A7, 6D6, 6Q7G, 25L6G, 25Z5, 6U5, L42F	456
642	Table Compact		520-18000	AC-DC	No	10x17x7½	15½	6A7, 6D6, 6Q7G, 25L6G, 25Z5, 6U5, L42F	456
643	Table Compact		520-1725; 17000-48000	AC-DC	No	10x17x7½	18½	6A7, 6D6, 6Q7G, 6Y6G, 6X5G, 6U5	456
645	Table Compact		520-1725; 17000-48000	AC-DC	No	10x17x7½	9	6A7, 6D6, 75, 25L6G, 25Z5, M49B	456
648	Table Compact		540-1700	AC-DC	No	9½x15x7	15½	6A7, 6D6, 6Q7G, 25L6G, 25Z5, 6U5	456
649	Table Compact		520-1725; 5620-18000	AC-DC	No	9x15x7	18½	6A7, 6D6, 76, 6F5G, 41, 84, 6U5	456
701*	Table Compact		535-1700	AC-DC	No	10½x16x7	14½	6A7, 6D6, 6Q7G, 25L6G, 25Z5, D150, L49F	456
102	Auto Radio		540-1550	6 DC	No	7½x17x7½	18½	2-6K6, 6A7, 75, 41, 6H6, 84	175
1002	Table Compact		520-1800; 1650-5700; 5500-20000	AC	No	21½x17x11	38	2-6K6, 6A7, 6H6, 2-6J5, 2-6F6, 6U5, 80	456
1003	Table Compact		520-1800; 1650-5700; 5500-20000	AC	No	21½x17x11	38	2-6K7, 6A7, 6H6, 2-6J5, 2-6F6, 6U5, 80	456
* Automatic tuning.									
<i>(RCA Mfg. Co., Camden, N. J. (RCA Victor))</i>									
HF8	*18th Century	\$250.00	540-1720; 2100-22000	AC	No	37x36x19½	176	3-6K7, 2-6J7, 2-6H6, 6U5, 6L7, 2-5T4, 3-6J5, 2-6L6	455
HF6	*Console Grand	200.00	540-1720; 2300-22000	AC	No	36x37x11½	149	3-6K7, 2-6J7, 6H6, 2-6F6, 6U5, 6L7, 5T4, 6R7, 2-6J5	455
HP4	*18th Century	175.00	540-1720; 2300-22000	AC	No	37x36x15½	120	2-6K7, 6J7, 6A8, 6H6, 2-6F6, 6U5, 5T4, 3-6J5	455
HP-2	*Console Grand	165.00	540-1720; 2300-22000	AC	No	36x35x15	117	2-6K7, 6J7, 6A8, 6H6, 2-6F6, 6U5, 5T4, 3-6J5	455
HP-1	*Console Grand	125.00	540-1550	AC	No	32½x24x13½	59½	6A8, 6K7, 6R7, 2-6J5, 2-6F6, 5T4	455
910KG	*Console Grand	125.00	540-1720; 2300-22000	AC	No	36x34x13½	95	6K7, 6J7, 6A8, 6H6, 2-6F5, 2-6F6, 6U5, 5T4	455
911K	*Console	145.00	540-1720; 2300-22000	AC	No	41x28x14½	92	2-6K7, 6J7, 6A8, 6H6, 2-6F5, 2-6F6, 6U5, 5T4	455
99K	*Console	99.95	540-1720; 2300-22000	AC	No	40x27x13½	82	6K7, 6A8, 6J7, 6O7, 6F5, 2-6F6, 6U5, 5T4	455
98K	*Console	89.95	540-1720; 2300-22000	AC	No	40x27x13½	75½	6K7, 6J7, 6A8, 6H6, 6F5, 6F6, 5W4, 6K8	455
97KG	*Console	85.00	540-1720; 2300-22000	AC	No	35x32x12	70	6K7, 6H6, 6F5, 6F6, 5W4, 6K8	455
96K-2	*Console	49.95	540-1720; 5800-18000	AC	No	37x22x9	40	6K7, 6H6, 6F5, 6F6, 5W4, 6K8	455
97B	*End Table	79.95	540-1720; 2300-22000	AC	No	30x26x12	64	6K7, 6H6, 6F5, 6F6, 5W4, 6K8	455
96B	*End Table	49.95	540-1720; 2300-22000	AC	No	31x22x9	60	6K7, 6H6, 6F5, 6F6, 5W4, 6K8	455
99T	*Table	89.95	540-1720; 2300-22000	AC	No	20½x19x11½	36	6K7, 6K6G, 5Y3G, 6H6, 6F5, 6A8C	455
98X	*Table	59.95	540-1720; 2300-22000	AC-DC	No	20½x19x11½	21	25Z6, 6K8, 6K7, 6H6, 6J7, 25L6, 6U5	455
97T	*Table	59.95	540-1720; 2300-22000	AC	No	12½x15x8½	28	6K7, 6H6, 6F5, 6F6, 5W4, 6U5, 6K8	455
97X	*Table	29.95	540-1720	AC-DC	No	9x11x6½	13	6K7, 6J7, 25L6, 25Z3, 6H6, 6U5, 6K8	455
96T-1	*Table	29.95	540-1720	AC	No	9x11x6½	17½	6K7, 6K6G, 5Y3G, 6H6, 6F5, 6A8C	455
96T-2	*Table	34.95	540-1720	AC	No	11x15x8½	15	6K7, 6K6G, 5Y3G, 6H6, 6F5, 6A8C	455
96T-3	*Table	39.95	540-1720	AC	No	12x15x8½	21	6K7, 6H6, 6F5, 6F6, 5W4, 6K8	455
95X	*Table	49.95	540-1720; 2300-22000	AC	No	12x15x8½	23	6K7, 6H6, 6F5, 6F6, 5W4, 6K8	455
95X-1	*Table		540-1720	AC-DC	No	7½x10½x5	8	6K7, 6J7, 25L6, 25Z6G	455
95X-1	*Table		540-1500	AC-DC	No	7½x10½x5	8½	6K7, 6J7, 25L6, 25Z6G, plus ballast tube	455
95T-1	*Table		540-1720	AC	No	8x10½x6	11	6K7, 6A8, 6O7G, 6K6G, 5Y3G	455
95T-5	*Table		540-1720	AC	No	8x10½x6	11	6K7, 6O7G, 6O6G, 5Y3G, 6A8C	455
9X	Compact Table	24.95	540-1720	AC	No	5½x7½x4	5	6K7, 6J7, 25L6, 25Z6G	455
U-134	*Phono. Comb.	355.00	540-1720; 2300-22000	AC	No	34x33x19	210	3-6K7, 2-6J7, 2-6H6, 6U5, 6L7, 2-5T, 3-6J5, 25L6	455

Specifications

SETS (continued)

Specifications

MODEL	TYPE	LIST PRICE	RANGE IN KILOCYCLES	SUPPLY VOLTAGE	ARE "B" BATT. REQUIRED	DIMENSIONS (H-W-D) (INCHES)	SHIPPING WEIGHT (LB.)	TUBES	INTER-MEDIATE FREQUENCY (K.C.)
<i>(RCA Mfg. Co., Cont.)</i>									
U-132	*Phono. Comb.	\$280.00	540-1720;	AC	No	35x37x18 1/2	184	3-6K7, 2-6J7, 6H6, 6R7, 6L7, 2-6J5, 2-6F6, 6T4, 6U5	455
U-130	*Phono. Comb.	230.00	540-1720;	AC	No	34x31x16 1/2	138	2-6K7, 6J7, 6A8, 6H6, 2-6F6, 6U5, 5T4, 3-6J5	455
U-128	*Phono. Comb.	185.00	540-1720;	AC	No	34x31x16 1/2	120	6K7, 6J7, 6A8, 6H6, 2-6F5, 2-6F6, 6U5, 5T4	455
U-126	*Phono. Comb.	155.00	540-1720;	AC	No	34x31x16 1/2	83	6K7, 6H6, 6F5, 6F6, 5W4, 6K8	455
U-124	*Phono. Comb.	99.95	540-1720;	AC	No	24 1/2 x 28 1/2 x 16 1/2	80	6K7, 6H6, 6F5, 6F6, 5W4, 6K8	455
U-122E	*Phono. Comb.	99.95	540-1720;	AC	No	16x16 1/2 x 13 1/2	36	6A8, 6K7, 6Q7G, 6K6G, 5Y3G	455
U-119	Phono. Comb. Table	79.95	540-1720;	AC	No	11x15 1/2 x 9 1/2	22	6T7G, 6I7, 3-6S7G, 6D8G, 6L5G, 6Z7G	455
80BK	Console Grand Farm	115.00	540-1720;	6 DC	No	34x32x12 1/2	90	6T7G, 6I7, 3-6S7G, 6D8G, 6L5G, 6Z7G	455
80B	Table Farm	89.95	540-1720;	6 DC	No	20 1/2 x 17 1/2 x 11 1/2	24 1/2	1C6, 1A4, 1F6, 30, 19	455
85-BT-6	Table Farm	89.95	540-1720;	6 DC	No	10 1/2 x 16 1/2 x 8 1/2	24 1/2	1C7G, 1D5G, 1F7G, 1G5G	455
94BK	Table Farm	44.95	540-1720;	6 DC or AC	No	37 1/2 x 22 5/8 x 8 1/2	37	1C7G, 1D5G, 1F7G, 1G5G	455
94BT-6	Console Farm	36.95	540-1720;	2 DC	Yes	13 1/2 x 10 1/2 x 6 1/2	9 1/2		455
9M-1	Table Farm	29.95	540-1720;	6 DC	Yes	13 1/2 x 10 1/2 x 6 1/2	13 1/2	1C7G, 1D5G, 1F7G, 1G5G	455
9M-2	†Auto Radio	24.95	550-1550	6 DC	No	6x6x10 1/2	15	6A8, 6K7, 6Q7, 6F6, 6X5	455
8M-1	Auto Radio	19.95	550-1550	6 DC	No	6x6x10 1/2	15 1/2	6A8, 6K7, 6Q7, 6F6, 6X5	455
8M-2	Auto Radio	34.95	550-1550	6 DC	No	5 1/2 x 6 1/2 x 10 1/2	13	6K7G, 6A8, 6K7, 6Q7G, 6K6G, 6X5G	260
8M-3	Auto Radio	44.95	550-1550	6 DC	No	7x10x7 1/2	23	6K7G, 6A8, 6K7, 6Q7G, 6K6G, 6X5G	260
8M-4	Auto Radio	59.95	550-1550	6 DC	No	7x10x7 1/2	24 1/2	6K7G, 6A8, 6K7, 6Q7G, 6J5, 6N7G	260
<i>*Electric tuning.</i>									
<i>†Automatic tuning.</i>									
Remler Co., Ltd., 2101 Bryant St., San Francisco, Calif. (Remler)									
89	Console	\$139.90	540-18000	AC	No	43x28x14	96	6C5, 6C5, 5X4G, 2-6K7, 6L7, 6H6, 2-6F5, 2-6V6G	450
72	Table	74.90	540-18000	AC	No	18 1/2 x 11 1/2	35	2-6K7, 6L7, 6H6, 6N7, 2-6F6, 6U5, 6G5, 5Z4	450
65	Table	44.90	540-18000	AC	No	10x10x8 1/2	24	6A7, 6K7, 75, 40, 80, 6C5, 76	450
61	Table	39.90	540-1715	AC	No	10x10x8 1/2	10	6A7, 6K7, 75, 40, 80, 6C5, 76	450
55	Table	29.90	540-1715	AC	No	8 1/2 x 12 1/2 x 8 1/2	15	6A7, 6K7, 75, 40, 80, 6C5, 76	450
14	Molded Compact	19.90	540-1715	AC	No	6 1/2 x 10 1/2 x 8 1/2	11	6A7, 6K7, 75, 40, 80, 6C5, 76	450
56	Molded Compact	29.90	540-1715;	AC	No	6 1/2 x 10 1/2 x 8 1/2	12	6A8, 6K7, 6Q7, 6F6, 5W4	450
28	Molded Compact	34.90	540-1715;	AC-DC	No	6 1/2 x 10 1/2 x 8 1/2	12	6A8, 6K7, 6Q7, 25Z6, 25A6	450
479	Table	34.90	540-1715	AC	No	9x17 1/2 x 7 1/2	18	6A7, 6K7, 76, 6D6, 42, 80	450
Setchell Carlson, Inc., 2233 University Ave., St. Paul, Minn.									
620	Table	\$44.95	540-1950;	6 DC AC	No	10x17 1/2 x 8 1/2	22	6D8G, 6S7G, 6T7G, 1-6K6G, 19, 6N5	465
600	Table	34.95	540-1950;	6 DC	Yes	10x17 1/2 x 8 1/2	17	1C7G, 1D5G, 1F7G, 1H4G, 1J6G	465
330	Table	42.95	540-1950;	32 DC	No	10x17 1/2 x 8 1/2	21	6A8G, 2-6K7G, 2-6J5G, 4-25L6G	465
602	Console	89.50	540-1850;	6 DC AC	No	40x24x13 1/2	66	6D8G, 6S7G, 6T7G, 6L5G, 6Z7G, 19, 6N5	465
332	Console	84.50	540-1850;	6 DC	Yes	40x24x13 1/2	61	1C7G, 2-1D5G, 1F7G, 2-1G5G, 6N5	465
610	Table	34.95	540-1950;	32 DC	No	40x24x13 1/2	61	6A8G, 2-6K7G, 2-6J5G, 4-25L6G	465
Sonora Radio & Telev. Corp., Merchandise Mart, Chicago, Ill. (Sonora)									
P-99	Teney-Weeny	550-1720	5650-18100	AC-DC	No	6 1/2 x 4 1/2 x 4 1/2	4 3/4	6K7, 6J7, 25L6, 25Z6G	456
PS-100	Teney-Weeny	530-1720	5650-18100	AC-DC	No	6 1/2 x 4 1/2 x 4 1/2	4 3/4	6K8, 6K7, 6Q7, 25L6, 25Z6	456
B-22	Table	530-1720	5650-18100	AC-DC	No	11 1/2 x 7 1/2 x 7 1/2	9	6A8G, 6K7, 6Q7G, 25L6G, 25Z6G, 165R4G	456
D-12	Table	530-1720	2200-7000	AC-DC	No	16x9x7 1/2	17	6A8G, 6K7, 6Q7G, 25L6G, 25Z6G, 165R4G	456
A-DJ-14	Table	530-1720	2200-7000	AC-DC	No	14x8x7 1/2	15	6A8G, 6K7, 6Q7G, 25L6G, 25Z6G, 165R4G	456
A-11	Table	530-1720	5650-18100	AC-DC	No	9 1/2 x 6 1/2 x 7 1/2	7 1/2	6D6, 6C6, 25L6G, 25Z5, 25L6G, 183R4G	456
R-86	*Console	535-1720;	1710-5650;	AC-DC	No	21 1/2 x 11 1/2 x 10 1/2	28	6K8, 6K7, 6Q7G, 2-25L6G, 25Z6G, BK17E1	456
C-22	*Console	535-1720;	1710-5650;	AC-DC	No	21 1/2 x 11 1/2 x 10 1/2	30	6A8G, 6K7, 6Q7G, 6J5G, 2-25Z6G, BK17E1	456
E-33	*Table	535-1720;	5650-18100	AC	No	17 1/2 x 10 1/2 x 8	11	6K8, 6K7, 6Q7G, 25A6G, 165R4G, 25Z6G	456
F-35	*Table	535-1720;	5650-18100	AC	No	17 1/2 x 10 1/2 x 8	11 1/2	6K8, 6K7, 6Q7G, 25A6G, 165R4G, 25Z6G	456
PA-55	*Table	535-1720;	5650-18100	AC	No	18 1/2 x 10 1/2 x 8	20 1/2	6K8, 6K7, 6Q7G, 6J5G, 2-25A6G, 25Z6G	456
G-66	*Table	535-1720;	5650-18100	AC	No	21 1/2 x 11 1/2 x 10 1/2	28	6K8, 6K7, 6Q7G, 6J5G, 2-25A6G, 25Z6G	456
PA-77	*Console	535-1720;	5650-18100	AC	No	21 1/2 x 11 1/2 x 10 1/2	30	6K8, 6K7, 6Q7G, 2-6J5G, 2-6F6G, 5Y3G	456
C-88	*Console	535-1720;	5650-18100	AC	No	40x24 1/2 x 12 1/2	62	6K8, 6K7, 6Q7G, 6J5G, 2-25A6G, 25Z6G	456
GA-88	*Console	535-1720;	5650-18100	AC	No	41x24x13	68	6K8, 6K7, 6Q7G, 6J5G, 2-25A6G, 25Z6G	456
L-22	Table	535-1720;	5650-18100	2 DC	Yes	11 1/2 x 7 1/2 x 7 1/2	9 1/2	1C7G, 1D5G, 1F7G, 1G5G	456

(Continued)

Specifications

SETS (continued)

MODEL	TYPE	LIST PRICE	RANGE IN KILOCYCLES	SUPPLY VOLTAGE	ARE "B" BATT. REQUIRED	DIMENSIONS (H-W-D) (INCHES)	SHIPPING WEIGHT (LB.)	TUBES	INTER-MEDIATE FREQUENCY (KC.)
<i>(Sonora Radio & Telev. Corp., Cont.)</i>									
M-22	Table	535-1720	5650-18100	6 DC	No	11 1/2 x 7 1/2 x 7 1/2	11 1/2	6A8G, 6K7, 6Q7G, 6G6G	456
Q-33	Table	535-1720	5650-18100	6 DC	No	17 1/2 x 10 1/2 x 8	22	6D8G, 1H4G, 6S7G, 6T7G, 6L5G, 1J6G	456
N-33	Table	535-1720	5650-18100	6 DC-110 AC	No	17 1/2 x 10 1/2 x 8	22	6D8G, 6S7G, 6T7G, 6L5G, 6G6G, 6ZV5G	456
KA-109	*Console	535-1720	1710-5650; 5650-18100	AC	No	42 x 26 x 13 1/2	80	3-6K7, 6K8, 6H6G, 4-6J5G, 2-6L6G, 5X4G	456
<i>*Automatic tuning.</i>									
Stewart Warner Radio Corp., 1824 Diversey Pkwy., Chicago, Ill. (Stewart Warner)									
9T-562	Table	540-1720		AC-DC	No	6 1/2 x 7 1/2 x 13			
9I-511	*Table	540-1720		AC	No	7 1/2 x 7 1/2 x 13 1/2			
9I-512	*Table	540-1720		AC	No	7 1/2 x 8 1/2 x 14 1/2			
9I-513	*Table	540-1720		AC	No	9 1/2 x 11 x 13 1/2			
9I-514	*Table	540-1720		AC	No	7 1/2 x 9 1/2 x 13 1/2			
9I-531	*Table	540-1725	5400-15400	AC	No	8 x 12 x 15 1/2			
9I-621	*Table	540-1725	5400-15400	AC	No	9 x 10 1/2 x 18 1/2			
9I-521	*Table	540-1720		AC-DC	No	7 1/2 x 7 1/2 x 13 1/2			
9I-524	*Table	540-1720		AC-DC	No	7 1/2 x 9 1/2 x 15 1/2			
9I-536	*Armchair	540-1725	5400-15400	AC	No	13 1/2 x 22 1/2 x 26 1/2			
9I-537	*Console	540 1725	5400-15400	AC	No	12 x 21 x 38			
9I-627	*Console	540-1725	5400-15400	AC	No	12 x 24 x 40			
9I-617	*Console	540-1720	2200-7000; 6700-23000	AC	No	12 1/2 x 24 1/2 x 40			
9I-717	Console	525-1760	1760-5600; 5350-17100	AC	No	12 1/2 x 23 1/2 x 38 1/2			
9I-817	Console	530-1730	2200-7000; 6800-22500	AC	No	14 1/2 x 23 1/2 x 41			
9I-1117	Console	530-1730	2200-7000; 6800-22500	AC	No	14 1/2 x 27 1/2 x 41 1/2			
<i>* Automatic tuning.</i>									
Troy Radio & Television Co., 1142-1144 Olive St., Los Angeles, Calif. (Troy)									
4	Table Compact	\$14.95	550-1750	AC		7 1/2 x 11 x 6	10	6D6, 76, 41, 80	TRP
45	Table Compact	19.95	550-1750	AC		7 1/2 x 12 1/2	10	6A7, 75, 6D6, 41, 80	465
45M	Table Compact	29.95	550-1750	AC		7 1/2 x 10 1/2	14	6A7, 75, 6D6, 41, 80	465
55	Table Compact	21.95	550-1750	AC		8 1/2 x 15 1/2	10	6A7, 75, 6D6, 41, 80	465
57	Table Compact	24.95	550-1750	AC		8 1/2 x 17 1/2	15	6A7, 75, 6D6, 41, 80	465
825	Table Compact	37.50	550-1750	AC		9 1/2 x 16 1/2	14	6A7, 75, 6D6, 41, 80	465
79	Table Compact	32.50	550-20000	AC		8 1/2 x 15 1/2	15	6A7, 6D6, 75, 41, 80, 6U5, 6I0-10	465
113	Table Compact	59.50	550-18000	AC		10 1/2 x 19 1/2	25	6A8G, 2-6K7G, 6H6G, 3-6C5G, 2-41, 5Y3, 6U5	465
400	Phono-Adaptor	24.95		AC		6 1/2 x 13 1/2 x 10			
401	Phono-Comb.	46.50		AC		12 1/2 x 13 1/2 x 11 1/2	25	6C6, 42, 80	465
58PC	Phono-Comb.	39.95	550-1750	AC		10 x 13 x 9 1/2	23	6A7, 6D6, 75, 41, 80	465
59PC	Phono-Comb.	49.95	550-1750	AC		12 x 13 1/2 x 11 1/2	26	6A7, 6D6, 75, 41, 80, 6U5, 6I0-10	465
79PC	Phono-Comb.	59.50	550-20000	AC		12 x 13 1/2 x 11 1/2	27	6A7, 6D6, 75, 41, 80, 6U5, 6I0-10	465
C-170-PC	Phono-Comb.	119.50	550-18000	AC		34 x 27 x 15 1/2	81	6A7, 6D6, 6R7G, 2-6V6G, 6U5, 5Y3	465
C-170-PC	Phono-Comb.	149.50	550-1800	AC		34 x 27 x 15 1/2	83	6A7, 6D6, 6R7G, 2-6V6G, 6U5, 5Y3	465
57-B	Auto-Phono.	29.95	550-1750	2 DC	Yes	8 1/2 x 17 x 7 1/2	14	1A6, 1A4, 1B5, 30, 19	465
Wilcox-Gay Corp., Charlotte, Mich. (Wilcox-Gay)									
A-43	Table Compact	\$27.50	1850-540	AC	No	3 x 11 x 11	14	6A8, 6F6, 6K7, 5Z4, 6Q7	456
A-44	Table Compact	27.50	1850-540	AC	No	3 x 11 x 11	14	6A8, 6F6, 6K7, 5Z4, 6Q7	456
A-46	Table Compact	22.95	1700-540	AC-DC	No	6 1/2 x 7 x 8	11	6D6, 43, 75, 25Z5, 6A7	456
A-51	Table Compact	14.98	1800-540	AC-DC	No	6 1/2 x 7 x 8	10	25Z6, 43, 75, 25Z5, 6A7	TRF
A-51	Table Compact	14.98	1600-540	AC-DC	No	4 1/2 x 7 x 4 1/2	5 1/2	25Z6, 25L6, 6J7, 6K7	TRF
A-51	Table Compact	13.98	1600-540	AC-DC	No	4 1/2 x 7 x 4 1/2	5 1/2	25Z6, 25L6, 6J7, 6K7	TRF
A-57	Table Compact	19.95	1800-540	AC	No	7 1/2 x 14 1/2 x 7	12	6D6, 42, 75, 80, 6A7	456
<i>*Inquiry and canary cabinets.</i>									
<i>†Black and mahogany cabinets.</i>									
Watterson Radio Mfg. Co., Dallas, Tex.									
500	Table	\$14.95	550-1720	AC-DC	No	12 x 6 1/2 x 8 1/2	10	6C6, 43, 25Z5, 6D6, L55C	TRF
500	Table	14.95	550-1720	AC-DC	No	12 x 6 1/2 x 8 1/2	10	6C6, 43, 25Z5, 6D6, L55C	TRF
600	Table	19.95	500-1700; 1600-4000	AC-DC	No	12 x 6 1/2 x 8 1/2	11	6A7, 6D6, 43, 6Q7, M49B	456
78	Table	34.95	540-15750	AC-DC	No	19 x 9 x 12	22	6A7, 6D6, 6K5, 80, 6F5, 76	456
78C	Console	49.50	540-15750	AC	No	39 1/2 x 22 x 11	40	6A7, 6D6, 6K5, 80, 6F5, 76	456
67	Console	39.50	540-1720; 5700-18000	6 DC	No	39 1/2 x 22 x 11	24	6D8, 6S7, 6T7, 41	456

(Continued)

SETS (continued)

Specifications

MODEL	TYPE	LIST PRICE	RANGE IN KILOCYCLES	SUPPLY VOLTAGE	ARE "B" BATT. REQUIRED	DIMENSIONS (H-W-D) (INCHES)	SHIPPING WEIGHT (LB.)	TUBES	INTER-MEDIATE FREQUENCY (KC.)
<i>(Waterson Radio Mfg. Co., Cont.)</i>									
67C	Console	\$49.50	540-1720; 5700-18000	6 DC	No	39x22x11	44	6D8, 6S7, 6T7, 41	456
85	Table	24.95	550-1720	2 DC	Yes	35x12x10	14	1A4, 1F6, 1G5G, 1C6, 1B1	456
85C	Console	29.95	550-1720	2 DC	Yes	39x12x10	30	1A4, 1F6, 1G5G, 1C6, 1B1	456
806	Table	29.95	550-1720	2 DC	Yes	39x12x10	18	34, 1C6, 1B5, 30, 1G5G, 1G1	456
806C	Console	39.95	550-1720	2 DC	Yes	39x12x10	40	34, 1C6, 1B5, 30, 1G5G, 1G1	456
86	Table	29.95	550-1720	2 DC	Yes	19x17x10	18	34, 1C6, 1B5, 30, 1G5G, 1G1	456
<i>Wholesale Radio Service Co., Inc., 100 Sixth Ave., New York, N. Y. (Lafayette)</i>									
C-6	Midget		540-1700	AC-DC	No	10x7x5 1/2	10	6D6, 6C6, 25L6, 25Z5, 6-133A	TRP
FS-17	Midget		550-1550	AC-DC	No	8 1/2 x 11 1/2 x 6 1/2	0	6D6, 6C6, 43, 25Z5, 9266	TRP
FS-19	Midget		550-1550	AC-DC	No	8 1/2 x 11 1/2 x 6 1/2	0	6D6, 6C6, 43, 25Z5, 9266	TRP
D-23	Midget			AC-DC	No	12x8 1/2 x 7 1/2	15	6A7, 25Z5, 6D8, 607G, 25B5, 1A2B	456
BA-2	Midget			AC-DC	No	18x10 1/2 x 8 1/2	25	6D6, 6A7, 76, 607G, 25B5, 6D5, 25Z5, 140R8	456
BA-4	Midget			AC-DC	No	18x10 1/2 x 8 1/2	16	6D6, 6A7, 76, 43, 25Z5, 165R8	456
B-14	Mantle			AC-DC	No	7 1/2 x 11 1/2 x 7 1/2	45	6K7, 617, 6C5, 6H6, 6P5, 6P6, 5Y3G, 6G5	456
BB-32	Console			AC	No	23 1/2 x 14 1/2 x 11 1/2	98	2-6K7, 2-617, 2-6C5, 2-6L6G, 2-6P6, 6G5, 5Y3	456
BB-40	Console			AC	No	41 1/2 x 24 1/2 x 14 1/2	110	3-6K7, 3-6C5, 2-6L6G, 617, 6H6, 6G5, 2-5Y3	456
B-46	Auto Phono. Comb.			AC	No	33 1/2 x 18	210	3-6K7, 3-6C5, 2-6L6G, 617, 6H6, 6G5, 2-5Y3	456
D-15	Auto		1550-540	6 DC	No	11x6x8	23	6K7, 6A8, 6K7G, 6R7G, 6R7, 6V6, 6X5	282
M-94	Auto		1550-540	6 DC	No	10 1/2 x 8 1/2 x 7	25	2-6D6, 6A7, 607G, 41, 0Z4	456
EM-16	*Auto		1550-540	6 DC	No	8 1/2 x 7 1/2 x 7 1/2	25	6A8G, 6K7, 607G, 6K6G, 6X5G	456
EB-52	Home		2600-540	6 DC	Yes	13 1/2 x 8 1/2 x 10	14	1A6, 1A4, 30, 1B4, 1P4	456
M-31	Mantle			32 DC	No	11 1/2 x 21 1/2 x 10	25	6A7, 6D6, 75, 76, 2-48	456
D-41	Mantle		15-560	6 DC	No	9 1/2 x 16 1/2 x 7 1/2	26	30, 1A6, 1A4, 6T7G, 6L5G, 19	456

*Touch tuning.

Zenith Radio Corp., 6001 West Dickens Ave., Chicago, Ill. (Zenith)

6-D-311	Bakelite Table	\$14.95	538-1760	AC-DC	No	6x11x6	9	6A8G, 6K7G, 607G, 25L6, 25Z6, 100-70	456
6-D-311W	Bakelite Table	17.95	538-1760	AC-DC	No	6x11x6	0	6A8G, 6K7G, 607G, 25L6, 25Z6, 100-70	456
6-D-312	Child's Console	19.95	548-1740	AC-DC	No	13x7x8	10 1/2	6A8G, 6K7G, 607G, 25L6, 25Z6, 100-70	456
6-D-312Y	*Bakelite Table	19.95	548-1740	AC-DC	No	8x12x6	12 1/2	6A8G, 6K7G, 607G, 25L6G, 25Z6G, 100-70	456
6-D-312W	*Bakelite Table	22.95	548-1740	AC-DC	No	8x12x6	12 1/2	6A8G, 6K7G, 607G, 25L6G, 25Z6G, 100-70	456
6-D-316	*Table	24.95	548-1740	AC-DC	No	8x14x6	12	6A8G, 6K7G, 607G, 25L6G, 25Z6G, 100-70	456
6-D-317	Table	29.95	548-1740	AC-DC	No	8x14x8	12	6A8G, 6K7G, 607G, 25L6G, 25Z6G, 100-70	456
5-R-312	*Bakelite Table	19.95	548-1740	AC	No	8x12x6	14 1/2	6A8G, 6K7G, 607G, 6K6G, 6X5G	456
5-R-312Y	*Bakelite Table	22.95	548-1740	AC	No	8x12x6	14 1/2	6A8G, 6K7G, 607G, 6K6G, 6X5G	456
5-R-312W	*Bakelite Table	22.95	548-1740	AC	No	8x14x6	14 1/2	6A8G, 6K7G, 607G, 6K6G, 6X5G	456
5-R-316	*Table	24.95	548-1740	AC	No	8x14x8	14	6A8G, 6K7G, 607G, 6K6G, 6X5G	456
5-R-317	*Table	29.95	548-1740	AC	No	18x14x9	27	6A8G, 6K7G, 607G, 6P5G, 6P6G, 5Y4G	456
6-S-330	Arm Chair	19.95	538-1760	AC-DC	No	20x13x11	17 1/2	6A8G, 6K7G, 607G, 25L6, 25Z6, 100-70	456
6-D-336	*Arm Chair	29.95	538-1760	AC-DC	No	21x18x11	21 1/2	6A8G, 6K7G, 607G, 25L6G, 25Z6G, 100-70	456
6-D-337	Console	29.95	538-1760	AC-DC	No	37x18x11	30	6A8G, 6K7G, 607G, 25L6, 25Z6, 100-70	456
6-D-360	Console	29.95	548-1752; 1740-5930; 5490-18400	AC	No	21x18x11	23	6A8G, 6K7G, 607G, 25L6, 25Z6, 100-70	456
5-R-337	*Arm Chair	29.95	548-1752; 1740-5930; 5490-18400	AC	No	22x29x18	66	6A8G, 6K7G, 607G, 6H6G, 6P5G, 6P6G, 5Y4G	456
6-S-341	*Arm Chair	49.95	540-1752; 1740-5930; 5490-18400	AC	No	39x24x13	68	6A8G, 6K7G, 6H6G, 6P5G, 6P6G, 5Y4G	456
6-S-361	*Console	39.95	540-1752; 1740-5930; 5490-18400	AC	No	40x24x14	79	6A8G, 6K7G, 6H6G, 6P5G, 6P6G, 5Y4G	456
6-S-362	*Console	89.95	540-1752; 1740-5930; 5490-18400	AC	No	42x27x17	89 1/2	2-6K7G, 6L7G, 6J5G, 6H6G, 6P5G, 6P6G, 5Y4G, 6T5	456

*Automatic tuning.

Zephyr Radio Co., 13139 Hamilton St., Detroit, Mich. (Zephyr)

2677	Auto	\$57.50	550-1550	6 DC	No	8 1/2 x 8 1/2 x 6	22	6A8, 2-6K7, 607, 6V6, 0Z4	455
40X4	Table Compact	29.95	550-1750	AC-DC	No	6x6x11	12 1/2	6K7, 617, 25L6, 25Z6G	455
36X5	Table Compact	14.95	550-1750	AC-DC	No	6 1/2 x 4 1/2 x 4 1/2	7	6K7G, 617, 25L6, 25Z6G	TRP
30X5	Table Compact	24.50	550-1750	AC-DC	No	8 1/2 x 5	10	6C6, 6C6, 43, 25Z5, 183R8	TRP
40X6	Table Compact	24.95	550-1750	AC-DC	No	10x7x5	8	6C6, 6C6, 43, 25Z5, 183R8	TRP
40X6	Table Compact	24.95	550-1500; 2000-4000	AC-DC	No	13x8x6	11	6A7, 6D6, 75, 43, 25Z5, 270R4	456
44X8	Table	44.95	500-2400	AC-DC	No	12x7x5	9	6D6, 6C6, 43, 25Z5, 2-270R4	TRP
64X8	Table	54.95	500-18000	AC-DC	No	18x10x8	27	6A7, 6D6, 76, 607G, 25B5, 6G5, 25Z5, 140R8	456
31VP6	Phono. Comb.	74.50	500-2400	AC	No	18x11x10	21	6A7, 6D6, 75, 76, 2-42, 6V5, 80	455
24A5	Table	39.95	500-2400	2 DC	Yes	20x10x10	35	6A7, 6D6, 75, 25B5, 25Z5, 270R4	456
33B6	Table	49.95	500-18000	6 DC	No	18x10x8	20	1A6, 1E4, 1B5, 30, 19	456

SOUND (continued)

Directory

MANUFACTURERS	TRADENAMES	Complete System			Inter-Comm.		Microphones			Horns—Baffles	Recording Blanks	Amplifiers	Record Changers	Pick-ups		Speakers		Recording Mach.	Microphone Stands	Hearing Aids	Recording Needles	Miscellaneous
		Portable	Fixed	Mobile	Wireless	Cabled	Pickup—Turntabl	Crystal	Dynamic					Carbon	Velocity	Condenser	Crystal					
Electronic Sound Labs, Inc., 5912 Melrose Ave., Hollywood, Calif.		•	•	•	•	•	•	•	•	•	•	•	•	•	•	•	•	•	•	•	•	•
Electro Voice Mfg. Co., 324 E. Collax Ave., South Bend, Ind.	Electro Voice	•	•	•	•	•	•	•	•	•	•	•	•	•	•	•	•	•	•	•	•	•
Electrovox Co., 424 Madison Ave., New York, N. Y.		•	•	•	•	•	•	•	•	•	•	•	•	•	•	•	•	•	•	•	•	•
Espey Mfg. Co., Inc., 67 Irving Pl., New York, N. Y.	Espey, Yorker	•	•	•	•	•	•	•	•	•	•	•	•	•	•	•	•	•	•	•	•	•
Fairchild Aerial Camera Corp., New York, N. Y.	Fairchild	•	•	•	•	•	•	•	•	•	•	•	•	•	•	•	•	•	•	•	•	•
Foraco Corp., 2111 Woodward Ave., Detroit, Mich.	F. E. C	•	•	•	•	•	•	•	•	•	•	•	•	•	•	•	•	•	•	•	•	•
Fox Sound Equip. Corp., 3120 Monroe St., Toledo, Ohio		•	•	•	•	•	•	•	•	•	•	•	•	•	•	•	•	•	•	•	•	•
Garrard Sales Corp., 17 Warren St., New York, N. Y.	Garrard	•	•	•	•	•	•	•	•	•	•	•	•	•	•	•	•	•	•	•	•	•
Gates Radio & Supply Co., 115 N. 4th St., Quincy, Ill.	GE	•	•	•	•	•	•	•	•	•	•	•	•	•	•	•	•	•	•	•	•	•
General Electric Co., 1285 Boston Ave., Bridgeport, Conn.		•	•	•	•	•	•	•	•	•	•	•	•	•	•	•	•	•	•	•	•	•
General Illuminating Corp., 16 Calendar St., Providence, R. I.		•	•	•	•	•	•	•	•	•	•	•	•	•	•	•	•	•	•	•	•	•
General Industries Co., 3214 Taylor St., Elyria, Ohio		•	•	•	•	•	•	•	•	•	•	•	•	•	•	•	•	•	•	•	•	•
Thomas B. Gibbs, 900 W. Lake St., Chicago, Ill.		•	•	•	•	•	•	•	•	•	•	•	•	•	•	•	•	•	•	•	•	•
Hardray, Inc., 524 W. Broadway, New York, N. Y.	Hardray	•	•	•	•	•	•	•	•	•	•	•	•	•	•	•	•	•	•	•	•	•
Hetro Electrical Industries, Inc., Chicago, Ill.	Hetro, Hetro Ear	•	•	•	•	•	•	•	•	•	•	•	•	•	•	•	•	•	•	•	•	•
Holtzer-Cabot Elec. Co., 125 Amory St., Boston, Mass.		•	•	•	•	•	•	•	•	•	•	•	•	•	•	•	•	•	•	•	•	•
Illinois Wood Products Corp., Chicago, Ill.	Illini	•	•	•	•	•	•	•	•	•	•	•	•	•	•	•	•	•	•	•	•	•
Intercall Systems, Inc., Fifth and Norwood, Dayton, Ohio	Intercall	•	•	•	•	•	•	•	•	•	•	•	•	•	•	•	•	•	•	•	•	•
Insuline Corp. of America, 23 Park Pl., New York, N. Y.		•	•	•	•	•	•	•	•	•	•	•	•	•	•	•	•	•	•	•	•	•
Jenkins & Adair, 3333 Belmont Ave., Chicago, Ill.		•	•	•	•	•	•	•	•	•	•	•	•	•	•	•	•	•	•	•	•	•
Jensen Radio Mfg. Co., 6601 S. Laramie Ave., Chicago, Ill.	Jensen	•	•	•	•	•	•	•	•	•	•	•	•	•	•	•	•	•	•	•	•	•
Lansing Mfg. Co., 6900 McKinley Ave., Los Angeles, Calif.	Lansing	•	•	•	•	•	•	•	•	•	•	•	•	•	•	•	•	•	•	•	•	•
La Salle Radio Corp., 140 Washington St., New York, N. Y.		•	•	•	•	•	•	•	•	•	•	•	•	•	•	•	•	•	•	•	•	•
Laurehk Radio Mfg. Co., Adrian, Mich.	Laurehk, Laurette	•	•	•	•	•	•	•	•	•	•	•	•	•	•	•	•	•	•	•	•	•
Leokone Radio, Inc., 63 Day St., New York, N. Y.		•	•	•	•	•	•	•	•	•	•	•	•	•	•	•	•	•	•	•	•	•
Lifetime Corp., 1012 Madison Ave., Toledo, Ohio	Lifetime	•	•	•	•	•	•	•	•	•	•	•	•	•	•	•	•	•	•	•	•	•
Lipman Eng. Co., 415 Van Braam St., Pittsburgh, Pa.		•	•	•	•	•	•	•	•	•	•	•	•	•	•	•	•	•	•	•	•	•
Fred M. Link, 125 W. 17th St., New York, N. Y.		•	•	•	•	•	•	•	•	•	•	•	•	•	•	•	•	•	•	•	•	•
Magnavox Co., 2131 Bueter Rd., Fort Wayne, Ind.		•	•	•	•	•	•	•	•	•	•	•	•	•	•	•	•	•	•	•	•	•
McMurdo Silver Corp., 2900 S. Michigan Ave., Chicago, Ill.		•	•	•	•	•	•	•	•	•	•	•	•	•	•	•	•	•	•	•	•	•
Meophone Corp., 714 University Ave., Rochester, N. Y.		•	•	•	•	•	•	•	•	•	•	•	•	•	•	•	•	•	•	•	•	•
Miles Reproducer Co., 812 Broadway, New York, N. Y.	Miles, Vocophone, Filmograph	•	•	•	•	•	•	•	•	•	•	•	•	•	•	•	•	•	•	•	•	•
Milton Radio and Television, 685 W. Ohio St., Chicago, Ill.	Milton	•	•	•	•	•	•	•	•	•	•	•	•	•	•	•	•	•	•	•	•	•
Mirror Record Corp., 34 W. 25th St., New York, N. Y.	Mirror	•	•	•	•	•	•	•	•	•	•	•	•	•	•	•	•	•	•	•	•	•
Morlen Electric Co., Inc., 60 W. 15th St., New York, N. Y.		•	•	•	•	•	•	•	•	•	•	•	•	•	•	•	•	•	•	•	•	•
National Co., Inc., 61 Sherman St., Malden, Mass.	National	•	•	•	•	•	•	•	•	•	•	•	•	•	•	•	•	•	•	•	•	•
Nordendale Mfg. Co., 2100 Fulton St., Chicago, Ill.		•	•	•	•	•	•	•	•	•	•	•	•	•	•	•	•	•	•	•	•	•
Operadio Mfg. Co., St. Charles, Ill.	Operadio	•	•	•	•	•	•	•	•	•	•	•	•	•	•	•	•	•	•	•	•	•
Ottawa Radio Co., 306 W. Lafayette St., Ottawa, Ill.		•	•	•	•	•	•	•	•	•	•	•	•	•	•	•	•	•	•	•	•	•
Oxford Tartak Radio Corp., 915 W. Van Buren St., Chicago, Ill.	Oxford	•	•	•	•	•	•	•	•	•	•	•	•	•	•	•	•	•	•	•	•	•
Pierce Airo, Inc., 510 Sixth Ave., New York, N. Y.		•	•	•	•	•	•	•	•	•	•	•	•	•	•	•	•	•	•	•	•	•
Facent Eng. Corp., 79 Madison Ave., New York, N. Y.		•	•	•	•	•	•	•	•	•	•	•	•	•	•	•	•	•	•	•	•	•
Packard Elec. Co., 717 Fayette, Philadelphia, Pa.	Philco-Philophone	•	•	•	•	•	•	•	•	•	•	•	•	•	•	•	•	•	•	•	•	•
Radio Radio & Tel. Corp., Philadelphia, Pa.		•	•	•	•	•	•	•	•	•	•	•	•	•	•	•	•	•	•	•	•	•
Picturo-Fone Co., 806 S. V. St., Lima, Ohio		•	•	•	•	•	•	•	•	•	•	•	•	•	•	•	•	•	•	•	•	•
Pictroelectric Labs, 612 Parkhill Ave., New Dorp, N. Y.		•	•	•	•	•	•	•	•	•	•	•	•	•	•	•	•	•	•	•	•	•
Pilgrim Elec. Corp., 21 W. 19th St., New York, N. Y.		•	•	•	•	•	•	•	•	•	•	•	•	•	•	•	•	•	•	•	•	•
Preston Recording Corp., 130 W. 19th St., New York, N. Y.		•	•	•	•	•	•	•	•	•	•	•	•	•	•	•	•	•	•	•	•	•
Proctor Co., Inc., 17 W. 60th St., New York, N. Y.	Proctor	•	•	•	•	•	•	•	•	•	•	•	•	•	•	•	•	•	•	•	•	•
Public-Ad, Inc., 2615 E. 65th St., Cleveland, Ohio		•	•	•	•	•	•	•	•	•	•	•	•	•	•	•	•	•	•	•	•	•
Quam-Nichols Co., Cottage Grove Ave., 33rd Pl., Chicago, Ill.	Quam	•	•	•	•	•	•	•	•	•	•	•	•	•	•	•	•	•	•	•	•	•
Rangertone, Inc., 201 Verona Ave., Newark, N. J.		•	•	•	•	•	•	•	•	•	•	•	•	•	•	•	•	•	•	•	•	•
Racon Elec. Co., 52 E. 19th St., New York, N. Y.		•	•	•	•	•	•	•	•	•	•	•	•	•	•	•	•	•	•	•	•	•
Radio Amplifier, 146 W. 22nd St., New York, N. Y.		•	•	•	•	•	•	•	•	•	•	•	•	•	•	•	•	•	•	•	•	•
Radioane Corp., 136 W. 22nd St., New York, N. Y.		•	•	•	•	•	•	•	•	•	•	•	•	•	•	•	•	•	•	•	•	•
Radio Receiver Co., 251 W. 19th St., New York, N. Y.		•	•	•	•	•	•	•	•	•	•	•	•	•	•	•	•	•	•	•	•	•
Radio Speakers, Inc., 1338 E. Mich. Ave., Chicago, Ill.	Radiofone	•	•	•	•	•	•	•	•	•	•	•	•	•	•	•	•	•	•	•	•	•

● THE CIRCUS

Just about one year ago today the drums started beating for the "World's Greatest Radio Season." The ballyhoo'ers shouted "Right this way dealers and jobbers! Right this way and see the greatest collection of Radio freaks ever gathered under one canvas—Variable tube complements, secret panels, sloping discounts, cockeyes and lazy chairs, mechanical marvels and magic bell ringers all for you to sell."

"Buy now and make big profits, the more you buy the more you make. Hurry! Hurry! Get under cover before the price raises. Now! Now! You're the lucky one—only a few can get this deal. It's all in one package. See, see what you get—a quota, an advertising program, a mess of radios with trade acceptances—from Hell to breakfast. Sign now and regret later."

... And Many Did.

● HI-LO PRESSURE

Radio merchandising is fundamentally a great business. It has for a market 90% of American homes and is of interest to every citizen. It's dollar volume is among the top industries.

There is a place in this industry for high pressure. There are retail customers who like to be fooled, dealers who wish to be oversold, distributors who love quotas and manufacturers who want to build ALL the radios.

But just as surely, there is a place and a profit in this industry for straight-thinking business people. Manufacturers who believe in honest value as the soundest sales appeal, distributors who live on something more substantial than excitement and ambition and dealers who are not babes in the woods.

● WHAT'S RIGHT—WHAT'S WRONG

14 tube midgets at \$19.95 . . . 6 tube consoles for \$79.95. New radios \$6.95 list . . . \$50.00 trade-in allowance for any old radio. "No radio is modern without a super-reverberator." "Super-reverberation is obsoleted by new over-animator."

What's right—what's wrong? The public doesn't know. It can't even guess. Advertising appeal breaks down and the confused customer searches out a dealer he knows and trusts to ask "I want to buy a radio, but I am confused with claims and counter-claims, gadgets, discounts, allowances, price cuts, premiums and features. Tell me—what do you recommend?"

THESE ARE THE DEALERS WHO SHOULD HANDLE WILCOX-GAY

ARE YOU THE ONE?

In most every territory there's a distributor who will find with Wilcox-Gay the line he needs for 1938. He'll be a good business man with a strong dealer following. He'll appreciate the Wilcox-Gay record for quality and their sound business policies proven by performance. He'll like the permanence of this 20 year old manufacturer.

He will carry a stock of Wilcox-Gay radio just large enough to serve his dealers efficiently—He won't buy "a pig in a poke" or specify October shipments in June and he won't be asked to. He will cover his territory efficiently and actively but he'll set his own quota and run his own business.

His salesman will "go for" Wilcox-Gay's new models, the competitive list prices, the favorable discounts, the attractive styling and the fact that every model fills a "sweet spot" in the radio market of today.

His dealers will take to Wilcox-Gay as something sound to tie to in a topsy-turvy world. Something to make a clean profit on in the radio business. A good product sanely sold.

IF YOU'RE ONE OF THESE DISTRIBUTORS,
DROP US A LINE TODAY

WILCOX-GAY CORPORATION
CHARLOTTE MICHIGAN U.S.A.

HORTON. *first every time*

A GROUP of keen craftsmen devoting their skill entirely to the specialized field of home laundry equipment . . . jealously protecting the mechanical fineness of their products . . . build America's top line of washing machines and ironers . . . Horton.

The in-built quality in every Horton product is assurance of satisfied customers. Write now for details of the Horton proposition.

finest every way · **HORTON**
HORTON MANUFACTURING CO., FORT WAYNE, INDIANA



Model 600

MODEL 200—police converter with variable condenser and illuminated dial. Covers 1500 to 3500 kilocycles. List Price \$17.95
MODEL 500—police converter with two metal tubes, variable condenser and illuminated dial. Very sensitive. Exceptional distance range. List Price \$21.95
Jobs and dealers wanted **ABC RADIO LABORATORIES** 3334 N. New Jersey St., Indianapolis, Indiana, U.S.A.

SHORT WAVE CONVERTERS FOR CAR RADIOS

Can be attached to any car radio. Has on and off switch. Does not affect the reception on the standard broadcast bands. MODEL 600—covers 49, 31, 25, 20, 19 and 16 meter bands. Designed for reception of American and Foreign short wave broadcast. Especially adapted to use in tropical countries and the more remote parts of the world. Distance range 5000 to 10000 miles. A very attractive unit. List Price \$24.95

POLICE UNITS

MODEL 100—police converter with fixed condenser. Covers 1500 to 2600 kilocycles. List Price \$11.95
Model 800 Super Sensitive police converter. Covers 1500 to 2600 kc. Two metal tubes. Long range. List price \$15.95

Boost PROFITS with this New WARD AERIAL

Here's a money-maker for you! WARD'S new Model CO, a 2-section telescopic hinge-type aerial, sells for only \$1.95 complete with 40" approved Low Loss Shielded Cable! Made of Admiralty metal. Easy-Tilt mounting Bracket. Easily installed.

Write for free catalog of WARD'S complete line of car aerials. See us at the Chicago Show 215-217 Hertz Avenue



The **WARD PRODUCTS Corp.**
WARD BUILDING CLEVELAND, OHIO

ACCESSORIES

Directory

MANUFACTURERS	TRADENAMES	Wind Generators and Electric Plants	Gas Generators and Electric Plants	Batteries	Antennas	Noise Filters	Converters, etc.	Cabinets	Earphones	Clocks and Timers	Tuning Aids and Globes	Battery Chargers and Eliminators	Push Button Tuning Accessories	Miscellaneous
ABC Radio Labs, 3334 N. New Jersey St., Indianapolis, Ind.														
Acme Specialty Co., 1770 W. Berteau Ave., Chicago, Ill.														
Adler Mfg. Co., Louisville, Kentucky														
Aerovox Corp., 70 Washington St., Brooklyn, N. Y.														
Air King Products Co., Inc., 19-35 Hooper St., Brooklyn, N. Y.	Air King													
Alden Corp., Asheville, N. C.														
Alden Products Co., 715 Center St., Brockton, Mass.														
Allied Radio Corp., 833 Jackson Blvd., Chicago, Ill.														
Alpha Wire Corp., 50 Howard St., New York, N. Y.	Alpha													
American Communications Corp., 1650 Broadway, New York, N. Y.	American													
American Radio Hardware Co., 476 Broadway, New York, N. Y.														
American Tel. & Radio Co., St. Paul, Minn.														
Amv. Aqvay & King, 11 W. 47th St., New York, N. Y.	ATR													
Arlovox Manufacturing Co., 430 S. Green St., Chicago, Ill.	Maltschouer													
Atlas Sound Corp., 1451 39th St., Brooklyn, N. Y.	Atlas, Vitavox													
Audio Development Co., 4351 France St., So. Minneapolis, Minn.	Atlas													
Autocrat Radio Co., 3855 N. Hamilton Ave., Chicago, Ill.	Autocrat													
Automatic Elec. Devices Co., 324 E. 3rd St., Cincinnati, Ohio	Autocrat													
Belden Mfg. Co., 4647 W. Van Buren St., Chicago, Ill.	Homocharger, Transfer, Filterad													
Birnbach Radio Co., 145 Hudson St., New York, N. Y.														
Bodine Elec. Co., 2254 W. Ohio St., Chicago, Ill.	Birco													
Bond Elec. Corp., 146 Munson St., New Haven, Conn.														
L. S. Brach Mfg. Co., 80 Duryea St., Newark, N. J.														
Breez-Electric Corp., 440 N. Oakley Blvd., Chicago, Ill.	Power-Charger													
Briggs & Stratton Corp., Milwaukee, Wis.														
Brush Development Co., Cleveland, Ohio														
Bud Radio, Inc., 1937 E. 55th St., Cleveland, Ohio	Burgess													
Burgess Battery Co., Freeport, Ill.														
Burton-Rogers Co., 857 Boylston St., Boston, Mass.														
C. F. Cannon Co., Springwater, N. Y.	Cannon-Ball													
Carter Motor Co., 1608 Milwaukee Ave., Chicago, Ill.	Genemotor													
Caswell Runyan Co., Huntington, Ind.														
Charlotte Furn. Co., Charlotte, Mich.														
Challicothe Furn. Co., Challicothe, Mo.														
Churchill Cabinet Co., 2121 Churchill St., Chicago, Ill.														
Clock Control Corp., 2003 W. 48th St., Los Angeles, Calif.														
Consolidated Wire & Assoc. Corps., 512 So. Peoria St., Chicago, Ill.	Continental Filternoys													
Continental Carbon Co., 13900 Lorain Ave., Cleveland, Ohio														
Continental Motors Corp., 12801 Jefferson St., Detroit, Mich.														
Continental Wire Co., 110 Lafayette St., New York, N. Y.														
Corbett Cabinet Mfg. Co., St. Marys, Pa.														
Cornell Dubilier Corp., South Plainfield, N. J.														
Cornish Wire Co., 30 Church St., New York, N. Y.	C-D Corwico													
Deutschmann Corp., Tobe, Canton, Mass.	Tobe, Filteretite													
D & H Mfg. Co., Inc., 1519 California St., Denver, Colo.														
Diehl Mfg. Co., Inc., 580 Fifth Ave., New York, N. Y.														
Diehl Mfg. Co., Elizabethport, N. J.														
Dumont Elec. Co., 514 Broadway, New York, N. Y.	Dumont Deco													
Electric Specialty Co., Stamford, Conn.														
Electric Storage Battery Co., Philadelphia, Pa.														
Electrical Products Co., 6537 Russell Ave., Detroit, Mich.														
Electro-Motive Mfg. Co., Inc., 797 E. 140th St., New York, N. Y.														
Electronic Labs., New York St., Indianapolis, Ind.														
Emerson Radio & Phonograph Corp., 111 Eighth Ave., New York	Emerson													
Espey Mfg. Co., Inc., 124 E. 25th St., New York, N. Y.														
Fairbanks Morse & Co. (Home Appliance Div.)	Fairbanks Morse													
Farmpower Products Corp., 2525 Clybourn Ave., Chicago, Ill.														
Ferranti Elec., Inc., 30 Rockefeller Plaza, New York, N. Y.														
F & H Radio Labs., Fargo, N. D.														

MANUFACTURERS	TRADENAMES	Wind Generators and Electric Plants	Gas Generators and Electric Plants	Batteries	Antennas	Noise Filters	Inverters, etc.	Cabinets	Earphones	Clocks and Timers	Tuning Aids and Globes	Battery Chargers and Eliminators	Push Button Tuning Accessories	Miscellaneous
Fishwick Radio Co., 407 E. 8th St., Cincinnati, Ohio.														
M. M. Fleron & Sons, 113 N. Broad St., Trenton, N. J.														
Foraco Corp., 2111 Woodward Ave., Detroit, Mich.														
Fordson Export Corp., 2111 Woodward Ave., Detroit, Mich.														
Franklin Mfg. Corp., 175 Varick St., New York, N. Y.	Franklin, Universal.													
General Dry Batteries, Inc., Cleveland, Ohio.	General.													
General Elec. Co., Bridgeport, Conn.	G-E.													
General Winding Co., 234 W. 31st St., New York, N. Y.														
Gen-E-Rotor, 908 Keo St., Des Moines, Iowa.	G-H.													
Ginsard-Hopkins, 1437 Twenty-Third Ave., Oakland, Calif.	Globe.													
Globe-Union, Inc., 900 E. Keefe Ave., Milwaukee, Wis.														
Greco Cabinet Co., 48 Mangin St., New York, N. Y.														
Guthman & Co., Inc., Edwin I., 400 S. Peoria St., Chicago, Ill.	Guthman.													
Haynes Radio Log, 161 W. Harrison St., Chicago, Ill.	Haynes.													
Hetro Electrical Industries, Inc., 4611 Ravenswood Ave., Chicago, Ill.	Hetro, Hetro-Ear.													
Home Furniture Co., York, Pa.														
Horn, Herbert H., 1201 S. Olive, Los Angeles, Calif.	Tiffany Tone.													
Illinois Wood Products Corp., 2512 S. Damen Ave., Chicago, Ill.	Illini.													
Inland Mfg. Div., Gen. Motors Corp., 14 Coleman Ave., Dayton, Ohio.	ICA.													
Insuline Corp. of America, 25 Park Pl., New York, N. Y.														
Janette Mfg. Co., 556 W. Monroe St., Chicago, Ill.	Janette.													
J. F. D. Mfg. Co., 4111 Ft. Hamilton Parkway, Brooklyn, N. Y.	J. F. D.													
E. F. Johnson Co., Waseco, Minn.	Johnson.													
Johnson Motors Co., 1930 Pershing Rd., Waukegan, Ill.	Iron Horse.													
Kato Engineering Co., Mankato, Minn.	Kato, Katolight.													
Laurehk Radio Mfg. Co., E. Michigan St., Adrian, Mich.	Laurehk, Laurette.													
Lauson Co., The, New Holstein, Wis.														
Luce Furn. Corp., 655 Godfrey Ave., S. W., Grand Rapids, Mich.														
P. R. Mallory Co., Inc., Indianapolis, Ind.														
McMurdo Silver Corp., 2900 S. Michigan Ave., Chicago, Ill.	McMurdo Silver.													
Meissner Mfg. Co., Mt. Carmel, Ill.	Meissner.													
Meiburn Radio Mfg. Co., 2218 S. Hoover St., Los Angeles, Calif.														
Mercury Elec. Co., 1045 Washington Blvd., Chicago, Ill.														
Miles Reproducer Co., 812 Broadway, New York, N. Y.	Miles, Vocophone, Filmograph.													
J. W. Miller Co., 5917 S. Main St., Los Angeles, Calif.	Miller.													
Monarch Battery Co., Chicago, Ill.	Monarch.													
Muter Co., The, 1255 S. Michigan Ave., Chicago, Ill.	Muter.													
National Carbon Co., 30 E. 42nd St., New York, N. Y.														
Norwest Radio Labs., 3454 Fullerton Ave., Chicago, Ill.														
Oak Mfg. Co., 711 W. Lake St., Chicago, Ill.	Oak.													
Ohmite Mfg. Co., 4845 W. Flourney Ave., Chicago, Ill.	Ohmite.													
D. W. Onan & Sons, 440 Royalston Ave., Minneapolis, Minn.	Onan.													
Pacnet Eng. Corp., 79 Madison Ave., New York, N. Y.														
Parris-Dunn Corp., Clarinda, Iowa.														
Philco Radio & Television Corp., Troga & C Sts., Philadelphia, Pa.	Philco.													
Philmore Mfg. Co., 113 University Pl., New York, N. Y.														
Pierson Co., Rockford, Ill.	Pierson.													
Pioneer Gen-E-Motor Corp., 466 W. Superior St., Chicago, Ill.	Pioneer.													
Porcelain Products, Inc., Findlay, Ohio.														
Potter Co., 1950 Sheridan Rd., No. Chicago, Ill.														
Premax Sales Div., Chisholm-Ryder Co., Niagara Falls, N. Y.	Premax.													
Quam-Nichols Co., Cottage Grove Ave., Chicago, Ill.	Quam.													
RCA Mfg Co., Camden, N. J.	RCA, RCA Victor.													
Radio Elec. Service, 1918 Newton St., Saginaw, Mich.														
Ray-O-Vac Co., Madison, Wis.	Ray-O-Vac.													

MANUFACTURERS	TRADE NAMES	Wind Generators and Electric Plants	Gas Generators and Electric Plants	Batteries	Antennas	Noise Filters	Converters, etc.	Cabinets	Earphones	Clocks and Timers	Tuning Aids and Globes	Battery Chargers and Eliminators	Push Button Tuning Accessories	Miscellaneous
Recording Equipment Mfg. Co., 6611 Sunset Blvd., Hollywood, Calif.														
Red Lion Cabinet Co., Red Lion, Pa.														
W. H. Reeks, 5653 N. Talmun Ave., Chicago, Ill.														
Republic Elec. Mfg. Co., 114 E. First St., Davenport, Iowa														
M. H. Rhodes, Inc., Rockefeller Plaza, New York, N. Y.														
Rider, John F., 404 Fourth Ave., New York, N. Y.	Rider													
Rivard Wire and Cable Corp., 1014 Madison Ave., Toledo, Ohio	Rivard													
Ruralite Co., The, P. O. Box 86, Sioux City, Iowa	Ruralite													(7)
Schiffman Bros., 3840 N. Ashland Ave., Chicago, Ill.														
Sentinel Radio Corp., 2222 Diversey Blvd., Chicago, Ill.	Sentinel													
Seth Thomas Clocks, Thomaston, Conn.														
Sky Pilot Organization, Radio Park, Pearl River, N. Y.														
Snyder, Inc., 813 Noble St., Philadelphia, Pa.	Snyder													
Solar Mfg. Co., 699 Broadway, New York, N. Y.	Solar													
Sound Apparatus Co., 150 W. 46th St., New York, N. Y.	Neumann													
Sprague Products Co., N. Adams, Mass.														
Standard Cabinet Co., 543 Union St., Brooklyn, N. Y.														
Steger Furn. Mfg. Co., Steger, Ill.														
Stettner Corp., 669 Kent Ave., Brooklyn, N. Y.														
Stromberg-Carlson Tel. Mfg. Co., 100 Carlson Rd., Rochester, N. Y.	Stromberg-Carlson													
Superior Cabinet Corp., 3611 Fourteenth Ave., Brooklyn, N. Y.														
L. Tatro Bros., Decorah, Iowa														
Technical Appliance Corp., 17 E. 16th St., New York, N. Y.	Taco													
Tichenor Co., 7323 W. Chicago Blvd., Chicago, Ill.														
Tillotson Furn. Corp., Jamestown, N. Y.														
Topstream, Inc., 1811 S. Myndale Ave., Minneapolis, Minn.	Topstream													
Tork Clock Co., Mt. Vernon, N. Y.														
Trimn Radio Mfg. Co., 1770 W. Berteau St., Chicago, Ill.	Trimn, Acme													
Ultramar Mfg. Corp., 1160 Howe St., Chicago, Ill.														
Union Chest and Cab. Corp., Rochester, N. Y.														
United Transformer Corp., 72 Spring St., New York, N. Y.														
Universal Battery Co., 3410 S. LaSalle St., Chicago, Ill.														
Universal Microphone Co., Ltd., Inglewood, Calif.	Universal													
U S L Battery Corp., Niagara Falls, N. Y.														
Victory Mfg. Co., Inc., 2021 S. Michigan Ave., Chicago, Ill.														
Ward Products Corp., Ward Bldg., Cleveland, Ohio														
Warren Furn. Co., Warren, Pa.														
Warren Telechron Co., Ashland, Mass.	Telechron													
Watterson Radio Mfg. Co., 2608 Rose Ave., Dallas, Tex.	Watterson													
Weber-Costello Co., Chicago Heights, Chicago, Ill.														
Wedge Mfg. Co., 2334 S. Michigan Ave., Chicago, Ill.														
White Wind Elec. Co., 2300 E. Douglas Ave., Wichita, Kan.														
Willard Storage Battery Co., Cleveland, Ohio	Willard													
Wincharger Corp., Sioux City, Iowa														
Wind-Impeller Electric Works, Ellsworth, Iowa	Wind Impeller													
F. C. Wornick & Co., Tully, Mass.														
Z & S Radio Products Co., 1215 Jackson St., Toledo, Ohio														

- (1) Code Reader, Telekey
- (2) And Earphone Adapters
- (3) Automatic Flexible Shaft-Handling Machine for Auto Radio
- (4) Transmitting
- (5) R. F. Power Line Type

- (6) Mast Ground Rods
- (7) Circuit Manuals
- (8) Ground Clamps
- (9) Also Master Antenna Systems

RCA Continues to Build America's Radio Audience!

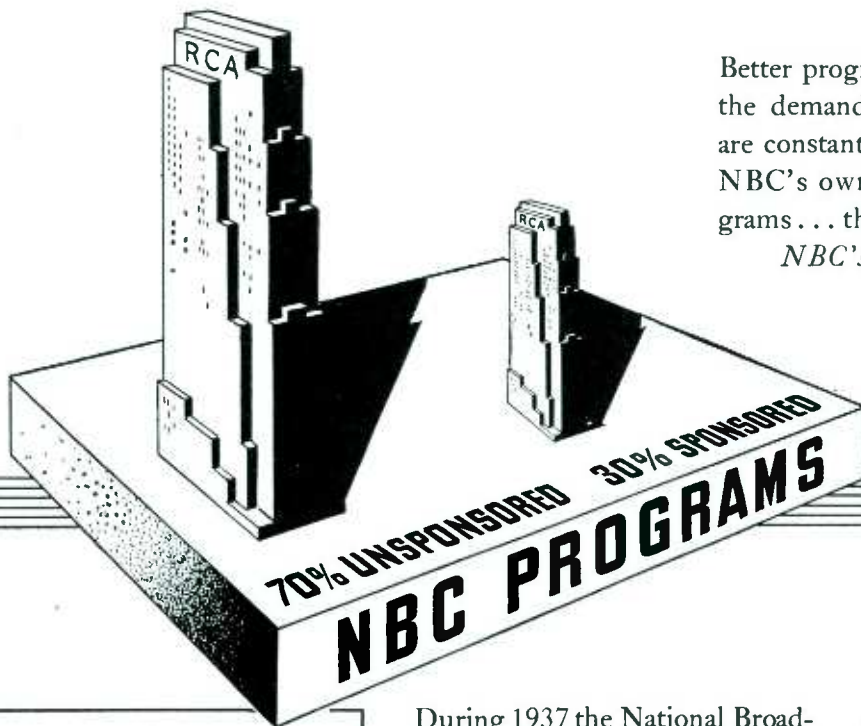

Better programs—which increase the demand for better radios—are constantly being fostered by NBC's own unsponsored programs... they constitute 70% of NBC's time on the air!

NBC HIGHLIGHTS

These are but a few of the many fine programs which make up NBC's 70% unsponsored time on the air!

- ★ Metropolitan Opera Broadcasts
- ★ NBC Symphony Broadcasts
- ★ Music Appreciation Hour
- ★ National Farm & Home Hour
- ★ NBC Radio Guild
- ★ America's Town Meeting of the Air
- ★ The Radio Pulpit
- ★ University of Chicago Round Table

RCA presents the Magic Key every Sunday, 2 to 3 P. M., E. D. S. T., on the NBC Blue Network.

During 1937 the National Broadcasting Company, a service of RCA, broadcast more than 50,000 unsponsored programs. Such service accounted for 70% of all NBC time on the air. The variety offered was as wide as human interests.

Through the miracle of radio such programs bring to millions entertainment, information and help which they could not receive otherwise. Through NBC, living rooms become boxes at the Metropolitan Opera. Or they are filled with the sonorous cadences of great symphonies, played by the NBC Symphony Orchestra, con-

ducted by Arturo Toscanini, or some other famous conductor.

Again, it may be current prices of eggs, or pork, or a discussion of books and plays. But whatever the subject, if it is of interest to any considerable part of the public, NBC provides programs which deal with it.

Programs such as these, together with the fine programs sponsored by NBC advertisers, have been largely responsible for the increased sale of radios. And in offering listeners better radios RCA further stimulates America's interest in fine radio programs.



Radio Corporation of America

RADIO CITY, N. Y.

RCA MANUFACTURING CO., INC. RCA INSTITUTES, INC. RCA COMMUNICATIONS, INC.
RADIOMARINE CORPORATION OF AMERICA NATIONAL BROADCASTING COMPANY

Directory

TESTERS

MANUFACTURERS	TRADENAME	Tube Checkers	Analyzers	Multimeters	Output Meters	Oscillographs	Frequency Modulators	Osc.		V. T. Meters	Capacity Analyzers	Bridges		Modulation Indicators	Speakers Testers	Vibrator Testers	Decibel Meters	Miscellaneous	
								RF	AF			Capacitor	Inductance						
Aome Electric & Mfg. Co., Cuba, N. Y.																		(1)	
American Comm. Corp., 1650 Broadway, New York, N. Y.	Ame. American																		(2)
Apparatus Design Co., Elizabeth & Randolph Sts., Chicago, Ill.																			(3)
Bendix Products Corp., 401 Bendix Dr., South Bend, Ind.																			(8)
Burton Rogers Co., 857 Boylston St., Boston, Mass.																			(12)
Carroll Mfg. Co., 415 S. Aberdeen St., Chicago, Ill.																			(1)
Clough-Brengle Co., 2815 W. 19th St., Chicago, Ill.	Clough-Brengle																		(2)
Consolidated Wire and Assoc. Corps., 512 E. Peoria St., Chicago, Ill.																			(3)
Dayco Radio Co., Dayton Ohio	Daven																		(8)
Tohe Deuschmann Corp., Canton, Mass.	Tohe Filterette																		(12)
Allen B. DuMont Labs., Inc., 542 Valley Rd., Upper Montclair, N. J.																			(1)
Electronics Design Corp., 162 N. May Street, Chicago, Ill.																			(2)
Ferris Inst. Corp., Borton Ave., Boonton, N. J.																			(3)
Foraco Corp., 2111 Woodward Ave., Detroit, Mich.	F. E. C.																		(8)
Fulton Radio Corp., 100 6th Ave., New York, N. Y.																			(12)
General Radio Co., 30 State St., Cambridge, Mass.																			(1)
Gray Inst. Co., 64 W. Jackson St., Philadelphia, Pa.																			(2)
Hickok Elec. Inst. Co., Dupont Ave., Cleveland, Ohio	Hickok																		(3)
Hoyt Elec. Inst. Co., Penacook, N. H.																			(8)
Insuline Corp. of America, 25 Park Pl., New York, N. Y.																			(12)
International Res. Co., 401 N. Broad St., Philadelphia, Pa.	IRC																		(1)
Jackson Elec. Inst. Co., 129 Wayne Ave., Dayton, Ohio.	Jackson																		(4)
J. M. P. Mfg. Co., Inc., 3049 N. 34th St., Milwaukee, Wis.																			(5)
Laurehk Radio Mfg. Co., Adrian, Mich.	Laurehk, Laurette																		(4)
L. & L. Elec. Co., 346 Madison Ave., Memphis, Tenn.																			(5)
Million Radio & Television Co., 685 W. Chio St., Chicago, Ill.	Million																		(5)
Monarch Mfg. Co., 3341 Belmont Ave., Chicago, Ill.	Monarch																		(5)
Multiplex Radio Service, Inc., 88 Fourth Ave., Brooklyn, N. Y.																			(5)
National Co., 61 Sherman St., Malden, Mass.	National																		(6)
Ohio Inst. Co., 9410 St. Catherine Ave., Cleveland, Ohio	Ohioite																		(6)
Philco Radio & Television Corp., Philadelphia, Pa.	Philco																		(6)
Potter Co., North Chicago, Ill.																			(6)
Preceptor Mfg. Co., 179 Minna St., San Francisco, Calif.	Preceptor																		(6)
Precision App. Corp., 821 E. New York Ave., Brooklyn, N. Y.	Precision																		(6)
Radio City Products Co., Inc., 88 Park Pl., New York, N. Y.	Dependable, Radio City																		(6)
Radio Products Co., 125 Sunrise Pl., Dayton, Ohio.																			(6)
Radio Technic Labs., Inc., 1328 Sherman Ave., Evanston, Ill.																			(6)
RCA Mfg. Co., Camden, N. J.	RCA																		(6)
Ra-Fone Co., 4105 Broadway, Oakland, Cal.	Preceptor																		(6)
Readrite Meter Works, 136 E. College Ave., Bluffton, Ohio.	Readrite, Ranger																		(6)
Shalleross Mfg. Co., 10 Jackson Ave., Collingdale, Pa.																			(6)
Simpson Elec. Co., 5216 W. Kinzie St., Chicago, Ill.	Simpson, Roto-Ranger																		(6)
Solar Mfg. Corp., 599 Broadway, New York, N. Y.	Solar																		(6)
Sound Apparatus Co., 150 W. 46th St., New York, N. Y.	Neumann																		(6)
Sundt Eng. Co., 1238 Lincoln Ave., Chicago, Ill.	Sunco																		(6)
Supreme Instrument Co., Greenwood, Miss.	Supreme																		(6)
Tech Labs., 703 Newark Ave., Jersey City, N. J.																			(6)
Teff Lab. Co., Plymouth, Mich.																			(6)
Triplet Elec. Inst. Corp., 122 Main St., Bluffton, Ohio.	Triplet																		(6)
Triumph Mfg. Co., 4017 W. Lake St., Chicago, Ill.	Triumph																		(6)
Ultramar Mfg. Corp., 1160 Chatham St., Chicago, Ill.																			(6)
Ultimate Motors Service, 3044 Grand Blvd., Detroit, Mich.																			(6)
United Sound Eng. Co., 2233 University Ave., St. Paul, Minn.																			(6)
Universal Microphone Co., Ltd., Ingelwood, Cal.	Universal																		(6)
Earl Webber Co., 1313 W. Randolph St., Chicago, Ill.	Webber																		(6)
Webster Electric Co., Racine, Wis.	Webster																		(6)
Westinghouse Electric & Mfg. Co., Newark, N. J.																			(6)
Weston Elect. Inst. Corp., 614 Frelinghuysen Ave., Newark, N. J.	Weston																		(6)

(1) Insulation voltage breakdown tester.
 (2) Radio-X-ray laboratories, demodulators.
 (3) Gainset, volume indicators.

(4) Resistance analyzer.
 (5) Audiometers.
 (6) Resistance box.

(7) Neobeam oscilloscope.
 (8) Noise meter.
 (9) Laboratory test bench panels.

(10) Stroboscopes.
 (11) Special equipment to order.
 (12) Maintenance

ALDEN PRODUCTS

Made under the trade-mark "NA-ALD"

A dependable source of supply for manufacturers, jobbers, dealers, servicemen, PA men and supply stores.

- CONNECTORS—Standard or to specifications; with or without leads; 2 to 58 wires; leads individually and completely insulated.
- TUNING EYE ASSEMBLIES—Connectors with contacts and resistors protected against movement or shorting. Non-leakage wire assemblies. Brackets encircling tube-base; allow rotating and locking.
- SPEAKER CONNECTORS—Standard equipment of most manufacturers. Single screw mounting, directly on speaker. Economical and space-saving. Also metal-seal socket and compact plug to break speaker connections at chassis. Also one-piece plug with standard 4 to 8 prong arrangement and rubber grip handles.
- POLARIZED CONNECTORS—For low or high voltage circuits.
- MINIATURE CABLE CONNECTORS—Extremely compact.
- SHIELDED PLUGS—For grounding to metal-seal sockets.
- MOLDED METAL-SEAL SOCKETS—For radio, PA, automotive.
- BATTERY PLUGS & CABLES—For home sets and auto radio. Has "A," "B" and "C" leads.
- CLIPS, SOCKETS AND SHIELDED CONNECTORS—For mounting new photocells 921-22 at any angle.
- INSULATED TUBE CAPS—For control grids, transmitting tubes, testing instruments, etc. Standard and heavy duty.
- MOLDED PRODUCTS—Bakelite, Thiokol (synthetic rubber) or the new high freq. insulation Polystyrol. Mouldings developed to the best shape and size to meet your requirements.
- PREPARED LEAD SERVICE—All kinds of wires furnished in specified lengths with ends prepared.
- BRAIDED METAL SHIELD OR BONDING LEADS.
- MULTI-WIRE FLAT WOVEN CABLE—Any number of leads.
- RUBBER COVERED FLAT CABLE—Heavy duty.
- SATURATED SLEEVING—Special inside and outside sizes at low cost for quantities.
- DETACHABLE PILOT LAMP SOCKETS—Various types, wired and unwired.

Special-price Seasonal Offer on Limited Quantities

- FLAT WOVEN EXTENSION CABLE—For house current and doublet antenna. Lies flat on floor or under rug. Armchair reception at any part of room.
- TUNING EYE ASSEMBLY KITS
- ANALYZER PLUGS AND ADAPTERS
- TUBE LEAKAGE AND SHORT TESTERS
- SPECIAL ADAPTER KITS—For checking various makes of sets
- UNIVERSAL TESTING ADAPTERS
- PLUGS, CABLES, ADAPTERS AND SOCKETS—For all requirements.
- CLIPS FOR MOUNTING PHOTO TUBES
- DETACHABLE PILOT LIGHT SOCKETS, with leads
- UNBRAIDED TWISTED CABLE
- RUBBER COVERED CABLE—Shielded; extra flexible
- HOOK-UP AND HIGH VOLTAGE INSULATED WIRE
- RESISTANCE WIRE
- NEON GLOW LAMPS
- BRASS AND COPPER TUBING
- CEMENT, LACQUER, FLUX, ETC.
- PLUG-IN COIL FORMS
- STAND-OFF INSULATORS
- R F CHOKES
- VICTRON VARIABLE CONDENSERS
- TRIMMERS—With stand-off mountings
- SOCKETS FOR ALL RECEIVING TUBES
- MOLDED KNOBS AND DIALS
- TOGGLE ON-OFF SWITCHES
- GRID CAPS AND GRID LEADS—Various styles
- HARDWARE, BINDING POSTS, etc.

Manufacturers send for engineering data sheets—Jobbers for catalog.



ALDEN PRODUCTS COMPANY
715 Centre St. Brockton, Mass.

SERVICEMEN!

\$75 WORTH OF MATERIAL AND SERVICE *FREE*

HERE'S WHAT THE RSA WILL DO FOR YOU

Give *YOU* a monthly Advanced Extension Course on the current developments in radio servicing. **THIS INFORMATION IS AVAILABLE ONLY TO RSA MEMBERS!**

Give *YOU* monthly Advertising and Business Promotion ideas to increase your business and make it *more profitable*.

Include *YOU* as a "REGISTERED AND QUALIFIED SERVICEMAN" in the big advertising and publicity campaign going on in newspapers and being broadcast over the air!

Give *YOU* a subscription to "The Radio Serviceman"—the Association's monthly magazine.

Give *YOU* a Certificate of Merit to hang in your shop.

Give *YOU* a pocket card of credentials.

Give *YOU* our big expert technical staff as a department in your service business. We will give you the *right* answer to your "impossible" service problems.

Give *YOU* (if you belong to a local servicemen's club) access to our National Speakers' Bureau—famous speakers for your meetings.

Give *YOU* advance technical information on new circuits.

\$75.00 Worth of Material and Service—*FREE!*

The RSA is an independent organization, owned and operated—*not for profit*—by its members. It has the backing of the entire Radio Industry in its aim to make servicing a real business, with regular hours, and with a *real profit* at the end of each week!

The RSA is already the largest and most powerful group the service business has ever seen. **JOIN NOW** and get in on all its benefits!

RADIO SERVICEMEN OF AMERICA

Joe Marty, Jr., Executive Sec'y, 304 S. Dearborn, St., Chicago

.....MAIL THIS COUPON.....

RADIO SERVICEMEN OF AMERICA, INC.
304 South Dearborn St., Chicago, Ill.

Gentlemen:

I hereby make application for membership in the Radio Servicemen of America.

Name

Home Address

City State.....

Firm Name

Address

.....I am enclosing \$2.00 National Yearly Dues.

.....Bill me \$2.00 National Yearly Dues.

MANUFACTURERS	TRADENAMES	Coils			Condensers			Resistors			Line Cords			Volume Controls			Tone Controls			Switches			Transformers		Miscellaneous				
		RF	IF	Choke	Variable	Mica	Paper	Electrol.	Fixed	Adjustable	Suppressor	Suppressor	Line Cords	Volume Controls	Tone Controls	Sockets	Power	Circuit *	Audio	Power	Vibrators	Wire	Cables	Plugs	Dials — Knobs	Insulation	Flexible-Shafts	Remote Controls	Miscellaneous
Aome Elec. & Mfg. Co., Cuba, N. Y.	Acme																												
Aome Wire Co., 1225 Dixwell Ave., New Haven, Conn.																													
Aerovox Corp., 70 Wash. St., Brooklyn, N. Y.																													
Aladdin Radio Industries, 466 W. Superior St., Chicago, Ill.																													
Alden Products Co., 715 Center St., Brockton, Mass.	Na-Ald, Alden																												
Allen-Bradley Co., 1326 S. Second St., Milwaukee, Wis.	Bradley Ohm, Bradley Stats																												
Alloy Transformer Co., Inc., 135 Liberty St., New York, N. Y.	Alpha																												
Alpha Wire Corp., 50 Howard St., New York, N. Y.																													
American Emblem Co., Inc., 235 N. Racine St., Racine, Ill.																													
Amer. Lava Corp., Cherokee Blvd. & Mfg. Rd., Chattanooga, Tenn.	Alsinag, Lava																												
Amer. Radio Hardware Co., 47 West St., New York, N. Y.	Amphenol																												
Amer. Radio Hardware Co., Inc., 476 Bway., New York, N. Y.	Defiance																												
Amer. Steel Package Co., Defiance, Ohio	ATR																												
American Transformer Co., 178 Emmet St., Newark, N. J.																													
Ariston Corp., 4045 Diversey Ave., Chicago, Ill.	Ariston																												
Arlavox Mfg. Co., 430 S. Green St., Chicago, Ill.	Arlab, Vitavor																												
Atlas Condenser Prod. Co., 548 Westchester Ave., N. Y. C.																													
Atlas Resistor Co., 423 Broome St., New York, N. Y.																													
Atlas Sound Corp., 1451 39th St., Brooklyn, N. Y.	Atlas Sound																												
Audio Development Co., 4351 France Ave., St. Paul, Minn.																													
Automatic Winding Co., 900 Passaic St., Newark, N. J.																													
Bakelite Corp., 247 Park Avenue, New York, N. Y.																													
Basian Bros. Co., 1600 N. Clinton Ave., Rochester, N. Y.																													
Balden Mfg. Co., 23rd & Western Ave., Chicago, Ill.																													
Best Mfg. Co., 1200 Grove St., Irvington, N. J.																													
Birnbach Radio Co., 145 Hudson St., New York, N. Y.																													
Boonton Moulding Co., Boonton, N. J.																													
Bond Radio Co., 13139 Hamilton Ave., Detroit, Mich.																													
Bond Radio Inc., 1937 E. 55th St., Cleveland, Ohio																													
Bull Dog Elec. Prod. Co., 7610 Los Campeau, Detroit, Mich.																													
W. Brand & Co., 288 Fourth Ave., New York, N. Y.																													
Carborundum Co., Globar Division, Niagara Falls, N. Y.	Globar																												
Cardwell Mfg. Co., 81 Prospect St., Brooklyn, N. Y.																													
Carling Tool & Machine Co., 626 Capitol Ave., Hartford, Conn.																													
Carroll Mfg. Co., 415 S. Aberdeen St., Chicago, Ill.																													
Centralab, 900 E. Keefe Ave., Milwaukee, Wis.	Centralab																												
Chicago Teleph. Supply Co., W. Bearshay Ave., Elkhart, Ind.																													
Chicago Transformer Corp., 3501 W. Adams St., Chicago, Ill.																													
Chic Mfg. Corp., 2335 W. Van Buren St., Chicago, Ill.																													
Chicaudgraph Corp., 2 Sallick St., Stamford, Conn.	Chicaudgraph																												
Clarestat Mfg. Co., 285 N. Sixth St., Brooklyn, N. Y.	Clarestat																												
Colortone Acoustic Devices, 205 Oliver Bldg., South Bend, Ind.	Colortone																												
Condense Condenser Co., 287 W.ates Ave., New York, N. Y.																													
Condenser Corp. of Amer., 259 Cornelson Ave., Jersey City, N. J.																													
Consolidated Products, 1569 N. Branch St., Chicago, Ill.																													
Consolidated Condenser Co., 618 W. Elm St., Chicago, Ill.																													
Consolidated Radio Prod. Co., 361 W. Superior St., Chicago, Ill.																													
Consolidated Wire & Assoc. Corps., 312 S. Peoria St., Chicago, Ill.																													
Continental Carbon Inc., 13922 Lorain Ave., Cleveland, Ohio	Continental, Filterneys																												
Continental Diamond Fibre Co., Newark, N. J.																													
Continental Elec. Co., St. Charles, Illinois																													
Cornell Dupilier Corp., S. Plainfield, N. J.	C-D																												
Cornish Wire Co., Inc., 30 Church St., New York, N. Y.	Corwico																												
Coto Coil Co., Providence, R. I.																													
Crowe Name Plate & Mfg. Co., 3701 Ravenswood Ave., Chicago, Ill.	Crowe																												
H. L. Crowley & Co., Inc., 1 Central Ave., W. Orange, N. J.																													
Curtis Condenser Corp., 3088 W. 106th St., Cleveland, Ohio																													
Cutler-Hammer Mfg. Co., Milwaukee, Wis.																													
Daven Co., The, 158 Summit St., Newark, N. J.	Daven																												
DeAdco Products Co., 1665 N. Monticello, Chicago, Ill.	De Jong																												
DeJr Ameco Corp., Shelton, Conn.																													
Dongan Electric Mfg. Co., 2987 Franklin St., Detroit, Mich.																													
Drake Mfg. Co., 1713 W. Hubbard St., Chicago, Ill.	Drake																												
Dumont Elec. Co., 514 Broadway, New York, N. Y.	Deco Dumont																												

PARTS (continued)

Directory

Directory

MANUFACTURERS	TRADENAMES	Coils		Condensers			Resistors			Volume Controls		Tone Controls		Sockets		Switches		Transformers		Vibrators	Wire	Cables	Plugs	Dials — Knobs	Insulation	Flexible-Shafts	Remote Controls	Miscellaneous	
		RF	IF	Choke	Variable	Mica	Paper	Electrol.	Fixed	Adjustable	Suppressor	Line Cords	Volume Controls	Power	Circuit *	Audio	Power												
Eby, Inc., 2068 Hunting Park Ave., Philadelphia, Pa.	Eby																												
Economy Condenser Corp., 3033 N. Puluski Rd., Chicago, Ill.																													
Eddie Manufacturing Co., 235 N. Racine Ave., Chicago, Ill.																													
Electrad, 3029 E. Washington St., Indianapolis, Ind.																													
Electrom vs Mfg. Co., Inc., 787 E. 140th St., New York, N. Y.																													
Electronic Lab. Vores, Inc., 122 W. N. Y. Ave., Indianapolis, Ind.																													
Ernie Resistor Corp., 644 W. 12th St., Erie, Pa.	Ernie Ceramicon				(4)																								
Fast & Co., John E. 3115 N. Puluski Rd., Chicago, Ill.																													
Federal Instruments Corp., 325 Clason Ave., Brooklyn, N. Y.																													
Ferranti Elec. Inc., 30 Rockefeller Plaza, New York, N. Y.																													
Filtermatic Mfg. Co., 6913 Duman St., Philadelphia, Pa.																													
Flechtman & Co., Inc., 692 Broadway, New York, N. Y.																													
Franklin, A. W., Mfg. Corp., 175 East 24th St., New York, N. Y.	Franklin, Universal																												
Franklin Transformer Mfg. Co., 67, 22d Ave., Minneapolis, Minn.																													
Freed Transformer Co., 72 Spring St., New York, N. Y.	Freed																												
Gaylord Mfg. Co., 605 W. Washington St., Chicago, Ill.																													
Gen. Instrument Corp., 829 Newark Ave., Elizabeth, N. J.																													
General Mfg. Co., 806 S. Chicago Ave., Chicago, Ill.	Gen-Ral				(5)																								
Gen. Transformer Corp., 490 S. 1st St., Chicago, Ill.																													
General Winding Co., 214 Fulton St., New York, N. Y.																													
Gen-E-Rotor, 808 E. 105th St., Des Moines, Iowa, N. Y.																													
Girard Continental Corp., 2341 Wolfram St., Chicago, Ill.																													
Girard Copakins, 1487 23rd St., Oakland, Calif.																													
Globe Corp., Niagara Falls, N. Y.																													
GM Laboratories, Inc., 1735 Belmont Ave., Chicago, Ill.																													
Grey Products Co., 19 Academy St., Paughkeepsie, N. Y.																													
Guthman & Co., Inc., Edwin I., 400 S. Peoria St., Chicago, Ill.	Guthman				(5)																								
Halderson Co., 4500 Ravenswood Ave., Chicago, Ill.																													
Hammond Mfg. Co., 424 W. 33rd St., New York, N. Y.																													
Hess Electr. & Mfg. Co., 805 E. Monroe St., Springfield, Ill.																													
Hertz and Kaufman, Ltd., South San Francisco, Calif.	Heintz & Kaufman				(8)																								
Howard Radio Co., 1735 Belmont Ave., Chicago, Ill.	Howard																												
Illinois Condenser Co., 3352 W. North Ave., Chicago, Ill.																													
Inca Mfg. Co., Ft. Wayne, Ind.																													
Insuline Corp. of America, 25 Park Pl., New York, N. Y.	I. C. A.																												
International Radio Corp., Ann Arbor, Mich.	Kadette-International																												
International Resistor Co., 401 N. Broad St., Philadelphia, Pa.																													
Internat. Transformer Co., 39 W. 20th St., New York, N. Y.																													
Icelandite, Inc., 233 Broadway, New York, N. Y.																													
J. F. D. Mfg. Co., 4111 Ft. Hamilton Pky., Brooklyn, N. Y.	J. F. D.				(9)																								
Jefferson Electric Co., 900 25th Ave., Bellwood, Ill.																													
Johnson Co., E. F. Waseca, Minn.	Johnson				(9)																								
Jones, H. B., 2300 Wabasha Ave., Chicago, Ill.																													
Kellogg Switchboard & Supply Co., 1066 W. Adams St., Chicago, Ill.																													
Kenyon Transformer Co., 840 Barry St., New York, N. Y.																													
Fred M. Link, 125 W. 17th St., New York, N. Y.																													
Lectrohm, Inc., 5133 W. 25th Pl., Cicero, Ill.	Lectrohm																												(11)
Leoline Radio Co., 63 Dey St., New York, N. Y.																													(12)
Lifetime Corp., The, 1010-1012 Madison Ave., Toledo, Ohio.	Lifetime																												
Lynch Mfg. Co., 33 N. Ave., Cranford, N. J.																													
Magnavox Co., 2131 Bueter Rd., Fort Wayne, Ind.																													
Mallory, P. R. & Co., Inc., 3029 E. Wash. St., Indianapolis, Ind.	Mallory, Yaxley																												(13)
Meissner Mfg. Co., Mt. Carmel, Ill.	Meissner																												
Melburn Mfg. Co., 2218 S. Hoover St., Los Angeles, Calif.																													
Micamold Products Corp., 1087 Flushing Ave., Brooklyn, N. Y.																													
Micarta Fabricators, Inc., 4619 Ravenswood Ave., Chicago, Ill.																													
Miles Reproducer Co., Inc., 812 Broadway, New York, N. Y.																													
J. W. Miller Co., 6917 S. Main St., Los Angeles, Calif.	Miller																												
Morrill & Morrill, 30 Church St., New York, N. Y.																													
Mutter Co., 1245 S. Michigan Ave., Chicago, Ill.																													
Mycolex Corp. of America, 101 W. 31st St., New York, N. Y.	Muter				(15)																								

MANUFACTURERS	TRADE NAMES	Coils		Condensers			Resistors		Line Cords	Volume Controls	Tone Controls	Sockets	Switches		Vibrators	Wire	Cables	Plugs	Dials — Knobs	Insulation	Flexible-Shafts	Remote Controls	Miscellaneous
		RF	IF	Choke	Variable	Mica	Paper	Electrol.					Fixed	Adjustable									
National Co., Malden, Mass.	National	•	•	•	•	•	•	•	•	•	•	•	•	•	•	•	•	•	•	•	•	•	•
National Union Radio Corp., 57 State St., Newark, N. J.	National Union	•	•	•	•	•	•	•	•	•	•	•	•	•	•	•	•	•	•	•	•	•	•
Nordendale Mfg. Co., 2100 Fulton St., Chicago, Ill.		•	•	•	•	•	•	•	•	•	•	•	•	•	•	•	•	•	•	•	•	•	•
Norwalk Eng. Co., S. Norwalk, Conn.		•	•	•	•	•	•	•	•	•	•	•	•	•	•	•	•	•	•	•	•	•	•
Oak Mfg. Co., 711 W. Lake St., Chicago, Ill.	Oak	•	•	•	•	•	•	•	•	•	•	•	•	•	•	•	•	•	•	•	•	•	•
Ohio Carbon Co., 12508 Herea Rd., Lakewood, Ohio		•	•	•	•	•	•	•	•	•	•	•	•	•	•	•	•	•	•	•	•	•	•
Ohmrite Mfg. Co., 4835 W. Flournoy St., Chicago, Ill.	Ohmrite	•	•	•	•	•	•	•	•	•	•	•	•	•	•	•	•	•	•	•	•	•	•
Oxford-Tartak Radio Corp., 215 W. Van Buren, Chicago, Ill.	Oxford	•	•	•	•	•	•	•	•	•	•	•	•	•	•	•	•	•	•	•	•	•	•
Pauley-James Corp., 4619 Ravenswood Ave., Chicago, Ill.	Vibrapour	•	•	•	•	•	•	•	•	•	•	•	•	•	•	•	•	•	•	•	•	•	•
Philco Dodge Corp., Fort Wayne, Ind.	Philco	•	•	•	•	•	•	•	•	•	•	•	•	•	•	•	•	•	•	•	•	•	•
Philco Radio & Television Corp., Toga & C. Sts., Philadelphia, Pa.		•	•	•	•	•	•	•	•	•	•	•	•	•	•	•	•	•	•	•	•	•	•
Portland Products, Inc., Findlay, Ohio		•	•	•	•	•	•	•	•	•	•	•	•	•	•	•	•	•	•	•	•	•	•
Potter Condenser Co., 1650 Sheridan Rd., N. Chicago, Ill.		•	•	•	•	•	•	•	•	•	•	•	•	•	•	•	•	•	•	•	•	•	•
Preceptor Mfg. Co., 179 Minna St., San Francisco, Calif.		•	•	•	•	•	•	•	•	•	•	•	•	•	•	•	•	•	•	•	•	•	•
Precision Resistor Co., 334 Badger Ave., Newark, N. J.	Microhim	•	•	•	•	•	•	•	•	•	•	•	•	•	•	•	•	•	•	•	•	•	•
Radlart Corp., Shaw Ave. & 133rd St., Cleveland, Ohio		•	•	•	•	•	•	•	•	•	•	•	•	•	•	•	•	•	•	•	•	•	•
Radio City Products Co., 55 Park Pl., New York, N. Y.	Dependable	•	•	•	•	•	•	•	•	•	•	•	•	•	•	•	•	•	•	•	•	•	•
Raytheon Mfg. Co., 190 Willow St., Waltham, Mass.	Re-Fone	•	•	•	•	•	•	•	•	•	•	•	•	•	•	•	•	•	•	•	•	•	•
Re-Fone Co., 4105 Broadway, Oakland, Calif.		•	•	•	•	•	•	•	•	•	•	•	•	•	•	•	•	•	•	•	•	•	•
RCA Manufacturing Co., Camden, N. J.	RCA	•	•	•	•	•	•	•	•	•	•	•	•	•	•	•	•	•	•	•	•	•	•
Rivard Wire & Cable Corp., 1014 Madison Ave., Toledo, Ohio	Rivard	•	•	•	•	•	•	•	•	•	•	•	•	•	•	•	•	•	•	•	•	•	•
Robertson Davis Co., 311 N. Desplaine St., Chicago, Ill.		•	•	•	•	•	•	•	•	•	•	•	•	•	•	•	•	•	•	•	•	•	•
Sangamo Elec. Co., 1301 N. 11th St., Springfield, Ill.		•	•	•	•	•	•	•	•	•	•	•	•	•	•	•	•	•	•	•	•	•	•
J & L Sara Co., 123 Liberty St., New York, N. Y.		•	•	•	•	•	•	•	•	•	•	•	•	•	•	•	•	•	•	•	•	•	•
Scoville Mfg. Co., 90 Mill St., Waterbury, Conn.		•	•	•	•	•	•	•	•	•	•	•	•	•	•	•	•	•	•	•	•	•	•
Severson Magneto Engineering Co., 379 Phillips Ave., Toledo, Ohio		•	•	•	•	•	•	•	•	•	•	•	•	•	•	•	•	•	•	•	•	•	•
Shallross Mfg. Co., Park Ave., Collingdale, Pa.		•	•	•	•	•	•	•	•	•	•	•	•	•	•	•	•	•	•	•	•	•	•
Sheet Metal Specialty Co., 1417 W. Pico St., Los Angeles, Calif.		•	•	•	•	•	•	•	•	•	•	•	•	•	•	•	•	•	•	•	•	•	•
Sickles Co., 300 Main St., Springfield, Mass.		•	•	•	•	•	•	•	•	•	•	•	•	•	•	•	•	•	•	•	•	•	•
Solar Mfg. Corp., 599-601 Broadway, New York, N. Y.	Solar	•	•	•	•	•	•	•	•	•	•	•	•	•	•	•	•	•	•	•	•	•	•
Speer Carbon Co., Theresa St., St. Marys, Pa.	Speer	•	•	•	•	•	•	•	•	•	•	•	•	•	•	•	•	•	•	•	•	•	•
Sprague Products Co., North Adams, Mass.		•	•	•	•	•	•	•	•	•	•	•	•	•	•	•	•	•	•	•	•	•	•
Stackpole Carbon Co., Tannery St., St. Marys, Pa.		•	•	•	•	•	•	•	•	•	•	•	•	•	•	•	•	•	•	•	•	•	•
Standard Electrical Products Co., 1500 N. Halstead St., Chicago, Ill.		•	•	•	•	•	•	•	•	•	•	•	•	•	•	•	•	•	•	•	•	•	•
Standard Transformer Corp., 850 Blackhawk St., Chicago, Ill.		•	•	•	•	•	•	•	•	•	•	•	•	•	•	•	•	•	•	•	•	•	•
Star Machine Mfgs., Inc., 1371-1379 East Bay Ave., Bronx, N. Y.	Star	•	•	•	•	•	•	•	•	•	•	•	•	•	•	•	•	•	•	•	•	•	•
Stromberg-Carlson Tel. Mfg. Co., 100 Carlson Rd., Rochester, N. Y.	Stromberg-Carlson	•	•	•	•	•	•	•	•	•	•	•	•	•	•	•	•	•	•	•	•	•	•
Teledio Eng. Corp., 484 Brooms St., New York, N. Y.		•	•	•	•	•	•	•	•	•	•	•	•	•	•	•	•	•	•	•	•	•	•
Thorndson Elec. Mfg. Co., 500 W. Huron St., Chicago, Ill.	Thornderson	•	•	•	•	•	•	•	•	•	•	•	•	•	•	•	•	•	•	•	•	•	•
Tilton Elec. Corp., 15 E. 26th St., New York, N. Y.		•	•	•	•	•	•	•	•	•	•	•	•	•	•	•	•	•	•	•	•	•	•
Tobe Deuschmann Corp., Canton, Mass.	co-X	•	•	•	•	•	•	•	•	•	•	•	•	•	•	•	•	•	•	•	•	•	•
Transducer Corp., 30 Rockefeller Pl., New York, N. Y.	Triumph	•	•	•	•	•	•	•	•	•	•	•	•	•	•	•	•	•	•	•	•	•	•
Triumph Mfg. Co., 1770 W. Berceau Ave., Chicago, Ill.		•	•	•	•	•	•	•	•	•	•	•	•	•	•	•	•	•	•	•	•	•	•
Triumph Mfg. Co., 4017 W. Lake St., Chicago, Ill.		•	•	•	•	•	•	•	•	•	•	•	•	•	•	•	•	•	•	•	•	•	•
Ultramar Mfg. Corp., 1160 Howe St., Chicago, Ill.		•	•	•	•	•	•	•	•	•	•	•	•	•	•	•	•	•	•	•	•	•	•
United Scientific Labs, Inc., 62 W. 14th St., New York, N. Y.		•	•	•	•	•	•	•	•	•	•	•	•	•	•	•	•	•	•	•	•	•	•
United Transformer Corp., 72 Spring St., New York, N. Y.		•	•	•	•	•	•	•	•	•	•	•	•	•	•	•	•	•	•	•	•	•	•
Universal Dashboard Controls, 21-07 40th Ave., Long Island City, N. Y.		•	•	•	•	•	•	•	•	•	•	•	•	•	•	•	•	•	•	•	•	•	•
Universal Microphone Co., Ltd., Inglewood, Calif.	Universal	•	•	•	•	•	•	•	•	•	•	•	•	•	•	•	•	•	•	•	•	•	•
Utah Radio Products Co., 820 Orleans St., Chicago, Ill.	Utah	•	•	•	•	•	•	•	•	•	•	•	•	•	•	•	•	•	•	•	•	•	•
Victory Mfg. Co., Inc., 2021 S. Mich. Ave., Chicago, Ill.		•	•	•	•	•	•	•	•	•	•	•	•	•	•	•	•	•	•	•	•	•	•
Ward Leonard Elec. Co., Mt. Vernon, N. Y.	Ward-Leonard	•	•	•	•	•	•	•	•	•	•	•	•	•	•	•	•	•	•	•	•	•	•
Water-town Mfg. Co., Echo Lake Rd., Watertown, Conn.		•	•	•	•	•	•	•	•	•	•	•	•	•	•	•	•	•	•	•	•	•	•
Webster Electric Co., Racine, Wis.	Webster Elec.	•	•	•	•	•	•	•	•	•	•	•	•	•	•	•	•	•	•	•	•	•	•
Wirt Co., 6221 Greene St., Philadelphia, Pa.		•	•	•	•	•	•	•	•	•	•	•	•	•	•	•	•	•	•	•	•	•	•
S. S. White Dent. Mfg. Co., Ind. Div., 10 E. 40th St., New York, N. Y.	S. S. White	•	•	•	•	•	•	•	•	•	•	•	•	•	•	•	•	•	•	•	•	•	•
White Wind Elec. Co., 2300 E. Douglas Ave., Wichita, Kans.		•	•	•	•	•	•	•	•	•	•	•	•	•	•	•	•	•	•	•	•	•	•
Wholesale Radio Service Co., 100 Sixth Ave., New York, N. Y.		•	•	•	•	•	•	•	•	•	•	•	•	•	•	•	•	•	•	•	•	•	•
Willard Storage Battery Co., 246-256 E. 131st St., Cleveland, Ohio	Willard	•	•	•	•	•	•	•	•	•	•	•	•	•	•	•	•	•	•	•	•	•	•
Yaxley Div., P. R. Mallory & Co., Inc., 3029 E. Wash. St., Indianapolis, Ind.		•	•	•	•	•	•	•	•	•	•	•	•	•	•	•	•	•	•	•	•	•	•

(14) Terminal Strips, Dial Light Sockets, Coil Forming Grid Caps
 (15) Ballast Resistors
 (16) Attenuators and Rheostats

(10) Trimmer
 (11) Core Assemblies, Field Coils and Cast Parts
 (12) Microphones and Speaker Diaphragms
 (13) Grid Bias Cells, Delay Discs, Rectifiers, Dial and Panel Lights, Attenuators, Radio Outlets

(5) Trimmers and Padders
 (6) Relay
 (7) Generator
 (8) Compressed Nitrogen
 (9) For Transmitters



The Name
**THAT MEANS A
 SATISFIED
 CUSTOMER**

Because

we affix the name "UTAH" onto the shield of every replacement vibrator we make. It is your guarantee that we back the performance of that vibrator **permanently**—and your assurance that you are using the vibrator that will back up your service claims.

You know that UTAH pioneered vibrators. You know that present UTAH vibrator designs are as far ahead as our first vibrator was ahead of "B" batteries. You know all about the superiorities of the flat frame, the tapered reed and the short leads. And that name on the shield is your guarantee that the vibrator inside will always be the best that money can buy.

Your parts jobber can supply you.

UTAH

**RADIO PRODUCTS CO.
 CHICAGO • CABLE: UTARADIO
 "DEPENDABLE SINCE 1922"**

CLAROSTAT

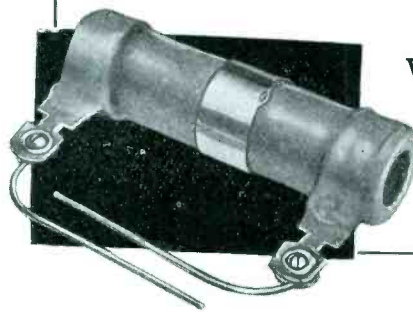

WIRE-WOUND
Power
 RESISTORS

Green finish for ready identification.

Inorganic cement coated. No blistering or cracking even at red heat.

Varnish coated for extreme humidity applications.

Soldering lugs and 1/2" pigtail leads.

5, 10 and 20 watts. 1 to 50,000 watts.

• Provably better wire-wound power resistors just released after most exhaustive tests by our engineers. Set entirely new standard of performance and life. Fully worthy of the CLAROSTAT name.

Ask for these new power resistors. Visit us at the Show, 208 Steinmetz Ave., or write direct for latest data and Service Manual.

CLAROSTAT
 MANUFACTURING CO.
 Incorporated
 285 North Sixth St.
 Brooklyn, N. Y.

**LOW
 PRICE**

...is only one reason why
**YOU'LL SELL LOTS OF
 THESE RCA MIKES!**

RCA JUNIOR VELOCITY MICROPHONE



Recommend this mike to those who want the best at low cost. It's the finest popular priced microphone RCA has ever created. Provides peak performance, is attractive, and offers the rugged construction and long life of RCA Velocity Microphones. Alnico magnets are used to provide exceptionally high signal-to-noise ratio. Is adaptable to most input circuits because of three output impedances. And it costs only \$43.50 list, less stand.

RCA AERODYNAMIC MICROPHONE



Here's a P. A. winner! It costs only \$26.50 list, less stand. Is so small it can be easily carried in the palm of your hand. Yet has quality features including excellent frequency response, fine tone and high sensitivity. Is used to good advantage for close talking. Has new Alnico permanent metal magnet. Requires no external excitation of power.

See your nearest RCA Commercial Sound Distributor for the new RCA Sound Catalog, or write direct to the address below.

ANY SOUND SYSTEM SOUNDS BETTER EQUIPPED WITH RCA RADIO TUBES

RCA presents the "Magic Key" every Sunday, 2 to 3 p.m., E.D.T., on NBC Blue Network



Commercial Sound

RCA MANUFACTURING CO., INC., CAMDEN, N. J.
 A Service of the Radio Corporation of America

NEWS

82 Per Cent Of Families Have Sets

Joint Committee saturation estimate nearly matches *Radio Retailing's* January figure

NEW YORK—The number of radio families in the United States, as of January 1, 1938 is estimated at 26,666,500, or 82 per cent of the total number of families by the Joint Committee on Radio Research, sponsored by the American Association of Advertising Agencies, Association of National Advertisers and National Association of Advertisers and National Association of Broadcasters.

Just released, the Joint Committee estimate regarding saturation is substantially the same as *Radio Retailing's* estimate of 81.99 per cent, published in the January, 1938 statistical number.



DIRECTOR ARTHUR MOSS—
Of Solar



DIRECTOR S. N. SHURE—
Of Shure Brothers

Four reasons Why Parts Show Plans Clicked

Philco Predicts Business Rise

Carpenter, Brown, Ramsdell voice concern's pre-season optimism

PHILADELPHIA—The replacement tube business may have a banner year during 1938, according to C. E. Carpenter, head of Philco Radio and Television Corporation's tube division. Within the past three months, according to Carpenter, Philco tube business has exceeded all expectations and has been moving with a consistently upward trend. Leading company division tube sales at this writing are the New York, Atlantic, and Pacific divisions, with the Central division close behind.

Speaking before the International Association of Sales Executives late last month, Harry Boyd Brown, Philco merchandising manager, pointed out that an unparalleled chance to achieve pre-eminence in the retail radio field existed because of the low ebb of the spirit of competition. Said Brown: "There is a golden opportunity for the business man who is wide-awake enough and courageous enough to push his business for all it is worth."

Returning from a cross-continent trip, Sayre M. Ramsdell, vice president of Philco, advises that the Pacific Coast may very well be the pivotal point for general business recovery. According to Ramsdell,



DIRECTOR H. OSMUN—
Of Centralab



DIRECTOR A. A. BERARD—
Of Ward-Leonard

the recession has made no appreciable dent in general business in California and on the West Coast. He expresses himself as especially surprised at the difference in attitude among business men there and those in the East.

New Utah Export Man

CHICAGO—Harry J. Scheel, at one time export manager for Grigsby-Grunow, has been appointed export sales manager for Utah Radio Products.

RCA Official Predicts Good Year

Bonfig says he thinks company sales will top last season

ATLANTIC CITY, N. J.—Optimism for the radio industry was expressed May 19 by Henry C. Bonfig, commercial vice-president of the RCA Manufacturing Company, who said that his Company anticipates a volume of business for the 1938-39 season which will at least equal that of last year, the best the Company has enjoyed since 1932. Bonfig spoke at the opening session of a convention of radio wholesalers and salesmen at Haddon Hall.

Convention delegates, from all points on the Eastern Seaboard and from a dozen foreign countries, were entertained at a three-day conclave which included an advance showing of more than 40 new RCA Victor radio and phonograph-radio combination instruments. David Sarnoff, president of the Radio Corporation of America, made an address at the convention banquet May 20.

Bonfig told the delegates that whereas last year automatic electric tuning was first introduced in radios costing \$150 and more, in the new 1938-39 instruments that feature has been incorporated in almost all the models, including two auto radios.

"There are about 31,000,000 manually tuned radios in use today," he told the convention. "These represent a potential replacement market. Automatic electric tuning insures greatly increased radio enjoyment, both in ease of tuning and in the scientific accuracy with which it is now possible to tune a radio automatically."

Other speakers were Robert Shannon, vice-president and general manager; Paul C. Richardson, manager of the radio and phonograph division, and Thomas F. Joyce, advertising and sales promotion manager.



ON HIS FEET—RCA vice president H. C. Bonfig outlines the merits of the new console-grand models at the company's Atlantic City convention May 19

Webster Electric At Show In Force

RACINE, WISC.—The Webster Electric Company, maker of sound equipment, plans to attend the Parts Show at the Hotel Stevens in force.

A breakfast for company reps and staff officers will be held for discussion of plans, policies, advertising programs, new products on the morning of June 9.

Representatives and Webster Electric jobbers from out of town expected include: Norman B. Neely of Hollywood; Jas. J. Backer of Seattle; J. Y. Schoonmaker of Dallas; J. P. Kay of Tulsa; N. B. Delavan of Des Moines; Blair H. Parker from New England; Frank A. Baumgarten of Pittsburgh; J. B. Higgins of Detroit; Murphy & Cota representative from Atlanta; Arthur Rocke, L. A. DeBarros and

J. E. Nestell from the Rocke International Corporation.

Representatives on deck will include: L. H. Mings from New York, J. A. Wherry from New Orleans, Martin Friedman from Philadelphia, W. T. Croysdill from Buffalo, L. C. Kohn from Omaha and C. G. Curry from Indianapolis.

Kadette Brings Out Shaver

ANN ARBOR, MICH.—The International Appliance Company, a division of the International Radio Corporation, has perfected a new popular priced electric shaver, called the "Glide Shaver," which will be released to dealers this month.

The Glide Shaver retails at \$7.50, and will be sold under a Fair Trade Agreement to dealers selected by the International Appliance Company on a charter franchise plan. The new shaver is available in three attractive colors, and will carry a two years complete servicing and overhauling guarantee to be done by the company at a nominal charge.

The cutting head of the new shaver has a moving blade with beveled edges which provides a shearing action that shears off the beard. This blade is made of hardest tool steel that holds its edge months longer than ordinary steel, and because of the new design the head is self-sharpening, thereby improving with use. The outer or stationary blade is constructed to smooth out the skin and hold the hairs erect so that they may be easily and cleanly sheared close to the skin.

W. Keene Jackson, sales manager, plans to attend the Radio Parts Manufacturers National Trade Show to be held June 8 to 11 at the Stevens Hotel, Chicago. He will introduce the Glide Shaver to dealers already acquainted with the "Kadette" radio.



LITTLE SETS FOR BIG BATTERS—Jack Ross, president of Detrola, presents "Pee-Wee" models to Mickey Cochrane of the Detroit Tigers and his players while sales manager Jim Davin looks on

Howard's Ham Sets Shown

CHICAGO—The Howard Radio Company announces for the first time its participation in the Radio Parts Show at the Hotel Stevens, Chicago, June 8th to 11th. The new "Howard" Communication receivers will be on exhibit in space #214 Marconi Street, in the Exhibition Hall.

In addition to the twelve-tube model "450" Amateur receiver, the new model "440" will be shown for the first time. This new receiver employing eight-tubes will be priced considerably lower than the "450".

In conjunction with the Parts Show, the company will also exhibit its new line of household radio receivers for 1939. This exhibit will be across the street at the Hotel Blackstone. All sales representatives and executives will be on hand at the Blackstone or the Stevens, during the entire period of the Show, and have set aside June 9th, as the day for the official Distributors Luncheon and Sales Meeting. A complete new line, compact in size, will be announced at that time.

Eastern Parts Men Stage All Day RMA Party At Sound View Golf Club

ON THE GREENS

Playing the practice green proved strenuous enough for *Charlie Golenpaul* of Aerovox, who missed this three-foot putt

Despite a bellyache *John Rider*, who turned in a good score, insisted upon retrieving his own shots and sparing the caddy (extreme right)



POST-MORTEM

Hygrade-Sylvania's *Paul Ellison* seemed much concerned over his score, spent an interested half-hour comparing notes

Sam Ruttenberg of Amperite (extreme right) must have had trouble on the short ones for he practiced on the 18th green after finishing his round



TO THE SHOWERS

Grateful for the cooling spray down in the locker rooms was *Eddie Metzger*, who knows the variable condenser business

Perspiration gone, *Vic Mucher* of Clarostat prepares for dinner after a strenuous foursome with three radio credit men (extreme right)



GAMES AGAIN

Out under the trees were little metal tables, many men we know, an innocent-looking game we used to think we knew

You can't stay on the outside looking in. The two gentlemen (extreme right) in the foreground, as you can see, eventually moved over to the next table



HERE'S YOUR BIG PROFIT LINE FOR SUMMER Mr. Radio Dealer!

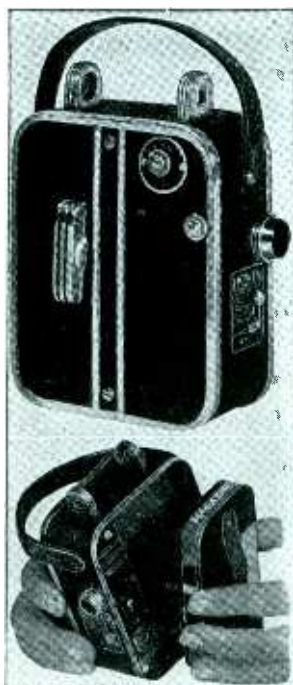

Every radio dealer can share in the profits from the sale of cameras. There is no recession to the sale of cameras . . . every sales report proves that the demand is increasing . . . and the radio dealer has the logical "set-up" to cash in on this consumer demand.

Feature the Sensational

IRWIN MAGAZINE LOADING
16mm Movie Camera
\$12.95

That lists for only for AC
Picture 4 times as large as 8mm
LOWEST 16mm FILM COST

No other 16 mm movie camera selling for less than \$60.00 combines such important selling features: LOW LIST PRICE! LOW MAINTENANCE COST! QUALITY PERFORMANCE! SIMPLEST TO OPERATE! TAKE LIFE-LIKE COLORED MOVIES! MAGAZINE LOADING! BEAUTIFUL APPEARANCE!

It's the greatest buy on the market!

**Irwin 8 and 16mm Zephyr
Air Conditioned \$18.95
PROJECTORS**

NATIONWIDE PROCESSING SERVICE

Deluxe Model for AC-DC Operation \$22.50

The finest low-priced 8 and 16 mm Projectors on the market. Possesses all the features found on projectors selling for twice their price. Rugged in construction, excellent in performance and professional in appearance. Just the item to turn summer losses into profits.

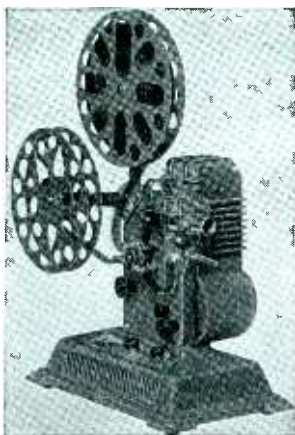

JOBBERS! DISTRIBUTORS!

Irwin has an interesting proposition for you . . . your letter will bring full details promptly

IRWIN CORPORATION

33 West 20th St. New York, N. Y.



GE UNVEILERS—(Top) *Ernie Vogel*, manager of GE's radio sales division, opens the firm's distributor's convention at Bridgeport. (Bottom) *W. R. G. "Doc" Baker*, managing engineer, brought a flock of charts to show how new models fit consumer pocketbooks

Kay Donates Show Bus

TULSA, OKLA.—In order to encourage jobbers from his territory to attend the Parts Show and to promote cooperation among these jobbers J. P. Kay of the Kay Sales Company sponsored a special bus to Chicago.

The bus, a luxury liner of 31 comfortable seats, left Tulsa Sunday noon, June 5, arrived at the Stevens 10 a.m. Monday morning. Jobbers who dealt with Kay during 1937 received one free round trip ticket for each \$5,000 worth of business on the record for that year.

New Rola Line

CLEVELAND—The Rola Company, Inc. expects to be ready with a new series of 5 inch speakers with 9/16 inch voice coils, in the popular price field, at last report was rushing production to make the Parts Show with an exhibit of these.

Arcturus Springs Midget Tubes

NEWARK—The Arcturus Radio Tube Company has introduced a new line of midget glass tubes. The following seven types are now available in the midget line, with others already in course of development: 6A8GT; 6K7GT; 6Q7GT; 6J7GT; 25A6GT; 25L6GT and 25Z6GT.

These new midgets are specifically designed for the currently popular small sets and may be used wherever space is at a premium. Electrical characteristics are identical with those of the same type numbers in "G" or metal tubes. The new Arcturus midgets range from a height of 2 1/4" to 3" depending upon the type. They are designed for use with standard octal sockets.

Still another development announced is a new line of glass ballast tubes in types most extensively used in AC-DC receivers. Additions to the line introduced within the past month or two bring the total of Arcturus ballast tube types to 38, with several additional types now being in course of production.

Miller Starts New Service

LOS ANGELES—The J. W. Miller Company has opened a separate coil repair department to meet the needs of servicemen for prompt and efficient service. The company's new department will make repairs or exact duplicates of defective radio frequency and intermediate frequency coils for any make of radio receiver. Most coils, according to the company, can be repaired in 24 hours, average repair cost is about \$1.50. Customers will be asked to send in remains of damaged coils, with shield, or shield dimensions.

Potter Upped By UM

DETROIT—W. N. Potter has been made vice-president and general sales manager of United Motors Service. C. B. Stiffler is president and general manager.

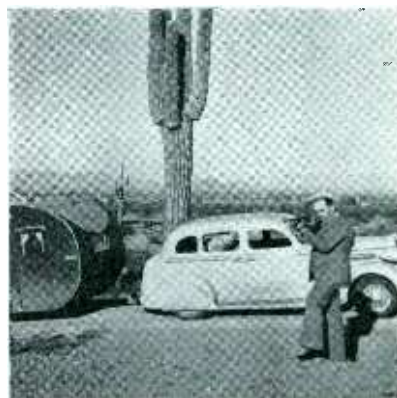

TRIUMPH—On the road representing Triumph Manufacturing and National Union in the Rocky Mountain states, *Francis M. Harvey* of Colorado Springs takes time out to knock over whatever they knock over out that way



"\$175 TO \$225"—Communicating System's 5-inch screen video television console, reported by this company to be ready for distribution

Television \$125

Low-priced units demonstrated to press by firm hitherto obscure said to be ready for market

NEW YORK—Demonstrated to the press late in May by vice-president Charles H. Sterenfeld and Louis W. Parker, chief engineer of Communicating Systems, Inc., 130 W. 56 Street, were two low-priced television receivers said to be available to the trade but not yet seen in any retailer's or wholesaler's stocks.

Two models were shown, demonstrated on Empire State test transmissions, both of them receiving pictures only, and not sound. (Separate sound track receivers, according to Sterenfeld, "might be sold for as little as \$15"). A table model video receiver in a cabinet 22 inches high will, according to this company, appear on the market at "about \$125." The picture appears on a 3-inch cathode ray tube. A console video receiver (illustrated) has 11 tubes, a 5-inch cathode ray screen, is to be priced at "between \$175 and \$225."

Webster-Chicago Meeting Planned

CHICAGO—John Erwood, vice-president of Webster-Chicago, advises that he will stage a meeting of his entire sales staff during the Parts Show. Place and time had not been announced when we went to press.

Neusch Ups At C.I.S.E.

NEW YORK—Roy Neusch has been advanced to the post of general sales manager in charge of the Transformer Corporation of America's Clarion Institute of Sound Engineers. Neusch has been associated with president Hubert L. Shortt of TCA since this company's inception, has been active in the sound re-inforcement field for many years.

Lunch For C-D Men

PLAINFIELD, N. J.—Cornell-Dubilier Electric Corporation, exhibiting at the Chicago Parts Show this month, will stage a luncheon and sales meeting during the affair. In attendance will be Octave Blake, president; Leon L. Adelman, sales manager of the jobber division; William M. Bailey, chief engineer; Paul McK. Deeley, chief engineer of the electrolytic division and Fred Neuberth, factory representative.

The following C-D representatives will be on deck: R. T. Perron, Taunton, Mass.; R. W. Mitscher, Buffalo; G. O. Tanner, Pittsburgh; H. A. Steinberg, New York; S. K. McDonald, Washington; James Millar, Atlanta; J. E. Muniot, Jr., New Or-

leans; Robert Campion, Dallas; W. Bert Knight, Los Angeles; R. C. James, Jr., Seattle; G. G. Moss, Denver; G. W. Piekens, St. Louis; R. Ritter, Chicago; H. E. Walton, Detroit; G. M. Cameron, Cleveland; Charles H. Caine, Chicago; D. S. Hill, Chicago and R. Becker, Chicago.

Kadette In Stevens

ANN ARBOR, MICH.—The International Radio Corporation will maintain an exhibit in Hotel Stevens rooms during the Parts Show this month, showing new "Kadette" receivers. W. Keene Jackson, general sales manager, and several territorial representatives will be on hand.



THE EXTRA MONEY

you make each week on the
NATIONAL UNION PLAN

is like

MONEY FOUND!

... do as thousands of
Service Engineers are
doing ... get **FREE EQUIP-**
MENT ... earn more money!

NEW! National Union "CERAMITE" Condensers

No Explosions! No Shorts! The new N.U. "Ceramide" ceramic shell Condensers are the "mighty" midjet electrolytics of the industry ... small in size but mighty in quality, performance and safety. You can rely on N.U. "Ceramites" as you have on other N.U. products. "Ceramites" have many scientific advantages you will appreciate. Buy Them—Try Them!

**They apply on FREE
EQUIPMENT contract
ASK YOUR JOBBER!**

You can benefit by the experience of thousands of your fellow Service Engineers who are cashing in on the National Union free equipment plan. These men have *proved* the plan is right. They're making more money because they can do more work, do it right. They are taking advantage of N.U. quality in tubes and condensers. They don't have to fear cut price 'dumping' of N.U. products. You should be growing with these men! Why don't you start now? It's easier than ever to cash in now that both National Union Tubes and Condensers apply on Free Equipment. Ask your jobber or send the coupon.

NATIONAL UNION TUBES and CONDENSERS

NATIONAL UNION THE ROAD TO BETTER BUSINESS

1. Full guarantee on highest quality radio tubes.
2. Cut price business not solicited.
3. Price Protection
4. N.U. jobber stocks are complete... No hunting for odd types.
5. Timely business building aids.

NATIONAL UNION RADIO CORP'N
57 State Street, Newark, N. J.

Who is the nearest N.U. jobber.....
Send me data on "Ceramites".....
Name
Address
City State



THE WILKINSON FAMILY—Into a new building of its own at 2406-08 Ross Avenue moves Dallas' Wilkinson Brothers early in June. The parts and sound distributor's personnel pictured: (Front row) *Elliott Wilkinson, Ruby Holcombrink, R. E. Gray, Billye Chrisman, L. H. Wilkinson.* (Back row) *C. F. Englehart, R. S. Benton, Jr., Noel McKey, S. Allen Baker, A. C. Marder, Jack Whitaker, W. F. Fox, Paul Gates*

NU, Now All In One City

NEWARK—Sales headquarters of the National Union Radio Corporation, formerly located at 570 Lexington Ave. in New York City, have been consolidated with the research and engineering headquarters of the company at 57 State Street, Newark.

The move, made on the decision of the firm's Board to centralize operations for greater efficiency, closer contact of all department heads, gives the sales department additional floor space. Located here will be S. W. Muldowny, R. H. VanDusen, J. H. Robinson, G. E. DeNike, F. M. Paret, J. J. Clune and Leroy Schenck.

New offices have also been developed for additional executives at 45 Spring St. Among those located at this office will be: H. R. Peters, H. G. Butterfield, Andrew A. Priest and R. E. Booth.

Additional manufacturing operations continue at 1181 McCarter Highway, also in Newark.

Direct wires to New York will be maintained so that the trade calling NU's existing New York number will be directly connected with Newark.

American Tele Moves

ST. PAUL, MINN.—American Television & Radio Company moved late in May to new and larger quarters at 300 East Fourth Street, this city.

Golfers Elect Officers

CHICAGO—The Radio Industries Golf Club of Chicago elected officers for the coming year at a dinner held recently at the Swedish Club. Fred Aylesworth, Crosley Distributing, is now president; Bill Tewksbury of Anaconda, vice-president; Norman P. Norlie of the Wilbur Driver

Company is treasurer and Oscar Holen of the Credit Clearing House (re-elected) secretary.

Plans were made at the meeting for the golf tournament to be held this month during the Parts Show.

Pauley-James Sales Rise

CHICAGO—From the Pauley-James Corporation of this city comes the report that sales of the James Vibrapower unit have risen sharply in the past two months, with more than 100 jobbers taking on the line since its initial promotion March 15.

Twelve new vibrator types have been added since the original 8 were introduced and all zinc container models have just been equipped with removable bases for still easier servicing.

Pauley-James exhibits this month at the Parts Show in Chicago, with a booth at 205 Ampere Street, Radio Parts City, in the Stevens Hotel.

Clarostat Goes 'Round

BROOKLYN, N. Y.—At the Clarostat booth at the Parts Show Vic Mucher and Eddie Trefz of the home office will be on hand to demonstrate the line, exhibited on a revolving display. Included will be a full line of new midget controls, a new fixed resistor.

Whole Aerovox Crew Goes West

BROOKLYN, N. Y.—Off to Chicago for the Parts Show are men of the Aerovox sales force. In Chicago in time for the opening will be: S. I. Cole, Charley Golenpaul, F. R. Ellinger, J. A. Simberkoff, C. H. Dolfuss, Jr., J. W. Beneke, W. C. Hitt, J. J. Backer, M. K. Franklin, H. Meinhard, J. P. Kay, G. G. Willison, B. Murphy, J. J. Cota, H. B. Parke, C. Heiner and F. J. Stevens.

New Stewart-Warner Sets Out

CHICAGO—Stewart-Warner introduced its 1939 line of radios at two sectional sales conferences arranged by radio and refrigerator division manager John F. Ditzell just at the May-June transition point. Distributors from the middle and far west saw the new merchandise at the Edgewater Beach Hotel, this city, May 31 and June 1. Those in the east gathered at the Ambassador, Atlantic City, June 6 and 7.

Stromberg Winners

ROCHESTER—Winners of Stromberg-Carlson's "General Manager's Week" sales drive for company representatives (directed by George A. Scoville and reported in the April issue) have been announced by sales manager L. L. Spencer, include: A. C. Barg, Chicago; J. A. Frye, Detroit; S. H. Manson, Rochester; J. S. Mills, New York; R. G. Bookless, San Francisco; Lawrence Loveless, Bath, N. Y.; L. H. McMillan, Chicago; Carl Erickson, Boston; J. E. McCauley, Pittsburgh and F. G. Cook, New Haven, Conn.



PHILCO PROMOTES EXECS—(Top) *Thomas A. Kennally*, sales manager for Philco Radio & Television, who has just been elected to the concern's board of directors. (Bottom) *William H. Grimditch*, in charge of Philco engineering, has been made a vice president, also elected to the board of directors

COR-NEX will steal the show!

(Booth 204—Marconi Blvd.)

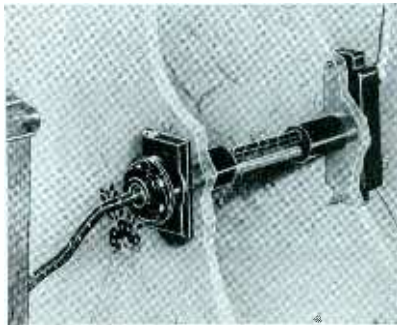

sponsors this amazing Connector for aerial and receiver, invented by a Service Man! Easily, quickly installed—profitable—revolutionary! Let us demonstrate at the Radio Parts Show—Money in YOUR pocket!

Cornish Wire Co., Inc.
30 Church Street
New York City

COMPLETE ELECTRIC PLANTS

NEW 1938 MODELS



OPERATE A.C. RADIO, PUBLIC ADDRESS, SOUND CAR, MOTION PICTURE EQUIPMENT AND RADIO TRANSMITTERS.

Also furnish power for Lights, Water Systems, all Household Appliances, for Camps, Farms, Lake Homes, or Standby Service. For use anywhere power is not available.

350 to 5000 Watts

110 volt A.C., 6, 12, 32 and 110 volt D.C., and Combination AC-DC Units. Anyone can Operate. Complete, ready to run.

Write for Details and Territory

D. W. ONAN & SONS
440 Royalston Ave. Minneapolis, Minn.

Janette Rotary Converters

Are Recommended By
PHILCO RADIO & TELEVISION CORPORATION
who is one of the many internationally known manufacturers who recommend Janette converters.

—TO ALL PHILCO DISTRIBUTORS—

"We have had a lot of experience with rotary converters used with radios and we recommend that you use Janette rotary converters . . . PHILCO radios will give entirely satisfactory performance with these converters" . . .

Why Experiment?—Insist on a JANETTE

Ask for bulletin No. 13-25

Janette Manufacturing Company

556-558 West Monroe Street Chicago, Ill. U.S.A.
BOSTON - NEW YORK - PHILADELPHIA - CLEVELAND - MILWAUKEE - LOS ANGELES
DETROIT - SEATTLE

What's Radio Retailing Say?

If you read it in RADIO RETAILING it is true—and timely.



That goes for both the editorial and the advertising contents of this, the radio industry's recognized leading publication!

RADIO RETAILING

330 W. 42d St., New York, N. Y.

ATR On Parade!!

See the ATR Exhibit 217 Henry Avenue at the Trade Show

D.C. - A.C. Inverters



AC CURRENT ANYWHERE!

Interference Free All-Wave Radio Operation. Improved Long Life ATR Vibrators of new design and construction having dual arms and using eight 3/4" diameter tungsten contacts assuring increased long life and reliable service. Four Point Voltage Regulators make possible the correct output voltage for input voltages which are lower or higher than normal. 32 Different Types for AC Input voltages ranging from 6 to 220 volts and having DC Output voltages of both 110 and 220 volts.

Vibrators



FOR AUTO AND FARM RADIOS

ATR Replacement Vibrators set new standards of performance and construction. Greater life and reliability made possible by new designs utilizing 3/16" diameter tungsten contacts. ATR Vibrators are proven units of the highest quality, engineered to perfection. They are backed by more than seven years of vibrator design and research, development and manufacturing.

"A" Eliminators



ESPECIALLY DESIGNED FOR

demonstrating and testing auto radio sets on regular AC lines, 105-125 volts, 50-60 cycles, has many other uses. Comes completely equipped with on-off Switch, Pilot Light Indicator, 10-ampere Fuse, Rubber Mounting Feet, 6-ft. Rubber Cord, Heavy Gauge Metal Cabinet. 4 Standard Models.

Battery Chargers



AUTOMATIC TAPERING

Keeps auto batteries fully charged. Operates from any 110 volt AC line. Current tapers as battery becomes charged. 2 Standard Models.

For Better Profits and More Sales . . . Line Up With ATR
AMERICAN TELEVISION AND RADIO CO.
ST. PAUL, MINN U. S. A. Cable "Likex" New York

A GOOD NAME GOES A LONG WAY



Tie in with Ken-Rad. Share the prestige of Ken-Rad's Good Name. It means better business and more complete customer satisfaction.

Ken-Rad Tube & Lamp Corp.
Owensboro, Ky.

KEN-RAD
DEPENDABLE RADIO TUBES

and only \$17.95

for this new Universal Push Button Tube Checker by

MILLION



- Direct Push Button Test
- New "Easy Reading" Scale
- Tests all Standard Tubes
- New Precision Design
- Looks like a Million

B-C-N-U at the SHOW!

Outstanding in performance, precision and design. Universal for all tubes with the convenience of direct "push button" readings.

MILLION RADIO AND TELEVISION LAB.
671 W. OHIO ST. CHICAGO, ILL.

NOW!
Compact... Flexible
60 WATT SOUND SYSTEM

FOR
 CROWDS IN
 EXCESS OF
 20,000
 PEOPLE



featuring:

MODEL FR60

- High Speed Expander • Remote Control • Dual Tone Compensation • Multi-Stage Degeneration • 4 Input Mixing Circuits • Variable Output Connections •

For those big jobs that used to look tough to handle such as ball parks, stadiums, arenas, amusement centers, comes this new Webster-Chicago 60-watt design. Compact and light in weight, it solves the big installation problems with the greatest of ease, even under the most trying conditions.

The dual tone compensation adapts the amplifier to a wide variety of acoustical conditions; the volume expander permits volume ranges heretofore unobtainable on phonograph reproduction; remote control permits monitoring the program from the audience. The unusually low inherent noise level in this amplifier despite its exceptional power output enables its use in smaller auditoriums with results that cannot be excelled.

Hear this unusual sound system at your jobbers. Write for more information and specifications.

New 1938-39 Catalog just off the press . . . send for free copy . . .

WEBSTER-CHICAGO

Manufactured under license arrangements with Electrical Research Products, Inc., subsidiary of Western Electric Co., Inc., and American Telephone and Telegraph Co.

WEBSTER-CHICAGO

Section JN-8 5622 Bloomingdale Ave., Chicago, Ill.

Please send me

- More information on Model FR60.
- Complete Catalog.

Name

Address

City.....

State.....

With the JOBBERS and REPS

STROMBERG-CARLSON — *Brown Supply* has this company's sound equipment line in the St. Louis area, in addition to sets bearing the same brand handled since last winter. Will distribute newly acquired sound equipment through retail outlets, according to vice president Fred Wiebe. Sales engineer Ken Gillespie will shoot especially at school installation.

ADMIRAL—J. H. Clippinger, vice-president of Continental Radio & Television Corporation, announces a still further territorial expansion for *Maurice Despres* and Associates of New York. The latest addition includes New England and Despres' field now includes greater New York, New York state and New England. Lew Dorfman and David Kopp are associated with this firm.

WEBSTER - CHICAGO — *Sam Egert*, popular New York sales representative, has been appointed representative for this line in the metropolitan New York territory.

DETROLA—New firms distributing this line include: *George A. Eberhard Co.* of San Francisco; *Watson and Wilson* of Los Angeles; *Hall-Young Co.* of Dallas. J. M. McNamara has been made Detrola divisional manager for the territory bounded by a line from Buffalo to Pittsburgh to Albany and from Bridgeport to Bangor as well as to Burlington, Vt.

WILCOX-GAY—New factory reps for this company are the *P. H. Eheling Co.* of Dallas and *Frank A. Baumgarten* of Pittsburgh.

ELECTRO - ACOUSTIC — *Dean A. Lewis*, headquarters in Kansas City, Mo., now has charge of Magnavox phonograph and combination sales throughout the southwest, including Kansas, Missouri, Oklahoma, Arkansas, Texas and northern Louisiana. Former connection . . . RCA since 1923.

PREMAX—*Bill Gold* of 53 Park Place, New York, has this line as sales rep in the metropolitan district, eastern Pennsylvania, New Jersey, Delaware, Maryland and the District of Columbia. *W. B. Pray*, 84 State, Boston, handles the entire New England territory on this line of masts, ground rods and other antenna accessories.

TUNG-SOL—*Herrlinger* Distributing Co. has moved to new and larger quarters at 1518 Race St., Cincinnati.

CROSLEY—*Ham Smith*, formerly with Alamo Dist. Corp., has accepted a position with Reader's Wholesale Distributors, Crosley distributor in Houston, Tex., as city representative. North Coast Elec. Co., Portland and Seattle, has been named distributor in Oregon and Washington.

FADA—*Ott-Heiskell Co.*, Wheeling, W. Va., is now handling this line in Wheeling and surrounding territory.



That's why we made the **NEW PREMAX STEEL ANTENNA** vertical . . .

Straight up and down—easy to erect in small space, this latest development in aerial design gives perfect world-wide reception. No overhead or unsightly guy wires—it's as modern as tomorrow!

Constructed of tubular steel which telescopes to 6-foot length. *Premax Safety Lock* permits erection to any height up to 24 feet. Comes complete, ready to install, with 4-section mast, steel ground post and insulator unit. Just the thing for slightly, efficient antenna erection.

Illustration shows ground type mounted with *RCA Antenna Coupling Unit* for use with *RCA Magic Wave Antenna*. Also available in roof type.

See It At The *Chicago Show*.

Ask your jobber or write today for prices and complete details

Made by



3842 Highland Ave., Niagara Falls, N. Y.

FAIRBANKS MORSE—The F-M line of radios and major appliances is now being distributed in Georgia and part of South Carolina by Peaslee-Gaulbert Corp., Atlanta; H. I. Sackett Elec. Co., Buffalo, N. Y., is serving the Buffalo area.

GIRARD-HOPKINS—The appointment of Loughnane & Co., Decatur, Ill., to cover Illinois, Ind. and Iowa has just been announced; H. C. Hipple, Philadelphia, will represent G-H in Pa., Del., Maryland, Dist. of Columbia, N. J., Virginia and New York.

TECH LABS—Segelsound, Inc., Gardner, Mass., has discontinued its manufacturing business and is specializing in the sale of sound equipment. It has just been appointed representative in New England for Tech Labs.

ANDREA—Wilmer (Bill) Trinkle has been made factory representative in eastern Pennsylvania, Delaware, Maryland and Virginia, headquartering at 1438 N. 13th St., Philadelphia.

MOTOROLA—Galvin Mfg. Co.'s Chicago distributor, the Jackson Distributing Co., has removed its offices, display rooms and warehouses to a new building at 1330 W. Washington Blvd.

PIERCE-AIRO—De Wald radios are now being distributed in Newark and surrounding territory by the New Jer-

sey Radio Distributing Co., Newark, which will handle this line exclusively.

ELECTRIC-MUSIC—*Rangertone, Inc.*, of 201 Verona Ave., Newark, N. J., has just published its first copy of "Rangertronics," a house-organ pertaining to the selling, installing of electric organs, electric chimes, electric recording instruments, public address systems.

MUELLER—Ben Joseph of 475 Fifth Ave., New York City, is now exclusive sales agent in New England, eastern Pennsylvania, New Jersey and eastern New York.

TOBE DEUTSCHMANN—Rowe Radio Research Laboratory Co., is Tobe's new technical sales representative for the Chicago area.

TURNER—Sam M. Harper, 53 Park Place, New York City, will handle New York City, Penna., Delaware, Maryland, Washington, D. C. and N. J.

MAJESTIC—*George H. Eberhard* has the line in the San Francisco area. *Watson and Wilson* take it over in Los Angeles.

WARD-LEONARD—State of Indiana is to be covered henceforward by *Charles D. Southern* of Fort Wayne.

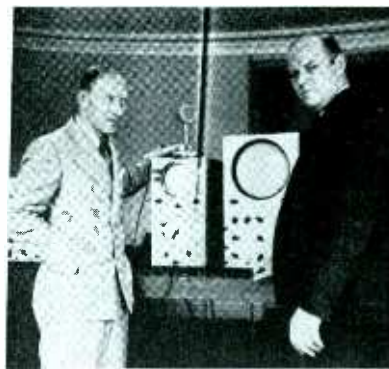

MONS. DUMONT—Perhaps it's the French-sounding name. Anyway, both *Allen B. DuMont* and his products are popular in France. The Upper Montclair manufacturer (right) talks with *M. Paul Fabricant*, head of "Radiophon"

Office For ElectroSound

CHICAGO — ElectroSound Products, Inc., has opened a distributing office and display room at 620 North Michigan, will feature "Radiotone" recording equipment. V. G. Geisel, vice-president who manages the new office, says there are several professional models, also three home models sold through music and radio dealers.

AIR KING RADIO

NEW "TUCK-IN" MODEL

Consistent leaders in the low priced radio field. Hundreds of live jobbers and dealers are now enjoying real profits by selling Air King radios.

All Air King sets are fully licensed under Radio Corporation of America, Hazeltine and Latour Patents.

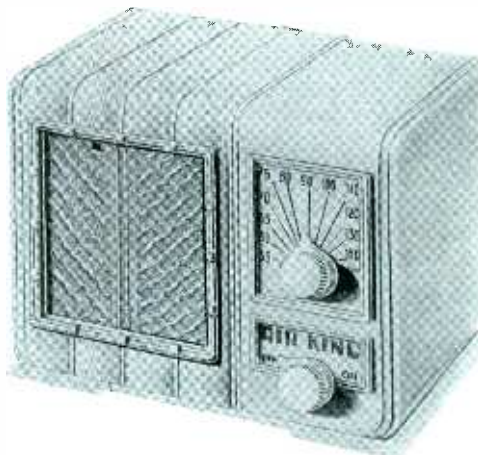

A number of good territories are now open for jobbers and sales representatives.

Illustrated — "Tuck-In" Model 222: full-size 5 inch dynamic speaker, Neo-Classic Moulded Cabinet, A.C.-D.C. Tubes: 6D6, 6C6, 25L6G, 25Z5. Colors: Walnut, Black, Ivory.

Visit our suite at the Blackstone Hotel, Chicago, during the radio show, June 8-11. Company executives will be available to discuss territories with representatives and distributors. Our full 1939 line will be on display.

Write or wire for literature and details.

AIR KING PRODUCTS CO., INC.

Established 1921

17-35 Hooper Street, Brooklyn, N. Y.

Phone: EVergreen 7-0580

Cable address: AIRKINGRAD, NEW YORK

Model Shop In Booth

EMPORIUM, PENNA.—On its way to the Parts Show, as this issue of *Radio Retailing* closed, was the "fixings" for a complete model service shop, to be installed by Hygrade-Sylvania in its booth at 204-206 Ampere St., Hotel Stevens.

Complete in every detail, including built-in bookcases, cabinets, instrument panels and tool drawers, the shop was designed at Emporium complete with windows containing company tube advertising helps, is considered ideal for the average operator of limited means, space.

JIM QUAM

Says



I've been getting more and more interested in Servicemen this last year and, by golly, those fellows use a lot of speakers. They've bought so many of ours from the parts jobbers, we've finally gotten up a real catalog showing all the replacement speakers we make and telling where we recommend using this one or that one. It covers all models from 4-inch to 12-inch in both Dynamics and P. M. Dynamics, and is really worth looking over. If your parts jobber hasn't already given you one, write me and I'll have one sent right out to you.

QUAM-NICHOLS CO.
 33rd Place & Cottage Grove CHICAGO 1674 Broadway NEW YORK



Handbooks, Catalogs, Guides

AMATEUR TUBE HANDBOOK—E. S. Riedel, general sales manager of the *Raytheon Production Corporation*, has just announced a new "Handbook of Amateur Tube Uses." This new handbook is an encyclopedia of technical information. Covered is modern transmitter design, with particular emphasis on tubes to fit each stage. Incorporated is a unique temperature color chart which permits the amateur to determine when his tubes are being operated properly merely by comparing the chart with the color of the tube's plate. Modulation, output impedance and L/C ratio, grid driving power, ratings, tube characteristics are all treated in separate chapters. The book is available from Raytheon distributors for 50 cents per copy.

TESTERS—A well illustrated and condensed catalog for 1938 may be obtained from the *Hickok Electrical Instrument Co.*, 10514 Dupont Ave., Cleveland, Ohio. Full line of radio testing equipment is shown.

TRANSFORMER-CHOKE GUIDE—*Standard Transformer Corp.* of 1500 N. Halsted St., Chicago, announced its "Stancor Service Guide" number 125, a 32-page manual containing accurate listings of over 2800 sets, showing transformers and chokes required for proper replacement. Material obtained from actual factory service notes and from all 8 Rider manuals. Includes much other valuable service information and is free to servicemen, available by request to jobbers or direct.

NEW ELECTROLYTIC BOOK—A new book, entitled "Electrolytic Capacitors," in which theory, construction, characteristics and applications are covered, has been written for *Cornel-Dubilier* by chief engineer Paul McKnight Deeley of the electrolytic division, is available from the South Plainfield, N. J. factory at \$3.

SALES BULLETIN—In the mails to distributors is Detrola's first news flash bulletin, to be issued weekly hereafter. Written by Jim Davin, sales manager, it gives useful dope on business conditions everywhere together with information designed to help Detrola distributors get their share of the gravy.

Cinaudagraph Execs Go West

STAMFORD, CONN.—On hand at the company's booth when the Parts Show opens this month will be the Cinaudagraph Corporation's H. W. Harwell, D. P. O'Brien, S. R. Hoyt and L. Cornwell. In addition, the following representatives will attend the show: Messrs. Augustine, Neuber, Croysdell, Clark, Campion, McCarthy, Strassner and Brown.

New Carolina Distributor

GREENVILLE, S. C.—Carolina Radio Supply opened here late in May, held open house for dealers, servicemen in the territory. Owner and manager is Miss Emma Flinkingshelt. Counterman is R. W. Hines. Outside salesman is E. L. Bell. All three were formerly connected with the Chisholm Supply Company and are well known in the section. Lines include Fada radio, Hygrade-Sylvania tubes, well-known parts brands.

Two New Winchargermen

SIOUX CITY, IOWA—L. G. Collins has taken over direction of the Wincharger Corporation's advertising department, replacing Mort Duff, who is now in charge of general sales promotion.

J. R. Espinola joins the export department's staff of advertising and sales promotion men, assisting manager A. A. Stewart.

AMPERITE offers "ADJUSTABLE RESPONSE"*

... made possible by
THE ACOUSTIC COMPENSATOR
(pat. pend.)



*Higher or lower pitch with the same microphone.

With the flip of a finger you can now (1) lower or raise the response of the microphone. . . (2) adjust the microphone for most desirable response for close talking or distant pickup. . . (3) adjust the system to any "taste", room condition, or equipment.

MODELS RBHk, RBMk, with Acoustic Compensator, frequency range 40 to 11000 cps, output, -65 db., complete with switch, cable connector and 25' of cable..... \$42.00 LIST

NEW LOW-PRICED CONTACT "MIKE"
 Model SKH (hi-imp); SKL (200 ohms) \$12.00 LIST

MODELS RAH-RAL, excellent for speech and music. Reduce feedback..... \$22.00 LIST
 Write for Complete Illustrated Bulletins and Valuable Sales Helps.

AMPERITE 561 BROADWAY, N. Y.
Cable Address: Alkern, New York

AMPERITE Velocity **MICROPHONE**

C. I. S. E. Plan

- 1-FACTORY PURCHASING POWER.
- 2-COMPETITION-DEFYING PRICES.
- 3-MOST COMPLETE LINE OF QUALITY P.A. EQUIPMENT.
- 4-EXCLUSIVE TERRITORY... SOLD ONLY THROUGH C.I.S.E. AGENTS.
- 5-FREE ENGINEERING AND CONSULTING SERVICE.

Have you joined? Limited territories still open! Send for application today!



Mr. Hubert Shortt, originator of the C.I.S.E. Plan, and President of T.C.A., will be at the Hotel Stevens, Room 2218-A, June 8-11, to greet members and discuss "sound" merchandising.

CLARION INSTITUTE OF SOUND ENGINEERS
 69 WOOSTER STREET, NEW YORK CITY

AMPLIFIER CATALOG — *Thordarson Electric Mfg. Co.* of Chicago advises that free amplifier catalog 600-C has just been released, is available on request. Contains descriptions, complete technical data on six sound amplifier models ranging from 8 to 600 watts. Speaker and portable case data is included.

TUBE MANUAL—*National Union* has a new leatherette-bound book selling for \$1, including complete dope on all tubes made by the company, design considerations, classification tables. Indexed with projecting tabs, the book is particularly easy to use in the experimental or service shop.

NEW SERVICING HINTS — The "Weston Pointer," illustrated journal published by the *Weston Electrical Instrument Corporation*, made its appearance in the field late in May, attracted considerable attention because of the general excellence of the technical material presented for consumption by servicemen. To be published periodically, sent to servicemen without charge.

TRANSFORMER SPECIALS — *General Transformer Corporation*, of 1250 W. Van Buren, Chicago, announces publication of a flyer entitled: "Sale of Sales." Includes special buys on transformers, chokes superceded by newer multi-tap items but still standard in every sense of the word. Worth looking over, especially to sound men.

MICROPHONES—The 1938 edition of the catalog-bulletin on velocity microphones will be sent to those interested. Address the *Amperite Co.*, 561 Broadway, New York City.

AUTO-RADIO KIT—A new dealer's kit is being made available to dealers by *Philco Radio & Tel. Corp.*, Philadelphia, Pa., in conjunction with its promotion campaign on auto-radio.

CAPACITORS—A special folder on its new motor starting capacitors, with more than 160 replacement listings by motor make and model number, will be sent by *P. R. Mallory & Co. Inc.*, Indianapolis, Ind., upon request.

EVERYTHING UNDER CONTROL —*International Resistance*, 401 N. Broad St., Philadelphia, offers a new 12-page catalog including the complete IRC resistor and control line. Some items included will be brand-new to servicemen who write.

NEW DECAL—*Hygrade Sylvania* has a new window decalomania for dealer identification featuring "set tested radio tubes." Available in two forms, one reads "Authorized Dealer," the other is exclusively for use by jobbers.

MOVIES FOR FARMERS—*Win-charger* dealers, by arrangement directly with the factory, may obtain three 60-second trailer films depicting the use of the accessory on the farm.

New Venture, Offices For Rider

Promises early introduction of "revolutionary instrument"

NEW YORK—John F. Rider is now located in new offices at 404 4th Ave., promises early introduction of "a new instrument which is revolutionary and with which servicemen can quickly solve one of the most baffling and annoying problems encountered in servicing."

Rider's new quarters permit expansion of his laboratories as well as his editorial department engaged in the production of circuit manuals.

Open House For Sonora

CHICAGO—Sonora Radio and Television Corp., will hold "open-house" for the trade during the Radio Show on June 8, 9 and 10. According to president Joe Gerl, space has been reserved at the Blackstone Hotel, conveniently accessible from the Show Location. Here the entire 1939 Sonora line will be on display for the duration of the show. Sonora distributors and the trade in general are invited to look over the line and to obtain details on Sonora's unusual distributor plan. A record-breaking attendance is anticipated on the basis of advance word from distributors all over the country.



When you sell a battery-operated radio, you know it's good business to sell a storage battery with it. And you'll find it an easy thing to do if you handle Exide. For it is a simple fact that nearly every one knows the Exide name and what it stands for in batteries.

Exide national advertising has been reaching your customers most of their lives. They have read about Exide in national magazines and farm papers, they have seen the name displayed on dealers' signs in every corner of the country. Millions have Exides in their cars. They have seen Exide in the news . . . many of them recall the first time radio was used to save a sink-

ing ship at sea, in the case of the *S.S. Republic*, when Jack Binns sent his CQD with the help of an Exide battery.

Exides are specially designed radio storage batteries, built for long life and full power. Priced competitively to the set buyer, and sold to you at the regular radio trade discounts. There are 2-volt and 6-volt Exides in various capacities, as well as a complete line of high capacity heavy-plate batteries for P.A. work. Mail the coupon now for details.



The Electric Storage Battery Co.

PHILADELPHIA

The World's Largest Manufacturers of Storage Batteries for Every Purpose

Exide Batteries of Canada, Limited
Toronto

Exide
RADIO
BATTERIES

THE ELECTRIC STORAGE BATTERY CO.

1900 W. Allegheny Ave., Philadelphia

Please see that I get complete details on your proposition.
My business is . . . % retail . . . % wholesale.

NAME.....

NAME OF FIRM.....

ADDRESS.....

Air King At Blackstone

BROOKLYN, N. Y.—H. D. (Hank) Halperin, vice-president and general manager of Air King Products Co., Inc., will show his new 1939 line of sets in a suite at the Blackstone Hotel during the Parts Show, is lining up distributors and representatives.

MORE RECORDS—A new and improved *Victor* record catalog containing 80 pages has just been put out by RCA. "Jitterbugs," "Ickies," will appreciate a new booklet entitled: "In The Groove With Victor Records," put out for swing-music addicts. Write Camden.

RADIO SLIDE RULE—Only one setting is needed to answer problems with the new slide rule offered by *National Union Radio Corp.*, 570 Lexington Ave., New York, and the position of the decimal place is automatically indicated. This rule is made available at a cost of \$3. Send orders direct to *National Union*.

SWITCH, IN USE—*Ward - Leonard Electric* of Mount Vernon, N. Y. has a new counter display which, when equipped with the concern's popular antenna changeover relay, actually shows the way the thing works in a standard circuit. Certain to catch the amateur's eye.

FUSTATS—*Jefferson Electric Company* "Fustats" are described and illustrated in the company's new bulletin 381-FA, just off the presses. Application and operating characteristics are given on 15, 30 and 60 to 4 ampere sizes.

SHORT WAVE MANUAL—The 1938 edition of *Hammarlund's* popular Short-wave Manual is out, includes 32 pages on one, two and three-tube battery and a.c. type receivers, short wave converters, two-stage preselector, ultra-high frequency superheterodyne with power supply. Also includes for the amateur details on a three-stage crystal controlled transmitter and an up to date five-meter transmitter with appropriate receivers and power supplies. Has extensive shortwave station list, illustrations of popular verification cards. 6 x 9 inches over, with stiff paper cover. Costs 10c.

MIKE STAND SHEETS—*Eastern Mike-Stand Company* of 56 Christopher Ave., Brooklyn, N. Y., has two new catalog sheets covering its line of microphone stands and accessories. One is intended for wall mounting, the other being a standard fold-sheet.

SPEAKERS, A to Z—*Magnavox*, of Fort Wayne, Indiana has just issued catalog R17. If you want to know anything about this firm's extremely complete line of speakers you'll find it in this booklet, probably with more details than you need. Nice to have on hand for emergency.

DECIBELS, WATTS, VOLTS—*Transducer Corporation*, 30 Rockefeller Plaza, New York, volunteers to send service and soundmen, free of charge, a full page chart showing the relationship between decibels, watts and volts. Useful for matching mikes, amplifiers, speakers.

SPEAKERS FOR STORMS—A new line of speakers built for outside work where complete weatherproofing is essential is described in catalog sheets available from *Atlas Sound*, 1447 39th St., Brooklyn, N. Y. Many other types, plus accessories, are described too.

SOUND FOR SCHOOLS—*Wright-DeCoster's* new bulletin A-18 gives many helpful hints relative to installation of sound equipment in schools, contains a complete description of new equipment available for a typical school job.

SOUND CATALOG—*Transformer Corporation of America*, through the Clarion Institute of Sound Engineers, has just released its new 1938-1939 catalog of Clarion "Unified" sound systems and associated accessories. The complete new line, ranging in size from the 5 to 8 watt system to the 70 to 98 watt system, and including portable systems ranging from 5 to 8 watts and from 40 to 54 watts, is fully described and illustrated in this two-color job, along with speakers and two new types of inter-communicating devices. Copies available from Clarion Institute of Sound Engineers, 69 Wooster St., New York.

Introducing AN INSTANTANEOUS RECORDING ACHIEVEMENT



THE FEDERAL RECORDER

- a PERFECT RECORDER
- an ELECTRIC PHONOGRAPH
- a LICENSED RADIO
- a PUBLIC ADDRESS SYSTEM

Presented by

One of America's oldest and best equipped Electrical and Engineering Plants

12 or 16 inch turnable, 33 & 78 RPM, built in radio tuner amplifies true fidelity on all frequencies.

A Console model with 12 or 16 inch recording tables, with built-in radio tuner, amplifier, and speaker. Also a studio model console with two 16 inch recording tables, built in radio tuner, amplifier speaker, with change over switch putting the amplifier into either of the two turntables providing continuous recording.

Incorporating the most recent sound engineering development, we guarantee the Federal Recorder to be an instrument of true fidelity and precision at remarkably low prices made possible by our exclusive engineering features.



"PERMA DISK"

A new discovery . . . "Novo Acetrigues" coating is revolutionizing the Instantaneous Recording Industry. Actual laboratory tests prove 100 PERFECT PLAYBACKS without noticeable surface noise. After 900 play-backs, melody and speech surprisingly audible.

For Details, Descriptive Matter, Distributorship and Prices, Please Write

FEDERAL RECORDER CO.

General Motors Bldg. 1775 Broadway, N.Y.
Phone Circle 5-8498



CONSOLE

NEWS

Extra

Survey Shows Saturation Point

Newspaper finds few homes without sets, but desire for several rising

MILWAUKEE—According to an analysis just released by the *Milwaukee Journal* 99 per cent of all Greater Milwaukee families own radios. The percentage was 94.5 in 1934, 95.4 in 1935, 97.4 in 1936 and 98.6 in 1937 so that a four-tenths per cent increase in saturation has been recorded in one year.

Equally interesting is the *Journal's* report on number of sets in use per radio-owning home. Figures are as follows on this point:

Sets	1938	1937	1936	1935
1	79.8%	84.7%	89.3%	92.2%
2	17.9	13.8	9.6	7.2
3 or more	2.3	1.5	1.1	.6

Philco Line Full Of Surprises

Mystery control, new type farm set, phono-combinations using special needles, vertical antenna, "Coldwave" air-conditioner, startle distributors

CHICAGO—With more than 800 officials and distributors convening at the Edgewater Beach Hotel May 26 the Philco Radio & Television Corporation drew a series of surprises out of the bag. Demonstrated to the trade and to the press by president Larry E. Gubb, vice-president Sayre M.



MAN WITH MYSTERY—Bombshell of Philco's Edgewater Beach convention was the new "Mystery Control." Any distributor could remote-tune a distant set from it . . . provided a company man was at his elbow to see that the "works" were not pruned. The guardian in this case is James M. Skinner

WHY AN "EXTRA"?

This issue of *Radio Retailing* closed June 1 to permit distribution at the Chicago Parts Show. Between that date and June 8, our regular deadline, additional news of particular importance to the trade as the new season opens occurred. Thus this tinted insert of last-minute flashes is included in all copies mailed to our regular subscribers.

Ramsdell and Philadelphia Storage Battery Company president James M. Skinner was Philco's "Mystery Control," a box without wires, small enough to be carried in the hand, permitting distant Philco radios to be tuned from station to station, raised or lowered in volume or turned off.

Second only to "Mystery Control" in importance was Philco's announcement of a new type of farm radio, utilizing lower-drain tubes, new batteries called "Power-



OTHER SURPRISES, TOO—Sayre M. Ramsdell, on the platform, told about them

Packs" designed to form an integral part of the receiver's sound chamber, a new type of speaker designed to reduce current drain.

Seen also was a line of phonograph-radios using new needles made to lengthen record life to 1,000 playings, a novel automatic playing and repeating feature enabling the user to play records by simply closing the unit's lid. Raising and closing the lid automatically repeats the record.

In the auto-radio division, Philco exhibited its new model 922, employing push-buttons using no current when pressed,

featuring six illuminated station windows.

Announced also was a unique, vertical type antenna . . . a metal rod rising as high as twelve feet, matched to Philco sets and equipped with protection against lightning or accidental powerline shorts. No guy wires, poles or supports are needed.

Concluding the convention Philco announced production of the first non-radio item in its line; a room air-conditioning unit with the trademark "Coldwave." It will list at about \$400.



PART OF THE NEW LINE—Distributors were treated to a complete description by Larry E. Gubb

Dance For Palestine

NEW YORK—The radio, refrigeration, sporting goods and electrical appliances division of the joint campaign of the United Palestine Appeal and Joint Distribution Committee plans to hold a dance in the grand ballroom of the Astor Hotel June 21. Object is to help raise \$10,000 as the industry's contribution.

In charge of arrangements are: Max Kassover, Jules Smith, D. W. May. Ticket committee includes: Louis Sack, Harry Stein and Sam Saltzman. Manufacturers' division representatives are: Perry Saftler, Harvey Tulle, Henry Halpern. Jobbers' division: Ben Gross, B. D. Colen, Hal Scheer, Irving Sarnoff, M. Olstein. General dealer's division: Louis LeWinter, Louis Titefsky, Jack Shanek, Jack Messenger, Ray Kline, M. Mazur. Sporting goods division representative is Henry Model.

Haugh To L.A.

JACKSON, MICH.—Art Haugh has resigned as general sales manager for Sparks-Withington's radio division, will establish a sales agency in Los Angeles in the near future.

RCA Shows 38 New Models

Wholesalers see line at Atlantic City, French Lick

CAMDEN—At Atlantic City and at French Lick, RCA Victor wholesalers attended a preview of 38 new models late in May. Included in the complete line seen were 22 a.c. table and console types, 5 a.c.-d.c. table models, 8 phono-radios, 5 battery sets, 7 automobile receivers. Featured were 18th century and console grand cabinets, a noise-reducing antenna system, Victrola push-button switch, a new kind of electrical "Magic Voice."

Received enthusiastically by wholesalers was the news (RR34May) that in addition to a line of tubes bearing the "Victor" trademark the company would so also identify all record playing instruments. Welcomed with enthusiasm was the news that a push-button designed to instantly permit record-playing (with the proper



MORE EXECS—L. W. Teegarden receives sealed envelopes containing data on the amount of money spent to advertise the name "Victor" from Vance C. Woodcox

accessory turntable) would be incorporated in all foreign band, electric tuning receivers using six tubes or more.



RCA EXECS AT DINNER—(Left to right) H. C. Bonfig, David Sarnoff and Robert Shannon chat with distributor Elmer Hamburg

An automatic record changer of new and novel design received much applause.

Winner of the Atlantic City convention quiz relative to RCA Victor line features was Jack Weissman, sales representative of the Shapiro Sporting Goods Co. of Newburgh, N. Y. Other winners were D. Wagman of Krich-Radisco, Newark; Frank Horning of Raymond Rosen, Philadelphia.

Six More RSA Chapters

CHICAGO—From headquarters of the Radio Servicemen of America, this city, comes word that six more hitherto local service associations have affiliated.

Alton, Illinois now becomes a chapter, with Robert W. Clayton chairman, R. L. Foster secretary-treasurer. The Staten Island, New York group has affiliated, as has Holyoke, Mass. and Lansing, Michigan.

Fremont, Ohio is now affiliated, with John Mutschler at the helm, leading membership in Fremont and other nearby towns. Steubenville, Ohio, under the leadership of chairman R. P. Harris, secretary; Edward Zysko, treasurer and J. B. Stringer, has come into the RSA fold.

Weston Branch Moves

NEW YORK—From 50 Church St. to 11 Park Place went the Weston Electrical Instrument Corporation's New York branch office last month. I. C. Nichols remains in charge, has more room, better facilities.



PUSHING PLASTICS—J. B. Price, now representing the Universal Plastics Corp. of New Brunswick, N. J., is working in close cooperation with vice-president Eric Marx in the design of new cabinets, knobs, escutcheons. Marx was for four years with United American Bosch. Price maintains offices at 12 East 41 St., New York, will work with manufacturers striving to complete molded product plans for the coming season

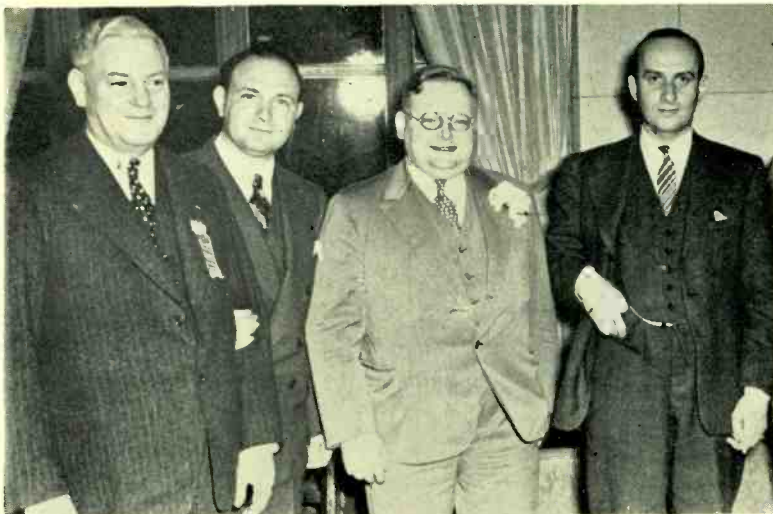

DISTRIBUTORS ON DECK—Just a few of the many present at the Haddon Hall: Ross Howard of Chicago, Irving Sarnoff of New York, Leo Gaumont (dealer), Alan Steinert of Cambridge, Mass.

Enter, Audiodiscs

NEW YORK—Audio Devices, Inc., of 1600 Broadway, is now putting out a new instantaneous recording material called "Audiodiscs." Claimed is exceptionally low surface noise and long playing life. According to Michael P. Walker, handling sales, the new material cuts like wax and wears like a pressing.

Freund To Sonora

NEW YORK—Joe Gerl, president of Sonora Radio & Television, has appointed Ben Freund vice-president in charge of engineering for the concern's radio division. An industry vet with 18 years of experience in the field, Freund was at one time chief radio engineer for Columbia Radio, pioneered in technical radio for the "Chicago Evening Post" and "American Farming," was recently with Continental Radio & Television.



BRIGHT LIGHTS — Our photographer's flash bothered exec Knowlsen (right). Frank Hiter seems able to take it

Stewart-Warner Line Shown

"Gadgetless" design featured. All models have push-button tuning

CHICAGO—In production since April 1, the Stewart-Warner Corporation exhibited a complete line of 1939 radio receivers to distributors May 31 and June 1 at the Edgewater Beach, was planning to duplicate the showing June 6 and 7 in Atlantic



ALL SMILES—Stewart-Warner's Ditzell (left) has reason to be pleased with the new line. Seated at his right: Treffeisen

Business Barometer

The "Business Barometer", a regular feature beginning with the April 1938 issue of *Radio Retailing*, is omitted this month due to the difficulty of obtaining figures from dealers at a time when they are preoccupied with conventions and new lines.

Publication will be resumed in the July number, both May and June retail sales figures appearing simultaneously in that issue.

City as *Radio Retailing* went to press.

In the line were 7 table models ranging in price from \$14.95 to \$37.95, an armchair model and six consoles at from \$39.95 to \$195. All receivers seen had "Magic Keyboard" push-button tuning, one console had remote control and it was understood that this feature could be added to any console for \$12 extra.

Stressed by John F. Ditzell, sales manager of the radio and refrigerator division, was "gadgetless design", the fact that new



CLOSE UP—Admiring a new refrigerator: M. O. Beckham of Dallas, E. L. Borzath and C. A. Lindevall of Oklahoma City



DISTRIBUTORS EAT—Left to right: W. N. Brandon, Jr., W. N. Brandon, Roberts

Stewart-Warner offerings featured extreme values calculated to induce purchasing even at a time when money is tight. Ditzell revealed that he anticipated a volume of sales above the general level of business, felt that buyers would replace obsolete sets but would shop closely for the best value.

Thirteen Stromberg Winners

ROCHESTER—Stromberg-Carlson dealers' salesmen who produced the best sales records in their territories during the first three months of this year have just been awarded Labyrinth models. In order to be eligible, each had first to earn six other valuable prizes including 17-jewel Longine wrist watches. Winners were: Francis T. White of Chickering & Sons, Boston; Stanley Lersch of Tri Par Radio, Chicago; A. L. Cavette of Grinnell Brothers, Bay City, Mich.; Roscoe C. Larkin of Larkin Radio, Los Angeles; John L. Larkin of Hickson Electric, Rochester; Herbert J. Konen of Noll Piano, Milwaukee; W. J. Dalton of G. Fox & Co., Hartford; Frank Krasa of Altenberg Piano, Elizabeth, N. J.; Fred Sobel, of Fred's Radio, Forest Hills, N. Y.; Joseph Holzman of Sun Radio, New York; Joseph Krause, Isadore Schiller and Irving Walker of Davega City Company, New York.

Federal In Recording Game

NEW YORK—Announced just as *Radio Retailing's* "News Extra" went to press was a unique line of instruments made by the Federal Recorder Company, affiliated with a well-known and long established electrical and engineering plant.

Featured was a unit having four distinct functions; comprising: A recorder, an electric phonograph, a licensed radio and a public address system. Manufactured in three styles: Portable, dual speed in 12 or 16 inch size; console, dual speed in 12 and 16 inch size and as a studio model console with two 16 inch recording tables plus the other features noted above. Models without the radio tuner are, we understand, also to be made available.

Controlled by Federal are recording disc called "Perma Disk" and "Perma Board." Both are said to permit at least 100 playbacks. The first mentioned has an aluminum base, the second a cardboard base.

New PRODUCTS

Extra

124 PHILCO

Philco Radio and Television Corp.
Philadelphia, Pa.

MODEL 116RX—Novel console type receiver with full vision ruler dial; wheel type knobs; automatic tuning of 8 favorite stations. Folding top covers dial when not in use.



126 PIERSON

Pierson Radio Corp.
Rockford, Ill.

PHONO-CHEST—Pull-up type, especially produced for the RCA R-93-B record player. Holds five albums; needle tray; hand rubbed walnut cabinet 25 x 12 x 20 inches; price \$24.50 list



247 COMMUNI-CALL

Chicago Sound Systems Co.
160 E. Illinois St., Chicago, Ill.

RECORD PLAYER—Will play 10 or 12 inch records. Self starting motor; 4½ watt amplifier; 6 inch speaker; crystal pickup; hand-rubbed walnut finished case; 110 volt a.c. operation

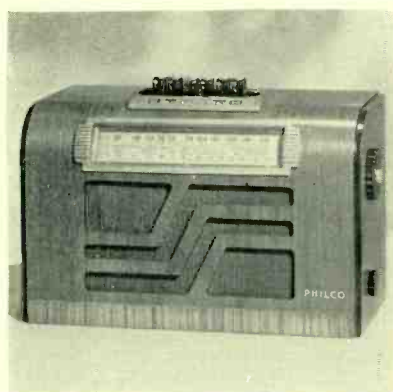

MODEL 19T—A six button automatic tuning table set with buttons conveniently built into the top. Tunes from 500 to 1700 kc., 6000 to 16000 kc. Ruler type dial; tuning knobs built into side.

125 GAROD

Garod Radio Corp.
115 Fourth Ave., New York, N. Y.

MODEL 309-P8—A phono-combination tuning from 540-1570; 1450-3650; 5650-19000 kc. Completely ac. operated; also available in ac.-dc. Price \$169.50



248 ACCURATE

Accurate Electric Co.
3575 Armitage Ave., Chicago, Ill.

REPLACEMENT SPEAKERS—Line of 5 p. m. speakers fully services any set. New plug-jack universal transformer allows easy connection to a circuit; priced from \$4.00 to \$14.25

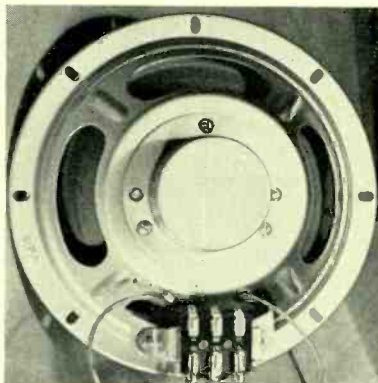

249 UTAH

Utah Radio Products Co.
812 Orleans St., Chicago, Ill.

P. M. SPEAKER—Model H-15-UP, high fidelity 15 inch speaker. Seven lb. permanent magnet; 15 inch cone; 45 watt peak; 30 watt continuous; response 50-9000 cycles; price \$38.50 list

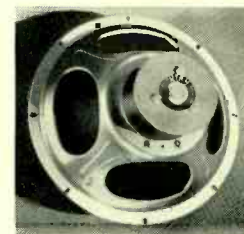

MODEL 8A4—An ac-dc table model super-het with four wave bands covering, 138-375; 540-1720; 2340-7400; 7100-23000 kc. Shipping weight 21 lb. Price \$59.95



Numbered card in this issue brings you additional details

Calling All RADIO DEALERS . . .



Howard quality is recognized by the amateur and the serviceman. These radio critics prefer Howard . . . ask them.

who didn't make a PROFIT in 1937-38

Try **HOWARD RADIOS**



MODEL 418

11 Tubes—All Wave
MOST BEAUTIFUL CONSOLE IN AMERICA. BASS BOOST TONE CONTROL—providing variable amplification of bass notes without sacrificing clarity.

Push Pull Beam Power Output—11 Watts Undistorted
 12" Auditorium Dynamic Speaker.

Perm-a-matic Iron Core Push Button Tuning—exclusive Howard development eliminating drift—easiest to set.

Showing a few of
HOWARD'S 12 MODELS



MODEL 200

Extremely compact midget receiver having iron core coils and indirect dial drive.

TYPICAL HOWARD 1939 VALUE . . .

Howard is an exclusive manufacturer of radio sets with a performance record of 17 years' experience in quality merchandise. Howard has learned through this long experience that in order for the dealer and the distributor to make a profit, radio manufacturing operations must be highly flexible with production under control at all times. Dealers must be permitted to order merchandise that sells without being loaded up with "dead Indians" that won't sell. The manufacturer must be set up to produce the right merchandise when it is needed and with quality that doesn't entail endless service. Distributors and dealers must be permitted to make their full profit at all times and must not be subjected to factory competition.

Howard's line for 1939 offers the most beautiful style appeal in their 17 years of radio set manufacturing and includes every tested new feature at prices made possible only because Howard manufactures more parts than any other manufacturer in the industry.

For complete catalog and information on sales, advertising and financing plans, write—



MODEL 220

5 Tube A.C. Super with push button tuning and dynamic speaker.

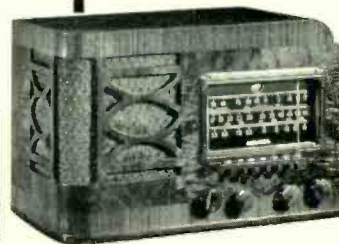

MODEL 468

8 Tube — 3 Band A.C. Super; 8-inch dynamic speaker; Bass boost tone control. Perm-a-matic push button tuning. The ultimate in a table model!

With Howard: Dealers Do Not Have to Worry About . . .

- **PRICE SLASHING RUINING YOUR BUSINESS:** No Howard set was ever dumped in any distributor's territory.
- **MANUFACTURER'S COMPETING WITH YOU:** Howard is sold under one name and exclusively through dealer-distributor channels.
- **EXCESSIVE SERVICE EXPENSE:** Howard has been universally recognized as manufacturing precision radio products for 17 years.
- **A LINE WITH EIGHT DOZEN MODELS ONLY A FEW OF WHICH SELL:** Howard covers the entire popular price range with 12 outstanding receivers.
- **HIGH PRESSURE TACTICS—NOR EXCESSIVE INVENTORY:** Howard Radios can be purchased when and as required.

DISTRIBUTORS: Jobbing proposition is open in some territories. Call or wire collect. Howard also offers Communication Receivers.

HOWARD RADIO CO.
 1731 West Belmont Avenue, Chicago, Illinois
 America's Oldest Radio Manufacturer

250 UNIT

Unit Reproducers Mfg. Co.
999 E. Main St., Rochester, N. Y.

PICKUP—Crystal type; impedance 1600 mmf. even frequency range of 70 to 7000 cycles. Voltage output is 1.5 volts at 1000 cycles; 500,000 load; weight 3 oz.; finish rubber black or dark bronze; price \$8.00 list

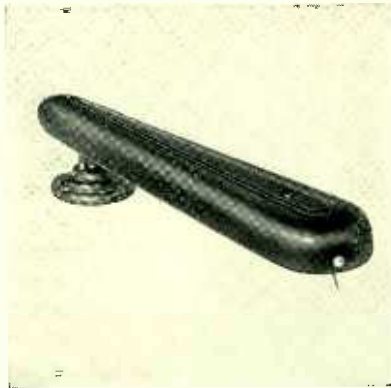

415 WEBBER

Earl Webber Co.
1313 W. Randolph St., Chicago, Ill.



VIBRATOR TESTER — Model 90 tests all popular vibrators. Good-Bad full vision meter indicates condition of vibrator. In carrying case with leather handle. Bar type control knobs.

347 RADIART

Radiart Corp.
13229 Shaw Ave., Cleveland



SHAVER PAK — Designed to furnish suitable power for electric shavers where 110 volt current is not available. Automobiles, trucks, trailers, boats, are typical examples. Device works from 6 volts dc., is available in portable or permanent mounting styles. Also available for 32 volts dc.

416 HOYT

Burton-Rogers Co.
857 Boylston St., Boston, Mass.

TEST BENCH METER— Model 83A volt-ohm-milliammeter complete with control unit. Meter sensitivity 500 microamperes, 400 ohms resistance, accuracy 2 per cent. Measures ac. and dc. to 1000 volts in 3 ranges. Ohms range is 500, 1 meg and 10 megs



348 GLIDE SHAVER

International Appliance Co.
Ann Arbor, Mich.

ELECTRIC SHAVERS— Available in three colors. Cutting head has moving blade with beveled edges, provides shearing action. Blade of hardest tool steel, self-sharpening. Outer, stationary blade designed to smooth out skin, hold hair erect. \$7.50



417 PHILCO

Philco Radio and Television Corp.
Philadelphia, Pa.

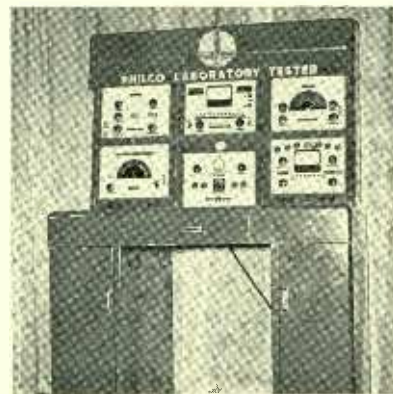

LAB TESTER—A complete test bench containing all the test instruments necessary for accurately repairing a receiver. Built in drawer houses small tools; doors each side of bench house larger tools and accessories.

349 IRWIN

Irwin Corporation
27 W. 20 St., New York, N. Y.

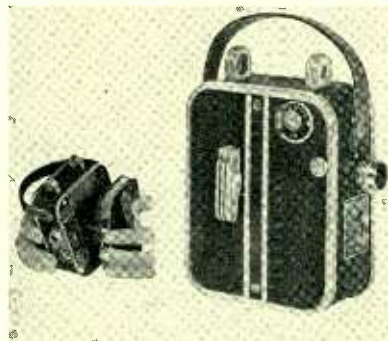

CAMERA AND PROJECTOR—A magazine loading type 16mm. movie camera. Built-in view finder, optical spyglass, and footage indicator. Fixed focus operation. Price of camera, \$12.95. Price of air conditioned projector, \$18.95

539 MEISSNER

Meissner Mfg. Co.
Mt. Carmel, Ill.

I.F. TRANSFORMER — Complete series of transformers to cover all popular ranges and receiver types. Available in 4 standard types of construction: Ferrocart-Align-aire, Standard Align-aire, Ferrocart-Micatrim, and Standard Micatrim, Frequency ranges from 121 kc. to 5600 kc.

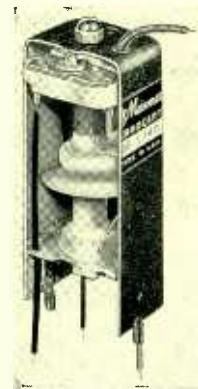

Numbered card in this issue brings you additional details

THE COMPANY WILL APPRECIATE SUGGESTIONS FROM ITS PATRONS CONCERNING ITS SERVICE

1220-S

WESTERN UNION (41)

CLASS OF SERVICE

This is a full-rate Telegram or Cablegram unless its deferred character is indicated by a suitable sign above or preceding the address.

SIGNS	
DL	= Day Letter
NM	= Night Message
NL	= Night Letter
LC	= Deferred Cable
NLT	= Cable Night Letter
Ship Radiogram	

R. B. WHITE
PRESIDENT

NEWCOMB CARLTON
CHAIRMAN OF THE BOARD

J. C. WILLEVER
FIRST VICE PRESIDENT

Received at

NW24 TWS PAID 4= DETROIT MICH 19 1013A
DAVID F BEARD, SALES MANAGER DIRECT MAIL DIVISION=
MCGRAW HILL PUBLISHING CO 339 WEST 42 ST=

SELDOMLY ONE HEARS JUST COMPLIMENTS BUT ALWAYS CRITICISMS ARE AUDIBLE STOP THE TREMENDOUS UNHEARD OF RETURNS WE RECEIVED FROM THE RECENT MAILING OF OUR FOUR COLOR CIRCULAR FEATURING THE PEEWEE AND SUPER PEEWEE DETROLA RADIOS OVER YOUR SELECTED RADIO JOBBER AND RADIO DEALER LISTS PROVES CONCLUSIVELY YOUR STATEMENTS OF ITS 99 9/10 PERCENT ACCURACY AND OUR SALES RETURNS PROVE THAT YOUR READERS ARE LEGION STOP CANNOT THANK YOU ENOUGH FOR SUCH SERVICE STOP MY ONLY REGRET BEING THAT ITS AVAILABLE TO COMPETITORS FOR I WOULD LIKE TO BE SELFISH AND USE IT EXCLUSIVELY STOP REGARDS= JIM DAVIN VICE PRESIDENT IN CHARGE OF SALES DETROLA CORP.

99 9/10.

THE QUICKEST, SUREST AND SAFEST WAY TO SEND MONEY IS BY TELEGRAPH OR CABLE

If you read this telegram we need only say that you too can get these results - ask any of our representatives, or wire, phone or write for details.

**Direct Mail Division
Mc Graw-Hill Publishing Co., Inc.
330 W. 42nd St. New York, N.Y.**

Kane With Galvin

CHICAGO—R. E. Kane has been appointed home set eastern manager for the Galvin Manufacturing Corporation, will handle the states of New York, Pennsylvania, Delaware, Maryland, Virginia and New Jersey.

Bob Kane, an old-timer in the field, was in 1919 assistant wholesale manager of Sherman, Clay & Company in San Francisco. In 1924 he joined the Chicago Victor distributor as sales manager, in 1927 he was made central district manager for this same firm and later district manager. He was then transferred to Boston as eastern district manager of RCA's set division and in 1924 became western district

manager in charge of RCA sales in 27 states.

For the past two years Kane has been central division manager for Grunow radio, covering Ohio, Michigan, Indiana and Kentucky.

Greyhound Equipment Formed

BROOKLYN, N. Y.—The Greyhound Equipment Company has been formed, with offices and factory at 1720 Church Ave., will specialize in radio and industrial coil-windings. F. K. Coppel heads the organization. Sylvan A. Wolin is representative in the metropolitan New York area for both domestic and export sales.

G.E. Execs On Nationwide Tour

Three groups take new sets to distributors in 48 cities

BRIDGEPORT—Announced just in time to make the "News Extra" is a series of distributor meetings already in progress under the auspices of General Electric radio executives, who have formed three groups, will take the new G.E. sets to 48 cities before June 15. Featured at these meetings will be important new design features including automatic program pre-selection, the "beam-a-scope" antenna eliminator, pre-tested tubes, remote keyboard control, cathode-ray tuning indicator, tone monitor circuit, automatic tone compensation, automatic band indicator, oscillator stabilization circuit and i.f. wavetrap.

New is the G.E. radio keyboard selling plan, based on facts gathered during the past year in a special national survey of hundreds of successful dealers. To assist dealers three new sales training films have been prepared with recordings by Dale Carnegie, R. C. Borden and E. H. Vogel, G.E. radio division manager.

Execs in group one, including P. F. Hadlock, A. A. Brandt and C. H. Bell, are working on the following exhibition schedule: May 24 Pittsburgh and Wheeling; May 25 Philadelphia; May 26 Baltimore; May 27 Washington and Richmond; June 1 Columbia; June 2 Atlanta; June 3 Birmingham; June 4 Nashville; June 5 St. Louis; June 6 Kansas City; June 7 Oklahoma City; June 8 Dallas; June 10 New Orleans.

Group two, comprising E. H. Vogel, C. T. Wandres and R. M. Hoey, covers: May 24 Boston; May 25 Buffalo; May 26 Cleveland and Canton; May 27 Detroit; May 31 and June 1 Chicago, South Bend, Rockford and Peoria; June 2 Milwaukee; June 3 St. Paul and Fargo; June 4 Omaha; June 6 Denver; June 7 Salt Lake; June 9 Portland; June 10 Seattle; June 13 San Francisco and June 15 Los Angeles.

In the third group are H. R. Shaw, J. Wood, E. N. Sampson and R. J. Meigs. Schedule: May 24 Albany; May 26 Syracuse; May 27 Binghamton; May 31 Williamsport; June 1 Lancaster; June 2 Allentown; June 4 Charleston; June 6 Louisville; June 7 Terre Haute; June 8 Indianapolis; June 9 Fort Wayne; June 10 Cincinnati; June 11 Columbus.

Lenz' Zender Coming East

NEW YORK—Ray Zender, sales manager of the Lenz Electric Manufacturing Company, 1751 North Western Avenue, Chicago, is coming east for the IRE's June 16 convention, will stop at the Hotel Pennsylvania, where the shindig is to be held.

Important products of the Lenz organization in the radio field are high "Q", low-capacity multi-conductor cables, shielded low-capacity auto radio leadins and r.f. circuit hookup wire especially adapted for all-wave switching systems, avc, plate and grid circuits. The r.f. hookup wire uses special insulation with extremely high dielectric characteristics, increases circuit gain, is impervious to moisture.

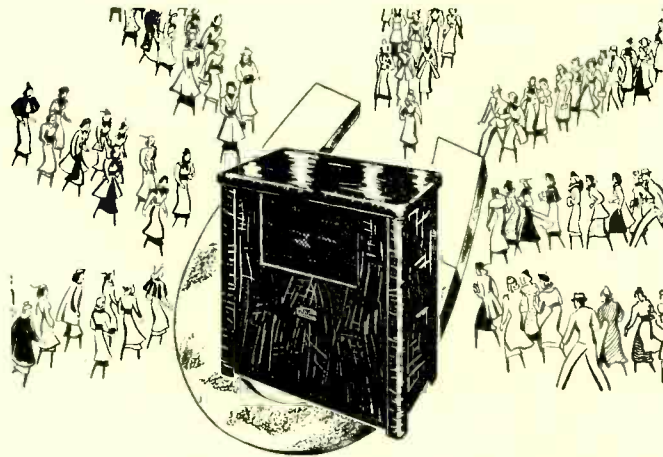

KOOLROOM—the MAGNET For Those "Hot Weather" Sales!

Offer Real Air-Conditioning For \$175

Scores of radio dealers find KOOLROOM pays for itself by preventing the customary summer slump in sales. Home owners will refuse to swelter when relief can now be had so inexpensively. **SELL KOOLROOM NOW! WIRE FOR FRANCHISE!** Koolroom is the all-purpose air conditioner . . . it cools, it dehumidifies, it purifies, it ventilates, it circulates. There are nine models, from a 1/3 ton capacity model at \$175 up to a 5-ton capacity model at \$1350. (Prices slightly higher west of the Rockies) Write or wire for the Koolroom franchise for your community.

KOOLROOM Division of Indian Products Corp.

2340-G INDIANA AVE., CABLE: "TRAILCO CHICAGO", U. S. A.

Supplementary

INDEX TO ADVERTISERS, JUNE 1938

HOWARD RADIO COMPANY	90E
KOOLROOM DIV., INDIAN PRODUCTS CORP.	90H
McGRAW-HILL PUBL. CO., DIRECT MAIL DIV.	90G

REGULAR INDEX for this issue will be found on page 115

McGRAW-HILL PUBLISHING COMPANY, INC. Publication office: 99-129 North Broadway, Albany, N. Y. Editorial and Executive offices: 330 West 42nd St., New York City.

CIRCUITS

New Automatic Tuning Design

The automatic tuning unit in the new Emerson is a separate unit even though contained in the same cabinet with the chassis. Connection to the chassis is made through an octal plug. This construction is unusual and offers several advantages.

According to the diagram the oscillator and antenna coil are contained in the automatic tuning unit. A system of padders and push-buttons tune each coil to the predetermined frequency. Usually, with capacity systems, the push-button tuning is accomplished by connection to the usual broadcast coils in the receiver. However, with this system the coils and padders are entirely separate. When push-button tuning is desired the range switch is set to "automatic." This disconnects the oscillator and input sections of the 6A7 mixer and connects these to the automatic unit through the octal socket.

The grid section of the oscillator coil has two taps. When switching from one button to another different amounts of the coil may be used. In this manner it is unnecessary to use high capacity trimmers on the low frequency end. Higher sensitivity results also.

Across the input of the antenna coil is a 3000 ohm resistor. This is in the circuit only when automatic tuning is used. Since locals are usually received in this position, the resistor decreases the sensitivity slightly and increases the band-width for higher fidelity.

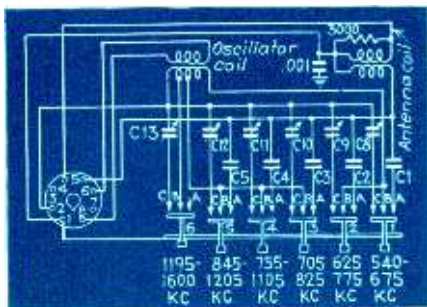

Universal Receiver

Merely by changing a cable plug the model 85-BT6 receiver by RCA can be converted from a standard a.c. receiver to a 6 volt d.c. type.

It is interesting to note the circuit connections of the power supply. Fig. 1 shows a standard a.c. supply with the addition of a 7-prong cable connector shown at the bottom of the diagram.

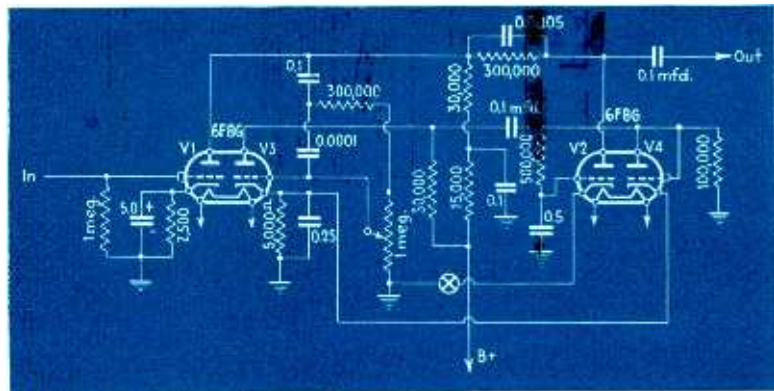

Volume Expander Attachment

The circuit shown herewith is the universal volume expander by McMurdo Silver; attachment may be made to any receiver.

One triode (V1) of the first 6F8 is used as signal amplifier, the second triode (V3) of this tube acts as amplifier for signal voltage to be employed for expansion control. The second 6F8 uses one triode (V4) as a diode rectifier and the remaining triode (V2) as a gain control, with its resistance varied by signal volume changes. When the 1 meg. potentiometer is turned to the off position, its switch opens the (V2) circuit allowing (V1) to increase total audio amplification approximately 23 db.

Connection to any receiver is made by feeding the output from the detector to the "in" lead. The "out" wire connects to the first audio stage which was previously connected to the audio detector output. If no blocking condenser is provided in the set between the audio detector and following audio amplifier, a .1 mfd. 400 volt paper condenser should be connected in series with the "in" wire.

Filament and plate voltage are taken from the receiver chassis and the unit is ready for operation.

For a.c. operation the winding L1 supplies the heaters and dial lights. When operated on 6 volts terminals 1 and 6 are disconnected. The 6 volt battery then supplies the heater voltage.

The plate voltage for the receiver is developed in the vibrator supply shown in Fig. 2. This supply is energized when the cable connector is inserted in the vibrator supply socket and a battery

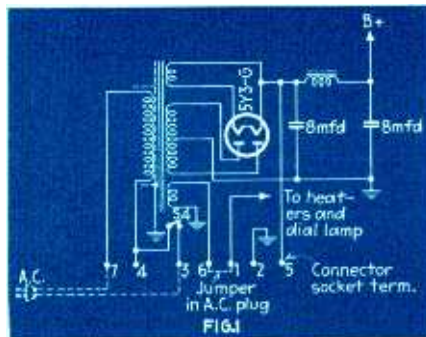

connected. The d.c. supply employs a synchronous vibrator for maximum efficiency.

When the set is to be converted to 6 volt operation it can be seen in Fig. 1 that switch S4 is left open. This is important, otherwise d.c. would damage the power transformer. The 543G rectifier does not operate nor is its filament lighted when the set works on 6 volts.

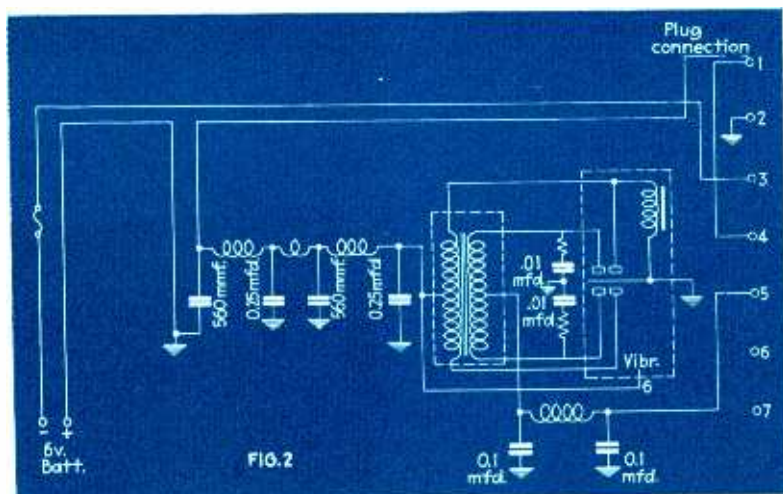

Degenerative Class B Driver

The use of degenerative circuits in the design of audio amplifiers is becoming more prevalent. Sylvania shows a degenerative system of economical design.

This system of degeneration depends upon the feeding back of part of the output voltage of the driver stage to the plate of the preceding tube as indicated in the circuit shown. This permits degeneration without the use of a series condenser as is necessary when the feedback is from plate to grid circuits. A further factor in economy is the elimination of the series plate resistor R_s , providing a high impedance tube, such as the Type 6T7G, is employed in the socket preceding the driver stage. In this case the plate impedance is sufficient to prevent any substantial reduction in the percentage of feedback. A low impedance input

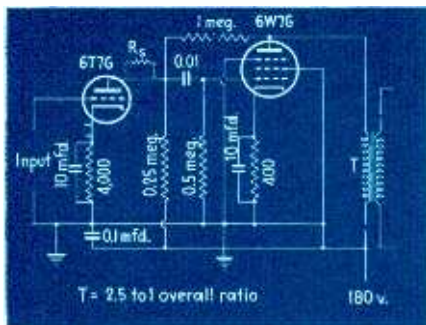

tube used without a series resistor would lower the effective load on the driver tube and reduce the percentage feedback.

The Type 6W7G is ordinarily suitable for use as a driver tube because of its high plate impedance. However, the feedback circuit employed reduces the output impedance to such an extent that the resistance of the interstage transformer windings becomes a large percentage of the driver impedance. At the same time, the high gain of the 6W7G is available for the driver circuit, this compensates for the reduction in sensitivity occasioned by the degeneration circuit.

Automobile Remote Tuner

Since the recent introduction of mechanical automatic tuning, a number of auto radio systems have appeared. Among these is the one by Belmont, the circuit of which is shown below. Although the mechanical tuning does not show, its adjustment is as follows:

To set up any of the six buttons

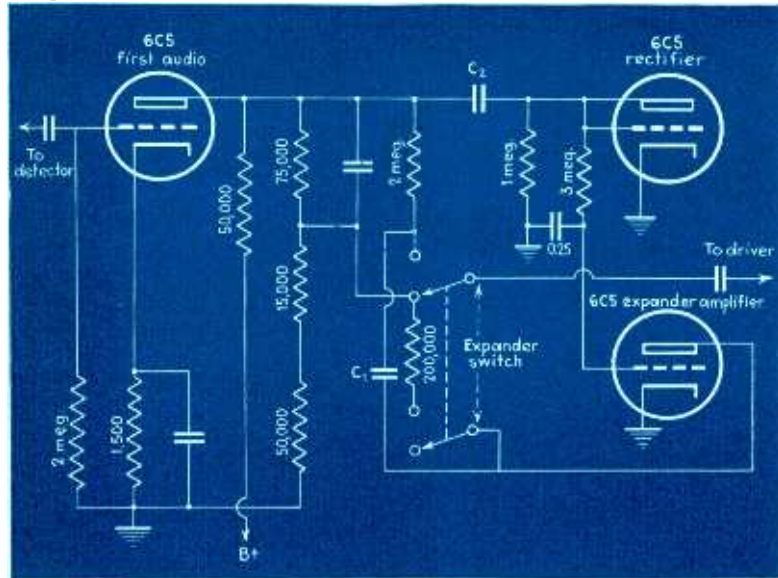

press any lever down and hold it there. Tune in the desired station with the manual control. When the station is perfectly in tune, release the lever. Repeat the procedure for the rest of the buttons. When all buttons are set, tighten the set screw at the left of the unit. This locks the buttons in place. To change any button, loosen the set screw and repeat the above. Make sure to tighten the set screw again otherwise the calibration will not hold.

An interesting feature of this set is that the tuning condenser, r.f., mixer, and oscillator coils are in a separate unit mounted on the dash. All tubes and other units are in the speaker chassis connected to the remote by a cable.

Input from the battery feeds into this unit as shown on the right of the diagram. From here it is sent to the various sections of the receiver.

In addition to tuning, provision is

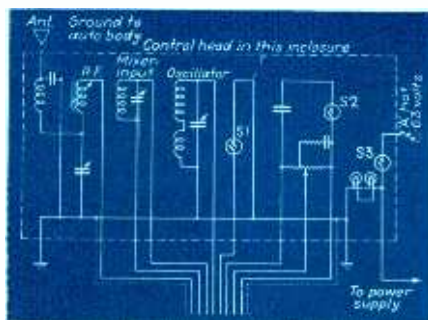

also made for volume control and tone control. Tone control is of the shunt-capacity type.

Coupling between the remote tuner and the set is made by a cable. The length of this cable should not be altered, otherwise the tuning will be affected. This would require that all tuned circuits within the remote head be realigned.

Simplified Volume Expander

The symphonizer in the new Emerson models is a modified type volume expander. Usually circuits of this type make use of special control tubes such as the 6L7. This circuit requires only 3 type 6C5s.

The first 6C5 to the left of the diagram serves as first audio amplifier. The plate circuit of this tube is divided into two main parts. Some of the signal feeds the 6C5 rectifier, the remaining signal passing out through the junction of the 75,000 and 15,000 ohm resistor to the driver stage.

With the expander switch in the normal position as is indicated, no expansion takes place. The signal feeds directly from the tapped plate circuit of the first 6C5, through the switch and to the grid of the driver. Even though the 6C5 rectifier is constantly in the circuit when no expansion is desired it is of little consequence since the expander amplifier circuit is incomplete.

When the expander switch is thrown in the up position the plate circuit of the expander amplifier is connected to B+ through the 200,000 ohm resistor between the two center switch contacts. At the same time the lead to the driver stage connects to the plate of the 6C5 expander through capacity C1.

When a signal passes through the first audio stage with the expander in the "on" position as shown above, it flows through the 1 megohm resistor to the right of C2 and is amplified by the expander amplifier. Also, part of the original signal is rectified by the 6C5 diode. The resultant rectified voltage biases the grid of the 6C5 expander positive, increasing the sensitivity and output.

These 3 instruments

MAKE AFC ALIGNMENT

Quick, Simple, Profitable!

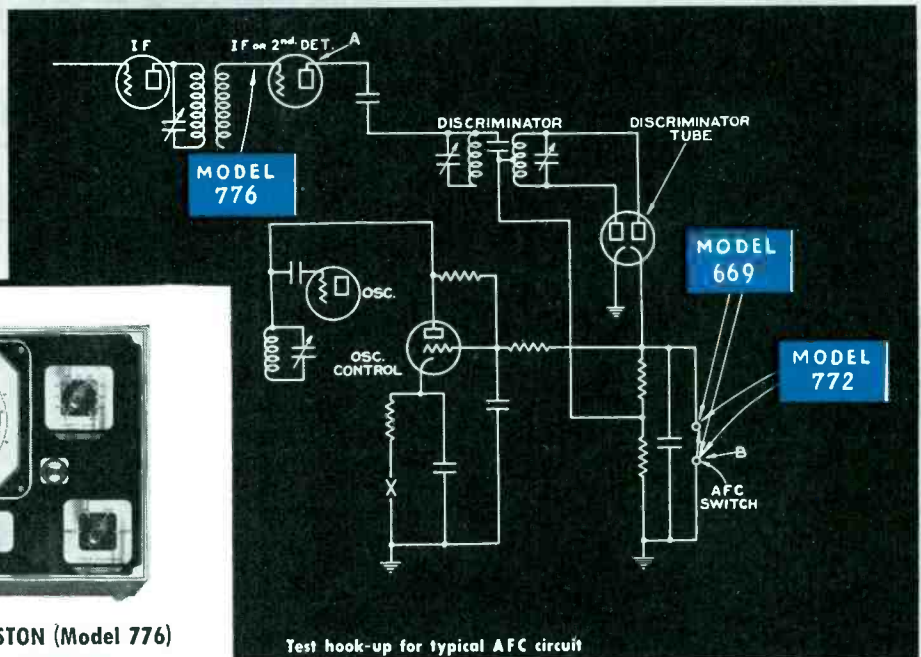
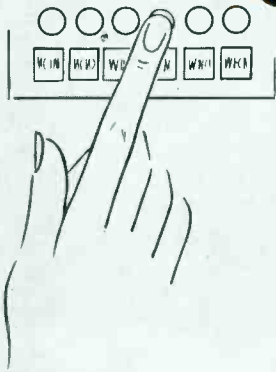

Test hook-up for typical AFC circuit

WESTON (Model 776)
Oscillator
individually hand
calibrated dials

WESTON (Model 669)
Vacuum Tube Voltmeter

WESTON (Model 772)
Super-Sensitive Analyzer
sensitivity
20,000 ohms-per-volt

Push button tuning provides another real opportunity for servicemen properly equipped. Nothing complex, nothing time-consuming about AFC alignment when you have these 3 dependable, WESTON instruments. Instead, perfect alignment is a quick, simple operation . . . *highly profitable* the WESTON way. And equipped with these 3 instruments, plus the WESTON Tube Checker, you are *set* for all servicing needs.

If you are anxious to *save money* on your instrument purchases over the years . . . *make more money* servicing *every year* . . . be sure your instruments are dependable WESTONS. The coupon will bring you complete information, as well as a copy of the "WESTON Pointer" . . . which gives profitable suggestions and short cuts for AFC alignment and on other servicing problems. Return the coupon today!

WESTON Instruments

WESTON ELECTRICAL INSTRUMENT CORPORATION
581 Frelinghuysen Avenue, Newark, N. J.
Send a copy of the WESTON POINTER, Vol. 1—and literature on WESTON Instruments.

NAME _____
ADDRESS _____
CITY _____ STATE _____

MICROPHONES AND PICKUPS

FOR SOUND

By **ROBERT S. NASH**

Nash Company, St. Louis

EQUALLY keeping pace with sound advances have been the microphone and pickup innovations—an extensive variety of microphones and record reproducers offered today to adequately handle any conceivable pickup requirement. High fidelity, heretofore available only at a prohibitive price, is within the reach of the smallest and limited sound equipment budget as to microphone and pickup accessories.

The complexity of selecting the proper microphone for each installation has been the bugaboo of every soundman at one time or another. Two identical installations of equal physical dimensions will require different microphone characteristics due to inherent acoustical conditions.

As the average public address man does not possess expensive measuring devices to determine the exact placement in public address installations, the soundman to a certain extent must depend upon the trial and error method of selecting microphone equipment.

Whether a church, a school or a tavern, microphone equipment is usually suited only for the purpose for which it is to be utilized. In a church pulpit, for example, it is presumed that little besides straight talking will be done.

Whereas in a tavern or school, singing is combined with announcement work, as well as dramatic acting and will

make necessary a microphone type different and probably not suited at all for the church installation.

Types of Microphones

Present day microphones are divided into the following basic types:

(1) **VELOCITY OR RIBBON TYPE.** These are well suited for pickup purposes from a distance three or four feet or more away from the microphone. For musical reproduction and singing, especially by artists in stage plays and vocalists with an orchestra, the velocity microphone is excellent.

(2) **CRYSTAL (Sound Cell and Diaphragm Types.)** Because of the high output, compactness and ruggedness of construction, these microphones are popular with P.A. men and sound equipment manufacturers alike. Due to the high impedance output, line transformers are not required over long distances, eliminating possible pickup of

hum through the transformer into the first stages of the amplifier.

A response from 60 to 7,500 cycles, as far as music and voice are concerned is more than adequate for average P.A. Lower frequencies are not necessary when voice is used exclusively and when eliminated by the use of a crystal microphone, reduce the boominess of the installation.

The crystal diaphragm type is most commonly used because of its high output, compared to output of the sound cell type.

(3) **DYNAMIC TYPE.** Used extensively in broadcasting, especially remote work, since 1931. This type is one of the best all around types available for pickup work. Many models do not show any appreciable signs of being affected by temperature, wind or atmospheric conditions. Close talking, necessary in the majority of cases, does not cause boominess.

The three types mentioned have their different models such as lapel microphones, non-directional models, semi-directional models, spherical and other different mechanical forms, all using the basic idea mentioned.

The condenser microphone, with its necessary associated preamplifier, and carbon button microphones with its power supply have been generally supplanted. The latter type, however, is useful where a relatively low gain amplifier must be used, has recently been appreciably improved.

Lapel microphones are not generally used in outdoor public address or in large halls when more than one person uses the same mike due to the possibility of breakage of the wires by the speakers feet. Two mikes offer a good solution to this problem, placed on either side of the speaker on the stand, one picking up his utterances on either side and also acting as an emergency precaution in the event one mike goes dead in the midst of the proceedings.

Microphones for general announcement work may well include a crystal mike for rental use and, where possible in a permanent installation, a ribbon velocity microphone. For music and singing a ribbon microphone would be desirable. A dynamic microphone would be suitable in any case. Carbon micro-

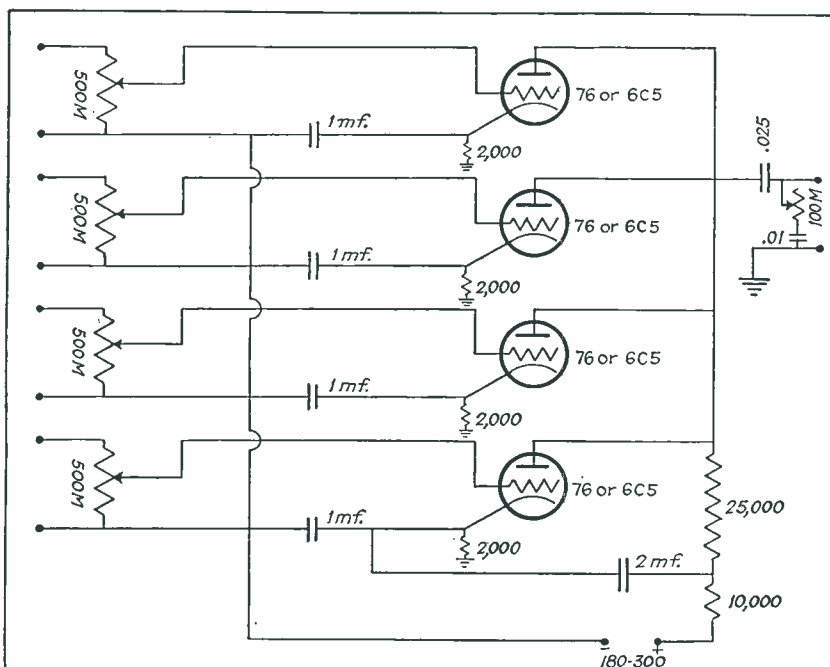

FOUR CHANNEL MIXER AND PRE-AMPLIFIER—Designed to enable the mixing of four input sources of 80,000 to 100,000 ohms to one amplifier channel. With this unit, combinations of four microphones may be added to each microphone input channel

phones are suitable for aircraft.

More and more "ham" type microphones are being used by soundmen because of their excellent characteristics for voice transmission. However their use for music, especially orchestra pieces is questionable due to their sharp cutoff characteristics.

As suggested in the first article of this series "How to Get Started in Sound," March, 1938, *Radio Retailing*, a 100,000 ohm input in the amplifier for microphones will capably handle any microphone requirement even if the microphone output is only 75,000 ohms. The use of a high impedance input eliminates the cost and inconvenience of matching transformers which are necessary for a 200 or 500 ohm microphone.

Feedback, explained in the preceding article with relation to speakers and their placement, must be overcome solely by the placement of speakers as the microphone must in any case be put in a certain position and the speakers installed where feedback is least obvious. Heavy drapes or celotex in back of the mike will reduce feedback.

Recording and Pickups

Reproduction of records is today becoming a big rental industry. As one person or organization can hardly keep all the new song hits in current favor due to the high cost, soundmen can furnish this service even if the client has a permanent installation. The rapidity with which recordings have been made successfully to recreate the original sound is giving "canned music" universal acceptance. One large factor leading to its acceptance by the public has been the avalanche of automatic phonographs of the 5-cent slot variety in restaurants, taverns, etc.

As the soundman with recordings available today can place at the disposal of the rental installation the nation's leading orchestras at a mere fraction of what a mediocre orchestra would cost, the rental possibilities are great.

Before purchasing any pickup the following essentials should carefully be noted:

Needle pressure of three ounces maximum is suggested.

Arm design free to travel with ease

and not binding in any position. The arm should also be free from vibration.

Two distinct types of pickups, crystal and magnetic are available for reproducing work; both of which have their adherents. Crystal pickups today are enjoying a large acceptance by the sound industry because of their remarkable high fidelity reproduction and high output. One manufacturer is about to release a pickup employing both principles.

The magnetic pickup, first electric pickup invented, is still apparently preferred in the broadcasting industry and

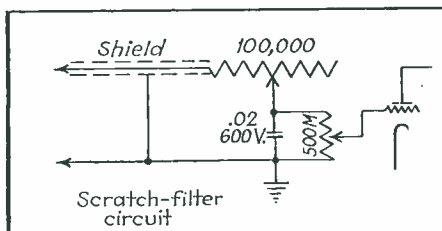

SCRATCH FILTER—A novel circuit offering advantages over the conventional design. By use of this filter circuit record scratch is attenuated without any modification on the part of the amplifier

also by numerous sound men. The selection in any case may be a personal preference because both type pickups have their advantages and disadvantages.

Some of the new pickup models offer a tangent or offset head which eliminates record wear to a certain extent by virtue of the fact that the tangency of the pickup to the record is more equal to that in recording than possible with the straight arm pickup. To accomplish this in a straight arm pickup would render necessary an infinite arm. These new improvements give better reproduction and lower surface noise.

Selection of needles as recommended by the manufacturers include half-tone steel needles with the preference on shadowgraphed needles. The shadowgraphed needle is scientifically tested and individually inspected by placing in front of a lens and the light from behind reproducing the needle point magnified several hundred times. The purpose of this test by the manufacturer

is to assure a perfectly round point as illustrated. Cheap needles do not seat in the record groove perfectly but scrape on the groove as shown. It is good practice to change most needles after each record even with the added inconvenience, assuring perfect reproduction of each record.

Circuit Accessories

The installation of the scratch filter shown in the illustration will materially remove much of the scratch from recordings without cutting down the high fidelity response of the system.

The decibel (db) table of sound loss and gain is the standard unit of measurement. Zero level in a system is referred to as .006 watt. By the use of this table, knowing the gain of the amplifier as stated by the manufacturer, it is a simple matter to determine just which microphone or phonograph pickup will render full excitation and output from the amplifier.

For example:

Overall gain + 130 db.

Power output, 60 watts or.. + 40 db.

Full output will be made

with a microphone of... — 90 db.

(Subtraction of power output from gain to give needed decible ratio of microphone or phonograph.)

As the majority of microphones range from —65 db to —42 db they would be well suited for this purpose.

Decibels—Watts Conversion Chart

DB.	Watts	DB.	Watts
— 20	0.00006	13	0.1187
— 19	0.00007	14	0.1518
— 18	0.00009	15	0.1898
— 17	0.00011	16	0.2372
— 16	0.00015	17	0.3037
— 14	0.00023	18	0.3795
— 13	0.00030	19	0.4744
— 12	0.00039	20	0.600
— 11	0.00047	21	0.759
— 10	0.0006	22	0.948
— 9	0.00076	23	1.185
— 8	0.00095	24	1.518
— 7	0.00119	26	2.371
— 6	0.00152	27	3.036
— 5	0.00190	28	3.795
— 4	0.00237	29	4.743
— 3	0.00303	30	6.000
— 2	0.00397	31	7.590
— 1	0.00474	32	9.487
0	0.006	33	11.859
1	0.0076	34	15.180
2	0.0095	35	18.975
3	0.0119	36	23.718
4	0.0153	37	30.360
6	0.0237	38	37.950
7	0.0305	39	47.43
8	0.0380	40	60.00
9	0.0474	41	75.90
10	0.060	42	94.87
11	0.0759	43	118.59
12	0.0948	44	151.8

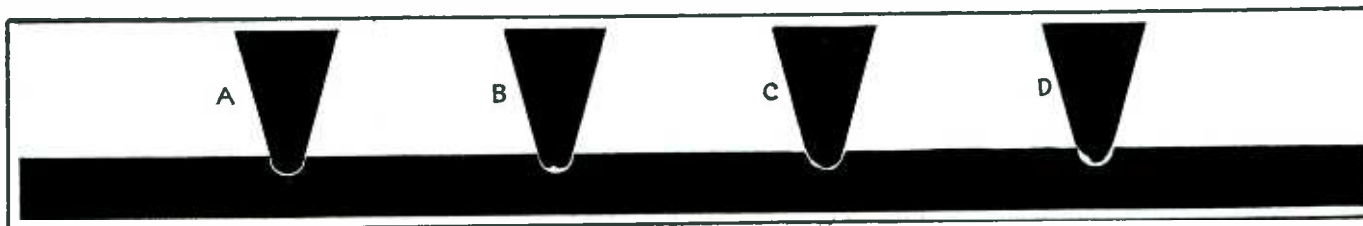

PERFECT AND FAULTY NEEDLES—(A) shows a perfect shadowgraphed needle, while (B) (C) (D) show imperfect needles and their effect on record grooves (Microscopic line drawing)

IRC

REG. U.S. PAT. OFF.

Initiative — Resourcefulness — Cooperation
to advance the interests
of the industry

WHAT IS AN

"Expensive"

VOLUME CONTROL?...



TYPE CS.

The ~~high~~ cost of all controls is just about the same—but don't be fooled! There's a big difference in the ultimate cost to you that only time can tell.

When a replacement control you have installed "goes noisy" you get the blame. Whatever may happen, it is almost certain that your loss of good will and prestige is out of all proportion to the cost of any control.

Service records show that most control troubles arise at one point . . . the sliding contact between center terminal and rotor arm. The IRC Type "CS" Control removes this trouble spot once and for all by replacing the "collector ring" with a positive connection . . . a silver plated spiral spring rigidly attached at each end. Because the IRC Control is quiet and stays quiet, it actually saves you money.

Compare its performance with ordinary units and convince yourself that it is by far, the least expensive control to use. It represents an investment that will pay bigger dividends the longer you use it!

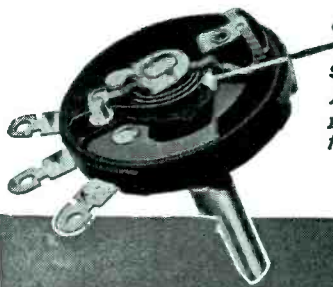

**THE SILENT
SPIRAL CONNECTOR**
Another development
pioneered and per-
fected by IRC.

INTERNATIONAL RESISTANCE COMPANY

403 NORTH BROAD STREET, PHILADELPHIA, PA

In Canada, 187 Duchess Street, Toronto, Ontario

MAKERS OF RESISTANCE UNITS OF MORE TYPES, IN MORE SHAPES, FOR
MORE APPLICATIONS THAN ANY OTHER MANUFACTURER IN THE WORLD

Servicing

COMMUNICATION

Receivers

By H. D. HOOTON

THE communications set has dominated the receiving field to such an extent that it may now be considered one of the most popular types of all-wave receivers. These sets are rapidly becoming more and more popular, and it is certain that before long the communications type of receiver, possibly installed in a console cabinet, will undoubtedly form a large percentage of the better all-wave receivers in use. The servicing of these sets has already become a lucrative profession for the radio man who possesses the necessary skill, experience and equipment to handle this type of work successfully.

Practically all communications receivers are superheterodynes. Some of the less expensive models may or may not have a tuned preselector or r.f. stage preceding the mixer, but they all contain the usual oscillator, mixer, i.f. amplifier, second detector and audio stages. The fundamental circuit and principle of operation, therefore, is identically the same as for the standard all-wave receiver familiar to all service men except that these circuits have been more highly developed in order to obtain optimum stability, gain and over-all performance. Hence the requirements for successful communications receiver servicing are much more rigid than for standard all-wave sets. However, the procedure to be followed when testing and servicing communications sets is not radically different from standard practice; the same analyzers, tube testers

and measuring instruments are employed—the only important point is that these instruments must be extremely accurate, especially the test oscillator.

Locating Bugs

The usual symptoms of misalignment in the communications receiver are low over-all gain, evidenced by low meter readings on signals which were formerly capable of producing higher readings, off-calibration of the dial readings on known frequencies, unequal sensitivity on the different bands or the extremities of any particular band, and an excessive or extremely high noise level. Due to the tremendous gain available in the audio section of most of these receivers, a loss of gain due to misalignment may not be noticed if the condition of the set is judged solely by the audio output since it is possible to turn the volume control to the maximum output position and still obtain a high volume level. Principal among the contributions to low gain is the part which the i.f. stages play in providing over-all sensitivity and selectivity of a high order.

If the service man has had sufficient experience with communications receivers to be able to judge the conditions prevalent in this type of set, misalign-

ment of the i.f. amplifier can be readily determined by means of a noise level check.

Loss of gain in the r.f. circuits is usually due to misalignment of the oscillator; in this case it is almost certain that the insensitive range or ranges will also be off calibration. It is always a good practice first to check the calibration of the receiver against known accurate frequencies before making any adjustments whatever in either the r.f. or i.f. circuits. If the calibration is correct, the trouble could be in the r.f. or mixer circuits; however, it is more than likely that the i.f. circuits are not properly aligned.

Aligning the Crystal

There are several methods by which the i.f. circuits may be aligned to the crystal frequency. It is absolutely essential that the i.f. transformers be aligned to the exact frequency of the crystal itself and not to any arbitrary calibration on the test oscillator; it has been found that commercial test oscillators for service work vary considerably, at least to an extent that will not permit the proper alignment of a quartz crystal filtered communications receiver. Radio Manufacturing Engineers, Inc., recommend the use of a standard 550 to 800 kilocycle broadcast signal of constant strength rather than an inaccurate oscillator, to furnish the test signal for alignment of the i.f. amplifier, using the quartz filter to establish the proper i.f. frequency. The Hallicrafters recommend that the receiver's own crystal be used in an external crystal-controlled oscillator for the i.f. circuit alignment. The latter method is especially desirable since the i.f. transformers will be peaked precisely on the crystal frequency. A suitable oscillator circuit is shown in Fig. 1. It is recommended that regeneration be

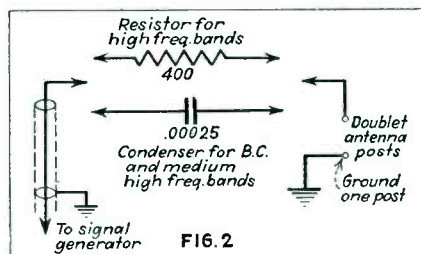
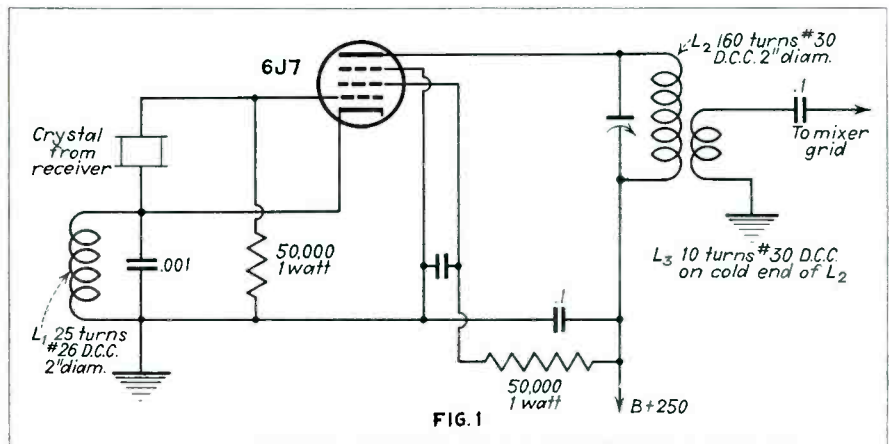

NEW push-button TESTING

FOR 1939 SERVICING



Rotating
Chart Shows
Correct Buttons
To Push

Plus Mutual
Conductance
Per Cent Scale

Model 1616
\$73.34
Dealer Price

ON DISPLAY AT THE
PARTS SHOW
OR SEE IT AT YOUR
JOBBER'S

Model 1615

Dynamic Mutual Conductance Tube Tester only with Push-Button testing. Same tube tester circuit and push-button panel as Model 1616, but for tube testing only. Complete with all necessary accessories.

Dealer Price..... **\$63.34**

Model 1610

Emission Type Tube Tester with Push-Button Testing. Has new R.M.A. approved circuit with every essential for dependable emission test on all type tubes. Testing greatly simplified by Triplett push-button testing. Installed in metal case with removable cover, of compact size; complete with all necessary accessories. An accepted test for practically all tubes.

Dealer Price..... **\$39.00**

Model 1611

Emission Type Tube Tester with Push-Button Testing and Volt-Ohm-Milliammeter. Similar to Model 1610 described above except Volt-Ohm-Milliammeter added. Ranges similar to those of Model 1616.

Dealer Price..... **\$49.50**

DYNAMIC MUTUAL CONDUCTANCE Tube Tester and Volt-Ohm-Milliammeter

This new Triplett model incorporates two revolutionary advancements in tube tester design. First, Push-Button control gives a new order of simplification. The buttons are clearly marked on chart at base. Just rotate the Chart to the tube to be tested—then the button to push is indicated in line under each row of push buttons. What could be simpler?

The second revolutionary improvement is the arrangement of the measuring circuit of the dynamic mutual conductance test for amplifiers and power tubes. The tube tested not only shows GOOD or BAD but the percentage of μ to the 100% Good Condition is also indicated. In critical sets this permits the service dealer to pick his tubes with confidence. . . . Diodes and rectifiers are tested for

emission according to the latest approved engineering standards. Gas and Ballast tube tests included.

Rotate Chart to Volt-Ohm-Milliammeter settings—push button for D.C. scale: 0-10-50-250-500-1000 Volts at 1000 Ohms per Volt; 0-10-50-250 M.A.; .2 Ohms-500 Ohms-300,000 Ohms-1½ Megohms 3 Megohms; 0-10-50-250-500-1000 A.C. Volts at 400 Ohms per Volt; decibel chart furnished to 42 db's. (Ohmmeter is line powered and provision is made for using batteries if desired). Uses plug-in type rectifier, simplifying replacement in case of unintentional damage.

Installed in attractive, all-metal case with lustrous finish. Removable cover. For portable or counter use . . . sloping panel.



TRIPLET
Precision
ELECTRICAL INSTRUMENTS

The Triplett Elec. Instrument Co.
206 Harmon Dr., Bluffton, Ohio

Please send me more information on

—Model 1616; —Model 1615;
—Model 1610; —Model 1611.

Name

Address

City State

used as shown; ordinary pentode 465 kc. crystal oscillators are sometimes a little difficult to start oscillating.

The coil, L2, may be of the plug-in type, if desired. This will permit the plate circuit of the 6J7 to be tuned to the second, third, fourth or higher harmonic of the crystal which will afford an accurate means of calibrating a portion of the r.f. and high-frequency oscillator circuits. Harmonics of a 465 kc. crystal higher than the fourth, however, are likely to be too weak to be of any practical value for alignment purposes.

In general, the following procedure is recommended: If the receiver is equipped with a crystal, place the crystal in a separate oscillator and align the i.f. circuits. Before aligning either the r.f. or i.f. circuits, be sure that: The a.v.c., crystal filter and beat oscillator switches are in the "off" positions; the selectivity control is in the "sharp" position; the audio and r.f. gain controls are set at maximum; and that the band switch is on position "one" with the tuning condenser open. Remove the oscillator tube from its socket. Remove the cap from the control grid of the mixer and feed the test signal directly to the tube through a 0.1 mfd. condenser. Adjust the i.f. trimmers for maximum output. If the receiver is aligned from the crystal oscillator's output, re-inserting the crystal in the circuit will show little difference in output whether the crystal is "in" or "out" as indicated by the crystal switch.

The r.f. alignment is carried out as follows: Use either a .00025 mfd. condenser or a 400 ohms resistor in series with the output lead from the signal generator to the receiver as shown in Fig. 2. Be sure that one of the doublet antenna posts remains connected to ground during the alignment. Check the calibration against accurately known frequencies (broadcast stations may be used if the oscillator is inaccurate) and adjust the high-frequency oscillator padder and trimmer condensers until the several known frequencies are received at corresponding points on the dial. Adjust the padders only for re-calibrating the low-frequency ends of the bands; the trimmers are for aligning the high-frequency portions (Fig. 3). Always "rock" the tuning condenser when making r.f. adjustments. It will be necessary to re-adjust each padder and trimmer several times; any small change in one will affect the other to a certain extent.

Shop Kinks

In some communications receivers, a high noise level may develop from a defective 6L7 mixer tube. This does not necessarily mean that the tube will test "bad" in the tube tester; it is not uncommon to find differences in the noise levels of brand new tubes of the same manufacture when placed in

the mixer circuit of a high-gain receiver. The usual procedure in cases of this kind is simply to try a number of tubes in actual operation and then select the one that appears to be most suitable for the purpose.

To make a rapid check of the receiver, remove the grid cap from the detector-A.V.C. tube and touch the grid of the tube with the finger tip. A loud hum or squealing noise indicates that the audio section is functioning O.K. In circuits using 6H6 detectors, touch the grid of the first audio tube.

In servicing a dead set, check the output transformer first of all; if this is O.K., the usual service procedure of pulling out tubes for the "click" may be used. If the audio section appears

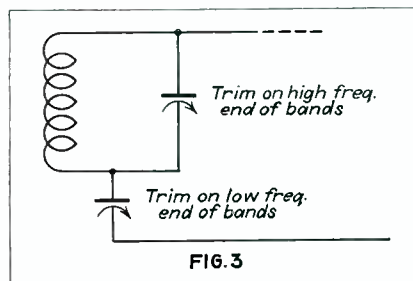

FIG. 3

to be operating, check the bias on the R.F. and I.F. tubes; sometimes an open R.F. gain control will cause an apparently dead set due to excessive bias on the R.F. or I.F. grids.

In cases of violent oscillation, the offending circuit can usually be located by placing the finger on the grid cap of each R.F. and I.F. tube in turn. Check for an open screen or plate bypass condenser. Check the tubes, allowing plenty of time for each to thoroughly "warm up". As a last resort, replace the usual 300 ohm bias resistor with a higher value (400 or 500 ohms) or reduce the screen voltage slightly. It is best not to change values unless it is absolutely necessary; remember that the engineers who designed the particular receiver chose those values for a purpose. Oscillation is usually due to either tubes or a defective by-pass condenser.

A low signal-to-noise level may be due to misalignment or a number of other causes; in about 75% of the cases, the condition can be improved by simply replacing the mixer tube. This is especially true where the receiver has been used around a high-powered transmitter; R.F. feeding back into the receiver tuned circuits frequently damages the tubes causing them to be noisy even though they may test "good" on the tube checker.

A frequent cause of low sensitivity, especially in "ham" receivers or those used in connection with commercial stations, is due to the R.F. trimmer dielectric becoming punctured by R.F. voltage from the transmitter. In most cases

of this kind the receiver will be sensitive on all bands except the one on which the transmitter operates. The trimmer may or may not completely short circuit; usually when tested for breakdown, a leakage of from 50,000 to 500,000 ohms is found. It is best to replace the defective unit with another one of the same type; however, the author repaired two punctured trimmers on a set by simply replacing the mica dielectric.

Noise Troubles

In some receivers, poor sensitivity and a high noise level can be caused by R.F. burns on the band-switch contacts. In one of these receivers, owned by a well-known 8th district "ham", the switch points had been badly burned by feedback from a kilowatt transmitter. Although tests with an ohmmeter did not indicate a high-resistance contact, the sensitivity on the ten and twenty meter bands was only a fraction of normal; a careful cleaning with a small brush and carbon tetrachloride restored the sensitivity to normal.

Noisy operation when the receiver is jarred is usually due to poor contact at the tuning condenser wipers. Clean thoroughly with carbon tetrachloride and increase the wiper tension. If the noise is present on a single band only, lightly tap the trimmers of the particular band in use; once located, the trimmer should be replaced. The same trouble is often caused by dirty or faulty switch contacts.



Microphonics are usually caused by sound waves from the speaker striking against some element in the receiver which is subject to variations in its electrical characteristics when placed in a strong sound field or a field where there is considerable vibration. A common source of this trouble lies in either or both the high-frequency oscillator and first audio tubes. About the only remedy is to replace the faulty tubes although glass tubes can sometimes be made less microphonic by simply wrapping them with tape.

Another element likely to cause microphonics is the oscillator tuning condenser. These plates act like small diaphragms when the sound intensity is large, causing the oscillator frequency to shift at an audio frequency rate. This condition is especially noticeable when the crystal filter is being used and the selectivity is very high and at the higher frequencies where the possible frequency variation is greatest. This condition can usually be improved by placing the speaker at a distance from the cabinet, by mounting the speaker or cabinet on a soft sponge rubber pad or by turning the speaker in a direction that directs the sound away from the receiver itself. Usually, by breaking of a stiff physical contact between the speaker housing and the receiver cabinet will stop the howl.

STRAIGHT FROM THE SHOULDER



There's been a lot of ballyhoo  about Tube Equipment Deals. 

But dig deeper into the facts  and you will find:  1. That Arcturus gives you the finest equipment.  2. That you get it at less

actual cost  than any other deal. 3. That not one cent  has been added to standard Arcturus Tube prices  to defray the cost

of the equipment we supply. 4. That Arcturus Down Payments are lower . . .  they average about ONE-SIXTH the amounts required by other deals!

More good news  comes in the fact that your tube purchases are held to an absolute minimum.  Arcturus brings you the finest tubes in

the World  —and helps you keep them moving  with the most complete line of merchandising helps on the market today! 

● THAT'S WHY WE SAY . . .

The Arcturus Equipment Deal is unquestionably the fairest, easiest and most PROFITABLE deal ever devised to enable dealers and servicemen to obtain up-to-the-minute shop equipment—at almost NO COST!

Get the facts! Compare the Arcturus Plan, point-for-point, with *any* other equipment deal—then *you* be the judge!

MAIL THE COUPON!

ARCTURUS

INDEPENDENT TUBES FOR DEALERS WHO DO THEIR OWN INDEPENDENT THINKING



Arcturus
Radio Tube
Co., Newark, N. J.
Gentlemen:
Send complete details of
your new Equipment Deal.
 I am a Dealer
 I am a Serviceman

Name.....
Address.....
City..... State.....

R-8

Announcing the

SUPREME COUNTER TUBE TESTER!

Zephyr

**NO DOWN PAYMENT!
10 DAY FREE TRIAL!**

**IF YOUR CLERK CAN HING UP A
SALE ON A CASH REGISTER—SHE
CAN ACCURATELY TEST TUBES
ON THE SUPREME Zephyr!**

Think of it—a tube tester so simple that instructions are not necessary. Even a child can operate it. Simply spin the numerical chart roll until the type number of the tube comes up—then punch the buttons according to the numbers shown (just like a cash register)—and the big illuminated meter reads "Good," "P" or "Bad." THAT IS ALL THERE IS TO IT. The large double scale meter is easily read from BOTH SIDES of the counter.

Here is an opportunity you cannot afford to overlook if you are selling tubes, for you can order and have delivered to you the SUPREME ZEPHYR Counter Tube Tester—without putting one cent down—and WITHOUT ANY RISK ON YOUR PART. Use the SUPREME ZEPHYR for a period of 10 days and if it does not meet with your expectations—send it back to us without any obligation on your part whatever. If after 10 days, you decide to keep the ZEPHYR you can pay for it by sending a small remittance each month. Order your SUPREME ZEPHYR today—here is a quicker, easier way for you to make extra tube profits.

Most reliable parts jobbers have SUPREME instruments in stock—write us if your own parts jobber cannot supply you.



**NO DOWN
PAYMENT**

**\$6.55 FOR 10 MONTHS
ON SUPREME'S OWN
S.I.C. EASY TERMS**

CASH PRICE \$59.50

Let your customers
test their own
old radio tubes!

SUPREME INSTRUMENTS CORP.

GREENWOOD, MISSISSIPPI, U. S. A.

Cable Address: LOPREH, New York

Export Dept., Associated Exporters Co.
145 W. 45th St., New York City

By
L. C. WALLER*

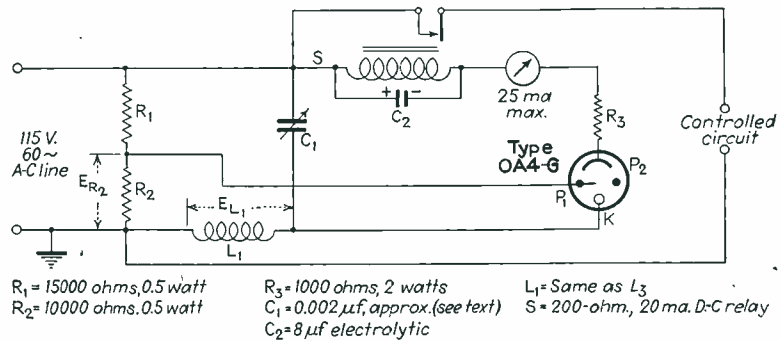

FIG. 2-Remote-Control Relay Circuit

Carrier Type

THERE are numerous applications for a simple, sure-fire, remote-control switching system—especially for one where no additional control wires need be installed. A typical example is an “off-on” switch for a radio receiver. A system can be set up so that the receiver (or other electrical device) can be turned off or on from any point in the house which is close to an a-c outlet, provided the “control” outlet and the receiver outlet are supplied from the same power distributing system.

A new glow-discharge relay tube, recently announced is designed primarily for this remote-control relay service. The tube, type OA4-G, is a gas triode having a cold cathode (K), a starter-anode (P₁), and an anode (P₂). Socket connections for the octal base of the OA4-G are given in Fig. 1. Operating characteristics and maximum ratings are as follows:

PEAK ANODE BREAK-DOWN VOLTAGE (Starter-anode tied to cathode)	225 min.	Volts
PEAK POSITIVE STARTER-ANODE BREAKDOWN VOLTAGE	70 min. 90 max.	Volts
STARTER-ANODE CURRENT (For transition of discharge to anode at 140 volts peak). 100 max.		Microamperes
STARTER-ANODE DROP	60 approx.	Volts
ANODE DROP	70 approx.	Volts

MAXIMUM RATINGS AND TYPICAL OPERATING CONDITIONS		
Relay Service		
PEAK CATHODE CURRENT	100 max.	Milliamperes
D-C CATHODE CURRENT	25 max.	Milliamperes
TYPICAL OPERATION WITH A-C SUPPLY:		
Anode-Supply Voltage (RMS)	105-130	Volts
A-C Starter-Anode Voltage (Peak)	70 max.	Volts
R-F Starter-Anode Voltage (Peak)	55 min.	Volts
Sum of A-C and R-F Starter-Anode Voltages (Peak)	110 min.	Volts

The OA4-G is also very useful as a voltage regulator in d-c power supplies

Remote Control

where the d-c load current does not exceed about 20 milliamperes. In this service, the tube is used essentially like the 874 gas diode, except that the OA4-G tube drop is only 70 volts instead of 90.

Tube Function

In normal operation, a relatively small amount of energy starts a glow-discharge between cathode and starter-anode. This discharge (ionized argon gas) produces free electrons which assist in starting the main discharge between cathode and anode. The anode current is of such magnitude that it will operate either a d-c or an a-c relay suitably connected in series with the anode and the anode-voltage supply. Thus, it is seen that the starter-anode serves to “trigger off” the main anode discharge. This is the design feature which makes the OA4-G adaptable to remote-control relay service.

As a remotely controlled relay tube, the OA4-G should find use in a wide

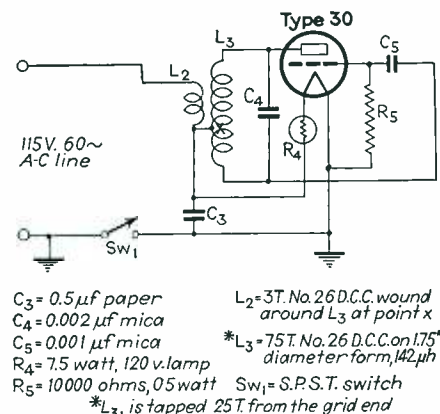

FIG. 3-300 Kc. Control Oscillator

variety of unrelated fields. Radio servicemen and radio amateurs will find numerous useful applications of this nature. The circuit of a typical relay arrangement is shown in Fig. 2. The operation of this circuit is quite simple. The starter-anode (P₁) is supplied with a 60-cycle voltage from the bleeder R₁ and R₂ which is connected directly across the line. The voltage E_{RS}, applied to P₁, is adjusted to have a peak value of about 65 volts which is almost, but not quite large enough to initiate a starter-anode discharge on the positive peaks of the line voltage. E_{RS} is, of course, in phase with the line voltage.

The a-c line is also made to carry a small radio-frequency voltage, which is supplied by a simple oscillator (to be described later). The frequency of this carrier voltage can be in the order of 50 to 350 kilocycles. Referring again to Fig. 2, we note that inductance L₁ and capacitance C₁ comprise a series-tuned circuit shunted across the a-c line. L₁ and C₁ have values such that they are series resonant with the carrier frequency. At resonance, a rela-

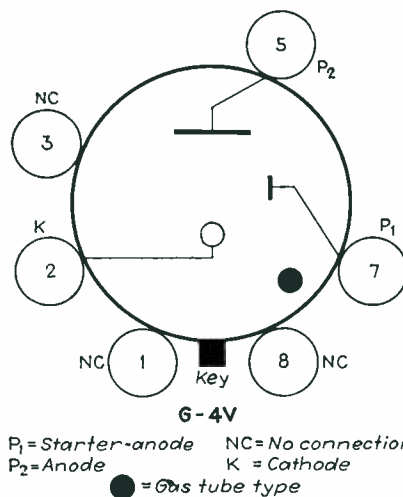

FIG. 1 Bottom View of Socket Connections

tively large r-f voltage is built up across L_1 . This voltage, in series with the cathode and P_1 , as well as with the cathode and P_2 , adds to the 60-cycle voltage already applied to these electrodes. Thus, the starter-anode discharges and this in turn starts the anode discharge, operating the relay (S).

The inductance of L_1 Fig. 2 is the same as L_2 Fig. 3; namely 75 turns of 26 dcc. on a $1\frac{3}{4}$ inch form. For power-line frequencies in the order of 60 cycles and carrier frequencies of 100 kilocycles, the sum of E_{R_2} and E_{L_1} , should be somewhat greater than 110 volts peak.

Control Unit Design

The control oscillator employs a type 30, which is quite economical of filament and plate power. In the circuit of Fig. 30, the tube draws a d-c plate current of about 7 milliamperes. The plate input power is about 0.36 watt and the filament power is 0.12 watt. Resistor R_1 is a 7.5-watt, 120-volt lamp, which limits the filament current of the 30 to the rated value of 60 milliamperes when the a-c line voltage is 115 volts RMS. The lamp thus consumes 6.9 watts, making the total oscillator power consumption 7.38 watts. The 30 will deliver enough power to operate the OA4-G over a-c lines in the order of 100 feet long, more or less, depending upon the nature of the line. A typical house line was found to have an impedance of about 35 ohms at 100 kilocycles. At 300 kilocycles, the operation frequency obtained with the circuit constants shown in Fig. 3, the impedance of the same line was estimated to be about 12 ohms.

The turns ratio of the inductances L_2 and L_3 can be determined by the relation

$$\sqrt{Z_P/Z_L} = N_P/N_L, \text{ or } N_L = N_P\sqrt{Z_L/P},$$

where N_L = number of turns on L_2
 N_P = number of turns on L_3
 Z_L = impedance of a-c line at the carrier frequency
 Z_P = operating (plate-load) impedance of the oscillator

In the example under discussion, N_P is 75 turns, Z_L is estimated to be 12 ohms at 300 kc., and Z_P is obtained from the relation, $Z_P = (225) E_b/I_b$,

where E_b = oscillator plate voltage, RMS a.c.
 I_b = oscillator d-c plate current, milliamperes.

Thus, $Z_P = (225) (115/7)$, or 3700 ohms for the circuit of Fig. 3. $N_L = (75) \sqrt{12/3700} = 2.44$, the required turns for L_2 to match a 12-ohm line. Actually, 3 turns were found to provide a suitable value of r-f voltage across the line.

Care should be taken not to make the grid condenser C_5 too large, because it

must have a high impedance at 60 cycles to prevent the grid from swinging positive in phase with the plate voltage. Such an occurrence will result in the prompt demise of the oscillator filament. A value of 0.001 uf was found

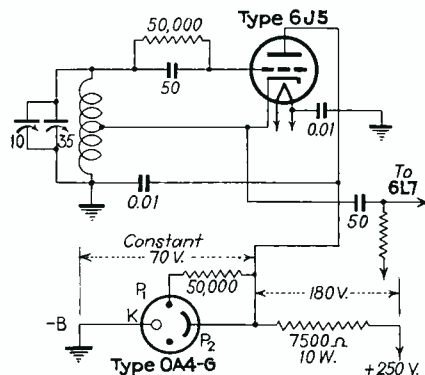

FIG. 4—Voltage-regulator circuit for a 30-Mc. superhet oscillator. 160 μ a of D-C grid current is obtained in the 6L7's No. 3 grid circuit. "Pulling" of the oscillator and mixer is reduced

to be satisfactory, with a 10000-ohm grid leak (R_5). The type 30 oscillator, with correct impedance matching to the line, delivered from 70 to 100 volts peak r-f voltage across L_1 . This was measured by means of a cathode-ray oscilloscope.

Operation

The switch SW_1 serves to turn the oscillator off and on, thus operating the remotely located relay with a slight time lag, due to the thermal inertia of the tube's filament. The relay can be keyed rapidly, if desired, by inserting the key or switch in the ground return of R_5 , the grid leak. Opening R_5 blocks the oscillations.

It is important to note that the r-f pulse delivered to the line occurs only on the positive half cycle of the line voltage, referred to the oscillator filament. The "receiver" line plug must be inserted so that P_1 and P_2 swing positive with respect to the OA4-G cathode on the same half cycle that the r-f pulse is generated in the oscillator. If the "polarity" is connected incorrectly at first, reversing the line plug of either the oscillator or the relay unit will allow correct operation.

The relay used in the test set-up is a 200-ohm d-c relay which operates on 15 to 25 milliamperes. The 8-uf electrolytic condenser (C_2) is necessary to smooth out the pulsating direct current passed by the OA4-G anode (the OA4-G operates somewhat like a half-wave rectifier). An a-c relay, or a d-c relay with a shaded pole, will operate satisfactorily without C_2 , and for that reason is preferable. In no case should the d-c anode current exceed an average value of 25 ma. (as measured by a d-c meter) or a peak value of 100 ma. (measured by taking a peak voltage

reading across R_5 with an oscilloscope). The 1000-ohm current-limiting resistor R_5 will limit the peak current satisfactorily. A smaller value should not be used for R_5 .

The variable condenser used to tune the series circuit of Fig. 2 consists of a 0.001-uf and a 0.00025-uf fixed mica condenser in parallel, shunted by a 500-1000-uuf mica padding condenser. Correct resonance can be obtained by means of an oscilloscope or by adjusting the trimmer capacitance till the OA4-G glows the brightest, indicating maximum starter-anode and anode currents.

Voltage-Regulator

The OA4-G is very useful as a voltage regulator where the d-c load current requirements are not severe. The circuit of Fig. 4 shows a typical application. A very constant voltage drop of about 70 volts is obtained across the OA4-G, regardless of variations (within limits) in the d-c load current or in the a-c line voltage. The circuit shown illustrates the use of the OA4-G to regulate the plate voltage of a 6J5 r-f oscillator in a 10-meter superheterodyne receiver. This set employs a 6L7 mixer, the injector grid of which is driven by the 6J5. Prior to the installation of the



OA4-G, the oscillator and mixer had a slight tendency to "pull" in step. The stable plate voltage provided by the OA4-G eliminated all traces of pulling, which was caused originally by the variation of the cathode current in the avc-controlled r-f and i-f stages, and the resultant shift in oscillator plate voltage.

If more than 70 volts are desired, two OA4-G's can be connected in cascade to provide 140 volts, three to provide 210 volts, etc. In any case, the series resistor in the bleeder circuit should limit the average direct current through the tube to 25 ma., with no load circuit connected. The load circuit should not draw more than about 20 ma., or the OA4-G will cease to discharge and thus lose control.

*RCA Mfg. Co., Harrison, N. J.



*Everything
You want in
SOUND
EQUIPMENT*

Manufactured
under license
arrangement
with E. R. P. I.

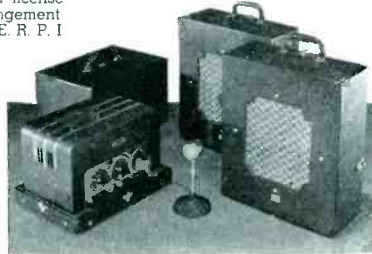

Model P.A. 435 is only one of the many Bell P.A. systems. And like all Bell products it is a superior piece of equipment. It is modern in design and performance. It is compact, durable and easily serviced. It is easily portable, has tone compensating controls, beam power tubes, three input channels, two 12" permanent magnet dynamic speakers, streamlined crystal microphone, and many other qualities that prove its value . . . including an attractive price. It has 35 watts output, and is suitable for even the larger installations, but regardless of your needs Bell makes a system that will "fill the bill." Write for catalog.

BELL SOUND SYSTEMS INC.

65 East Goodale St. Columbus, Ohio
Export Office: 308 W. Washington St. Chicago, Ill.

**PERMANENT
P. A. SYSTEMS**

**PORTABLE
P. A. SYSTEMS**

**MOBILE
P. A. SYSTEMS**

**INTEROFFICE
COMMUNICATING
SYSTEMS**

**CUSTOM-BUILT
EQUIPMENT**

**SIZES AND
TYPES FOR
EVERY NEED**

McGraw-Hill

DIRECT MAIL LISTS

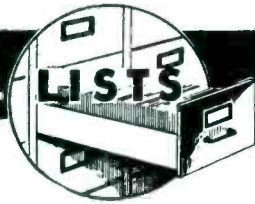

As publishers of Radio Retailing for twelve years, McGraw-Hill is uniquely equipped to offer complete, authoritative Direct Mail coverage of the Radio Trade. Extreme accuracy (guaranteed 98%) is maintained on a daily corrected basis and the widest possible selections are available. Send for folder entitled "Hundreds of Thousands of Reasons Why" which describes how McGraw-Hill lists are built and maintained.

What Selection Do You Want to Reach?

- Radio Wholesalers
- Radio Dealers
 - Larger Dealers
 - Smaller Dealers
- Occupational Groups
 - Automotive Stores
 - Central Station Stores
 - Hardware Stores
 - Etc.

- Radio Service Dealers and Service Men
- Geographical Selections
- Population Groups

Write for folder "Radio Trade Outlets" giving details on selections, state counts, prices, etc. . . . or ask any representative.



DIRECT MAIL DIVISION . . .
McGraw-Hill Publishing Co.
330 W. 42nd STREET NEW YORK, N. Y.

Quality above all

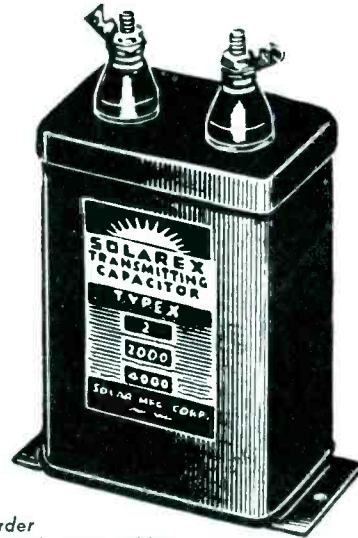

Order
through your jobber

SOLAR MFG. CORP.

599-601 Broadway

New York, N. Y.

This Is HOT!

THE SENSATION OF THE INDUSTRY

Lifetime Gives You the World's Lowest Priced Velocity Microphone.

A leader in a FULL LINE of VALUES. Model 20, Range 50 to 8000 CPS. Output minus 68 DB. Complete with 25 ft. cable. Exclusive floating element . . . no cavity response. Unrestricted guarantee.



Get this Microphone TODAY! It shatters all former ideas of value. **Dealers Net Only \$9.97**

LIFETIME CORPORATION, TOLEDO, O.

"Outstanding Value in Sound Equipment"

Postpaid on Receipt of Remittance and Your Jobbers Name. **ACT NOW!**

110 VOLTS AC ANYWHERE!

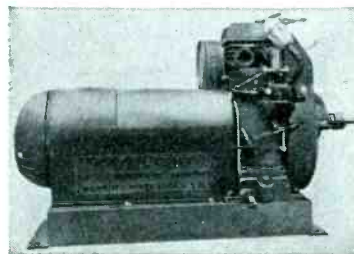

With KATOLIGHT. Furnish standard 60-cycle AC for operating sound truck equipment, AC radios, transmitters, flood lights, motors, moving picture projectors, etc.

A Few Popular Sizes

350 Watts AC, JRA3, \$89.50

500 Watts AC, JR55 \$130.00

1000 Watts AC, 26AL \$228.00

A complete line of light and power plants ranging up to 10,000 watts.

Also 6, 12 and 32 volt battery charging plants, Diesel plants, rotary converters, and frequency changers.

KATO ENGINEERING COMPANY

Mankato, Minn., U. S. A.

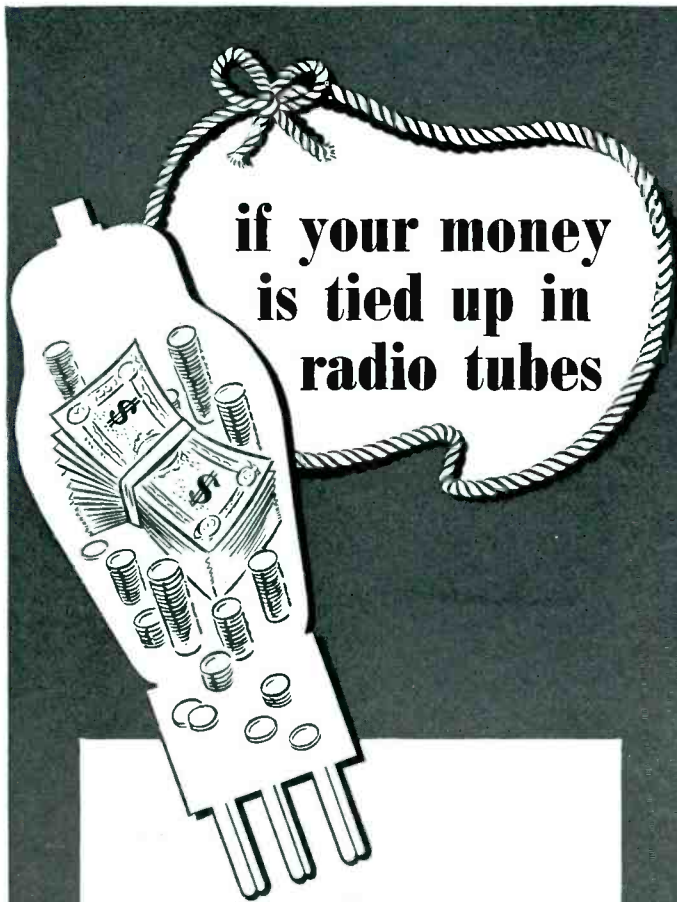

if your money
is tied up in
radio tubes

... you'll want to know more about Tung-Sol's Consignment Plan, under which the dealer sells first, then pays. Thus he is guaranteed against losses due to slow turnover, obsolete stock, or price declines.

Because Tung-Sol dealers are carefully chosen as to location and qualifications, each is assured of his share of the business as well as full profit from every sale.

Responsible dealers and service men should investigate the Tung-Sol Consignment Plan. Write to our nearest sales office today to learn whether you can qualify.

Radio Trade Show: — Booths 110-112
Marconi Blvd. Stevens Hotel

TUNG-SOL LAMP WORKS, INC.
Dept. B Radio Tube Division

SALES OFFICES: Atlanta • Boston • Chicago
Dallas • Denver • Kansas City • Los Angeles
Detroit • New York • General Offices, Newark, N. J.

TUNG-SOL
Tone-flow Radio Tubes

★THERE'S
PROFIT
IN PUSH
BUTTON
TUNING...

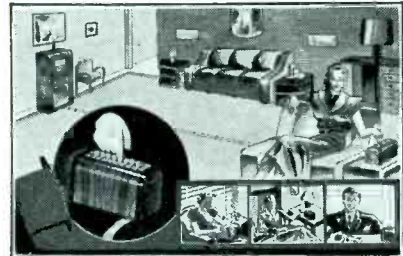

For homes—remote touch tuning at any distance.

Install **ADDISON** AUTOMATIC PUSH BUTTON TUNERS

List Prices

	Model	
5 button	500	\$5.50
6 button	600	7.00
7 button	700	8.50
8 button	800	10.00

Work perfectly on any radio—easy to install—no special tools needed. Install these tuners on every radio you sell and those already in service. Learn more about this outstanding development of the season—TOUCH TUNING. Get complete details and information on special Distributors and Dealers discounts.

For cars—electric touch tuning—accurate—simple. Manufactured and Guaranteed by

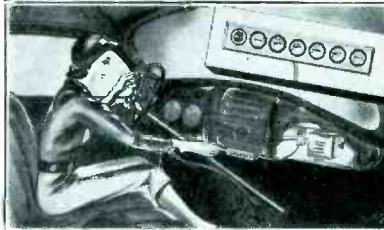

ADDISON
RADIO MFG. CO., INC.
3017 Carroll Ave.
Chicago, Ill.

"PINCOR" POWER SUPPLY UNITS

DYNAMOTORS GEN-E-MOTORS CONVERTERS

"PINCOR" dynamotors, gen-e-motors and rotary converters provide the last word in power supply units for air craft, police, marine and auto radios; also for public address systems. Now widely used by leading air lines and municipal and federal agencies throughout the world. Available in a wide range of capacities for every requirement. Compact, light weight. Sturdily constructed to assure long dependable service. Write for catalogue and complete information.

PIONEER GEN-E-MOTOR CORP.
Manufacturer of "PINCOR" Products
Dept. R-IF
466 W. Superior St., Chicago, Illinois

OTHER
"PINCOR"
PRODUCTS

RED TOP and GOLD CROWN gas-engine driven electric light and power plants, 100 to 2000 watts; alternating or direct current; air or water cooled; remote control. Send for literature.



SHORTCUTS

Repair for Slipping Dial Belts

By R. H. Hertel

Many dial belts in some of the newer sets are of the fabricated type, similar to automobile fan belts. Through wear and climatic conditions they gradually stretch and begin to slip. Sometimes a glaze forms on the inside of the belt and increases the slippage.

A good remedy for this is as follows: Dissolve powdered rosin in a small quantity of alcohol, so as to form a heavy paste. Apply this paste sparingly with a match stick to the inside of the belt at various points. Revolve the dial while applying, so as to cover the belt with a thin film.

Keep the mixture in a small bottle, tightly corked. If it dries out from time to time, add a few drops of alcohol.

Service Kinks

By Eugene J. Krzysko

When checking a speaker field to see if it is receiving excitation, hold a steel screwdriver about $\frac{1}{4}$ inch away from the

pole piece. It should be strongly attracted if the field is not shorted or open.

To determine whether a superhet oscillator is functioning properly, touch the ungrounded side of the oscillator

coil with a moist finger. This will cause a click to be heard, usually removing all signals while the position is held. Removing the finger will cause another click. If a set is dead and only the first click is heard, suspect the oscillator.

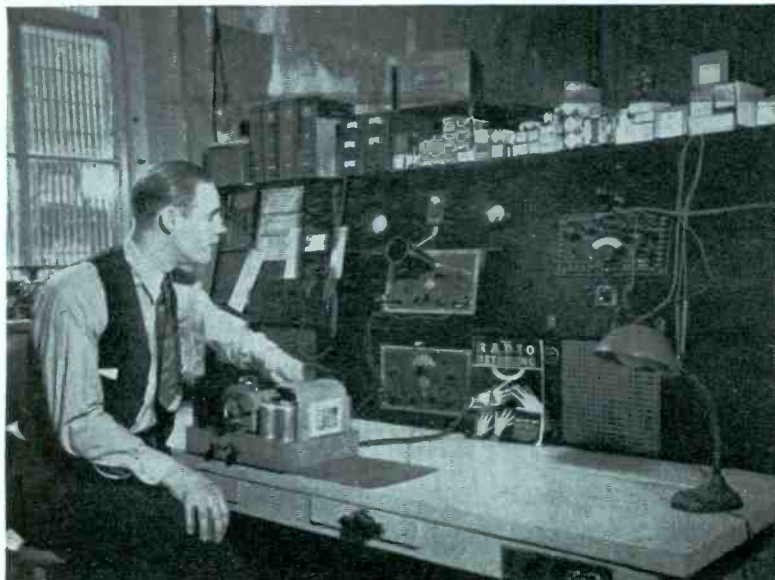

SAY POPPA—Tom Brown of the firm of Luther A. Ely, Jr., Carbondale, Pa., cross-examining a job which replies via the medium of a cathode-ray oscillograph. Tom has all the test instruments necessary for a thorough test job built into the bench.

AMPLIFIERS

By THORDARSON

Built by Audio Experts for Audio Experts

*The Amplifier
of "Tomorrow"
in*

- PERFORMANCE
- APPEARANCE

See Your Jobber or
Write Factory for
Catalog No. 600-C

THORDARSON ELECTRIC MFG. CO.

Amplifier Division

500 W. HURON ST. CHICAGO, ILL.





PREVIEW of 6 RADIART SMASH HITS

NEW VIBRATOR UNIPAK
Hits a New High in
Vibrator Merchandising

NEW COWL AERIAL
A Low-Cost, Single
mount model for volume

NEW SHAVER-PAK
6-volt and 32-volt
power for Electric Shavers

NEW VIPOWER
Plenty of business waiting
for this Power Supply Unit

NEW D-5 DEAL
A new Aerial Display
with an Extra Profit . .

NEW POLICE AERIALS
Yes, and new ones
for amateurs, too

**SEE THEM
at the SHOW**
(105 Ampere Street)
or Write for Bulletins
THE
RADIART
CORPORATION
Shaw at 133d • CLEVELAND



TRICKS

ARVIN 1237-1427

Too much bass at low setting of volume control . . . remove bass compensating connection on volume control. This consists of an 18,000 ohm resistor in series with a .03 mfd condenser.

ARVIN 1427

Station shift on push-buttons . . . replace original fibre oscillator trimmer strip with new type isolantite type. Seal trimmers after adjusting.

ARVIN 1937 AUTO RADIOS

Vibrator hash . . . warm up for 30 minutes then tighten the 4 screws holding the power transformer to chassis. It is important to warm up the set first, otherwise the initial heat will cause the screws to loosen.

ATWATER KENT 165,185,525

Oscillation when volume is turned on full . . . replace double 250 mmf condenser with two single bakelite units. This condenser connects from the plate of 58 i.f. to the two diode plates of the 2A6.

BREMER TULLY 640, 641

Dead, with ohmmeter indicating short between plate of 71A and chassis . . . socket not at fault. Trouble due to receding of insulation on plate lead of output transformer, which is housed in metal container (under chassis) with other audio transformers. Bared lead shortening to another normally bare wire at ground potential. Though short occurs within container, the following procedure will likely clear trouble without breaking can open. Apply hot soldering iron to lug which connects to the transformer lead (coming up through hole in lug) with external lead going to 71A plate; and when solder starts to melt, grasp transformer lead with pliers and gently draw as much of it from inside of can as possible. Wind wire brought out around lug and solder to prevent wire from slipping back. The remainder of lead within container is now likely insulated throughout its entire length and the short removed.

Oscillation after installing new 26 type tubes in r.f. stages, interchanging old tubes in these stages or adding to length of aerial . . . turn adjusting screw of compensating condenser (connected between plate and grid of first r.f. tube) counter-clockwise till oscillation ceases.

Full volume at other than maximum setting of control . . . volume control worn in spots. Replace.

YOU NEED THEM BOTH

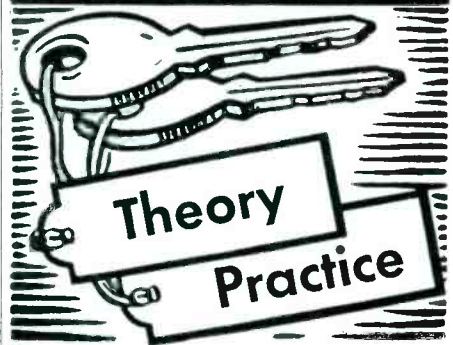

LIKE TWIN KEYS—both of which are required to open the safe deposit vault—THEORY and PRACTICE are both necessary if you are to get the most from your efforts.

Whether you are a serviceman whose profits depend upon the speed of your work—or an amateur whose pleasure depends upon the performance of your instruments—you know the value of a thorough grounding in theory and the importance of having factual information constantly at your fingertips. Know "how" and "why" a set performs. Order the Rider Books you need—RIGHT NOW!

RIDER BOOKS BANISH

Bewilderment

AUTOMATIC FREQUENCY

CONTROL SYSTEMS

With Automatic Frequency Control Circuits in most new higher-priced models, knowledge of "AFC" means money in your pocket! Learn the practical facts, from these easy-to-understand explanations. Get your copy today. Cash in on profitable "AFC" work. Hard covers. 144 pp. \$1.00.

THE CATHODE-RAY TUBE

Written especially so you can understand the subject. With introduction of new, cheaper Cathode-Ray Tubes, this book is even more indispensable for its complete practical information on Oscillographs, etc. 336 pp. 450 illustrations. \$2.50

SERVICING SUPERHETERODYNES

Changes, changes, changes! That has been the history of the superheterodyne circuit. Make repairs quickly by analyzing the different parts of the circuit quickly. Rider shows you how in this revised edition which has 288 profusely illustrated pages. \$1.00

"AN HOUR A DAY WITH

RIDER" BOOKS —60¢ each

ON AUTOMATIC VOLUME CONTROL will speed up your AVC work. 96 pp. 65 illus.
ON RESONANCE & ALIGNMENT. You need this! 96 pp. 48 illus.
ON D-C VOLTAGE DISTRIBUTION IN RADIO RECEIVERS. How d-c voltages are led to tube elements, etc. 96 pp. 69 illus.
ON ALTERNATING CURRENTS IN RADIO RECEIVERS—with drawings and diagrams.

JOHN F. RIDER, PUBLISHER
404 Fourth Ave., New York

Remember

**YOU NEED ALL 8
Rider
MANUALS**

TRICKS

CROSLLEY 515, 5515, FIVER

No reception . . . often due to open in two-section Candohm resistor at rear of chassis sub-base. Overall resistance: 33,500 ohms; long section, 25,000 ohms; short section: 8,500 ohms. In event of open in either section, and original replacement not available, use 5-watt resistor of corresponding ohmage.

CROSLLEY 1127, 1117

Poor tuning-eye action . . . remove cathode lead from ground (black wire) and connect to the lower end of the diode load resistor.

EDISON R6 AND R7

Tendency to oscillate after all usual causes such as bypass condensers and rotor wipers have been checked. Connect a .01 mfd. 600 volt from power transformer primary to ground.

EMERSON 38, 42, 49

No reception . . . check for open in 0.01 mfd. tubular condenser, connected between grid of 75 tube and low end of i.f. winding feeding diode plates of same tube.

Dead . . . heat generated in filament voltage-dropping resistor frequently causes loose connections of terminals of unit. Wind leads securely on terminals, resolder.

EMERSON H5

Loud hum; filter condensers and tubes check O.K. . . inspect the ballast resistor for leakage from taps to ground. This resistor is covered with asbestos then protected with a metal sheath. If leakage is found, insulate sheath from chassis.

EMERSON K116, K121, K123

Inability to rotate tuning condensers with panel control . . . remove chassis from cabinet; if belt in good condition, slip spring off bracket; and, with pair of pliers, bend spring so that when replaced it pushes pulley more firmly against belt.

AUTO SETS

Many of the older auto sets using early type output tubes may be improved by installing a 6V6 beam tube. Change the socket to an octal type; replace the cathode bias resistor with 250 ohms, bypassed with a 10 mfd. 50 volt electrolytic.

RADIO RETAILING, JUNE, 1938

Jensen

Predominant Always

PERI-DYNAMIC REPRODUCERS and Bass Reflex . . . the industry's outstanding achievement

consider these TWO recent developments and their profit value to you

HIGH QUALITY Low Cost Speakers for REPLACEMENT and GENERAL USE

Model KM, available with specially designed 8, 10, 12, 15, 18-inch and Auditorium Speakers, recommended for all kinds of reproduction and reinforcement involving both voice and music; incorporates the *Bass Reflex* principle. To be used with radio receivers, phonographs, P.A. systems and in all cases where reproduction of music at high quality is the predominating requirement.

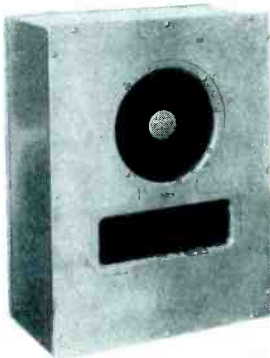

Model KV, available with specially designed 8, 10 and 12-inch Jensen speakers, recommended where reproduction of voice is the predominating requirement for speech reinforcement, stage, ballroom, for paging and similar uses.

Peri-dynamic Reproducers and Bass Reflex, exclusive Jensen developments, mark a new era as definite as that created by the electro dynamic speaker. It adds whole octaves to music, makes speech crisp and intelligible, and eliminates objectionable resonance and boom.

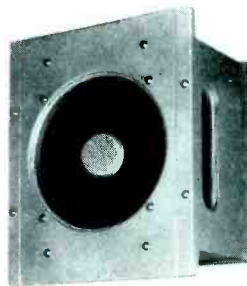

New Series "S"; 5", 6" and 8" speakers available with field coils or permanent magnets.

Developed by Jensen to answer the problem with which every dealer and serviceman has struggled; namely, a speaker at a price the public will pay with guaranteed quality and reliability. Anybody can build cheap speakers but it requires an expert to build a good speaker at a low price.

It is no longer necessary for the reliable radio service dealer to jeopardize his reputation by offering an ill-fitting, poorly designed replacement part or a nondescript complete speaker to meet the owner's demand for low price.

PRICES

With Permanent Magnets

PM5-FS . . . \$2.70 less Transformer
PM6-ES . . . 3.30 less Transformer
PM8-DS . . . 4.65 less Transformer

With Field Coil

H5-S . . . \$2.30 less Transformer
H6-S . . . 2.70 less Transformer
F8-RS . . . 3.90 less Transformer

Complete literature available from your jobber or write.

All KM and KV Models are offered in knock-down enclosures at money-saving prices, particularly when it is considered no baffle is necessary. For example, Model KM with 8-inch speaker, list price is only \$20.50 Model KV with 8-inch speaker, list price is only \$12.50.

Besides these models, *Peri-dynamic* reproducers can be obtained in a wide variety of cabinet models. Write for complete literature.



Jensen Radio Manufacturing Co. RR-638

6601 South Laramie Ave., Chicago, Ill.

Please send me complete literature

1. Peri-dynamic Reproducers and Bass Reflex
2. New Series "S" Speakers

Name

Address

City State

BOGEN SOUND SYSTEMS

Maintaining leadership
and reputation
"Always first with the latest"

Wireless Remote Control (two channel)

Sound Men—Don't miss this amazing new development. Perfect remote control of volume by WIRELESS on any Bogen Amplifier.

Another Bogen Exclusive! SELECTIVE WIRELESS INTERCOMMUNICATION!

Up to 10 Master Stations
Any station can call any other station *privately* or page them all at once.

The most complete line of sound systems and intercommunicators on the market.

See and hear this equipment demonstrated in Rooms 556-557-560—Hotel Stevens, or Booth 206 Steinmetz Avenue, National Radio Trade Show.

For those not attending Show Complete literature available

WRITE

David Bogen Co., Inc.
663 Broadway, New York City

T R I C K S

GRUNOW 116

Dead . . . 0.1 mfd. tubular condenser, (part No. 29,135) bypassing screen of 6K7 in first I.F. stage, shorted.

GRUNOW 660, 661, 662

Weak or no reception . . . test 0.02 mfd. condenser, bypassing plate supply of 6D6 r.f. stage, for short. 2,000 ohm, $\frac{1}{4}$ -watt resistor in plate circuit of same tube also likely damaged if condenser defective.

LYRIC MODEL D

Low volume . . . Check plate and grid circuit bypasses for high resistance.

MAJESTIC 44, 49, 194

Hum, reception blanketed by oscillation . . . open section in 6.4 mfd. electrolytic condenser block.

MAJESTIC 66 AUTO RADIO

One side of rectifier tube not working . . . adjust the vibrator carefully according to original directions so that both plates handle equal load.

MAJESTIC 71, 72

Dead . . . look for open windings in audio transformers in these early electric receivers.

PHILCO 70, 70A

Dead, with rectifier plates red hot . . . if filter condensers check okeh, inspect filament leads of tubes at rear of chassis at points where leads pass under primary trimmer condensers of I.F. transformers. Leads sometimes come in contact with edges of condenser plates, the latter in time cuts through the insulation on the wire shortening of entire "B" supply.



★BROWN DEVILS—the famous extra-sturdy Ohmite wire-wound vitreous-enameled replacement Resistors, 10 and 20 watt sizes. Resistance values 1 to 100,000 ohms **★ DIVID-OHMS**—the handy Ohmite vitreous-enameled Adjustable Resistors that solve most any power resistor problem in a pinch **★ RHEOSTATS**—Ohmite all-porcelain vitreous-enameled Rheostats—for smooth, safe, close-control of motor speed, filament voltage, lamp dimming, etc. **★ R. F. and POWER LINE CHOKES**—for transmitter and receiver R. F. circuits, interference elimination, etc.

See Your Jobber, or Write for Free Copy of New Ohmite Catalog 17.

Visit the Ohmite Booth, National Radio Parts Trade Show, Chicago, June 8-11.

OHMITE MANUFACTURING CO.
4845 W. Flounoy Ave., Chicago, U.S.A.



Can You Handle More Volume in Combinations?

EQUIP your sets with low-cost, efficient, built-for-service General Industries automatic record changer units . . . and get demand. People are surprised and appreciate getting the great convenience at such a low additional cost over hand-changing equipment.

Complete units, assembled and self-enclosed, ready to place in your cabinets. Famous Flyer induction-type, governor-controlled, self-starting motor with turn-table-accurate speed—silent, dependable. Simplified, trouble-free automatic changer mechanism.

Act on this now, for a well-directed, timely move to enlarge your market.



Model
M



Plays and automatically changes eight 10" or seven 12" records, repeating the last. Model "K" plays and changes eight 10" records and plays 12" records changed by hand . . . Order samples for testing. Kindly specify whether AC or Universal AC-DC and give exact voltage and frequency of the current you use.

The GENERAL INDUSTRIES CO. 3837 Taylor St.
Elyria, Ohio

Coming

AN INSTRUMENT DESTINED TO Revolutionize SERVICING!!

Developed in John F. Rider's *Successful Servicing Laboratories*, to fill a long-existing need in the service industry, the *Rider Chanalyst* will soon be available to the service engineer.

The *Rider Chanalyst* is the one instrument which:

1. Has universal application to all types of receivers,
2. Provides new, uniform method of testing for *all* servicemen.
3. Makes possible the most rapid analysis of set troubles.
4. Eliminates the difficulties of locating troubles in intermittent receivers.
5. Enables servicemen to make *quick*, practical estimates *in the home*.
6. Has longer life as a useful test instrument.
7. Is remarkable in its ease of operation.
8. Is priced within the reach of every forward-going serviceman.

The *Rider Chanalyst* is, without question, one of the most important and far-reaching service developments of the last ten years. The amazing results obtained through its use will make it an indispensable instrument to every progressive serviceman.

The **RIDER Chanalyst**

T R I C K S

MAJESTIC 44, 49, 194 (CHASSIS 440)

Dead, with pinkish glow in rectifier . . . high voltage arcs over to chassis from tube prongs of rectifier due to small chassis cutout for socket. Arcing causes socket to carbonize, necessitating replacement. Before removing damaged unit, make six pencil marks around circumference of socket hole. (one opposite each prong hole of socket) Then remove socket, making note when unsoldering leads as to what terminals they came from. Now, with a tapered-blade hack-saw, cut out notches around circumference of hole at points marked with pencil. Make notches sufficiently deep and wide so that when new socket is installed there will be ample clearance between tube prongs and chassis to prevent repetition of trouble. The job can be made neat if the notches are rounded with a small rat-tail file.

MAJESTIC 92

Loud hum modulating signal, disappears when station is tuned out . . . remove cover from power pack and connect .1 mfd condenser from ground to one side of a.c. line. Try both sides as one is more effective.

Heavy frying noise in speaker . . . take ballast apart and disconnect long screw running through porcelain insulator, clean top of ballast with sandpaper; also clean screw.

MAJESTIC 381 (CHASSIS 380)

Dead . . . if ohmmeter applied between G84 rectifier filament and chassis indicates full scale, 8 mfd. section of 8.4 mfd. electrolytic condenser block is shorted.

MOTOROLA 124

Tuning motor runs constantly . . . white wire grounded where it goes through dial assembly.

OLDSMOBILE 405046, PONTIAC 544268

Mushy tone, fading . . . replace .02 mfd (C21A) condenser coupling triode plate of 6F7 to control grid of 85. Also .04 mfd (C21B) between triode grid and center top of volume control.

PHILCO 45L

Noisy with weak or no reception all plate voltages normal . . . check first i.f. transformer for open.

PHILCO 47

Intermittent reception, frequent burn-out of tubes and pilots . . . check pilot light socket behind the tuning meter for short to chassis.

EXTRA! EXTRA! PRECISION A.C. and D.C. POCKET-TESTER

ONLY \$12.00



Model 736

Volt-Ohm-Milliammeter Uses TRIPLETT Precision INSTRUMENT

- Molded Case
- Jacks for All Ranges
- Copper Oxide Rectifier for A.C. Ranges
- All Accessories Included
- For A.C.-D.C. Voltage, D.C. Current and Resistance Analyses

A precision A.C. and D.C. tester at the unheard price of \$12.00. Uses Triplett precision instrument.

READINGS: 0-1½-15-150 D.C. Mils; A.C. and D.C. Volts, 0-15-150-750 D.C. at 1000 Ohms per volt, A.C. at 400 Ohms per volt. Low Ohms, ½ to 1000; 0-100,000 high ohms at 1½ volts; External batteries can be used for higher resistance.

Sturdy molded case with rounded corners . . . 3-1/16"x5 7/8"x2 1/8" . . . Attractive silver and black panel. Sold complete with all necessary accessories.

You need this tester—it will make money for you—just look it over at your jobbers. Made and guaranteed by a company in business 34 years and noted for reliability.



READRITE METER WORKS
620 College Ave., Bluffton, Ohio
Please send me more information on

Model 736

Name

Address

City..... State.....



A QUALITY PRODUCT— Specify CONTINENTAL CARBON

RESISTORS FILTERNOYS SUPPRESSORS



Wire wound resistors encased in dense hard cement which resists moisture, abrasion, chipping, and heat. In 5-10-20-watt sizes at 30c, 40c, and 65c list.



Carbon hermetically sealed in bakelite is the brief description of these compact new CONTINENTAL CARBON 1/2, 1, and 3-watt units. New positive silent end lead connections, 17c, 20c, and 30c list.



Carbon insulated in ceramic: The first practical insulated carbon resistors, 1/2, 1, and 3-watt sizes at 17c, 20c, and 30c list.



Filternoys, F01DH, plug-in interference suppressor combines filter chokes with diverting capacitors to ground electrical disturbances from many types of home appliances.

F01DH, list price \$1.00



Filternoys, F18, the latest most compact CONTINENTAL CARBON noise suppressor for use on all household appliances on domestic power lines with a neutral ground. Only 35c list. Eleven other Filternoys devices to throttle noise and boost your profits.

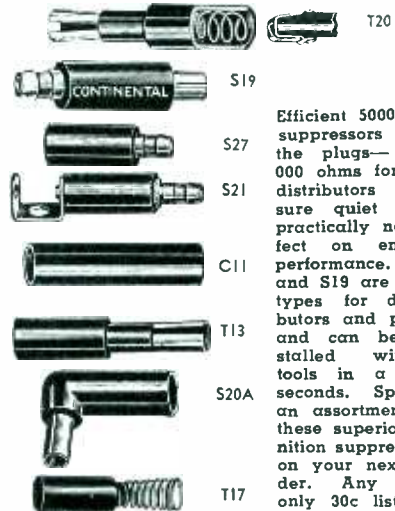

Efficient 5000-ohm suppressors for the plugs— 10,000 ohms for the distributors assure quiet with practically no effect on engine performance. T20 and S19 are new types for distributors and plugs and can be installed without tools in a few seconds. Specify an assortment of these superior ignition suppressors on your next order. Any size, only 30c list.

CONTINENTAL CARBON INC.

13902 LORAIN AVENUE

Canadian Plant—Toronto, Ontario

CLEVELAND, OHIO, U. S. A.

**PUSH UP PROFITS . . .
WITH STEWART ALL-ELECTRIC
PUSH BUTTON TUNING
FOR ANY AUTO RADIO**



PROFIT FEATURES

Adaptable to any make of auto radio on any make of car. Electric motor driven unit push button remote control. Lightening station selection.

The Stewart all electric push button tuning unit comprises the best in automotive tuning engineering. It's easy to install . . . demonstrate . . . and sell. Gain additional customer good will and "push up profits" with Stewart.

Write today. Complete information, without obligation.



Electric motor control unit complete with wiring and mounting brackets.

**F. W. STEWART MFG. CORP.
342 W. HURON STREET, CHICAGO, ILLINOIS**

• REMLER

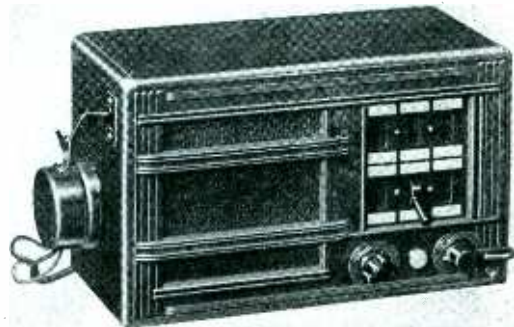

Quality P. A. and Inter-Communication Systems • Profitable Territories Open

Build a permanent business with reliable Remler equipment—famous for quality since 1918. Modern inter-communication systems flexibly designed to meet every requirement. Portable P. A. and units for permanent installations. Dealers and distributors given fullest cooperation. Write for complete details.

REMLER COMPANY, LTD.

19th at Bryant

San Francisco

TRICKS

NEW SET TRICKS

The following are pointers applicable to modern sets. These peculiarities of design which arise from time to time were outlined in a recent RCA bulletin.

USE OF PENTAGRID CONVERTER WITH SEPARATE OSCILLATOR

When a pentagrid converter type of tube is used with a separate oscillator, oscillator voltage is usually connected to the No. 1 grid of the pentagrid converter; its anode-grid may be grounded or connected to screen. With anode-grid grounded, a peculiar form of oscillation, which is evidenced by tunable noise in the receiver, may be generated. The remedy is to connect anode-grid to screen, because the oscillation and, hence, the noise are not present with this connection.

TUNING INDICATOR TIP

In some receivers, the cathode current of the 6E5, 6G5, 6N5, or 6U5 flows through the cathode resistor of another tube. When the value of this current is an appreciable part of the total current through the resistor, changes in the cathode current of the "magic eye" during life may cause a change in bias on the other tube. To avoid difficulties due to change in bias, it is recommended

that the cathode of the 6E5, 6G5, 6N5, or 6U6 be grounded.

GROUND OCTAL-BASE SOCKETS

Receivers designed for octal-base glass tubes often use the blank No. 1 lug on a socket as a terminal post for B+ or other high potential leads. When a metal equivalent of a glass tube is inserted in such a socket, it is possible to receive a shock, violate fire underwriters' regulations, and impair receiver performance because the shell of the metal tube is not at ground potential. It is suggested that the No. 1 pin of octal-base sockets be grounded in order to avoid these difficulties.

HUM IN AC/DC SETS

When abnormally high hum modulation is present in a-c/d-c receivers, it is suggested that the heater of the pentagrid converter be located as near chassis potential as possible. In several cases where this condition was investigated, hum modulation was reduced considerably by rearranging heater connections in such a manner that the heater of the pentagrid converter was second from the chassis. The heater of the first a-f tube was located at chassis potential in order to reduce hum introduced in the grid circuit of this tube.



- ★ The DANDEE is the ideal general-utility electrolytic for servicing AC-DC sets and for by-pass functions.
- ★ Small. Fits anywhere. No larger than usual paper tubular. Yet packs from 4 to 40 mfd. 150, 250, 350 and 450 v. D.C. working.
- ★ And it's genuine, full-rated, long-life capacity and voltage. Positively no cheating.
- ★ Dry electrolytic section. Hermetically-sealed can. Protected by insulated paper jacket.
- ★ Ends of jacket spun over aluminum can rim. No chance for "shorts" if leads are bent close to can. Jacket can't slip off.
- ★ Fully vented! Note vent plug on one end. Eliminates dangerous gas pressures.
- ★ Polarity-indicating red and black end disks. Corrosion-proof. Thoroughly aged. Individually tested. Yet it costs only 40 to 90 c. list, depending on capacity and voltage.

Ask Your Jobber. . .

- ★ Ask him to show you these DANDEE midget electrolytics. Better still, order an assortment and have them on hand for those midget set jobs.



...but do you know

CINAUDAGRAPH SPEAKERS

cost no more . . .

You know well the superior quality Cinaudagraph builds into its speaker units; you know the painstaking exactness of Cinaudagraph engineers. Indeed, this is common knowledge to the radio industry today. But—and here is news—do you know that Cinaudagraph speakers are now competitively priced . . . that you can specify these superb quality instruments on your jobs at no extra cost?

Cinaudagraph P.M.'s are available in a complete range from 5 to 18 inches—new line of electro-dynamics from 5 to 10 inches. • Visit with us at the National Parts Show in Chicago, Booth 214 Faraday Avenue, and demonstration room No. 502-A at the Stevens Hotel.

CINAUDAGRAPH offers you today the biggest money's worth in the permanent magnet speaker field. In workmanship, in high frequency tested performance and now in price, you can't beat Cinaudagraph.

ENJOY THEIR EXTRA VALUE at no extra cost!

CINAUDAGRAPH CORPORATION

SPEAKER DIVISION

STAMFORD, CONNECTICUT

CINAUDAGRAPH PERMANENT MAGNET SPEAKERS

BIGGER AND BETTER THAN EVER AND STILL **FREE**

TO RADIO DEALERS AND SERVICEMEN! 3rd Revised Edition of **"TRICKS OF THE TRADE"**

Contains accurate answers to 956 set troubles
— 11 reference charts — 24 auto circuits

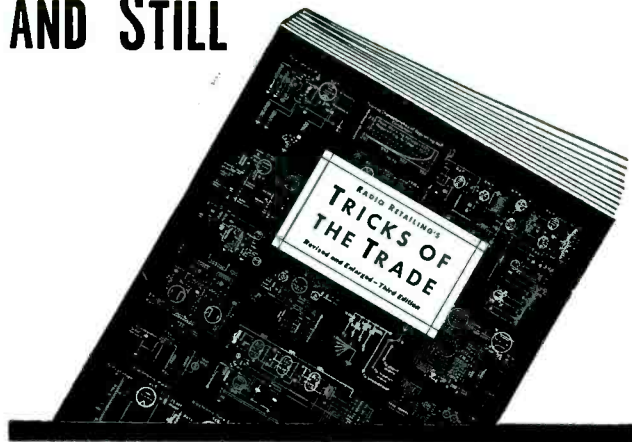

SAVES YOUR TIME! SAVES YOUR MONEY! ENDS SET WORRIES!

HUNDREDS of radio men are using this unequalled, trouble-shooting guide to take the "bugs" out of their toughest repair jobs and pour EXTRA profits into their service work. Already in its third edition, "Tricks of the Trade" has really clicked. But it should. It contains not one bit of useless data, no waste descriptions, no theories, no help for fans or amateurs. Every one of its 76 pages is packed with practical, "how to" information that answers the questions on set troubles that crop up in your work every day.

"Tricks of the Trade" is one service book that is different. Once you have had a copy you won't part with it for a minute. I know many men who consider it more valuable than their tool kit. This one, new edition contains:

- 956 tested ways of finding and fixing the troubles common to specific makes and models.
- 102 tube socket diagrams showing the connections for more than that many types of new tubes.
- Valuable reference charts showing—why service can't be cheap—types of auto aerials—analysis of common set troubles—24 automobile ignition circuits—why servicemen charge for inspection—and others.
- Why are these "Tricks" good? Because every one of them came right from the actual

experience of professional radio experts. (See typical examples in column to right of page.) Why spend hours of your time testing and re-testing a balky circuit, when, with this new book, you can put your finger on the most probable cause of the trouble in a few seconds.

- These "Tricks" will show you how to spot a lot of set troubles that don't show up in any circuit tests you make. If your time is worth money and you like to duck plenty of grief—get yourself a copy of "Tricks of the Trade"—today. **IT IS FREE IF YOU ACCEPT THIS OFFER NOW.**

HOW YOU CAN GET THIS VALUABLE BOOK **FREE**

- Simply fill in and return the order blank below with the subscription fee to cover one year of Radio Retailing for \$1 or three years for the reduced rate of \$2. The new editions of "Tricks of the Trade" is included as our gift.
- This book is not for sale separately. Credit orders cannot be accepted. Be sure to enclose remittance with your subscription order. **ACT NOW.** This new edition is going fast. Don't be sorry. Do it today.

Time-Saving Information

Certain radio sets develop trouble peculiar to their particular type of circuit. Each month "Tricks of the Trade" explains how to locate and fix specific set failures. The following are examples of the curt, practical way Radio Retailing offers this vital information to you.

BREMER-TULLY, BRUNS-WICK 58

Bad volume control . . . Often due to fibre projecting too high, causing rotor arm to miss. Push fibre down before replacing control.

CLARION 60, 61

Set dead or very scratchy . . . Look for failure of special audio input transformer primary. Replace with same device or substitute resistance coupler. Tone will suffer if ordinary transformer is used for replacement due to special characteristics of original.

CROSLLEY 143

Neon pilot lights when set switch is in Off position . . . Replace leaky 8 mike, 150 volt condenser.

MOTOROLA 77

Poor tone . . . Check to see if voice-coil or field wires have been reversed. This causes voice-coil form to become blackened and charred inside due to heat. If swollen, discolored appearance is noted replace.

RCA 120

Operates at low volume on strong signals, intermittently comes up to good volume . . . Check .05 condenser between center terminal of volume control and control grid lead of 2B7 second detector.

Every issue of Radio Retailing will bring you more of these "Tricks". File them and in a short time with this FREE book you'll have a service manual of un-equalled value.

Mail this coupon and payment—Today!

FREE-BOOK SUBSCRIPTION ORDER FORM

PRESENT SUBSCRIBERS NOTICE

Present subscribers may obtain a copy of this FREE book by renewing their present subscription. Regardless of when your present subscription expires, you must send in another PREPAID renewal order. Your subscription will be extended for additional time without duplication. No previous renewal orders count. We must show a matching order for every book sent out. Mail in your order and payment today.

This offer only applies to U. S. and possessions, Canada, Mexico and Central and South America. All other countries add 50c to foreign rate of \$2 a year to cover postage charges on book.

All books are sent out by express to insure safe delivery. There is a small handling charge of 15c—payable to the expressman upon delivery of the book. If you prefer book sent prepaid, add 15c to the subscription fee at time of ordering.

O. K. Attached is \$2 for a 3 year subscription to Radio Retailing. With this order I am to get a FREE copy of the 76-page service book—"Tricks of the Trade". I'll pay the expressman 15c for delivery charges. Send the book at once. Check here if this is renewal order.

Name..... Position.....
Street.....
City..... State.....
Our Main Business Is.....

Check here and remit \$1 if you wish only one year subscription PLUS FREE book. 6-38

No orders accepted without payment attached

RADIO RETAILING
330 West 42nd Street
New York, N. Y.

This offer expires after August 1st, 1938

Pin
\$1 or \$2
Here

Audio Frequency...

Boosts

During these past fourteen years I have read and dropped many publications in the radio field but find from experience that I am unable to drop *Radio Retailing* if I wish to keep up with the constant changes and progress in the radio field.

HOBOKEN, N. J. EDWARD A. TURNIER
Edward's Radio Service

I have received your volume "Tricks of the Trade." This volume contains more real information for the serviceman than any book I have ever bought. I hope you will continue these helps as I feel sure every serviceman will welcome them. I have paid four times as much and received less information.

RAVENNA, OHIO C. D. MARSH

Your paper comes as a monthly tonic to me. The December issue, in particular, is as good as a week in Switzerland!

What a pity you can't run a *Radio Retailing* in England.

Best wishes from all the boys in the Midlands.

BIRMINGHAM, ENGLAND FRANK C. RICHARDSON
Gen'l Mgr., Philco Midland Dist., Ltd.



"This week's special is a Crystal Set inside of this cabinet."

In your February issue on page 68, under "Audio Frequency" is a letter from someone who signs himself "Reader". I am one who agrees with him. I have hunted but have had little success.

FLEMINGSBURG, KY. CARL R. GRIGSBY

Slams

I find your magazine *Radio Retailing* satisfactory except for the arrangement of the "Tricks." I think they should all be on the same page because when you cut them out it leaves the magazine cut up so bad. This would be a great improvement for the serviceman.

WAYNESVILLE, OHIO ROBERT HYMAN

We can't always do this and handle advertising. And, after all, it is the support of the advertiser as well as the reader that permits us to give you so much costly data for so small a subscription price. After all, we do religiously avoid "backing up" Tricks of the Trade items with other material that the average serviceman wants to file. This is tough enough in practice.

And Welcome

In the March issue of *Radio Retailing* appeared an article entitled: "How To Get Started With Sound," written by Robert S. Nash.

We enjoyed reading this article and feel there are quite a number of our dealers throughout Canada who could gain some very valuable knowledge on the subject dealt with, and are asking your permission to have this article, and future articles on this subject mimeographed, giving full credit to *Radio Retailing*, and send to our dealers.

TORONTO CECIL E. LITTLE
Salcs Mgr., The N. H. Speight Labs.

Distributorship Wanted

Am open for a distributorship for the state of Michigan of a nationally-known line of home and auto radios. Have an experienced organization with ample capital as well as a dealer organization.

If you know of any of your advertisers who are looking for such a connection would you kindly have them communicate with me. The address is 2690 Boston Boulevard.

DETROIT A. S. ISAACS

NEW SEASON OUTLOOK

(Continued from page 15)

crops later in the year should carry retail sales with much higher totals.

For those who believe that increased building and construction activities hold the key to better business, current reports by *Engineering News-Record* hold great promise in that major engineering awards during April 1938 averaged the highest weekly volume since 1931, with private construction 5% and public works 18% above April 1937. All kinds of public works construction and business of steel and machinery workers will be boosted substantially when the President's new five billion dollar pump priming program gets under way.

Finally, recent reports give further support to the premise that retail business and with it retail set sales soon will begin to go up.

For instance, in April the sales of most drug, shoe, apparel, and variety chain store organizations went decidedly ahead of April 1937. The department store sales of sporting goods and pianos, all considered as luxury items, were approximately 6% higher during the first 3 months of this year than in the same period of 1937, and cameras chalked up an increase of 20%.

To the student such figures are testimony of the buoyancy and responsiveness of retail sales and gain added significance when it is remembered that steel production and general industrial activity are still at low ebb and automobile output is down to less than 50% of 1937 volume.

Therefore, when above and other known factors are weighed, it seems more of a certainty that retail sales in general and radio set sales in particular soon will start to go up.

However it will be well to remember that the average dollar value per set sold will be considerably lower than in 1937, and therefore, compared with 1937, the dealer will have to produce a substantial increase in the number of units sold, in order to earn a given amount of gross profit.

30% TO 50% MORE **ELECTRIC POWER**



NEW MODEL '39

WINCHARGER

6 VOLT—DELUXE

New PROPELLER:

15% to 25% more efficient

New GENERATOR:

15% to 25% more powerful

New OUTPUT:

30% to 50% more power

Like every other successful product, Winchargers are imitated. *But there is only one Genuine Wincharger.* It alone has the famous air-brake governor, developed and patented by the Albers Brothers, founders of the Wincharger Corporation. You can distinguish the *genuine* Wincharger by the air-brake governor on the propeller. It is the *one* Wincharger that has proved its dependability all over the world. Year in and year out, genuine Winchargers furnish electricity to more than half a million farm folks in over 100 different countries.

This new 1939 Six-Volt Wincharger has all the proved dependable features of the world-famous Model '37 PLUS an improved 15% to 25% more powerful generator PLUS a 15% to 25% more efficient propeller. It actually generates 30% to 50% more electricity which means extra current for more hours of radio operation and more lights. *But that's not all!* The new Model '39 starts charging in a 7½ to 8 mile breeze—one mile per hour lower wind velocity than any other previous model. And there are many OTHER PLUS FEATURES including an enclosed *weather-protected* collector ring with double *carbon* brushes—new sturdier 4-legged tower—simpler tower construction for easier installation—and large tower feet for easier mounting. The most powerful, thoroughly dependable radio wind-charger ever built!

NEW 32-Volt

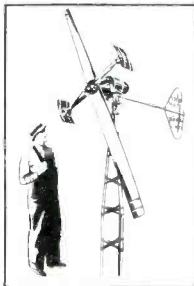

WINCHARGER

1000 Watt

A more powerful Giant 32-volt Wincharger for heavier light and power loads. Operates refrigerator, water system, larger motors, washer, ironer, radio and other power appliances. Protected territories for aggressive dealers. For full information write: Agency Department, Wincharger Corporation, Sioux City, Iowa.

Write or Wire for Complete Details

WINCHARGER CORPORATION • SIOUX CITY, IOWA, U. S. A.

World's Largest Manufacturer of Wind Electric Equipment

You are cordially invited to preview

THE **SCOOP LINE** OF



**SEE THE LINE WITH THE GREATEST ROLL CALL
OF PRECEDENT BREAKING FEATURES IN OUR RADIO HISTORY**

Hold everything! Until you've previewed this sensational new G-E Radio line. Watch for announcement of showings in your vicinity arranged by your local G-E Radio Distributor . . . or get in touch with him for full details.

GENERAL  ELECTRIC

**YOU'LL APPLAUD
SCOOP No. 1
WHAT IS IT**

**YOU'LL ACCLAIM
SCOOP No. 2
WHAT IS IT**



**YOU'LL CHEER FOR
SCOOP No. 3
WHAT IS IT**

**YOU'LL GO FOR
SCOOP LINE of 1939
WHAT IS IT**

