

# RADIO RETAILING

McGraw-Hill Publishing Co.

25 CENTS PER COPY

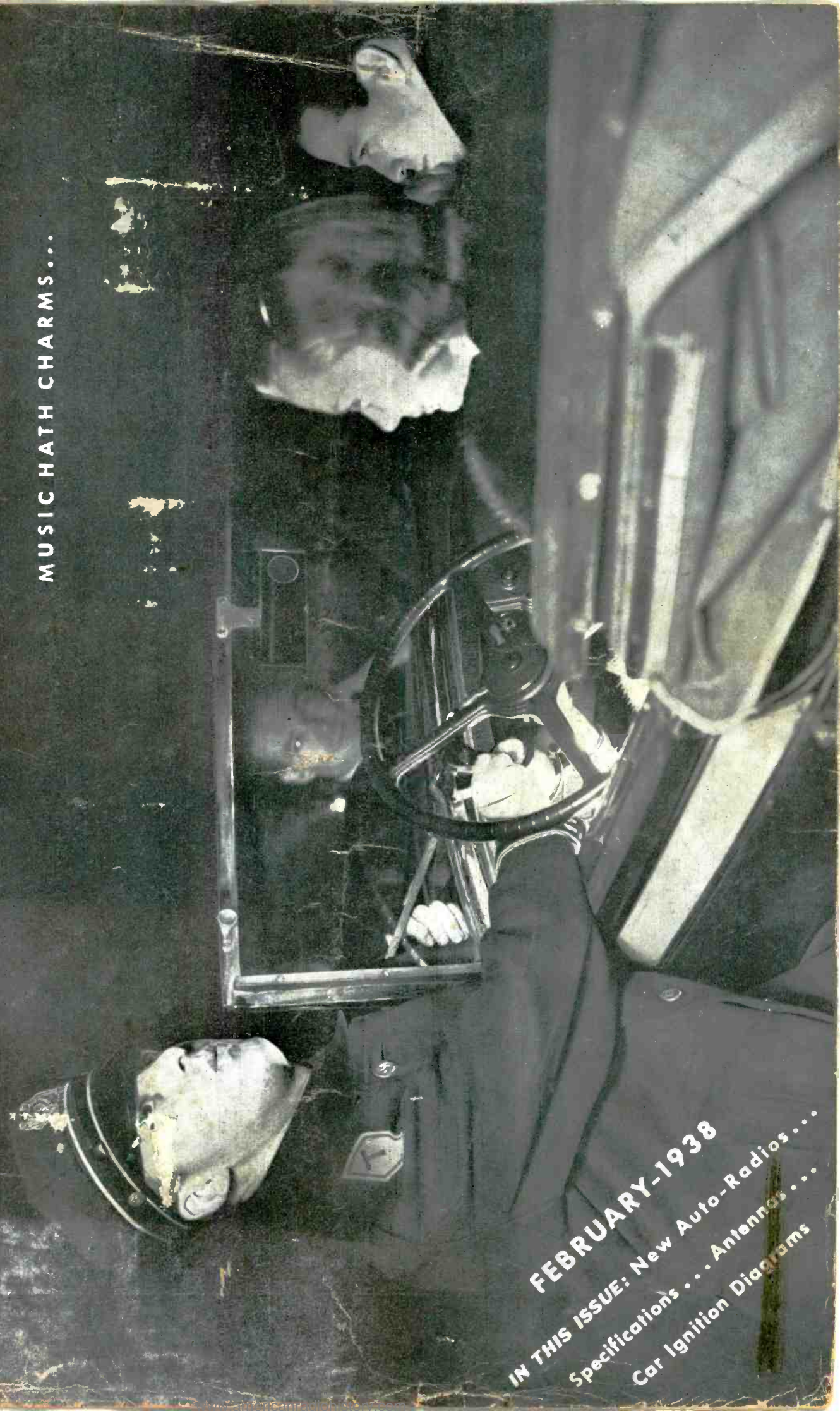

MUSIC HATH CHARMS...

**FEBRUARY-1938**  
IN THIS ISSUE: New Auto-Radios...  
Specifications... Antennas...  
Car Ignition Diagrams



What will Mallory-Yaxley do next?

Here's  
Answer No. 1

... A Complete Line of

P. R. MALLORY & CO., Inc.

# MALLORY Condensers

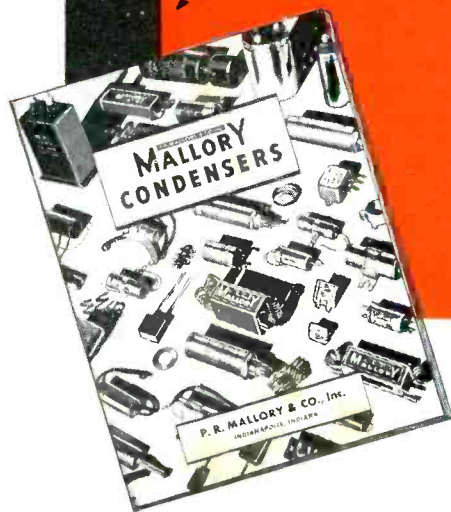

Now! Mallory offers a *Complete Condenser Line*... with all the features that have made Mallory Condensers famous. Surge-proof! Humidity-proof! Universal mounting! Smaller sizes! Easier installation! See your Mallory-Yaxley distributor for a copy of the new Mallory condenser catalog which gives complete information on all the new condensers described below.

## NEW Tubular Papers

The addition of four new TP condensers with 1,000 volt ratings, plus a number of new units in the lower voltage range make the Mallory TP line more attractive than ever.

## NEW Padding and Trimmer Condensers

All are made with the finest India Ruby Mica, and are designed to prevent drift, or change with temperature or moisture. Adjusting screws are equipped with fine threads for accurate setting. Available in four general types—both single and dual units. Bakelite and ceramic bases.

## NEW Auto Radio Types

Condensers, r.f. chokes and other noise suppression condensers—built on the basis of Mallory's experience as the pioneer manufacturer of vibrators and vibrator power supplies. Not a single make-shift adaptation among them—each is specifically built for its intended applications.

## NEW Transmitting Condensers

Two new types, incorporating a new impregnating compound which has many advantages over the usual wax or oil impregnations. The compound has a high dielectric constant and insulation resistance that make possible the relatively small sizes of these condensers. These high voltage condensers are ideal for use in radio transmitter power supplies and for heavy duty power amplifier service.

## NEW Mica Condensers

Compact, mechanically strong and moisture-proof. Made of the finest grade of clear India mica.

## NEW Cased By-Pass and Uncased Condensers

An example of the completeness of the Mallory line is the introduction of new type CB cased by-pass condensers and type UB uncased dielectric filter condensers.

**NOW! WHAT WILL MALLORY-YAXLEY DO NEXT?**

*Watch for further important announcements!*

Use

**MALLORY**  
REPLACEMENT  
CONDENSERS...VIBRATORS

P. R. MALLORY & CO., Inc.  
INDIANAPOLIS INDIANA

Cable Address—PELMALLO

Use

**YAXLEY**  
REPLACEMENT  
VOLUME CONTROLS

# RADIO RETAILING

FEBRUARY, 1938

RADIO MONTH .....	7
PHOTOSHORTS .....	9
EYES STAY ON THE ROAD .....	12
551 PARTS MAKE A RADIO .....	16
FIGURES .....	19
YOU CAN COMPETE WITH CAR DEALERS.....	20
HOW TO BRING IN RECORD PROSPECTS.....	23
NEW AUTO RADIO SPECIFICATIONS.....	24
MINUTE BIOGRAPHIES .....	27
CAR SET PICTURES.....	30
PREVUE OF NEW PRODUCTS.....	33
FEBRUARY NEWS .....	37
AUTO RADIO INSTALLATION TIPS.....	45
CIRCUITS .....	46
TESTING TOMORROW'S TELEVISORS.....	49
1938 AUTOMOBILE IGNITION DIAGRAMS.....	52
SHOP SHORTCUTS .....	57
TRICKS OF THE TRADE.....	62
AUDIO FREQUENCY .....	68

O. FRED. ROST..... Editor  
 W. MacDONALD... Managing Editor  
 C. A. NUEBLING... Technical Editor  
 T. H. PURINTON... Assistant Editor  
 HARRY PHILLIPS..... Art Director

Tom Blackburn  
 Chicago

George Tenney  
 San Francisco

H. S. Knowlton  
 Boston

HOWARD EHRlich  
 Executive Vice-President

H. W. MATEER  
 Manager

## SALES STATIC

"No, I don't remember the name of the set I want. But it looks just like these other radios."

## McGraw-Hill Publishing Company, Inc.

Publication Office  
 99-129 North Broadway, Albany, N. Y.  
 Editorial and Executive Offices  
 330 West 42nd Street, New York, N. Y.

Cable Address: MCGRAWHILL, New York  
 Member A.B.P. Member A.B.C.

James H. McGraw, Jr. .... President  
 Howard Ehrlich ..... Executive Vice-President  
 James H. McGraw ..... Honorary Chairman  
 B. R. Putnam ..... Treasurer  
 D. C. McGraw ..... Secretary  
 A. W. Morrison ..... Circulation Manager

RADIO RETAILING. February, 1938, Vol. 23, No. 2. Published monthly, price 25c copy. Subscription rates—United States and possessions, Canada, Mexico and Central American countries \$1. All other countries \$2 a year or eight shillings. Printed in U. S. A. Entered as Second Class Matter, September 8, 1936, at Post Office, Albany, N. Y., under the Act of March 3, 1879. Cable address "McGrawhill, New York." Member of A.B.P. Member of A.B.C. Copyright 1937 by McGraw-Hill Publishing Co., Inc., 330 West 42nd Street, New York, N. Y.

Branch Offices: 520 North Michigan Ave., Chicago; 883 Mission St., San Francisco; Aldwych House, Aldwych, London, W.C. 2; Washington; Philadelphia; Cleveland; Detroit; St. Louis; Boston; Atlanta, Ga.



**THERE IS THE COMPLETE TUNING UNIT!**

**AND IT'S ABSOLUTELY FOOLPROOF!**



# The New ELECTRIC Flash TUNING



Electric Flash Tuning Dial. The labels under Push Buttons are illuminated when tuning automatically. Dial and eye are lighted when tuning manually. Electric-Manual Tuning Switch at upper right.

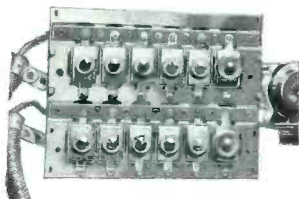

Top shield removed to show sturdy construction. Mica, isolantite and bakelite are used for insulation. Note two shielded connecting leads.

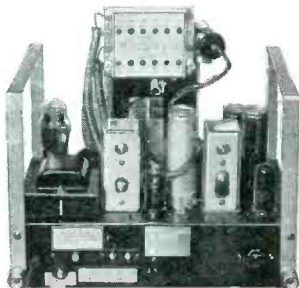

Tuning unit in position. Mounted on cabinet, it leaves the chassis floating freely. A. F. C. cut-off switch on chassis base next to speaker plug-in socket. All electric tuning contacts are silver plated and self-cleaning.

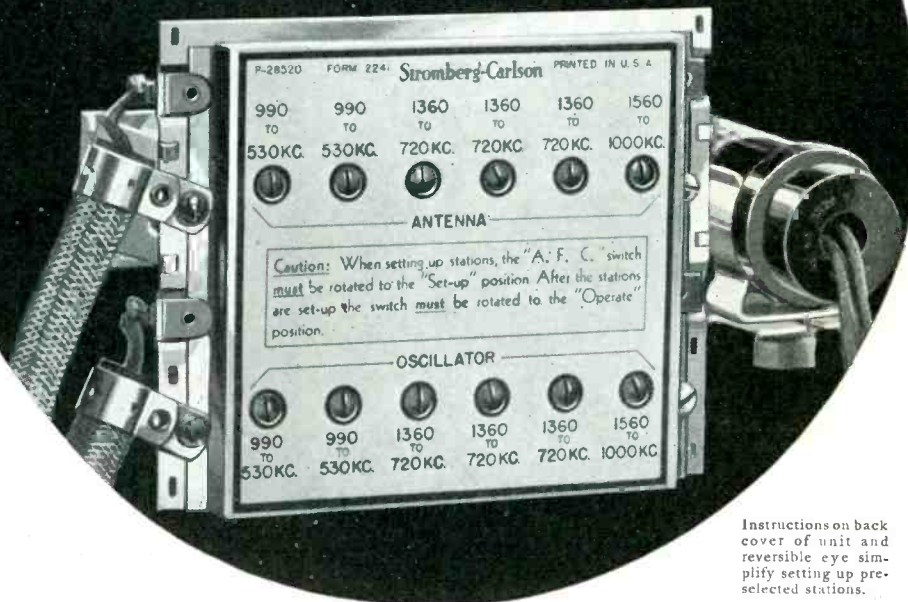

Instructions on back cover of unit and reversible eye simplify setting up pre-selected stations.

THE automatic tuning on many radios spells "grief" for the user—and the installer. Profits vanish as service calls mount.

With a Stromberg-Carlson, the tuning unit connects to the chassis by just two shielded wires (only 4 connections)—not a whole lot of soldered joints to breed trouble. It's very easy to set up a station. You do it by turning only *two* screws. The A.F.C. cut-off switch and the Tuning Eye allow the installer to tune *accurately*. And the A.F.C. system is so efficient that once the set is installed, it stays in satisfactory operation. Electric Flash Tuning is one of the things that makes selling Stromberg-Carlsons easy and profitable.

STROMBERG-CARLSON TELEPHONE MFG. CO., ROCHESTER, N. Y.

*There Is Nothing Finer than a*  
**Stromberg-Carlson**

# SHATTERING VIBRATIONS

## FROM GIANT GUNS!

### - BUT RAYTHEONS CAN "TAKE" IT!

The ear-splitting roar of giant guns . . . shattering vibrations that fairly rock the earth . . . these are the daily conditions under which Raytheon's tubes go through with "flying colors" in army communications!

That's because Raytheons are built *right* . . . built to stand up and "take" it! Built by the greatest engineers in the country—and with best materials available! A fact known by engineers of leading licensed set manufacturers who constantly use Raytheons as standard equipment. Consider Raytheons for your replacements.

Enjoy greater permanent tube profits.

# RAYTHEON

CHICAGO  
ATLANTA

NEWTON,

SAN FRANCISCO  
NEW YORK

MASS.



"WORLD'S LARGEST EXCLUSIVE RADIO TUBE MANUFACTURERS"

*Here's  
Why—*

# Cunningham Radio Tubes are the **SERVICE MAN'S SPECIAL**

1—Designed for the Service Man

2—Engineered for the Service Man

3—Manufactured for the Service Man

4—Advertised for the Service Man

5—Priced for the Service Man



*Get full details from your distributor*

OVER 90,000,000 CUNNINGHAM TUBES HAVE BEEN SOLD  
FOR REPLACEMENT SERVICE WORK

# Cunningham Radio Tubes

STANDARD SINCE 1915

**AGAIN**

**Motorola**

**LEADS**

**With "Spot"  
Automatic  
Tuning**

*at* **\$39<sup>95</sup>**

**THE HOTTEST FEATURE IN AUTO RADIO**



HARRY BOYD BROWN  
National Merchandising  
Manager of Philco

## A RADIO BUSINESS THAT REACHES ITS PEAK IN THE SPRING MONTHS

OVER 20 million automobiles—not equipped with radio—are in operation in the United States today. And it is estimated that 2,500,000 new cars—not equipped with radio by either car manufacturer or car dealer—will be delivered to buyers in 1938.

Automobile Radios—a tremendous, unsaturated market for Philco radio dealers! A business that reaches its peak in the Spring months—retail sales that certainly help keep the radio dealer's business on a steady even keel the year around.

Better still, Philco Auto Radios sell Philco Home Radios, and Philco Home Radios, in turn, bring auto radio sales. One hand washes the other. And remember, the American public has bought over 10 million Philco Home Radios. This means millions of satisfied Philco Home Radio owners that constitute a vast, nation-wide market for Philco Auto Radio.

And now—only \$24.95 for a PHILCO Automobile Radio! The model 920—quality and beauty—without question the greatest auto radio value ever built. Remarkable power! Superb clarity of tone! Amazing performance! The advertising leader, the big volume number of Philco's marvelous new auto radio line for 1938.

The public demands performance as well as price in auto radio today. And the Philco model 920 gives you *real sensitivity*—remarkable ability to get stations. And also *real selectivity*—which means no interference—no cross talk. A 5-tube auto radio with 3-Gang Condenser—Electro-Dynamic Speaker—Full Wave Vibrator—Automatic Volume Control. Furthermore, no Spark Plug Suppressors are necessary, and installation is easy, speedy, surprisingly simple. *No one on earth but Philco could build this radio to sell for \$24.95.*

Then when it comes to “selling up”—Philco's new auto radio line fits the selling situation perfectly. Four splendid models—priced in easy logical steps from \$24.95 to \$59.95—added features—added beauty—more power—more distance range—and still more marvelous performance.

Every Philco Auto Radio model has its own properly matched and properly tuned Philco aerial in *any type* you need for any model car. Cowl aerials, under-car aerials or rooftop aerials—each designed, matched and tuned to the particular Philco model. *And for those radio dealers who do not have the facilities for installation, Philco covers the United States with over 1500 Authorized Service Stations to install and service Philco Automobile Radios.*

*Harry Boyd Brown*

# PHILCO



# The RADIO MONTH

FEBRUARY

1938

**Auto Intoxication** The potential market for automobile radios is so large that the question of possible sales in 1938 can best be answered by the old conundrum: How high is up?

Last year approximately 25 million passenger cars were registered, of which more than 10 million were over 7 years old. The owners of at least one third of those 10 million jallopies are potential buyers of used chariots of more recent vintage and when they do get the swapping bug they will be susceptible to further persuasion—a radio set.

Also last year, of the 5 million new cars actually manufactured less than one million drew radio equipment—a net of 4 million practically new cars, the owners of which now see the end of their time payments in sight and might be sold on the idea that an auto radio should be added to increase their pleasures.

Last, but not least, another 3 million new cars will be sold this year, which, if last year's proportion holds good, will call for at least 750,000 new auto radios.

To sum up, the right kind of tie-up between radio retailers and the local dealers in new as well as used cars and service stations should boost auto radio sales far above last year's total. It's all in hitting the right people at the right time and—hitting them hard enough. Go to it.

**You, Too** Despite the current trend of tax boosting there is a real chance of getting the 5 per cent excise tax on radio sets repealed. Reason: A congressional sub-committee has proposed the repeal of \$25,000,000 worth of excise taxes, named various commodities now taxed, but it did not include radio sets.

Through strenuous efforts of the radio industry, the RMA and *Radio Retailing* the committee has been

made aware of the fact that radio set taxes should be FIRST on the list of repeal candidates. Wide usefulness of radio as a public convenience, means of rapid communication, to disseminate information and education were among reasons cited why radio ranks as a necessity and therefore should no longer be taxed as a luxury. The committee was impressed with the justice and force of our argument but more follow-up pleas are needed.

You, too, can help by writing Hon. Robert L. Doughton, chairman, House Ways and Means Committee, Washington, D. C., restating some of the above arguments and asking for repeal of the 5 per cent excise tax on radio sets.

**Contrast** We note that down in South Africa radio set owners have to pay 35 shillings (\$8.75) per year for the privilege of listening. Several European countries impose similar annual fees, ranging from \$2.50 up. In this country we have no such fee and instead the advertisers foot our broadcasting bill.

Last year the 105 leading radio advertisers spent \$64 millions on the ether waves, nearly 30 per cent more than in 1936 and 60 per cent above the \$39 million total spent by the same advertisers on their radio programs in 1935.

That's big money, spent by the other fellow to keep the gas tanks of our radio sets filled up and for it we get programs that are the envy of the world. To keep on getting our gas free we have to see that the donors get their money's worth. In other words—boost interest in broadcast programs. It's a sure way of boosting your sales and service jobs.

**Of, By, For Servicemen** Servicemen have been crying for it. Now they've apparently got it and the industry wonders what they will do with it.

This cryptic reference is to an organization designed to fight their battles nationally with a minimum of pain to the individual pocketbook. Its name is the Radio Servicemen of America, Inc.

Assured of manufacturer cooperation, the RSA has been formed to give servicemen a truly national voice. Principle new to the field and one likely to make "all the difference" is its absolute insistence that men desiring to affiliate must first be members of a local association, if there is one. The new group will coordinate the activities of individual members in connection with common objectives. But it will religiously refrain from meddling in the affairs of local associations to which its members may also belong.

RSA is growing rapidly. But not as rapidly as executive secretary Joe Marty believes an association so closely modelled around the serviceman's professed ideals should grow. The whole future of the group is likely to be determined in the next sixty days by the number of applications for membership received at 304 South Dearborn St., Chicago.

Cards are on the table for local association secretaries or individual servicemen in remote areas to see. If it's details you want before signing your application blank, reference to this *Radio Retailing* item in a note to the above address, plus a 3-cent stamp, will bring them.



EDITOR

LET'S  
TALK  
ABOUT

Your  
Washer  
Business

for this

SPRING!

WHAT ABOUT  
FARM HI-LINES?

Only 17% of all farms are electrified today—and hi-lines are coming slowly. If your farmer prospect says he is waiting for a hi-line, show him the advantages of buying a gas-powered washer now—and then when the "juice" comes, he can change over to an electric at little expense.

THE years 1936 and 1937 brought to appliance dealers the largest volume of sales of power washing machines in the history of the industry . . . And 1938 offers the same opportunity — but with this difference. Today, *it's the farmers who are your best prospects.*

#### SELL WHERE THE MONEY IS

Government figures show that farmers today are in the best financial condition—have more spendable income—than at any time since 1929.

It's always easiest to sell where the money is.

And a good time to sell the farmer is when he has time to talk to you — during the spring months, before he is all tied up with heavy seasonal work.

#### SELL WHAT THEY CAN BUY

You can't sell electric washing machines to those without electricity—and only 17% of all U. S. farms have electricity today — with little likelihood that this percentage will be changed materially for a number of years to come.

So 5 out of 6 farm homes are prospects for gas powered washers.

They have the need and the desire to purchase—and they have the money. So, now's the time to sell the farmer prospect—electric washers if he has electricity—gas powered washers to all the others—the 5 out of 6 without hi-lines.

#### WHAT ABOUT HI-LINES?

If the prospect is waiting for a hi-line, sell him a gas washer now—explaining that it can be changed over later to an electric, at any time, at little expense. There is no need for anyone to wait for a hi-line which may never come, to have the advantages and the economy of power washing.

Latest models gas and electric washers have the same features — same advantages — the same quick starting and economies. The only

difference is in the power unit. There's nothing to be gained by waiting.

#### TO HELP YOU MAKE THESE SALES

Convinced that this gas washer business is there — convinced that the farmer has the need and the desire — and the money to buy — Briggs & Stratton has released the largest Spring Advertising Campaign in farm papers in the history of the company.

A total of 28 farm papers — with a combined circulation of 9,940,000 copies are being used to help you make these sales.

#### AND ANOTHER SALES AID

New washer models are also available with the sensational Briggs & Stratton Start-Charger. This unit combines the latest model WM Briggs & Stratton Washer Motor with a specially designed 6-volt generator and starter motor. With the Start-Charger and a storage battery the motor is cranked electrically and charges 6-volt radio and other storage batteries while washing.

#### TO MAKE SALES EASIER

Farmers know Briggs & Stratton 4-cycle gasoline motors. Over a million in farm use testify to their rugged dependability and economy — their easy starting. Your gas washer sales will be all the easier if the models you offer are "Powered by Briggs & Stratton."

Those dealers who display and feature the latest model gas powered washers — those dealers who take advantage of the opportunity to sell their farmer prospects now — are the ones who will profit most. Discuss this with your washer manufacturer, or his representative.

**BRIGGS & STRATTON CORP., Milwaukee, Wis., U. S. A.**

Dealers have found equipment "Powered by Briggs & Stratton" easier to sell — not only power washers, but also pumps, lighting plants, small tractors, lawn mowers, and many other farm tools and equipment.



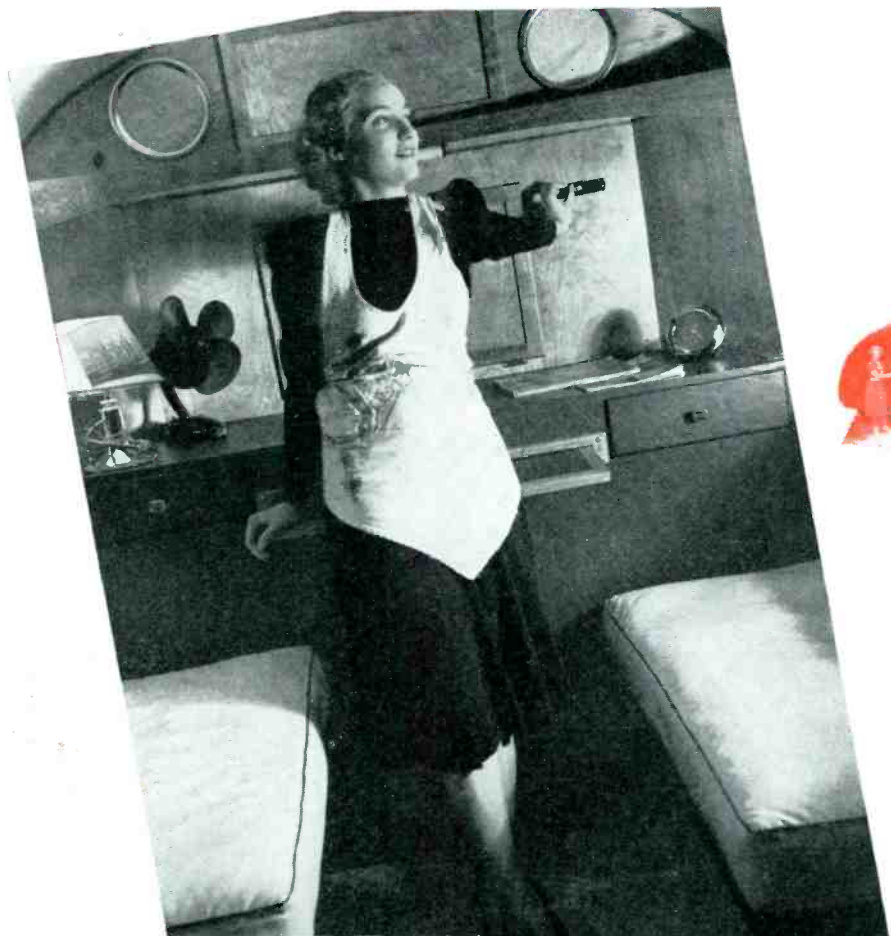

## TRAIL No Longer Lonesome

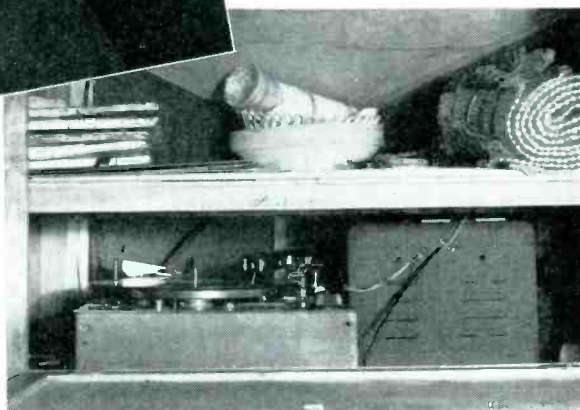

**I**N the road in a \$3,600 trailer. Mrs. A. J. S. of New York keeps pace with programs by means of an auto-radio, switches to records when the airwaves grow dim or dull, talks to friend husband up ahead in the towcar over an inter-communicator.

Above the radio's remote control is its speaker. At the left is the cone which gives tongue when Mr. S. addresses his mike. Behind the top cen-

ter panel is the tuner, turntable and amplifier. Elsewhere is a powerpack functioning on 110 volts, used when the trailer makes an extended stop, turns off its 6-volt batteries and taps into a power line. Barry & Cortley made the installation, collected \$300 for it. Since then, the job has covered 6,000 miles along the eastern seaboard, soon leaves for the west coast.

Auto-radio sales don't stop with pas-

senger cars. More than 2,000,000 Americans travel in trailers. In Florida alone there are nearly 400 trailer parks, virtually "cities without saturation." And why stop at trailers? Auto-radio fits long-haul trucks. Cross-country busmen are missing a good bet to promote customer relations.

Also, auto-radio is generally best for boats. And prospects are already calking and scraping away in boatyards.

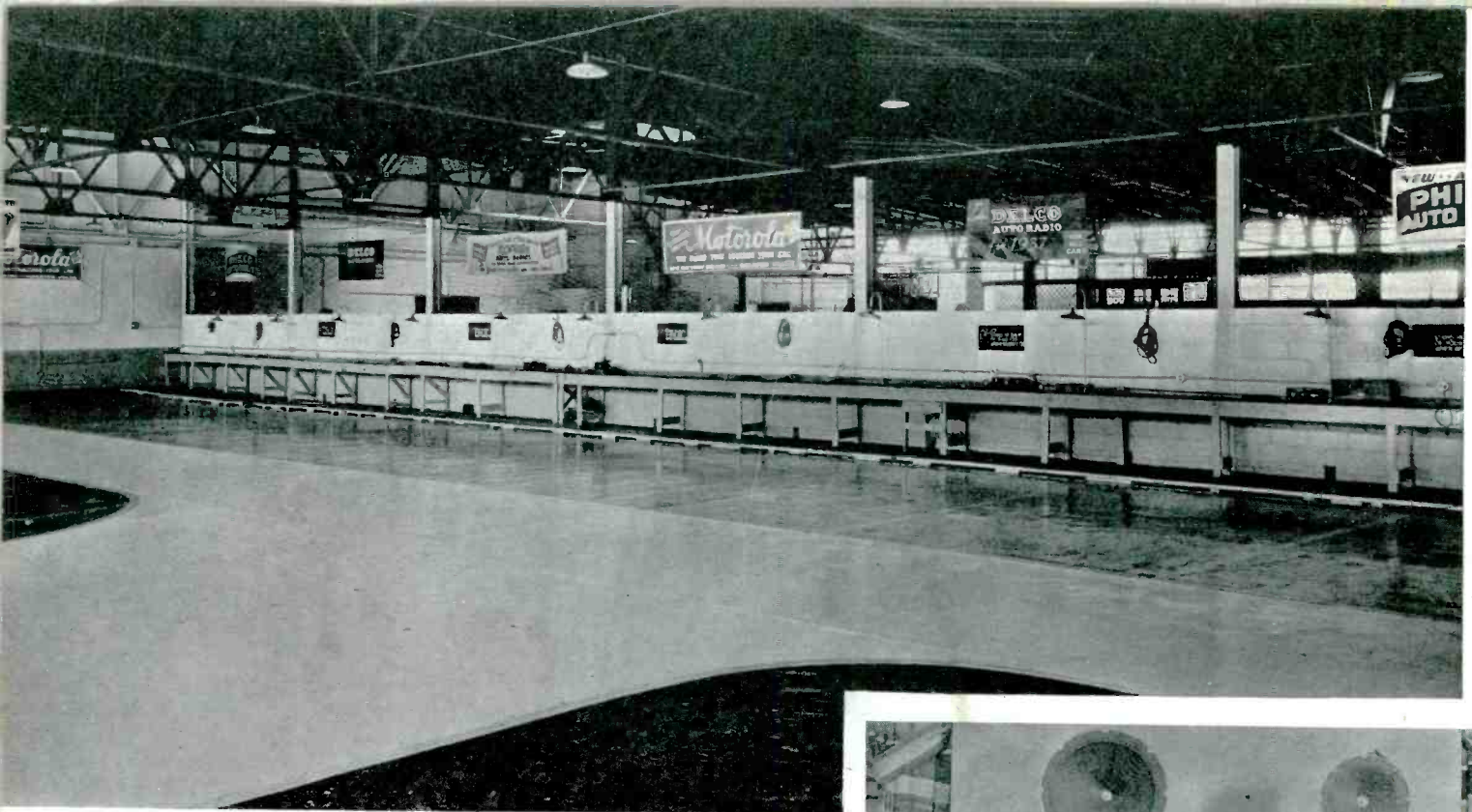

### INSTALLED 20,000 AUTO-RADIOS LAST YEAR

From B. R. Peacock of RCA Victor comes this photo of Detroit's Michigan Dealers Auto Radio Service shop. Twenty-thousand sets went into cars here during 1937, for both radio and automobile dealers. Twice this number were repaired. Proprietor Jack Lynch says he can handle 50 cars at once. Day's record is 187

### BREAD, PLUS CAKE

Radios and washers complement each other nicely for Brown's Radio Center, Florence, Alabama. When Watson Brown's eight salesmen move in a demonstration machine on blue monday they automatically take a set along, give the prospect music while the washer works. Brown tries to keep 50 radios, 30 washers out on demo



### SHOWS HOW THEY'RE BUILT

Up top on the console and on the table model, spare chassis accompanied by neat, explanatory cards help sell electrical and mechanical workmanship. Novel, too, is the double pedestal arrangement which gives both sets equal prominence. Would make a good island display as well



### PLUGS CAR SETS

For rent is this Austin sound car, when there are "takers." In between time it scoots around New York on radio service calls, boosts its owner's auto-radio department. Small car, large sign . . . the tail almost wags this dog

### PIANOS FOR RADIOS

Ordinarily considered a drug on the market, used pianos are taken in trade against console radio purchases by Brown's Radio of Ripon, Wisconsin. Robert Brown takes them cheap from private owners, reconditions, then sells them to clubs, people with summer cabins

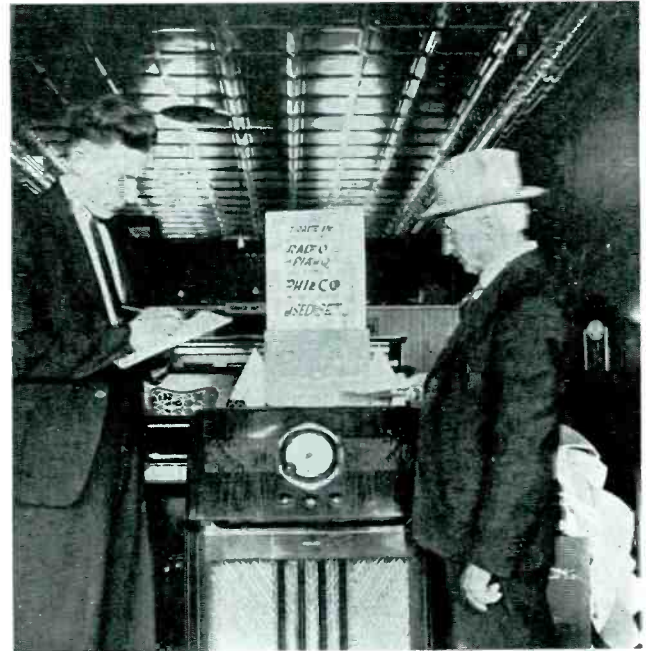

### VOLUME FOR SWEET CHARITY

Crosley's showpiece 36-tube, 6-speaker set aided needy kids at Christmas. Installed in a protective booth in Cincinnati's Fountain Square, it was tuned by Harry Koester, the city's tallest cop . . . six feet, nine inches overall. The *Cincinnati Post* made all the arrangements

### BRILLE, FOR THE BLIND

To the American Foundation for the Blind December 16, from famous though sightless Helen Keller, went a GE console with raised, Braille, touch-tuning station call-letters. In this country are 130,000 blind, to whom radio is the only complete form of entertainment

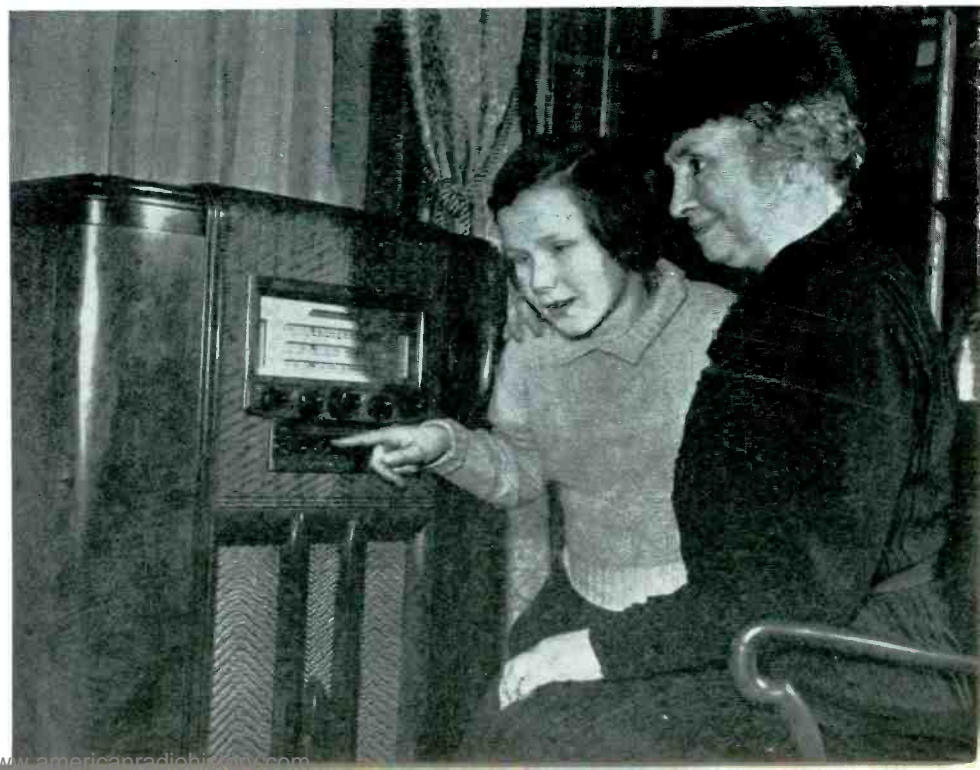

H I G H



## EYES STAY ON THE ROAD

**RELAXED**—Push-button tuning, automatic frequency control, better conventional dial design, more convenient chassis mounting positions . . . any one of these several new car set features still further removes the already remote possibility of driver-distraction

**S**NOW may be adhering to your whiskers. Certainly the landscape in the vicinity of our editorial offices is no Palm Beach. And yet we insist that this is the time to decide what auto-radio lines you are going to stock and sell after the ice breaks up.

Not all manufacturers have new lines ready as we go to press but most of them are getting ready for production fully a month earlier than last year. The bigwigs at the factories are gambling that car sets

By

**W. MAC DONALD**

will be the first models to pull the radio business up by the slack of its pants in the early spring, ironing out the creases left by a last-quarter general business recession. And it is a good gamble, too. For automobile makers, according to the public prints, are leading the industrial procession in an effort to snap the country out of it and the weight of their national advertising is certain to have a salutary effect on auto-radio sales to both new car and old car owners. The public is to be made more car-conscious. And this automatically boosts accessory sales.

To take a good, healthy crack at the car set business . . . and we don't see how any man in the already narrow retail radio field can afford to ignore it just because it is not strictly "package" merchandise . . . you'll need time, time to tell your home set customers you sell auto-radio so they'll come to you for it.

### **Push The Button**

In order to plan your attack, be it signs for the storefront, newspaper, handbill, radio advertising or just word-of-mouth promotion, it is necessary for you yourself to know about the bag of tricks incorporated in new car set lines. To make the educational pill easier to swallow we've loaded this issue of *Radio Retailing* to the hilt with good dope on the subject and we suspect most of it will be news to you, arriving even before distributors' salesmen.

Our cover may give you an idea for the window or an ad. In the "Photoshort" pages are several good selling stunts. Tom Blackburn's story covers the auto showroom competition angle. There are two pages of complete specifications, including prices, in the book. We've published all the auto-radio photos manufacturers could supply, back in the New Products Section. Under "Technical Topics" servicemen will find some good ideas relative to the installation of antennas, plus circuit diagrams of 1938 automobile ignition systems. And in this article itself (turn to next page) you'll find a complete statistical

study of new sets on the market as we close.

Highspot of new auto-radio design, we think, is the obvious attempt on the part of manufacturers to make sets easier to tune. No one yet has ever succeeded in proving that radio in a car is a distraction and, in fact, every investigation has disclosed that radio, because it soothes the nerves of the driver, adds additional safety factor. Nevertheless, there have been attempts at adverse legislation. And greater tuning convenience clearly makes car sets easier to sell.

Many new models are equipped with push-button tuning, more important even in car sets than in home models, to our way of thinking.

Some models include colored tops for each button so that the user doesn't have to identify station call-letters. Sets without push-button tuning mechanisms have likewise been designed for greater tuning ease. Giant dials are seen in many types, may be expected to exert the same selling influence they did when generally adopted by home set makers some three years ago. "Spot" tuning devices of various kinds are seen. A mechanism which registers a definite "click" at the user's fingertips when a station is tuned right on the button is among these.

Knobs used on dash-mounted controls have been made larger, easier to grip. Steering column controls have been provided with more flexible mountings which bring them closer to the driver's hand. "Backlash" has been reduced in remotely tuned model dials, and sets designed to mount, complete with controls,

**STRAINED**—Gone is another breeder of crank-criticism . . . for even the sets with built-in controls have cleverly placed bulges and curves which bring knobs closer to the motorist



under the dash, have been given trick bulges and curves that bring them forward into the driver's compartment so that they may be operated at least as easily as the gear-shift lever. Everything possible has been done this season to make the driver's . . . *Eyes Stay On The Road!*

#### Antennas For Aesthetes

Speaking of eyes . . . the added convenience built into new car set models should make them easier to sell to the replacement market as well as to owners of relatively new machines, admittedly the "cream of the crop." The car set business has now developed to a point where, we think, replacement sales may not be thrown over one's left shoulder. And eye-value will be, perhaps, the leading replacement sales tool.

Aside from the new tuning units, there are many other design features which should aid sales. Practically all new sets include tone controls, for example, and several manufacturers have exercised considerable ingenuity in labelling the various positions of these controls so that the public will instantly grasp their importance. Several models include tone-compensating controls labelled "Speech—Music—Carline", the latter being an especially dramatic sales word, especially for people who have already operated car sets under overhead trolley wires and elevated railways.

Automatic frequency control is found in a number of sets and is certain to impress prospects to which it is properly demonstrated. Then, too, considerable attention has been paid to further reduction of noise pickup by all designers. Conspicuous are features such as the "Phantom Filter" and the "Eliminode", intended to prevent noise generated in the car's own wiring from passing to the set through the storage-battery, or through the antenna lead-in, or both.

Perhaps the most important trend with respect to noise-reducing auto-radio design is the rather general use of vastly improved input circuits. By using such things as series tuning the signal-to-noise ratio of today's auto-radio has been measurably increased. Many new sets include trimmers which permit the installation man to match them to whatever antenna type is used. Overlooked in early design, this fea-

ture has, perhaps, done more than anything else to improve the performance of 1938 models.

Antennas, themselves, running heavily to outside-the-car types but by no means to the exclusion of under-car varieties, have been much improved. Chief improvement appears to be an increase in the pickup area, accomplished by equipping over-the-top types with "fins" or other appendages which at once give additional mechanical strength and greater surface. Manufacturers have been singularly successful in combining efficiency, and durability with improved appearance. Thus we find many over-the-top types supported by well-designed decorative brackets and figures which accomplish all three things at once.

Of course, much of this improvement has been made possible by the

fact that the public is now educated to the point where visible auto-antennas are not objectionable. When such types were first introduced much emphasis, of necessity, was placed on the fact that the user did not have to drill holes or otherwise mar his car. Now the manufacturer takes the acceptance of the overhead antenna type for granted, does a really substantial design job with the assurance that the customer will give permission to mount a good job securely and permanently. One example of this trend is the increased popularity of cowl rod types, which necessitate drilling of holes in the very belly of the car. Of course, antenna types relying upon suction and "stickum" are still available for people who insist, but it is felt that we are now well over this initial sales hurdle.

## THE LOW-DOWN ON NEW LINES

<b>PRICES</b>	\$40 is the average price per line \$19.95 is the lowest we've seen, \$79.95 the highest
<b>CONTROLS</b>	18% are automatically tuned 49% mount dials on the dash 19% project controls from beneath the dash 12% are supplied with any type control, optional 5% may be obtained for under-dash or steering column control 75% have tone control or equivalent
<b>OUTPUT</b>	4.8 watts is the average
<b>DRAIN</b>	6.7 amperes is the average
<b>SPEAKERS</b>	92% have built-in dynamics (average 5.8 inches) 6% have built-in p.m. dynamics (average 7.1 inches) 37% provide for external dynamics (average 8 inches) 21% provide for external p.m. dynamics (average 7.3 inches)
<b>TUBES</b>	6.2 is the average number per set 91% of all sets use single power output tubes 9% of all sets use power output tubes in push-pull 40% of all sets use type 41 tubes in the output 13% use 6K6's 11% use 6N7's 9% use 6F6's 8% use 6V6's and the remainder use 42's, 6A6's, 6B5's, etc.
<b>VIBRATORS</b>	81% employ non-synchronous vibrators 19% use synchronous vibrators
<b>INTERMEDIATES</b>	29% use 456 kc. 21% use 262 kc. 13% use 175 kc. 9% use 465 kc. and the remainder use odd frequencies



# DELCO

*Presents*  
**A TRIPLE SENSATION**

## DELCO AUTO RADIOS for 1938

Again, in 1938, Delco is a step ahead of the auto radio field with three important new contributions . . . the new DELCO ACOUSTILATOR, DELCO-MATIC FLASH TUNING, and the new DELCO 6-TUBE, 3-GANG CONDENSER LOW-PRICED SET.



### DELCO ACOUSTILATOR

The Delco Acoustilator—the outstanding feature of 1938 auto radios—is a simple device designed and patented by Delco engineers to give Delco Radios perfect sound distribution in all makes and types of motor cars. It is easily adjusted to eliminate all muffle and blare, regardless of the car's interior construction with respect to acoustical properties. Remember—only Delco Auto Radios have the Delco Acoustilator.

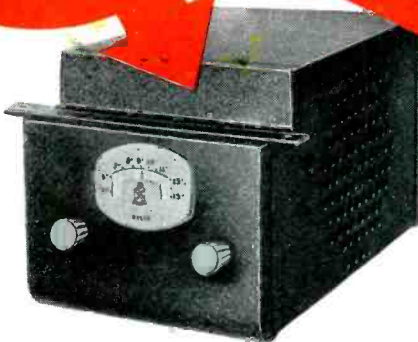

### DELCO **6-3** AUTO RADIO \$2795

Here's the sensation in the low-price field. For the first time, a quality 6-tube, 3-Gang Condenser Auto Radio set is offered at so low a price. Its six tubes give maximum sensitivity and power output at high-speed driving. Its 3-Gang Condenser supplies sharper tuning and the greatest selectivity. Only three bolts are required to install the Delco 6-3 Auto Radio, and it is finished to harmonize with the instrument panel. It is the value of values in auto radios for 1938.

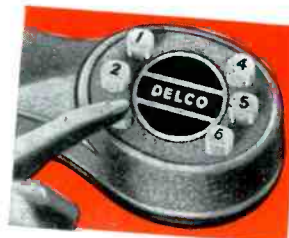

### DELCO-MATIC FLASH TUNING

Simply pressing a button provides instant and accurate tuning of any of six pre-selected stations—yet does not interfere with manual tuning for other stations desired. To change any pre-selected station, simply press down the button, tune the set manually to the desired station, release button—and the new station is automatically set.

## \* Helps that really aid Auto Radio Sales

Delco offers a complete advertising and merchandising plan with sure-fire sales helps, including attractive display stands complete with built-in antenna and battery rack . . . punchy cooperative newspaper ads

. . . colorful broadsides . . . attention-getting posters . . . striking banners . . . eye-catching window trims . . . bright, neon-effect signs . . . result-bringing direct mail pieces and handbills.

For full particulars, write, wire or phone your nearest Delco Auto Radio Distributor or United Motors Branch.

## \* Sell the complete line of Delco Auto Radios for 1938



### THE CHAMPION

The peer of all auto radios.

With Delco Acoustilator

**\$6795**

With Delco Acoustilator and Delco-Matic Tuning

**\$7895**



### THE ACE

A real leader in the auto radio field.

With Delco Acoustilator

**\$5795**

With Delco Acoustilator and Delco-Matic Tuning

**\$6895**



### THE SAMSON

A powerful, well-toned, single-unit set.

**\$5195**



### THE CHALLENGER

A real 6-tube station-getter.

**\$3995**

CUSTOM-BUILT CONTROLS FOR ALL CARS

# UNITED MOTORS SERVICE

3044 W. GRAND BLVD.

DETROIT, MICH.

# 551 PARTS *make a* RADIO

... each one as delicate as the hair-spring in a fine watch

**They Call It  
WIRELESS!**

**3/4 of a Mile (3977 ft.)  
of Wire . . . . .**

**213 Soldered Joints**

... and the following 144 RAW MATERIALS

Adhesive tape  
Alcohol  
Aluminum  
Ammonium chloride  
Argelic  
Arsenic trioxide  
Asphalt base potting compound

Bakelite  
Bakelized tubing  
Barium  
Barium carbonate  
Barium nitrate  
"B" flute corrugated cardboard  
Bismarck brown  
Black lacquer  
Bond paper  
Borax  
Brown lacquer  
Bus wire  
Butt walnut  
Cadmium  
Caesium  
Calcium  
Calcium aluminum fluoride  
Calcium carbonate  
Calcium oxide  
Carbon  
Cellulose base lacquer  
Chromium  
Cleaner  
Cobalt  
Cobalt oxide  
Cone paper  
Copper  
Copper wire  
Decalcomania  
Enameled wire  
Ethyl alcohol  
Felt  
Fernico  
Filler

Flat lacquer  
Glass  
Gloss lacquer  
Glue  
Glycerine  
Glyptal cement  
Gum  
Gummed sticker  
Heart walnut  
Heavy oil  
Horn fiber  
Household cement  
Ink  
Iridium  
Iron  
Isolantite  
Kraft paper  
Latex  
Lava  
Lead acetate  
Lead oxide  
Linen  
Litz wire  
Magnesia  
Magnesium  
Magnetite powder  
Malachite green  
Manilla gum  
Marble dust  
Mercury  
Mica

Micarta  
Misch metal  
Molybdenum  
Monel  
Naphthol yellow  
Nickel  
Nigrosine  
Orange gum  
Orinoka grille cloth  
Paper  
Paper covered cement coated wire  
Paraffin  
Petrolatum  
Petroleum  
Petroleum jelly  
Phosphor bronze  
Phosphorous  
Platinum  
Poplar  
Porcelain  
Potassium carbonate  
Resin  
Red lacquer  
Rubber  
Rubber compound  
Rubber and cloth covered wire  
Rubber covered wire  
Safety solvents  
Salt  
Sapale veneer

Scotch tape  
Sealer  
Sheet iron  
Sheet steel  
Silica  
Silicon  
Silicon steel  
Silk wire  
Silver  
Silver oxide  
Silver plated copper wire  
Sinclair "D" oil  
Soap  
Sodium carbonate  
Sodium nitrate  
Staples  
Stearic acid  
Strip steel  
Strontium  
Strontium carbonate  
Strontium nitrate  
Synthetic resin  
Tenite  
Thinner  
Thorium nitrate  
Tin  
Tin plated copper wire  
Titanium  
Trotter's compound  
Tungsten  
Vinegar  
V.M.M.P. naphtha  
Water  
Wax  
White shellac  
Whiting  
Wood fiber  
Wool orange  
Xylol  
Zinc  
Zinc chloride  
Zinc oxide

**You Get More Than Your Money's Worth When You Buy**

Photo and figures from a typical, medium-priced console of standard make. Complete assemblies only are shown in the picture. If each part illustrated was broken down to its individual components many would be too small to be seen in the illustration.

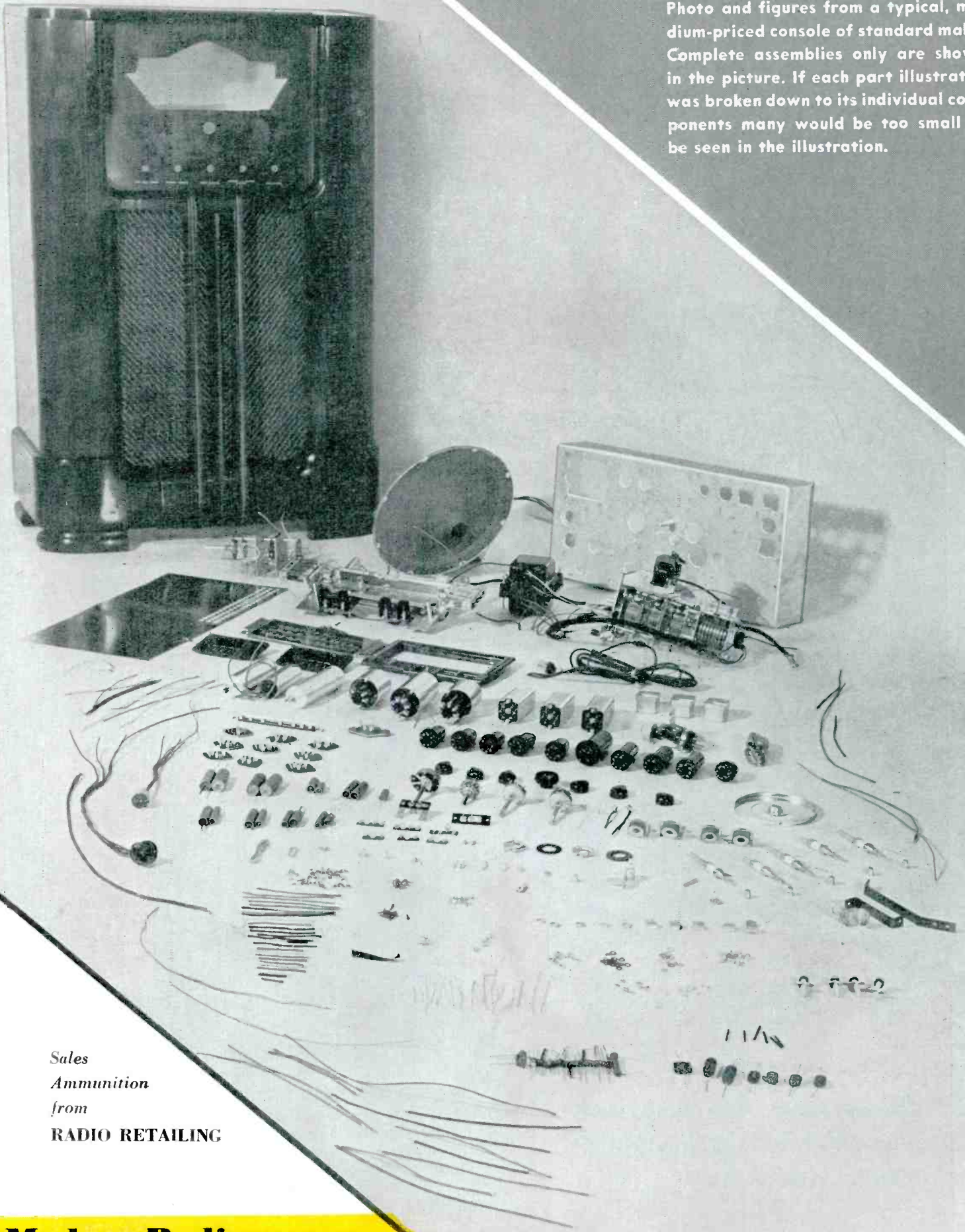

*Sales  
Ammunition  
from*  
**RADIO RETAILING**

**a Modern Radio**

RADIO RETAILING, FEBRUARY, 1938

# ARVIN Sets you up FOR 1938 CAR RADIO PROFITS

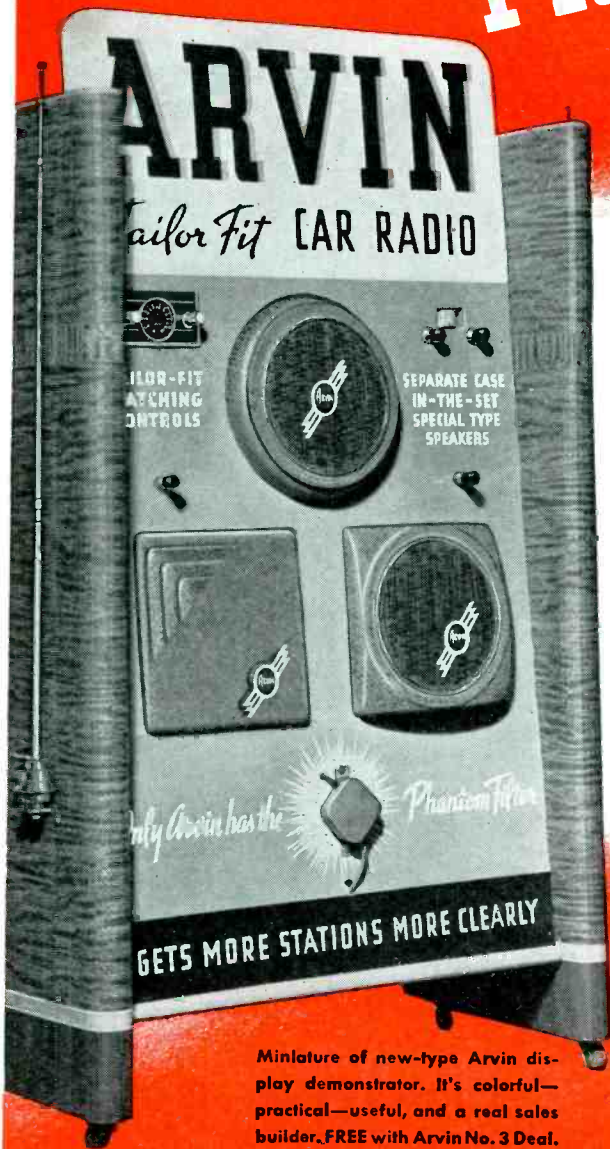

Miniature of new-type Arvin display demonstrator. It's colorful—practical—useful, and a real sales builder. FREE with Arvin No. 3 Deal.

Coming soon! New low-priced Arvin Car Radio with **AUTOMATIC TUNING**... watch for it.

Miniature of impressive Arvin Wall Chart Series Guide printed in 3 colors. This is but one of a series of colorful and effective sales helps—all Free with Arvin Floor Plan Deals. ➔➔➔



## New models . . . amazing performance . . . low prices!

You have all three with the 1938 Arvin Car Radios—plus a merchandising program that enables you to increase sales and profits. The new Arvins with the Famous Phantom Filter are the smoothest, sweetest-playing radios you've ever heard. They get *more* stations, and get them *better*. Arvin's Tailor-Fit idea on speakers and controls—and a complete set for only \$24.95—give you everything to match new cars and customer preferences.

You've never seen such business-building merchandising as the Arvin Floor Plan Deals and the free sales helps that go with them. They really set you up to get more prospects, make more sales and profits. Ask your jobber all about it and order your Arvins now.

NOBLITT-SPARKS INDUSTRIES, Inc., COLUMBUS, INDIANA.



### Universal Scout Model 5

A complete set with special remote control and dynamic speaker mounted in front of radio chassis. Complete set all in one package, only . . . . .

**\$24.95** LIST  
Complete Set

# FIGURES

## TAXES PEAK DESPITE DECEMBER DROP

Treasury tax collection figures show that 1937 revenue on radio and phonograph apparatus set a new high mark, the \$6,658,962 garnered being about 2.2 per cent over 1936's former record breaking \$6,514,898. This despite the fact that December '37 collections were 26.1 per cent below the equivalent month of the previous year.

Since the federal excise tax law became operative in June 1932, manufacturers have paid total radio taxes of \$24,912,261.84, exclusive of additional taxes on automobile radios and accessories.

## NOT "SPILT MILK" YET

Although approximately half of radios found in homes covered in Philco's door-to-door survey of 65,000 families were classified as obsolete by company's investigators, majority of owners of these sets had never been approached by any planned sales drive by retailers, their answers revealed.

What could be interpreted as need for wider dealer advertising and merchandising was revelation that few of

the owners knew, more than vaguely, exactly where they might go to purchase a radio. Many could not remember where they had bought their present sets.

Market presented by owners of obsolete sets may be pictured in light of the fact that almost 65 per cent of the radios in use were over 2 years old, and 12 per cent were over 5. Add to this, the interesting point that 70 per cent of all set owners hadn't bought a tube since they bought their radio, and that more than half of the remainder had bought only one replacement tube.

Families interviewed voted quality of tone the most desirable feature in a radio, 55 per cent of all questioned specifying this characteristic. Selectivity was valued most by 10 per cent, sensitivity by 8 per cent. Only a small number named foreign reception. Not many considered appearance of the set of first importance, but a large percentage admitted that it had been a major factor in the choice of their present sets.

Interesting sidelight presented by the Philco study is that approximately 81 per cent of the 65,000 families inter-

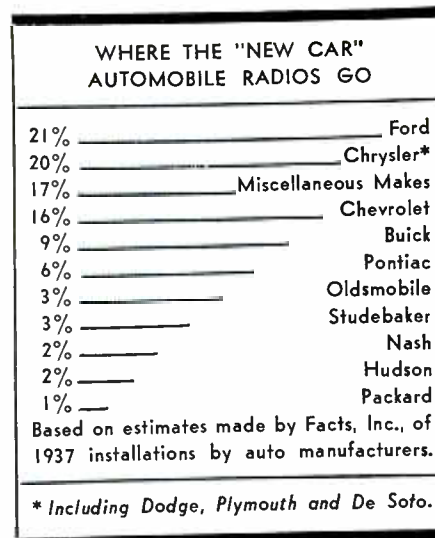

viewed were set owners; *Radio Retailing's* national estimate (RR,1-38) checks with this within a fraction of a point.

## RADIO COMPETITION GREATER

*Harvard Business Review* offers figures to show that while pianos and phonographs taken together accounted for from 35 to 50 per cent of the total spent for recreation products up to 1923, radio reached 39 per cent only once, in 1929. This may be attributed to the increasing number of attractions now competing for the consumer's dollar.

Barring the emergence of some new product of wide appeal, the *Review* continues, radio will probably receive about 25 per cent of the total of annual recreation products expenditures except during depressions.

## HIGH WATER MARK

Advertisers spent \$69,236,224 for national network time in 1937, a 16.21 per-cent gain over the \$59,577,034 volume attained in 1936. Columbia Broadcasting System, with network billings of \$28,722,368 was up 24 per-cent, National Broadcasting System volume jumped 12 per-cent to \$38,651,286, and Mutual Broadcasting System dropped slightly (1.17%) to \$1,862,820.

Figures for each of the networks include only costs for facilities. If talent costs were added, national advertisers' total expenditure for network advertising would go up some \$40,000,000 more.

Also to be considered are sales of non-network time to national advertisers for spot broadcasting. This sum, which jumped from \$17,000,000 in 1935 to \$23,000,000 in 1936 is estimated to have again increased some 45 per-cent last year.

## WHY PEOPLE BUY OUT-OF-TOWN\*

ARTICLE	SOURCE OF SUPPLY			REASON WHY							
	OUT-OF-TOWN STORES	PEDDLERS	MAIL-ORDER	LOWER PRICES	BETTER QUALITY	SPECIAL SALE	COURTEOUS SALESPERSON	GREATER VARIETY	NEW STYLES	BETTER SERVICE	LIBERAL CREDIT
Auto Supplies...	18	..	21	21	6	3	3	3	..	3	..
Food.....	18	3	..	6	3	..	..	..	..	3	..
Lumber.....	27	..	..	12	..	..	..	6	..	..	9
Drugs.....	6	12	15	15	3	..	3	6	..	..	..
Hardware.....	6	3	11	12	1	3	3	..	1	3	..
Dry Goods.....	37	..	64	24	18	9	..	39	6	3	3
Electrical Goods..	9	..	18	18	..	..	..	6	..	..	..
Elect. Refrigerators	9	..	6	9	..	..	..	2	1	..	3
<b>RADIOS</b> .....	3	..	15	9	3	..	..	..	..	3	..
Men's Clothing...	27	..	39	12	6	3	..	24	12	..	9
Children's Clothing	24	..	72	33	9	6	..	18	6	..	12
Ladies' Clothing..	43	..	114	45	24	15	6	21	21	3	12
Shoes.....	31	..	29	21	9	..	..	9	15	3	6
Hosiery.....	9	..	27	9	21	..	3	..	3	..	..
Stationery.....	3	3	6	3	..	..	..	..	..	..	..
Brushes.....	6	6	6	3	..	..	..	..	..	..	..
Furniture.....	3	..	24	15	..	..	..	..	..	..	..

\* Survey of Richmond Center, Wisconsin.



# You Can COMPETE

By TOM BLACKBURN

WHERE PROSPECTS CAN HEAR IT—Forrest Wehnes, Columbus distributor, says every man in the auto-radio business must both own and continuously operate a car set. He places the speaker out front, under the hood, for the benefit of the passerby

**G**RANTED that the automobile salesman, usually a handsome dog, is going to have the first crack at a lot of auto-radio prospects this spring. He will have the prospect in a buying mood, will probably have a slick installation ready to go, and no doubt will put on a fairly decent demonstration out on the road.

What is going to rake sales of this sort out of the fire for independent radio dealers?

That is what *Radio Retailing* asked Forrest Wehnes of the M. & M. Company, down in Columbus, Ohio. In reply Mr. Wehnes put on his hat, jumped in his car, and gave a demonstration of his strategy.

"First of all, you have to give the public an idea of what advantages you—as a radio dealer—have to offer in competition. Believe it or not, many people do not suspect that a lot of dealers have auto-radio for sale. I always have a loud speaker under the hood of my car so that

people on the sidewalk can hear a sample of auto-radio reception. They stop, listen, and look, and this makes an impression at very little cost."

Next, Wehnes advises radio dealers, take advantage of an opportunity that obviously exists. The auto dealer gets first crack at a prospect because he goes there when he wants a car. But filling stations, too, get many, many cracks at both new and old car owners. Team up with the filling station owner!

There are entirely too many filling stations in the United States. In fact, one national refiner hazards the guess that there are four times too many. Little stations that earn the owner less than \$6 to \$10 a week give him a lot of idle time for puttering around.

Help get the station owner some extra income selling automobile radio. Set out a display on each lot so that the car owner who drives in will have a tempting proposition right

under his nose as he waits for oil or gasoline. Consign the radio display if necessary. Get the filling station operator to shoot over to your shop every nibble, sale, or installation. Give him a salesman's commission on the job, and take all liability off his hands.

Remember this: Chain gas stations are already doing this successfully, but the independents, with equal facilities, have not yet been buttoned up.

If you have any doots, as the Scotchman said, talk to C. B. Hollingshead, manager of the Goodrich Silvertown station at 19 South Fourth St., Columbus, as *Radio Retailing* did. Arriving in Columbus May 1, 1937, Hollingshead immediately asked himself why the station he had taken charge of could not sell radio as well as bicycles, batteries and tires.

"We immediately introduced an outside display, and between May 1

# with **CAR DEALERS**

## 5 WAYS TO GET THE BUSINESS

1. Advertise that you sell car sets, making demonstrations in your own car
2. Tie up with as many filling stations as possible, on a sales commission basis
3. Stress the fact that the radios you sell can be moved from car to car
4. Talk up the features your set has that automobile dealers do not offer
5. Stress the fact that you personally install and service car radios

and August 10 we sold 65 sets," he said.

Independent dealers have not acquainted the public with their most convincing sales argument, Forrest Wehnes declares. "Automobiles, due to road wear, depreciate faster than almost any other kind of machinery. A really good automobile radio will outlast a couple of hard-driven cars. When a radio comes factory installed, chances are that it must be traded with the car, as each model is different and a neat transfer cannot easily be made. Manufacturers of independent brands supply new escutcheons each year for all makes of cars. You can put a 1938 radio into a 1939 car, if you wish. This way car owners get a great deal more for their money and stretch the enjoyment of their radio out over a number of years. I think this story,

properly told, will often outweigh, in an automobile prospect's mind, the convenience of driving away with his new radio in his new car."

Then, too, Wehnes points out, car buyers are usually limited to one make of radio. Inasmuch as many of them admire aerials or other gadgets that are not obtainable on that particular line, this is a fly in the ointment that plays into the radio dealer's hands.

Jim Long, of Long & Stouder, Columbus service shop, puts the angle of service in the story. "The public realizes that the automobile dealer is not the man who installs and services car radio," he says. "It is beginning to understand that the more places it can have a radio taken care of, the better enjoyment it will get. Therefore, I think that the dealer has a selling advantage when he can put over the fact that he is johnny-on-the-spot in company with a lot of other radio dealers—to keep that car radio going."

**WHERE PROSPECTS CAN SEE IT**—Gas station manager C. B. Hollingshead swears by a sidewalk display like this, says it has produced 65 car radio sales in the last three months

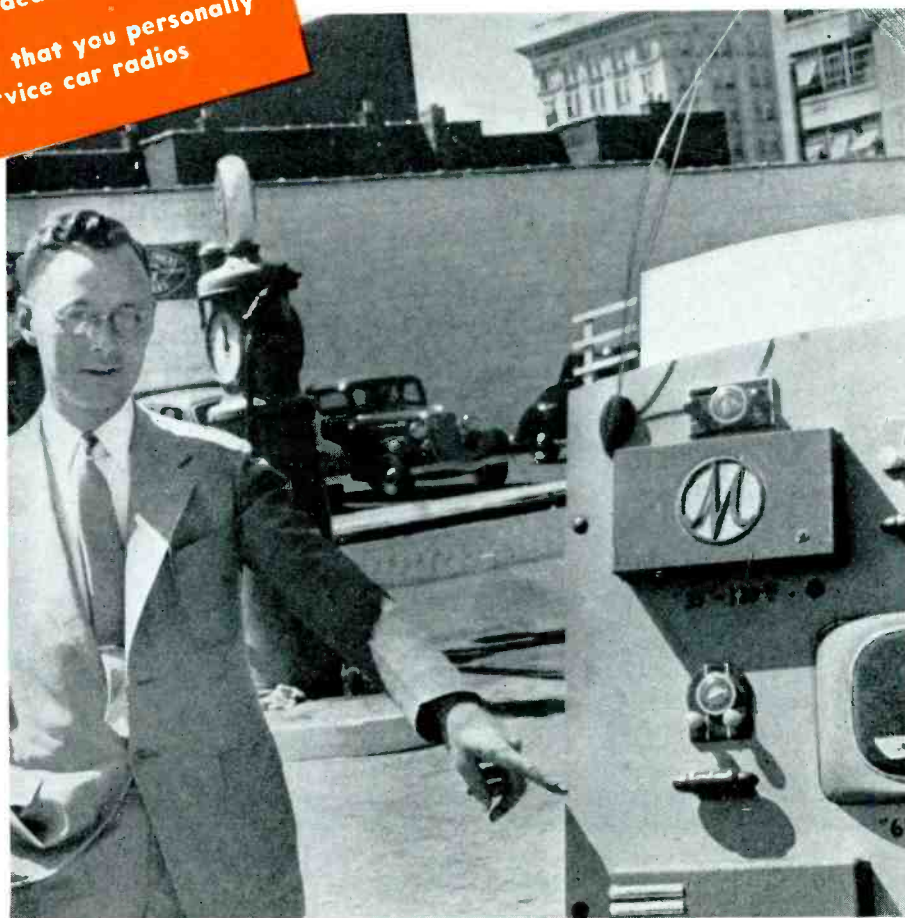

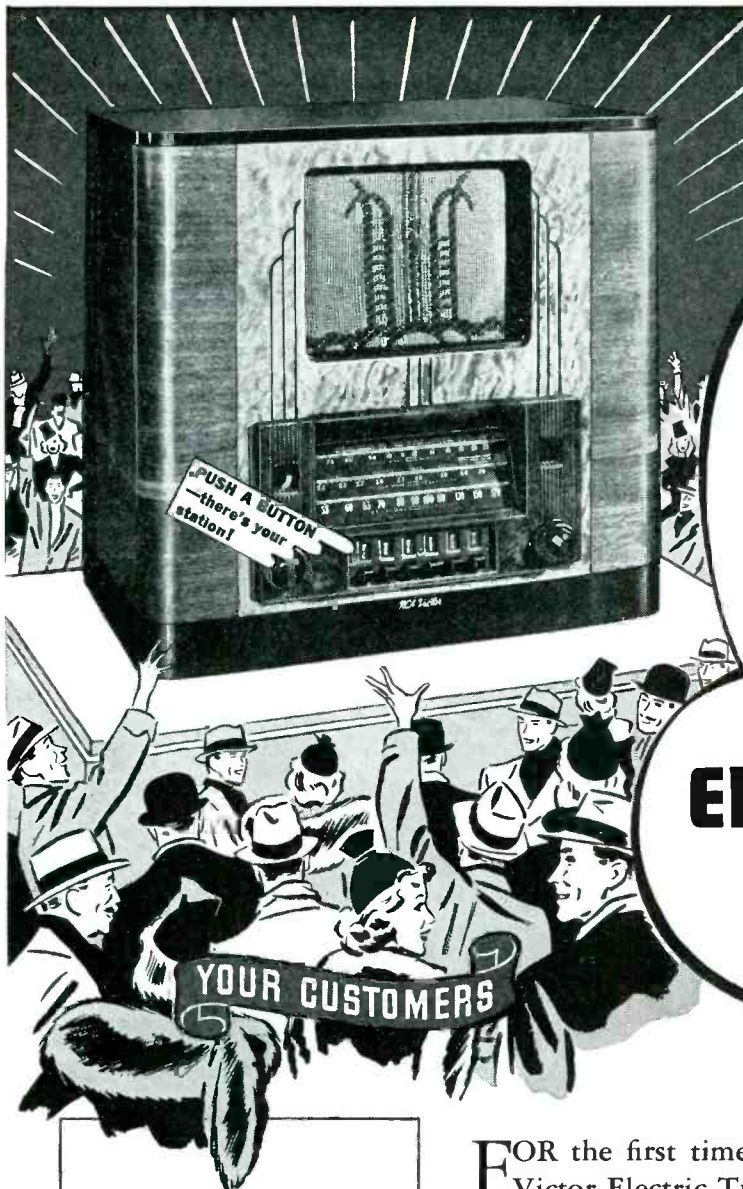

THEY'LL  
**Marvel**  
 at this New  
**RCA VICTOR  
 ELECTRIC TUNING  
 VALUE!**

**\$69<sup>95</sup>\***

**'NUF SAID!**

RCA Victor Electric Tuning Table Model 87T-2. Brings Electric Tuning to the thousands who've wanted it—but couldn't afford it! Just push a button—and any one of six favorite stations is tuned as quick as a wink! In addition to Electric Tuning, this instrument provides such other extra value features as famous Magic Eye, RCA Metal Tubes, Straight-Line Dial, Beauty-Tone Cabinet, Phonograph Connection, and many more. A sales WOW with a capital "W"!

**F**OR the first time—RCA Victor Electric Tuning—in a table model! Here's a spectacular new value that will bring you more and greater sales and profits—a radio set with the year's most sensational development that sells for only \$69.95\*.

(\*F.O.B. Camden, N.J., subject to change)

RCA presents the "Magic Key" every Sunday, 2 to 3 P.M., E.S.T., on the NBC Blue Network



**RCA Victor**

A SERVICE OF RADIO CORPORATION OF AMERICA • RCA MFG. CO., INC., CAMDEN, N. J.

**OVER 300 MILLION** RCA RADIO TUBES HAVE BEEN PURCHASED BY RADIO USERS. IN TUBES, AS IN RADIO SETS, IT PAYS TO GO RCA ALL THE WAY



# *How To* **BRING THEM IN**

*By*  
**RICHARD  
GILBERT**



GALLOWAY

---

**FOURTH of a SERIES**

*November: Getting Started With Records*

*December: How to Keep From Overstocking*

*January: Best Record Prospects*

**NEXT MONTH: Demonstrating Records**

---

**Y**OUR success in getting record buyers into your store depends largely upon the intelligent exploitation of four principal avenues through which to call attention to your merchandise and service: direct-mail; use of the telephone; newspaper, radio and theatre-program advertising and window display.

The key to the first and second is, of course, your mailing list. Beginning with your very first record sale you should not fail to get the customer's name and address; enter it on a library card, filling in at the bottom the nature of the purchase, the amount and date, and any remarks relating to musical preferences the customer may have made during the transaction.

All subsequent sales should be similarly noted. Once you have accumulated this information (it is surprising how quickly a mailing list can grow when you keep after it) you have a ready reference index to sales possibilities that money cannot buy.

Each month manufacturers supply you, free of charge, with as many supplements or catalogues, listing and describing the new records, as you require for both mailing and distribution over the counter and in your listening booths. These supplements interest the record buyer. They should be mailed regularly and as early as possible to your complete list regardless of classifications you may have made. I have never found the separation of

"classical" and "popular" of much value as you never know when an item in one category will attract a buyer previously interested in the other.

Mailing pieces printed by the publisher should never be sent out or placed on the counter without your store's imprint. A rubber stamp is not as impressive as the inexpensive job a printer can do using the same type-face and ink-color as that with which the supplement is printed. Your mailing envelopes might carry an additional line in display type such as "The New Records," "News for Record Buyers," "This Month of Music," or an effective slogan.

Several weeks previous to the re-

*(Please turn to page 41)*

# 1938 Auto-Radio Specifications\*

Model	Price (List)	Dimensions (Chassis)	Tone Control	Built-in Speaker Type & Size	Ext. Speaker Type & Size	Tuning Controls	Vibrator Synchronous or Non-Syn	Recommended Antenna†	Tubes — Types	Battery Drain (Amps)	Output (Watts)	Inter-Freq. (K.C.)
Automatic Radio Mfg. Co., 122 Brookline Ave., Boston, Mass.												
M-10		10 1/2 x 6 1/2 x 5	No	5" El. Dyn.	.....	UD	Non-Syn.	B-C-F	6A7, 6D6, 75, 41, 84	4	1.75	456
M-20		10 x 6 x 4	Yes	5" El. Dyn.	.....	UD	Non-Syn.	B-C-F	6A7, 78, 75, 41, 84	4	1.75	456
M-30		10 x 6 x 4	Yes	5" El. Dyn.	.....	UD	Non-Syn.	B-C-F	6A7, 78, 75, 41, 84, 6E5	4.5	1.75	456
M-60		10 1/2 x 6 1/2 x 5	No	5" El. Dyn.	.....	UD	Non-Syn.	B-C-F-W	6A7, 2-6D6, 6Q7G, 41, 84	4.5	2.0	456
M-70		8 1/2 x 6 1/2 x 4 1/2	Yes	6" El. Dyn.	.....	DT	Non-Syn.	B-C-F-W	6A7, 2-6D6, 6Q7G, 6B5, 0Z4	6.0	3.0	456
M-80		8 1/2 x 7 x 6 1/2	Yes	6" El. Dyn.	.....	DT	Non-Syn.	B-C-F-W	6A7, 2-6D6, 6Q7G, 2-6B5, 76, 0Z4	7.0	7.0	456
Cavalier Motors Associates, Ltd., 1028 Linden Avenue, Baltimore, Md.—"Autophone"												
M53T	\$25.95	7 x 7 x 10	No	6" El. Dyn.	None	UD	Non-Syn.	W	2-6K7MG, 6I7MG, 6K6MG, 6N5MG	5	2	TRF
M55S	30.95	6 1/2 x 7 1/2 x 9 1/2	No	6" El. Dyn.	None	DT, UD, SC	Non-Syn.	W	6K7MG, 6A8MG, 6Q7MG,	5.5	3	456
Detroit Radio Corp., 3630 W. Fort St., Detroit, Mich.												
		6 1/2 x 7 1/2 x 9 3/4	.....	5" Dyn.	.....	Yes	Non-Syn.	.....	6D6, 78, 75, 76, 42, 84	6	3	456
		6 1/2 x 7 x 9 1/2	.....	6" P.M. Dyn.	.....	Yes	Non-Syn.	.....	2-78, 6A7, 75, 6AB6, 0Z4	5	3.5	456
		7 x 8 x 9 1/2	.....	6" P.M. Dyn.	6" P.M. Dyn.	Yes	Non-Syn.	.....	2-78, 6A7, 6R7, 2-6V6, 0Z4	7	8.5	456
Fada Radio & Elec. Co., Long Island City, N. Y.—"Fada Moto Set"												
A50		10 x 6 x 7	No	5 1/2" Dyn.	.....	.....	Non-Syn.	B-C-F-W-U	6A8, 6K7, 6Q7G, 6K6G, 6N5,	5	.....	456
267		8 1/2 x 7 1/2 x 7	Yes	6" Dyn.	8" Dyn.	DT, UD, SC	Non-Syn.	B-C-F-W-U	6A7, 78, 75, 41, 84	6	.....	175
Galvin Mfg. Corp., 4545 Augusta Boulevard, Chicago, Ill.—"Motorola"												
8-30	\$29.95	6 1/2 x 7 1/2 x 10 1/2	No	5 1/2" El. Dyn.	No	DT	Non-Syn.	C	2-78, 6A7, 75, 41, 84	6.3	3.5	262
8-40	39.95	6 1/2 x 7 1/2 x 10 1/2	Yes	6 1/2" El. Dyn.	Optional	DT	Non-Syn.	C	2-78, 6A7, 75, 41, 84	6.5	3.6	262
8-50	49.95	6 x 8 x 4 x 11	**	8" El. Dyn.	Optional	DT	Non-Syn.	C	2-78, 6A7, 75, 42, 0Z4	6.5	4.5	262
8-60*	59.95	7 1/2 x 8 1/2 x 12 1/2	**	6" El. Dyn.	No	DT	Non-Syn.	C	2-78, 6A7, 75, 41, 0Z4	6.5	4.5	262
8-70	69.95	6 x 8 1/2 x 11	**	No	8" P.M. Dyn.	DT	Non-Syn.	C	2-6K7G, 6A8G, 6V7G, 6C5G,	8.0	15	262
Golden Voice*	79.95	7 1/2 x 8 1/2 x 12 1/2	**	No	8" P.M. Dyn.	DT	Non-Syn.	C	2-6K7G, 6A8G, 6V7G, 6C5G,	8.0	15	262
* Electric Automatic "Push-Button Network" Tuning. ** Acoustinator — Personal preference selector.												
General Electric Co., 1285 Boston Ave., Bridgeport, Conn.—"G. E."												
F.A-60*	\$29.95**	9 x 8 x 7	No	6 1/2" El. Dyn.	.....	DT	Syn.	Any	2-6K7, 6A8, 6H6, 6F5, 6F6	7.25	4	175
F.A-61*	39.95***	9 x 8 x 7	Yes	6 1/2" El. Dyn.	.....	DT	Syn.	Any	2-6K7, 6A8, 6H6, 6F5, 6F6	7.25	4	175
* Tone Monitor. ** Does not include Escutcheon Kit. *** Including Escutcheon Kit.												
Herbert H. Horn Co., 1201 S. Olive, Los Angeles, Calif.—"Tiffany Tone"												
557	\$29.95	6 1/2 x 7 x 11	Yes	5" Dyn.	.....	DT, SC	Non-Syn.	C-F-W	6A8G, 6K7G, 75, 6F6G, 6X5G	6	3	465
Howard Radio Co., 1735 Belmont Ave., Chicago, Ill.												
HA7	\$42.95	7 1/2 x 6 x 9 1/2	Yes	6" Dyn.	*	DT	Syn.	C	6K7, 6A8G, 6K7G, 6Q7G, 6V6G, 0Z4	7.6	4.5	465
HAS	64.50	7 1/4 x 6 x 9 1/2	Yes	.....	8" P.M.	DT	Syn.	C	2-6K7G, 6A8G, 6C5G, 6Q7G,	5.5	9	465
HA9	49.95	7 1/2 x 6 x 9 1/2	Yes	.....	8" P.M.	DT	Syn.	C	6K7, 6A8G, 6K7G, 6Q7G, 6V6G, 0Z4	5.5	4.5	465
* Provision for external speaker.												
Mission Bell Radio Mfg. Co., Inc., 831 Venice Blvd., Los Angeles Calif.												
638	\$39.95	6 1/2 x 8 x 9	Yes	6" Dyn.	.....	DT	Non-Syn.	F-U	6A7, 6K7, 6Q7, 6H6, 41, 84	5 1/4	3	267 1/2
638A*	49.95	6 1/2 x 8 x 9	Yes	6" Dyn.	.....	DT	Non-Syn.	F-U	6A7, 6K7, 6Q7, 6H6, 41, 84	5 1/4	3	267 1/2
738	49.95	6 1/2 x 8 x 9	Yes	6" Dyn.	.....	DT	Non-Syn.	F-U	2-6K7, 6A8, 6H6, 6F5, 6F6, 84	6 1/4	4	267 1/2
738A*	59.95	6 1/2 x 8 x 9	Yes	6" Dyn.	.....	DT	Non-Syn.	F-U	2-6K7, 6A8, 6H6, 6F5, 6F6, 84	6 1/4	4	267 1/2
* Automatic tuning.												
Montgomery Ward & Co., Chicago, Ill.—"Aplime"												
62-258	\$32.95	6 x 7 x 10	Yes	6" El. Dyn.	.....	DT, UD, SC	Syn.	Any	2-6K7, 6J7, 6B7, 41, 6A6	8.2	6	175
62-263	24.95	6 x 7 x 8	Yes	5 1/2" El. Dyn.	.....	DT, UD, SC	Non-Syn.	Any	2-6D6, 6C6, 75, 41, 84	7.3	2.4	175
Noblitt-Sparkes Industries, Inc., Columbus, Ind.—"Arvin"												
5	\$24.95	8 1/4 x 8 1/2 x 6 1/2	No	5" Dyn.	.....	UD	Non-Syn.	F-W	6A8, 6K7, 6Q7G, 6K6G, 6X5G	5.3	3	455
22A	37.95	8 1/4 x 8 1/2 x 6 1/2	No	5" Dyn.	.....	DT	Non-Syn.	F-W	2-6K7, 6A8, 6Q7G, 6K6G, 6X5G	5.7	3	170
32*	49.95	8 1/4 x 8 1/2 x 6 1/2	Yes	8" Dyn.	.....	DT	Non-Syn.	F-W	2-6K7, 6A8, 6Q7G, 6V6G, 6X5G	6.2	5	170
42*	59.95	8 1/4 x 8 1/2 x 6 1/2	Yes	8" Dyn.**	8" Dyn.**	DT	Non-Syn.	F-W	2-6K7, 6A8, 6Q7G, 6C5G, 6N7G	7.2†	7 1/2	170
* Phantom Filter. ** Or 10" P.M. Dynamic. † 5.6 with P.M. Speaker.												
Pierce Airo, Inc., 440 Lafayette St., New York, N. Y.—"Devald"												
527	\$29.95	11 1/2 x 6 1/2 x 4	Yes	5" Dyn.	.....	UD	Non-Syn.	Any	6A7, 6D6, 41, 75, 84	6	3 1/2	456
702	44.95	9 x 7 1/2 x 7 1/2	Yes	6" Dyn.	.....	DT, UD	Non-Syn.	Any	6H6, 6A7, 75, 41, 84, 2-6D6	6.25	3 1/2	175

Model	Price (List)	Dimensions (Chassis)	Tone Control	Built-in Speaker Type & Size	Ext. Speaker Type & Size	Tuning Controls▲	Vibrator Synchronous or Non-Syn.	Recommended Antenna†	Tubes — Types	Battery Drain (Amps)	Output (Watts)	Inter-Freq. (K.C.)
<b>RCA Mfg. Co., Camden, N. J.</b>												
8M	\$19.95	5 7/8x6x10 7/8	No	5" El. Dyn.	.....	UD	Non-Syn.	F-W-U	6A8G, 6K7G, 6Q7G, 6K6G, 6X5G	6	3.5	460
8M-1	34.95	7x7 1/2x10	No	5" El. Dyn.	.....	DT	Non-Syn.	F-W-U	6K7G, 6A8, 6K7, 6Q7G, 6K6G, 6X5G	6.6	3.5	260
8M-2	44.95	7x7 1/2x10	Yes	8" El. Dyn. *	8" El. Dyn. *	DT	Non-Syn.	F-W-U	6K7G, 6A8, 6K7, 6Q7G, 6K6G, 6X5G	6.6	3.5	260
8M-3	49.95	7x7 1/2x10	Yes	6" El. Dyn.	.....	DT	Syn.	F-W-U	6K7G, 6A8, 6K7, 6R7G, 6J5, 6N7G	7.5	9.0	260
8M-4	59.95	7x7 1/2x10	Yes	.....	8" El. Dyn.	DT	Syn.	F-W-U	6K7G, 6A8, 6K7, 6R7G, 6J5, 6N7G	7.5	9.0	260
* Provision for external speaker.												
<b>Sears Roebuck, Chicago, Ill. — "Silver-tone"</b>												
6100	\$29.95	7x8 3/8x7 3/4	*	8" Dyn.	**	DT	Non-Syn.	Any	2-6U7G, 6A8G, 6B8G, 6V6G, 0Z4G	7	3.5	262
6101	39.95	7x8 3/8x7 3/4	*	8" P.M.	**	DT	Non-Syn.	Any	3-6U7G, 6A8G, 6R7G, 6N7G, 0Z4G	6	7.0	262
** Provision for separate tone and sensitivity controls. *** Provision for external speaker.												
<b>Transitone Automobile Radio Corp., Tioga and "C" Streets, Philadelphia, Pa. — "Philco 'Transitone'"</b>												
920*	\$24.95	7 1/2x5 7/8x9 7/8	No	5 1/2" El. Dyn.	No	UD	Non-Syn.	Any	6A7, 78, 75, 41, 84	.....	.....	260
926	39.95	9x8 3/8x6 7/8	**	6 3/8" El. Dyn.	No	UD, SC	Non-Syn.	Any	2-78, 6A7, 75, 41, 84	.....	.....	260
927	49.95	9x8 3/8x7 1/8	**	7 1/2" El. Dyn.	No	UD, SC	Non-Syn.	Any	2-78, 6A7, 75, 2-41, 84	.....	.....	260
928K	59.95	9x8 3/8x6 1/8	**	No	7 1/2" El. Dyn.	UD, SC	Non-Syn.	Any	2-78, 6A7, 75, 2-41, 84	.....	.....	260
*** "Speech-Carline-Music" push button control.												
<b>Tray-Ler Radio &amp; Television Corp., 1036 W. Van Buren St., Chicago, Ill.</b>												
610*	\$39.95	8 1/2x7 1/2x6	Yes	6 1/2" Dyn.	No	DT, UD	Non-Syn.	U	6A8, 6K7, 6H6, 6V6, 6F5, 0Z4	6	4	456
710*	49.95	8 7/8x7 1/2x6	Yes	6 1/2" Dyn.	8" P.M. or Dyn.	DT, UD	Non-Syn.	U	6A8, 6Q7, 6J5, 6N7, 0Z4, 2-6K7	7	8	456
711*	59.95	8 7/8x7 1/2x6	Yes	.....	8" Dyn.	DT, UD	Non-Syn.	U	6A8, 6Q7, 6J5, 6N7, 0Z4, 2-6K7	7	8	456
* Automatic tuning optional.												
<b>Troy Radio Mfg. Co., 1144 So. Olive St., Los Angeles, Calif.</b>												
86	\$29.95	8 3/4x7 1/4x6 3/4	No	5" Dyn.	.....	DT, UD, SC	Non-Syn.	Any	6A7, 6D6, 6H6, 41, 75, 84	6	2 1/2	465
87	35.95	9x8x7	Yes	6" Dyn.	.....	DT, UD, SC	Non-Syn.	Any	6A7, 2-6D6, 6H6, 75, 84, 41	6.5	2 1/2	465
<b>United Motors Service, 3044 W. Grand Blvd., Detroit, Mich. — "Delco"</b>												
R-663	\$27.95	6 1/2x10 1/2x6 3/8	No	5" Dyn.	.....	UD	Non-Syn.	F-W	2-6K7G, 6A8G, 6Q7G, 6K6G, 6X5G	5	2.5	262
R-664	39.95	7 3/4x6 1/2x10 5/8	Yes	6" Dyn.	.....	DT	Non-Syn.	F-W	2-6K7G, 6A8G, 6Q7G, 6V6G, 6X5G	6	4.5	262
R-665	51.95	8 3/4x6 1/2x10 5/8	Yes	8" Dyn.	.....	DT	Non-Syn.	F-W	2-6K7G, 6A8G, 6Q7G, 6V6G, 0Z4G	6	5	262
R-666	57.95	8 3/4x6 1/2x10 5/8	Yes	8" Dyn.	.....	DT	Non-Syn.	F-W	2-6K7G, 6A8G, 6Q7G, 6V6G, 0Z4G	6	6	262
R-667*	68.95	8 3/4x6 1/2x10 5/8	Yes	.....	8" Dyn.	DT	Non-Syn.	F-W	2-6K7G, 6A8G, 6Q7G, 6V6G, 0Z4G	6	6	262
R-668	67.95	8 3/4x6 1/2x10 5/8	Yes	.....	8" Dyn.	DT	Non-Syn.	F-W	2-6K7G, 6A8G, 6R7G, 6J5G, 6N7G, 0Z4G	6.5	12	262
R-66d*	78.95	8 3/4x6 1/2x10 5/8	Yes	.....	8" Dyn.	DT	Non-Syn.	F-W	2-6K7G, 6A8G, 6R7G, 6J5G, 6N7G, 0Z4G	6.5	12	262
* Push button tuning.												
<b>Universal Battery Co., 3410 So. LaSalle St., Chicago, Ill.</b>												
60*	\$39.95	11 1/2x6 1/2x7 1/2	Yes	6 3/4" P.M. Dyn.	.....	DT, UD	Non-Syn.	F-W-U-C	6K7, 6A8, 6D6, 75, 41, 84	6	3 1/4	262
70*	54.95	11 1/2x6 1/2x7 1/2	Yes	6 3/4" P.M. Dyn.	8" P.M. Dyn.	DT, UD	Non-Syn.	F-W-U-C	6K7, 6A8, 6K7G, 6Q7G, 6J5G, 6N7G, 0Z4	7	7 1/2	262
* Finger Tip Control.												
80*	65.95	11 1/2x6 1/2x7 1/2	Yes	6 3/4" P.M. Dyn.	8" P.M. Dyn.	DT, UD	Non-Syn.	F-W-U-C	6K7, 6A8, 6K7G, 6Q7G, 6J5G, 6N7G, 0Z4, 6K7	7	8 1/2	262
<b>Wells-Gardner &amp; Co., 2701 N. Kildare Ave., Chicago, Ill. — "Arcadia"</b>												
46C1-41	.....	8 1/2x7 1/2x6 1/2	Yes	5 1/2" Dyn.	.....	DT	Non-Syn.	F-W	84, 75, 41, 6D6, 6C6	6	3	175
4613	.....	10 1/2x7 1/2x6 1/2	Yes	6" Dyn.	.....	DT	Syn.	F-W	6K7, 6I7, 6B7, 41, 6A6	8.3	6	175
<b>Wholesale Radio Service Co., Inc., 100 Sixth Ave., New York, N. Y. — "Lafayette"</b>												
S-9	\$31.90	6 1/2x12 1/2x6 1/2	Yes	5" El. Dyn.	.....	UD	Non-Syn.	F-U	6A7, 6D6, 75, 41, 84	5	2	456
D-37	59.90	11 1/2x5Wx7 3/8	Yes	6" El. Dyn.	.....	DT	Non-Syn.	B-C-U-F	6T5, 6N7G, 0Z4, 2-6K7, 6A8, 0Q7G	8	7	262
EB-17-A	39.70	9x6x8	Yes	5" El. Dyn.	.....	DT	Non-Syn.	U-F	6Q7G, 2-6D6, 6A7, 6Z4, 41	6	2 1/2	456
<b>Zephyr Radio Co., 13139 Hamilton, Detroit, Mich.</b>												
3M7	\$47.50	7x9x8	Yes	6 1/2" Dyn.	.....	DT, UD	Non-Syn.	F-W	6A7, 2-6D6, 6Q7, 0Z4, 206, 41	5	3	262 1/2
3M5	34.95	6x5x10	No	5" Dyn.	.....	UD	Non-Syn.	F-W	6A7, 6D6, 75, 41, 0Z4	4	2	456

▲ DT — Dash Type  
 UD — Under dash  
 SC — Steering Column

B — Built-in Roof  
 C — Car Top  
 F — Fish pole  
 W — Whip  
 U — Under car

†

\* ADDITIONAL LINES NEXT MONTH!—Still in process of design as we go to press are sets made by *Crosley, Emerson, Gillman, Lauchlin, Stewart-Warner, Western Auto, Zenith, and others.*

# YOU CAN SELL



## SERVEL ELECTROLUX

*Any* **DAY**  
*Any* **SEASON**  
*to*  
*Any* **FAMILY**  
*Any* **WHERE**

**Runs on gas, kerosene, or bottled gas—offers famous “No Moving Parts” freezing system and amazing new conveniences**

**T**HERE are no “ifs” about Servel Electrolux. This famous refrigerator can today be enjoyed by any family—no matter where they live. City? Town? Country? It makes no difference. For there are Servel Electrolux models that run on manufactured gas . . . or on bottled gas . . . or on kerosene.

#### **MORE PROFITS FOR YOU**

Just think what that means to you! It means a chance to make money all year round with a refrigerator that’s renowned for *permanent silence* . . . *savings* . . . and the “no moving parts” freezing system.

It means that every family in your territory is a potential prospect.

#### **GREATEST ADVERTISING PROGRAM**

In 1938, Servel Electrolux is being backed by its biggest, most aggressive advertising program—three separate campaigns in eleven of the Nation’s leading magazines. More than ever before, it will be the refrigerator your prospect will *hear about*. There’s money to be made—*right now*. So write for information about available franchises. Servel, Inc., Servel Electrolux Sales Division, Evansville, Indiana.

*Sell the Refrigerator* **THEY HEAR ABOUT  
BUT NEVER HEAR**

# BIOGRAPHIES IN TEN MINUTE RECORDS



ARTHUR C. SCHLEIGER—(Shadbolt-Boyd) Outfit has been distributing radio for ten years but does not remember first line. Four men flood the state with Stewart-Warner radios and refrigerators, Everhot roasters and Manning-Bowman small appliances. Likes to cook, a knack picked up in the army. Recognized as a drink-mixer par-excellence. Mrs. Schleiger dusts the manager off to be shot.



ALVIN VAN ANTWERPEN—(Radio Specialty Company) Started with Lempke Electric, distributor of automotive equipment. Joined Radio Specialty in 1924 and brought Atwater Kent's radios with him. Then jobbed Thompson receivers. Today, 16 salesmen push Philco in fifty-four counties, plus Norge refrigerators and, locally, heating. Absorbed in house-building at present, studying polychrome whoopee room design.

## MORE BIOGRAPHIES ON NEXT PAGE

J. A. TAYLOR—(Taylor Electric Company) Ran a retail electrical shop in Madison, Wisconsin, and sold crystal receivers in 1919, jobbing DeForest's first receiver in 1920. Now has seven men pushing RCA radios in fifty counties, together with Leonard refrigerators and Bendix washers. His hobby, well ridden, is golf and his best pal is camera-bug son.



WILLIAM SAICHEK—(Community Stores) Copped the job as secretary of this firm, of which Charles Lubotsky is president and Abe Lubotsky vice-president, out of the downtown Atlas store, where he was a salesman in the early days. Distributes Admiral radio, Pyro and Silver King bicycles in major line. Hobby is definitely pinochle. Cleaned up recently in remarkable exhibition of this game of skill.



CHARLES E. WILLERT—(Morley-Murphy) Was with concern when it was solely a floor covering house. Zenith was first radio line. Today sells Zenith radio, Kelvinator refrigerators, Chambers ranges, Duo-Therm oil heaters and floor-coverings to twenty-five Wisconsin counties, travelling seven men. Firm advocate of "jobber franchises." Goes in for fishing in a big way.

First of a Series . . .  
**MILWAUKEE**  
**Set Distributors**

# MINUTE BIOGRAPHIES



**J. J. DOUGHERTY**—(J. J. Dougherty Company) His three men cover the eastern half of the state on Sparton radio and Conlon washers, along with Ohio oil stoves. Best friend and companion is "Sparky," the office dog. Rumor has it that the gentleman is so chummy with the animal that he occasionally consumes a dog biscuit with it.



**J. T. URBAN**—(Westinghouse Electric Supply Company) As branch manager, is probably better known to radio dealers than Henry Czech, who heads the office. Travels seven men in thirty-five northeast counties with complete Westinghouse radio and appliance line. Hobby is urging trade to carry complete stock that will turn twelve times yearly, hire and train enough good retail salesmen.

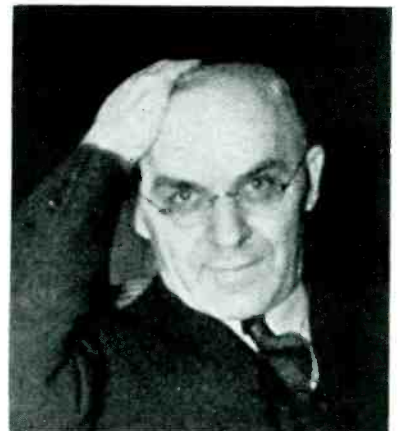

**D. C. LAPPIN**—(Lappin Electric Company) Started with Philco in 1928, liked the taste of the radio business and now jobs Kadette radios, Grunow radios and refrigerators. Forty counties are covered by four men who work on the lines noted above. Four more sell supplies. Spends his hard-earned play hours at pinochle but insists that he is a small stake man and likes the game for itself.



**CHARLES E. TURNOCK**—(Charles E. Turnock Company) Born in Salem, Wisconsin. First jobbed dry-goods, then candy. Later accumulated a garage and insurance business. First radio line was United American Bosch. Now has four men working half the state with Fairbanks-Morse sets and appliances. Lives in Kenosha. Keeps scrapbooks of poetry. Once sent one with a bill. Back came reply: "We're not so far back you got to send poetry to us!"



**FRANK W. GREUSEL**—(Greusel Distributing Corporation) Sold Radolek's line in 1923 and catwhisker models even before that. Now directs ten salesmen who spread the story of Crosley radio over forty-five counties, along with Thor washers and ironers, Toastmaster toasters, Nesco roasters and Hamilton-Beach appliances. Extremely active in local trade association affairs.

# NORGE

## HOME APPLIANCES

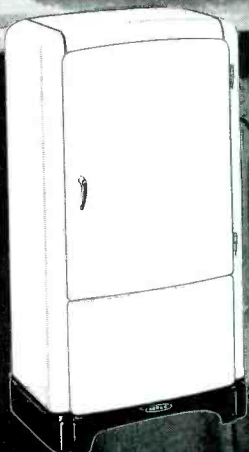

**ROLLATOR REFRIGERATION . . .** Protected by 10-Year Warranty on the 3-moving-parts Rollator Compressor.



**CONCENTRATOR GAS AND ELECTRIC RANGES . . .** Advanced styling plus many special convenience features.



**AUTOBUILT WASHERS AND DUOTROL IRONERS . . .** America's first fully styled home laundry line.



### A SURE SIGN OF SUCCESS IN THE APPLIANCE BUSINESS

**A SIGN OF BETTER PRODUCTS . . .** Norge leads again with a new line of home appliances that are the greatest in Norge history. Products backed by new, tested methods of *visual selling*—stronger advertising and sales promotion—more dramatic store and window displays.

**A SIGN OF YEAR 'ROUND PROFIT . . .** There is always sales activity in the Norge line of Rollator Refrigerators, Concentrator Gas and Electric Ranges, Autobuilt Washers, Duotrol Ironers, and package heating and commercial refrigeration equipment. High product turnover and liberal finance plans keep a Norge Master Merchant's capital working all the time. Get the facts about the valuable Norge franchise today.

NORGE DIVISION Borg-Warner Corporation, Detroit, Michigan



**MAIL  
TODAY!**

*Free  
to Appliance  
Dealers*

A 64-page volume on appliance selling and promotion. Describes a complete plan of store operation. No matter what products you sell, this book will show you how to make more money in the appliance business.

NORGE DIVISION Borg-Warner Corp.,  
654 E. Woodbridge St., Detroit, Mich.  
I would like to receive a copy of your new book for  
appliance dealers.

NAME .....  
ADDRESS .....  
CITY ..... STATE .....

# Preview of New

# A U T O



ARVIN

Arvin Scout Model 5 auto radio made by Noblitt Sparks Industries, Inc., Columbus, Ind., is a complete set all in one package including special under panel control and dynamic speaker mounted in front of radio chassis; dial is softly lighted and has large easy-to-read figures; 6 tubes; \$24.95

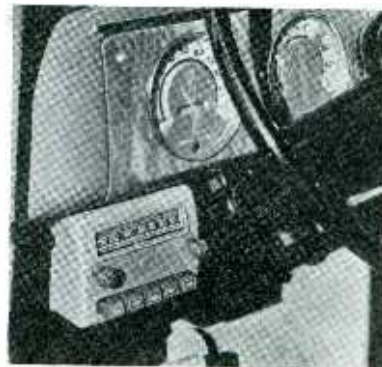

CROSLLEY

A push button auto set to sell for slightly under \$25 is announced by Crosley Radio Corp., Cincinnati, Ohio; the safety tuning mechanism is instantaneous; five push buttons; can easily be set by customer without removing any parts; station tuned in is indicated on horizontal dial; push button or dial tuning without throwing a control

Other Arvin 1938 models include Deluxe Commander 42, 7 tubes, two units, \$59.95; 32, 6 tubes, single unit, \$49.95; 22A, 6 tubes, single unit, \$37.95; a full line of special aeri-als built to deliver maximum efficiency is also offered as well as matching panel controls for 1935-36-37-38 cars

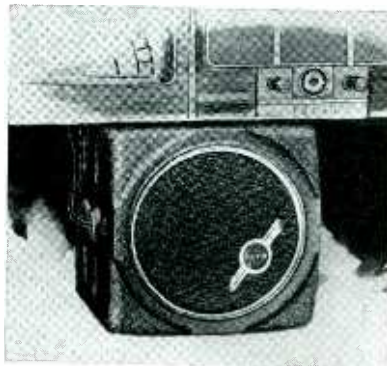

ARVIN

Not only is push button tuning available in some of the 1938 Motorola auto-sets made by Galvin Mfg. Co., 4545 W. Augusta Blvd., Chicago, but colored buttons are used to identify the three leading chains—simplifying tuning still further; another feature is "spot tuning", a manual-automatic device to tune in stations with hairline precision; \$29.95-\$79.95



MOTOROLA

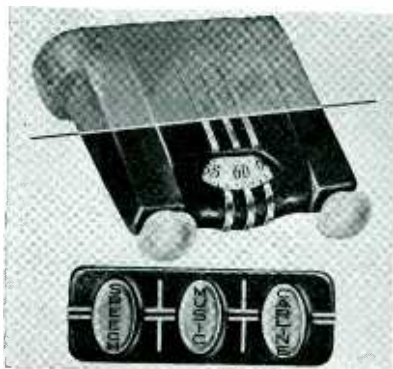

PHILCO

Fully visible reception control — labelled Speech, Music, Carline — is to be found on three of the four 1938 auto sets now ready for distribution by Philco Radio & Tel. Corp., Philadelphia, Pa.; prices range from \$24.95 (\$15 less than last year) to \$59.95

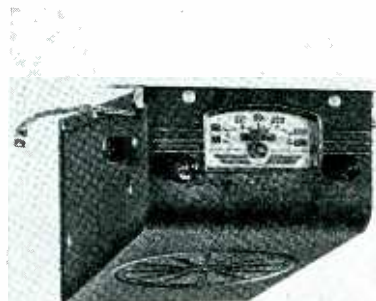

DE WALD

Model 527 motor car set (illustrated) just announced by Pierce-Airo, Inc., 440 Lafayette St., New York City, is made for flush mounting without removing glove compartment; 5 tubes; \$29.95; Model 702, for single hole mounting, uses 7 tubes; dash or under dash tuning controls, \$44.95



# R A D I O S



RCA

Five auto sets have been developed by RCA Mfg. Co., Camden, N. J., at a price range of from \$19.95 to \$59.95; all cover from 550-1550 kc. and are equipped with Magnetite core transformers; the four larger models have new watch-type dial with a special translucent diffuser

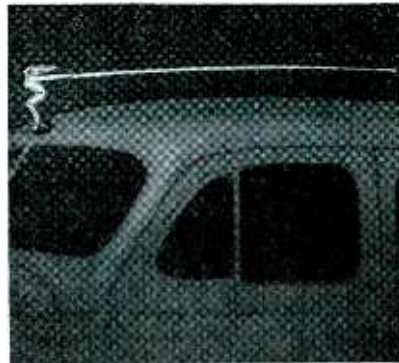

RADIART

A complete line of auto-radio aerials to suit any type of installation is ready at the plant of the Radiart Corp., Shaw Ave. at East 133rd St., Cleveland, Ohio; special attention has been given to choosing the right metal and right insulation for maximum performance

The illustrated auto-radio of the Cavalier Motor Associates, Ltd., 1028 Linden Ave., Baltimore, Md., has chromium front to harmonize with car interior; custom built controls for dash or steering column; "noise eliminating" filter system; single hole mounting



CAVALIER

All ratios are self-contained in the 1938 auto-radio control of Star Machine Mfrs. Inc., 1371 E. Bay Ave., Bronx, N. Y.; a single unit takes care of any re-installation job regardless of gear ratio or opening on dash; complete line of custom matched escutcheon plates also ready

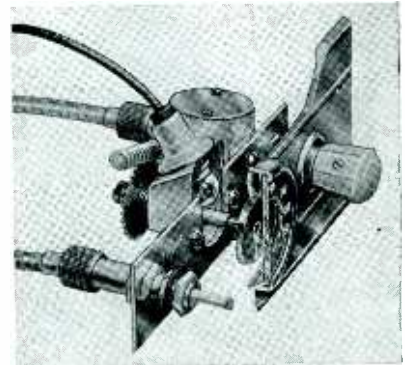

STAR

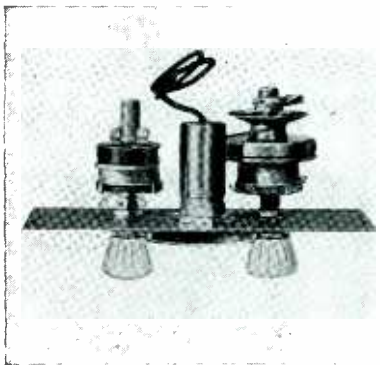

STEWART

In a good percentage of the 1938 automobiles, the control unit made by F. W. Stewart Mfg. Corp., 340 W. Huron St., Chicago, will eliminate the necessity of panel plates; unit is arranged with three independent mechanisms which may be placed in any position on the instrument panel

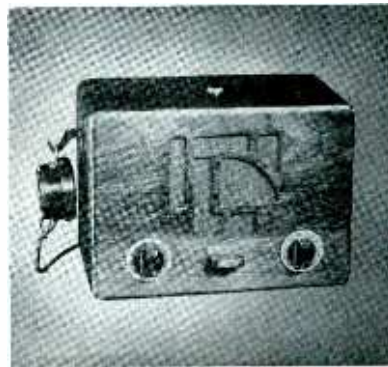

BELL

Announcement has just been made by Bell Sound Systems, Inc., Columbus, Ohio, of a new wireless intercommunicator, Model 315-C; this unit has an ear-receiver which permits incoming conversation to be confidential; when receiver is raised it automatically cuts off the loud speaker; rotary type selector switch; treadle type send-receiver switch

# MORE

ICE CUBES • *Food Capacity*  
*More* PROFIT OPPORTUNITY!

Twelve resplendent 1938 Gibsons, styled and equipped to crowd people in, priced to sell in volume, forced ahead by a national sales and advertising program with power behind it! . . . MORE ice cubes, MORE usable food capacity, MORE of everything that prospects want, MORE of what you want! . . . Get set now for your biggest year in Gibson's biggest year—1938! GIBSON ELECTRIC REFRIGERATOR CORPORATION, Greenville, Michigan. *Chicago: American Furniture Mart. Export Sales Dept.: 201 North Wells St., Chicago, U.S.A. Cable Address: Gibselco, Bentley Code.*

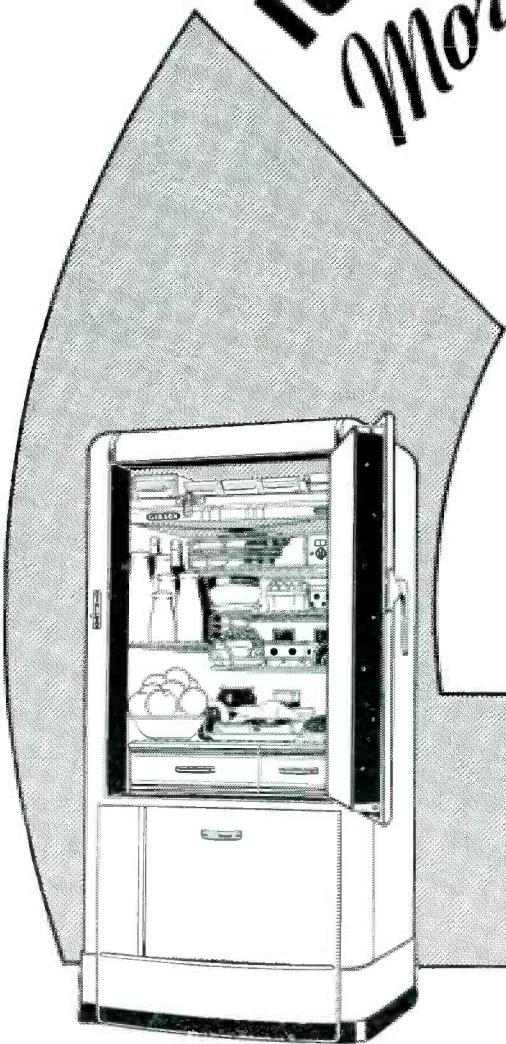

**GIBSON**  
THE FREEZ'R SHELF REFRIGERATOR

## PREVUE OF NEW RADIO MERCHANDISE



RCA-VICTOR

Three low-cost radios, including a console with electric tuning, have been introduced by RCA Mfg. Co., Camden, N. J.; leader of the line is Model 87K-1, a 7 tube console with electric tuning, Magic Eye, straight line dial and 12 in. speaker, \$89.95; Model 87T-1 replaces 87T, has Magic Eye, phonograph connection, table cabinet is of the chest type, \$49.95; Model 86T-3 (illustrated) is an upright table set listing at \$39.95.

Six station Touch-O-Matic electric motor tuning is available on this new Admiral table model at \$29.95; 6 tubes; full vision, 6 1/4 in. slide-rule dial; 6 in. speaker; American broadcast and 19, 25, 31 and 49 meter foreign, police, amateur, aviation and ship-at-sea calls; Continental Radio & Tel. Corp., 3800 Courtland St., Chicago.

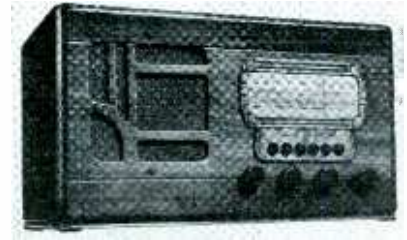

CONTINENTAL

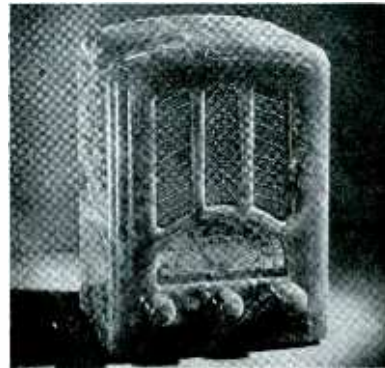

EMERSON

A moulded cabinet in natural or Brazilian onyx houses the new Model AU-190 made by Emerson Radio & Phonograph Corp., 111 Eighth Ave., New York City; 5 tubes; 540-4200 kc.; beam power tube; built-in antenna; full size dynamic speaker; avc; Gemloid dial; \$29.95

"Time Tuning" is an automatic radio tuning device which pre-selects any desired station at any pre-determined time in a 24 hour period; made by Wean Engineering Co. Inc., Warren, Ohio; a device for securing motorized push button control is also offered by this company



WEAN

A greatly improved Visasig radio telegraph recorder has been brought out by Universal Signal Appliances, 64 W. 22nd St., New York City; records words effectively at a speed up to 200 wpm; has audio-frequency band pass filter to allow recording through interference; low pass filter for weak signals when noise level is high



VISASIG



ARGUS

A miniature type 35 mm. Argus camera to list at \$25 has been placed on the market by International Research Corp., Ann Arbor, Mich.; Cintar f3.5 lens; built-in range finder; 5 1/8 x 2 3/4 in.; adaptable to all types of color work; range of 10 speeds from 1/5 second to 1/300 second including "bulb"



PRESTO

In response to the demand for an inexpensive recording turntable which would make instantaneous recordings and play them back in connection with a p.a. amplifier or radio set Presto Recording Corp., 139 W. 19th St., New York City, has placed on the market its Radic Recorder at \$98.50

# PREVUE OF NEW RADIO MERCHANDISE



HOWARD

A communication receiver with new four channel i.f. unit has been developed by Howard Radio Co., 1731 Belmont Ave., Chicago; this provides for increased band width and image ratio in the 5 and 10 meter bands, broad tuning for improved tone quality where extreme selectivity is not required, normal sharp tuning and a crystal filtered channel, all of which is controlled by one four-position selector switch

The new "H" series of ac-dc regulators brought out by Amperite Co., 561 Broadway, New York City, are equipped with the patented starting resistor which prevents overloading of pilot lights when the set is first turned on; will take care of a wide variation in the number of tubes used in a set



AMPERITE



OPERADIO

A 25-watt mobile p.a. system using beam power tubes may be obtained from Operadio Mfg. Co., St. Charles, Ill.; electronically mixes one microphone and one phonograph; includes dual diaphragm crystal mike but can also be used with velocity, velotron or high impedance dynamic mike; two 12 in. p.m. dynamic speakers



MONARCH

Model 32 all-wave ac-dc signal generator of the Monarch Mfg. Co., 3341 Belmont Ave., Chicago, is direct reading; thoroughly shielded; leakage is extremely low; full frequency coverage to 29 megacycles



CORNELL-DUBILIER

Type DH Dykanol capacitors are designed to operate efficiently under any humidity and temperature conditions; impregnated and filled with Dykanol, the non-flammable and non-explosive chlorinated-diphenol impregnating compound; light in weight and compact; Cornell Dubilier Electric Corp., South Plainfield, N. J.

Design of a sound system to list at \$50 complete with microphone, amplifier, tubes, speaker and speaker housing is announced by Vocagraph Sound Systems, 164 N. May St., Chicago, Ill.; this Model 30-05 offers extreme simplicity to allow easy temporary installation for demonstrations and rentals



VOCAGRAPH

Illustrated is a high voltage, heavy current-carrying Transmica mica dielectric transmitting capacitor engineered by Solar Mfg. Corp., 599 Broadway, New York City; exceptionally stable due to special Solar clamp construction; hermetically sealed glazed porcelain case



SOLAR

## PREVUE OF NEW RADIO MERCHANDISE



MUELLER

There are 77 pieces for only \$4 (net to dealer) in the radio Clip Kit of the Mueller Electric Co., 1583 E. 31st St., Cleveland, Ohio; contains a handy and useful assortment of clips, grounds, clamps, insulators, etc., two No. 99 snappers and a battery carrier are included



Types TX and TZ condensers for radio transmitter and high-power amplifier applications, just placed on the market by P. R. Mallory & Co. Inc., Indianapolis, Ind., are housed in compact rectangular metal cans; TZ is dual purpose unit for use in either transmitter filters or heavy duty power amplifier circuits

The 1938 line of electric plants of D. W. Onan & Sons, 43 Royalston Ave., Minneapolis, Minn., is just being shipped; there are six models—350, 400, 500, 600 watts ac and dc, also dual voltage ac-dc; small dimensions and light weight are featured; high tension magneto with radio shielding

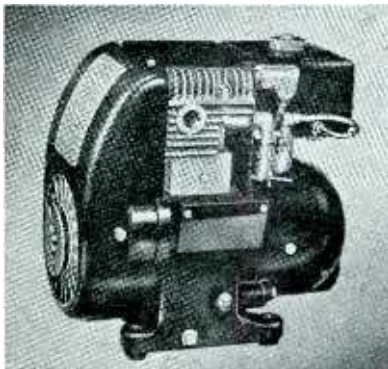

ONAN

"The smallest condenser manufactured" is the claim of the Micamold Radio Corp., 1087 Flushing Ave., Brooklyn, N. Y., for its new GL mica condenser molded in Bakelite; any capacity from 2.5 mmf. to 50 mmf. can be supplied with a minimum tolerance of plus or minus 1 mmf.

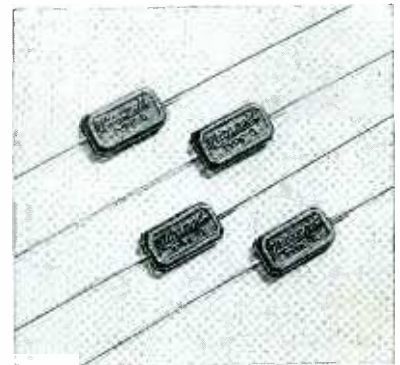

MICAMOLD

Vitrohm Plaque resistors, rated at 20, 40 and 100 watts with full ventilation, have been placed on the market by Ward Leonard Electric Co., Mt. Vernon, N. Y.; resistance wire is so arranged as to give lowest obtainable values of inductance and distributed capacitance for a power resistor; \$1.50, \$2, \$3

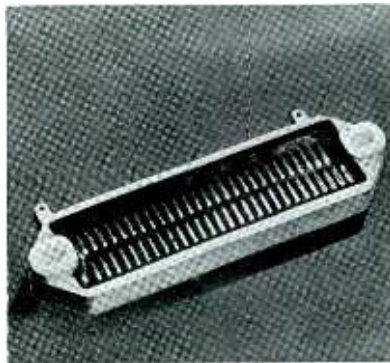

WARD LEONARD

Introduction of the Univex Minicam folding camera, carrying a list of \$3.50, is announced by Universal Camera Corp., 32 W. 23rd St., New York City; negative size of pictures is 1 1/2 x 1 1/8 in. from which 3 x 4 prints may be secured; new type Achromar precision lens, uses standard #100 Ultrachrome film



UNIVEX

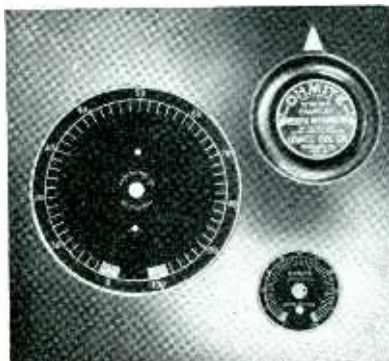

OHMITE

Specially designed dial plates are available for Ohmite vitreous enameled rheostats to provide easy and accurate setting; plates are brass and etched black; dials are calibrated numerically and read directly in percentages of resistance in the circuit; Ohmite Mfg. Co., 4835 Flournoy St., Chicago

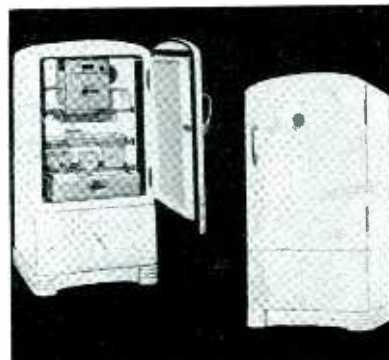

GRUNOW

Three completely new and modernly styled refrigerators to operate from natural or manufactured gas mains, or bottled gas, have just been announced by General Household Utilities Corp., 2650 N. Crawford Ave., Chicago; this system of refrigeration has been given the name "Thermene"; suggested FOB factory lists are \$169.50, \$199.50, \$219.50

# Smooth Sailing

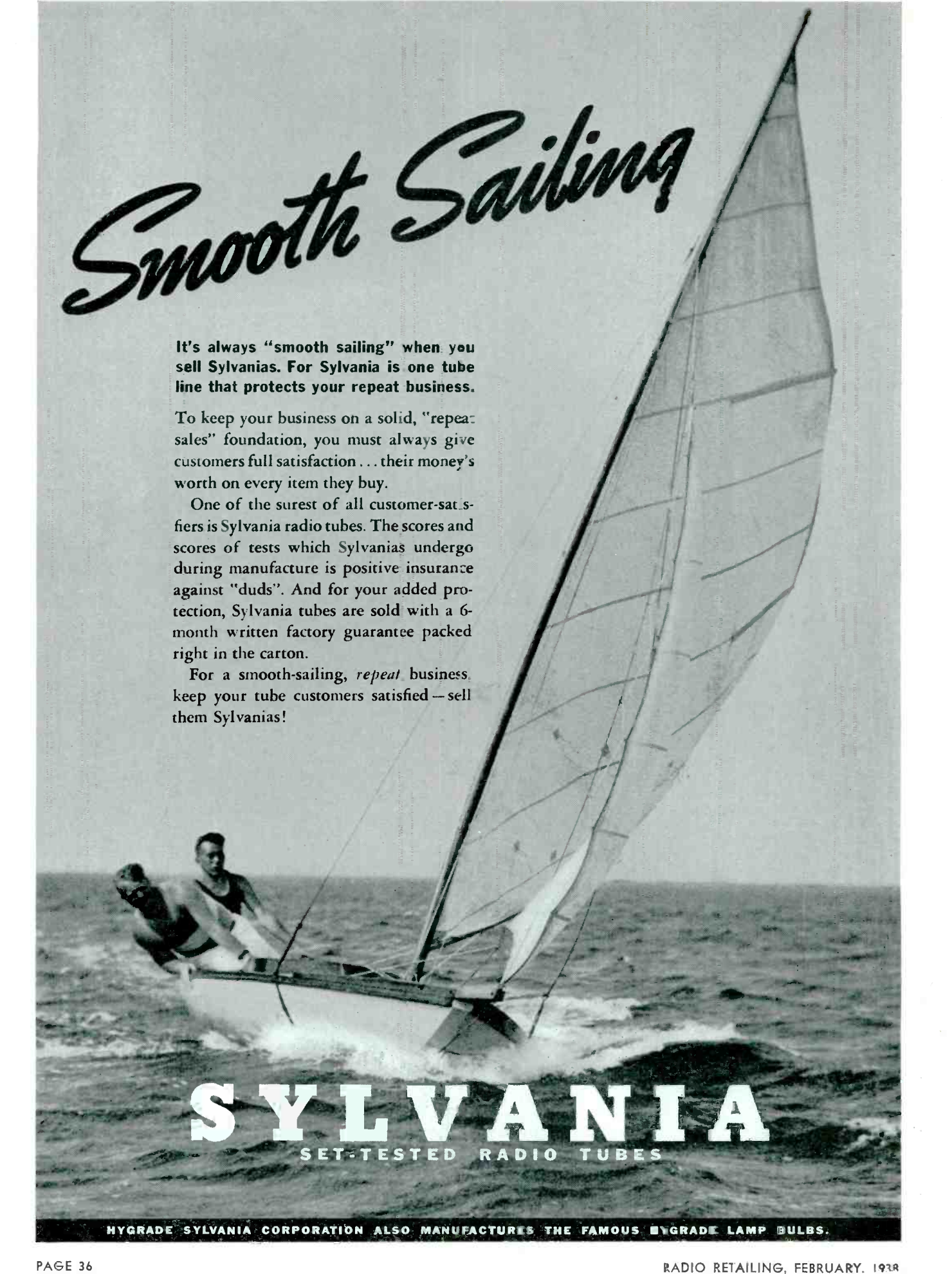

It's always "smooth sailing" when you sell Sylvania. For Sylvania is one tube line that protects your repeat business.

To keep your business on a solid, "repeat sales" foundation, you must always give customers full satisfaction . . . their money's worth on every item they buy.

One of the surest of all customer-satisfiers is Sylvania radio tubes. The scores and scores of tests which Sylvania undergoes during manufacture is positive insurance against "duds". And for your added protection, Sylvania tubes are sold with a 6-month written factory guarantee packed right in the carton.

For a smooth-sailing, *repeat* business, keep your tube customers satisfied — sell them Sylvania!

# SYLVANIA

SET-TESTED RADIO TUBES

HYGRADE SYLVANIA CORPORATION ALSO MANUFACTURES THE FAMOUS HYGRADE LAMP BULBS.

# NEWS

## RSA Now Has 19 Chapters

Membership applications from individual servicemen hit 1800-mark in 60 days

CHICAGO—From Joe Marty of the Radio Servicemen of America office comes word that as of January 1 the following local servicemen's associations have affiliated: Manchester, N. H.; Boston; Newark; Binghamton; Tri-County of Johnstown, Penna.; Cleveland; Detroit; Pontiac; Flint; Chicago; Freeport, Ill.; Interstate Chapter of Davenport, Iowa; Peoria; Duluth; St. Paul; Oklahoma City; Waco, Texas; Abilene, Texas and Dallas. Over 1800 applications from individual servicemen, in addition, have been received in the last 60 days.

Officers and board of the RSA, under the direction of T. P. Robinson of Dallas, are pushing on organization work with every means at their command. A general election is to be held shortly, at which time members of RSA will elect directors to represent them on the national board.

Individual chapters have been active. The national office, for example, is cooperating with the Peoria and Davenport Chapters to clear up interference with local broadcast stations by certain foreign stations. Petitions calling for adjustment of existing treaties are being prepared for presentation to congressman. Active in the effort are chapter officers Fred E. Degenford, F. N. Moore and F. W. Templeman.

The Radio Servicemen of New Jersey, headquarters at Newark, is working against local misbranding of sets. Newest RSA chapter, this group is piloted by Carl Rauber, Norman L. Andreatta, Albert Fasanello.

The Chicago group held a set-chassis show late in January, exhibited 15 different makes of touch-tuning radios. Just elected are: chairman, Ray Mason; vice chairman, Lew Evans; secretary, Robert Storey and treasurer, S. A. Gazinski.

Associated Radio Servicemen of Duluth, one of the first groups to affiliate, is in the midst of a membership drive likely to bring in practically all qualified men in the area within the next two months. Officers are: M. O. Endersen, Eric N. Holmlund, Edward J. Durand.

Officers have just been elected by the Cleveland group, include: L. F. Vangunten, Horace M. Ricks, Joseph Repar, Rudolph Trammell. A. J. Theriault was



**SERVICE AND SALES**—Joe Marty (left) of the Radio Servicemen of America dines with Arthur Berard of the Sales Managers Club

selected as a candidate for the national board from this district.

In Boston, a group representing the old IRSM and another group representing the RTG have consolidated, affiliated with

RSA. Officers elected are: Al Wells, Ingvar Paulsen and members Staples, Shirks and Kemmes.

Davenport holds its first annual election of officers as we go to press, reports that membership has doubled since December 10.

## Cordiner Goes Up

Made GE appliance and merchandise manager by vice president Wilson

NEW YORK—Ralph J. Cordiner has been made manager of the appliance and merchandise department of the General Electric Company. Appointed to the post by Charles E. Wilson, who until recently had this important job, later becoming executive vice president, Mr. Cordiner will be responsible for the company's radio, household appliance, specialty appliance and construction material sales.

Temporarily vacant is Cordiner's old job, that of assistant manager of the GE appliance and merchandise department.



**THREE MEN AND A BOAT**—Signing a contract for a dealer cruise to South America March 12 are (left to right) D. W. May of General Electric's New York branch, Earle Poorman, the company's appliance and merchandise sales manager, David Israels, passenger traffic manager of the Gdynia American Line, operators of the "Pilsudski"

## NAPRI Combats Noise

New association rapidly building membership. Asks no dues

NEW YORK—Rapidly building membership is the National Association for Prevention of Radio Interference, with headquarters at East Rockaway, Long Island, New York. From its president, Frank L. Carter, comes the following statement of the association's purpose:

"The purpose of this association is solely to work for improvement of radio reception throughout the entire spectrum, through elimination by law and in other ways, unreasonable, preventable and unnecessary electrical disturbances which are knowingly and wilfully created and which distort radio signals to the detriment not only of listeners' enjoyment of their radio receivers but also constitute serious menaces to efficient operation of military, police, aviation and general commercial point-to-point radio communication.

"Achievement of this purpose will be brought about chiefly through the cooperation of manufacturers and users of electrical apparatus which causes radio interference. This cooperation eventually will result in improvement of such devices so that they will no longer radiate interference.

"Inasmuch as it has only been very recently that radio interference has come to be recognized both as a public nuisance and a menace to public safety, very few communities as yet have suitable legislation providing for control of interference causing apparatus. One of the primary purposes of this association is to devise and bring about the passage and enforcement of such legislation.

"Radio interference is an international as well as a local problem, and should be governed both by local and international law.

"Associate membership in this association entails no responsibility upon the member for the actions of the association or its financial obligations; *there are no dues or other expenses devolving upon the member.* In becoming an associate member your only obligation is your pledge to support suitable local and international legislation for control of interference and where possible to use only such electrical equipment as has been so designed and constructed that it will not cause radio interference."

Membership application blanks read, simply: "National Association for Prevention of Radio Interference, East Rockaway, Long Island, N. Y.: Dear Sirs: Please enroll me as an associate member of the NAPRI. I agree to do all in my power to further the purpose of the association in securing passage of adequate legislation for control of preventable radio interference. I also agree that wherever possible I will avoid the use of any electrical apparatus which causes such interference."

Among members of the association's advisory council is W. MacDonald, managing editor of *Radio Retailing*.

## AT CHICAGO'S MART



**NEW HONOR**—W. Neal Gallagher of Automatic, just elected president of the American Washing Machine Manufacturers's Association



**FRIENDLY ENEMIES**—A. M. Sweeney of G.E.'s domestic refrigeration division and "Rock" Smith, rival from Hotpoint



**24-HOUR DAY**—That's what R. G. Warner put in at the Stevens Hotel show for Horton

## Kennedy To WHAM

ROCHESTER—J. W. Kennedy, Jr., for some time sales promotion manager for Stromberg-Carlson, assumed the duties of commercial sales manager at Stromberg-owned and operated radio station WHAM January 24. Offices in the Sagamore Hotel.

## Washermen Elect Officers

Gallagher of Automatic heads AWMMA

CHICAGO—W. Neal Gallagher, favorite son of What Cheer, Iowa, became president of the American Washing Machine Manufacturers Association at the January election. Gallagher is chief executive of the Automatic Washer Company, Newton, Ia.

Going into office with Neal Gallagher were R. D. Hunt of Dexter, R. C. Stuart of Barlow & Seeliger, and I. N. Merritt of Meadows. Treasurer is W. H. Voss, assisted by Walter K. Voss. Executive committee consists of A. H. Labisky of Barton, L. L. Shawber of Westinghouse, J. M. Wicht of G. E., G. M. Umbreit of Maytag and L. C. Upton of 1900. Advisory board is J. C. Nelson of Easy, E. N. Hurley Jr. and C. G. Frantz of Apex.

Chief fly in the ointment at the present time, Neal Gallagher told *Radio Retailing*, is the fact that the refrigerator set-up has spoiled distributors for washers. Longer profit margins permit distributors to take care of washer service, which is not the case with refrigerators, and the habit of throwing it back to manufacturers is unfair, in his opinion.

## New Tops For Reps

Saftler, Bittan and Sonkin pilot group this year

NEW YORK—The Representatives, active group of men representing radio parts manufacturers, has just elected Perry Saftler president, Dan R. Bittan vice-president and David Sonkin secretary-treasurer.

New board of governors includes Jack B. Price, chairman, Dan R. Bittan, David Sonkin, Adolph Friedman, Martin Camber. The membership committee for 1938 consists of John Forshay, chairman, Adolph Friedman, Julius Kaelber, Perch Mack and Irving Golden. Entertainment committee-men are Martin Camber, chairman, John Koepple, Marvin Royce, Jack Scharf. And the publicity committee is made up of Dan R. Bittan, chairman, Leo Freed and Sam Egert.

## New Duties For Deacon

CAMDEN—Eugene N. Deacon, formerly manager of the RCA radio tube and parts division, took up new duties covering market research and analysis late in January, now reports to the president, vice-president and general manager.

The six departments of the division heretofore headed by Deacon are now under the direct supervision of Vance Woodcox, vice-president in charge of package goods sales. Department managers are as follows: J. T. Bray, export sales; Meade Brunet, equipment tube sales; J. A. Milling, radio parts sales; D. Y. Smith, power tube sales; L. W. Tegarden, renewal tube sales; L. S. Thees, tube parts and machinery.





**EAT CAKE AND HAVE IT TOO**—This was the theme song of Galvin's January 6 Chicago shindig introducing new Motorola auto-radios, hence the bibs and bonnets. Four hundred distributors and their salesmen attended. President P. V. Galvin (at mike) received a silver plaque from appreciative distributors while Frank Kearns of Atlantic City, Maurice Horowitch of Birmingham and J. E. Galvin (sans bonnet) looked on. The whiskered four are: Galvinmen Walter H. Stellner, C. T. McKelvy, Victor A. Irvine and E. H. Wavering

### Car Set Experts To Detroit

PHILADELPHIA—To the city of Detroit, where a close eye may be kept on car development, went Philco's automobile radio engineering laboratories late last month. The move, according to company officials, is a natural one of benefit to both set and car designers, and will be permanent.

### Tolles To Coast

SAN FRANCISCO—R. P. Tolles, former assistant manager of the eastern division of the National Carbon Company, Inc., has been sent here as manager of the Pacific Coast division. C. O. Kleinsmith, former sales manager of the Atlanta district, takes his place in New York.

### "Cylo-Meter"

NEW YORK—Pratt Mirror Glass Radios, 665 Fifth Avenue, distributor of the Penwood line of "jump numeral" electric clocks in the metropolitan area, has obtained the exclusive right to incorporate the Penwood movement within a radio receiver. Pratt is working on a three-tube t.r.f. receiver incorporating the Penwood clock movement to be named "Pratt Radio Cylo-Meter", will build up a stock of 1500 models before offering it to the trade.

### Another Pilot Award

NEW YORK—Jack Haley's Log Cabin program was awarded the first Pilot Radio award of merit for 1938. Alvin Austin flew to Hollywood to make the presentation.

## Score Industrial Discounts

Northwest dealers follow Milwaukee's lead, contact big plants and wholesalers

MINNEAPOLIS—Closely following the lead of the Wisconsin Radio, Refrigeration and Appliance Association, (RR16Jan) fifteen of the leading trade associations with headquarters in this city have started an intensive mail campaign to induce industrial firms to stop employees from buying home appliances and equipment at a discount by using purchasing department order blanks.

Actively supporting this campaign is the Northwest Radio, Refrigeration and Appliance Association, which informs *Radio Retailing* that five hundred industrial firms have been sent a series of letters on the subject. Over 100 have already replied, 80 endorsing the project without reservations, 20 approving but not wholly.

In addition to the letters mailed industrial firms large cards stating clearly that the firm sold only to established retail dealers were mailed to all wholesale firms in the city.

## \$1,000,000 Gamble

Bendix to spend large part of 1938 promotion money in first four months, dominating newspapers, magazines, while others play cards close

NEW YORK—Declaring that Bendix Home Appliances, Inc., is treating the current business recession as a real opportunity, Judson S. Sayre, vice-president in charge of sales, has announced a new advertising and merchandising plan even more aggressive and thorough than that used to introduce the Bendix home laundry last fall.

Bendix Home Appliances has appropriated a million dollars for advertising and sales promotion in 1938, will spend a large part of this sum in the first four months of the year.

Said Mr. Sayre, commenting on the new appropriation: "We expect advertising pages in national magazines to be thin from now until next fall. We will use double spreads in color and full pages in six of the leading magazines beginning with February. Our ads will have little competition from other manufacturers for the reader's attention, and therefore we believe we will receive more than our money's worth."

### Sears Prices Down

CHICAGO—An average drop of 9.36 per cent in price on the models listed in the general fall and winter catalog of Sears, Roebuck & Company is revealed in a sales flyer now being circulated. This is on eleven electric and battery sets.

## "Welcome" On The Mat

Stewart-Warner execs given keys to city following Marmon plant acquisition. Celebrate 25th anniversary

INDIANAPOLIS—Stewart-Warner executives were tendered a testimonial dinner late in December following acquisition of the Marmon plant here, a move that jacks employment up 2,000, adds \$3,000,000 to the annual payroll. Nicely dovetailing was the company's 25th anniversary.

Presiding was George S. Olive, president of the Indianapolis Chamber of Commerce, his audience the Stewart-Warner execs plus nearly 500 leading business and professional men of the city and state, together with prominent state, county and city government officials.

Principle speakers at the event were the Honorable M. Clifford Townsend, Governor of Indiana, J. S. Knowlson, chairman of the Stewart-Warner board. Horace Heidt and his "Brigadiers" entertained. And, the following morning, Stewart-Warner officials went on a tour of the new properties.

Published by the *Indianapolis Star* was a special Stewart-Warner newspaper edition.

## New Car Radios Safer

Crosley calls push-button tuning greatest advance since original automobile set design

CINCINNATI—"What we believe is the greatest contribution in auto radios is the development of safety tuning," Powell Crosley III, vice-president in charge of Crosley Radio Corporation's radio division, said late in January when interviewed concerning opportunities for trade sales of car sets.

Continued Mr. Crosley: "We believe this new feature will obsolete all automobile radios that are not so tuned. There are more than 22 million automobiles registered in the United States and, of these, only about 6,000,000 are equipped with radio of any kind. This makes the potential market of new users 16,000,000, not counting further sales of new and used cars and the obsolescence of sets now in use. It is the greatest opportunity for the dealer since car radios were first introduced."

## Catalog No. 1.

SAN ANTONIO—John Ventura of Olsen Radio Supply reports that this company will be out on February 1 with the first radio part, supply and equipment catalog it has ever published, says it was compiled by United Catalog Publishers, Inc.

## C.I.T.

ALBANY, GA.—The C.I.T. Corporation opened an office here January 26 in the Whitehead Building. Harold L. Dorsey is in charge.



**BEFORE**—Standing, waiting for someone to make the first break for knife and fork at Stewart-Warner's 25th anniversary banquet tendered by the Indianapolis Chamber of Commerce: J. E. Otis, Jr., president; J. S. Knowlson, board chairman; F. E. Shortemeier, H. F. Schricker, Indiana's Lieutenant Governor and T. T. Sullivan, company treasurer

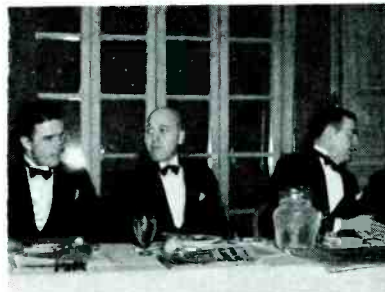

**DURING**—New Indianapolis works manager D. W. Alexander, plying eating utensils and tongue with H. T. Pritchard, president of Indianapolis Power and F. R. Cross, Stewart-Warner adman

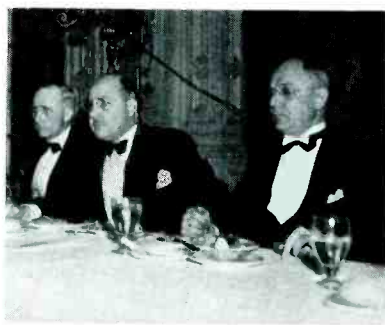

**AFTER**—Listening with obvious intensity to an address after the dessert is refrigeration sales manager J. F. Ditzell, flanked by chamber of commerce

## GE Personnel Changes

NEW YORK—R. V. MacDonald, district appliance sales manager for the General Electric Company in St. Louis since 1933, has been transferred to Dallas in a similar capacity, is succeeded by B. C. Bowe, formerly district manager of St. Louis radio sales. F. W. Wheeler relinquishes his post in Dallas to assume other duties with the appliance sales organization.

## Big Range Drive Breaks

Up-and-coming appliance to be nationally advertised for first time by Modern Kitchen Bureau. Twelve manufacturers give support.

NEW YORK—The Modern Kitchen Bureau, sponsored by the National Electric Manufacturers Association and the Edison Electric Institute, plans its first national advertising program in the interests of electric range sales. A six-point promotional schedule includes:

1. An aggressive copy campaign using color pages in leading women's magazines reaching over 13 million homes.
2. A national electric range "Spring Showing" April 11 to 30, sponsored locally by utilities and dealers.
3. A special, four-page newspaper section, supplied to local papers, carrying feature stories about electric ranges by leading authorities, distributors and dealers.
4. Newspaper advertising mat service to tie in with the national job.
5. A nationwide window display competition, with \$1,200 in cash awards for utilities, dealers and department stores.
6. A variety of sales helps, including cook books, radio spot announcements, placards and window display material.

Manufacturers closely supporting the activity include: Borg-Warner's Norge Division, Edison G. E. Appliance, Electromaster, Estate, General Electric, General Motors Sales, A. J. Lindemann & Hoverson, Malleable Iron, Nash-Kelvinator, Roberts & Mander, Walker & Pratt and Westinghouse Electric.

## Emerson \$9.95

NEW YORK—Interviewed here concerning plans to market a new model at \$9.95 list, Ben Abrams, president of Emerson Radio & Phonograph Corporation, made the following statement:

"As our offering to help speed business out of the doldrums, to promote the distribution of millions of dollars, and provide additional employment for thousands throughout the nation, we have embarked a new plan providing for the production of a new compact radio to be sold at the lowest price in Emerson history."

One of the first ads to appear in the newspapers on the new model was a four-color job in the "Philadelphia Inquirer", January 9, by Stern & Co. The ad included a coupon, aimed at mail-order as well as store business.

## Leahy Wins

CHICAGO—Awarded here late in January was Philco's sales managers' cup for the second half of 1937.

Jack Leahy of the concern's Central division copped it, with Ed Shepherd, manager of the Northwest division placing second, Cliff Bettinger of the Pacific coast division placing third and Peter Kain of the Atlantic division fourth.

lease of new records you will receive advance notices from the wholesalers. Check the new discs with your annotated list of customers; whenever you find a purchase that would indicate an interest in a new recording, call the customer on the 'phone. He will appreciate the advance dope. If you can't reach him by 'phone (or it seems advisable not to try) write a letter. Besides telling him of music in which you know he is especially interested run over the other releases on the list. Proper telephone technique and the personal touch to the sales letter will impress the customer with your type of service, leading inevitably to sales. Results from these calls and letters are tremendously helpful in your own buying.

Getting new customers and new names for your mailing list can be accomplished by intelligent, timely advertising. A small amount of space will go a long way if it is properly planned and timed. If the record company whose product you sell advertises in a local paper, tie in with a small ad on the same page. You can get preferred position immediately under the large ad if you consult your

wholesaler and the paper's space salesman. The former, incidentally, will cooperate with you and share some percentage of the cost of your advertising whenever you restrict it exclusively to his product.

Many newspapers and most college publications now carry regular record reviews along with other columns devoted to entertainment. A small well-designed ad proclaiming, "All discs reviewed in *The News* can be heard at 'The Disc Shop', etc.," alongside one of these columns commands more attention than a larger ad placed elsewhere. Always key your ads by indicating "record catalogues free upon request."

You can also tie in with theatre ads and moving picture publicity. For example, *Snow White and the Seven Dwarfs* plays at your local theatre, hence your ad on the entertainment page tells the public that you have records of the song hits exactly as produced in this amazingly popular film. Use the programs of local music events. Make your copy conform to the musical fare foremost in the public mind at the time and place you advertise. Toscanini's records should be

advertised Saturday (the day of his broadcasts) on the radio page with emphasis on "Toscanini plays tonight—*Every night.*"

The smaller radio stations broadcast a lot of recorded music. Contact the advertising manager of your local 500 or 1000-watt station and see what can be done in the way of a program advertising your record department and service. Every announcement should include a line that "Record bulletins—*together with interesting facts and stories about music and musicians*—will be sent free upon request." Names to add to your mailing list and to work on.

Make window displays timely and interesting. Some of the companies supply attractive material free. Your local theatre and concert managers will be glad to cooperate with "stills" and posters featuring musical pictures and local appearances of concert artists. Use a record player in the window, showing how simply it can be attached, making a phonograph out of any radio.

Get busy on that mailing list. It's the secret to successful repeat business.

**COMPLETE ELECTRIC PLANTS**

**NEW 1938 MODELS**



**OPERATE A.C. RADIO, PUBLIC ADDRESS, SOUND CAR, MOTION PICTURE EQUIPMENT AND RADIO TRANSMITTERS.**

Also furnish power for Lights, Water Systems, all Household Appliances, for Camps, Farms, Lake Homes, or Standby Service. For use anywhere power is not available.

350 to 5000 Watts

110 volt A.C., 6, 12, 32 and 110 volt D.C., and Combination AC-DC Units. Anyone can Operate. Complete, ready to run.

Write for Details and Territory  
**D. W. ONAN & SONS**  
437 Royalston Ave. Minneapolis, Minn.

**BOOST PROFITS WITH WARD AUTO AERIALS!**

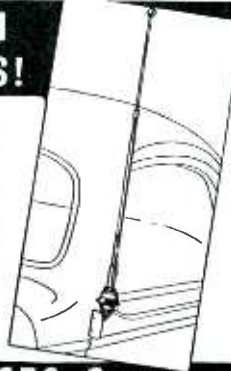

WARD aerials are easy to sell, easy to install. There are models at prices to suit every prospect. And WARD backs up this fast-selling "all-star" line with a complete set of dealer helps — furnishing everything you need to cash in.

**FREE!** See what's new in car and home aerials for 1938. Write today for free catalog

**The WARD PRODUCTS Corp.**  
WARD BUILDING CLEVELAND, OHIO

**DIFFERENT**

**CHIEFTAN**



The new revolutionary self-starting, electrical numeral clock

Retailing for **\$4.95** Complete with cord and connector

**THE FIRST REVOLUTIONARY CHANGE IN TIME TELLING IN 50 YEARS!**

*Sensationally different from the dial faced clock.*

**TELLS TIME AT A GLANCE**

**THE CLOCK INDUSTRY'S NEWEST AND GREATEST STIMULANT**

*Opens up new avenues of merchandising and profit.*

**IT'S NEW! IT'S A HIT!**

Cash in Now • Go Pennwood

**ACT AT ONCE. ASK FOR CATALOG CONTAINING OTHER MODELS AND FULL DETAILS SEE YOUR JOBBER OR WRITE DIRECT TO**

**THE PENNWOOD CO.—Pioneers of Numeral Clocks**  
Dept. R, 7525 KENSINGTON ST., PITTSBURGH, PA.  
West Coast Sales Office: E. R. TREIBER, 470 Daniels Drive, Beverly Hills, Calif.

## Grunow In Gas

Springs "Thermene" system of refrigeration at distributor convention

CHICAGO—What the "Thermene" system of refrigeration is, and what the plans of General Household Utilities Company are for 1938, were outlined to a convention of 150 distributors held in the Hotel Sherman, January 25 and 26. Announced and exhibited were three home refrigerator models designed to operate from natural or manufactured gas mains, or bottled gas.

Speaking before the assembled distributors, President Harry Alter pointed out the competitive advantages of the product in the market. Chairman of the board W. C. Grunow paid tribute to the engineering staff which has produced this new product. Dr. J. D. Jordan, research engineer, told how the adsorptive power of "activated" carbon was used to pull carrene out of the new evaporator and secure refrigeration. M. W. Thompson, advertising manager, outlined the company's promotion and advertising plans.

Concluding the program was J. J. Davin, sales promotion manager, armed with an imposing sheaf of figures proving that for this year at least Grunow distributors could find markets for all the refrigerators the company could make right in their first and secondary trading areas.

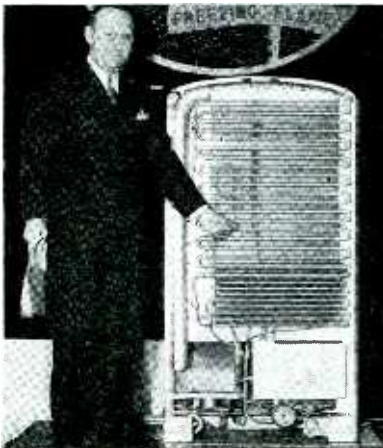
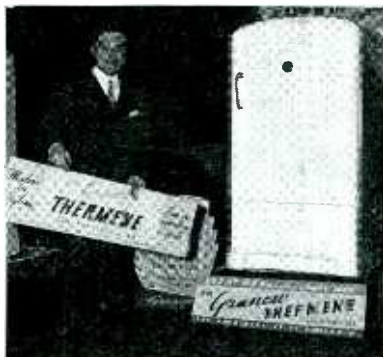

GRUNOW BIG FOUR—W. C. (Bill) Grunow, chairman of the board; Harry Alter, president; M. W. (Tommy) Thompson, advertising manager and J. J. (Jimmy) Davin, sales promotion manager

## Thordarson Boosts Three

Hires fourth for replacement transformer division

CHICAGO—From general sales manager Charles P. Cushway of Thordarson Electric Mfg. Co. comes word of three personnel advancements, hiring of a new man.

Roy E. Davy, formerly chief sales engineer, is advanced to the newly created position of industrial sales engineer. Jerome H. Kleker becomes chief sales engineer, continues his duties in the sound division as well. Doug Fortune, W9UVC in amateur circles, is promoted from the engineering staff to the sales engineering department, in charge of ham equipment activities.

Leland S. Hicks has been hired as sales engineer, replacement transformer division.

**TEST EQUIPMENT**—A new bulletin describing its multi-range test equipment of high flexibility for industry, school and laboratory is ready for distribution by the *Weston Electrical Instrument Corp.*, Newark, N. J.

**BATTERIES**—The "ABC of Radio Battery Life" is the title of a valuable booklet prepared to provide complete information on the subject of radio batteries. Generously illustrated. *National Carbon Co., Inc.*, 30 E. 42nd St., New York.

## Once There Were Two Frogs...

Tommy Thompson of Arvin tells an amusing story with a moral

COLUMBUS, IND.—To Tommy Thompson of Noblitt-Sparks Industries goes the palm-of-the-month for unearthing a story with a moral applicable to the radio business. Tommy's using it in a new Arvin promotional booklet. The story goes like this:

"Once upon a time, so the old fable goes, two adventurous frogs fell into a jar of sour cream. One frog gulped, 'I can't swim in anything but water. What's the use of trying.' He sank to the bottom without a struggle. The other one said, 'Gosh almighty, I got to put on steam and get out of this,' and he did. He swam and kicked so darn hard and fast that he soon had the sour cream churned into butter. And there he sat high and dry—on top of everything, including his die-easy brother!"

Tommy goes on to show how the auto-radio market is getting bigger and bigger, how many sales the car dealers themselves are missing and so leaving wide-open for independent radio dealers, how radiomen may tie up with auto-showrooms and service stations, winding up with the reasons why he thinks Arvin is the line to do the job.

## Says Servicemen Lack Tools

BROOKLYN, N. Y.—A survey of dealers and servicemen installing and repairing automobile radios, made by J. Finkel, president of the J. F. D. Manufacturing Company, maker of the "Remote-O-Cable Replacer," indicates that many lack the proper tools for handling flexible shafting.

Says Mr. Finkel: "Our close contact with jobbers, dealers and servicemen has convinced us that thousands of these organizations lack the proper equipment for efficient and economical installation and repair work. Proper tools are, to my mind, of paramount importance to men who expect to make money in this field as repeat business requires that neat, substantial jobs be done in rapid time."

**AUTO RADIO CATALOG**—An attractive black and red 16-page brochure has been made up by Noblitt Sparks, Industries, Inc., Columbus, Ind., on the new Arvin auto sets. Each model is completely described and illustrated; the advantages of the Phantom Filter are clearly stated and all matching panel controls and aerials are shown. In addition a Sales Guide Chart showing tailor-fit controls and speakers to order for all cars is supplied and the many sales helps supplied by Arvin, including its "Budget Selling System", are listed.

**TUBE CHARACTERISTICS**—A revised edition of the popular *Sylvania* tube characteristics sheet may be obtained upon request to jobbers of *Sylvania* tubes.



Originators and Manufacturers of the famous  
**KADETTE**  
RADIO

Original  
AC-DC  
Compact

Complete line of compact, console, chairside and plastic models. Get in touch with your distributor today or write or wire us for full information.

**INTERNATIONAL RADIO CORPORATION**  
568 Williams St. Ann Arbor, Mich.

**A GOOD NAME GOES A LONG WAY**



The name, Ken-Rad, stands for quality manufacture and perfect performance. Stock Ken-Rad Tubes for increased business.

Ken-Rad Tube & Lamp Corp.  
Owensboro, Ky.

**KEN-RAD**  
DEPENDABLE RADIO TUBES

**PUR-A-TONE**

TRADE MARK  
**ANTENNA SYSTEMS**

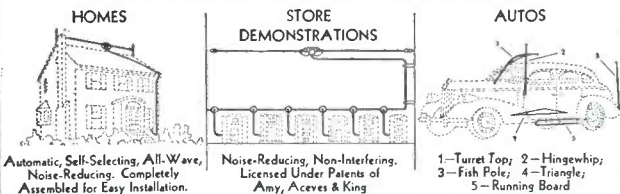

World's Largest Manufacturers of Antenna Systems  
**L. S. BRACH MFG. CORP.** Newark, N. J.

**Janette Rotary Converters**



The original D.C. to A.C. converters with all wave filters developed exclusively for radio and sound apparatus.

CAPACITIES: 35 to 3250 watts. 6, 12, 32, 115 and 230 volts D.C. to 110 or 220 volts, 1 phase, 60 cycle A.C.

Insist on a Janette  
Ask For Bulletin No. 13-25

**Janette Manufacturing Company**  
556-558 West Monroe Street Chicago, Ill., U.S.A.  
BOSTON - NEW YORK - PHILADELPHIA - CLEVELAND - MILWAUKEE - LOS ANGELES  
DETROIT - SEATTLE

*A Sensation at the Show*  
**THE HORTON Economizer**

**SAVES** SOAP . . . 50% UP TO 90%  
FABRICS . 30% TO 50% LONGER LIFE  
TIME . . . UP TO 1/2 ON WASHING DAY

● A smash hit . . . at the National House Furnishings Show in Chicago. This amazing water refiner provides perfectly conditioned water for home laundering. Filters out dirt . . . extracts "hardening" minerals common to all natural waters . . . eliminates non-rinsable scum . . . saves soap, fabrics and time. Engineered especially for Horton Washers. Operates at faucet speed. Highly refined water cannot injure finest fabric or most delicate skin. Gives Horton Washer owner delight and economy of perfect home laundering.

The Economizer—*exclusively Horton*—retails for only \$15.00—puts a big new profit into washer sales. Get the whole story now, while it's hottest. Write

**HORTON MANUFACTURING COMPANY**  
206 Osage St., Fort Wayne, Ind.

TAKE UP THE  
INDUSTRY'S NEW SLOGAN—

A "SIGN-OFF" FOR  
CONVERSATIONS  
AND LETTERS

THE  
BIG ANNUAL  
HOMECOMING  
FOR ALL

**"SEE YOU AT THE TRADE SHOW!"**

SERVICEMEN • AMATEURS • ENGINEERS • DEALERS •  
JOBBERS • REPRESENTATIVES • MANUFACTURERS

YOU ARE INVITED TO

**RADIO PARTS CITY**

STEVENS HOTEL—CHICAGO

HOME OF THE

NATIONAL RADIO PARTS TRADE SHOW

WHERE RADIO'S LATEST APPARATUS WILL BE DISPLAYED

**JUNE 8-9-10-11, 1938**

SEE  
YOU  
AT  
THE  
TRADE  
SHOW

THE ONLY TRADE SHOW IN 1938  
SPONSORED BY RADIO MANUFACTURERS ASSN  
AND SALES MANAGERS CLUB

FOR PARTICULARS WRITE  
RADIO PARTS MANUFACTURERS NATIONAL TRADE SHOW  
53 WEST JACKSON BOULEVARD CHICAGO, ILLINOIS

# 5-POINT PROGRAM for PHILCO DEALERS

W  
I  
T  
H

## CROWE CUSTOM STYLED PANEL CONTROLS

FOR 1938--PHILCO Distributors are *again* provided with a special Crowe Program. Its purpose is to help you increase your Auto Radio sales.

Crowe's Five - Point Program speeds up sales and increases profits with Crowe ON-THE-PANEL Kits--at no extra cost!

Special features for Crowe 1938 On-the-Panel Kits include:

- Exact Custom Styling
- Official Philco Specifications
- New No-Glare Dials
- Improved Anti-Backlash Designs
- Adaptable to Any Car
- Quickly Installed—Easily Moved

Ask for  
Crowe Bulletin 205

### PARTS JOBBERS!

Enlarge your market! Increase your sales! Radio Dealers — New - Car Dealers — Used-Car Dealers — ALL need Crowe On-the-Panel Controls —for modernizing or changing old radios from car to car.

Ask for Bulletin No. 206.

**CROWE NAME PLATE & MFG. CO.**  
1745 Grace Street  
CHICAGO, ILL.



**KING APPOINTS WILSON**—To the newly created position of public address, sound and amplifier trade division sales manager goes *Howard A. Wilson*, appointed by Larry King, general sales manager of the Operadio Manufacturing Company. Wilson has been with the company several years as division manager calling on jobbers and dealers in the eastern and southern territories. His new job, created because of the rapid growth of this portion of the business, puts him in active charge of all sales to jobbers and dealers in the United States and Canada.

## K. C. Drive Sells 598 Sets

Campaign in dull last quarter boosts average sale to \$89.

KANSAS CITY, MO.—Figures are in on the results of the Electric and Radio Association of Kansas City's five-week (October–November) drive to increase the sale of new and better sets, stimulate listening to boost repair business.

Cooperating were the local utility (K. C. Power & Light), seven set distributors and dealers. From association secretary-manager G. W. Weston comes word that 63 salesmen, working for 23 dealers, reported the sale of 598 radios having a retail value of \$51,576. Sales averaged \$89, despite the fact that all business suffered due to general conditions in the last quarter in which the campaign ran.

Promotion included delivery of a broad-side by messengers to 80,000 homes, a competition involving distribution of 40 radios, a 14-point, \$2.50 checkup for 99¢, 20 radios as awards for salesmen.

## Business About Booths

CHICAGO—It is already apparent that the 1938 National Radio Parts Trade Show to be held at the Stevens Hotel, June 8-11, will surpass its predecessors. A total of 108 booths have been contracted for to date, as compared with 79 this far in advance of the actual show date last year. Total in 1937 was 143, leaving only 35 to go with four months to sell them in.

*Telling the engineer and manufacturer what is being done with electron tubes in industry—and how it is being done*

*Just published — New second edition*

## Electron Tubes in Industry

by KEITH HENNEY, Editor, *Electronics*  
539 pages, 6 x 9, 397 illustrations, \$5.00

ENGINEERS and manufacturing executives interested in cheapening or quickening industrial processes will find in this book a thorough presentation of the practical aspects of electronics —what the electron tube is doing toward making processes simpler, cheaper, safer, and in making possible new methods of control. Describes in detail amplifier, rectifier, and other tubes and photocells and their applications in industry, including circuit diagrams, performance charts, and comparisons with other types of apparatus.

*See this edition for developments in:*

- circuits using newer tubes, elements and principles
- motor control, welding, illumination, and register control
- ignition tubes, cathode-ray tubes, and other types
- capacity relays, relay circuits.
- application of tubes to power conversion, inversion, and transmission
- invisible light control methods, etc.

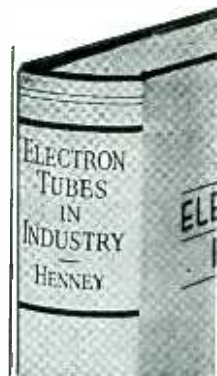

SEND THIS ON-APPROVAL EXAMINATION COUPON

McGRAW-HILL BOOK COMPANY, INC.  
330 West 42d Street, New York, N. Y.

Send me Henney's *Electron Tubes in Industry* for 10 days' examination, on approval. In 10 days I agree to pay \$5.00 plus a few cents postage and delivery, or return book postpaid. (We pay postage on orders accompanied by remittance.)

Name .....

Address .....

City and State .....

Position .....

Company .....

(Books sent on approval in U. S. and Canada only.)

FRR-2-38

# TECHNICAL TOPICS

SERVICE • SOUND • CIRCUITS • INSTALLATION • PARTS



**WATERPROOF STREAMLINERS**—Lead-in wire under windshield raises rubber gasket, lets water drip inside. Fill openings each side of wire with flexible celluloid cement.



**WHIP NECESSITY**—With door slightly ajar drill hole in body channel to lead in whip-type antenna; otherwise channel construction cuts wire insulation.



**GROUND SHIELDING**—Short ground leads essential on undercar systems. Shield connection (center) grounds on running-board two inches from antenna. Taped connection (left) grounds shield to car frame.



**FISHPOLE LINE**—Use low capacity 7 mm. cable for rear bumper fishpoles. Ground shield to car frame every few feet to insure freedom from noise.

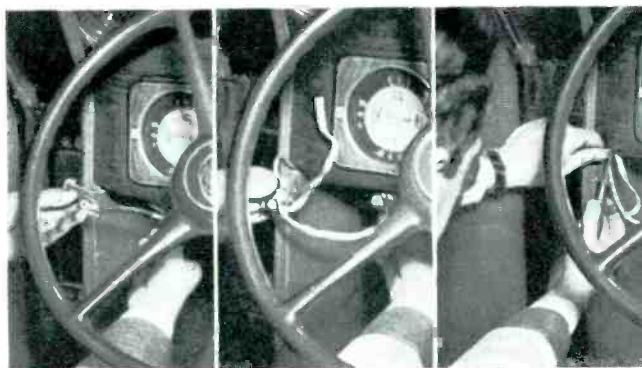

**CONNECTING TO SET**—Most antenna connectors corrode quickly, become noisy. Remove connector, splice set lead to lead-in, solder, tape well. Solder shield loom over splice. Ground shield pigtail under dash.

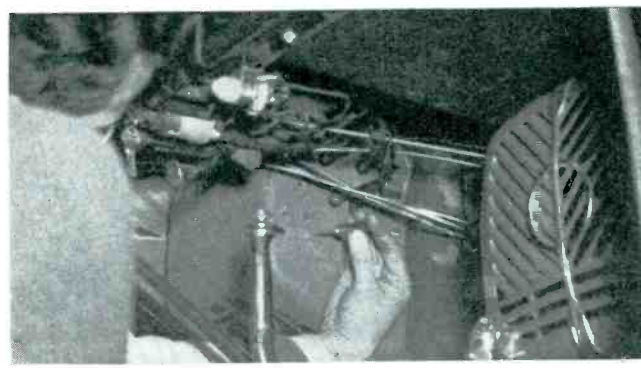

**FINAL TOUCH**—Trim r.f. stage to compensate for antenna loading. Most manufacturers suggest adjustment at high end of band. Check set specifications for correct aligning frequency.

• I N S T A L L I N G   A U T O   A N T E N N A S   •

# CIRCUITS

## Push-Button Converter

An improved version of remote push-button tuning is shown in the accompanying schematic by Howard. The unit is self powered from the 110 volt line, requires no circuit changes in the set; the necessary set connections are made at the antenna and ground terminals.

The circuit is essentially a superhet converter similar to those used on short waves in the past. It may be used on any t.r.f. or superhet receiver. When used with a t.r.f. receiver it theoretically converts it to a super. A standard superhet would become a double super by virtue of the converter action.

Signals arriving at the antenna are transferred to the tuned secondary coil. Tuning of this circuit is accomplished by the usual capacity trimmer method. The control grid of the 6A7 then receives the signal. Likewise, the oscillator coil  $L_1$  is tuned by an additional set of trimmers gauged to the push-button switch contacts. The 6A7 then operates as a standard superhet converter, with one exception. The i.f. frequency generated by the 6A7 falls somewhere in the broadcast band so that it may be tuned in on the receiver.

The two brown and black leads to the right of the diagram go to the antenna and ground connections, respectively. The i.f. signal generated in the converter passes along these leads and into the set. It is then necessary to tune the set to the frequency of this signal. By adjusting the trimmers controlled by each push-button to the stations desired the system is complete. It may then be tuned to any of the 8 pre-selected stations provided the set remains tuned to the frequency generated by the converter.

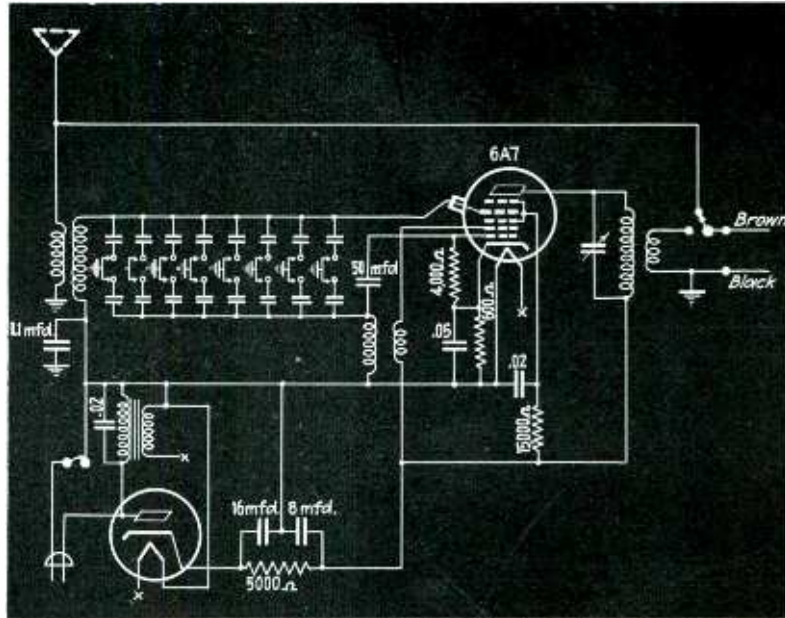

dropping resistor. This is wound with ordinary resistance wire. The 50 ohm section which shunts across the pilot lights is of pure nickel which has a temperature coefficient of .006. At the operating temperature, this shunt increases its value to about 115 ohms. Thus when the set is turned on, this 50 ohm shunt prevents excessive voltage drop through the pilot lights. As the set reaches operating temperature, the shunt resistance has sufficiently increased to bring the pilot lights up to full brilliancy.

circuit.  $E_a$  is equivalent to the induced signal voltage in the antenna;  $C_a$  is the antenna capacity;  $R_a$  the series resistance of the wiring and antenna;  $R_1$  is

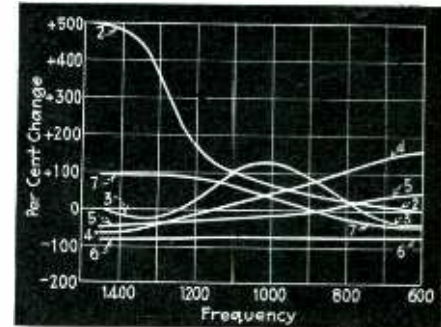

the insulation resistance. No antenna inductance is shown, the antenna is so short as to have negligible inductance on broadcast frequencies. By inserting the resonator in the circuit the circuit inductance is increased. The resonator has 7 taps so that the proper inductance value may be chosen, depending on whether the antenna circuit is high or low impedance. This is shown in Fig. 1 by a broken line.

The chart in Fig. 2 illustrates the per cent of improvement with the resonator connected to a low capacity antenna over the same antenna without the resonator. Taps 2, 3, and 4 are the most beneficial for this particular antenna. Tap 2 gives high signal pickup on the high frequency end of the band. Tap 3 increases sensitivity at the center of the band. The correct tap is the one which gives the most sensitivity in the section of the band most used. Taps 5, 6 and 7 do not improve performance when a low capacity antenna is used. These positions are for use with high capacity systems.

## Thermostatic Ballast Tube

The ballast tube in one of the new G.E. ac-dc receivers has an additional resistance for protection against pilot light burnouts.

The connections of the tube and pilot light circuit are shown below. The 150 ohm resistance is the normal filament

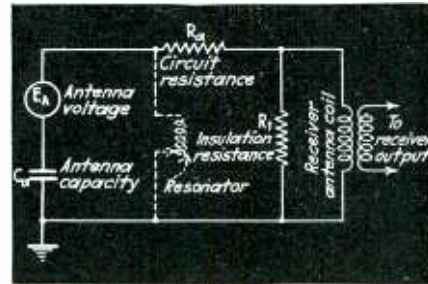
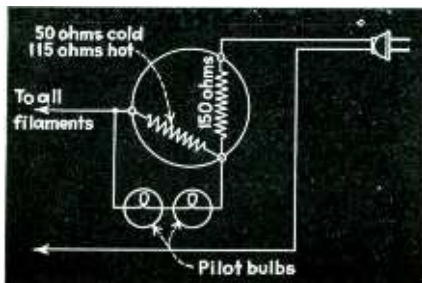

## Auto Antenna Resonator

Since auto antenna systems must be compact it is natural that the antenna itself contain very little inductance. This results in a non-resonant condition. It would be impractical to load the antenna with a high capacity as this would reduce the antenna impedance. A matching resonator has been devised by Radiart which tunes the antenna circuit by inserting the correct value of series inductance.

The diagram shown in Fig. 1 shows the electrical equivalent of an antenna



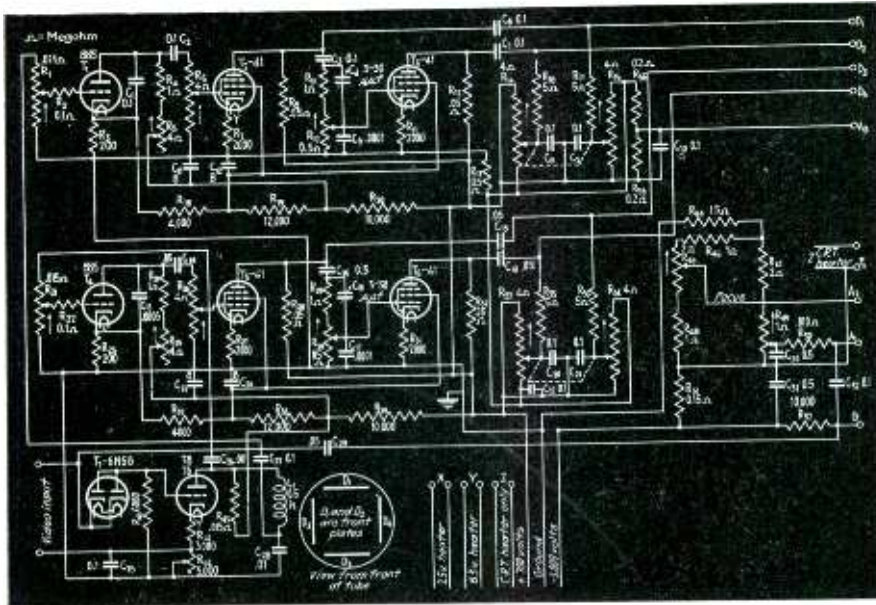

**TELEVISION TRANSDUCER**—Schematic of the video circuits in Du Mont's new television. Designed to operate in conjunction with a special wide band-pass receiver, it is comparable to the speaker unit on our present-day audio receivers. Detector output of the video receiver feeds the terminals at the lower left of the diagram

## High Capacity Filter

A new idea in a.c.-d.c. power supply circuits has recently been developed by Magnavox. Essentially the new circuit contemplates elimination of the filter chokes, using in its place the impedance of one section of the 25Z5 rectifier. Although the impedance value of the rectifier section is not quite equal to its resistance at the lower frequencies, this fact is compensated for by using special high capacity capacitors.

The drop across the rectifier elements serves a two-fold purpose. Since it occurs in the negative lead of the filter, it provides the grid bias voltage for the output tube in the receiver. One section of the 25Z5 provides the correct bias for a 25L6. With other tubes, such as a 43, a small resistance or r.f. choke may be added in series with the rectifier element to give the correct voltage drop. The addition of the r.f. choke materially aids in balancing out the higher harmonics in connection with the grid filter shown in the bias lead.

When a 25L6 output tube is used, a dual 50 mfd. electrolytic capacitor is

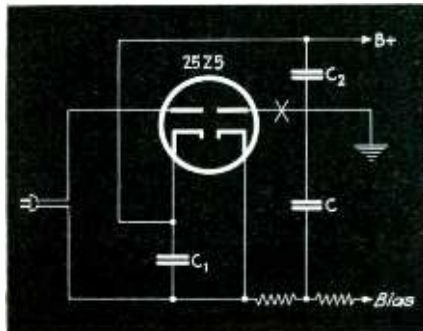

necessary. This is shown in the diagram as C1 and C2. With a 43 tube in the output these values may be reduced to 35 mfd. each.

## Eye-Opener for Tuning Indicator

It is possible to increase the shadow-angle sensitivity of the 6E5, 6G5, or 6U5 as a tuning indicator by increasing the maximum shadow angle from the usual value of 90 degrees to approxi-

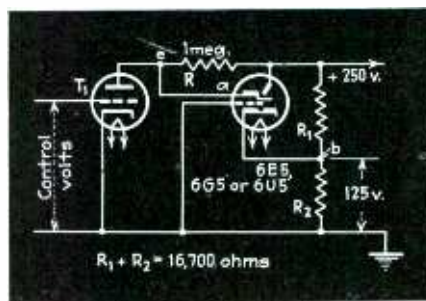

mately 180 degrees. This improvement is obtained by using a separate triode in a new circuit by RCA to control the action of the ray-control electrode in the tuning-indicator tube.

The circuit for obtaining wide-angle tuning is shown in the diagram. When a high negative bias is applied to T<sub>1</sub>, the plate current of the T<sub>1</sub> is nearly zero and the voltage drop across R is nearly zero. Under this condition, the shadow angle is zero. When the grid of T<sub>1</sub> is at zero potential, the plate current of T<sub>1</sub> is high and the potential of

point (a) as nearly -125 volts with respect to the cathode of the 6E5, 6G5, or 6U5. The shadow angle under these conditions is approximately 180 degrees. In the usual circuit, the maximum shadow angle is only 90 degrees because the potential of the ray-control electrode (a) does not become negative with respect to cathode.

The accompanying curve shows the relation between shadow angle and control voltage when T<sub>1</sub> is a type 76. Other tube types may be used in place of the 76; the shadow-angle characteristic with the 76 is shown merely to illustrate the performance of the circuit. For example, when T<sub>1</sub> is a 6J5, the cut-off voltage is approximately -12 volts; when T<sub>1</sub> is a 6K7, the cut-off voltage is approximately -40 volts, provided the suppressor is connected to the control grid and screen voltage is obtained from the 250-volt source through a 5-megohm resistor.

A well-defined shadow angle is not

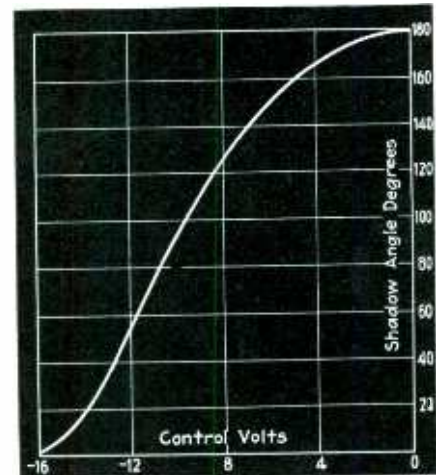

obtained over the entire range of 180 degrees. The edges of the pattern are sharp for shadow angles from 0 to approximately 150 degrees; from 150 degrees to 180 degrees, the edges of the pattern are not sharp. A suitable compromise can be made easily. In order to stabilize the potential of point (b), it is suggested that the bleeder current through R<sub>1</sub> be approximately 15 milliamperes.

## New Tubes

**884.**—Gas triode by RCA similar to the 885 with the exception of a 6.3 heater.

Sweep-Circuit Oscillator Characteristics are:  
 Heater Voltage ..... 6.3 volts  
 Heater Current ..... .6 amp.  
 Internal Voltage Drop ..... .16 volts  
 Plate Voltage ..... 300 volts  
 Peak Plate Current ..... 300 ma.  
 Average Plate Current below 200 Cycles 3 ma.  
 Average Plate Current above 200 Cycles 2 ma.  
 Grid Resistor—not less than 1000 ohms  
 or more than 500,000 ohms.....

# RADIO SERVICEMEN of AMERICA, INC.

304 SO. DEARBORN STREET  
CHICAGO, ILLINOIS

President—T. P. Robinson  
Vice President—A. C. W. Saunders  
Secretary—Ingvar Paulsen  
Treasurer—Lee Taylor  
Joe Marty, Jr.—Executive Secretary

Mr. Qualified Serviceman  
Anywhere, U. S. A.

Dear Mr. Serviceman:

The organization, Radio Servicemen of America, Inc., grew out of a desire of outstanding radio servicemen from all parts of the country to have an association that was qualified to assume its rightful place in the industry. The whole aim and desire of RSA is to provide an organization of such character that servicemen will be proud to belong to it that the radio industry will consider an integral part of its structure; and that the public will accept because of the high business and professional character of its membership.

The first step taken was to insure, through its by-laws, that the control of the policies and business affairs of the organization should be forever vested in its qualified members, anyone of whom is eligible for service on the board of directors. The by-laws further guarantee that the organization shall be independent and free from subsidy or domination.

An equitable method of representation based directly on radio set population has been worked out whereby the country has been divided into twenty districts. Before June of 1938, the members in each district will elect a director to represent them on the board of directors. As specified in the by-laws, the directors thus elected will constitute the governing body of RSA and will carry on and expand the work thus far done by the first organizing board. The term of office of directors is two years, at the end of which time new directors will be elected by the members in each of the districts.

Qualifications for membership are determined by the local chapters of RSA. Further provision has been made that wherever a local affiliated chapter exists, an applicant must become a member of such local chapter and must be certified to the national office by the proper chapter officers before he can be accepted as a member of the national body; likewise, when a member at large moves into an existing chapter area, he must become a member of the local chapter. RSA feels that local problems can best be solved by a

united local group acting in the best interests of the majority.

In carrying out these expressed aims and desires, RSA is definitely not interested in a quantity membership, as such. This organization will continue to build its membership from the ranks of radio servicemen who are willing to assume the responsibility of leadership in their profession, true to the ethics of good business and to the welfare of the public they serve.

RSA is the only national service organization that has ever enjoyed the support and cooperation of outstanding individuals as well as *all* the organized groups within the industry.

Upon acceptance of applications, a member will immediately receive a certificate of membership suitable for framing and a pocket membership card. Regular mailings will be made of advance circuit diagrams which we are receiving by virtue of the cooperation of set manufacturers. A monthly house organ containing interesting news and editorials will be mailed to members. We stand ready at all times to help local chapters and individuals solve problems that affect their welfare. We are embarking upon a program designed to educate the public to the need of reliable radio servicing and will use such media as newspapers, periodicals and local broadcasts in towns where local chapters already exist. Through the pledged cooperation of publishers, manufacturers and trade journals, we offer our members accurate, expert information and technical advice at no cost. Through these same contacts, a National Speakers Bureau is being established to provide outstanding speakers for all chapters desiring experienced lecturers. Education in actual service problems as well as technical theory is planned for the immediate future.

All of the above services are rendered to our members at only \$2.00 per year for national dues for 1938. Fill out the application and send to the national office at once. Where a local affiliated chapter exists, this application will be sent to the proper local Secretary for certification and upon your admission to the local chapter and upon payment of local and national dues for 1938, you will receive immediately your membership card and other material mentioned above.

**Radio Servicemen of America, Inc.**  
(Incorporated Not for Profit)

304 South Dearborn St., Chicago, Ill.

## APPLICATION FOR MEMBERSHIP

Gentlemen:

I hereby make application for membership in the Radio Servicemen of America, Inc.

Affiliated with Local Chapter in.....

Personal Name.....

Home Address.....

City..... State.....

Firm Name.....

Address..... (firm)

Telephone (home).....

Years Experience..... Age.....

Membership in other Associations.....

Whole or Part time Radio Serviceman.....

If Part Time, what portion is devoted to Radio Servicing (¼, ½, ¾, etc.).....

What are your other duties.....

Education other than Radio.....

Radio Training or Courses.....

Testing Equipment.....

.....

It is my sincere desire to become a member and adhere to your principles of fair competition and ethics and if accepted do solemnly swear (or affirm) that I will faithfully fulfill my obligation as a member of the Radio Servicemen of America, Inc.

Signed..... Applicant

Approved: Chapter Secretary.....

Executive Secretary.....

Please address your replies to Radio Servicemen of America, Inc., 304 South Dearborn Street, Chicago, Illinois, Attention of Joe Marty, Jr., Executive Secretary.



**VIDEO TESTING**—The author servicing a modern television receiver with the monotron oscilloscope shown below. The receiver is of British manufacture.

**(Below) MONOTRON OSCILLOSCOPE**—Supplies a complex television signal to the video circuits under test. An image of bars, wedges and circles imprinted on the screen of the tall tube on the left is made to appear on the screen of the receiver; thus supplying a standard while adjusting receiver definition.

By

**MARSHALL P. WILDER**

*Research and Development Engineer  
National Union Radio Corp.*

# Testing Tomorrow's Televisors

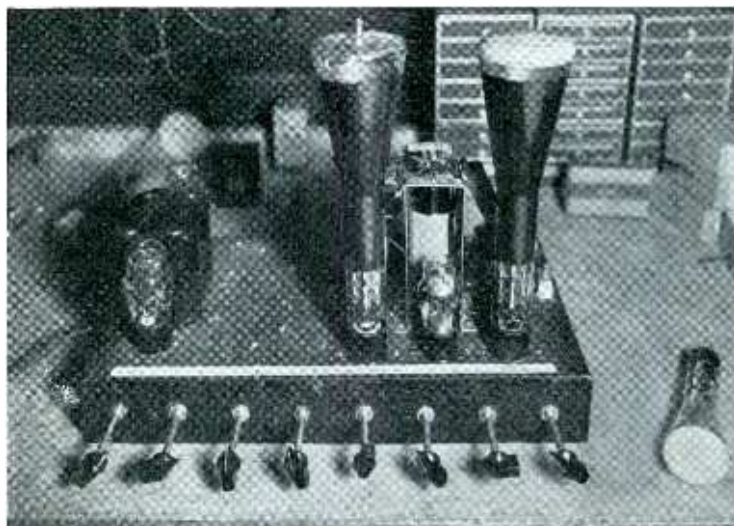

erly line up the receiver. It will be assumed that this receiver is a super-heterodyne, capable of receiving sight and sound at television frequency.

## *Receiver Design*

For the purpose of proper match to the antenna, it is convenient to use a stage of radio frequency or two before the mixer or first detector. These stages of radio frequency are at the fundamental frequency of the transmitting station, which in the case of the Empire State transmissions, is 46.5 megacycles. The gain of the one or more stages of radio frequency is very low, two or three being considered satisfactory. This is because each stage must pass a band approximately 5 megacycles wide. In order to pass this wide band the tuned circuits are heavily damped by resistors. Both sight and sound will come through the same radio frequency amplifier and enter the grids of two first detectors. These first detectors will convert the frequencies to two different intermediate frequencies. One oscillator is used to generate both I. F. frequencies. The intermediate frequency amplifiers for the sight and sound are properly chosen so that if the vision intermediate frequency amplifier is 10 megacycles and the oscillator set to 56.5 megacycles, the intermediate frequency amplifier for the sound will automatically be 6.75 megacycles, as the sound is transmitted on 49.7 megacycles. Thus, the same oscillator will beat with the sound channel at 49.7 megacycles resulting in 6.5 megacycle side bands, and the same oscillator will beat with the 45.6 megacycle vision channel, producing 10 mega-

**W**HILE television is still in the indeterminate future, its final, finished form beyond prediction, enough is known of the basic principles upon which companies experimenting with equipment are working to permit a reasonably accurate picture of initial equipment to be drawn. For servicemen who wish to familiarize themselves as early as possible with typical television circuit problems, Mr. Wilder has written this article, throwing as much light on the probable methods of testing as a thorough knowledge of the art today permits. ED.

**T**HE advent of Television will face the serviceman with a new problem, but this should not unduly alarm him as most of the circuits are similar to those he has already faced in servicing modern radio receivers. Three entirely new problems however, are present. The maintenance and adjustment of sweep circuits, the importance of phase shift, and wide band pass. Some of the

old problems are greatly simplified. At present there is only one wave band. Ganging of the tuning control will be fairly simple. The bands passed are so wide and the intermediate frequencies so high, approximately 10 megacycles, that slight misadjustment in the line up is not as important from a frequency standpoint as it is from that of phase distortion.

Where formerly a serviceman was generally in the dark as to the ultimate result of his adjustments, with television, a great deal can be told by observing, on the surface of the cathode ray tube screen, the changes in the quality of the picture as adjustments are made. This ability to see what is happening is of the greatest importance and it will greatly simplify the servicing problem.

Let us start at the beginning of a television receiver and see what adjustments have to be made in order to prop-

cycle side bands. The 10 megacycle vision side bands are amplified by the vision intermediate frequency amplifier and the 6.5 megacycle signal is amplified by the sound intermediate frequency amplifier. The intermediate frequency amplifier for the sound will have one or two stages before a second detector with automatic volume control followed by a power output stage. The vision amplifier must pass a band  $2\frac{1}{2}$  or more megacycles wide—this will require at least four or five stages with an overall gain of 1000.

### Avoid Phase Distortion

To pass the necessary band without phase distortion, care must be taken in adjustments of the I F transformers. The importance of avoiding phase distortion is perhaps not familiar to the average service man and can be best explained by saying what difficulties will arise if this type of distortion is present. If one stage of intermediate frequency is tuned to one frequency, and the next to another frequency, and so on, in order to pass a wide band, the phase of the frequencies being passed will not be the same and will result in certain frequencies arriving at the grid of the cathode ray tube earlier than other frequencies.

It is not necessary that there be no phase shift. Just as long as phase shift is proportional to frequency no difficulty will arise. The result of one frequency arriving at the cathode ray tube grid earlier than it would without phase shift is that some picture elements will be displaced three or four lines with the result that the edges or outlines of objects may be turned black where they should be light or even displaced to right or left as much as eight to ten picture elements.

The second detector of the receiver can be a diode as the input to this tube will seldom be less than 1 volt. The linearity of a diode at this level is very good. The output of this second detector, in the case of the vision will be coupled to one or more stages of video amplification. The word video is used rather than the word audio to differentiate between the two types of amplification after demodulation. This amplifier must be capable of passing a wide band similar to the i.f. stages.

### Other Circuits

After video amplification the signal is applied to the cathode ray tube grid circuit which sets the average brightness, and to the synchronizing signal selection and separation circuit. From the average brightness setting circuit, sometimes called a d.c. restoring circuit, the signal passes to the synchronizing impulse separation circuit. In order to separate the synchronizing impulses from the picture content of the transmitting signal, it is necessary to have an amplitude discrimination circuit, such as a diode biased so that only the peaks of

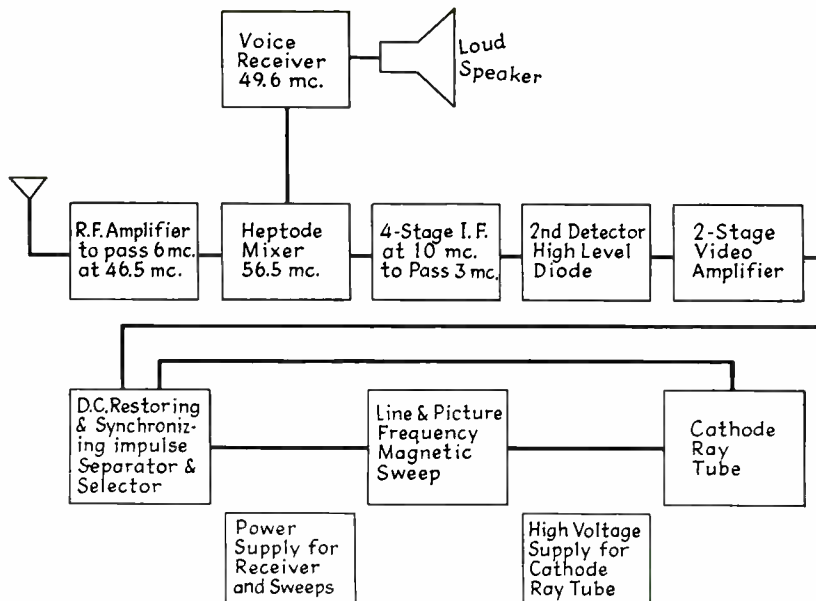

SIGHT AND SOUND—Block diagram depicting components of a modern television. Note especially the single r.f. and converter stage for both audio and video receivers.

the signal will be passed through this circuit, eliminating the video picture portion. The peaks or synchronizing impulses are then allowed to enter the synchronizing impulse selection circuit. This circuit is a simple frequency separation circuit, one filter to pass the high or 13,000 cycles synchronizing impulse and the second filter to pass the low or 60 cycle field synchronizing impulse. These two signals are applied to the grids of the sweep circuit oscillators in order to synchronize them.

There are many types of sweep circuit oscillators, some employing gas triodes, such as are used in the conventional cathode ray oscilloscope with which every service man should be familiar; others employ tubes which are of the high vacuum type. One of the simplest and most generally used is that suggested by Kobayashi of the Western Electric Company, which employs a feed back transformer coupling the grid back to the plate in such a fashion that when the synchronizing impulse arrive at the grid of this tube, the tube becomes conductive and a condenser across the anode to ground circuit begins to discharge through the windings of the coupling transformer. The direction of the field of the transformer is such that at the start of the anode current the grid will be made more positive, greatly accelerating the flow of current and rapidly discharging the condenser. When this condenser in the anode circuit is empty, the field in the transformer reverses itself and the potential of the grid becomes very negative. This polarity is maintained by the grid circuit condenser and blocking the tube until the condenser between anode and ground once more is completely charged, then the cycle will begin again. These circuits are not very critical and will usually oscillate approximately at the frequency for which they are designed.

To check the high frequency sweep

oscillator, it is necessary to employ a beat frequency oscillator adjusted for some frequency which is a multiple of 13,320 cycles. The other oscillator can be compared with the a.c. line frequency in order to make certain that it is operating at 60 cycles. The output of these oscillators is fed into a power amplifier tube and from there transformer coupled to a pair of deflecting coils on the cathode ray tube.

### Magnetic Deflection Popular

It may be interesting and new to some servicemen that magnetic deflection is used in television, rather than electrostatic. Magnetic deflection is used because it is much easier to obtain a wide deflection of the beam, and because the spot focus is less distorted during deflection.

A few words regarding average brightness restoring circuits are in order. These circuits are essentially peak detectors as they detect the peak amplitude of the synchronizing impulses. The amplitude of these pulses is slowly changing, according to the average brightness of the picture transmitted and is measured automatically and applied to the cathode ray tube grid as bias, setting the background or average brightness of the picture. In modern television receivers, seldom less than 6000 volts are used on the final anode of the cathode ray tube. Care and new standards of insulation are required. The employment of such high voltages need not alarm the serviceman, as the currents used are very small. In fact, these voltages, with the exception of those used in projection tubes are not much higher than the voltages employed in the average ignition system of the family car. All modern television receivers that have been brought to the notice of the writer employ interlocks,

which, when the back of the receiver is open in order to service, automatically cut off the high tension.

#### Test Instruments

It is very difficult to foresee what new instruments will be used in the servicing of a television receiver, but it is very easy to tell in which direction the development of these instruments will lead. Possibly the cathode ray oscilloscope will be the basic tool, around which other instruments could be built. There will probably be one or more multi vibrators, one oscillating at 13,000 cycles and one at 60 cycles to test the deflecting coils of the receiver that is being serviced. At the same time, these same signals will deflect the beam of a tube in the instrument which looks like a cathode ray tube, except for the screen, which is an aluminum plate with a design marked on it consisting of bars and lines properly interlaced with each other to cause a signal to be developed when the beam crosses. This tube is known as a Monotron\*, and the signal is generated because the secondary emission from the aluminum plate rises and falls, depending upon whether the beam strikes the bare aluminum or the black carbon ink which makes up the markings. Obviously, the secondary emission is higher from the aluminum than it would be from the carbon and this is amplified by an amplifier. The signals thus developed can be applied to the grid of the cathode ray tube in the receiver under adjustment so that the image or exact duplicate of the image drawn on the plate in the monotron should appear on the screen of the cathode ray tube being serviced.

From the resulting pattern, a great deal can be told. Vertical and horizontal resolution in any or all portions of the screen can be monitored and corrections applied to the video amplifier of the receiver to bring this resolution to maximum. It is possible to note from this image the high frequency cut off of the video amplifier and associated circuits, the amount of phase distortion present, the focus of the spot at any time on any portion of the screen, the quality of the half tones, the aspect ratio and the linearity of the sweep circuit.

The signal generator used to service a television receiver will be in itself a high quality transmitter capable of wide band modulation. This same oscillator will also be capable of frequency modulation. With this instrument, it will be possible to measure the overall response curve of the radio frequency section and see it on a normal cathode ray tube screen in the same manner as visual aligners are used today.

\* The monotron is similar to a monoscope but is not interchangeable due to a difference in physical characteristics. The word monoscope is a trade name copyrighted by the Radio Corporation of America.

*Silent  
Spiral  
Connector*



**NO SLIDE  
NO FRICTION  
NO NOISE**

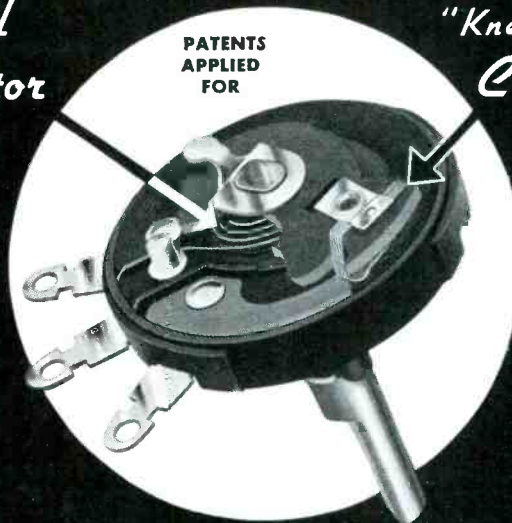

**PATENTS  
APPLIED  
FOR**

*5-Finger  
"Knee Action"  
Contact*



**AMAZINGLY  
SMOOTH  
PERMANENTLY  
QUIET**

## **SPECIAL REPLACEMENT *Metallized* CONTROLS**

*with the New SILENT SPIRAL CONNECTOR  
plus 5-FINGER "Knee Action" ELEMENT CONTACT*

Out goes noise at the two most critical points in any control!

Sliding, metal-to-metal contact—the most common cause of control noise — is definitely eliminated by the latest IRC engineering triumph, the Silent Spiral Connector. Because it provides positive, continuous electrical connection between the center terminal and volume adjustment arm, there is no chance for noise to originate. With element noise also eliminated by the famous IRC 5-Finger "Knee Action" Silent Element Contact, you have double assurance of the smoothest controls you've ever used—controls that are quiet and stay quiet!

**GET THIS  
NEW GUIDE FREE!**

The most complete guide ever offered. Contains more than 200 pages listing IRC Standard and Special Replacement Controls for practically every receiver.



**INTERNATIONAL RESISTANCE COMPANY**

401 NORTH BROAD STREET, PHILADELPHIA, PA.

Factories or Licensees in Canada, England, France, Germany, Italy, Denmark and Australia

**MAKERS OF RESISTANCE UNITS OF MORE TYPES, IN MORE SHAPES, FOR  
MORE APPLICATIONS THAN ANY OTHER MANUFACTURER IN THE WORLD**

# 1938 AUTO IGNITION CIRCUITS

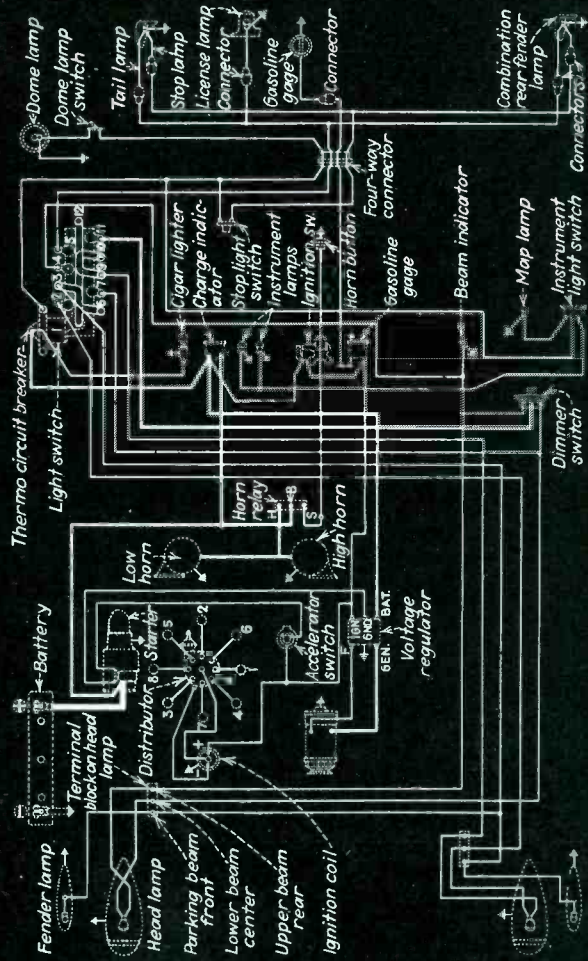

**Buick Series 40**

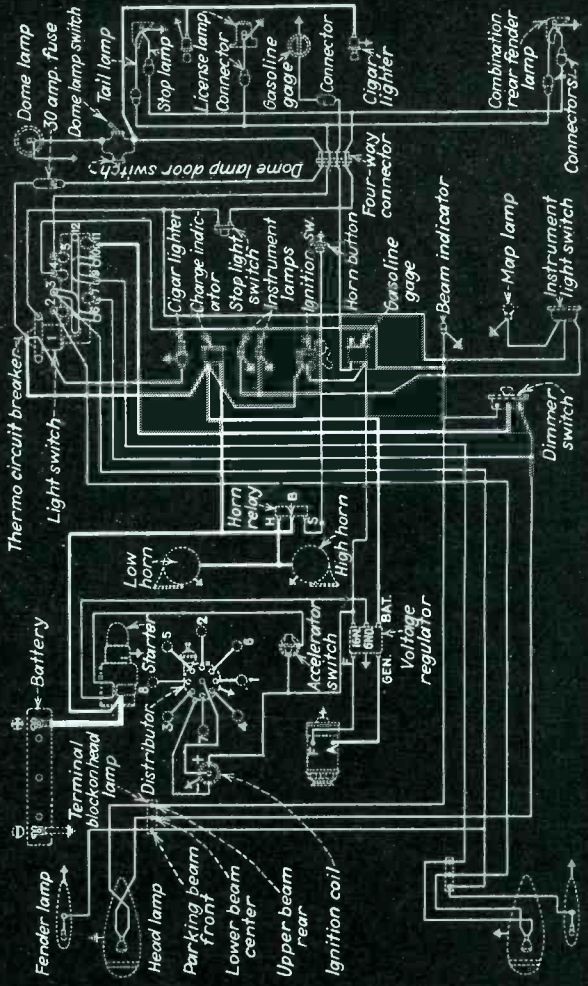

**Buick Series 60-80-90**

## RADIO RETAILING

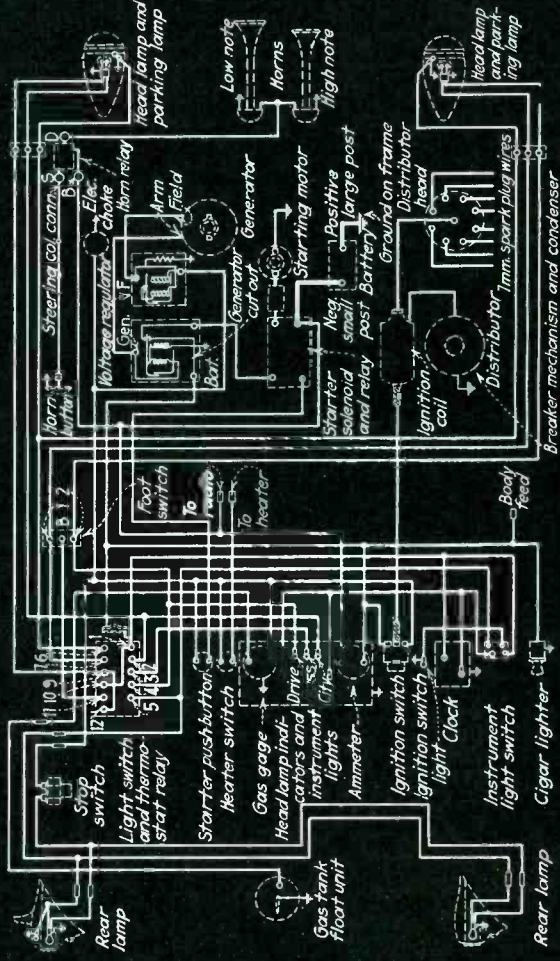

**Cadillac Series 38-50, 60 and 65**

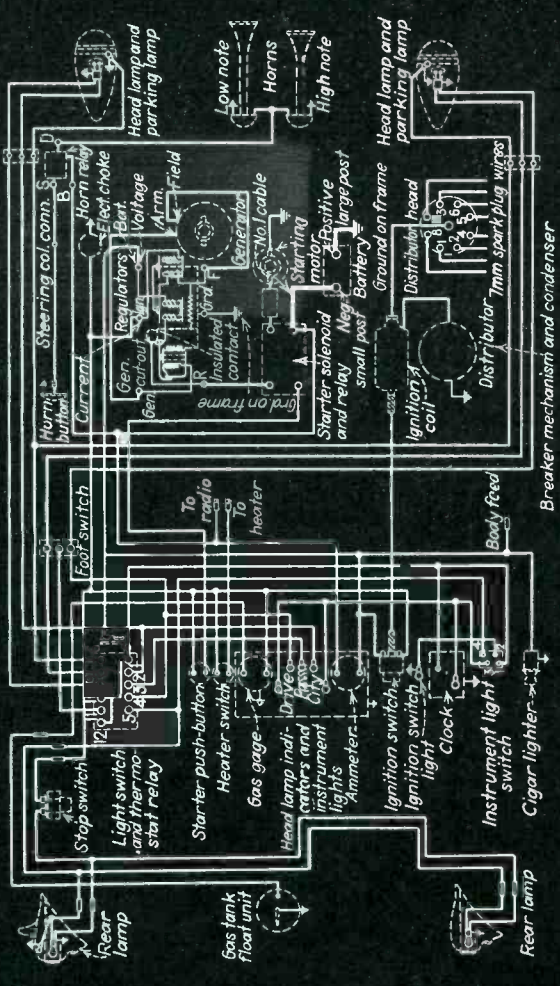

**Cadillac Series 38-75**

## SELL MORE AUTO RADIOS IN 1938 by demonstrating with the B-L AUTO RADIO FILTERPAC

By operating your display models from the 110 volt AC line with a B-L Filterpac, you can be sure of top-notch demonstrations. No more embarrassment and lost sales because of batteries that weaken at the critical moment when your radio should be at its best.

The B-L Filterpac requires no watering or charging, contains no vibrators, bulbs, or moving parts, and creates no radio interference.

Tested and Approved by Leading Radio Manufacturers



Two models for all sets:

1. Type 160C4 for all radios requiring up to 6 1/2 amperes. List price \$19.50.
2. Type 160C4S for all radios requiring up to 10 amperes. List price \$21.75.

**DEALERS:** Order from your distributor, or send your remittance to the factory with his name and address. Usual trade discounts apply.

**DISTRIBUTORS:** Write for further information and special prices.

**The B-L ELECTRIC MFG. CO.**  
ST. LOUIS, MO.

# Compact!

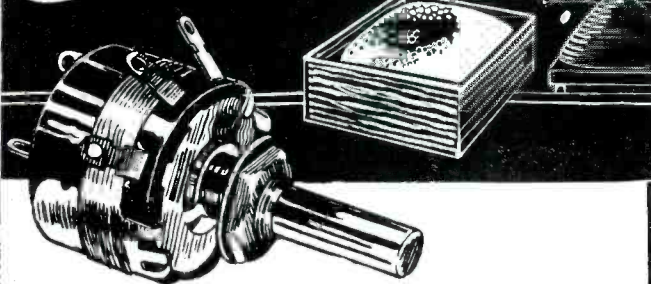

● **SPACE-SAVING**—that's the prime feature of the new **CLAROSTAT MIDGET CONTROL**. Only 1 1/8" in dia. by 1/2" (without switch) or 13/16" (with switch). Yet this small control will do everything the large control does, **PLUS** fitting into very tight places. That makes it a more universal control. And ideal for servicemen's requirements.

**New MANUAL:** Pocket-sized.

Over 208 pages of control and resistor replacements, for all makes and models of sets. Also abundant servicing notes. Free on request—from your jobber or from us direct.

**CLAROSTAT** *Manufacturing Co. Inc.*



285-287 NORTH SIXTH STREET  
BROOKLYN, NEW YORK, U.S.A.

• OFFICES IN PRINCIPAL CITIES •

## 3 PLUS FEATURES



### THE TUNG-SOL CONSIGNMENT PLAN

*First*—You carry an adequate stock of the long-established, well-known brand of Tung-Sol quality tubes.

*Second*—You are protected. Only carefully located high class retailers who maintain prices, can qualify for the Tung-Sol franchise.

*Third*—You don't pay for the tubes until they're sold. This is one of the outstanding features of the Tung-Sol plan.

• • •

Our ability to finance dealers' stocks is utilized to make them Tung-Sol Retail Partners in fact as well as in name. You pay no premium for this financing.

That is why more and more high class retailers are writing to find out if they can qualify. If you haven't already inquired, call your Tung-Sol jobber. If necessary, write us for his name.

## TUNG-SOL

*Tone-flow Radio Tubes*

TUNG-SOL LAMP WORKS, INC.  
Dept. B Radio Tube Division

Sales Offices: Atlanta, Boston, Chicago, Dallas, Kansas City,  
Los Angeles, Detroit, New York. Gen'l Offices, Newark, N. J.

# 1938 AUTO IGNITION CIRCUITS

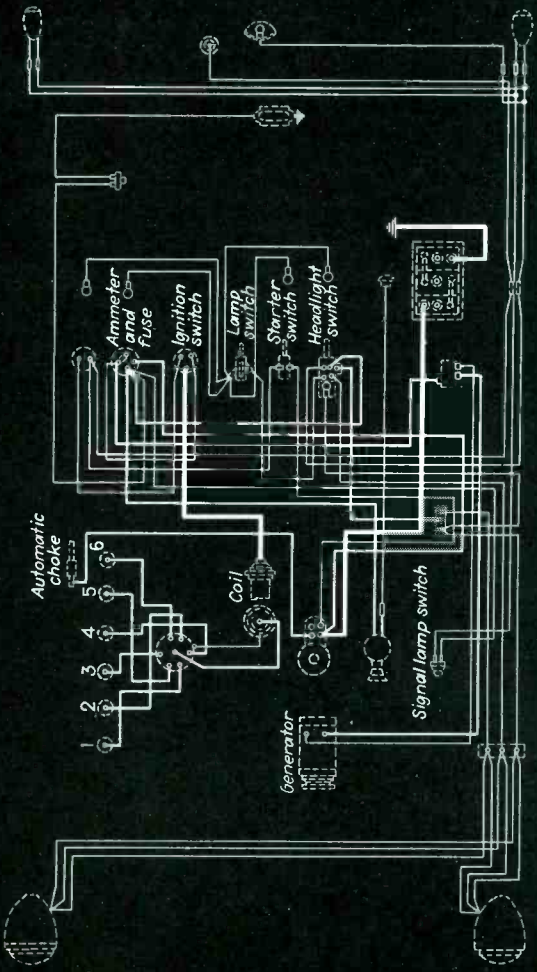

**Chrysler Royal**

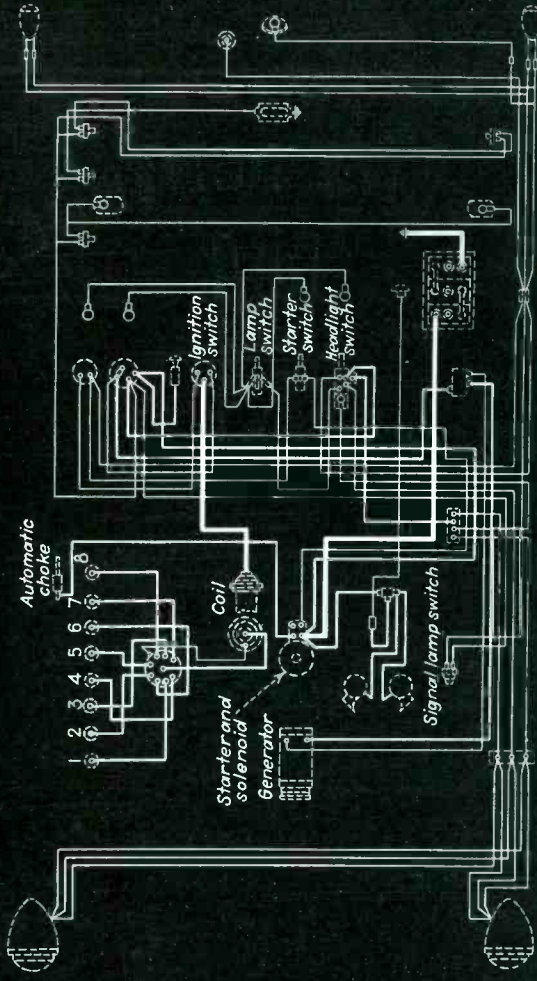

**Chrysler Custom Imperial**

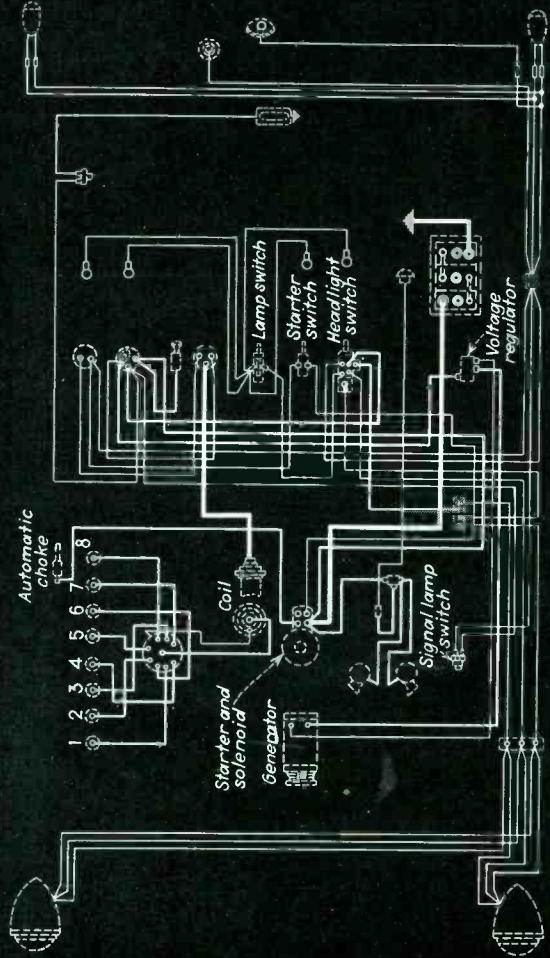

**Chrysler Imperial**

## RADIO RETAILING

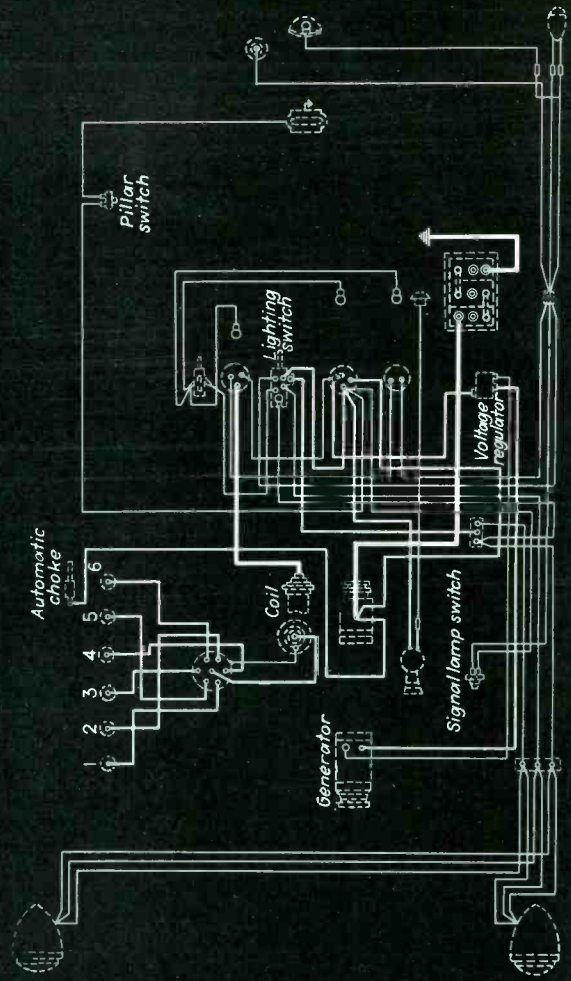

**DeSoto S5**



# NEW! - AN A. C. OSCILLATOR THAT HOLDS ITS ACCURACY

(Individually hand calibrated dials)

**ACCURATE** frequency calibration assured by large 330° fully visible hand calibrated dial! (Not troublesome trimmers or padders used.)

**UNIFORM** output level regardless of frequency assured by new WESTON A.A.C. circuit. Tuning oscillator or shifting frequency band does not increase or decrease signal strength.

**CONSTANT** signal free from drift or shift in frequency assured by A. A. C. circuit which automatically regulates mutual conductance of oscillator tube.

**COMPLETE** attenuation of signal on all bands assured by new WESTON design, thorough double shielding, and elimination of line feedback.

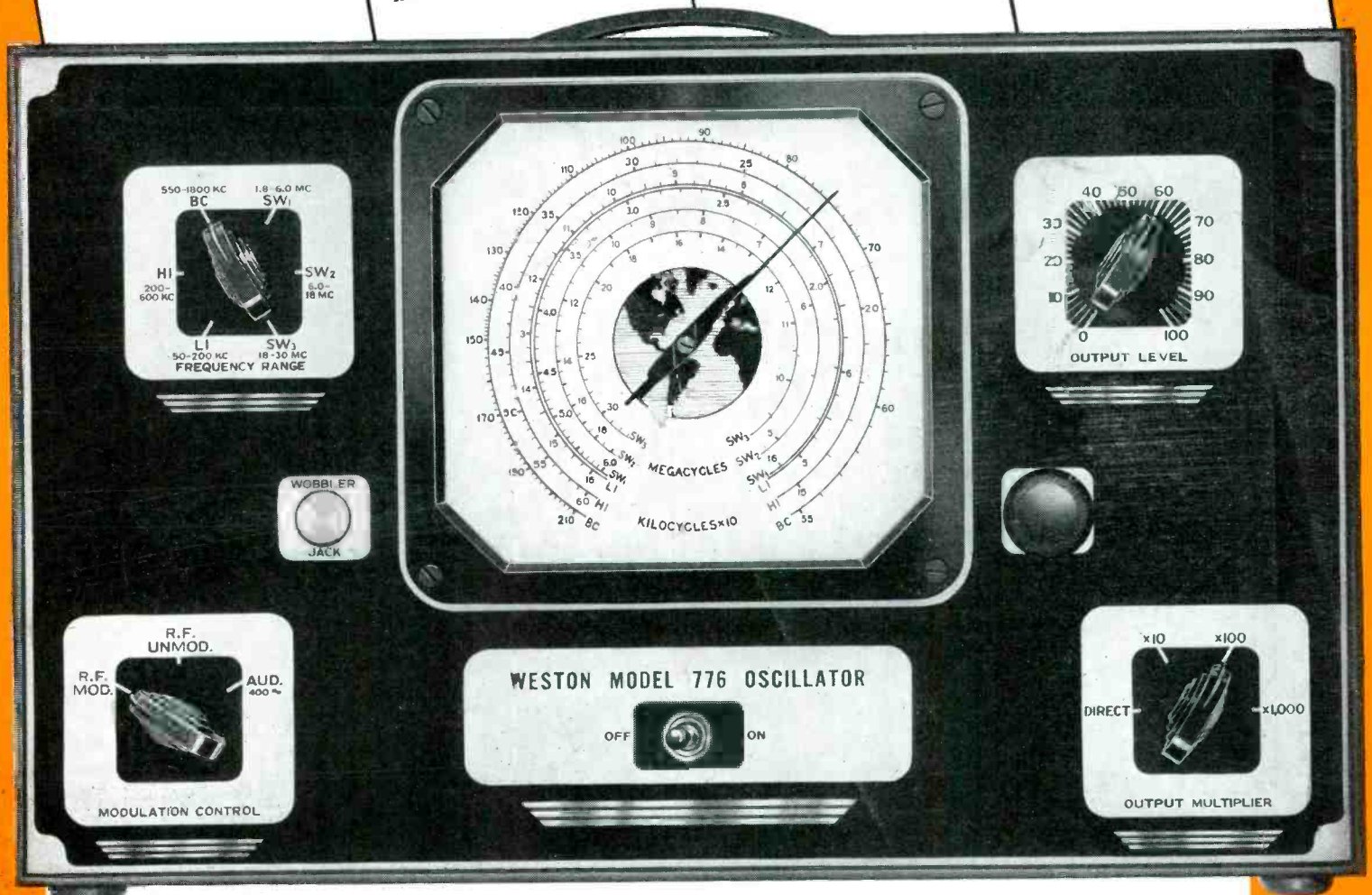

The above 4 features, heretofore available only in high priced laboratory oscillators... yet recognized as essential for thorough radio servicing... now are available *for the first time* in a practical service oscillator, *at a serviceman's price*. The new WESTON Model 776 Oscillator gives you all "four," *plus* 12

additional features and refinements. In addition, it has been styled to match other recent and widely popular instruments in the WESTON line. You will want all the facts on Model 776... a serviceman's oscillator that fully meets WESTON'S high standards of accuracy and durability. The coupon will bring you complete literature.

Weston Electrical Instrument Corp.,  
581 Frelinghuysen Ave., Newark, N. J.

Send data on Model 776 Oscillator.

Name.....

Address.....

City..... State.....

# WESTON Instruments



# SHORTCUTS

## Using Headphones to Locate Distortion

By H. D. Hooton

Although the service man who uses headphones on the job is often referred to with amusement, a pair of modern wide-range headphones, such as the crystal type, are invaluable in localizing distortion and similar troubles, especially where the shop is not equipped with a cathode ray oscillograph. Fig. 1 shows how the phones are used; the blocking condensers are 0.25 mfd., 600 working volts or higher each and one must be used in each test lead not only to prevent possible damage to the crystal phones but to lessen the danger of shock should the test prods be accidentally reversed when connecting across a high voltage circuit.

The diagram in Fig. 2 shows where

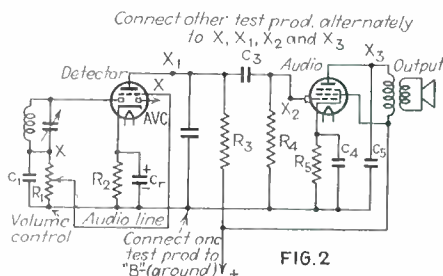
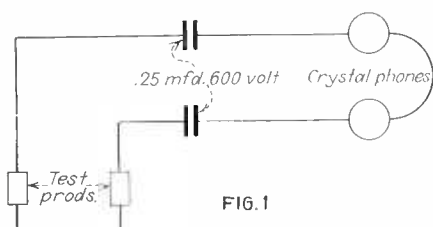

the phones are usually connected for tracing down distortion in the audio stages. When the prods are connected

between points "x" and the chassis and distortion exists, the difficulty may be due to a defect in the circuit, R1-C1, or, if a blocking condenser and grid leak are used in the grid line, to a leaky condenser, a changed-value resistor or a high-resistance connection. Distortion at "x1" would be due to a defective condenser, C2, resistor, R2, or a bad tube. Any defect in C2 and/or R2 usually manifests itself by a disturbance in the plate voltage or current of the tube which is easily detected by means of the ordi-

(Continued on page 59)



"YES MA'M!"

... is your answer if you get FREE EQUIPMENT the

## EASY NATIONAL UNION WAY

Man, it's a great feeling to know that you are set up to handle even the toughest service job. That feeling of confidence will keep you alert, pepped up to go after more business. You'll be able to take it, too . . . and make more money! No need to wish you might have the fine modern equipment you see advertised . . . you can have it.

National Union will give it to you with purchases of National Union radio tubes and condensers. It's easier now than ever with both tubes and condensers to apply against your purchase agreement. Find out . . . Ask your distributor. If you don't know who your nearest N.U. distributor is, send coupon or write . . . right now!

### N. U. TUBES and CONDENSERS ARE QUALITY PRODUCTS

Thousands of top notchers in the Radio Service Engineering profession are depending on National Union quality. It's the kind of precision and value that makes

good friends for you. National Union quality will never let you down . . . The National Union guarantee is your assurance.



Model MK 30

Priced from \$19.50 to \$90.

### 'BULLET' MICROPHONES

Made only by

### TRANSDUCER CORPORATION

30 Rockefeller Plaza, New York, N. Y.

**THE ROAD TO BETTER BUSINESS**

**NATIONAL UNION**

1. Full guarantee on highest quality radio tubes.
2. Cut price business not solicited.
3. Price Protection.
4. N. U. jobber stocks are complete... No hunting for odd types.
5. Timely business building aids.

**NATIONAL UNION RADIO CORPORATION**  
570 Lexington Avenue  
New York City RR-238

Who is the nearest N.U. distributor?

Name.....

Address.....

City..... State.....

**LOW PRICE**

...is only one reason why YOU'LL SELL LOTS OF THESE RCA MIKES!

**RCA JUNIOR VELOCITY MICROPHONE**



Recommend this mike to those who want the best at low cost. It's the finest popular priced microphone RCA has ever created. Provides peak performance, is attractive, and offers the rugged construction and long life of RCA Velocity Microphones. Alnico magnets are used to provide exceptionally high signal-to-noise ratio. Is adaptable to most input circuits because of three output impedances. And it costs only \$43.50 list, less stand.

**RCA AERODYNAMIC MICROPHONE**



Here's a P. A. winner! It costs only \$26.50 list, less stand. Is so small it can be easily carried in the palm of your hand. Yet has quality features including excellent frequency response, fine tone and high sensitivity. Is used to good advantage for close talking. Has new Alnico permanent metal magnet. Requires no external excitation of power.

See your nearest RCA Commercial Sound Distributor for the new RCA Sound Catalog, or write direct to the address below.

ANY SOUND SYSTEM SOUNDS BETTER EQUIPPED WITH RCA RADIO TUBES

RCA presents the "Magic Key" every Sunday, 2 to 3 p. m., E. S. T., on NBC Blue Network



*Commercial Sound*

RCA MANUFACTURING CO., INC., CAMDEN, N. J.  
A Service of the Radio Corporation of America



**RIDER BOOKS BANISH Bewilderment**

**"RIDER'S . . . . . Out Front Again"**

Says Service Manager of Set Manufacturer

Banish bewildering complexity of modern service problems with up-to-date Rider Books.

"That extra HOW IT WORKS section with the new RIDER MANUAL Volume VIII, certainly puts Rider out front again! It makes clear by practical example the underlying theory you must understand when up against the increasingly complicated 1938 receivers."

ALIGNING PHILCO RECEIVERS—New! Authentic instructions for aligning ANY of the 8,000,000 Philcos. Over 160 pp. \$1.00 Only

Remember! Volume VIII includes in addition, 1650 pages of essential service data on 1715 models of over 100 manufacturers—the most comprehensive service information available, and the price is the same as for last year—\$10.00!

CATHODE-RAY TUBE AT WORK—Complete, practical, written for servicemen. Information on Oscillograph, etc. 336 pp. \$2.50 450 ill.

JOHN F. RIDER, Publisher

1440 BROADWAY  
NEW YORK CITY

Remember YOU NEED ALL 8 Rider MANUALS

**JFD 1938 AUTO RADIO ANTENNAS**

**15 MOST POPULAR TYPES**

Double grip all rubber covered running board antennas . . . Cowl antennas . . . Four different top-pers—fit all cars . . . Door hinge antennas . . . Bumper antennas . . . Special insulators for Oldsmobile and Buick cars.

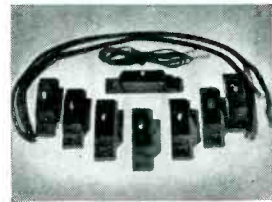
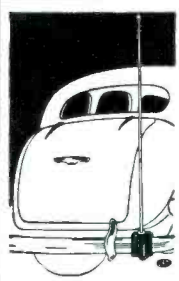

BUICK INSULATORS



OLDSMOBILE INSULATORS

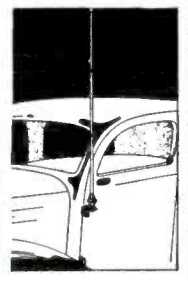

Ask for Our Complete Catalog



J. F. D. MANUFACTURING COMPANY  
4109 Ft. Hamilton Parkway, Brooklyn, N. Y.  
Export Dept.  
116 Broad St., New York, U.S.A.  
Cable: ICARAD, N.Y.

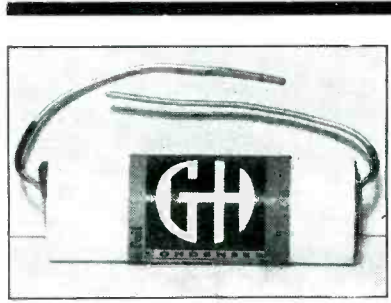
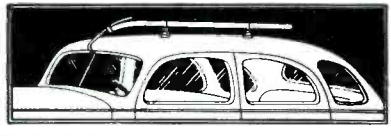

**CERAMATIC cased TUBULAR CONDENSERS**  
Entirely New & Different  
Write for Details

**CONDENSERS**  
of all types  
Paper and Electrolytic

*Girard - Hopkins*

1437 23rd AVE.

OAKLAND, CALIF.



**MUELLER RADIO CLIP KIT!**

A complete and handy outfit for the radio shop at a bargain price.—See it at your Jobber's or write factory for details.

ASK US FOR NEW 1938 CATALOG 701

**Mueller Electric Co.**  
1584 E. 31st St.  
CLEVELAND, OHIO

# MODERNIZE YOUR SHOP FOR GREATER PROFITS

... at almost  
no cost to you!..



## ... with the **ARCTURUS EQUIPMENT DEAL**

You profit three ways with the Arcturus Equipment Deal. You get needed shop equipment of standard make—immediately—at almost no cost. You get Radio's finest, best engineered tubes. This means real customer satisfaction on every sale. Last but not least, you get these tubes at standard prices, less standard discounts. Not one cent has been added to allow for the shop or test equipment you get. Arcturus brings it to you practically FREE!

- QUICK DELIVERY  
TO YOU!**
- SMALL DOWN  
PAYMENT**
- TUBES AT STANDARD  
LIST PRICES**
- ARCTURUS  
HELPS YOU SELL**  
The finest line of dealers before  
on the market today...  
Write for descriptive catalog.

### You Can't Lose!

If you need new radio test equipment, typewriters, etc. . . .

If you want to make yours the best equipped shop in town . . .

Then get the facts today. Join with the countless servicemen and dealers who are already profiting from Radio's finest, fairest and easiest deal!

MAIL THE COUPON!

# ARCTURUS

ARCTURUS RADIO TUBE CO., Newark, N. J. R-4  
Without cost or obligation on my part, send details of your new equipment deal.

Name .....

Street .....

City..... State.....

I am a dealer     I am a serviceman

My jobber is.....

For your convenience this coupon can be pasted on a penny postcard

# SHORTCUTS

nary volt-ohm-milliammeter. Sometimes, however, a tube that checks satisfactorily in the tester will give distorted output even though all circuit conditions are correct.

Distortion between "x2" and the chassis would indicate an open or excessively high resistance grid leak in this circuit. Distorted output at "x3" would be due to either a defect in R5 or C4, a leaky coupling condenser, C3, or a partially short-circuited output transformer. A leaky coupling condenser usually places a high positive bias on the grid of the following tube resulting in excessive plate and screen currents; the partially shorted output transformer will cause little or no change in plate or screen potential or current. The distortion is usually due to the incorrect impedance match created by the partial short-circuit.

## Fusing Converter-Operated A.C. Sets

By W. V. Henderson

The prevention of transformer and filter damage is sometimes quite a problem when operating a standard

110 volt AC receiver or amplifier from a DC to AC converter, due to the high voltage surges encountered. In one case, two power transformer replacements were necessary before the author hit upon the idea of fusing the secondary winding by means of a small flashlight bulb, as shown in Fig. 1.

The exact size of the bulb will depend upon the particular type of set or amplifier and the current rating of the power transformer. It is usually a good practice to choose some value that will show some brilliance during normal operation; this makes it easy for the customer to replace the bulbs if and when they do burn out. The two-cell 2.5 volt type is satisfactory.

The line or primary fuses are the standard 110 volt type; the formula for calculating primary fuses is as follows:

$$\text{Fuse rating (amperes)} = \frac{\text{Watts rating of set}}{\text{Line supply volts}}$$

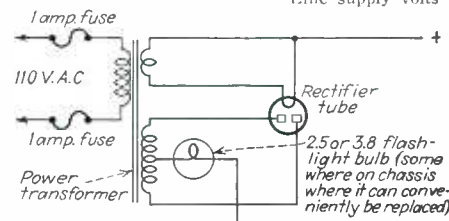

# LEADING SERVICING ORGANIZATIONS

Use this combination

## VOLT-OHM-MILLIAMMETER AND FREE POINT TESTER

Model 640-740

Precision built throughout, yet designed to withstand rough field work. That's why you find Readrite-Ranger testers used by so many leading service organizations. Volt-Ohm-Milliammeters, Tube Testers, Free Point Testers, Oscillators, available in combinations or in single units. No extra cases to buy. Today's biggest values in Precision Testers.

The Readrite-Ranger Model 640 Free Point Tester has eight automatic switch type and ten single action jacks. Five sockets will handle any type radio tube. Model 740 Volt-Ohm-Milliammeter has 3" Square Triplet Precision Instrument. Scale readings: 10-50-250-500-1000 AC and DC Volts at 1000 Ohms per Volt (DC Accuracy 2%; AC 5%); 1-10-50-250 DC M.A.; 0-300 Low Ohms; High Ohms to 250,000 at 1/2 Volts. (Rheostat adjustment for 13 1/2 Volts for Ohms readings to 2 1/2 Megohms. Batteries may be added permitting such readings in 250,000 Ohms steps.) Low Ohms to 1/2 Ohm with 25 Ohms in center of scale. Backup circuit used. Current draw is only 1 M.A. Batteries, accessories and instructions included.

Also Available in Single Units . . . No Extra Cases to Buy



PRECISION  
BUILT

ONLY \$2835

**Readrite**  
RANGER  
TESTERS METER METER

Readrite Meter Works  
220 College Ave., Bluffton, Ohio  
—Please send me more information  
on Model 640-740; I am also interested  
in .....

Name .....

Address .....

City..... State.....

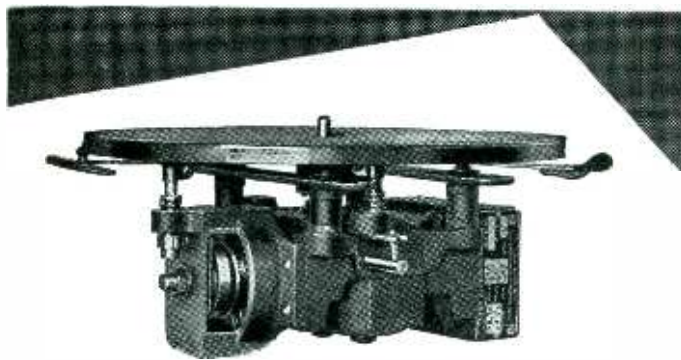

## Better Performance Sells General Industries Motors

**C**RITICAL America appreciates the difference—the better playing—of radio-phonographs and phonographs equipped with General Industries Motors. Order them for your trade. Famous Flyer Motors, selected to suit your production or demand. Self-starting, governor controlled induction type. Ample power. Long trouble-free service built into every motor. Above all, providing uniform speed though all variations of record drag. Silent laminated gears, running in oil. Long oversize bearings. No overheating. Furnished for AC, DC, or universal AC-DC. Order samples for testing.

**The GENERAL INDUSTRIES CO.**

3837 Taylor Street, Elyria, Ohio

## GUARANTEE THE JOB



**with Ohmite  
Brown Devils**

★ End replacement resistor failures—eliminate call-backs—do a service job you can safely guarantee—use OHMITE Vitreous Enamelled BROWN DEVIL Wire Wound RESISTORS. They're tough, extra-sturdy units—built of the same materials and to the same rigid standards as the big Ohmite industrial resistors. The wire is accurately space-wound over a porcelain core and coated with Ohmite Vitreous Enamel—the coating that has been proved by many years of service to give the best possible protection against extreme humidity and other severe operating conditions. 10 and 20 watt sizes. Resistance values through 100,000 ohms.

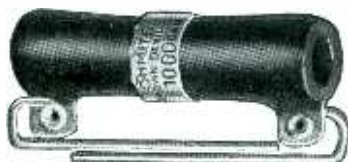

Do the job *right* with Ohmite! Ask your jobber or Write for Catalog 16.

**OHMITE MANUFACTURING COMPANY**

4845 Flournoy Street



Chicago, Ill., U. S. A.

**OHMITE**

Rheostats  
Resistors  
Tap Switches

THE *Eyes* HAVE IT!



Write for  
Descriptive  
Literature

*Solar  
Capacitor  
Analyzer*

Your eyes and the MAGIC TUBE...  
see all, know all, quick as a wink!

**SOLAR MFG. CORP.**

599-601 Broadway New York, N. Y.

McGRAW-HILL

**DIRECT MAIL LISTS**



As publishers of Radio Retailing for twelve years, McGraw-Hill is uniquely equipped to offer complete, authoritative Direct Mail coverage of the Radio Trade. Extreme accuracy (guaranteed 98%) is maintained on a daily corrected basis and the widest possible selections are available. Send for folder entitled "Hundreds of Thousands of Reasons Why" which describes how McGraw-Hill lists are built and maintained.

### What Selection Do You Want to Reach?

- Radio Wholesalers
- Radio Dealers
  - Larger Dealers
  - Smaller Dealers
- Occupational Groups
  - Automotive Stores
  - Central Station Stores
  - Hardware Stores
  - Etc.
- Radio Service Dealers and Service Men
- Geographical Selections
- Population Groups

Write for folder "Radio Trade Outlets" giving details on selections, state counts, prices, etc. . . . or ask any representative.



DIRECT MAIL DIVISION . . .

**McGRAW-HILL PUBLISHING CO.**

330 W. 42nd STREET

NEW YORK, N. Y.

# SHORTCUTS

## Improving Battery Sets

By Gerald Evans

It is desirable to keep the sensitivity of battery sets as high as possible, thereby getting the most possible gain with limited "B" battery power. A novel idea is shown herewith for improving sensitivity and selectivity. This idea may also be applied to a.c. sets which have lost pep.

As shown in diagram, a typical i.f. stage, energy is fed from the i.f. plate back to the grid or preceding plate cir-

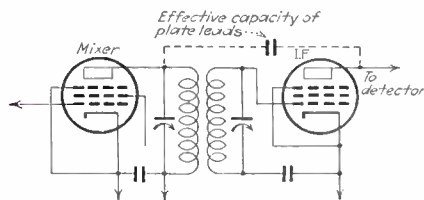

cuit through a small capacity. This can best be accomplished by lengthening the plate leads on the mixer and i.f. stages. Bring these leads close together to increase the capacity. If the set begins to oscillate when this is done, move the leads apart slightly. Both gain and selectivity will increase greatly by the added regeneration.

If a set is particularly insensitive, check the spacing between the i.f. coils. To adjust this spacing an oscillograph, signal generator and wobulator can be used to advantage. Increased coupling in the first stage will usually improve the gain without affecting the selectivity seriously.

## Crystal Pickup Repair

By E. Ola

Should the output of a crystal pickup fall off; before searching further dry out the unit.

Remove the cartridge from the arm and place it near a 25 watt bulb or stove. Care should be taken to see that the cartridge should not become too warm; it should be allowed to dry slowly. When the crystal is thoroughly dry it will be found to have returned to its original efficiency.

How often have you lost your temper trying to remove a badly corroded nut from a wet electrolytic? The next time slip out to your local auto supply store and pick up a spark plug wrench.

Incidentally, while you're there you might drum up a little business by telling him you service auto radios.

# UNDERWRITERS' LABORATORIES' APPROVED

# UL

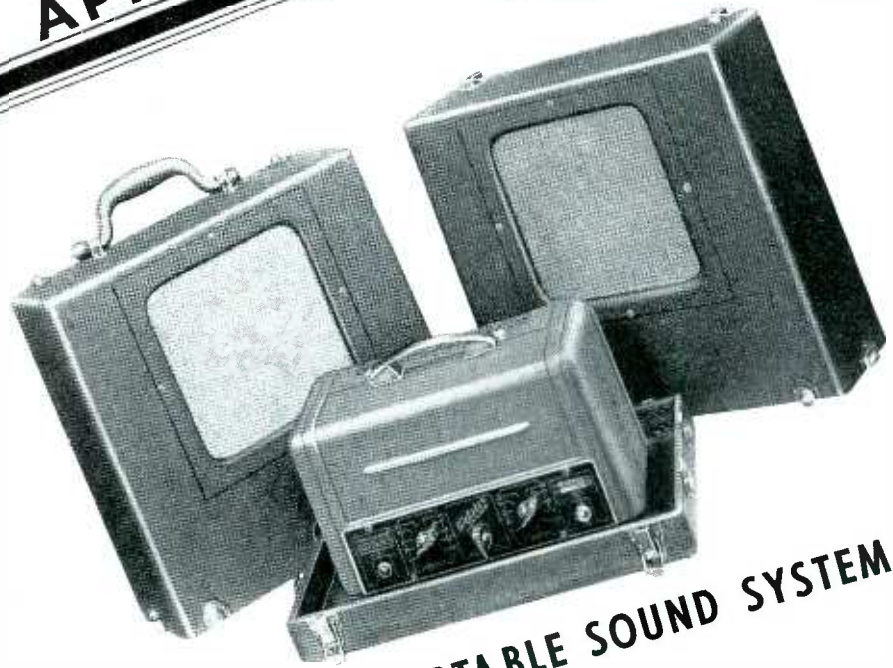

## IMPROVED DESIGN—PORTABLE SOUND SYSTEM 14 WATT OUTPUT

★ Tone Control

★ Tubes Completely Covered

★ Full Length Microphone

★ Inverse Feed Back Circuit

★ Screw Type Microphone Connections

Model PA-714 meets all the requirements of the Underwriters' Laboratories. It has been tested and approved by them. Using inverse feed back and other improvements this design has increased frequency range and an exceptionally flat frequency response. Up to its rated output distortion is kept within 2% and there is complete absence of thinness, mushiness or boom. A new Webster-Chicago design . . . . Amplifier is light with beautiful gun-metal finish, full length velotron microphone, 2 speakers . . . all fits in one case. Only standard parts are used throughout. Economically priced. Manufactured under license arrangements with Electrical Research Products, Inc., subsidiary of Western Electric Company, Inc., and American Telephone & Telegraph Company.

Write for Catalog and Complete Information

## WEBSTER-CHICAGO

The Complete Line of Public Address Systems, Sound Equipment Accessories  
Popular Priced Leaders in the Sound Field for Over 12 Years

WEBSTER-CHICAGO  
Section F-8, 5622 Bloomingdale Ave., Chicago, Ill.

Please send me more information on Model PA-714:  
Send Catalog.

Name ..... State .....

Address .....

City .....



## AUTO RADIO CONTROLS

Simplest of all to install

**THE ONLY CONTROL WITH ALL RATIOS SELF CONTAINED**

Works clockwise or counter-clockwise with same dial

Absolutely no back-lash. No cord, no cable, positive gear drive

No mutilating of instrument panel

100% universal in every way

No excessive stock to carry

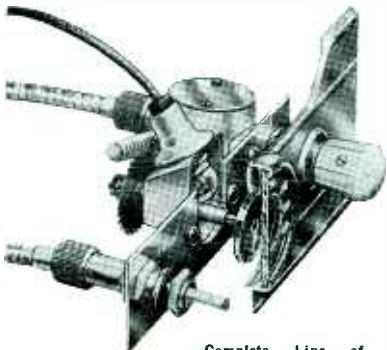

Complete Line of 1934-35-36-37 and 1938

Custom Matched Escutcheon Plates with Edge Illuminated Non-Glare Glass Dials.



Chrysler 1938



De Soto 1938



Chevrolet 1938

Send for new illustrated catalog no. 381

**STAR MACHINE MFG'S, Inc.**

1377 East Bay Ave., Bronx, N. Y. C.

Cable Address: STARCON—NEW YORK

## TRICKS

### AIR CASTLE ALL WAVE

Oscillator tube cuts on and off intermittently. Changing the tube, grid condenser, resistor did not cure the trouble. Check the tuning condenser for leakage in the oscillator section. If a resistance reading is obtained replace the condenser.

### GRUNOW 6D

Motorboating when volume control is turned to reduce volume . . . replace 1 mfd condenser connected to low end of volume control (end with black unshielded wire) and ground.

### GRUNOW 901, 902

This receiver employs a 6B7 in an unorthodox a.v.c. circuit. Special manufacturer's instructions must be followed in order to correctly align the set. In adjusting the a.v.c. trimmer on the underside of the chassis, located between the two pairs of i.f. trimmers, the correct adjustment is between the two peaks obtained on the output meter when the a.v.c. trimmer is turned counter-clockwise from the maximum.

## MONARCH ALL-WAVE SIGNAL GENERATOR

### ★ FOLLOW THE LEAD OF THE RECEIVER MANUFACTURERS!!

Monarch Signal Generators are world famous among receiver manufacturers and hundreds of them are used daily on production lines.

The Model 32 is built to the same standards but is designed particularly for service work.

Some outstanding features are:— 10 inch scale reads direct in frequency — AC-DC operated — fully shielded with additional complete shielding around output control, line filter and oscillator coils— additional front panel encloses pointer— does not project to catch on other objects and destroy calibration— low leakage.



- ac-dc
- 125 to 29000 k.c. all fundamentals.
- separate A. F. signal
- low leakage
- harmonic calibration to 60 megacycles.

**\$27.60**

See this instrument at your jobbers' and write us direct for literature on this and other Monarch test instruments

**MONARCH MANUFACTURING CO.**  
3341 BELMONT AVE. CHICAGO, ILL.

# TRIAD

## RADIO TUBES

*Insure*

## SATISFACTION

Used by Leading Set Manufacturers, and Preferred by Expert Servicemen

*A Profitable Line to Handle*

**TRIAD**  
**MANUFACTURING COMPANY**  
INCORPORATED

PAWTUCKET RHODE ISLAND

*The Quality Name in Radio Tubes*

HEADLINE NEWS FOR 1938

FEBRUARY

ST. PAUL, MINNESOTA

# ATR SMASHES VIBRATOR PRICES

**DRASTIC PRICE REDUCTIONS EFFECTIVE IMMEDIATELY ON COMPLETE ATR REPLACEMENT VIBRATOR LINE**

Examples of ATR price reductions:

ATR Vibrator	FORMER List Price	PRESENT List Price
303	\$3.50	<b>\$2.50</b>
324	4.00	<b>2.75</b>
326	4.50	<b>2.90</b>
521	5.00	<b>3.75</b>
536	5.25	<b>3.95</b>

New prices subject to normal discounts.

ATR Replacement Vibrators set new high standards of performance and construction. Greater life and reliability made



possible by new designs utilizing 3/16" diameter tungsten contacts.

ATR Vibrators are proven units of the highest quality, engineered to perfection. They are backed by more than seven years of vibrator design and research, development and manufacturing

**Write for your FREE copy of the new 1938 ATR Vibrator Guide and Name of your Nearest ATR Vibrator Distributor**

Manufacturers of D.C.—A.C. Inverters, Inverter Vibrators, "A" Battery Eliminators, and Battery Chargers.

**AMERICAN TELEVISION & RADIO CO.**  
128 EAST TENTH ST. ST. PAUL, MINNESOTA

—ATR pioneered in the vibrator field.

FREE—Win an ATR Auto Radio "A" ELIMINATOR on special introductory ATR vibrator deal. Full details sent on request.

Insist on ATR VIBRATORS. the Best by Test.



# TRICKS

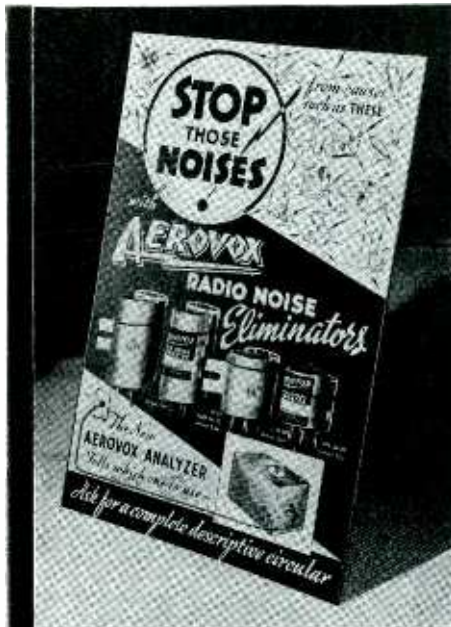

## Money Makers

• AEROVOX NOISE ELIMINATORS sell over the counter (note effective display card) or on service calls, to practically every set owner. Six different types to choose from. Two-color folder "Clear Reception" helps select right type. Simply plug in. And they do kill noises!



• AEROVOX NOISE ANALYZER indicates which noise eliminator to use and how to install. Handsome instrument which has all six types incorporated within its compact chassis. Plugs into line. Knob cuts in different types of filters. Dial indicates filter for very best results. Connection cords, clips and plugs, carried in compartment, for various trial connections. Only \$7.50 dealer's or serviceman's net cost.

**Ask** your jobber to show you the Noise Analyzer and Noise Eliminators. Then start cashing in on those noises. Remember, there's a buck or two in each noise! Literature on request.



### COLUMBIA C2

Intermittent frying noise . . . usually caused by defective insulation between primary and secondary of the r.f. coils. Very often a small amount of moisture in the coils will cause a similar trouble. Dry the set out thoroughly by placing near a source of heat for a few hours.

### CORONADO AUTO SET

Buzzes and crackles . . . poor internal connection in buffer condenser. Replace with new .01 mfd. 1600 volt unit soldered across plates of the 84. Buzzing may also be due to open grid return filter in output tube circuit. Connect .25 mfd. condenser between junction of two grid resistors and ground. This procedure eliminates vibrator ripple from the bias voltage. Condenser may be low voltage type.

### G.E. A-85

Low volume or no reception . . . check voltage across 3000 ohm first audio cathode resistor. If less than 2 or 3 volts replace electrolytic bypassing this section with 5 to 10 mfd. 25 volt unit.

### MIDWEST 16-35

Weak, accompanied by distortion on strong locals. Dimmer pilot light operates in reverse when using sensitivity control on locals . . . too much a.v.c. being applied to second i.f. stage. Diagram shows a.v.c. for this lead connected to high side of diode load resistor on 6 B7. Disconnect this lead and connect to tap on diode load resistor as shown in the diagram by the dotted line. This is the same tap supplying a.v.c. to the first i.f.

### MOTOROLA 65, 70 GOLDEN VOICE

Dead . . . Check dual .0008 condenser located near bottom of OZ4 Tubes.

### SPARTON 410

Microphonic howls and fading . . . check vitreous enameled voltage divider riveted to shielding panel. Rivets are used to secure the divider to the shield, also to make contact to the circuit lugs. To repair, solder resistor lugs to circuit lugs, also solder pumper to shielding. Since two of the divider terminals are insulated from the chassis, care should be exercised when soldering the lugs not to them to the shield panel.

## GIVE ALL TUBES A COMPLETE TEST

# on P.O.E. Testers

POWER OUTPUT-EMISSION

### Now Equipped With PLUG-IN TYPE RECTIFIER

#### (exclusive Triplett feature)

- Radio Tubes have three different functions: to amplify, to deliver power, to rectify.
- For Amplifiers (75% or more of all tubes) the Power Output Test is absolutely the final word in determining the worth of the tube. The Power Output Test in Triplett P.O.E. Tester simulates actual operating conditions in the radio receiving set.
- For Power Tubes, the Power Output Test determines the amplification factor. The Emission Test determines the power handling ability. Both tests are necessary to properly analyze these tubes, available only in the P.O.E. Tester.
- The function of the Diode is to rectify. Here the Emission Test only is made to determine the condition of the tube. P.O.E. tests these under both voltage and current load. The proper high voltages used in the P.O.E. Tester will detect any flash overs.

Model 1502 has shadow graph line voltage indicator. Neon inter-element short test made while tube is hot. Complete in quartered oak case. Dealer Price \$40.33  
Model 1503 same as above but also combines sepa-

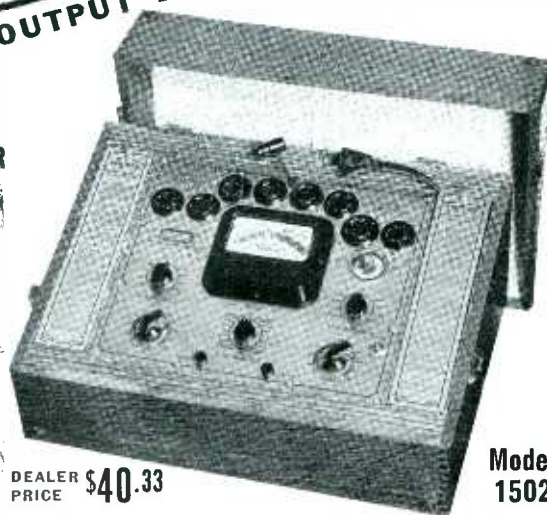

DEALER \$40.33  
PRICE

Model 1502

rate Universal Volt-Ohm-Millammeter, Condenser Tester and Decibel Meter. . . . In same case as Model 1502 . . . Dealer Price \$51.33  
Model 1504 same as 1503 but also combines Free Point Tester in side panels. . . . Dealer Price \$62.33



The Triplett Electrical Instrument Co.  
202 Harmon Dr., Bluffton, Ohio  
Please send me more information on — Model 1502;  
— Model 1503; — Model 1504. I am also interested in \_\_\_\_\_  
Name \_\_\_\_\_  
Address \_\_\_\_\_  
City \_\_\_\_\_ State \_\_\_\_\_



The New

**STANCOR**

**SERVICE GUIDE**

LISTING OVER **2800** RADIO SETS

WILL BE READY ABOUT  
**APRIL 1<sup>ST</sup>**

But Here's

**BIGGER NEWS**

With the Stancor Line, as shown in the new SERVICE GUIDE, you have the most complete coverage of service needs WITH A LESSER NUMBER OF TRANSFORMERS than with any other transformer line.

**14** Power Transformers  
SERVICE **1945** SETS

**10** Other Transformers  
SERVICE **400** SETS

**EXACT DUPLICATES**

(for 56 makes of radios)

and Stancor "Tailor-made" Transformers  
SERVICE ALL OTHER A. C. SETS



Your jobber will take your reservation for a personal copy of the new SERVICE MANUAL or—if you wish—drop us a post card and say "Save one for me."

**STANDARD  
TRANSFORMER  
CORPORATION**

850 BLACKHAWK STREET • CHICAGO

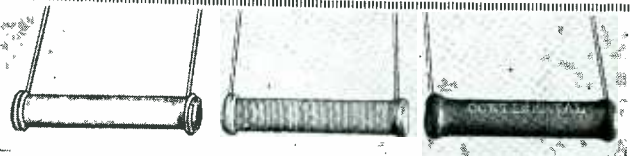

**A Better Wire-Wound Resistor!**

In the new 10-watt CONTINENTAL W10 wire-wound resistor, resistance wire of very low temperature coefficient is wound on a ceramic tube to which the leads are firmly bonded. The entire resistor is covered with a firm ceramic jacket, impervious to moisture, which protects the wire from corrosion and oxidation. The W10 resistor is inherently quiet and stable. It is especially suited for final stage bias in powerful amplifiers and as a bleeder resistor. And the list price is only 40¢, in values from 1 to 25,000 ohms, tolerance  $\pm$  5%. Available from your CONTINENTAL CARBON distributor.

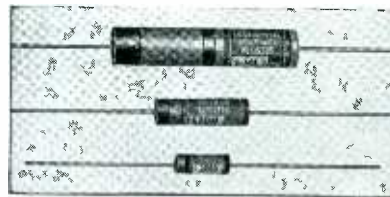

Bakelite insulated carbon resistors for auto and midjet sets: M3, 2"x13/32", 3 watt, 30¢; M1, 1"x9/32", 1 watt, 20¢; M1/2, 5/8"x7/32", 1/2 watt, 17¢. All values to 10 megohms.



Ceramic insulated carbon resistors for replacement: E2, 2"x3/8", 3 watt, 30¢; D2, 1 1/4" x 1/4", 1 watt, 20¢; G4, 1" x 1/4", 1/2 watt, 17¢. D2 is also available in 5% tolerance at 30¢.

**CONTINENTAL CARBON Inc.**

13902 LORAIN AVE., CLEVELAND, OHIO  
In Canada, Toronto, Ontario

**6 NEW MOBILE AERIALS  
By TOPSTREAM**

The Famous V type aerial for powerful performance and a complete line of whip and telescopic aerials to fit any car.

**GUARANTEED RUSTLESS  
NEW LOW PRICES**

**DYNAMIC PERFORMANCE**

JOBBERS, DEALERS—Write or wire for complete information. A few choice territories still open for Factory Representatives

**TOPSTREAM, INC.**  
1330 NICOLLET AVE., MINNEAPOLIS, MINN.

**What's Radio Retailing Say?**

If you read it in RADIO RETAILING it is true—and timely.

That goes for both the editorial and the advertising contents of this, the radio industry's recognized leading publication!

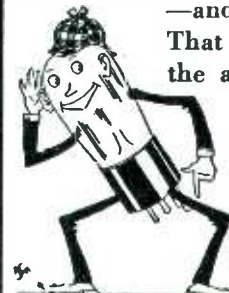

**RADIO  
RETAILING**

330 W. 42d St., New York, N. Y.

# ...MODERN EQUIPMENT

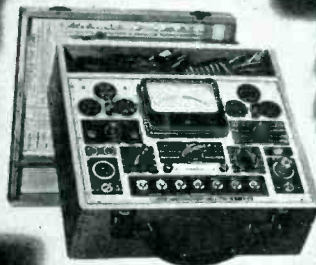

## ELECTROMETER SERIES 700 \$49.95

A complete laboratory of compact size for thorough tube analyzing and point to point set testing, incorporating 22 ranges for measurements of A.C. and D.C. voltages, current resistance, decibel and output.

Accuracy guaranteed by use of wire wound shunts of 1% tolerance and matched resistors of 1% tolerance.

Endorsed and used by leading engineering concerns, broadcast stations and institutions.

See "PRECISION" instruments at your distributors or write for literature.

## PRECISION APPARATUS CORP.

821 EAST NEW YORK AVENUE  
BROOKLYN, NEW YORK

# It's RADIART



## for AERIALS

in '38

Here's Why

DO YOU KNOW Why RADIART AERIALS are QUIET electrically?

Radiart-made Aerials feature the ONLY insulated mounting bolt on double-support cowl models. Radiart Aerials feature fully-shielded lead-in bolts. Radiart Aerials feature the POSITIVE ground washer.



by the makers of RADIART VIBRATORS

THE RADIART CORP. CLEVELAND, O.

# TRICKS

## MAJESTIC 44, 49, 194

Distortion . . . check for open or decreased capacity in electrolytic filter block.

## MIDWEST 16, 35

Distortion when volume control is turned more than  $\frac{1}{4}$  on . . . look for broken lead on .1 condenser connected from plate of first audio tube (76) to tone control.

## MOTOROLA 50, 60, 80

Intermittent operation . . . inspect the ground return lead inside the vibrator for loose or broken connection.

## MOTOROLA 65

Motor noise, especially on Ford V8 . . . Shield hot "A" lead connecting set to fuse block with double layer of copper braid. Ground braid at set end only.

## PHILCO 70

Distortion, fades out completely . . . replace .25 mg resistor in grid circuit of 47.

## PHILCO 80

Weak . . . Check mixer cathode resistor for change in resistance.

## WELLS-GARDNER 02AA

Volume control will not reduce volume completely, distortion at low settings . . . disconnect suppressor grids of i.f. tubes from series resistor (R13 in schematic) and connect suppressors to cathode. Add 5 mfd or more in parallel with C5, the cathode bypass for the 55 tube. These changes cause the tuning meter to deflect somewhat further to the right than usual, but this increase is not objectionable.

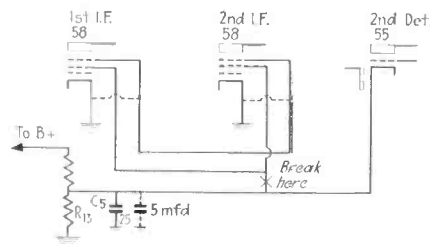

## ZENITH 134F

Noisy, weak . . . check both i.f. transformers with low range ohmmeter. If more than 10 ohms, replace transformer.

# FOR EFFICIENT TESTING...



## SERIES 840 L -VOLT-OHM-DECIBEL - MILLIAMMETER

including a 2500 VOLT A.C. and D.C. RANGE and a 1000 M.A. RANGE

Specifications  
 \* 5 A.C.—D.C. VOLTAGE RANGES from 0 to 2500 volts at 1000 ohms per volt.  
 \* 4 D.C. CURRENT RANGES from 0 to 1 amp.  
 \* 5 OUTPUT RANGES  
 \* 3 RESISTANCE RANGES from 0 to 10 meg. (provision for self-contained batteries).  
 \* 5 DECIBEL RANGES from -10 to plus 63DB

Net price less batteries and test leads. \$19.95

## PRECISION APPARATUS CORP.

821 EAST NEW YORK AVENUE  
BROOKLYN, NEW YORK

# NOW!

PUSH BUTTON TUNING  
for EVERY Radio

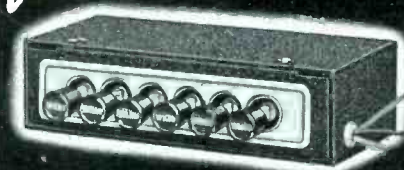

Every customer you have is a prospect for a push button installation. This device makes ANY radio a modern, up-to-the-minute push button set. Installed in a few minutes. Increase your profits by selling this compact, fool-proof unit! Write today for complete details!

Model B6 for 2 Gang Var. Cond. Receivers

LIST \$660

Serviceman's Net Price

\$395

Model B6JA for 3 and 4 Gang Var. Cond. Receivers

LIST \$725

Serviceman's \$425 Net Price

- Only 3 leads to connect.
- 6 Push Buttons.
- Compact  $5\frac{1}{2}$ " wide,  $1\frac{1}{2}$ " high,  $2\frac{1}{2}$ " deep.
- Adaptable for remote control.
- Manual control of receiver as well as push button control.
- Completely shielded by metal container.
- Unit complete with instructions, escutcheon, station tabs, hardware, etc.

## AUTOMATIC DEVICE MANUFACTURERS

Dept. 4B, 4243 West Ogden Ave., Chicago, U. S. A.

# INDEX TO ADVERTISERS

February, 1938

	Page		Page		Page
AEROVOX CORP. ....	63	INTERNATIONAL RADIO CORP. ....	43	READRITE METER WORKS. ....	59
(Condensers)		(Radio Sets)		(Test Equipment)	
AMERICAN TELEVISION & RADIO CORP. ....	62	INTERNATIONAL RESISTANCE CORP. 51		RIDER, JOHN F. ....	58
(Vibrators)		(Volume Controls)		(Service Manuals)	
ARCTURUS RADIO TUBE CO. ....	59	JANETTE MANUFACTURING CO. ....	43	SERVEL, INC. ....	26
(Tubes)		(Rotary Converters)		(Refrigerators)	
AUTOMATIC DEVICE MFGS. ....	65	J. F. D. MANUFACTURING CO. ....	58	SOLAR MANUFACTURING CO. ....	60
(Automatic Tuning Units)		(Auto Radio Antennas)		(Condensers)	
B-L ELECTRIC MFG. CO. ....	53	KEN-RAD TUBE & LAMP CORP. ....	43	STANDARD TRANSFORMER CO. ....	64
(Battery Eliminators)		(Radio Tubes)		(Transformers)	
BRACH MFG. CO., L. S. ....	43	KOOLROOM, DIVISION OF INDIAN PRODUCTS CORP. ....	44	STAR MACHINE MFG'S, INC. ....	62
(Antenna Systems)		MALLORY & CO., INC., P. R. Inside Front Cover		(Auto Radio Controls)	
BRIGGS & STRATTON CORP. ....	8	(Replacement Parts & Power Packs)		STROMBERG CARLSON TELE. MFG. CO. ....	2
(Gas Engines & Generators)		MONARCH MFG. CO. ....	62	(Radio Sets)	
CLAROSTAT MFG. CO. ....	53	MUELLER ELECTRIC CO. ....	58	TOPSTREAM, INC. ....	64
(Volume Controls)		(Wire Clips)		(Auto Radio Antennas)	
CONTINENTAL CARBON INC. ....	64	NATIONAL UNION RADIO CORP. ....	57	TRANSDUCER CORP. ....	57
(Resistors)		(Radio Tubes)		(Microphones)	
CROSLY RADIO CORP. Auto Radios	Inside Back Cover	NOBLITT-SPARKS INDUSTRIES. ....	18	TRIAD MANUFACTURING CO. ....	62
CROWE NAMEPLATE & MFG. CO. ....	44	(Radio Sets)		(Tubes)	
(Remote Controls & Escutcheons)		NORGE DIVISION, BORG-WARNER CORP. ....	29	TRIPLETT ELECTRICAL INSTRUMENT CO. ....	63
DELCO APPLIANCE DIV., UNITED MOTORS SERVICE ....	15	(Refrigerators)		(Test Equipment)	
(Auto Radio Sets)		OHMITE MFG. CO. ....	60	TUNGSOL RADIO TUBES, INC. ....	53
GALVIN MFG. CO. ....	5	(Resistors)		(Tubes)	
(Auto Radios)		ONAN & SONS, INC., D. W. ....	41	WARD PRODUCTS CO. ....	41
GENERAL ELECTRIC CO. ....	Back Cover	(Gas-Electric Plants)		(Auto Antennas)	
(Radio Sets)		PENNWOOD CO., THE. ....	41	WEBSTER-CHICAGO ....	61
GENERAL INDUSTRIES CO. ....	60	(Electric Clocks)		(Sound Equipment)	
(Phono. Motors, Record Changers)		PHILCO RADIO & TELEVISION CORP. 6		WESTON ELEC. INSTRUMENT CO. ...	55
GIBSON ELECTRIC REFRIGERATOR CORP. ....	32	(Radio Sets & Tubes)		(Test Equipment)	
(Refrigerators)		PRECISION APPARATUS CORP. ....	65		
GIRARD-HOPKINS ....	58	(Test Equipment)			
(Condensers)		RADIART CORP. ....	65		
HORTON MFG. CO. ....	43	(Vibrators)			
(Refrigerators)		RAYTHEON PRODUCTION CORP. ....	3		
HYGRADE-SYLVANIA CORP. ....	36	(Tubes)			
(Tubes)		RCA MANUFACTURING CO. ....	4, 22, 58		
		(Radio Sets, Tubes, Parts)			

---

SEARCHLIGHT SECTION  
(Classified Advertising)

Classification	Page
CATALOGS	67
<b>RADIO STOCKS</b>	
Burstein-Applebee Co. ....	67
Midwest Appliance Parts Co. ....	67
Radolek Co. ....	67

Although Radio Retailing takes every precaution to insure accuracy, we cannot assume responsibility for an occasional change or omission in the above index.

McGraw-Hill Publishing Company, Inc. Publication Office: 99-129 North Broadway, Albany, N. Y. Editorial and Executive Offices: 330 West 42d Street, New York, N. Y. Branch Offices: 520 North Michigan Avenue, Chicago; 883 Mission Street, San Francisco; Aldwych House, Aldwych, London, W. C. 2; Washington; Philadelphia; Cleveland; Detroit; St. Louis; Boston; Atlanta, Ga.

Now—A high-powered

# RADIO ENGINEERING LIBRARY

—especially selected by radio specialists of McGraw-Hill publications

—to give most complete, dependable coverage of facts needed by all whose fields are grounded on radio fundamentals

—available at a special price and terms.

THESE books cover circuit phenomena, tube theory, networks, measurements, and other subjects—give specialized treatment of all fields of practical design and application. They are books of recognized position in the literature—books you will refer to and be referred to often. If you are a researcher or experimenter—if your interest in radio is deep-set and based on a real desire to go further in this field—you want these books for the help they give in hundreds of problems throughout the whole field of radio engineering.

5 volumes, 3064 pages, 2000 illustrations

1. Glasgow's PRINCIPLES OF RADIO ENGINEERING
2. Terman's MEASUREMENTS IN RADIO ENGINEERING
3. Chaffee's THEORY OF THERMONIC VACUUM TUBES
4. Hund's PHENOMENA IN HIGH-FREQUENCY MEASUREMENTS
5. Henney's RADIO ENGINEERING HANDBOOK



**New**  
The Library now comprises a revised selection of books culled from latest McGraw-Hill publications in the radio field.

## Special Low Price Easy Terms

Bought singly, the five volumes comprising this library would cost you \$26.00. Under this offer you save \$2.50 and, in addition have the privilege of paying in easy installments beginning with \$2.50, 10 days after receipt of the books, and \$3.00 monthly thereafter. Already these books are recognized as standard works that you are bound to require sooner or later. Take advantage of these convenient terms to add them to your library now.

### McGraw-Hill ON-APPROVAL COUPON

SEND THIS ON-APPROVAL COUPON  
McGraw-Hill Book Company, Inc.  
320 West 42d Street, New York, N. Y.

Send me Radio Engineering Library 5 vols., for 10 days' examination on approval. In 10 days I will send \$2.50, plus few cents postage, and \$3.00 monthly till \$23.50 is paid, or return books postpaid. (We pay postage on orders accompanied by remittance of first installment.)

Name .....

Address .....

City and State .....

Position .....

Company ..... R.R-12-37  
(Books sent on approval in U. S. and Canada only.)

# SEARCHLIGHT SECTION

For Rates See Last Issue

## REPRESENTATIVE WANTED

REPRESENTATIVES WANTED. Nationally known manufacturer of a complete line of electronic devices including radio receiving tubes, power tubes, and tubes for amateur radio have several desirable territories to experienced representatives calling on the jobbing trade. Write giving full details, RW-116, Radio Retailing, 330 West 42nd Street, New York City.

## RADIO IN IT'S ENTIRETY!

"B-A" serves the trade with every need in radio—complete 160-page catalog of nationally known radio receivers, public address, parts, supplies and equipment. Orders shipped same day received.

COMPLETE CATALOG AVAILABLE

BURSTEIN-APPLEBEE CO. 1012-14 MCGEE ST. KANSAS CITY, MO.



## OVER 10,000 PARTS FOR VACUUM CLEANERS AND WASHING MACHINES

24-HOUR SERVICE!  
Attach this "Ad" to Your Inquiry and Receive  
Complete Catalog  
Manufacturers Factory Representatives  
MIDWEST APPLIANCE PARTS CO.  
2722 W. Division St. CHICAGO, ILL.

# STOP SEARCHING!

HERE IS YOUR  
"GUIDE"

LOWEST  
PRICES

SEND FOR YOUR COPY NOW!

GUARANTEED  
QUALITY

The new 1938 Radolek Radio Profit Guide contains complete showings of Radio Repair Parts, Radio Receivers, Public Address Amplifiers, Speakers, Microphones, Service Test Instruments, Radio Technical Books, Special Radio Tools. Leading Standard Brands! Everything you will ever need in the Radio Business all at Lowest Prices. You save money at Radolek!

FASTEST  
SERVICE

Every item you get from Radolek is guaranteed. It must be right or we make it right. Standard merchandise produced by leading Manufacturers with Radolek's guarantee added!

Everything in Radio promptly when you want it—and exactly what you want. Radolek's efficient organization backed by a huge stock of standard guaranteed quality merchandise insures you the fastest service in the Radio business. Twenty-five Thousand Servicemen customers depend on Radolek service and benefit by Radolek's LOWEST PRICES. Send Now for your copy of the Radolek Radio Profit Guide. It will help you make money.

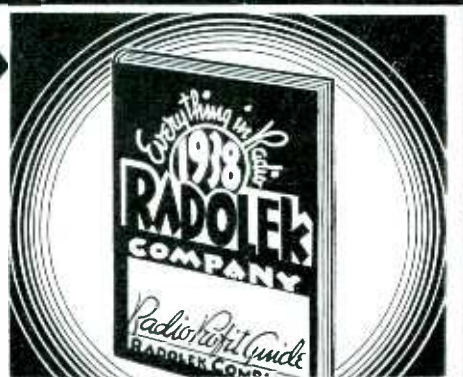

# RADOLEK

601 W. Randolph St., Dept. A-16, CHICAGO

Name .....

Address .....

Serviceman?  Dealer?  Experimenter?

## Rely on Radolek for "Everything in Radio"

# Audio Frequency...

## Crime Can't Stand Spotlights

Recently I picked up a copy of a local college paper and in it I saw an ad for a so-called "College Music Shop". It seems that at this particular college there has been formed a wholesale outlet for the convenience of already wealthy boys. In the ad were offered—radios at discounts as high as 40 per cent. IES lamps and all makes of electric razors were also shown. This astounded me and made me wonder why, if the students are allowed the cut, are not the public afforded the same privilege?

There are two active radio dealers in this town and I can't see just how they are expected to sell any sets with this competition staring them in the face as even the dealer does no better than 40 off. How this is allowed by reputable manufacturers is beyond me. If the dealer has no protection from such cutthroat competition as this we might as well fold up and crawl into a hole.

What can be done about this "crime", so to speak?

AMHERST, MASS. ROBERT RUSSELL

Read "5 Letters About Industrial Discounts", in the January issue. See, also, the news item in this present issue relative to a similar drive by Minneapolis associations.

## Liked Our Statistics

Permit us to congratulate you on the statistical section which appears in the January issue of *Radio Retailing*. We find this type of information extremely valuable in our business and feel that if it were possible to produce this information more often it would render a tremendously valuable service to agencies and manufacturers alike.

CHICAGO LORIN C. COLLINS  
*Lorin Collins & Associates*

## Can You Keep Such a Secret?

With the return of more used radios than the resales can take care of, I want to suggest that all manufacturers add 2 per cent or up to 5 per cent on resale price of all merchandise.

This amount could be used by such manufacturers to purchase old sets from stores at the rate of \$5 to \$8 for consoles and \$3.50 to \$5 for table models. And all trade-ins of this type could be destroyed.

It would be necessary to maintain absolute secrecy so that the public and some store salesmen had no knowledge of this as they might not use it correctly.

If store owners would use this idea right it would be an "out" for old junk.

We use 1½ per cent of our advertising budget for such a purpose with success. If all manufacturers had a set, a nice one, with a \$10 inflated list this could be used for trade-ins.

LONG BEACH, CALIF. H. E. WARD, JR.  
*Ward Brothers*

The idea you suggest has been tried in isolated territories. We won't say its not a good one. But we will say that its success has in the past been questionable. Perhaps the thought in your third paragraph is the answer. Keeping a secret in this business is no easy matter.

## Something In What You Say

In your December issue Jim Kirk censures radio service technicians for their lack of professional stationary equipment and fixtures. I would place the blame upon the manufacturers.

Not so long ago I mailed inquiries to two manufacturers, seeking prices and specifications of complete laboratory equipment. I was willing to spend five or six hundred dollars for fixtures. Both manufacturers sent me bulletins of their portable equipment, of which I have plenty.

When manufacturers produce stationary radio service equipment comparable in appearance with X-ray, diathermy and similar doctor's apparatus, for the radio technicians whose offices are in their homes, and impressive panelboard types for radio-men who operate from stores, I feel certain the better class of men in the service business will be glad to do business with them and will not resort to makeshifts, as they are now forced to do.

I'd like to contact an instrument manufacturer who has more vision than that displayed by those now in the radio business. I believe I can show him how to make some real money.

READER

Ok. Come out from behind those false whiskers. Send us your name and address and we'll guarantee to flood you with manufacturer mail.

## Praise, Gratefully Received

According to my files my subscription to *Radio Retailing* has a little over two years yet to go but, knowing what I do about the publication, I am sure I will want to subscribe to it for many years to come.

So, here's my money for an additional three years.

Wishing you many years of success.  
HOUSTON, TEXAS E. C. ROSEBERRY

I have received my first copy of your magazine. As a new subscriber I can truthfully say that I am more than satisfied. "Tricks of the Trade" arrived the same day and I am surprised at the great amount of information found in so few pages.

FALL RIVER, MASS. ADRIAN MELLO

I received my first copy of *Radio Retailing* a few days ago and read it from cover to cover at one sitting. I could not lay it down.

REINERTON, PA. HARRY H. MEASE

"Yeah, Lady. Your radio is ok now."

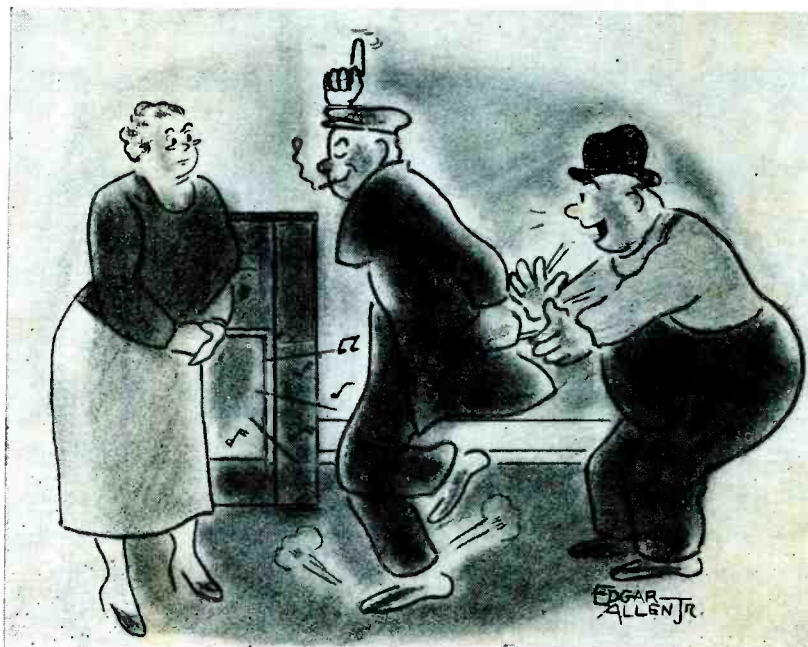

**MORE "DYNAMITE" FROM CROSLEY**  
**THE NEW**

**CROSLEY SAFETY-TUNE**  
 (PATENT PENDING)  
**FIVER-ROAMIO**

**THE LOWEST PRICED PUSH-BUTTON TUNING AUTO RADIO**

**As Easy To Tune As  
 Sounding Your Horn**

**\$24.<sup>95</sup>**

1. Highest signal to noise ratio in any 5-tube radio.
2. Full size, full wave, vibrator transformer for long life.
3. 5 Octal base tubes in standard circuit.
4. Antenna system designed to compensate for any type antenna.
5. Fully equipped with distributor compressor and generator condenser.
6. Easy to read, edge-lighted, slide rule type dial.
7. Full automatic volume control.
8. Low battery drain.
9. Sufficient volume to be heard at any speed.
10. Single unit, easily and quickly installed in any car.

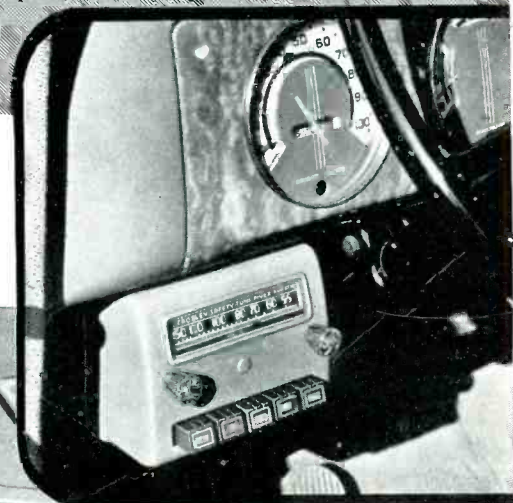

*(Prices slightly higher in South and West)*



**FIVER ROAMIO**

The famous Crosley Fiver Roamio with conventional tuning is also available at **\$19.99**

Last year Crosley startled the radio world with the most sensational value in the automobile radio field—the Crosley Fiver Roamio selling for \$19.99 . . . and car radio sales skyrocketed to a new high.

Now Crosley again scoops the industry with another record-breaking sales-leader—the Safety-Tune Fiver Roamio with automatic push-button tuning for \$24.95! It has marvelous improvements and sensational refinements. The safety-tuning mechanism is instantaneous. Here is the best in car radio reception and tuning at a price suited to the means of practically every car owner. Here's a real sales booster.

**THE CROSLEY RADIO CORPORATION - CINCINNATI**      **POWEL CROSLEY, Jr., President**  
 Home of "the Nation's Station"—WLW—500,000 watts—70 on your dial.

**YOU'RE THERE WITH A CROSLEY**

*The  
New  
1938*



# TOUCH TUNING RADIO

*The Sensational Model F-96*

Now Smashing  
Through to Still  
Greater Success

These are the Features  
**THAT SHIFT YOUR  
SALES INTO HIGH**

#### **G-E TOUCH TUNING**

The highest development in automatic tuning. Just press a button—that's all. There are separate buttons for your favorite stations—all at your fingertips. A touch of your finger and there's your program—perfectly tuned.

#### **G-E LOUVER DIAL**

It's "as easy to read as a ruler"—each scale calibrated in a straight line—a separate scale for each band.

#### **G-E VISUAL TONE AND VOLUME CONTROLS**

Enable even a child to adjust the receiver, visually, to the most desirable level for a station or program.

#### **G-E TONE MONITOR**

A radio circuit, of radical, new design, that corrects tone distortion. Enables you to distinguish the full range of notes of every instrument and voice.

#### **G-E "Custom-craft" CABINETS**

Superb custom craftsmanship in details of construction, acoustical design and selection of rich, rare woods and veneers.



**GENERAL**  **ELECTRIC**