

RADIO RETAILING

McGraw-Hill Publishing Co.

25 CENTS PER COPY



RADIO SELLING WEATHER
December • 1937

Step up Servicing Profits by making more repairs per day

Only MALLORY-YAXLEY
provide all three steps to profit

P. R. MALLORY & CO. Inc.

Three steps are necessary in successful, profitable servicing:

- (1) Accurate knowledge of the receiver circuit to permit prompt diagnosis of the trouble.
- (2) Easy availability of the required quality repair parts.
- (3) Complete information on the methods of making the correct installations.

Only Mallory-Yaxley give you the help you need at *all three stages!*

The Mallory-Yaxley Radio Service Encyclopedia provides circuit information—*analyzed and simplified* to save you time and effort.

Mallory-Yaxley Precision Radio Products are designed on a basis of straight-forward engineering in which penny-pinching plays no part. They are not mere duplicates of manufacturers' original equipment. Every feature contributing to universal application is added, so that the inventory required to maintain a complete stock of repair parts is amazingly small. This means that you can get the correct part you want *when you want*

it—there is no tedious waiting for delivery from some factory.

Mallory-Yaxley products are easy to use. They are neither tricky nor obscure in design. But—where unusual receiver construction necessitates special treatment in installing the replacement, you will find that the Mallory-Yaxley Radio Service Encyclopedia provides complete notes that tell you the simple, easy ways to make the required repairs.

Use Mallory-Yaxley Precision Radio Products—use the Mallory-Yaxley Radio Service Encyclopedia—and take full advantage of *the three steps to profit* that only Mallory-Yaxley provide!

And now . . . what will Mallory-Yaxley do next?

That's the question asked each year throughout the entire radio replacement field. And—it's a question that is always answered with *sensational advances* that promote more profitable servicing! What Mallory-Yaxley will *do next*, will enable you to *do more*—and *make more*—throughout 1938. Watch for the major announcement of the New Year!

Use

P. R. MALLORY & CO. Inc.
MALLORY
REPLACEMENT
CONDENSERS . . . VIBRATORS

P. R. MALLORY & CO., Inc.
INDIANAPOLIS INDIANA
Cable Address — PELMALLO

Use

YAXLEY
REPLACEMENT
VOLUME CONTROLS

RADIO RETAILING

DECEMBER, 1937

O. FRED. ROST Editor
W. MacDONALD Managing Editor
C. A. NUEBLING Technical Editor
T. H. PURINTON Assistant Editor
HARRY PHILLIPS Art Director

•
Tom Blackburn **George Tenney**
 Chicago San Francisco

H. S. Knowlton
 Boston

•
HOWARD EHRLICH
 Executive Vice-President

H. W. MATEER
 Manager

McGRAW-HILL PUBLISHING COMPANY, INC.

Publication Office
 99-129 North Broadway, Albany, N. Y.
Editorial and Executive Offices
 330 West 42nd Street, New York, N. Y.

Cable Address: MCGRAWHILL, New York
 Member A.B.P. Member A.B.C.

James H. McGraw, Jr. President
Howard Ehrlich Executive Vice-President
James H. McGraw Honorary Chairman
B. R. Putnam Treasurer
D. C. McGraw Secretary
A. W. Morrison Circulation Manager

RADIO RETAILING, December, 1937, Vol. 22, No. 12. Published monthly, price 25c copy. Subscription rates—United States and possessions, Canada, Mexico and Central American countries \$1. All other countries \$2 a year or eight shillings. Printed in U. S. A. Entered as Second Class Matter, September 8, 1936, at Post Office, Albany, N. Y., under the Act of March 3, 1879. Cable address "McGrawhill, New York." Member of A.B.P. Member of A.B.C. Copyright 1937 by McGraw-Hill Publishing Co., Inc., 330 West 42d Street, New York, N. Y.

Branch Offices: 520 North Michigan Ave., Chicago; 833 Mission St., San Francisco; Aldwych House, Aldwych, London, W.C. 2; Washington; Philadelphia; Cleveland; Detroit; St. Louis; Boston; Atlanta, Ga.

RADIO MONTH	By O. Fred. Rost	7
PHOTOSHORTS		9
IS OUR SHORTWAVE SELLING ALL WRONG?	By Zeh Bouck	12
PORTRAIT OF THE PARTS BUSINESS	By Jack Grand	16
STATEMENTS ON TELEVISION	By S. M. Ramsdell and W. S. Paley	18
YOU CAN BEND GLASS	By I. L. Cochrane	23
MODERN METHODS OF PAYING SALESMEN	By Fred Merish	24
RADIO AND REFRIGERATION DOVETAIL	By Russell Rich	27
WHAT YOU WANT WHEN YOU WANT IT		30
HOW TO KEEP FROM OVERSTOCKING	By Richard Gilbert	33
SEVEN STEPS TO A SALE		36
PREVIEW OF NEW RADIO MERCHANDISE		41
NEW ELECTRICAL APPLIANCES		47
DECEMBER NEWS		49
TECHNICAL TOPICS		57
CIRCUITS		58
IMPROVING THE SERVICE BENCH	By Jim Kirk	62
TRICKS OF THE TRADE		64
MICROPHONE AND PICKUP SPECIFICATIONS		71
AUDIO-FREQUENCY		76

SALES STATIC "I know I said someone would be home.
 My wife must have just stepped out to the store."





Only **LABYRINTH** Radio

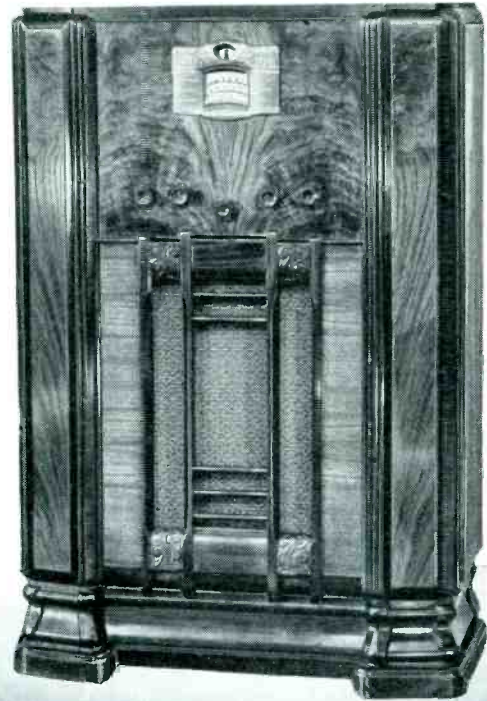

Gives You
"EAR-CONDITIONED" TONE

How the Labyrinth IMPROVES TONE

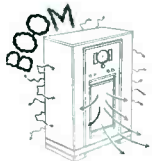

HERE IS THE TROUBLE—The empty cabinet space in back of the speaker causes "boom" and distorts the pure tone from the front of the speaker. Low notes are not reproduced in proper balance.

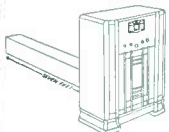

THE THEORY—A long tube of sound absorbent material would absorb unwanted sounds and reinforce bass tones. Such a tube would also "load" the loud speaker for better operation at loud volume.

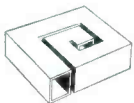

THE THEORY MADE PRACTICAL—Such a tube is out of the question. So Stromberg-Carlson folded it into a Labyrinth.

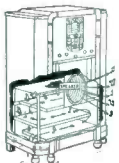

THE PATENTED LABYRINTH—The Labyrinth in one of the new Stromberg-Carlsons. It is the necessary baffle wrapped up, folded over and placed within the troublesome space in the cabinet. Patented in the United States and Canada.

Let a prospective buyer once hear Labyrinth Tone and no other radio quite satisfies. The Stromberg-Carlson Labyrinth which no one can duplicate without infringing many patents, does away with faults of ordinary radio reproduction. It gives tone which is pure—natural—beautiful—tone which is "ear-conditioned." For quality of tone—and for beauty of cabinet Stromberg-Carlsons lead the field. They range from \$57.50 to \$1050 (Eastern prices).

STROMBERG-CARLSON TELEPHONE MFG. CO., ROCHESTER, N. Y.

There is nothing finer than a

Stromberg-Carlson

RAYTHEON MEETS EXACTING STANDARDS OF

More Set Engineers

THAN ANY OTHER TUBE!



RAYTHEON makes tubes for the majority of licensed set manufacturers in the United States. For that reason, RAYTHEON tubes not only meet the exacting standards of more Chief Engineers than any other—but they must perform in more diversified circuits than any other tube!

Your RAYTHEON jobber gives you these same standard tubes in sealed cartons for exact replacement in *any* receiver!

Order RAYTHEON for greater permanent tube profits.



RAYTHEON

445 Lake Shore Drive, Chicago, Ill.
55 Chapel Street, Newton, Mass.

420 Lexington Ave., New York, N. Y.
555 Howard St., San Francisco, Cal.

415 Peachtree St., N. E., Atlanta, Ga.

“WORLD'S LARGEST EXCLUSIVE RADIO TUBE MANUFACTURERS”

SEE HOTPOINT



YOU CAN'T AFFORD TO PASS UP HOTPOINT!

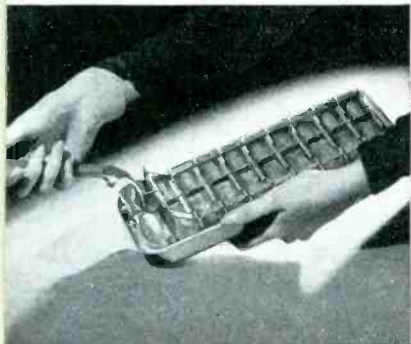

POP-ICE TRAY—Ice cubes—2 or a trayful—instantly! Ice in a trice. A real selling feature.

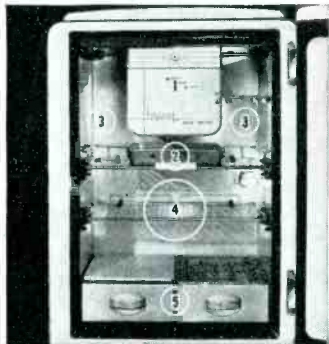

5 ZONES OF COLD—Individual zones of cold provide exactly the right temperature for all foods.

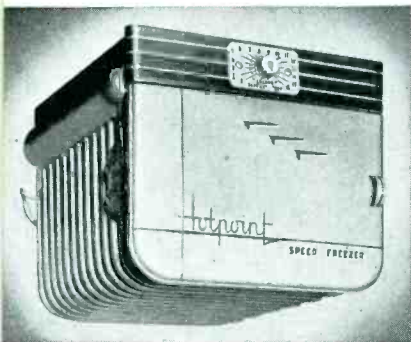

SPEED FREEZER—Faster freezing at lower cost. Foods are kept safe, crispy-fresh in a gently floating blanket of frosty air.



FLEXIBLE INTERIOR ARRANGEMENT—Bottom sections removable for storage of watermelon, large turkey or other bulky foods. Tip-up shelves adjustable—double storage capacity for unusually large bottles.

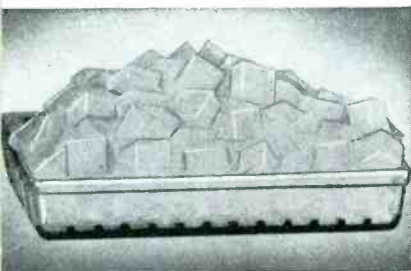

LARGE ICE CAPACITY—All the ice you want—when you want it! Hotpoint Speed Freezer gives you ice for all needs in half the usual time without fuss or waiting.

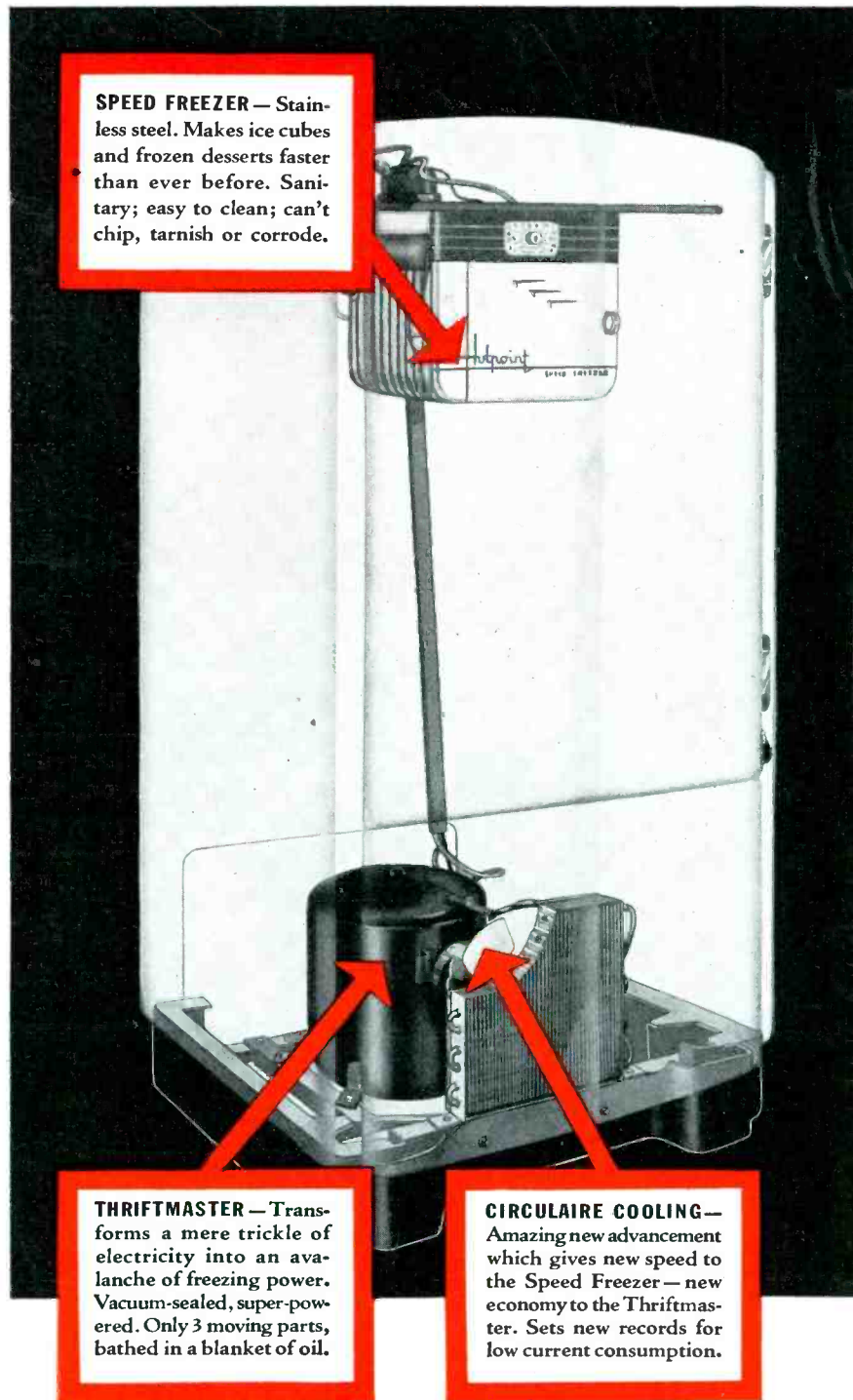

SPEED FREEZER—Stainless steel. Makes ice cubes and frozen desserts faster than ever before. Sanitary; easy to clean; can't chip, tarnish or corrode.

THRIFTMASTER—Transforms a mere trickle of electricity into an avalanche of freezing power. Vacuum-sealed, super-powered. Only 3 moving parts, bathed in a blanket of oil.

CIRCULAIRE COOLING—Amazing new advancement which gives new speed to the Speed Freezer—new economy to the Thriftmaster. Sets new records for low current consumption.

Hotpoint

THE NAME EVERYBODY KNOWS

ELECTRIC REFRIGERATORS

before you sign up for 1938

3 ADVANCED LINES OF REFRIGERATORS . . . NEW CIRCULAIRE COOLING PROVIDES 20% FASTER FREEZING AT EVEN LOWER COST!

STANDARD LINE

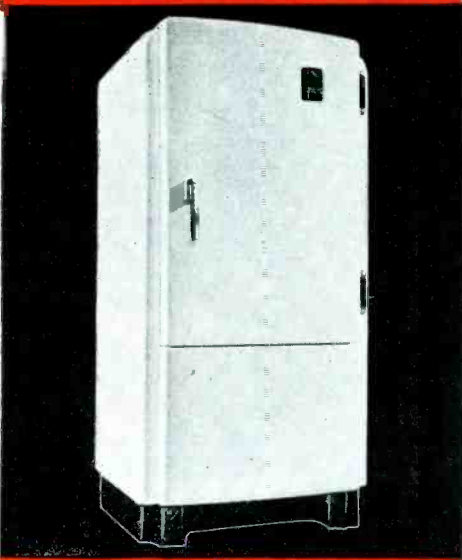

Streamlined beauty and sturdy Hotpoint dependability at exceptionally low prices. A four-model profit line designed for volume selling. Handsome one-piece, all-steel cabinets. Circulaire Cooling, Speed Freezer, Thriftmaster. Gleaming white baked Glyptal finish. Outstanding value.

DE LUXE LINE

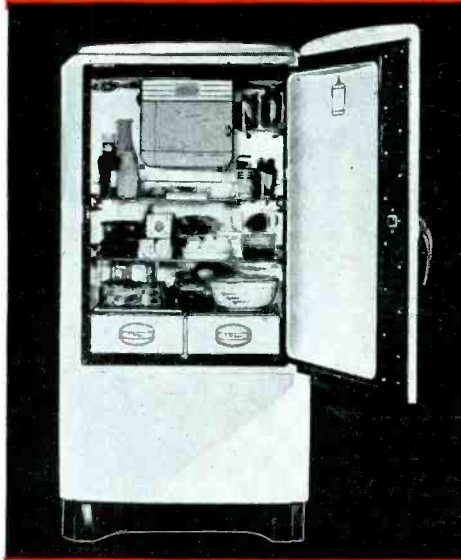

Smartly styled, all-steel cabinets, exclusive Hotpoint De Luxe features. Circulaire Cooling, Pop-Ice Trays, Speed Freezer, Thriftmaster. Five zones of cold. Gleaming white baked Glyptal finish; porcelain interior. Five outstanding models. Dependable Hotpoint quality in every detail.

IMPERIAL LINE

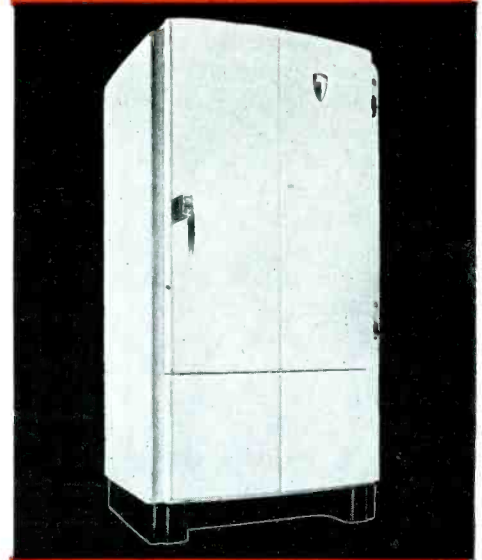

Aristocrat of refrigerators, with all of Hotpoint's advanced features and improvements, plus sales-compelling refinements and accessories. Five zones of cold, large ice capacity, Pop-Ice Trays, flexible interior arrangement, Thriftmaster. America's finest refrigerators. Six superb models.

YOU'LL MAKE MORE MONEY WITH HOTPOINT!

DON'T MOVE — until you have seen the sensational new Hotpoint Refrigerators for 1938!

New beauty, new style, amazing new performance that will make refrigerator history — and more money for you!

3 complete lines — 15 striking new models — in sizes from 3 to 16-cubic foot capacity.

Circulaire Cooling, the revolutionary new principle, provides 20% FASTER

EDISON GENERAL ELECTRIC APPLIANCE CO., Inc. 5680 W. Taylor Street, Chicago, Illinois

FREEZING at even lower cost.

Pop-Ice Tray — Releases ice cubes — “2 or a trayful.” Ice in a trice — plenty of it.

5 Zones of Cold — the exact temperature for all foods.

Thriftmaster and Speed Freezer — talk of the industry in '37 — improved to an even higher standard of trouble-free performance for '38 — and a score of *plus* features to help you sell!

So don't jump the gun! See Hotpoint before you sign. Put the complete line to work for you. Get ready for the biggest profits in your career. Call or write your nearest Hotpoint distributor today!



GET THE FACTS

FROM YOUR HOTPOINT DISTRIBUTOR!

ELECTRIC RANGES • WATER HEATERS
SANI-SINKS AND DISHWASHERS
WASHERS AND IRONERS



**A NEW INDUSTRY
IS BORN!**
Read the Amazing Story of This
Group of Scientists Who Crossed
the Last Frontier of Wireless
Communication!

NOTHING in years has fired the imagination and enthusiasm of laymen and merchandisers more than the possibility of a foolproof method of instantaneous wireless intercommunication. But, unfortunately, many concerns in an endeavor to capitalize this enthusiasm and need, began the manufacture of systems which failed to meet either the engineering requirements or those of modern business.

Intercommunication systems fell into the category of "unproven merchandise", yet the need for a practical, foolproof wireless intercommunication method continued to exist.

From the beginning Intercommunication has been a "step child", a by-product of Radio Manufacturers who have made them merely to increase their volume without consideration of the special characteristics and requirements of the art. Such practices brought intercommunication systems into disrepute.

But today, after a long period of exhaustive research and experiments and the expenditure of thousands of dollars for these purposes, a group of Electronic and Sound Scientists announce the birth of a New Industry! It is founded upon proven principles as distinct and exact in their science and application as those in any industry serving the specialized requirements of modern business.

Radiofone Corporation has been organized for permanent existence. It is a manufacturing and merchandising enterprise dedicated to the principle of manufacturing wireless devices to meet the specialized requirements of Intercommunication and to merchandising these products thru accepted, ethical channels.

The opportunities in this New Industry as visualized in the minds of our Founders are practically

limitless. The genius of scientists from Europe and America has been pooled to make possible at last, the finest wireless Intercommunicating systems yet developed . . . systems which have attained such engineering perfection that they may be classed as "PACKAGE MERCHANDISE."

In this Complex, modern age where time and speed are always of the essence, the social and industrial applications of wireless intercommunication in homes, schools, hospitals, factories, offices, etc., make the use of Radiofone wireless communication systems indispensable.

Inquiries are invited from responsible merchants who are willing to cast off the yoke of skepticism and are ready to grasp the opportunities for profit in this New Industry. Your request for additional detailed information will receive our prompt attention.

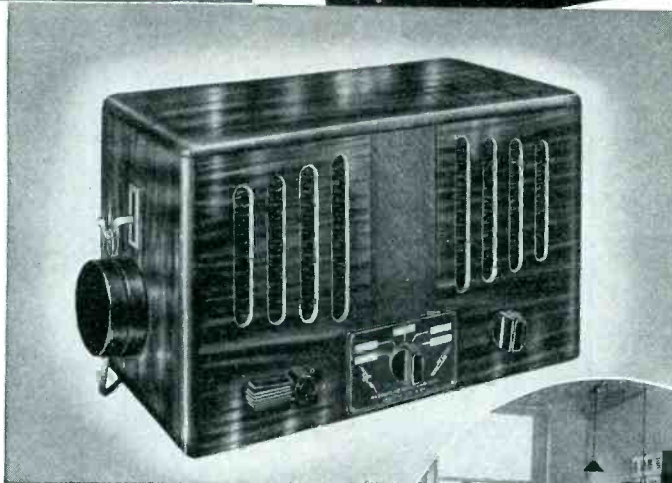

The multiple, selective, wireless, AC Radiofone is the only system of its kind on the market. It operates merely by plugging each station into an AC outlet. It consists of 1 Master station (model MM-O) and 5 remote stations (models MM-1, MM-2, etc.) for use on 110-120 v. AC, 50-60 cycle power lines. The Master can communicate with remote stations at will, selectively while remote stations can communicate with the Master station. All units are equipped with automatic loud speaker cut-off earphones for privacy. They will communicate from room to room, floor to floor and building to building in the same general plant. Absolutely no bridging or condensers are needed for the operation of Radiofones regardless as to the number of circuits or phases existing in any building.



View of part of the Radiofone Corp. Laboratory where thousands of dollars worth of modern equipment is available to check all components and every step in the manufacture of Radiofones to assure perfection in the finished product. Here Electronic Scientists are constantly evolving new principles and methods to advance the art.



RADIOFONE CORPORATION

136 WEST 22nd STREET
NEW YORK, N. Y.



Cable Address
FONERADIO, NEW YORK

The

RADIO MONTH

Remember Major Objective Reported in preparation by retail trade associations are several trade-in allowance blue-books, a sign that the dealer is now fully aware that without some accepted standard on trade-ins all anti-price-cutting effort falls to the ground. (Our own nationally applicable Bluebook figures, suggested in June, apparently started it all.)

Studying the recommendations of many dealers, striving to establish locally figures which suit all members, association committeemen are torn between high allowances lobbied for by merchants doing a volume business on slim margins and lower values preferred by conservative houses concerned with making a reasonable net on less dollar business.

To the already numerous words of advice no doubt flooding committeemen from among their own association membership may we add ours? The primary object of any bluebook schedule must be to reasonably satisfy the consumer without materially nicking the average dealer's gross margin on new radios. Clearly, these are not so wide that a man with average overhead can afford to give much away. And turnover of a used set at a profit is, at best, very much of a gamble.

No Log Jam All along the sales front we have heard talk about huge overstocks of radio sets. At some points we saw accumulations of sets that would constitute overstocks *at any other season of the year*. Those accumulations would be a serious handicap IF manufacturers had kept on making sets AFTER stocks began to back up into their warehouses BUT—they DID NOT.

Production totals as compared to last year actually began to taper off in September and have continued to decline so that November and December totals will drop below 1936 levels BUT retail radio

sales need be NO BETTER than last December to *absorb all the sets that are actually in the hands of* distributors and dealers, and take a good share of manufacturers' stocks.

Indications are that in general retail sales *will* reach last year's December totals, but—realization rests in the lap of the Gods.

New Models Click A field check-up among distributors and dealers indicates that the 1938 models with outstanding new features such as slanting front, push-button or phone-dial tuning, some chair-sides, have clicked with the public better than was expected and in fact too well.

Advertising by manufacturers was so effectively geared to those new features, has focussed public attention so completely on them, that in the minds of many people those models that do not include such features are considered outdated, obsolete, old fashioned.

Only prompt action on the part of manufacturers, distributors and dealers can avoid the obsoleting of thousands of brand new 1938 conventional consoles, now in stock, and what it will take is just simply good old fashioned merchandising technique and salesmanship.

Good salesmanship has enabled certain automobile makers to sell 90% of their output WITHOUT automatic transmissions while they played up that feature in their advertising—certainly then, the radio industry can sell that big stock of conventional consoles while advertising the various new but not necessarily essential features.

Stick Forward The tailspin of retail sales with which we were seriously threatened was arrested through encouraging resumption of consumer buying late in November and now smart retailers are pushing their sales back to higher levels via the well-known route of

aggressive promotions and intensive sales effort.

After consumer sales threatened to crash to near-depression lows the reversal has carried totals upward again so that at this writing retail sales are running well ahead of the same period of last year. Trading centers in the Northwest, South and Southwest are reporting increases that range up to 15% while in the more conservative East and frugal New England increases range up to 5%.

This means that Christmas buying of radio sets and appliances should reach at least 1936 levels but dealers must remember that competition for the consumers' dollars is extremely keen.

Wanted, Political Pioneer To the mayor, state or national legislator who introduces and pushes through an ordinance or law compelling owners of motor buses to filter radiated radio noise out of those machines will go a vote of thanks from the many users of shortwave receivers located near main roads.

Buses are really hell-on-wheels when it comes to generating radio noise, frequently interrupt programs coming in on radios more than a block away. Particularly around the wavelengths where new ultra-high-frequency police and fire department transmitters operate is such interference prevalent. And television, particularly, will be materially retarded by such racket.

Ignition noise radiation is easily and cheaply cured. And busses, operating under franchise and thus public utilities, should be the first to stop being a public nuisance. After that attention can be focused on trucks and passenger cars.



EDITOR

Here's Where You Can Increase Sales

Now

FARM INCOME RISES 743 MILLIONS IN NINE MONTHS

Washington, D. C., Nov. 9.—(AP)—The bureau of agricultural economics reported today that American farmers received approximately \$743,000,000 more from the sale of principal farm products, and from government payments during the first nine months of 1937, than during the same period last year.

from Chicago Tribune,
November 9, 1937

LATEST government releases from Washington report that American farmers have more money to spend today than at any time since 1929 . . . farm income up 743 millions the first nine months of 1937.

There's the market to shoot at. Remember, 5 out of every 6 American farms have no electric service — so it's gasoline powered washers, as well as other gasoline powered equipment, that they are going to buy.

Government reports also indicate that rural electrification is moving slowly — and it will be many years at least before any material number of additional farms will be on hi-lines.

So there's your market — but these orders won't come to you — you'll have to go after them. By all means display models of gasoline powered equipment on your floor and in your windows — demonstrate them to every customer who comes in your store. Orders will be easier to get if the equipment you sell is powered by a Briggs & Stratton motor.

One million of these world-famous 4 cycle gasoline motors, now in use on American farms, have earned the respect and confidence of your farmer prospects . . . Sell where the money is — out on the R. F. D. routes!

BRIGGS & STRATTON CORP., Milwaukee, Wisconsin, U. S. A.

This Selling Statement for the Prospect Who Expects a Hi-Line Shortly

There is no need for him to wait for the conveniences and comforts of modern appliances. He and his family can have them right now.

Then, if the hi-line comes, these gasoline powered appliances can be changed over for electricity at small expense, and the gasoline motors used elsewhere on a great many jobs on the farm.

A Timely Suggestion: Now's the opportune time to reach your farmer prospects. See your Postmaster about placing advertising matter — furnished you by manufacturers of gasoline powered equipment — in every R. F. D. box in your territory — without addressing or stamping.





FIGHT FIRE with SOUND

HIGH in the air on long ladders, their vision obscured by smoke, Chicago's firemen yet speed unerringly to each new outcropping of flame, quench it with high-pressure hose or chemical before it gets out of hand.

For on the ground, out in the clear with an unobstructed view of the entire conflagration and adjacent property, in a perfect position to coordinate the efforts of his men, is fire marshal M. J.

Corrigan. And with him is a light truck equipped with a 100-watt sound amplifier, speakers capable of carrying more than a mile, six arc lights for night, a motor generator eliminating the need for external power.

To the tops of the windy-city's tallest buildings goes Corrigan's voice, directing, encouraging. Truly, a novel, new use for sound. And one that once again suggests sales possibilities.



SETS THAT PASS IN THE NIGHT

Rapidly from set to set around the main salesroom customers who go to the John Breuner Company of Oakland, California, are piloted, until they express preference for a certain brand. Then, into one of seven soundproof rooms where this line is

featured they go. Should other makes again come up the solicitation is not interrupted. The salesman simply flags a team-mate on the floor, has him slide the model in question in. A. F. Dahnert and Val Wilson show how it is done



BELIEVES IN SIGNS

To the sign seen just over his tester August D'Amico of Milwaukee's Modern Radio Sales attributes much extra tube business. It induces many people who would ordinarily replace just one or two to buy a whole new set, seems more effective than when the statement is made verbally. A box of old tubes nearby helps prove others replace all

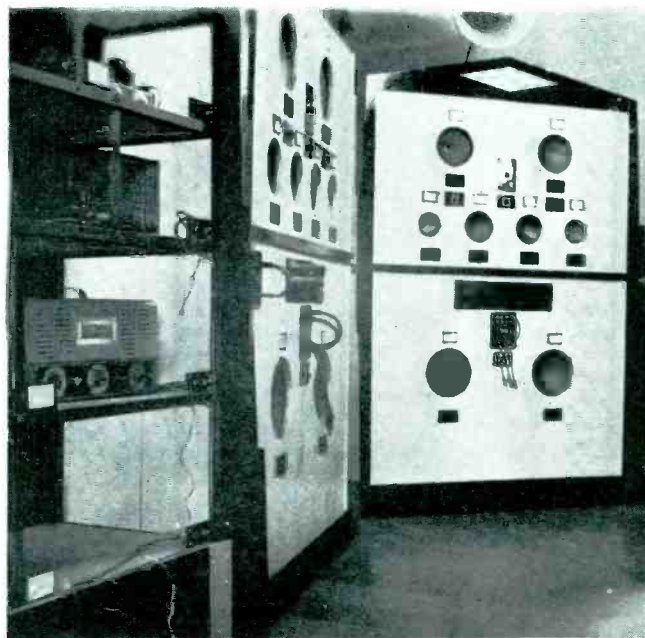

SEE, COMPARE SIMPLY

Speakers are more readily sold, according to M. N. Beitman of Chicago, when they are displayed simultaneously on large baffle panels, rigged so that they may be quickly switched one after the other to a given amplifier. Sales are frequently swelled by connecting two or more units at once, showing the customer how this improves realism

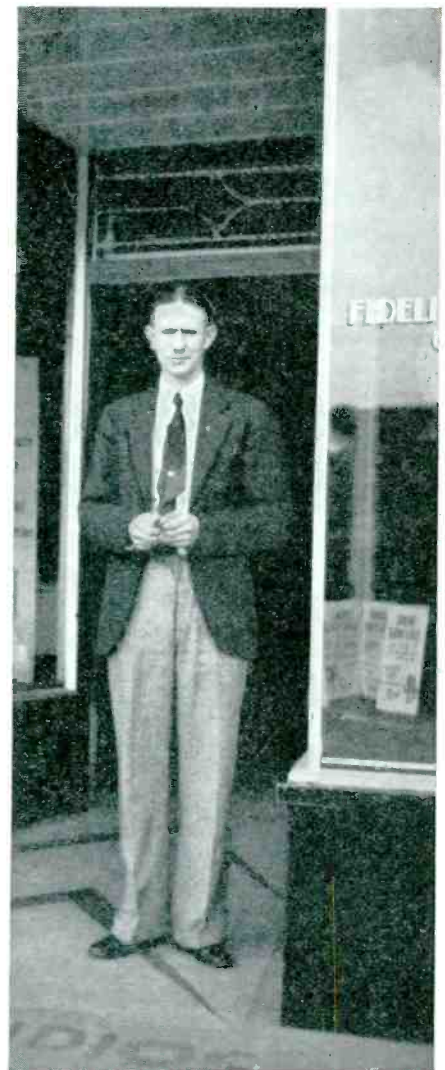

PRACTICAL PUBLICITY

At once a means of advertising and a test laboratory for auto-radio antennas is this unique car maintained by E. A. Guderian of San Francisco. Equipped with a cream-colored set mounted out front, plus every common type of pickup device, it attracts attention, permits comparative demonstration

KITES SALES

In came 254 people with kids when W. W. Cowley of Salt Lake City's Radio Studios broadcast the message: "Bring in your tubes for testing and receive one of our kites." Novel, effective and cheap were these premiums made of paper, sticks, twine



MOUNTAIN COMES TO MAHOMET

To the prospect's front door Peoples Outfitting Company of Detroit brings its stock of radios, refrigerators, cleaners, washers in this modern truck-and-trailer. Outside, appearance disgraces no residential district. Inside, display is quite as effective as it would be off wheels, selling and demonstrating space uncramped

RADIO RETAILING, DECEMBER, 1937



IS OUR

SHORT WAVE

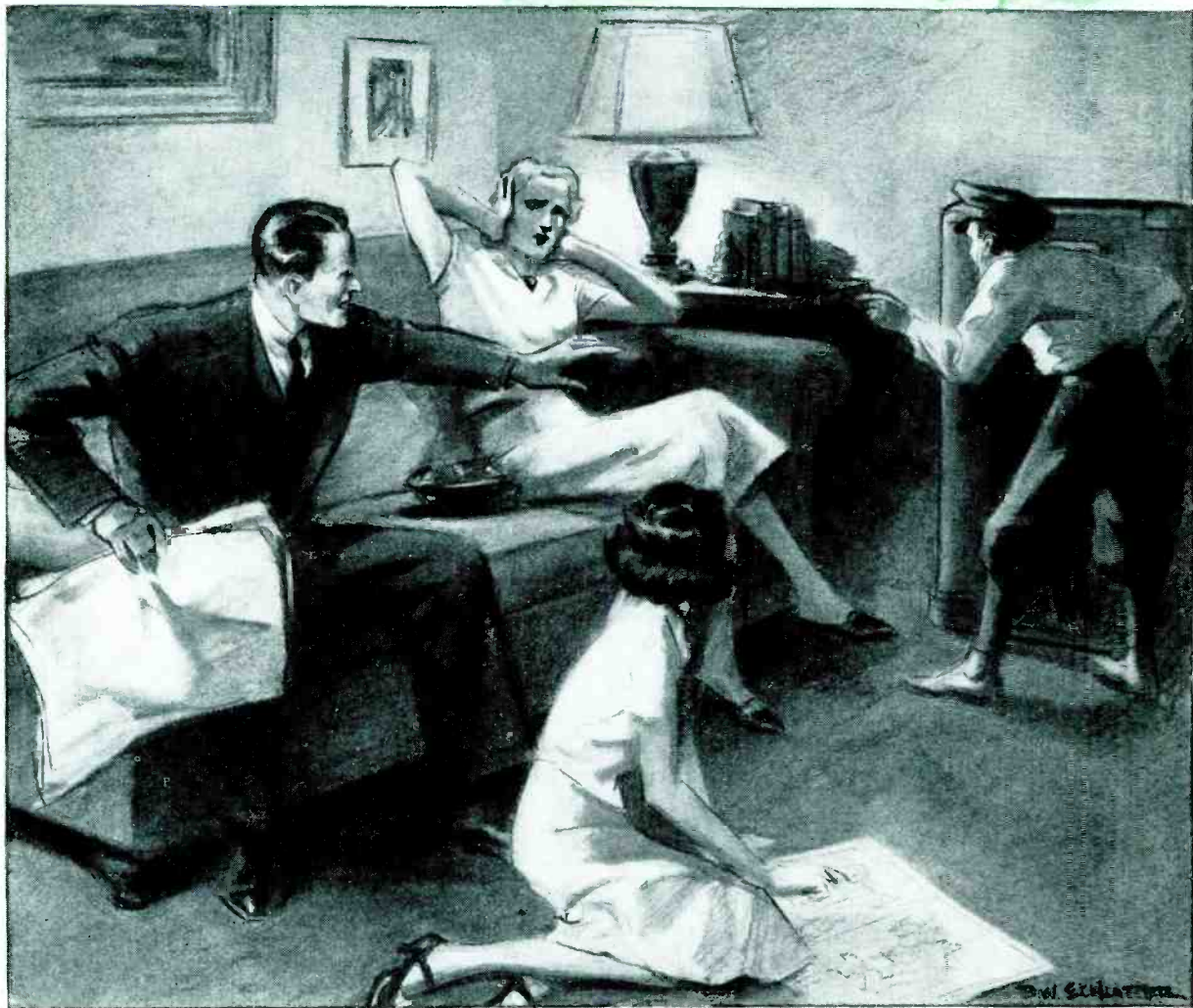

NOVELTY RARELY WEARS WELL—We've been headlining thrills . . . police-calls, aircraft, ships at sea, distance merely as "dx" . . . so long that the public erroneously assumes that shortwaves have little lasting entertainment value

By ZEH BOUCK

SELLING ALL WRONG?

THE present writer is paid for listening to short-wave broadcasts. It happens to have been one of his jobs for the past fifteen years. The novelty, if it ever existed for him, wore off a decade ago. And yet something remains—a stable, definite interest not wholly stimulated by the remuneration he receives for listening—an enthusiasm that is intimately akin to his approval of any program, foreign or domestic. I like the symphonic music by the Ford and General Motors orchestras. I like Charlie McCarthy and occasionally One Man's Family. Similarly, I enjoy the BBC Empire Orchestra, Geraldo and his orchestra (Geraldo plays 150 selections in one hour) and the Howard Rose dramatic productions via Daventry.

The short-wave feature of a modern radio receiver has been overstressed as a novelty. Sold as a novelty, it is inevitable that some prospects not interested in novelties are lost. Bought as a novelty, the high-frequency bands will be tuned as a novelty. And novelties are notorious for their ability to wear off. Even when so used for the benefit of some friend, the demonstration will rarely be impressive enough to interest seriously the listener in a similar feature.

Aircraft! Amateur Stations! Police!

Aircraft broadcasts are characterized by about the same amount of

entertainment value as a contract bridge post mortem. Amateur conversations are vaguely reminiscent of a phonograph record with a crossed groove, and of similar interest to anyone but an amateur. Police broadcasts are distinctly a novelty and hold no permanent entertainment value except for some Milquetoast who derives therefrom a vicarious satisfaction at some drunk beating up his wife in a third floor rear.

True, every manufacturer plays up foreign reception! But mainly as a novelty. Listen to Big Ben—the laugh of the Kookaburra bird! Thrilling foreign reception! Once heard, Big Ben possesses little virtue other than accuracy over a clock in the village steeple. As for the Kookaburra bird, its risibilities provide little justification for getting up before the chickens.

Thrilling foreign reception? The

word “thrilling” itself immediately puts foreign reception in the novelty class. Actually, there is little of an actually thrilling nature in ninety or more per cent of foreign reception. One excepts the dx addict, of course.

Rather, the emphasis should be placed on the excellent program material which can be consistently received from a few “foreign locals,” such as Berlin and London. Employing super-power transmitters, with simultaneous transmissions beamed in different directions, these stations can be received with considerable reliability. There are other countries too—notably France, Holland and Italy—that broadcast material of high entertainment content and which can be received consistently enough for enjoyable reception. The short waves should be considered merely as an extension of the regular broadcast band, and DJD or GSH thought of and referred to as broadcasters of genuine entertainment, in the same category with WEAF, WGY, etc.

There is no class of listener to whom the entertainment value of this sort of short-wave reception will not appeal.

First, there is Mr. and Mrs. Average Citizen, located in the average suburb, and interested in Amos 'n' Andy, the Goldbergs, light classical music, an occasional good voice and jazz. The fact that there are stations on Band C that will provide him and her with similar, highly enjoyable fare will be of more interest than irrelevant ballyhoo a n e n t Police, Amateur, Aircraft, etc. And for Mr.

and Mrs. Av. Citizen living at some distance from the larger stations, the short waves contribute an additional utility in supplementing the often un-



ENTERTAINMENT OVERLOOKED — From at least four “foreign locals” and several American shortwave stations with reasonable consistency come quality programs the average consumer could regularly enjoy

satisfactory long-wave outlets for such favorites as Ma Perkins and Mary Marlin with our own s-w stations carrying the same programs. Reception from a given program from a short-wave station located a thousand miles away is often superior to that available from a chain long-wave station a hundred miles or so distant, poor reception in the latter case usually being due to selective fading or inadequacies in transmission. If the short-wave station is intimately associated with the key station, the quality may be superior even to that of a local station carrying the program because of poorly compensated land-line frequency losses at the nearby outlet.

There is also a class of folks—larger than the broadcasting moguls suspect—who agree with some prominent educators that a considerable percentage of our domestic fare is drivel. Such people are entitled to their opinions—and, incidentally, they are rarely interested in novelties. However, they would be definitely intrigued by the assurance that there is escape for them from Pepper Young's *Family and Mrs. Wiggs of the Cabbage Patch*—that surcease from these programs exists on the short waves, where they can listen to a highly dramatic presentation of the *Merchant of Venice* via Daventry, "As I See It," by Ian Hay, grand opera from Rome, a symphonic concert from Berlin, a well-spiced and sophisticated British farce without being asked to buy a single box of soap chips, tear off a coupon or draw so much as a facsimile. Broadcasts of similar appeal to those who do not find the average commercial programs over-much to their tastes are scheduled daily from WIXAL, Boston. To this type of listener, the foreign newscasts hold particular interest—Daventry with its reasonably impartial survey of international affairs, Germany and Italy with their naive and obvious propaganda.

The question of how best to emphasize the entertainment value in the more consistent short-wave broadcasts arises. Demonstrations will help of course, as well as will the usual sales argument modified to stress the points adduced above.

The manufacturer has already put across the novelty angle in the pamphlets and other literature with which you are supplied. These should be supplemented with other material, and we suggest keeping on hand a file



AUTHOR—" . . . novelty, if it ever existed for him, wore off a decade ago. And yet something remains . . . a stable, definite interest . . . an enthusiasm that is definitely akin to his approval of *any* good program, foreign or domestic"

of the program schedules supplied by foreign stations. This should be conspicuously displayed, on counter or radios, where it can be conveniently thumbed by the casual visitor and prospect.

Best among such sheets is the BBC EMPIRE BROADCASTING which is published weekly. It runs twelve pages, is attractively made up and illustrated. In addition to advance schedules it contains considerable material on programs and personalities written in a light, interesting style. A year's subscription costs \$2.40, and the address is Broadcasting House, London, England. This is the only service for which a charge is made. Other bulletins are supplied free-of-charge, and can be obtained from the following addresses: Germany—Dr. Schroeder, Kurzwellender, Charlottenburg 9, Berlin; Italy—E.I.A.R., 5 Via Montello, Rome; Japan—Broadcasting Corp. of Japan, Hibiya Park, Tokyo, c/o Overseas Section; France—Ministry of Posts, Telegraphs and Telephones, Broadcasting Department, Blvd. Haussmann, Paris; Holland—Edward Startz, PHOHI, Hilversum; Boston—WIXAL, University Club.

The above has been written with relatively little consideration of the dealer sales angle. It exists, of

course. Even the cheapest of the all-wave receivers can perform with sufficient adequacy to justify the novelty point-of-view. However, this is decidedly not the case when a prospective customer has been sold on the short waves as a *supplementary and practical source of radio entertainment*. A good receiver, in the higher profit brackets, is in order. The a-v-c action should be effective. A slow tuning drive, with no backlash from knob to pointer is essential, and it is highly desirable that some form of logging device, in the form of a supplementary dial or pointer, be provided. Also, consistent short-wave entertainment cannot be guaranteed by the receiver alone. It must be intelligently installed with an adequate antenna system.

In summation: From the dealer's point-of-view, if an all-wave receiver is sold with the short-wave feature played up as a novelty, he may sell a relatively inexpensive radio. If the consistent entertainment angle is stressed, the dealer stands a chance of selling a better set with an installation fee possibly to a customer who would not otherwise be seriously interested in purchasing. From the customer's point-of-view, he is buying more varied and enjoyable radio entertainment.



MODEL K-1040
Tunes broadcast, police
and 49 M. foreign bands.

KADETTE RADIO Autuner

**PROVIDES INSTANTANEOUS TUNING
10 TUBES \$29⁹⁵**

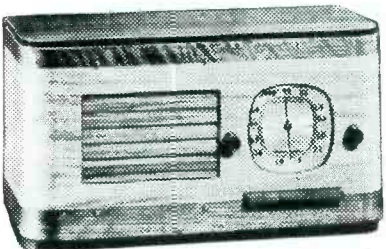

MODEL K-1035
10 tubes—\$34.50
Tunes broadcast, police
and 49 M. foreign bands.

ACTION! That's what you get from Kadette's new condenser type push-button tuning. A touch of your finger—and there is one of your four favorite stations. Instant tuning that's simple—sure—foolproof.

MORE ACTION! Is what you'll get when the public sees this sensational model. There's nothing like it at the price! If you are interested in profits—just feature this phenomenal new Kadette. It's the biggest producer of floor traffic you have ever seen. See your jobber—or write or wire TODAY.

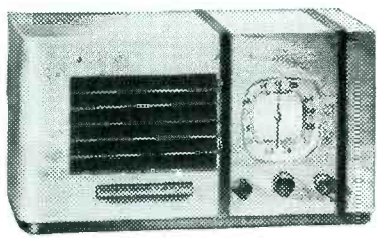

MODEL K-1140
11 tubes—\$36.50
Full tone control. Tunes broadcast,
police and 49 M. foreign bands.

INTERNATIONAL RADIO CORPORATION • 563 Williams Street • Ann Arbor, Michigan

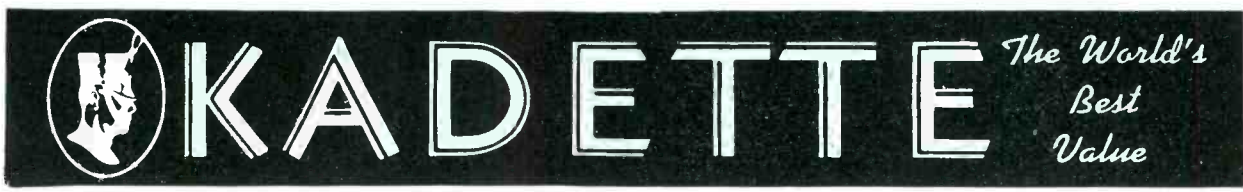

PORTRAIT

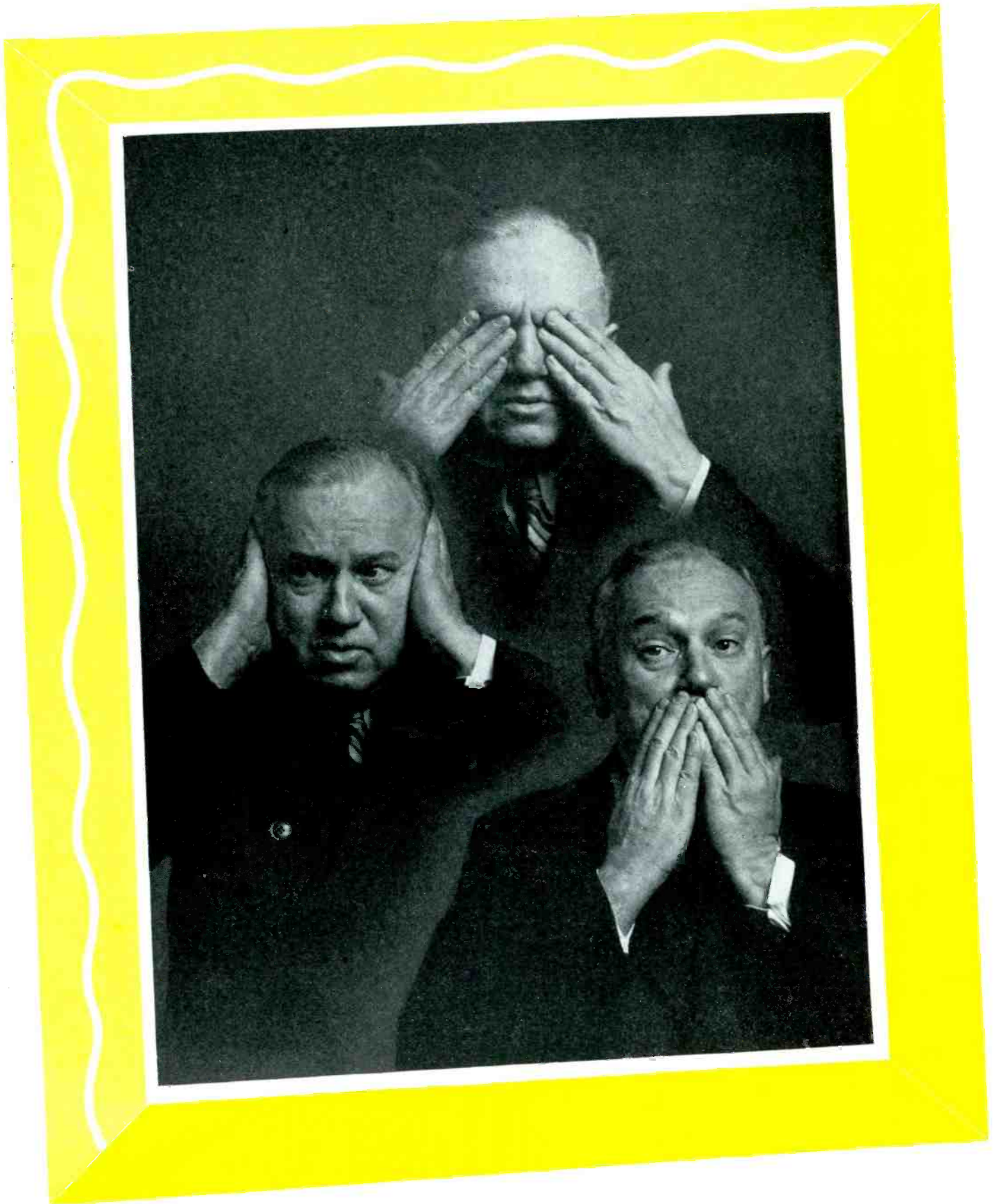

of the

PARTS BUSINESS

By JACK GRAND

EVERY successful industry makes it a policy to keep records of past phases of its particular business. The history of distribution, sales, methods of obtaining these sales, yearly dollar volume, cost of transacting business, as well as the rise, peak and decline over a certain number of years, is recorded. It is good business to study these records occasionally for in this manner faults may be analyzed and proper steps taken to effect a cure.

By a comparison of past and present methods of merchandising, and a discussion of a few evils that were and still are prevalent, it is hoped that the present wave of buying may be maintained and possibly increased to a higher level.

In the early stages of the radio industry the only manufacturers were those of parts. Many of these manufacturers also assembled kits in convenient forms. This merchandise was sold through regular channels, namely, to the distributor, then to the dealer, and finally to the consumer. The regular standards of discounts prevailed for each classification, ending with the consumer paying the list price.

Beginning with the manufacturer, his objective was to design and produce parts to meet the conditions and demands of the day. He made it a point to advertise and publish interesting circuits in magazines to stimulate a demand. He appointed distributors in various parts of the country who would stock his merchandise and place it in the hands of

dealers so that this merchandise would be available for the created consumer demand. He would judiciously appoint distributors so that there would be no harmful competition to cause price concessions. He watched the market so as to avoid over-production that would force him to dump his product.

The distributor, in turn, carefully selected merchandise in which he could place his confidence and on which he felt he could do a good job. He assumed the credit risk. He made a careful selection of dealers who would stock the merchandise so that the customer could readily obtain the desired parts.

The dealer located himself in as convenient a spot as possible so consumers would find his place readily accessible when they were ready to build the sets described in various magazines by the manufacturer.

With this completed chain, the consumer found it interesting and convenient to adopt radio set building as a hobby.

This condition actually existed for a while. The manufacturer made no attempt to sell past his regularly appointed distributor. The distributor would check up an account and under no condition would he consider anyone a dealer who did not have a store. The distributor would never make an over-the-counter sale except to a recognized dealer.

If this condition existed today, this story would now be happily ended. But such is not the case.

Eventually the demand for parts

increased. The chain stores, always on the alert for new business, saw an opportunity in the radio parts field. They immediately set up radio departments and because of their large number of outlets were in a position to purchase in substantial quantities at a price concession. Because of this, they were able to offer parts below the list price and thus take customers away from regular dealers. As the chain stores proved their ability to dispose of large quantities of parts, manufacturers vied with one another in offering inducements to these stores—a break down of policy.

Dealers selling at list prices and, therefore, losing business, complained to their distributors, who in turn complained to the manufacturers. Because of the large volume of business obtained from the chains, complaints were usually sidetracked. Naturally, the dealers wishing to survive sought means to combat this disturbing situation. Large dealers soon were able to buy direct. Price cutting from this point on was the rule. By this time, as a result of the manufacturers' publicity and the ever increasing interest in building sets, the volume of sales was rising rapidly. The war was on!

The average manufacturer, when it came to large orders, would listen to a price proposition. Large orders from various sources caused him to expand and increase production. He ceased to worry about the effects on his customers for wasn't he selling more than he ever did before? Evi-

(Please turn to page 46)

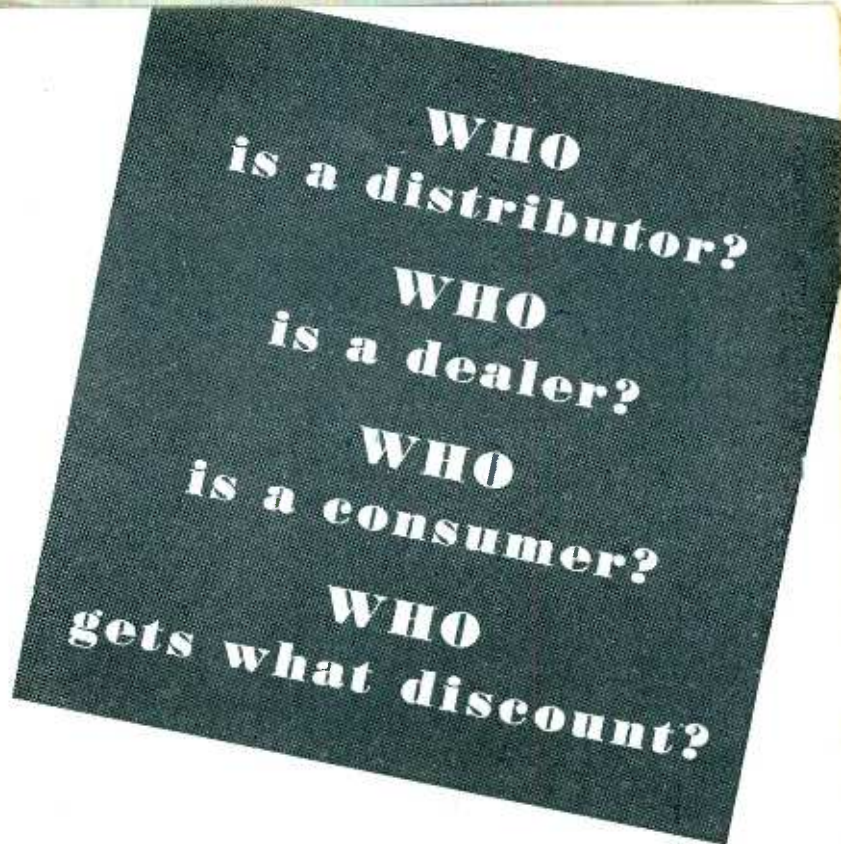

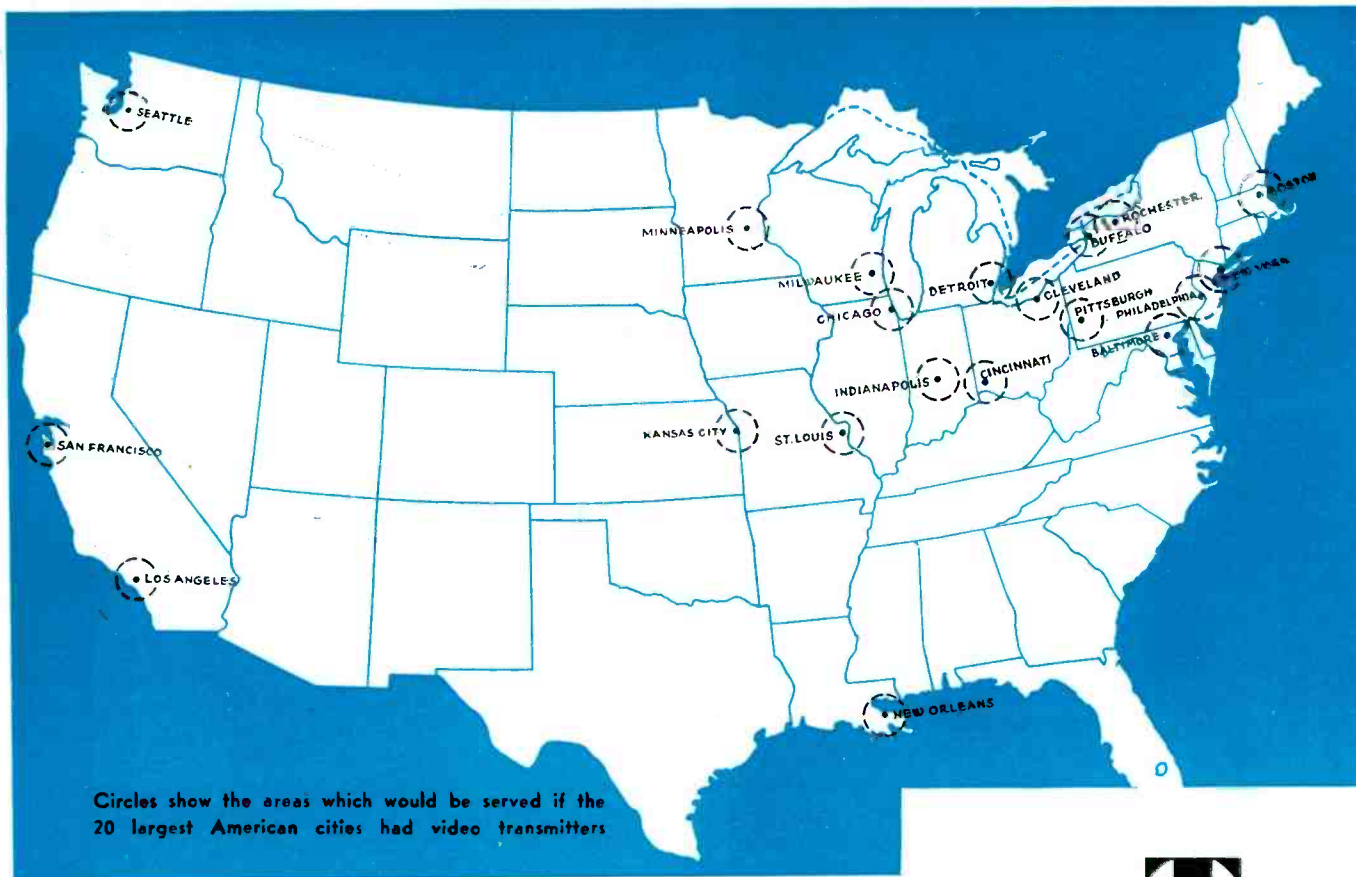

Two

Mr. Ramsdell SAYS . . . Developments in the field of television have been continuous, sound and encouraging during the past year, and give rise to the belief that some of the technical problems confronting companies carrying forward experimental work are being steadily evolved with improved sending and receiving definitely assured.

However, we do not feel for one minute that such a thing as commercial television is yet in sight in this country, or that the coming year will bring this to pass.

There remains a great deal to be done before the United States can even have television such as London has today. We must go through many experimental stages, and we must work out many problems that are peculiar to the United States, these being largely of an engineering nature.

Add to this the problems of licenses, patents and programs, and you have some idea of the ground

that still remains to be covered. There can be no great progress in television in this country until stations are sending regularly scheduled programs, and that will take much time, experiment and thought.

However, during the past year, technical progress has been steady, and we have a feeling that it will go forward even more rapidly this year, so that when the time arrives that television is a practicality in this country the public will have something distinctly worthwhile, and will have the dispatch of programs and a reception of programs that will justify the high hopes held for this new field of information and entertainment.

For instance, one of the outstanding new developments is High Fidelity Transmission Line Modulation, brought out by Philco engineers, which has contributed to Philco's high definition television pictures.

Field tests have continued in the Philco Research Laboratories, and



By SAYRE M. RAMSDELL
Vice-President, Philco Radio & Television Corp.

they have made worthwhile steps in improving picture detail and in simplifying the television receiver circuits and in making receiver operation simpler and more reliable.

Studio and outdoor scenes now can be reproduced on experimental receivers in engineers' homes in and around Philadelphia. These white and black pictures measure $7\frac{1}{2}$ by 10 inches. The fidelity of transmission from Philco's experimental station W3XE has been greatly increased due to a new invention called transmission line modulation. By using this unique system in television transmission 441 line pictures can be flashed over Philadelphia with amazing clarity.

With the whole industry studying the problems and intensifying research we have a feeling that when the day arrives for projecting this subject commercially, the United States will have something of which the industry and the public may well be proud.

From a SET MANUFACTURER and a BROADCASTER . . .

MUCH that has been said and printed in the past on the subject of television appears to have created erroneous conceptions, false expectations and misunderstandings of the problems involved. Existing limitations of the art are still not generally appreciated. This condition *Radio Retailing* endeavors to correct.

Last month we reported on England's actual experience with commercial television in order to provide a practical yardstick which the American radio industry might use in evaluating its progress and potentials. In the following pages we take up where last month's article left off . . . shifting the scene, now, to the status of television in America.

Introduction of television in the United States depends primarily upon two fac-

tors. (1) Technical development of equipment deemed suitable for the job at hand, and (2) solution of commercial and economic problems.

With respect to technical development, the United States lags behind no country. That we appear to have lagged in the solution of commercial and economic problems involved is because (a) the new art must be supported by private capital rather than the government, (b) because it must be made available over a much larger area than European countries contain and (c) because Americans who hold the destiny of this new art in their hands are, it appears, determined to look well before they leap.

Here, in these pages, are two important statements from men intimately concerned with the problem of television. Others will follow in forthcoming issues.

Statements on TELEVISION



By WILLIAM S. PALEY
*President, Columbia Broadcasting System,
Inc.*

Mr. Paley SAYS . . . A few years ago, when the invention of electronic television was announced, many people, including some experts, believed that all of its problems were solved and that television would alter the whole structure of American entertainment overnight. In fact, there were rumors that television would not only rival radio and the moving picture, but would actually take their place.

Today we have more reason than ever to be enthusiastic about the technical magic of television; but we have also come face to face with

facts which sober our prophecies. We know that the introduction of television, not as a laboratory invention, but as a form of entertainment must be a gradual process. The invention itself has revealed unsuspected difficulties and the problems of creating programs satisfactory to the American people have not yet been solved. With boundless faith in the eventual value of television as a third element—with radio and the movies—in the scheme of American entertainment, we feel that the public will be neither served nor satisfied if television is rushed into

the market before it is developed substantially beyond its present state. To that development, we are devoting ourselves in the two closely related fields of engineering technique and program technique. Everyone working on television is an enthusiast for its future; and everyone, I believe, is aware of the temporary difficulties in its way.

The technical difficulties are these: the wave band demanded by electronic transmission is extensive and the supply of wave bands is limited; the distance over which television is effective is less than fifty miles from the transmitter; and we are not yet sure that the engineering specifications for the best possible results have been discovered. All of these technical problems have a decided bearing on the kinds of programs television will transmit. The enlargement of the screen, for instance, will give us greater freedom in the studio and out of doors; if network transmission becomes feasible, the number and variety of programs will be multiplied.

WE are so hopeful that the right answers to such questions will be found that we are confidently proceeding with a series of experiments in creating programs. We do this because our interest in television is primarily a broadcasting interest. Columbia places itself in the position of the man looking at the television receiver. We ask ourselves what he will see and how well he will like it. These are the basic questions, because in the long run the future of television will be shaped neither by the engineer nor the program director; it will be shaped by public response or lack of public response.

We want to be sure that whenever television is technically ready, the public will receive the best possible programs, in order to form a reasonable judgment.

Can television give the public the same *kind* of entertainment it gets from the movies? The answer is a brutal "No"—and this is a good thing for television because it forces

us to discover new methods and new materials, instead of trying to imitate Hollywood. We are barred from competition by cost, because we would be paying for a single evening's program as much as Hollywood pays for a picture shown a thousand times. But the effect is good, because television is thrown on its own resources and will have to develop its own strength in a sane and natural way.

WE have two other excellent sources of program material. If we use them properly, we are sure we can create television programs equal in *quality* to motion picture entertainment, but different in *kind*.

First is the immediate transmission of actual events. Television alone can bring you an event when it happens, exactly as it happens—not merely a fragment of an event, hours or days late. For every event, television will bring you a favored seat—with telescopic lenses for eyes. Had television been not only a fact, but a broad scale operation in 1937, and had your home been within 50 miles of a television transmitter, you might have seen both the splendor and the excitement of the Legion parade in New York; you might have seen a sit-down strike in Detroit, or followed an inter-sectional football game play by play; you might have watched the President of the United States as he raised his hand to take the oath of office before the Chief Justice of the Supreme Court. All the drama and all the significance of national events will become the prime material for television to transmit to the public.

The second field is the creation of new kinds of programs in the studio. We know that radio will continue its vast and varied activities and that television must develop differently—because it requires a different kind of attention. Slowly, as television comes into general use, it will make its own place—but not by taking the place of other entertainments.

We are unearthing new material and experimenting with new meth-

ods. What we want most of all is to be ready with satisfactory programs—and we are impressed by the high standards of entertainment of the American people.

These public standards bring us back to the question of technical standards. We are not committed to any specifications, and our experiments all have one direction: to discover whether the most skillful program, using the best equipment available, will be satisfactory entertainment. If it is, we shall be happy. If it is not, we shall not delude ourselves, but continue to experiment and to reconsider the technical standards. Only a few weeks ago, the report was published that television engineers working for foreign governments have been experimenting with an 800-line picture and that the results of these experiments are being carefully observed by British engineers who have been transmitting on a 405-line standard. We do not feel that it would be of service to the public or to ourselves if television were catapulted into the market with a set of standards which would either have to be abandoned (at the expense of the public) or retained, in spite of their deficiencies, because we had stopped experimenting too soon.

FRANKLY, I do not think that the combined engineering and program techniques, in their present stage, constitute a satisfactory television standard for the American public. What I have seen here and abroad has been far more important and impressive as experiment than as entertainment. In the next year or two, engineering experience will, I am sure, develop scanners and transmitters closer to the requirements of the programs; and program experience will teach us how to make more intelligent use of the equipment we will have. The moment will come when these two lines of research converge and create genuine entertainment on a satisfactory screen; that will be the moment when television can be fairly offered to the public.

1938's BIG NEWS FOR AIR-CONDITIONING DEALERS

Think of it!

A FULL SIZED
UNIT THAT SELLS
FOR **\$175**

DELIVERS GREATER
PERFORMANCE
BUT IS PRICED AT
LEAST \$150 BELOW
ALL COMPETITION



MODEL 33-W

≡ Koolroom ≡

Act now . . . WIRE US IMMEDIATELY . . . and make 1938 your banner year on air-conditioning sales. Do you want to establish your store as air-conditioning headquarters? Then we say don't lose a minute; because the KOOLROOM franchise is being grabbed up with the speed of lightning. Dealers see the tremendous possibilities in this line of units that deliver so much at such a low price . . . \$150 below all competition. *KOOLROOM is the most sensational home appliance to be announced this year.* It is mechanically sound in all details, foolproof in performance and with beautifully finished cabinets.

KOOLROOM is backed by a powerful advertising campaign in newspapers and magazines and with a bang-up campaign of dealers' helps and point-of-sale advertising. Don't miss this golden opportunity. Write or wire today. Even now we can't guarantee that a franchise is available in your community.



Tear out this section of ad, clip it to your letterhead and mail it today. Get all the facts on KOOLROOM. The complete KOOLROOM line is on permanent display at the American Furniture Mart, Chicago.

Model 33A-WS (Portable). Circulates 200 cubic feet of conditioned air per minute. Capacity—4,000 B.T.U. per hour. Equal to melting 600 lbs. ice per day. 1/3 H.P. Motor.

\$175

Model 33-W. Circulates 225 cubic feet of conditioned air per minute. Capacity—4,500 B.T.U. per hour. Equal to melting 660 lbs. ice per day. 1/3 H.P. Motor.

\$250

Model 50-W. Circulates 329 cubic feet of conditioned air per minute. Capacity 6,925 B.T.U. per hour. Equal to melting 1,100 lbs. ice per day. 1/2 H.P. Motor.

\$350

Model 100-W. Circulates 450 cubic feet of conditioned air per minute. Capacity—14,400 B.T.U. per hour. Equal to melting 2,400 lbs. ice per day. One H.P. Motor.

\$450

Model 150-W. Circulates 600 cubic feet of conditioned air per minute. Capacity—19,000 B.T.U. per hour. Equal to melting 3,100 lbs. ice per day. 1 1/2 H.P. Motor.

\$550

KOOLROOM • DIVISION OF INDIAN PRODUCTS CORP. • 2340 SOUTH INDIANA AVENUE • CABLE "TRAILCO," CHICAGO
Subsidiary of INDIAN TRAILER CORPORATION OF AMERICA

SELL MORE AIR-CONDITIONING FOR LESS MONEY—WITH KOOLROOM

Next month it will be here!

the **ELECTRICAL MANUFACTURER'S NEW SALES TOOL . . . for INCREASING 1938 PROFITS**

Beginning next month—continuing throughout the year—manufacturers of radios, radio accessories, and electrical appliances can take direct and forceful action—

to get electrical wholesale salesmen to "push" their lines over the many others they are expected to sell.

to win their proportionate increase of next year's estimated \$261,000,000 sales of radios, radio accessories, and appliances by these salesmen.

Manufacturers may take this direct and forceful action through use of a new sales tool—**THE WHOLESALER'S SALESMAN** (formerly *Electrical Wholesaling*).

New from cover to cover—in editorial content and format—**THE WHOLESALER'S SALESMAN** will be geared to a new merchandising tempo—will go straight to the heart of the salesman's daily problems.

"SELLING APPLIANCES"

Adding increased effectiveness to **THE WHOLESALER'S SALESMAN** as a direct and forceful tool for manufacturers to increase sales of radios, radio accessories and appliances is the new monthly section, **SELLING APPLIANCES**. This section is devoted to helping the salesman increase his growing sales of these products at an even faster pace.

For increased profits through these salesmen in 1938

use **THE WHOLESALER'S SALESMAN**

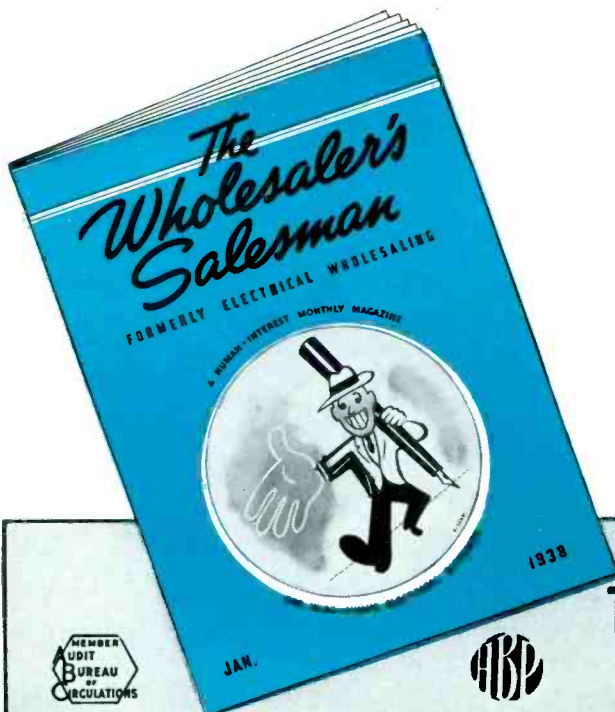

A McGraw-Hill Publication

THE WHOLESALER'S SALESMAN

FORMERLY "ELECTRICAL WHOLESALING"

330 W. 42d St., New York, N. Y.

You Can **BEND** Glass

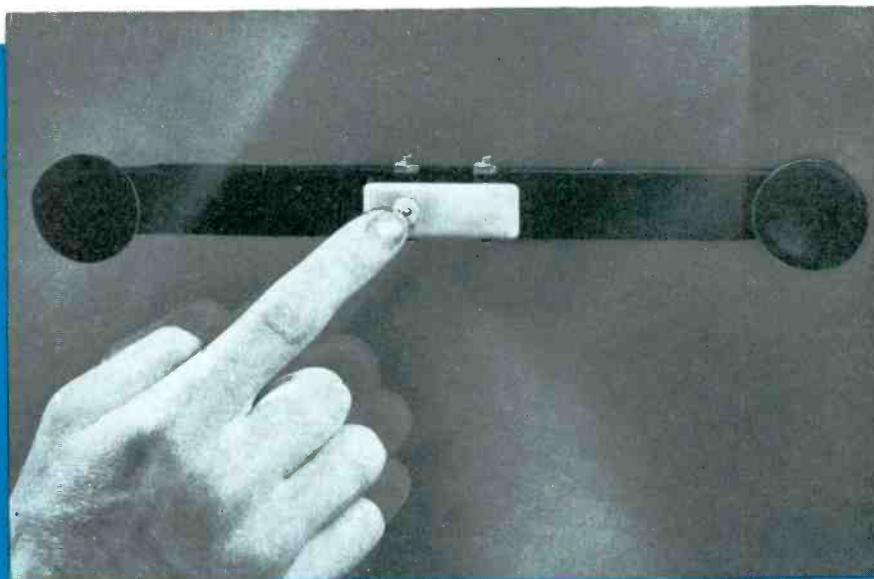

MICRO-SWITCH—Mounted in the center of a rigid piece of angle-iron fastened to the inner surface of the store window by means of suction-cups, it is sensitive enough to be actuated by pressure of a finger from outside

By I. L. COCHRANE

THERE'S sales magic in getting people to do things. The showmen of the Automobile Association proved that by having exhibits in which folks were invited to pull levers, turn wheels and push buttons to see what happened. And, wherever one of those manually operated exhibits was in operation someone was working it, with a large group looking on. The same interest may be aroused in a window demonstration, but we cannot pull levers and turn wheels through a plate glass front—or can we?

The capacity control is one way, as was seen on page 13 of the October number of *Radio Retailing*. And here is another method more simple and less expensive. By placing one of the new, sensitive switches just placed on the market in the center of a short length of channel iron, and rubber suction cups at either end to hold the gadget in a fixed position, a slight pressure of a finger on the outside of window glass closes a circuit—and another station is tuned in.

Remove the cord and plug ordinarily attached to the Phantom Control bar pictured and run fine enameled wire from its terminals to a station control by cutting in back of the regular push button. The button on the Phantom Control thus replaces the regular button. The wire between the two sets of terminals should be as fine

and as nearly invisible as possible. If you use not more than 15 watts and the distance between the bar and the radio set is about 10 feet, #40 enameled wire may be employed. If a heavier current is transmitted a larger wire will be necessary.

The center decorative piece in the sketched window may be set on the floor, on a platform, or it may stand on a radio set, according to the size of the window and the number of sets on show. The bottom section is heavy cardboard, painted dark blue with white stars, which may be applied with a set of variable sized stars, sold

by most art supply stores and where Dennison goods can be obtained. The oval might well be in shades of green and the panel in turquoise blue and white, with a cut-out of a bright metallic gold or silver star at the top of the panel. The oval and panel might be separate pieces and set out about one-half inch from the base section. The circles designating the stations may be glued to the glass, and the cardboard panels inviting pedestrians to press the glass are either glued to the glass or suspended.

Of course, a radio set must be in
(Please turn to page 54)

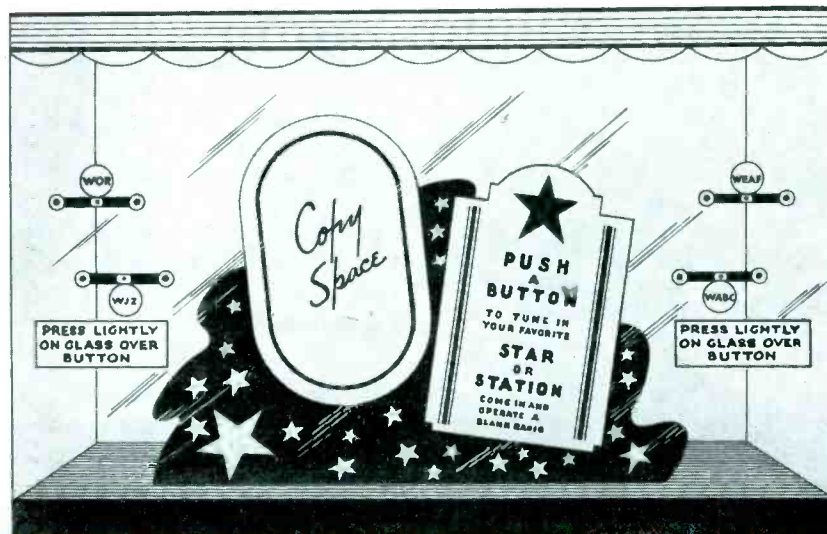

AT WORK IN A WINDOW—A novel window permitting the passerby to operate push-button tuned radios from outside is easily constructed

THE problem of maintaining profitable margins in these tax-laden days when overhead is mounting and prices are kept down for fear of consumer resistance or through price-cutting competition is causing many retailers of radios and electrical appliances to streamline their methods of compensating salespeople as well as other employees.

Straight salary, straight commission or salary plus commission are old models that lack sufficient pep these days to procure maximum profits via sales help. Employers have come to recognize that employees also have a profit motive, that it must be satisfied before the employer's own profit motive can be satisfied. For this reason, most compensation plans in use today are geared in one way or another to profit-sharing.

From field investigations we have conducted on modernized compensation in retail fields, we offer this symposium of effective remunerative methods used by radio and electrical dealers and department managers to produce maximum profits, methods that may be applied with equal efficiency to inside and outside sales help.

We find that dealers have sighted the weakness in figuring any form of compensation on sales, that the salesman selling \$1,000 worth of merchandise may earn less profit for his employer than the salesman selling \$600. The former may have sold price lines, the latter long-margin goods. For that reason, many dealers now gauge sales bonuses from the standpoint of gross margins or expenses and have re-named them profit-participations. The higher the margin, the lower the ratio of expenses to sales, the higher the profit-participation fund.

If margins drop below a set minimum, if expenses exceed a certain maximum, sales people do not participate in profits or the percentage is reduced. Where expense ratios have been high, profit-participations are figured on the percentage of expenses to sales volume. One dealer pays 10 per cent of the excess over an estimated percentage of margin to sales help. For example, if monthly sales total \$10,000 with a recorded gross margin of 40 per cent or \$4,000, against estimated gross margin of 35 per cent or \$3,500, one tenth of the \$500 difference, or \$50, is divided that month with salespeople. The efficiency of the sales force is governed more by its ability to maintain an average

"... employers have come to recognize that employees also have a profit motive, that it must be satisfied before the employer's own profit motive can be satisfied. For this reason, most compensation plans in use today are geared in one way or another to profit-sharing..."

Modern Methods of

high profit margin and a low expense ratio than upon sales volume.

Step-up commissions are becoming more popular. Dealers use a salesman's average sales for the past 6 months as the base salary, figured on a certain commission percentage, usually 10 per cent. Every 6 months, the salesman's sales are totaled and a new base salary set. For example, the salesman who averaged \$1,000 monthly for the past 6 months is given a base salary of \$25 weekly, all over \$1,000 done during a current month gives the salesman 2 per cent additional, for the next \$1,000, 1 per cent additional, all over \$3,000 in sales $\frac{1}{2}$ of 1 per cent additional. This gives a dual profit motive, first to get the additional commission, second to increase the salesman's base salary for the next 6 months.

Where salary plus commission is paid, the modernized method is to limit the compensation paid all salespeople to a certain percentage of the store's sales, depending on the esti-

mated salary-to-sales ratio of the business, 10, 12, 14 per cent or whatever it is. If the store salaries for inside and outside salespeople exceed this percentage, the difference is deducted, pro rata, from all sales help, on the basis of size of remuneration. If salaries are less than this estimated percentage, the difference is divided between the salespeople. For example, if salary-to-sales ratio is 10 per cent, and sales are \$3,000 weekly, salaries \$250 weekly, there is \$50 to divide between the sales help because the salary-to-sales ratio of 10 per cent would allow a sales payroll of \$300, whereas, it is only \$250, leaving \$50 for profit-participation.

The advantage of this method is that it maintains an equalized salary-to-sales ratio, so important to the dealer who suffers from a high monthly ratio in certain months when sales are low and a low monthly ratio in other months when sales are high. The dealer is better able to budget his business operations if he can

figure on an equalized salary-to-sales ratio. Department managers are sometimes paid an overriding commission plus salary; in one case reviewed, 1 per cent, while salesmen in that store received 6 per cent plus a modest salary.

We found cases where the base salary was geared to regular margin items. For example, a salesman receiving \$25 weekly salary must sell \$250 in regular margin items weekly. If he sells \$350 he gets 15 per cent on the excess or \$15 more, giving him \$40 weekly salary. If he sells \$150 he is penalized 15 per cent on

the deficiency of \$100 or \$15, giving him \$10 weekly credit. He may make up the difference by selling bait merchandise or other off-margin lines but these carry lower commissions, as low as 5 per cent. The tendency to keep up gross margin is very noticeable. Dealers are adjusting their compensation methods to that end. In fact, this survey indicated that the maintenance of margin for the time being at least, is more important than pressing for higher sales volume, which in the past, has often been accompanied by cut prices and profitless margins. High sales vol-

ume at low margins often means less net profit than low sales volume at substantial margins.

Certain stores contacted in our survey pay commission in ratio to volume, 8 per cent up to \$1,000 monthly, 8½ per cent to \$2,000 monthly, 9 per cent to \$3,000 monthly and so on. The dealer must set his own quotas because they differ with the store. To keep salesman turnover low, some stores use a sliding commission arrangement, such as 10 per cent for 6 months' service, 11 per cent for 1 year's service and 12 per cent for 2 years' employment. After that no further increases. This step-up tends to reduce salesman turnover and it was reported that it was less expensive in the long run



PAYING SALESMEN

to pay the additional commission. To keep trade-in allowances at minimum, one store gives the salesman one-half the saving. If the authorized allowance is \$20 and the salesman closes the sale with a \$10 allowance, he gets \$5. To further the sale of higher-priced appliances or radios, many stores give up to 50 per cent more for selling big ticket merchandise. A salesman getting 10 per cent on radios up to \$100 may be given 15 per cent, 50 per cent more commission, on radios over \$100.

Some dealers pay employes one tenth the net profits earned by the business; in one case, one half the net profits after deducting interest on capital invested and a certain percentage of sales for reserve funds. All employees share in profit-participations, if more than 6 months in service. All awards over basic wages are usually conditioned to minimize turnover of employes. Seniority receives biggest rewards, sometimes 50 per cent more. One dealer carries profit-participations to the nth degree. Every product sold is computed as to cost and certain fixed charges, then the profit split 50/50 between company and salesman. One radio and electrical appliance retailer uses a similar plan on "stickers." Instead of cutting prices to move, he shares

(Please turn to page 46)



We pause to thank our customers for the splendid support they have given us during 1937. Heartiest wishes for a very merry Christmas . . . and a prosperous New Year.

HYGRADE SYLVANIA CORPORATION

HOW Radio and Refrigeration DOVETAIL

MANY dealers have learned from first hand experience that the larger electrical appliances, particularly home refrigerators, are natural and logical companion lines to radio.

The writer has been questioned as to whether this relationship is one of absolute necessity or merely desirability from the standpoint of profits. He has tried to find the answer by analyzing the sales figures of a more or less typical radio store, reducing them to a relative basis of percentage. These cover the year from October 1, 1936 to September 30, 1937.

Two conditions must be kept in mind. Auto radios were not intensively pushed and the peak season of refrigeration's biggest year is within the period under discussion.



By **RUSSELL B. RICH**

RADIO RETAILING, DECEMBER, 1937



SCHEDULE 1—PERCENTAGES OF GROUP SALES

	Sales	Cost of Sales	Gross Profit
Radios	100%	58%	42%
Refrigeration	100%	70%	30%
Other appliances	100%	76%	24%
Consolidated Sales	100%	67%	33%

The above schedule shows in percentages of group sales the gross profit ratio realized from each group. The gross profit margin on radios works out to 42% of radio sales. Refrigeration produces 30% and other appliances 24% of their respective sales totals. The business as a whole shows a gross profit of 33%.

SCHEDULE 2—PERCENTAGES OF TOTAL

	% of Total Sales	% of Total Cost of Sales	% of Total Gross Profit
Radios	34%	29%	42%
Refrigeration	44%	46%	41%
Other Appliances	22%	25%	17%
Total	100%	100%	100%

Schedule 2 is given in percentages of total sales, cost of sales and gross profit. Of the store's total sales, 34% were radios, costing 29% of the total cost of sales and creating 42% of the total gross profit.

Schedule 3 distributes in percentages of total sales, the sales, cost of sales and gross profits of each merchandise group.

SCHEDULE 3—GROSS PROFITS IN PERCENTAGES OF TOTAL SALES

	Total Sales	Radios	Refrigeration	Other
Sales,	100%	34%	44%	22%
Less: Cost of Sales	67%	19%	31%	17%
Gross Profit	33%	15%	13%	5%

Radios showing a gross profit margin of 42% (schedule 1) comprised 34% of total sales (schedule 2), incidentally produced 42% of the total gross profit, but produced a gross profit amounting to 15% of total sales (schedule 3).

On the other hand refrigeration (Please turn to page 46)

TAKE THE WORD OF SOME

"I consider Norge by far the outstanding refrigerator both from the selling and the user viewpoint. The Norge Rollator Compressor is the greatest sales feature it has been my good fortune to use in my entire selling experience."

"Selling good merchandise and giving service is the foundation of any successful business. My partner and I decided to make Norge our leading line because we were thoroughly sold on Norge products. We have been very successful."

"We maintain our own service department in which we see that not a nickel is ever charged to our customers for repair or upkeep of Norge products. In three years time we find the cost of maintenance to be exactly \$12.00."



ROLLATOR REFRIGERATION

Rollator Refrigeration protected by 10-Year Warranty on the three-moving-parts Rollator Compression Unit



CONCENTRATOR GAS and ELECTRIC RANGES

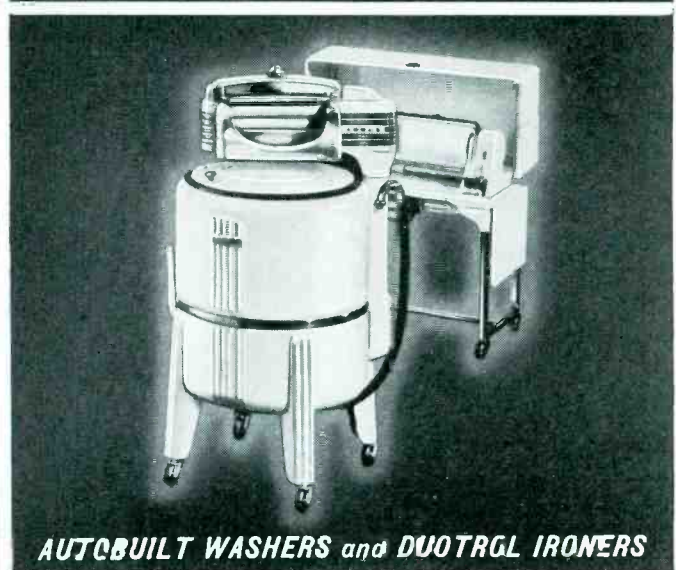

AUTOBUILT WASHERS and DUOTRGL IRONERS

TYPICAL NORGE DEALERS*

"I not only sell Norge, but I use Norge products in my home—everything from the Low-Temp refrigerator to the range, washer, ironer and oil burner. I always sell prospects the idea of a Norge-equipped home."

"The Norge refrigerator power plant tops all others in performance and service. The refrigerator is a beautiful addition to any home. The outlook for business in 1938 is very good in this district."

"It has been a pleasure to sell Norge equipment. After a thorough study of all refrigerators in this market, I feel I made a very wise move to sell Norge exclusively. The Rollator puts all other refrigerators in the shade."

*NAMES ON REQUEST

NORGE erases "Red Ink" Months with ... BETTER PRODUCTS—MORE PROFITS—HIGHER TURNOVER

Every month is a profit month for appliance dealers who handle the full Norge line! There is always sales activity in Norge Rollator Refrigeration, Concentrator Gas or Electric Ranges, Auto-built Washers, Duotrol Ironers, and package heating and commercial refrigeration equipment. 1938 products—greatest in Norge history—give dealers dramatic sales features that *prove* Norge superiority in convincing showroom demonstrations.

Get full details about the valuable franchise Norge is offering now to aggressive dealers who want to make money the year around as Norge Master Merchants. Product turnover is *high*—dealer and salesman turnover is *low* in the Norge picture. Liberal finance plans and a smashing new advertising and sales promotion program back the man who sells Norge to the limit. You owe it to yourself to get the whole story *now*.

NORGE DIVISION Borg-Warner Corporation, Detroit, Michigan



NORGE

FREE TO APPLIANCE DEALERS!

A full volume on appliance selling and promotion. One of the greatest dealer helps ever produced. Describes a complete plan of store operation. Tells how to get the most out of advertising and sales promotion. Reveals for the first time a new tested method of visual selling. No matter what products you sell, this book will show you how to make more money in the appliance business.

Mail Today!

NORGE DIVISION Borg-Warner Corporation,
654 East Woodbridge Street, Detroit, Michigan.

I would like to receive a copy of your new book for appliance dealers.

NAME
ADDRESS
CITY STATE

TP-2



Collegians, bachelor girls, apartment dwellers—all will like the compactness of Model U-101 of the RCA Mfg. Co., Camden, N. J.; can be moved about or permanently fixed in some little niche

What You Want

A picture and text panorama of



This versatile portable transcription reproducer and record player will play 8, 10 or 12 in. recordings as well as 16 in. transcriptions and may be obtained from Allied Radio Corp., Chicago



In order to make its Electrotone an attractive piece of luggage when in transit, Harris Mfg. Co., Los Angeles, offers it in red, blue, green, alligator, and white, black or brown shark and airplane luggage linen

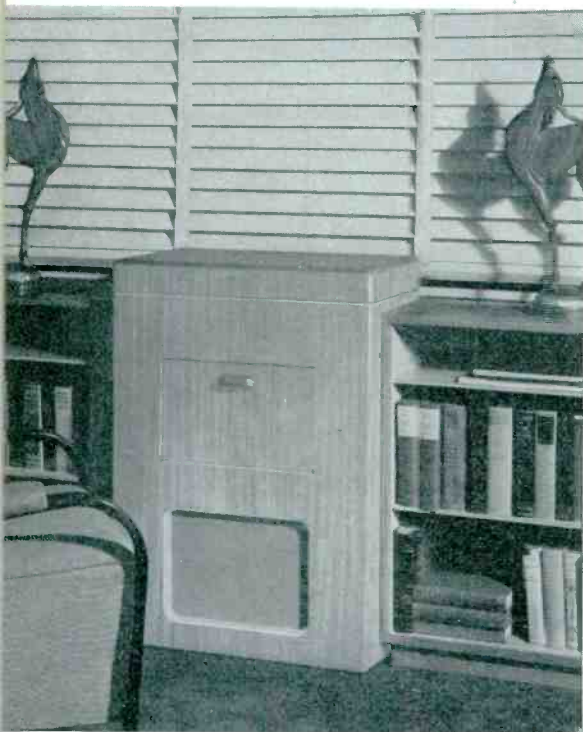

This attractive modern cabinet of natural mahogany houses a 13 tube Dynaphone combination; Ansley Radio Corp., New York City.



This de luxe radio-phonograph in a walnut finish cabinet automatically shifts and plays 10 or 12 in. records, is but one of many models made by the Stromberg Carlson Tel. Mfg. Co., Rochester, N. Y.

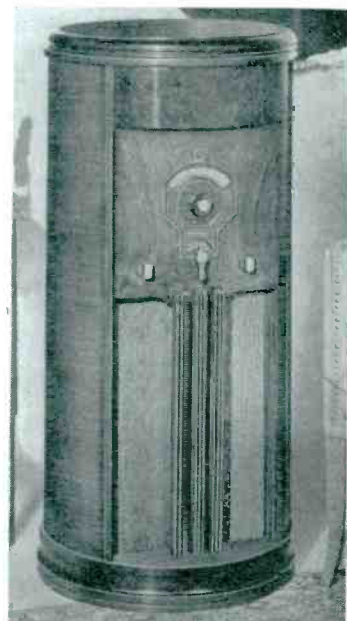

Because it looks well in a corner and takes up less space this circular radio-phonograph of the Galvin Mfg. Corp., Chicago, Ill., is proving particularly popular

The recessed grille opening, roll-over top and bookshelf below phonograph add to the striking appearance of the Arvin Phantom Vogue (left) included in the line of Noblitt Sparks Industries, Inc., Columbus, Ind.

When You Want It

1938's modernly styled phono-radios



To reach the two outstanding price brackets in the combination field, General Electric Co., Bridgeport, Conn. has announced a deluxe automatic model in the \$300 class and the illustrated model F-88 in the \$140-\$150 bracket

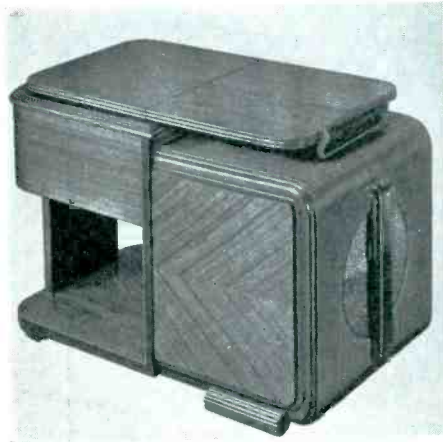

The lift-top of the chairside combination of Travler Radio and Television Corp., Chicago, discloses the radio on the one side and the phonograph on the other; may be used as a serving tray

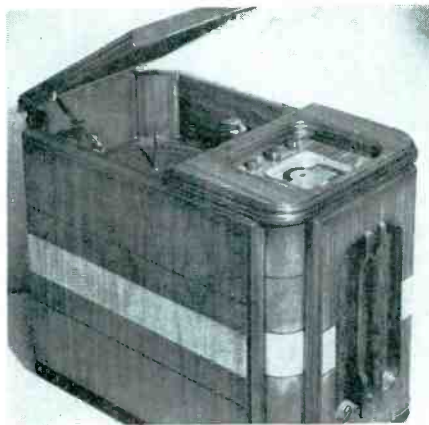

Convenience is combined with grace in Troy Radio & Television Co.'s (Los Angeles) arm-chair model; comes in walnut or walnut and white; automatic record changer



There are two record files of the "tip-out" type, one on either side of the cabinet, on the Model 1283-P of the Sparks Withington Co., Jackson, Mich.; push button tuning



The extreme simplicity of line and careful blending of woods in this model, offered by Gard Radio Corp., New York City, assures adaptability to any surroundings



The phonograph and pickup are enclosed in a drawer which pulls out; the radio has six tubes and covers the broadcast band only; Mission Bell Radio Mfg. Co., Inc., Los Angeles

Ina Ray Hutton, leader of the well known girl orchestra, enjoying her Model AR-165 chairside combination made by Emerson Radio and Phonograph Co., New York City



The cellarette compartment, alcohol-proof sliding top and book shelf add a utilitarian as well as decorative note to the chairside combination offered by Majestic Radio and Tel. Co., Chicago



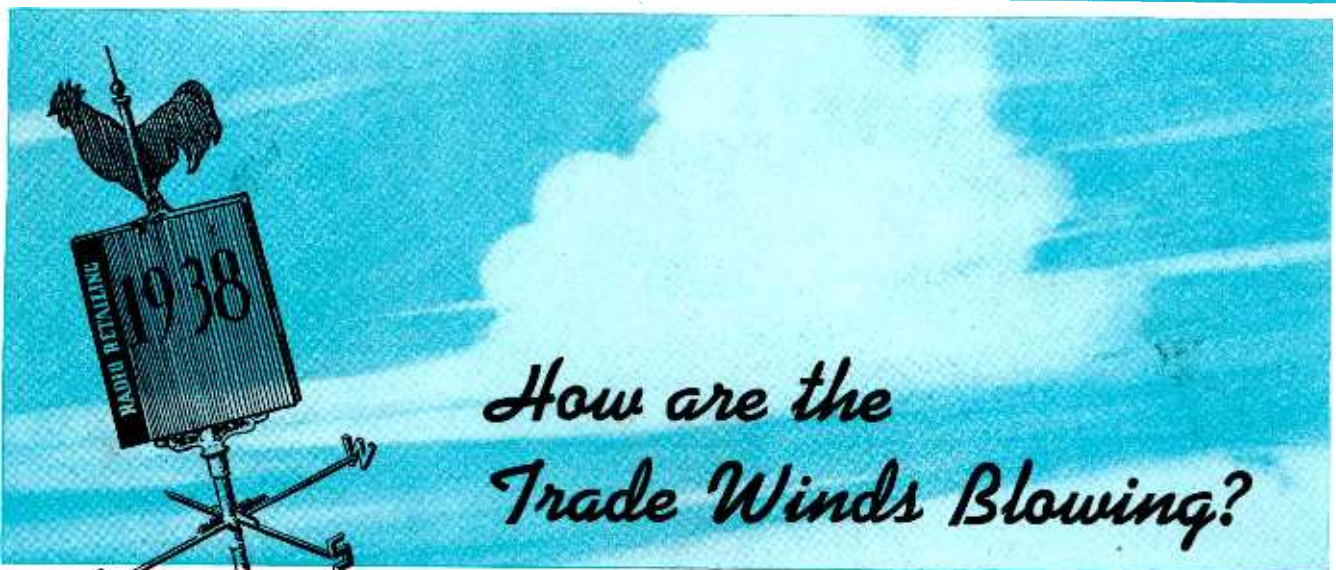

How are the Trade Winds Blowing?

What happened to Radio in 1937? How did progress compare with 1936? What about market saturation? Replacements? And what's in the wind for **1938?**

These, and other questions of vital importance to makers and merchandisers of radio sets and equipment will be answered in the

January Statistical and Sales Planning Issue of RADIO RETAILING

Manufacturers want this important January Issue, with its facts, figures and forecasts to guide them in planning production and sales schedules. Distributors and dealers want it to measure *their* progress by that of the industry,—to set their sales quotas, plan their sales promotions and *prompt their buying*.

Advertisers, with important messages for the *important people and concerns* in Radio—as represented by the

25,000 Monthly Circulation of RADIO RETAILING—

want the important January Issue to tell about their products, policies and plans for 1938,—particularly since RADIO RETAILING insures them *greater distribution, more worthwhile trade outlets . . . more and finer editorial background for their messages . . . higher degree of reader interest and responsiveness than any other journal in its field,—and most of all because they save money by using RADIO RETAILING.*

Contents — January Issue

1936-1937 SET AND TUBE SALES
(All types)

1937 SALES DATA ON PARTS,
ACCESSORIES, TESTERS, SOUND,
RECORDS, ELECTRICAL APPLIANCES,
etc.

SATURATION OF RADIO MARKET
(Homes, farms, autos equipped
with radio)

WIRED HOMES (By States)

MISCELLANEOUS MARKET AND
SALES DATA

Special Editorial Features . . . News
. . . Service, etc.

Concentrate your Advertising in this January Statistical Issue . . .

1. Because it gives your sales messages longer, more useful life. It is read, re-read and referred to by the distributors *you now have* and those *you hope to sell*—
2. It focusses the attention of leading trade buyers on your sales messages at a *psychological time when they are making their buying plans*—
3. It helps the trade shape intelligent sales and marketing plans for *your type and kind of merchandise in 1938*—
4. Your message in this January Issue cuts your sales costs by speeding the work of your salesmen, “softening the trade,” reaching influential buyers your salesmen never see, and influencing your dealers’ salesmen to *trade up on your merchandise*. Therefore—

Concentrate your advertising in RADIO RETAILING in 1938 and start with this all-important January Statistical & Sales Planning Issue!

RADIO RETAILING

A McGraw-Hill Publication

330 W. 42nd St., New York, N. Y.

How to keep from Overstocking

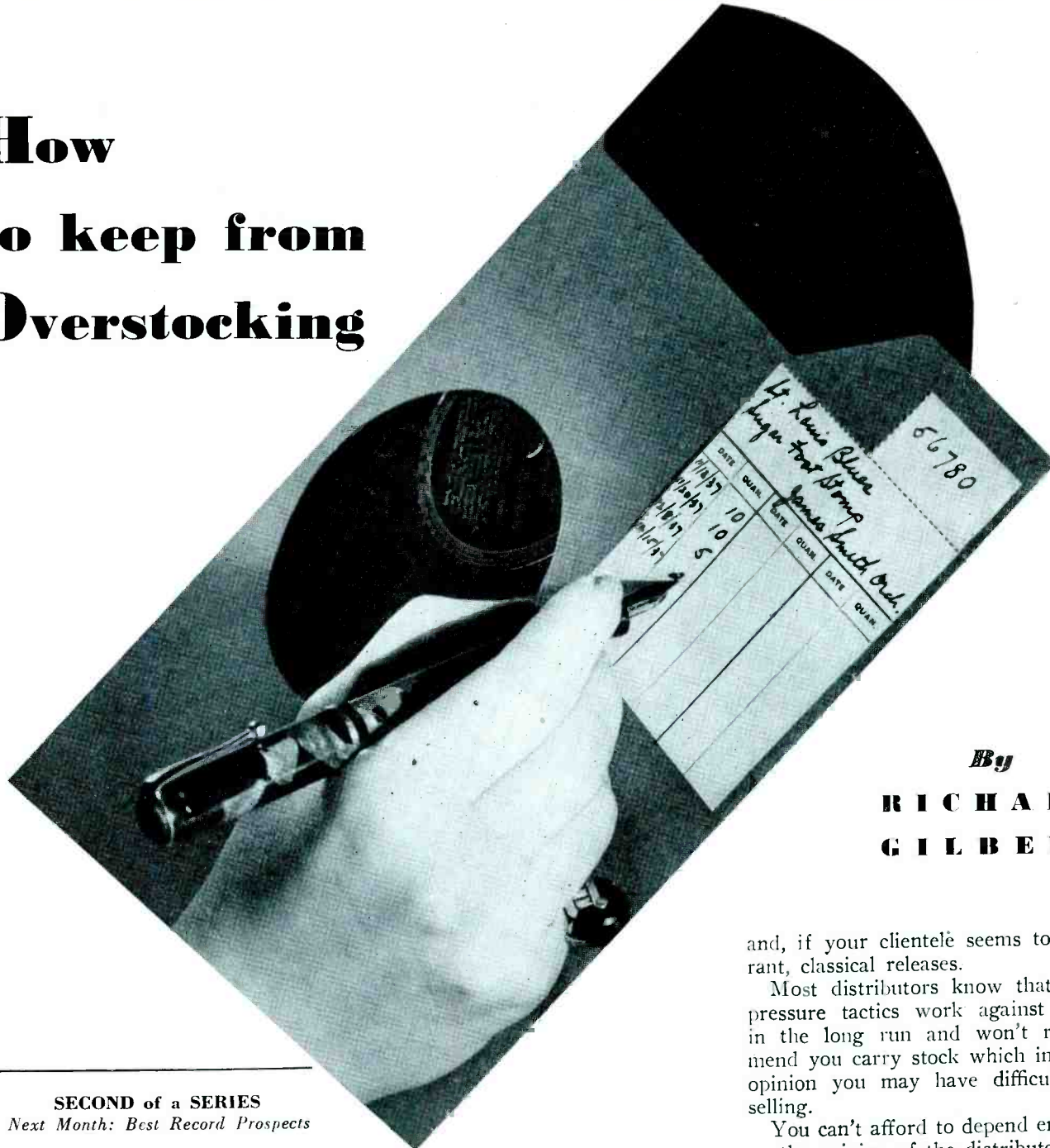

SECOND of a SERIES
Next Month: Best Record Prospects

LAST month we pointed out the physical requirements for a phonograph record department and attempted to answer dealers' questions as to the investment necessary to handle records profitably. The article dealt with layout, considerations of space, reproducing equipment, personnel and need for managerial control.

This month's subject follows naturally; it is one of vital importance to the success of a record business whether it is conducted along the lines previously discussed or in a much more modest manner. How to keep from overstocking is not nearly as puzzling as you might think. Stock control is made simple by simply applying to the record inventory the

same intelligent methods any wise merchant uses for buying in any other line. *Buy only what you know you can sell.*

Your local distributor will assist you with your initial inventory, suggesting that you take on discs which his records have shown to be outstanding sellers in his catalog. He will also tell you that you need a surplus stock of the new hits—five of this, ten of that—to take care of the demand he hopefully anticipates you will encounter the moment these items are on your shelves. If he is a conscientious distributor he won't saddle you with a lot of strange merchandise right away. But chances are he'll suggest you give him a standing order for future popular

and, if your clientele seems to warrant, classical releases.

Most distributors know that high pressure tactics work against them in the long run and won't recommend you carry stock which in their opinion you may have difficulty in selling.

You can't afford to depend entirely on the opinion of the distributor and his sales force and the advance-list blurbs for your future buying. From the very first you must set up your own checking system and buy only that kind of merchandise you know you can sell from actual sales records made over a period of time.

Before long you will be stocking a variety of labels. Your customers will have evinced a preference for a dance band or an artist not obtainable in one catalog, and you will begin to stock competitive labels in order to maintain a varied and adequate supply of popular hits and perennial favorites.

Comparatively few dealers stock the complete monthly output of any individual record publisher; rather they stock an assortment of those classifications which appeal partic-

(Please turn to page 55)

By

RICHARD
GILBERT

ALL RIGHT WHO GETS

DON'T LET THIS HAPPEN TO YOU!

ONE CENT NEVER BOUGHT SO MUCH COLD AND ICE!

Kelvinator has an all-time sensation in the new "POLAR POWER" Unit, with its tremendous cold-making power and economy... as all-time VALUE in its brilliantly planned new convenience!

PROVES ICE-MAKER!

KELVINATOR'S ICE-MAKING!

Kelvinator THE CHAMPION ICE-MAKER

Kelvinator THE CHAMPION ICE-MAKER

Kelvinator THE CHAMPION ICE-MAKER

HERE'S WHERE YOU CAN SEE THIS MIRACLE OF COLD-MAKING TOMORROW

HERE'S WHERE YOU CAN SEE THIS MIRACLE OF COLD-MAKING TOMORROW

HERE'S WHERE YOU CAN SEE THIS MIRACLE OF COLD-MAKING TOMORROW

4-COLOR PAGES
Brilliant, smashing ads... running continuously in SATURDAY EVENING POST WEEKLY AMERICAN and other Powerful magazines!

BREAKING THE GREATEST STORY IN REFRIGERATOR HISTORY!

You have never seen refrigerator ads like the tornado Kelvinator is turning loose for 1938. There's plenty in them to get excited about!

They're in full color... they're full pages... they run continuously (and we mean continuously) in the most popular, most influential magazines in the country.

They've got new "interest getting" power that starts with the first word and never lets up.

They've got a new way of glorifying a beautiful refrigerator in pictures... and telling a whole sales-story in pictures... that will be one of the big wallops of the year.

Then there's a smashing, fighting campaign of power-house space in Key Cities... listing dealers.

BUT THAT'S ONLY A SMALL PART OF IT! There's a complete, balanced, carefully-

planned, "tailored to order" program for each individual dealer's local use.

And every detail, every word and line of it is sharp-pointed fighting, **SELLING HELP**—right on the target of making sales **NOW!**

It's so big and so good that you'll kick yourself all year if you don't find out about it... and get in on it... **right now!**

Gangway for the 1938

KELVINATOR

THE \$5,000 FIRST PRIZE

AND THE 7 OTHER PRIZES IN THIS \$8,000 KELVINATOR CONTEST THAT'S OPEN TO THE WHOLE ELECTRIC APPLIANCE INDUSTRY?

FULL DETAILS HERE!

Everyone in the industry can get in on it—presidents or office boys—ANYONE who is not on the Kelvinator office or factory payroll. IT'S WIDE OPEN!

There's something mighty big happening at Kelvinator . . . *again* this year! So big we want every person in the industry to know and understand it from A to Z. That's the purpose of this \$8,000 contest—with its \$5,000 first prize.

Now for the facts you need to get in on it . . . simple . . . straight-forward . . . no red tape nor strings.

First—See the 1938 Kelvinator line, and learn about the 1938 Program, through your nearest Kelvinator distributor.

Second—Decide which of the following three factors will be most helpful to Kelvinator Dealers in 1938 . . . and tell, in a letter of 50 words or less, why you think so.

① **THE PRODUCT**—12 beautiful new 1938 models . . . sealed, silent Polar Power unit so amazingly efficient and economical it delivers 72 big ice cubes for 1c (figured at the national average rate for electric current) . . . sensational new Speedy-Cube ice release . . . remarkable, exclusive new shelf adjustability . . . and a score more great selling features.

② **1938 ADVERTISING PROGRAM**—tremendous, continuous full-page, four color campaign in foremost magazines . . . tremendous "key city" campaign, listing dealers . . . and individually tailored local program for every Kelvinator dealer.

③ **1938 SALES-CLOSING PROGRAM**—tested and proved sales-training materials . . . door openers . . . care-

fully planned seasonal selling-campaigns . . . generous customer financing-plans . . . and plenty more!

\$5,000 FOR FIFTY FRANK WORDS!
See the products and get the facts from your Kelvinator distributor.

Use your own good judgment as to which of the above factors in the whole mighty program will add most to its success.

Then tell us, in a letter of 50 frank words or less, why you figure it that way. Doesn't matter a bit which factor you think counts most—whether or not that factor actually does turn out to be most important.

We're after frank opinions . . . good business thinking by the people in our own industry. And an office boy's letter will be read and considered on absolutely even footing with the letter from a president of a company.

THE PRIZES will be: \$5,000 first prize; \$1,500 second; \$500 third; and five prizes, fourth to eighth inclusive, of \$200 each. Substantial enough to be worth trying for, in any man's time.

THE RULES are just three: anyone in the electrical appliance industry can compete except people on the Kelvinator office or factory payrolls; letters must be limited to 50 words; and all letters must be postmarked before midnight, January 30, 1938, addressed to **DÉPT. K, Kelvinator, Division of Nash-Kelvinator Corporation, Plymouth Road, Detroit, Mich.**

There you are. Come one, come all!

LIST OF KELVINATOR DISTRIBUTORS

Albany, N. Y.	Albany Garage Co., 28 Howard St.
Albuquerque, N. M.	Raabe-Mauger Co., 112 W. Copper St.
Amarillo, Tex.	Amarillo Hdwe. Co., 506 Tyler St.
Atlanta, Ga.	Graybar Elec. Co., Inc., 167 Walton St., N.W.
Baltimore, Md.	Nash-Kelvinator Corp., 1426 N. Charles St.
Bay City, Mich.	George F. Dent Co., 210 Fifth Ave.
Birmingham, Ala.	R. P. McDavid & Co., 2104 First Ave., No.
Boise, Idaho	Walker Electric Co., 10th & Grove Sts.
Brooklyn, N. Y.	E. A. Wildermuth, 1102 Atlantic Ave.
Buffalo, N. Y.	Appliance Wholesalers, Inc., 320 Franklin St.
Burlington, Vt.	G. S. Blodgett Co., Inc., 190-200 Bank St.
Cambridge, Mass.	The Eastern Co., 620 Memorial Drive
Casper, Wyo.	Casper Supply Co., 444 S. Center St.
Chicago, Ill.	Nash-Kelvinator Corp., 2451 So. Mich. Ave.
Cincinnati, Ohio	Graybar Elec. Co., Inc., 310 Elm St.
Clarksburg, W. Va.	Williams Distributing Co., 406 N. Sixth St.
Cleveland, Ohio	Graybar Electric Co., 1010 Rockwell Ave.
Columbus, Ohio	Pixley Electric Supply Co., 129 Chestnut St.
Dallas, Texas	Graybar Electric Co., Inc., 400 S. Austin St.
Davenport, Iowa	The Elec. Equipment Corp., 116-118 E. First St.
Des Moines, Iowa	Sidles Co., 118 Tenth St.
Detroit, Mich.	Nash-Kelvinator Corp., 4809 Woodward
Erie, Pa.	Winter Co. of Erie, 1015 State St.
Fresno, Calif.	Devin Drew Co., 718 F Street
Gastonia, N. C.	Moore & Stewart, Inc., 105 E. Franklin St.
Green Bay, Wisc.	Morley-Murphy Co., 112-14 Washington St.
Greenville, N. C.	Carolina Sales Corp., Third & Cotanche Sts.
Hagerstown, Md.	Bohman-Warne, Inc., 16 Summit Ave.
Helena, Mont.	Modern Utilities Co., Fuller & Lawrence Sts.
Henderson, Ky.	Lambert-Grisham Co., Inc.
Houston, Texas	Straus Bodenheimer Co., 1510 Preston Ave.
Huntington, W. Va.	Emmons Hawkins Hdwe. Co., 1028 Third Ave.
Indianapolis, Ind.	Kiefer-Stewart Co., 141 W. Georgia St.
Jacksonville, Fla.	Graybar Electric Co., Inc., 2302 Main St.
Kalamazoo, Mich.	North Davis, Inc., 439 Portage St.
Kansas City, Mo.	Richards & Conover Hdwe. 5th & Wyandotte Sts.
Knoxville, Tenn.	East Tennessee Elec. Co., 612 E. Depot St.
Lancaster, Pa.	Landis Electric Shop, 121 N. Duke St.
Lansing, Mich.	Garlock Sales Co., 105 W. Washtenaw Ave.
Lincoln, Neb.	Sidles Co., 1228 P Street
Little Rock, Ark.	555 Incorporated, Broadway & Second
Long Island City, N. Y.	Nash-Kelvinator Corp., 27th St. & Pearson Pl.
Louisville, Ky.	Graybar Electric Co., Inc., 626 6th St.
Memphis, Tenn.	Arthur Fulmer, 260-270 Monroe Ave.
Miami, Fla.	Graybar Elec. Co., Inc., 68 N. E. 20th St.
Milwaukee, Wisc.	Morley-Murphy Co., 424 N. Plankinton Ave.
Minneapolis, Minn.	Graybar Electric Co., Inc., 413 S. Fourth St.
Newark, N. J.	Krich-Radisco, Inc., 422-43 Elizabeth Ave.
New Britain, Conn.	Rackliffe Bros. Co., Inc., Park & Bigelow Sts.
New Orleans, La.	C. T. Patterson Co., Inc., 800 S. Peters St.
Norfolk, Va.	Tidewater Electric Co., 127-135 E. Olney Rd.
Omaha, Neb.	Sidles Co., 502 S. 19th St.
Pensacola, Fla.	Pensacola Hardware Co.
Peoria, Ill.	Marquette Appliance Co., 800 S. Wash. St.
Philadelphia, Pa.	Raymond Rosen & Co., N.W. Cor. 31st & Walnut
Phoenix, Ariz.	Electrical Equipment Co., 424 N. Central Ave.
Pittsburgh, Pa.	C. R. Rogers Co., 5434 Penn Ave.
Portland, Ore.	Appliance Wholesalers of Ore., 123 N. E. 3rd Ave.
Poughkeepsie, N. Y.	Poucher, Wood & Wallin, Inc., 407-9 Main St.
Providence, R. I.	Post & Lester Co. of R. I., Inc., 89 Broadway
Richmond, Va.	Gathright's, Inc., 416 E. Grace St.
Roanoke, Va.	Thurman & Boone, Inc.
Roswell, N. M.	Mable Lowrey Hdwe. Co., 115 N. Main St.
Salt Lake City, Utah	Flint Distributing Co., Box 1470
San Antonio, Texas	Southern Equip. Co., Cor. Villita & Navarro
San Diego, Calif.	San Diego Standard Elec. Corp., 1407 Columbia
San Francisco, Calif.	H. R. Basford Co., 425 Second St.
Savannah, Ga.	M. Wilensky & Son, Inc., 223 E. Broughton St.
Seattle, Wash.	Graybar Electric Co., Inc., King & Occidental Sts.
Sioux City, Ia.	M. H. Kirchbaum, 417 W. 3rd St.
Sioux Falls, S. D.	Tri-State Electric Co., 407 E. Eighth St.
South Bend, Ind.	Radio Equipment Co., 213 W. Jefferson Ave.
Spokane, Wash.	Tull & Gibbs, Inc., First & Wall Sts.
Springfield, Mo.	Ozark Motor & Supply Co., 308-19 S. Jefferson
St. Louis, Mo.	Graybar Electric, Inc., 1220 Spruce St.
Syracuse, N. Y.	Graybar Elec. Co., Inc., 327 North West St.
Tampa, Fla.	Graybar Electric Co., Inc., 416 Ella Mae St.
Toledo, Ohio	V. J. McGranahan Dist. Co., 1702-04 Madison St.
Welch, W. Va.	Jones Cornett Elec. Co.
Wheeling, W. Va.	Earle Rogers Co., Main & 12th Sts.
Williamsport, Pa.	Williamsport Auto Parts Co., 241 W. Third St.
York, Pa.	The Careva Co., Inc., 145-47 W. Market St.
Youngstown, Ohio	Stambaugh-Thompson Co., 114-118 W. Fed. St.

SEE THE NEW KELVINATORS AND GET FULL 1938 PROGRAM STORY FROM YOUR NEAREST KELVINATOR DISTRIBUTOR!

The Champion Ice Maker!

7

STEPS TO A SALE

NOVEL and instructive is this picture-story of a walk-in sale by Gilbert Kohn, on the floor at St. Louis' Stix, Baer & Fuller Company. Illustrated is a carefully planned and practiced routine that regularly converts shoppers into buyers, moves better sets than the prospect had in mind, reduces the number of order postponements, avoids cancellation after the deal is made and brings the customer back for other merchandise. Here is a skeleton sales technique which, we think, many other storemen would do well to adapt.



1 How do you do. May I help you? (They can't easily walk out now)



2 Will you please be seated, Madam (Makes it even harder to leave)



3 Note how simply this set tunes (Enthusiasm is clearly contagious)



4 May I light your cigarette for you? (An opportunity to make her relax)

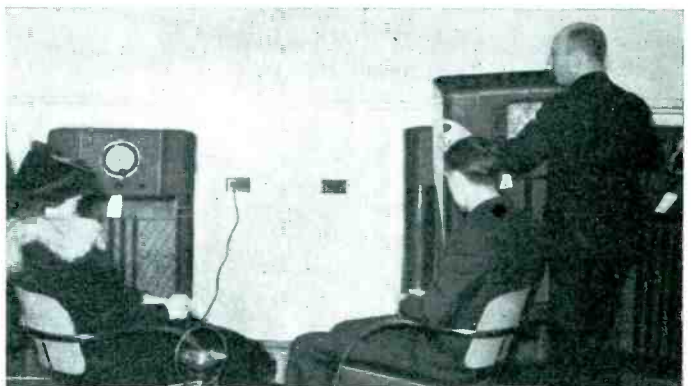

5 Compare these two new radio models (Why look elsewhere for variety?)



6 Isn't this one really worth more? (Subtle selling-up now enters)



7 You've made an excellent buy, sir (At last, the man gets attention!)

Congress Needs YOUR Guidance NOW

*An Opportunity for the Million Readers
of McGraw-Hill Publications to Help
Business Recovery*

TODAY, everybody sees that private industry *alone* can lead the march back to prosperous times. Business leaders, labor leaders, legislative leaders, and now the National Administration, all agree that the leadership must pass from government to private enterprise. As spokesman for the Administration, Secretary Morgenthau has said:

"The basic need today is to foster the full application of the driving force of private capital. We want to see capital go into the productive channels of private industry. We want to see private business expand."

So do we all. Nothing can take the place of expanding business. The business man needs it to meet his expenses and earn a profit. The investor needs it to put his capital to productive use. More than anyone else, the workman needs it for a steady job at regular wages. And the government needs it to get the revenues required to carry on. Everyone needs better business; there is no other way forward. But if business is to resume its leadership, government must revise its policies to make the shift possible.

Everyone who knows anything about federal taxes knows that the present system is not sound; it has been made even less so by some of the experiments of the last few years.

However good those experiments may be in theory, their practical result is to frighten business men and investors from taking the risks that are necessary for business revival. As Secretary Morgenthau puts it:

"We realize that our tax laws are too complicated; we want to make them less so. We realize that there are inequalities; we want to eliminate as many of them as we can."

With this encouragement from the Administration, Congress now must get at the job. Many see the need, but it is Congress that must do something about it. What it does will depend on how it interprets the views of the people. *The time has come for the people to tell their Congress what they want.*

At no time since 1929 have business people — employers and employees — had so promising an opportunity to impress their views and their needs on the Washington government. The iron is hot; now is the time to strike!

Specifically, these three needs are urgent:

First — *Repeal the undistributed earnings tax.* As a producer of revenue it is discredited. Its chief effect has been to obstruct recovery and curtail employment by holding back the normal plant improvements by industry. Such improvements make for higher efficiency, *the only means by which consumers can get more*

for their money, without loss of income as producers. Altogether, the undistributed earnings tax obstructs development, destroys employment, and encourages unsound financial practices. It should be repealed.

Second—*Repeal or amend the capital gains tax.* As it now stands, the investor who sells securities when prices are rising must give the government a large slice of his profit; but when he sells on a falling market he must eat his own losses. That is a one-sided, unfair proposition. It is heads-the-government-wins, tails-you-lose. It discourages the sound investment practice required by stable business. It should be repealed or amended to allow adequate deductions for losses.

Third—*Reduce the excessive personal surtaxes.* These high taxes were designed to reach for 75 per cent of the rich man's income. Whatever may be said for that objective in theory, it doesn't work in practice. It *appears* to "soak the rich" but in fact it is a blow in the air. For the rich can escape by hoarding their wealth in tax-exempt securities—municipal and government bonds rather than industrial securities. It is the latter that create productive enterprise, with orders for business and jobs for workers. So the effort to exact excessive taxes from the rich drives funds out of industrial employment and into government bonds; at the same time it dries

up the source of the desired taxes. Excessive surtaxes are a good example of losing all by over-reaching; they should be amended to encourage enterprise and increase revenues.

The America of today is possessed of the same driving force that created it. All it asks is a chance to resume its progress. In the early days of our national development, government paid huge bounties to encourage private construction of the railroads. Today industry asks no bounties; it asks only a chance to invest in national progress the surplus wealth that it has itself created. It is willing to meet the increased obligations of social progress and to pay its share of the governmental costs, but it asks relief from the shackles of restrictive and confiscatory taxation. It is ready to resume its interrupted march toward restored prosperity if only Congress will loosen the bonds that now confine it. Only Congress can effect that release. It can do so only by revising restrictive taxation. And only the American people can prevail upon Congress to meet that appeal *and to meet it NOW.*

Congress needs *YOUR* guidance. Will you give it *NOW?*



President, McGraw-Hill Publishing Co., Inc.

If private capital and business initiative are to take a leading role in recovery—then it is the obligation of the business and technical press to study ways and means by which this is possible; to keep business and industry currently informed; to mobilize opinion and to make that opinion felt and understood by the government, which has the power to obstruct or to encourage business and industrial progress. The McGraw-Hill Publications recognize that obligation. We are seeking in this editorial effort to provide an avenue through which our one million readers—America's business and industrial leaders—may indicate to the Congress the need to change the tax system so that industry can move forward more surely and rapidly.

USE THESE CARDS...NOW!

To encourage Congress to revise taxes NOW

To secure extra copies of this editorial

To get a comprehensive analysis of taxes

To encourage Congress to act now along the lines of this editorial, send in one of the cards below—now. Studies have shown that an average of 4 persons read each copy of this publication—so four cards are here provided—one for each reader.

Extra copies of this editorial are available for you—at cost—should you desire to put

this into the hands of your associates, employees or friends. You may order these on the card below, too.

Business Week is publishing in one of its December issues a comprehensive analysis of the tax situation. You may secure a free copy of this analysis by checking and mailing the card below.



BUSINESS REPLY CARD
First Class Permit No. 64, Sec. 510 P. L. & R. New York, N. Y.

McGRAW-HILL PUBLISHING CO., INC.
(Washington Bureau)

1252 National Press Building

(13)

WASHINGTON, D. C.

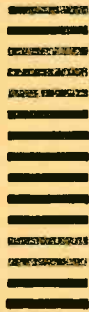

BUSINESS REPLY CARD
First Class Permit No. 64, Sec. 510 P. L. & R. New York, N. Y.

McGRAW-HILL PUBLISHING CO., INC.
(Washington Bureau)

1252 National Press Building

(13)

WASHINGTON, D. C.

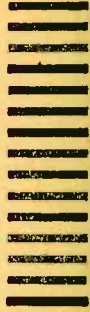

BUSINESS REPLY CARD
First Class Permit No. 64, Sec. 510 P. L. & R. New York, N. Y.

McGRAW-HILL PUBLISHING CO., INC.
(Washington Bureau)

1252 National Press Building

(13)

WASHINGTON, D. C.



BUSINESS REPLY CARD
First Class Permit No. 64, Sec. 510 P. L. & R. New York, N. Y.

McGRAW-HILL PUBLISHING CO., INC.
(Washington Bureau)

1252 National Press Building

(13)

WASHINGTON, D. C.



This editorial appeal is being made to more than a million persons through the following McGraw-Hill Publications...

American Machinist
 Aviation
 Bus Transportation
 Business Week
 Chemical & Metallurgical Engineering
 Coal Age
 Construction Methods and Equipment

Electrical Contracting
 Electrical Merchandising
 Electrical Wholesaling
 Electrical World
 Electronics
 Engineering and Mining Journal
 Engineering News-Record

Factory Management and Maintenance
 Food Industries
 Mill Supplies
 Power
 Product Engineering
 Radio Retailing
 Textile World
 Transit Journal

McGRAW-HILL PUBLISHING CO. (Washington Bureau)
 National Press Building, Washington, D. C.

- I agree with the recommendations made in this editorial. Please submit this card with all others you receive from my congressional district to my congressman together with a copy of this editorial.
- Please send me.....copies of this editorial for distribution among my associates and bill me at 50 cents per 100 copies.
- Please send, without cost to me, a copy of the comprehensive analysis of the tax situation Business Week has prepared.
- I do not agree with the recommendations made in this editorial -- in whole or in part.

Name

Company

Title

City and State

McGRAW-HILL PUBLISHING CO. (Washington Bureau)
 National Press Building, Washington, D. C.

- I agree with the recommendations made in this editorial. Please submit this card with all others you receive from my congressional district to my congressman together with a copy of this editorial.
- Please send me.....copies of this editorial for distribution among my associates and bill me at 50 cents per 100 copies.
- Please send, without cost to me, a copy of the comprehensive analysis of the tax situation Business Week has prepared.
- I do not agree with the recommendations made in this editorial -- in whole or in part.

Name

Company

Title

City and State

McGRAW-HILL PUBLISHING CO. (Washington Bureau)
 National Press Building, Washington, D. C.

- I agree with the recommendations made in this editorial. Please submit this card with all others you receive from my congressional district to my congressman together with a copy of this editorial.
- Please send me.....copies of this editorial for distribution among my associates and bill me at 50 cents per 100 copies.
- Please send, without cost to me, a copy of the comprehensive analysis of the tax situation Business Week has prepared.
- I do not agree with the recommendations made in this editorial -- in whole or in part.

Name

Company

Title

City and State

McGRAW-HILL PUBLISHING CO. (Washington Bureau)
 National Press Building, Washington, D. C.

- I agree with the recommendations made in this editorial. Please submit this card with all others you receive from my congressional district to my congressman together with a copy of this editorial.
- Please send me.....copies of this editorial for distribution among my associates and bill me at 50 cents per 100 copies.
- Please send, without cost to me, a copy of the comprehensive analysis of the tax situation Business Week has prepared.
- I do not agree with the recommendations made in this editorial -- in whole or in part.

Name

Company

Title

City and State

Preview of New Radio Merchandise



EMERSON

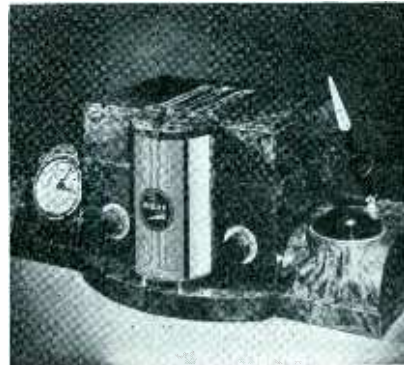

AIRITE

The 1938 model of the Airite radio desk set has an improved 5 tube receiver with shortwave pickup; also included is a writing set with Dip-ady pen and an 8-day clock; Bakelite or Plaskon case, \$42.50 to \$45; Sengbusch Self-Closing Inkstand Co., Milwaukee, Wis.

A Syrocwood table set in Chippendale carved effect design, finished in antique ivory can be obtained from the Emerson Radio & Phonograph Corp., 111 Eighth Ave., New York City; 6 tube ac-dc superhet; American, foreign and police calls; avc; 6 1/2 inch dynamic speaker

Multiple Radiofone is a wireless communication system consisting of one master unit and five remote stations for use on 110-120 ac; master station may carry on private conversation with any one outlying unit; each station in turn may call master privately; Radiofone Corp., 136 W. 22nd St., New York.

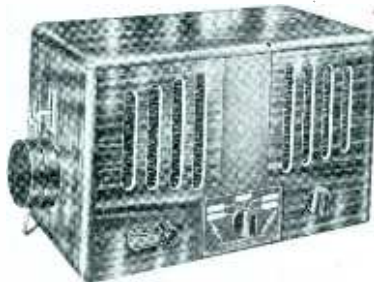

RADIOFONE

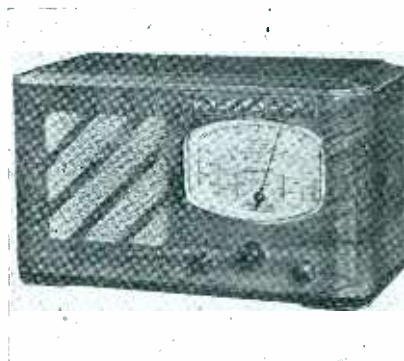

ANDREA

Instantaneous electric push-a-button tuning is provided on Model 6-D-5 of the Andrea Radio Corp., 4820 48th Ave., Woodside, N. Y.; it is a 5 tube, two band set for ac operation; the light walnut cabinet measures 14 1/2 x 6 1/2 x 8 3/4 in.; \$34.95



UNITED SOUND PRODUCTS

A wireless inter-office system may be obtained from United Sound Products, Inc., 816 W. North Ave., Chicago; cabinets are walnut finished and measure 8x12x6 in.; operates on 110-118 ac. or 110-120 dc; this company also makes a line of wired systems and p.a. equipment

A record player for use with a standard radio is now ready for distribution by the Stromberg-Carlson Tel. Mfg. Co., Rochester, N. Y.; attractively cased in a small walnut cabinet it employs the same crystal pickup and 12 in. single record turntable used in S-C Model 229P and 231P combinations



STROMBERG CARLSON

PREVIEW OF NEW RADIO MERCHANDISE



RADIOBAR

In place of the radio-phonograph with bar equipment previously made, the Radiobar Co. of America, 7100 McKinley Ave., Los Angeles, Calif. now offers the illustrated "phonograph with Philco"; this combination is housed in a conservatively modern cabinet, accented with inlays, and has automatic tuning; listening in are George Eldredge and Christine McIntyre soon to be seen in "Saddle Your Blues"

A small, compact p.a. system, adaptable to practically any use has been brought out by Operadio Mfg. Co., St. Charles, Ill.; rated at 8 watts normal and 15 watts maximum; velotron type microphone can be used as a hand mike or on banquet type stand; amplifier may be removed from case



OPERADIO



WINCHARGER

"Pressure control" has been introduced in the 1938 line of Winchargers made by the Wincharger Corp., Sioux City, Iowa; designed for 5 types of installation to meet all requirements; supply sufficient battery current to take care of radio, four or five electric lights, small appliances

A longwave converter for auto-radios is announced by the ABC Radio Labs., 3334 N. New Jersey St., Indianapolis, Ind., two metal tubes are used, one providing r.f. amplification of long wave signals, the other acting as a converter; useful in boats and cars in waterfront districts; \$24.95



ABC RADIO LABS

Matched dial plates for all standard Yaxley controls, rheostats and potentiometers may be obtained from P. R. Mallory & Co., Inc., Indianapolis, Ind.; marked in 100 divisions of the active rotation, and calibrated numerically from 1 to 10; 2 1/4 in. in diameter

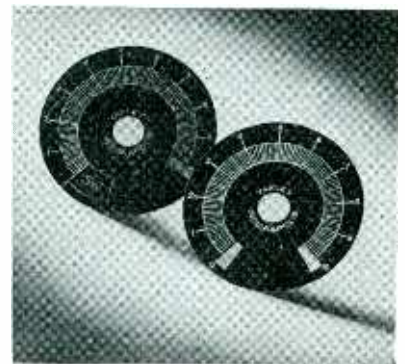

YAXLEY



IRC

Center tap wire wound resistors with moulded insulation have been announced by the International Resistance Co., 401 N. Broad St., Philadelphia, Pa.; available in six popular ranges and known as Type MW-2J; will carry up to 5 watts if mounted on a metal chassis and 2 1/2 watts if mounted in the open air



SUPREME

Model 531 oscilloscope contains a 2 in. tube and power supply, intensity and focus controls, input jacks to vertical and horizontal plates and an internal sinusoidal sweep supply with gain control; external linear sweep may be used; \$21.95; Supreme Instruments Corp., Greenwood, Miss.

PREVUE OF NEW RADIO MERCHANDISE



AMPERITE

The acoustic compensator on the velocity microphone of Amperite Co., 561 Broadway, New York City, permits adjusting the response of the p.a. system to the requirements of any particular room or condition by merely a flip of the finger



PILOT

The largest plastic cabinet ever molded in this country for radios, and designed by Jan Strang houses Model BG-562 of the Pilot Radio Corp., Long Island City, N. Y.; measures $18\frac{3}{8} \times 13\frac{5}{8} \times 10\frac{3}{8}$ in.; 6 tubes; phone jack; 540-1650 and 5700-18800 kc.; all important stations are logged on dial

Greasy, rusted and dirty surfaces can be soldered with the arc solderer of the Ultramar Mfg. Corp., 1160 Howe St., Chicago; eliminates need for acids or other fluxes; solders with a high melting point may be used because of intense heat; operates from 6 or 12 v. storage battery

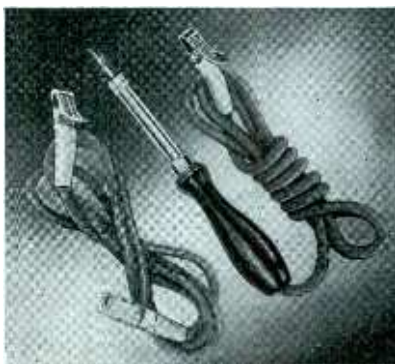

ULTRAMAR



SOLAR

Illustrated is the new series of Transoil capacitors of the Solar Mfg. Corp., 599 Broadway, New York; these are rugged oil capacitors for special use in transmitting; the complete Solar family consists of Transoil, Transmica and Solarex

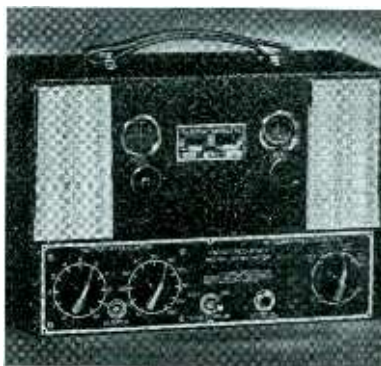

CLOUGH BRENGLE

The calibrations on the big, clear "Meter Reading Dial" on Model 110 signal generator of the Clough Brengle Co., 2815 W. 19th St., Chicago, are so spaced that flat spots are negligible and they are unified—set one beneath the other for all 5 bands

Mechanical difficulties in mounting high voltage filter capacitors are eliminated with the universal mounting brackets introduced by the Cornell-Dubilier Elec. Corp., S. Plainfield, N. J.; as shown in the illustration mounting in all positions is easily accomplished

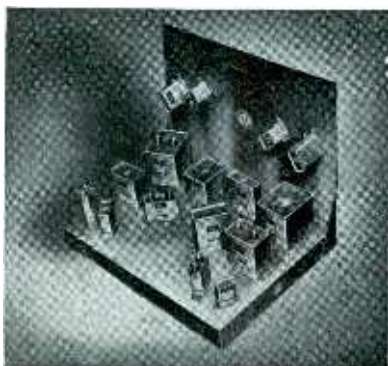

CORNELL-DUBILIER

Riteohm 81, made by Ohmite Mfg. Co., 4835 W. Flournoy St., Chicago, is a vacuum impregnated, non-inductively pie-wound precision resistor of 1% accuracy and 1 watt rating; suited for use in voltmeter multipliers, laboratory equipment and radio and electrical test sets



OHMITE

HERE'S ONE



The sales organization of the Joseph Strauss Company views Leonard's 1938 plans

During the summer of 1937 six hundred women tested the 1938 Leonard Refrigerator in their homes. These 600 homes are located all over the United States—in every state of the Union.

The owners of these 600 Leonards kept accurate records of the performance of their refrigerators. Records of their operating cost—daily recordings of kitchen temperatures and temperatures inside the cabinets. Service calls were also carefully noted. These records, now in Detroit, prove two things—and prove them conclusively.

First that the 1938 Leonards are more efficient, more economical to operate, more usable and convenient than ever before.

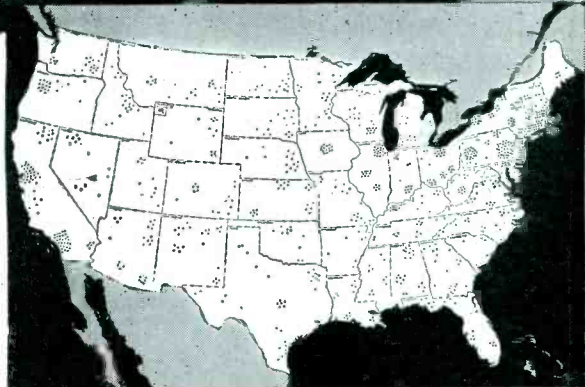

Second that they will reach dealers ready to perform 100 percent; that they will operate under any conditions in the homes of users anywhere. Truly the 1938 Leonard will be a "tried and proven refrigerator".

Get this!

1938 LEONARD

YOU CAN GO TO TOWN ON!

NO REFRIGERATOR DISTRIBUTOR EVER HAD A STORY LIKE THIS TO TELL HIS SELLING ORGANIZATION



600 LIKE HER WROTE THE 1938 LEONARD STORY And no refrigerator manufacturer has ever had a Selling Story like this to tell!

"When I got a glimpse of the Leonard Story—product and program—for 1938, my worries about selling refrigerators

next year went out the window.

"The minute I saw it I knew that here was a story that my wholesale men would literally eat up and go to town on. Not merely because I felt they would like the story itself but because I knew they'd get the same reaction that I got—it would sell Leonards to dealers and to consumers.

"I was 100 percent right. When I broke it to my boys, they actually cheered!

"And no wonder—because this 1938 Leonard story has got everything it takes. A product that has been built from the ground up to make a woman's mouth

water when she looks at it. A product with a new mechanical unit that has been proved and enthusiastically endorsed by 600 women a full year in advance! An economy story that has never had an equal.

"Plus sure-fire advertising and promotion plans that we know will produce store traffic for dealers. Plus a floor selling set-up that even a cub salesman will quickly grasp and effectively use.

"Yes sir—the 1938 Leonard story is a honey and I'm sure I voice the opinion of every Leonard distributor when I say that here's a story that the wholesale man, the dealer and the salesman will *all* go to town on!

"It's got power and punch—and better still, it's *believable*."

Secretary

THE JOSEPH STRAUSS CO., INC.
25-41 High St., Buffalo, N. Y.

LEONARD—Division of Nash-Kelvinator Corporation Detroit, Michigan

"Biggest Bargain in Refrigeration Today"

PORTRAIT OF PARTS BUSINESS

(Continued from page 17)

dently this was all right with him. Furthermore, since the demand was heavy, why should he advertise and why should he create interest in new circuits?—he could just coast along.

This was the beginning of the decline. With the manufacturer paying less attention to circuits the public began to lose interest; they had nothing new to work on. Manufactured sets started replacing home constructed ones. Dealers and chain stores, not getting as much parts business as before, did not reorder.

What followed is history. Parts distributors practically disappeared and very few of the old line manufacturers remained in existence. Many radio periodicals dropped out of the picture. Conditions were such that in the year of 1930 one could name the number of parts distributors in the United States in a couple of minutes—largely the result of that first break down of policy.

Today the picture is different, and more complicated. Since 1932 the parts business has been increasing to such an extent that parts distributors are now located in every important center of the United States. The methods of distribution are more complicated than ever. Discounts and who to give them to is quite a problem. For now we have the manufacturer, the distributor, the mail order houses—but who and where is the dealer and who is the consumer?

The mail order houses have introduced a new era in merchandising. In most instances these mail order houses sell a binding post or a replacement transformer at wholesale discounts to every Tom, Dick, and Harry. Therefore, there no longer is room for the dealer who used to sell at list prices. He has been eliminated from the picture.

The condition as it exists today is such that no one pays list prices for parts. A serviceman who goes out on a job can get 40 per cent off list on the parts needed—so usually can his customer. If the serviceman wants to make a profit on parts he has two alternatives—either get a better price from his distributor or make an attempt to buy direct—a forced attempt to break down the policy.

Today, instead of having true parts manufacturers we have a variety from set manufacturers down to the

small back room p.a. amplifier manufacturers. Some that are rated as distributors are mail order houses, or the larger dealers, who in some instances take the place of the distributor. In addition a new group that feels it is entitled to discounts includes colleges, laboratories and technical schools.

As for the manufacturer, it is noticed that a goodly number do not believe that a dark cloud can possibly mean rain. These manufacturers, particularly in the larger centers, do not hesitate to put on as many distributors as will accept their lines. And in some instances certain manufacturers will not refuse to sell direct to large service organizations—a breaking down of policy.

The distributor has his hands full. He carries a good variety of parts for the convenience of his customers. As soon as a customer develops into a good potential buyer the distributor discovers that some manufacturer is selling this account direct.

The buying power today is of a more substantial nature than in the past. There are ever so many more industries that are continually developing and experimenting. This creates a much broader base than in previous years. As mentioned in a previous article, many more industries are finding use for radio parts in their particular fields of endeavor.

Is this new parts business prosperity to be marred by a week-kneed distribution policy? In the rush for volume at the expense of the industry's future will manufacturers continue to see no evil, hear no evil, speak no evil about the discount structure?

In my estimation, now is the time to:

1. Classify all branches of the parts industry into proper divisions.
2. Establish and adhere strictly to properly graded discounts for each group.
3. Limit distribution to quantities for which there is a reasonably certain market.
4. Speed up advertising and publicity to stimulate the demand for quality parts.

PAYING SALESMEN

(Continued from page 25)

gross profits with the salesman selling from the floor or on the outside. The longer a "floor hog" sticks around, the higher he increases the salesman's

profit for selling it. Using this plan he seldom cuts prices and says it is profitable, even when a salesman gets a larger slice of the margin than he does.

The practice of paying compensation bonuses on salaries has been accelerated greatly during the past year, running from 1 to 10 per cent of compensation, depending on length of service, sometimes paid semi-annually, sometimes at Christmas. Up to a few years ago the compensation bonus was paid only by banks and large organizations. Now department stores, laundries, bottlers, small retailers and others are paying compensation bonuses.

This is the age of modernization, the radio replaces the music box, the washing machine the scrubbing board and the evolution has now hit the payroll. The old model compensation plans are being streamlined in many ways. The new models mentioned in this article may be used with or without variations because they are fundamental in application, designed for one purpose, to stimulate the natural and normal profit motive.

RADIO & REFRIGERATION DOVETAIL

(Continued from page 27)

accounted for 44% of the total business, 41% of the total gross profit and produced a gross profit of 13% of total sales.

Now there is one principle that we all know. Up to a certain point sales of any one article can be made economically at normal operating costs without incurring extra heavy expense. Beyond this point too intensive pushing means price concessions in one form or another, heavy advertising expense, over-extension of credit terms with consequent increases in collection and repossession costs, and the increased business if pushed too far produces a loss.

Taking all the above facts into consideration it is obvious that refrigeration and other large appliances are very desirable supplements to radio from the standpoint of steadying sales without inflating selling cost ratios and in absorbing a large portion of overhead. However, in formulating sales policies in this instance anyway, we must bear in mind that radios give us a gross profit margin of 42% to work with, refrigeration 30%.

New Electrical Appliances



GIBSON

Freezer shelf, Defroster, tray lifter, swing shelf and ice cube trays have been redesigned; MonoUnit compressor mechanism has quieting element in conjunction with head; all 8 models are finished in Hylux, a newly developed flexible, gum based white lacquer; Gibson Elec. Refrigerator Corp., Greenville, Mich.

"Circulaire" cooling and a Pop-Ice Tray, which releases two cubes at a time, are the high spots of the new line of Hotpoint refrigerators; an exterior fan which operates only when the refrigerator is running is responsible for the new cooling feature; Edison General Elec. Co., Chicago



EDISON GE HOTPOINT

The Conservador has been greatly improved on this year's models of Fairbanks-Morse & Co., Indianapolis, Ind.; delphinium blue trim adds a cheerful note of color; glass wool insulation on all models; 26% more quickly-usable space; oversized freezing unit; visible thermometer



FAIRBANKS MORSE

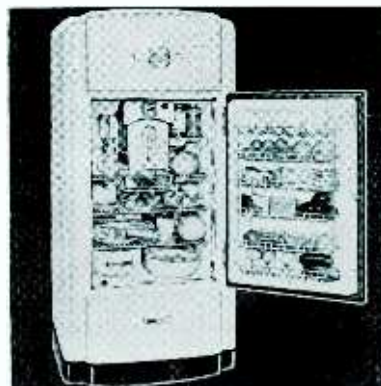

CROSLEY

Speed-cube release, built-in thermometer and knee-action door handle—all contribute to greater convenience in the 1938 line of refrigerators just brought out by Crosley Radio Corp., Cincinnati, Ohio; Model KL5, illustrated, has net food storage capacity of 5.03 cu. ft.; total shelf area of 12.62 sq. ft.

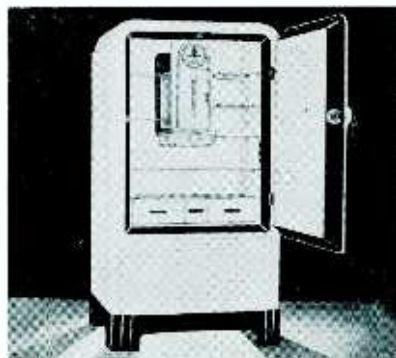

SERVEL

The new line of Electrolux gas refrigerators just announced by Servel, Inc., Evansville, Ind., has been restyled both inside and out for greater convenience; a "disappearing" hinge eliminates all hinge parts from the outside; an ice cube grid sends cubes popping out of the freezing tray.

Seven newly designed Autobuilt washers including a Spin Dry type are offered by Norge Division, Borg Warner Corp., Detroit, Mich.; equipped with every convenience and safety feature; 6 floor model rotary type ironers and one press ironer are also ready; cabinet cover serves as utility table when not in operation



NORGE

Two new styles in Bond Electric Corp.'s (New Haven, Conn.) flashlights of golden lustre solid bronze are the No. 2298 standard 2-cell Spotlite and the 252 2-cell Baby Spotlite; each has been restyled, adding symmetry; the lengthwise barrel corrugations provide handling security; 99c and 79c respectively



BOND



HEXCEL

In size and appearance the portable humidifier made by Hexcel Radiator Co., Racine, Wis., resembles a table radio; outer casing is two tone walnut; unit is of the vapor type, generated by a heating element giving scientific humidification; entire mechanism inserted in cabinet from rear, simplifying service; \$37.50

HORTON WASHES CLOTHES
"Hospital Clean"

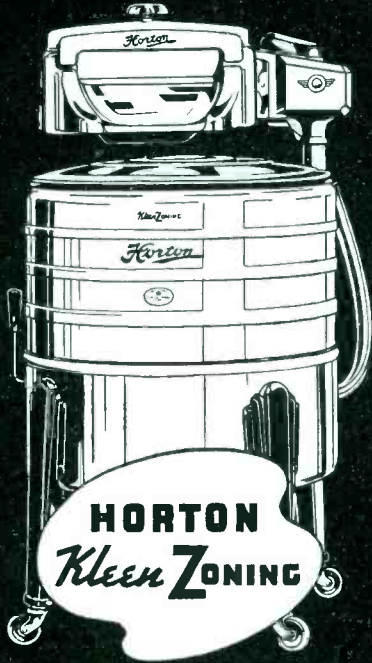

HORTON
Kleen ZONING

Linens, snowy white, clothes sparkling bright, and all the washing with the fresh sweet smell of absolute cleanliness.

Horton Kleen-ZONING makes it easy to keep the entire inside of the washer—including under and inside the agitator—spotlessly clean and sanitary. No chance for sticky, germ-laden accumulations to ruin later washings, endanger health!

Remember Kleen-ZONING is exclusive with Horton. No other washer can give you this extraordinary feature.

Write or wire us—do it in a hurry!

HORTON MFG. CO.
 1206 OSAGE ST.
 FORT WAYNE, IND.

HORTON WASHERS—IRONERS, SINCE 1871

Janette Rotary Converters



The original D.C. to A.C. converters with all wave filters developed exclusively for radio and sound apparatus.

CAPACITIES: 35 to 3250 watts.
 6, 12, 32, 115 and 230 volts D.C. to 110 or 220 volts, 1 phase, 60 cycle A.C.

Insist on a Janette
 Ask For Bulletin No. 13-25

Janette Manufacturing Company

556-558 West Monroe Street Chicago, Ill. U. S. A.
 BOSTON - NEW YORK - PHILADELPHIA - CLEVELAND - MILWAUKEE - LOS ANGELES
 DETROIT - SEATTLE

PUR-A-TONE

ANTENNA SYSTEMS

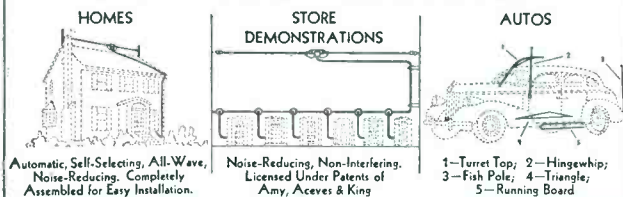

Automatic, Self-Selecting, All-Wave, Noise-Reducing, Completely Assembled for Easy Installation.

Noise-Reducing, Non-Interfering. Licensed Under Patents of Amy, Aceves & King

1-Turret Top; 2-Hingewhip; 3-Fish Pole; 4-Triangle; 5-Running Board

World's Largest Manufacturers of Antenna Systems

EST. 1906

L. S. BRACH MFG. CORP.

Newark, N. J.

WIN-
with WARD

"TRANS-O-MATIC" ANTENNA KIT

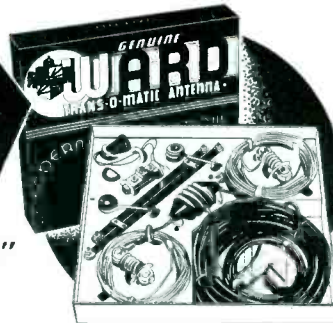

This kit comes completely soldered and ready to install. Features extra heavy enameled wire, molded bakelite junction coupler, and rubber covered transmission line—in an attractive display package.

WRITE FOR CATALOG

The WARD PRODUCTS Corp.
 WARD BUILDING CLEVELAND, OHIO



NEW ANTENNA BATTING 1000% No Slump

This Season!

Completely assembled ready to install. New type top coupler housing. No. 6066. List Price \$3.25.

Sold Through Distributors Only. Send for complete information.

RIVARD WIRE AND CABLE CORP.
 1014 Madison Avenue Toledo, Ohio

CORWICO NOISE-MASTER ALL-WAVE ANTENNA

Licensed by A.A.&K., produced with typical CORWICO attention to scientific detail. Warranted to banish man-made static on broadcast as well as shortwave frequencies. Write for information regarding this and other CORWICO units. . . .
 MADE BY ENGINEERS FOR ENGINEERS

CORNISH WIRE CO., Inc. 30 Church Street New York City

What's Radio Retailing Say?

If you read it in RADIO RETAILING it is true—and timely.

That goes for both the editorial and the advertising contents of this, the radio industry's recognized leading publication!



RADIO RETAILING

330 W. 42d St., New York, N. Y.

NEWS

Parts Show In June

Chicago chosen by RMA. New York exhibit in Fall not planned

WASHINGTON—The annual RMA convention and National Radio Parts Show again will be held together next June at the Stevens Hotel in Chicago. RMA's convention, membership meetings and annual industry banquet will take place June 7-8. The parts show will be held June 8-11, inclusive.

Plans were formulated by the Association's Board of Directors at its meeting late in November at Chicago, at which time the show was discussed with representatives of the Sales Managers Club, joint sponsoring organization.

It was decided to dispense with the usual Sunday show session and also to hold only one parts show annually at Chicago, dispensing with a fall exhibit in New York.

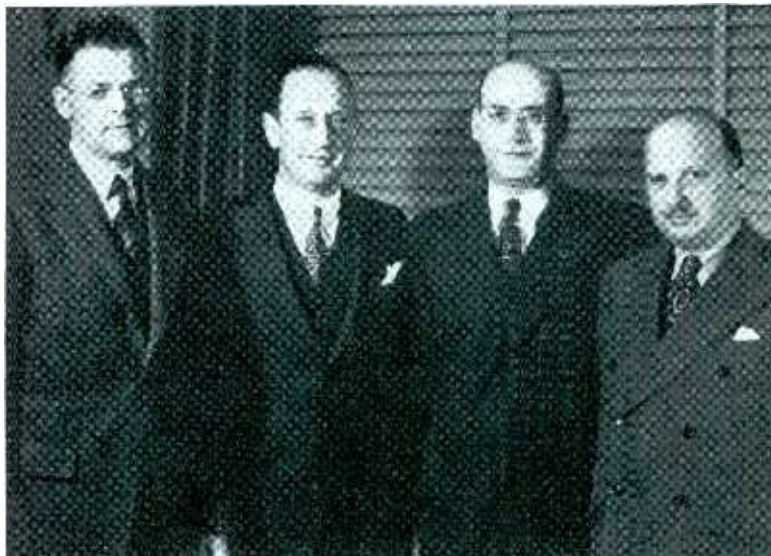

SHOWMEN—Board of Directors of the Radio Parts Manufacturers National Trade Show (left to right): H. E. Osmun of Centralab, Arthur Moss of Solar, S. N. Shure of Shure Brothers and Arthur Berard of Ward-Leonard. Messrs. Moss and Osmun are representatives of the RMA, Messrs. Shure and Berard represent the Sales Managers Club

RMA OK's RSA

Manufacturers offer to aid in organization of new national service group

WASHINGTON—From the Radio Manufacturers Association comes the following statement: "Assistance in organization of the new Radio Servicemen's Association



FIRST BRITISH BUYER—"Doug" Fair banks, Sr. of movie fame buys the first *McMurdo Silver* radio made in England, choosing it from a drawing while "Mac" (left foreground) stands fondly by. Next two customers were the Duke of Kent and Compton McKenzie

into a national, representative and effective trade body will be given by RMA. The new national organization of servicemen succeeds the former Institute of Radio Service Men and is a combination of a number of local service organizations in the principal cities of the country.

"T. P. Robinson of Dallas, Texas, is the new president of the RSA, which held its first Board meeting in Chicago on October 11. Ingvar Paulsen of Boston is secretary, and Lee Taylor of Chicago is treasurer.

"The RSA is attempting to weld the principal groups of servicemen in the country into a national organization. To encourage and assist the new Association, the RMA Board of Directors appointed a committee at Chicago on November 17 to report back to the RMA Board."

Trade Show Officers Chosen

CHICAGO—Officers of Radio Parts Manufacturers National Trade Show elected at the regular annual meeting of the Board of Directors are: S. N. Shure, president; A. A. Berard, vice-president, Arthur Moss, secretary-treasurer.

The Board itself includes: A. A. Berard of Ward-Leonard, Arthur Moss of Solar,

H. E. Osmun of Centralab and S. N. Shure of Shure Brothers. Ken Hathaway is managing director of shows and K. C. Prince legal counsel.

Johnson Refrig. Plant Moves

GALESBURG, ILL.—Johnson Motors has just completed construction of a



TEN-MILLIONTH—Secretary of War Harry W. Woodring receives Philco's ten-millionth radio in behalf of the Walter Reed Hospital of Washington while Boake Carter and district rep Ray Ridav look on

building 250 by 115 feet, on the outskirts of town; will make Briggs refrigerators, compressors, evaporators here.

FTC Holds Fair Trade Rules Hearing

RMA recommendations hit misleading ads, trick labelling, exaggeration of range, dummy tubes, "spiffs"

WASHINGTON—Highlights of the RMA-drafted fair trade practice rules for receiver manufacturers, tentatively approved by the Federal Trade Commission late in November and up for public hearing as we go to press, are as follows:

False or misleading statements regarding grade, quality, quantity, substance, use, performance, receptive capacity, material, content, character, size, model, origin, construction, manufacture or distribution of any receiver, part therefor, or other product made by the group is considered unfair trade practice.

False or deceptive branding or labelling is specifically condemned.

Nothing prevents sale of receivers by one manufacturer to another for re-sale. The seller must not, however, state that he is the manufacturer unless the plant of the actual maker is owned, operated or directly controlled.

The terms "allwave", "worldwave", "worldwide wave" or others of like import may not be used unless the receiver so described is constructed to receive and capable of receiving with reasonable, adequate consistency the entire spectrum of radio frequencies, namely, all longwave broadcasts and transmissions, all medium-wave and shortwave broadcasts and transmissions and all other waves transmitted or broadcast, including both foreign and domestic; excepting, however, that such a set need not include within its range point-to-point transmissions which are illegal for general reception nor such unchanging signals as radio beacons.

Nothing prevents the use of such terms as "limited allwave", "limited worldwave", "limited worldwide wave" when sets so described receive at least a continuous spectrum of frequencies from 540 to 18,000 kc., but such terms must be accompanied by figures showing the exact frequency range, including any or all skipped portions.

Words such as "allwave" may be used in phrases when given no more printed prominence than other words of the phrase, provided the frequencies covered are at least from 540 to 18,000 kc. and skipped frequencies and omitted higher or lower frequencies are plainly stated. Disclosure of exact frequency ranges is specifically recommended in all advertising and promotion of radio.

Discouraged are statements implying that distant stations or foreign stations may be as readily or as satisfactorily received as locals, when such is not the fact. Similarly condemned is the implication that such distant reception is not subject to inter-



CARDBOARD LOVER—Seeing is not always believing. Troy ("Tiny") Luster of Huntington, West Virginia's Air-Ola Radio is really embracing RCA's new, life-size cutout

ference or interruption by fading, noise, etc., where such is not the fact.

Advertisement or representations stating that any receiver contains a certain number of tubes when one or more are so-called "ballast" tubes or are dummies, or fakes, is prohibited.

Distribution or sale of sets on which the name-plate, serial number or other identifying mark of the original manufacturer has been altered, effaced or removed is considered unfair trade practice.

"Spiffs" or "push-money" are condemned where the retail store concerned handles two or more competitive lines.

More Room For Wholesale

ATLANTA—Shortly after January 15 Wholesale Radio Service Company's branch here will open new and larger quarters at 265 Peachtree St. Takes over the whole building.



SELLS WORLD FOR IRC—Robert E. Keiser, International Resistance Company's new foreign sales manager. Used to be with United American Bosch

Eastern Dealers Lay Trade-in Bluebook Plans

Interest in plan out of town leads committee to believe time is ripe for national dealer association

NEW YORK—Intriguing the trade here is a suggestion that a national association of radio and electrical appliance dealers be formed. Origin is the Brooklyn Electrical Appliance Dealers Association, with which groups from Manhattan and the Bronx, Queens and Westchester counties are at present cooperating to formulate a new and workable policy on trade-in allowances.

Appointed last month to study the local trade-in situation, lay plans for a bluebook directory of allowance values, make recommendations to manufacturers operating under fair trade enactments such as New York's Feld-Crawford Act, was a committee including Bert Albert, Jack Shaneck, Irving Sonenberg and Edward Lowe. Following consultation with members, attorneys, authorities on fair trade regulations, the following schedule was tentatively suggested, is being studied for possible adoption:

Age of Set	Max. Allowance
1 yr.	50 % off original list
2	42½ %
3	35 %
4	25 %
5	15 %

After the fifth year, sets are, the committee believes, of little value for re-sale, should carry a maximum allowance of not more than \$10.

Other trade problems to be attacked locally, deemed of sufficient importance to warrant formation of a national organization, are: Elimination of discounts frequently offered in a "confidential" way by big city distributors to blocs of retail employees in large stores, selling of sets to

repair men at trade discounts, cleaning up of excessive territorial competition caused by overanxiousness for volume among manufacturers.

Groups in other parts of the country, interested in New York's effort to clean house, starting with trade-ins, are flooding the offices of The Blue Book Committee, Radio Dealers Associations of Metropolitan New York, 728 RCA Building, Rockefeller Plaza, with requests for additional information.

FAIRBANKS-MORSE PRESENTS



COLOR SCHEME—W. Paul Jones, at a late November convention, tells about new blue and white refrigerators



SHOWMAN—Radio salesmanager Parker H. Ericksen stands the audience on its ear with a spectacular display



GUESTS—I. R. Loosen of Jenkins Music, Parker A. Levesque of Manchester, N.H.'s Radio Service Lab. join chief engineer, radio division, E. B. Passow at dinner

NORGE SHINDIG



COMPANY EXECS—John H. Knapp, assistant to the president, P. B. Zimmerman, v.p. in charge of Norge sales and C. D. Donaven, v.p. in charge of manufacturing



BELIEVE IT OR NOT—Guest Bob Ripley (center) chats with Howard E. Blood (left), president, and George Borg, chairman of Borg-Warner's Board



A FEW DISTRIBUTORS — Alvin VanAntwerpen, Tyler Carlisle and Ray Harten

PR15 Changes Hands

Communication receiver to be made by new west coast firm

LOS ANGELES—Pierson-DeLance, Inc. has been formed at 2345 W. Washington Blvd., will take over manufacture and distribution of the communications receiver model known as the PR15 from the Patterson Radio Company.

Karl Pierson, who designed the set for Patterson, is chief engineer. W. B. Delaplain, out of Hollywood's sound studios, is general manager. L. E. Abbott is associated. And Charles Weinberg, southern California manufacturers' agent, later sales manager for Patterson, assumes similar

duties with the new firm.

Distribution will be national, through jobbers.

McRae Appoints Browd

TROY, N. Y.—P. C. Ford, president of H. A. McRae & Company, Inc., of this city and Albany, has appointed "Rudy" Browd general manager and vice-president, stepping him up from the position of sales manager and vice-president.

AT STEWART-WARNER'S CONVENTION



HITER ON REFRIGERATION—V.p. and g.s.m. F. A. Hiter, on the platform, amid flowers, tells the boys about Stewart-Warner's new models



DISTRIBUTOR RELATIONS—J. Isaacman, Monroe, Louisiana distributor, chats with J. F. Ditzell, radio and refrigeration s.m., and F. A. Cross, ad mgr.



VICE-PRESIDENT'S CUP—Awarded to district managers: Beckham, Biel, Doherty, Riese, Palmgreen, McLeod, Rutledge, Rogovin and Tobin

Rewards For Motorolamen

Galvin awards prizes in big distributor sales drive

CHICAGO—Motorola's Network Campaign designed to stimulate opening up of new retail accounts by Galvin Manufacturing Corporation distributors is over and prizes have been announced.

First string winners are: Disco Distributing, St. Louis; Morris Distributing, Binghamton; Roberts-Toledo; Big Boys Auto Parts, Snubury and Ferguson of Paducah. Runner-ups also receiving cash awards are: United Distributing, Indianapolis; Porter Burgess, Dallas; M & M, Cleveland; Simon Distributing, Washington; York Automotive, New York; Moore Bros., Houston; Southland Distributors, Jacksonville; MotoTrunk, Kansas City; Alexander-Seewald, Atlanta; Motorola Sales, Grand Rapids; Kemp Equipment, Rochester; Gifford-Brown-Holliday, Des Moines; Motor Equipment, Wichita; Radio Distributing, South Bend; Kearns Auto, Atlantic City; Offenbauer, Lansing; Radio Parts, Saginaw; Chisolm Supply, Greenville; Gillette Sales, Rockford; Bryant & Trimble, Chattanooga and Ft. Worth Battery, Fort Worth.

Wholesale salesmen turning in the most business at the half-way mark were: Sidney Orzack of York Automotive, I. H. Bouchard of Radio Distributing, South Bend; C. M. Furman, Jr. of Chisolm Supply, George Roberts of Alexander Seewald and Halsey Butler of Motorola Sales, Grand Rapids. Grand prizes for salesman with top totals at the end of the contest were: Lou Goldman of York Distributing, George Roberts of Alexander-Seewald, Halsey Butler of Motorola Sales, Leo Friedman of Big Boys Auto and I. Strickland of Ferguson.

Hayes With Admiral

CHICAGO—James Hayes has been appointed "Admiral" district manager for the Continental Radio & Television Corporation's New England territory; will make his headquarters in Boston.



THE LADY'S INITIALS—Clever Christmas sales-boosting stunt by Crosley is this company's offer to put the customer's initials (in metal, gold-finished letters) on any new model, free of charge

Tech Moves

JERSEY CITY—The Tech Laboratories has moved to 7 Lincoln St., tripling production facilities.

New TCA Idea

NEW YORK—The Transformer Corporation of America, maker of sound equipment, is at present sponsoring the formation of an organization called the Clarion Institute of Sound Engineers. Sound specialists of proven ability are invited to join, will be granted direct factory purchasing power, will have available facilities of TCA's engineering departments.

Exclusive territories are to be assigned to charter members and a cooperative advertising plan instituted. All inquiries resulting from this campaign will be turned over to members.

Shure Wins

CHICAGO—Shure Brothers Zephyr Crystal Record Reproducer has won an award for excellence of design in the second Modern Plastics Competition.

Cruise For GE-ers

D. W. ("Winnie") May hires S. S. Pilsudski for January trip

NEW YORK—D. W. ("Winnie") May, district radio sales manager for General Electric, credited with originating the cruise idea for dealers and their wives some years back, plans a new edition early in January.

S. S. Pilsudski, new and lavish trans-Atlantic liner, is the vehicle, will stop at Miami, Havana, Curacao (Dutch West Indies), La Guara and Caracas (Venezuela). A fourteen day winter season jount.

New York and New Jersey dealers are eligible.

FRIGIDAIRE KINGPINS



HAD BAD COLD—So Dan Packard, furniture and department store division head, couldn't talk at the recent Frigidaire convention



GREEN ONIONS—They build up the strength of washer sales manager W. I. Buchanan for his new and important task



EXPLAINS—Why do new range grids "toe out"? Joe Rushton, newly appointed chief of this division, tells the audience

Raytheon Promotes Two

NEWTON, MASS.—Art Akeroyd, Ohio representative for the Raytheon Production Corporation, has been transferred to this firm's New York office in the capacity of manager and assistant to Earl S. Dietrich, manager of distributor sales.

Carl M. Lundquist, formerly in the Chicago office, has been promoted to the position of district sales manager in the Cleveland territory.

LATEST DEALER HELPS

VOLUME CONTROL GUIDE—This 208-page book contains a special replacement control index by manufacturer and model, analysis of volume and tone control circuits, numerical listing of controls, etc. Dealers will find this a handy guide to keep on the bench. Write the *International Resistance Co.*, Philadelphia, Pa., for your copy.

HIGH FIDELITY RECEPTION—A 11 page booklet explaining high fidelity reception in non-technical terms has been issued by the *Philco Radio and Tel. Corp.*, Philadelphia, Pa.

SPEAKERS—The new line of p.m. speakers utilizing Nipermag in their construction are covered in an amply illustrated catalog which may be obtained by writing *Cinaudagraph Corp.*, Stamford, Conn.

TEST EQUIPMENT — Specifications and photos of the line of test equipment made by *Precision Apparatus Corp.*, 821 E. New York Ave., is yours for the asking.

SERVICE CHARTS—Complete service charts will be sent upon request to *Traveler Radio & Tel. Corp.*, 1036 W. Van Buren St., Chicago.

BILLBOARD POSTER—A charming girl listening to an Emerson radio is shown on the outdoor advertising poster being supplied by *Emerson Radio & Phonograph Corp.*, 111 Eighth Ave., New York. Dealers name appears in large letters.

SET CATALOG—Frank Andrea has made up a new handy size folder on his new domestic line. Complete details and photos of every model. *Andrea Radio Corp.*, 48-20 48th Ave., Woodside, Long Island, N. Y.

DECALCOMANIA—A smart, colored decal identifying users as Stancor outlets are available to jobbers of this line. *Standard Transformer Corp.*, 850 Blackhawk St., Chicago, Ill.

CONTROLS—*Clarostat Mfg. Co.* announces this month a 200-page service manual containing an extensive listing of exact duplicate and standard volume controls and resistor tube replacements for sets in use in the field. Included also are circuit diagrams, servicing hints, ballast data, and attenuator data invaluable to servicemen.

PUBLIC ADDRESS—A "Blue Book" on P. A. put out by Bogen shows its complete line of sound systems, amplifiers, record players and Communo-Phones. *David Bogen Co. Inc.*, 663 Broadway, New York, N. Y.

RADIO RETAILING, DECEMBER, 1937

Exide

... a name your customers all know



PRACTICALLY every customer you have, and every prospect, knows the Exide name. When you think of it that way, doesn't it seem logical to pick the Exide line of storage batteries to go with your battery radios?

It's playing fair with yourself and your customers too. It never takes high-pressure tactics to sell an Exide. So your battery profits come easy. And your customer benefits by getting better performance from the radio you've sold. Dealers find that it cuts down come-backs to sell an Exide with each battery set.

Exides are specially designed radio storage batteries, built for long life and full power. Priced competitively to the set buyer and sold to you at the

EXIDE RADIO BATTERIES

Type	CAPACITIES		Price, Each Consumer
	R.M.A. 100-hr. Rate Amp. Hrs.	Approximate OPERATING HOURS	
2R-105	105	210 at .5 Amp. Drain	\$4.95
2R-160	160	320 at .5 Amp. Drain	6.95
2R-230	230	460 at .5 Amp. Drain	8.95
6R-100	100	50 at 2 Amp. Drain	11.10
6R-150	150	75 at 2 Amp. Drain	19.95

Other types and sizes described in folder.

regular radio trade discounts. There are 2-volt and 6-volt Exides in various capacities, as well as 6-volt batteries for wind-driven chargers and gas-engine generator systems. Mail the coupon now for full details.

THE ELECTRIC STORAGE BATTERY CO., Philadelphia
The World's Largest Manufacturers of Storage Batteries for Every Purpose
Exide Batteries of Canada, Limited, Toronto

Exide RADIO BATTERIES

THE ELECTRIC STORAGE BATTERY CO.
1900 W. Allegheny Ave., Philadelphia

Please see that I get complete details on your proposition.
My business is % retail % wholesale.

NAME _____
NAME OF FIRM _____
ADDRESS _____

PAGE 53

CROWE

Announces!

CHRYSLER '38

CHEVROLET '38

PLYMOUTH '38

New Panel Mounting Kits for 1938 CARS

A GAIN CROWE leads! Its on-the-panel program is out-in-front with: Official Styling! Interchangeable Controls and Shafts! Harmonizing knobs! All insure harmonious appearance and custom-built workmanship.

Interchangeable Controls

Interchangeable feature of Crowe controls and shafts permits re-installation of auto-radio set in another car simply by changing Panel Mounting Kit. Airplane and drum-type dials. Individual styling! Fine quality! Gear ratios and switches to suit every radio.

Increase Sales!

Give the customer more convenience—more beauty—more interchangeability! Sell him "Crowe" and increase your auto-radio sales!

PHILCO DEALERS!

Crowe-Philco program increases sale of Philco auto radios. Stock Crowe Panel Mounting Kits.

Ask for Supplement 204 and Bulletin 201.

MANUFACTURERS!

Crowe Method of Distribution reduces inventory—improves service—standardizes prices—simplifies selling—stabilizes profits.

Write for details.

CROWE NAME PLATE & MFG. CO.
1745 Grace Street
CHICAGO, ILL.

NEW REPS AND DISTRIBUTORS

FADA—Radio Parts, Inc., Milwaukee, will cover Wisconsin. This company has a branch at Madison.

PHILCO—E. B. Price has been employed by Transitone as special representative covering the Atlantic, Eastern and East Central divisions on Philco auto-radio.

MESSNER—Bill Carduner, New York, manufacturers' representative, has moved to 17 Warren St.

AMPERITE—New representatives: G. W. Sipe, 130 N. Belvedere, Memphis; Don A. Burchman, 917 S. W. Oak, Portland, Ore; W. J. Purdy, 420 Market, San Francisco; J. Earl Smith, P. O. Box 1805, Dallas and M. K. Smith, 635 N. Highland, N. E., Atlanta.

WARD LEONARD—W. Bert Knight, Inc., of 115 West Venice Blvd., Los Angeles, heretofore covering the immediate vicinity only, now has this line of resistors, rheostats and relays for all of California.



PLACQUE FOR PERFECTION—The Kadette set at the right won the plaque at the left in a recent modern plastics competition

APEX—Krauss Distributors, Inc., Cincinnati, recently appointed distributor for southern Ohio. North Central New York goes to C. L. Hartmann Corp., Rochester. E. S. Cowie Electric Co., Wichita, Kansas, will serve central and western Kansas. Ferguson Brothers, Waterloo, Iowa, new distributor for central Iowa.

YOU CAN BEND GLASS

(Continued from page 23)

actual operation so it can be heard. The set in operation may be placed in the center of the window, with the showcard on top of it and a speaker placed outside the window or just above the door. That arrangement depends upon your window size and other conditions.

Be sure to place the control bars beyond the reach of little fingers. Glass bends slightly under the pressure of the finger, and that concaving of the glass presses against the sensitive switch, establishing contact through to the tuning mechanism. The control bars are held firmly to the glass when the suction cups are moistened with glycerine and pressed firmly on the glass. When this has been done one man adjusts the two set screws behind each suction cup

until a man on the outside is able to tune each station by a slight pressure of a finger over the switch button. Make the two cards, one on either side, which instruct the pedestrian to press on the glass in order to tune the designated station, very conspicuous in color scheme and large as possible but not hiding anything you want seen.

This Phantom Control is extremely simple and may be used in many ways at a later date, especially if you sell appliances. By cutting in a relay #40 wire may be run from bar to relay and any wattage required to operate an appliance can be switched on and off. The Phantom Control (\$5.25, Andrews & Perillo, 39-30 Crescent St., Long Island City, N. Y.) may also be used to demonstrate good and bad lighting. Its uses are wide and are controlled largely by mechanical ingenuity and imagination.

Would You Trade—?

Competing with . . . a dozen nearby dealers . . .
Advertising for . . . a dozen nearby dealers . . .
Price cutting by . . . a dozen nearby dealers . . .
Sharing turnover with . . . a dozen nearby dealers . . .

For . . .

No competition . . . your city exclusively yours . . .
Directly profiting on your every penny spent for advertising . . .
Stabilized price and a full profit . . .
Building sales today and for the future . . . with quality . . .

● Of course you would trade. You CAN . . . if you act at once. Certain cities and territories are yet available to serious radio merchants. The product is the outstanding MASTER-PIECE radio, custom built by McMurdo Silver . . . One-half of America is already closed to America's best music merchants. Don't delay . . . write or wire now for full details to:

McMURDO SILVER CORP., 2900 S. Michigan Blvd., Chicago

HOW TO KEEP FROM OVERSTOCKING

(Continued from page 33)

ularly to their locality. The average monthly release of dance records from each company manufacturing a seventy-five-cent item yields about twenty discs. The thirty-five-cent lists yield about forty-five. If you stock the latter, your investment (on a sample, one-copy-each basis) is about the same as for the former. Which bands are the most popular and which duplications among two, three or more labels should be avoided are problems best solved in the light of your own experience.

Let your buying angle be governed largely by the following system for checking your inventory at any given time, determining by your own sales records the advisability of future investment, the quantities you need to supply the demand. Keep a record on a record. For every new number that goes into your stock provide a green kraft paper stock envelope (distributors supply these in both 10- and 12-inch sizes). These stock envelopes are filed numerically (slipshod methods of storing and displaying records contribute greatly to overstocking), surplus copies are put on the shelves behind the stock envelope, or placed on the counter for display. On the upper right hand corner of the stock envelope write the number of the record and, if you wish, the names of its two selections. On the opposite corner you jot down the date of original purchase and quantity. Re-orders are logged chronologically as they are made. For album sets use a piece of durable cardboard on which you write the names of the composition, the composer, recording artist or organization, make and number of the set. Below this indicate the date of purchase and quantity, re-orders, etc. Clip this card to the first album pocket, to be removed when the album is sold.

Stock envelopes and cards when empty and unattached indicate your "shorts" and are placed under your counter (a special drawer or shelf set aside for them). When you re-order from them, all the facts you need to know are right before you: the time required to turn over your stock and the quantity sold during that period, indicating the quantity you should re-order. If the turn-over was not a quick one and the music apparently is no longer in demand,

you may want to discontinue the record. Erase your data and use the envelope for a new item.

This system will also help you to determine the sales possibilities of new discs. For example, Joe Swingit's orchestra makes a new record. You note, by glancing at the stock envelopes of his past discs, that his records don't sell well for you. Hence, you order or ignore the new Swingit record with that in mind. The same check-up applies to classical items. You perceive that the two old albums of Bach transcriptions by Stokowski and the Philadelphia Orchestra have sold exceptionally well. So when Victor announces a third album of similar music you are prepared, on the basis of the business you did with albums Nos. 1 and 2, to order a quantity sufficient to supply the demand you have every reason to expect. If, however, you note from your stock cards that other Bach albums haven't sold as well, you are perfectly right in coming to the conclusion that in this case the recording orchestra and director are important factors. The salesperson might very well arrive at the same conclusion without recourse to figures but it's best to have the data in black and white.

The advance lists regularly issued by the phonograph companies are highly important adjuncts to discriminate record purchasing. Study them with an eye to the class of records you have found the most successful in your location. Note the bands and artists represented and check your sales records on the discs of these particular bands and artists. Note the movies in which some of the new tunes appear as well as the composers represented, then check on former sales of similar material. Best of all, order sample copies of new discs, listen to them with your sales persons before placing a bulk order. Those single discs you do not care to stock permanently may be placed on the display counter. It won't be long before some inquiring customer takes them off your hands.

Check your records and albums on display daily. Don't allow your stock envelopes or album cards to become separated from the merchandise they represent unless these records are actually out-of-stock. Whenever fast-selling stock appears low re-order immediately on the strength of the quantity you have sold since the time of your last purchase.

A record on a record tells everything.



is the Leader!

- Streamlined to "dress up" all automobiles, WARD leads again with brilliant new aerials, featuring Mol-en-ac, a new white metal that cannot rust.

WARD aerials are easy to install; fit any car, and add power to the reception of any radio.

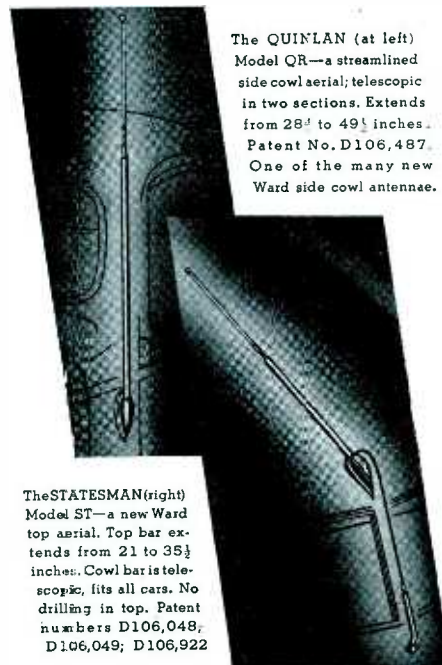

The QUINLAN (at left) Model QR—a streamlined side cowl aerial; telescopic in two sections. Extends from 28" to 49" inches. Patent No. D106,487. One of the many new Ward side cowl antennae.

The STATESMAN (right) Model ST—a new Ward top aerial. Top bar extends from 21 to 35½ inches. Cowl bar is telescopic, fits all cars. No drilling in top. Patent numbers D106,048; D106,049; D106,922

WRITE FOR ILLUSTRATED CATALOG

The WARD PRODUCTS Corp.

WARD BUILDING CLEVELAND, OHIO

TODAY'S BIGGEST VALUE IN Precision RADIO TESTERS

Precision built throughout, Readrite-Ranger Radio Testers need no apology from the highest class servicing shops. In fact, you will find them using these rugged testers on calls because they have been particularly designed to withstand rough field work. Ask your jobber to show you today's biggest values in precision radio testers.

The Readrite-Ranger Model 640 Free Point Tester has eight automatic switch type and ten single action jacks. Five sockets will handle any type radio tube. Model 740 Volt-Ohm-Milliammeter has 3" Square Triplet Precision Instrument. Scale readings: 10-50-250-500-1000 AC and DC Volts at 1000 Ohms per Volt (DC Accuracy 2%; AC 5%); 1-10-50-250 DC M.A.; 0-300 Low Ohms; High Ohms to 250,000 at 1 1/2 Volts. (Rheostat adjustment for 13 1/2 Volts for Ohms readings to 2 1/2 Megohms. Batteries may be added permitting such readings in 250,000 Ohms steps.) Low Ohms to 1/2 Ohm with 25 Ohms in center of scale. Backup circuit used. Current draw is only 1 M.A. Batteries, accessories and instructions included.

Bill - This is the Volt Ohm Milliammeter I spoke to you about. It's a honey.
 RADIO SERVICE INC.
 2024 MAIN STREET
 CITY
 JAMES SMITH
 PHONE
 RAD 102



Model 640-740

PRECISION BUILT
 ONLY \$28³⁵

Readrite
 TESTERS **RANGER** METERS

Combination Volt-Ohm-Milliammeter and Free-Point Tester ...

Also Available in Single Units . . . No Extra Cases to Buy!

1938 Up-to-the-Minute Tube Tester



\$19.80

Model 430

Five flush type sockets provide for all tubes. The tester operation is very simple and indicates condition of the tube for dealer and customer on Direct Reading (GOOD-BAD) colored scale of Triplet instrument. Will also test for inter-element shorts and leakages. Complete in attractive, sturdy, quartered-oak case. Sloping etched panel of silver and black. Suitable for portable or counter use.

Direct Reading Signal Generator



Model 557
 \$18.90



Model 557 Direct Reading Signal Generator uses plug-in type coils. Five frequency bands are covered from 110 to 20,000 K.C., all fundamentals. Completely shielded for static and magnetic fields. Attenuation and stability are outstanding features. Strong signals both modulated and unmodulated are furnished.

Combination Tube Tester and Signal Generator

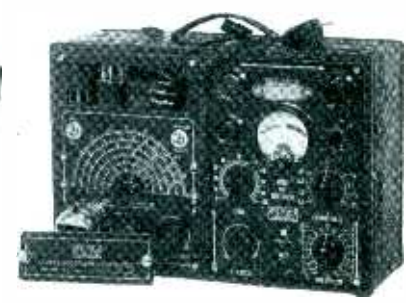

Model 440-540
 \$36.90

Model 440-540 consists of two separate testers installed in a sturdy, metal carrying case for shop or field use, with built-in compartment having "snap-on" cover for accessories, finished in electro black baked enamel. Silver and black panels. Strong leather strap handle for convenience in carrying. To use one means you will be glad to own one.

TODAY'S BIGGEST VALUES IN PRECISION TESTERS



Readrite Meter Works, 1220 College Dr., Bluffton, Ohio

....Please send me more information on Model 640-740;Model 430;Model 557;Model 440-540.

Name

Address

City..... State.....

TECHNICAL TOPICS

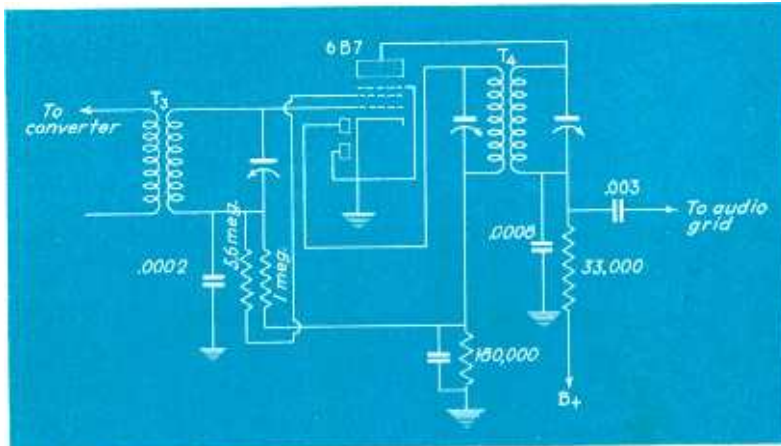

Triple Purpose Circuit

The 6B7 tube in the new G.E. F-40 performs three functions simultaneously. It operates as i.f. amplifier, detector and audio amplifier at the same time.

Referring to the schematic, the 6B7 grid receives an i.f. signal from a 6A7 converter. After amplification at the i.f. frequency, the signal is coupled through the i.f. transformer T4 to the diode section of the same tube. Here it is rectified, a.v.c. voltage is developed across the 180,000 ohm resistor. This a.v.c. voltage is in turn applied through the 1 megohm resistor, causing a control of amplification dependent on the strength of the carrier. The audio voltage developed across the 180,000 ohm resistor is also fed through the 1 megohm resistor and the secondary of T3 to the same grid of the 6B7. Thus the pentode section works as an audio amplifier while it is also operating at an i.f. frequency.

Audio voltage developed in the 6B7 passes out through the plate circuit and through the primary of T4. This voltage is developed across the 33,000 ohm resistor and coupled directly to the grid of the output tube.

Two Terminal Oscillator

A novel oscillator circuit is shown herewith. The term "two terminal" is derived from the fact that only two con-

tacts are necessary in switching the oscillator from band to band. All that is needed is to change the value of the inductance L; contrast this to a tickler feedback system. In addition to simplified switching, this circuit supplies a reasonably constant output voltage according to an RCA bulletin.

Three variations of the circuit are shown in Figs. 1, 2, and 3. In these circuits, the output of T₁ feeds the grid of T₂; the output of T₂ feeds the grid of T₁. Thus, the action of T₂ is analo-

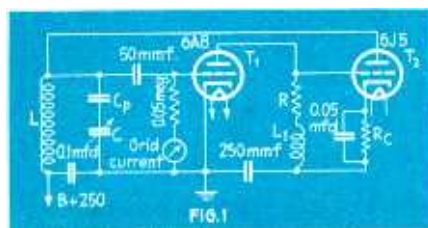

gous to that of the tickler in a conventional tickler-feedback circuit. Fig. 1 represents a direct-coupled arrangement. In this circuit, signal and bias for T₂ are obtained directly from T₁. Because of the direct coupling, the internal plate resistance of one tube is connected in series with the internal plate resistance of the other; hence, the B-supply voltage is divided between T₁ and T₂. In the circuit of Fig. 2 and of Fig. 3, capacity coupling between T₁ and T₂ is used; hence, nearly full B-supply voltage is applied to each tube. Fig. 2 differs from Fig. 3 merely in the manner in which B-supply voltage is fed to T₂.

In determining the value of R, tune

the oscillator to the low-frequency end of the high-frequency band and adjust the value of R for nearly maximum output. Tune the oscillator to the high-frequency end of that band and adjust L₁ for the same output that was obtained at the low-frequency end. Now, measure oscillator amplitude over the tuning range of the wave band; a convenient measure of oscillator amplitude is the value of oscillator grid current. It may be necessary to change these values of R and L₁ in order to obtain a suitable compromise between desired values of tuning range, oscillator amplitude, and uniformity of output. When the values of R and L₁ are determined in this manner, they need not be changed when the oscillator is switched to any of the lower

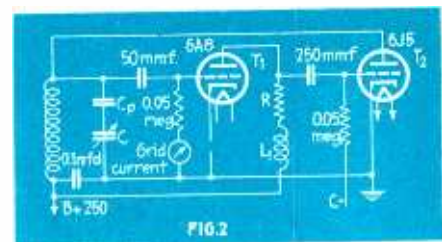

frequency bands. In these bands, oscillator amplitude is independent of the value of L₁ and is nearly constant over the tuning range of the band.

Typical values of R and L₁ are 200 ohms and 1.5 microhenries respectively. These values are suggested as guides; final values should be determined by test. The condensers C_p are used to isolate the high voltage from the tuning condenser C; condenser C_p may be a padding condenser when the oscillator tracks with a signal circuit in a superheterodyne receiver. The bias on the grid of T₂ is used to limit the plate current of T₂ to a safe value. This bias is not required under some conditions of operation.

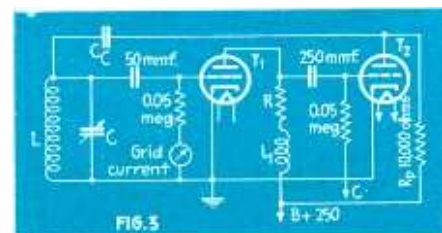

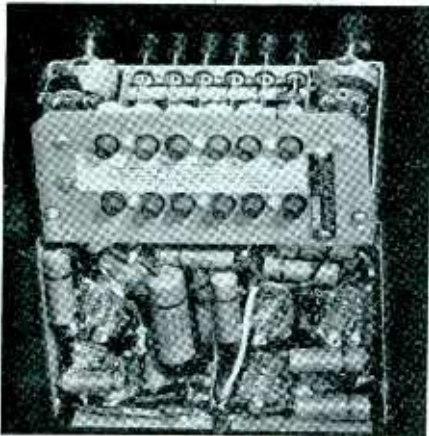

Push-Button Midget

The accompanying schematic is evidence that automatic tuning has invaded the small-set field. This is contrary to many expectations since many assumed that automatic tuning would be limited to high priced models. This particular set, the underside of which is shown, is a 5 tube ac-dc model by Wilcox-Gay.

The receiver consists of a combined mixer and oscillator, single i.f., combined second detector and first audio and a pentode output. Since no r.f. stage is used, it is only necessary to pre-tune the mixer input and oscillator. The trimmers and switches for pre-tuning are shown at the left of the schematic between the antenna coil and the mixer stage. One column of these trimmers tune the mixer, the other the oscillator.

The tuning range of the trimmers is divided into two sections. Three buttons may be tuned to any frequency from 540 to 1000 kc. The other three buttons tune from 950 to 1700 kc.

The under-chassis photo shows the adjusting knobs for tuning the trimmer sections. The lower row of knobs tune the oscillator, the top row the mixer. These knobs are adjusted in pairs to any

one frequency. By using knobs instead of the usual screw driver adjustment the frequency position of any one button may be altered easily and quickly.

Remote Automatic Tuning

The new GE, model F-135 has provision for tuning and silencing the receiver from a remote point. Ten leads run from the set to the remote control box. Two leads are used for the silencing switch, one lead is common to the push buttons. This leaves 7 leads to

stations from the remote control unit. These leads are to be connected to pins on the contact segment at the rear of the chassis.

In order to connect the remote control box it is necessary to remove the least desirable station's call letter from one of the push buttons of the receiver and insert "Remote Control." Note the number of this button as marked on the escutcheon.

Remove from the pin on the contact segment of the receiver the lead that bears this number and connect it to the number 10 lead of the remote control cable. This pin is left vacant.

When connecting the leads from the push buttons of the remote control box, first remove the original leads from the selector pins at the rear of the chassis. Connect the remote control lead first and tighten it in position with a hex nut. Now replace the original lead.

It is important to note that the "silent button" must be released at both the receiver and remote control unit, otherwise no audio output will be obtained.

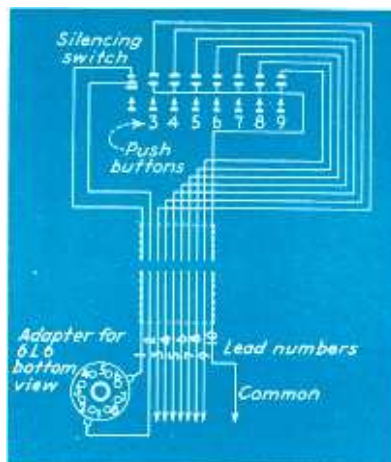

connect to 7 individual station selector push buttons.

Referring to the schematic, number 1 and 2 leads are connected to an octal base adapter, serving to connect the silencing button to the output tube. The silencing circuit shorts the grid of the 6L6 to ground.

The number 3 to 9 leads correspond to the button numbers and, with the number 10 lead, provide the selection of

Resistance Coupled I.F. Stage

The first i.f. stage in a number of the new Crosley models is coupled to the second stage by a resistance-capacity

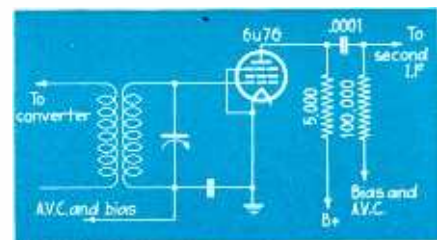

network. This method of coupling is a simple and easy way to obtain a broad resonance curve, aiding high-fidelity reception.

The input to the first i.f. from the converter is transformer coupled in the standard manner. This provides maximum transfer of energy from the converter. Likewise, the output of the second i.f. is transformer coupled to the detector.

By choosing the proper values of capacity and resistance, a resistance-capacity network can provide a resonant circuit similar to a tuned coil. The selectivity is a great deal less, however. Hence such a circuit will pass a relatively wide range of frequencies. Thus the response of this receiver is increased on the high frequency end.

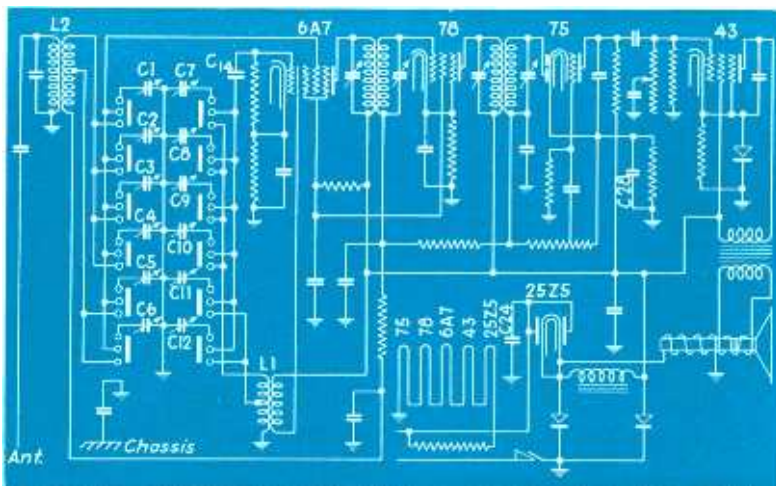

BIGGER AND BETTER THAN EVER AND STILL

FREE

TO RADIO DEALERS AND SERVICEMEN!

3rd Revised Edition of

"TRICKS OF THE TRADE"

Contains accurate answers to 956 set troubles
— 11 reference charts — 24 auto circuits

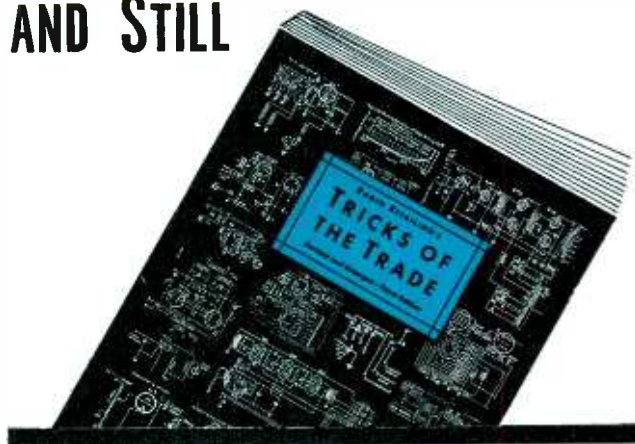

SAVES YOUR TIME! SAVES YOUR MONEY! ENDS SET WORRIES!

HUNDREDS of radio men are using this unequalled, trouble-shooting guide to take the "bugs" out of their toughest repair jobs and pour EXTRA profits into their service work. Already in its third edition, "Tricks of the Trade" has really clicked. But it should. It contains not one bit of useless data, no waste descriptions, no theories, no help for fans or amateurs. Every one of its 76 pages is packed with practical, "how to" information that answers the questions on set troubles that crop up in your work every day.

"Tricks of the Trade" is one service book that is different. Once you have had a copy you won't part with it for a minute. I know many men who consider it more valuable than their tool kit. This one, new edition contains:

- 956 tested ways of finding and fixing the troubles common to specific makes and models.
- 102 tube socket diagrams showing the connections for more than that many types of new tubes.
- Valuable reference charts showing—why service can't be cheap—types of auto aerials—analysis of common set troubles—24 automobile ignition circuits—why servicemen charge for inspection—and others.
- Why are these "Tricks" good? Because every one of them came right from the actual

experience of professional radio experts. (See typical examples in column to right of page.) Why spend hours of your time testing and re-testing a balky circuit, when, with this new book, you can put your finger on the most probable cause of the trouble in a few seconds.

- These "Tricks" will show you how to spot a lot of set troubles that don't show up in any circuit tests you make. If your time is worth money and you like to duck plenty of grief—get yourself a copy of "Tricks of the Trade"—today. **IT IS FREE IF YOU ACCEPT THIS OFFER NOW.**

HOW YOU CAN GET THIS VALUABLE BOOK FREE

- Simply fill in and return the order blank below with the subscription fee to cover one year of Radio Retailing for \$1 or three years for the reduced rate of \$2. The new editions of "Tricks of the Trade" is included as our gift.
- This book is not for sale separately. Credit orders cannot be accepted. Be sure to enclose remittance with your subscription order. ACT NOW. This new edition is going fast. Don't be sorry. Do it today.

Time-Saving Information

Certain radio sets develop trouble peculiar to their particular type of circuit. Each month "Tricks of the Trade" explains how to locate and fix specific set failures. The following are examples of the curt, practical way Radio Retailing offers this vital information to you.

BREMER-TULLY, BRUNS-WICK S8

Bad volume control . . . Often due to fibre projecting too high, causing rotor arm to miss. Push fibre down before replacing control.

CLARION 60, 61

Set dead or very scratchy . . . Look for failure of special audio input transformer primary. Replace with same device or substitute resistance coupling. Tone will suffer if ordinary transformer is used for replacement due to special characteristics of original.

CROSLEY 143

Neon pilot lights when set switch is in OFF position . . . Replace leaky 8 mike, 150 volt condenser.

MOTOROLA 77

Poor tone . . . Check to see if voice-coil or field wires have been reversed. This causes voice-coil form to become blackened and charred inside due to heat. If swollen, discolored appearance is noted replace.

RCA 120

Operates at low volume on strong signals, intermittently comes up to good volume . . . Check .05 condenser between center terminal of volume control and control grid lead of 2B7 second detector.

Every issue of Radio Retailing will bring you more of these "Tricks". File them and in a short time with this FREE book you'll have a service manual of un-equalled value.

Mail this coupon and payment—Today!

FREE-BOOK SUBSCRIPTION ORDER FORM

PRESENT SUBSCRIBERS NOTICE

Present subscribers may obtain a copy of this FREE book by renewing their present subscription. Regardless of when your present subscription expires, you must send in another PRE-Paid renewal order. Your subscription will be extended for additional time without duplication. No previous renewal orders count. We must show a matching order for every book sent out. Mail in your order and payment today.

This offer only applies to U. S. and possessions, Canada, Mexico and Central and South America. All other countries add 50c to foreign rate of \$2 a year to cover postage charges on book.

All books are sent out by express to insure safe delivery. There is a small handling charge of 15c—payable to the expressman upon delivery of the book. If you prefer book sent prepaid, add 15c to the subscription fee at time of ordering.

O. K. Attached is \$2 for a 3-year subscription to Radio Retailing. With this order I am to get a FREE copy of the 76-page service book—"Tricks of the Trade". I'll pay the expressman 15c for delivery charges. Send the book at once. Check here if this is renewal order.

Name..... Position.....
Street.....
City..... State.....
Our Main Business Is.....

Check here and remit \$1 if you wish only one year subscription PLUS FREE book. 12-37

No orders accepted without payment attached

RADIO RETAILING
330 West 42nd Street
New York, N. Y.

This offer void after May 1st, 1938

Pin
\$1 or \$2
Here

CIRCUITS

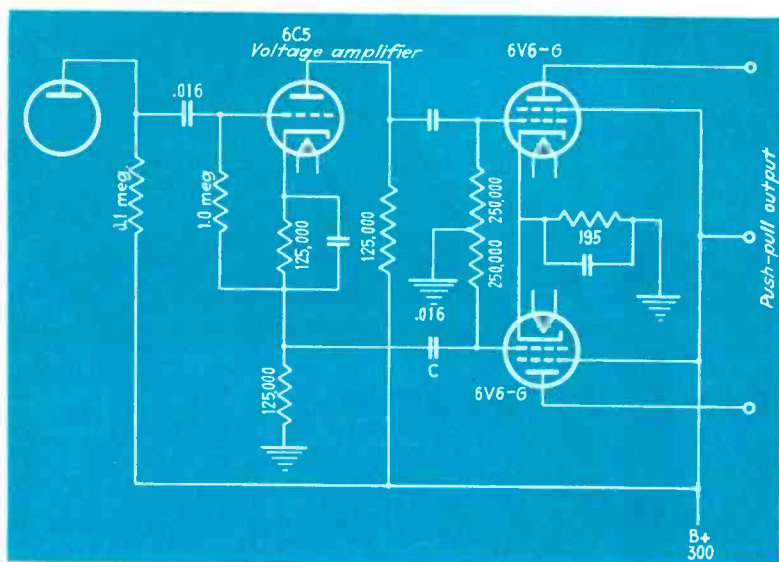

Degenerative Phase Inverter

The phase inverter circuit shown has practical advantages over other circuits in that the effects of possible variations between tubes are small. Normal variations when replacing tubes in the 6C5 voltage amplifier position affect the input to each 6V6G tube a negligible amount because of the inverse feedback arrangement.

Degeneration takes place in the cathode circuit of the 6C5 inverter. This results when voltages in the input and output circuits of the 6C5 are present across the cathode resistor. Since the input and output circuits are out of phase, inverse feedback results. This has the effect of maintaining the audio voltage developed across the plate and cathode resistor at an equal value.

One disadvantage of the circuit is the possibility of hum through cathode leakage when the gain following the 6C5 is high.

to transmit the r.f. power. This resulted in serious shortcomings when three wire lines were encountered. Also, different lighting circuits made the signals travel a round-about path to reach its destination. To overcome these difficulties it was necessary to trace the house wiring and bridge circuits with condensers to supply a suitable path.

The circuit shown illustrates the method used by Bogen in a new wireless communicator. Individual legs of the power line are connected together by a .5 mfd condenser. Both wires constitute one leg of the r.f. line. A flexible lead on the wall plug is then attached to the b-x cable or screwed firmly to the wall plate. The b-x shield and the inner wires then become the transmission line connecting the units. In effect it is similar to a concentric line used on large transmitters.

Since the b-x shield is common to all lighting circuits much less trouble is experienced in multi-circuit buildings.

54-10-T—A 5-in. cathode ray tube with electrostatic deflection.

Heater Voltage	2.5 volts
Heater Current	2.1 amps.
Third Anode Voltage	3000 volts
Second Anode Voltage	750 volts
First Anode Voltage	0 to 375 volts
Grid Bias	100 volts
Screen Color	Green or White
Maximum Diameter	5 1/4 in.
Tube length	20 in.
Grid Signal (peak to peak)	6 volts

Plug-In Meter Rectifier

Copper oxide rectifiers used in test instruments are often subject to replacement due to line surges, accidental misuse or overload. This usually means opening up the piece of equipment. Sometimes it is necessary to recalibrate

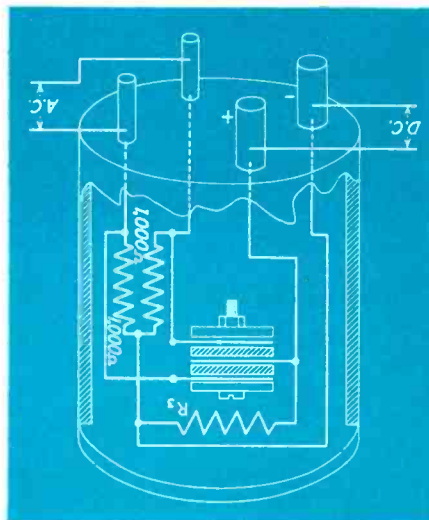

the instrument. A plug-in type rectifier by Triplett, precalibrated for a particular instrument now solves the problem.

The rectifier is mounted in a small plug with regular tube base prongs. Inside the shell with the rectifier are the necessary calibrating resistors making it possible to interchange rectifiers without affecting the meter accuracy. As shown in the diagram, a.c. is placed across the two smaller prongs causing the d.c. voltage to be delivered at the other two.

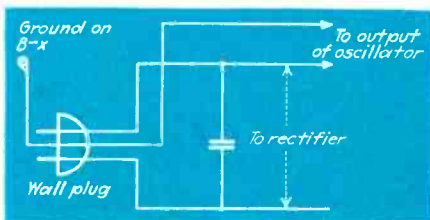

Intercommunicator Transmission Line

Early models of wireless communicators used both legs of the power line

Television Tubes

Two new tubes for television reception have just appeared. Manufactured by DuMont, one has a 5 in. screen, the other a 12 in. screen. Characteristics are as follows:

144-10-T—A 12-in. electrostatically controlled cathode-ray tube.

Heater Voltage	2.5 volts
Heater Current	2.1 amps.
Third Anode Voltage	6000 volts
Second Anode Voltage	1500 volts
First Anode Voltage	0 to 750 volts
Grid Bias	200 volts
Screen Color	Green or White
Maximum Diameter	14 in.
Tube Length	26 in.
Grid Signal (peak to peak)	14 volts

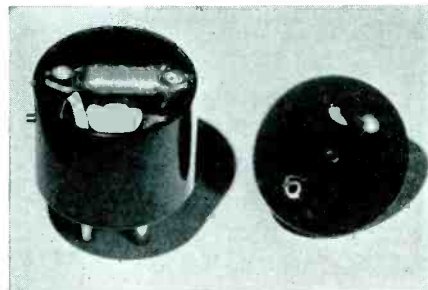

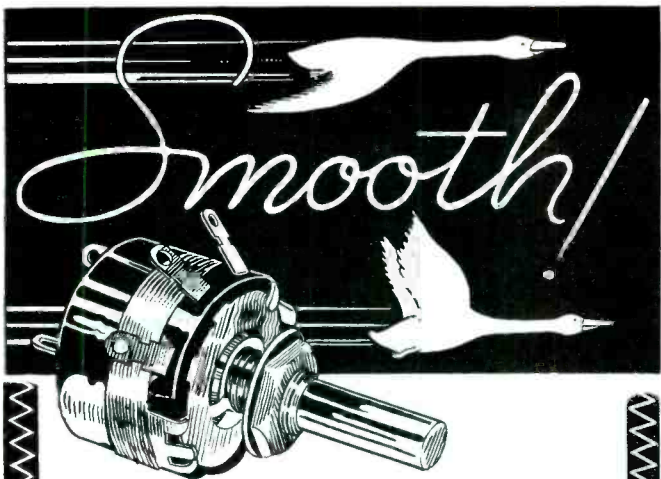

● If you want that velvety, easy, silent twist of the V.C. knob, then it's CLAROSTAT for you. The latest development in carbon elements, a newly designed contact shoe, and an alloy based on years of research, provide a new conception of how good a volume control can be.

Let's Prove It!

Don't waste time on loose claims. Just try a CLAROSTAT for yourself. Meanwhile, ask your jobber or us for that new CLAROSTAT (208 page) Service Manual. It's free!

CLAROSTAT *Manufacturing Co., Inc.*



285-287 NORTH SIXTH STREET
BROOKLYN, NEW YORK, U.S.A.

• OFFICES IN PRINCIPAL CITIES •

**Look for the Name MUELLER
WHEN YOU BUY YOUR CLIPS**



Made to Last Longer

THE ONLY COMPLETE LINE

8 Different Sizes—Copper—Steel—Insulated and Uninsulated
Send for FREE SAMPLES and Catalog 780

Mueller Electric Co.

Clip Makers for 29 Years

1583 E. 31st St., Cleveland, Ohio

GET THIS NEW 1938

FREE

Catalog!



Just published. The very latest items in Radio. Thousands of parts—dozens of test instruments, kits, radio sets, tools, books, selected by radio experts from a choice of the world's leading lines. Over 10,000 items.

LOW PRICES—FAST SERVICE

Dependable merchandise at the right price. Every article GUARANTEED. Orders filled same day received. Omaha local shipping point west of Mississippi. Fast service in any direction.

Write Today. Dept. L

RADIO ACCESSORIES CO.
Omaha, Nebraska

YOU DON'T PAY
UNTIL YOU'VE
SOLD THE TUBES

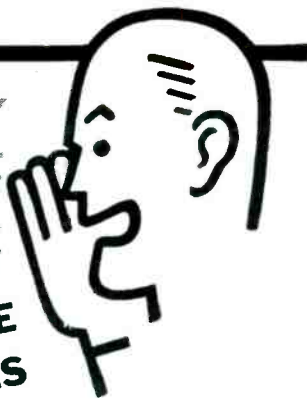

YOU DON'T PAY
UNTIL YOU'VE
SOLD THE TUBES

*we have to say it TWICE
before they really believe it!*

THAT'S a fact. A lot of dealers say "H'm! Sounds too good. Where's the catch?"

There isn't any catch! If you meet Tung-Sol's requirements as a responsible dealer (and more than 8,000 dealers have), *you don't pay one red cent for your Tung-Sol Tubes until you sell them and collect your profits.* And mind you—the price is NO HIGHER than you pay for any recognized brand. Consignment costs you nothing.

Nationally advertised, reputable Tung-Sol Tubes, placed in your charge without investment—to be sold before you pay for them. It's as simple as that. Write today to learn whether you can qualify for a Tung-Sol Consignment franchise in your neighborhood.

TUNG-SOL
Flow Radio Tubes

TUNG-SOL LAMP WORKS, INC.
Dept. B Radio Tube Division

SALES OFFICES: Atlanta, Boston, Charlotte, Chicago, Dallas, Detroit, Kansas City, Los Angeles, New York
General Office, Newark, N. J.

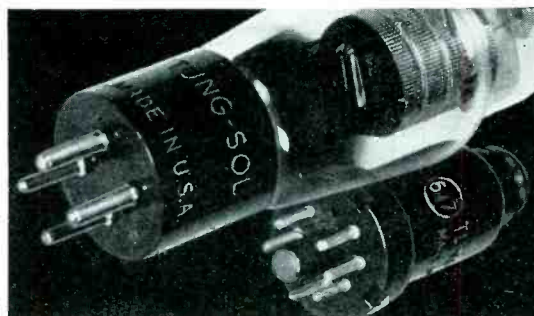

IMPROVING *the Service Bench*

By JIM KIRK

IDEAL radio service benches are far in the minority in our United States. Mr. Robert L. Stewart of the American Radio Equipment Company, of Shanghai, China, wrote me telling of a recent visit to the United States. He was looking for ideal service bench installations, hoping to get some useful pointers to take back to China and apply. But he found many poor layouts and few attractive service laboratories.

Surveys show Inadequacy

At the same time I visited the majority of my brother servicemen and found the conditions, as a whole, deplorable. Making a survey of the East Bay district of Los Angeles servicemen, I was struck with the blindness of the majority of servicemen as to the great asset of an attractive, efficient service bench.

Rewards

What are the rewards to be gained from service shop improvement? Here are six in the order of their importance.

First is the increased customer confidence resulting in increased business. Without the confidence of the customer, you are sunk, because the average customer doesn't know anything about radio or your ability. They are afraid to entrust even a \$5.95 midget in your care unless you have an impressive, neat exhibit of gadgets in your shop.

Second—It helps you secure a reasonable price for your time. I don't care what your ability is—the customer will not be willing to pay a fair price if all you can exhibit for a work shop is a pile of junk.

Third—It will enable you to turn out a greater amount of work with conveniences and time savers and a bench arranged so you know where things are.

Fourth—Of course, you can do better work with better tools.

Fifth—There is a great deal of pleasure in working in an ordered environment. It is certainly distracting and uncomfortable to the mind to struggle along with disorder and forever have junk in your way.

Sixth—The last point is the pride of



BOTTLE BENCH—Glass jars are a neat and effective way to keep small parts. This bench of Jackson Furniture Co., Oakland, Calif., is conspicuous by the absence of junk, dust and dirt.

ownership that comes with the knowledge that you have a shop of which you can be proud.

The Typical Service Bench

The typical radio service bench is hidden in the back room. That's bad because the sales value of an attractive bench (if it is attractive) is lost. Besides that, the lighting is likely to be poor in the dark corner that the typical radio serviceman hides in.

The average service bench has the remains of what started out to be a switchboard. Holes in the panel-board

mark where parts have been removed. Shell holes in the bench mark the spot where the serviceman removed the bright-idea time-saver. Probably, the bench is home made and is of rough lumber. Undoubtedly there are wide cracks where screws and other small parts may fall through.

The typical service bench has no order about it whatsoever. A dozen or so worn cardboard boxes contain screws, resistors and small parts, but even these boxes are of different sizes, contain mixed assortments, and are not arranged in order but help to clutter up the bench.

There are no shelves separating the

ONE AT A TIME—Never clutter the bench with a flock of sets. The same applies to tools; only commonly used tools should be on the bench top as shown (center). The M. Knox bench also contains a tester shelf (left) for neatly displaying test instruments.

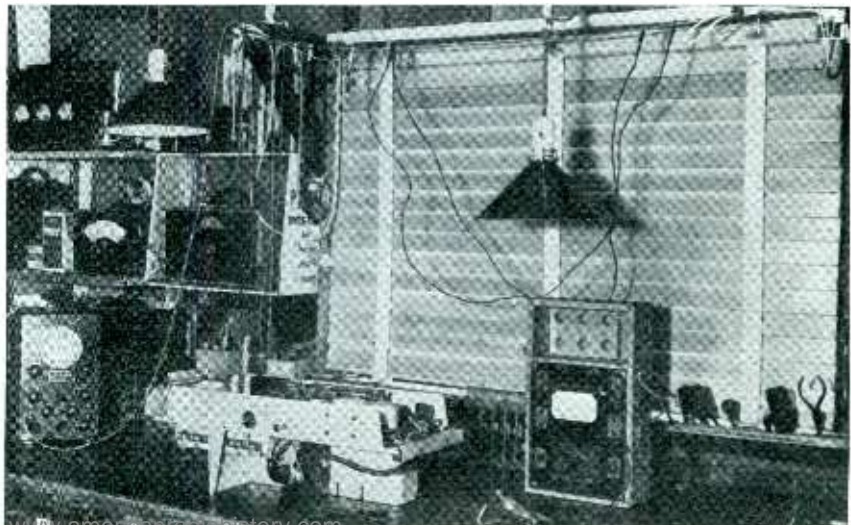

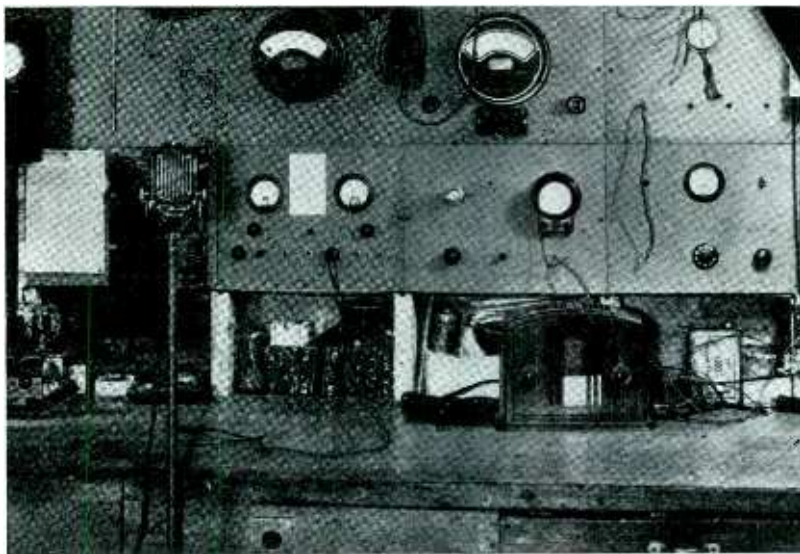

SWITCHBOARD TESTER—A time-saving and convenient layout. Sectional masonite panels allow changes to be easily and inexpensively made. Metered panels lend prestige to this shop of W. E. King.

incoming sets, the sets under test or the completed work. Obsolete and unless junk is never thrown away. There seems to be a sort of sentimental attachment to these antiques.

The typical service shop is never clean. Dust, solder paste, bits of solder and plain old-fashioned filth are never removed. The radio service man should take a tip from the gas stations. Gas stations handle a product that is oily and greasy; and yet they shine their copper work, clean their windows and dress their attendants in white. Contrast the radio service man handling a clean product.

Improvements

To improve this situation and get the maximum of benefit from the minimum of cost, I would first consider moving the bench into the front room, or at least where it could be seen from the front room. I know it is a very poor policy to allow the customer to watch you repair his set, but this does not necessarily follow, even if the service bench is in the front room. It can be separated from the public by a railing. Sets should never be "repaired while you watch and wait."

If you are not a carpenter better have a carpenter build a simple, sturdy, substantial bench for you. Cover it with battleship linoleum with a metal border, say aluminum angles.

Have plenty of shelves or cabinets. Put small parts in glass jars and build racks for the jars. Have everything in order. Have an incoming and outgoing set apartment in which to store sets. Only the sets being worked on will be on the bench.

Now as to the problem of switchboards

and instruments. The expensive way to solve this problem (I'm not denying that the results are magnificent) is to buy a great big bakelite panel and build in some beautiful test equipment. The trouble with this is that radio service men are constantly changing and improving their equipment. That either means unused, unsightly holes or else the highly expensive purchase of another panel of bakelite.

Neatness and Order Important

Mr. Charles Dickenson, of Oakland, has solved the problem in what, to my mind, was the ideal way. He thoughtfully all desired factors in mind when designing his bench. These desired factors are impressive appearance, convenience, neatness and economy. His bench occupied all one end of the front room. It was separated from the public by a counter. The bench was covered with brown battleship linoleum. All wood work was painted and kept scrupulously clean. Neatness and order were two watchwords. He and his servicemen wore smocks at their work. The switchboard consisted of several rather small cabinets extending across the room with the instruments built in the doors. These doors were made of masonite finished to resemble bakelite and it was only necessary to discard one small inexpensive door and build a new one whenever a change or a new circuit was to be attempted.

I can see only one disadvantage to his method of building instruments in small panels. At times it would be desirable to have two test instruments near the set being worked on and these two instruments might be located at opposite ends of the bench. I conclude, therefore,

that a better method would be to provide shelves over the bench, build the instruments in small portable cabinets and buy some commercial instruments. Then the instruments can be easily moved around and replaced when not in use. A rack and panel always looks good, some equipment that is not portable could be built into panels and mounted on the rack. Changes would only mean replacing one panel. Individual taste will govern the choice of methods.

Service motto

The Morris Knox shop employs Mr. Don Caples for service work. Don said one thing he was particular about was the presence of only one set on the bench at a time. A very large amount of business is handled daily, but this rule is adhered to.

All the latest test equipment is used. Perhaps the most useful piece of equipment was the compressed air for blowing dust out of sets. Speaker cones can be cleaned without removing the head, every set can be made spotless and many other uses can be found for this piece of equipment seldom found in radio service shops.

Consider the lighting

The most outstanding feature of Mr. W. E. King's shop does not show in the picture. I refer to the skylight installed right over the bench. King said he formerly owned a shop in another part of the city and he was troubled with blinding glare in some spots and insufficient light in others and vowed that in the next shop he would install a skylight. It's delightful to work in so much light as radio parts are often small. This bench belongs to the small-masonite-panel school of thought as indicated by the masonite instrument boards over the bench. They can be discarded with little loss whenever it is desired to make changes.

It was necessary to take the photograph of Jackson's Furniture Co. Radio Shop at night because it is one of the busiest shops in town. The middle of the room is so full of consoles that there is no place to set up the camera. The photograph shows only one corner of the room and does not show all the benches.

Here is an example of a well managed shop. Glass jars containing small parts are arranged neatly on shelves. Plenty of room is given to test equipment and tools. Benches are well lighted and conveniently placed.

A neat and well arranged service bench pays dollars in dividends to the serviceman. Your bench is your best advertisement.

In addition, time spent considering a careful layout makes every repair job that much easier. Here is truly a method to greater profit.

TRICKS

AC-DC SET

The older models of this type often give trouble at the connections of the high-wattage dropping resistor. To prevent the leads from working loose due to heat, bolt the lead securely.

ARVIN 17

Hum . . . Replace original 12.4 mfd electrolytic filter with a triple 8 mfd section. This can be obtained in one can to fit in the original mounting. Connect two 8 mfd sections to cathode of 84. The other section should go to connection from which original 4 mfd unit was removed.

CLARION AC-160

Volume control inoperative . . . Check .35 mfd condenser in plate circuit of second detector. Replace with .1 mfd 600 volt unit.

COLUMBIA C-101

Distortion . . . Replace 40,000 ohm 1 watt resistor in cathode circuit of detector. The original resistor has changed to high value. Resistor is located under a triple bank of coils.

CROSBY

On some models the bolts that hold the chassis to the cabinet are different lengths. Always be careful to replace these bolts exactly as they were originally. Replacing a long bolt in the wrong position could result in a punctured filter condenser or similar damage.

FORD PHILCO 1937

Ignition interference . . . Male end of antenna lead making poor contact in set socket. Solder short heavy braid to shield on male cap and fasten securely under edge of junction box after first cleaning off paint.

If some noise still persists, bond the middle screw on set cover to dash, also junction box to emergency brake bracket screw.

G.E. A65

Weak or dead, 2,000 ohm plate dropping resistor burned . . . replace .05 mfd bypass in grid circuit of 6K7 i.f.

G.E. M65

Oscillation when volume control turned on full . . . Check all filter condensers. Replace 8 mfd section with red leads with new unit.

PHILCO 16

Bad frequency drift . . . defective trimmer on third i.f. transformer. Replace with new transformer.

PHILCO 19

Dead, voltages check O.K. . . . measure the 15,000 ohm ½ watt resistor on the resistor and condenser block. This often changes value. Replace with 1 watt unit.

PUSH-BUTTON SETS

If call letter stickers for pushbutton knobs refuse to stay in place they can be fastened permanently with ordinary rubber cement. This is available at almost any stationery store; it is the same material that is used to glue photos in albums.

Now—A high-powered

RADIO ENGINEERING LIBRARY

—especially selected by radio specialists of McGraw-Hill publications

—to give most complete, dependable coverage of facts needed by all whose fields are grounded on radio fundamentals

—available at a special price and terms.

THESE books cover circuit phenomena, tube theory, networks, measurements, and other subjects—give specialized treatment of all fields of practical design and application. They are books of recognized position in the literature—books you will refer to and be referred to often. If you are a researcher or experimenter—if your interest in radio is deep-set and based on a real desire to go further in this field—you want these books for the help they give in hundreds of problems throughout the whole field of radio engineering.

5 volumes, 3064 pages, 2000 illustrations

1. Glasgow's PRINCIPLES OF RADIO ENGINEERING
2. Terman's MEASUREMENTS IN RADIO ENGINEERING
3. Chaffee's THEORY OF THERMONIC VACUUM TUBES
4. Hund's PHENOMENA IN HIGH-FREQUENCY MEASUREMENTS
5. Henney's RADIO ENGINEERING HANDBOOK



New

The Library now comprises a revised selection of books culled from latest McGraw-Hill publications in the radio field.

Special Low Price Easy Terms

Bought singly, the five volumes comprising this library would cost you \$26.00. Under this offer you save \$2.50 and, in addition have the privilege of paying in easy installments beginning with \$2.50, 10 days after receipt of the books, and \$3.00 monthly thereafter. Already these books are recognized as standard works that you are bound to require sooner or later. Take advantage of these convenient terms to add them to your library now.

McGraw-Hill ON-APPROVAL COUPON

SEND THIS ON-APPROVAL COUPON
McGraw-Hill BOOK COMPANY, INC.
330 West 42d Street, New York, N. Y.

Send me Radio Engineering Library 5 vols., for 10 days' examination on approval. In 10 days I will send \$2.50, plus few cents postage, and \$3.00 monthly till \$23.50 is paid, or return books postpaid. (We pay postage on orders accompanied by remittance of first installment.)

Name

Address

City and State.....

Position

Company RR-12-37

(Books sent on approval in U. S. and Canada only.)



Better Motors Help Radio-Phonograph Sales

RADIO-PHONOGRAPHS equipped with General Industries Flyer Motors give the kind of service that builds trade. More combination sets sold. Bigger, steadily growing demand for good records.

Dependable for high fidelity in playing all records, regardless of changing record drag. Self lubricating, quiet, precision-built for long trouble-free operation. Easily and quickly installed. Low cost.

ORDER SAMPLES TO TEST

Find out how remarkably efficient these motors are. Precision-built by phonograph motor specialists. Types for AC, DC, or Universal AC-DC. Types for two speeds can be furnished. When ordering, please specify exact voltage and frequency of current you use.

The **GENERAL INDUSTRIES CO.**

3737 Taylor Street

Elyria, Ohio

"PINCO" THE ONLY COMPLETE GAS-O-LECTRIC POWER PLANT LINE



**RED TOP
COMBINATION AC-DC
POWER PLANT**



**GOLD CROWN
HEAVY DUTY
POWER PLANT**

Time Now for Power Plant SALES!

Here is an exclusive dealer-jobber line of portable electric light, power and battery-charging plants, priced for quick sale and big profit. "PINCO" combination AC-DC and DC RED TOP and GOLD CROWN heavy duty power plants are a necessity for millions of farms, homes, industrials, etc., where "city" electricity is not available. Provide instant power for lights, radios, electrical equipment and appliances. Now is the time to cash in on this waiting market. Write for literature and discounts.

One Line for Every Requirement

"PINCO"—the only complete power plant line! Full price range; 100 to 2000 watts; alternating or direct current; air or water cooled; remote control; filter and ignition shielding; push button starting.

PIONEER GEN-E-MOTOR CORPORATION
Dept. No. R-11, 466 West Superior Street, Chicago, Illinois

Please send me complete information on:

"RED TOP" "GOLD CROWN" Converters Dynamotors

Name
Address
City..... State.....

**WILL YOU TAKE THIS PORTABLE
RADIO SERVICE LABORATORY as
a GIFT from NATIONAL UNION?**

(Special Offer Expires February 15th)



the
**NEW Simpson
"TEST MASTER"**

MODEL 440

**If you bought it you'd pay \$59.00
but you can have it FREE* with
N. U. Tube and Condenser Purchases!**

Here in this 12-pound, compact, high efficiency unit are all the features the Service Engineer needs to test tubes and analyze radios in the home.

FOR SET TESTS

6 AC-DC Voltage Ranges
4 Current Ranges
6 Decibel Ranges
1 Ampere Range for automobile test work

FOR TUBE TESTS

Tests special types without adapters. Tests for noise. Tests all types regardless of filament terminal location. Tests screen fluorescence and angle on tuning indicator types.

Ruggedly constructed to Simpson quality standards. Own a Test Master the easy N. U. way. Get it during the 45-day special offer period. Ask your N. U. jobber or write for full details . . . now!

*** You deposit only \$29.75 during
SPECIAL—SAVE! ACT NOW!**

Quality! National Union's By-Word

So many thousands of Radio Service Engineers have proved National Union quality in the field that it is taken for granted. Due credit however should be given to the large staff of research engineers who are constantly at work in the National Union Laboratories striving to improve N. U. Products and develop new and finer merchandise. The N. U. research staff is your assurance that National Union Products will never let you down.

NATIONAL UNION THE ROAD TO BETTER BUSINESS

1. Full guarantee on highest quality radio tubes.
2. Cut price business not solicited.
3. Price Protection.
4. N. U. jobber stocks are complete. No hunting for odd types.
5. Timely business building aids.

NATIONAL UNION RADIO CORPORATION
570 Lexington Avenue, New York, N. Y.

RR-1237

Who's the nearest N. U. distributor?.....
Send details of Jan. special.....
Name.....
Street.....
City..... State.....

ARCTURUS

Radio's finest tubes
plus radio's fairest
equipment deal spell
double profit to you.
Get the facts!

**HERE IS
THE GREATEST
OPPORTUNITY
YOU'VE EVER HAD**

to obtain the **WORLD'S
FINEST SHOP EQUIP-
MENT** at almost no cost
to you . . . !

**This coupon
will bring com-
plete details of
the sensational
ARCTURUS
EQUIPMENT
DEAL . . .**

**Mail it
Now!**

ARCTURUS RADIO TUBE CO.
Newark, N. J.

Without cost or obligation on my part,
send details of your new equipment deal.

Name _____

Street _____

City _____ State _____

I am a dealer I am a serviceman

My Jobber is _____

For your convenience, this coupon
can be pasted on a penny postcard.

TRICKS

BRUNSWICK 11, 12, 16, 33

Weak or no reception on low frequency end of dial . . . look for open 910 mmf. condenser located between stator of oscillator tuning condenser and high side of oscillator plate coil.

G.E. F63, 65, 66

Pointer does not move when dial knob is turned. . . . Not enough friction in drive assembly. Insert small fibre or cardboard strips between pressure plates.

G.E. F63

Distortion on strong signals. . . . Resistor (R3 in diagram) connected to wrong lug on terminal strip.

G.E. A67

Dead. . . . test condenser shunting candohm resistor for short.

G.E. F75

Noisy when tapped. . . . Louvre dial not properly grounded. Suspect copper ribbons at points where they are spot welded to chassis.

G.E. E155, E126

Noisy volume control. . . . Before replacing volume control, replace 6C5 first A.F. In models E86, E95, and E105 try replacing 6F5 first A.F.

GENERAL ELECTRIC F107, F135

Loud noise when station is tuned in by means of buttons. . . . Contacts of switch not opening in proper sequence: center contacts (motor) should open first, contacts farthest from armature (A.F.C.) second, and contacts nearest armatures (silent tuning) should open last.

Skipping of stations. . . . Backstop for relay armature should be adjusted so that a potential of 4.5 volts is sufficient to snap relay closed. The backstop must make positive contact with armature when relay is open. If the relay will not close at 4.5 volts and still maintain proper travel and sequence, weaken the spring holding armature open.

Hum when relay is energized. . . . The pole-piece of the relay is divided to form two semi-circles. The relay armature should touch only the semi-

(Continued on page 68)

*Cash in
on those
Noises*



- Remember, there's a buck or more in every radio noise—if you sell AEROVOX Radio Noise Eliminators.
- Sold on service calls or over the counter. Attractive "silent salesman" shown displays best sellers, and makes the sales.
- Meanwhile, AEROVOX Noise Analyzer indicates which unit and what connections work best. Handsome portable instrument. Necessary connection cords, plugs and clips. Inexpensive.
- Attractive 8-page folder, "Clear Reception", tells story of noise suppression to set owners and paves way for service calls and sales.

Ask . . .

for your copy of latest catalog. Lists most extensive line of exact-duplicate replacements.



AEROVOX
CORPORATION
70 Washington St. Brooklyn, N. Y.
IN CANADA: AEROVOX CANADA, Limited, Hamilton, Ont.

**YOU ASKED FOR IT
HERE
IT IS!**

**New
RIDER
BOOK**

**VIBRATOR POWER
SUPPLIES**
by Garstang and Rider

It becomes increasingly important that servicemen have the information on Vibrator Supply Systems which is contained in this book. 280 Pages—Profusely Illustrated \$3.00—Hard Covers

**JOHN F. RIDER
Publisher
1440 BROADWAY
New York City**

**EVERYTHING . . .
Just as You Want it!**

Before assembling Volume VIII we asked servicemen WHAT they wanted and HOW they wanted that information arranged.

**RIDER MANUAL VOLUME VIII
JUST OFF THE PRESS**

gives you the servicing data you need—simplified and standardized.

Included with Volume VIII is a special EXTRA section entitled, "How It Works." Covering operations peculiar to the more complicated 1938 receivers. This is in addition to the complete information on the sets of over 100 manufacturers—1650 pages of indispensable facts—and the price is the same as last year.

**YOU NEED ALL 8
Rider
MANUALS**

NEW Standardized Test Bench Panels

by
TRIPLET

- Standard Size Panels Accommodate Any Master or DeLuxe Models
- Panel Cabinets Can be Bolted Together if Desired
- Handy Lamp May Be Attached Easily



Model 1404
(complete as shown
less lamp)

\$95.50

Model 1404 As Shown Contains the
Following Models:

1210-A Tube Tester	Single Unit Price...\$22.00
1209-D D.C. Volt-Ohm-Milliammeter	Single Unit Price...\$20.00
1209-A A.C. Voltmeter	Single Unit Price...\$16.00
1241 Condenser Tester	Single Unit Price...\$27.50

Triplet offers for the test bench the same kind of standardization that has made Triplet Master Models outstanding among portable testers. You can start with cabinet and one tester and build up as circumstances dictate.

Testers are held firmly in the panel compartments by flexible rubber grommets with compression fit. Testers are in regular metal cases and can be removed for portable use when necessary.

Model 1181-E

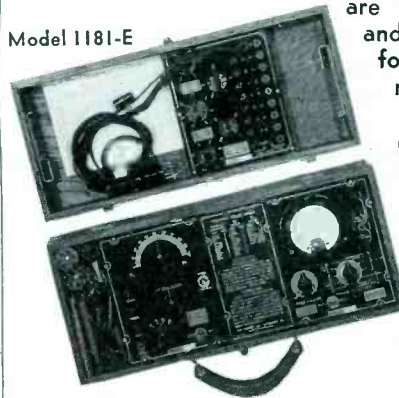

Model 1181-E Portable Laboratory combines: Models 1125-A Volt-Ohm-Milliammeter, 1151 All-Wave Oscillator, 1166-A Free-Point Auxiliary Set Tester. Quartered oak case size—16 1/2" x 7 1/2" x 4 3/4" deep. Cover is removable. Complete with necessary batteries and accessories, DEALER NET \$41.83.

TRIPLET

Precision
Electrical Instruments

The Triplet Electrical Instrument Co.
2012 Harmon Ave., Bluffton, Ohio

Please send me more information on
Model 1404; Model 1181-E.

Name

Address

City..... State.....

THE Eyes HAVE IT!

Write for
Descriptive
Literature

**Solar
Capacitor
Analyzer**

Your eyes and the MAGIC TUBE...
see all, know all, quick as a wink!

SOLAR MFG. CORP.
599-601 Broadway New York, N. Y.

Reproduction of WEBSTER-CHICAGO Ad In Leading Industrial Publications

WHERE IS ELMER

... Find Him Instantly

... locate any executive or factory personnel
... increase efficiency
... speed up service
with

AMPLICALL

A complete sound system that can be economically installed in any size plant. Webster-Chicago engineers have perfected a sectionalized system that can be added to without loss of efficiency by plugging in additional units.

This modern system sweeps away all previous objections to sound installations, giving fine reproduction and speakers with adjustable volume to suit any location. Unit construction makes mass production possible and greatly lowers previous conceptions of cost.

Don't be without this modern business aid . . . Increase your plant efficiency. Please your customers with improved telephone service. Write for More Information.

AMPLICALL Gives Control — and it's IN-EXPENSIVE!

★ The importance of Labor Relations points to the great need for closer contact between executives and employees. With a Webster-Chicago Sound System, you can talk to all employees at any time, no matter what size factory.

WEBSTER-CHICAGO
One of the Oldest Manufacturers of
Public Address Systems, Sound
Equipment & Accessories



WEBSTER-CHICAGO SOUND EQUIPMENT MAKES MORE MONEY FOR DEALERS. Direct Advertising creates direct leads and excellent sales promotion material makes it easy for dealer to solicit.

WEBSTER-CHICAGO . . . The Complete Line of Public Address Systems, Sound Equipment and Accessories . . . Popular Priced Leaders in the Sound Field for Over 12 Years!

For Complete Catalog or Other Information Address Section D-8

WEBSTER-CHICAGO
5622 Bloomingdale Ave. CHICAGO, ILL.

All Inquiries Referred Directly to the Trade

TRICKS

circle nearest the motor shaft. There should be a 10-mil clearance between the other segment and relay armature when the relay is energized. Bending the entire armature support may correct this condition otherwise the pole-piece should be filed down. Hum may also be caused by a bump on the segment with which the armature comes in contact. This may be removed by filing. Be sure all filings are removed after adjustments have been made.

After any adjustment on relay, sequence in which contacts open should be checked to open in order indicated above.

Motor hums but no torque. . . . Shorted motor capacitor, 1000 mfd. 12 volts, A.C. working voltage.

Motor inoperative. . . . Center contacts on relay not making good contact.

Defective motor reversing switch.

Cold solder connection on motor reversing switch.

Open or shorted coil in motor, characterized by no torque or low torque in one direction.

No action when button is pressed. . . . Push button escutcheon grounded to chassis of set. This trouble is usually caused by control shafts touching escutcheon. Centering chassis in cabinet or placing fibre sleeves on shafts will remedy this trouble. This trouble is characterized by the relay remaining closed.

Motor scans but does not stop at desired station. Contacts at the rear of the button shafts do not make good contact. Adjust by bending contacts.

Motor scans but stops at wrong station. Contacts at the rear of the button shafts touching, or, shaft is touching contact. Adjust by bending contacts.

Motor-boating when station is tuned in by means of buttons. . . . A.F.C. out of line, adjust hex nut on A.F.C. transformer, until "pull-in" is equal on both sides of station carrier.

Belt slips. . . . Loosen 2 screws holding motor to support and lift motor higher, tighten screws.

Low frequency stations weak or inaudible, higher frequencies normal. . . . Shorted 580 kc. padder.

Excessive hum, volume control off. . . . Reverse voice coil leads on speaker. Make sure both contacts for plates of rectifier (5Z3) are making good contact.

SILVERTONE 1802, 1803

Oscillation . . . test 160 volt 1 mfd. condenser between chassis and high voltage centertap of power transformer for open.

New "PRECISION" ELECTRONOMETER SERIES 700



A complete laboratory of compact size for thorough tube analyzing and point to point set testing incorporating 22 ranges for measurements of A.C. and D.C. voltages, current, resistance, decibel and output; paper condenser leakage tests; current leakage of electrolytic condensers and other important features. See it at your jobber.

\$49.95

FREE to owners of "PRECISION" ELECTRONOMETER 500 or 600, the latest tube chart for use with these instruments. Write for yours.

PRECISION APPARATUS CORP.
821 EAST NEW YORK AVENUE
BROOKLYN, NEW YORK

Photo Shown is Type 840-P. Net price \$21.95

TRIAD

BALLAST TUBES
(Resistor Units)

NOW AVAILABLE FOR REPLACEMENT

Assortment No. 1 Consists of 50 Units (Assorted Types) Glass and Metal of Fast-Selling Numbers

Assortment No. 2 Consists of 100 Units (Assorted Types) Glass and Metal

Other Types Supplied on Request

Also a Complete Line of Radio Receiving Tubes

A Profitable Line to Handle

TRIAD MANUFACTURING COMPANY
INCORPORATED
PAWTUCKET RHODE ISLAND

The Quality Name in Radio

TRICKS

RCA R7

Low volume, oscillation . . . Check 14,300 ohm resistor between the high voltage and the screen grids. This resistor often gets as low as 5,000 ohms, resulting in high voltage on the screen grids. This causes the 8000 ohm resistor between screen and cathode to heat and increase value.

RCA RE-20

Tone control noisy, volume decreases in bass position . . . replace small choke in metal can located below chassis. As this choke may be difficult to obtain it may be replaced with a midget filter choke.

SILVER MARSHALL

Dead . . . Replace 6500 ohm resistor in 56 tube circuit (fourth tube to right looking from rear).

SILVERTONE 1829

Weak, tuning meter becomes hot . . . shorted .1 mfd condenser in plate of 6A7. Meter may be replaced with 1,000 ohm resistor, connect same as meter.

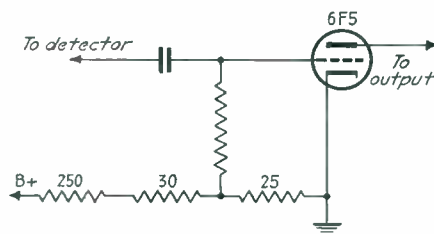

STEWART WARNER R-145

Severe distortion, excessive bias on the 6F5 tube . . . Trouble may be checked to 25 ohm resistor section shown above. A change of only a few ohm in this resistor will cause the trouble.

Dead . . . Check for open circuit in one of the resistors shown above. Motorboating can usually be stopped by bypassing the 25 ohm section with a 10 or 15 mfd electrolytic.

STEWART WARNER R-161-D, R-16-4D

Burned out driver transformers . . . Check .0011 mfd condenser from plate to ground for leak or short. If this condenser shorts it places 135 volts directly across the driver transformer primary.

New "PRECISION" SERIES 840L



AC-DC Volt-Ohm-Decibel-Milliammeter including a 2500 VOLT A.C. and D.C. RANGE and a 1000 M.A. RANGE

Specifications
 * 5 A.C.—D.C. VOLTAGE RANGES from 0 to 2500 volts at 1000 ohms per volt.
 * 4 D.C. CURRENT RANGES from 0 to 1 amp.
 * 5 OUTPUT RANGES from 3 RESISTANCE RANGES from 0 to 10 mega. (provision for self-contained batteries)
 * 5 DECIBEL RANGES from —10 to plus 60DB

Net price less batteries and test leads \$19.95

Write for catalog listing complete line of "PRECISION" TEST EQUIPMENT

PRECISION APPARATUS CORP.
821 EAST NEW YORK AVENUE
BROOKLYN, NEW YORK

HOME RADIOS AUTO RADIOS

HOME RADIO POCKET TROUBLE SHOOTER
AUTO RADIO POCKET TROUBLE SHOOTER

In-a-Flash!

Ghirardi's "GADGETS" TURN UP 800

IN TROUBLE SHOOTING! CLEW UP

SPEED UP YOUR SERVICE WORK with these amazing new "TWIN" pocket-size radio TROUBLE-SHOOTER "GADGETS." Don't fumble and puzzle over "sick" radio receivers you must repair—get the habit of CHECKING FIRST with Ghirardi's Troubleshooting Gadgets for they point the way directly to over 800 DIFFERENT RECEIVER TROUBLES—and their REMEDIES. These "lightning-like" trouble finders are the cleverest, handiest servicing aids you've ever seen! **HOW THEY WORK:** Easy as pie to use—em—you take up your Gadget, peek out the eyeletted card marked for the particular Trouble Symptom you find in the "sick" receiver. Flip the card around, and there you'll see all the possible causes for the particular Trouble, the exact Tests to make, and the Remedies to apply. Work quick as a flash—almost like magic! Get you right to the trouble in a jiffy, without "fussing" around.

9-card Gadget for HOME RADIOS—one with 12-cards for AUTO RADIOS—Only \$1 a pair, \$1.20 for 3.

KEEP 'EM IN YOUR POCKET

MAIL \$1 NOW!

WRITE YOUR NAME AND ADDRESS IN THE MARGIN, and mail it NOW for both Gadgets! Sent postpaid anywhere on 5-day trial!

RADIO & TECHNICAL PUBL. CO.
Dept. RR-127
45 Astor Place, New York

417 THINGS

Every Service Man Must Know!

Test Instruments—Circuit Diagrams—Trouble-Shooting—Up-to-date Repair Methods—"Case Histories" of over 1,500 Receivers—3,000 I.F. Auto-Radio servicing Data—etc. GHIRARDI gives you ALL this INVALUABLE DOPE and MUCH MORE in these 2 great servicing books—one for test and repair methods—the other for quick-use job and receiver data. Regular Supplement Sheet Service for Data Book. Send for Free Circular.

RADIO & TECHNICAL PUBLISHING CO.
Dept. RR-127, 45 Astor Place, New York

1,832 PAGES 813 ILLUS. Free Circular

\$6 for MODERN RADIO SERVICING BOTH BOOKS RADIO FIELD SERVICE DATA



Wishing you
a very merry
Christmas
AND THE HAPPIEST
OF **NEW YEARS!**

UTAH RADIO PRODUCTS CO.
CHICAGO, U. S. A.
TORONTO BUENOS AIRES
ONTARIO, CANADA UCOA RADIO PRODUCTS CO.
16 YEARS OF LEADERSHIP

T R I C K S

PHILCO 38

Intermittent, dead . . . in this model the i.f. transformers are wound on wood dowels. Small staples are used to fasten the leads to the dowel.

In some cases it has been found that the staples were driven so far into the dowel that the insulation on the wire was cut. At the same time the ends of two staples met inside the dowel, shorting the coil. The most effective method for finding this trouble is to use a low-range ohmmeter.

RCA 118, 211

Distortion, all voltages check with service sheet. . . . Replace cathode filter in 6B7.

RCA 120

Distortion, circuit and voltages check O.K. . . . Connect a 150,000 ohm resistor between yellow lead on volume control and common screen circuit. This raises the bias on the 6B7 slightly, reducing plate voltage drop in plate coupling resistor. Oscillation when

volume is increased . . . check screen bypasses and filter from Bx to ground.

RCA-VICTOR 140, 141

Code interference . . . install wave trap in antenna circuit. One can be made from old 456 k.c. transformer.

RCA 262, G. E. M107

Crackling noise . . . Check push-pull audio transformer between driver and output stage by imposing an equal load on each plate lead of the transformer. Low voltage on one lead will indicate defective winding. Replace transformer.

RCA 281

Distortion on locals . . . make sure 76 and 6D6 tubes in special a.v.c. circuit are O.K. Hum . . . check 42 output tubes for plate current balance.

RCA 811K

Periodic noises and intermittent, especially at lower frequency end of broadcast band . . . remove can from oscillator coil at top center of chassis, resolder all lugs on top and bottom of coil.

Yes, There Is a Santa Claus!

CB **FIFTEEN DOLLARS** from us to you! That's our Xmas gift to purchasers of our CRA oscillograph at the holiday price of \$64.50—regular value \$79.50. It's the same super-dependable, precision instrument that so long has led the field. Nothing cheapened, nothing left out! Greatly speeds up and simplifies service procedure through visual examination of every vital receiver function. You can see what you're doing and know you're right. A real **\$64.50** Xmas gift at the new price.

SUPERIOR features of Model 110 Signal Generator make it "tops" in performance and value. (1) Greater accuracy than any other signal generator in the service field. (2) Greater output, valuable for driving signals through receivers badly out of line. (3) Quicker, more accurate direct reading jumbo dial, with exclusive matched-band calibration. (4) Better control of signal attenuation. (5) Lower strays because of individual shielding of internal sections and double shielding over all. Easily your best buy. **\$43.50**



FREE VISUAL RADIO SERVICE COURSE WITH ANY C-B INSTRUMENT

Learn to handle tough service jobs with ease and confidence. The C-B Visual Service Course gives you required "know how." Specially designed for service men by Midland Television School, one of America's largest, and C-B engineers. You cannot afford to fall behind by going without this valuable knowledge. Learn more that you may earn more! Ask your jobber, or write us. Time is money. Don't delay. Act today.

The CLOUGH-BRENGLE CO.

2819 W. 19th St. Chicago, Ill.

MODERN MICROPHONES

MODEL Number	Type	Impedance (ohms)	Output (db.)	Frequency Response and db. Variation	Directivity	Polarizing Voltage (volts)	Cable Supplied (feet)	Finish	Price	Special Features
American Microphone Co., Inc., 1915 S. Western Ave., Los Angeles, Calif.										
D-3	Dynamic	50	-81	30-10,000±2	Semi-dir.	25	25	Bronze	Swivel Yoke
D-5	Dynamic	50	-80	50-9,500±3	Semi-dir.	25	25	Chrome	Swivel Mount
D-5-T	Dynamic	15,000	-56	50-9,000±3	Semi-dir.	25	25	Chrome	Swivel Mount
D-7	Dynamic	40	-82	60-9,000±3½	Semi-dir.	8	8	Chrome	Small Size
D-7-T	Dynamic	15,000	-56	70-8,500±3½	Semi-dir.	8	8	Chrome	Small Size
C-5	Crystal	65,000	-54	40-9,000±3	Non-dir.	8	8	Chrome008 Capacity
AG	Crystal	125,000	-52	40-8,700±4	Semi-dir.	8	8	Chrome	Yoke Mounting
CL-2	Crystal	125,000	-52	70-6,500±3	Semi-dir.	25	25	Black	Light Weight
B-7	Crystal	125,000	-54	40-9,000±3	Non-dir.	25	25	Chrome008 Capacity
A-1	Carbon	400	-38	50-8,800±3½	Semi-dir.	1½	Chrome	Ring Mounting
C-D-4	Carbon	400	-35	70-6,600±3	Semi-dir.	3	Chrome	Yoke Supplied
EL-4	Carbon	400	-32	70-6,000±4	Semi-dir.	3	Chrome	Yoke Supplied
PH	Carbon	75	-17	700-4,000±6	Semi-dir.	4½	Black	Telephone
BH	Carbon	200	-28	500-4,500±4½	Semi-dir.	3	Black	Lapel
SJ	Carbon	200	-16	700-4,000±6	Semi-dir.	4½	Chrome	Sensitivity
SB	Carbon	200	-17	500-3,800±5	Semi-dir.	4½	15	Black	Hand
DB-2	Carbon	400	-26	125-4,700±4	Semi-dir.	3	15	Chrome	Switch
DeLuxe	Carbon	70	-42	40-7,800±3	Semi-dir.	3	Black	Lapel
AH	Crystal	200,000	-52	40-8,700±4	Semi-dir.	15	Chrome	Switch
GA	El. static	200,000	-53	50-7,700±4	Semi-dir.	180	8	Chrome	High Output
GB	El. static	200,000	-53	50-7,700±4	Semi-dir.	180	15	Chrome	Switch
PA	Condenser	50 or 200	-13	60-8,000±3	Semi-dir.	180	15	Black	Small Size
Bullet	Condenser	50 or 200	-13	50-8,200±2½	Semi-dir.	180	15	Black, Chrome	High Output
Amperite Co., 561 Broadway, New York, N. Y.										
RBHn	Velocity	2,000	-65	40-11,000	Bi-dir.	25	25	Gunmetal	42.00	Switch & cable conn.
RBMn	Velocity	200	-65	40-11,000	Bi-dir.	25	25	Chrome	43.00	Switch & cable conn.
RBHk	Velocity	2,000	-65	40-11,000	Bi-dir.	25	25	Gunmetal	42.00	Switch & cable conn.
RBMh	Velocity	200	-65	40-11,000	Bi-dir.	25	25	Chrome	43.00	Switch & cable conn.
RBBHn	Velocity	2,000	-68	40-11,000	Bi-dir.	25	25	Gunmetal	42.00	Switch & cable conn.
RBBn	Velocity	200	-68	40-11,000	Bi-dir.	25	25	Chrome	43.00	Switch & cable conn.
RSHn	Velocity	2,000	-68	60-8,000	Bi-dir.	12	Gunmetal	32.00	Switch
RBSn	Velocity	200	-68	60-8,000	Bi-dir.	8	Chrome	33.00	Switch
SR80-Hn	Velocity	2,000	-56	40-15,000	Bi-dir.	25	25	Gunmetal	80.00	Switch & cable conn.
SR80n	Velocity	200	-56	40-15,000	Bi-dir.	25	25	Chrome	82.00	Switch & cable conn.
RAH	Velocity	2,000	-68	60-7,500	Bi-dir.	12	Gunmetal	22.00	
RAL	Velocity	200	-68	60-7,500	Bi-dir.	8	Chrome	23.00	
7JH	Velocity	2,000	-70	60-7,500	Bi-dir.	25	25	Gunmetal	22.00	
7J	Velocity	200	-70	60-7,500	Bi-dir.	25	25	Chrome	23.00	
HAM	Velocity	2,000	-68	60-7,500	Bi-dir.	12	Gunmetal	22.00	
HAL	Velocity	200	-68	60-7,500	Bi-dir.	8	Chrome	23.00	
HDH	Velocity	2,000	-68	60-7,500	12	Gunmetal	22.00	
HDL	Velocity	200	-68	60-7,500	12	Gunmetal	22.00	
KTH	*Velocity	2,000	-40	40-9,000	25	Gunmetal	22.00	Cable connector
KTL	*Velocity	200	-40	40-9,000	25	Gunmetal	22.00	Cable connector
S-1	El. static	5 Meg.	-52	110-9,000	22-300	12	Chrome	16.00	
* Contact microphone.										
All models except the 7J-7JH have swivels and rubber shock absorbers.										
Astatic Microphone Lab., Inc., 830 Market St., Youngstown, Ohio										
T-3	Crystal	5,000,000	-52	30-10,000±5	Semi-dir.	8'	Chrome	\$25.00	Tilting plug & socket
D-104	Crystal	5,000,000	-48	30-7,500*	Semi-dir.	8'	Chrome	22.50	Plug & socket
K-2	Crystal	5,000,000	-60	30-10,000±3†	Non-dir.	8'	Chrome	27.50	Plug & socket
D-2	Crystal	5,000,000	-61	30-10,000±5	Non-dir.	8'	Chrome	25.00	Plug & socket
L-1	Crystal	5,000,000	-62	30-10,000±3	Non-dir.	25'	Telephone black	25.00	
218	Crystal	5,000,000	-46	30-5,500*	Semi-dir.	8'	Telephone black	22.50	
* Rising characteristic above 500 C.P.S. † Rising characteristic above 6,000 C.P.S.										
Bell Sound Systems, Inc., 61 E. Goodale St., Columbus, Ohio										
50	Velocity	1-5 meg.	-68	30-14,000	Dir.	25	Black and chrome	37.50	Swivel mount
53	Velocity	1-5 meg.	-64	30-10,000	Dir.	25	Black and chrome	27.50	Swivel mount
55	Crystal	5 meg.	-60	30-10,000±5	Uni-dir.	25	Chrome	25.00	
56	Crystal	5 meg.	-60	30-10,000±5	Uni-dir.	25	Chrome	27.50	Swivel mount
58	Crystal	5 meg.	-68	30-10,000±8	Uni-dir.	25	Black	27.50	Lapel Type
59	Crystal	5 meg.	-60	30-10,000±5	Uni- or non-dir.	25	Chrome	27.50	Swivel mount
56HS	Crystal	5 meg.	-60	30-10,000±5	Uni-dir.	7	Chrome	26.50	Hand type
70	Crystal cell	5 meg.	-68	30-10,000±3	Non-dir.	25	Chrome	35.00	Spherical
Bruno Laboratories, Inc., 30 W. 15th St., New York, N. Y.										
A	Velotron	To grid	-50	30-14,000	Bi-dir.	150 to 350	Chrome	20.50	Swivel
SP	Velotron	To grid	-50	30-14,000	Bi-dir.	150 to 350	Gunmetal	19.50	
WS	Velotron	To grid	-50	30-14,000	Bi-dir.	150 to 350	Chrome	14.50	Lapel
HA	Velotron	To grid	-50	30-14,000	Bi-dir.	150 to 350	Gunmetal	13.50	
VD—	Velocity	200	-69	50-10,000	Bi-dir.	Chrome	31.00	Swivel
VR—	Velocity	200	-67	50-12,000	Bi-dir.	Gunmetal	30.00	
WM—	Velocity	200	-65	50-12,000	Bi-dir.	Gunmetal	23.00	Handle
PR—	Velocity	200	-61	30-14,000	Bi-dir.	35	Gunmetal	21.00	Swivel
OR—	Velocity	200	-65	50-12,000	Bi-dir.	Gunmetal	to 23.00	
and 33.00										
to 39.00										
to 43.00										
to 90.00 Professional type										
to 135.00										
47.00 Desk type										
49.00										
Brush Development Co., 3311 Perkins Ave., Cleveland, Ohio										
BR2S	Sound cell	-66	30-10,000±3	Non-dir.	Chrome	
B-1	Sound cell	-66	30-10,000±3	Non-dir.	Chrome	
BL-1	Sound cell	-72	30-10,000±3	Non-dir.	15	Black	
AR43	Sound cell	-60	30-10,000±2	Non-dir.	Chrome	
AR26	Sound cell	-66	30-10,000±2	Non-dir.	Chrome	
AR26*	Sound cell	-74	30-10,000±2	Non-dir.	Chrome	
BT-4	Sound cell	-66	30-10,000±3	Aluminum	
R-22	Sound cell	-70	30-10,000±2	Non-dir.	Chrome	
R-34	Sound cell	-67	30-10,000±2	Non-dir.	Chrome	
Lab.	Sound cell	-80	30-20,000±1	Non-dir.	Chrome	
* With Transformer.										
Carrier Microphone Co., 525 So. Commercial St., Inglewood, Calif.										
300-A	Velocity	50-200-2000	-70	30-10,000±2	120°	20	Statuary crackle	
618-D	Dynamic	30	-60	30-10,000±3	145° & 360°	Statuary bronze	
500-A	Condenser	50-200	-25	30-10,000±2	145° & 360°	180	Crackle	
65	Condenser	50-200-2000	-18	60-8000±3	120°	180	20	Crackle	

MODEL Number	Type	Impedance (ohms)	Output (db.)	Frequency Response and db. Variation	Directivity	Polarizing Voltage (volts)	Cable Supplied (feet)	Finish	Price	Special Features
Electro-Voice Mfg. Co., Inc., 325 E. Colfax, South Bend, Ind.										
K-20	Velocity	Optional	-68	40-8,000 ± 3	Bi-dir.	8	Black	\$19.50	
K-21	Velocity	Optional	-66	40-8,000 ± 3	Bi-dir.	8	Black and chrome	24.50	
K-22	Velocity	Optional	-64	40-8,000 ± 3	Bi-dir.	8	Chrome	29.50	
V-1	Velocity	Optional	-68	35-10,000 ± 3	Bi-dir.	8	Black and chrome	25.00	
V-2	Velocity	Optional	-67	35-12,000 ± 3	Bi-dir.	20	Black and chrome	35.00	
V-3	Velocity	Optional	-66	30-12,000 ± 2	20	Black and chrome	50.00	
V-4	Velocity	Optional	-64	30-12,000 ± 2	20	Black and chrome	75.00	
50	D. B. Carbon	400	-42	40-6,000 ± 5	Uni-dir.	6	Gunmetal	5.00	
75	D. B. Carbon	400	-44	40-7,000 ± 4	Uni-dir.	6	Gunmetal	7.50	
100	D. B. Carbon	400	-44	40-7,000 ± 4	Uni-dir.	6	Chrome	10.00	
Insuline Corp. of America, 23 Park Place, New York, N. Y.										
1852	S. B. Carbon	200	Non-dir.	10	Black crackle	\$2.75	On-off sw. in handle
Lifetime Corp., 1010 Madison Ave., Toledo, Ohio										
20	Velocity	5,000	-68	48-10,000 ± 3	Bi-dir.	15	Black wrinkle	\$20.00	
80	Velocity	5,000	-64	35-11,000 ± 2	Bi-dir.	25	Maroon and chrome	25.00	Swivel yoke
90	Velocity	5,000	-62	28-12,000 ± 2	Bi-dir.	25	Chrome and black		
Radio Receptor Co., Inc., 251 W. 19th St., New York, N. Y.										
7A	Dynamic	30	-59	50-9,000	Wide angle	Bronze	\$60.00	
7B	Dynamic	30	-51	100-5,000	Wide angle	Bronze	45.00	
7C	Dynamic	30	-61	100-5,000	Wide angle	Bronze	29.00	
RCA Manufacturing Company, Inc., Camden, New Jersey										
4000	Velocity	50-250	-63	70-6,000 ± 3	Bi-dir.	30	Dull black nickel	\$77.75	
4001	Lapel velocity	250	-80	80-7,000	Non-dir.	30	Black nickel	44.35	
4026A	Velocity	50-250	-61	30-15,000	Bi-dir.	30	Black nickel	132.20	Swivel mount
4027A	Velocity	50-250	-61	30-15,000	Bi-dir.	30	Chrome	137.75	Swivel mount
4030D	Inductor	50-250	-67	60-10,000	Non-dir.	30	Oxidized bronze	100.00	Swivel mount
4036	Velocity	50-250-15,000	-63	40-9,000 ± 2	Bi-dir.	30	Chromium and black	43.50	Swivel mount
4040	Velocity	50-250	-69	60-9,000	Uni-dir.	30	Polished black	190.00	Swivel mount
6225	D. B. Carbon	250	-43	50-6,500	Non-dir.	4 to 6	Gunmetal	11.50	
6226	Aerodynamic	250	-68	100-8,000	Non-dir.	30	Chrome	29.95	
6226A	Aerodynamic	250	-68	100-8,000	Non-dir.	6	Chrome	26.50	
6228	Aerodynamic	40,000	-68	100-8,000	Non-dir.	30	Chrome	29.95	
Remler Company, Ltd., 2101 Bryant St., San Francisco, Calif.										
XT-185	Crystal cell	500,000	30-10,000 ± 2	Uni-dir.	25	Satin chrome	32.50	Plug connectors
Shure Brothers, 225 W. Huron St., Chicago, Ill.										
700A	Crystal	5 Megohms	-52	30-10,000 ± 3 1/2	Semi-dir.	7	Chrome	\$25.00	Swivel mount
701A	Crystal	5 Megohms	-52	30-10,000 ± 5	Semi-dir.	7	Chrome	25.00	Grille case
702A	Crystal	5 Megohms	-52	30-10,000 ± 5	Semi-dir.	7	Chrome	25.00	Spherical case
703S	Crystal	1/2 Meg.	-52	Sp. rising charac.	Semi-dir.	7	Chrome	27.50	With desk mount
720A	Crystal	5 Megohms	-54	30-10,000 ± 5	Non-dir.	25	Chrome	39.50	Switch-con. dir.
720A	Crystal	5 Megohms	-69	30-10,000 ± 5	Uni-dir.	25	Chrome	39.50	Switch-con. dir.
720A	Crystal	5 Megohms	-74	40-10,000 ± 5	Bi-dir.	25	Chrome	39.50	Switch-con. dir.
750A	Crystal	5 Megohms	-49	30-10,000 ± 7 1/2	Semi-dir.	7	Black	25.00	Fits in palm of hand
760A	Crystal	5 Megohms	-40	High intell.	Semi-dir.	7	Black	30.00	Fits in palm of hand
70H	Crystal	5 Megohms	-49	30-10,000 ± 7 1/2	Semi-dir.	7	Chrome	22.50	Heavy duty model
70S	Crystal	1/2 Meg.	-50	Sp. rising charac.	Semi-dir.	7	Chrome	25.00	Commun. Type
76A	Crystal	5 Megohms	-54	↑	Semi-dir.	25	Black	25.00	Lapel type
85A	Crystal cell	5 Megohms	-68	30-10,000 ± 3	Non-dir.	7	Chrome	45.00	High-fidelity
3B	Carbon	200	-42	30-5,000 ± 10	Semi-dir.	Nickel	5.50	Spring mount
5B	Carbon	200	-42	30-7,000 ± 10	Semi-dir.	Chrome	10.00	Spring mount
10B	Carbon	200	-42	30-5,000 ± 10	Semi-dir.	6	Nickel	10.00	Convertible
15A	Carbon	200	-42	30-5,000 ± 10	Semi-dir.	7	Bakelite	15.00	Fits in palm of hand
16A	Carbon	200	-30	High intell.	Semi-dir.	7	Bakelite	20.00	Fits in palm of hand
† Special characteristic for angular pick-up.										
Stromberg-Carlson Tel. Mfg. Co., 100 Carlson Rd., Rochester, N. Y.										
5	S. B. Carbon	100	-40	200-4,000 ± 8	Semi-dir.	1.5	6	Black	12.00	Desk stand
5	*S. B. Carbon	200	-43	200-4,000 ± 8	Semi-dir.	1.5	6	Black	Desk stand
D-2948	S. B. Carbon	100	-40	200-4,000 ± 8	Semi-dir.	1.5	6	Black	10.80	Push Button
6	S. B. Carbon	100	-40	200-4,000 ± 8	Semi-dir.	1.5	2.5	Black	8.50	Hand type
* Dummy resistor and 3 connector cord permits use in double button circuit.										
Transducer Corp., 30 Rockefeller Plaza, New York, N. Y.										
MK-20	Dynamic	200-500,000	-55	90-9,000 ± 4	Uni-dir.	Black	\$19.50	Bullet
MK-30	Dynamic	200-500,000	-55	50-10,000 ± 3	Uni-dir.	25	Black	27.50	Bullet
MK-35	Dynamic	200-500,000	-55	30-10,000 ± 3	Uni-and non-dir.	25	Bakelite	34.50	Ball swivel
MK-40	Dynamic	200-500,000	-50	30-12,000 ± 3	Uni-and non-dir.	25	Bakelite	39.50	Bullet swivel
TR-6	Dynamic	200-500,000	-40	100-8,000 ± 5	Uni-dir.	25	Bakelite	39.50	Reversible
MK-60	Dynamic	10-500,000	-45	25-12,000 ± 3	Uni-and non-dir.	25	Bakelite	60.00	Bullet swivel
TR-11	Dynamic	10	-38	200-6,000 ± 6	Uni-dir.	25	Bakelite	60.00	Marine waterproof
MK-90	Dynamic	10-500,000	-45	25-12,000 ± 2	Uni-and non-dir.	25	Bakelite	90.00	Bullet swivel
Turner Co., Cedar Rapids, Iowa										
T9	Crystal	-51	50-6,000 ± 2	Uni-dir.	8	Chrome and black	\$19.50	Shock proof interior
VT73	Crystal	-54	Uni-dir.	8	Chrome and black	25.25	Stand to match
24G	Crystal	-48	50-8,000 ± 3	Uni-dir.	8	Chrome	22.50	Hi-level
Universal Microphone Co., Ltd., 424 Warren Lane, Inglewood, Calif.										
W	S. B. Carbon	200	-38	200-2,000 ± 5	Semi-dir.	1.5	Nickel	3.00	
A	S. B. Carbon	200	-45	100-3,500 ± 3	Semi-dir.	1.5	Chrome	15.00	Sound detection
XX	D. B. Carbon	400	-50	100-4,000 ± 3	Semi-dir.	1.5	Chrome	10.00	
X-1	S. B. Carbon	200	-50	100-4,000 ± 3	Semi-dir.	1.5	Chrome	7.50	
BB	D. B. Carbon	400	-50	50-5,000 ± 3	Semi-dir.	1.5	Chrome	25.00	
1-Button handy	S. B. Carbon	200	-40	150-3,000 ± 3	Uni-dir.	1.5	6	Chrome & Black	10.00	
2-Button handy	S. B. Carbon	400	-55	100-4,000 ± 3	Uni-dir.	1.5	6	Chrome & Black	15.00	
Stand type	Crystal	500,000	-65	50-5,000 ± 3	Semi-dir.	10	Chrome & Black	18.50	
Hand type	Crystal	500,000	-70	50-5,000 ± 3	Uni-dir.	1.5	10	Chrome & Black	18.50	
.....	Dynamic	33-200-500-2,500	-58	40-8,000 ± 2	Semi-dir.	1.5	25	Chrome & Black	44.50	
E	Condenser	200-500	-32	35-10,000 ± 2	Semi-dir.	P'wr Sup'ly	25	Chrome & Black	100.00	
G	Condenser	200-500	-32	70-7,000 ± 2	Semi-dir.	P'wr Sup'ly	25	Chrome & Black	84.00	
RH	Velocity	33-200-500-2,000	-63	40-10,000 ± 2	Bi-dir.	10	Chrome & Black	22.50	
AV	Air velocity	33-200-500-10,000	-60	30-12,000 ± 1	Bi-dir.	P'wr Sup'ly	25	Satin chrome	44.50	
Lapel	D. B. Carbon	400	-55	50-4,500 ± 3	Semi-dir.	1.5	6	Black Bakelite	25.00	
Aircraft	S. B. Carbon	200	-30	200-4,000 ± 3	Uni-dir.	1.5-6	6	Dural	27.00	Anti-noise
Western Electric Co., Inc., 195 Broadway, New York, N. Y.										
600A	D. B. Carbon	200	Steel		
618A	Dynamic	28	-84	Semi-dir.	Bronze		
630A	Dynamic	20	-90	Non-dir.	Black		
633A	Dynamic	20	-90	Semi-dir.	Gray		

PICKUPS

MODEL NUMBER	Type	Impedance (ohms)	Output (db.)	Frequency Response (cycles) and db. Variation	Pressure of Head (oz.)	Length of Arm (inches)	Maximum Record Size (inches)	Cable Supplied (feet)	Finish	Price	Special Features
Astatic Microphone Lab., Inc., 830 Market St., Youngstown, Ohio											
S-8	Crystal	500,000	-22	30-7,000	2.5	9½	12	4	Black Wrinkle	\$10.00	
S-12	Crystal	500,000	-22	30-7,000	2.5	15	16	4	Black Wrinkle	12.50	
B-10	Crystal	500,000	-22	30-7,000	2.5	12	12	4	Black Chrome	17.50	Off-set head.
B-16	Crystal	500,000	-22	30-7,000	2.5	14	16	4	Black Chrome	27.50	Off-set head.
O-7	Crystal	750,000	-25	30-10,000	2.5	9	12	4	Telephone black	12.00	Off-set head.
Audak Company, 500 Fifth Ave., New York, N. Y.											
HR-34	Magnetic	*	-18	60-5,000	2.4	9¾	12	3	Black & Gold	9.50	
HR-38	Magnetic	*	-18	50-5,500	2.4	10¾	12	3	Black & Silver	12.25	
HR-64	Magnetic	*	-18	60-5,500	2.4	10	12	3	Black & Silver	14.50	
HR-62	Magnetic	*	-18	60-5,000	2.4	9	12	3	Black & Silver	9.50	
PR-66	Magnetic	*	-18	50-5,800	2.4	13	18	3	Black & Silver	20.00	
Prof.	Magnetic	*	-18	50-5,800	2.4	18	18	3	Black & Silver	25.00	
Pro. 2	Magnetic	*	-18	50-5,800	2.4	13½	18	3	Black & Gold	20.00	
AA-74	Magnetic	*	-18	50-5,800	2.4	10	12	3	Black & Silver	24.00	
AA-76	Magnetic	*	-18	50-6,000	2.4	13	18	3	Bronze & Gold	29.00	
100	Magnetic	*	-18	65-5,000	2.4	9	12	3	Black	7.50	
RF-4	Relayed-freq.*		-30	50-10,000	38 grams	14¼	18	3	Black & Bronze	125.00	
RF-2	Relayed-freq.*		-30	50-7,000	38 grams	14¼	18	3	Black & Bronze	80.00	
RF-1	Relayed-freq.*		-25	70-6,500	38 grams	11	12	3	Black & Bronze	40.00	
Hilldale	Relayed-freq.*		-30	50-10,000	38 grams	14¼	18	3	260.00	
* Any impedance from 2 to 20,000 ohms.											
Bell Sound Systems, Inc., 61 E. Goodale St., Columbus, Ohio											
1S	Crystal	500,000	2.5	8	12	3	Black crackle	10.00	Co-Axial Mtg.
2S	Crystal	500,000	3	12	16	3	Black crackle	12.00	Co-Axial Mtg.
3S	Crystal	500,000	2	8	12	3	Black crackle	12.00	Off-set head
Brush Development Co., 3311 Perkins Ave., Cleveland, Ohio											
Hi. Fi.	Crystal	.001 mfd.	30-10,000 ± 1.5	1	12	16	Black crackle		
Fairchild Aerial Camera Corp., 88-06 Van Wyck Boulevard, Jamaica, L. I., N. Y.											
209	Crystal	150,000	-22	60-5400	1 to 3	12	16	3	Tel. black	\$40.00	
Pacent Engineering Corp., 79 Madison Ave., New York, N. Y.											
120	Magnetic	12,000	Adjustable	7½	12	5	Black & bronze		
120L	Magnetic	200	Adjustable	7½	12	5	Black & bronze		
160	Magnetic	12,000	Adjustable	12	16	5	Black & bronze		
160L	Magnetic	200	Adjustable	12	16	5	Black & bronze		
108A	Magnetic	2,000	Adjustable	8½	12	5	Black & bronze		
108AL	Magnetic	200	Adjustable	8½	12	5	Black & bronze		
108B	Magnetic	2,000	Black		
108BL	Magnetic	200	Black		
1225	Magnetic	20,000	Adjustable	7½	12	5	Black & bronze		
B. A. Proctor Company, Inc., 17 West 60th St., New York, N. Y.											
.....	Crystal	150,000	-20	40-10,000	Adjustable	14	16	4	Black	\$24.00	
RCA Manufacturing Co., Inc., Camden, N. J.											
12329	Magnetic	1400	70-5500	4.3	7¾	12	13	Bronze	6.75	
11950	Magnetic	1400	70-5500	4.3	7¾	12	17	Bronze	8.50	
14818	Crystal	80000	40-8000	3	11¼	12	16	Brown & Chrome	14.95	Adjustable needle pressure
9661	Magnetic	8.5	40-6000	Head only	Walnut	6.50	
9665	Magnetic	30	40-6000	Head only	Walnut	6.50	
9669	Magnetic	700	40-6000	Head only	Walnut	6.50	
9670	Magnetic	2800	40-5000	Head only	Walnut	6.50	
9675	Magnetic	8500	40-5000	Head only	Black	6.50	
9676	Magnetic	400	40-6000	Head only	Black	6.50	
11481	Magnetic	22	40-6000	Head only	Brown lacquer	7.50	Humbucking coil
9678	Arm only	10½	12	48	Walnut	7.50	
9679	Arm only	10½	12	48	Black	7.50	
Shure Brothers, 225 W. Huron St., Chicago, Ill.											
99B	Crystal	½ to 5 meg.	Wide range	2½	8	12	3½	Black bakelite	\$12.00	*
910A	Crystal	½ to 5 meg.	Ultra-wide range	2½	10	12	3½	Black morocco	14.50	†
912A	Crystal	½ to 5 meg.	Ultra-wide range	2½	12	16	3½	Black morocco	15.00	†
* Needle-tilt tracking error correction.											
† Automatic arm and head lock. Needle-tilt tracking error.											
Sundt Engineering Co., 4238 Lincoln Ave., Chicago, Ill.											
156	Crystal	2 meg.	-40	10-1000	8	8	8	Black crackle	\$25.00	*
157	Crystal	2 meg.	-70	30-8000	2	15	Aluminum	12.50	†
* For vibration study.											
† For attachment to musical instruments.											
Unit Reproducers Mfg. Co., 999 E. Main St., Rochester, N. Y.											
8-S	Magnetic	*	30-6500	2.2	8¾	Black crackle	\$6.70	
V-8-S	Magnetic	*	30-6500	2.2	11¼	Black crackle	6.70	
V-11-S	Magnetic	*	30-6500	2.2	15½	Black crackle	7.50	
11-S	Magnetic	*	30-6500	2.2	Black crackle	7.50	
V-W-11	Magnetic	*	30-6500	2.2	Black crackle	9.15	
R-W-11	Magnetic	*	30-6500	2.2	Black crackle	9.15	
P-W-15	Magnetic	*	30-6500	2.2	Chrome	10.50	
V-W-15	Magnetic	*	30-6500	2.2	Nickle	10.50	
* Available from 2 to 50,000 ohms.											
Universal Microphone Co., Ltd., 424 Warren Lane, Inglewood, Calif.											
Full freq.	Magnetic	15-50-200-500	-24	30-10,000 ± 8	Adjustable	15	17	3	Black & chrome	15.00	Adjustable damper s
Upco Engineering Laboratories, Inc., 254 Canal St., New York, N. Y.											
M-1	Magnetic	10,000	90-4500 ± 2	2	8½	12	3	Black crackle	7.25	
M-2	Magnetic	10,000	90-4500 ± 2	2	8½	12	3	Black crackle	8.00	
Webster Company (Webster-Chicago) 5622 Bloomingdale Ave., Chicago, I. Il.											
305	Magnetic	5000	65-6500 ± 6	3.05	8½	12	1.5	Gray Wrinkle	\$7.50	
310	Magnetic	200	65-6500 ± 6	3.05	8½	12	1.5	Gray Wrinkle	\$7.50	
Webster Electric Company, Clark & DeKoven Aves., Racine, Wis.											
40A-5	Magnetic	18,000	60-5000 ± 5	3.25	12	28	Black	8.00	
41A-5	Magnetic	36,000	60-7000 ± 5	3.25	12	28	Black	9.00	
30A-2	Magnetic	9,100	70-7000 ± 3	3.25	12	26	Gold	9.75	Built in V. C.
31A-4	Magnetic	36,500	70-7000 ± 5	3.25	12	26	Gold	10.75	Built in V. C.
X-73A-2	Crystal	80,000	50-7000 ± 6	2.5	12	26	Copper Bronze	12.00	Built in V. C.
X-75A-3	Crystal	80,000	50-7000 ± 6	2.5	12	28	Copper Bronze	10.00	Built in V. C.
X-73D	Crystal	80,000	50-7000 ± 6	2.25	16	50	Black	18.50	Built in V. C.
X-73D-3	Crystal	80,000	50-7000 ± 6	2.25	16	50	Black	17.50	

INDEX TO ADVERTISERS

December, 1937

	Page		Page		Page
AEROVOX CORP.	66	KELVINATOR, DIVISION OF NASH-KELVINATOR CORP.	34, 35	STANDARD TRANSFORMER CORP.	64
(Condensers)		(Refrigerators)		(Transformers)	
ARCTURUS RADIO TUBE CO.	66	KOOLROOM, DIVISION OF INDIAN PRODUCTS CORP.	21	SOLAR MANUFACTURING CO.	67
(Tubes)		(Air-Conditioners)		(Condensers)	
BRACH MFG. CO., L. S.	48	LEONARD, DIVISION OF NASH-KELVINATOR CORP.	44, 45	STROMBERG-CARLSON TELE. MFG. CO.	2
(Antenna Systems)		(Refrigerators)		(Radio Sets)	
BRIGGS & STRATTON CORP.	8	MALLORY & CO., INC., P. R.	Inside Front Cover	TRIAD MANUFACTURING CO.	69
(Gas Engines & Generators)		(Replacement Parts & Power Packs)		(Tubes)	
CLAROSTAT MFG. CO.	61	McMURDO-SILVER CORP.	54	TRIPLETT ELECTRICAL INSTRUMENT CO.	67
(Volume Controls)		(Radio Sets)		(Test Equipment)	
CLOUGH-BREngle CO.	70	MUELLER ELECTRIC CO.	61	TUNGSOL RADIO TUBES, INC.	61
(Test Equipment)		(Wire Clips)		(Tubes)	
CORNISH WIRE CO.	48	NATIONAL UNION RADIO CORP.	65	UTAH RADIO PRODUCTS CO.	70
(Antennas)		(Radio Tubes)		(Vibrators)	
CROSLY RADIO CORP.	Inside Back Cover	NORGE DIVISION, BORG-WARNER CORP.	28, 29	WARD PRODUCTS CO.	48, 55
(Refrigerators)		(Refrigerators)		(Auto-Radio Antennas)	
CROWE NAMEPLATE & MFG. CO.	54	PIONEER GEN-E-MOTOR CORP.	65	WEBSTER-CHICAGO	68
(Auto-Radio Controls)		(Electric Plants)		(Sound Equipment)	
EDISON GENERAL ELECTRIC APPLIANCE CO., INC.	4, 5	PRECISION APPARATUS CORP.	69	WHOLESALE'S SALESMAN	22
(Refrigerators)		(Test Equipment)		(Publication)	
ELECTRIC STORAGE BATTERY CO.	53	RADIOFONE CORPORATION	6	SEARCHLIGHT SECTION	
(Storage Batteries)		(Inter-Communicators)		<i>Classified Advertising</i>	
GENERAL ELECTRIC CO.	Back Cover	RADIO ACCESSORIES CO.	61	Classification	Page
(Radio Sets)		(Radio Parts)		BOOKKEEPING SERVICE	
GENERAL INDUSTRIES CO.	65	RADIO & TECHNICAL PUBL. CO.	69	Appliance Bookkeeping Service.	75
(Phono. Motors, Record Changers)		(Service Manuals)		CATALOGS	75
HORTON MFG. CO.	48	RAYTHEON PRODUCTION CORP. ..	3	RADIO STOCKS	
(Electric Washers)		(Tubes)		Burstein-Applebee Co.	75
HYGRADE-SYLVANIA CORP.	26	READRITE METER WORKS	56	G & G Majestic Refrig. & Radio Parts Service	75
(Tubes)		(Test Equipment)		Midwest Appliance Parts Co.	75
INTERNATIONAL RADIO CORP.	15	RIDER, JOHN F.	67	Radolek Co.	75
(Radio Sets)		(Service Manuals)			
JANETTE MANUFACTURING CO.	48	RIVARD WIRE & CABLE CORP.	48		
(Rotary Converters)		(Antenna Systems)			

McGRAW-HILL PUBLISHING COMPANY, INC. Publication Office: 99-129 North Broadway, Albany, N. Y. Editorial and Executive Offices: 330 West 42d Street, New York, N. Y. Branch Offices: 520 North Michigan Avenue, Chicago; 883 Mission Street, San Francisco; Aldwych House, Aldwych, London, W. C. 2; Washington; Philadelphia; Cleveland; Detroit; St. Louis; Boston; Atlanta, Ga.

SEARCHLIGHT SECTION

EMPLOYMENT and BUSINESS OPPORTUNITIES—SURPLUS STOCKS—DISCONTINUED MODELS

UNDISPLAYED RATE:
 15 cents a word, minimum charge \$2.00.
 Positions Wanted (full or part-time salaried employment only) ½ the above rates, payable in advance.

(See ¶ on Box Numbers.)
 Proposals, 50 cents a line an insertion.

INFORMATION:
 Box Numbers in care of our New York, Chicago and San Francisco offices count 10 words additional in undisplayed ads. Replies forwarded without extra charge.
 Discount of 10% if one payment is made in advance for four consecutive insertions of undisplayed ads (not including proposals).

DISPLAYED—RATE PER INCH:
 1 inch\$8.00
 2 to 3 inches..... 7.80 per inch
 4 to 7 inches..... 7.60 per inch
 An advertising inch is measured vertically on one column, 3 columns—30 inches—to a page. Contract Rates on request.

Radio Retailing

(New advertisements must be received by Dec. 27th for the January issue)

At Your Service

—for bringing business needs or “opportunities” to the attention of men associated in executive, management, sales and responsible technical, engineering and operating capacities with the industries served by the following McGraw-Hill publications:

The SEARCHLIGHT SECTIONS

(Classified Advertising)

- American Machinist
- Aviation
- Bus Transportation
- Chemical and Metallurgical Engineering
- Coal Age
- Construction Methods and Equipment
- Electrical Merchandising
- Electrical World
- Electronics
- Engineering News-Record
- Engineering and Mining Journal
- E. & M. J. Markets
- Factory Management and Maintenance
- Food Industries
- Power
- Product Engineering
- Radio Retailing
- Textile World
- Transit Journal

For advertising rates or other information address the

Departmental Staff

McGraw-Hill Publications

330 W. 42nd St., New York, N. Y.

A REAL OPPORTUNITY

SERVICER SALESMEN

Centrally located national distributor parts and public address equipment, requires local representatives to solicit orders from dealers and servicemen. Excellent opportunity for live wires. Must be familiar with local service trade. Liberal commissions. This is a real proposition for go-getters. Write full details, training, experience and background in trade.

Box R. W. 115, Radio Retailing
 330 W. 42nd St., New York City

YOU ARE ONE

of more than 20,000 readers of RADIO RETAILING.

Your problems of selling radio sets, accessories and other home merchandise—whether business or individual—are duplicated with other readers, but—

Still OTHER readers can provide the solution of your problem IF THEY KNOW WHAT IT IS!

Tell them! Here!

Through classified advertising in the Searchlight Section of RADIO RETAILING—your business paper and theirs.

BOOKKEEPING SYSTEM

Designed especially for the small radio sales and repair store. Larger systems for the general appliance dealer.

Don't guess at—profits, social security tax and loads of detail which this system will give you. Sales, repairs, customer's payments and expenses all entered on daily cash balancing sheet. Totals are transferred to properly designed records. Simple but complete.

Start the New Year Right!

Write today for particulars—stating your case of business

Reasonably priced. Complete instructions

APPLIANCE BOOKKEEPING SERVICE

111 W. Jackson Blvd. CHICAGO, ILL.

RADIO IN IT'S ENTIRETY!

“B-A” serves the trade with every need in radio—complete 160-page catalog of nationally known radio receivers, public address, parts, supplies and equipment. Orders shipped same day received.

COMPLETE CATALOG AVAILABLE

BURSTEIN-APPLEBEE CO. 1612-14 McGEE ST. KANSAS CITY, MO.

OVER 10,000 PARTS

FOR VACUUM CLEANERS AND WASHING MACHINES

24-HOUR SERVICE!

Attach this “Ad” to Your Inquiry and Receive Complete Catalog

Manufacturers Factory Representatives
 MIDWEST APPLIANCE PARTS CO.
 2722 W. Division St. CHICAGO, ILL.

\$500,000 GENUINE

MAJESTIC GRIGSBY GRUNOW REFRIGERATOR & RADIO PARTS. UNITS GUARANTEED 18 MONTHS. SEND FOR PRICE LIST. G & G GENUINE MAJESTIC REFRIGERATOR & RADIO PARTS SERVICE 5801 W. DICKENS AVE. CHICAGO, ILL.

STOP SEARCHING!

HERE IS YOUR “GUIDE”

LOWEST PRICES

SEND FOR YOUR COPY NOW!

The new 1938 Radolek Radio Profit Guide contains complete showings of Radio Repair Parts, Radio Receivers, Public Address Amplifiers, Speakers, Microphones, Service Test Instruments, Radio Technical Books, Special Radio Tools. Leading Standard Brands! Everything you will ever need in the Radio Business all at Lowest Prices. You save money at Radolek!

GUARANTEED QUALITY

Every item you get from Radolek is guaranteed. It must be right or we make it right. Standard merchandise produced by leading Manufacturers with Radolek's guarantee added!

FASTEST SERVICE

Everything in Radio promptly when you want it—and exactly what you want. Radolek's efficient organization backed by a huge stock of standard guaranteed quality merchandise insures you the fastest service in the Radio business. Twenty-five Thousand Servicemen customers depend on Radolek service and benefit by Radolek's LOWEST PRICES. Send Now for your copy of the Radolek Radio Profit Guide. It will help you make money.



RADOLEK

601 W. Randolph St., Dept. A-14, CHICAGO

Name

Address

Serviceman? Dealer? Experimenter?

Rely on Radolek for “Everything in Radio”

Audio Frequency...

Praise, In Anonymity*

Your article in the November issue of *Radio Retailing* on "Television Retailing" is to me the same as "manna from heaven". Having been in the radio business since its inception, I quite naturally have followed it closely and find at the present time a certain tendency on the part of radio retailers to cast their eyes toward other fields which, in their opinion, might be more lucrative.

The mere fact that you have mentioned television in a manner which would indicate we may possibly—someday—expect it, is a step in the right direction. It affords me the opportunity to talk to my radio salesmen regarding the future of this great industry and it will enable them to hold in line dealers who rightfully belong in the radio business and should stay in it. We need every possible bit of help we can get in the radio industry at this time, particularly in view of the chaotic merchandising conditions so prevalent in the metropolitan areas.

May I express my personal thanks—and I believe anyone connected with this great industry will feel the same as I, after having read your television article.

For your information I am inclosing a confidential letter to my own salesman which will give you, perhaps, a new viewpoint as to the great good you can accomplish through continuance of television articles and the future of radio. Please do not publish anything I have written to you, unless it be used anonymously.*

WISCONSIN (A VICE-PRESIDENT)
Radio Distributor

We Intend To

I read with eagerness your published dope on Television (Television Retailing in England, November). I shouldn't have to tell you that as a radio dealer I feel this to be the coming saviour of the business.

Please give us all the information you can about television.

SEATTLE

V. LUFORINI
Vic's Radio Shop

Expert Export Criticism

American radios are becoming more and more alike and it appears that one can buy at least 12 makes of radios which are identical in every detail, except for the name.

This naturally upsets us to a very large extent, inasmuch as we cannot quote our 8-tube models at a fair retail price when a "retail-wholesaler" quotes the same receiver with a different name at a much lower price.

If only you could impress on some manu-

facturers the importance of different cabinets and dials, even where chassis must be the same, it would assist all dealers operating under the conditions we are.

F. E. BOTT
Border Radio Distributors
KING WILLIAMS TOWN, EAST LONION

"I Can Buy It For You Wholesale"

In reference to an article in the news section of your current issue (November) headed: "New No-Discount Drive", as suggested by a Milwaukee group, would it be possible to secure a copy of each of these six letters for presentation to our local radio group?

AKRON

D. C. BRUNER
Union Radio Service

We've sent your letter directly to the group at Milwaukee and feel sure that the form letters you ask for will be forthcoming.

About Man-Made Noise

I would like to see a note in the magazine about electric razors. Why are these devices permitted to make radio noise when other appliances sold here must be quieted?

If you try to sell the owner a \$1.50 filter after he buys a \$15 razor he feels that this is an imposition. They should be cured of noise before shipment by the manufacturer.

J. A. BELLEMARE
SHAWINIGAN FALLS, QUEBEC

We ran a series of articles about noise generated by all sorts of electrical devices last year, tried to sell makers the idea of filtering them in production to aid the radio business and at the same time improve their own consumer relations. Little came of it for each manufacturer is unwilling to add even a few cents to the cost of production unless all competitors do likewise. And nobody will start the ball rolling. Legislation seems to be the only way and without concerted effort by the radio business itself this is hard to secure.

Do We Need a National Association of Radio-Appliance Retailers?

In our next issue, the January 1938 issue of *RADIO RETAILING*, we will present for the consideration of our readers an entirely factual and impartial discussion of this question.

We are convinced that the time is here when the industry should give serious thought to this subject.

We will present facts and figures that are pertinent to its intelligent consideration—pro as well as con.

We will publish detailed information on practical procedure, if such an organization is to be brought about, suggesting also suitable provisions for fitting into the NATIONAL set-up as independent associated entities the various now-existing local or regional associations, clubs or leagues.

We will open the editorial pages of *RADIO RETAILING* to a free discussion of the subject by our readers and invite letters, plans and suggestions.

We will offer all possible assistance

by our staff if members of the trade or specific groups wish it.

However, neither *RADIO RETAILING* nor members of its staff desire or will assume any official identification with such national organization as may result.

If the industry wants a NATIONAL association, we are ready to meet all reasonable demands for assistance and cooperation to that end.



EDITOR

"THIS MUCH MORE IN A SHELVADOR"

The Greatest Sales Story Ever Told!!!

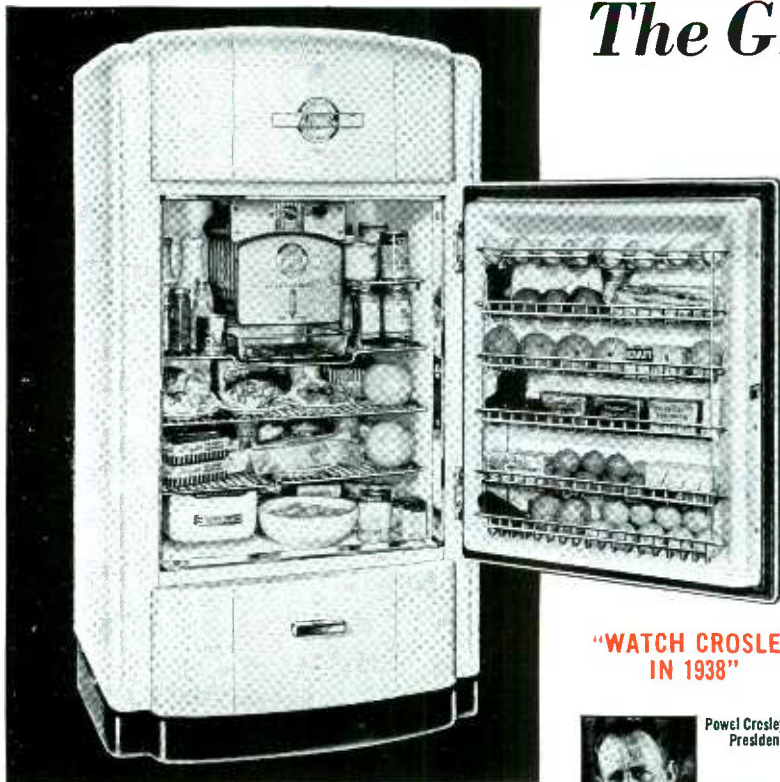

The new 1938 Crosley Shelvador Electric Refrigerator is now available in 11 distinctive models that meet every requirement in capacity and price.



New "Inside Proving Ground" at the Crosley Cincinnati Plant.



Engineering Staff, Refrigeration Division of The Crosley Radio Corporation.

"WATCH CROSLY IN 1938"



Powell Crosley, Jr.
President



T. W. Berger
Gen. Sales
Manager



Chas. R. D'Olive
Vice-President,
Refrigeration
Division



Herbert Money
Chief Engineer
Refrigeration
Division



John W. Craig
Asst. to Chief
Refrigeration
Engineer

These are the men up in the front line as the 1938 Crosley Shelvador "Big Push" for record refrigerator sales begins.

In the past six years Crosley has experienced phenomenal growth with the exclusive Shelvador Electric Refrigerator. This growth dictated plans for an expansion program unrivalled in the Electric Refrigeration Industry . . . a program now in full operation.

The dominating features of this program are the new \$1,000,000 Crosley plant at Richmond, Ind., and the great, new "Proving Ground" installed at the Cincinnati plant. The Richmond plant, the first of four units to be built on this 90-acre industrial tract, is 200 feet wide by 1200 feet long and incorporates the most efficient production facilities known to the industry. It is served by two main trunkline railroads and is *already producing* at the rate of 1500 Shelvador refrigerators daily. In the new "Proving Ground" Crosley has developed the most modern air conditioned testing chambers for *product quality control*. Shelvador refrigerating units are tested under controlled temperature and humidity conditions that approximate extremely severe climatic conditions.

Supporting this program is a product that establishes new standards for quality manufacture and low cost of operation—the new 1938 Crosley Shelvador Electric Refrigerator—unquestionably the greatest Shelvador in Crosley history! Record carload shipments have been made . . . more are now on the rails . . . and on thousands of sales floors women are eying and buying the new Shelvador. All over the nation *sales* are proving that "This Much More In A Shelvador" is still "the greatest sales story ever told."



Shown above is the recently completed first unit of four to be built by Crosley on the 90-acre tract at Richmond, Ind. This first unit, 200 feet wide by 1200 feet long, is the last word in production efficiency with a capacity of 1500 Shelvador cabinets per day.

THE CROSLY RADIO CORPORATION • CINCINNATI

POWELL CROSLY, Jr., President

Home of "the Nation's Station"—WLW—500,000 watts—70 on your dial

CROSLY SHELVADOR

*"Take it from me
G-E TOUCH TUNING is Tops"*
IT'S SWEEPING THE COUNTRY AT POPULAR PRICES



*Press a button
That's all*

GENERAL ELECTRIC TOUCH TUNING MODEL F-96

General Electric Touch Tuning—the highest development in automatic tuning—is not only sensational in performance but sensational in price. New G-E Touch Tuning series includes Model F-96—9 tubes with 7 Touch Tuning buttons; Model F-107—10 tubes with 16 Touch Tuning buttons; Model F-135—13 tubes with 16 Touch Tuning buttons; and radio-phonograph combination Model F-109—10 tubes with 16 Touch Tuning buttons.

The General Electric Radio advertising and merchandising plan is geared to speed up your sales. And of course, each model carries a money profit worth working for.

ALL OF THEM GREAT HOLIDAY NUMBERS



*The
New
1938*



**GENERAL ELECTRIC
RADIO**

FOR REPLACEMENTS SPECIFY GENERAL ELECTRIC PRE-TESTED TUBES
APPLIANCE AND MERCHANDISE DEPARTMENT, GENERAL ELECTRIC CO., BRIDGEPORT, CONN.