

ANNUAL TRADE SHOW NUMBER

Radio Retailing

The Business Magazine of the Radio Industry

A McGraw-Hill Publication

JUNE, 1929



SPARTON'S SHOW MESSAGE

Sparton accomplishments in the past may be accepted as indications of what is to come when we promise

IMPORTANT NEW DEVELOPMENTS

STEVENS HOTEL

Demonstration Rooms

Suite 800, 801 801-A, 802, 802-A

Sparton Display

STEVENS EXHIBITION HALL

Booths 103-104

THE SPARKS-WITHINGTON CO. (Established 1900)
JACKSON, MICH., U. S. A.

Pioneers of Electric Radio without batteries of any kind
(325)



SPARTON RADIO

Radio's Richest Voice

For the *really* NEW
in DYNAMIC
SPEAKERS

SEE and HEAR

the

NEW *Farrand*

ELECTRO DYNAMIC

the

NEW *Farrand*

INDUCTOR DYNAMIC

R.M.A. SHOW , , STEVENS HOTEL, CHICAGO
BOOTH 85 , , , DEMONSTRATION ROOM 509-A

FARRAND MANUFACTURING CO. INC. LONG ISLAND CITY, N. Y.

281.50
16.890^{6c}

RAY V. SUTLIFFE,
Western Editor, Chicago
S. J. RYAN,
Merchandising Counsellor
HENRY W. BAUKAT,
Technical Editor
M. E. HERRING,
Publishing Director

Radio Retailing

The Business Magazine of the Radio Industry

O. H. CALDWELL, *Editor*

Editorial Staff
OVID RISO
HARRY PHILLIPS
C. GRUNSKY, *San Francisco*
PAUL WOOTON, *Washington*

JUNE, 1929

GENERAL

- Is a Wider Margin for Dealers Justified? 76B
Two prominent manufacturers discuss a question of vital interest to radio dealers.
- What Will Screen Grid Do to Radio? 76D
A summary of the latest technical radio development and its effect on the industry.

AT THE RADIO TRADE SHOW

- A Survey of the Sets on Display at the Trade Show 78
- Reproducers 82
- Combination Radio-Phonograph Sets 84
- Directory of Trade Show Exhibitors and Their Products 114

SALES

- Sit Down and Check Yourself Up 88
Ten questions which will provide a good analysis of your sales performance.

THE EDITORS SAY—

- The Radio Trade Show of 1929 76A
- America Has Invested a Quarter Billion Dollars in Radio 104

NEWS

- This Month in the Radio Industry 110
- New Products for the Dealer to Sell 106

Advertising That Sells

94
Some fundamental principles that have contributed to the success of three Chicago radio dealers.

Speaker Sales Increased by Quick Comparison Method

96
Waltham's, of New York, has a control board and speaker arrangement with special wiring which makes selection and demonstration easy and convenient.

Get Pep in Your Summer Window

101
How to install a live, cool-looking, summer window, with an electric fan and colored crepe paper.

MANAGEMENT

- Start the Fiscal Year in July 92
- "We Make Radio Pay" 86
The President of the National Association of Music Merchants states the radio policies of his 87-year-old selling organization.

Avoid Service Collection Troubles

98
E. A. Portal, of San Francisco, tells how he has practically eliminated all difficulties in collecting service charges.

BROADCASTING

- The "Low-Down" on Wired Broadcasting 90
- Timetable of Principal Morning and Afternoon Chain Programs 117

MANUFACTURING

- Dramatizing the Sales Convention 119

In the July Issue—
THERE will be some excellent information on ways and means of advertising and selling radio during the summer months. How this has actually been done by many dealers in various parts of the country and to what extent profits have been made, will be told in detail.
Then there will also be a complete and detailed review of the Trade Show. Developments and trends will be described. The various types of products exhibited at the Show will be completely analyzed. Also, there will be illustrations of the latest type of radio furniture that will be marketed during the coming season.

Member Audit Bureau of Circulations and Associated Business Papers.

All Material in This Publication Copyrighted, June, 1929

McGRAW-HILL PUBLISHING COMPANY, INC., Tenth Ave. at 36th St., New York, N. Y.

JAMES H. MCGRAW, Chairman of the Board
MALCOLM MUIR, President
JAMES H. MCGRAW, JR., Vice-Pres. and Treas.
EDWARD J. MERRIN, Vice-President
MASON BRITTON, Vice-President
EDGAR KORAK, Vice-President
HAROLD W. MCGRAW, Vice-President
C. H. THOMPSON, Secretary

NEW YORK DISTRICT OFFICE, 285 Madison Ave.
Electrical World Electrical West Ingenieria Internacional
Engineering and Mining Journal Food Industries
Chemical & Metallurgical Engineering American Machinist
Electrical Merchandising Power Electric Railway Journal
Bus Transportation Engineering News-Record
Coal Age Aviation Construction Methods
Copyright, 1929, by McGraw-Hill Publishing Company, Inc.
Cable Address: "Machinist, N. Y."
Annual subscription rate is \$2 in United States and Canada.

WASHINGTON, National Press Bldg.
CHICAGO, 520 N. Michigan Bldg.
PHILADELPHIA, 1600 Arch St.
CLEVELAND, Guardian Bldg.
ST. LOUIS, Bell Telephone Bldg.
SAN FRANCISCO, 883 Mission St. ext
LONDON, E. C. 8 Bouverie St.

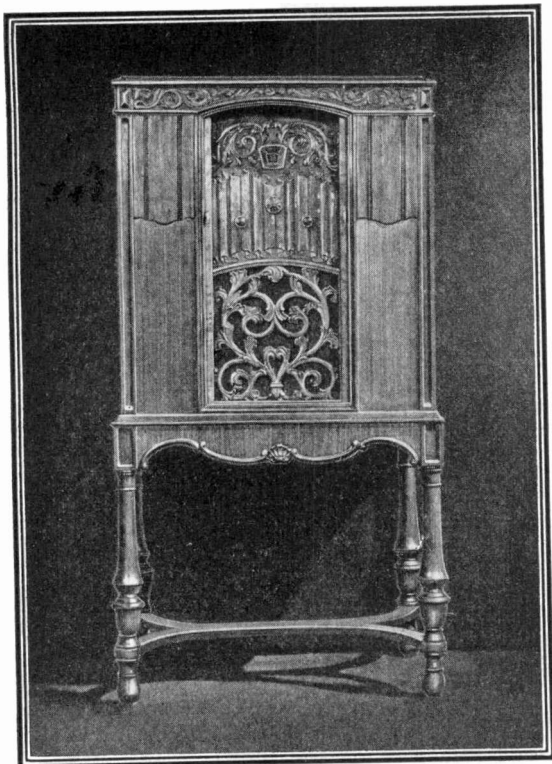

NEW CONSOLE NEW TONE

Three A. C. Screen Grid Tubes — Built-in Dynamic Speaker

1. Linear Power Detection with automatic grid bias.
2. Detector directly coupled to output stage.
3. New UX-245 Power Output Tube.
4. Single dial station selector [illuminated] with divisional and kilocycle markings.
5. A. C. Operation — direct from the

house-lighting circuit.

6. Scientific Shielding — radio frequency and detector stages "totally shielded" individually and over-all.
7. Phonograph jack at back of Receiver — allows permanent phonograph connection.
8. Period Cabinet — Finished in American Walnut.

No. 642
Stromberg-Carlson
Art Console, uses three UY-224, one UY-227, one UX-245 and one UX-280 Radiotrons. Built-in Dynamic Speaker.

Price, without tubes, East of Rockies . . .

\$247.50

Visit the Stromberg-Carlson Radio Exhibit, June 3-6 at the Drake Hotel, Chicago, Room Nos. 224-5-7

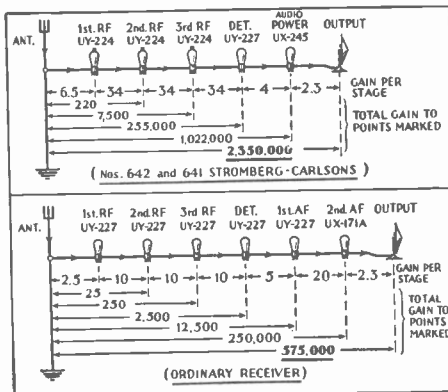

Titanic Amplification

See the tremendous difference in the total amplification between the new screen grid Stromberg-Carlson and an ordinary Receiver. It is 2,350,000 as compared with 575,000. This titanic amplification is an important factor for building a new tone standard in radio.

STROMBERG-CARLSON TELEPHONE MANUFACTURING CO., ROCHESTER, N. Y.

Stromberg-Carlson

MAKERS OF VOICE TRANSMISSION AND VOICE RECEPTION APPARATUS FOR MORE THAN THIRTY-FIVE YEARS

NOW Ready . . .

UTAH

Large STADIUM Speaker

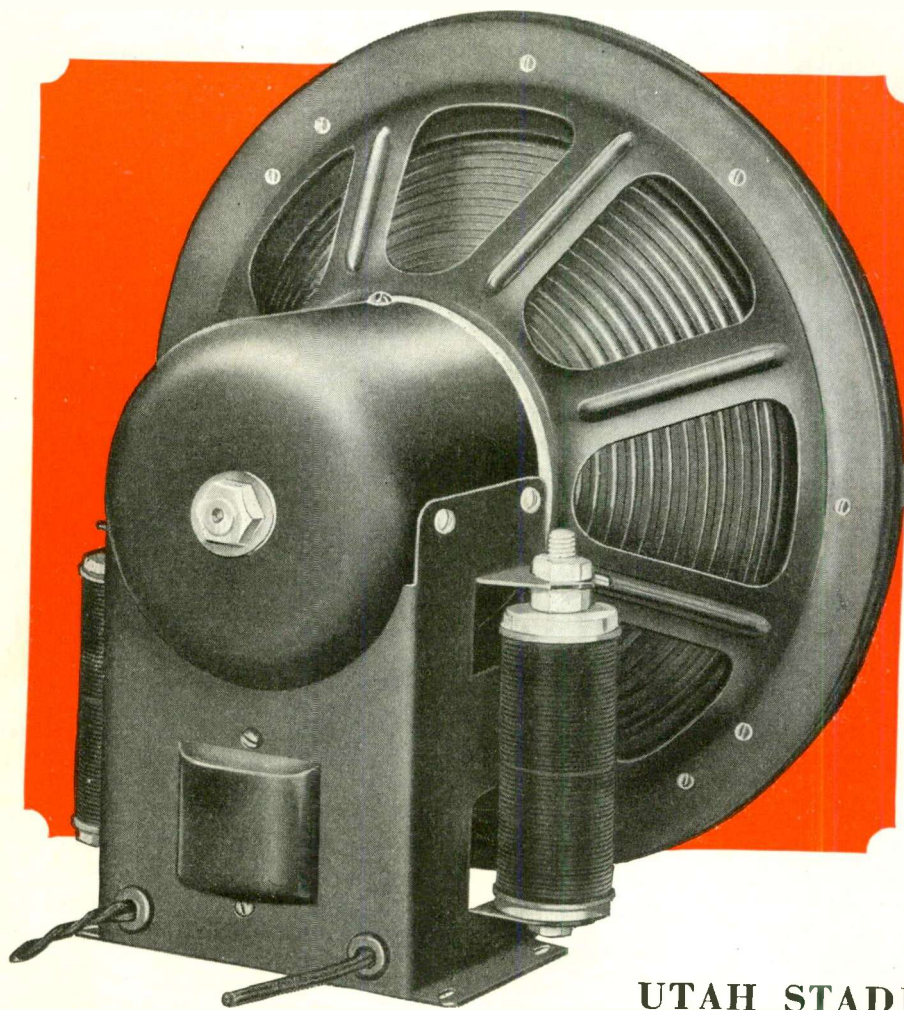

Built to meet the needs of manufacturers, jobbers and dealers who feel the necessity of giving superior reproduction qualities to their products.

Ideal for largest output... a superior speaker for home, theatre, large hall and outdoor use.

UTAH RADIO PRODUCTS CO.
1737 South Michigan Ave., Chicago, Ill.

UTAH STADIUM
Model 66-A

110 A.C. Operation. Diameter over-all 12 1/4". Cone 10 1/4". Equipped with Westinghouse full wave high voltage rectifier—eliminating step down transformer—can be used on 25 to 60 cycles. No hum.

\$45.00
LIST

See the complete line of UTAH Speakers for all purposes at the R. M. A. Show Booth 92 - Demonstrating Rooms 500, 501 and 501A. Hotel Stevens, Chicago - Week of June 3rd.



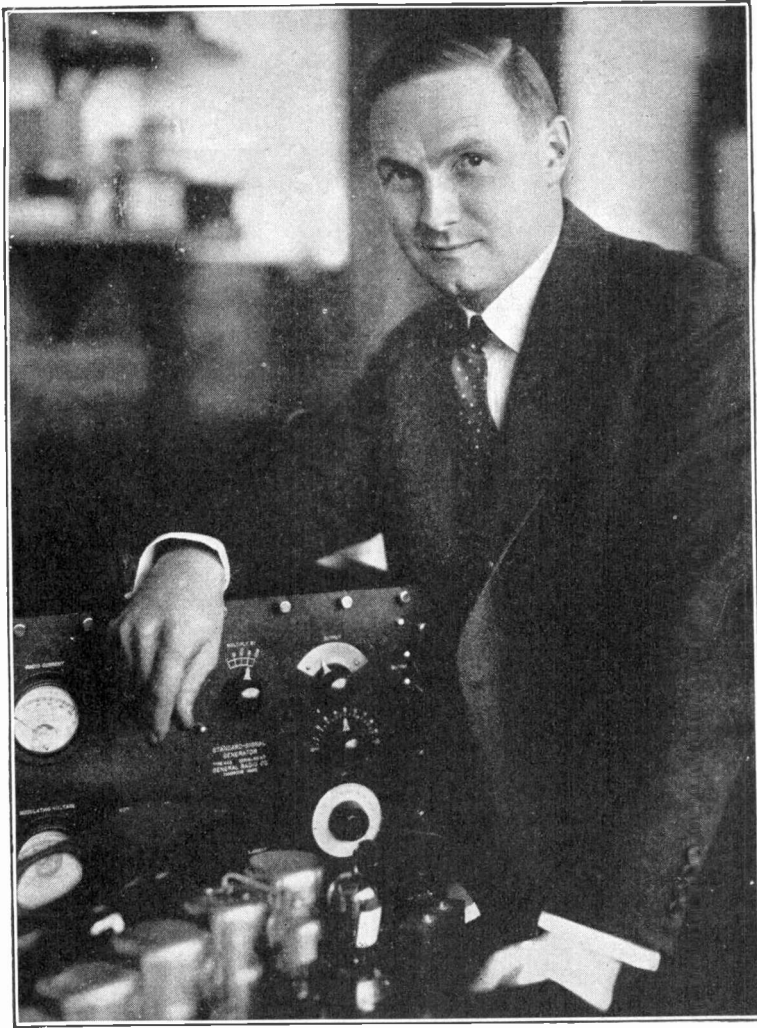

Alfred H. Grebe, President of A. H. Grebe & Company, has personally directed the work of his research laboratories in the design and development of the 1929 Grebe Radio

"We worked day and night to get this TONE"

In designing our 1929 set we wanted to take full advantage of the newest developments in tubes. But we wanted to go farther than that. We wanted the best radio and musical performance that it was possible to get. Our research staff has worked night and day to build into the new model a practical realization of this ideal. I believe they have succeeded.

ALFRED H. GREBE

This new 1929 Grebe might well carry a 1932 Serial Number...

You'll find in this 1929 Grebe a set that demonstrates as you have wanted to demonstrate since you sold your first radio. The generous volume capabilities of the screen-grid tube have been fully utilized. A special application of the "Band Pass Filter" and variable input coupling has been worked out to meet completely the long sought for ideal condition of equal sensitivity at both ends of the broadcast band. Every element harmonizes with every other element. The assembly is as finely balanced as the grouping of instruments in a symphony orchestra. You'll find some of the features of the new Grebe listed on the opposite page.

GET IT BETTER

How 4 Grebe officers feel about the new set



Douglas Rigney
Treasurer

Unless you worked with our Engineers from day to day you could form no adequate picture of the lengths to which these men went in order to reach their objective. Hear the set, and you will agree with us—they did it!



B. H. Baker
Sales Manager

This year, as in each of the twenty years of our history, we stick to limited production. Not everyone can own a Grebe, but each set carries with it the experience of years in the manufacture of *good* radio receivers.

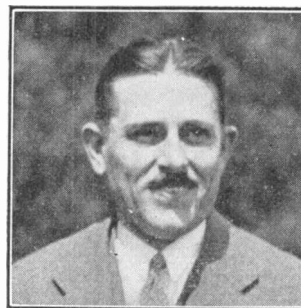

George Rhodes
Sales Promotion Manager

Dealers who are successful in getting the Grebe franchise this year will tune in on a program of sales promotion as carefully worked out as the set itself . . . a program designed specifically for this particular set.

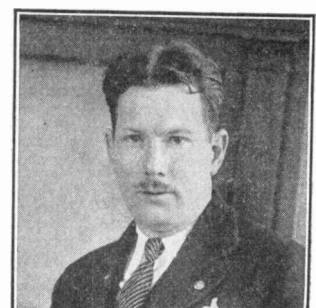

F. B. Ostman
In charge of Service and Research

Our service experience has been drawn upon at every step in the development of this new set. With our Service Department reporting to the Sales Manager we are certain of the sort of service Grebe dealers naturally expect.

Innovations you'll like in the new Grebe

Equalized Band Pass Filter—Gives remarkably sharp tuning, making crowded low-wave stations just as easy to separate as those in the higher waves.

Combined Screen-grid and Neutralized R. F. Stages—Used to utmost advantage, producing great sensitivity and volume with minimum antenna requirements.

Power Detector—Automatic variable bias ensures true fidelity on strongest signals.

Push-Pull Output Stage—Two of the new type 245 tubes used with a symmetrical high-quality input transformer.

Large Diameter Dynamic Speaker—Designed especially for and built as an integral part of the new receiver. Light weight. Large radiating surface . . . delivers great volume with full tone character.

Phonograph Pick-up with Independent Input Transformer—Adapted for high quality low impedance pick-up. Permits reproduction of records with a higher degree of tone fidelity and volume.

Cabinets—Designed by Recognized Authority—Grebe cabinets are available in several different designs, each type a representative piece of American Furniture.

Try the new Grebe yourself . . . at the R. M. A. Trade Show. Grebe headquarters at the R. M. A., June 3-7, will be Room 1505, Blackstone Hotel. Demonstrations will be handled in the Colonial Room, Blackstone Hotel. Exhibition Space: Booth 115, Stevens Hotel.

• • •

A. H. GREBE & COMPANY, INC.
Richmond Hill, N. Y.

Western Branch:
443 So. San Pedro Street
Los Angeles, Calif.

GREBE
SYNCHROPHASE
RADIO

WITH A GREBE

It's the *Local Strength* of National Advertising that *HELPS YOU*

NATIONAL advertising moves merchandise *into your store*. It is on the strength of national campaigns that you are most frequently induced to stock and display merchandise.



But only *the* circulation of that national advertising concentrated in your trading territory can help in moving that merchandise *out of your store*.



The American Weekly is the only publication that blankets nationally and dominates locally.

What is The American Weekly?

The American Weekly is the magazine distributed through seventeen great Hearst Sunday newspapers from seven-

teen principal American cities.* It concentrates and dominates in 485 of the Nation's 784 towns and cities of 10,000 population and over.



In each of 153 cities, it reaches one out of every two families.

In another 119 cities, it reaches from 40 to 50%.

In an additional 108 cities, it reaches from 30 to 40%.

In 105 more cities, it reaches from 20 to 30%.



And in thousands of other populous areas, almost 2,000,000 additional families buy and read The American Weekly —making a colossal national total circulation of 5,646,898, the greatest and the most responsive circulation of any publication in the world!

THE AMERICAN *Greatest Circulation in the World* AWEEKLY

Main Office: 9 East 40th Street, New York City

Branch Offices:

Wrigley Bldg., Chicago
5 Winthrop Square, Boston
753 Bonnie Brae, Los Angeles
222 Monadnock Bldg., San Francisco
1138 Hanna Bldg., Cleveland
101 Marietta St., Atlanta
12-231 General Motors Bldg., Detroit

*Albany
Atlanta
Baltimore
Boston
Chicago
Detroit
Los Angeles
Milwaukee
New York
Omaha
Pittsburgh
Rochester
San Antonio
San Francisco
Seattle
Syracuse
Washington

MAIL THIS COUPON

The American Weekly
9 East 40th Street
New York City

Please send me a copy of the American Weekly and a statement of its circulation in my trading territory.

Name.....

Address.....

Town.....State.....



now - the world has a finer radio tube

**THE NEW
IMPROVED
SONATRON
AC TUBES**

**SETTING
A NEW
STANDARD
FOR THE
INDUSTRY**

ENTHUSIASTIC comment on the new improved Sonatron tubes come from every part of the country! "... marvelous tone;" "... real distance;" "... clear, humless operation;" "... what volume!" And exhaustive tests indicate that the new Sonatrons will deliver *much longer life.*

Leading the new Sonatron line is Sonatron's marvelous instantaneous heating Y227AC detector. The X224AC and the X245 are two Sonatrons which will soon be national favorites. Types 226, 280, 281, 210, 250, 171A and 171AC have been redesigned—the perfected products of new methods and new machinery. Already broadcasting and magazine and newspaper advertising have made these new Sonatrons famous. *Write for the Sonatron proposition—it means more than ever!*

At the R.M.A. Show—Booth 91, Stevens Hotel

Every Sunday night, 8:30 to 9:00 P. M., E. S. T., Sonatron sends a program of unusual merit over the Columbia Broadcasting System from coast to coast—and hundreds of thousands listen!

SONATRON
**THE WORLD'S LARGEST RADIO
TUBE LINE**



Welcome



OF COURSE you are going to the R. M. A. Show! You want to see and examine the latest and finest equipment known to modern Radio science. This instantly brings to mind LASALLE High Vacuum Tubes and you will want to visit our demonstration room, 453, Stevens Hotel.

We extend to you, also, a most cordial invitation to visit our new factory.

Here, the precision processes necessary for high vacuum tube quality will amaze and interest you.

As a jobber or dealer of fine quality radio tubes it will pay you well to see LA SALLE tubes manufactured. We hope you will make use of this opportunity while in Chicago.

Every Radio Tube bearing the name, LA SALLE, is made, complete, in our own plant.

LASALLE RADIO CORPORATION

Division of Matchless Electric Co.

1500 North Ogden Ave., CHICAGO, ILL.

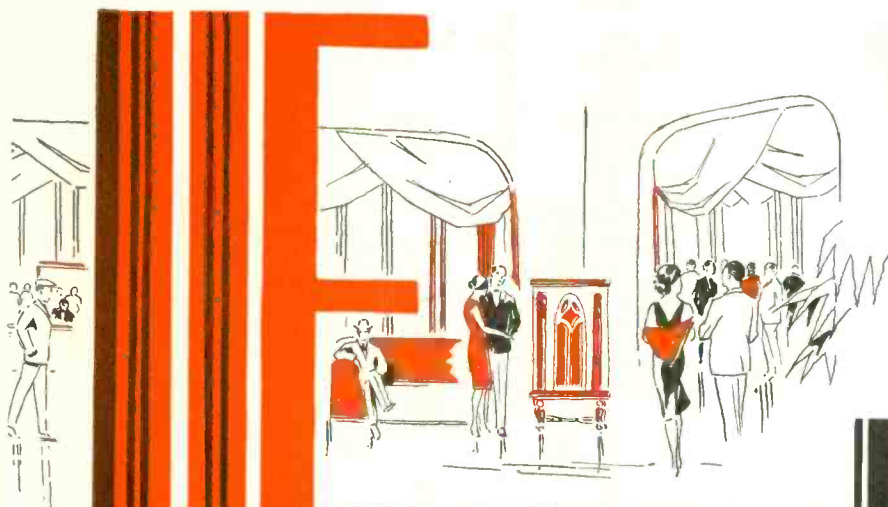

Everybody



La Salle

HIGH VACUUM

RADIO TUBES

SPEED

FOUNDED
1899
29 years
ago

Landay's Radio Fair

21 Stores
Largest
Radio Chain
in the East

Would you [?] like to see
the test that led us to
endorse

SPEED RADIO TUBES

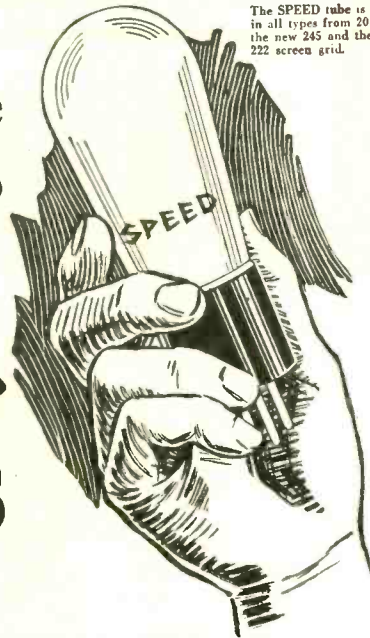

The SPEED tube is made in all types from 201A to the new 245 and the new 222 screen grid.

Come to
Landay's Radio Fair Today
and see a demonstration that will amaze you!

SPEED

These are triple tested first selection—our leader. Come in and see the most scientific testing of tubes you ever witnessed, showing why we selected the speed tube. These tubes will be sold by us at following prices regularly:

226	2.00	201A	\$1.40
227	3.00	171A	2.50
280	3.50	245	3.50
281	7.25	210A	8.00
224AC	4.00	250	10.50

Exhaustive tests warranted Landay Brothers' stamp of approval on the new SPEED Radio Tube. Tests, that included investigation of every single detail of tube construction and tube performance proved the SPEED Tube worthy of our O. K.

We selected this outstanding tube line because we found by test that SPEED Tubes will satisfy our customers—and that's what counts with us.

Scientific machines convinced us; your ears and purse will show you. Would you like to see just how we tested SPEED for tone, durability, and other tube essential characteristics? Then come in to our new Cortlandt Street Store on Saturday and see the factory test!

We will have our special laboratory testing apparatus set up and operating so that everyone can see for himself the reasons why we selected SPEED Tubes. In addition, the Chief Engineer of the SPEED Factory will be on hand to tell you about tubes, and to answer any question you may have on tubes and circuits. His valuable services are yours for the asking. Bring him your radio problem Saturday. Remember, Saturday is the day; SPEED is the Tube at LANDAY'S RADIO FAIR

Reprinted from the New York Sun of April 27th

Ok-Landay

SPEED

RADIO TUBES

TESTED and APPROVED by Landay Brothers

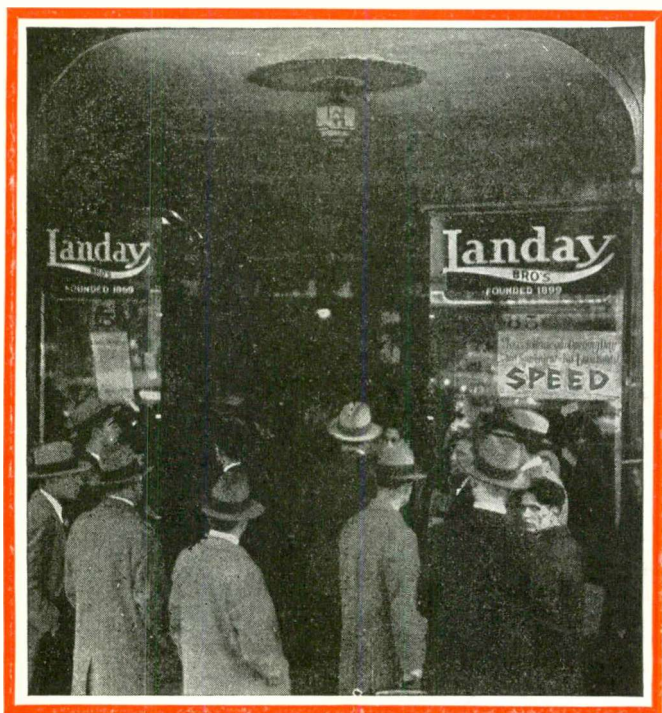

AND BY THE
METROPOLITAN
PUBLIC

Thousands of radio fans saw
SPEED RADIO TUBES
tested before their eyes

LANDAY BROTHERS, one of the largest radio outlets in the East, tested **SPEED** Tubes, found they were everything we said they were, and then some, and put their o. k. on the **SPEED** Tube Line.

Then Landay showed New York why they chose **SPEED**. All day Saturday,

April 27th, thousands of radio users milled into Landay's to see the laboratory tests on **SPEED** Tubes. "How did it go?" we asked Landay. "It was a great **SPEED** day," they said. (and it certainly looked like it from the sales figures they showed).

But we expected **SPEED'S** success. Every place **SPEED** has gone, it has gone over with a resounding bang. Why not, when the line is right — right in price, right in quality, right all the way through. There's a **SPEED** Tube for every radio and every radio need.

SPEED — short, snappy, easy to remember. A far-flung advertising campaign — Saturday Evening Post, newspapers and fan magazines — will engrave it in every mind — make **SPEED** just another word for Tube. Now's the time to check into the best money-making tube proposition in the field.

SPEED
CABLE RADIO TUBE CORPORATION

(Formerly Cable Supply Co.)

84-90 N. Ninth St., Brooklyn, N. Y.

MAKERS OF RADIO TUBES SINCE 1924



Majestic in the Magazines



The Majestic Plan makes it possible for a Majestic Dealer to dispose of his installment paper at the lowest discount rates prevailing, to maintain his business on a cash basis and greatly increase his sales volume.

An important factor in the \$4,750,000 advertising campaign for Majestic Radio this year is the schedule for National Magazines. Full page ads in The Saturday Evening Post, Collier's, Liberty . . . every month in Cosmopolitan . . . back covers on Life . . . full pages in Pictorial Review and Woman's Home Companion. A total circulation of 14,000,000 to class . . . mass . . . men . . . women . . . going into every community in the country!

The Majestic program includes 1,000 newspapers, 10,000 billboards, car cards, sales promotion helps and the weekly Theatre of the Air over 47 stations. Majestic dealers will have a big year in 1929.

GRIGSBY-GRUNOW COMPANY, CHICAGO, ILL.

Majestic

ELECTRIC-RADIO



The AUDAk *Electro-Chromatic* PICK-UP

The clearest, purest, most life-like speech or music is that which comes direct from human throat or actual instrument. The nearest approach to this perfection in reproduced sound is made possible by AUDAk Chromatic Pick-up . . . for a very simple and very powerful reason. Due to its highly sensitive construction, this carefully adjusted instrument can catch the shadowy color-tones and hair-line values which go to make a piece of music

REAL. Where another pick-up, even a fairly good one, mind you, would slur the fine chromatic changes that form the main charm of any composition, AUDAk Chromatic Pick-up, "gets" EVERYTHING. That is how this truly remarkable mechanism differs from the rest . . . winning the frank acclaim of all who listen to it, by reproducing NATURALLY.

The AUDAk COMPANY, 565 Fifth Avenue, New York

"Creators of High Grade Electrical and Acoustical Apparatus Since 1915"

Look alive, mate!

Here's the Fleet of

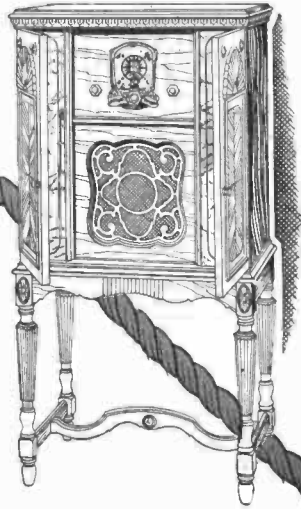

MODEL AC—9990
List Price, \$188

A highboy console of faintly modernistic design with doors of four-way matched Oriental walnut. Equipped with Jensen D.C. dynamic speaker.

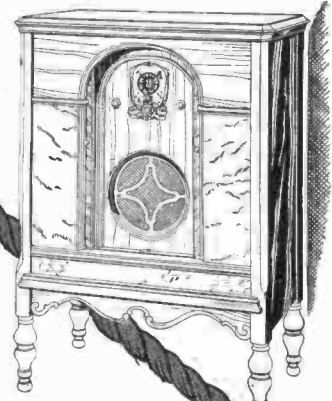

MODEL AC—9970
List Price, \$165

A lowboy console, distinguished by its massive design and striking line treatment. Equipped with Jensen D.C. dynamic speaker.

OTHER MODELS, NOT ILLUSTRATED

MODEL AC—99100
List Price, \$234

"Navigator" radio receiver, combined with a high-class motor-driven phonograph, and installed in a highly polished burl walnut console with Jensen D.C. dynamic speaker. Impressive, but in no way cumbersome.

MODEL AC—9980
List Price, \$185

A radically individualized lowboy console of Moorish design. Those desiring something off the beaten path will be especially pleased with its different treatment of the speaker grill. Jensen D.C. dynamic speaker.

Table models, including those battery-operated, are described under Model AC-98, illustrated on the facing page.

Holgers
A-C DAYTON

...Your ship is in!

Winners You've Been Waiting For

YOU know better than anyone else that, from the viewpoint of engineering and results, "all radios are good radios today." The public has ears, and it is using them. Mechanically inferior sets just won't sell!

That's why A-C Dayton says to you—"Your ship is in!"... your ship of sales opportunity, of money profits, of greater prosperity. For Dayton offers, in its new "Navigator" line, a receiver which not only pleases people's ears and charms their eyes, but also *catches their imaginations*.

Illustrated on these pages are four of the seven "Navigator" models. Here are no mere pieces of furniture—no mere mechanical playthings. Each "Navigator" . . . be it the sumptuous Radio-Phonograph combination at \$234, or the modest

battery Table Model at \$69, is a gallant sea-rover's treasure chest . . . with a mariner's compass for an escutcheon plate, and a ship's wheel for a station control. You have radio *plus romance* to sell!

Consoles are the finest work of Globe-Wernicke, Cincinnati; and are equipped with the Jensen dynamic speaker. The chassis is the same in all electric models: nine tubes, including rectifier and two of the giant new 245's; push-pull amplification; and the new Selectaphase system of complete tuning under the Technidyne circuit. Inside and out, a quality job!

"Navigator" advertising and sales helps are as individual and arresting as the receiver itself. It's going to be easier to sell *with* Dolly Dayton this year than *against* her. For full details of our liberal dealer proposition, write the A-C Dayton Company, Dept. 3, Dayton, Ohio, *today*. Look alive, mate! Your ship is in!

Prices quoted are without tubes

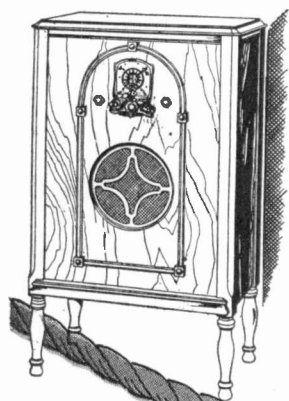

MODEL AC—9960
List Price, \$148.50

A compact walnut lowboy console finished richly in a dull lustre. Equipped with Jensen D.C. dynamic speaker.

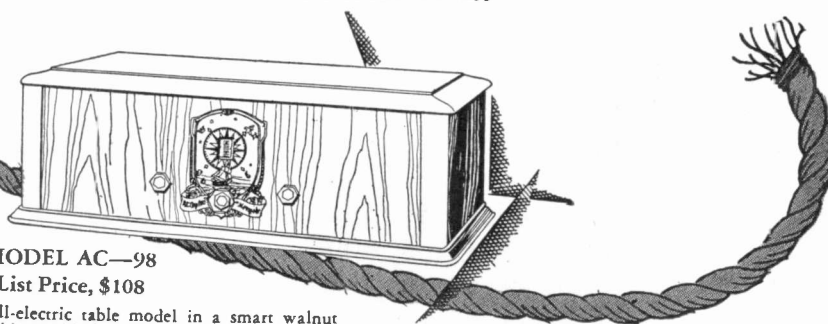

MODEL AC—98
List Price, \$108

All-electric table model in a smart walnut cabinet with four-way matched burl walnut lid. Same model in slightly smaller walnut finish cabinet, list price, \$98. Corresponding battery models, list prices, \$79 and \$69.

“FOR THE MAN WHO BELIEVES HIS OWN EARS”
NAVIGATOR”

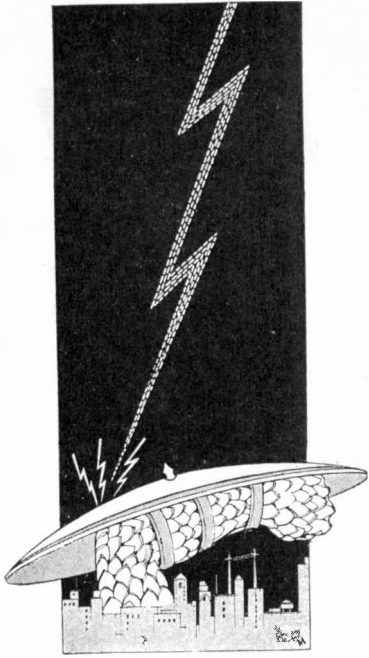

ALUMINUM FOR RADIO

means
manufacturing economy
better reception
greater selectivity...

IT is now a matter of proven record that Aluminum's workability, lightness, resistance to corrosion and high electrical conductivity make it the one metal that most efficiently meets the differing conditions encountered in radio design.

Used as shielding Aluminum reduces interference. It eliminates electrostatic and electro-magnetic interaction between the various stages of radio-frequency amplification. It eliminates modulation of radio frequency stages by feed back from audio-frequency amplifier. It is so easily worked into cans, boxes or casings that it presents few limitations of sizes and shapes, and makes possible more compact designs.

Used as variable condenser blades, Aluminum is available in special sheets of an accuracy and uniformity beyond anything previously developed for that purpose. Gauge tolerance in thickness is limited to $\pm .001$

inch, with a total variation within one sheet never exceeding .0005 inch.

For fixed condensers Aluminum Foil is ideal, because of its high electrical conductivity and its great covering area. A pound of Aluminum Foil .0003 in thickness covers 34,000 square inches.

And Aluminum Die Castings combine lightness, strength and accuracy. They are used with great success for loud speaker frames and bases, condensers and condenser frames, drum dials, chassis and cabinets.

We solicit inquiries for Aluminum foil, sheet, wire, rod, tubing, stamping, die castings, sand castings, extruded shapes, screw machine products, wood grain panels, strong Aluminum alloys and magnesium products.

Aluminum Company of America
 2462 Oliver Building Pittsburgh, Pa.
 Offices in 19 Principal American Cities

ALUMINUM

The mark of Quality in Radio

COLIN B. KENNEDY CORPORATION



SOUTH BEND
INDIANA

YOUR PERSONAL
INVITATION

This is your personal invitation to visit
the first formal showing of the new Kennedy Line at

BOOTH No. 11

CONGRESS HOTEL

R. M. A. CONVENTION

Not only does "The Royalty of Radio" signify the par excellence always associated with Kennedy--but it typifies the royal scale of Kennedy's tremendous expansion in carrying this famous radio name to still greater heights of achievement. A huge, modern plant--a most stable financial structure--the backing of such nationally recognized business leaders as F. H. Wellington, Colin E. Kennedy, Col. George M. Studebaker, Clement Studebaker III--a product with Royalty engineered and built into it--these are just a few of the highlights which indicate the extent to which "The Royalty of Radio" idea has penetrated the entire Kennedy organization.

Full details at Booth No. 11, Congress Hotel. See you there!

KENNEDY

*A*n unusually forceful and extensive merchandising campaign will place Kennedy Radio uppermost in the public mind . . . It stands apart — its individuality and strength will create that “pride of ownership” appeal always linked with “Radio by Kennedy”.

Prices for all models are under \$200

*Left—Royal Model 310
Right—Royal Model 210*

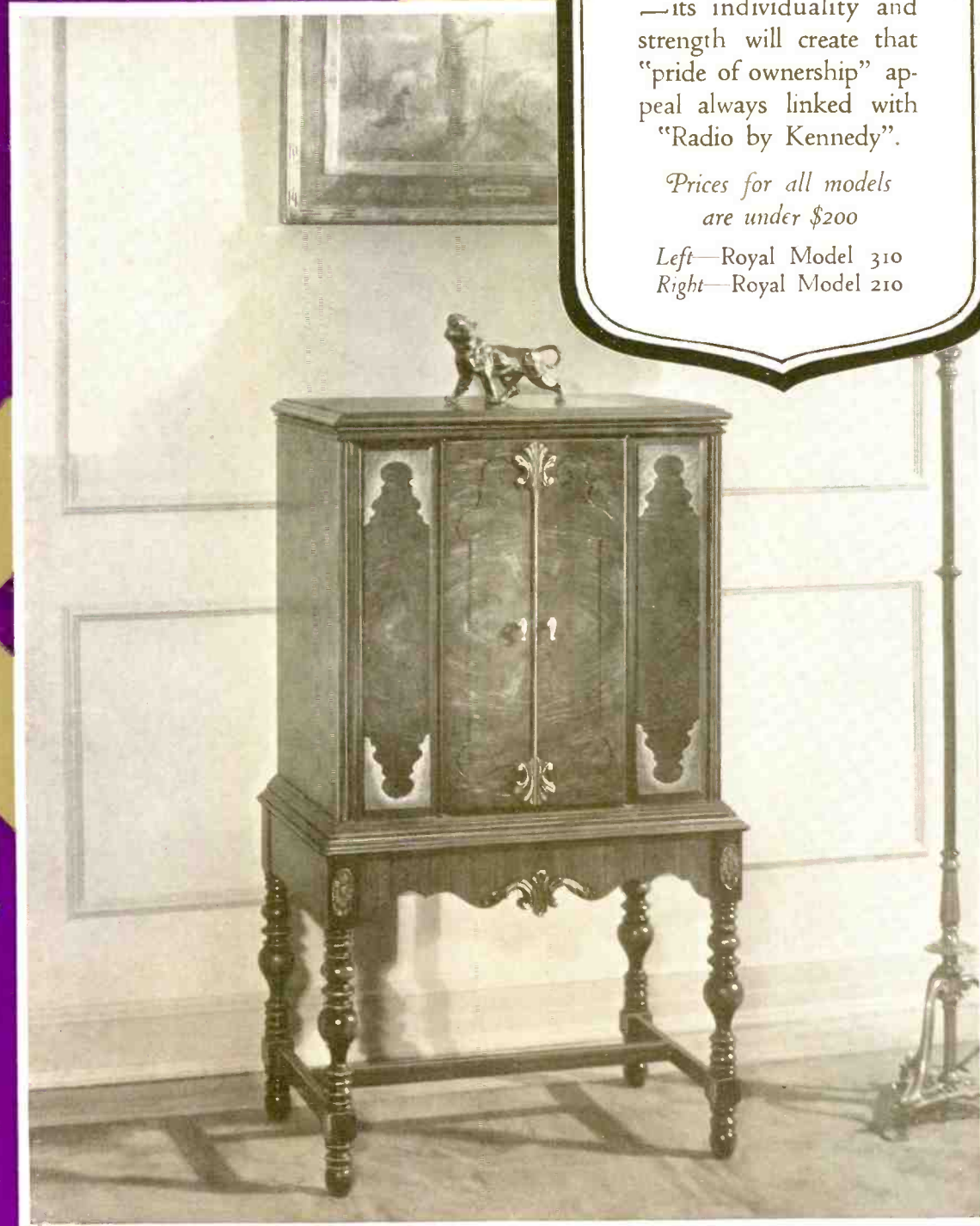

Colin B. Kennedy Corporation
South Bend, Indiana

The Royalty of **RADIO**

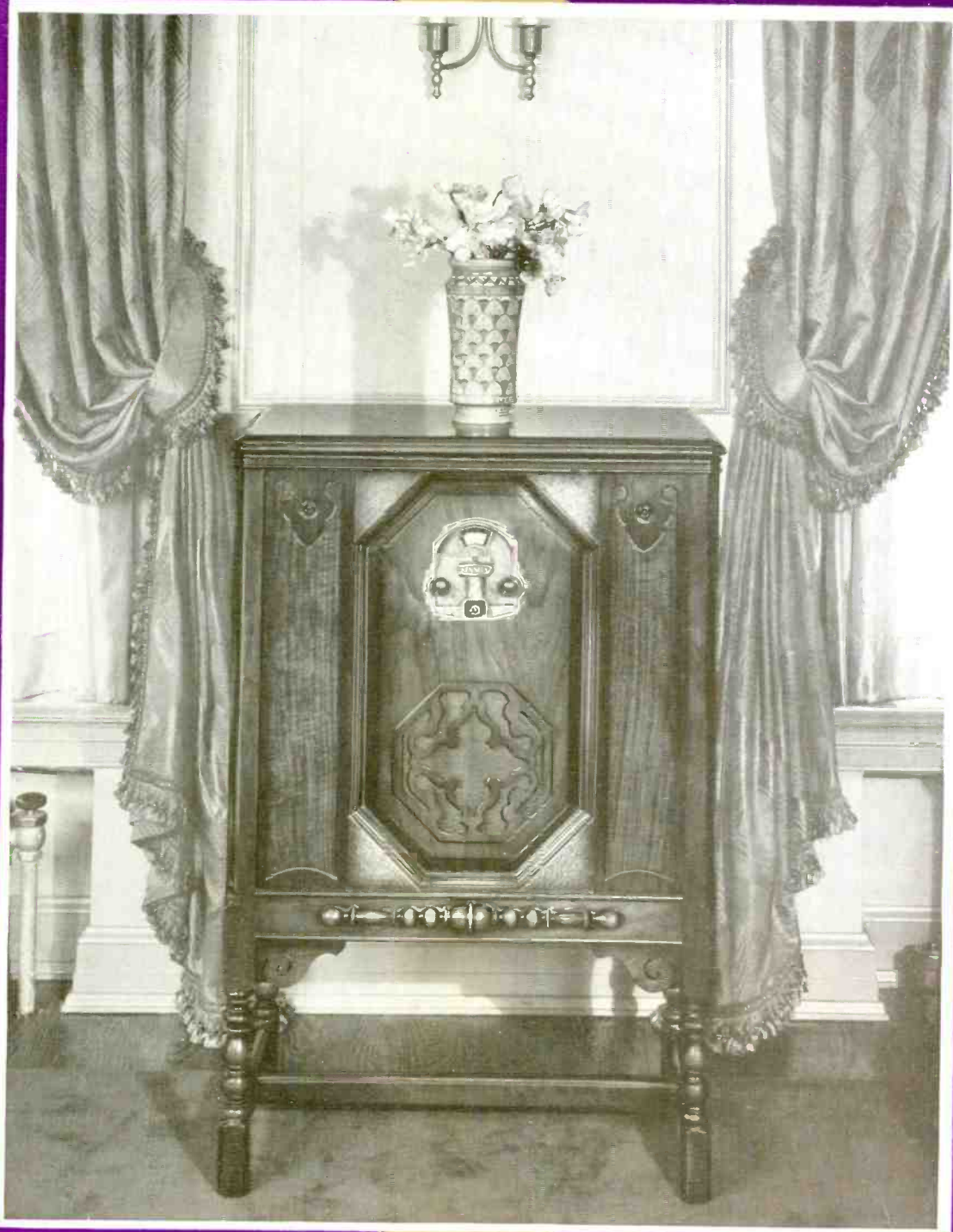

R. M. A. Convention - June 3-7
Booth No. 11 - Congress Hotel

KENNEDY



THE Kennedy Protective Franchise is still in full force. Originated by Kennedy — proved by years of success—it takes on added strength when viewed against the solid background of Kennedy's Greater Achievement.

Hundreds of franchise applications received definitely confirm this fact.

The Royalty of Radio

ATWATER KENT RADIO

THREE

MORE PROOFS OF
ATWATER KENT
LEADERSHIP

1



2



3



ATWATER KENT RADIO

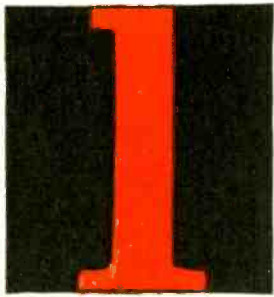

LEADS WITH PERFECTED SCREEN-GRID RADIO

ALWAYS first with *proved* improvements, Atwater Kent has produced another acknowledged winner in the perfected Atwater Kent Screen-Grid Radio... A winner that satisfies people everywhere with its absolute rightness—its new power, sensitivity,

range, needle-point selectivity, glorious Electro-Dynamic tone and quiet operation—its sturdiness and its Atwater Kent dependability—a winner that brings more good will, more sales, more profits to merchants who feature Atwater Kent Radio.

THE TABLE MODEL

Model 55—Screen-Grid receiver, \$88

Model F-4—Electro-Dynamic table speaker, \$34



ATWATER KENT RADIO



LEADS WITH VARIETY OF CABINETS

BUILT BY AMERICA'S FINEST DESIGNERS FOR THE NEW
ATWATER KENT SCREEN-GRID RADIO

THE foremost furniture manufacturers in the country are building cabinets for the new Screen-Grid Radio . . . that's another big step forward! Here are cabinets to suit any taste, any pocketbook. If customers want compactness . . . you have it for them. If they want a bit of

elaboration in a period reproduction . . . you have it for them. Atwater Kent Radio to blend with appointments of any room . . . you can supply it. The new cabinet plan gives Atwater Kent merchants a wide-open field for more business.

HOW EASY! Placing an Atwater Kent Electro-Dynamic Speaker in a cabinet is as simple as hanging up your coat.

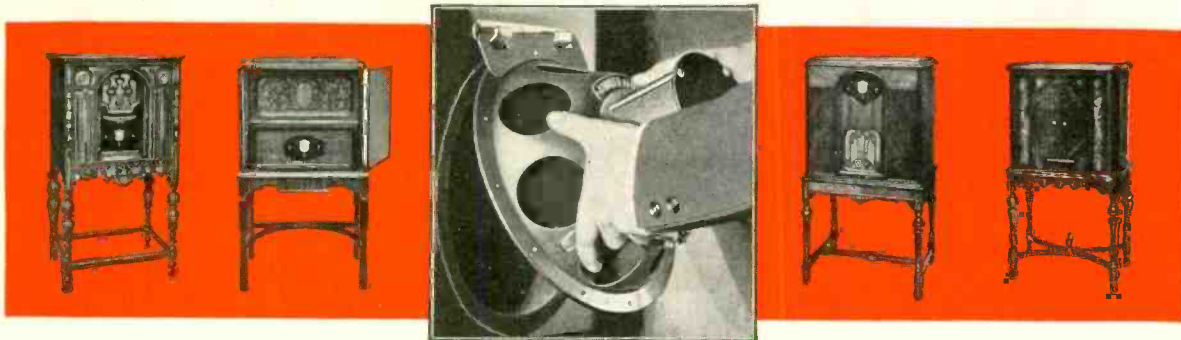

ATWATER KENT RADIO

3

LEADS IN MANUFACTURING RESOURCES

WORLD'S LARGEST RADIO FACTORY NOW DOUBLED

WAS 15 acres, now *doubled* to 32 to meet the ever-growing demand for Atwater Kent Radio! Covers more space than 28 football fields, than 17 Madison Square Gardens, than nine Capitols at Washington... Built solely for radio.

Equipped with every conceivable modern device for making Atwater Kent Screen-Grid Radio—with one out of every eight workers an inspector or tester . . . *Speed*

without hurry . . . Not only more, but still better, Atwater Kent Radio—the world's most popular radio, the dealers' greatest profit-maker.



ATWATER KENT MANUFACTURING CO. A. ATWATER KENT, PRES. 4733 WISSAHICKON AVE., PHILADELPHIA, PA.

BOOTH 75 ROOMS 1605A-1606A STEVENS HOTEL

Knoxville Radio Cabinets for **ATWATER KENT** **RADIO**



No. 3067

*Designed with care for
the Living Room*

GEO. F. CLINGMAN, JR.
Designer



No. 3046

We are featuring period designs that have the appeal of beauty combined with moderate price so necessary to a profitable sale.

KNOXVILLE TABLE & CHAIR CO. KNOXVILLE, TENN.

ATWATER KENT
Radio Dealers

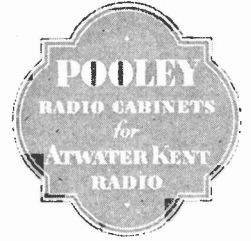

have done well with
POOLEY Cabinets

600,000
POOLEY Cabinets
now in use

make warm friends
for Atwater Kent
Radio Dealers

New Pooley models
up to the minute
for 1929-1930

have quality—looks
—price that drive
the urge to possess

The models are right
The prices are right

THE POOLEY COMPANY
1600 Indiana Avenue Philadelphia, U. S. A.

*Canadian Pooley Radio Cabinets are manufactured by
Malcolm & Hill, Ltd., Kitchener, Canada*



See them . !

POOLEY

**THE UNIVERSALLY ACCEPTED FURNITURE
FOR ALL ATWATER KENT RADIO**

*At the RMA show in Chicago,
visit the Pooley Display, Booth 8,
and demonstration room, Suite F
22, 24, 26, 28 Congress Hotel.*

How to turn more **A·K** prospects into buyers

The fact that you sell Atwater Kent is your assurance that a large percentage of radio prospects in your community will see your line before making final decisions . . . *How can you convert the largest number of these prospects into buyers?*

The new Atwater Kent Cabinet by ADLER-ROYAL has been produced with the full knowledge that *cabinets* influence mightily the decision to buy or not to buy . . . Its design and construction were approved only after careful investigations to determine the line of least resistance to easy, satisfactory sales . . . As a result, we conscientiously believe that this new cabinet stands unique in obvious sales appeals . . . Place the ADLER-ROYAL beside any cabinet in the same price class, and let your customer decide . . . *That's all we ask.*



Richly resonant, vibrationless, acoustically correct; graining soft and colorful as moire; finished with the typical thoroughness of ADLER-ROYAL.

Send for complete information. Better yet, see this new cabinet at the R. M. A. Trade Show, Space 5, Ball Room, Blackstone Hotel.

ADLER MANUFACTURING CO.
Incorporated
LOUISVILLE, KENTUCKY

ADLER-ROYAL
RADIO CABINETS

EBERT



OF RED LION, PA



MODEL 77

Height, 43". Width, 28". Depth, 15½". Five-ply veneers throughout. Top and sides of straight walnut. Front is laid with plain American Walnut, Burl Walnut, and genuine Bird's Eye Maple

\$33²⁵ List



MODEL 81

Height, 52". Width, 27". Depth, 17". Five-ply veneers throughout. Sliding doors Oriental walnut face veneer. Cabinet front is covered with plain American and Burl Walnut, decorated with a beautiful design Lignite carving. Set and speaker panel faced with plain American walnut veneer.

\$46²⁵ List

RADIO CABINETS

exclusively manufactured to meet the exacting requirements of the

ATWATER KENT MANUFACTURING COMPANY

Designed and built by a quality cabinet making organization of 75 years' experience.

The **EBERT** line offers

1. A quality product throughout.
2. A graduated price range to suit every requirement.
3. An established and *maintained* selling and merchandising policy.
4. A fine spirit of co-operation.
5. Recommended Ebert cabinets sold to Atwater Kent distributors exclusively.
6. No entangling contracts, assuring deliveries when and as promised.

EBERT FURNITURE CO. of Red Lion, Pa. *Established 1854*

A. Irving Witz

Martin J. Polikoff

National Sales Agents

611 Widener Bldg., Phila.

225 W. 34th St., N. Y. C.

See our complete line at the RMA Show. Exhibition Hall Space No. 3, Stevens Hotel, and Demonstration Room, 524-A Stevens Hotel

Cabinets with Personality *for* Atwater Kent Radio

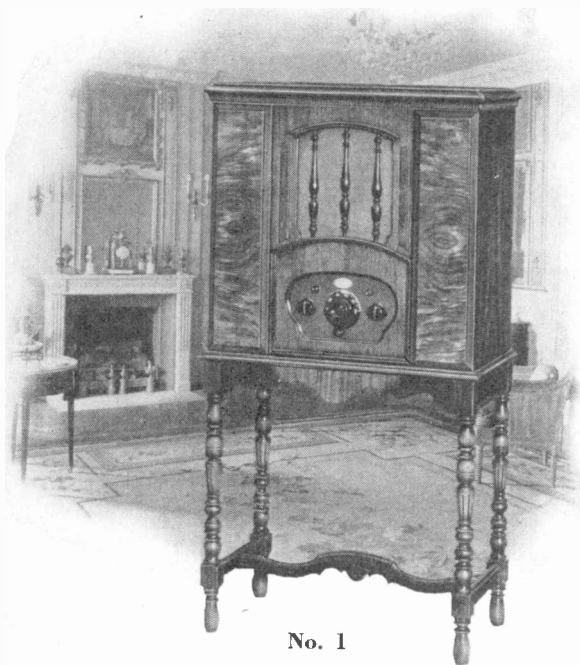

No. 1

Atwater Kent Cabinet No. 1 by Caswell-Runyan.

Height, $47\frac{1}{4}$ inches; width, $24\frac{3}{4}$ inches; depth, $13\frac{1}{4}$ inches. Top ends, and instrument panel of five-ply striped walnut; front side pilasters of five-ply butt walnut.

Height, $47\frac{3}{4}$ inches; width, $26\frac{1}{4}$ inches; depth, $15\frac{3}{4}$ inches. Top, ends, and instrument panel of five-ply striped walnut, rounded corner post of solid walnut, doors of five-ply butt walnut, with diamond matched Oriental walnut overlays on side pilaster.

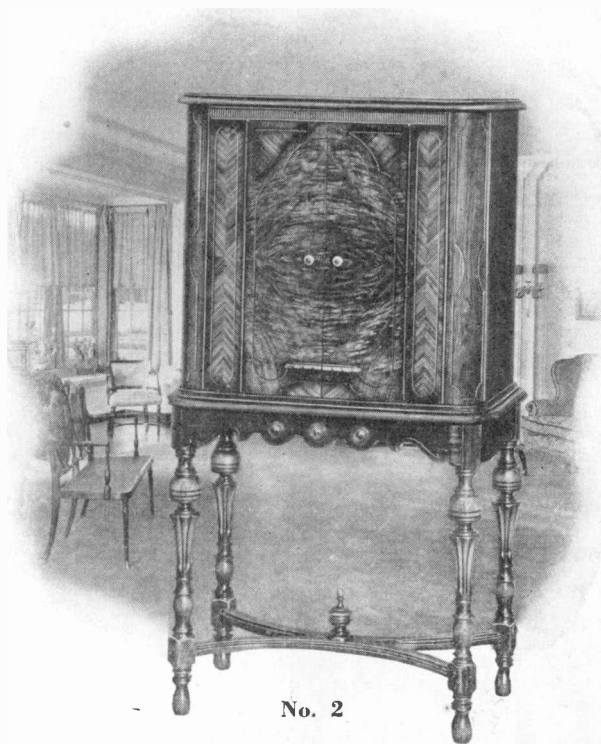

No. 2

Quality Workmanship

Period Styles

Beautiful Eye Value

Sure Sellers

Atwater Kent Jobbers Will Give You Full Details

THE CASWELL-RUNYAN CO.

HUNTINGTON, IND.

SEE RADIO'S TOMORROW Chicago Trade Show - June 3-8

Tomorrow — next winter — what are you going to sell? How are you going to sell it?

What have manufacturers to offer you for the 1929-1930 season?

What trend will radio take? What are the developments in sets, cabinets and accessories?

You want to know the answers to these questions—they are vital to your business.

As far as manufacturers can, they will answer them for you at the Radio Trade Show, Chicago, the week of June 3.



CABINET BY
Radio Master
BAY CITY, MICH

Radio Master

THE SETTING BEAUTIFUL

RADIO MASTER ANSWERS THE CABINET QUESTION-

**Space 22, Gold Room
Also Suites 6 And 8...
Congress Hotel.....**



IF you delight in beautiful things—if splendid design; rare, colorful, lovely woods; master craftsmanship; satiny finish, appeal to you—if you like to turn good profits and make satisfied customers—

You won't want to miss the Radio Master Display at the Trade Show, Chicago, week of June 3, space 22, Gold Room, Congress Hotel, also suites 6 and 8, The Congress.

Radio Master Corp. has achieved a position high among the leading cabinet builders. Radio Master will show their answer to the cabinet question for 1929-1930.

The seven cabinets illustrated here, plus cabinets for every type of set, and every purse, will be found in our Trade Show Exhibit.

RADIO MASTER CORPORATION, Bay City, Mich.

Cabinets

FOR ANY RADIO

AUTHORIZED CABINET MAKERS FOR ALL ATWATER KENT SETS

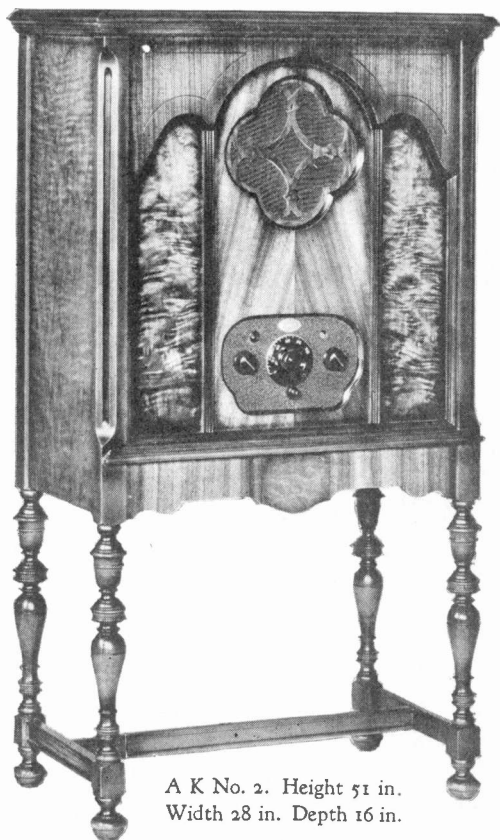

A K No. 2. Height 51 in.
Width 28 in. Depth 16 in.

THE
RARE BEAUTY
OF CHOICEST WOODS
PLUS THE PERFORMANCE
OF THE ATWATER KENT SETS

An invincible sales combination

Atwater Kent executives realize that beautiful cabinet work is a trade, requiring long years of specialization. They have therefore specified the Union Furniture Co.,—fine furniture builders for many decades—as an authorized source of supply for Atwater Kent sets. There are many fine furniture builders—but not so many who can supply the great volume required for the sets sold by Atwater Kent dealers—at a price in keeping with the A K low prices.

We are fortunate in our ability to supply



Atwater Kent dealers with rich, correct cabinets—each a work of art. These cabinets are recommended by The Atwater Kent Company. The prices are right for quick turnover. The profit is unusually substantial.

Sell prospects twice! Sell them Atwater Kent sets—sell them Union Cabinets. The two together spell the finest in popular priced radio.

The Union line now comprises five fine cabinets including both lowboys and highboys.

Union Furniture Company
Jamestown, N. Y.

Matching Set Value ...with Cabinet Value!

New 1929-30 R.C.M. Cabinets give new No. 55-C Atwater Kent sets added selling value



SO fine a set as the new No. 55-C Atwater Kent deserves a cabinet that is fine in proportion with its outstanding qualities. To make the R. C. M. cabinet to match the quality of the set . . . we present Cabinets Nos. 270, 260 and 280.

Cabinet No. 270 "Louvre" pictured here is the work of master designers, master cabinet makers and expert engineers. It is built especially for Atwater Kent No. 55-C and has been engineered to meet the requirements of the new set. Genuine quality throughout . . . you can see it yourself in any original model. Sturdy, beautiful and popular priced . . . only \$39.75 list. Model No. 260 "L'Academie" matches No. 270 in every respect except that the panel is open—no sliding doors. The price of No. 260 is \$34.75 list. Model No. 280 "Da Vinci" is priced at \$29.75 list.

Order from your jobber, or write us for information.

Hidden Qualities

The Cabinets speak for themselves on the outside. They have real "EYE VALUE"! Here are some features of the unseen parts . . . hidden qualities. Dust-proof bottoms; two coats of stain inside; rigidly inspected; baffle board of 5-ply gum 13/16 in. thick runs full length of cabinet and is securely bolted in corner posts; all sets equipped with metal hanger for Speaker No. F4C and felt ring; instrument board and speaker grill are in one piece to eliminate vibration and rattle.



Composite view of our 5 big plants with a total output of 2,500 radio cabinets daily.



"Louvre" Model 270

TOP 15 x 28 in., height 47 in., leg 3 in. Top 5-ply walnut face, 3/4-in. ends. Veneered 5-ply walnut face with figured maple scroll overlay. Grill 5-ply stripe walnut face 2 part match laid on 45 degree angle. Two noiseless sliding doors veneered 5-ply 4 part match burl walnut face; top and bottom metal runners. Solid parts gumwood. Base rail carved. Fancy striped overlay of Zebra wood on front frame. Embossed moulding on top front rail. Fancy shaped bottom stretchers. Front and back legs turned. Metal floor glides. 5-ply chassis shelf, 5-ply baffle board, ply-wood bottom. Approximate shipping weight 85 pounds. Shelves 5-ply gum 13/16 in. thick, securely mortised, glued into side panels of cabinet.

*Prices slightly higher west of the Rockies.

All prices f.o.b. factory, Evansville, Ind.



\$ 39⁷⁵
List *

"Da Vinci" Model 280

Top 15 1/2 x 27 in., height 44 in., legs 1 5/8 in. Top 5-ply walnut face; ends 3-ply spliced walnut face; front side panels 3-ply sliced walnut face; grill 5-ply striped African walnut, two part matched laid on 45 degree angle; burl walnut overlays on top panels and bottom rails; attractive fancy turned ornaments on each front rail panel; shaped bottom stretchers; solid parts gumwood; front and back legs turned; metal floor glides; 5-ply chassis shelf; 5-ply baffle board; plywood bottoms.

Approximate shipping weight 64 pounds.

Four-coat lacquered finish, hand-rubbed.

"L'Academie" Model 260

Same as Model No. 270 except open panel. No sliding doors.

RADIO **C**ABINET **M**ANUFACTURING **C**ORPORATION
666 Lake Shore Drive Chicago, Illinois

The home of good and now Radios

The
**NEXT MARKET
AND STYLE SHOW**

**JULY
8 to 20**

Now **in the American
Furniture Mart**

RADIO MANUFACTURERS

Atwater Kent Mfg. Co. Kellogg Switchboard &
Broadcaster Corp. Supply Co.
Buckingham Radio Corp. Stewart-Warner Co.
Grigsby-Grunow Co.

RADIO FURNITURE

Alonzi Furn. Co. Geo. L. Lamb
Acme Co. Logan Furn. Co.
Amer. Furn. Nov. Co. Logan Mfg. Co.
Albert Furn. Co. Madewell Chair Co.
Athens Table & Mfg. Co. Meinecke Mfg. Co.
Art Specialty Co. Metal Stampings Corp.
Bemis Mfg. Co. Meyer & Danziger, Inc.
Beneke Mfg. Co. Mutual Furn. Mfg. Co.
The Booth Co. North Vernon Lumber Mills
Caswell Runyan Co. North-Western Cabinet Co.
Charlotte Chair Co. Park Furn. Co.
Chicago Hardware Foundry The Phoenix Co.
Co. Peterson Art Furn. Co.
Chittenden & Eastman Co. Player-Tone Talking
Drake Mfg. Co. Machine Co.
Cochran Chair Co. Pioneer Furn. Co.
N. S. Dalsimer & Co. The F. T. Plimpton Co.
Diversey Foundry Co. Richmond Furn. Mfg. Co.
Edison Wood Products, Inc. Rockford Standard Furn. Co.
The Empire, Ltd. Milano Furn. Co.
Empire Furn. Co. Mutual-Sunset Lamp Mfg.
Excel Mfg. Co. Co.
Ferguson Brothers Mfg. Co. Platt-Rubin Co.
Frank & Son, Inc. A. Robineau Furn. Co.
Martin M. Fleishman Percy M. Rose
The Friedlaender Co. St. Johns Table Co.
J. D. Freese & Sons Co. Selrite Products Co., Inc.
D. H. Fritts & Co. Seville Studios, Inc.
The Goldmack Furn. Co. Sheets Mfg. Co.
Bert H. Guterman Sherrard Furn. Co.
Hannahe Mfg. Co. Showers Brothers Co.
The A. G. Harden Sales Co. Steinfield, Inc.
Heywood-Wakefield Co. Sun-Glow Mfg. Co.
Indiana Furn. Mfg. Co. Tyndale & Peters, Inc.
Kaplan, Inc. The Udell Works
Frank M. Katz Co., Inc. U. S. Wicker Furn. Co.
Geo. C. Kindt & Co. Inc. Virginia Table Co.
Kingsley Furn. Co. Wausau Novelty Co.
C. A. Kitz Furn. Mfg. Co. West End Furn. Co.
Klamer Furn. Corp. Western Picture Frame Co.
Knoxville Table & Chair Co. Yeager Furn. Co.
Krebs, Stengel & Co.

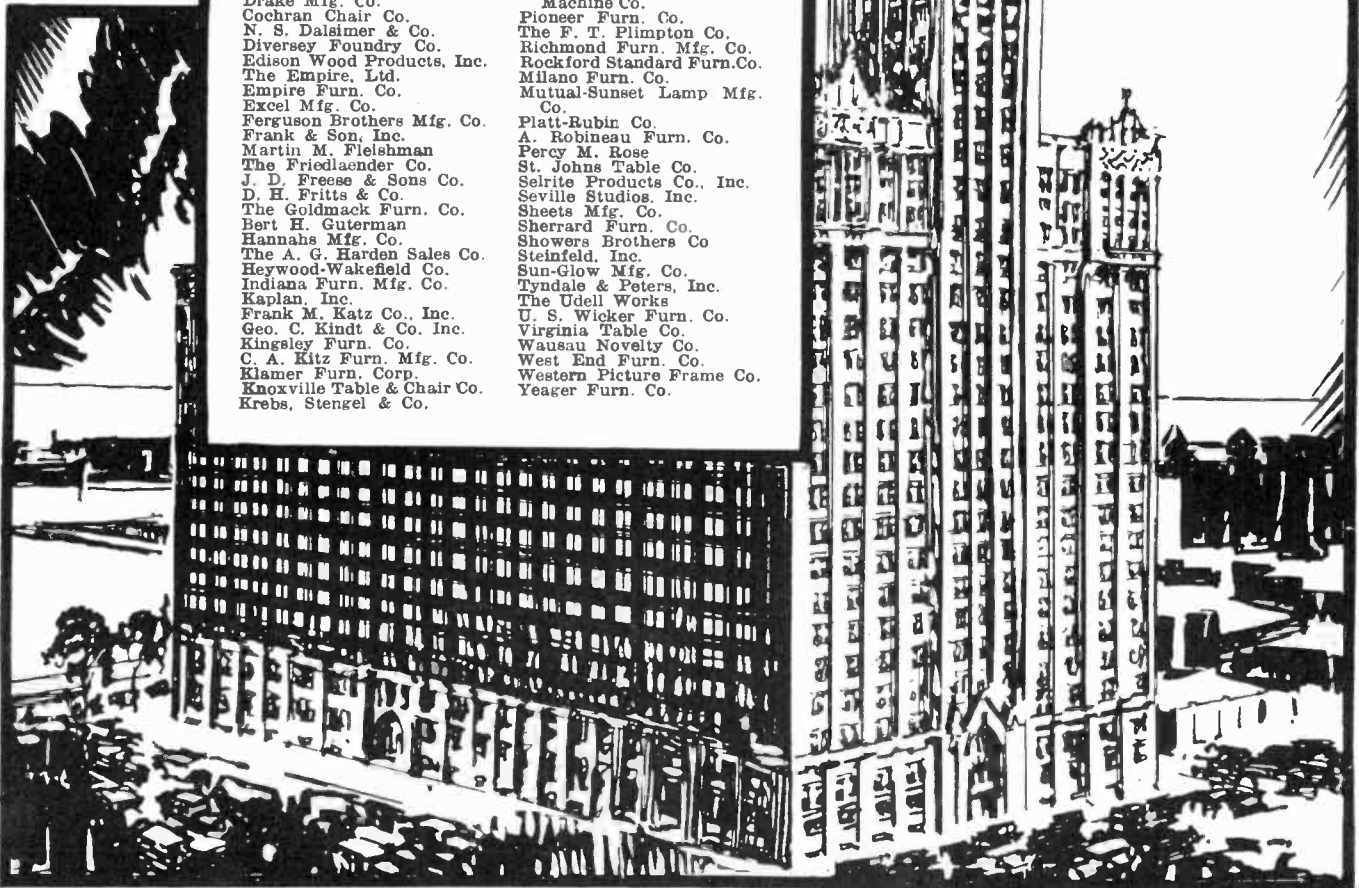

*Furniture
are good*

Furniture

Today no home is complete without one good Radio . . . But that Radio must be beautiful if it is to satisfy modern artistry in home decoration . . . Every homelover has a decorative plan and all things about the home must harmonize with it . . . Being furniture—and necessarily attractive furniture—the greatest means of retail distribution for Radios is through the well-financed, well-located and merchandising-trained furniture retailers . . . The American Furniture Mart is the buying headquarters for furniture merchants of the nation, and therefore becomes at once the logical merchandising headquarters for Radios.

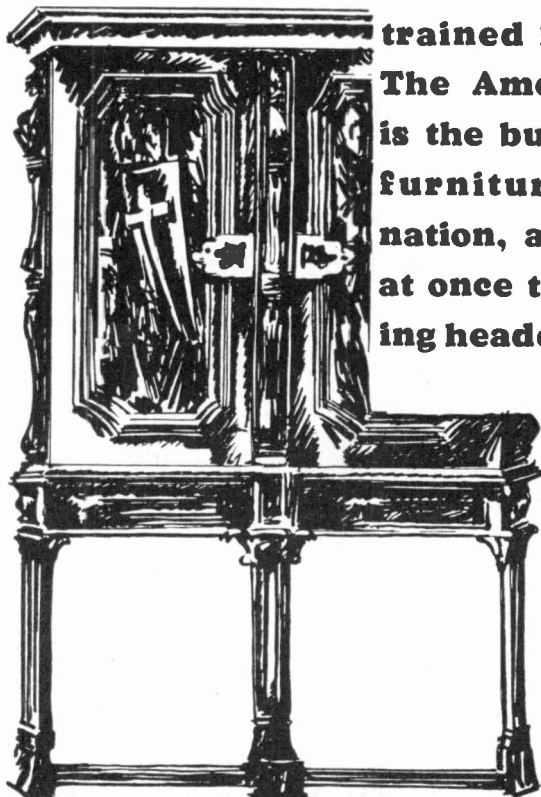

**American Furniture Mart
666 Lake Shore Drive
Chicago**

SPONSORED by the world's largest
manufacturers of tables and radio cabinets

ACCREDITED
by leading manufacturers of receiving sets

ST. JOHNS RADIO CABINETS

Every buyer or owner of a table model radio receiving set is a ready prospect for a St. Johns Console Cabinet to house it properly and suitably. ☞ By adding only a few dollars to his investment he owns a radio rivalling in every detail console radios that sell for two to three times as much. ☞ No matter what line or lines of radio you sell, if you are marketing a table model or chassis don't fail to investigate ST. JOHNS CONSOLES and the opportunities they offer for increasing your profits. ☞ Compare their amazingly low cost to you. Consider how easy it is to net a handsome profit on these consoles and yet undersell all competition.

SEE THEM AT CHICAGO when you attend the radio show June 3rd to 7th inc. Visit our displays. Booth 3 and Demonstration Room D-1, 2 and 4 at the Congress Hotel, also Demonstration Room Number 512 at the Stevens Hotel.

ST. JOHNS TABLE CO., CADILLAC, MICHIGAN

RAYTHEON

RAYTHEON has done something more than imitate the design of other tubes. Raytheon has made a very real contribution to radio.

RAYTHEON *was* **FIRST**

To produce a practical, heavy duty rectifier tube for B-elimination.

And when Raytheon brought out a full line of A.C. and receiving tubes, RAYTHEON was FIRST

To anchor receiving tube elements at the top with mica, increasing rigidity and uniformity of performance.

To produce a long-life, quick-heating tube for A. C. operation.

And RAYTHEON **ALONE**

Builds a tube of **FOUR-PILLAR CONSTRUCTION**, cross-anchored top and bottom—a tube so sturdy that its laboratory-tested performance cannot be changed by the shocks and knocks of shipment and handling.

In addition to the many outstanding improvements and patents which can be used by Raytheon *only*, Raytheon will benefit by all R. C. A. tube patents, present and future.

Due to the license granted Raytheon—*jobbers and dealers can sell these high-quality tubes with no danger of legal entanglements or "frozen" stock.*



EVEREADY RAYTHEON

THE NEWEST NAME IN RADIO

NATIONAL CARBON COMPANY, Inc., now controls production and sale of licensed Raytheon Tubes. This combines not only the names, but the facilities of these two companies.

Effective June 1, 1929, Eveready Raytheon Tubes will be produced and merchandised under the control of the great Eveready organization.

Plant enlargements are now under way. Additional equipment is being installed. Production of Eveready Raytheon Tubes will be enormously increased. An adequate supply is assured.

Eveready Raytheon is a large individual division of the National Carbon Company, Inc., and will have all of the usual aggressive Eveready advertising and merchandising activities back of it. Extensive Publicity . . . Broadcasting . . . Advertising.

This means increased opportunities for present Raytheon dealers. Additional franchises will be allotted. There will be full co-operation with the trade.

Plan now to take full advantage of this great new development in the radio tube market. Be sure to order an adequate stock of Eveready Raytheon Tubes.

NATIONAL CARBON COMPANY, Inc., New York
Branches: Atlanta, Chicago, Kansas City, Long Island City, San Francisco

Unit of Union Carbide  and Carbon Corporation

EVEREADY RAYTHEON

EVEREADY RAYTHEON



EVEREADY Raytheon Tubes will be sold in this package, made in the Eveready colors—red, blue and gray. It brings the prestige of two well-known names together in a striking display.

The change in name will mean even more than a great expansion of production and distribution. In addition to the specialized activities of the famous Raytheon laboratories at Cambridge, Eveready Raytheon will have the benefit of all research and development facilities of the National Carbon Company, Inc.

Eveready Raytheon will continue to lead in radio tube development. As an Eveready Raytheon dealer, the many developments in principle and design which are constantly in progress in the Eveready Raytheon laboratories assure you of radio tubes abreast of the moment . . . ahead of it.

Don't miss this opportunity to profit by all that Eveready Raytheon will have to offer you. Get in touch with your jobber or distributor today.

NATIONAL CARBON COMPANY, Inc., New York
Branches: Atlanta, Chicago, Kansas City, Long Island City, San Francisco

Unit of Union Carbide  and Carbon Corporation

EVEREADY RAYTHEON



**EVEREADY
RAYTHEON PACKAGE**
*and great new E R 224
Screen Grid Tube*

**EVEREADY
RAYTHEON**



*Eveready Raytheon Tubes are a
complete line*

ER Rectifier BH	ER 240
ER Rectifier BA	ER 280
ER 201-A	ER 281
ER 200-A	ER 226
ER 112-A	ER 227
ER 171-A	ER 224
ER 210	ER Type A
ER 250	Cartridge Rectifier
ER 245	ER Photo-cell
ER Kino Lamp	

*ER 224 tube with exclusive four-pillar
construction, cross-anchored top and
bottom*

SEE US AT CHICAGO!
 THE FINEST TUBE PROPOSITION IN THE COUNTRY!
 NO MORE TUBE GRIEF!
 GET THE VAN HORNE PROPOSITION!
 QUALITY FOR 15 YEARS
WATCH
VAN HORNE
THIS SEASON
 BIGGEST PROFITS FOR JOBBERS
 PLENTY OF ADVERTISING!
 BIGGEST PROFITS FOR DEALERS!
 LOWEST REPLACEMENT RATIO IN THE BUSINESS!
 THE "LIVE WIRE" TUBE LINE!
 LOTS OF SELLING HELPS!
 SEE YOU AT CHICAGO?
FOR EVERY SOCKET!

BIG things are happening in tube merchandising this year. There is new life in the VAN HORNE organization with its 15-year reputation for quality. VAN HORNE is putting new zip and zoom into the business of making tube profits bigger for dealers and distributors.

VAN HORNE offers a new kind of tube proposition, unlike any other in the radio industry. Bigger profits for you. None of the bothersome grief. Dominating adver-

tising to help you sell. Dealer co-operation to the limit. And with it all, the same high quality tubes that have made the name VAN HORNE one of the most respected names in radio history.

Before you consider your set-up complete for the season, by all means hear what VAN HORNE offers you. We promise you it's the sweetest tube proposition you've ever had. VAN HORNE TUBE CO., FRANKLIN, OHIO.

Quality for 15 years

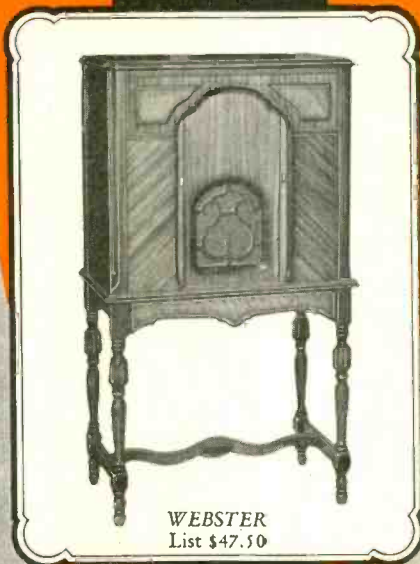
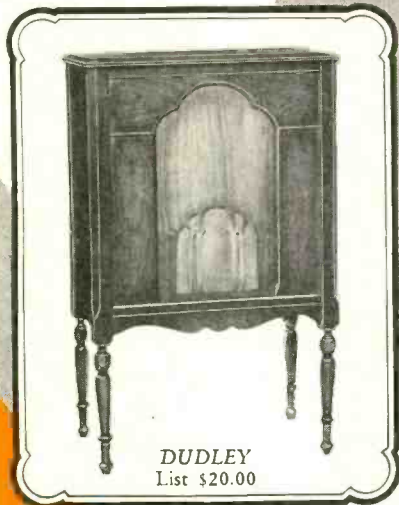

Announcement
TRADE SHOW
BOOTH No. 36
EXHIBITION HALL
STEVENS HOTEL
Chicago



Cary
CABINETS
at astounding
Prices



Made Entirely of Walnut in the "Walnut Center of America"

Cary Cabinet Corporation,
— SPRINGFIELD, MISSOURI —

You can sell Trav-Ler to Vacationists . . .

*Let this Portable Receiver Fill the Summer Sales Gap
with Profits . . . Insure Satisfactory Performance with
Trav-Ler Batteries*

Make up your mind that there isn't going to be any slump in your sales curve this summer! Here is a receiver particularly suited to summer trade. Every vacationist, every tourist, every week-end is a logical prospect.

For the Trav-Ler Portable one-dial receiver is light, compact and completely self-contained. Instantly portable, with its own loop and speaker, it needs no outside connections whatever.

To help you push this

quick-selling summer item, we are advertising the vacation, week-end and outdoor use of this receiver in *Field and Stream*, and the large metropolitan newspapers.

We also have window and counter material ready for you.

The world's largest manufacturer of portable receivers, we stand back of every Trav-Ler sold. You are fully protected under our sales policy.

Don't wait! Write or wire *today* for details.

Trav-Ler Mfg. Corporation
1818 Washington Ave., St. Louis, Mo.
Chicago, Ill. New York, N. Y.



Realizing the need for a special battery for Portable Receiver operation, we present the new Trav-Ler A and B Batteries. They give longer life and more power than ordinary dry cells. These batteries are a profitable line for any dealer.

57⁵⁰
STANDARD

\$75 DE LUXE
\$100 ARISTOCRAT . . .
ALL PRICES LESS ACCESSORIES
Slightly higher west of Rockies

TRAV-LER

Planes, trains,

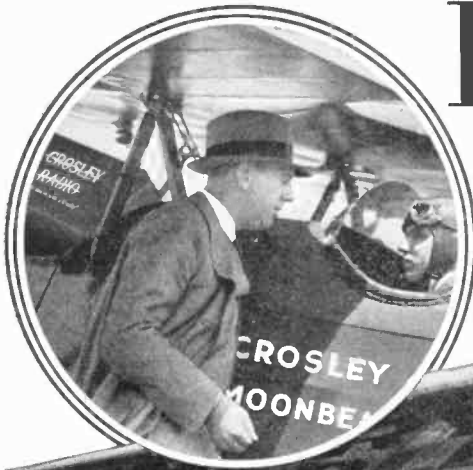

Powel Crosley, Jr., pioneer in radio, chats with the pilot of the Crosley-built Moonbeam, which will be the first plane to take off with "the big news in radio"

What does it carry? On June 18 the public will know! Then Crosley dealers everywhere will announce "the big news in radio." Visit the nearest Crosley distributor. See the amazing opportunity this new line offers the dealer. Watch Crosley!



Typical of Crosley's advanced methods is the fleet of cargo-planes which will carry "the big news in radio" via the highways of the sky to Crosley dealers throughout the nation. Scenes like this will soon be observed daily at the Cincinnati Airport. Time after time Crosley has led the way in radio. Now—watch Crosley on June 18!



Powel Crosley, Jr., gives the final okay to the plans for "the big news in radio." The great Crosley plant, one of America's mass-production wonders, has done the rest. See the amazing result on June 18!

Rush it! Crack express trains will speed day and night across the continent with "the big news in radio." From Maine to California the news will "break" on June 18. Watch for the announcement in this paper. And don't fail to visit your nearest Crosley distributor

Motor fleets roar in all directions from the great Crosley plant in Cincinnati—to airports, express trains, distributor points, with "the big news in radio."



motors, to rush *"Big news in Radio"* nation-wide

FROM the great Crosley plant at Cincinnati, airplanes will soon be leaving daily with "the big news in radio."

Crosley distributors in all parts of the country are sending planes for air shipments. The Cincinnati Airport will be humming with activity and the whir of propellers.

Every form of transportation will be utilized to supply Crosley dealers—planes, fast express trains, motor fleets.

June 18 is the date. Then Crosley dealers everywhere will reveal the radio sensation of 1929. Then the public will waken to a new idea of radio excellence at low cost. And Crosley dealers will begin to draw profits from the greatest business opportunity ever offered dealers by a Radio Manufacturer.

If you want to participate in these profits, see a Crosley distributor *now*. He will tell you about Crosley's greatest contribution to radio advance.

He will show you the astonishing new line that will revolutionize all popular ideas of radio performance and radio price. Visit the nearest Crosley distributor, or write the Crosley Radio Corporation for full information.

THE CROSLLEY RADIO CORPORATION

Cincinnati, Ohio

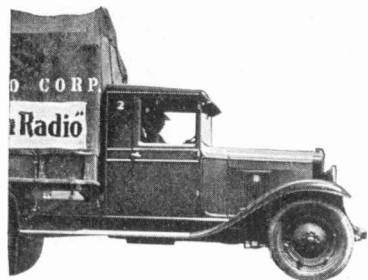

You're there with a

CROSLLEY

YOU
 may be just the man
 who can use ~ ~ ~

BOHNALITE

62% LIGHTER THAN IRON

Many men believe they must continue to use iron in the products or merchandise they make merely because they have always done so.

As a rule, these same executives are not familiar with the economical advantages of Bohnalite.

Are you?

You may be just the man who can use Bohnalite to advantage.

For here is a metal 62% lighter than iron—possessing all the advantages of iron but none of its disadvantages.

Bohnalite has high uniform hardness—great

density—fine grained structure—exceptional strength—excellent bearing qualities—and is ductile.

Many of these important refinements are due to the special processes and series of heat treatments developed by Bohn metallurgists over a long period of years.

Why not send us your blue prints and samples. Let us figure with your engineers and show you the many advantages of Bohnalite, a new light alloy.

Send us your blue prints and ask for the latest Bohnalite booklet.

BOHN ALUMINUM & BRASS CORPORATION, DETROIT, MICHIGAN

New York

Chicago

Philadelphia

Cleveland

Pittsburgh

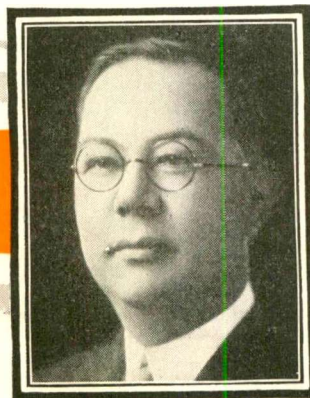

CHAS. B. BOHN
 The authority who
 developed Bohnalite



Each of Fada's nine years has marked another step forward—new contributions to the radio industry. And 1929 will be the outstanding success of them all— for never before has Fada offered to the radio buying public such values as these newest Fada models in which price and quality meet on a level that places Fada within reach of all. I wish to take this opportunity to publicly congratulate the Fada engineering and production forces whose untiring efforts made these new sets possible.

F. A. S. Andrews
PRESIDENT



The greatest Fada



FADA 25 \$165
HIGHBOY Without Tubes

ANNOUNCEMENT has ever made!

The New Fada Models

Every Modern Feature

Fada Quality at lowest
prices ever

All Electric Radio
operates
without loop, antenna or
ground

Screen Grid Tubes

New type 245 power
Tubes in
Push-Pull Amplification

Phonograph Attachments

Illuminated Single Dial

Gorgeous Consoles

Fada full power
Dynamic Speaker built in
and for use with
table models

Combination Radio and
Phonograph

See the advertising
announcement on the
next page



FADA 35

HIGHBOY

\$245

Without Tubes

Every man, woman and child in the country will hear about Fada Radio

NEWSPAPERS

Dominant Fada advertising will appear in 150 newspapers in a national campaign.

BROADCASTING

Beginning July 9th, over 30 million radio listeners will hear the Fada Salon Hour broadcast over the Columbia Chain, from stations:

WABC	WHK	WCAU	WFMB	KMOX
WCAO	WGHP	WJAS	WIBW	KRLD
WNAC	WOWO	WEAN	WCCO	KLRA
WKBW	WADC	WFBL	WISN	KFJF
WBBM	WLBW	WSPD	KMBC	KTSA
WKRC	WMAL		KOIL	KFH

MAGAZINES

These National magazines will carry two-page and full-page Fada advertisements in color and black and white to over 27 million homes each month this Fall.

<i>Saturday Evening Post</i>	<i>Liberty</i>	<i>Country Gentleman</i>
<i>Ladies' Home Journal</i>	<i>Collier's</i>	
<i>Woman's Home Companion</i>	<i>Literary Digest</i>	<i>Conde Nast Group</i>
<i>American Magazine</i>	<i>American Weekly</i>	<i>Vogue</i>
<i>National Geographic</i>	<i>Cosmopolitan</i>	<i>Vanity Fair</i>
		<i>House & Garden</i>

It's going to be a Fada year... dominated by Fada publicity... and Fada dealers will ride into greater profits than ever before on a National wave of popularity for Fada Radio.

See exhibit at R. M. A. Show, week of June 3rd, Booths 89 and 90, Stevens Hotel, Chicago. Demonstration in the large French Room, Blackstone Hotel, Chicago

MAIL THIS FOR FADA FRANCHISE INFORMATION

F. A. D. ANDREA, Inc., Long Island City, New York

Gentlemen:—Without obligation to us, will you send us details regarding a Fada franchise in our territory?

Name.....

Address.....

City..... State.....



FADA 20

\$99.50

Without Tubes



FADA 75

\$360.00

Without Tubes

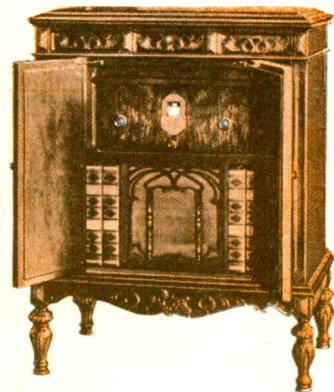

FADA 77

\$675.00

Without Tubes



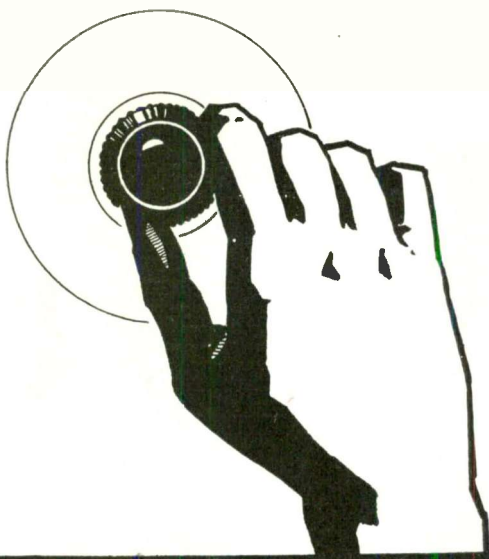

WHAT'S BEHIND THE KNOB ?

THE volume control on the set you sell may seem like a small thing to you . . . and yet that little unit behind the knob can either make or break the satisfaction of the family to whom you sell a radio.

When they get the set it may work fine, but what will they say after a few months when noise, both mechanical and electrical, develops . . . as well as an unevenness of control? The signals come through in "spurts" and locals are almost impossible to control. What then?

Here's the answer: Be sure the volume control has "Centralab" stamped on the back.

And here is why: Centralab precision controls give a perfect control of all stations smoothly and evenly . . . the exclusive rocking disc construction is insurance against any change in the resistance as well as against the development of mechanical or electrical noise.

THIS shows the exclusive rocking disc construction of Centralab volume control. "R" is the resistance. Contact

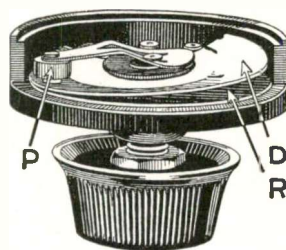

disc "D" has only a rocking action on the resistance. Pressure arm "P", together with shaft and bushing is fully insulated.

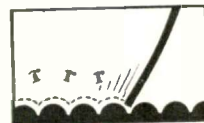

This is the action of the usual wire wound control after it has been in use for some time . . . like dragging a stick over a cobblestone pavement.



The tailor uses the same principle as Centralab. He does not want to ruin the garment by placing the iron on it so he places a cloth in between. Centralab controls can not ruin the resistance because the rocking disc is in between the pressure arm and the resistance.

Centralab

CENTRAL RADIO  LABORATORIES

20 KEEFE AVENUE, MILWAUKEE, WIS.

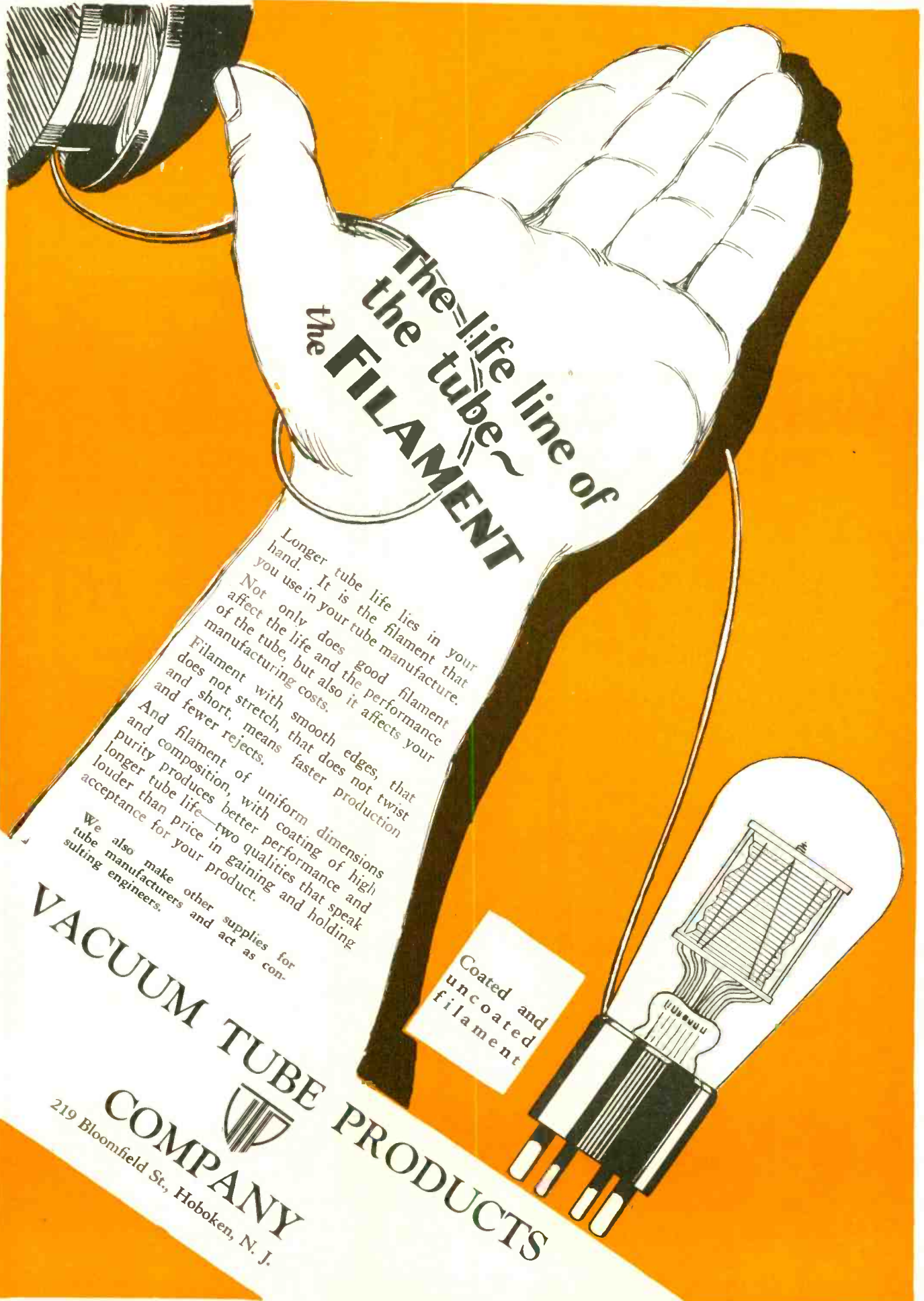

The life line of
the tube
The **FILAMENT**

Longer tube life lies in your hand. It is the filament that you use in your tube manufacture. Not only does good filament affect the life and the performance of the tube, but also it affects your manufacturing costs. Filament with smooth edges, that does not stretch, that does not twist and short, means faster production and fewer rejects. And filament of uniform dimensions and composition, with coating of high purity produces better performance and longer tube life—two qualities that speak louder than price in gaining and holding acceptance for your product. We also make other supplies for tube manufacturers and act as consulting engineers.

Coated and uncoated filament

VACUUM TUBE PRODUCTS

COMPANY

219 Bloomfield St., Hoboken, N. J.

IN FOUR MONTHS OF 1929 The New York Times gained 89,886 agate lines of radio advertising over the corresponding period last year—a greater gain than any other New York standard size morning newspaper. The Times total radio advertising in the four months was 192,635 agate lines.

In the past seven months, the active season of radio sales, The Times has led all New York morning newspapers of standard size with a total volume of 452,806 agate lines of radio advertising. This represents a gain of 122,367 lines over the corresponding period a year ago and an excess of 33,457 lines over the next morning newspaper. More cooperative radio dealer advertising appeared in The Times in the four months this year than in all other New York newspapers combined.

Large quantity and quality of circulation, together with careful censorship which rejects all fraudulent or misleading announcements, are chiefly responsible for The Times position as a radio advertising medium. Net paid sale weekdays exceeds four hundred and thirty-five thousand copies, Sundays seven hundred and fifty thousand.

The New York Times

Send for a copy of The Times "Radio Survey of the New York Market."

RADIO BY VICTOR

The climax of 30 years of leadership

Behind micro-synchronous radio are decades of experience in scientific acoustics and musical reproduction: unmatched resources and craftsmanship. Victor-Radio was put on the market only when it was certain that it was a long step in advance: in design, in quality and in performance.

The only Micro-Synchronous radio

Every vital element of the Victor-Radio is constantly and automatically in micro-exact harmony with every other. Perfect performance is *in-built*. Victor micro-synchronized condensers are *always in resonance*. Interference is eliminated. Unlike other receivers, Victor-Radio operates at full efficiency over the *entire* range-in-kilocycles used in broadcasting.

Thus Victor tuning is simplified to a point never before attained. There is no guesswork.

The result: Acoustic Symmetry

The Victor electro-dynamic reproducer is constructed on a radically new principle. Both tones and overtones are recreated—*duplicated* just as they go into the microphone.

With the *micro-synchronous* Victor circuit, this means, for the first time, *scientific fidelity*. Victor-Radio is realistic from top to bottom of the musical scale: for the first time the music-lover gets from the air proper *emphasis*—the quality which has been the goal of radio engineers for years.

Full-vision, super-automatic station selector: all stations plainly and permanently visible . . . just slide the knob to right or left—and in comes the station you want! A child can operate Victor-Radio!

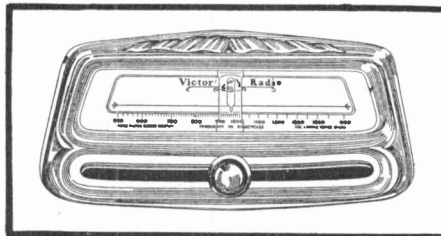

Console
Victor-Radio Console \$ **155**
R-32 List Price,
less Radiotrons

9 OUTSTANDING VICTOR FEATURES

1. *Micro-synchronous* balance: Every element constantly in micro-exact resonance. Condensers automatically harmonized. Unprecedented sensitivity and selectivity. Perfect performance through the *entire* range of the dial.
2. Super-automatic, full-vision illuminated station selector. . . brings in station after station at a touch. Numbers on the Victor dial mean what they say.
3. Improved circuit developed by Victor . . . unparalleled stability and fidelity.
4. Push-pull amplification . . . introducing two new RCA power Radiotrons 245. Greater and *undistorted* volume throughout the *entire* musical scale. From whisper to full orchestra at will.
5. Radically new Victor-electro-dynamic reproducer . . . recreates the quality of voice or instrument in all its color, all its lifelike realism. For the first time acoustic symmetry attained.
6. Three separate and distinct units —interchangeable . . . all accessible . . . all parts shielded with scientific thoroughness.
7. Victor Radio construction reduces the necessity for servicing to the vanishing point. Victor Radio is fool-proof. Any necessary servicing is simple and easy, without inconvenience to the owner.
8. Compact cabinet design of all-Victor craftsmanship . . . exquisite in every line. Harmonizes with the furnishings in the finest homes.
9. Lasting Victor quality and uncompromising craftsmanship: assurance of dependable service for years to come.

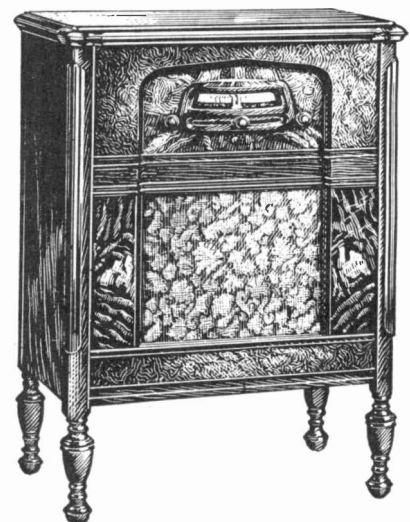

AND WITH NEW ELECTROLA

The Instrument of the New Musical Age

Thousands upon thousands who have never thought of buying a radio before will buy Victor-Radio. The development of micro-synchronous reception breaks the radio market wide open.

The development of the new all Victor-Radio-Electrola annihilates the final barrier that has handicapped the music dealer. Here, in one compact cabinet, much smaller than the Credenza, is music from air and record that sets a completely new standard of both radio and talking-machine performance. This remarkable instrument will give the world a new conception of musical reproduction. All dealers agree: "Millions are waiting for the Victor-Radio-Electrola."

Combination
Victor-Radio-Electrola **\$275**
RE-45 List Price,
less Radiotrons

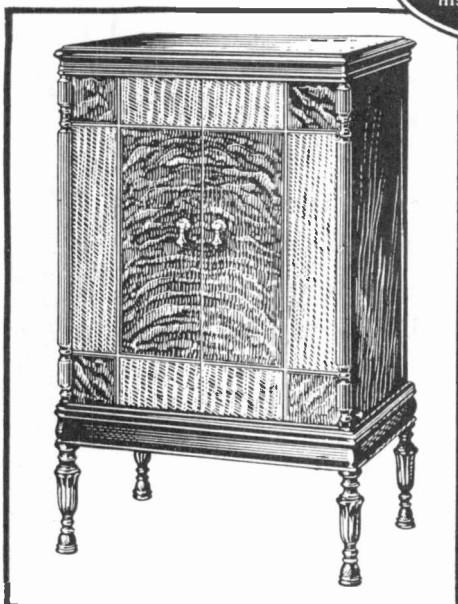

Selling expense brought to a new low limit

VICTOR DEALERS: You have in Victor-Radio and Victor-Radio-Electrola two completely new products of unequalled saleability.

Behind you is the largest, most powerful newspaper and dominating magazine campaign ever run by Victor. The nation will be blanketed.

Bill-boards, direct mail, display material: one of the greatest, most complete promotional campaigns ever launched is at your command to help you sell Victor instruments. Every possible method will be utilized—to the full—to make Victor-Radio and Victor-Radio-Electrola the most sensational success in the history of the music and radio industry.

With Victor Micro-synchronous Radio your service problems are reduced to the minimum.

Victor instruments meet all your requirements. They enable you to give in-built quality and dollar-for-dollar value never before equalled.

Your selling costs will be reduced to a minimum. With the name "Victor," the sale is half made at the beginning. Let the prospect hear the instrument . . . it is completed. Victor Talking Machine Division of Radio-Victor Corporation of America, Camden, N.J., U.S.A.





READY!

For Any Challenge

AMERVOX

Super-Dreadnaught
DYNAMIC REPRODUCER

Built for **POWER** and **PERFORMANCE**

Launched! The New Amervox Super-Dynamic is under way! The tide of public opinion is in its favor.

Radio sets today are well-nigh perfect—the public *demand*s perfect reproduction. It has learned to “Look Behind the Grill” for speaker perfection.

Our terms to jobbers and wholesalers are as attractive as the speaker is to the customers. We will send full information on application.

Jobbers, Dealers and Manufacturers, a surprise awaits you at our demonstration room, Congress Hotel, Suite No. B 32, at the Chicago Show.

AMERICAN REPRODUCER CORPORATION

1200 Summit Ave.

Jersey City, N. J.

Additions TO THE LINE !

EDISON RADIO

with

LIGHT-O-MATIC TUNING

and at sensationally low prices

This is news! Golden news! An Edison Radio at \$167.50 Think of that! An Edison Radio with the wonderful new and intriguing Light-O-Matic Tuner! A great Dynamic Speaker! A powerful new circuit! Superlative cabinet beauty! Performance of punch and pep; selectivity, distance and realism that is astounding. And all the fine workmanship, electrical efficiency and reliability for which the great name of Edison stands. There are two other Light-O-Matic models equally remarkable. All are sensational values. Truly this will be an Edison Radio year—a golden year for Edison dealers!

What is LIGHT-O-MATIC TUNING?

Light-O-Matic Tuning arouses instant interest in the new Edison models. It's new, different, uncanny! You want a station—a click—a flash of light—you have it! That's Light-O-Matic Tuning! And remember, it's exclusive with Edison. Light-O-Matic Tuning makes radio logs obsolete. Stations are plainly and permanently logged on the dial. Simple—nothing to get out of order—and it's mighty good looking, too. This tuning device, unlike others,

actually enhances the appearance of the Radio. And don't forget this—the Light-O-Matic Tuner is but one of the new Edison developments. The new models have forceful talking points aplenty. But best of all is the way they sell themselves! By a performance that upsets all radio standards. By value comparison that makes them outstanding. Indeed from every angle, the new models are worthy additions to the great line of Edison Radios.



EDISON RADIO... THE SET



The New Edison Radio Model R-5

There's been a great cry for an Edison to sell at less than \$200. complete with tubes. Here it is! The greatest value of the year. This strikingly handsome console will harmonize with the decorations of any home. Blended walnut finish, with matched butt walnut pilasters and sliding doors. Relieved with birdseye maple. Dynamic Speaker. Phonograph Jack. Size: $42\frac{1}{2}$ " x $23\frac{1}{4}$ " x $15\frac{1}{2}$ ". **List Price \$167.50** Less tubes (Slightly higher in far West.)

The New Edison Radio Model R-4

This model marks the acme of cabinet beauty and radio performance. It is a rich, dignified console bearing the impress of the world's finest artistry. Blended walnut finish, with quarter matched sliding doors and raised butt walnut panels. Appearance is enhanced by carved moldings and ornaments. Dynamic Speaker. Phonograph Jack. Size: 46" x $26\frac{3}{4}$ " x 17". **List Price \$197.50** Less tubes (Slightly higher in far West.)

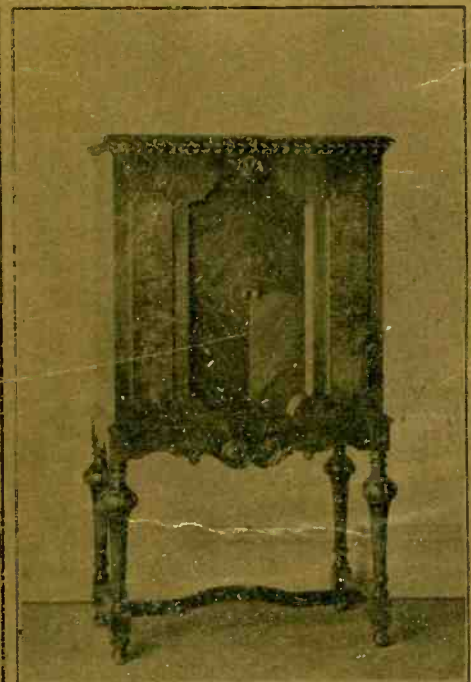

THE WORLD AWAITED...

The New Edison Radio and Electric Phonograph Model C-4

A wonderful combination all-electric radio and phonograph in a massive studio cabinet. Edison electric pickup—automatic stop that operates without setting, on all makes of records. Blended walnut finish, with sliding doors of matched butt walnut and front relieved with butt walnut panels. Size: 48" x 28⁵/₈" x 19". **List Price \$295.00** Less tubes (Slightly higher in far West.)

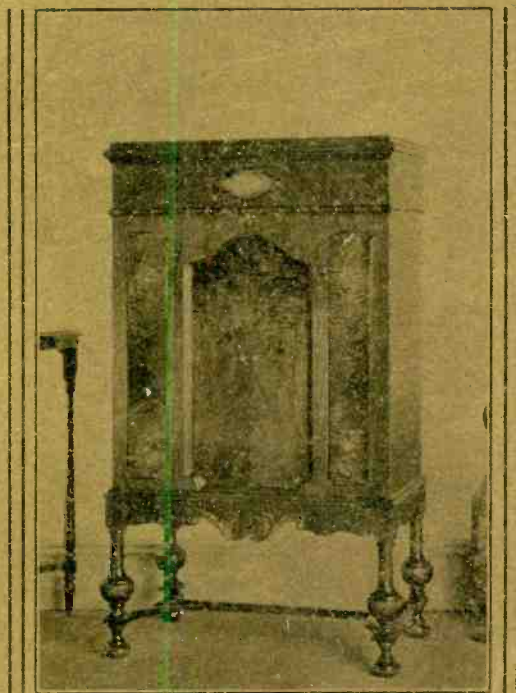

EDISON LABORATORY NOTES

A powerful new radio-frequency circuit of undreamed power, using the neutrodyne principle with new features, insuring highest selectivity, uniform amplification at all radio frequencies, tremendous distance-getting—the absolute ultimate in sensitivity. For local reception, no aerial external to cabinet is necessary. Dynamic speaker with perfect response curve—uniform amplification at all musical frequencies. New receiver unit, totally

shielded, all parts readily accessible—using five 227 AC tubes. Power unit—special Edison design, using two 245 tubes in new balanced push-pull arrangement, and one 280 rectifying tube. All radio models equipped with phonograph jacks. Phonograph models use exclusive Edison electric pickup. Light-O-Matic Tuning—found exclusively on the three Edison models here illustrated.

See the New Edison Models at the Chicago Show

Exhibit—Gold Room, Congress Hotel

Demonstrations—Suite 1177, Congress Hotel; Room 529, Stevens Hotel

Thomas A. Edison, Inc., Orange, N. J.

EDISON

The year's outstanding portables



Outstanding is the word! Because these new Edison Portables are to be compared only with the finest of large cabinet models both for volume and tonal qualities. They're light in weight but heavy in volume. And a supreme tonal beauty is their sales-clinching argument.

Priced at \$25. and \$35.

coming!

EDISON *needle type* RECORDS

Records that can be played on any phonograph—needle records—by the laboratories that first produced the phonograph. The culmination of over fifty years of research and experience in sound reproduction.

Records by artists the public wants to hear—electrically recorded, of course. These new Edison Records will set high marks of sales volume for any store—you'll understand why when you hear them!



TRADE MARK
Thomas A. Edison

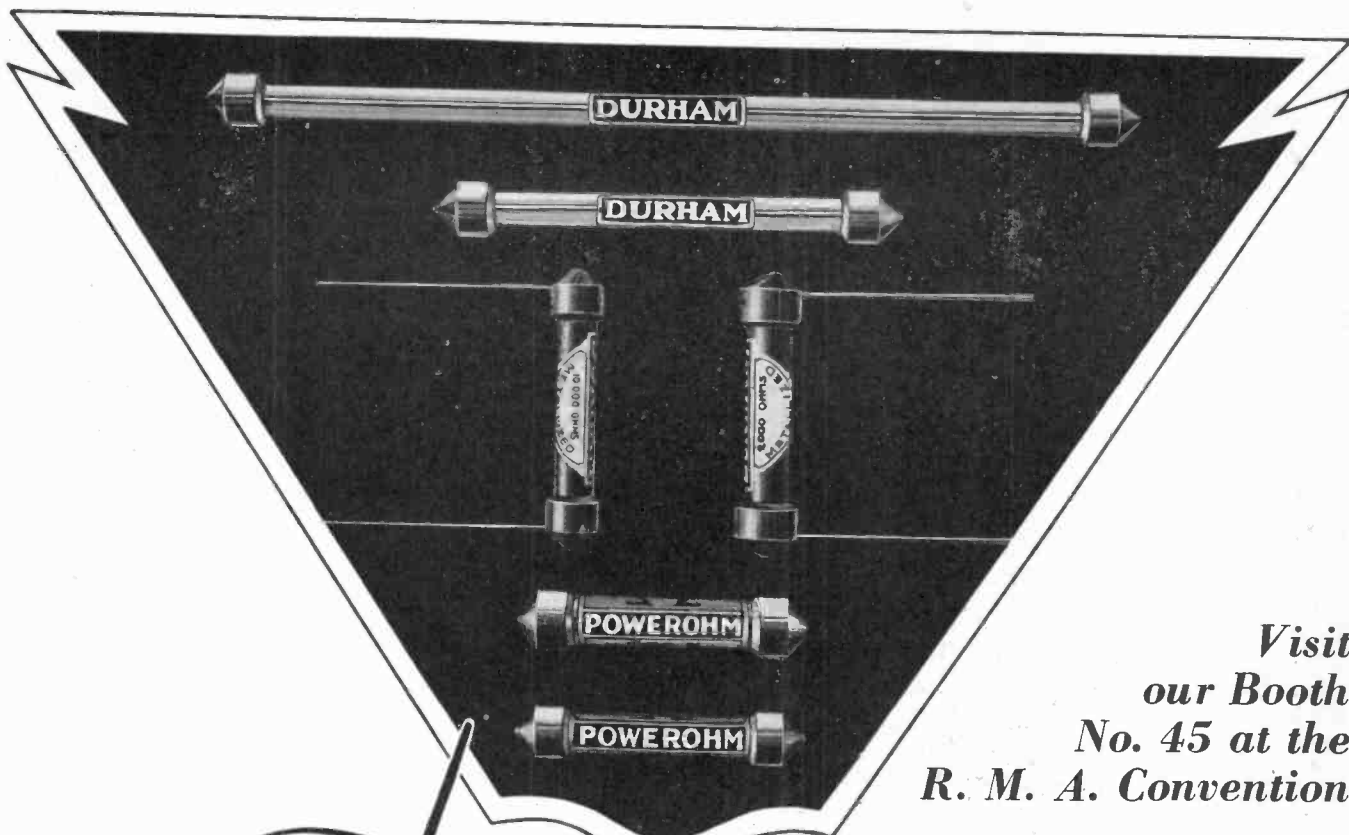

*Visit
our Booth
No. 45 at the
R. M. A. Convention*

The New Improved DURHAM POWEROHMS

Each succeeding year, more and more important manufacturers of radio, television and talking movies are standardizing on DURHAMS—the resistances which are dependable, accurate in rating, and can be relied upon for long continued and uninterrupted service.

Supplied in 1 and 2 watt types in standard, pig-tail or special tips; temperature rise at 1 watt is 45°c and at 2 watts 74°c; all types are flash tested at double the rated power load as an extra precaution against electrical or mechanical weaknesses; extremely rugged

construction; supplied in all ranges from 500 to 200,000 ohms in power types and from 1 to 100 megohms in resistor types.

Samples for testing gladly sent upon request, together with engineering data sheets. Please state ratings in which you are interested.

DURHAM

METALLIZED

RESISTORS & POWEROHMS

INTERNATIONAL RESISTANCE CO., 2006 Chestnut Street, Philadelphia, Pa.



TYPE
AC-24

for

**Don't Forget to see us at the
R.M.A. Show - Stevens Hotel
Chicago - June 3 to 8!**

*Already in
3rd PLACE -
and gaining fast*

Listen in on the CECO Couriers, every
Monday evening at 8:30 Eastern
Daylight Saving Time over the
Columbia Broadcasting System.



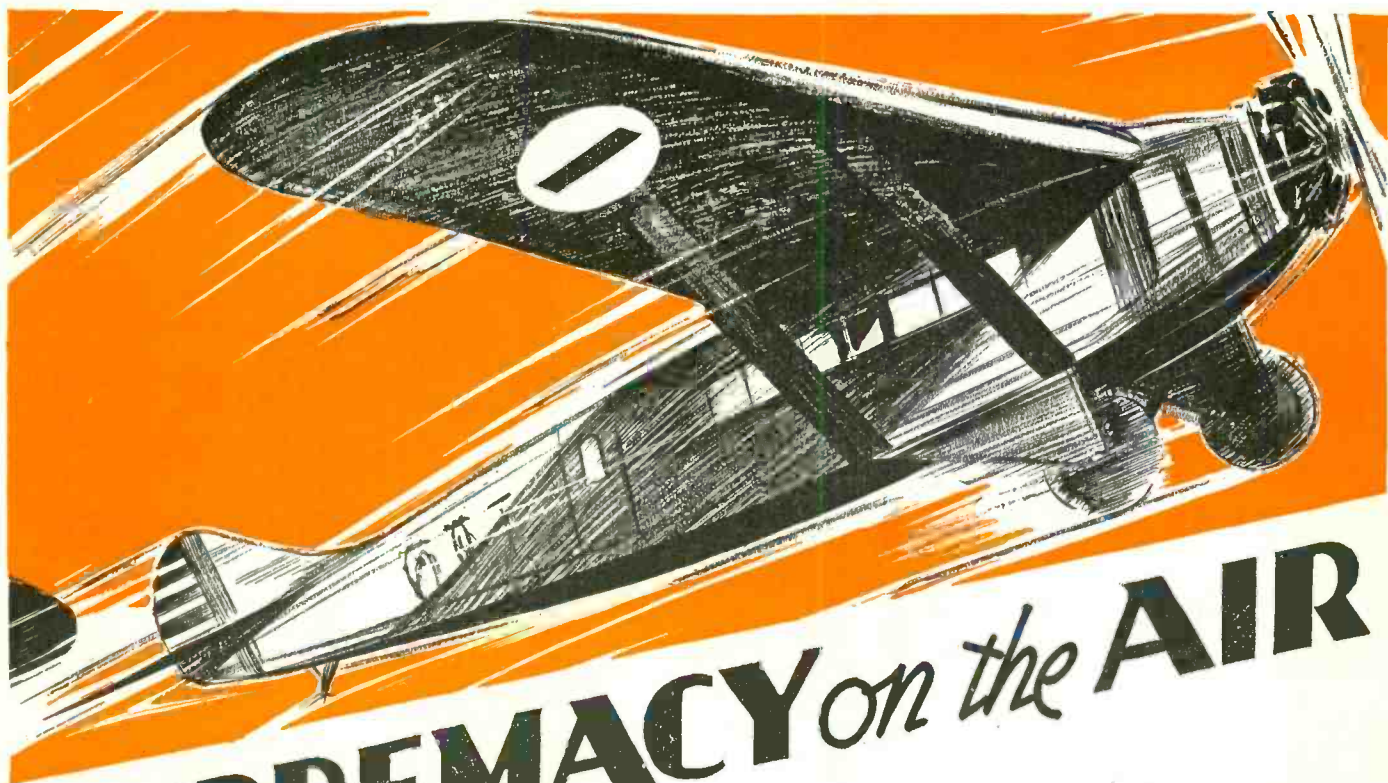

SUPREMACY *on the* AIR

IT TAKES more than a *wish* to make the finest possible radio tube. It takes man-power, ability, and the willingness to go to any length to insure perfection ~ all the qualifications that CECo has and puts whole-heartedly into the making of CECo Tubes.

Quality is CECo's first and only consideration. That the resulting volume of sales has brought CECo to third place in point of quantity sold is incidental, but ~ *it is a fact.*

CECO MANUFACTURING COMPANY, INC. - PROVIDENCE, R. I.



THE REMARKABLE NEW **42**
First of a series of 15th Anniversary Zenith receivers



WITH
Automatic
Tuning
Screen-Grid
Circuit
True Dynamic
Speaker
Exquisite
Console

\$175
less tubes

The Greatest advancement in RADIO VALUE in radio history ▲ ▲ ▲ ▲

Vast production expansion now makes available Zenith's exclusive quality at a popular price range

The sensational Zenith Model 42, already oversold, offers but a hint of the even more sensational Zenith Radios to come. No radio manufacturer has ever successfully competed with Zenith quality....none, from now hence, will rival Zenith value-giving. Every home has wanted Zenith quality....now every home will be able to afford it. Not only is this Zenith's 15th Anniversary....it's a Zenith year wherever radio is sold. Don't wait. Now is the time to sign the Zenith Franchise. Get in touch with your Zenith Distributor NOW.



ZENITH RADIO CORPORATION, 3620 Iron Street, Chicago, Ill.
WORLD'S LARGEST MAKERS OF HIGH GRADE RADIO



Zenith Exhibit
R. M. A. SHOW
BOOTH 86
Stevens Hotel, Chicago

"Automatic Radio" Owned and Controlled by The Zenith Radio Corp., Chicago, U. S. A., under the following patents—Vasselli 1581145, Re-issue 17002, Heath 1638734, Marvin 1704754, Canada 264391, Gt. Britain 257138, France 607436, Belgium 331166. Also under other U. S. and foreign patents pending.
Licensed only for Radio amateur, experimental and broadcast reception. Western United States prices slightly higher

Dealers *Listen!*

THE SET YOUR CUSTOMER WANTS - THE SET THAT MEANS QUICK SALES

Tom Thumb

SCREEN GRID PORTABLE RADIO

Speaks in the tone
of PROFITS



PROFITS because it's beautiful, light, shock-proof; unique among portables, and SCREEN GRID. PROFITS because it's TRULY PORTABLE.

Dependability plus low price—that is why this FOUR-TUBE PORTABLE SET, requiring neither aerial nor ground, is winning dealers from coast to coast.

It Will Pay
You To
SEND
for
Dealer's
Proposition
Now!
Wire or Write

List Price
TOM THUMB
PORTABLE

\$ 57.50

(East of Rockies)
LESS
EQUIPMENT

ALSO TWO OTHER MODELS

ALL ELECTRIC PORTABLES

Just Plug Into the Light Socket—and Tune In!

D.C. (direct) ALL ELECTRIC MODEL, 110 Volts

Same in appearance and construction as battery model, but completely electrified. Ideal Portable for SCHOOLS, HOSPITALS, HOTELS, CLUBS—any place where D. C. Electric current is available.

\$87.50
LIST
LESS TUBES

A.C. PORTABLE ALL ELECTRIC, SCREEN GRID, 110 Volts

Operates on 60 Cycles; complete with specially designed cone speaker mounted in front cover; planned to handle the large output which this set delivers; assures QUALITY REPRODUCTION.

\$95.00
LIST
LESS TUBES



AUTOMATIC RADIO MANUFACTURING COMPANY, INC.
332 "A" STREET (Dept. C.) BOSTON, MASS.

DESIGNED BY EVEREADY

MADE BY EVEREADY

EXCLUSIVELY

EVEREADY offers an exclusive line, unique in those particulars where improvement was possible, conventional in those respects where public taste dominates all manufacturers.

All-electric—dynamic speaker—walnut-finish consoles of great furniture appeal—antenna operated—phonograph jack—prices based on a popular console at \$175—these are the conventional requirements which Eveready meets 100%.

Increased sensitivity due to unique variometer—protection against humidity and temperature—Eveready's famous, unbeatable tone fidelity—a *full year's guarantee*—these are some of the exclusive Eveready features.

In spite of the great sales value of the new Eveready Receivers we are making no effort to dominate the market. Dealer franchises will be limited, in order that each dealer may capitalize the Eveready line to the limit.

Production will be ample but not excessive. Distress merchandise never has and never will worry an Eveready dealer.

The Eveready time-payment plan is so arranged as to assist dealer and customer alike.

The Eveready service system, so impressively proved last year, is being continued. The chassis is made in two sections, easily removed and replaced. No Eveready Receiver need be silent for any longer than it takes you to supply a new unit! We guarantee each Eveready Receiver against defects for a *full year*, the longest guarantee in the industry.

And newspaper advertising focuses public demand on your shop!

Today the Eveready Franchise is not only an immediate source of profit, but it is also an investment that will bring rich returns through the years to come.

1. Made by Eveready in an Eveready factory.
2. Shipped to you complete including speaker and cabinet, assembled in a single unit. Nothing to buy or add but the tubes.
3. Popularly priced.
4. Backed by years of laboratory experiment and research—a finished product.
5. Performance second to none.
6. **GUARANTEED FOR ONE FULL YEAR!**
7. Time-payment plan to assist dealer and customer.
8. Production will be ample but limited. No distress merchandise.
9. Careful analysis of trading areas apportions dealerships and quotas on an exact, just, equitable and profitable basis.
10. Merchandising plan is backed by extensive newspaper advertising carrying dealers' names.

\$210

Model 33, a larger and more luxurious console, in walnut finish with decorative carvings. Same all-electric chassis as Model 32. All cabinet designs are exclusive with Eveready.

LIST \$210 without tubes

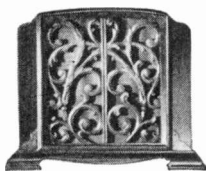
\$50

Eveready Speaker, Model 6. A sensitive and powerful dynamic, accurately matched with the Eveready Radio Set for the utmost fidelity. LIST \$50

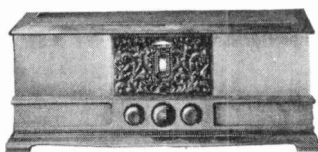
\$115

Model 31, table type. Cabinet in rich walnut finish with contrasting carved grill. Same radio chassis as the consoles. Will operate either dynamic or magnetic speaker.

LIST \$115 without tubes

EVEREADY
TRADE MARK REGISTERED
RADIO RECEIVERS

SERVICED—PRICED
CONTROLLED BY EVEREADY

EVEREADY!

11. This year we also assist individual dealers in co-operative newspaper advertising.
12. Through past years the trade has learned that pleasant and profitable business is always done in Eveready products.
13. To the public the mere name Eveready is a great guarantee of perfect merchandise.
14. Fully licensed by RCA and RFL—we utilize and are protected by the strongest and best patents.
15. Dealers now have a unique opportunity to secure a radio set franchise of tremendous present and future value—the Eveready.

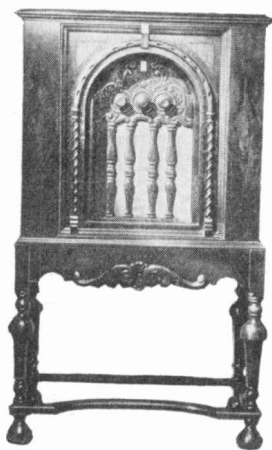

\$225

Model 34, a de luxe console in the grand manner, for the most luxurious homes. Will harmonize with any background. Walnut finish in rich grain, with delicate carvings. A triumph of craftsmanship.

LIST \$225 without tubes



\$175

Model 32, console, in a cabinet of rich walnut finish that fits in any decorative scheme whatever. Dynamic speaker built in. Chassis has eight tubes, including rectifier.

LIST \$175 without tubes

EVEREADY builds for the future. Right now, Eveready sales are mighty fine, but present conditions look like nothing at all compared with the vision we have of what this business is going to be. We want only the best dealers, who will grow up from bed-rock with us; who will adopt the policies we know mean certain success; who are confident that we will put Eveready Radio on the map in the same way we have promoted other Eveready products that have made us the biggest of our kind in the country and have made profits for thousands of dealers.

SEE OUR EXHIBIT
In the Stevens Hotel, 3rd Annual Radio Manufacturers' Association Trade Show, Chicago, June 3 to 7. Come get an earful and an eyeful of this unbeatable new Eveready line of tremendous popular appeal.

NATIONAL CARBON COMPANY, Inc.

New York, N. Y.

Unit of Union Carbide  and Carbon Corporation
Licensed under patents and applications of RCA and RFL

Branches: Atlanta, Chicago, Kansas City,
Long Island City, San Francisco

Now...for YOU...the Most Vital Profit

▲ ▲ ▲ The Year's Most Sensational Radio Value
on a Definite Price and Profit Basis...Now
Available to Individual Dealers

The NEW

Backed by a National Reputation of Manufacturing Integrity



The NEW EMERSON RADIO

Model C illustrated. 8-tube, all-electric...Dynamic Speaker... Push-Pull amplification... fluctuating current control... illuminated bronze dial... highly selective...engineered up to well known Emerson standards... a QUALITY set. Cabinet top, sides and front of selected striped 5-ply walnut veneer. High-lighted maple overlay on apron with spindle turned carving. Hand lacquered and rubbed walnut finish.



EMERSON Guaranteed VACUUM TUBES

Each Emerson set is sold complete with EIGHT Emerson Vacuum Tubes, including rectifier. Engineered in accordance with Emerson standards. Long life. High efficiency. Guaranteed. Replacement always authorized if customer complains of quality or performance.



They live up to their name

GUARANTEED

COMPLETE

\$100.00

LIST PRICE

With DYNAMIC SPEAKER and 8 EMERSON TUBES
Advertised, Maintained Price

LICENSED
Under Patents of R. C. A.
and Associated Companies

Emerson Radio and Phonograph Corporation
307-309 SIXTH AVENUE, NEW YORK, N. Y.

Maker Ever Offered to the Radio Retailer

▲ ▲ ▲ Emerson's Irresistible Merchandising Plan
Makes Your ALL-SUMMER SUCCESS
Inevitable. Put it to Work...NOW!

Emerson

..... Won by Fifteen Years of Public Service

An
"Automatic"
BUSINESS
BUILDER

The Emerson COMPLETE MERCHANDISING UNIT...consisting of carefully conceived plans, proved newspaper advertisements, literature, point-of-sale displays and materials... provides everything you need for the volume sale of Emerson Radio. You get a COMPLETE service, regardless of the amount of business placed.

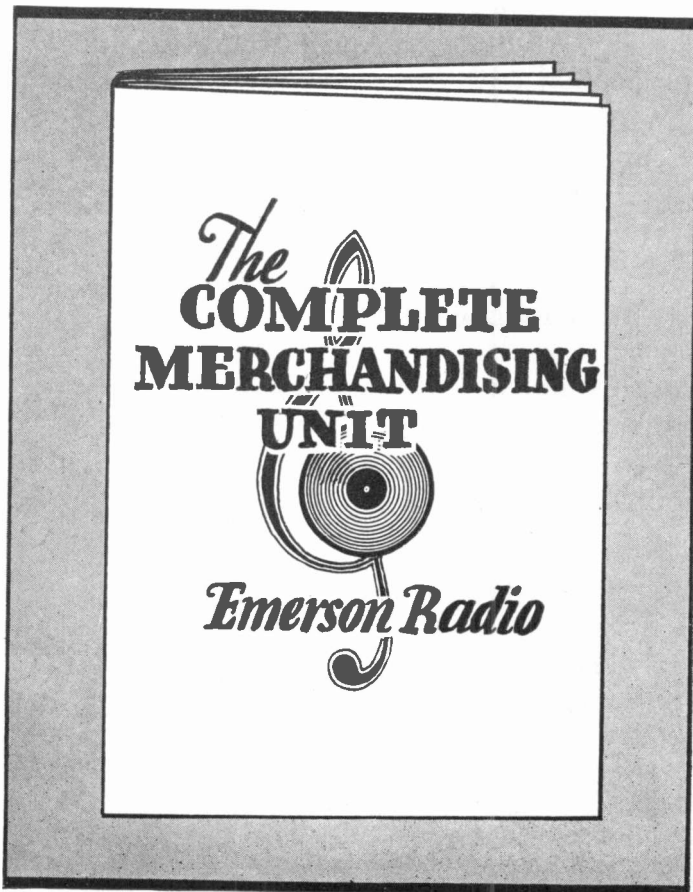

The
PLAN that
has NEVER
FAILED

This is Emerson's unchallenged record. Wherever the Emerson COMPLETE MERCHANDISING UNIT has been employed, successful business invariably resulted. It is RIGHT. Everything about the Emerson plan has been tested, perfected, PROVED in hundreds of retail stores throughout the United States. It will work for you... all summer... all year.

*These dealers have averaged more than
1,000 Emerson Radios a Year*

*Write or Wire
for Details*

Ampico Hall, Philadelphia; Boston Store, Chicago; Colonial Radio Sales Co., New York; Houghton & Dutton, Boston; A. I. Namm, Brooklyn; The Rosenbaum Co., Pittsburgh.

Smaller Outlets Have Done Even More Proportionate Business

Visit us at
Rooms
1339 and 1340
Stevens Hotel
Chicago
R. M. A. Week

Emerson Radio and Phonograph Corporation
307-309 SIXTH AVENUE, NEW YORK, N. Y.

A NEW TUBE

WITH A RENEWABLE HEATING UNIT

HERE is a radio tube—a tube of phenomenal performance—marking a great step forward in tube history and the results of years' experimental and development work by C. E. Quinn.

To dealers it means a great reduction of his servicing costs, and radio troubles. To the radio user it means that when the tube burns out he does not have to buy a new tube. He buys only the heating element.

A big saving in tube costs

The heating element of this tube is contained in a hollow sleeve which goes up through the grid from the base.

The heating element does not burn in the vacuum.

This absolutely eliminates humming and prevents breaking down of the vacuum by gases given off as the heating unit slowly disintegrates—a condition to be found in other radio tubes. The element may be renewed at comparatively low cost.

This tube may be used in all types of either DC or AC sets—it is only necessary to insert the proper heating element! It's been tried—it's been tested—it's been proved. See us in Booth S-108 RMA Trade Show. If you'll not be at the show, let us send you complete details.

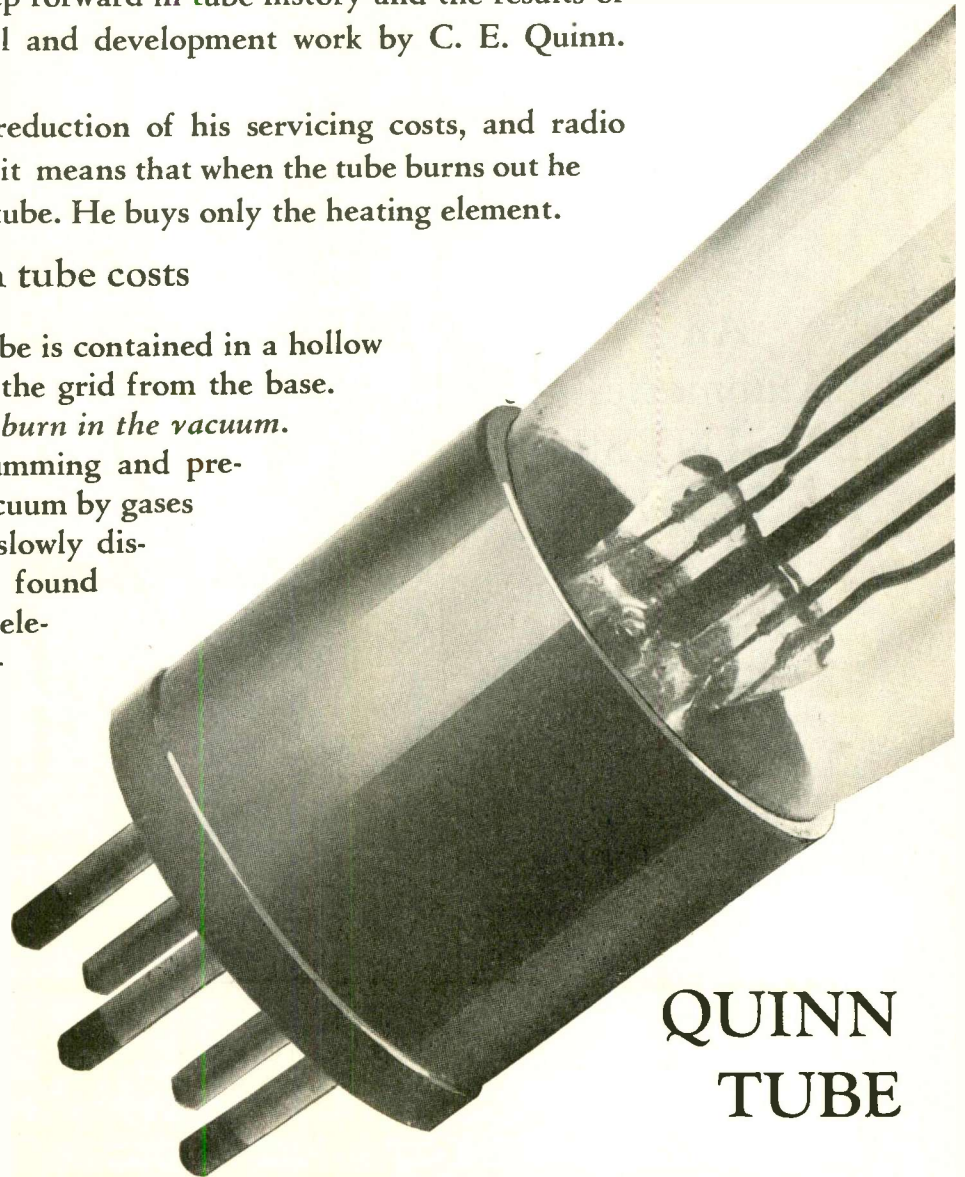

QUINN
TUBE

COMES TO RADIO

PATENT No. 1667977

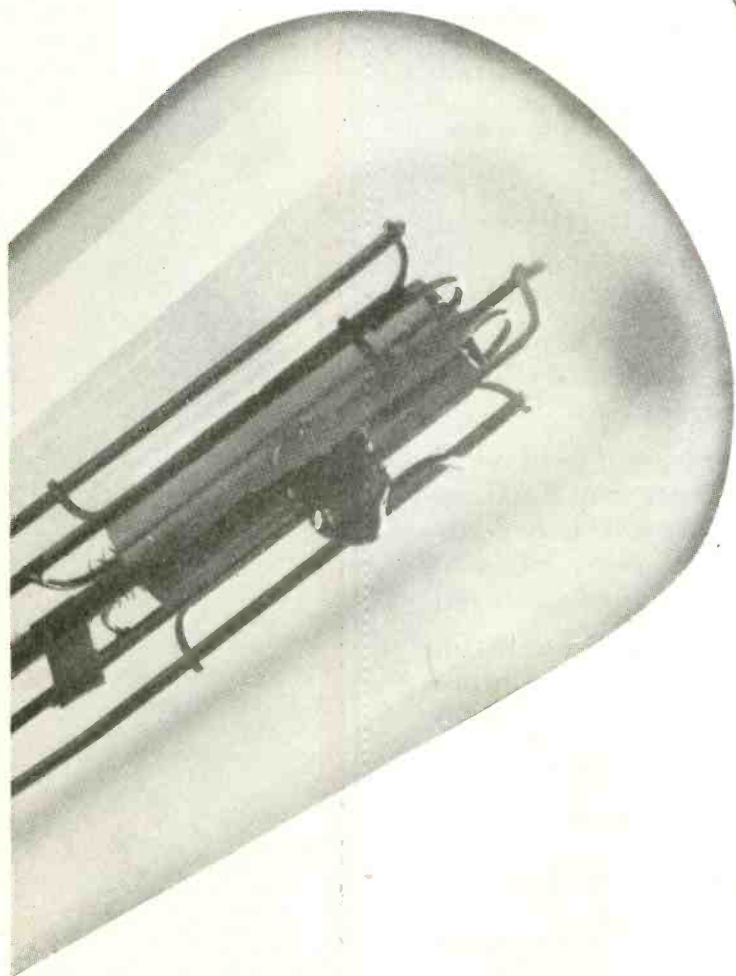

THIS is the heating element shown withdrawn from the tube. It is only necessary to remove a small screw to pull off the base to which the element is attached.

A tube is only as good as its heating element—and its vacuum. This new tube insures perfect vacuum, and one heating element will last the lifetime of an ordinary tube.

Model UY 224 tubes will be available in quantities.

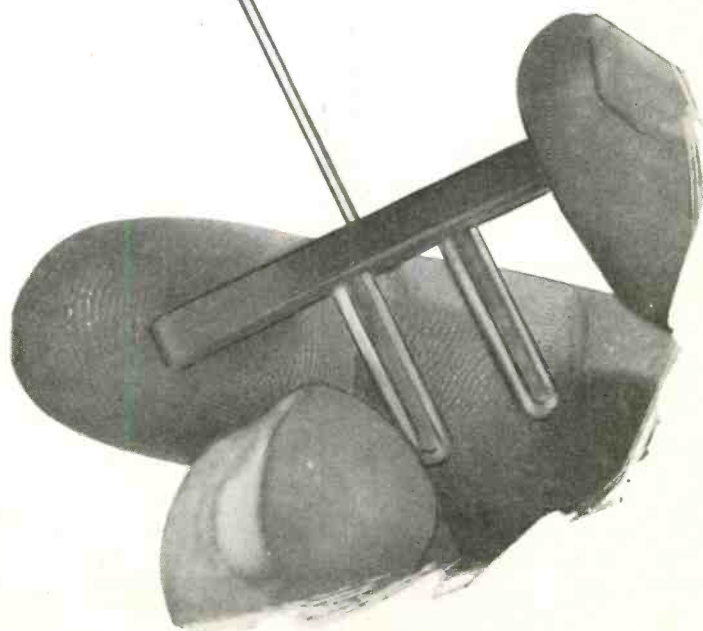

“THE QUINN TUBE”

Manufactured in Cleveland, Ohio

1890 E. 40th St.

CLEVELAND

LONG LIFE ASSURED



Type B-12
B-L Rectifier.

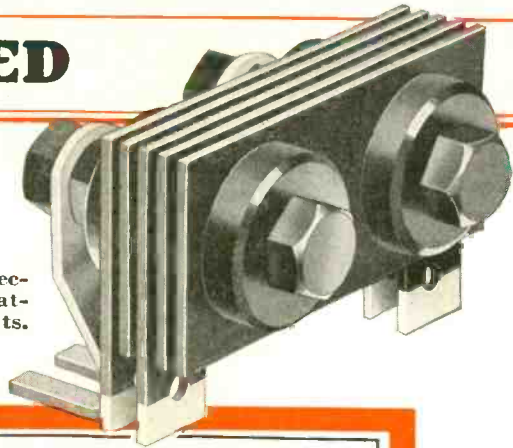

Type B-402 B-L Rectifier
Max. D. C. Rating,
3 Amps. 2 Volts.



Type C-110 B-L
Rectifier Replacement
Unit.

Advancement...

The new Type B-402 B-L Rectifier Unit has caused a decided advancement in the manufacture of dynamic speakers.

An advancement because it permits these economies for the dynamic speaker manufacturer:

Allows a low voltage type of field winding—less turns of larger wire and consequent lower winding and wire costs. Thus a more rugged field winding with a better space factor is assured.

The B-402 is a truly notable addition to the long line of stable, proven and successful B-L Rectifiers.

Write us for complete literature on all B-L Rectifier Units . . . Complete data and engineering service is available at all times.

The B-L Electric Mfg. Co.

(Formerly Mfg. Div. of the Benwood-Linze Co.)

19th & Washington Aves. ' St. Louis, Mo.



Type A B-L
Rectifier.

B-L
RECTIFIERS

TRADE MARK REG.

DRY...DURABLE...COMPACT...COMPLETE...NOISELESS

CASWELL ACHIEVEMENTS

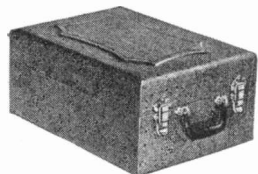
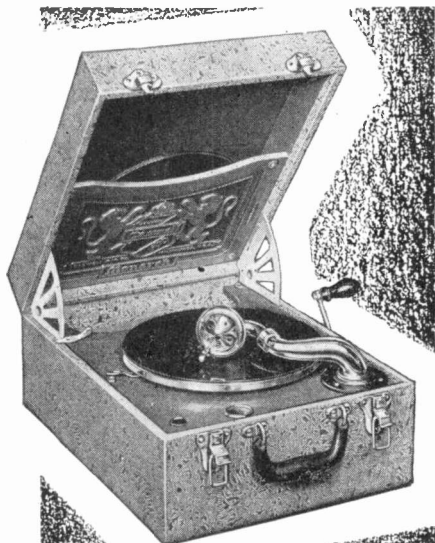
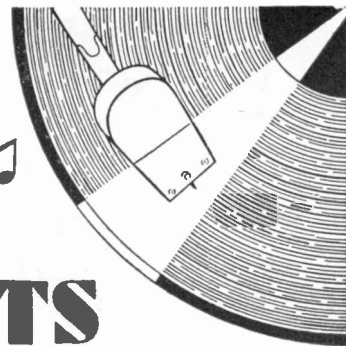

The new Monarch—
The famous and popular Caswell model in a new and more beautiful dress. Incorporates many refinements. Lists at \$25.00.

...that will amaze the industry!

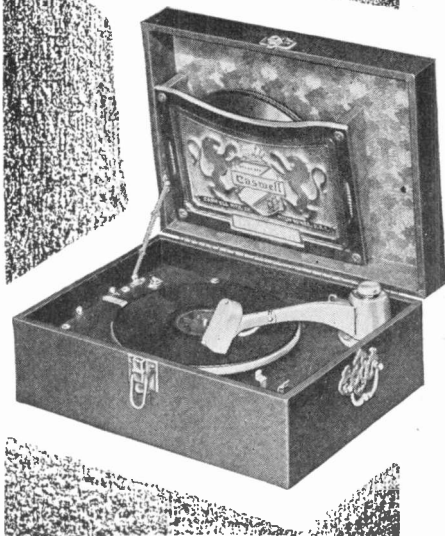

The new Caswell PowerTone—
This latest achievement of Caswell strikes the newest note in electrical pick-ups. Retail for \$49.50

A GAIN Caswell has scored! In the new and improved Monarch . . . and in the greatest electrical pick-up achievement of the day—the new Caswell PowerTone.

Faithful reproduction is assured in the new Caswell PowerTone by a precision pick-up device. A General Electric Synchronous Type motor is used. An impulse starter, antiqued brass effect hardware, and a built-in, art-crafted record album are provided. In appearance the Caswell PowerTone is indeed a treasure chest. In value it is the wonder of the industry.

The new Monarch introduces a highly developed type of reproducer providing greater dynamic tone and volume than ever before achieved. It is equipped with a full throw-back, low serpentine

type tone arm. The case is embossed with the outline of the Caswell crest of quality and is finished in a new leather grain fabric. Colors: red, blue, and black.

Jobbers and dealers everywhere are amazed at the big profits in the Caswell line. List prices range from \$12.50 to \$49.50. Write for details or see our representatives at the show.

CASWELL MANUFACTURING CO.
10th and St. Paul Ave., Milwaukee, Wisconsin

At the show see the new PowerTone Monarch and full line in Suite 201-202, Drake Hotel.

CASWELL

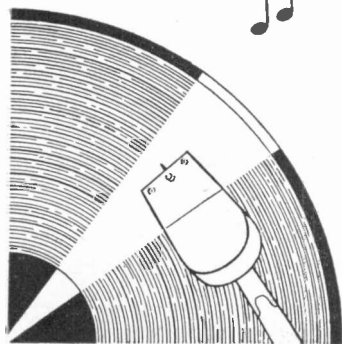

IMPORTANT
to every Radio-
Phonograph
Dealer and
Manufacturer.

The world's of phono-radio

From every angle...design, construction, performance, durability, simplicity, eye-value and easy saleability.

Don't miss these 4 star profit makers!

FIRST the famous SUPER Phonovox... the new Pacent Pick-up that has again brought startling advances in both design and reproduction... a degree of naturalness and tone beauty never before possible! It is trouble-free—fashioned of the finest materials—and offers many new structural improvements including ENGLISH 36% COBALT MAGNETS, besides new refinements and new finishes. Here's a piece of merchandise that sells on sight, that means extra, easily-made profits when you're selling a radio set. Almost every customer is a prospect. The little extra effort it takes to sell a Phonovox pays big returns. You're doing the customer a service he'll thank you for... and making more money for yourself.

Two beautiful models, both of which work perfectly with the new screen grid tubes, catalog No. 106-A, without Tone Arm, \$12.00. **\$15.00**
Catalog No. 106-B, with Tone Arm, as illustrated

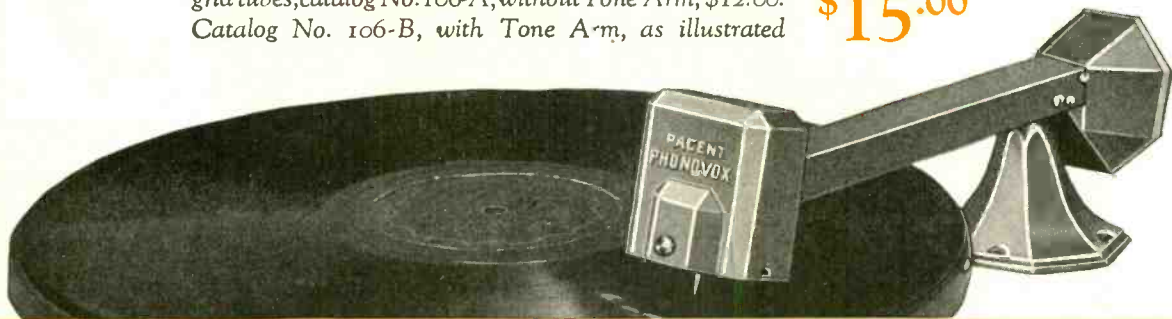

PACENT

foremost line accessories

New Pacent Phonograph Motor

THE AMAZING new model Pacent Induction Phonograph Motor provides an excess reserve power and starting torque beyond ordinary needs. A dynamically balanced rotor eliminates vibration. Phosphor bronze bearings, a micrometer-type speed regulator, a die-cast main frame—absolutely insulated against noise throughout . . . these are a few of its advantages which, together with its design, construction, and the quality of its materials, make it the finest electric phonograph motor which is to be had. Operates on 110 volts—50 or 60 cycles A.C. Due to large scale production in the new and modern Pacent plant, it is available at the lowest price ever offered for a high class motor.

The new Pacent Electrovox provides all the advantages of a combination—electric operation and electric reproduction—with a tone quality and volume that equal, and even surpass, instruments costing hundreds of dollars. Makes a readily sold, highly profitable unit for the progressive dealer.

Attractive dealer helps on all Pacent merchandise, folders, mailing pieces, etc., help you to boost sales on this unusually profitable, fast selling line. See your jobber today for complete Pacent proposition—or write us direct.

PACENT ELECTRIC CO., Inc., 91 7th Ave., N. Y.

Pioneers in Radio and Electric Reproduction for Over 20 Years

Manufacturing Licensee for Great Britain and Ireland:

Igranic Electric Co., Ltd., Bedford, England

Licensee for Canada: White Radio Limited, Hamilton, Ont.

New Pacent Induction-Type Phonograph Motor

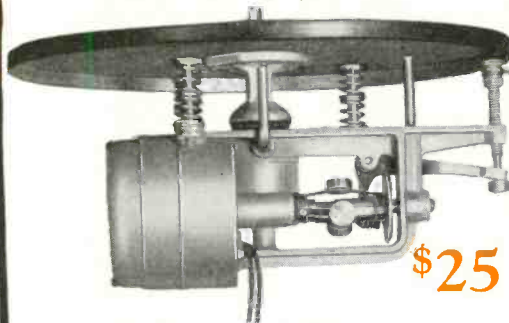

\$25

(Cat. No. 140) Finest electric phonograph made—with 12" turn-table, operating on 110 volts—50 or 60 cycles A.C.

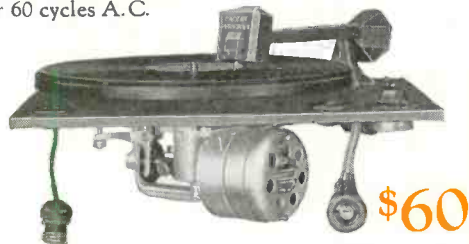

\$60

Pacent Electrovox Chassis

(Cat. No. 311) Completely mounted with the Pacent SUPER Phonovox and Pacent Induction-Type Motor—including automatic stop and radio record switch.

Pacent Electrovox

\$75



(Cat. No. 310) In beautifully finished walnut cabinet—complete with Pacent Electric Motor, SUPER Phonovox, automatic stop and radio record switch (which permits instant change from radio to records without changing a connection in the set).

PACENT



Five Things to Think About When You Buy Radio Tubes



After all the arguments are over—and all the radio tube propositions have had their hearing, you'll emulate Christopher Columbus and make a few discoveries.

You'll find that those who make Sylvania Radio Tubes haven't forgotten they were little fellows once upon a time—and the friendliness of the Sylvania organization in every contact you have is pleasant, happy. No high-handed treatment. No clubbing you into line. No distinction between big dealers and small ones.

You discover five things about Sylvania's proposition—sales features that no other manufacturer assures you. You'll get one or two or three. But not five. Except with Sylvania Radio Tubes.

First—You get radio tubes that are fifteen times inspected before they are shipped. *Every* Sylvania Tube has to pass these tests. Or we junk it. And because the five years' experienced workers aren't rushed by Simon Legree production methods, you get tubes that are pretty near perfection. If any one of them isn't—if it falls down for any reason—

Second—You have Sylvania's Guarantee—the cleanest kind of tube adjustment policy. The judgment of the straight thinking Sylvania Dealer is okay with the Sylvania

Products Company. We appreciate square shooting dealers. . . . *As for the other kind of dealer—*

Third—Sylvania's strict policy is to play the legitimate dealer from hell to breakfast. And thumbs down on the retailer who tries to wreck a good profitable market. *As to price declines, price wars, over-production wars—*

Fourth—Sylvania protects its dealers all the way. You don't worry under any market circumstances because Sylvania leads in production and financial strength. *And there's no wondering about Sylvania Demand—*

Fifth—Sylvania broadcasting through the Sylvania Foresters is building constantly greater demand. And more stations are being added all the time. The Sylvania Newspaper Advertising appears regularly all over the United States. National magazine advertising on a big scale is planned for this fall. And electric signs, transparencies, counter displays, window trims and dozens of other helps are yours if you're a Sylvania Dealer.

Think it over. Then *talk* it over. With one of the hundreds of good Sylvania Jobbers.

B. G. ERSKINE, President

Sylvania Products Company
Emporium, Pennsylvania

Sylvania

RADIO TUBES

Licensed Under RCA Patents

McGraw-Hill Publishing Co., Inc.
JAMES H. MCGRAW,
Chairman of the Board
MALCOLM MUIR, President
EDGAR KOBAK, Vice-President

Radio Retailing

The Business Magazine of the Radio Industry

O. H. CALDWELL,
Editor
M. E. HERRING,
Publishing Director

Vol. 9

JUNE, 1929

No. 6

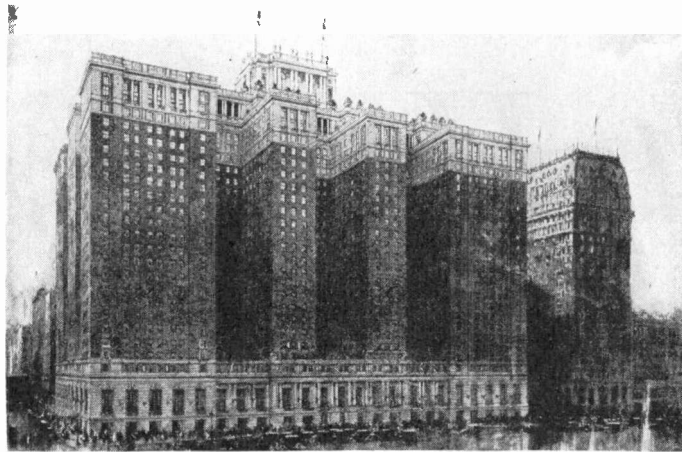

Chicago
June 3 to 7

The

Radio Trade Show of 1929

AT CHICAGO, this week, the stage is set for the greatest display of radio products and the largest attendance of radio merchandising men in the history of the radio trade.

Coming at a time when this vigorous young industry is driving ahead to new triumphs and new extensions of public service and public entertainment, the Third Annual Radio Show will undoubtedly set new high-water marks of practical usefulness to the manufacturers, distributors and dealers who attend.

* * *

THE present annual Trade Show, as sponsored by the Radio Manufacturers Association, serves an important purpose. Historically, it is the specialized outgrowth of those exhibition efforts in the early days of radio broadcasting, when competitive radio expositions and "fairs" filled every available auditorium or armory, and a frenzied public fought for admission into these new chambers of wonders. After a season or two of such public shows, in which dealers and jobbers competed with Mr. Jones and Mrs. Brown for attention in the crowds around manufacturers' booths, leaders in the industry began to discuss the need for an exclusive trade exhibition, held in advance of the customer shows. *Radio Retailing* took up the promotion of this idea vigorously and urged the value of such an "annual market" for the radio trade.

The first Trade Show was accordingly held at Chicago in 1927 and surprised even the most optimistic prophets with an attendance of twelve thousand, surpassing any similar event ever held in any single trade or industry. For months before the exhibition was held, *Radio Retailing* had interpreted the philosophy of this show to its 25,000 readers in the trade and urged them to make the trip to Chicago. In the following year, the 1928 show repeated the success of 1927 on even a larger

scale. And now 1929 will be the biggest of them all.

At the first Trade Show and at each succeeding show *Radio Retailing* has issued a daily newspaper for the benefit of those in attendance. This *Trade Show Daily* is published without advertising and is delivered gratis to all persons registered at the Trade Show or associated conventions. This year, with the exhibits being held in four widely separated hotels and with four conventions going on, *Radio Retailing's Trade Show Daily* seems destined to be even more useful than ever to delegates desiring to keep in touch with all the week's events.

* * *

THOUSANDS of readers of these pages will be in Chicago this week, but many more thousands will not be able to get away from their businesses to make the trip. For this larger majority who remain at home and on the job, *Radio Retailing* has prepared, on the following pages, a preview of the new lines on display at the show, thus presenting "a Trade Show on paper." Leaders of the radio and music industries have also contributed to pages in this issue some of their best thinking on radio trade problems of the day. All this, of course, is in addition to the regular articles and features.

And next month, in the July issue of *Radio Retailing*, full reports and details of new products, convention events and outstanding features will be published.

Thus in July *Radio Retailing* a complete record of the Trade Show will be available for all—both those thousands of stay-at-homes who have been devoting themselves to their businesses and keeping the wheels turning, and those other thousands who made the Chicago pilgrimage, but will want in permanent, condensed, form a summary of the significant trends discernible among the crowding events of the Radio Trade Show of 1929.

In a discount situation where margins of "40 per cent to the dealer" have hitherto been considered adequate, a new school of merchandisers has injected itself during the past year, offering 40 and 5, or 40 and 10, (or more) to the retail trade.

Is *A Wider Margin*



"YES!" *says*

B. J. GRIGSBY

President, Grigsby-Grunow Company, Chicago

THE amount of the dealer's margin or differential depends, primarily, upon the article and its rate of turnover. Fast selling lines obviously require less cost per sale than slow-moving, higher-priced, lines. Arbitrarily to lengthen a dealer's discount, leaving a high sales price, is an obvious fallacy as the rate of turnover is so slow that the dealer's prompt recourse is the one left so invitingly, viz., price-cutting.

For the mutual success of the manufacturer and the dealer, the dealer's "differential" or gross margin must be one which will give him a fair profit based upon a fair cost of doing business. Anything under that invites financial disaster to the dealer; anything over that opens the door to that "easiest way," namely, sales by price or other concessions detrimental alike to dealer and manufacturer.

In establishing list and net trade prices, the manufacturer should bear in mind the above dealer factors—average cost of doing business, fair profit, and rate of turnover of the particular products concerned. He can take into consideration other factors if they enter into the retail sales problem of his particular merchandise, such as service work to be performed by the dealer, local advertising paid all or in part by the dealer, etc. Each article of merchandise should be individually considered by the manufacturer in establishing the net trade price to be placed upon that article.

With these factors in mind we have felt that a discount slightly higher than the customary 40 per cent would meet the special expense elements involved in the retailing—and servicing—of radio receivers. Fourteen months' experience with this slightly wider differential has entirely justified this policy and convinced me that it is the "happy medium" solution of this particular radio problem.

Under it list prices have *not* been tampered with, sales initiative has developed surprisingly and sets have been promptly serviced to the mutual satisfaction of both dealer and user.

And what is more, our dealers report net profit margins for 1928 from ten to eighty per cent greater than for any previous year.

With a sharp difference of opinion on this discount question dividing radio manufacturers into two camps, Radio Retailing has asked leading representatives of the two points of view to state fully the arguments in support of their respective positions.

for Dealers **J**USTIFIED?

AT PRESENT, discounts to jobbers and suggested resale to dealers are based on expediency rather than on a knowledge of the cost of doing business under good management. The Radio Manufacturers Association has voted an appropriation for the purpose of studying distribution costs in the radio industry. Next spring, it hopes to do the same thing with respect to dealer differentials.

The importance of exact knowledge of the facts in any merchandising situation cannot be over-emphasized. Facts—and scientific analysis of those facts—must determine any course.

Successful radio dealers know that profit comes through turnover and operating efficiencies rather than discount alone. Any gross margin beyond the amount needed to show a fair return on the capital investment, under good management, puts a premium on poor management and makes for price cutting and other unsound policies.

The history of other industries shows that branded articles which are demanded by the consumer are priced to meet public favor, with a fair profit to the dealer. Branded goods which have lost out have frequently been priced to provide an artificial, unearned, margin for the retailer.

In other words, there are many factors which must be taken into consideration in a study of this nature. To illustrate: generally speaking, the more rapid the turnover, the narrower the gross margin; again, a two-dollar item generally carries a larger discount than a \$200 product.

An article hard to move or costly to keep sold, requires a wider margin. Further, a particular make of article, the Ford car, for example, which has wide public acceptance, can be merchandised profitably on a comparatively narrow margin.

It will thus be seen that the matter of equitable discounts is highly involved. Adapting the foregoing considerations to the retailing of radio products, and until such time as a most careful analysis points otherwise, it would appear that the present status quo should be maintained.



“NO!” says

H. H. FROST
Vice-President, Kolster Radio Corp.

What Will Screen Grid Do

That is the question which will be uppermost at the Chicago Trade Show and conventions. Some arguments pro and con.

WHAT about the new screen-grid models? Will they dominate the receiver-set market this fall?

Will "screen-grid" junk the old-line standard models and tubes?

Or is the screen-grid demand merely a passing fad?

* * *

Are screen-grid sets as good in actual use, as originally predicted?

Will they stand up in service, to the customer's full satisfaction?

In what way are screen-grid receivers really any better, anyway?

Should we stock screen-grid sets exclusively, from now on, to make a killing?

* * *

ALL over the North American continent questions like these are being asked today. In radio dealers' stores, in jobbers' offices, and in manufacturers' inner sanctums "screen-grid" is the great enigma—the "un-

known quantity" of all merchandising plans for the 1929-30 season.

The trains going to Chicago will be loaded with puzzled radio makers and radio merchants, each trying to find the answer. On the floors of the exhibit halls along Michigan Boulevard and in Chicago hotel rooms, screen-grid will be the one big question mark. Screen-grid, in other words, is the name of the cat whose next jump everybody is trying to guess—and get ready for.

The screen-grid alternating-current tube, originally announced months ago, certainly marks a tremendous technical advance in tube design, in the matter of both amplification and sensitiveness of operation. On that, all engineering advice seems to agree.

The outstanding characteristic of the screen-grid tube, of course, is that it greatly increases amplification in both radio and audio-frequency stages. This, together with its use as a power detector, gives increased distance reception and added quality of reproduction.

From the electricity-supply standpoint it is important

The CYNICS Say:

**"Screen Grid Is Only a Flash
in the Pan"**

because—

Present popularity is merely a passing fad.

Great sensitiveness is not needed. "Static level" is reached by other sets.

Sets are unsatisfactory unless tubes are carefully selected and balanced.

Present sets promise trouble when re-tubed with stock tubes.

Shortage of tube supply is foreseen this fall.

Many so-called "screen-grid" sets now offered do not utilize the new tubes efficiently.

"Screen-grid" name is mere talking point.

Screen-grid sets are no better than any good, commercial, old-line set.

Screen-grid models will eventually take their place as "merely another model."

The ADVOCATES Say:

**"Screen Grid will Sweep Away
All Other Models"**

because it—

Tremendously increases amplification.

Makes greater sensitivity and selectivity.

Will produce great volume with fidelity of tone.

Is independent of line-voltage fluctuations.

Simplifies design and construction of receiver.

Insures more rapid start after turning on.

Will have adequate and dependable tube production by fall.

Reduces factory cost of set while improving characteristics.

Is in an unparalleled state of popular demand today.

Popularity is based upon customer satisfaction, and will be permanent.

to Radio?

Dealers and manufacturers are puzzled. Will Screen-Grid "junk" old-line sets and tubes?



to note that the screen-grid tube remains unaffected by small line-voltage changes. Due to the high-amplification possibilities of this tube, an extremely sensitive set can be designed. Also, because of the screen-grid tube has characteristics which eliminate the necessity for certain balancing or neutralizing practices which heretofore have been commonplace.

Furthermore, it may be safely said that the screen-grid tube for radio frequency amplification is the first major engineering change which has come to the aid of the radio industry by *reducing* rather than increasing the cost of manufacture. Most engineering progress which has been the landmark of past years has increased costs, even while commercial competition at the same time was depressing prices.

THE new trend toward improved performance at lower cost makes itself felt just at the moment when it seemed inevitable that the industry would ultimately establish itself on a basis of profitless prosperity. Competition had been reducing margins rapidly and the trend in that direction needed only to continue a few seasons longer to make the manufacture of radio receivers a charitable pursuit for all but a few quantity producers. Only by reducing costs with each improvement do we make substantial progress.

The economies offered by the screen-grid tube, its friends point out, extend right down to the consumer.

The manufacturer secures as much radio-frequency amplification as he can use advantageously, with a substantially smaller number of radio-frequency stages; that, in turn, means less condensers and inductances to build, and less labor cost to match them accurately, smaller chassis, simpler wiring, and more compact cabinets. The consumer enjoys lower power-supply cost and maintenance expense.

But are the commercial screen-grid sets of 1929 going to live up to the ambitious predictions of their designers, in the present state of tube design and manufacture? This question is asked by practically every screen-grid critic.

Most of the screen-grid sets now in use by the public, were shipped "with tubes." These tubes, it is declared, were all carefully matched and balanced for each individual set. When these original tubes are replaced with stock tubes taken off dealers' shelves, it is predicted that the user is likely to find himself with a totally different-sounding set.

For the tolerances possible in screen-grid tube manufacture are necessarily much narrower than those in the old-line tubes, and unless the tube accurately fits the specifications laid down, trouble is ahead for the listener. If sets now in the public's hands should prove disappointing during the next few months, a sharp reversal of public favor toward screen-grid may quickly follow.

(Please turn to page 112)

A Survey of the Radio

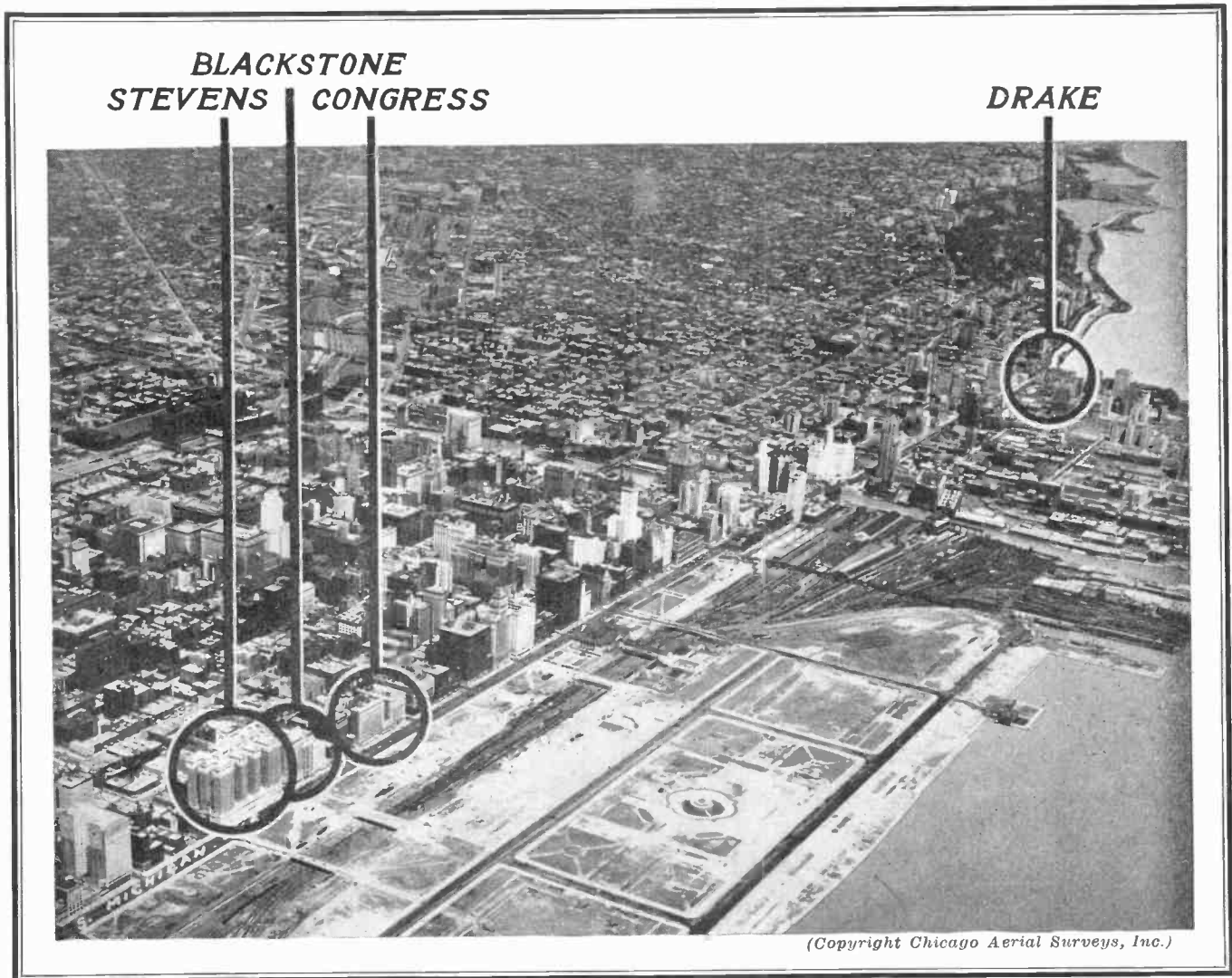

**BLACKSTONE
STEVENS CONGRESS**

DRAKE

(Copyright Chicago Aerial Surveys, Inc.)

Looking down, on the shore of Lake Michigan, at the four great Chicago hotels where the Radio and Music industries will gather for their annual conventions.

By H. W. Baukat

FOR the thousands of *Radio Retailing's* readers who are unable to attend the Chicago Trade Show, the following pictorial review of the merchandise being exhibited has been prepared. While these photos do not represent complete presentations of manufacturers' lines, they are important to dealers as showing the trends for the coming season.

Receivers: In receivers, the outstanding development is, of course, the use of the screen-grid tube. This, with 245 power tubes, used in push-pull, and increased plate voltages, shows a decided movement on the manufacturers' part to improve sets at no increase in cost to the consumer. There is also a serious attempt by several manufacturers, to incorporate the added convenience of real remote control. This, however, is expensive.

Reproducers: Improved electro-dynamic speakers predominate in the field of reproduction. The much dis-

cussed electro-static, or condenser speaker, will be displayed but there is yet much work to be done with it. The magnetic type is giving way to the inductor speaker which is a superior and cheaper type to make.

Combinations: The radio-phonograph combination seems to be holding its own. Pick-ups have been improved during the year past and there is a leaning towards lowering the list prices in order to make this instrument more popular.

Furniture: Walnut continues to be the foremost wood for cabinets. Consoles are assuming neater and smaller designs. Paneling effects and highly grained trims are in great favor. Sliding doors, which although neat looking, give trouble due to warping are being superseded by small doors, opening outward on hinges, each being one-fourth of the width of the front and having a panel effect on both sides.

Trade Show, June 3 to 7

Some of the Latest Console Sets

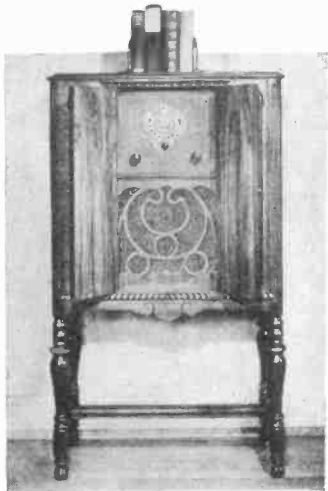

Columbia Phonograph
Co., Model C-11.



Edison, Thomas A., Inc.,
Model R5, \$167.50.



Kolster Radio Corp.,
Model K-45, \$500.



King Mfg. Corp.



Patterson Radio Mfg.
Co., Model 97, \$97.50.



Day-Fan
Electric Co.



Grebe,
A. H. & Co., Inc.



Victor Talking
Machine Co.,
Model R-32, \$155.



Brunswick-Balke-
Collender Co., Model 14

DIRECTORY OF TRADE SHOW EXHIBITORS ON PAGE 114

Console Sets Shown AT THE CHICAGO

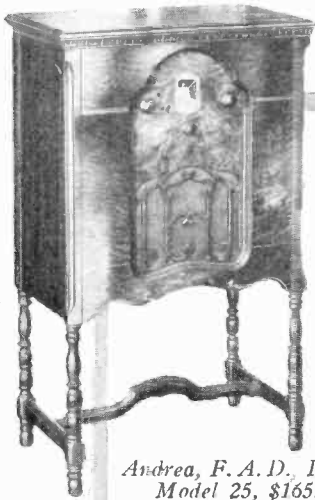

*Andrea, F. A. D., Inc.,
Model 25, \$165.*



*Radio-Victor Corp.
of America,
Model 62, \$375.*



*Electrical
Research Laboratories,
Model CAF, \$187.50.*



*Buckingham Radio
Corp., \$112.50.*

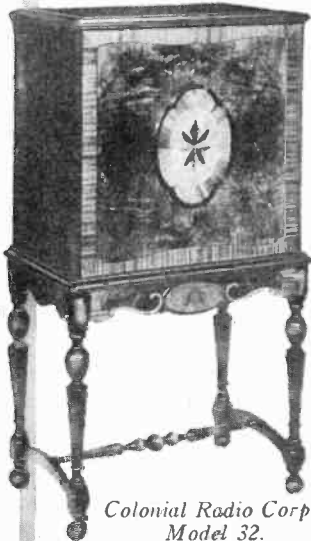

*Colonial Radio Corp.,
Model 32.*

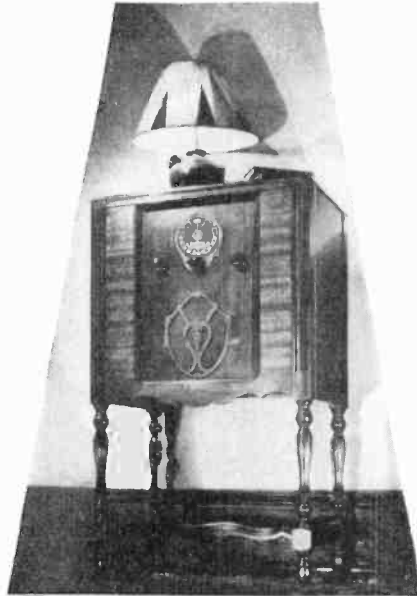

*Brandes Corp.,
Model B15, \$149.50.*



*Kellogg Switchboard
& Supply Co.,
Model 524, \$295.*



*Continental
Radio Corp.,
Model R-20, \$435.*



*Federal Radio Corp.,
Model M41, \$295.*



*Stewart-Warner Corp.,
\$142.50.*

TRADE SHOW and Radio-Phono. Combinations



Temple Corp.,
\$289.

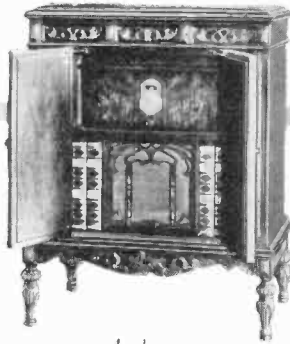

Andrea,
R. A. D., Inc.,
Model 77, \$675.



Brunswick-
Balke-
Collender Co.,
Model 31

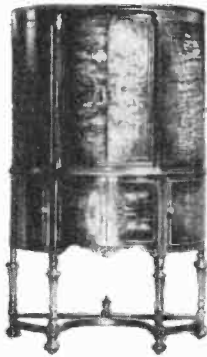

American Bosch
Magneto Corp.,
\$475.

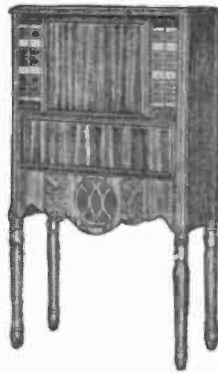

Bush & Lane Piano
Co., Model 12C,
\$297.50.

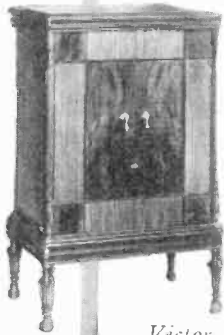

Victor
Talking
Machine
Co., Model
RE-45,
\$275.



Electrical Research
Laboratories,
Model C5F, \$247.50.

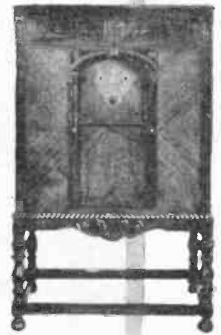

Columbia
Phono-
graph Co.,
Model 940



Edison,
Thomas A., Inc.,
Model C4, \$295.

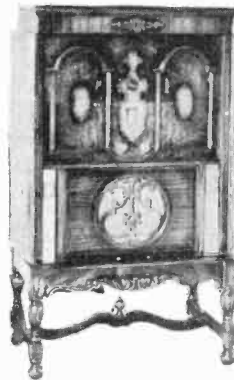

Steinbe Radio Co.
Model 102, \$250.

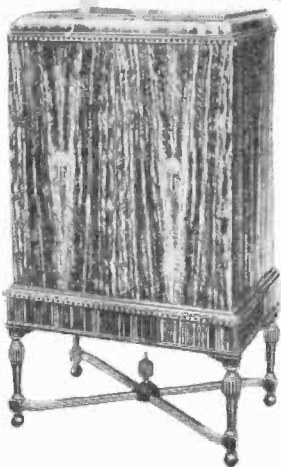

Amrad Corp., \$495.



Continental Radio Corp.,
Model R40, \$725.



Buckingham
Radio Corp., \$169.

COMPLETE EXHIBITOR'S DIRECTORY ON PAGE 114

New Console Sets AT THE CHICAGO



*Leutz, C. R., Inc.,
Model 7CS, \$410.*



Stromberg-Carlson Tel. Mfg. Co., Model 642, \$247.50



Minerva Radio Co., \$175.



Silver-Marshall, Inc., \$195.



Emerson Radio & Phono. Corp., Model C, \$100.

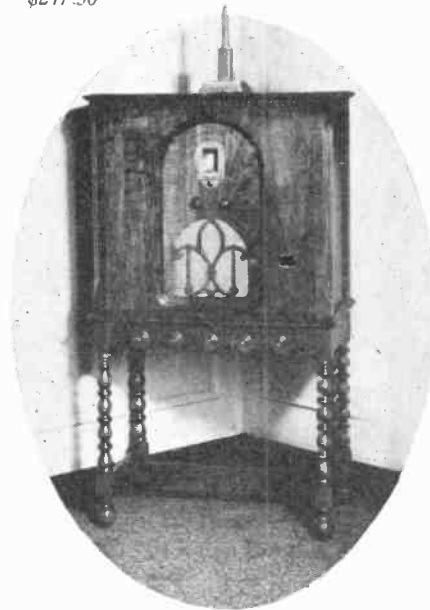

Steinite Radio Co., Model 40, \$135.

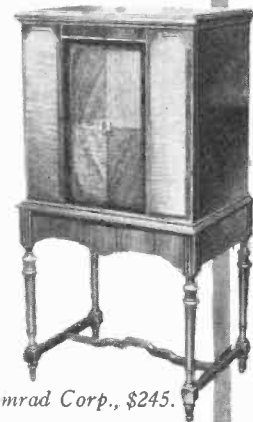

Amrad Corp., \$245.

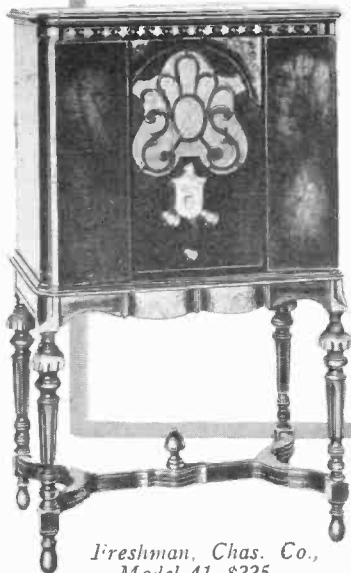

Freshman, Chas. Co., Model 41, \$225.

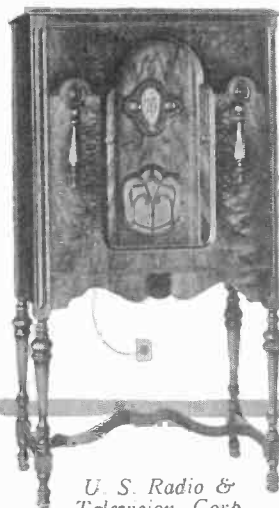

U. S. Radio & Television Corp. (Apex) Model 70 \$149.95

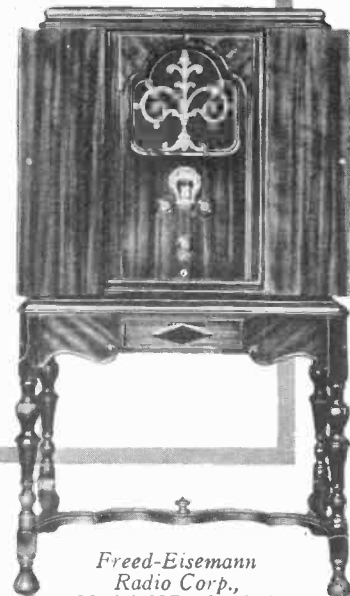

Freed-Eisemann Radio Corp., Model NR-95, \$225.

TRADE SHOW *For the 1930 Season*



*Temple Corp.,
Model 8-80,
\$189.*



*Zenith Radio Corp.,
Model 42, \$175.*



*National Carbon Co.
Model 33, \$210.*



*Bremer-Tully
Mfg. Co.,
Model 82, \$200.*



*Balkeit Radio Co.,
Model C, \$175.*



*American Bosch Magneto
Corp., \$168.50.*



*Howard Radio Co.,
Model 5, \$199.50.*



*Philadelphia Storage Battery
Co., \$119.50.*



*Kennedy, Colin B.
Corp., Model 310, \$197.*

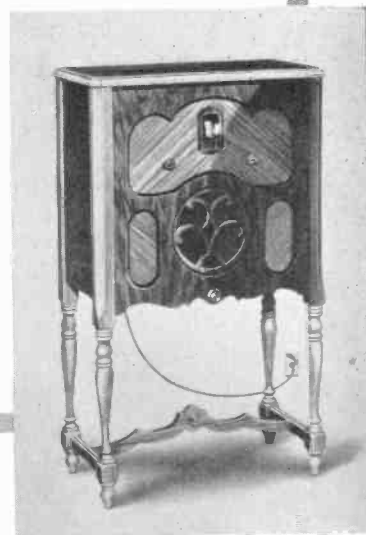

*Consolidated Radio Corp.
(Arborphone),
Model 430, \$119.*

COMPLETE EXHIBITORS' DIRECTORY ON PAGE 114

Table Type Sets Shown AT THE CHICAGO



Andrea,
F. A. D., Inc.,
Model 20, \$99.50.

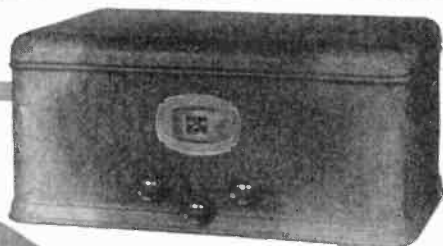

Audiola Radio
Co., \$95

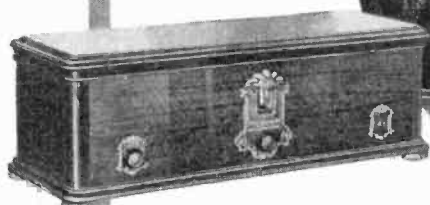

Radio-Victor Corp. of
America, Model 60, \$175.

Stewart-Warner Corp.,
Model 902, \$89.75.



Stromberg-Carlson Tel.
Mfg. Co., Model 641, \$155.



National Carbon Co.,
Model 31, \$115.



Kennedy, Colin B. Corp.,
Model 110, \$115.

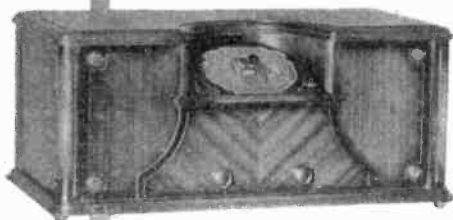

Zenith Radio Corp.,
Model 41, \$100.

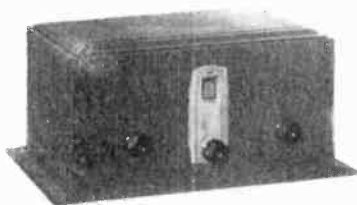

National Co.

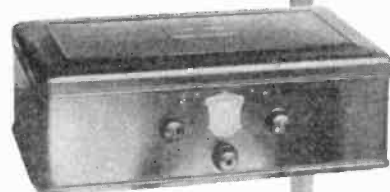

Atwater Kent Mfg.
Co., Model 55, \$88.

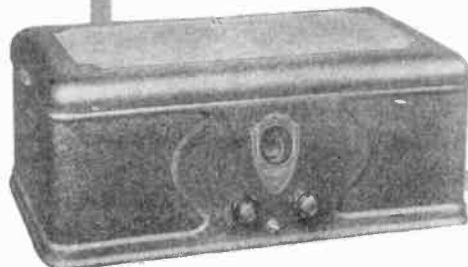

U. S. Radio & Television Corp.
(Apex), Model 89, \$89.95.

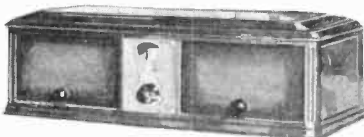

Philadelphia Storage Battery
Co., \$67.



Ware Mfg. Co., \$195.

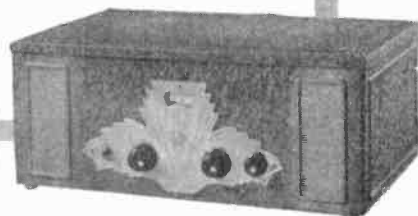

Buckingham Radio Corp., \$69.50.

TRADE SHOW-also *Magnetic and Dynamic Speakers*



Utah Radio Products Co., \$65.

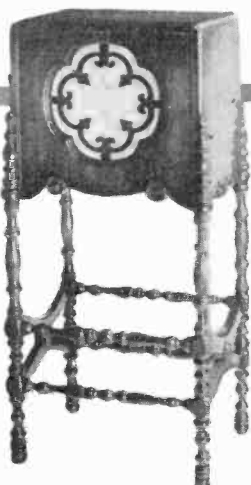

Wright-DeCoster, Inc. \$100.



Andrea, F. A. D., Inc. \$72.50.



Radio-Victor Corp. of America, \$30.



Stewart-Warner Corp., \$19.25.

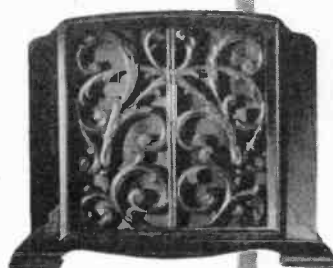

National Carbon Co., \$50.



Davis Industries, Inc.



Borkman Radio Corp., \$40.



Temple Corp., \$39.



Trinan Radio Mfg. Co., \$25.



Atwater Kent Mfg. Co., \$34.



Philadelphia Storage Battery Co., \$32.50.



Rola Co., \$30.

COMPLETE EXHIBITORS' DIRECTORY ON PAGE 114



C. J. Roberts, president of the National Association of Music Merchants and secretary and general manager of Charles M. Stieff, Inc., Baltimore, Maryland, discusses with C. L. Dennis, for RADIO RETAILING, how his company has met the various problems of merchandising radio.

“WE Make Radio PAY!”

RADIO has been a profitable addition to our retail business; the radio and talking machine departments of our stores give us about 25 per cent of our total retail business. This made up for the reduction of our retail piano business. The talking machine business came first into the operations of the House of Stieff, an old, exclusive, piano establishment of unusual tradition. The combination sets brought radio into our business, and as radio became more important we sold more sets.

Radio has come into the music business in three waves—first, as a novelty, without any guarantee as to dependable merchandise or musical attainment, then second with the later, improved, sets and a better brand of musical program. The present or third phase is marked by the electrical set with high-class, dependable merchandise, and the broadcasting of high-grade programs. In none of these phases has the music merchant made substantial profits, in fact, most of them have made none, although the discounts have increased. Unless there is a general tightening up of merchandising methods, there will be a third recession of radio in the music business which will hurt both the radio industry and the retail music trade seriously. I look for this recession soon, too, unless something is done about the conditions existing today.

I have particular reference to the methods which encourage the retail buyer to shop around for reduced prices. For example, the floor salesmen of our piano departments are expected to close sales to 50 per cent of the “drop-ins”—by “drop-ins” I mean the people who

The President of the National Association of Music Merchants states the radio policies of his 87-year-old selling organization.

As told to C. L. Dennis

By C. J. Roberts

*Secretary and General Manager
Charles M. Stieff, Inc., Baltimore, Md.
Dealers in Musical Merchandise Since 1842*

voluntarily call at a wareroom to get information—and an absolute minimum of 40 per cent. In the radio business, our floor men are unable to complete sales to more than 10 or 15 per cent of our “drop-in” prospects. We do not have to go far to find the reason. Our sales in all departments are made at established prices, while the majority of our prospective radio customers are

able to buy at cut prices. The greatest detrimental factor is the leakage in wholesale distribution.

FIRST of all, there is the small, irresponsible, dealer, usually the small shop or agent, without much overhead expense, if any, who, without carrying a real line of display merchandise for demonstration, is enabled to go to the jobber's showroom and demonstrate to customers the expensive models which the pricecutter would never think of putting on his own floor. The sales are then made at cut prices which represent so low a margin of profit that no legitimate retail business could exist on it.

Next to this is the more direct leakage—the sales representatives for jobbers and manufacturers themselves are responsible for a good percentage of the sales which go elsewhere than to the legitimate retailer. These salesmen accommodate their friends and relatives, and then the friends of their friends. It is quite evident that this is destructive to successful radio business through legitimate retail channels.

Yet I believe in jobber distribution for radio even through it has been so severely criticised. No retailer, even a large one, is able to carry a complete stock of various lines and models under the constant changes of radio production. The stocking of all models by a large number of dealers in the same territory, followed by changes of models and the sacrifice of stock would keep the distribution of radio in a constant turmoil. The jobber takes up the slack in this scheme of things, and enables us to keep up with the latest developments in radio without making disastrous investments. We are able to make a turnover of six times a year on our inventory, through close attention to the new developments and our use of the jobber for his reserve stock. I can also point out how the jobber helps us in the organization and development of our retail sales force. With all his faults, I have come to regard the jobber as a worthwhile agency in handling radio and talking machines.

Our radio business is principally in the larger units; probably an average of \$300 per set. We sell at established list prices and we put a carrying charge on time payments. Without the carrying charge our radio business would not be profitable. Our time limit on straight sets is twelve months, on combination sets eighteen months, and our contracts are usually for ten months, with a carrying charge of one half of one per cent a month. This has proved to be a satisfactory arrangement.

WE DO not mix our radio business with our piano sales. When we employ salesmen we endeavor to secure specialty salesmen from various lines—washing machines, electric refrigerators, vacuum cleaners, etc.—salesmen who are accustomed to working with people in the home. I should say 50 per cent or more of our successful radio salesmen have sold talking machines. But we do not have our piano salesmen sell radio. Their training is wrong.

"Our radio business is principally in the larger units; probably an average of \$300 a set. We sell at list prices and put a carrying charge on time payments."

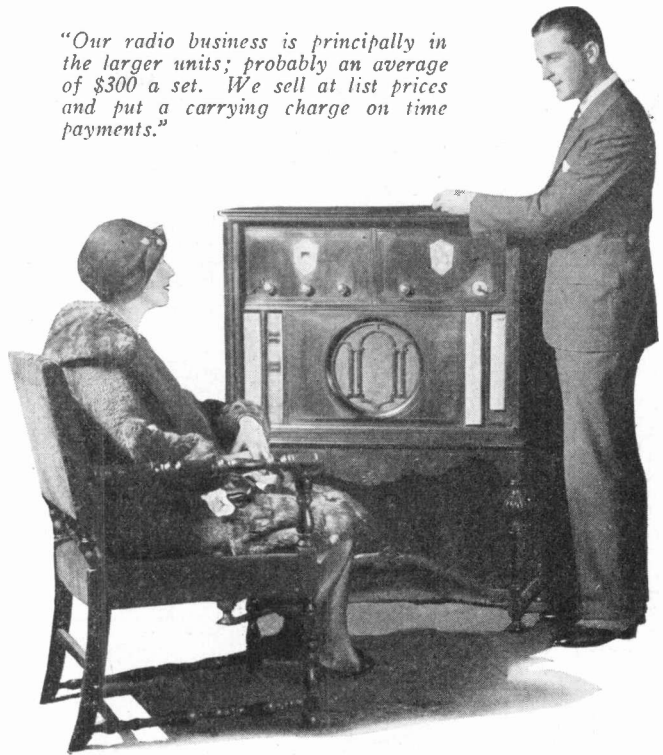

They are accustomed to large figures, long time contracts, and they despise the smaller transactions. They do not place a value in the advantage of short time and quick turnover. When we open a new radio department or recruit a larger sales force for a new line, we advertise for specialty salesmen who are interested in selling radio. The jobbers' and manufacturers' representatives help us to get men, and they help us to educate the sales recruits we get through advertising.

Having the right kind of men and seeing that they have the proper background and start is essential to the proper merchandising of radio.

We pay our salesmen \$30, \$40 or \$50 a week and 2 per cent on sales. For example, a \$30 a week man is rated on \$30,000 sales a year, a \$40 man on \$40,000 a year, and on sales above this rating a double commission is paid. We also give a bonus of 1 per cent on cash down payments above the minimum of 20 per cent on straight radio sets, 10 per cent on combination sets. We allow the salesman \$1.50 a day for auto expense

instead of carfare. We give our employees 5 per cent commission on new leads. We employ three or more outside men on an average to one inside man.

One result of our increased commissions for cash payments is that 35 to 40 per cent of our radio revenue is cash. About 70 per cent of our sales are on time payments.

(CONCLUDED ON PAGE 120)

"We appropriate 5 per cent for our radio advertising and we use the newspapers almost entirely. Occasionally, we broadcast from local stations, but we use no patent sales processes."

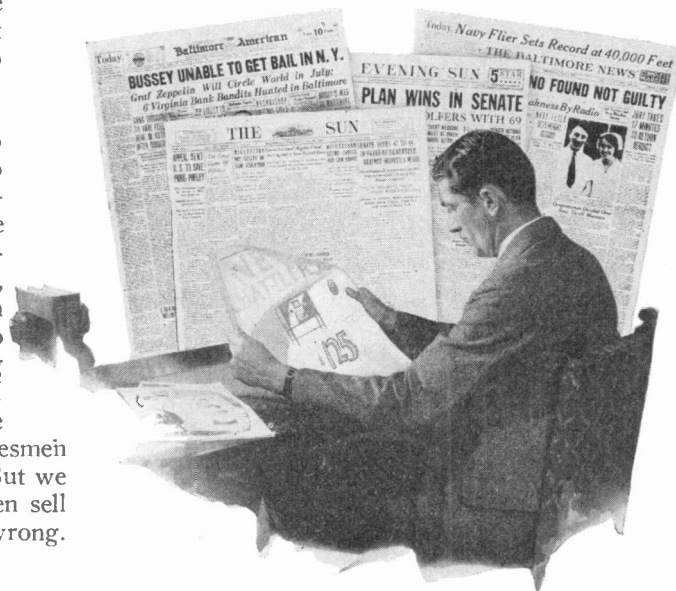

Sit Down and CHECK

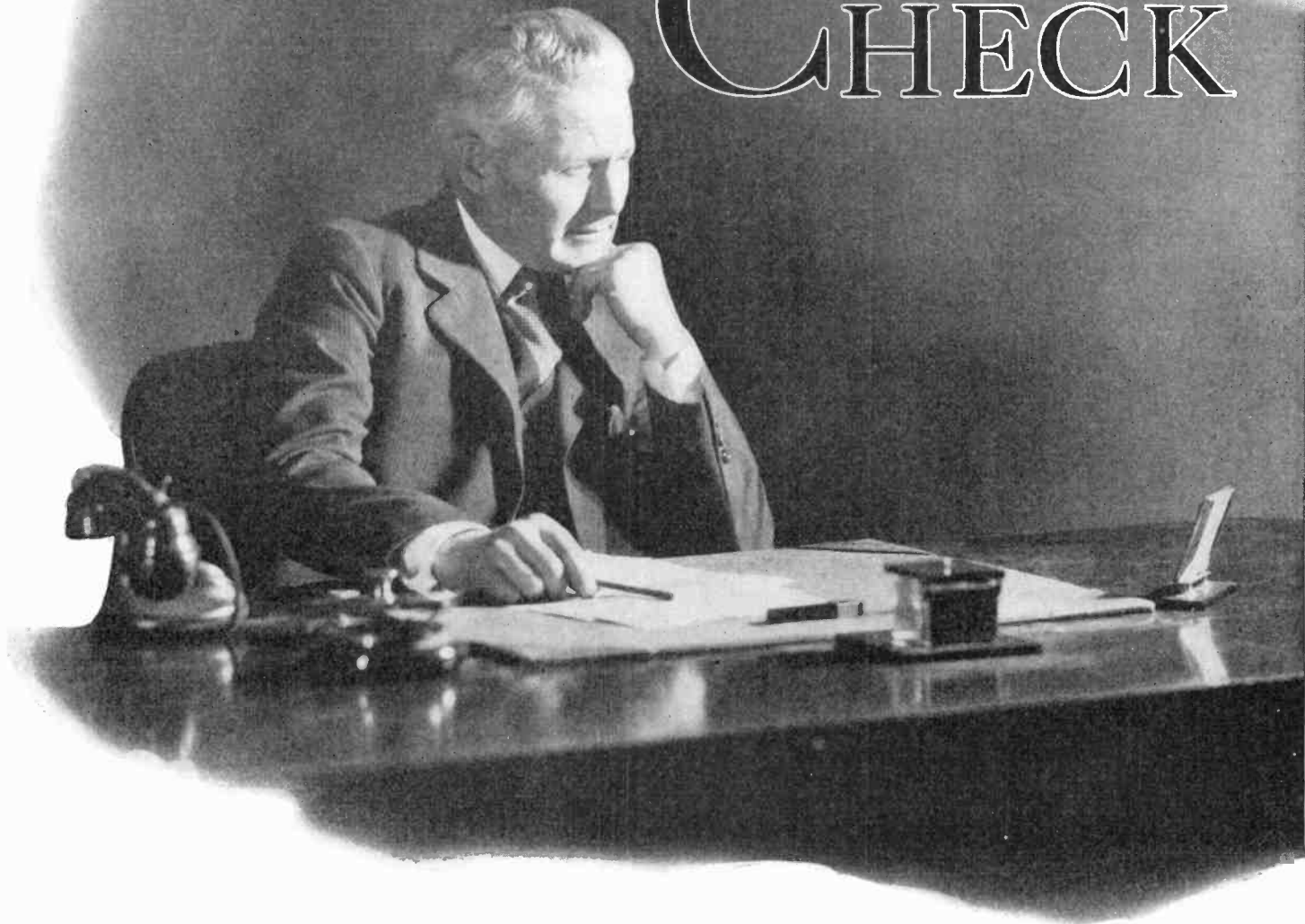

GO INTO a far, dark, corner with a pencil and a piece of paper and this little game. Do it tonight at home—with no one around to disturb you, no one to look over your shoulders, no one to see the answers. Write, as frankly as though you were keeping a detailed diary, the exact answer to each question, in accordance with the instructions. Do it exactly—do it honestly. You'll then be able to get for yourself a true report on your desirability as a radio salesman—and if you want to tear the paper into bits and keep it a dark secret from the world—who but yourself will know the truth? For here is a searching analysis into your capacities.

It will reveal the truth—the whole truth.

Question No. 1 *Of the last ten sales that you closed, how many can you consider sales that you personally made?*

Every salesman gets some orders, "wrap-ups." And every salesman makes sales, too. People who never expected to close the deal on that visit, are sold. People who come in and ask for the low-priced set in the window, find themselves buying a good outfit. These are real sales. And the purpose of the question is to find out how many sales you yourself actually made. If every one of the last ten were created sales, give yourself 100 points. Give yourself ten points for each made sale. Six or more would be exceptionally good. Four would be satisfactory. How many did you sell?

Question No. 2 *Of the last ten sales you closed, how many of these customers might have been convinced that a higher-priced set would have been more satisfactory, if you had really tried to sell them something better than they actually decided upon?*

The test here, of course, is of your own fairness. Every salesman says to himself after certain sales have been made, "I could have sold them a much better one, but I didn't want to take the time." You've said that yourself. Now think about the last ten sales you actually closed and if you are satisfied that not one of them would have bought, or been able to pay for, a better set than they selected, give yourself 100. For each one that *might* have bought a better outfit, deduct 10 points.

Question No. 3 *Of the last ten sales closed, of how many can you say to yourself that you made absolutely no misrepresentation of any kind?*

To this question, 100 points is a probable answer. By misrepresentation, is meant even a statement that might have a double meaning. For instance, did you promise free service for a longer time than it is your company's policy to render such service? Did you let the customer go out with a misunderstanding as to what the set will do in the way of tone or volume or D X reception? Did you slur over the name of the speaker or the type so that the customer thinks he is getting something other than he is actually receiving? For every one of the last ten sales where some misunderstanding may have occurred, deduct 10 points from 100.

YOURSELF UP

Here are TEN Questions which, if answered honestly and frankly, will give a good analysis of your sales performance.

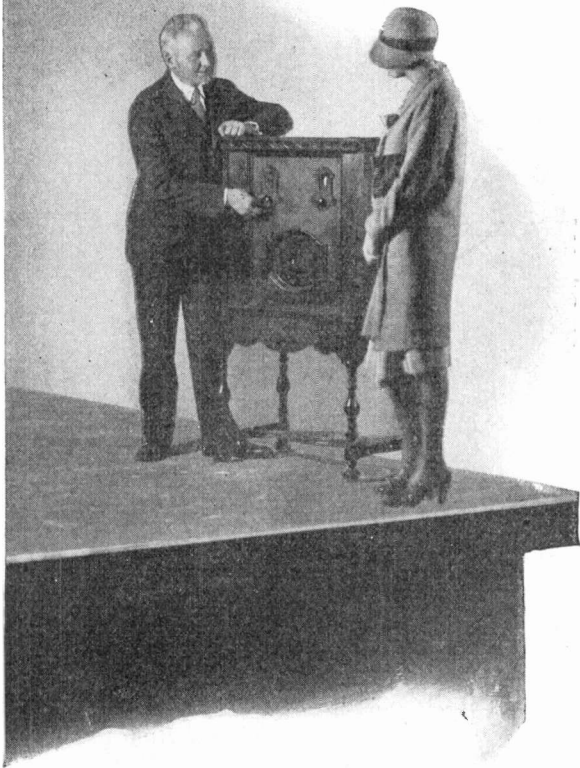

Question No. 4 *Of the last ten customers who bought from you, how many were shown the older merchandise on the floor—the hard-to-sell models, etc.?*

Now every store has perfectly good items in stock which somehow don't move freely. And they are not undesirable items either. Some stores put P M's spiffs, or extra commissions on such items. They may be the top price models of any certain make; they may be extra good cabinets; they may be some odd design which doesn't seem to sell but requires pushing. If you've shown these hard-to-sell models to every one of the last ten customers, give yourself 100—deducting ten points for each sale made where such models were not shown or mentioned.

Question No. 5 *Of the last ten sales you made, are you sure that you secured the best possible terms for payment?*

Did you, in the case of installment sales, try to get as large a down payment as possible? Did you try to cut the terms of payments down to as few months as you believed the customer could afford to pay them in? Did you take an installment contract and feel afterward that perhaps if you had tried you might have had a cash sale? If you believe that in every case you secured the best possible terms, give yourself 100, deducting 10 points for each case where you believe that better results would have been obtained with a little more effort on your part.

Question No. 6 *Of the last ten sales made, was your trade-in allowance as low as possible?*

Regardless of what your employers' policy may be on trade-ins and regardless of whether or not the sale was accepted, there are many cases where the salesman knows after the sale has been closed that the customer was elated over the trade-in allowance—that had he (the salesman) been a little more cautious in handling the sale, the customer might have accepted a smaller allowance for the old set and been delighted! Sometimes the customer will tell you! Many a customer has said: "Well, I never expected as much as that. Thank you, very much!" You yourself and nobody else can answer this one—deduct 10 points for every case where you feel you gave too great an allowance.

Question No. 7 *Of the last ten customers who purchased from you, are you sure that everyone will be a satisfied booster for the house and for yourself?*

As sure, that is, as you can possibly be. In other words, there'll be no after-taste in the customer's mouth—the transaction will be thoroughly satisfactory from every standpoint? You haven't deliberately sold a set that won't work satisfactorily in that customer's home, have you? You haven't sold some thing that you *know* is not suitable merely to follow the line of least resistance, have you? Deduct 10 points for each—give yourself 100 if you are thoroughly sure in each case.

Question No. 8 *Are you satisfied with your handling of each of the last ten sales you closed?*

You are satisfied with your own selling job—you didn't bungle the demonstration and then have the customer buy anyway did you? Are you your own worst critic? Answer this question—look yourself squarely in the eye and deduct 10 points for each case where you are *not* perfectly pleased with yourself—100 points if you are.

Question No. 9 *Of the last ten customers you sold, how many have you used to help you make further sales?*

Did you ask them for names and addresses of friends who might be interested in a similar set? Did they drop any hint that they know someone else who's thinking of buying a set? Did you phone any of them to ask whether any of the people who heard their set the first few days it was working, expressed a desire to get one like it? Ten points come off the par score of 100 for every case where you didn't make the effort.

Question No. 10 *Of the last ten sales made, how many were closed without any special inducements of any kind?*

Extra long terms; low, down payments; special installation price or conditions—these are inducements. Did you offer inducements to close the deal? For each of the last ten sales made where inducements were offered by you deduct 10 points from the perfect score of 100.

Now you have finished the ten questions—add your answers. If you find the total over 800, don't you think you ought to go over them again?

The "LOW-DOWN" on

Wired Called

*Investigation discloses
destructive, development*

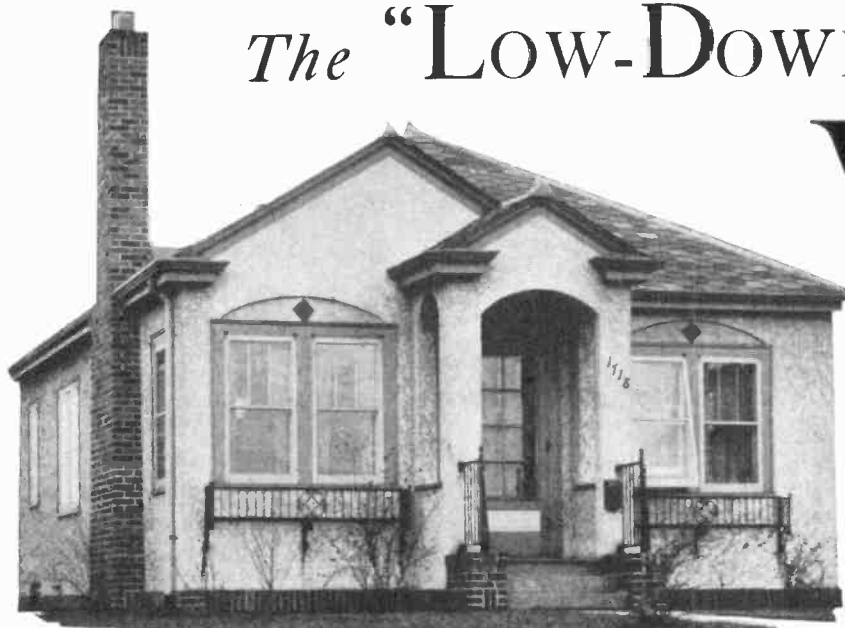

Studio of the Program Service Company, St. Paul, Minn.

LAST winter, for the first time in the history of radio, "wired wireless" or wired program service, was displayed in connection with a dealers' radio show. The place was St. Paul, Minn., and the exhibitor the Program Service Company. No more and no less interest was displayed on the part of the public than for any other demonstration. This was significant.

Wired broadcasting has been recognized by the trade and has been given a place in the industry, but its enthusiastic acceptance by the prospective user is yet to be proven. As the result of a comprehensive survey recently concluded by the editors of *Radio Retailing*, it is apparent that this potential competitor of today's radio sets will require as much selling effort to gain recognition as any other means of home entertainment.

The two methods so far developed for the re-transmission of radio, or other types of programs, may be classified as first, the low-impedance system and second, the carrier-wave system. The former employs independent telephone circuits, on the house end of each of which is a speaker and, at the operating end, a bank of audio-amplification tubes and the necessary pick-up apparatus. The "carrier-wave plan" impresses one or more high-frequency wave bands as carriers on operating telephone or lighting cables.

The low-impedance system is used by approximately 20 concerns affiliated with independent telephone companies. They are well organized and hold frequent meet-

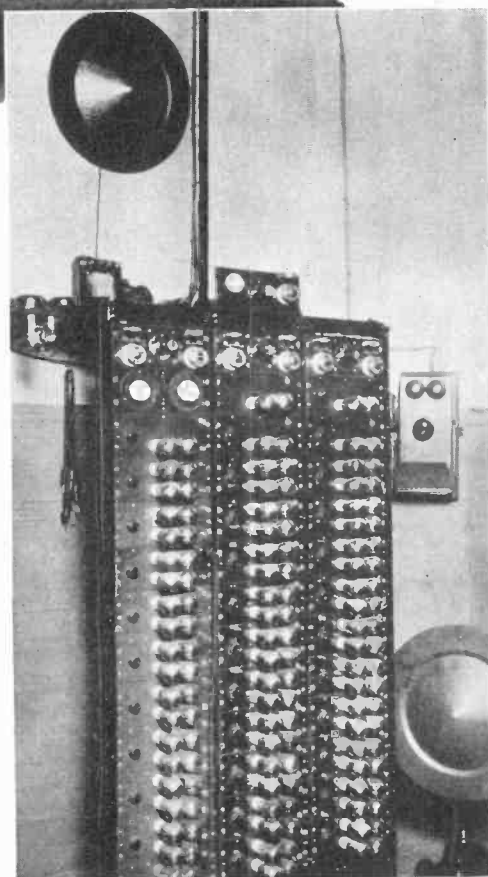

This bank of 130 amplifying tubes in a sub-station of the Tri-State Telephone and Telegraph Company, St. Paul, provides wired radio service for 300 subscribers.

ings. The chief exponent of this system is the Program Service Company of St. Paul, which now has about 2,500 subscribers. The carrier-wave system is at present in an experimental but semi-perfected stage. Credit is given Major-Gen. George O. Squier for its invention. The Kellogg Switchboard and Supply Company, Chicago; the Stromberg-Carlson Telephone Company, Rochester, N. Y., and recently, the Kolster Radio Corporation in conjunction with the North American Company, one of the largest public utility systems in the country, are interested in this method. Wired Radio, Inc. is the name of the subsidiary company representing the latter utility interests. Cleveland, Ohio, has been picked as the initial experimental city for tests this summer or fall.

THE ST. PAUL OPERATION

THE St. Paul activity is the largest and the best example of the practical operation of wired broadcasting to date. The Public Service Company leases from the Tri-State Telephone and Tele-

graph Company the latter's wire facilities. It charges a rental fee of \$5 a month for domestic, one-program, service, and \$6 for commercial installations. During 1928, there was a gain of approximately 500 subscribers bringing its grand total to about 2,500 users.

The majority of these customers, it is claimed, are not the type who otherwise would have radio receivers. They are elderly persons, invalids, "lazy" individuals who prefer simply to turn a switch and listen to whatever entertainment is on tap. Those who cannot afford to purchase a radio set also belong in this category. Poolrooms,

Broadcasting

Incorrectly "Wired Wireless"

*music by wire as a supplementary, not a
to radio — Growth will be moderate*

hotels and other public places are also likely prospects.

That sales resistance is a factor to be reckoned with is evidenced by the fact that an average of four salesmen, on a commission basis, are employed to solicit these \$60 to \$72 per annum accounts and that their best efforts added a gross income of but \$32,000 last year.

The Program Service Company argues that its service frequently functions as a "pioneer" which stimulates the ultimate sale of independently operated sets. "Many persons who at first prefer to spend \$5 a month for radio entertainment become enthused and eventually call on a radio dealer," it states.

A number of St. Paul radio merchants are inclined to agree with this statement and cited the fact that the retail radio business in St. Paul was fully as good last year as in the neighboring city of Minneapolis, which does not have "wired" competition.

On the other hand, two dealers felt that the quality and limitations of a wired-program service gives radio in general a "black eye" and that this activity also encroaches on the market. Because the telephone company, a licensed public utility, endorses this movement, the cry of "unfair competition" has been raised. In view of the fact that the accounting, collection, mailing and servicing facilities of Tri-State are used by the Program Service

(Concluded on page 120)



The customer simply has a speaker like this in the home. This plugs into an outlet connected to the distribution system over which come the programs.



The WHAT, WHY and HOW of Business Control

What	Why	How
The Balance Sheet	Shows relation of assets to liabilities.	A two-to-one ratio is considered by most bankers as safe.
	For establishment of credit with banks and jobbers. Denotes growth or decline of business.	Compare total assets over a period of years
The Profit and Loss Statement	To determine net profit.	Difference between total receipts and cost of merchandise plus operating expense.
	Return on investment.	Relation of net profit to capital invested.
	Status of operating expenses.	By comparing with previous years.
	Gross sales.	Remember to deduct returns.
Inventory	To check stock losses.	By checking actual cost of merchandise sold against cost computed from inventories.
	To determine cost of goods sold.	If actual cost is lower than inventory cost, look for stock leaks.
	For entry as a current asset on balance sheet.	Net purchases plus inventory, at beginning of period less inventory at its end equals cost of goods sold.
	To determine stock turns for past year.	Figure at present worth.
Turnover	Because a high stock turn rate is directly reflected in increased net profit.	Average turnover = $\frac{\text{Total sales}}{\text{Inventory}}$ See above equation; should be at least 6 times in retail radio business.
"Frozen" Stock	Because dead stock slows up turnover.	Hold a "clearance" sale. Buy carefully. Do not overstock.

IN MANY respects, July is a better month for the radio dealer to perform his major business-record recapitulations than January. The latter month comes at the peak of selling activity. Business studies made on the first of the year find stocks near their peak and in a state of rapid flux. Furthermore, the difference between accounts payable and accounts receivable is then apt to be at its greatest.

The June-to-June analysis will constitute a complete business cycle for the average radio merchant. In July, plans for the coming year are being made, inventory is lowest, time and help is available.

Those who decide to pause for a few days in mid-summer, and take stock of past performances and consider future plans, should bear in mind that there are two angles to this matter of business housecleaning—the accounting and the sales promotional. The chief purpose of the former is to furnish information which will aid the merchant *control* his business. The latter activity has to do with the *contacting* of prospects. This article deals with the subject of business control.

There are two control reports which should be compiled as of July first: the balance sheet and the profit and loss statement. The balance sheet, if properly drawn, will reveal the true relation of assets to liabilities. The profit and loss statement analyzes the operating history of the concern. It deals with gross sales, overhead, merchandise costs and net profit.

THE USES OF INVENTORY

INVENTORY is closely related to both these subjects. It is an important item in any asset list; second, it is used to determine the *cost* of merchandise. The latter factor is a very vital thing—yet how many dealers can state authoritatively the actual *cost* of merchandise sold over any given period.

When inventory is used to determine the cost of goods sold it is necessary to know also the total value of the merchandise stock, at *cost*, as of the beginning of the period under consideration. The formula is this: To your inventory, at the beginning of a given period, add purchases for the period being considered, then deduct your inventory at the end of this period.

Average inventory is also used as the divisor in the equation for the determination of stock turns; of which total sales is the dividend. When applying this rule be sure that inventory and sales are both figured either at cost or at retail prices.

When we direct our thoughts to the important subject of stock turnover, it should be remembered that it has

two aspects. First, the relation of "frozen" stock to turnover and, second, the relation of turnover to prices and profits.

These two angles can best be explained by actual examples:

Assume an average stock of \$10,000 and an annual business of \$40,000. If \$2,000 of this inventory is dead or "frozen," then stock will be turned but four times a year. If, however, we could eliminate that item of \$2,000 dead stock we would get a five-time turnover—\$8,000 into \$40,000.

Assume an operating expense of 30 per cent and a desired net profit of 6 per cent. Then, with four turns, total gross margin will have to be 31½ per cent (6/4 + 30). With five turns and the same gross margin net profit can be increased 1½ per cent or to a total of 7½ per cent. In other words: as it costs, generally speaking, but little more to speed stock turns, the savings thus obtained apply directly to that all-important desideratum—net profit.

An analysis of the sales-promotion policies of three Chicago dealers brings out some fundamental principles of

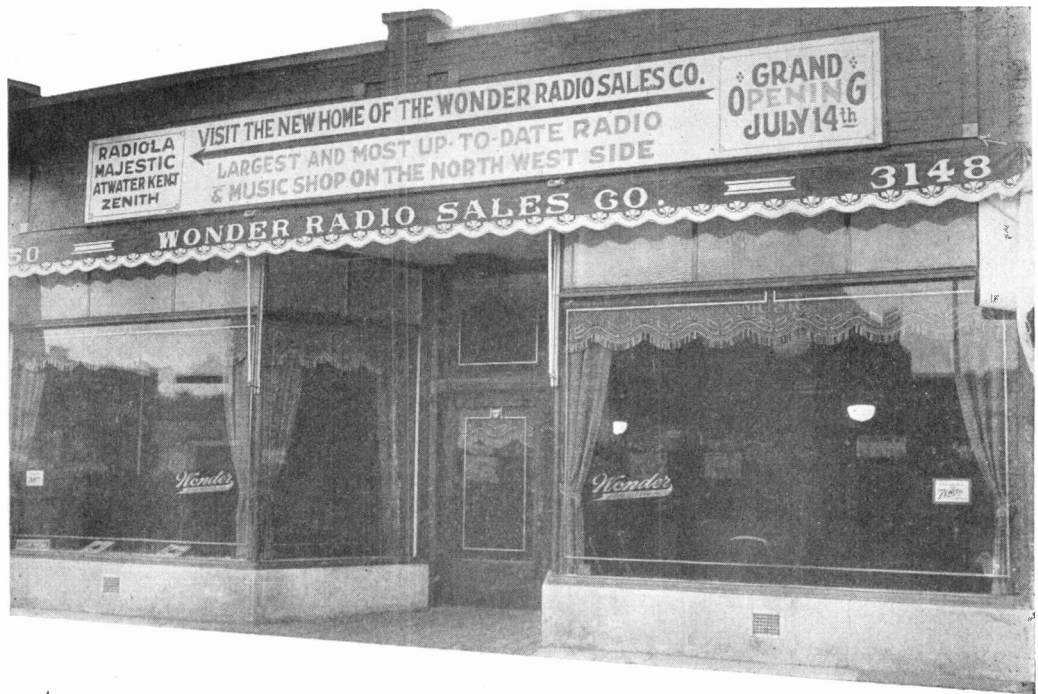

ADVERTISING *That*

10 Advertising Principles for Radio Dealers

By Ray V.

- 1 *Keep in the public eye the year 'round.*
- 2 *Use dominant newspaper location, preferably the upper right position of page three or five.*
- 3 *Sunday and Friday issues pull best.*
- 4 *Use manufacturers' copy for cuts and suggestions but supplement this with local timely and personal messages written to apply specifically to your neighborhood.*
- 5 *Sensational price appeals have lost their power. Use clear-cut explanations concerning the merits of the sets handled and about your firm, to coordinate with a policy of real service to the buyer.*
- 6 *Show windows should afford a clear view of the store. Change trims weekly.*
- 7 *Use direct mail for personalized contact—but be sure your letters and circulars carry a definite story with a "news" value element.*
- 8 *Billboards are good secondary media. Use advisedly to build prestige.*
- 9 *Scrutinize miscellaneous mediums closely. Those entering the house are best.*
- 10 *Appropriate 4 per cent of expected sales volume for advertising.*

WHAT is effective retail advertising? How may radio dealers improve their publicity opportunities?

To answer these questions, the advertising practices of three unusually successful radio merchants in Chicago have been analyzed. These men have been able consistently to expand their respective enterprises over a period of five years; their aggregate gross volume for 1928 exceeded \$500,000; their net profit for the past two years has been over 7 per cent.

Although individual methods varied according to local conditions, it was significant that these "key" dealers agreed as to the *fundamentals* of productive advertising—methods which can be applied by the dealer in Texas, or in Maine, as well as by the fellow in the Middle West.

"Keep in the public eye the year 'round. Use manufacturers' copy, yes! but also get your own personality into the message. Use original, written, circulars. Apportion four per cent of anticipated sales for publicity."

These were the points that were stressed emphatically by every dealer interviewed.

Justin Brothers, of Cicero, for example, average a quarter-page a week in their local paper throughout the summer months and triple that space during the busier season.

To get that happy mixture of the professional touch *plus* local atmosphere Frank Justin spreads an assortment of manufacturers' advertisements before him and then recasts the best ideas, from one or more of these

The
ADVERTISING WORTH of VARIOUS MEDIA
according to 3 Chicago Dealers

	% of Appropriation	Value Per Cent
Newspapers.....	60	45
Windows and Electric Sign....	5	23
Direct Mail.....	20	14
Billboards.....	5	8
Miscellaneous Media*.....	5	10
Novelty Advertising—doubtful	5	
	100	100

*Local broadcasting, movie slides, programs.

Below—The Manor Radio Company, Chicago, combines manufacturers' copy with its own very successfully. Below that is the two-color circular sent out by Justin Brothers, also of Chicago, and at the bottom is one of their physical advertisements.

SELLS!

Sutcliffe

examples, into a piece of copy which carries also his firm's personality and is adapted for local consumption.

The preparation of an advertisement is a matter of logical procedure, declares Mr. Justin, who, incidentally, directs a monthly expenditure of \$900 for publicity.

Before starting a new piece of copy he asks himself this question: "Have I a pertinent message to deliver?"

After assembling his materials he checks the "mechanics" of the job against these seven points:

1. Is my headline sufficiently unique to attract attention?
2. What is the definite appeal in the body matter that will incite action from the reader?
3. Is the text concise, so that it will be read, yet long enough to tell a clear story?
4. Have I made the advertisement attractive—readable—by such tricks of the trade as the use of short sentences, frequent paragraphs, white space, sub-heads, boxes?
5. Are the prices properly displayed?
6. Is the illustration interesting?
7. Does the display carry a distinctive border and characteristic firm signature?

BECAUSE the local press is not doing a 100 per cent coverage job, Justin is a particularly active user of hand bills and mailing pieces. He conducts two circularizations per month, one to a mailing list of over 2,000 genuine

(Concluded on page 113)

Be at the Tunney-Heeney Fight
July 26th

Action! Tune in on the Great Championship Fight

Be at the ringside with the Majestic "See" the world's heavyweight championship "kick" in from on the Majestic.

ORDER YOUR SET NOW TO AVOID DISAPPOINTMENT

To-day's
RADIO
SENSATION
New Majestic All-Electric
7-Tube Radio

ALL MAJESTIC MODELS NOW ON DISPLAY IN OUR SHOW ROOMS
Let Us Bring This Important Event and Other Wonderful Programs to Your Home

BY OUR
FREE DEMONSTRATION PLAN
Conservation Terms

"The Best in Radio"
Manor Radio Co

MEMBER MIDWEST RADIO TRADES ASSOCIATION
7403 COTTAGE GROVE AVENUE
For Demonstration in Your Home, Phone Tri-4121 7295
Open Evenings

Here Are
Your
Grandstand
Seats!

JUSTIN BROS.
"THE HOUSE OF MUSIC"
HOME UTILITIES
5205-07 West 25th Street
CICERO, ILL.

Mr. J. M. Mailson
4134 Jackson Ave.

JUSTIN BROS.
Invite you to hear the greatest of all radio sets:

SPARTON EQUASSONNE

Richer - Finer - Amazingly New

A new sound - a new principle - but best of all, a completely new method of tone. This unique feature EQUASSONNE will give you the depth, the fullness, the "roundness" and "bite" that cannot be duplicated by any other radio set.

\$147 to \$495

Model shown below in this 50-50 dollar set, complete with tubes and cabinet costs only \$199.50

Model 50, set only \$147.00

\$2.50 A WEEK!
SMALL DEPOSIT DOWN
Trade in Your Old Radio or Phonograph
at Price Payment
FREE INSTALLATION

SPARTON RADIO
"The Pathfinder of the Air"

Listen to the Justin Firm, Bohemian Program Every Friday Evening, Station WDCB (1310 Eds.), 7 P. M. to 8 P. M.

SERVICE
Our Service Department, consisting of five experienced radio specialists, is always ready to give you IMMEDIATE and EFFICIENT SERVICE.

OPEN EVERY EVENING UNTIL 10 O'CLOCK

LARGEST BOHEMIAN MUSIC HOUSE IN AMERICA

Mail this Coupon for Catalogue showing the complete SPARTON line and prices:
Name _____
Address _____
Phone _____

Electrical Household Appliances

JUSTIN BROS.
5205-07 W. 25th St. Cicero

The House of Music

“ Portal says: AVOID Service

IF THERE is one particular “grief” in the radio industry, it is the collection of service department accounts. How many merchants have decided upon a safe and conservative servicing policy, have charged for additional service at a reasonable rate, have fixed their credit limit at 30 days and have provided that only good credit risks shall be allowed charge accounts—and yet have endless trouble with this feature of their business?

Mrs. Jones, let us say, has had trouble with her radio set and calls in to ask the help of your service department. She has had dealings with your store before and it is admitted that she is entitled to credit. The service man calls, remedies the difficulty in a few minutes’ time and checks the set, convincing himself that it is operating properly. Mrs. Jones seems satisfied with results. In due course, at the regular billing period, a statement of her indebtedness is sent. This bears, somewhere on its face, the announcement that credit terms are 30 days and that a prompt remittance is desired by the company.

For some reason or other, payment is slow. Mrs. Jones has been a good customer, however, and the matter is allowed to run for as much as ninety days, with nothing more than reminders at the first of each month. At the end of three months, an effort is made to collect the bill.

“No, I shall not pay it.” announces the lady with some heat. “The man was only in my house for a minute and hardly looked at the set. The charge is absurd. Moreover, the set hasn’t been operating properly since and I have no intention of paying until the thing is put in working order. I have been annoyed about this bill long enough. If this is the way you treat customers, I certainly shan’t recommend you to my friends.”

Overwhelmed by this outburst, the representative of the radio company ventures to ask why she did not report the matter earlier.

“Why, I did,” Mrs. Jones assures him. “I met your Mr. Gray on the street the very next day and told him we weren’t satisfied at all and he promised to do something about it. Besides, I phoned in. No, I don’t know whom I talked to—a young lady, I think.”

ON INQUIRY, Mr. Gray denies having met Mrs. Jones on the street and there is no record of any call which, of course, would have been transferred by the operator to the service desk. But what are you going to do about it? Write off a legitimate bill as uncollectible in order to keep a customer’s good will

(and thus, incidentally, confirm Mrs. Jones in her opinion that there *was* something funny about that service charge)? Or put it in the hands of a collection agency and make an enemy for life?

This is by no means an isolated or exaggerated case, as any radio retailer can testify. In fact, you can probably furnish Mrs. Jones’s right name at this very moment from your own experience.

Studying the successive difficulties which arose with our own collections, I became convinced that complaints originated from two sources. We carry about 5,000 active accounts on the books of our service department and it is to be assumed that every name on the list represents a safe credit risk. We maintain membership in the Retail Credit Bureau and carefully check every new customer on his credit rating before any sale is made. When a call comes to the service department from a name not already on our books, the same careful procedure is followed. The customer is asked whether she wishes to pay cash for the service call (in which case the collection is made before the service man leaves the premises) or if she wishes to open an account.

If she says she wishes to charge the amount, she is asked her name and address, her husband’s business and address and whether or not she has charge accounts in any of the local stores. The credit rating is then carefully checked before the name is entered on the books—and this is all done before any service call is made.

Failure to pay, therefore, probably did not arise from any of the causes that go to make up a poor credit risk.

What do you do if, after a service call has been made, you send a bill to the customer and she says:

“NO, I shall not pay it. The man was only in my house for a minute and hardly looked at the set. The charge is absurd. Furthermore, the set hasn’t been operating properly since and I have no intention of paying until the thing is put in working order.”

IT DID appear, however, that in many cases the customer had delayed payment because she thought the service charge excessive. She could not understand the reason for a labor charge, for instance, when the time consumed in making the repair was so short. Experienced service men know just where to look for trouble and in nine cases out of ten can locate the difficulty and remedy it in a few minutes’ time.

It may be only a tube in need of replacement or a connection in need of tightening. The fact that it was necessary to send a man and service truck to her home to make the repair and that there is a legitimate charge to be made for the experience and skill which was able

Editor’s Note—This is the second of a series of articles written exclusively for *Radio Retailing* by E. A. Portal, head of the company which bears his name. Mr. Portal is a pioneer Pacific Coast radio merchant and is known as one of the most progressive retailers on the West Coast.

Collection Troubles

By

☐ *Making the calls last at least 20 minutes.*



☐ *Printing the credit terms on the bills in large, red type.*

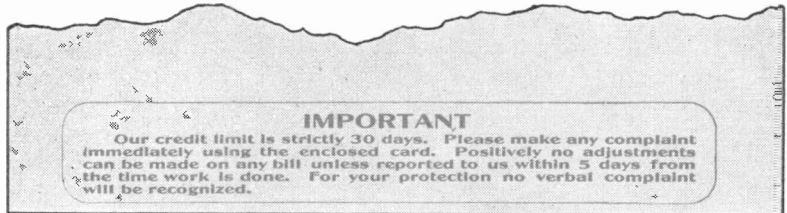

☐ *Sending the bills out 24 hours after the call is made.*



☐ *Including return post cards for further complaints.*

DATE..... INVOICE NO..... SERVICED BY.....

IMPORTANT: Positively no adjustments can be made on any bill unless reported on this card within 5 days from the time work is done. Kindly list any complaint below so that we may investigate it immediately.

.....

.....

.....

Please Have Your Service Man Call Again Date..... A. M..... P. M.....

NAME..... ADDRESS..... PHONE.....

to recognize the difficulty, does not always make itself clear to the customer.

This was easily remedied by making a rule that the minimum time to be consumed in any service call shall be twenty minutes. The service man is required to test the set thoroughly, even though the immediate trouble has already been remedied, noting aërial connections, testing tubes and checking other common sources of trouble. Not only does this impress the customer with the fact that she is actually getting a service for which she should legitimately pay, but it also occasionally uncovers incipient trouble which might shortly have necessitated another service call.

Here is another cause of collection difficulty. Suppose after your man has called and put a set in working order by replacing a tube, that two days later it develops trouble from quite another source and refuses to operate properly. Will not the immediate reaction of the customer be that your man did not do his business properly and that the cause of the trouble is the same as that before his call? The perfectly legitimate charge for the original call will thereafter always be in dispute. Checking the set and catching such troubles before they develop make such a possibility extremely unlikely to arise.

After the adoption of this policy of insisting upon a twenty-minute call on the part of the service man, complaints against service charge dropped fully ten per cent.

THE second major classification of collection troubles arose from the fact that considerable time was allowed to elapse before the bill was presented for payment.

The customer had time to forget the urgency of her need and the importance of the service rendered. She may not have been at home at the time the call was made and the servant may have failed to report what was done. Furthermore, in the weeks, or months intervening, there has been every opportunity for the set to develop other troubles.

The set is out of order again—it certainly seems hard to have to pay for a repair job which apparently produced only temporary improvement. Asked why the trouble had not been reported, it is very human to meet the implied rebuke by "remembering" a telephone call which somebody had failed to report or a conversation now impossible to check.

It must not be overlooked that some of these complaints are actually justified. The set may really not have operated properly after the service call and there is legitimate dissatisfaction to be remedied. Here the lack of contact with the customer has allowed an unfortunate situation to arise. Had a prompt second call and perfect courtesy bettered the fault, a friend might have been made whose good will would be of value. By letting it go until an attempt at collection has added insult to injury, diplomatic relations become difficult to restore.

Two simple changes in procedure have almost eliminated this source of trouble. First, bills are sent within twenty-four hours after the service call has been made. This is infinitely better than waiting until any stated billing period, for the occasion is fresh in the customer's mind, there has been no time for a servant or for any one else to forget what has been done, and, moreover, the set is likely to be in the same working condition as when the service man left.

SECONDLY—and this has proved to be the real solution to the problem—there is printed on the bill the statement:

IMPORTANT

Our credit limit is strictly 30 days. Positively no adjustments can be made on any bill unless reported to us within 5 days from the time work is done. For your protection, no verbal report will be recognized.

This for some time appeared at the bottom of the bill in small type, but it was frequently overlooked. Not until we printed it in red, in much larger type across the face of the bill, did it receive proper attention. At the same time we included a post card which carried the same message with the additional appeal "Kindly list any complaint below so that we may investigate it immediately."

At the bottom of this card is space for the customer to enter the date and time at which a second service call will be convenient.

This has turned the trick. First, and most important of all, is the fact that it has enabled us to check back on service calls and to remedy any misunderstanding or dissatisfaction at once. This is more important than may appear to the retailer who has not tried it. It is an easy matter for the merchant to blame his service collection troubles on the idiosyncrasies of human nature, confident of the infallibility of his service department.

But his service department is not infallible. We have seventeen men employed in service work and we have made every effort to insure that they are experts and that our service is dependable, but nevertheless, out of 75 to 80 calls, we receive back every day one or two of these cards asking for further service. Frequently, it is only a misunderstanding or ignorance on the part of the customer, but it is invaluable that we should have an opportunity of clearing up the situation before it develops to anything of moment.

It is gratifying to record that it is this aspect of the situation which has appealed to the customer. There has been no objection expressed to the restriction printed across the face of the bill, but, on the other hand, an appreciation of the willingness of the company to make good any situation that is not satisfactory to the customer.

HARDLY less important from the standpoint of later collections is the acknowledgment of satisfaction which failure to return the card implies. The customer, after a month or so, can have no excuse for protesting the bill.

Note also that complaint must be in writing—the imaginary telephone conversation is ruled out of consideration in advance.

These simple changes in billing procedure have almost entirely eliminated trouble. The service man takes twenty minutes or longer for his call. Bills are sent out at once and payments come in, some of them immediately, which is all to the good, the average within sixty days' time. The occasional bill which must go into the hands of the collector is not protested. We are keeping our friends and collecting our bills at the same time—surely the aim of every efficient collection department.

It can be done.

Get PEP in your Summer Windows

The use of an electric fan and colored crepe paper will enable you to build a live, cool-looking, summer display.

By I. L. Cochrane

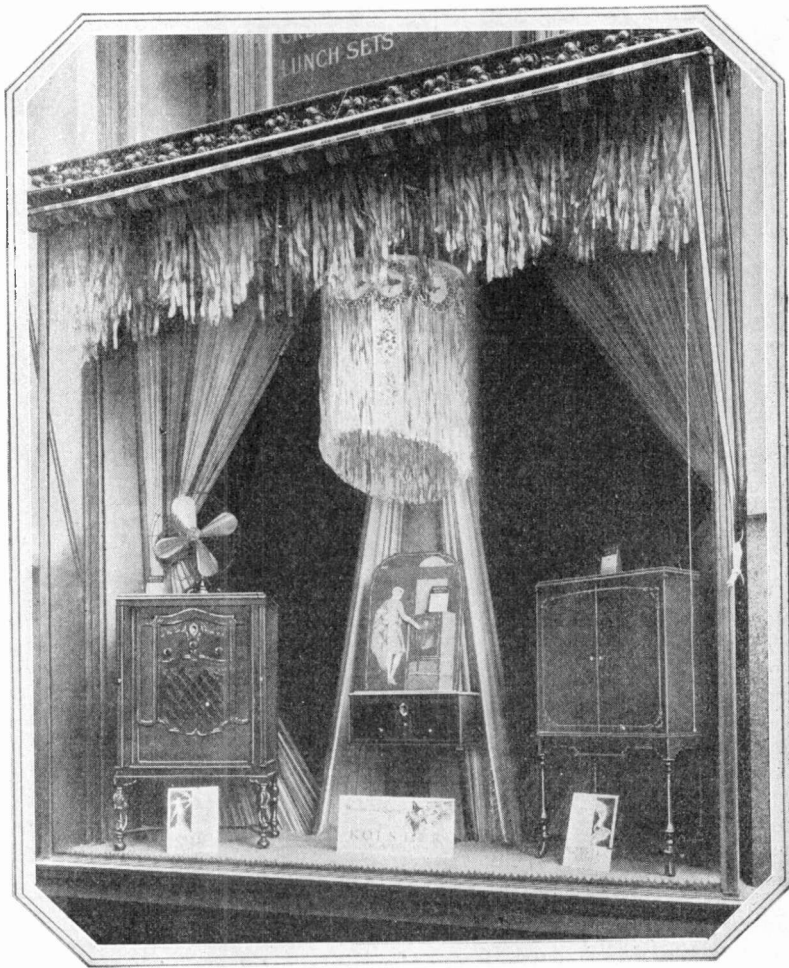

The fan makes the crepe paper shade and valance flutter in a light breeze, thus getting action in the window and creating a striking suggestion of coolness.

HERE is a cool-looking summer window in which the element of action rivets the attention of the passer-by and arouses his interest in the display. An electric fan, visible or concealed, as preferred, imparts a fluttering motion to the fringed paper lamp shade and valance, and gives life to the whole window.

The simple, colorful, arrangement of cool green, shades and light brown crepe paper, profusely fringed, and fluttering as though in a light breeze, create a striking suggestion of coolness. The entire cost of the material used in this display is \$3.63.

In the illustration, a shallow window is shown. If your window is deeper, add a small wicker table and a chair and place two tall glasses on the table. The glasses, partly filled with an amber-colored fluid (to imitate, say, ginger ale) and a couple of straws projecting out of each, will add a human-interest touch.

The material used in this window is Dennison's crepe paper, as follows: one dozen folds No. 47; 3 folds No. 71; 1 fold No. 42 and 1 fold decorated crepe No. 415.

THE lamp shade is a very simple affair. Take a keg hoop or a ring of stout wire to form a circle for the top, about 15 inches in diameter. Criss cross string so as to form a center from which the shade is suspended. Then take four pieces of No. 47 jade green crepe paper, fold in half and cut a fringe, the uncut end being pinned to the circular top. The decorated crepe No. 415 is then cut out, following the pattern. The decoration around the top cuts out in one strip and is pasted over the green

base at the top. Four pendant strips are then pinned or pasted so they hang free with the fringe. When the shade has been hung to correct height, trim bottom in long, sweeping curves, in order to give the bottom an irregular edge.

Into the shade place an electric socket so that it is concealed by the decorated top. One white lamp gives a dainty effect. However, by using a three-way socket a still better effect may be secured. With one lamp white and continuously burning; the two others should be blue lamps with a flasher button in each socket. If no blue lamps are available place a wire guard over each of two white lamps, and cover the guards with blue or green tissue paper. The decorated paper top of the shade conceals the lamps, while the varying intensity of colored light adds another touch of action—and interest.

The valance is of slashed crepe paper, in sections of jade green and light brown, the depth being the width of the sheet. The sides and back section are formed with 4 pieces of crepe, 2 jade green, 2 light green, and cut in half, which gives 8 pieces, using 4 on top and 4 on the bottom. Rosettes are formed from 1 fold of light brown crepe. The side pieces are folded on bias, the rough side of the crepe turned out as usual.

The brown edges are tubular. These are formed by cutting crepe in 3-inch strips, folded back and forth 5 or 6 times and then folded back to meet each edge. There are three tubes on each side and four in the center. Cover the floor with jade green. If grass mats are available they make an attractive floor covering.

The finest
RADIOLOLA
*ever built at anywhere
 near this price*

THE NEW RCA 33—

\$77⁵⁰
 LESS RADIOTRONS

Ride with Radiola 33 on the crest of the wave of popular approval—the latest achievement of RCA, Westinghouse and General Electric laboratories.

A console type cabinet receiver of charming design and superb tone. Its slender gracefulness and beauty fits into any scheme of interior decoration—in a cozy apartment or a spacious drawing room.

Radiola 33 has everything—plus RCA dependability. Truly a quality receiver priced remarkably low. \$77.50 (less Radiotrons.)

RADIO-VICTOR CORPORATION OF AMERICA
 RADIOLOLA DIVISION
 NEW YORK CHICAGO ATLANTA DALLAS SAN FRANCISCO

RCA RADIOLOLA

MADE BY THE MAKERS OF THE RADIOTRON



*This sign marks
the leading center
in every commu-
nity.*

RCA RADIOLA 33—Tuned radio frequency receiver, console type, for A. C. house current operation. \$77.50 (less Radiotrons.)

RCA LOUDSPEAKER 100B—To match Radiola 33—unique in design and in tone fidelity. \$22.

RADIOLA DIVISION
RADIO-VICTOR CORPORATION OF AMERICA NEW YORK CHICAGO ATLANTA DALLAS SAN FRANCISCO

RCA RADIOLA

MADE BY THE MAKERS OF THE RADIOTRON

Radio Retailing

A McGraw-Hill Publication

JUNE, 1929

Vol. 9, No. 6

Business

A QUARTER

We Want No Receiving-Set Licenses

ONCE more the question of requiring a government license for all radio receivers is raised at Washington. Senator Brookhart, of Iowa, seems to think that each radio listener should pay a dollar or two a year for use of the air.

Federal radio administration now costs the taxpayers about \$800,000 a year, as set up with the present wasteful dual system of Commerce Department and Commission control. (The Commerce Department could handle it alone for \$500,000 or less).

But even this means an actual present tax burden of less than one-half to two-thirds of a cent per year per person for each of our 110,000,000 citizens. Under a license plan, imposing a dollar or two per listener, half to two-thirds of the fees collected would have to go to maintain the license system itself.

The present plan is simple and effective. Why change it, simply to create one more, costly, inefficient bureau, to be manned by politicians and burdened upon the radio public?

Would February Be a Better Month?

WITH the events and style changes which have come crowding upon the radio trade this spring, we hear comments that the interest of the radio industry as a whole would be better served if the Annual Trade Show could be held *early in the year*, rather than in June.

There seems to be developing a strong feeling that along about the first of the year would be the most desirable date. Of course, January would be out of the question on account of inventories, and winding up the preceding year's business, including the Christmas rush. But by February, these things are all out of the way and so February seems a logical time.

If samples of all the new lines were to be shown to the radio trade in February, and orders placed then, or shortly afterward, production would be stabilized and more time given for manufacture against fall delivery.

What Does It Cost to Sell Radio?

RADIO RETAILING is undertaking a big job of getting some information vital to the radio industry.

What is it costing to retail radio?

Your prosperity as a dealer—and that of other radio dealers in other cities—depends upon accurate knowledge of such costs.

Manufacturers' discounts to dealers and jobbers must

be based upon dependable figures on the cost of distribution.

Nobody has such figures on radio selling as it exists today.

Yet everybody in the radio business needs them.

So *Radio Retailing* is setting out to get them for the industry.

You can help us by filling out one of our questionnaire blanks, and in return for your assistance in supplying your confidential figures, we will, before the close of the survey, furnish you with similar figures (names and addresses, of course, omitted) on businesses comparable to yours.

Here is invaluable information which you may have—at the cost of only the time to answer a dozen or so questions about your business.

What We're Trying to Do

THE other day, some one asked us to state, in one paragraph, the underlying purpose of *Radio Retailing*. Here's our answer:

"*Radio Retailing's* major editorial objective is to equip the homes of America with adequate radio and other home-entertainment devices, enriching the lives of our millions. In accomplishing this great purpose, *Radio Retailing* seeks to build up a prosperous, substantial, radio industry and trade, and therefore devotes its pages to the improvement of distribution methods, through the exchange of ideas on sales promotion, advertising, sales operation, financing business administration, servicing, etc., together with news of the latest radio products offered for sale."

Mark the Dials in Kilocycles

IN A statement recently issued by the engineering division of the Radio Manufacturers Association, it is recommended that radio-set manufacturers mark dials in kilocycle designations only.

The chairman of this committee, H. B. Richmond, Cambridge, Mass., states that the kilocycle designation on receiving set dials is becoming general and follows the adoption of the kilocycle standard by the Federal Radio Commission and other scientific bodies. He finds that last year's practice of calibrating dials in wave lengths, as well as kilocycles, was confusing and concludes, "The tendency in new receiver design is decidedly in favor of marking dials with but a single scale, that of kilocycles."

The kilocycle scale provides a simple, uniform mark-

Has Invested

BILLION Dollars in Radio

ing for identifying broadcasters, and should be generally adopted. It is now up to the individual manufacturers to lead the way, each in the design of his forthcoming sets.

We're a \$235,000,000 Business

RADIO is growing up. We have \$235,000,000 invested in plant facilities for manufacturing and broadcasting, and we employ 110,000 people to make and distribute sets and programs. And our annual gross sales total \$630,000,000. Here are the complete figures as estimated by the editors of *Radio Retailing*, in response to a request from a pioneer in the business:

	Investment	Annual Gross Revenue	Number of Employees	Annual Payrolls
Broadcasting Stations . . .	\$25,000,000	\$30,000,000	10,000	\$10,000,000
Manufacture and Distribution of Radio Sets,	\$210,000,000	*\$650,550,000	100,000	\$200,000,000

*at retail

When Distributors Cut Prices

SOME manufacturers appear not to have a clear understanding of their legal rights should they desire to regulate distributors who are cutting prices.

Decisions rendered by the courts have repeatedly held that such a manufacturer may, entirely within the law, "withhold his goods from those who will not sell them at the prices which he fixes for their resale." To do this is within the statute.

What the law does *not* allow, is for the manufacturer to make agreements or accept promises or assurances from distributors that they will conform with the suggested minimum resale prices. The manufacturer is allowed *only* to make a statement of his policy, and to enforce it.

Captain Guy Hill, "Watchdog" of the Listeners' Interests

EVERY radio listener, every radio dealer and every radio manufacturer owes a debt of gratitude to Captain Guy Hill, of the Signal Corps, United States Army, for his devoted services in clearing the broadcasting

wavelengths of interference, in his capacity as engineer for the Federal Radio Commission.

Holding a true vision of radio's possibilities for service to 110,000,000 fellow-Americans, Captain Hill, for twelve months past, has indeed played the part of "watch dog of the ether waves."

Against political pressure, broadcasters' pleadings, legal threats, and personal pleas, he has stood fast and hewn squarely to the engineering principles involved. In thus holding the lines unflinchingly against daily attempts at encroachment, Captain Hill has performed a splendid and necessary service, that has made radio better for every listener,—and business better for the radio trade.

People Have More Money to Spend

THE volume of business during May in the United States as a whole was 2 per cent above the same month last year, while Canadian business was about 14 per cent greater. Four sections of the country, however, report current business under last year, the South Atlantic States leading with a drop of 10 per cent. General retail trade during April was 3 per cent above that of last year, and the outlook for the next 90 days is for a volume of about 5 per cent above that of the same period a year ago.

These optimistic trends in general business are the result of the continually increasing buying power of the American consumer. The spending margin of the average consumer, as indicated by the accompanying chart has increased by about 5.5 per cent during the past twelve months until today it is almost 38 per cent greater than it was in 1914.

While the trend in the cost of living has been downward since the war, the weekly money earnings have been almost continually upward, thus leaving a greater and greater spending margin.

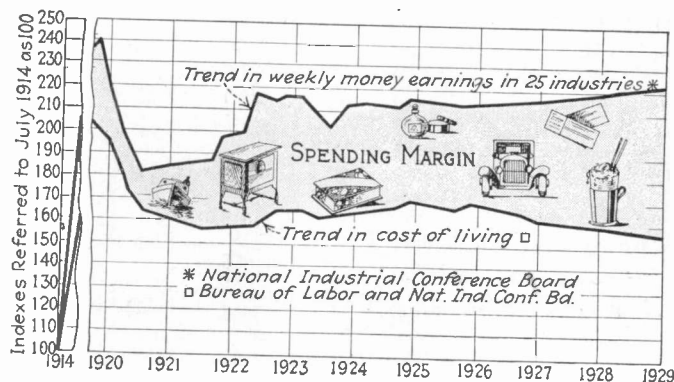

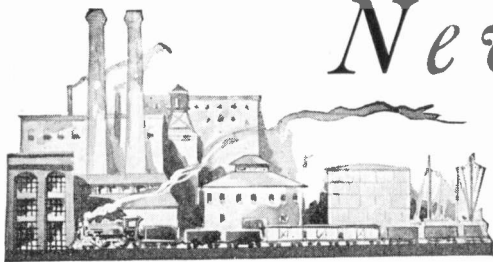

New Products for

This editorial section is prepared purely as a news service, to keep readers of "Radio Retailing" informed of new products.

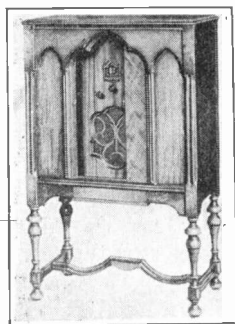

Kellogg's New Line

Two radio receivers and a radio-phonograph combination have been introduced by the Kellogg Switchboard and Supply Company, 1066 W. Adams Street, Chicago, Ill. A feature of the line is the control knob on the panel to set the limit within which the volume is automatically controlled by a K-27 heater tube.

Model 523, illustrated, uses three K-24's, three K-27's, two 245's in push-pull, and a 280 rectifier. The cabinet measures 46 in. by 29 in. by 16 in. The intended retail price is \$250.

Model 524 uses three K-24's, three K-27's, two K-50's in push-pull and two 281 rectifiers. It comes in a slightly larger cabinet than the 523. Price, \$295.

Model 525, the radio-phonograph model, has the same chassis as model 524. The overall dimensions are 51½ in. by 30½ in. by 20 in. Price, \$395. —Radio Retailing, June, 1929.

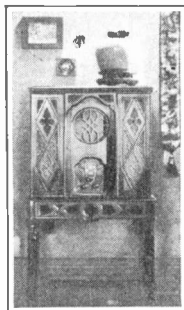

Bosch Receivers

The American Bosch Magneto Corporation, Springfield, Mass., announces three new sets, all with the screen grid tube. The chassis has seven tubes—three 224's in the r.f. circuit, one 227 in the detector, two 245's in push-pull and a 280 rectifier.

The table set has two sliding doors to enclose the control knobs. The intended retail price is \$119.50 less tubes.

The combined set and speaker console has the new Bosch dynamic reproducer and lists at \$163.50.

The illustrated highboy model with an attractively carved front and sliding doors, is \$240, less tubes. —Radio Retailing, June, 1929.

New Edison Line

A feature of the new line presented by Thomas A. Edison, Inc., Orange, N. J., is the "Light-o-matic" tuning. By simply pressing a knob the station is brought in and the dial lighted up automatically. The standard chassis, based on neutrodyne principles, has five 227's in three stages of r.f., detector and audio, with two 245's in push-pull, and a rectifier. Combined with the power unit is the dynamic speaker.

The illustrated console model, R-4, in a blended walnut finish cabinet with quarter matched sliding doors and raised butt walnut panels, is \$197.50.

Model R-5 comes in a blended walnut finish cabinet with sliding doors. It is slightly smaller in size and lists at \$167.50.

Model C-4, a radio-phonograph combination, has the Edison electric pick-up (needle type), and an automatic stop, which operates on all makes of records without setting. It is 48 in. high by 28½ in. by 19 in. Price, \$295. —Radio Retailing, June, 1929.

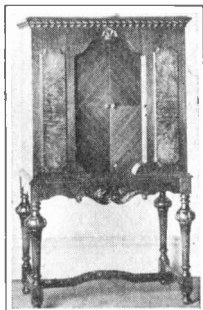

Day-Fan Receivers

The new set just announced by the Day-Fan Electric Company, Dayton, Ohio, is available in three walnut console models and a table model. The standard eight tube r.f. circuit with improvements is used.

The tubes employed are four 226's in the r.f. stages, 227 detector, 226 in the first audio two 245's in push-pull, and a 280 rectifier. A newly developed dynamic speaker matched to the output stage is enclosed in the console models. A switch-operated phonograph pick-up connection is provided. —Radio Retailing, June, 1929.

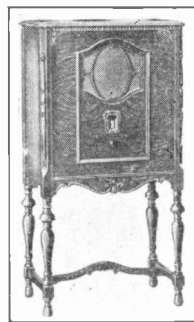
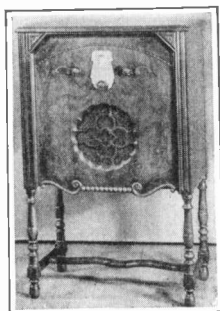

Bremer-Tully Sets

A battery operated set and two a.c. receivers are announced by the Bremer-Tully Manufacturing Company 656 W. Washington Boulevard, Chicago, Ill.

The battery set, model 80, employs a tuned, neutralized and shielded circuit having three stages of r.f. amplification, detector and two audio stages. The four tuned stages are operated by a single control with trimmer control in the antenna stage. It comes in a console cabinet made of walnut and stands 39½ in. high. The intended retail price is \$89.50, less tubes and speaker.

Model 81, illustrated, is an a.c. set using 227's in three stages of r.f. amplification, detector, with two 245's in push-pull in the audio. The figured walnut cabinet is 49 in. high and encloses a 10 inch special B-T dynamic speaker. Price \$164, less tubes.

Model 82 has the same chassis as model 81, and comes in a walnut cabinet with French doors of burl walnut. It is 49 inches high and equipped with the same type speaker. Price \$200, less tubes. —Radio Retailing, June, 1929.

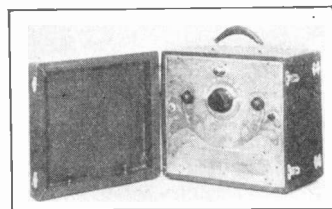

Portable Radio Set

Three improved models of the Baird portable radio set made by the Shortwave Radio and Television Laboratory, Inc., 104 Brookline Avenue, Boston, Mass., are now ready.

The battery operated set uses one 222 screen grid tube and three 199's. The screen grid is the radio frequency stage and the 199's are employed in detector and two stages of audio. The output impedances are tuned by a gang of .00035 condensers and a midjet trimming condenser is used across the loop. A Baldwin Rival speaker unit is used. The case measures 12½ in. high by 13 in. wide by 9 in. deep and weighs 23

pounds with batteries. The necessary equipment includes besides the tubes, 3 dry cells, two 245-volt portable size B batteries and one 2½ volt C-battery. \$60, less equipment.

The a.c. model uses a 224, a 227 for detector and a 112. Price, \$97.50, less tubes.

The d.c. model uses ½ amperes tubes in series. The intended retail price is \$87.50, less tubes. —Radio Retailing, June, 1929.

New Apex Line

The United States Radio and Television Corporation, 1338 S. Michigan Avenue, Chicago, Ill., has just announced its new line for the coming season. The neutrodyne chassis has seven tubes, including rectifier.

Model 36, a table set, comes in a walnut finish metal cabinet. The intended retail price is \$49.95.

Model 50, a console, comes in an American walnut and red gum cabinet, measuring 36½ in. by 25½ in. by 13½ in. Price, with electro-magnetic speaker, \$79.95.

Model 60, the illustrated console, is inclosed in an American

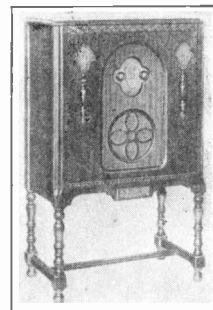

walnut and red gum cabinet with blended lacewood overlays, and a high-lighted finish. The size is 40 in. by 25½ in. by 14 in. Price, with electro-dynamic reproducer, \$99.95.

Model 89 is a neutrodyne receiver with four tuned circuits, employing eight tubes, including rectifier, with 171-A's in push-pull. It is a table model and comes in a two-toned walnut finished metal cabinet, \$89.95.

Model 70, a console with the same chassis as the 89, is housed in an American walnut, oriental walnut and red gum cabinet with sliding doors of oriental walnut. The dimensions are 50½ in. by 27½ in. by 12½ in. Price, with electro-dynamic speaker, \$149.95. —Radio Retailing, June, 1929.

Audiola Set

The latest addition to the line of the Audiola Radio Company, 430 S. Green Street, Chicago, Ill., is the 8430 chassis and music box.

The chassis has four tuned stages, controlled regenerative bridge circuit, and antenna trimmer. It uses five 227 tubes, two 245's in push-pull and a 280 rectifier. This chassis in a table set is \$95. —Radio Retailing, June, 1929.

Dealers to SELL

All announcements appearing on these pages are published without advertising considerations of any kind whatsoever.

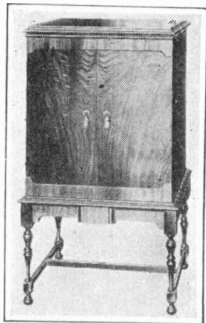

New Amrad Line

The Amrad Corporation, Medford Hillside, Mass., announces three new radio sets and a radio-phonograph combination for the coming season.

The "Aria" contains the standard shield grid chassis and has a dynamic speaker. The console cabinet is made of butt walnut and African walnut veneers. The intended retail price is \$198, less tubes.

The "Serenata" has an eight tube shield grid chassis with two 245 power tubes in push-pull. The diamond matched walnut console is inlaid with ebony and has sliding doors. Price, with RCA dynamic speaker, \$245, less tubes.

The "Symphony" is housed in a cabinet of East Indian laurelwood decorated with inlays of ebony. The speaker in this set is the RCA 106. Price, \$295.

The "Duet" is a radio-phonograph combination. It comes in an oriental laurelwood cabinet decorated with inlays of ebony and maple. Four phonograph record albums are provided. Price, with 106 speaker, \$495, less tubes. — *Radio Retailing*, June, 1929.

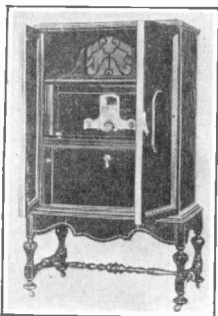

New Federal Line

Three new sets, to be known as the M line, have been introduced by the Federal Radio Corporation, Buffalo, N. Y. The chassis is triple shielded, having separate shielding for the r.f. stages, over-all shielding and tube shielding. It has five 227 tubes, two 245 tubes in the push-pull audio stage housed in the power pack, and a 280 rectifier. Arrangements are made in the chassis for pin jacks and a switch for phonograph pick-up. A Jensen dynamic reproducer is

used in each of these sets. The console cabinets are made of mahogany and walnut with hand carving.

M-36 has an intended retail price of \$245, less tubes, and models M-41 and M-46 (illustrated) are \$295, less tubes. — *Radio Retailing*, June, 1929.

King Receivers

The King Manufacturing Corporation, Buffalo, N. Y., is presenting two new sets.

The illustrated console is the Royal model. It has a neutrodyne circuit utilizing three 226's and two 227's in two stages of r.f. detector and first audio, with two 171's in push-pull in the second audio, and a 280 rectifier.

The Imperial model is an eight tube receiver, using 227's in the four stages of r.f. detector and first audio, with two 245's in push-pull in the second audio stage, and a rectifier. This model, as well as the Royal, comes in a walnut veneer cabinet, matched for color and grain. Each has a dynamic power speaker and phonograph attachment. — *Radio Retailing*, June, 1929.



New Victor Line

"Micro-synchronism" is being featured in the line introduced by the Victor Talking Machine Company, Camden, N. J. By means of this principle all elements of the receiver are in resonance at all points of the scale. This is accomplished by micro-synchronous condensers which automatically and simultaneously adjust the elements to their proper relation.

The improved t.r.f. circuit is of the antenna type, and uses five 226's in the four stages of r.f., a 226 in the first audio, two 245's in push-pull in the second audio, a 227 detector and a 280 rectifier. A 245 is used in the power amplifier. Tuning is accomplished by means of a new single lever control which moves from side to side.

The console model set is enclosed in a burl walnut and bird's-eye maple veneer cabinet with an improved electro-dynamic reproducer. The intended retail price is \$155.

The radio-phonograph combination is equipped with electro-trola 91 induction disk motor. Price, \$225, less tubes. — *Radio Retailing*, June, 1929.

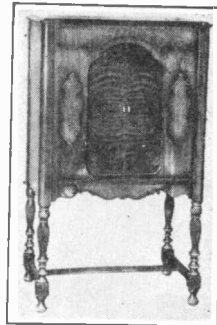

Two Emerson Sets

The chassis of the two sets offered by the Emerson Radio and Phonograph Corporation, 307 Sixth Avenue, New York City, employs four 226's, one 227, two 171's in push-pull and a 280 rectifier.

Model C comes in a five-ply walnut veneer, hand lacquered cabinet with maple overlay on apron. The intended retail price is \$100, complete.

Model D, illustrated, is enclosed in a walnut veneer cabinet, with sliding doors. Price, \$100 complete. — *Radio Retailing*, June, 1929.

Dynamic Speaker

The new dynamic speaker introduced by Davis Industries, Inc., 314 W. 43rd Street, Chicago, Ill., embodies a new development in dynamic speaker construction, according to the manufacturer, which improves the tone. It may be had as complete table model in a solid walnut cabinet or in chassis form. — *Radio Retailing*, June, 1929.

A.C. Sets

The Patterson Radio Corporation, 239 S. Los Angeles Street, Los Angeles, Calif., presents two sets and a chassis for the coming season.

The chassis uses three 226's, one 227, one 171 and a 280 rectifier. The intended retail price is \$59.

Model 79, illustrated, comes in an open face cabinet and lists at \$79.50. Model 97, in a cabinet of American walnut veneer with sliding doors, is \$97.50, with semi-dynamic speaker. — *Radio Retailing*, June, 1929.

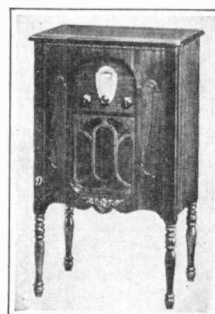

Three Philco Sets and a Speaker

The line of radio receivers made by the Philadelphia Storage Battery Company, Philadelphia, Pa., has been augmented by the addition of models 65 and 87.

Model 65 is a five tube screen grid receiver with tuned antenna stage, two tuned stages of r.f. using 224 tubes, biased power detector using a 227, two 245's in push-pull, and a 280 rectifier.

Model 87 is a seven tube neutrodyne-plus receiver with tuned antenna stage. The tubes used are 226's in three stages of t.r.f., a 227 detector, two audio stages with two 245's in push-pull in the second stage, and a rectifier. A built-in aerial is used.

Both models have the new matched 10 in. electro-dynamic speaker and an acoustic equalizer to prevent undesirable cabinet resonance.

The lowboy model is an open face cabinet, measuring 40 in. by 26 1/2 in. by 14 in. The intended retail price with the 65 chassis is \$119.50, less tubes; and \$129.50, less tubes, with the 87 chassis.

The highboy cabinet has matched butt walnut side panels with half doors of matched oriental walnut. The size is 47

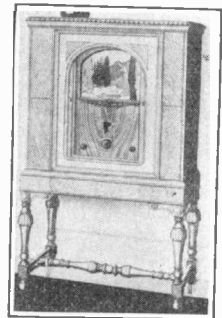

in. by 27 1/2 in. by 14 in. Price, with 65 chassis, \$139.50; with 87 chassis, \$149.50, less tubes.

The highboy de luxe model, shown above is finished in butt walnut with sliding doors. The measurements are 50 in. by 28 in. by 16 in. Price, with 65 chassis, \$195; with 87 chassis, \$205, less tubes.

The table model has the screen grid chassis and comes in a two-tone brown cabinet. Price, \$67, less tubes.

The electro-dynamic speaker is of the mantel type, finished in walnut with silver trim, and has a 10-inch cone. Price, \$32.50. — *Radio Retailing*, June, 1929.

A.C. Portable Set

The Automatic Radio Manufacturing Co. Inc., 332 A Street, Boston, Mass., is now making an a.c. model of its Tom Thumb screen grid portable receiver. The intended retail price is \$95, less tubes. — *Radio Retailing*, June, 1929.

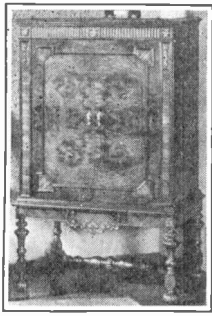

New Continental Sets

A new line has just been announced by the Continental Radio Corporation, Fort Wayne, Ind., to be known as the "Star-Raider" line.

The chassis has the technidyne circuit employing eleven tubes—seven 227's, two 250 power tubes and two 281 rectifiers. There are six r.f. stages, three of which are tuned and three are untuned, and one a.f. stage utilizing two 250 tubes in push-pull. Detector is of the untuned, high plate voltage grid bias type. Each set has a 14-inch matched dynamic speaker which is mounted on the power unit chassis. They are also equipped with an automatic voltage regulator and phonograph pick-up jack.

Model R-20 is inclosed in a Jacobean period cabinet, wanut finish, with decorations and veneers of English Pollard oak, burl and butt walnut. It is 30 in. wide by 18 in. deep by 52 in. high. The intended retail price is \$435, less tubes.

Model R-30, shown above, is made of walnut with matched veneer panels. The measurements are 30 in. wide by 21 in. deep by 49 1/2 in. high. Price, \$525, less tubes.

Model RP-40 is a radio-phonograph combination with an electric motor. The magnetic pick-up has special impedance. The control switch is located on the panel. The solid walnut cabinet has panels and decorations of matched English Pollard oak, burl walnut and matched butt walnut, with hand carvings. The dimensions are 24 in. deep, 35 in. wide by 49 in. high. Price, \$725, less tubes.—*Radio Retailing*, June, 1929.

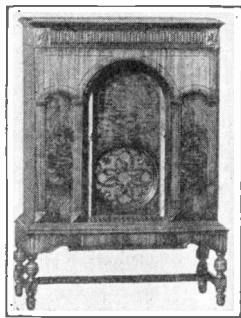

Radio-Phono. Cabinet

A cabinet for a radio-phonograph combination is now offered by the Radio Cabinet Company, 318 Butterworth, S.W., Grand Rapids, Mich. The legs, stretchers, moldings and carvings are solid walnut, as is the phonograph compartment. The doors are diamond matched oriental walnut with butt walnut panels on either side. The cabinet measures 46 1/2 in. x 32 in. x 18 in. with a 15 in. x 13 in. phonograph board. The inside dimensions of the set compartment are 9 in. x 24 in. x 13 in. The speaker space measures 12 in. x 27 1/2 in. x 13 in. The intended retail price is \$180.—*Radio Retailing*, June, 1929.

New Grebe Set

The new receiver being introduced by A. H. Grebe & Co. Inc., Richmond Hill, N. Y., uses screen grid tubes. There are five tuned circuits, a linear power detector with two 245's in push-pull in the last audio stage. Provision is made for phonograph pick-up. The console cabinet has sliding doors of matched burl walnut with decorated side panels, and encloses the electro-dynamic speaker.—*Radio Retailing*, June, 1929.

Fada Sets and Speakers

A table set, three consoles and a radio-phonograph combination make up the 1929 line just announced by F. A. D. Andrea, Inc., Long Island City, N. Y.

Console model 75 has three stages of t.r.f. amplification, plate circuit power detector, and two stages of transformer coupled audio frequency amplification, employing three 224's, two 227's, two 210's in push-pull and a 281 rectifier. The cabinet is made of two-tone high-lighted walnut with drop front panel. The intended retail price, with 14-B super-dynamic speaker is \$360.

Table model 20 uses five 227's in three stages of t.r.f., two 171A's in push-pull, and a 280. The set is designed for use with the Fada 6 dynamic speaker. The cabinet is two-tone metal with velvetex finish. Price, \$99.50.

Console model 25 uses 227's, 245's in push-pull and a 280

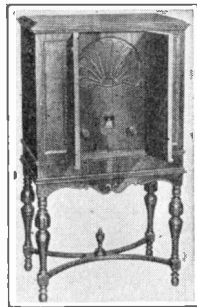

rectifier. It has three stages of tuned neutralized r.f. amplification. The audio system can be used with commercial microphones for public address systems. The walnut cabinet encloses a 15-C dynamic reproducer. Price, \$165.

Model 35, illustrated, uses two 227's, two 224's and two 245's in push-pull and a 281 rectifier. It comes in a Jacobean period cabinet of walnut with full length doors of matched panel burl walnut and has a 7-C dynamic speaker. Price, \$245.

The radio-phonograph combination, model 77, has the 75 receiver, an electric drive phonograph turn table and an electro-magnetic pick-up. The cabinet is hand carved walnut with full length doors of matched burl walnut. For 50-60 cycle operation only. Price \$675.

Improved models of speakers Nos. 4, 6, 14 and 15 are offered also. Model 14 now has an intended retail price of \$72.50.—*Radio Retailing*, June, 1929.

Speaker Chassis

Three dynamic speaker chassis are now being made by the Oxford Radio Corporation, 3200 W. Carroll Ave., Chicago, Ill. Model 23, complete with rectifier and step-down transformer, and mounted on a pressed steel sub-base, for operation on 110 volts a.c., is \$39.50; model 24 for operation on 80-115 volts, d.c. is \$31.50; and model 22 for operation on 6 volts, d.c., is \$29.50.—*Radio Retailing*, June, 1929.

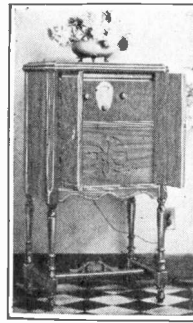

Cabinets

The line of radio cabinets being made by the International Equipment Company, 1322 Chestnut Avenue, Kansas City, Mo., has been supplemented.

Model 666 is of the table type with a Peerless reproducer built-in underneath. The dimensions are 25 1/2 in. wide by 15 1/2 in. deep by 30 in. high. It is made of walnut.

Model 888, illustrated, may be had either with or without reproducer. It is made of walnut in period design, with doors of burl walnut. This cabinet is especially adapted for Crosley, Atwater Kent, Apex, Freshman, Arborphone and Steinite sets but may be used with any set having a 7 in. x 18 in. panel. It may be also had with blank panel. The dimensions are 22 in. wide by 17 in. by 41 high. Price, \$40.—*Radio Retailing*, June, 1929.

Speaker Chassis

The dynamic speaker chassis placed on the market by the Operadio Manufacturing Company, St. Charles, Ill., has a cast steel frame with integral pole piece, assuring alignment between cone apex and edge. The 9 1/2 inch one-piece, free edge cone is made of "Accoustex."—*Radio Retailing*, June, 1929.

Rola Speakers

Two new electro-dynamic units have been added to the line of speakers made by the Rola Company, 45th Street and Hollis Streets, Oakland, Calif. Further improvements in the "J" line are also announced.

The "J" series, with the 7 1/2 in. cone, now have a laminated Bakelite spider support, ventilated field coil and more effective slot openings behind the cone. Included in this series are J-90 for field excitation from standard power pack, \$25; J-110 for light socket operation with any set or amplifier; and 30-J, the illustrated model, \$60.

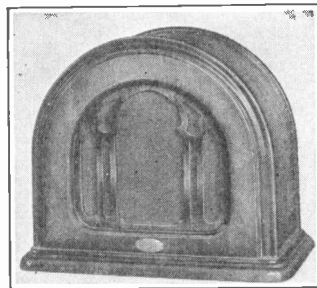

The new "C" or Concert series units are similar to the "J" units except for their 9 inch cone diameter. They are particularly adapted for use with amplifiers using 245 tubes in push-pull. Model C-90 is \$31.50.

The "R" or auditorium electro-dynamic unit, has a cone diameter of 12 inches. It possesses a magnetic field structure of great size and power. R-AC is \$70.—*Radio Retailing*, June, 1929.

New Kennedy Line

The new "Royal" line of radio sets just presented by the Colin B. Kennedy Corporation, South Bend, Ind., includes a table model, an open console and a de luxe console. The chassis in all models is identical. It is a seven tube neutrodyne set employing five 227 tubes, two 245's in push-pull and a 280 rectifier. All models are equipped with jacks for phonograph pick-up, with a change-over switch located on the panel.

Model 110 is the table model, housed in a hand-finished cabinet. The intended retail price is \$115.

Model 210, illustrated, is the open console of walnut construction, with a trimming of grained oak overlay. Price, \$159.

Model 310 is a console of walnut trimmed with matched maple. It has double-hinged French doors. Price, \$197.—*Radio Retailing*, June, 1929.

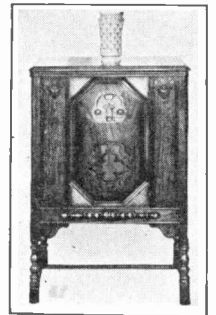

Kolster Sets

All controls on the K-45 set just announced by the Kolster Radio Corporation, 39 Broadway, New York City, are on the side of the cabinet. A small glass window is set in one corner of the top of the cabinet, through which the illuminated dial is seen. A feature of this model is the remote control box which is actuated by a motor in the set. It can be located anywhere in the room. On this box are six buttons marked for six selected stations and corresponding to the buttons on the set, a volume control, on and off switch, and two colored lights which tell if the set is correctly tuned. While the automatic tuner is turning the dial, the reproducer is short-circuited so that no intervening stations are heard. There are three 224's in the r. f. side and the audio amplifier makes use of three stages, the first employing one 227 tube, the second two 227's in push-pull and the third two 250's in push-pull. The intended retail price is \$590.

Model K-43 and 44 have the "selector" tuning. With this system, tuning is accomplished by pressing one of the marked selector buttons on the panel and turning the dial until it automatically locks at the correct point. These buttons may be set for any desired stations. K-44 uses three 224's, two 227's, two 245's in push-pull and two 281 rectifiers. K-43 has the same tubes but with one 281 rectifier. Both are console models equipped with the master dynamic speaker. K-44 is \$325 and K-43 is \$235.—*Radio Retailing*, June, 1929.

Electric Pick-Up Arm

The Oro-Tone Company, 1010 George Street, Chicago, Ill., is now supplying its model 16 1/2 pick-up arm in a 12 1/2 inch length, measuring from needle to center of base. The new arm will play all records from fifteen inches to twenty-two inches in diameter.—*Radio Retailing*, June, 1929.

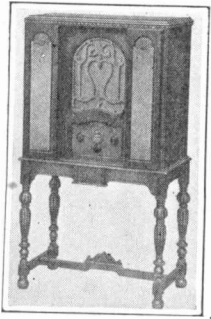

Adler Cabinets

The "Royal" line of cabinets made by the Adler Manufacturing Company, Louisville, Ky., has just been added to.

Model 324 is made of half round American walnut, with doors of burl and figured stump walnut. The dimensions are 51½ in. by 28½ in. by 19½ in. The set compartment measures 9¼ in. by 24½ in. by 13¼ in. The intended retail price is \$95.

Model 325 has sliding doors of solid walnut, with a figured butt walnut panel on either side. The overall dimensions are 52 in. by 32 in. by 19 in. The set compartment size is 11½ in. by 28½ in. by 14½ in. Price, \$105.

The illustrated cabinet, model 326, is made for Atwater Kent sets. The doors are made of figured stump walnut, matched with front side panels of butt walnut. It stands 48 in. high by 27 in. wide by 15 in. deep. Price, \$65.—*Radio Retailing*, June, 1929.

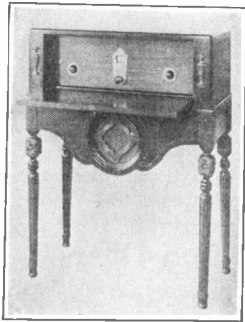

A.C. Sets

The Radio Products Corporation, 3816 N. 28th Street, Birmingham, Ala., announces three new sets.

Model D has six tubes with two 171A's in the last stage of audio. It is a table set and has an intended retail price of \$100.

Model C is a console with large magnetic speaker built-in. Price, \$185, less tubes.

Model E, illustrated, is made in the desk style with drop front lid. A magnetic speaker is built in. Price \$150, less tubes.—*Radio Retailing*, June, 1929.

Acme A.C. Chassis

Two a.c. set chassis have been placed on the market by the Acme Radio & Electric, Inc., 1444 Hamilton Ave., Cleveland, Ohio.

Model 77 uses five 227 tubes, one 245 and a 280 rectifier. It has three shielded r.f. coils, phonograph pick-up and current supply for d.c. dynamic reproducer. Price \$62.

Model 88 has seven tubes and rectifier,—five 227's, two 245's in push-pull and a 280 rectifier. A 4-gang heavy duty tuning condenser, automatic voltage regulator, built-in antenna, dual volume control, and instantaneous change-over from radio to phonograph, are some of the features. Price, \$80.—*Radio Retailing*, June, 1929.

Brandes Line

The seven tube sets just brought out by the Brandes Corporation, 200 Mt. Pleasant Avenue, Newark, N. J., use five 227's, two 245's in push-pull, and a rectifier. With a slight wiring change 171A's can be used in place of the 245's. "Selector" tuning is being featured in these sets. A series of buttons are located on the panel. These are marked and set for the desired stations. To tune in, press the button and turn the dial until the dial automatically locks at the desired station.

B-10, a table model, is designed for either a dynamic or a magnetic speaker, with a special power unit. The intended retail price is \$85.

B-16, illustrated, is \$189.50, and B-15 is \$149.50.—*Radio Retailing*, June, 1929.

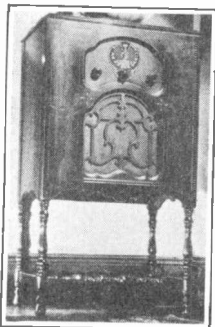

Simplex A.C. Set

An a.c. set using the new 245 power tubes is announced by the Simplex Radio Company, Sandusky, Ohio. It has four tuned stages with five 227's, two 245's in push pull and a 280 rectifier tube. The necessary jacks for connecting television apparatus are provided, as is a built-in light socket antenna.

The receiver is known as model F and is housed in a Louis XVI period console of matched Oriental overlays, with sliding doors. The intended retail price with dynamic speaker is \$171.50, less tubes.—*Radio Retailing*, June, 1929.



Dynamic Speaker Chassis

The diaphragm of the new dynamic speaker chassis of the Transformer Corporation of America, 2309 S. Keeler Avenue, Chicago, Ill., is made in one piece and is larger than usual. The suspension spider at the apex of the diaphragm has been eliminated, which makes more perfect centering of the pole piece and improves tone quality, according to the maker. All leads are grouped at the back of the unit and end in convenient lugs on a Bakelite rear panel.—*Radio Retailing*, June, 1929.

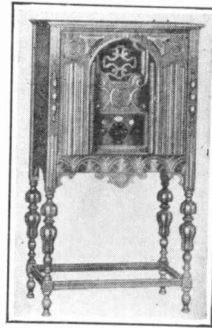

Showers' Cabinets

Five new cabinets for Atwater Kent sets have been added to the line of the Showers Brothers Company, Bloomington, Ind.

Model S-1 has an oak exterior with linen fold overlays and carvings, and is 45½ in. high by 24½ in. wide. The price is \$28.

Model S-2 has more walnut panels and diamond matched Australian walnut veneer sliding doors. Price, \$45.

Model S-3 has maple overlays and bird's-eye maple panels topped by wood carvings. The doors are made of four-way matched burl walnut. It measures 48 in. high by 26½ in. wide. Price, \$54.75.

Model S-4 has the cathedral effect front. The American walnut finish provides an attractive background for the linen fold effect on the panels and sliding doors. It is 50 in. high by 26½ in. wide. Price, \$60.

Model S-5 is built of sovereign oak and is of the same design as S-4. Price, \$65.—*Radio Retailing*, June, 1929.

Balkeitt Receiver

The new model C console receiver which has been placed on the market by the Balkeitt Radio Company, North State Street, Chicago, Ill., is a nine tube super-neutrodyne set with five tuned stages. It uses 227's in the four r.f. stages, power detector and first audio stage, two 245's in push-pull and a rectifier.

The walnut finish cabinet has the "quarter door" type of cabinet front. The intended retail price is \$175, less tubes.—*Radio Retailing*, June, 1929.

Audio Transformers

The line of audio transformers made by the Thordarson Electric Manufacturing Company, Huron, Kingsbury and Larrabee Streets, Chicago, Ill., has been added to and now includes three new models.

Model R-100, left, is a replacement audio transformer, with the universal mounting bracket permitting mounting on either side or the end. Price, \$2.25.

Model R-260, right, is wound on a core of Thordarson "DX-metal." It is entirely devoid of

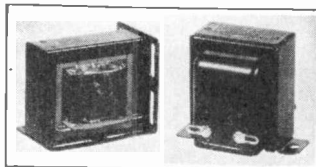

resonant peaks, according to the manufacturer. Price, \$5.

Model R-400 is built expressly for use with a.c. tubes, and works well under high primary current conditions such as are encountered in coupling the first and second audio stages of audio amplifiers using 226 or 227 types tubes in the first stage. The list price is \$9.—*Radio Retailing*, June, 1929.

Stromberg 642 Set

The new model 642 receiver brought out by the Stromberg-Carlson Telephone Manufacturing Company, Rochester, N. Y., has three 224's in the radio amplifier stages, a 245 in the single audio output stage, a 227 arranged as a linear power detector with automatic bias, and a 280 rectifier. The cabinet has sliding doors and is large in size to afford an adequate baffle for the built-in dynamic speaker. The control panel and speaker grille are made of Haskelite pressed wood to represent hand carving. The usual provision is made for the use of the audio system in conjunction with a pick-up for the reproduction of phonograph records. The intended retail price is \$247.50, less tubes.—*Radio Retailing*, June, 1929.

National Amplifier

The "Velvetone" amplifier just brought out by the National Company, Inc., Malden, Mass., uses the new 245 power tubes in push-pull, a 227 in the first audio stage, and a 280 rectifier. The unit also supplies a.c. heater voltage as well as B-voltages for an r.f. tuner. A jack is provided for use with phonograph pick-up. This combination amplifier and power supply is compact, measuring 12½ in. x 10½ in. x 7 in. The intended retail price is \$97.50.—*Radio Retailing*, June, 1929.

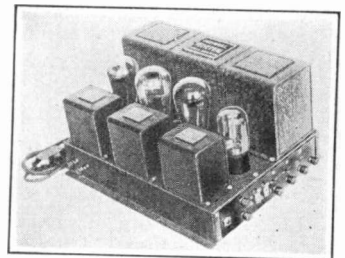

Short Wave Receiver Kit

A new short-wave receiver, known as the "Super-Wasp," supplied in kit form for home assembly, has been placed on the market by the Pilot Electric Manufacturing Company, 323 Berry Street, Brooklyn, N. Y. Four tubes are used; a 222 screen grid, for r.f.; a 201A or 200A, as regenerative detector; a 201A, as first audio frequency amplifier and a 112A or 171A, as second audio amplifier. The wide wavelength range, which covers both the short-wave and the regular broadcast channels, is made possible by plug-in coils that fit in convenient receptacles inside the shield cans. The ranges of the coils in meters are as follows: 14-27, 26-50, 50-100, 100-200 and 200-500. The intended retail price of the complete kit of parts is \$29.50.—*Radio Retailing*, June, 1929.

Colonial Set

The model 32 a.c. set just announced by the Colonial Radio Corporation, Long Island City, N. Y., features "sound radiation" as developed by Dr. Fulton Cutting. By means of a specially designed audio amplifier and the placing of the speaker so that the sound comes from the back and bottom of the cabinet, the original effect is re-created, according to the manufacturer. Four 224's are used for r.f. amplification and detection, with two 245's in push-pull. A radio-phonograph switch-over is located on the panel. Three styles of cabinet are available.—*Radio Retailing*, June, 1929.

THIS MONTH in the Radio Industry

RCA and Victor Form New Manufacturing Unit

A new company, the Audio-Vision Appliance Company, has been formed to take over the manufacture of RCA sets and appliances, which have heretofore been made by General Electric and Westinghouse. The Camden plant of the Victor Talking Machine Company has also been taken over and in the future Victor products will also be made by the new concern. The Audio-Vision company will be the manufacturing unit of the RCA-Victor interests with the new Radio-Victor Corporation of America handling the sales activities of the two companies.

E. E. Shumaker, president of Victor, has been elected president and general manager of the Audio-Vision Company. The board of directors includes representatives of the Radio Corporation, Victor, Westinghouse and General Electric.

Freshman-Freed Eisemann Form Canadian Company

The Freshman-Freed Eisemann Radio, Ltd., has been organized with headquarters at 20 Trinity Street, Toronto, Canada. The new Canadian corporation has \$400,000 preferred stock and one thousand shares of common stock, all of which has been absorbed by private subscription. C. A. Earl, president of the Chas. Freshman Co., Inc., heads the new corporation and George H. Gooderhan, of Toronto, is vice-president. The board of directors includes C. A. Earl, Joseph D. R. Freed and Warren J. Keyes, representing the Freshman interests and George H. Gooderhan, H. S. Gooderhan, W. S. Turnley and K. S. MacLachlan, representing the Canadian interests. Sets will be assembled in Canada under special Canadian licenses which have been granted by the Neutrodyne and other patent owners to the new corporation.

Six Tube Companies Consolidate

A new corporation, the Marvin Radio Tube Corporation, Irvington, N. J., has been formed following the merger of the Universal Electric Lamp Company, the Sunlight Lamp Company, the Special Electric Corporation, the Continental Corporation, the Globe Electric Company and the A.C.M. Corporation. A factory at Irvington, N. J., will shortly be placed in operation, bringing these companies under one roof. One of the features of the consolidation is that the tubes, in their entirety, will be manufactured by the Marvin Company.

P. D. Jackson is chairman of the board with Thomas F. James as president. William J. Bennett is first vice-president, Stephen F. Dunn, second vice-president, William F. Tait, treasurer, Harold T. Wakefield, secretary, and Raymond Pitchell, assistant secretary.



On the Sea and On the Air

Eugene F. McDonald, Jr., president of the Zenith Radio Corporation, Chicago, likes motor-boating but not the kind you find in radio sets. His luxurious yacht, Mizpah, is equipped with "automatic" steering. Press button number one and the boat sails for the Solomon Islands, number two takes you to the Ivory Coast, and so on through the night.

Studebaker Acquires Interest in Colin B. Kennedy, Inc.

A new company, to be known as the Colin B. Kennedy Corporation, has been organized as the result of the Studebaker interests of South Bend, Ind., acquiring a substantial interest in the business and assets of Colin B. Kennedy, Inc., South Bend. The Kennedy company has license arrangements with the Radio Corporation group, including Westinghouse, General Electric and the American Telegraph and Telephone Company, and also has a license under the Hazeltine and Latour patents.

Colin B. Kennedy, founder of the business, is president. The other officers are: F. H. Wellington, chairman of the board and treasurer; Clement Studebaker, III, vice-president; Julius J. Spindler, vice-president; John J. Seerley, secretary, and J. Howard Haley, assistant treasurer. The directors are Col. George M. Studebaker, Mr. Kennedy, F. H. Wellington, Clement Studebaker, III, John C. Tobin, Orville J. Taylor, and Julius J. Spindler. Dr. Charles C. Lauritsen, formerly chief engineer, has resumed his original position with the new company.

T. J. Molloy Heads New Cabinet Co.

The Wood Cabinet Corporation has just been formed by T. J. Molloy, to take over the business of the Molloy-Davis Company. The new company has contracted for the output of several large furniture plants located in the East and Middle West for direct shipment to the dealer trade. A sales force of about fifty men, covering the entire United States, will be in the field early in June. A cabinet display room is now open at 196 Lexington Ave., New York City.

New Legislative Service Planned by RMA

A co-operative information service, designed to protect radio interests in state and local legislation, was ordered by the board of directors of the Radio Manufacturers Association, at its meeting in Cleveland. C. C. Colby of Boston, head of the Legislative Committee, was instructed to make arrangements for this new service in co-operation with the Federated Radio Trades Association. The assistance of Frank D. Scott, legislative counsel at Washington, will be enlisted.

Action is now being taken in connection with "serial number" bills pending before the Missouri, Illinois and other legislatures, and in opposition to a bill in Maine proposing a license tax on receiving sets. Efforts are also being made to reduce excessive commercialism in radio programs and to secure their proper presentation in the press.

New radio legislation in Congress, including the proposed Communication Committee to succeed the Federal Radio Commission, was considered.

Twenty-five new applications for membership were acted upon by the Board and plans made to include as future members, manufacturers of new radio apparatus such as parts of talking movies, group address systems, etc., in which radio frequency and amplification are incorporated.

Thomas A. Edison Offers Free Scholarship

A four-year scholarship at any recognized technical school will be given by Thomas A. Edison to the schoolboy who best answers a questionnaire personally prepared by the inventor. A committee to select the boy who is best representative of American boyhood and in addition has shown the highest ability in scientific subjects during the school year, will be appointed by the governor of each state and the commissioners of the District of Columbia.

The forty-nine winners will be brought to the Edison Laboratory in Orange, N. J., about August 1, at Mr. Edison's expense, to answer the questions prepared by him. Each of the boys will also receive a radio-phonograph combination.

Sylvania Gets RCA Tube License

A license to manufacture tubes under the patents owned by General Electric, Westinghouse and the Radio Corporation, has been granted to the Nilco Lamp Works, Inc., the associate company of the Sylvania Products Company, Emporium, Pa. The license privileges of Nilco have been extended to Sylvania.

THE EMERSON RADIO AND PHONOGRAPH COMPANY, New York City, has opened a merchandising bureau where its dealers may secure aid in handling their advertising and sales promotion work.

Apex Jobbers Convene In Two Cities

The convention of the distributors of the Apex division, United States Radio and Television Company, Chicago, opened at Indianapolis on April 29, and concluded at Marion, Ind., the next day. The group went through the plant of the Robbins Body Company, Indianapolis, which was taken over a short time ago by Apex and turned into a cabinet factory. Following this inspection tour, there was open discussion on various subjects, conducted by Jack Binns.

The next day, a special train took the jobbers, about 160 in number, to Marion, where the chassis are made in the old Case factory, which has been enlarged. Following luncheon at the country club, the new line was shown the delegates. In the evening a banquet was given at the Coliseum, at which 400 guests were present. The program for the two days was arranged by Charles Strawn, who acted as the busy and successful master of ceremonies.

Peerless Merges With Cabinet Co.

The third consolidation within a year by the United Reproducers Corporation, Rochester, N. Y., is that with the Buckeye Cabinet Company, Springfield, Ohio. About ten months ago, United consolidated with Newcombe-Hawley, Inc., St. Charles, Ill., maker of reproducers. This was followed by the merger with the Consolidated Radio Corporation, Ann Arbor, Mich., manufacturers of radio receivers, a few weeks ago. Arthur Hill, newly elected president of the company, announces that everything that enters into reproducer and receiver construction will be made by the United Reproducers Corporation in its own plants.

RDMR to Meet in Detroit June 25

Plans are now complete for the third annual pre-season radio show to be held by the Radio Distributors and Manufacturers' Representatives at the Book-Cadillac

Hotel in Detroit from June 25 to 28. This is a "dealer" show, providing a first exhibition of the new models. A great many of the radio dealers in eastern Michigan launch their buying plans and franchise arrangements for the coming season at this show.

Philco Takes Jobbers on Lake Cruise

Instead of holding its annual convention of distributors in the usual manner at a hotel during Trade Show week, the Philadelphia Storage Battery Company, Philadelphia, Pa., arranged a cruise on the Great Lakes on the three days immediately preceding.

The S.S. *Noronic*, which was chartered for the trip, left Detroit at 10 a.m., Friday, May 31, arriving at Sault Ste. Marie, Canada, at noon, the following day. The afternoon was spent on shore, the party leaving for Detroit at 5 o'clock that day. Those who were attending the Trade Show, entrained for Chicago upon their arrival.

Dallas Dealers Hold Radio Show

Eleven of the leading radio dealers of Dallas, Tex., recently held a spring radio show. The exhibit was open every afternoon and evening for four days and no admission was charged. Broadcasting from the show and many novel entertainment features were arranged. There was dancing every night and the affair proved most successful.

THE HARVARD GRADUATE SCHOOL OF BUSINESS ADMINISTRATION, Cambridge, Mass., announces a special summer session from July 1 to August 10, for business executives. The courses offered include: management and economics, sales management and retail distribution.

THE WALBERT RADIO CORPORATION, Grand Haven, Mich., is planning to develop its manufacturing facilities, following the acquisition of a license from the Radio Corporation.

Sparks-Withington and RCA Adjust Patent Situation

In an interview on May 18, Captain William Sparks, president of the Sparks-Withington Company, Jackson, Mich., stated that "the Radio Corporation has purchased from the Sparks-Withington Company various valuable patents on radio construction and the Radio Corporation has granted to the Sparks-Withington Company a license under all its patents. This ends litigation between these two companies which has been pending for years and which no doubt will be of great satisfaction to the customers of both parties."

Captain Sparks further stated that his company had purchased factory additions which will more than double its capacity for the coming season.

Joy-Kelsey Changes Name

A reorganization of the Joy-Kelsey Corporation, Chicago, has been effected. The management remains the same, but the company will now be known as the Oxford Radio Corporation. A new and enlarged factory at 3200 West Carroll Avenue, has been secured and will be devoted exclusively to the manufacture of reproducers. A license has been obtained from the Lektrophone Corporation. Contracts for dynamic reproducers have just been received from the Zenith Radio Corporation and Wells-Gardner & Company, both of Chicago, the latter planning to use these speakers exclusively in its new line.

THE BARRETT ELECTRICAL SUPPLY COMPANY, St. Louis, Mo., has just been appointed exclusive distributor in metropolitan St. Louis, eastern Missouri and southwestern Illinois by the A. C. Dayton Company, Dayton, Ohio.

THE HYVAC TUBE COMPANY, INC., Newark, N. J., is now in full production on a complete line of tubes, including the new 224's and 245's.

Federal Radio Commission Membership Now Complete



With the confirmation of the appointments of Major General Saltzman and William D. L. Starbuck to fill the positions made vacant by the resignations of Sam Pickard and O. H. Caldwell, the membership of the Federal Radio Commission is complete for the first time since February, 1929.

Reading from left to right, are, seated, Major General Charles McKinley Saltzman, Judge Eugene O. Sykes, Judge Ira E. Robinson, chairman, Harold F. Lafount, and William D. L. Starbuck. Standing, are, Carl H. Butman, secretary, and E. Webster, general counsel.

May Reorganize Broadcasting Set-Up in Canada

By W. M. Gladish

Because of the prospect of Government control of radio broadcasting in Canada, through the Royal Canadian Radio Commission, considerable interest is being shown by radio manufacturers, dealers and broadcasters in the Dominion in the general make-up of radio units of the country and the possibility of their reorganization under Federal or Provincial auspices.

According to a government report, there are 36 major stations in the Dominion. A number of these stations rent time to holders of phantom broadcasting licenses, while there are also 32 stations which give only intermittent service.

Of the 36 main stations, 13 are owned by radio manufacturers, four by other manufacturers, eight by newspapers of Canada, four by government organizations, four by grain brokers and three by miscellaneous enterprises. The investment in the 36 principal stations is estimated at \$1,104,500 and they cover the Dominion from coast to coast.

There is a hint from Canadian Government circles, following a tour of Europe by the members of the Royal Canadian Radio Commission, that the policy to be adopted in the Dominion will provide for the establishment of stations of 25,000 and 50,000 watt rating under the direct control of provincial governments. These would rent time to various enterprises in order to secure revenue and they would replace privately-owned stations of small power.

E. J. BRENNAN, for the past two years assistant to J. K. Utz, radio sales manager of Kellogg, has been advanced to the position of Chicago district sales manager.

CARL T. DICKMAN is radio representative for Bush & Lane in central and southern Ohio.

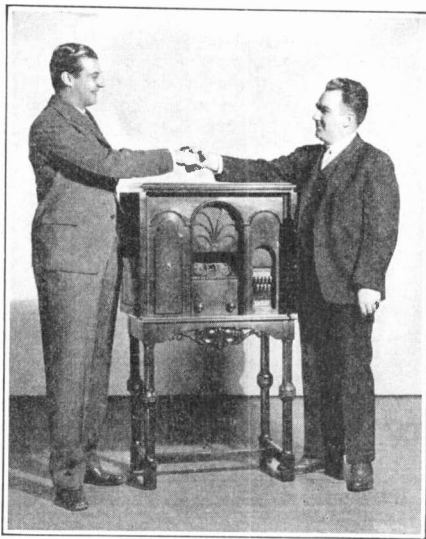

Wins Set in Zenith Contest

William T. Gaynor (right), Zenith eastern sales manager, presenting a Zenith automatic set to one of the three prize winners in the slogan contest recently conducted over station WOR, Newark, N. J., by the Zenith Radio Corporation, Chicago, to find the slogan most descriptive of its automatic receiver. "From air to ear instantly" was awarded first prize.

THE BENWOOD-LINZE COMPANY, St. Louis, Mo., has separated its manufacturing business from the distributing business and has formed the B-L Electric Manufacturing Company to take over that part of its activities.

THE HYGRADE LAMP COMPANY, Salem, Mass., is now selling its tubes under the trade name of "Hygrade", the old name of Neutron having been discontinued.

CARLE W. GUINZBURG, formerly with the Symphonic Sales Corporation, has opened an eastern office at 103 Park Avenue, New York City, for Wasmuth-Goodrich.

Personnel Changes

NEAL E. NEWMAN, who has been with the Felt and Tarrant Company, comptometer manufacturer, as assistant general sales manager, is now general sales manager of Crosley.

FRED S. WELLMAN has taken over the direction of radio sales for the Gulbransen Company. He was formerly vice-president of the Electrical Research Laboratories.

JOSEPH C. BUCKLEY, who has had extensive sales and advertising experience, is now advertising manager of CeCo.

B. H. BAKER and GEORGE F. RHODES, both with Grebe, have just received promotions. Mr. Baker is now sales manager and Mr. Rhodes has been made sales promotion manager.

HARRY E. STEINER and JAMES T. MANGAN are now with the Mills Novelty Company, Chicago, as general sales manager and advertising manager, respectively. Mr. Steiner held the same position with Holcomb and Hoke, and Mr. Mangan was formerly account executive with an advertising agency and advertising manager for Loftis Bros., jewelers.

DAVID KAHN, who joined the American Reproducers Corporation as mentioned in the May issue, is not the David E. Kahn who is president of the Federal Wood Products Corporation and vice-president of Federal Furniture Factories, Inc.

W. C. EVANS, until recently assistant superintendent of radio operations at Westinghouse, now has full responsibility for that work. He was formerly manager of KYW, Chicago, a Westinghouse station.

OTTO HEINEMAN has been elected to the board of directors of the Polymet Manufacturing Corporation. He is president of the Okeh Phonograph Corporation and the General Phonograph Manufacturing Corporation and a director in the General Industries Corporation and other companies.

What Will Screen-Grid Do to Radio?

(Continued from page 77)

MANUFACTURE of the screen-grid tube in sufficient quantities is a problem being rapidly solved as more and more production facilities are each day thrown into screen-grid supply. There should be no shortage this fall if one can analyze correctly the turn production has taken since the first alarms of famine went out.

Manufacturers of receiving sets are, of course, sharply divided as to the screen-grid opportunity. Some makers have gone over, 100 per cent, to the new model and are planning enormous productions around an expected popular demand which they are stimulating by big advertising.

Others are planning "duplicated lines,"—with both old and new models, 50 per cent to each,—being thus ready to throw their full heft into the battle on either side of the screen-grid controversy after they see "which way the cat jumps."

Still other makers express cynicism at the whole screen-grid situation and declare they will continue their present old-line models without change, until the future of the screen-grid demand is definitely known.

Right here, it should also be pointed out that some manufacturers will use screen-grid tubes largely as selling points, rather than for the improvement in reception resulting. For certain of the circuits proposed do not

use the screen-grid tube up to more than a fraction of its possible output and so do not take full advantage of the new tube's remarkable characteristics.

THE alternating-current screen-grid tube, rightly used, is to be regarded not only as a technical achievement, making for better radio reception, but its advocates look to it as the first triumph of economic improvement.

If it can accomplish this end, and if it can also clear itself creditably of the charges and complaints which its critics have brought against it, the industry will have taken a long step ahead and the "Screen-Grid Era" will be with us!

At the Chicago Trade Show, a majority of screen-grid sets will be exhibited, perhaps in the ratio of two to one in comparison with the old-line models. This proves that the manufacturers are alert for progress, from whatever quarter, and that they are watching vigilantly the new trends.

But manufacturers as well as dealers do not yet see the full answer. All are taking testimony, asking questions, testing sets, sifting evidence. And the final verdict will not be handed down until quotas are finally confirmed in July or August.

STUART KENT
 FORDMAN
 MAESTRI
 CHOLEY

The Best in Radio

Manor Radio Co

7403 COTTAGE GROVE AVENUE
PHOENIX TRIANGLE 7705

RADIOLA
 ZENITH
 HOLLER
 SPARTON

Dear Friend:

THIS LETTER MAY BE WORTH \$25.00 OR MORE TO YOU!

* We should be pleased to have you fill out the Name Blank on this sheet with the names of those whom you know who are interested in a Radio; have no set; or a Radio Set that is not working properly.

For EVERY one whom we sell, whether it be a small or large set, we will as a return for your favor, send you a card entitling you to FREE PERSONAL SERVICE for six months on your present set and equipment.

Here is a chance to get service from six months to a year or more that would otherwise cost you from \$15.00 to \$25.00 per year.

DON'T DELAY! Fill in and mail back to us TODAY. A stamped envelope is enclosed for your convenience.

Very truly yours,
MANOR RADIO COMPANY.

FILL IN AS MANY AS POSSIBLE! Mark "X" before name if you do not wish your name mentioned.

1. _____ Address _____
2. _____
3. _____
4. _____
5. _____

Should you need more space - use back of this letter.

Your Name _____
 Address _____

This form letter brought a 12 per cent response. Note that the reward for prospects' names is free service instead of cash. A return stamped envelope is enclosed. Frequently customers take advantage of this facility to mail a remittance on account.

(Continued from page 95)

prospects and the other a general hand-distributed job to 30,000 residents of Chicago's west side. Both circulars are written by Mr. Justin. They are printed in two colors. They stress moderate terms and special values. White space, for readability's sake, is used liberally.

A NORTH side firm, the Wonder Radio Company, in place of using professional copy as an "idea reservoir," devotes the upper half of its display space to manufacturers' suggestions but uses the rest of the space to tell of its special servicing facilities or to feature some timely item. It distributes manufacturers' literature frequently and extensively.

The third dealer whose advertising methods were studied was Richard Baskind, owner of the Manor Radio Company, located in the heart of a south side residential district. Mr. Baskind spends approximately 15 per cent of his publicity appropriation for direct-mail propaganda. He relies on Uncle Sam to carry to users his offer of "Six months free service for the name of a live prospect." A return address envelope, with stamp affixed, is inclosed. The last mailing of this nature brought a 12 per cent response.

"The unique offer of six additional months, free service seems to be more attractive to the user than the customary plan of paying \$5 for live leads," he states.

These dealers have solved the problem of how best to reach the neighborhood prospect by suiting the message, and the medium, to their knowledge of local conditions. Justin's difficulty is one of insufficient newspaper coverage. He meets it by the aggressive use of circulars. Baskind, on the other hand, finds his neighborhood press all sufficient for general publicity and devotes his direct-mail efforts, therefore, to the admirable plan of using the user as a prime source of prospect names.

It is worthy of note, however, that each executive endorses the moderate use of well-located poster boards to

obtain that necessary leaven of "prestige" publicity. In the matter of window design these men also concur. Making the window an integral part of the store attracts more trade than the platform window with its impenetrable background, all agreed. Two of these concerns have large, double windows flanking a center entrance. In both instances the floor of the store extended to the front of the window.

Better to fix the firm's advertising in the reader's mind each firm also has adopted an individualistic design for its signature.

A SUBJECT frequently overlooked, and which is closely allied with advertising, is that of the sales possibilities of the telephone. While the firms interviewed are not at present running systematic telephone solicitations one thing was noticeable, each had plenty of phones.

"That's one thing we learned early in the game," declares William Haedike, in charge of advertising for the Wonder Company. "Have enough trunk lines so that customers will have no difficulty getting the store at once and so that salesmen will not have to wait if they wish to call a group of prospects."

Perhaps the best guide for the radio retailer who would strengthen his advertising is found in the terse expression of "Dick" Baskind—a sentiment stated also, in other language, by Messrs. Justin and Haedike: "There is no set of exact formulas for advertising," he declared, "but if I were to lay down one rule which has helped me most it is this: don't spend money for printer's ink unless you have a real message to deliver and a medium that will carry that message right into the home of the prospective buyer."

How Justin Checks His Ads

When Frank Justin, of Justin Brothers, Cicero, Illinois, writes an advertisement, he checks it up by asking himself these questions:

1. *Is my headline sufficiently unique to attract attention?*
 2. *What is the definite appeal in the body matter that will incite action from the reader?*
 3. *Is the text concise, so that it will be read; yet long enough to tell a clear story?*
 4. *Have I made the advertisement attractive—readable—by the use of short sentences, frequent paragraphs, white space, sub-heads, boxes and variations of type sizes?*
 5. *Are the prices properly displayed?*
 6. *Are the illustrations interesting?*
 7. *Does the display carry a distinctive border?*
-

Trade Show Exhibitors

and PRODUCTS Displayed

On these two pages are listed all exhibitors and products on display at the third annual Trade Show of the Radio Manufacturers Association, held in Chicago, June 3 to 7, at the Stevens, Congress and Blackstone Hotels.

A

A-C Dayton Co., 300 East First St., Dayton, Ohio—Receivers, short-wave adapters.
Acme Radio & Mfg. Co., 1444 Hamilton Ave., Cleveland, Ohio—Radio chassis, console combination to use with chassis and including dynamic speaker.
Acme Wire Co., New Haven, Conn.—Parvoit condensers, celatsite, pushbak, spaghetti, aerial wire.
Adler Mfg. Co., 39th & Chestnut Sts., Louisville, Ky.—Cabinets.
Aerial Insulator Co., Green Bay, Wis.—Insulators.
Aero Products, Inc., 4611 E. Ravenswood Ave., Chicago, Ill.—Converters, monitor, wave meter, kit of parts.
Aerovox Wireless Corp., 70 Washington St., Brooklyn, N. Y.—Condensers, mica and paper, "A."
All-American Mohawk Corp., 4201 Belmont Ave., Chicago, Ill.—Receivers.
Allen-Hough Carryola Co., Milwaukee, Wis.—Portable phonographs, electric and mechanical; pickups.
Aluminum Co. of America, Edgewater, N. J.—Aluminum for all purposes, magnesium products.
American Bosh Magneto Corp., Springfield, Mass.—Receivers, reproducers, pick-ups.
American Reproducers Corp., 1204 Summit Ave., Jersey City, N. J.—Dynamic reproducers.
Amrad Corp., Medford Hillside, Mass.—Radio receivers, Mershon condensers.
Andrea, F. A. D., Inc., Long Island City, N. Y.—Receivers, reproducers.
Arborphone Division, (see United Reproducers, Inc.).
Areo Electrical Corp., 207 E. Columbia St., Fort Wayne, Ind.—Chargers, Power units, automatic switches, transformers, coils, condenser tanks.
Areturus Radio Tube Co., 160 Sherman Ave., Newark, N. J.—A. C. tubes.
Aston Cabinet Mfrs., 1223 W. Lake St., Chicago, Ill.—Cabinets.
Atwater Kent Mfg. Co., Philadelphia, Pa.—Sets, speakers.
Auld, D. L. Co., Columbus, Ohio—Embossed escutcheons, metal clad panels.
Audak Co., Inc., 565 Fifth Ave., New York, N. Y.—Pick-ups.

B

Baldwin, Inc., Nathaniel, Salt Lake City, Utah—Console and table cabinets, dynamic speakers, air column, phono-speakers, electrical reproducers, Baldwin headsets.
Balket Radio Co., 22d St., N. Chicago, Ill.—Receivers.
Belden Mfg. Co., 2300 S. Western Ave., Chicago, Ill.—Antenna equipment.
Best Mfg. Co., 1200 Grove St., Irvington, N. J.—Magnetic speaker, units, pick-up, dynamic speaker chassis.
Birnback Radio Co., 254 W. 31st St., New York City—Extension and reproducer cords, R. F. coils, connectors, flexible wire.
Brach, L. S. Mfg. Corp., 127 Sussex Ave., Newark, N. J.—Lightning arresters, antenna outfits, plugs, connectors, window lead-ins, hydrometers, insulators, crystal detectors, relays, solder. A and B power units, power amplifiers, antenna plugs, Brachstats.
Brandes Corp., 200 Mt. Pleasant Ave., Newark, N. J.—Receivers.
Bremer Tully Mfg. Co., 656 Washington St., Chicago, Ill.—Receivers.
Brooklyn Metal Stamping Corp., 718 Atlantic Ave., Brooklyn, N. Y.—Home talkie machine, Home broadcaster, pick-ups,

jacks, crystal set, dials, plugs, switches, midjet jacks, fixed detector, tip jacks, connectors, rheostats, rheostat switches.
Brown & Caine, Inc., 2317 Calumet Ave., Chicago, Ill.—Fixed condensers.
Brunswick-Balke-Collender Co., 629 S. Wabash Ave., Chicago, Ill.—Radio-phonographs, receivers.
Buckeye Mfg. Co., (see United Reproducers, Inc.).
Buckingham Radio Corp., 440 W. Superior St., Chicago, Ill.—Receivers, pick-up.
Burgess Battery Co., 111 W. Monroe St., Chicago, Ill.—Dry batteries.
Bush & Lane Piano Co., Holland, Mich.—Radio-phonograph, furniture, receivers.

C

Cable Supply Co., Inc., 84 N. Ninth St., Brooklyn, N. Y.—Tubes.
Carter Radio Co., 407 S. Aberdeen St., Chicago, Ill.—Resistors, jacks, rheostats, switches, valve controls.
Caphart Automatic Phonograph Corp., Huntington, Ind.—Automatic phonograph.
Caswell Runyan Co., Huntington, Ind.—Furniture.
Ceco Mfg. Co., Inc., Providence, R. I.—Tubes.
Central Radio Corp., Roosevelt and 5th Sts., Beloit, Wis.—Kits, sockets, receptacles, panels.
Central Radio Labs., 16 Keefe Ave., Milwaukee, Wis.—Volume controls, voltage controls.
Champion Radio Works, 138 Pine St., Danvers, Mass.—Tubes.
Chillicothe Furniture Co., 1 Cherry St., Chillicothe, Mo.—Furniture.
Clurostat Mfg. Co., Inc., 285 N. Sixth St., Brooklyn, N. Y.—Controls, grid leaks, resistors, power, rheostats, socket antenna plugs, line control.
Colonial Radio Corp., 25 Wilbur Ave., Long Island City, N. Y.—Receivers.
Columbia Phonograph Co., Inc., 1819 Broadway, New York City—Receivers, radio-phonographs, portables.
Connor Furniture Co., New Albany, Ind.—Furniture.
Continental-Diamond Fibre Co., 3208 Palmolive Bldg., Chicago, Ill.—Laminated bakelite and fibre-sheets, rods and tubes.
Continental Radio Corp., Fort Wayne, Ind.—Insulating material.
Cornish Wire Co., 30 Church St., New York City—Wire and cable of all kinds.
Crosley Radio Corp., Cincinnati, Ohio—Receivers, reproducers.
Crowe Name Plate & Mfg. Co., 1749 W. Grace St., Chicago, Ill.—Metal escutcheons and face plates, etched and lithographed metal panels, metal dials and scales, name and serial number plates for radio accessories.
Cunningham, Inc., E. T., 370 Seventh Ave., New York, N. Y.—Tubes.
Day-Fan Elec. Co., 1320 Wisconsin Blvd., Dayton, Ohio—Receivers.

D

De Forest Radio Co., 139 Franklin St., Jersey City, N. J.—Tubes.
De Jur-Amsco Corp., 418 Broome St., New York City—Ballast units, a. c. line voltage controls, wirewound resistances, metalized grid-leaks and resistors, variable condensers, sockets, heavy duty resistances, R. F. coils, binding post strip, illuminated dials, fixed mica condensers, plugs, resistance coupled units, resistor mountings.
Demco Corp., Wheeling, W. Va.—Power units.
Deutschmann, Tobe Corp., Washington St., Canton, Mass.—Condensers, paper A-filter, interference eliminators.

Diamond Electric Corp., 780 Frelinghuysen Ave., Newark, N. J.—Dry batteries, tubes.
Diamond Vacuum Prod. Co., 4049 Diversey Ave., Chicago, Ill.—Tubes.
Dongan Electric Mfg. Co., 2987 Franklin St., Detroit, Mich.—Audio transformers, power transformers, filament transformers, choke coils, fixed condensers.

E

Ebert Furniture Co., Red Lion, Pa.—Furniture.
Eby, H. H. Mfg. Co., Inc., 4710 Stenton Ave., Philadelphia, Pa.—Binding posts, tip jacks, tube sockets.
Edison, Thos. A., Inc., Orange, N. J.—Receivers, radio-phonographs.
Ekko Co., 111 W. Monroe St., Chicago, Ill.—Ground clamps, connectors.
Electrad, Inc., 175 Varick St., New York, N. Y.—Volt divider fixed resistances, variable resistances, center tap resistance, wire grid resistance, brackets, phasatrol, lead-in, socket antenna, lightning arresters, switches, jacks, tonatrols, metallic leaks and resistors, rheostats and potentiometers, by-pass and filter condensers, grid leak mountings, glass grid leaks, mica fixed condensers, five-watt variable high resistances, covered wire-wound resistors.
Electrical Research Labs., Inc., 2500 Cottage Grove Ave., Chicago, Ill.—Receivers, electric phonographs, amplifiers, pick-ups, dynamic speakers.
Elgin Cabinet Corp., Union & W. Chicago Sts., Elgin, Ill.—Furniture.
Elkon, Inc., 3029 E. Washington St., Indianapolis, Ind.—Chargers, A-eliminators, replacement rectifiers, 110-V rectifier for dynamic speakers.
Empire, Ltd., 11th St. & Harris Ave., Rockford, Ill.—Furniture.
Essenbee Radio Devices Co., 2016 W. Lake St., Chicago, Ill.—Ball antennas.
Eureka Talking Machine Corp., 5939 S. Lowen Ave., Chicago, Ill.—Portable phonographs.
Exello Products Corp., 4820 W. 16th St., Chicago, Ill.—Furniture.

F

Farrand Mfg. Co., Inc., Long Island City, N. Y.—Dynamic and inductor speakers, table model speakers.
Fast, John E., & Co., 3982 Barry Ave., Chicago, Ill.—Condensers.
Federal Furniture Factories, 206 Lexington Ave., New York, N. Y.—Furniture.
Federal Radio Corp., 1738 Elmwood Ave., Buffalo, N. Y.—Receivers.
Findlay Mfg. Co., Robert, Inc., Metropolitan & Morgan Aves., Brooklyn, N. Y.—Furniture.
Formica Insulation Co., Cincinnati, Ohio—Panels, sub-panels, insulating parts, tubes, sheets, rods.
Freed-Eisemann Radio Corp., 122 East 42d St., New York City—Receivers, inductor & dynamic speakers.
French Battery Co., Madison, Wis.—Dry batteries, flash lights, radio tubes.
Freshman Co., Inc., Chas., 122 E. 42d St., New York, N. Y.—Receivers, inductor & dynamic speakers.
Frost, Inc., Herbert H., 1124 W. Beardsley Ave., Elkhart, Ind.—Volume controls, rheostats, potentiometer, hum balancers, fixed resistors, sockets, jacks, switches, headphones, microphones, extension cords, hook-up wire, plugs, adapters, wall outlets, cables & plugs, jack-boxes, moulded mica condensers, filter condensers, by-pass condensers, "B" blocks.

G

General Dry Batteries, Inc., 13100 Athens Ave., Cleveland, Ohio—Dry batteries.
General Instrument Corp., 477 Broadway, New York City—Variable condensers, power units, rheostats, experimental equipment.
General Radio Co., 30 State St., Cambridge, Mass.—Laboratory apparatus.
Gilby Wire Co., 217 N. Desplaines St., Chicago, Ill.—Nickel and nickel alloys, resistance and strip, heat and acid resisting castings, special alloys, filament wire, thermocouple wire, manganun wire, aluminum wire, phosphor bronze wire, monel metal wire, manganese nickel, seamless nickel tubing.
Gold Seal Electrical Co., 250 Park Ave., New York City—Tubes.
Grebe & Co., Inc., A. H., Richmond Hill, N. Y.—Receivers.
Grigsby-Grunow Co., 5801 Dickens Ave., Chicago, Ill.—Radio-phono. combinations, receivers.

H

Hamilton Mfg. Co., Two Rivers, Wis.—Cabinets.
Herald Electric Co., 29 East End Ave., New York City—Speakers.
High Frequency Labs., 28 N. Sheldon St., Chicago, Ill.—Radio chassis, power amplifier.
Howard Radio Co., South Haven, Mich.—Receivers.
Hubbell, H. L., 59 Market Ave., N. W., Grand Rapids, Mich.—Furniture.
Hygrade Lamp Co., Salem, Mass.—Tubes.

I

Insuline Corp. of America, 78 Cortlandt St., New York City—Panels, parts, television kits.
International Resistance Co., 2006 Chestnut St., Philadelphia, Pa.—Resistors, grid leaks, accessory resistor devices, resistor test outfits.
Jefferson Electric Co., 1500 S. Laflin St., Chicago, Ill.—Transformers, tube rejuvenator, radio fuse and base, radio fuses, radio fuse clips, fuse cutout base, eliminator plug fuse.
Jensen Radio Mfg. Co., 338 N. Kedzie Ave., Chicago, Ill.—Reproducers.
Jewell Electrical Inst. Co., 1640 Walnut St., Chicago, Ill.—Electrical testing instruments of all kinds.
Jones, Howard B., 2300 Wabsania Ave., Chicago, Ill.—Multi-plugs.

K

Kellogg Switchboard & Supply Co., 1066 W. Adams St., Chicago, Ill.—Receivers, radio-phonograph combination.
Kennedy Corp., Colin B., 212 West Ewing Ave., South Bend, Ind.—Receivers.
Ken Rad Corp., Owensboro, Ky.—Tubes.
Kersten Radio Equip., Inc., Kalamazoo, Mich.—Radio and theatrical horns, dynamic and magnetic cone units.
Kester Solder Co., 4201 Wrightwood Ave., Chicago, Ill.—Solder (self-fluxing).
King Mfg. Corp., 254 Rano St., Buffalo N. Y.—Receivers.
Knoxville Table & Chair Co., Knoxville, Tenn.—Furniture.
Kodol Elec. & Mfg. Co., 507 E. Pearl St., Chicago, Ill.—Dry rectifiers, replacement units, power packs, chargers.
Kolster Radio Corp., 39 Broadway, New York City—Receivers.

L

Logan Furniture Mfg. Co., Logan, Ohio—Furniture.
Lund, I. A., Corp., 1018 S. Wabash Ave., Chicago, Ill.—Furniture.

M

Magnavox Co., 4250 Horton St., Oakland, Calif.—Dynamic speakers.
Markel Elec. Prod. Co., 145 E. Seneca St., Buffalo, N. Y.—Furniture (metal).
Maring Wire Co., Muskegon, Mich.—Magnet wire.
Marvin Radio Tube Corp., Irvington, N. J.—Tubes.
Master Engr. Co., 122 S. Michigan Ave., Chicago, Ill.—Line voltage control.
Matchless Electric Co., 143 W. Austin St., Chicago, Ill.—Tubes (La Salle).
McMillan Radio Corp., 1421 S. Michigan Ave., Chicago, Ill.—Receivers.
Micarta Fabricators, Inc., 500 S. Peoria St., Chicago, Ill.—Insulation.
Minerva Radio Co., 154 E. Erie St., Chicago, Ill.—Receivers.
Muter Co., Leslie F., 8440 So. Chicago Ave., Chicago, Ill.—Dynamic speaker, B power unit, filter and by-pass condensers, lightning arresters, lead-ins, ground clamps, aerial kits, phone plug, knife switches, fixed rheostats, grid leak and resistance mtg., fixed grid leaks, audio choke, R. F. choke, var., high resist. fixed wire wound

resistances, interference elim., A. C. power unit, A. C. fila., trans., adapter sockets, variable A. C. resistances.

N

National Carbon Co., Inc., 30 E. 42d St., New York, N. Y.—Receivers, speakers.
National Co., Inc., 61 Sherman St., Malden, Mass.—Vernier dials, variable condensers, tuning units, complete sets, short wave parts, "B" eliminators, A-B power supplies, power amplifiers, audio and push pull transformers, tone filters, scratch filters, radio freq., chokes, power and filament transformers.
National Electrical Products Co., 8 E. Kenzie St., Chicago, Ill.—Receivers.
National Vulcanized Fibre Co., Maryland Ave. and Beech St., Wilmington, Del.—Insulation.
Newcombe Hawley (see United Reproducers, Inc.)
Northern Mfg. Co., 371 Ogden Ave., Newark, N. J.—Tubes.

O

O'Neil Mfg. Co., 715 Palisade Ave., West New York, N. Y.—Speakers.
Operadio Mfg. Co., 13th & Indiana St., St. Charles, Ill.—Dynamic speakers, amplifiers, air column speakers, conamic speakers, special theater type speakers.
Oxford Radio Corp., 3200 West Carroll Ave., Chicago, Ill.—Dynamic speakers.

P

Pacent Electric Co., Inc., 91 Seventh Ave., New York, N. Y.—Phonovox, electrovox, electrovox chassis, electric phonograph motor, transformers, plugs, rheostats.
Perryman Electric Co., Inc., 33 W. 60th St., New York City—Tubes.
Philadelphia Storage Battery Co., Philadelphia, Pa.—Receivers, speakers.
Phillmore Mfg. Co., Inc., 106 Seventh Ave., New York City—Crystal set, receiving set, short-wave converter, single plugs, double plugs, crystal detectors, aerial kits, lightning arresters, rheostats, sockets.
Pierson Co., Rockford, Ill.—Furniture.
Pioneer Radio Corp., Plano, Ill.—Receiving sets, moulded sockets, moulded drum dial.
Platter Cabinet Co., North Vernon, Ind.—Furniture.
Polymet Mfg. Corp., 599 Broadway, New York City—Condensers, resistances.
Pooley Co., 16th & Indiana Ave., Philadelphia, Pa.—Cabinets for Atwater Kent sets.
Potter Co., North Chicago, Ill.—Condensers.

Q

Quam Radio Prod. Corp., 9705 Cottage New York, N. Y.—Speaker horns.
QRS. De Vry Corp., 333 N. Michigan Ave., Chicago, Ill.—Home talking movie machine.

R

Racon Elec. Co., Inc., 18 Washington Place, New York, N. Y.—Speaker, horns.
Radio Cabinet Co., Grand Rapids, Mich.—Furniture.
Radio Cabinet Co., Rockford, Ill.—Furniture.
Radio-Victor Corp., 233 Broadway, New York City—Receivers, tubes, speakers.
Radio Master Corp., Bay City, Mich.—Furniture.
Raytheon Mfg. Co., 238 Main St., Cambridge, Mass.—Tubes, kino lamps, photo electric cells.
Red Lion Cabinet Co., Red Lion, Pa.—Furniture.
Rola Co., 4250 Hollis St., Oakland, Calif.—Reproducers.
Radio Prod. Co., Dayton, Ohio—Short-wave adapter, a.c. tube checker.

S

Samson Electric Co., Canton, Mass.—Amplifiers, audio transformers, power transformers.
Sangamo Electric Co., Springfield, Ill.—Audio transformers, mica condensers.
Seoville Mfg. Co., 99 Mill St., Waterbury, Conn.—Condenser, dials, knobs, machine screws.
Sentinel Mfg. Co., 9705 Cottage Grove Ave., Chicago, Ill.—Receivers, chassis, United Electric pick-up, United Electric motor.
Shamrock Mfg. Co., 196 Waverly Ave., Newark, N. J.—Receivers.
Showers Bros., Co., Bloomington, Ind.—Cabinets.
Silver-Marshall, Inc., 6401-51 W. 65th St., Chicago, Ill.—Receivers, private brand receivers, power amplifiers, speakers and parts.
Sonatron Tube Co., 1020 So. Central Park Ave., Chicago, Ill.—Tubes.
Sonora Phonograph Co., 50 W. 57th St., New York City—Receivers, radio-phonographs.

Sparks-Withington Co., Jackson, Mich.—Receivers.
Starr Piano Co., Richmond, Ind.—Furniture.
Steinite Radio Co., 506 S. Wabash Ave., Chicago, Ill.—Receivers, radio-phonographs.
Sterling Mfg. Co., 2831 Prospect Ave., Cleveland, Ohio—Tube tester and reactor dynamic speakers, magnetic cone speakers, hum eliminator for a.c. dynamic speakers, receivers, portable set and tube tester, power units.
Stevens Mfg. Corp., 42 Spring St., Newark, N. J.—Magnetic and dynamic speakers, motors and pick-ups.
Stewart-Warner Corp., 1826 Diversey Parkway, Chicago, Ill.—Receivers, dyphonic speakers, dynamic speakers.
Story & Clark Piano Co., 173 N. Michigan Ave., Chicago, Ill.—Furniture.
St. Johns Table Co., Cadillac, Mich.—Furniture.
Super-Ball Antenna Co., Green Bay, Wis.—Super-Ball, ball aerial, super ground clamp, kabintenna.
Superior Cabinet Corp., 206 Broadway, New York City—Cabinets.
Supreme Inst. Corp., Greenwood, Miss.—Testing instruments.
Swan-Haverstick, Inc., Muirhead Ave., Trenton, N. J.—Aerial kits, porcelain battery switches, window lead-in strips, ground clamps, lead-in wire, indoor aerial kit, light socket antenna, lightning arresters, porcelain insulators, glass insulators, porcelain screw eye insulators.
Sylvania Prod. Co., Emporium, Pa.—Tubes.

T

Televoal Corp., 588 12th St., West New York, N. J.—Tubes.
Temple Corp., 5253 W. 65th St., Chicago, Ill.—Receivers, speakers, combinations.
Thordarson Elec. Mfg. Co., 500 W. Huron St., Chicago, Ill.—Transformers and chokes for all purposes.
Tower Mfg. Corp., 122 Brookline Ave., Boston, Mass.—Headsets.
Transformer Corp. of America, 2309 S. Keeler Ave., Chicago, Ill.—Transformers, (audio, power) chokes, filter, outputs, power packs, dynamic speakers to mfrs. exclusively.
Tyrman Elec. Corp., 314 W. Superior St., Chicago, Ill.—Portable receiver.

U

Udell Works, 28th St. at Barnes Ave., Indianapolis, Ind.—Cabinets.
Union Furniture Co., Jamestown, N. J.—Furniture.
United Air Cleaner Corp., 9705 Cottage Grove Ave., Chicago, Ill.—Electric phonograph turntable.
United Reproducers Corp.—(Arborphone—Buckeye—Peerless—Newcombe-Hawley Divisions), Rochester, N. Y.—Receivers, speakers.
United Scientific Labs., Inc., 113 Fourth Ave., New York City—Chassis, variable condensers.
U. S. Radio & Television Corp., 1338 S. Michigan Ave., Chicago, Ill.—Receivers.
Universal Elec. Lamp Co., 26 Treat Place, Newark, N. J.—Tubes.
Utah Radio Prod. Co., 1615 S. Michigan Ave., Chicago, Ill.—Speakers, ultra-violet sun ray lamp.

V

Valley Appliances Co., 634 Lexington Ave., Rochester, N. Y.—Reproducers.
Victoreen Radio Co., 2825 Chester Ave., Cleveland, Ohio—Receiver.
Victor Talking Machine Co., Camden, N. J.—Receivers, radio phonographs.

W

Walbert Mfg. Co., 1000 Fullerton Ave., Chicago, Ill.—Receivers.
Wasmuth-Goodrich Co., Peru, Ind.—Cabinets.
Webster Co., 850 Blackhawk St., Chicago, Ill.—Power units.
Webster Elec. Co., DeKoven & Clark Sts., Racine, Wis.—Electric phonograph pick-up, power amplifiers, audio input, output transformers, chokes. Made to manufacturers' specifications.
Wells-Gardner & Co., Chicago and Kedzie Aves., Chicago, Ill.—Receivers.
Weston Elec. Inst. Corp., 614 Freylinghuyssen Ave., Newark, N. J.—Meters and electrical testing equipment of all kinds.
Wilcox Labs., Charlotte, Mich.—Receivers, reproducers.
Wright-DeCoster, Inc., St. Paul, Minn.—Speakers.

Y

Yahr & Lang Co., Milwaukee, Wis.—Antennas.
Yaxley Mfg. Co., 1103 W. Munroe St., Chicago, Ill.—Switches, plugs, radio convenience outlets, resistances.

Z

Zenith Radio Corp., 3620 Iron St., Chicago, Ill.—Receivers.

BROADCASTING NEW PROFITS ACROSS THE LAND

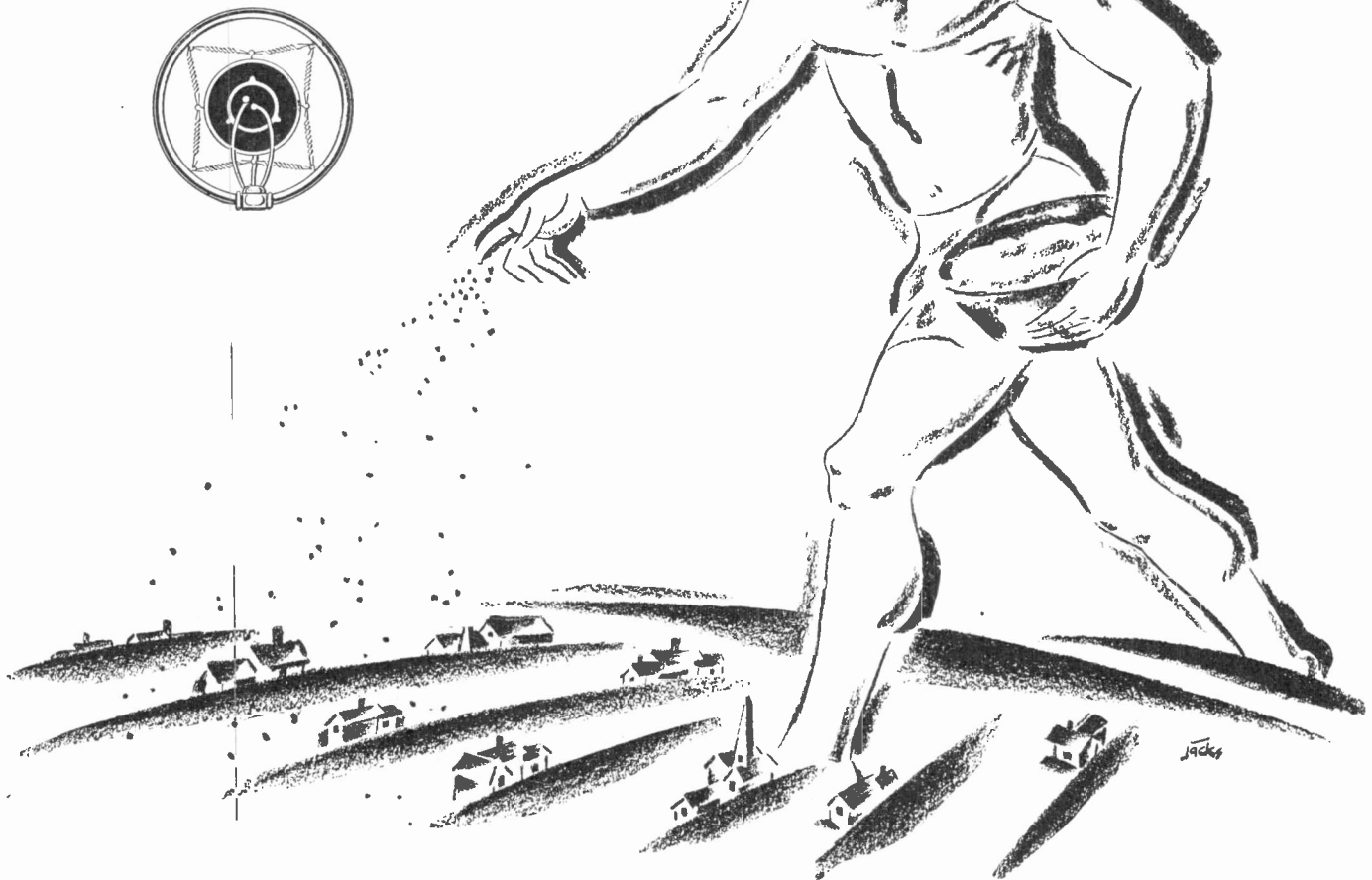

A gigantic hook-up including all the salient points in nation-wide broadcasting speeds the name of FREED RADIO into homes all over the country. On Tuesday evenings a golden web of harmony, spun from the baton of Phil Spitalny, leader of the Freed Orchestradians, is spread over all Radioland. ¶ A mighty voice broadcasting its message of newer and better reception makes endless numbers of converts weekly. ¶ The programs presented by the FREED Orchestradians are creating a market of vast sales possibilities, impressing the listener, often the owner of an obsolete battery set, with the name and value of FREED RADIO. The wise dealer will reap the fruits of this all-embracing Freed broadcasting and insure his business with a set that automatically becomes his sales leader.

FREED RADIO

FREED-EISEMANN RADIO CORPORATION

122 EAST FORTY-SECOND STREET, NEW YORK CITY

Timetable of Principal Chain Broadcasting Programs

Use this chart in tuning in for demonstrations. A timetable of evening programs will be published next month

DAY	CHAIN	6:45 A.M.	8:00	9:00	10:00	10:30	11:00	12:00 M	1:00 P.M.	1:30	2:00	3:00	3:30	4:00	4:30	5:00		
SUNDAY	NBC (WEAF)			Children's Hour			Spanish String Orch.											
	NBC (WJZ)						12:30-Amer. String Quart.										5:30-Twilight Voices	
	Columbia																Twilight Reveries	
	NBC (PACIFIC)																5:30-Rev. Barnhouse Hour	
MONDAY	NBC (WEAF)	Tower Health Exercises	8:30 Cheerio	9:15-Mercur's Orchestra			11:15-Radio Household	Dr. S. P. Cadman	Dr. S. P. Cadman	Sunday Concert	2:30-Anglo Persians	Sunday Concert	Sunday Concert	Great Moments			A. K. Hour	
	NBC (WJZ)	7:30-Rise and Shine	On the 8:15	9:15-Three Little Maids	The Bluebirds		Melody Muskeeters	12:45-Palais D'Or	Palais D'Or	Palais D'Or	2:15-La Salle String Quart.		3:45-Studio Program	Opera Digest			5:30-Jolly Bill and Jane	
	Columbia							The Luncheon 5	Hotel St. Regis Orch.	Hotel St. Regis Orch.	Band of 1000 Melodies						5:35-Market Summary	
	NBC (PACIFIC)						Magazine (Cont.)											
TUESDAY	NBC (WEAF)	Tower Health Exercises	8:30 Cheerio	Milk Colman	La Salle String Quart.		11:15-Radio Household	12:45-Hotel Penn. Orch.	Pennsylvania (Cont.)	Pennsylvania	Edna Bennett	Gotham String Quart.	Mellow Melodies	Music Critic			Edson Program	
	NBC (WJZ)	7:30-Rise and Shine	On the 8:15	9:15-Three Little Maids	The Bluebirds		Melody Muskeeters	Luncheon 5	Yoeng's Orchestra	Yoeng's Orchestra	Your Daily Menu	Band of 1000 Melodies	3:45-Studio Program	Dancing Melodies			Rudy Vallee	
	Columbia						Ida Bailey Allen		Yoeng's Orchestra	Yoeng's Orchestra	2:45 Health Talk						Studio Program	
	NBC (PACIFIC)						Magazine (Cont.)				The Wanderers	Vote's Service					Eveready Hour	
WEDNESDAY	NBC (WEAF)	Tower Health Exercises	8:30 Cheerio	Mercur's or.	National Home Hour		11:15-Radio Household	12:45-Palais D'Or	Palais D'Or	Palais D'Or	2:15-Gotham String Quart.						5:30-Jolly Bill and Jane	
	NBC (WJZ)	7:30-Rise and Shine	On the 8:15	9:15-Three Little Maids	The Bluebirds		Melody Muskeeters	Luncheon 5	Yoeng's Orchestra	Yoeng's Orchestra	3:45 Talks	Band of 1000 Melodies	3:45 Talks	Musical Moments			Stage and Screen	
	Columbia						Ida Bailey Allen											
	NBC (PACIFIC)						Magazine (Cont.)											Land O'Health
THURSDAY	NBC (WEAF)	Tower Health Exercises	8:30 Cheerio	Mercur's or.	National Home Hour		11:15-Radio Household	12:45-Hotel Penn. Orch.	Pennsylvania	Pennsylvania	12:15-La Salle String Quart.						5:30-Jolly Bill and Jane	
	NBC (WJZ)	7:30-Rise and Shine	On the 8:15	9:15-Three Little Maids	The Bluebirds		Melody Muskeeters	Luncheon 5	Hotel St. Regis Orch.	Hotel St. Regis Orch.	3:45 Talks	Band of 1000 Melodies	3:45 Talks	Happy Harmonies			Larry Brier's Orchestra	
	Columbia						Ida Bailey Allen											
	NBC (PACIFIC)						Magazine (Cont.)											Seiberling Program
FRIDAY	NBC (WEAF)	Tower Health Exercises	8:30 Cheerio	9:15-Mercur's or.	National Home Hour		11:15-Radio Household	12:45-Palais D'Or	12:45-Palais D'Or	12:45-Palais D'Or	Elsie Harmon	House of Myths	House of Myths	Cap't. Scully			Larry Brier's Orchestra	
	NBC (WJZ)	7:30-Rise and Shine	On the 8:15	9:15-Three Little Maids	The Bluebirds		Melody Muskeeters	Yoeng's Orchestra	Hotel St. Regis Orch.	Hotel St. Regis Orch.	3:45 Talks	Band of 1000 Melodies	3:45 Talks	Pacific Little Symphony				
	Columbia						Ida Bailey Allen											
	NBC (PACIFIC)						Magazine (Cont.)											Interwoven Pair
SATURDAY	NBC (WEAF)	Tower Health Exercises	8:30 Cheerio	9:30-U. S. Army Band	U. S. Navy Band		11:15-Radio Household	12:30 Sherry's Orch	12:30 Sherry's Orch	Yoeng's Orchestra	Yoeng's Orchestra	Gotham Trio	Marie Damrosch	Whites' Orchestra	Clover Club Trio		Al Laek's	
	NBC (WJZ)	7:30-Rise and Shine	On the 8:15	9:15-Three Little Maids	The Bluebirds		Magazine (Cont.)	Luncheon 5	Pennsylvania Lunch. Music	Pennsylvania Lunch. Music	Hotel Manger Orch.	Band of 1000 Melodies	Demonstration R.C.A.	RCA. (Con.)			Stock Reports	
	Columbia						Ida Bailey Allen											
	NBC (PACIFIC)						Magazine (Cont.)											White and Hunt
SUNDAY	NBC (WEAF)																	E. Hour

In first column at left, NBC-WEAF indicates the National Broadcasting Company chain with WEAF as key station. NBC-WJZ indicates the chain of which WJZ is the key station. Note—Time figures are for Eastern Daylight Saving Time, except for Pacific Coast programs. Time figures then indicate Pacific Coast Standard Time. This chart is copyrighted by Radio Retaining. Permission to reproduce is granted only if proper credit is given.

Radio Retaining, June, 1929

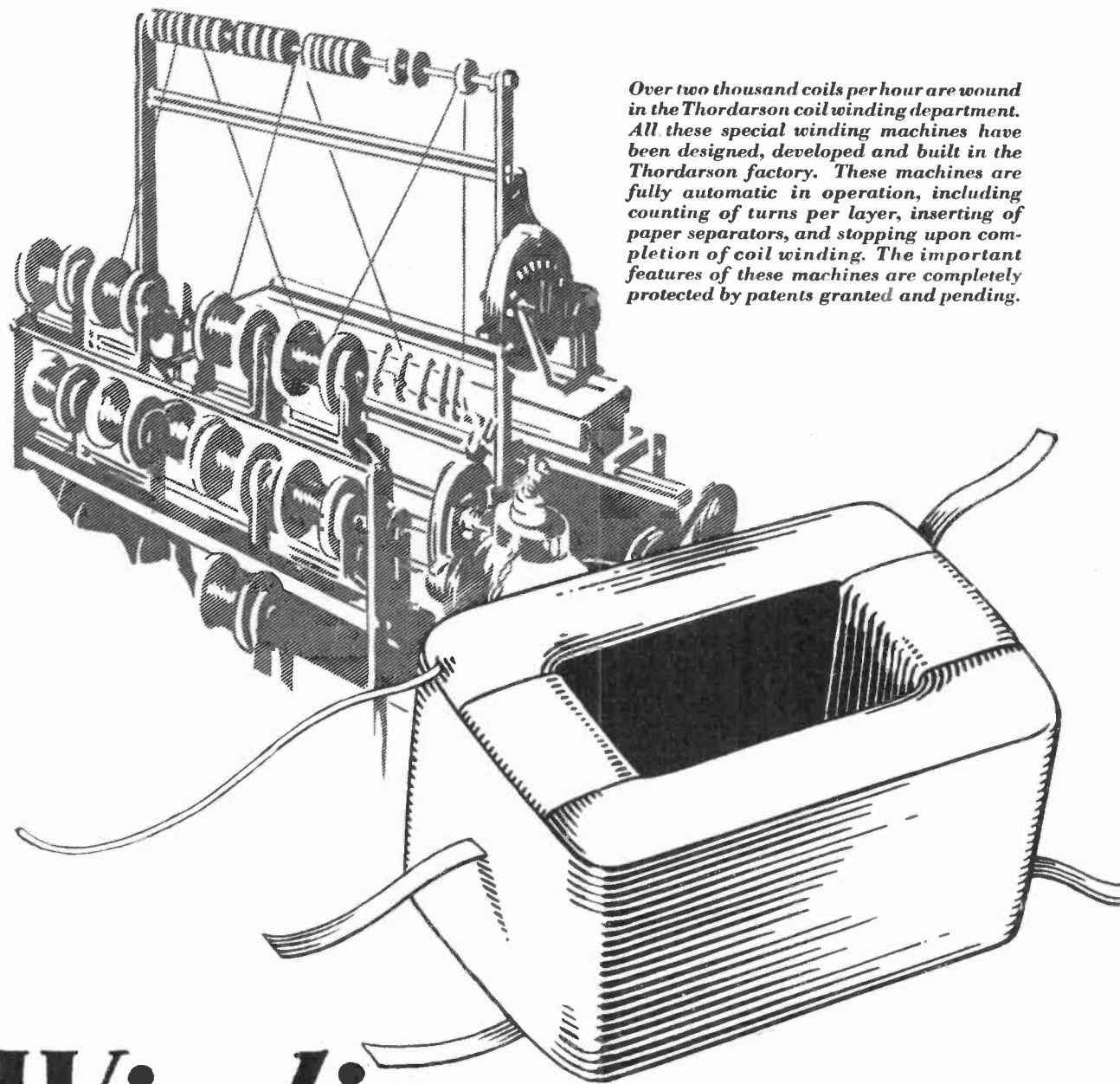

Over two thousand coils per hour are wound in the Thordarson coil winding department. All these special winding machines have been designed, developed and built in the Thordarson factory. These machines are fully automatic in operation, including counting of turns per layer, inserting of paper separators, and stopping upon completion of coil winding. The important features of these machines are completely protected by patents granted and pending.

Windings—

Thordarson coil windings are wound in the Thordarson factory — according to Thordarson designs — on machinery patented, built and owned by Thordarson.

They are combined with other Thordarson built parts to make transformers and chokes that are 100% Thordarson.

THORDARSON

Transformer Specialists Since 1895

THORDARSON ELECTRIC MANUFACTURING CO.
Huron, Kingsbury and Larabee Streets, Chicago, Ill.

Dramatizing *the Sales Convention*

A manufacturer finds that the efficiency of sales conventions is greatly increased through the medium of a film talk.

IT HAS been well said that we are a nation of organizations and conventions. Certainly the latter is true of the radio industry. This matter, therefore, of convention planning has become of prime importance to sales managers.

How best to hold attention, to "get over" the story with the maximum effectiveness and the least amount of boredom, is a problem which is being solved by the Kellogg Switchboard and Supply Company, Chicago, by the liberal use of educational films.

Under the old system of "mouth-to-ear," manufacturer to distributor to dealer to user, it is a safe bet that less than thirty per cent of the original story is effectively presented on the firing line.

Science claims that 87 per cent of retained impressions come through the eye. For this reason, the Kellogg company is using the darkened room and silver screen to tell the story of its manufacturing facilities, its product and its sales policies. Thus it substitutes an expert presentation for the uncertainties of talks by amateurs. It substitutes dramatic action for monotonous inaction.

A typical Kellogg distributor convention program is as follows:

- 8:00 p.m.—Five-minute address of welcome by the sales manager.
- 8:05 p.m.—Motion pictures showing manufacturing processes and the plant.
- 8:30 p.m.—Motion dramatization—"The Right and Wrong Way to Sell Radio."
- 8:50 p.m.—A still-film presentation of sales policies.
- 9:15 p.m.—A still-film presentation of advertising plans.
- 9:40 p.m.—Summation by sales manager.
- 9:50 p.m.—Discussion.
- 10:00 p.m.—Adjournment.

OBSERVE the impressive amount of instruction that has been imparted in two snappy hours of intensive application. During this interval, the distributor, or dealer, sitting in a comfortable chair, in a darkened room, has taken a trip through the factory and has been shown the advertising campaign plans for the coming year. He actually has visited a poor, a medium, and an excellent type of store, and has talked with their proprietors. He has been shown the value of window display. He has learned, in an impressive way, the salient selling features of the set being considered.

Following the first presentation of this character, held in the Palmer House, Chicago, sales manager Mac Harlan declared that he had never been able to transact so much business of vital importance to the company and to its distributors in so short a time.

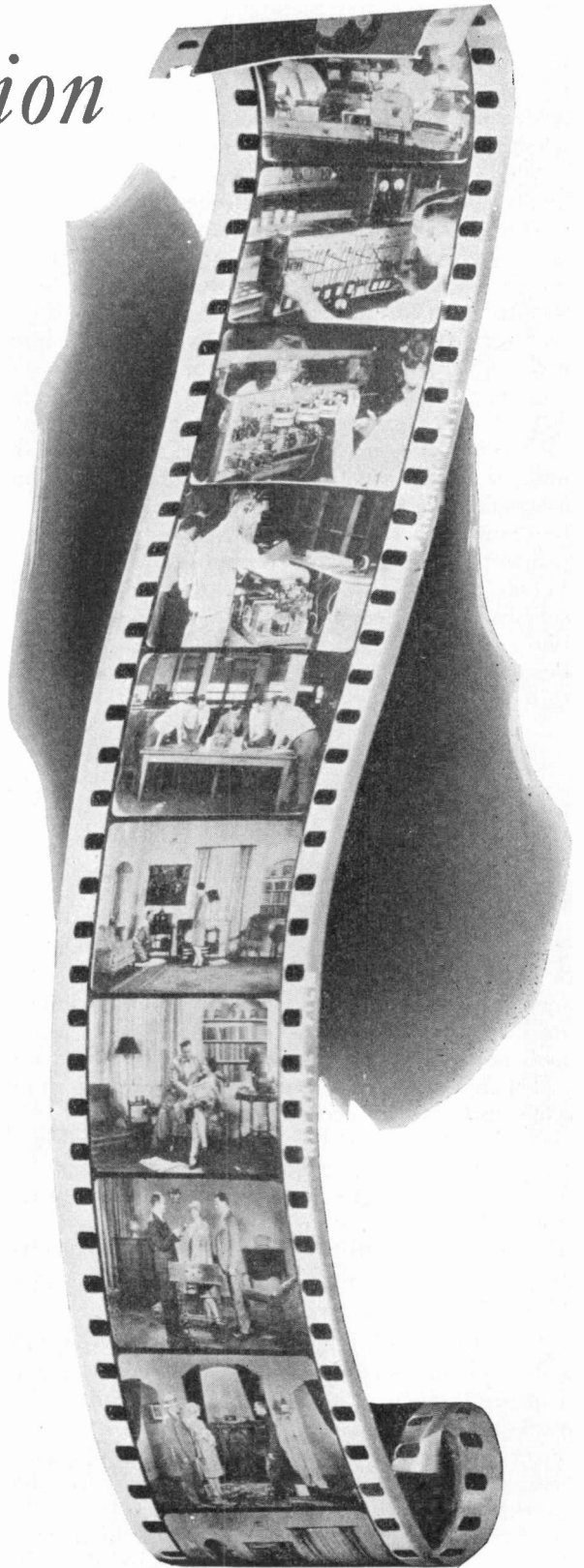

If you want the sales story to stick in the minds of your dealers and jobbers, give it to them in a visual way. It is instructive, entertaining and a great time-saver.

We Make Radio Pay

(Continued from page 87)

Our trade-ins are almost negligible—about one sale in forty. We do not take in second-hand radio merchandise of any description in excess of 10 per cent on any sale. In comparison to this, it may be interesting to note that on piano trade-ins we allow 66 $\frac{2}{3}$ per cent of the estimated market value of the trade-in. Recently we sold to a dealer specializing in second-hand talking machine and radio merchandise, all of our traded-in stock for a lump sum which was approximately what we allowed for it, \$10 per unit.

We give free service for three months, but no replacements, except on guaranteed tubes, for that period. We charge \$2 for service calls, and extra time over one hour is charged for at the rate of \$2 an hour, plus materials. We do not figure a profit on radio service; we simply take care of our customers. We do not find that service calls lead to sales to any great extent. We make a straight charge of \$15 for antennae installations.

WE PAY our service men an average straight salary of \$30 a week. When we start a radio department it is on a small scale—a manager first, and a store assistant. At first our service is on piece work; handled by some man connected with a jobber, or by an independent service man recommended by the jobber. When the department grows to warrant it, our own service man is employed. We have developed one or two successful radio service men from our piano tuning departments, who have had to have instruction from

radio men. Some of our service people have had factory experience, coming to us from the manufacturers' representatives. A number of our service men have developed into salesmen—a few salesmen have turned into service men. A number of the best radio salesmen I know are young men who first became interested in radio through the building of amateur sets at home, and who then drifted into the business.

We give radio, talking machines and combination sets a prominent place in the front of our warerooms, even in the piano headquarters in exclusive Stieff Hall.

OUR radio advertising is entirely separated from our piano advertising as a rule. We use the newspapers almost entirely. Our advertising manager in Baltimore places the copy for all our branches. He believes that the manufacturers' dealer copy is not suited to our needs. He says, by the way, that there are not enough cuts of various models, and that the manufacturer should furnish suitable line cuts of all models for use in newspapers. The factory advertising departments do not furnish envelope stuffers as they should.

Occasionally we use radio broadcasting from local stations. We use no patented sales processes, and we never enter into the combination advertising schemes which are so frequently urged upon us. We figure on 5 per cent cost for radio advertising, the same as our other lines.

The "Low Down" on Wired Broadcasting

(Continued from page 91)

Company—as well as its customer list—they urge that this contention is justifiable.

PROGRAM SERVICE maintains a broadcast studio from which it disseminates three types of entertainments: programs which it "lifts" from the ether through its own receiver and re-transmits; phonograph records, and, occasionally, original studio entertainment.

During the winter months the former dominates. In the summer time, records occupy 60 per cent of its seventeen-hour (7 a.m. to 12 p.m.), service. A study of a typical program reveals that music from local and chain broadcasting stations predominates. This concern is now enlarging its facilities to provide a two-program selection. It is doing this in order to overcome the chief obstacle it has encountered in selling its service, namely, no choice of programs.

SINCE its inception in 1925, the Program Service Company has expended over \$140,000 for radio apparatus. Much of this sum has found its way into the pockets of radio parts manufacturers. It is apparent, therefore, that an operation of this nature involves the use of considerable equipment and offers an interesting market for specialty manufacturers.

Program Service, for example, has purchased approximately 3,000 speakers, each equipped with a special volume-control device. It is a voracious user of amplifying tubes. An amplifier bank of two, specially designed No. 171 tubes is required for every five speakers.

Since many subscribers turn on the service in the morning and let it run all day, averaging ten hours use per day, tubes must be replaced twice a year. Programs are sent through a master amplifier and then transmitted by wire to one of nine telephone sub-stations. It is then sent through the banks of local circuit amplifying tubes and thence over leased telephone circuits to the subscriber.

Those advocating the wire method of re-transmitting programs, as exemplified by the St. Paul system, while admitting the very considerable amount of capital and equipment required, claim that this is justified because local interference noises are entirely eliminated. That this argument, to date, is not without merit, is evidenced in the fact that, so far, those companies experimenting with the carrier-wave system have experienced considerable trouble with local interference noises.

In other words when radio programs are impressed on an entire telephone or electric light installation they are at once brought in close juxtaposition with all kinds of electrical disturbances.

Summarizing the facts obtainable at this writing it is apparent that "wired broadcasting" has many problems to overcome before it will be a serious contender for universal acceptance as the radio of the future. Apparently it will continue to serve a type of public peculiarly its own and it will be obliged to invest in equipment which will necessitate a schedule of rental fees sufficiently high to provide more than a fighting-chance opportunity for the alert dealer in radio receivers.

Radio Retailing

Radio Manufacturers' Association
Annual Trade Show Exhibitors' Section

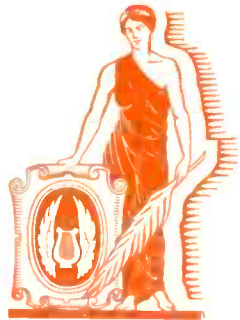

VALLEY APPLIANCES, INC.
ROCHESTER, NEW YORK
INVITES YOU TO INSPECT THE

Symington

FERRO-DYNAMIC & SUPER-DYNAMIC
REPRODUCERS AT THE R. M. A.
TRADE SHOW, BOOTH 16, JUNE 3-7

THE NEW SYMINGTON LINE, of Maloff-Serge design, is shown for the first time, publicly, at the R. M. A. Trade Show.

Symington brings to the dynamic field, two new quality speakers to retail at amazingly low prices. We believe they represent the utmost in performance and in price. We invite you to see them at the show, hear them in our Demonstration Room at the Hotel Stevens, or ask for samples to test in your own way . . . in comparison with any speaker you KNOW!

There is no secret about Symington super-value. First, a great manufact-

uring plant that FABRICATES every part . . . not merely assembles. Second, a sincere One-Profit Policy that aims for big volume with Super-Value prices.

We believe we have the Experience, the Engineers, the Plant, the Personnel, the Policy and the Price to make an outstanding success as independent speaker manufacturers. We invite you to pass judgment at the Trade Show.

VALLEY APPLIANCES, INC.
Rochester, New York

Licensed Under
Lecktophone Patents



VA-1

KNOW



KNOWN
by The Box



NO!



Tune In!

Champion *Weatherman*

Broadcast Daily by
Westinghouse Stations
KDKA, KYW, WBZ, WBZA.



There Is Still A Shortage

Ponderous production records!

Whoopee! 50,000—75,000—even 100,000 tubes daily are commonplace figures nowadays. But for modesty, possibly many tube manufacturers, would reveal even greater factory output—yet, the demand is still unsatisfied. There is still a shortage.

Good tubes are still scarce.

CHAMPION RADIO TUBES just don't seem to come through the mill in such overwhelming quantities—struggle as we may, and with all our 28 years' experience manufacturing just such products. Champions are held rigidly to quality standards in production.

If you are using Champions you will understand. If you are not—try them and you will.

Champion Radio Tubes are manufactured under patents owned and/or controlled by Radio Corporation of America and Associated Companies.

Champion Radio Works, Inc.

138-142 Pine Street

DAN VERS

MASSACHUSETTS

Champion

Radio Tubes



A BATTERY THAT SELLS!

There is a radio "B" battery you can sell . . . it's a battery with a lot of talking points. You can tell your customers about Cell Pocket Construction, for instance . . . and you can point out that they'll get some thirty per cent longer service from

this battery at only thirteen per cent greater cost. The battery? Ray-O-Vac No. 8303 Extra Heavy-Duty Radio "B". Your jobber will supply you.

FRENCH BATTERY COMPANY

FACTORY: MADISON, WISCONSIN

SALES OFFICE: 30 NORTH MICHIGAN AVENUE, CHICAGO

Makers also of Ray-O-Vac "A" and "C" radio batteries, Ray-O-Vac telephone, flashlight, and ignition batteries.

RAY-O-VAC
extra heavy-duty
 battery

RAY-O-VAC TUBES ARE HERE



When your customer says "tubes" you say "Ray-O-Vac". For now there's a complete line of radio tubes . . . every type . . . bearing this good name that has meant so much in the radio field. Ray-O-Vac Tubes are made to match the Ray-O-Vac reputation; and there's not much more that anyone . . . dealer or user . . . can ask. Your jobber is waiting to give you full information about Ray-O-Vac Tubes. Ask him.

FRENCH BATTERY COMPANY

FACTORY: MADISON, WISCONSIN
Sales Office: 30 North Michigan Avenue, Chicago
Makers also of Ray-O-Vac "A," "B" and "C" radio batteries, Ray-O-Vactelephone, flashlight, and ignition batteries. Rotomatic and standard flashlight cases.

RAY-O-VAC radio tubes

1927

In June 1927 the first Jensen Dynamic Speakers were being built. And instantly a new and higher standard of radio reproduction was established by the success of Jensen Dynamic Speakers.

1928

June 1928 saw the dynamic speaker become the "backbone" of progress in the radio industry. The dynamic speakers sold the radio receiver. And Jensen was the acknowledged leader in the quality field.

1929

In January the introduction of the Jensen Auditorium Dynamic (with 12 inch cone) again set a new and higher standard of reproduction. Now, the announcement of the Jensen Concert Dynamic (with 10 inch cone) with startling improvements in design and ability definitely sets the 1929 and 1930 standard.



JENSEN CONCERT DYNAMIC
With 10 inch cone

Model D7AC For AC operation . . . \$35.00
Model D7DC For DC operation . . . \$27.50

THE laboratories of America's leading radio set manufacturers have acknowledged the superiority of this new dynamic speaker and their engineers in collaboration with Peter L. Jensen have adapted it to their own specific requirements. The trade and public will acknowledge just as readily the marked superiority of radio sets equipped with this new reproducer.

JENSEN PATENTS ALLOWED AND PENDING. LICENSED UNDER LEKTOPHONE PATENTS

R. M. A. SHOW, STEVENS HOTEL. SPACE NO. 125. EXHIBITION

Jensen

CONCERT DYNAMIC

by PETER L. JENSEN

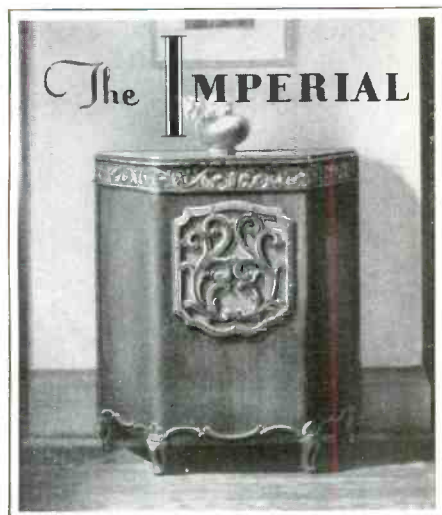

This beautiful cabinet is now available with the Jensen Concert Dynamic at a price placing it in the reach of everyone.

Jensen Imperial with Concert Unit (AC Model) . . . \$80.00
 Jensen Imperial with Concert Unit (DC Model) . . . \$72.50
 Jensen Imperial with Auditorium Unit (AC Model) \$100.00
 Jensen Imperial with Auditorium Unit (DC Model) \$90.00

HEAR this remarkable new reproducer at the R. M. A. Show!

No need of a "side by side" comparison. The superiority of this new Jensen speaker is impressive wherever it is heard, for in it Peter L. Jensen has applied entirely new and original principles.

The moving coil represents an innovation in design. The cone is ten inches in diameter. Great rigidity and strength is maintained with exceptional freedom of motion in the cone assembly.

This speaker, with extreme sensitivity, reproduces with enormous volume from the amplifier of any radio set. The entire musical range is reproduced with a quality of brilliance never heard before.

Completing the Jensen line is the *Standard Dynamic*, *Auditorium Dynamic*, the *Model 6 Cabinet*, and the new *Jensen Imperial* now available equipped with the Concert Dynamic as well as the Auditorium Dynamic. This is the most complete line of dynamic reproducers on the market. The prices of all models are surprisingly low; the result of volume production in a new and efficient factory.

JENSEN RADIO MFG. COMPANY
 6601 S. Laramie Ave. Chicago, Ill.
 212 Ninth Street Oakland, Cal.



JENSEN AUDITORIUM DYNAMIC
 With 12 inch cone
 Model DA5 AC For 110 volt AC operation \$70.00
 Model DA5 For 220 volt DC operation \$55.00
 Model DA4 For 110 volt DC operation \$55.00



MODEL 6 CABINET
 Equipped with Jensen Standard Dynamic
 Model D64AC For 110 volt AC operation \$50.00
 Model 65 For 110 volt DC operation \$42.50
 Model D64 For 6 volt DC operation \$42.50

HALL — DEMONSTRATION ROOMS, NUMBERS 905A AND 906A

**THE SPEAKER
SELLS THE SET**

MAGNAVOX

***Freedom from hum and
rattle at any volume***

Magnavox sets the speaker pace. First, with the original loud speaker. Next, with the modern dynamic. Now, with the new X-core principle of construction that brings actual new heights of fidelity to reproduction.

The Magnavox X-core Dynamic will be used as built-in equipment by several manufacturers of fine radio sets and is also sold as a separate unit under the Magnavox name.



REAL

EBY Products are a Tonic for your Business

EBY offers the dealer a line of radio products that give him good turnover and fair profit. Eby designs and develops with radio trends—every new Eby product reaches the market when demand is most active.

Dealers will find it profitable to sell their customers on Eby quality

—for quality in these small items is expected. A customer disappointed is a costly reflection upon the dealer.

Eby products, through their service, design and price, build the dealer's reputation and stimulate his business.

Further information about Eby products will gladly be sent you.



Eby posts have been the standard of quality for more than six years. Specified on most of the popular circuits and standard equipment on the majority of the better known receivers. The tops can't come off. List price 15c.

EBY SOCKETS



Eby UX and UY sockets are made of Bakelite with practically indestructible phosphor bronze contacts. That's one reason why most manufacturers of tube testing equipment use them. List price UX type 40c., UY type 50c.

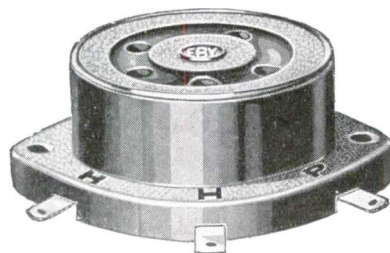

NEW

A pair of tip jacks moulded as inserts in a brown Bakelite strip marked Speaker, Phono or Field. No insulating washers. List price 35c.

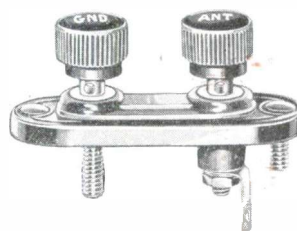

Antenna and ground twin posts. Ground post automatically grounded, Antenna post insulated. Attractive, profitable, fast selling. List price 50c.

The H. H. EBY
4710 Stenton Ave.
Makers of Eby



MFG. CO., Inc.
Philadelphia
Binding Posts

At the R·M·A· Show

BOOTH 71
Stevens Hotel

ROOM 537A
Stevens Hotel

ROLA

Review These
Outstanding
Contributions
to

QUALITY Reproduction



Model Thirty-J

Rola Electro-dynamic cabinet model equipped for light socket operation with any table receiving set. Unequaled for brilliant performance. List Price \$60



Model Twenty

Rola Electro-magnetic cabinet model distinguished for its beauty, tremendous power capacity and proven reliability.

List Price \$30



Model Fifteen

Rola Electro-magnetic cabinet model equipped with the same unit as Model 20—a remarkable value and a rapid seller.

List Price \$22.50



"J" SERIES

Electro-dynamic Model J-90 for field excitation from standard power pack. Cone diameter 7 3/4 inches.

List Price \$25



"C" SERIES

New Electro-dynamic Model C-90 with cone diameter 9 inches—for amplifiers using 245 tubes in push-pull combination.

List Price \$31.50



"R" SERIES

New Rola Electro-dynamic Model R-AC with large powerful magnetic field structure using full output of type 280 tube rectifier.

List Price \$70

NOW Rola brings not only brilliant performance, but new safety factors . . . exclusive refinements which indicate reliability unequalled among loudspeakers.

Brilliant Performance. Rola has attained a rare degree of sensitivity due to the high magnetic densities resulting from Rola's short, precision air-gap—without additional field energizing power. This feature gives high output efficiency with economy of power consumption, and is extremely important where the field current is supplied from the radio power-pack.

Simplified Construction. At a glance one realizes that here is beautiful mechanical simplicity and compactness—found in no other loudspeaker. A distinct engineering triumph of refinement in design closely approximating mechanical perfection!

New High Safety Factors. The new Rola ventilated field coil minimizes temperature changes and eliminates voltage fluctuation in the B-voltage supply circuit. The adjustable center-pole tip—an exclusive Rola feature which enables easy elimination of any magnetic particles which might enter the air-gap has been retained. The exclusive welded housing-to-shell construction prevents disaligning of moving coil even under extreme conditions of cabinet or baffle-board warping. Rola leads by practically eliminating service demands

SEE these new, exclusive features which mark a tremendous forward step toward finer, more reliable sound reproduction—at the R.M.A. Show, Stevens Hotel, Booth 71 and in Demonstrating Room 537A. Rola reproducers are furnished in the above cabinets and are used as standard equipment by prominent manufacturers of radio receiving sets, electric phonographs, talking pictures, public address systems in schools and auditoriums—wherever the utmost dependability and performance is desired in fine sound re-creation.

The
ROLA
COMPANY

CLEVELAND, OHIO
2570 E. Superior Ave.

OAKLAND, CALIFORNIA
45th and Hollis Streets

Cunningham RADIO TUBES



Be guided by a name that has meant absolute tube integrity for the past fourteen years. Ⓞ The name is Cunningham—choice of the American home.

Cunningham Booth No. 5, R M A Trade Show, Congress Hotel, Chicago, June 3-7

E. T. CUNNINGHAM, INC.

NEW YORK

CHICAGO

SAN FRANCISCO

DALLAS

ATLANTA

Manufactured and sold under rights, patents and inventions owned and/or controlled by Radio Corporation of America

Pam

Performance Speaks Louder
Than Claims

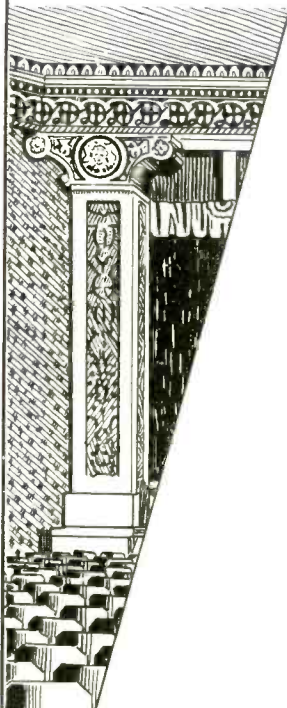

THE PLATTER CABINET CO.
DIVISION OF
NORTH VERNON LUMBER MILLS
A COMMON LAW TRUST
MANUFACTURERS PHOTOTONE
PLATTER CABINETS
NORTH VERNON, INDIANA

February 11th, 1929.

Samson Electric Company
Canton, Mass.

Dear Sir: - - Attention of Mr. R. W. Cotton.

I wish to take this opportunity to tell you how we are pleased with your amplifiers, which we are now using in our equipment.

We have installed approximately eleven hundred of our non-synchronous Phototones in theatres in every state and in several foreign countries. Of the eleven hundred installations, approximately one third used Samson amplifiers.

In checking over our service records we find the percentages of returns for all causes, as follows: -

- Amplifier No. 1 - - - - - 4 1/2%
- Amplifier No. 2 - - - - - 10%
- Amplifier No. 3 - Samson - - - - - None.

Truly yours,
James R. Martin
PLATTER CABINET COMPANY

By James R. Martin.

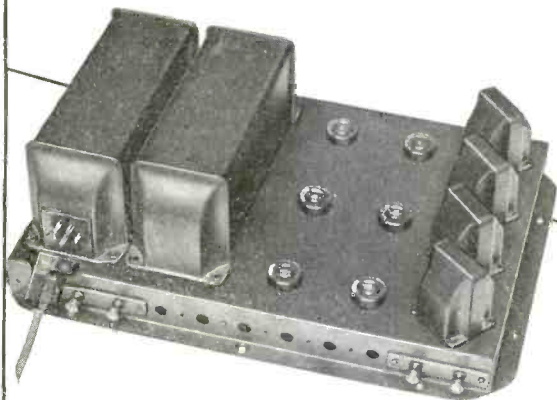

PAM 19
Price, without tubes, \$175.00

Demonstration Rooms 805, 806, Hotel Stevens

Samson Electric Co.



Main Office:
CANTON, MASS.

Send for Bulletin RR-1.

Factories at
CANTON and WATERTOWN



PERRYMAN HEADQUARTERS

HOTEL STEVENS

SUITE 1405-06

EXHIBITION HALL BOOTH No. 112



CHICAGO OFFICE

McCormick Building

332 South Michigan Avenue



Jobbers! Dealers! Manufacturers!

Ask for complete details about the

NEW MERCHANDISING PLAN

in back of the

Perryman National Advertising Campaign



PERRYMAN ELECTRIC Co., Inc.

NORTH BERGEN, N.J.

PERRYMAN RADIO TUBES



The NEW CARTON

This new, bright, attractive carton now identifies Perryman Radio Tubes. Its sturdy construction protects the tube against the possibility of breakage. All shipments from the factory since May 1st have been made in this new carton.

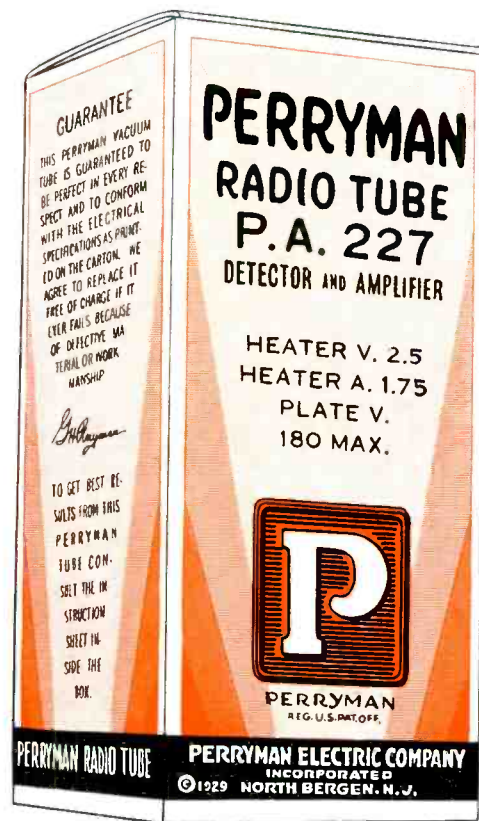

Keep these new bright Perryman cartons before the eyes of your customers. Pyramid cartons in the window, put several on your counter. This means more sales and greater profits for you.

Write today for Dummies



PERRYMAN RADIO TUBES

A Perryman Tube for Every Purpose

PERRYMAN A. C. TUBES

and accompanying Rectifiers and Power Amplifiers

DETECTOR-AMPLIFIERS

P. A. 227—heater type, for use with unrectified A. C. current direct on the filament through stepdown transformer. Exclusive Perryman processes have eliminated excessive hum and produced far above average life for this type of tube.

***P. A. 226**—for use with unrectified A. C. current direct on the filament in radio frequency amplification stages and first audio frequency stages.

POWER AMPLIFIERS

All tubes in this group are equipped with exclusive Perryman process oxide coated filaments. A product of Perryman chemical laboratories, unusually rugged, active and long-lived.

***P. A. 245**—This is the new power tube with longer life and greater undistorted output.

***P. A. 112-A**—a general purpose tube for radio frequency and audio frequency amplification. Can also be used as a detector. Filament current, one quarter-ampere.

***P. A. 171-A**—for last stage audio amplification. Quarter-ampere filament current.

***P. A. 210-A**—Super-power amplifier, delivers full volume of undistorted output. Especially suitable as an oscillator for amateur radio transmission.

***P. A. 250**—Super-power amplifier specially designed for amplifying circuit devices. Used in last audio stage of many new A. C. receivers.

***P. A. C. 224**—This is a new radio frequency amplifier of the screen grid type for A. C. operation.

RECTIFIERS

***P. R. 280**—a full wave rectifier, employing exclusive Perryman process oxide coated filament, insuring long life, satisfactorily used in power plants of most A. C. sets. Maximum D. C. output 125 mils.

***P. R. 281**—a half-wave rectifier, using exclusive Perryman process oxide coated filament, delivering an output of 110 mils. Used chiefly in the power plant of power amplifiers and B eliminators.

PERRYMAN D. C. TUBES

DETECTOR-AMPLIFIERS

***R. H. 201-A**—a general-purpose tube famous for its long life and fine quality.

R. H. 199—built in two type bases, miniature (small U.V.), long pin (standard V.X.). Rigidly made and especially reinforced.

P. A. 120—for last audio stage operated with 3-volt dry battery supply.

P. A. 200-A—a super sensitive detector tube of soft vacuum (gaseous) type. Pronounced ability to strengthen weak signals. Uses 45 volts on plate.

***P. A. 240**—especially designed for first audio resistance coupled amplification. It is a high mu tube and may also be used as a detector.

(*) Perryman Tubes equipped with the Patented Perryman Bridge.

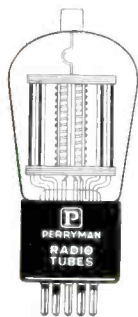

P. A. C. 224



P. A. 171-A



P. A. 245

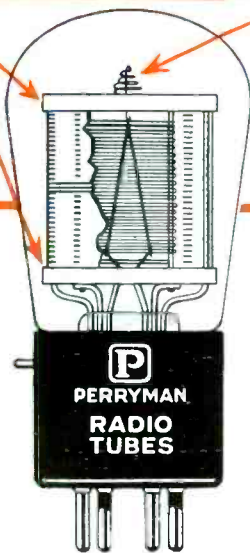

The Patented Perryman Bridge

... holds the filament, plate and grid, top and bottom, in permanent, parallel alignment. This sturdy construction feature is exclusive to Perryman Tubes.

The Perryman Spring

... allows for the uniform expansion and contraction of the filament due to temperature changes. Another construction feature exclusive to Perryman Tubes.



P. A. 227



P. A. 250



P. A. 226



THE NEW PERRYMAN Merchandising Plan *increases your tube profits*

▲ ▲ ▲ **T**HE 1929 Perryman Merchandising Plan includes you. National newspaper advertising is under way. Schedules are planned in conference with jobbers and dealers—newspapers are chosen in your own territory—right where it will do you the most good.

The extensive national newspaper advertising is *your* advertising. Cash in on it. Display Perryman Tubes—in your window—on your counter. Keep them in front of your customers' eyes.

Use the attractive, modern window and counter displays—consumer booklet, Perryman cuts and electros in your own advertising. Mats of the very same advertisements Perryman is using in the national advertising campaign are available for your use.

Remember, the Perryman Merchandising Plan means greater tube sales—more profits for you. Ask your jobber for complete details.





New creations by Red Lion

PAST popularity is the best criterion of the future. And on this basis dealers who feature Red Lion Cabinets are assured of a highly successful and profitable year. For Red Lion designers have proved their ability to anticipate the public fancy and to create cabinets that rank as "best sellers" every year.

Each cabinet is a master creation whose gracefully balanced design, beautiful finish, sound construction and excellent workmanship are indicative of the finest type of furniture.

*You are cordially invited to see these new Red Lion Cabinets
... Booth 6 at the R. M. A. Trade Show in Chicago*

RED LION CABINET COMPANY, RED LION, PA.

Makers of the famous Red Lion Furniture

Model R. L. 55 C

is an unusually attractive console type, finished in walnut. The grilled panel, finished in French walnut with frame of antique metallic finish, the old gold fabric over the speaker outlet, the fine molding outlining the arch, the interesting molding down the sides and the English turned legs are artistic touches which greatly enhance the pleasing appearance of this fine piece of furniture. A most unusual value at an exceptionally moderate price.



*The new
ATWATER KENT
Screen-Grid
Radio*

*Cabinet by
RED LION*

The Furniture for all ATWATER KENT Radios

“THEY’RE OFF!”



There's a new entry in the National Radio Sweepstakes! And the name it carries is famous since the pioneer days of wireless — *Brandes!* . . . The months of preparation are over! The years of experimenting are done! The new Brandes Radio—with Selector Tuning—is off to a flying start! . . . It's backed by a tremendous advertising campaign—different from any radio advertising you have ever seen—and *better!* And it features a *complete* merchandising plan—devised to keep every Brandes dealer in business *at a profit!* . . . See the Brandes models at the show! Compare them price for price! Pick yourself a winner for 1929!

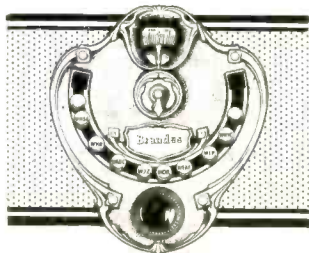

New...SELECTOR TUNER!

No more hunting on the dial! Adjust the Brandes Selector Tuner *once!* Thereafter, 8 different stations are in full view and instantly available!

R. M. A. Show, June 3rd to 8th inclusive. DISPLAY in Booth No. 19, the Gold Room.
DEMONSTRATION in Suite No. 1166, Hotel Congress, Chicago

The NEW Brandes Radio

[A DIVISION OF KOLSTER RADIO CORPORATION]

Copyright by The Brandes Corporation. 1929

PRICED RIGHT

THE MOST MODERN A. C. RADIO WITH MANY EXCLUSIVE FEATURES

Sell the finest distance-getting radio money can buy! Set your own list price . . . enjoy a full margin of profit, with ample to spare for trade-ins and selling costs! Read carefully the brief description of exclusive selling features shown for these musical instruments! Then . . . you'll want action . . . send at once for samples and prices . . . we will give you immediate attention!

As beautiful a radio as you've ever seen—super-selective—gets real distance—equipped with the wonderful new 245 tube (radio's latest forward step) . . . supplied complete with exclusive Pitch Control (makes possible reception just as you want to hear it) . . . a marvelous 9 tube tuned radio frequency set encased in a handsome walnut cabinet . . . equipped complete . . . all ready to play. To see and hear it, is to be convinced that something truly new has come to radio . . . priced right! Send today for sample and prices!



The Model 555



The Model 444

A marvelous 6 tube A. C. radio—a distance getter—super-selective—equipped with all the exclusive fea-

tures described at the right for the Model 555 complete and ready to play, in a most artistic walnut cabinet of newest design . . . priced right for volume selling! Our quotations will astound you send now for sample with prices!



You'll find it profitable to see our display
Room 502 Stevens Hotel
Chicago

*Chassis also quoted favorably, if desired alone.

SENTINEL



SENTINEL MANUFACTURING COMPANY

9715 COTTAGE GROVE AVENUE, CHICAGO, ILL.

Division of United Air Cleaner Company

"Victoreen is building a complete receiver!" is the word that has been passed around in trade circles during the past several months. We doubt if any new receiver has ever excited such interest. For both the Dealer and Consumer have learned to expect something different—and better from Victoreen.

A Revolutionary New Super Heterodyne

Embodying new fundamentals which, for the first time, enable the Super Heterodyne circuit to function at its best. It is the logical development of a seven year domination of the Super Heterodyne parts field, now expressed in a revolutionary new receiver built complete in the Victoreen factory.

Here is a receiver that will *stay sold*. It is a revelation in chassis construction. Built in two units—receiver and amplifier—each housed in cast aluminum cases with all parts completely shielded. Every tube works well within its rated voltage. Highest grade parts and construction throughout.

See and hear this new Receiver at the *June Trade Show*. Visit us at Booth No. 62 or at our demonstrating room in the Stevens Hotel. A thrill awaits you.

For Distributor or Dealer franchise as well as full information write

The Geo. W. Walker Co.
2825 Chester Ave.,
Cleveland, Ohio



Single dial control.
Simplified tuning with but two panel controls.

Compact and sturdy construction.
One spot reception.

Extreme sensitivity and selectivity
Finest tone quality and truest reproduction.

Volume controlled from a whisper to a shout without distortion.
Adjusted and aligned at factory ready for immediate service.

Drum dial calibrated in kilocycles.
Artistry in cabinet designs.

Finest Quality Throughout

Victoreen

THE FASTEST
SELLING PRODUCT
AT THE
RADIO SHOW

REQUEST FOR SAMPLE AND DETAILS

Send all details and name of nearest Jobber who will deliver sample ROTROLA upon my request.

Name.....

Address.....

*Samples sent at once to interested jobbers.



See our Display
Room 507-A
Stevens Hotel
Chicago

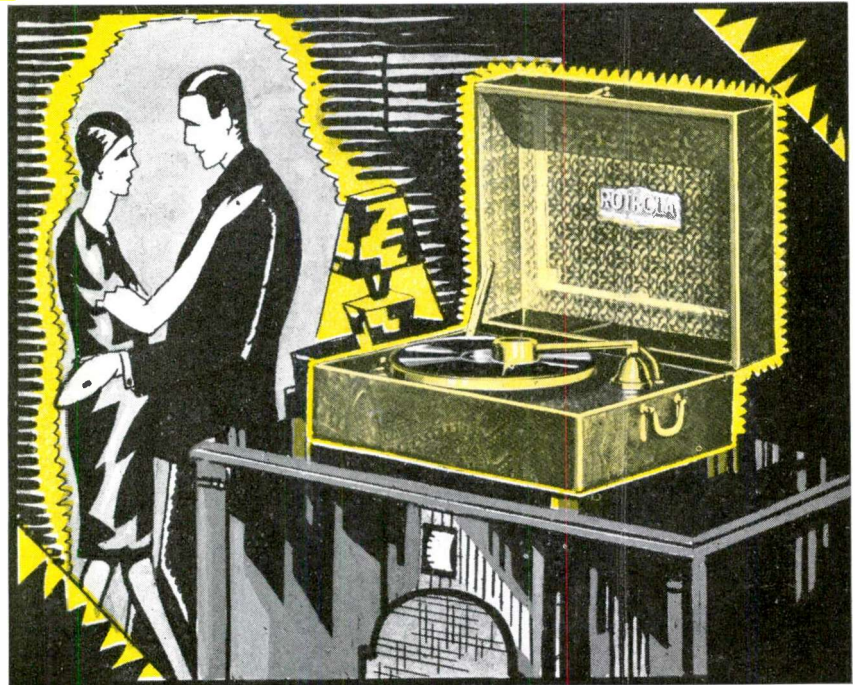

The NEW ROTROLA

Quick sales . . . every customer on your books is a preferred prospect for the new Rotrola. Dealers and Jobbers who see and hear it at the show, will marvel at the profit opportunity it affords. Those not attending, will wisely wire at once for sample. You can sell plenty at \$45 retail list price . . . you have no competition! Every home with a radio actually needs a Rotrola . . . connected in an instant, it broadcasts electrically all recorded music right through the radio. Equipped with famous Rotor, electric motor, and Webster Pick-up (or any other standard pick-up, if you desire), this new musical instrument is in a class by itself in performance . . . beauty and efficiency.

Keep Your Radio Organization Intact During the Summer

. . . you may now do so profitably . . . with the Rotrola. Your sales and service men can sell this instrument to every customer on your books. They will sell plenty . . . ask anyone returning from the show . . . or better, address us at once for sample and full details. Act Today . . . Obey that impulse!



ALLEN-HOUGH
CARRYOLA CO.

279 Walker Street, Milwaukee
New York, 225 West 34th Street

World's Largest Makers of Portable Musical Instruments

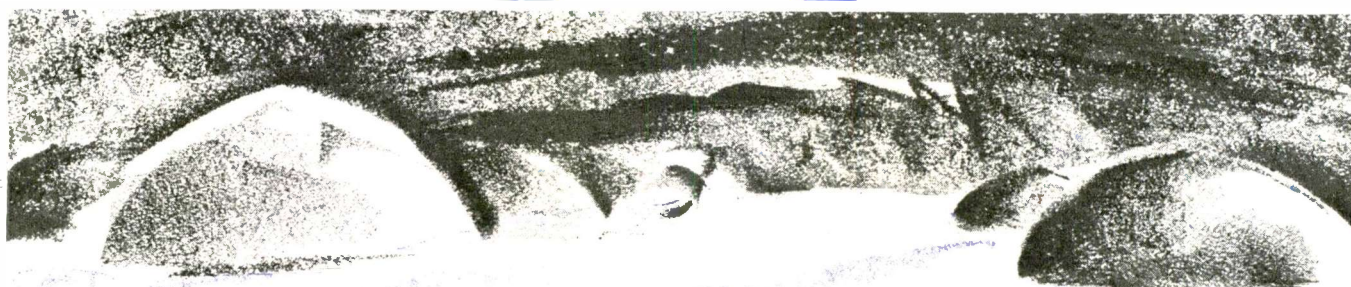

WHEN a pebble is dropped into a stream its ripples spread far and wide. When one Kolster is sold in a community it starts ripples of satisfaction that carry Kolster sets to almost every block in the



**"In the radio business
at a profit!"**

That's the title of a new merchandising plan — prepared by experts especially for Kolster! Nothing so *complete* has ever been done before! It's packed full of valuable ideas on every phase of radio retailing! Available—now—to all Kolster merchants!



district. This actual market condition has blazed the way to success for dealers everywhere. Why not experience it in your store?

R. M. A. SHOW, JUNE 3RD TO 8TH INCLUSIVE. DISPLAY-
BOOTH No. 18, THE GOLD ROOM. DEMONSTRATION—
SUITE No. 1166, HOTEL CONGRESS, CHICAGO

Copyright, 1929, by Kolster Radio Corporation, Newark, N. J.

Let us help

WHEN we gave our dealers the C. A. Earl radio we gave them a set with a new Hair-line Super-selectivity—a set proved by actual test for outstanding performance in each particular locality. Yet our job is only half done. We must now help those dealers to sell more C. A. Earl sets this year than their biggest previous records for all other makes combined.

We propose to do this by the most practical and comprehensive retail selling co-operation ever put behind a radio.

1 **A Complete Price Range**

enables you to concentrate on a single line. Thus you will reduce your Stock Investment, increase your Turnover and Profit and get more Results per advertising dollar expended.

2 **Coast-to-Coast Broadcasting**

by the C. A. Earl Orchestradians, Phil Spitalny conducting. Every Tuesday evening these headliners of the air, with brilliant guest artists, delight millions of radio fans. And these fans represent millions of prospects for C. A. Earl dealers.

3 **National Magazine and Newspaper ADVERTISING**

A list headed by *The Saturday Evening Post*, and including the leading newspapers of the country, carries a selling message whose powerful appeal is made doubly effective by dominant space.

4 **Co-operative Campaign for Dealers**

This three-fold campaign includes all three types of advertising—(a) “*Producer*,” such as newspaper advertisements, booklets, folders, etc. (b) “*Identifier*,” such as window and store displays, etc. (c) “*Reminder*,” such as attractive novelties carrying the dealer’s name.

5 **A Unique Merchandising Service**

by which our Trade Research Bureau solves many of the dealer’s practical retail selling problems, and helps him in all kinds of ways, from selling over the telephone to arranging partial payment terms.



you sell

MODEL 22 \$99.50
(less tubes)

All Electric 8-Tube Set
Complete with
Arcturus tubes \$120
Neutrodyne. Four tuned
circuits. Push-Pull am-
plification. Inductor Dy-
namic Speaker. Walnut
finish cabinet.

MODEL 32 \$169
(less tubes)

All Electric 8-Tube Set
Complete with
Arcturus tubes \$194.50
Neutrodyne. Four tuned
circuits. Push-Pull am-
plification. Dynamic
Speaker. Phonograph
Pick-up. Walnut cabinet
with contrasting panels.



MODEL 31 \$139
(less tubes)

All Electric 8-Tube Set
Complete with
Arcturus tubes \$164.50
Neutrodyne. Four tuned
circuits. Push-Pull am-
plification. Inductor
Dynamic Speaker. Phono-
graph Pick-up. Open type
cabinet, walnut finish.

MODEL 41 \$225
(less tubes)

All Electric 9-Tube Set
Complete with
Arcturus tubes \$253.50
Neutrodyne. Five tuned
circuits. Push-Pull am-
plification. Dynamic
Speaker. Phonograph
Pick-up. Walnut cabinet.

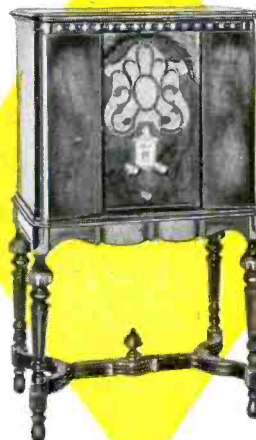

The Price Range of C. A. Earl Radios is

\$75 to \$225 (less tubes)

Prices slightly higher in Canada

IMPORTANT

Earl Radio SALES

FEATURES

- 1** Super-Selectivity—that picks the particular station you want out of the thickest “traffic jam” on the air.
- 2** Sensitivity—that brings in a program with a lifelike fidelity never attained in radio until this season.
- 3** All Neutrodyne Four Tuned Circuits.
- 4** Antenna Variometer — for increased selectivity on short waves and increased sensitivity on long waves. This is an exclusive feature.
- 5** Single Control with Illuminated Dial.

- 6** Phonograph Pick-up is a feature of all console models with the exception of Models 21 and 22.
- 7** Push - Pull Amplification — using the latest development of audio amplifiers — the 145 tubes.
- 8** Artistic Cabinets—each a really beautiful example of the cabinet-maker’s craft — will prove particularly appealing to your feminine customers.
- 9** Light Socket Antenna with all sets except Model No. 22.

Write or wire for information regarding C. A. Earl Franchises still available—and where you may hear C. A. Earl Radio.

CHAS. FRESHMAN CO., Inc.

C. A. Earl, President

122 East 42nd Street, New York, N. Y.

CHICAGO — SAN FRANCISCO — LOS ANGELES
KANSAS CITY — ATLANTA

Canada: Freshman Freed-Eisemann Radio, Ltd.,
20 Trinity Street, Toronto, Ont.

C.A. Earl Radio

Performance - insured

Radio performance can be no better than the performance of each component part.

Your finest engineering efforts are defeated unless each purchased part performs precisely as your specifications require.

The T·C·A standard of quality is your best insurance that these important units, at least, will function as you would have them.

Look us up at the Radio Show and let's talk it over. Booth No. 64D. Demonstrations at Room 516, Stevens Hotel.

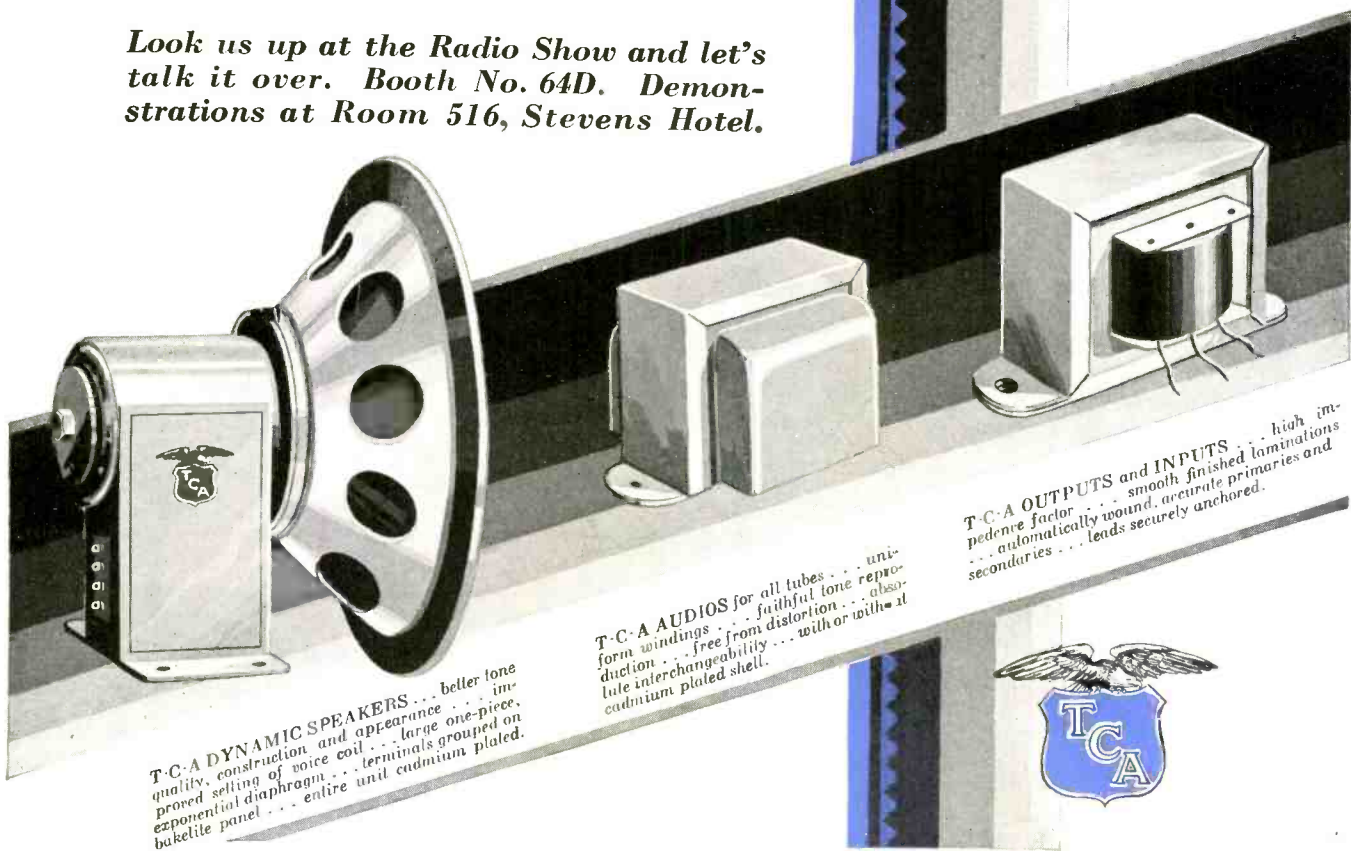

T·C·A DYNAMIC SPEAKERS . . . better tone quality, construction and appearance . . . improved setting of voice coil . . . large one-piece, exponential diaphragm . . . terminals grouped on bakelite panel . . . entire unit cadmium plated.

T·C·A AUDIOS for all tubes . . . uniform windings . . . faithful tone reproduction . . . free from distortion . . . absolute interchangeability . . . with or without cadmium plated shell.

T·C·A OUTPUTS and INPUTS . . . high impedance factor . . . smooth finished laminations . . . automatically wound, accurate primaries and secondaries . . . leads securely anchored.



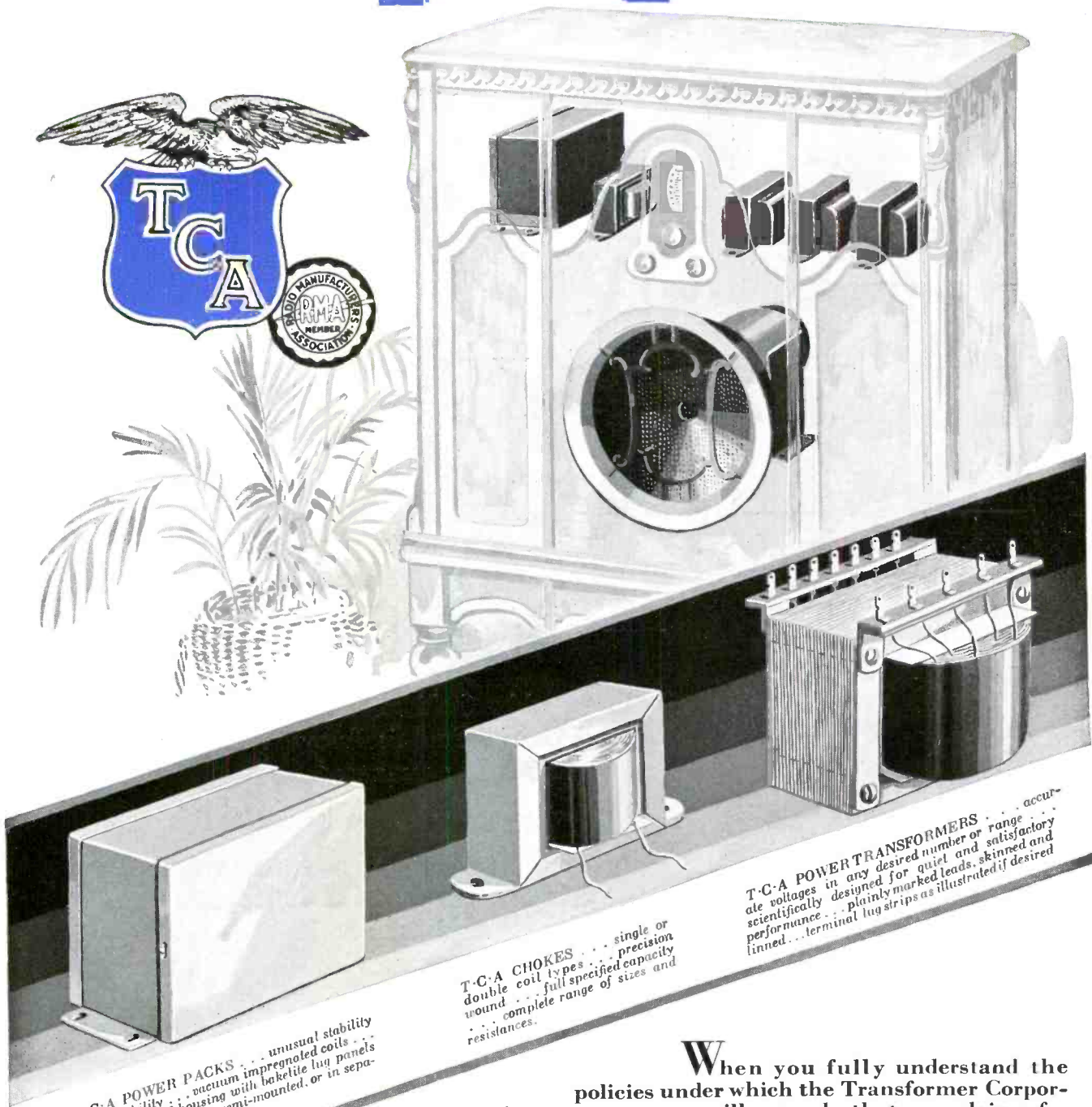

T-C-A POWER PACKS . . . unusual stability and durability . . . vacuum impregnated coils . . . cadmium plated housing with bakelite lug panels . . . furnished complete, semi-mounted, or in separate units.

T-C-A CHOKES . . . single or double coil types . . . precision wound . . . full specified capacity . . . complete range of sizes and resistances.

T-C-A POWER TRANSFORMERS . . . accurate voltages in any desired number or range . . . scientifically designed for quiet and satisfactory performance . . . plainly marked leads, skinned and tinned . . . terminal lug strips as illustrated if desired

Core laminations are all of special soft steel of high magnetic capacity, and separated by a silicate treatment that raises their value. Blanks are clean cut and free from burrs. Cadmium plated shields supplied if desired. All leads securely anchored, and insulated leads thoroughly skinned and tinned for rapid handling and perfect soldering.

Complete data and samples available. T-C-A engineers will gladly assist in your audio and power supply developments.

When you fully understand the policies under which the Transformer Corporation operates, you will concede that our claims for T-C-A products are reasonable and conservative. Specialization, we all know, has its advantages. It makes intensive and critical engineering possible.

It has enabled us to perfect our product to a point where a large demand has developed. We have built millions of units. This volume has encouraged us to build and install special machinery, more accurate and more speedy than human hands. T-C-A Transformers meet the quality requirements of your engineers, as well as the price requirements of your production department.

Transformers and dynamic speakers have much in common from a manufacturing standpoint. So the T-C-A Dynamic was a natural development for this organization.

And the same precision through controlled quantity production that made T-C-A transformers and power packs standard in the country's finest sets, is securing a quality in T-C-A Dynamics that is receiving quick recognition. They are a real contribution to the industry.

TRANSFORMER CORP. OF AMERICA, 2301-2319 South Keeler Avenue, CHICAGO

Gold Seal's Exclusive Development

—the new GSY227



Invented by Gold Seal's own engineers;
produced in Gold Seal's own factories;
and positively guaranteed.

Full, silent service for its entire life.

It heats in 5 seconds—faster than
any other tube—and it heats as
quickly at the end of 1000 hours
as when it was new.

A real sensation in radio

Now in Production

Orders being accepted for immediate delivery

BULLETIN

See us at the Chicago
Show Booth 161, Stevens
Hotel, Demonstration
Room, 422A.

Telegraphic orders from accredited
Gold Seal representatives will be
shipped day order is received.
Others in the trade write at once
for full information about Gold
Seal's complete sales proposition.

Gold Seal Electrical Co., Inc.

250 Park Ave., New York

Gold Seal Tubes are now the equipment of leading receiving-set manufacturers. They know.

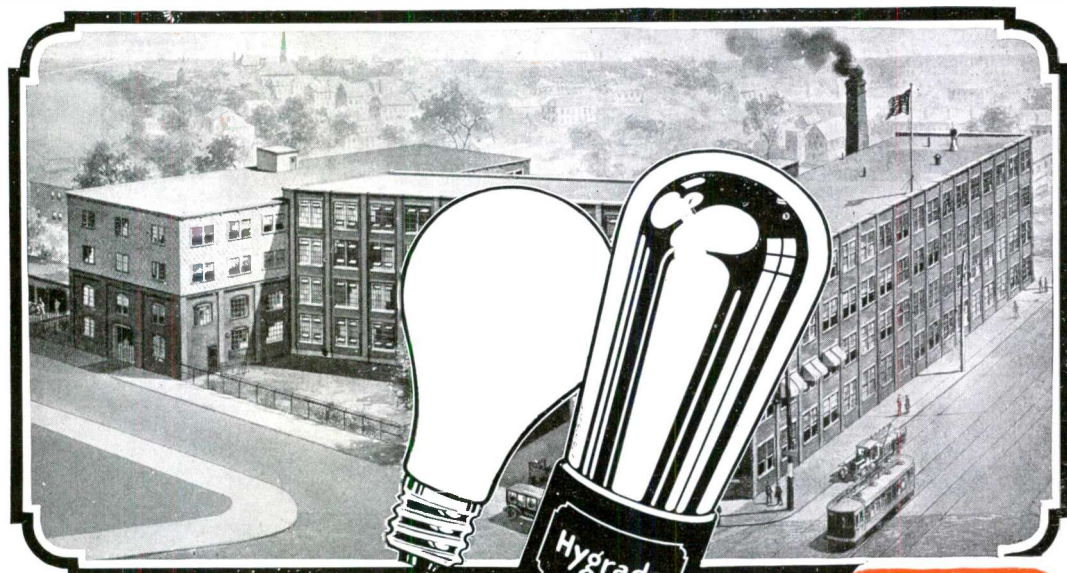

*A Head Start
of 28 Years*

Electric light bulbs and radio tubes are both vacuum products, the manufacture of which requires a high degree of technical skill.

Every minute spent in the manufacture of bulbs, therefore, can be counted as precious experience in the production of radio tubes.

THE HYGRADE LAMP COMPANY has been manufacturing electric light bulbs for twenty-eight years and during that time has built up the third largest business of its kind in the country.

Now Hygrade presents a radio tube whose excellence has already been recognized by hundreds of the company's customers.

Dealers who sell it will find it a contributing factor toward their permanent business success.

Look for the Red Triangle on the package. It identifies Hygrade



HYGRADE Radio Tubes

Made in Salem, Massachusetts by
HYGRADE LAMP CO.

PRESENTING

DAY

FAN

UNHURRIED DEVELOPMENT

ADVANCED DESIGN

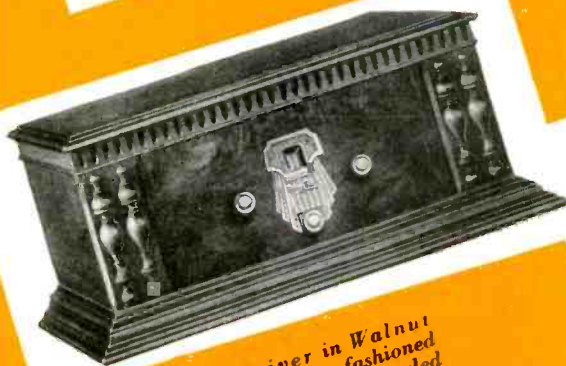

Day-Fan 9-tube receiver in Walnut Table Model. Beautifully fashioned cabinet of high grade walnut...burlled walnut panel...hinged top...constructed with care for every detail.



Day-Fan 9-tube receiver in large Console Cabinet with built-in Dynamic Speaker, specially designed for this set. Sliding doors. High grade walnut; matched-burl walnut panels. A piece of furniture that will win approval of the discriminating.
\$225.00 Less Tubes

THE
CHAMPION

of Sound Radio Merchandising
STABILIZED QUALITY
for a YEAR ahead

RADIO THE CHAMPION

BRING LEADERSHIP TUBES FOR ANOTHER YEAR



PERFORMANCE!

Through refinement and perfection of established Day-Fan Radio quality, a new ideal of all-electric radio performance has been achieved. It is evident in:

- Marvelous Brilliancy of Tone
- True Reproduction of Every Note
- Faithful Presentation of Greater Volume
- New Effective Power ... "Pick-up"
- Improved Selective Tuning over Entire Broadcasting Range
- Absence of any Annoying Hum

This improved Day-Fan **QUALITY** is offered at a remarkably low level of prices that provide full profit opportunities for dealers.



Here is a smaller console of walnut that is most pleasing in proportions, design and finish. The Day-Fan 9-tube receiver with specially designed built-in Dynamic Speaker.

\$169.50 Less Tubes

Design and Construction

OUTSTANDING FEATURES

1. Two UX-245 Power Tubes used in Push-Pull. 9 tubes in all.
2. Specially matched Improved Dynamic Reproducer.
3. Each part of amplifier carefully matched in impedance one with another.
4. Tuning Condenser, reatly calibrated.
5. Complete Shielding. Shielded Placement of Tubes. Detector Tube Shielded.
6. Simplified and more efficient layout of all parts.
7. Dial graduated in kilocycles and index numbers. Dial light in drum.
8. Switch-operated Phonograph Pick-up Concentration.
9. Every set tested by "air-check".

SEE IT FIRST AT CHICAGO DEALERS

R. M. A. Show... June 3-7
Booth 53 Stevens Hotel
Ball Room. Demonstration:
Suite 822-23 Stevens

Responsible, aggressive dealers have an opportunity with Day-Fan Radio to take a more important position in radio distribution. Send this coupon for details.
Day-Fan Electric Company, 1106 Wisconsin Blvd., Dayton, Ohio

Bush & Lane Radio

Built Like a *fine* Piano



EXCLUSIVE
AGENCY
FRANCHISE

MAXIMUM
PROFITS
IN RADIO



BUSH & LANE 34



BUSH & LANE 32

THE HIGH CHARACTER of Bush & Lane Radio makes it advisable to throw all the weight of an aggressive merchandising program back of one dealer in each trading area. If you can qualify as that dealer an **EXCLUSIVE FRANCHISE AGENCY** will open for you the doors of Radio's greatest opportunity.

SEE THE LINE—GET THE STORY—ACT QUICK

See this Line at the Show

STEVENS HOTEL

Booth 40—Rooms 1105-6

BUSH & LANE PIANO CO.

HOLLAND, MICHIGAN

BUSH &
LANE 60



BUSH &
LANE 70

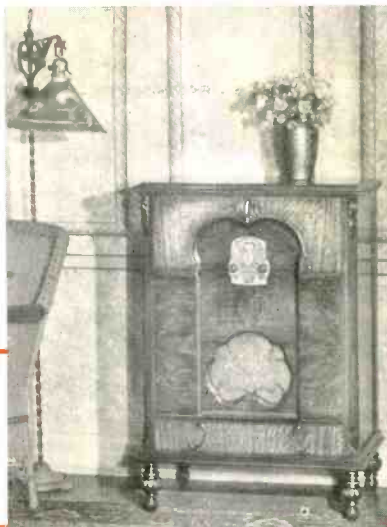

CLIP THE COUPON—LET IT BE YOUR BID FOR RADIO'S MOST GENEROUS OPPORTUNITY—A CHANCE TO EARN MAXIMUM PROFITS THROUGH BUSH & LANE'S EXCLUSIVE AGENCY FRANCHISE

Alright, Bush & Lane, send along the details of your EXCLUSIVE AGENCY PLAN.

Name

Address R.R. 6

Announcing

TRIAD RADIO TUBES

Achieved at last — the tube perfection for which the radio world has waited! Exhaustive research, a radically new engineering process, greatly advanced laboratory methods, a care in production and testing which has never been known before — from all these has been created an infinitely higher standard in tube quality, a standard which only Triad Tubes offer! Tests have proved their unparalleled clarity of tone, their longer life and their greater sensitivity and volume. ▲ ▲ Back of every Triad Tube is the personal guarantee of a group of pioneers in the radio industry, whose integrity and resourcefulness has been proved through years of intimate contact with both trade and public. ▲ ▲ Their product, better tubes could be manufactured, now makes possible a greater and more economical enjoyment of radio reception!



GEORGE COBY
President

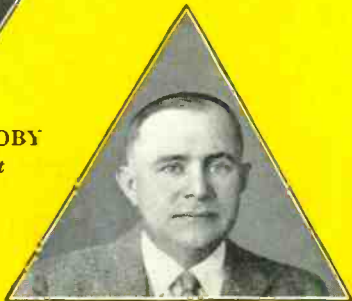

ELY EGNATOFF
Treasurer



WILLIAM CEPEK
Secretary



HARRY H. STEINLE
*Vice-President and
General Sales Manager*



“Quality ▲ Service ▲ Durability”



Dealers!



TRIAD brings you a definite, well-planned policy of sales cooperation. Unequalled quality, a continuous supply, prompt deliveries, close factory contact—in short, every possible bit of assistance will be yours. A tremendous advertising, radio and publicity campaign has been launched that will make Triad the world's most popular tube. Tie-up material will be provided to each dealer in any quantity desired. And there is a generous profit margin with Triad—one that will bring real satisfaction to you with every sale. A greater tube business with greater profits is waiting for you in 1929 with Triad. Write or wire now for the special sales and merchandising proposition we have arranged for you!

The Triad Line—Complete!

A complete line of A. C. tubes is included in the Triad line—also D. C. types, Special Purpose tubes and Television and Photo Electric Cells. The Triad Line enables you to meet your customer's demand instantly—and Triad quality assures absolute satisfaction with every sale.

The TRIADORS will broadcast a popular program every week over a national network. This selling cooperation will mean a steady consumer demand for Triad Tubes.

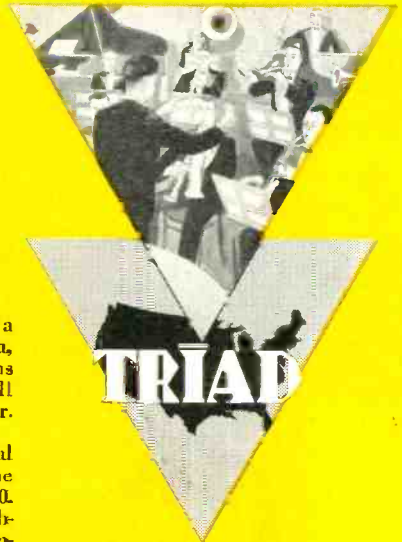

Triad Publicity

Broadcasting: Fifty-two weeks of broadcasting over a national network, have been arranged. A famous orchestra, stars of the stage and concert world, elaborate presentations of varied nature—all these and many other features will sell Triad Tubes in the homes of every radio owner.

Newspapers and Magazines: An extensive national newspaper and magazine campaign will keep the Triad line constantly before the reading millions in 1929 and 1930. This powerful advertising, together with interesting publicity items will aid materially in building a steady consumer demand.

Dealer Helps: Attractive window strips, fliers and broadsides for counter or mailing purposes, plates and matrixes for local advertising—these are only a few of the many merchandising helps available to every Triad dealer. Every possible aid will be extended in helping the individual dealer to tie up with the national newspaper and radio campaigns.

New! "Tube Insurance"

A certificate is enclosed with every Triad Tube, guaranteeing thoroughly satisfactory service. Here is a unique and valuable Triad merchandising feature! It means satisfaction to both customer and dealer—and a saving in the dealer's selling time and expense. Remember—only Triad offers "TUBE INSURANCE".

"The Tube in the Triangular Box"



The Triad box itself is of tremendous merchandising value. Its unique shape and design lend themselves easily to spectacular displays. Your trade will soon learn to "Ask for the tube in the triangular box."



NEWSPAPER AND MAGAZINE
ADVERTISEMENTS

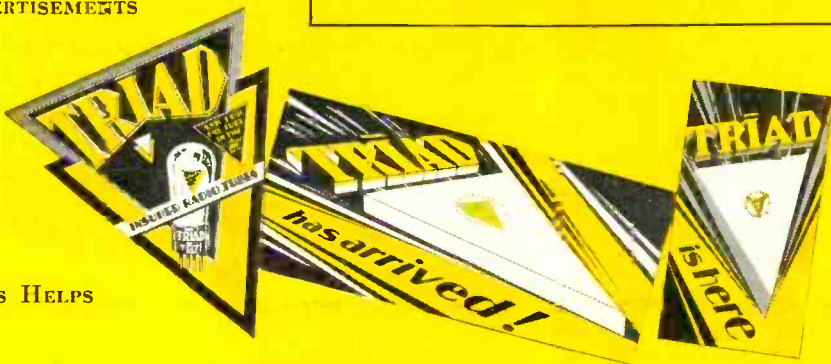

DEALER'S HELPS

SENSATIONAL ANNOUNCEMENT

Mammoth new ERLA factory brings tremendous savings now passed on to you in a sensational **NEW SCALE OF PRICES**

With 288,000 feet of floor space in Erla's new mammoth factory, all parts entering into the manufacture of Erla products will be produced under one roof . . . from parts to complete cabinets.

The resulting economies in manufacture are passed on to you. This sensational new scale of prices is effective at once. Your requirements can now be met immediately.

The 8-Tube Duo-Concerto Console, \$119.50. This two-purpose instrument is Erla's latest triumph, engineered to give life-like reproduction of phonograph music by the simple attachment of the Erla electro-magnetic pickup. A snap of the switch instantly transports you from superb radio reception to your favorite phonograph record. The tones are all transmitted through the chassis of the

Erla Duo-Concerto and through the Erla duo-dynamic speaker.

The 8-tube Duo-Concerto Radio and Phonographic Combination, \$189.50. In this instrument, the phonographic reproducing mechanism is contained in the same cabinet with the radio receiving set.

Both models are **GUARANTEED** to provide selectivity, sensitiveness and range in excess of any other 8-tube receiver made. It is these two new Erla products which have been winning new friends for Erla dealers everywhere.

Write today for details of the Erla franchise.

Electrical Research Laboratories
2500 Cottage Grove Ave., Chicago



8-tube Duo-Concerto Console **\$119.50**



\$189.50 **8-tube Duo-Concerto Radio-Phonograph Combination**



ERLA Electro-Magnetic Pick-up

Another Erla triumph, the one electro-magnetic pick-up that assures perfect sound reproduction, uniform purity of tone without extraneous noises. Model P-16 with built-in volume control, replaces tone arm of any **\$13.00** phonograph.



ERLA Duo-Dynamic Cone Speaker

A major scientific advancement in sound reproduction. Actual comparative demonstration invariably proves its superiority and makes a profitable sale. Write for further information regarding 110-volt A-C cone **\$42.50** in cabinet.



At the Show—See and hear STAR-RAIDER . . .
Booth 83—Exhibition Hall—Stevens Hotel
Demonstration Room 522—Stevens Hotel



Star-Raider model RP-40 nine tube Radio-Phonograph combination. Cabinet of English Renaissance period of imported English Pollard Oak, Burl Walnut, and matched American Butt Walnut. Price (less tubes) \$725.00



Star-Raider model R-30 nine tube radio. Cabinet in Elizabethan period design . . . of genuine Australian Walnut, Acacia, and Rare Zebra-wood. Price (less tubes) \$525.00

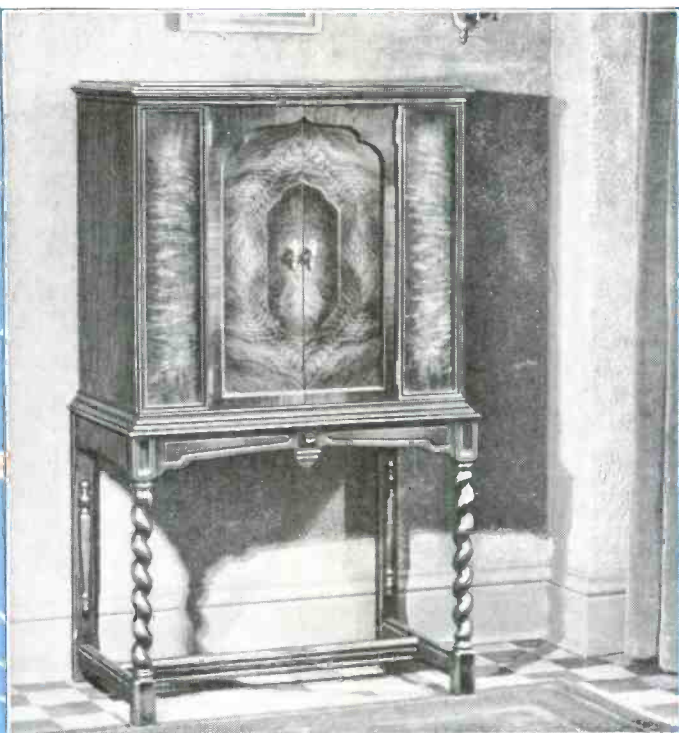

Star-Raider model R-20 nine tube radio. Cabinet in Jacobean period design . . . of imported English Pollard Oak, American Burl Walnut, and American Butt Walnut. Price (less tubes) \$435.00

BROADENING THE INDUSTRY'S OPPORTUNITY

Continental now broadens the brilliant Star-Raider line with another new model.

Continental presents the new Star-Raider Radio model R-20.

The Star-Raider model R-20 marks the low figure on the Star-Raider price range. With it, the selling field is further broadened.

Here is additional opportunity for the industry.

For the world no longer picks receivers by the dollar sign alone.

Now, performance and appearance have

the final say. And, Star-Raider is the final word in both.

It raids the stars for harmony . . . as no other radio can. Built with custom-care on the Technidyne Circuit . . . Star-Raider can never be equaled by mass production.

Here indeed is the industry's opportunity!

Here is the correct answer to this season's sales and profits question. And Star-Raider is the answer for many seasons to come.

CONTINENTAL RADIO CORPORATION, FORT WAYNE, INDIANA
(FORMERLY SLAGLE RADIO COMPANY)

the
STAR-RAIDER
America's Finest Radio Made Finer
© C. R. C., 1929

Only
ARCTURUS
gives you all these
EXTRA FEATURES:

- 1 Acts in 7 seconds.
- 2 Immune to line surge.
- 3 Exclusive construction throughout.
- 4 Liberal replacement policy.
- 5 World's record for long life.
- 6 Endorsed by 29 set manufacturers.
- 7 Sold by reliable jobbers and dealers.
- 8 Superiority easily demonstrated.
- 9 Improvements protected by patents.
- 10 137 inspections keep quality high.
- 11 New features constantly pioneered.
- 12 Colored blue for positive identification.
- 13 Millions of Arcturus Tubes now in use, giving unusual service.
- 14 Name and trade mark well known to the radio trade and the radio public throughout the country.

**A
CHALLENGE
TO THE
TRADE**

**ARCTURUS
DETECTOR
- 127 -**

**137
FACTORY
INSPECTIONS
GUARD
ARCTURUS
QUALITY**

**ARC
BLUE**

All additional PROFIT POINTS in ARCTURUS TUBES!

IF YOU want to sell a tube that keeps your customers satisfied... if you want to boost your sales of A-C sets as well as A-C tubes... if you want the sets you sell to give the best possible service and stay sold... then feature *Arcturus Blue A-C Tubes*.

These perfected tubes sell sets because they act in 7 seconds—

- Programs come in clearly, with no annoying hum —
- There's no danger from line surge; — Arcturus Tubes are built to stand that strain —
- And Arcturus A-C Tubes hold the world's record for long life.

In addition, Arcturus offers you many other important features, found in no other tube. Study this list of profit points. Then write for all the facts about Arcturus Blue Tubes, and put your A-C radio business on a better basis than ever before.

ARCTURUS RADIO TUBE CO., Newark, N. J.

TURUS

A-C
LONG LIFE TUBES

New

NEW FEATURES

plus the well known Webster precision tone



FOLLOWING its introduction to the industry at last year's Radio Trades Convention, the Webster Electric Pick-up met with practically universal acceptance by the trade. It set a new standard of performance by its matchless fidelity of tone.

Now, with many refinements in appearance, with new and improved features and greatly increased tone precision, there is little doubt that it will continue to merit the leadership which it already has been accorded.

The features which have been introduced are typical of the basic superiorities in

design and construction, which unfailingly characterize the products of this institution.

Throughout the development of these improvements, one thought has been uppermost in the minds of the Webster engineers. That is, *the further perfection of the now well-known Webster tone.*

How well they have succeeded is readily apparent in the list of new features set forth below. Each of these features plays its own small part in assisting in the improvement of the precise, accurate and faithful Webster tone reproduction.

Be sure to see the Webster Electric Pick-

up at the Radio Trades Convention. Be sure to hear it. Compare it — with all the others — and then decide for yourself that the Webster is the pick-up you are going to offer your trade during the coming year

The new Webster Pick-up is available in two models, for either battery operated or A. C. sets. Both models are packed in attractive self-selling display cartons.

Place your order now. Deliveries will be made beginning July 1st. Leading jobbers are now placing their orders — if your jobber has not stocked the Webster, order direct.

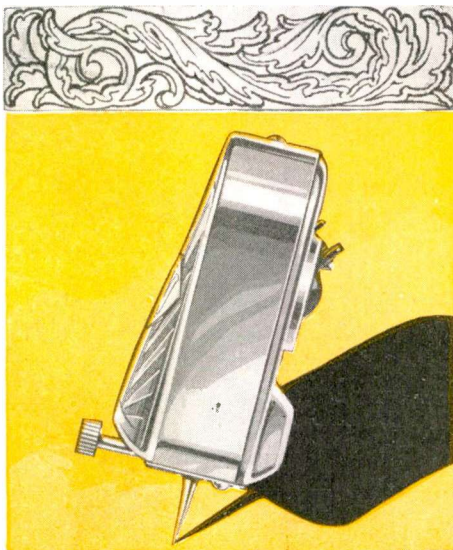

The New Webster Model A includes Pick-up head, supporting arm, built-in volume control and adapters.

Model B includes Pick-up head, separate volume control, and necessary adapters.

These Features Make the Webster Supreme

1. The famous Webster low-inertia stylus bearing, utilizing an all-metal pivoting action, eliminates necessity for bulky construction. Positively no rubber on bearings. Perfect balance is assured.
2. The Webster Pick-up head is small and compact, perfectly balanced, light in weight. Weight of head on record only 4½ ozs. No counterbalancing or springs necessary.
3. Highest grade Cobalt magnet of greatest possible density is used.
4. Shock-absorbing arm bearing with pivot at base — an exclusive Webster development.
5. Unique method of turning head with arm to conveniently insert playing needle.
6. Volume control incorporated in base — compact and easiest to install — an original Webster feature.
7. Base is weighted. Can be screwed to motor board or merely set in place.
8. Card completely concealed — all bearings free from play and chatter.
9. Construction lends itself easily to use of varied lengths of arm for either standard or talking picture records.

WEBSTER ELECTRIC COMPANY
RACINE, WISCONSIN

Export Department, 154 Nassau Street, New York City

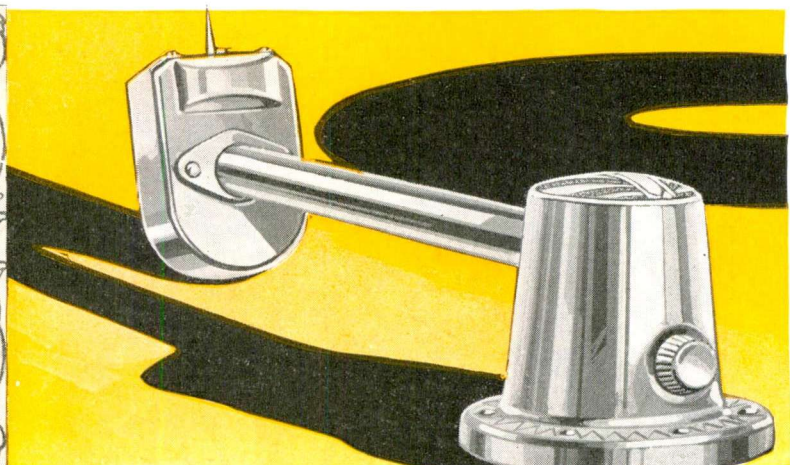

Appearance...

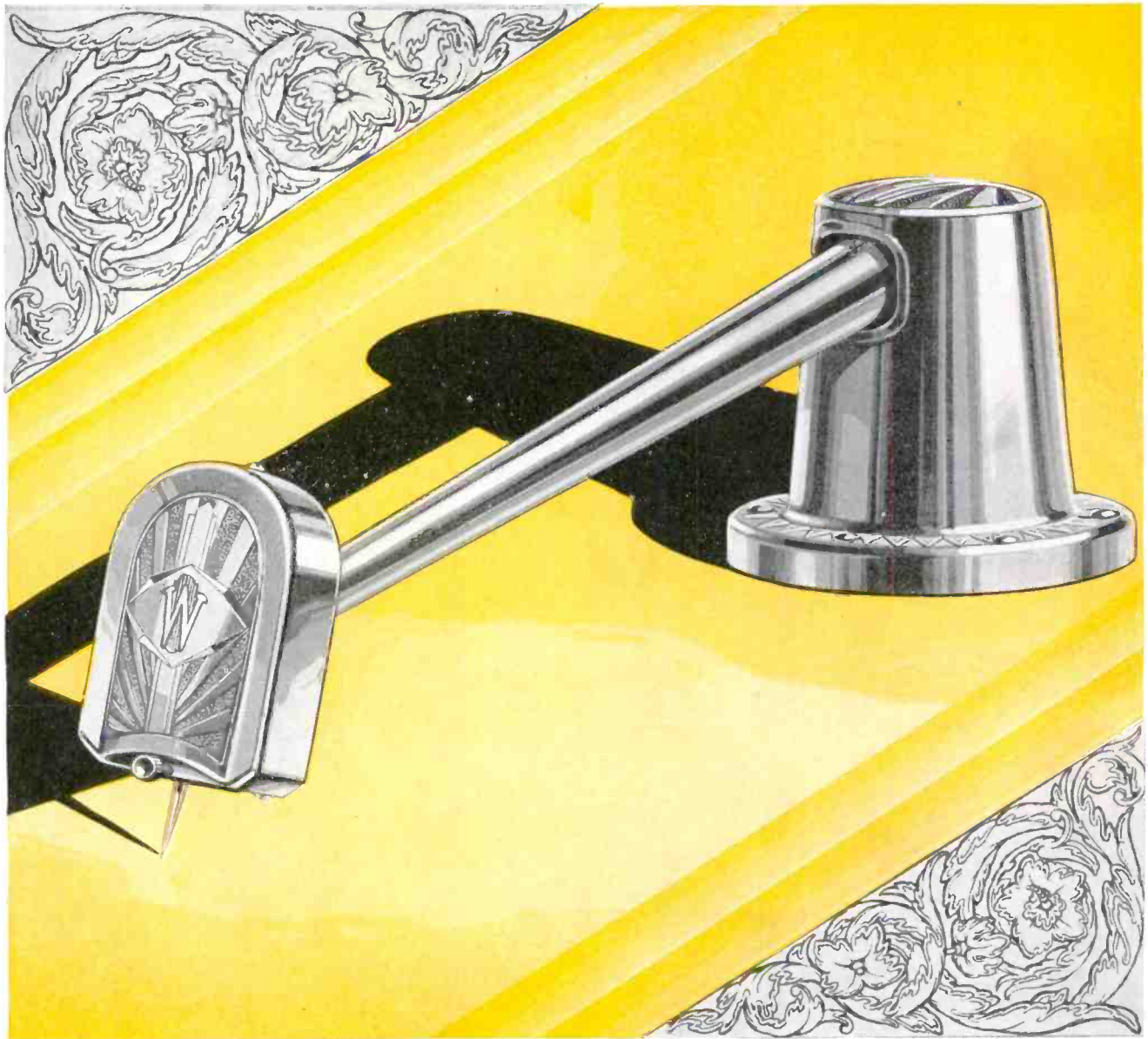

Webster



Electric Pick-up

Make our Demonstration Room 549, Stevens Hotel, your headquarters during the Convention. See our Exhibit, Booth 50, in Exhibition Hall at the Stevens.

EX

VOGUE
NONPAREIL

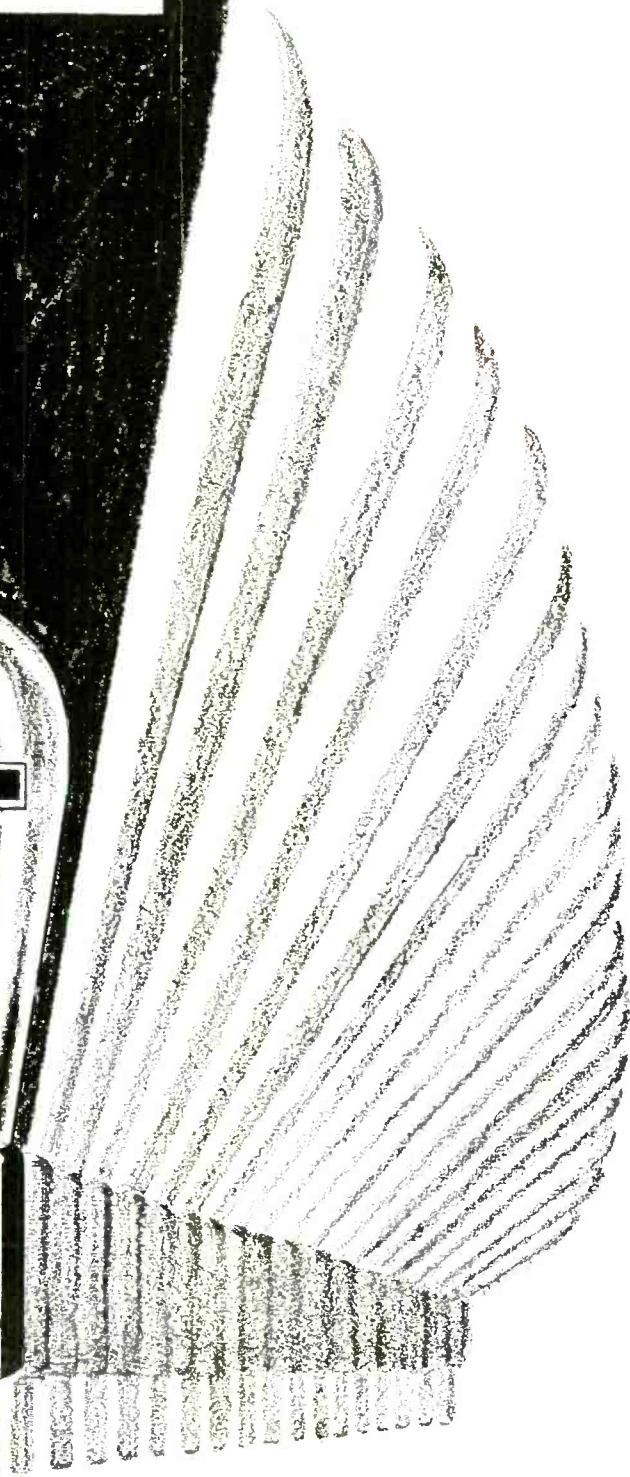

R.M.A. TRADE SHOW

Demonstration
Room 450-A
Hotel Stevens

EXHIBITORS SECTION

PANSION

*Two plants now ready to serve you.
Join this huge expansion program
and start this season **RIGHT!**
Six Sweet Months Ahead
for the **WISE BUYER***



Get full details

VOGUE
NON PAREIL
RADIO TUBES

Demonstration
ROOM 450A
STEVENS HOTEL



ALLAN
MANUFACTURING AND ELECTRICAL CORP.
HARRISON NEW JERSEY
LOS ANGELES 407 E. PICQ ST.



SCREEN GRID*** BOSCH RADIO

The new Bosch Radio Model 48 is completely engineered to the new screen-grid—four element tubes. Three are used. There are two type 245 amplifiers arranged in push-pull. There is a type 227 powered detector and a type 280 full wave rectifier—seven tubes arranged to give results new to radio. Rightfully you have always looked to Bosch for well designed, excellent performing radio, moderately priced. In the Model 48 you will see even finer engineering, better construction, superior performance and greater values. Bosch Radio dealers have made money. They will make more money this season. The Bosch Dealer franchise is again protected by a fair and square merchandising policy, an unparalleled price position, a distinctive flexibility of inventory investment. Bosch factory to dealer cooperation and the volume of Bosch Radio advertising will be greater and finer than ever. Write for Bosch selling plans if you want to be included in them this season.

Bosch Radio is licensed under patents and applications of R. C. A., R. F. L. and Lektophone
Prices slightly higher west of Rockies and in Canada.

AMERICAN BOSCH MAGNETO CORP.
Springfield Massachusetts
Branches: New York Detroit Chicago San Francisco

Bosch Radio Tubes add a new quality
of performance to any radio receiver.



The Bosch Radio Combination Receiver and Speaker Console will be in great demand because it embodies Screen Grid quality radio in an inexpensive combination of charming individuality. Perfectly chosen woods and veneers combined with rich carving make this console one of beauty. It has the Bosch Dynamic type speaker. List price, less tubes, \$168.50



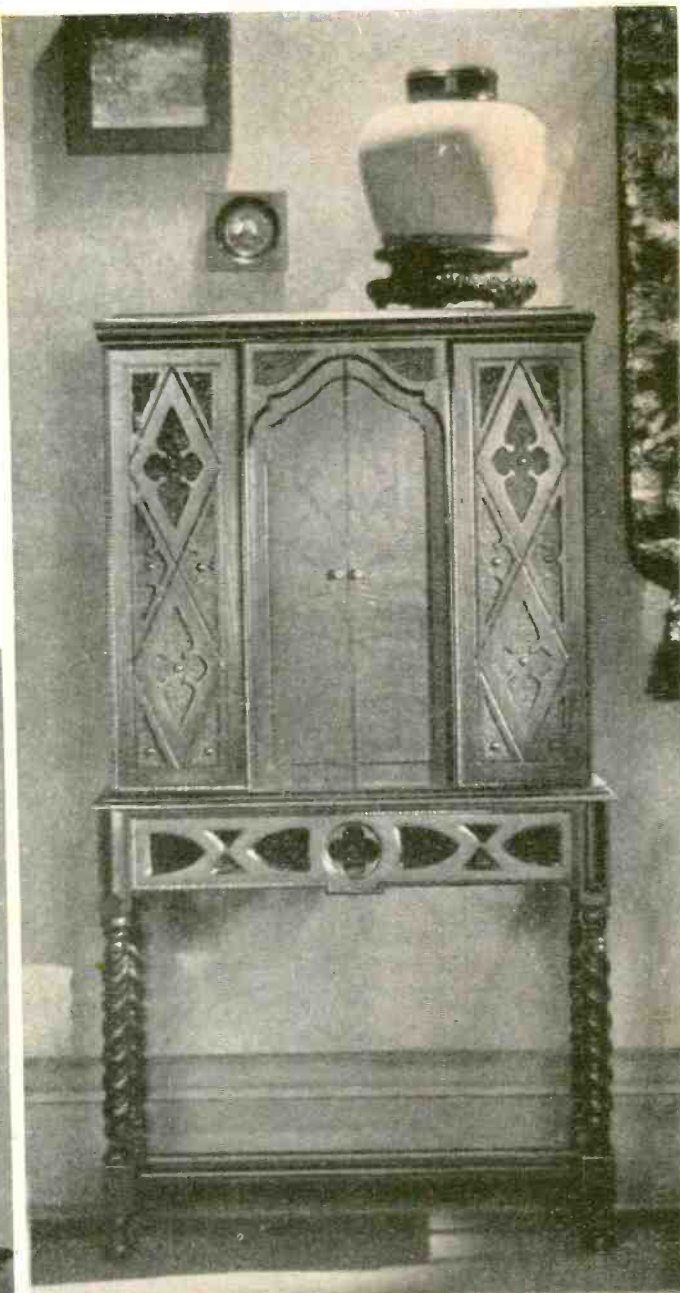

The new Bosch Radio The Luxe Console is truly the last word in radio. The chassis, employing the most modern scientific developments in radio engineering, uses seven tubes, three of which are the new Screen Grid type, and two of which are the large new audio amplifiers arranged in push-pull. The cabinet, with tall sliding doors concealing octal dial panel and dynamic type speaker, is strikingly different. The finish is antique in Old English line, and set off with well selected walnut veneers. List price, less tubes \$240.00

The new Bosch Radio Table Model 23 contains the perfectly shielded chassis with seven tubes, three of which are the new Screen Grid amplifier type, housed in handsome table cabinet of grained walnut veneers. Sliding doors are introduced in a table model with a distinct sales appeal. List price, less tubes \$113.50.

BOND

REG. U.S. PAT. OFF.

Super Heavy-Duty RADIO "B" BATTERIES



"Rest Renews the Current You Use"

The above slogan, so descriptive of the astonishing "Recuperation" feature of BOND Batteries, captured the first prize of \$2000 in the great nation-wide BOND \$10,000 Prize Contest. To a greater extent than any others, BOND Radio Batteries *recuperate*—rebuild their used energies during rest hours—and deliver a *premium* of steady, vigorous power . . . No wonder that so many thousands of contestants instinctively picked the "Recuperation" feature as the one on which to write their slogans . . . No wonder that the tremendous interest aroused by the contest is sending an army of customers into Authorized BOND Dealers' stores . . . No wonder that our daily reports from the trade indicate a *bigger business* on BOND Batteries than ever before!

"BOND BATTERIES COST LESS PER RADIO HOUR"

BOND ELECTRIC CORPORATION

CHICAGO

JERSEY CITY, N. J.

SAN FRANCISCO



High Vacuum RADIO TUBES

In the manufacture of fine radio tubes, the higher the degree of vacuum the greater the efficiency of the tube. BOND High Vacuum Radio Tubes are the perfected development of an ideal for which the public has long been waiting. They embody a revolutionary improvement in tube construction, offering the highest vacuum ever achieved by radio science!



BOND Radio Tubes bring to the trade, in a new field, the highest traditions of BOND quality, value and performance. Into their design has gone the same engineering genius that gave the world the famous BOND Batteries and Flashlights. Full details regarding our special "Introductory Assortments" will be supplied upon request.

*The plant behind
the product*

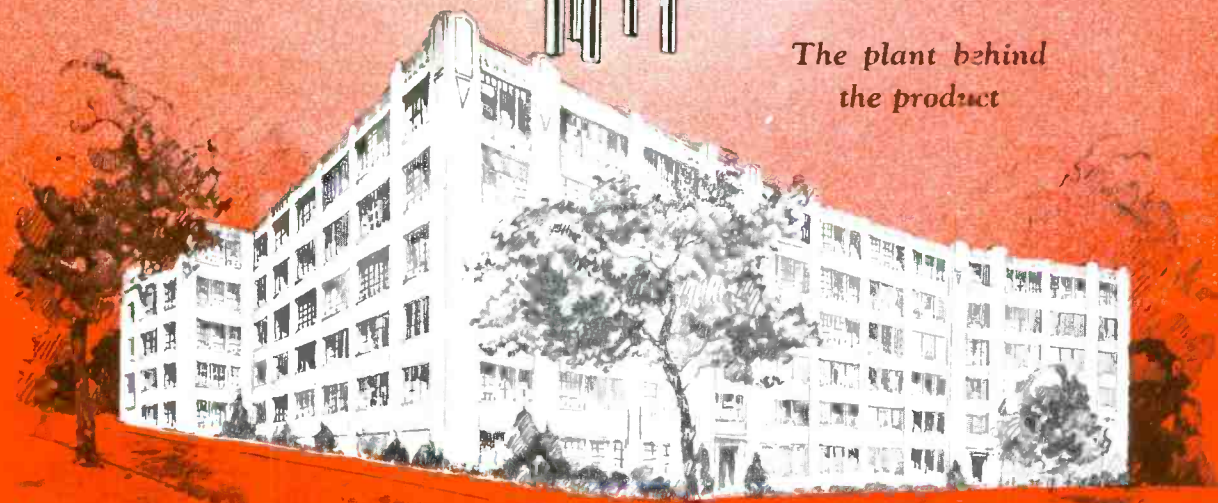

BOND ELECTRIC CORPORATION

CHICAGO

JERSEY CITY, N. J.

SAN FRANCISCO

Champions

Here's "the set with the PUNCH"—so powerful it brings distant stations booming in with the wallop of a "local"—so selective it picks out stations you knew only by hearsay—so accurate it's as if the actual performers were right in the room. Here's the champion of the air!

The sensational "Balanced Bridge" circuit of the new 900 Stewart-Warner is the year's outstanding development in radio engineering—completely eliminating oscillation—resulting in a radio set that combines distance, volume, selectivity and realism of tone as never before possible.

Exclusive features contained in no other radio set at any price.

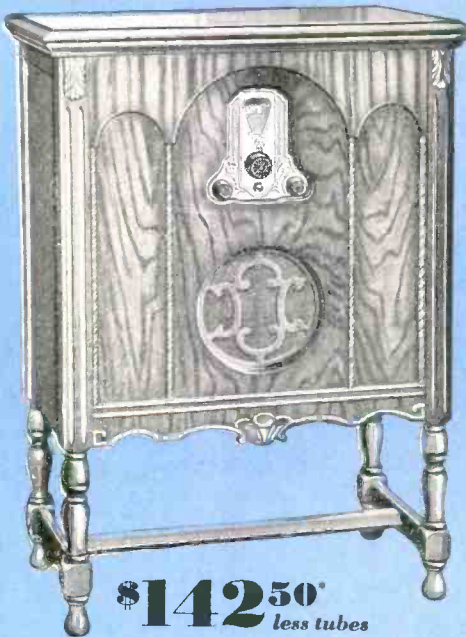

\$142.50*
less tubes

Approved Jacobean Cabinet No. 35 with Stewart-Warner Model 900 Radio and Electro-Dynamic Reproducer. Cabinet of American Walnut with enclosed back and hinged top. Height 38 in., width 27 in., depth 15 in.

*West of Rockies, \$147 less tubes.

Connections for Television—Stewart-Warner is the *only* producer of radio to equip with this advanced feature—five years ahead.

Crystal Controlled Oscillators are the test equipment used to assure accuracy of tuning coils and condensers—*precisely the same* equipment as used by the better broadcasting stations to keep on exact wave length.

The finest assembly of precision parts and materials ever brought together in a radio set.

And the finest precision workmanship—every fourth employee a supervisor and inspector.

No wonder trade and public alike have named it "the set with the PUNCH"!

And now "the Franchise with the Punch"—with features you never saw in a dealer franchise before. Get the details today! Pick up the phone or shoot a wire now.

STEWART-WARNER CORPORATION
Diversey Parkway, Chicago

STEWART-

The Voice of Authority

of the Air!

No less sensational than Lieut. Darcy Greig's annihilation of space at a speed of 321 miles per hour is the new Stewart-Warner's performance in annihilating all former standards of radio reception!



Note These Big Features:



Approved Sheraton Cabinet — doors closed

- 8 tubes, including rectifier.
- "Balanced Bridge" circuit.
- Air-cooled built-in Power Pack.
- Automatic Line Voltage Regulator.
- Drawn Copper Shielding.
- Built-in Aerial.
- 3 Aerial Taps.
- Four Variable Condensers.
- Four tuned circuits.
- Special Vernier Tuner for Distant Stations.
- Plug-in for Phonograph.
- Plug-in for Television.
- Illuminated Visible Angle Dial—scaled in Kilocycles and 0 to 100.
- 22-Carat Gold Plating on all connections; easily serviced—only 6 screws to remove.

Stewart-Warner Radio comes in 60-cycle and 25-cycle A. C., 100 to 130 volts, models for any current. Also D. C. and battery operated.

Cabinets by Louis Hanson Co., Chicago, and Burnham Phonograph Corp., Los Angeles.



\$165.50*
less tubes

Approved Sheraton Cabinet No. 58 with Model 900 Stewart-Warner Radio. New Stewart-Warner Electric-Dynamic Reproducer. Cabinet of American Walnut and Australian Lacewood, with silent sliding doors—height 52½ in., width 25½ in., depth 17 in.

The Consolette Ensemble in hammered gold bronze or jade green and black, Electro-Dynamic Speaker, \$123.25 less tubes. West of Rockies, \$128.50.

Table Models in same finishes as Consolettes, \$89.75. West of Rockies, \$92.25.
*West of Rockies, \$170.50 less tubes

WARNER

The Voice of Authority

A Proclamation of Importance

The name Walbert

The name, Walbert, in the past, has always been associated with the pioneers in what was best and newest in Radio Engineering and production. One of the first to manufacture an A.C. Receiver and always noted for the quality of its products and precision of manufacture, any announcement over this name should be of interest to every progressive dealer and distributor.

A new factory at Grand Haven, Michigan, equipped with the newest and most ingenious of machinery, a personnel of executives and engineers with an extensive background of experience in design, manufacture, and merchandising of radio apparatus, and unlimited resources, this combination has produced a new Screen Grid Tube Receiver startling in its efficiency and beauty of design.

This new receiver will be manufactured on a production schedule of 1,000 per day, yet, every one of the 1,000 will be given the same personal care and inspection that characterizes the custom-built set. Modern manufacturing methods have made it possible to market this set within extremely interesting price range.

Walbert has been licensed by the Radio Corporation of America and associate companies and this receiver will be sold only through authorized distributors.

The Walbert Radio Corporation

Executive Offices and
Research Laboratories:
Chicago, Illinois

Factories:
Grand Haven,
Mich.

The new Walbert Line will be exhibited
at the Radio Trade Show, June 3 - 7.
Stevens Hotel, Suite 557.

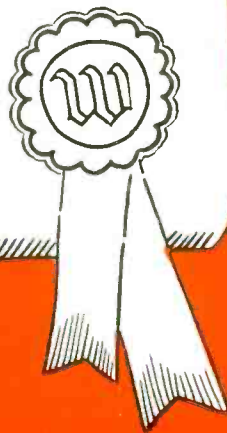

1929

IS THE

PHILCO

YEAR

*Screen Grid!
Neutrodynne Plus!*

PHILCO



THE LOWBOY. This model is an unusually attractive open-face cabinet with Oriental Walnut raised side panels and set back Bird's-eye Maple center panel. Beautiful new and smaller bezel plate. Philco matched *Electro-Dynamic* Speaker and Acoustic Equalizers built in.

Price, Philco **\$129⁵⁰** Price, Philco **\$119⁵⁰**
Neutrodyne Plus Screen Grid



THE HIGHBOY. This distinguished cabinet has a balanced Philco *Electro-Dynamic* Speaker and Acoustic Equalizers built in. Half doors which are out of the way when the set is in use; matched Oriental Walnut on doors. Butt Walnut side panels. Bird's-eye Maple panel inside. Beautiful tapestry over the speaker.

Price, Philco **\$149⁵⁰** Price, Philco **\$139⁵⁰**
Neutrodyne Plus Screen Grid

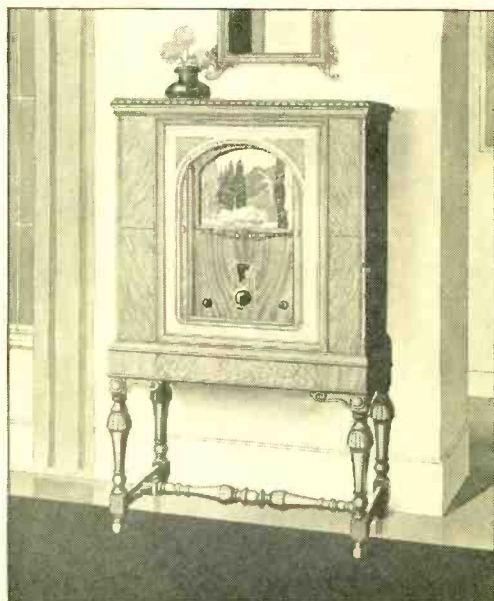

THE HIGHBOY DE LUXE. A more expensive cabinet. Sliding doors on metal runners which disappear into recesses at the sides. Philco matched *Electro-Dynamic* Speaker and Acoustic Equalizers. Cabinet is exquisitely finished in Burled Walnut. Framed and overlaid with costly, imported woods. Genuine tapestry over speaker.

Price, Philco **\$205⁰⁰** Price, Philco **\$195⁰⁰**
Neutrodyne Plus Screen Grid

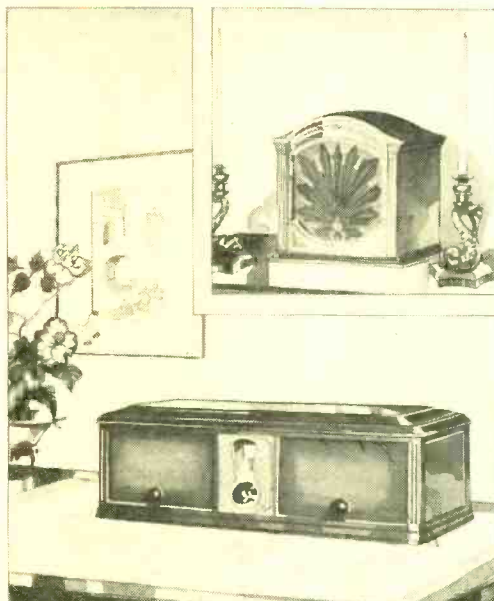

TABLE MODEL. The Philco Screen Grid is also available in an attractive Table Model, complete with matched Philco *Electro-Dynamic* Speaker, extra large to ensure full, round tone.

Price, *Electro-Dynamic* Speaker **\$32⁵⁰** Price, Philco **\$67⁰⁰**
Screen Grid Receiver

(Tubes extra. Prices slightly higher in Canada, Rocky Mountains and West)

Announces >>

NEW *all-electric* MODELS BALANCED-UNIT RADIO

An amazing advance in Radio Reception!

Just as the tone of a fine orchestra can only be clear and unified if all its instruments are perfectly balanced, just so the receptivity of a radio is in proportion to the balance of its units. By extraordinary engineering, both in design and manufacture, the units of the new Philco have been balanced with a hitherto unknown precision. As a result, the new Philco offers clearer, truer, fuller tone; vastly improved selectivity, and a remarkable ability to pick up distant stations.

The Philco Screen Grid

takes full advantage of radio's newest triumph—the extra powerful screen grid tubes. It is selective and sensitive. Three tuned stages in the radio frequency amplifier are balanced to give maximum selectivity and enormous amplification, thus making possible the use of a power detector, with grid bias. The great power of the screen grid tubes and the biased detector permits the use of a single push-pull audio stage with two 245 power output tubes, giving remarkable sweetness and purity of tone.

Every Philco set is balanced to use two of the wonderful new 245 power tubes with push-pull amplification.

The Philco Neutrodyne Plus

is the same receiver which made such marvelous records last year but with improvements that make its performance even more outstanding. For instance, two 245 power output tubes are used, giving even greater tonal range and purity and even more volume. As before, no aerial is needed.

So far as we know, no other radio at any price equalled last season's Philco Neutrodyne Plus in distance, range, selectivity and tone. Thousands of letters from dealers and owners all over the country prove this. And now with the improved chassis, its performance is greater than ever. Philco Neutrodyne Plus will be the sensation of the radio industry this year.

Reasons why it will pay you to concentrate on Philco

1. The Philco line is complete and provides a radio to meet every demand of price or luxury. You need handle no other line. 2. Enormous public demand for the new Philco is going to be created through Philco's tremendous advertising campaign. 3. Philco maintains a firm fur-

niture policy. The new Philco chassis are offered only in cabinets manufactured by Philco. No need to clutter up your store with special cabinets; no possibility of other dealers taking Philco chassis and, by installing in cheaper furniture, offering Philco at lower selling prices than yours. 4. The sturdiness which is built into every Philco set cuts servicing to a minimum. 5. All Philco dealers are allotted protected territory, and their territorial rights strictly upheld. 6. The

Philco finance plan is available for all Philco dealers. Its terms are unusually liberal. 7. Philco prepares a special kit for dealers on a cooperative basis, containing descriptive cards and price cards for each model; a window trim service with timely changes all through the season; a Philco moving light sign; a window transfer and descriptive booklets. 8. Philco sliding scale discounts are unusually liberal. Write or wire the nearest Philco office for details TODAY!

PHILCO, Ontario and C Streets, Philadelphia, Pa., and 218 Fremont Street, San Francisco, Cal.

CABINETS THAT actually *sell themselves*

NO GLOWING superlatives are needed to interest prospects in cabinets by ADLER-ROYAL. Place any ADLER-ROYAL beside any other cabinet of comparable price, and let your customer make his own decision.

ADLER-ROYAL thoroughness of workmanship, perfection of finish and acoustical accuracy are the results of twenty-five years devoted to the production of cabinets for musical application.

Today in radio, the cabinet itself is a powerful influence in making sales. . . Dealers who appreciate this fact will appreciate ADLER-ROYAL. ADLER MANUFACTURING CO., *Incorporated*, Louisville, Ky.

The new ADLER-ROYAL Cabinets on display at R. M. A. Trade Show, Space 5, Ball Room, Blackstone Hotel.



ADLER-ROYAL
Model No. 324



ADLER-ROYAL
Model No. 325



ADLER-ROYAL
Model No. 322

ADLER-ROYAL
RADIO CABINETS



With FOUR

with the **CUTTING DYNAMIC SPEAKER**
 the **NEW COLONIAL Ushers**



The Cavalier

Front of rich, dark brown burled walnut—an edging of cross-banded oriental walnut—legs, apron and other parts with high-lighted walnut finish. The top half of the center cameo decoration opens to form the door. The same cameo motif appears on the apron. List Price \$235

VISIT THE COLONIAL BOOTH

No. 77 and 78

AT THE R. M. A. SHOW IN CHICAGO

EXHIBITION HALL

IN THE HOTEL STEVENS

NEW Principles...NEW Construction... NEW Beauty...a NEW Type of Performance

Here is the news for which the entire radio industry has been waiting...a description of the NEW Colonial... Here you will find successful utilization of FOUR Screen Grid Tubes.

Here you will find the improved Cutting Dynamic Speaker...plus Cutting Sound Radiation.

Here you will find beauty and performance and value which place the Colonial line at radio's very forefront.

Improved cabinet design is made possible by the elimination of the speaker grille from the front panel. The sound emanates from the back and bottom of the cabinet and radiates to all points in the room. This method of sound distribution adds greater naturalness to the reproduction of either vocal or instrumental music. It re-creates the dimensional impressions received when listening to an original performance. The effect of a beam of sound resulting from the concentration of all vibrations into the confines of the ordinary loud speaker is overcome through this novel arrangement and the result is rather an enveloping blanket of music over the entire room.

Both receiving and reproducing units of the new Colonial are combined on a common base of steel channels and Z-bars, the four radio frequency stages being mounted on the upper side and the power supply, audio amplifier and speaker suspended beneath. Special design of the audio amplifier and the exclusive Cutting Dynamic Power Speaker make possible the incorporation of the sound diffusing principle.

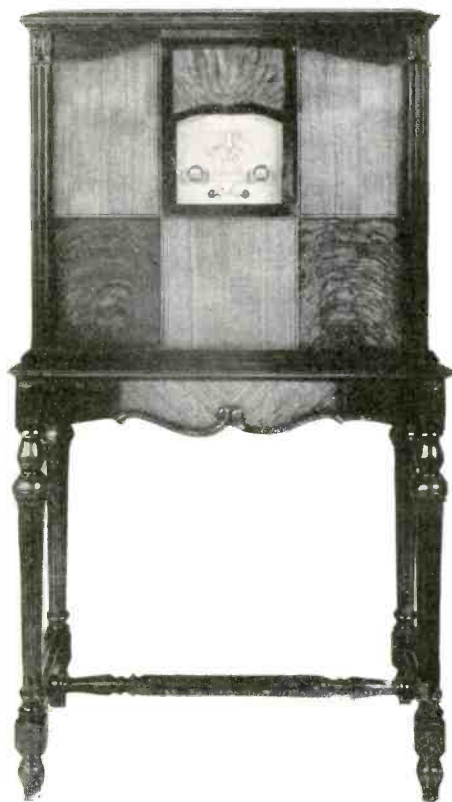

The Piccadilly

Alternate panels of grained and burled walnut, with carved decorations on top of corner posts and legs. Edging of dark (almost black) walnut. Legs and apron high-lighted. Top is matched grained walnut. A two-tone walnut cabinet throughout. List Price \$235

COLONIAL RADIO CORPORATION - LONG ISLAND CITY, N. Y.

Screen Grid Tubes

...plus **CUTTING SOUND RADIATION**
in a **NEW Reception ERA!**.....

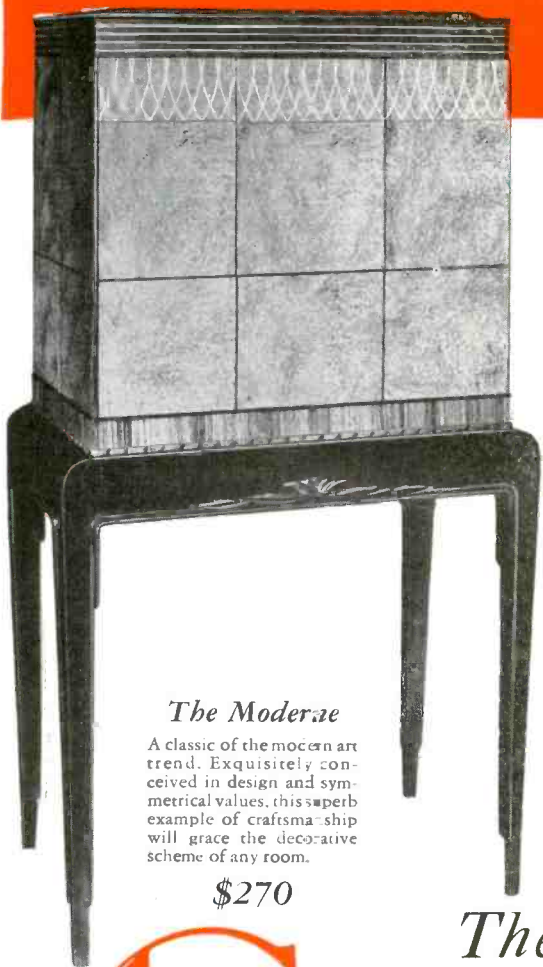

The Moderne

A classic of the modern art trend. Exquisitely conceived in design and symmetrical values, this superb example of craftsmanship will grace the decorative scheme of any room.

\$270

Colonial's Famous Slogan, "Radio's Clearest Voice" Is Again Emphasized

The use of four A. C. type 224 screen grid tubes for radio frequency amplification and detection results in amplification to spare. There are also two 245-output tubes. The coupling circuits are designed to maintain high sensitivity uniformly throughout the entire broadcast spectrum. *The selectivity YOU NEED extends consistently over the entire wave band.* This is accomplished by four sharply tuned circuits, doubly shielded from each other and staggered in such a way as to secure a flat-top resonance curve and retain the side bands.

A unique filter network serves to prevent the possibility of cross talk from strong local stations. The stupendous amplification is regulated by a new system of volume control which simultaneously increases the bias on the control grid, and decreases the screen grid voltage, at the same time holding the plate voltage constant. The screen grid power detector gives **LINEAR DETECTION**. A resistance-coupled first audio stage and two of the new LX-245 power tubes in push-pull produces both high quality reproduction and high volume. An automatic regulating feature in the audio system allows equal quality of reproduction on both high and low volumes.

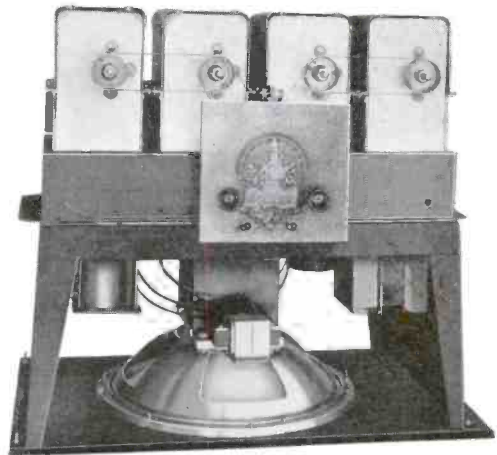

The **NEW**
COLONIAL
Trade Mark *Radio*

OPERADIO Announces



AN ENTIRELY NEW IDEA IN
DYNAMIC SPEAKER DESIGN
A STARTLING NEW CREATION
IN BEAUTY... IN PERFORMANCE

BECAUSE of the *design of the Operadio Dynamic Chassis* it has been possible for Operadio to create new conceptions in Radio Speakers for the home—*types never thought of before* because no usual Dynamic could adapt itself to such treatment.

The adaptability and ruggedness of this new Chassis, and the splendid performance of the Speaker itself will delight you. It not only responds faithfully to low input energy but at the same time *stands up under tremendous power. Cabinets are delightful.*

New!
Unique!
See
Them



At The
RMA
Trade
Show

*Illustration Shows New
Operadio Dynamic Chassis*

OPERADIO

Manufacturing Company

Room 513 Stevens
ST. CHARLES, ILLINOIS
Booth 88 Stevens



A

New Development

by

United Reproducers Corporation

that will

Revolutionize Radio

United Reproducers Corporation is the merger of United Radio Corporation (Peerless), Newcombe-Hawley Company, Precision Products Company (Arborphone) and Buckeye Manufacturing Company. It gives to the industry complete radio units built entirely by one organization. This means harmonized, synchronized sets at tremendous values due to the consolidation and economies of manufacture.



United Reproducers

Greater than

THOUSANDS of dealers throughout the United States have watched with the keenest interest, the formation of United Reproducers Corporation—one of the greatest powers in the radio industry.

And now to justify their expectations, United Reproducers offer something as radically new and different as the first tube set.

A radio without electro-magnet, without the floating needle, without cone or horn—a radio that gives selectivity never dreamed of before and photographic accuracy of reproduction.

Kylectron...the greatest development in radio

Kylectron embodies a principle so important that it will not only revolutionize the radio industry but the talking moving pictures as well. And at the Radio Show you'll hear it.

Kylectron will create a *new* radio market. At the start of the buying season it will already be established from coast to coast, as the outstanding development of years. And those dealers who accept the cooperation of United Reproducers today will find that they have stocked the greatest money-maker in the history of radio.

For this new development is indeed greater than radio itself.

We don't want to tell you more about Kylectron now. For the only possible way to appreciate it is to see and hear it. And this opportunity will be yours at the Show in Chicago.



Corp. Offers Something

Radio

Kylectron

*—the greatest development
in Radio*

United Reproducers will have on display a complete new line in their booths in the Stevens and Blackstone Hotels. This display will dominate the Show. You simply can't afford not to see it.

We cordially invite you to make United Reproducers your headquarters while in Chicago—and to see for yourself the development which, within three months time, the World will have hailed as something greater than radio itself.

*Dominant Advertising in Magazines,
Newspapers and through Radio
Broadcasting*

The new Kylectron, and Peerless and Newcombe-Hawley-Arborphone radio sets will be backed with a dominant, nation-wide advertising campaign. All the details will be given at the Chicago Show. Be sure to learn what our advertising and sales promotion campaigns will mean to you.

TWO COMPLETE LINES

United Reproducers offer two complete new lines. The Peerless will range in price from \$195 to \$600. The Newcombe-Hawley-Arborphone Line will offer the greatest value in the history of radio at prices ranging from \$85 to \$165 . . . prices and values made possible only by the combined resources of four great producing companies.

In these two lines United Reproducers offer a receiving set for *every* customer.

Get all the details at the Chicago Radio Show or wire direct—*today*.

TWO LINES OF SPEAKERS: The speakers we offer are well known. They offer you tremendous sales opportunities. They will be offered under these names: **Peerless** ♦ **Newcombe-Hawley**



4 Great Organizations Unite *to Become the Most Powerful Influence in Radio*

UNITED REPRODUCERS is an amalgamation of four of the most powerful organizations in the radio industry. United Radio Corporation of Rochester, makers of Peerless Radio and Peerless Speakers, the world's largest selling reproducer; Newcombe-Hawley Company of St. Charles, Illinois; Precision Products of Ann Arbor, Michigan, makers of Arborphone receiving sets; and Buckeye Manufacturing Company of Springfield, Ohio, outstanding manufacturers of radio cabinets.

United Reproducers offer the greatest values in the industry and the greatest profit-making possibilities dealers and distributors have ever had. For United Reproducers build their radios *complete* in their own factories—under their own supervision.

Quick delivery and unmatched service are provided by the great combined manufacturing facilities of four specializing factories.

Within a year the United Reproducers' franchise will have become the most valuable franchise in the business. Those distributors who are fortunate enough to secure their franchise now will be in on the ground floor of what is absolutely certain to become the greatest money-making proposition in radio.

United Reproducers Corporation

Rochester, N. Y.

(Complete License Protection)



NOW

BOSCH RADIO TUBES

Now you can sell a radio tube built to a quality standard—the Bosch quality standard.

Bosch Radio Quality Tubes have an unparalleled acceptance with a public which for a generation has recognized that in any Bosch product is quality of manufacture and performance that is a tradition.

They have withstood the severest laboratory and field tests.

They are guaranteed.

They are offered in standard types and at standard prices but very different in performance, uniformity and long life.

AMERICAN BOSCH MAGNETO CORP. . . Springfield, Mass.

Makers of Bosch Screen-Grid Radio
Branches: NEW YORK CHICAGO
DETROIT SAN FRANCISCO



Laboratory and field-tested to the utmost satisfaction. They add a new quality of performance to any radio. . . .

THE SENSATIONS OF THE SHOW



HUGE . . . heavy . . . the symbolism of power . . . of undistorted energy . . . of beauty . . . That is the Best *Theatre Dynamic*.

This huge dynamic dwarfs any other on the market in performance, as well as size.

Never, in the history of radio has there been so much undistorted output. Never has there been a dynamic so free from troublesome hum.

Your conception of speaker performance will be entirely altered by the Best *Theatre Dynamic*. The first dynamic which gets the high notes as well as the low, resulting in a brilliance of tone heretofore unknown to radio.

The Best *Theatre Dynamic* was designed with one idea in mind—to make the finest dynamic possible, regardless of cost. Price has been the last consideration—as it should be, and is, with every truly quality product. The Best *Theatre Dynamic* is for use in the better homes and in theatre installations.

List price, chassis only, \$95.00 less the two 281 rectifier tubes. For use with 105-120 volts AC 50 to 60 cycles. Write for information about 6 volt DC models.

The G-R-E-A-T BBL Electric Motor Speaker

The only speaker with the tone selector. The BBL Electric Motor Speaker is built for any set. Three tapped windings with a switch enables you to match the impedance of any amplifier. You can mold the tone to suit your individual taste, stressing the high

notes or the low or you can have just the perfect tone as broadcast from the studio. Twice the sensitivity and one and one half times the volume of dynamics, (the Best *Theatre Dynamic* excepted). See illustration numbered 1. Complete speaker in a beautiful walnut cabinet, 12" diaphragm, list price \$35.00. Chassis only 12" diaphragm, list price \$22.50. Chassis only 9" diaphragm, list price \$20.00.

The Improved BBL Speaker

The famous BBL Motor, for the first time in a complete speaker. Made by the makers of the BBL unit complete in a beautiful walnut cabinet (see illustration marked No. 2) list price \$20. Chassis only with 9" diaphragm, list price \$10.

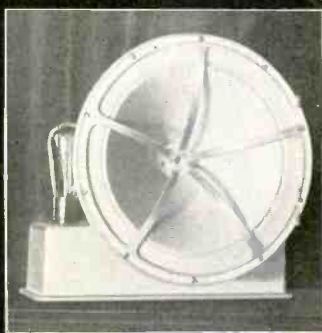

No. 1



No. 2



The BEST Theatre DYNAMIC For Home and Theatre

ARE ON THESE PAGES



Largest Pick-up Ever Put on the Market

The Best Theatre Pick-up is the largest, heaviest and most powerful pick-up available to the general public. Naturally, to get power you must have size. And with size you must have weight. The Best Suspension Bridge Counter-Balance makes it possible to use this weight with but the weight of a feather on the delicate record.

Thunderous Volume!

Volume . . . thunderous volume . . . enough to tax the capacity of any speaker . . . and yet you can cut down the volume to the barest whisper. And without the slightest distortion! Performance that beggars description, so much better than ordinary pick-ups, that there is no comparison.

Guaranteed Longer Record Life and Less Needle Noise

Although the Best Theatre Pick-up has by far the heaviest head, it also has by far the lightest weight on the record, giving longer record life and less needle noise than was ever thought possible before this wonderful development in the art of Pick-ups.

Know the Best by the Box

Individually packed in the most sumptuous display box known to the Radio Industry. To place one of these display boxes on your counter, is to sell it. Complete with volume control and adapter for four or five prong tubes (in case the set does not have a phonograph jack).

List price \$17.50. With longer arm for theatre disks \$20.00.

BEST MANUFACTURING CO.
1200 GROVE ST., IRVINGTON, N. J.



COUNTER BALANCED!

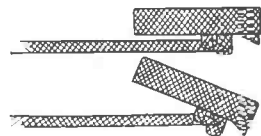

The Best Theatre Pick-up, is built like a suspension bridge. So delicate is it balanced, that only a feather weight is placed on the record. When finished playing a record, simply tip the head — it stays — no danger of ruining record or woodwork. Perfect balance does it.



The BEST
Theatre PICK-UP
For Home and Theatre

Best Manufacturing Company,
1200 Grove St., Irvington, N. J.

Send us complete information on the following:—

- Best Theatre Pick-up
- Best Theatre Dynamic
- BBL Electric Speaker
- Electric Motor Speaker
- Improved BBL Speaker

Name

Address

AUDIOLA



MODEL
8430-27

Eight tubes, four-tuned circuit, five 227, two 245 and one 280 tube.

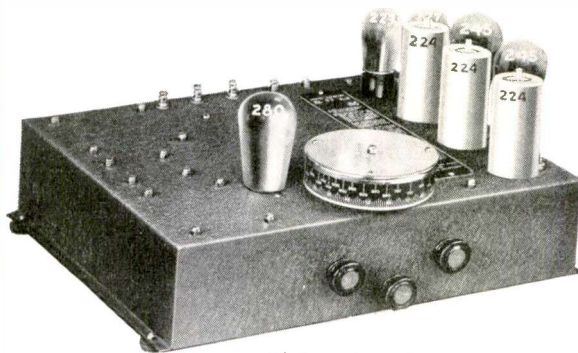

MODEL
8430-24

Eight tubes, four-tuned circuit, three 224, two 227, two 245 and one 280 tube.

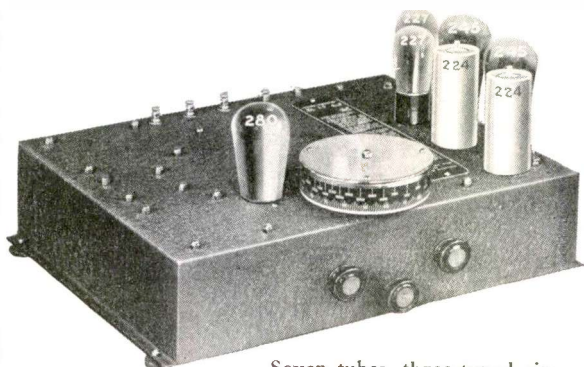

MODEL
7330

Seven tubes, three-tuned circuit, two 224, two 227, two 245 and one 280 tube.

Perfected by 8 Years of continuous manufacturing

... These Three New Audiola Receivers

represent constant improvement in receiver construction. In the crystal set days of 1921, Audiola made a quality product that was universally recognized as such and each year better and better sets have been made.

... These Three New Audiola Receivers

are totally enclosed incorporating the latest features—224 A.C. Shield Grid Tubes, 245 Power Audio Tubes in push-pull, antenna trimmer, an unusually high degree of selectivity and sensitivity and truly faithful tone reproduction. Each receiver operates D.C. dynamic speaker direct without the need of incorporating transformers, rectifiers, or other elements in the speaker.

... These Three New Audiola Receivers

can be sold with the carefree assurance that they are quality merchandise, free from grief and sure to produce repeat business.

Write today for our proposition.

430 SO.
GREEN ST.

AUDIOLA

RADIO CO.

CHICAGO,
ILLINOIS



The
APEX*
of the
Industry

The
APEX*
of the

TRADE
SHOW

CHICAGO Week of June 3rd, 1929

**APEX means "highest point"—Superlative Merit.*

THE new 1929-30 APEX radio makes its bow at the Chicago Trade Show, held during the week of June 3rd, 1929. This product of the United States Radio and Television Corporation is pre-

sented as an unprecedented value—the most complete line of radios on the market. Five distinctive models at unheard of low prices. APEX promises to be the high point of the 1929 show. See it!

United States Radio and Television

CHICAGO, ILLINOIS

Dominant Price



\$99.95

MODEL 60—The beautiful radio that is as good to look at as it is to listen to. Walnut cabinet. Set employs 7 tubes on a genuine Neutrodyne circuit. Full Electro Dynamic Speaker.



\$79.95

MODEL 58—An appealing cabinet of American Walnut with a genuine Neutrodyne set, seven tubes, complete with speaker.

\$49.95

\$149.95

MODEL 70—A nine-tube radio—Neutrodyne circuit—complete with Full Electro Dynamic Speaker, in a gorgeous American Walnut Cabinet.



\$49.95

MODEL 36—A genuine Neutrodyne, seven-tube radio with a highly perfected power pack—the dominant price appeal of the field—\$49.95.

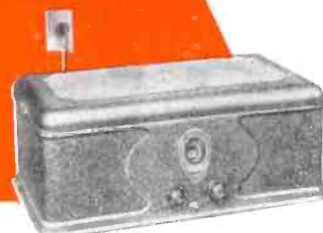

\$89.95

MODEL 89—A genuine Neutrodyne, nine-tube radio—single control, without compensators. A great value that will attract customers—\$89.95.

A GREAT organization — the United States Radio and Television Corporation — makes the APEX radio. Its commanding situation in the industry; its ample financial resources; its wealth of man power and engineer-

ing skill is sufficient guarantee of excellence in its product. Five great plants with manufacturing facilities for 6500 sets per day assures prompt shipments. It's wise to tie-up with such an organization. Past incidents prove it.

United States Radio and Television Corporation
CHICAGO, ILLINOIS

ICA scores again for 1929-30



Specialties that place all factory built radios years ahead in the advantages of technical development . . .

FILTERVOLT JR.

A light duty line noise eliminator that filters out disturbances caused by small motors and minor household appliances. List . . . \$3.00

RESISTOVOLT

An automatic voltage controller that protects costly A.C. tubes and expensive set wiring from burning out caused by overloading and short circuit. List . . . \$1.75

ANTEENAVOLT

A combination socket antenna and voltage controller that protects A.C. tubes and set wiring from damage as well as giving the superior advantages of a socket antenna. List . . . \$2.25

FILTERVOLT

Line Noise Eliminator

For electric sets or sets using any kind of electric eliminator. It filters out line noise disturbances caused by electric signs, elevator motors, vacuum cleaners, washing machines, electric refrigerators and the like operated in or near the house. Filtervolt has brought back clear radio reception for the electrically operated radio.

List . . . \$15.00

SELECTUNER

A Station Selector and static reducer that cuts right through the locals for distance reception and eliminates one of two conflicting distant stations. List . . . \$1.50

DYNATROL

A dynamic speaker-electric radio relay that automatically throws on and off all current supply for set and speaker at its source the moment the set switch is thrown. List . . . \$2.50

POWER TENNA

A combination socket antenna and dual current outlets for set and dynamic speaker or for set and other appliance. Powertenna utilizes the hundreds of feet of all-directional wiring already installed in the electric lighting systems of private houses and apartment houses. List . . . \$1.25



INSULINE CORPORATION of AMERICA

"Quality Radio Products Since 1921"

78-80 Cortlandt Street, New York City



Announcing the

MARVIN

MASTER-BUILT

RADIO TUBES



*These companies
have consolidated into the*

MARVIN RADIO TUBE CORP.

UNIVERSAL ELECTRIC LAMP CO.
Newark, N. J.

SUNLIGHT LAMP CO.
Irvington, N. J.

SPECIALECTRIC CORP.
Newark, N. J.

CONTINENTAL CORP.
Chicago, Ill.

GLOBE ELECTRIC CO.
Newark, N. J.

A. C. M. CORP.
Newark, N. J.

The Marvin Radio Tube Corporation is now located in its new modern plant at Irvington, New Jersey, which provides the largest capacity of any independent radio tube manufacturer. The combined laboratories and engineering departments of these several companies insure Marvin customers that they will get Master Built radio tubes that will
Serve Better and Live Longer.

MARVIN MASTER-BUILT RADIO TUBES

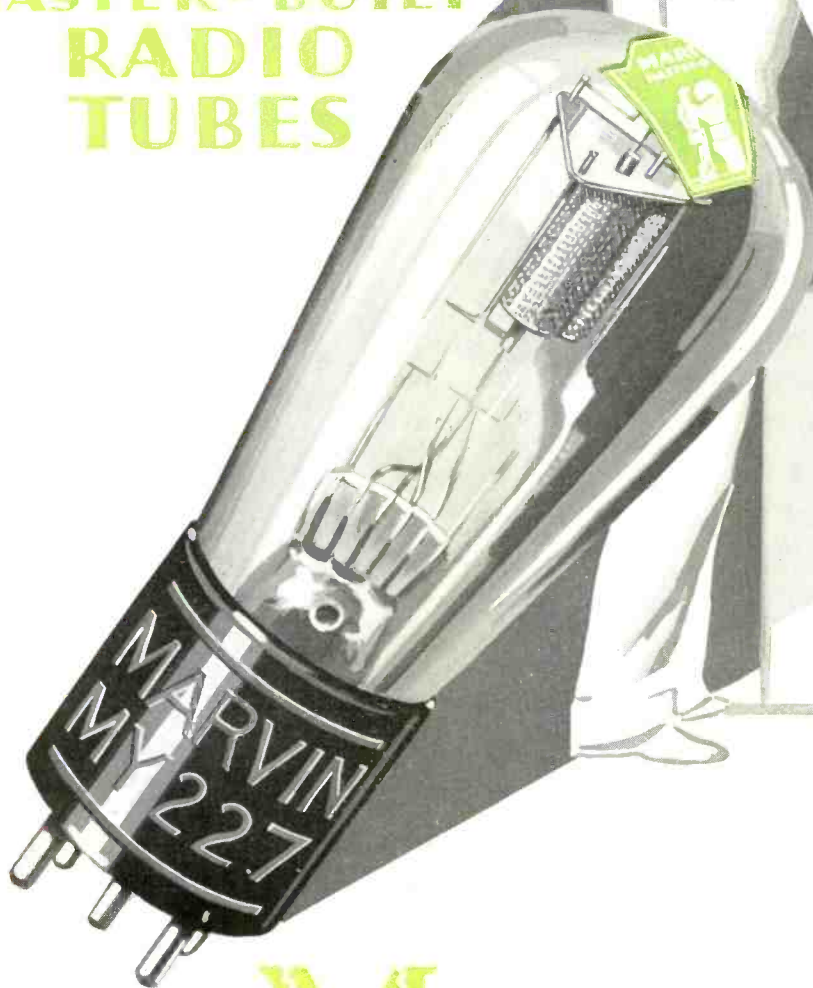

MY227 creates a new world's record for heater type detector tubes in heating up in *five seconds flat*. This tube is the product of Marvin Laboratories and is in production now. You will find it invaluable for demonstrating purposes and more profitable to sell. We will gladly send you complete information on the Marvin line of Master Built radio tubes.

**MARVIN RADIO TUBE CORP.
IRVINGTON N.J.**

General Sales Offices: NEW YORK CITY, 225 BROADWAY, Transportation Building
Western Sales Office and Warehouse: 1603 South Michigan Avenue, Chicago, Ill.

OXFORD

Dynamic Speaker

Licensed under Lektophone patents

GOODWILL IS GOOD BUSINESS

Behind and directing everything that the manufacturers of the Oxford Dynamic Speaker are doing is one dominating air—that is

TO SERVE—

By building the finest radio speakers in the World in large mass production—at the lowest prices consistent with the highest ideals—



OXFORD
definitely
stands for
THE FINEST
THE LATEST
THE MOST
DEPENDABLE
IN RADIO
SPEAKERS

Let Speaker Specialists fill your Speaker Requirements. Our spacious new plant provides for the production of thousands of speakers daily.

Oxford Speakers are available, correctly engineered, for the new model chassis of practically all the radio set builders who sell separate radio chassis. Among our thirty-five models we have D. C. speakers now available for chassis of Wells Gardner, Silver Marshall, Audiola, Premier, Shamrock, Day-Fan, Minerva, Buckingham, Wexstark, Pierce-Arrow, Sentinel, Liberty, Walbert, Peerless-Pioneer, National, and Krasberg-Gollos.

The Oxford line includes all Dynamic Speakers, such as the Direct Current Models, A. C. Rectified types, tube operated speakers, and theater models.

OXFORD RADIO CORP.

Successors to Joy-Kelsey Corporation

G. A. Joy, President

Roy W. Augustine, Secy. and Treas.

Frank Reichmann, Gen'l Sales Mgr. and Chief Engr.

3200 W. Carroll Ave.

CHICAGO, U. S. A.

SEE OUR EXHIBIT AT THE JUNE TRADE SHOW,
HOTEL STEVENS, BOOTH 41-D, Room 523-A

THE *Sylvania* FORESTERS *Every Week in the Year*

On stations of the NBC System including KDKA and KWK and KYW and WBAL and WBZ and WBZA and WBT and WHAM and WJR and WJZ and WLW and WREN and WRVA and additional stations as quickly as they are available.



“You are listening to the program of the Sylvania Foresters Quartette and Orchestra. If your loud speaker complains that your tubes need replacement—visit the dealer whose window displays the Flashing S on a green oak leaf. For tube troubles move out when Sylvania Tubes move in.”

AND *Sylvania* FOLLOW-UP Every Day in the Week



Sylvania's dealers have newspaper advertising and electric flashing signs and six handsome counter cards and wall hangers and a beautifully colored three panel window trim. And book matches. And technical bulletins. And attractive literature and window transparencies. And business building letters. All tying into the constant reminder of Sylvania's broadcasting announcements which urge the consumer to "visit the dealer who displays the Flashing S on a green oak leaf."

*If You Visit Chicago for the RMA Show
Visit Sylvania Lodge—
First Floor of the Blackstone*

SYLVANIA PRODUCTS CO., Emporium, Penna.

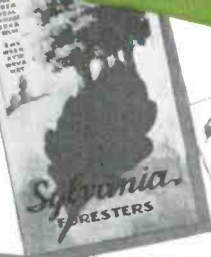

Sylvania RADIO TUBE PRICE LIST

5X-201-A	\$1.45	5X-226	\$2.00
5X-208-A	\$2.50	5X-227	\$4.00
5X-240	\$2.00	5X-224	\$3.50
5X-112-A	\$2.50	5X-215	\$3.00
5X-111-A	\$2.50	5X-210	\$11.00
5X-111-A	\$6.50	5X-250	\$3.50
5X-222	\$2.00	5X-280	\$7.25
5X-201	\$1.00		



A New Market



OUTDOOR MODEL
For amusement parks, chalet-casinos, auditoriums, resorts and other enterprises requiring huge volume. Absolutely fireproof and weatherproof.

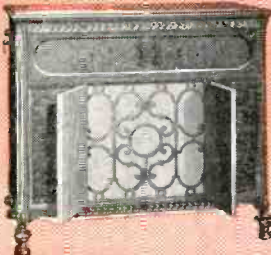

ARISTOCRAT MODEL
A cabinet of exquisite design and finest workmanship for use in clubs and homes. Will adorn the finest surroundings.



AUDITORIUM MODEL
Recommended for public auditoriums, dancing academies, in fact any place where a great amount of volume is desired and excellent tone quality required.

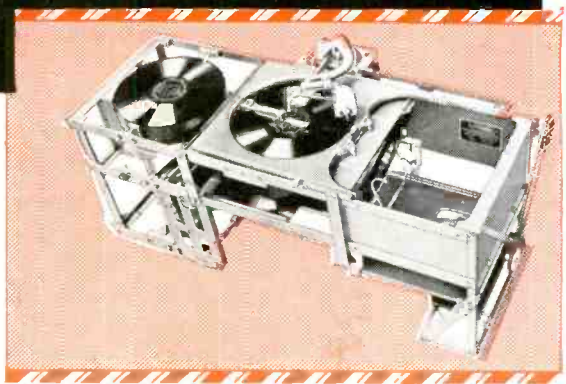

Through an ingenious, patented mechanism, the Caphart Orchestrope does more than has been possible before in a commercial instrument.

THE Caphart Orchestrope is the first and only completely automatic instrument that plays 56 selections—28 records on *both sides*, playing and turning them automatically and continuously; a four hour program without repetition. It plays 24 hours a day, if desired, without requiring a moment's attention. No restacking or reversing records. No chance for the instrument to remain silent through lack of attention. No attendant required—does not take anyone away from his regular business duties, even for a moment!

The tone is brought through three stages of audio amplification and an electric dynamic speaker. Listeners are amazed at its lifelike quality. The world of recorded music, the greatest stars and the most famous orchestras are available to any user with all the beauty and volume of original performance.

Volume is adjustable to any requirement whether it be for a large hall filled with noisy dancers or the intimate atmosphere of exclusive salons.

NOW— for the first time in the industry — a Complete Line!

See and Hear the Orchestrope

rich in Profits!

Investigate this new and valuable dealer franchise—mail the coupon

EXTRA volume, at a big profit, added to your present business. That's the opportunity the Capehart Orchestrope brings.

Business needs music. Wherever you find an establishment that can afford an orchestra, they'll tell you that *music pays!* It attracts new trade; it holds old customers; it makes people spend more money.

Now, thanks to the Capehart Orchestrope music is no longer an expensive luxury. Even the smallest business can offer good music to its patrons *on a profitable basis.*

A Large Market!

The Capehart Orchestrope is suited to every character and class of establishment. To the fine hotel

249,753 Prospects!

An independent and impartial survey by Radio Retailing and published in their March, 1929, issue, revealed the following prospects for instruments like the Capehart Orchestrope:

4,278 Country Clubs
1,166 Dancing Academies
634 Athletic Clubs
1,786 Boarding Schools
932 Catholic Academies
1,380 Elks Lodges
4,500 Miscellaneous Clubs
4,100 Fraternity Houses
12,000 Druggists
15,000 Hotels
1,840 Y.M.C.A.'s & Y.W.C.A.'s
197 Steamship Companies
70,000 Soft Drink Parlors
82,000 Eating Places
23,000 Billiard Halls
1,440 Bowling Alleys
4,000 Beauty Shops
6,000 General Stores
500 Terminal Stations
15,000 Amusement Parks
249,753 Total Prospects

or club which desires to create a friendly, homelike atmosphere in its public rooms; to the exclusive cafe which wishes to supplement the music of an orchestra for entertainment or dancing; to restaurants, refreshment parlors, road houses, drug stores or any place of amusement who may derive an actual profit from a coin box attachment. Many hundreds of such establishments now use the Capehart Orchestrope. They tell of as high as 75% increase in business; of coin box receipts averaging \$25.00 per week and more!

Valuable Franchise

The exclusive Capehart franchise is already tremendously valuable wherever it has been assigned. The aggressive Capehart advertising campaign in trade papers, consumer magazines and direct mail is making that franchise more valuable every day. Every type of assistance is given to Capehart dealers. *And the dollar margin in every sale leaves room for big profits.* Valuable territories are being rapidly assigned. *Investigate!*

Mail the Coupon

Find out about the Capehart Orchestrope and the valuable Capehart franchise. The coupon brings full details, entirely without obligation. We'll show you what other dealers are doing and the big profit that awaits you in YOUR territory. Mail coupon.

**CAPEHART
AUTOMATIC
PHONOGRAPH
CORP.**

FORT WAYNE, INDIANA

Prospects like these—
We show below a few typical Capehart Orchestrope installations. Every such place in your community needs the Orchestrope!

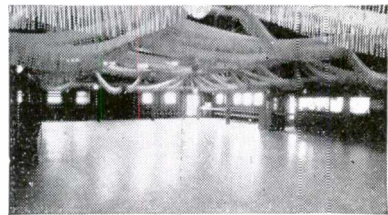

Haddon Hall, McCordsville, Indiana, uses the Orchestrope for dancing.

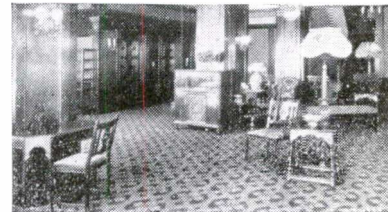

Hotel Conant, Omaha, Nebraska
A cheerful lobby more inviting than ever.

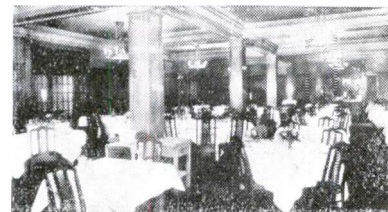

A hint for restaurants from the Bannock Hotel, Pocatello, Idaho

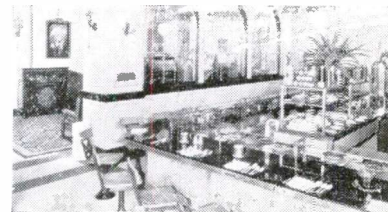

Lunchroom of Hotel Belmont, Milwaukee, Wis.
It attracts trade and increases business.

THE CAPEHART
Orchestrope
at the R M A Trade Shows

Capehart Automatic Phonograph Corp.
Dept. A485, Ft. Wayne, Indiana

Please send me, without obligation, descriptions of all Capehart Orchestrope models and details of the Capehart Dealer's Franchise.

Name

Address

City State

THE NEW RADIO SET TESTER

See it at the R.M.A. convention

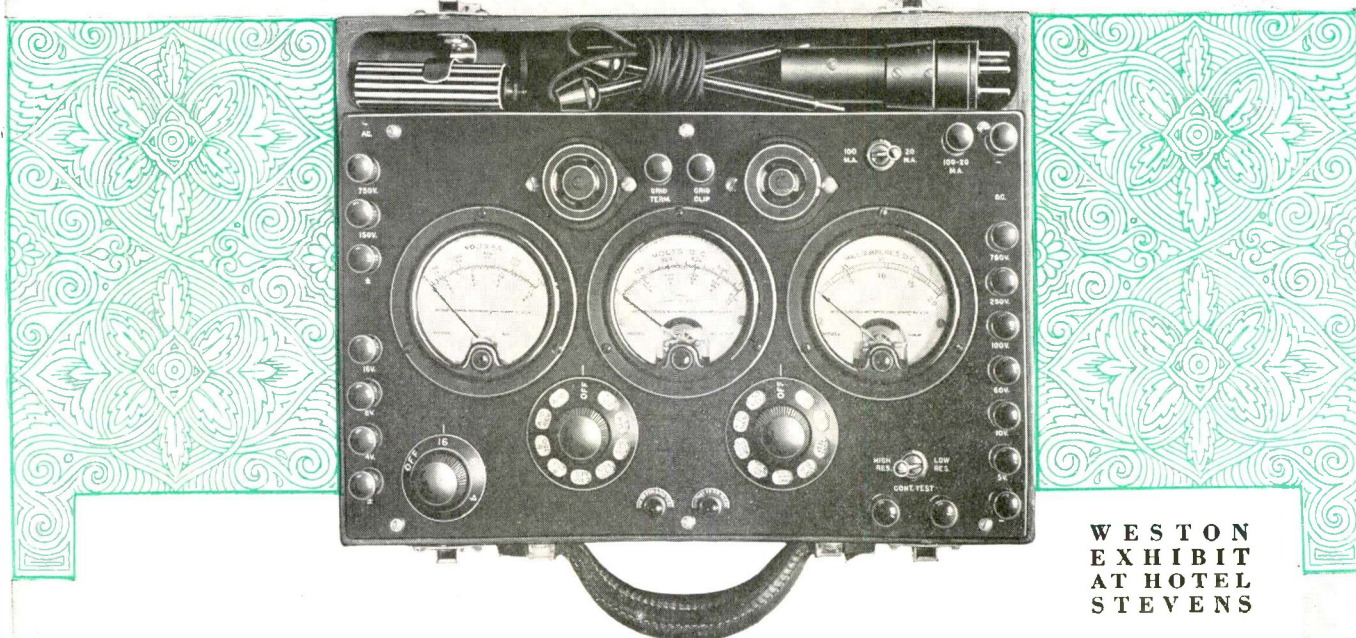

WESTON
EXHIBIT
AT HOTEL
STEVENS

The radio industry is familiar with the Weston Model 537 Radio Set Tester—for A. C. and D. C. receivers. Service men hailed it with great acclaim a year ago, noting its many advantages over the Weston Model 519—for D. C. only.

And NOW—here is another great advance—the Weston Model 547—incorporating many additional features to meet the service testing requirements of radio's latest developments. And there have been many since the last R. M. A. Convention. But with this NEW SET TESTER radio servicing is still further

simplified, even taking into account the number of new tubes, sets and circuits. Space won't permit description here—nor would words alone do this new set tester justice. You must see it for yourself—operate it—try to think up some service problem it can't solve. Try as you will the Model 547 will give you a quick and accurate answer every time. Convenient—complete—light and rugged. Handsome in appearance—and it will yield you handsome profits. It will increase your business and your prestige. **YOU CAN BANK ON IT!**

OUTSTANDING FEATURES OF THE MODEL 547

First of all it is a WESTON—assuring you exquisite workmanship and complete service reliability. It is provided with three instruments—all 3 1/4" diameter and furnished with bakelite cases. Carrying case, removable cover, panel and fittings are also made of sturdy bakelite.

A. C. Voltmeter—750/150/16/8/4 volts. The three lower ranges are brought out to the Tester plug, and all five ranges are brought out to binding posts. 750 volt range is for testing secondaries of power transformers. 16 volt range is to provide for 15 volt A. C. tubes. Operations have been reduced—only one selector switch being necessary.

D. C. Voltmeter—High range increased to 750 volts. Other ranges—250/100/50/10/5—all six ranges brought out to binding posts and Tester plug.

D. C. Milliammeter—Double range—100/20 M. A. provides for lower

readings with better scale characteristics. **Tests**—On A. C. sets the heater voltage and plate current can be read throughout the test while the D. C. voltmeter may be indicating plate bias or cathode voltage. Self-contained, double-sensitivity continuity test provided. This can also be used for measuring resistance as well as testing for open circuits. Grid test can be made on A. C. or D. C. screen grid tubes—also the '27 tubes when used as a detector—without the use of adapters. Two sockets on the panel—U Y tube adapters eliminated.

Weston
PIONEERS
SINCE 1888
INSTRUMENTS

FINDLAY RADIO FURNITURE

"Makes finer sets sound finest"

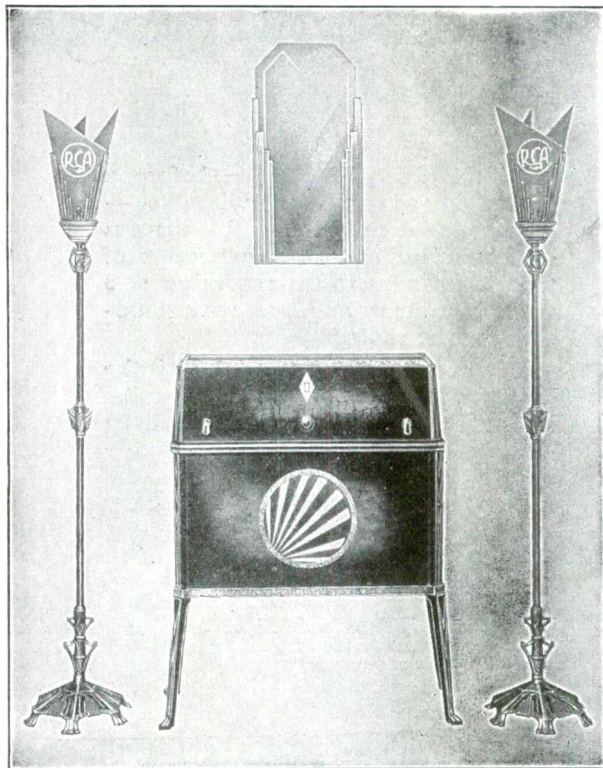

Radiola 33 Ensemble

exclusive
models
for
all
popular
makes
of radio

Illustrated is the new Findlay Console Grand with the Radiola No. 33 in place. The Pewter Finished Torchiers and Modernistic Console Mirror complete the ideal radio corner. May be retailed with RCA Speaker No. 100B Chassis for \$169.50 complete, less tubes.

Atwater Kent

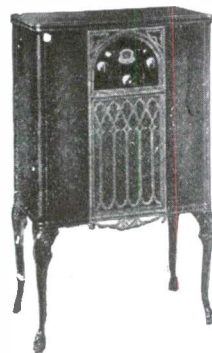

FINDLAY Cabinet No. RF 2/55M Designed expressly for the new Atwater Kent No. 55, and to accommodate AK Dynamic Speaker F 4C. Finished in rich African Mahogany with exceptionally ornamental statuary bronze finished speaker grill and escutcheon frame. Either table model set or chassis set will fit perfectly on shelf provided. Dials will protrude through escutcheon frame.



FINDLAY Console Grand No. RF 2/550 — Modernly simple speaker console with top especially molded to accommodate Atwater Kent No. 55. This Console Grand is designed especially for and finished to match the Atwater Kent No. 55 Table Model. For the Modern home — where space is at a premium — this Console Grand is the ideal piece of furniture.

Crosley

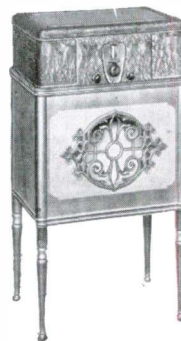

FINDLAY Console Grand No. 3/84 — Designed exclusively for Crosley Table Models and in finishes to harmonize. The same exclusive Findlay Baffle Construction that distinguishes all other Findlay Radio Furniture is incorporated in this Console Grand. When set is in place it gives the appearance of a single piece of furniture because of the artistic molding provided.

MR. RADIO DEALER:—We lay our case frankly before you. The Radio Furniture Field is already so crowded that it has reached the state of the "battle of adjectives"—each manufacturer saying fine, finer, or finest. Yet, only Findlay Radio Furniture is made of sturdy, durable metal by Master Craftsmen.

We will let you tell yourself just what is to be said about Findlay Consoles—we don't know any words descriptive enough to do Findlay Radio Furniture justice.

Have your Jobber demonstrate your favorite set and speaker properly placed on a Findlay Console. Note the improved tone—the exclusive Findlay Baffle Construction makes even the finest sets sound finer.

Take yourself out of competition—feature Findlay Radio Furniture. Earn bigger profits!

Findlay Radio Furniture's Superiority

Smartly simple, modern in feeling, and noteworthy for compactness. Designed and finished to harmonize with the sets for which they are made—in neutral finishes that fit the modern mode of interior decoration. Improved tone assured by the exclusive Findlay Baffle Construction—made of sturdy metal—no joints to loosen—no veneers to warp—and no distortion from vibration.

Ask your jobber or write us for more information about Findlay Radio Furniture and Findlay Radio Accessories —these Build Dealer Profits.

findlay Consoles are made by ROBERT FINDLAY MFG. CO., Inc.
Metropolitan and Morgan Avenues
BROOKLYN, NEW YORK

Prove Brunswick

At the Chicago

At midnight, May 3rd — before a great body of competent witnesses — Brunswick demonstrated, by a most critical scientific test, a perfection of tone in its new radio receiving sets so extraordinary as to set new standards for the radio industry.

You are cordially invited to visit the Brunswick Booth and Demonstration Rooms at the two Chicago conventions — June 3rd to June 6th, inclusive — and to prove to your complete satisfaction the tone supremacy of the new

Brunswick Radio Receiving Sets



Brunswick Combination Panatrop
with Radio. Model No. 31



Brunswick Highboy Console
Model No. 21

Tone Supremacy Conventions

*Brunswick Lowboy
Console
Model No. 14*



At Exhibition Hall, Stevens Hotel:
Space 141 and 142

Demonstration Rooms

At the Stevens Hotel: Room 435-A

At the Drake Hotel:
Rooms 507-508-509

Brunswick Radio Receiving Sets

THE BRUNSWICK-BALKE-COLLENDER CO., Chicago, New York, Toronto — Branches in All Principal Cities

Radio Retailing, June, 1929



THE BEL CANTO SERIES

AMRAD

P R E S E N T S

4 Distinguished MODELS

AMRAD has very keenly felt its responsibility in producing a fine radio line, not only in mechanical and electrical performance, but also in the beauty of its consoles and the maintenance of its reputation for "the finest tone in radio."

It is all the more gratifying, therefore, that we are able to offer to authorized AMRAD dealers what we believe to be the finest line of radio receivers in the market and at moderate prices but out of the extremely competitive field.

The AMRAD distributor in your community now has a line which you can be proud to sell and which will be backed by a powerful national advertising campaign. Each AMRAD model represents a fine, exquisitely beautiful piece of furniture. Each AMRAD model is designed to give the listener gloriously beautiful tone.

Write today for full information as to sales opportunities and complete detail of the 1929 line.

THE AMRAD CORPORATION
MEDFORD HILLSIDE, MASS.

JAMES E. HAHN
President

POWEL CROSLLEY, JR.
Chairman of the Board

The new extra-heavy Amrad chassis, built for ultra sensitivity and selectivity, is especially designed for the new screen grid tube used in three stages. Tubes used are:

3 UX-224 or C-324
2 UY-227
2 UX-245
1 UX-280

Enormous power is provided by use of two 245 tubes in push-pull.

THE BEL CANTO SERIES



*Prices slightly higher
West of the Rockies.*



The ARIA

Doors of selected Butt Walnut Veneer, with African Walnut overlay top and bottom. The inside of this modified Art Moderne cabinet has a fine figured walnut face in an attractive Gothic design. New ultra-sensitive Amrad chassis using shielded grid tubes; equipped with nine-inch Peerless Dynamic Speaker. *List.....\$198*



The SERENATA

The simplicity of this modern sliding door cabinet sets off the rich beauty of diamond matched Oriental Walnut, and other fine woods. Uses standard Amrad shielded grid chassis with R. C. A. 106 Dynamic Speaker. Escutcheon plate and door pulls of old bronze finish, in harmony with console. *List..... \$245*



The SYMPHONY

Beautiful cabinet of Art Moderne design. Front and sides veneered in highly figured East Indian Laurel Wood, with base rail of Macassa Ebony, decorated with inlays of ebony and holly. Rounded and recessed top of Oriental Walnut. Inside panel of matched Oriental Walnut Veneer. The Amrad screen grid chassis is especially designed for utmost selectivity and sensitivity. The special audio system, in combination with the built-in R. C. A. 106 Dynamic Speaker, gives an unequalled rich tone production. The chassis uses 8 tubes. *List.....\$295*

The DUET

A combination electrical radio and phonograph, inspired by the finest Art Moderne furniture. The beautiful veneers in this cabinet are of Oriental Laurel, appropriately decorated by inlays of ebony and maple with Macassa Ebony base rail.

The inside front panel is of finely matched Oriental Walnut with inlaid border. The grille is extremely beautiful and the escutcheon plate is of silver with a shield enamelled in scarlet and blue. The door pulls are of antique silver.

Shielded grid tubes are used in the chassis, which is extremely powerful and unusually sensitive and includes the R. C. A. 106 Dynamic Speaker built in cabinet. *List.....\$495*

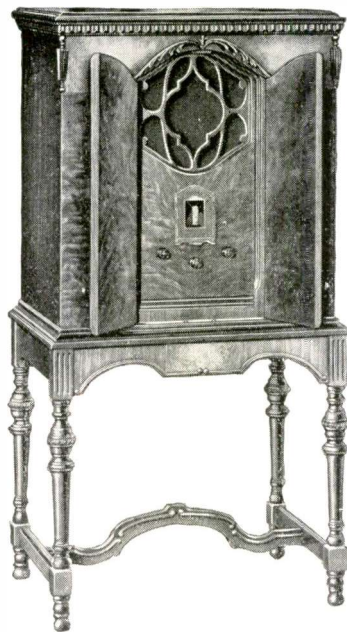

BREMER

*Presents a*TWO NEW
1929 CONSO*backed*Unusual Ad
Sales*A Big Future*NEW, IMPROVED
CHASSIS—7 TUBES

Perfectly balanced, tuned and shielded circuit, 227 type tubes in four tuned stages. Push-pull audio with two 245 tubes. Full wave rectification. Additional regulator tube for constant voltage. Antenna Trimmer. 10-inch dynamic speaker specially designed to eliminate "hum"

Model 82—DELUXE FRENCH DOOR CONSOLE
Genuine butt walnut veneer with Carpathian Maple overlay.
\$195, less tubes; slightly higher west of Rockies

Profit by Experience. In introducing these exquisite new A C consoles Bremer-Tully engineers bring you a triumphant achievement—the climax of eight years' experience. Known throughout the radio world for always pioneering *the best*, Bremer-Tully's reputation is the strongest selling point in radio; your guarantee of customer satisfaction . . .

And For Homes Without Electricity: Bremer-Tully has not forgotten your rural prospects. The line also includes Model 80, a new 1929 designed 6 tube shielded chassis console, battery operated, equal in performance to the A C Models.

A
BREMER-TULLY
Instrument

A Great Sales Story. Magnificent tone, amazing distance, hair-line selectivity, quiet operation—these are the big selling features of the new models. Plus a new super-dynamic speaker, "distortion-free" and tone-true throughout the entire vocal and instrumental range, even at full concert strength. In split-hair accuracy of performance Models 82, 81 and 80 excel Bremer-Tully's already recognized high standards.

Big Production—Positive Deliveries.

Greatly increased production facilities assure deliveries. You can plan your selling campaign with complete confidence.

See the new Bremer-Tully at the R. M. A. Trade Show, Stevens Hotel, Booth 79. Demonstration: Rooms 1500, 1501, 1501A, 1502, 1502A

A P E R M A N E N T

- T U L L Y

*New Leader ~*DE LUXE
LE MODELS*by an*vertising and
Program*With Big Profits*RICH BEAUTIFUL
CABINETS

Both models are worthily cabineted in luxurious consoles of butt walnut, built by master woodworkers in authentic period design. Hand-rubbed, satin finish; furniture built for the finest homes

Model 81—DE LUXE STANDARD CONSOLE
Chassis identical with Model 82.
\$164, less tubes; slightly higher west of Rockies

Selective Franchises—a Real Sales Program. A live and let live policy which builds a permanent business for Bremer-Tully dealers and safeguards their profits. Only a limited number of dealers will be franchised in a territory. New finance plan which makes every “time” transaction virtually a cash deal . . . a plan that makes it easier to sell the big-profit, quality Bremer-Tully line.

A Powerful Advertising Campaign for Dealers. These new instruments will be consistently advertised to millions. Commanding full pages in The Saturday Evening Post and

other national magazines *every month!* Dominating newspaper space to drive the story home when it will profit you most. Window displays, consumer folders, dealer ads—everything needed to cash in on this great program is ready for you.

Build a Permanent Name in Radio. Success builds success. Bremer-Tully has prospered since the beginning of radio by straightforward dealing and tested “right” merchandise. Bremer-Tully dealers *stay* Bremer-Tully dealers, prospering with us year after year! For permanent success, write *today* for details of our splendid new proposition.

A
BREMER-TULLY
Instrument

BREMER-TULLY MANUFACTURING COMPANY, 656 WEST WASHINGTON, CHICAGO

N A M E I N R A D I O

1927

was **A.C.** year

lucky dealers who picked a tried and proven a. c. set made money then—lots of it.

dealers who stuck to battery sets and “pooh-poohed” the new fashion of a. c. sets awoke too late—the season over, their shelves full of obsolete sets, their pockets empty.

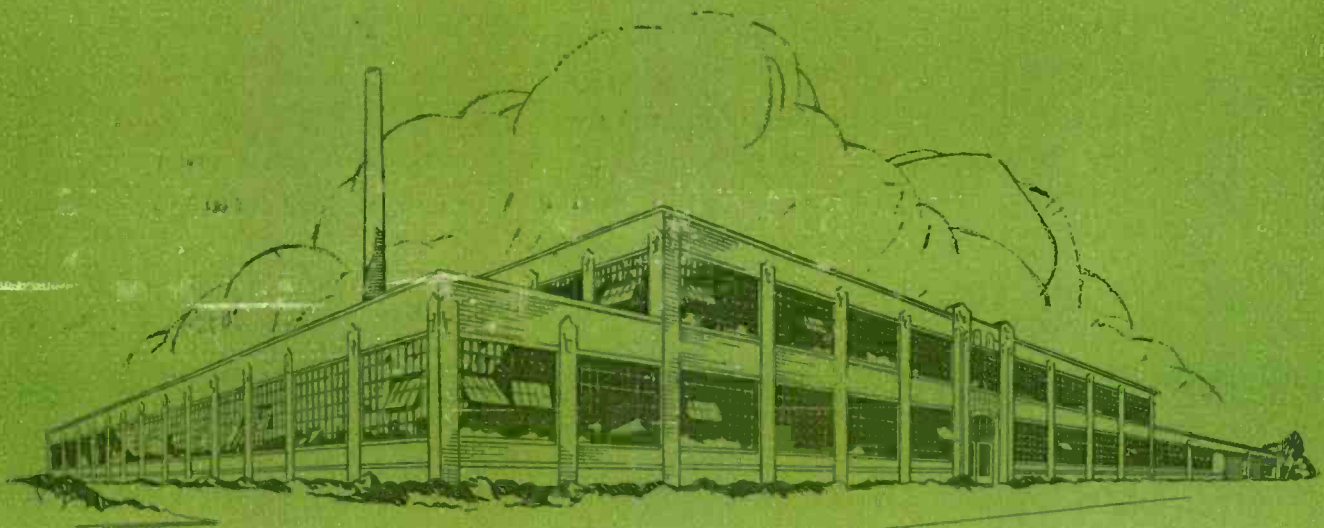

It is significant that SILVER RADIO is produced in a plant—one of the largest in America devoted to radio—financed and built entirely from the profits of successful screen-grid merchandising over a period of eighteen months.

1929

is **SCREEN-GRID** year

the trade show proves it positively—screen-grid is the fashion for 1929. two facts stand out significant, amid the welter of trade-show talk ranging from “screen-grid is the bunk” to “you bet our new set’s screen-grid.”

one manufacturer alone possesses more than a few weeks actual screen-grid production and sales experience—Silver-Marshall, Inc.

one set alone has behind it the successful sale of over 25,000 screen-grid predecessors through the last eighteen months—SILVER RADIO.

and, on the cold morning after, the “hip-hip-hurrah-let’s-go-boys” parties and high-pressure sales conventions don’t mean a thing but “promises.”

SILVER RADIO is in production—on sale in the shops of progressive dealers—and backed by a screen-grid reputation possessed by no other manufacturer. SILVER RADIO is not a “promise”—it is a fact.

we’re not putting pictures and prices of SILVER RADIO in this advertisement. the exclusive SILVER distributor in your territory will tell you the story and arrange a demonstration—or write for detailed announcement.

SILVER-MARSHALL, Inc., 6421 W. 65th St., Chicago, U. S. A.



SM

**SILVER · ON · RADIO · IS · LIKE
STERLING · ON · SILVER**

SHORT-WAVE RADIO RECEPTION IS HERE

PLUG IT INTO YOUR RADIO SET

AERO-CALL

SHORT WAVE CONVERTER



SHIELDED—FILTERED—Size, only 9x5½x2½ in.

Complete Factory-Built
Short-Wave Converter Box

PLUGS INSTANTLY
INTO ANY RADIO!

A. C. and D. C. Models

Made by
AERO PRODUCTS, Inc.

Pioneer Short-Wave and
Coil Specialists

**TAKE ADVANTAGE OF THIS OPPORTUNITY TO
BOOST YOUR SUMMER SALES WITH SHORT WAVE**

THE Aero-Call Converter Box brings to radio dealers a real opportunity to increase sales and profits for summer. Here is an entirely new adaptation of the wonders of radio. Heretofore, short waves have been appreciated only by "hams." Now they are available instantly to every radio set owner by the use of the Aero-Call Short-Wave Converter Box. A compact, shielded, filtered, factory-built short-wave adapter, equipped with special short-wave coils. Designed for both A.C. and D.C. sets. Operates without motor-boating, by an auxiliary filter system control, an exclusive feature (patent applied for) that entirely eliminates the failure of most converters heretofore offered to the public. It can be plugged into any regular radio set. List of short-wave stations here and abroad, with time of broadcasts, enclosed with each set.

No change or wiring required. All complete, ready to operate, tubes and coils hidden, no apparatus in sight, except the neat, golden-brown, compact metal cabinet in crackle finish, that harmonizes splendidly with the finest radio cabinet. Cushioned feet prevent marring cabinet.

Size, only 9 x 5½ x 2½ inches.

The only converter we know of that really works on all sets. Two models—A.C. and D.C.

Have Something to "Shoot At"

We don't guarantee that every Aero-Call owner can get Europe or Australia—but it is being done regularly—and practice makes perfect. At least, there's something to "shoot at" that you couldn't get on a regular radio set in a blue moon. There's plenty of thrills in tuning in on short waves to keep one busy for hours. And when London, Paris or Berlin is tuned in, there's something to brag about.

Every Set Owner a Prospect!

The public's interest in short waves has been nation-wide. Jobbers and Dealers will find an instant demand for Aero products from radio users everywhere, both A.C. and D.C. Order your demonstrator now.

MODEL A. for A.C. Sets—
MODEL D. for D.C. Sets—

LIST PRICE

\$ 25

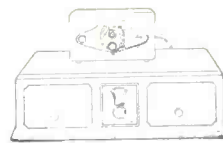

**Fan Hears England
and Holland**

An Aero-Call user in Pennsylvania writes:—"With an old 5-tube receiver—SSW (Chelmsford, England) was received at excellent telephone strength, as was also PHI, Hulzon, Holland.—GBS (Rugby, England), also received—will vouch for its ability to get Java—A fine piece of work, and you are to be complimented—recommended it to a number of my friends—in Pittsburgh."

(Signed) G. E. M.,

(Name and Address on file).

Other similar records have been secured on the Aero-Call, but it takes expert tuning to do it. Short-wave reception is not as good as regular broadcasts, but it furnishes a new and novel method of experimentation.

Dealers, write for literature and discounts, and name of your nearest jobber. Jobbers, stock up now.

Mail this Coupon for advance information

AERO PRODUCTS, Inc., 4611 E. Ravenswood Ave.
Dept. 2169, Chicago

Send me advance information and prices on your new complete short-wave converters, sets and new developments—that will boost my summer sales.

Dealer's Name

Street and Number

City

Name and Address of Jobber

AERO PRODUCTS, Inc.

4611 E. Ravenswood Ave., Dept. 2169, Chicago, Illinois

Don't be the child
don't be the rat.





Large space newspaper advertisements ready for heavy artillery bombardment at the exact time and in the exact places that sell most sets for you.

FACTS

Instead Of Claims

ADVERTISING contracts have already been signed—over half-a-million dollars worth—making the Temple advertising program one of the biggest.

Newspapers, magazines, radio broadcasting, dealer advertisements, decals, booklets and circulars—never before has there been such a sound, businesslike, maximum-coverage Radio campaign.

The advertising tells the Public one great truth—and tells it hard—the truth that

In Radio TONE is Everything

THE TEMPLE is the Musician's set. And the Dealer's Set. Built to the specifications prescribed by both. It brings you what more than a thousand of the keenest dealers in America have asked for for years.

Don't forget that America has always changed from one make of product to another, the moment superiority is proved!

The trade has "Gone Temple" this year. For Five very good reasons.

THE 5 Reasons

TO THE dealer who has cut his eye-teeth, we point out *Five Reasons* which are making many anxious to become a part of the Temple success—Reasons which the experienced dealer himself knows to be sound business:

1. Dependability of Set—Temple—with factories in five countries—has a background of record as makers of the finest speakers the industry has yet developed. In designing and testing its set, Dependability has been stressed. The scientific accomplishments that have given Temple Speakers the finest tone the industry has ever known, have now put into Temple Radio Receivers the correct engineering and simplicity of design which permits of no inherent defects and reduces service cost to the absolute minimum. These—*Plus Radio's Proudest Achievement in Tone—Templetone.*

2. Interesting in Style—With distinct style appeal that is authentic, artistic, of the moment—yet so beautifully practical as to appeal to all.

3. Competitively Priced—Many a fine set has failed to get to first base through the lack of this fundamental principle so strongly stressed by Temple.

4. Properly Merchandised—More than half-a-million dollars being spent in the most highly concentrated areas where your sales are surest to be.

5. And Last But Not Least—Resources—The credit and standing of this company warrant the fullest investigation. There are branch Temple factories in five countries as a result of Temple's outstanding achievement in Radio. The character, the integrity and the experience of not one but the entire group which comprises the Temple organization will rank with any of the names which have made the Radio industry gigantic.

TEMPLE CORPORATION
5253 W. 65th STREET CLEARING STATION CHICAGO, ILL.

TO ME

in a Tiffany setting



The Temple 8-80 Grand Console with 14-in. dynamic speaker...\$189.00 (without tubes)



The Temple 8-60 Console with dynamic speaker... \$149.00 (without tubes)



Housed in beauty, The Temple Dynamic is the only speaker with the adjustable hum eliminator feature. Separate table type speakers are available for those who do not own a Temple Receiver.

\$39.00 for the Dynamic Speaker
\$20.00 for the Magnetic Speaker

Announcing—the magnificent Temple combination phonograph and radio receiver... the final luxury that millions want, now for the first time at a price that millions can afford—\$289. Scientifically the farthest advanced instrument in its class. Combines all of the phonograph improvements that have revived the phonograph industry, with all of the latest and best scientific advances of radio. A superb, *lifetime*, musical instrument at a price which makes it easy for you to turn many sales into bigger unit sales.

All-electric, of course.

Dynamic, of course—not just “also” dynamic, but instead, a newly-developed dynamic speaker, especially engineered with exclusive Temple features.

Single control, of course.

Tone, of unrivalled superiority.

Selectivity and DX—Heretofore associated with only the outstanding laboratory sets. A whole advertising campaign could be built around these alone.

Eight tubes and rectifier—Six 227 tubes—push pull amplification—using the two new 245 power tubes—full wave rectification, a power supply over-sized in every respect in combination with the Temple Humless Dynamic Speaker assures matchless tone for Temple Receivers.

Prices—The Temple 8-80 Grand Console, with 14" dynamic speaker—\$189 (without tubes). The Temple 8-60 Console, with dynamic speaker—\$149 (without tubes). The Temple 8-90 Combination Phonograph Radio Receiver with 14" dynamic speaker—\$289 (without tubes).

PRICES SLIGHTLY HIGHER WEST OF THE ROCKY MOUNTAINS

The Temple Receivers are licensed by RCA and Associated Companies. Exclusive patents allowed by U. S. Patent Office on its various special details.

TEMPLE

TEMPLE TONE  *Radio*

© 1929 T.C.

"THE SWITCHBOARD OF A NATION"

TEMPLE CORPORATION
5752 W. 85th STREET CLEARING STATION CHICAGO, ILL.

Meet our Engineering Staff



Maj. W. D. DOOLEY
B. Sc. and E.E., M.E.-AD.

Chief of research laboratory of Demco Corp. Mr. Dooley's inventions and contributions to the art of radio, telegraphy and broadcasting are nationally known.



C. T. AKERS
B. Sc. and E.E.

Formerly associated with R. C. A. and Magnavox in research and production and just recently Mr. Akers severed connections with Grigsby-Grunow Corporation to affiliate with DEMCO.



F. E. ENGELHARDT
M.E.

Chief mechanical and designing engineer. Formerly of the General Electric Co., Schenectady, N. Y.



D. R. WILDER
B. Sc. and E.E.

Has made a name for himself with several of the world's leading radio manufacturers; at one time Director of Consulting Engineers, Inc. of Chicago, Ill. Now Assistant Chief Consulting Engineer with the Demco Corp.

Like the mighty rock of Gibraltar stands the bulwark of the Demco Corporation which owns the controlling interest in the following fast-growing industries:

Dooley Rectifier Co., manufacturers of Demco socket powers and rectifiers.

Demco Products Co., manufacturers of Demco radio receivers and accessories.

Ohio Valley Cabinet Co., manufacturers of radio furniture.

Dooleyphone Co., manufacturers of synchronized and Non-synchronized theatre equipment, and public address systems.

ALL of these famed industries are housed in our gigantic factories at Warwood, West Virginia, occupying over 200,000 square feet of floor space.

The authorized capital of the Demco Corporation is \$3,500,000.00 and any dealer or jobber who signs up with any of these subsidiary companies for any of their products can rest assured of prompt delivery, first quality material and financial responsibility. Through our vast financial resources we are able to buy raw materials in vast quantities at prices far lower than any competitor. Then, too, our financial responsibility makes

it possible for us to obtain and hold some of the greatest research engineers in existence.

Demco Corporation maintains at its own expense, a \$100,000.00 research laboratory in which the experimental and research engineering of its subsidiary companies are done.

Whenever you see the name DEMCO, DOOLEYPHONE, DOOLEY RECTIFIER or OHIO VALLEY CABINET CO., you can rest assured you are purchasing a product of one or more of these subsidiary companies of Demco Corp. *Don't forget the name!*

DEMCO CORPORATION: Wheeling (Warwood) W. Va.

*Don't fail to see our merchandise in booth 41, in the ballroom of the Stevens Hotel, Chicago, Ill.
If you wish demonstration and full particulars call at room 550-A, Stevens Hotel.*

'DEMCO' RADIO

"The Golden Voice of Magic"

→✻ A-C or D-C Chassis ✻←

See It...Hear Its Clearer Tone!

Room 550-A

STEVENS HOTEL

Booth 41, Ballroom

The Improved D-C Chassis

Last year we said that "when a better electrically operated Radio Set could be built, DEMCO would build it." We have kept our promise! In addition we present to the trade, for its approval and criticism, for the first time an all-electric radio receiving set with all the advantages of D-C operation, minus the disadvantages of the shield grid or 226 and 227 tubes. For the first time, this year, in Booth 41 Ballroom of the Hotel Stevens, during the R.M.A. Trade

Show in Chicago, the trade will have an opportunity to see, hear and appreciate the mighty engineering achievement which stands out as the climax in perfect radio set production!

Radio Engineers are all of the opinion that no tube has yet been developed that will compare in gain, clarity and fidelity of reproduction with the 201-A tube.

DEMCO offers an all-aluminum 7-tube shielded chassis with 201-A tubes and 171 push-pull power amplification and no series-filament connection, but a straight parallel-filament connection. This is made possible thru the recent perfection of Major Dooley's Dry Plate Rectifier which has been so successful for the past few years, that it is now being universally used by some of the country's largest manufacturers of Dynamic Speakers and Public Addressing Devices. It is with this rectifier and filter that we supply the D-C Current necessary for the operation of our seven-tube chassis, and do not use series connection. You can readily visualize what such a receiver will do! No other receiver can possibly surpass the fidelity of

DEMCO reproduction—the chromatic shading of the high and low notes which are characteristic of DEMCO REPRODUCTION. The DEMCO All-Electric D-C Chassis offers the many engineering advantages which are scientifically impossible with A-C operation.

The DEMCO D-C Chassis gives the SELECTIVITY of the SUPER, the AMPLIFICATION GAIN of the shield-grid, and the POWER and FIDELITY OF REPRODUCTION of a 250 tube. The DEMCO D-C Chassis is the finest Radio that modern science and engineering can possibly build into ONE UNIT. Its marvelous selectivity, distance-getting ability, tone-quality and simplicity of operation is MYSTIFYING. SEE IT! HEAR IT! All this week at the R.M.A. Show.

The A-C Chassis

The same rugged, efficient A-C Chassis that startled Radio Engineers, when presented last year at the R.M.A. Trade Show, whose uncanny performance created such a sensation. New refinements and improvements have been added, making it a better radio in every respect. Absolute filament voltage control . . . Single dial tuning. Chromatic shading of high and low notes simultaneously . . . Fidelity of reproduction . . . Simplicity of operation and mechanical ruggedness of construction . . . No other A-C Radio Set has these advantages.

DEMCO PRODUCTS Co.

A Subsidiary of the Demco Corporation
WHEELING-WARWOOD, W. VA.

For proposition as dealer or distributor consult Messrs. J. H. Klieves and C. T. Harden of the Har-Kle Radio Distributing Co., distributors for Ohio, West Virginia and Pennsylvania, who will be in attendance in our booth, at the Show.

DEMCO PRODUCTS CO.
Wheeling-Warwood, W. Va.

Gentlemen:

Please mail us information regarding DEMCO RADIO SETS.

Jobber

Dealer

Name

Street and Number.....

City..... State.....

"OHIO VALLEY" RADIO CABINETS

*Have Exceptional Eye-Appeal in
Their Originality of Design!*

UPON the good appearance of the cabinet, depends half of the impression made by a Radio Receiver. It must harmonize with the finest home furnishings. It must be more than a "housing" for a radio set: it must be ornamental as well.

With this in mind our designers went to work, analyzing, comparing, perfecting, accepting, rejecting, until they succeeded in bringing forth true masterpieces of cabinet design. Practically every period that's popular is included in our regular line. Their finish is typical of DEMCO RADIO CABINETS . . . the only Radio Cabinets with a PIANO FINISH! The workmanship is comparable only to custom-made cabinets. Sturdily constructed to withstand continuous service. Finished for lasting BEAUTY! Yet, their prices are very moderate.

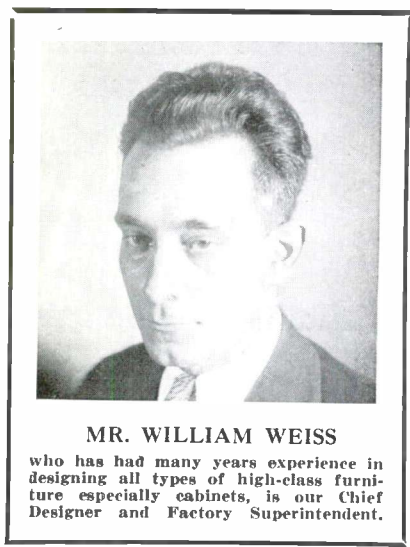

MR. WILLIAM WEISS
who has had many years experience in designing all types of high-class furniture especially cabinets, is our Chief Designer and Factory Superintendent.

THE improved Marquetry Inlays and the one-hundred per cent figures in the imported woods used for the front paneling, give an air of refinement which places DEMCO CABINETS in a class by themselves.

Maintaining an entire factory devoted solely to the manufacture of Cabinets gives us facilities not possessed by ordinary cabinet-makers. The Trade-Mark* under the lid of the Cabinet is the symbol of master craftsmen. Men who have devoted a lifetime in the perfection of designing fine furniture and cabinets.

Manufacturers interested in obtaining the best in Radio Cabinets, should consult Mr. Weiss, who will have personal supervision of our booth at the show, and arrange for personal interview. We make a specialty of making Radio Cabinets to the customers' specifications, even make special designs for their approval. Don't fail to consult Mr. Weiss.



*Look for this
Trade Mark**

* Whenever you see a beautiful Radio Cabinet and are tempted to look at it twice, nine times out of ten you will find this trade mark under the lid.

OHIO VALLEY CABINET CO.
A Subsidiary of the Demco Corporation
WHEELING-WARWOOD, W. VA.

Our display of Radio Cabinets will be a revelation to you. You will admire their exclusive features of design and their exceptionally high-class Piano Finish.

OHIO VALLEY CABINET CO.
Wheeling-Warwood, W. Va.

Gentlemen:

Please send us full particulars regarding your Radio Furniture.

Jobber Dealer Manufacturer

Name

Street and Number

City..... State.....



DOOLEY RECTIFIER CO.

A Subsidiary of DEMCO Corporation

Manufacturers of the Nationally Known **DEMCO** line of

RECTIFIERS

THESE rectifiers are manufactured under license granted by Major W. D. Dooley, and are made for any manufacturer for use in dynamic speaker fields, power packs, burglar alarm systems, telephone work, railway dispatching and signal systems and are unconditionally guaranteed against

replacement for the life of any transformer to which they are connected. Available in any amperage and voltage. Dooley Rectifiers are time-tested and proven entirely satisfactory, having been manufactured and sold and in actual operation for more than two years without a single replacement.

*Enduring as
the Rock of
Gibraltar*

◆

*Unfailing as
the Power
of Niagara*

For full details

consult our engineers in room 550-A or at our display booth number 41 located in the Stevens Hotel, Chicago, Ill.

DOOLEY RECTIFIER CO.
Wheeling (WARWOOD) W. Va.

DOOLEY RECTIFIER CO.
Warwood, W. Va.

Gentlemen:—
Please send us detailed information on your rectifiers.

Jobber Dealer Manufacturer

Name

Address

A NEW JEWELL 199 Set Analyzer

TESTS
SCREEN
GRID Sets



The rapid development of screen grid tubes and the marketing of screen grid receivers by large radio manufacturers demands a set analyzer for testing screen grid sets.

With the keen foresight which has characterized Jewell efforts in the radio service field, Jewell Engineers have already solved this problem. The New Jewell 199 Set Analyzer is equipped to test screen receivers.

Through a remarkable engineering achievement, this valuable feature has been added to the 199 without increasing the selling price. Today you can get a Jewell 199, equipped for testing screen grid receivers, at no extra cost.

THE New Jewell Pattern 199 Set Analyzer answers every requirement of accurate and rapid radio service. It is the same unit which has proved so popular with radio servicemen everywhere, plus the provision for testing screen grid sets.

Equip your servicemen today with Jewell 199's and let them pave the way to satisfied customers and profitable sales by making service calls on radio users. It is the most profitable way to utilize their spare time during the summer months, and is a sure road to accessory sales and leads to new set sales. Sold by radio jobbers everywhere.

MAIL THE COUPON

29 YEARS MAKING GOOD INSTRUMENTS
JEWELL
199 Set Analyzer



Jewell Electrical Instrument Company
1650 Walnut Street, Chicago, Illinois

Of course we want to make our radio servicing more effective. Send your book, "Instructions for Servicing Radio Receivers," and information about the New 199 Set Analyzer for testing screen grid sets.

Name _____

Address _____

THE LINE DESIGNED TO MAKE YOUR



FREED RADIO
gives you the program
JUST AS THE MICROPHONE
GETS IT



\$99.50
(less tubes)

MODEL NR-55
8-Tube NEUTRODYNE
for house-current operation.
Push-Pull amplification.
Inductor Dynamic Speaker.
Cabinet of Walnut veneer

THE FREED NR-55, shown here, by rights should never be listed as low as \$99.50. But we have a two-fold object in under-pricing this attractive model. We wish to interest those of your customers who hitherto have felt they could not afford a really fine radio. And we desire to provide you with a sensational "price leader" to be used to attract prospects to your store.

SELLING EASIER



\$172.50
(less tubes)

MODEL NR-79

8-Tube NEUTRODYNE for house-current operation. Push-Pull amplification. Four tuning condensers. Uses 245 type tubes for richness of overtone reproduction. Electro-Dynamic Speaker. Self-enclosed Highboy Console of Walnut veneer.

THE entire Freed Line is designed with an eye to meet the competition you will have this season.

In demonstrating any Freed Model to a prospect you can truthfully say:

"Here is a set which in those essential parts—chassis and speaker—represents all that Radio has to offer. Notice the absolutely lifelike tone, which gives you the program *just as the microphone gets it*. The beauty of the cabinet speaks for itself. And now that you have heard what Freed Radio can do, I have an agreeable surprise for you. If you are familiar with the prices of other good radios, you will realize that this Freed Model offers you value which has never before been available."

Freed Radio will convincingly substantiate your claims as to Freed performance. Freed prices furnish you with a most effective argument to clinch the sale.

There may be a Freed Dealer Franchise available in your territory. Write or wire us for information and an outline of our national advertising campaign and our comprehensive co-operative retail selling plan.

FREED-EISEMANN RADIO CORPORATION
122 East 42nd STREET, NEW YORK CITY

A Division of Chas. Freshman Co., Inc.

Canada: Freshman, Freed-Eisemann Radio, Ltd., 20 Trinity St., Toronto, Ont.

Prices slightly higher in Canada.



\$225
(less tubes)

MODEL NR-95

9-Tube NEUTRODYNE for house-current operation. De luxe model, embodying many exclusive features and using 245 type tubes. Push-Pull amplification. Electro-Dynamic Speaker. Remarkable selectivity is accomplished by a special Antenna Tuning Circuit. Magnificent Highboy Console of Walnut veneer.

\$145
(less tubes)

MODEL NR-78

8-Tube NEUTRODYNE for house-current operation. Push-Pull amplification. Four tuning condensers. Inductor Dynamic Speaker. Walnut veneer Console, with two-tone panels. Uses 245 type tubes.

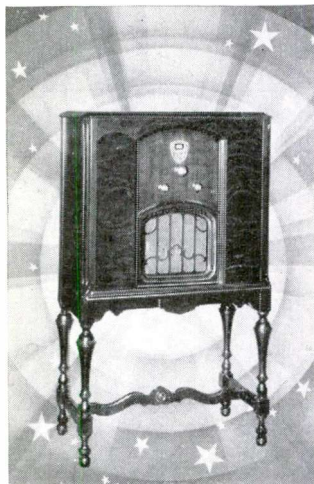

See Freed Radio
at the
Congress Hotel
during the
Chicago Trade Show
June 3 to 7, 1929

FREED RADIO

Famous Since Broadcasting Began



**“I am proud
to have these
new Audions
bear my name”**

Lee de Forest

de Forest



The tube sensation of the year. Perfected by De Forest Engineers for the new A. C. sets, these three 2½ volt "high vacuum" tubes will double your sales and cut service costs in half. In addition to marked superiority over tubes of similar characteristics, they have the refinements of all De Forest Audions—a vacuum, fifteen times greater than that of average tubes, oxide coated filaments, mica spaced elements, strong rugged construction and longer life.

De Forest Audions are backed by an aggres-

sive, far-reaching advertising campaign—broadcasting, billboards, newspapers, magazines, dealer helps. Every customer you have already knows about De Forest Audions. They will welcome the opportunity to secure these "high vacuum" tubes for their sets. Make your store headquarters for De Forest Audions. It is the biggest tube opportunity of the year for dealers.

DE FOREST RADIO COMPANY
JERSEY CITY, N. J.

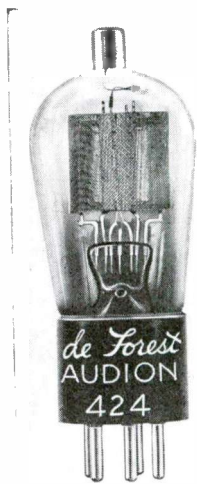

A humless Screen
Grid Tube
De Forest Audion
424

Screen Grid is the latest development of radio featured by many leading set manufacturers. With Screen Grid Audion 424 you are assured the best results these sets can produce. It amplifies 420 times. The "high vacuum" and sturdy construction add many hours to the life of this remarkable tube.



A humless
Heater Tube
De Forest Audion
427

The distinctive characteristic of this tube is humless reception with A. C. sets. It gives the purity of tone of a battery set. Another marked difference of Audion 427 is reduction of heating time to 10 to 15 seconds. Audion 427 is a distinct new design of -27 type tubes exclusive with De Forest.



A Power Tube
Audion
445

This remarkable tube makes a radio set a musical instrument. With this tube you amplify organ music, orchestras or choruses without a trace of blasting or distortion. Whether it is the roar of the crowd at a football game or the top notes of a Coloratura soprano, the tone value is preserved with life-like fidelity.

AUDIONS

"HIGH VACUUM" RADIO TUBES

*Important
Announcement*

**LASALLE RADIO
CORPORATION**

—has been granted a license
to manufacture and sell its

**LaSalle HIGH VACUUM
Radio Tubes**

under the Patents of

**RADIO CORPORATION OF AMERICA
GENERAL ELECTRIC
MANUFACTURING CO.,**

and the

**WESTINGHOUSE ELECTRIC
and MANUFACTURING CO.**

LaSalle Radio Corporation

(Division of Matchless Electric Co.)

1500 North Ogden Ave.

Chicago, Ill.

DUOVAC



DUOVAC RADIO TUBE CORPORATION'S NEW HOME · 75th X DOCK TRADE FACILITIES BUILDING · BROOKLYN · NEW YORK

An organization composed of Pioneers Radio Engineers and Executives whose products have achieved fame everywhere, occupies a new plant and presents DUOVAC, a NEW and better tube. DUOVACS are made in the world's FINEST equipped tube factory. Every detail is precisely performed by skilled operators in broad bright daylight with the aid of the newest automatic tube-making machinery.

DUOVAC RADIO TUBE CORPORATION, 350 FURMAN ST., BROOKLYN, N. Y.



introducing mr. Vox

Increasing production of Vox Radio Tubes now allows us to offer valuable dealer franchises in many parts of the country.

Backed by Munder, a name famous in the vacuum tube field for over thirty years, Vox Radio Tubes carry a quality and prestige which brings rapidly increasing popularity.

Exceptional performance, absolute guarantees, fewer replacements, and carefully planned advertising! What more could you wish?

Write for complete details of our franchise offer. Don't delay the introduction of Vox Tubes in your territory.

RADIO

VOX

TUBES

VOICE

Speak for themselves

Munder

ELECTRICAL CO., SPRINGFIELD, MASS.



JUST OPEN THE DOOR



AND TUNE IN

**Screen
Grid**

The **BAIRD**

**Covers the
Whole
Broadcast
Band**

Portaradio

—defeats that slow summer sales bugaboo

Every vacationist—the camper, the “seasider”, the “mountaineer”, the “week-ender”, those who have summer homes—more than these, too—every hospital ward, every office, every farm, *everyone* is a prospective purchaser of a good portable set.

And the Portaradio is just that, an

exceptionally efficient portable outfit, designed by H. S. Baird to meet a growing demand.

Now is the time for you to defeat the slow summer business “bugaboo”—the Portaradio can help you—just use the coupon for the special offer and sales literature.

All prices less equipment. Every Portaradio fully guaranteed.

Portable Division: SHORTWAVE & TELEVISION LABORATORY, Inc.
ORIGINAL MANUFACTURERS OF SINGLE DIAL SHIELD GRID PORTABLES.
104 BROOKLINE AVE. BOSTON, MASS.

Battery Model

\$60.00

D. C. All Electric

\$87.50

A.C. All Electric

\$97.50



A Portaradio
for every need.

COUPON

Please send me....Portaradio Portable (s).....Model at your special dealer's discount of 40% and 10%, also send sales literature.

Name

Address

Credit my jobber with the sale.

Jobber's Name

Address

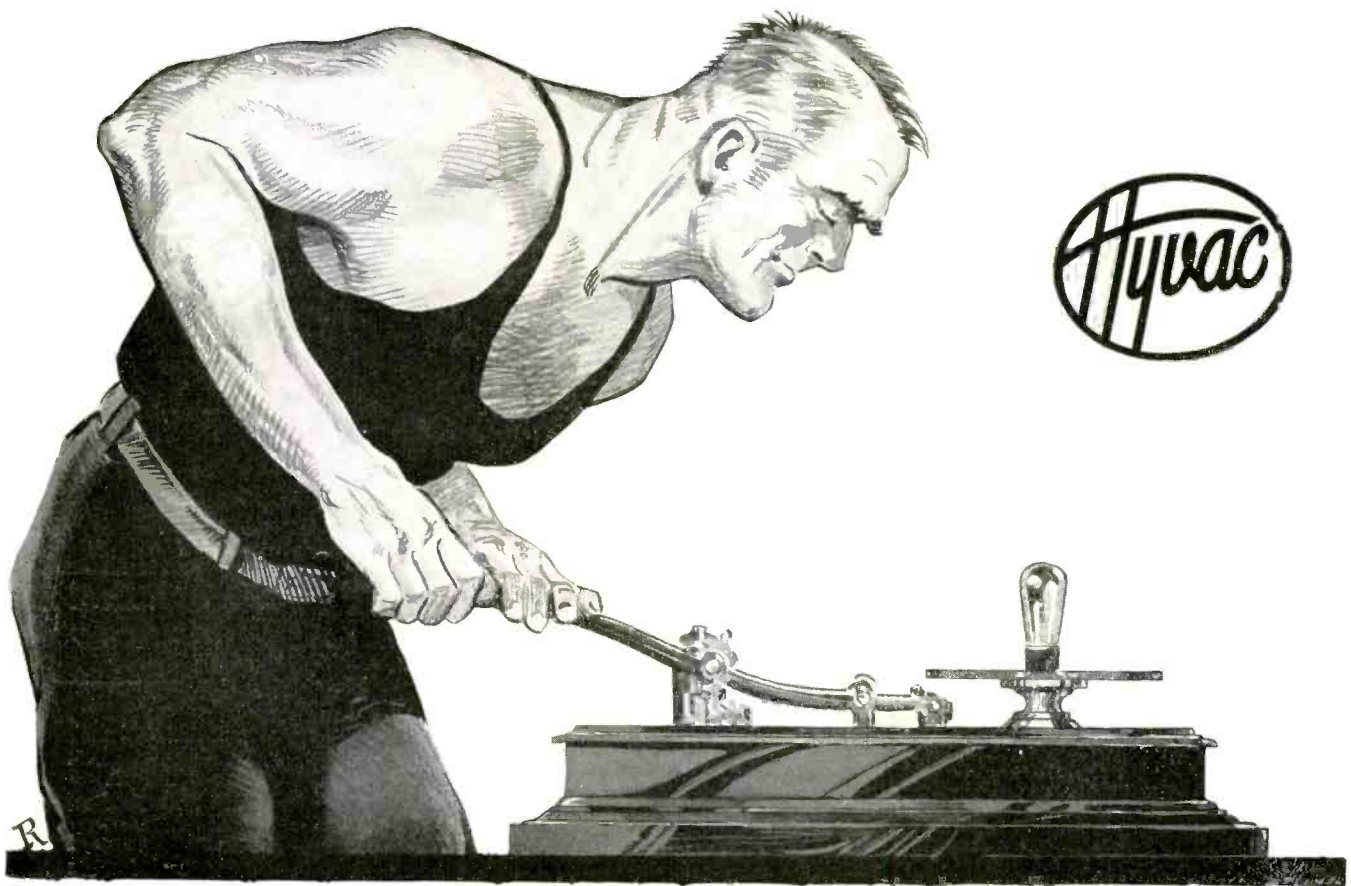

One of the earliest known methods of securing vacuum

HYVAC—the super-vacuum RADIO TUBE

TREMENDOUS strides have been made in the manner of creating vacuum since the primitive method illustrated above and to this progress the radio tube industry largely owes its present high standard of perfection.

However, the basic principle of tube efficiency, namely "the degree of high vacuum" obtained in a radio tube, remains the same. Modern methods and equipment, combined with the special Hyvac process of exhaust, have made it possible for Hyvac engineers to create radio tubes that set a new standard for crystal-clear reception, humless tone and long life.

To assure your customers the ultimate in radio reception, plus liberal profits for you, stock Hyvac Radio Tubes.

Distributors: Guaranteed exclusive distribution only. Write at once for full information on this outstanding tube proposition in the radio industry.

HYVAC RADIO TUBE CO.

Incorporated 1926

38 Spring Street

NEWARK, N. J.



How does \$500 a week clean profit strike you?

One Sale a Week Means Over
\$26,000 Profit a Year!

THIS opportunity now stares you in the face . . . for the Mills Automatic Phonograph has come to bring you an entirely new field of profit . . . to overcome forever summer slumps in sales!

The big selling season for this new musical instrument is now here, and we want the *livest* dealer in your community to handle our sales . . . to sell the most modern all-electric phonograph the world has ever known . . . a beautiful instrument of just the right size, one which needs no service, a coin-operated automatic equipped with *exclusive record selector*, and other important sales features!



Quick, easy selling, with a *margin of profit* which actually makes it worth your while . . . for right in your town there isn't a restaurant, confectionery, ice cream parlor or any store which attracts crowds, where there isn't actual need for the Mills Automatic Phonograph . . . it brings in customers, increases business 20% to 50%, and yields up to \$150 and more a month in direct *cash profits*!

You will quickly see how this demand means money in your pocket . . . so send *today* for our co-operative dealer plan, which includes factory sales help; a big national advertising program; financing of sales, if desired; and real profit-making discounts! Obey that impulse . . . **ACT NOW** . . . Mail the coupon!

WHY IT SELLS SO WELL

Libertyville, Illinois
"I've tried all makes of phonographs but yours is the **BEST OF THEM ALL**. I own a Mills—and I'm coining money at the rate of \$225 a month, while this instrument has increased my trade at least 50%. I've been a storekeeper for many years and this is the **BEST INVESTMENT I EVER MADE**."
(Gust Sigales.)

San Francisco, California
"The Mills Automatic Phonograph has increased my business 50%. Needless to say I am more than pleased with the results from this wonderful instrument. The quality of the music is too good for words. If you asked me, I would say this instrument plays the records even better than the artists would in person."
(Andy Mubell.)

Fayetteville, North Carolina
"Not only does this beautiful piece of furniture make my place look more attractive, but it has increased my business 50%. Needless to say I am more than pleased with the results from this wonderful instrument."
(Steve's Place.)

Mills Automatic Phonograph

World's Largest Makers
of Coin Operated
Products



MILLS NOVELTY COMPANY, 4100 FULLERTON AVE., CHICAGO, ILL.

MILLS NOVELTY CO., Dept. A-5
4100 Fullerton Ave., Chicago, Ill.
With no obligation to me, send at once big free 24-page book in colors, and full details of how to make these cash profits!

Name _____
Street _____
Town _____

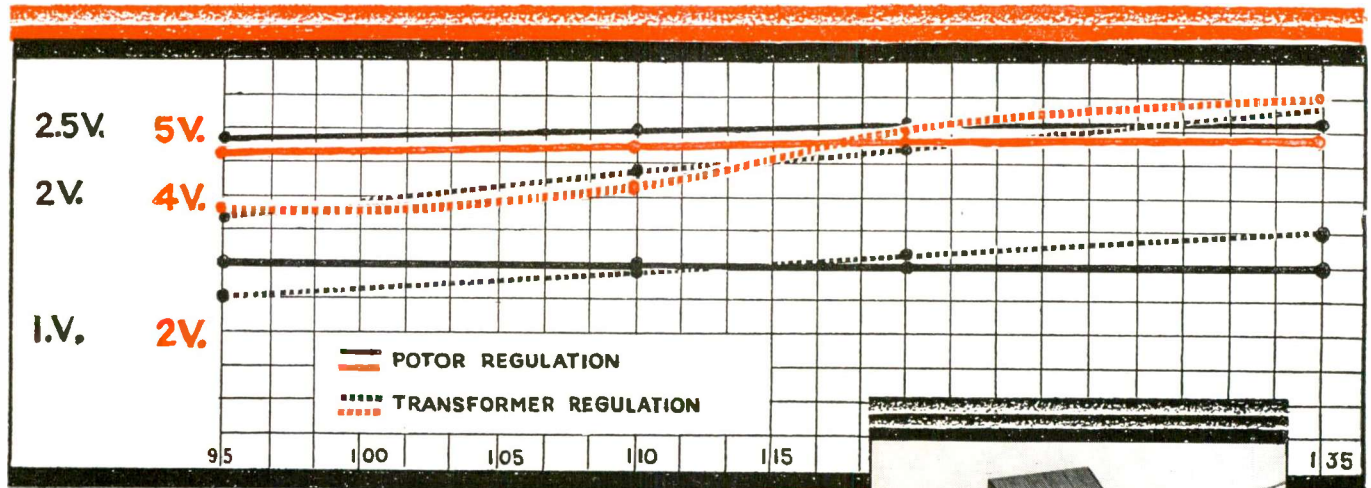

POTOR

A NEW A.C. VOLTAGE REGULATOR

POTOR (Ward Leonard AC Voltage Regulator) replaces, for the manufacturer, the power transformer in any radio receiver. It is made of wire, insulation, and steel—the same components used in transformer construction. POTOR is entirely magnetic in operation. There are, of course, no condensers, resistors, moving parts, or thermally operated units used in, or in connection with, its design.

Any desired degree of regulation may be obtained (manufacturing costs are higher for very close regulation), and POTOR may be designed for any primary voltage range, frequency, and to provide the necessary secondary voltages.

Once the design data has been



POTOR replaces the transformer in a radio receiver. Illustrated is a typical model.

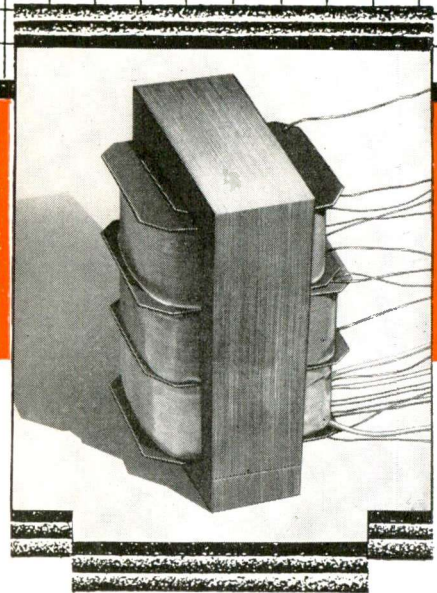

established, POTOR may be placed in production with no more difficulty than is associated with the manufacture of transformers.

Information on POTOR (Ward Leonard AC Voltage Regulator) will be sent upon request to the Chief Engineers and other executives of radio companies. If you have a specific regulator problem demanding immediate solution, please send us complete data, or preferably, plan to visit our plant yourself. We will show you POTOR in many applications, and discuss the manufacturing arrangements.

WARD LEONARD ELECTRIC CO.

MOUNT VERNON, N.Y.

FOUNDING A NEW KEYNOTE IN RADIO MERCHANDISING

Here is a
merchandising
statement
more important
than any
announcement
of model, hook-up
or set.
E.A. Brunel

REAL dealer success must come from a sound merchandising policy. Turn the page to learn how ACME builds dealer sales.



RADIO SALES ARE NOT COMPLETE UNTIL YOUR CUSTOMERS ARE SOLD

LOOK at your shelves—look to your stock room! How many old sets are you carrying that may never sell—or if sold, may mean a loss? No matter what's inside the set—it's not the machinery that sells radios—it's the *entertainment* that they deliver! And it's delivering entertainment that makes dealer profits that are worth while.

ACME has a new radio. A radio so different that it will still be modern long after it's sold, a radio that will never be a shelf-loafer. Tuning in this new ACME is like getting a free ticket to the world's best entertainment. And ACME'S policy is not to load the dealer with a lot of sets and hope to heaven that they sell. We'd rather have *you* satisfied that they'll sell before you stock them.

You've read a lot about new receiving sets. The RMA Trade Show will be full of them. But remember that the merchandising policy behind any radio is more important than illuminated dials or double-throw gadgets. May we send you the ACME plan today? We know you can profit through ACME Sales—make us prove it!

IT'S WHAT COMES OUT OF THE SET THAT COUNTS

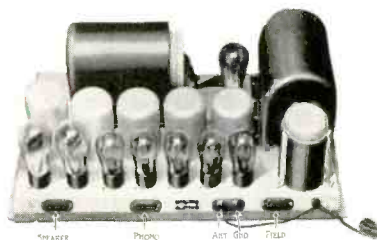

It is recognized that parts do not *sell* any radio receivers. The public wants to hear the tone—the volume—wants selectivity. The dealer wants profits. But quality is vitally necessary to build a permanently profitable business; and the new ACME'S uphold ACME leadership. For those who are interested in ACME engineering and electrical precision, the following details of the new ACME 88 chassis will be interesting. Most of these details are incorporated in the ACME 77 as well.

- Eight tubes including rectifier.
- Four gang condenser tuning four stages.
- One Dial volume control for both radio and phonograph.
- Built-in antenna.
- Single illuminated drum dial calibrated in Kilocycles and figures.
- Completely shielded parts.



THE



ELECTRIC & MFG. CO.

1440 Hamilton Ave.
Cleveland, Ohio

MEMBER RMA

ESTABLISHED 1917

The ACME ELECTRIC & MFG. CO.
1440 Hamilton Ave.
Cleveland, Ohio

Send me leaflet on the ACME Merchandising Plan and tell me more about the new ACME radios.

Name

Street

City

State

**THE
HIGHEST
PRICED**

Why?



Electric Turntable Unit

BECAUSE Bodine Turntable units are built UP to an unyielding standard of fine quality—not DOWN to a price.

Here are some exceptional features built into Bodine units:

- Bakelite gears (instead of fibre gears)
- Baked enamel finish (not sprayed lacquer)
- Double contact self-aligning governor brake (not single contact)
- Enclosed governor (no exposed parts)
- Ventilating fan on motor (no overheating)
- Double mounting plate with 4-point spring suspension (no noise)
- Ground shafts to .00025 in. tolerance, minus only (no bearing trouble)
- Running test of 24 hours for each unit (no service annoyance)
- Powerful motor (no delay in acceleration of turntable)

There are many other extraordinary features that will interest you.

Mail the Coupon for these details

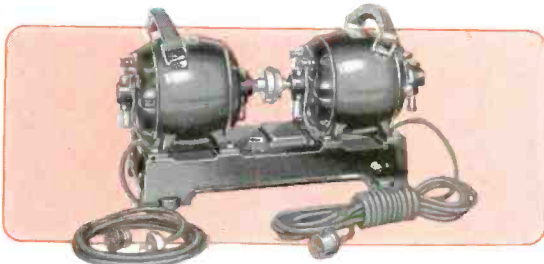

FOR DEMONSTRATING A. C. SETS

Bodine Model 1031 R Motor Generator Set is ideal for demonstrating A. C. sets and phonographs in D. C. districts. Two-unit construction eliminates hum. Produces 110-volt 60-cycle current. Units available for 110-115 volt or 32 volt D. C. Circuits. Built-in filter.



FOR TELEVISION OR THE TALKIES

Bodine Model AE Synchronous Motor from 1/20 to 1/4 H. P. for television experimental work or driving motion picture projectors and mechanical turntables synchronously for talking pictures. Speed absolutely constant at 1800 R. P. M.

BODINE

SMALL-MOTOR SPECIALISTS FOR 24 YEARS

BODINE ELECTRIC CO.
2242 W. Ohio Street, Chicago

Please send us information and prices on items checked below.

- Bodine RC-10 Electric Turntable Unit
- Bodine 1031 R Motor Generator Set
- Bodine Synchronous Motor

Name.....

Address.....

Buckingham

Stood The Test Last Year!

...but it's Better Than Ever Now!



RADIO buyers know of the satisfying record of dependable performance achieved by last season's Buckingham Chassis.

Now—at the threshold of another radio year, we announce the new 1930 Chassis that will meet the requirements of an even more critical radio public.

The latest and best in modern radio design, skillful assembling of the finest radio parts, painstaking and continuous testing . . . all of these outstanding factors guarantee the satisfactory performance of the new *Buckingham RCA Licensed Receiver*.

8 TUBE
Push-Pull
All Electric

LIST PRICE
\$69⁵⁰
 LESS TUBES
 IN METAL CABINET

R.C.A. Licensed Chassis

TONE QUALITY—The tone quality is unsurpassed due to two reasons. First: the use of specially designed audio transformers of extremely large size. Second: the use of two power tubes in push-pull arrangement in the last audio stage.

VOLUME—Use of two power tubes in **PUSH-PULL**, operated at full efficiency, coupled to radio frequency unit of good sensitivity, assures more than required volume of sound for every purpose.

SELECTIVITY—Twelve kilocycle selectivity is guaranteed and is obtained by the use of scientifically **COPPER** shielded radio frequency units, a **FOUR-SECTION GANG CONDENSER**, and a separately controlled trimmer, tuning arrangement in the antenna circuit.

SENSITIVITY—Each Model 80 Buckingham receiver must pass a sensitivity measurement of 50 micro volts per meter. This sensitivity level has been standardized upon as that required for one hundred per cent satisfaction for all broadcast purposes.

TUBES—The following tubes are used: One Type UX-280 (rectifier), one Type UY-227 (detector), four Type UX-226 (radio frequency and audio), two Type UX-171-A (power tubes).

GENERAL—Adjustable center tapped resistances for control of AC hum. All metal parts cadmium plated. All wiring completely shielded.

SIZES OF CHASSIS—17½ inches long, 11 inches deep, 6¾ inches high. Weight 35 pounds.

POWER SUPPLY—Designed to operate on line supply of 110-120 volts, 50-60 cycle, alternating current.

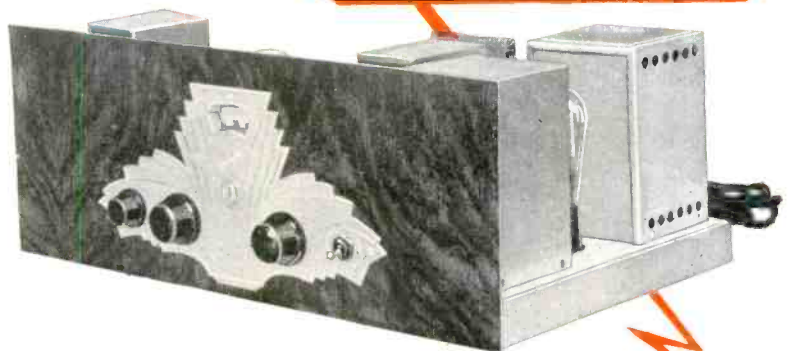
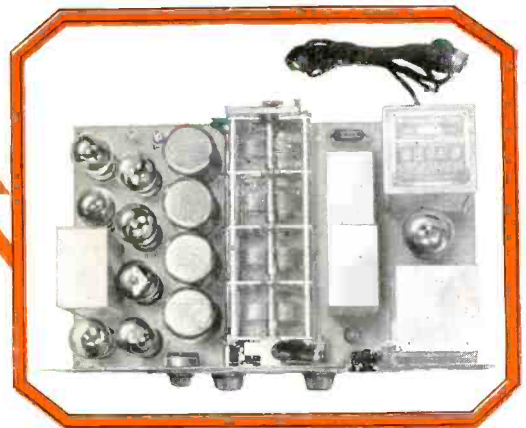

BUCKINGHAM RADIO CORPORATION
 440 West Superior St. Chicago, Illinois



Jobbers! Select Your OWN Exclusive Line of **AC Dynamic Electric Radios** Over 20 Buckingham Cabinet Models to choose from. . . .

THESE four cabinets are typical of the beauty of our exclusive line. They offer jobbers an opportunity to individualize their radios with the aid of Buckingham products.

The cabinets we have selected were designed exclusively for Buckingham Chassis, Dynamic Speakers and Electric Phono-trope Units by some of America's prominent cabinet factories.

The low list prices of Buckingham products, together with our attractive discounts, present a most unusual money-making opportunity to radio distributors and dealers.

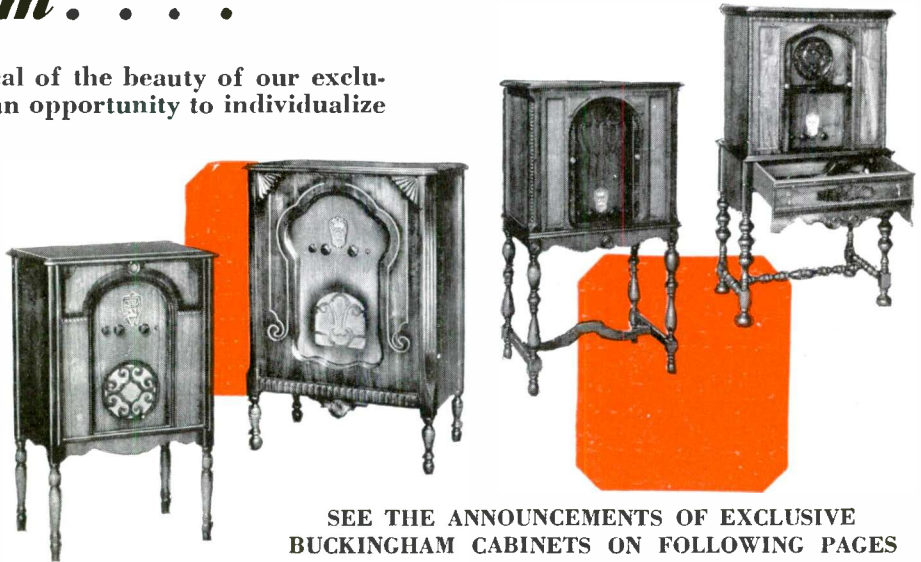

SEE THE ANNOUNCEMENTS OF EXCLUSIVE BUCKINGHAM CABINETS ON FOLLOWING PAGES

Super Electric **DYNAMIC** Speaker

Built for and Sold only with the **BUCKINGHAM CHASSIS**
List Price, \$30 including rectifier tube

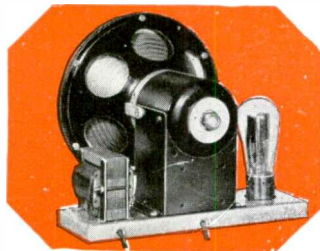

Buckingham Model 80 A. C. Dynamic Speaker overcomes the objectionable hum found in ordinary Dynamic Speakers. It is manufactured exclusively for the new Buckingham Chassis with which it is so perfectly coordinated that it gives practically double the volume of other dynamic speakers.

It is equipped with a UX-280 type Rectifier Tube, Transformer and Special Filter and the entire unit is mounted on a neat, cadmium plated steel base. Easily, quickly installed.

Its fidelity of reproduction and extraordinary volume, without a bit of hum, insures 100 per cent efficient operation of this marvelous Dynamic Speaker.

P HONOTROPE

Makes a Radio-Phonograph combination out of any radio set

A complete unit including the famous Buckingham Electric Pick-up, Electric Motor, tone arm, turn-table, automatic stop and accessories, all enclosed in a beautiful, compact walnut case which can be placed on top of any radio cabinet. Easily and quickly connected. The Phono-trope is also furnished without case. Completely mounted and ready to slide into space provided in many Buckingham cabinet models.



LIST PRICES
In Cabinet . . . \$69.50
Without Cabinet . . . 60.00



See the **BUCKINGHAM EXHIBIT** at the **R. M. A. Radio SHOW** Stevens Hotel Exhibition Hall
Demonstrating Rooms 1205-A-1206-A

BUCKINGHAM RADIO CORPORATION
440 West Superior St. Chicago, Illinois



Sell Your Own Exclusive Radios

Buckingham Recommends These Fine Radio Cabinets



The Buckingham Chassis.
RCA Licensed.
8 Tube Push-Pull AC Electric.

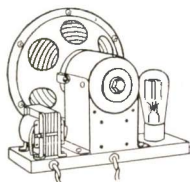

Model 80 Buckingham Electric Dynamic Speaker.
It's free from hum.



The Buckingham Electric Phonotrope.
Makes a radio phonograph combination of any radio set.

BUCKINGHAM RADIOS

Look Right
Perform Right
and are
Priced Right.
That's Why
They Sell!



Radio buyers select their cabinets as thoughtfully as they select their radio sets. Lovers of fine furniture will appreciate these distinctively modern designs. Note the specifications under illustrations.

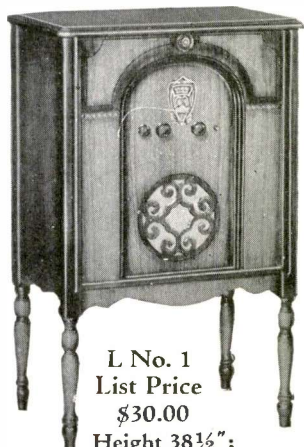

L No. 1
List Price \$30.00
Height 38½"; Width 24"; Depth 15".
Genuine walnut top, front panel and apron.

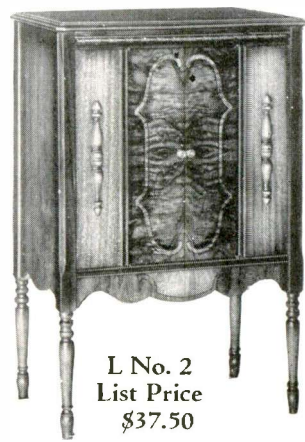

L No. 2
List Price \$37.50
Height 40½"; Width 27½"; Depth 16½".
Genuine walnut top, sides and apron. Butt walnut French doors with high light routed panel effect.



L No. 3
List Price \$50.00
Height 50½"; Width 27½"; Depth 16½".
Genuine walnut top, front, sides, end panels and apron. Sliding doors of oriental walnut, V matched; Hungarian ash overlays on side panels and doors. Carved mouldings on legs and top rail.



L No. 4
List Price \$60.00
Height 52½"; Width 27½"; Depth 16½".
Genuine walnut plywood top, side and front panel. French doors of V shape Betula woods with Zebra wood overlays on side panels and center of apron. With carved mouldings.

See These Cabinets at the R. M. A. Radio Show STEVENS HOTEL Buckingham Exhibit Exhibition Hall BOOTH 93 DEMONSTRATING ROOMS 1205A - 1206A

J.A. Lund Corporation
Cabinets by a Cabinet Maker

1018 S. Wabash Avenue
Chicago, Ill.

Sell Your Own Exclusive Radios

Buckingham Recommends These Fine Radio Cabinets

Beauty of design plus low price are embodied in these truly modern radio console cabinets. Be sure to include them in your line of Buckingham Radios.



E No. 2
List Price
\$30.75

Width 26 3/4"; Height 38 1/2";
Depth 17 1/4".
Genuine walnut front and top
with butt walnut overlays.

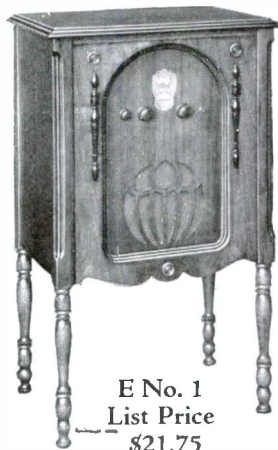

E No. 1
List Price
\$21.75

Width 22 1/2"; Height 39";
Depth 16".
Genuine walnut top
and front.



E No. 4—List Price \$53.75
Width 28 1/2"; Height 52 1/2";
Depth 17".

Genuine walnut top and sides. Front
panels all butt walnut.

E No. 5 — Combination
List Price \$58.25

Same as E No. 4, with pull drawer for
Phonotrope Unit, as illustrated.

See
These Cabinets
at the
R. M. A. Radio Show
STEVENS HOTEL
Buckingham Exhibit
Exhibition Hall
BOOTH 93
▼
DEMONSTRATING
ROOMS 1205A - 1206A

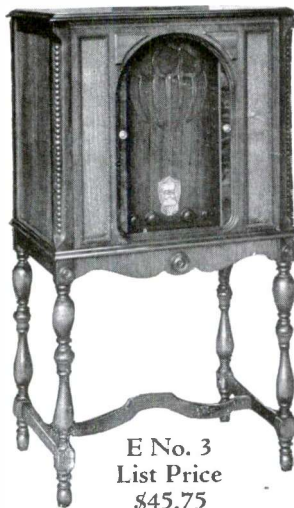

E No. 3
List Price
\$45.75

Width 27"; Height 49";
Depth 18 1/2".
Genuine walnut front, top and
sides. Butt walnut sliding doors
and panel.

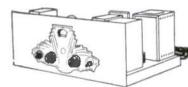

The Buckingham
Chassis.
RCA Licensed.
8 Tube Push-Pull
AC Electric.

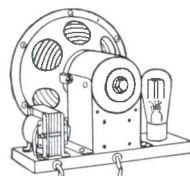

Model 80
Buckingham.
Electric Dynamic
Speaker.
It's free from hum.



The Buckingham
Electric Phonotrope.
Makes a radio phono-
graph combination of
any radio set.

**BUCKINGHAM
RADIOS**
Look Right
Perform Right
and are
Priced Right.
*That's Why
They Sell!*



EXCEL PHONOGRAPH MFG. CO.
Phonographs and Radio Cabinets

400-412 West Erie Street

Chicago, Illinois

Sell Your Own Exclusive Radios

Buckingham Recommends These Fine Radio Cabinets



The Buckingham Chassis.
RCA Licensed.
8 Tube Push-Pull
AC Elect. ic.

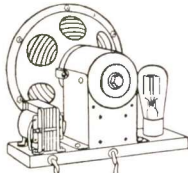

Model 80
Buckingham.
Electric Dynamic
Speaker.
It's free from hum.

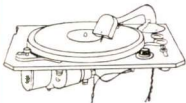

The Buckingham Electric Phonotrope.
Makes a radio phono-graph combination of any radio set.

BUCKINGHAM RADIOS

Look Right
Perform Right
and are
Priced Right.
That's Why
They Sell!



A good radio set is worthy of a good cabinet. These models, designed for Buckingham, will satisfy the most discriminating purchasers. Conform with the newest styles in radio consoles. Each is described in detail.



PR No. 1
List Price
\$21.00
Width 24"; Depth 14½";
Height 37".
Walnut finished.



PR No. 2
List Price
\$32.75
Width 27"; Depth 16";
Height 39".
Genuine walnut front and top.
Genuine walnut front carvings.

See
These Cabinets
at the
R. M. A. Radio Show
STEVENS HOTEL
Buckingham Exhibit
Exhibition Hall
BOOTH 95
▼
DEMONSTRATING
ROOMS 1205A-1206A

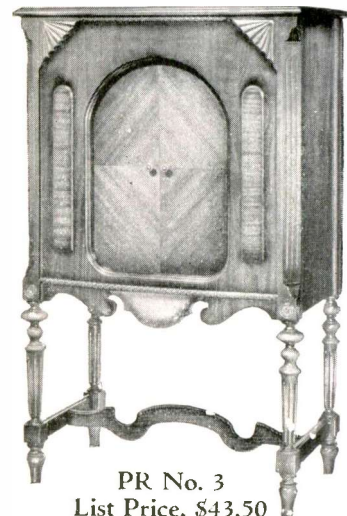

PR No. 3
List Price, \$43.50
Width 28"; Depth 16½";
Height 46".
Genuine walnut plywood front, top,
sides. Diamond matched sliding doors.
Mahogany and satinwood overlays.
Genuine walnut front carvings.

PR No. 4—List Price \$49.25
(Combination)
Width 28"; Depth 20";
Height 49".

This is same as PR No. 3 but in larger dimensions, and is adaptable for phonotrope unit.

We manufacture a complete line of Consoles for Atwater-Kent, Fada, Spartan, Crosley and all other standard receivers



Scott-Rubin Co.,

600-626 West 22nd Street, CHICAGO

Sell Your Own Exclusive Radios

Buckingham Recommends These Fine Radio Cabinets

Thoughtful designing created these new consoles. When offered in conjunction with Buckingham products, sales are more easily made. The specifications under each model speak for its high quality.

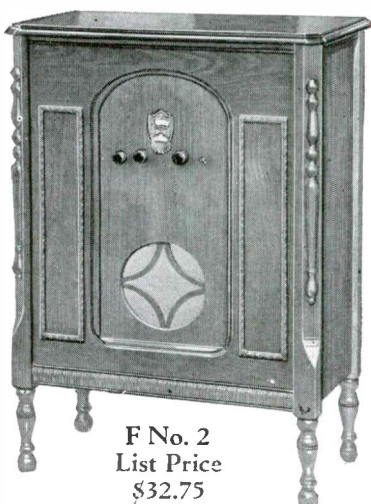

F No. 2
List Price
\$32.75

Height 39"; Width 27½";
Depth 16".

Genuine walnut 5 plywood front
and top and panels.

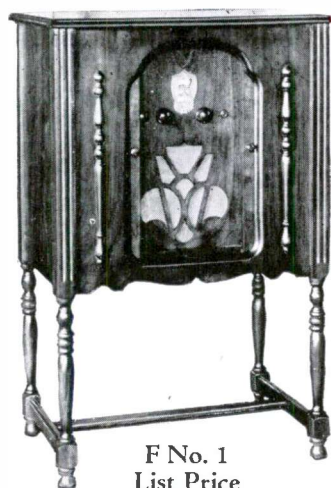

F No. 1
List Price
\$32.25

Height 42"; Width 27";
Depth 17".

Genuine walnut 5 plywood front and
top. Walnut plywood sliding doors.



F No. 4
List Price
\$67.00

Height 43½"; Width 27";
Depth 17".

Genuine walnut 5 plywood top,
front and sides, and sliding
doors. Satinwood overlays.

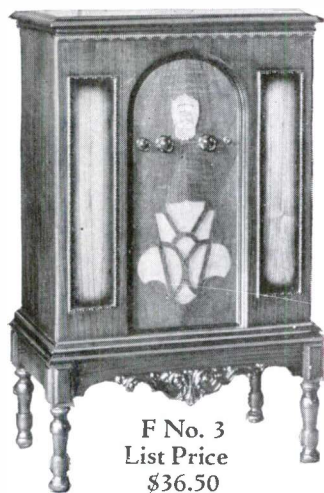

F No. 3
List Price
\$36.50

Height 40½"; Width 24";
Depth 15½".

Genuine walnut 5 plywood top, front
and sides.

See
These Cabinets
at the
R. M. A. Radio Show
STEVENS HOTEL
Buckingham Exhibit
Exhibition Hall
BOOTH 85
▼
DEMONSTRATING
ROOMS 1205A - 1206A

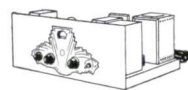

The Buckingham
Chassis.
RCA Licensed.
8 Tube Push-Pull
AC Electric.

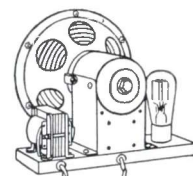

Model 80
Buckingham.
Electric Dynamic
Speaker.
It's free from hum.



The Buckingham
Electric Phonotrope.
Makes a radio phono-
graph combination of
any radio set.

BUCKINGHAM RADIOS

Look Right
Perform Right
and are
Priced Right.
*That's Why
They Sell!*



"Built by Fischer"

THE FISCHER FURNITURE COMPANY

416 North May Street, CHICAGO, ILL.

Sell Your Own Exclusive Radios

Buckingham Recommends These Fine Radio Cabinets



The Buckingham Chassis.
RCA Licensed.
8 Tube Push-Pull
AC Electric.

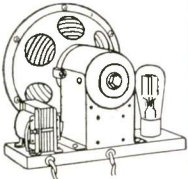

Model 80
Buckingham.
Electric Dynamic
Speaker.
It's free from hum.



The Buckingham
Electric Phonotrope.
Makes a radio phonograph
combination of
any radio set.

**BUCKINGHAM
RADIOS**

Look Right
Perform Right
and are
Priced Right.
*That's Why
They Sell!*



Let your customers' first impression help you make sales. The newest in radio cabinets suggest the newest in radio. These models are right up to the minute in design, finish and all-around high quality.

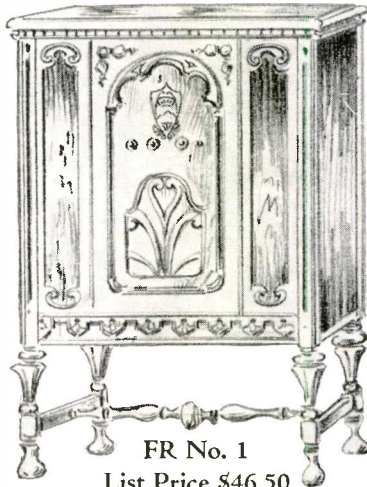

FR No. 1
List Price \$46.50
Width 25"; Depth 15"; Height 45"
Genuine walnut top and front.
Selected butt walnut overlays.

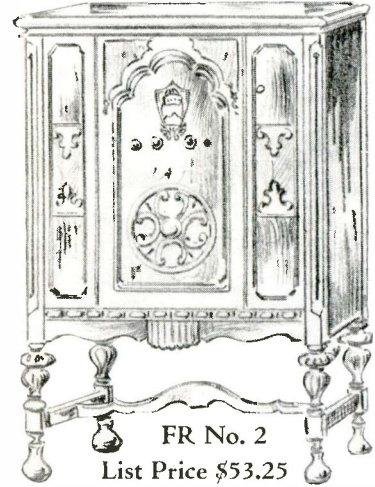

FR No. 2
List Price \$53.25
Width 25"; Depth 15"; Height 45"
Genuine walnut top and front.
Butt walnut sliding doors. Se-
lected butt walnut overlays.

**See
These Cabinets**
at the
R. M. A. Radio Show
STEVENS HOTEL
Buckingham Exhibit
Exhibition Hall
BOOTH 93
▼
DEMONSTRATING
ROOMS 1205A - 1206A

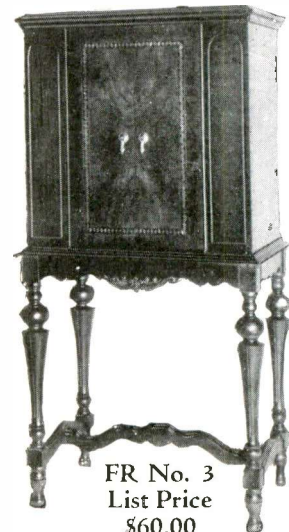

FR No. 3
List Price \$60.00
Width 25"; Depth 15";
Height 50"
Genuine butt walnut
front with walnut top
and sides. Antique ma-
hogany front panels . . .
marquetry inlays.

J. D. Freese & Sons Co.

*Designers and Manufacturers of
Distinctive Furniture*

2501 Homer St., Chicago, Ill.

Sell Your Own Exclusive Radios

Buckingham recommends

EXCELLO Radio Consoles



Model R 61

MODEL R 61 (EX 1)—A gorgeously rich cabinet of impressive proportions and dignity. Framing, legs and rails of selected American walnut with oriental walnut front. Smartly trimmed with balanced Japan ash overlays. Matched butt walnut sliding doors—beautiful imported marquetrie border. Accommodates any standard receiver. Dimensions: Height, 56 inches; width, 31 inches; depth, 18½ inches. List price, \$125.00.

MODEL R 53 (EX 2)—A quality walnut cabinet with selected matched butt walnut doors and inset panels of madrone burl. Dimensions: Height, 50 inches; width, 30 inches; depth, 19½ inches. List price, \$80.00.

MODEL R 54 (EX 2C)—Same as above but with hinged top and plain motor board for phonograph combination. List price, \$85.00.

THEY attract and satisfy the ever increasing number of discriminating buyers who demand Radio Consoles of *beauty, quality and refinement* in design, material and craftsmanship.

Excello Consoles will not only prove a popular and profitable line, but also give you a better conception of values in Radio Furniture.

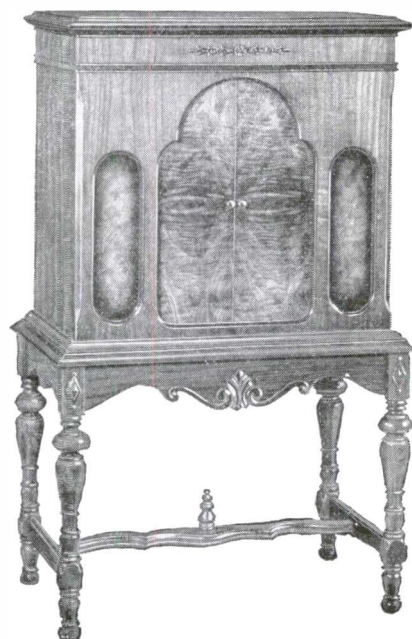

Model R 54

MODEL R 63 (EX 3)—Graceful in appearance, authentic in design. Walnut veneer panels; birdseye maple overlay; butt walnut sliding doors. Dimensions: Height, 50 inches; width, 28½ inches; depth, 18½ inches. List price, \$60.00.

MODEL R 64 (EX 3C)—Same as above but with top hinged and plain motor board for phonograph combination. List price, \$65.00.

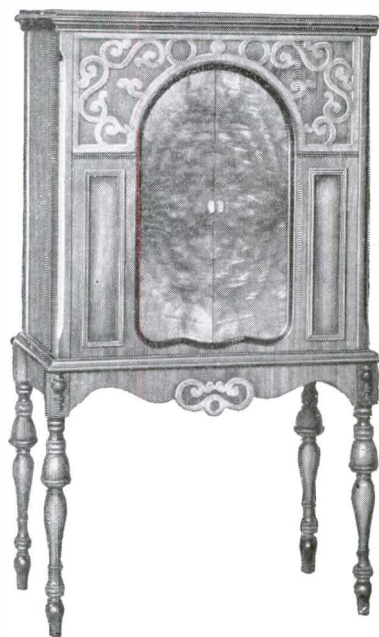

Model R 63

Write for catalog illustrating and describing complete line of Consoles accommodating Atwater Kent, Fada, Sparton, Crosley, and all other standard receivers.

EXCELLO Radio Consoles

**EXCELLO PRODUCTS
CORPORATION**

4834 W. 16th St., Cicero, Ill.

**See
These Cabinets**

at the
R. M. A. Radio Show
STEVENS HOTEL
Buckingham Exhibit
Exhibition Hall
BOOTH 95

▼
DEMONSTRATING
ROOMS 1205A-1206A

NEW...NOW

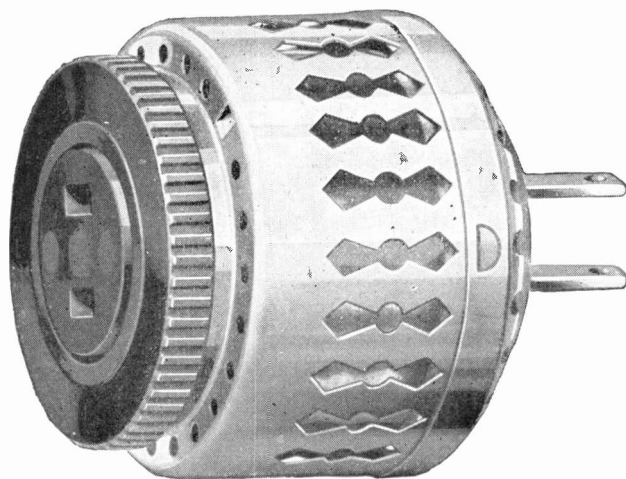

The New No. 211-B

WIRT VOLTAGE REGULATOR for 150 Watts

Following its policy of supplying the radio trade with a complete line of inexpensive, automatic voltage regulators, the Wirt Company now offers the new No.211-B. This variable regulator is built to fully protect radio sets that are equipped with dynamic speakers, sets having 7 or more tubes, and sets consuming up to 150 watts.

The nationally advertised Wirt Voltage Regulators, both No. 211-B and the smaller No. 211, perform a real service to A. C. radio owners. By giving variable, automatic regulation, they keep out current surges and line overloads. They add to the life of each tube. They cut down line noises to a minimum. And they are priced right—211 sells for \$2.25, 211-B sells for \$3.25. Both are fully guaranteed! Big sellers all through the summer.

Any jobber's salesman will take your order—or fill in and mail the coupon below. We'll bill through any jobber you name.

WIRT COMPANY

You've heard of Dim-a-lite and you'll hear of it again. Women like the easy way that Dim-a-lite changes the light from any bulb to just the intensity desired. It's cooler in summer to have lowered lights—and much easier on children's eyes. Dim-a-lites give the modern, smart lighting control. Your customers need at least one in nearly every room. Two sizes—No. 23 (for 25-40 watt bulbs), list \$1.00—No. 23-A (for 50-60 watt bulbs), \$1.25. Usual discounts. Use the coupon for ordering a supply today!



DIM-A-LITE

WIRT COMPANY, 5221 Greene St., Philadelphia, Pennsylvania
Please ship me by return mail: R. R. 6-29

.....display cartons of 10 Voltage Regulators, No. 211-B
display cartons of 10 Voltage Regulators, No. 211
display cards of 10 No. 23 Dim-a-lites
display cartons of 10 No. 23-A Dim-a-lites
display cartons of 10 Wirt Lightning Arresters

Bill through.....(jobber)

Name.....

Address.....

SHELBY

presents perfected screen-grid radio!

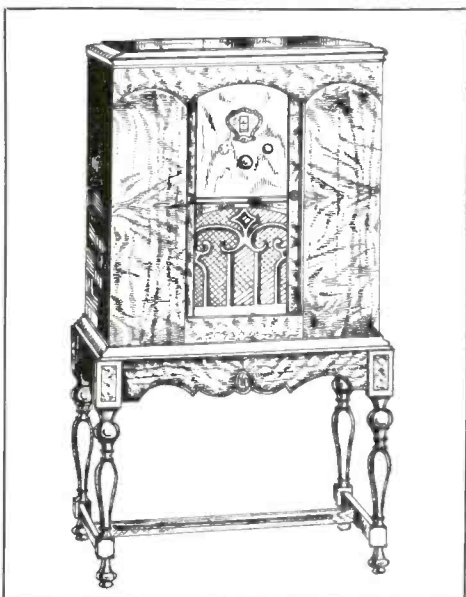

MODEL H-32	Models H-32 and H-42 use same high-boy cabinet. Priced complete with tubes.	MODEL H-42
PRICE \$239.50	Size of cabinet 48-in. high, 27-in. wide, 15-in. deep.	PRICE \$219.50

Model H-32, sensational in performance—away from the beaten track in engineering, with a newly discovered principle of tuned circuits, and with new straight-line non-distorting power detector action, this set with 4 screen-grid tubes and two No. 45 power tubes in push-pull, is an instrument destined to top the market.

Housed in a sliding door cabinet of finely matched butt walnut veneers with built-in dynamic speaker.

There are two fitting companions to Model H-32 also embodying brand new circuit arrangements . . . Model H-42 and Model 52, both using standard No. 27 type tubes with push-pull power output and power detector, Dynamic speakers, of course, and housed in rich cabinets of the accepted mode.

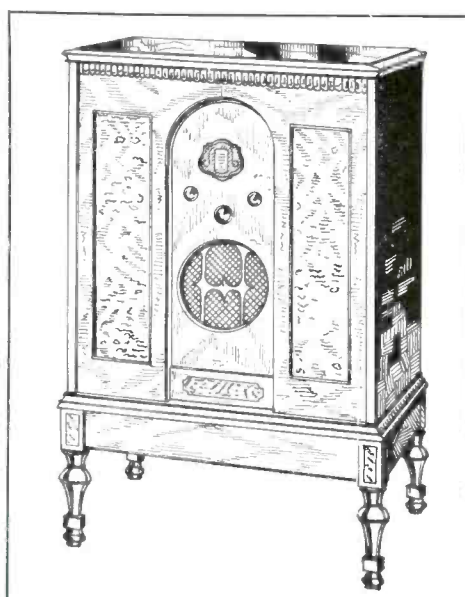

MODEL 52	This attractive low-boy of accepted design, in matched burl walnut, 40-in. high, 25-in. wide, 14-in. deep. Priced complete with tubes.
PRICE \$179.50	

All Shelby receivers are shipped complete with tubes in sockets and may be tested without removal from cases . . . another unique Shelby feature.

There is real profit and protection in the Shelby franchise, backed by national advertising. Progressive distributors and dealers will like the completely formulated, closely cooperative Shelby merchandising program. Let us tell you about it now.



SHELBY RADIO

The Shelby Company

TRENTON, N. J.

GULBRANSEN *Nine*

Completely made by Gulbransen

THIS year's Radio Show will reveal the new Gulbransen screen-grid Nine-in-Line Radio of challenging performance and outstanding sales appeal.

Backed by a \$5,000,000 company, with 500,000 square feet of unsurpassed manufacturing facilities. An outstanding organization. Twenty-three years of fair play to dealers and public.

Matching the screen-grid performance are cabinets designed and executed by piano craftsmen. "245" tubes in push-pull. 10-inch dynamic speaker operated through extra high quality audio system. So sensitive that distant reception is limited only by static. Exceptional freedom from background disturbance on ordinary reception through unique dual-range switch. Advanced double primary circuit gives equal efficiency on high waves and low. Phono-radio switch, operated by the same knob as



*Licensed under
R. C. A., Hazeltine
and Miessner patents*

the a. c. switch (patent applied for) instantly converts Gulbransen Nine-in-Line into a high power electric phonograph amplifier for use with electromagnetic pick-up, which is permanently plugged in, without adaptors or other makeshifts.

Competitively priced! Prices withheld for announcement until the Radio Show.

Through purchase of Wells-Gardner & Co., we obtain R. C. A., Hazeltine and Miessner licenses and offer patent position and radio experience second to none. So well made is Nine-in-Line that profiteering service costs have been reduced to relative insignificance.

Few propositions in the music industry have made

SCREEN GRID *in line*

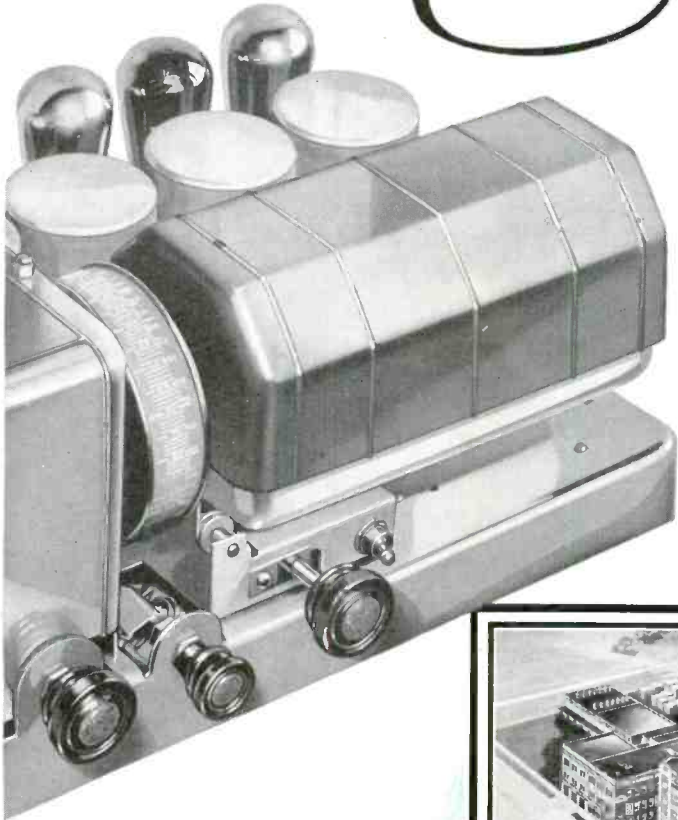

*A Challenge
to the Radio
Industry*



500,000 square feet of daylight manufacturing space.
Modern equipment. Experienced workers

and are making as much money for merchants as Gulbransen pianos. Watch dealers repeat with Gulbransen Radio!

Get set to sell Gulbransen. Our program means volume sales. Descriptive literature ready now.

Welcome to our displays—445A Stevens Hotel; M-9 Drake Hotel or at the factory, 3232 Chicago Avenue.

DEALERS! Be first to get information on Gulbransen Screen-Grid Radio and money-making dealer franchise.

DISTRIBUTORS! Unique proposition ready now. Ask for details.

WRITE OR WIRE

Gulbransen Company, Chicago
Please forward immediately full information on Gulbransen Radio.

Indicate whether you are retailer or jobber.

Retailer Jobber

Firm Name.....

Individual.....

Street Address.....

City and State.....

GULBRANSEN COMPANY, Chicago, Kedzie, Sawyer and Spaulding Avenues, CHICAGO
World's Largest Piano Manufacturers

SCREEN-GRID RADIO • RADIO CABINETS • METAL PRODUCTS

Readrite

RADIO INSTRUMENTS

Are now offered in over one hundred different items: Set Analyzers, Tube Checkers, Special Adapters, Ammeters, Voltmeters, Milliammeters, etc.

An item for every need.

SPECIAL ADAPTERS FOR TESTING ANY TUBE IN ANY SOCKET

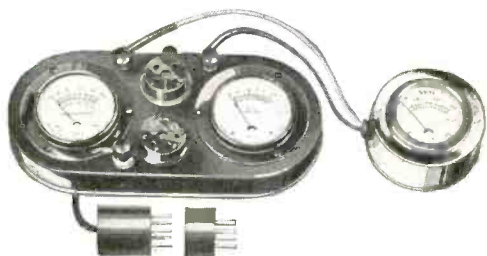

NO. 215 UNIVERSAL SET TESTER

List Price \$17

Operates equally well on A. C. or D. C. circuits. Largest selling radio set tester. Used and endorsed by thousands of service men. Simple and practical.

READRITE MODEL 15 SET ANALYZER & SERVICE KIT

List Price \$35 Complete

An ideal outfit for servicing. Embodies new and valuable features. Complete in every detail. Equally suitable for A. C. or D. C. sets or tubes. Equipped with regular adapters, and new adapters for testing screen grid and Kellogg tubes, as well as special switch adapter for full wave rectifying tubes.

Instrument ranges: DC volts 0-60, 0-300 and 0-600; AC volts 0-10 and 0-140; milliamperes 0-20 and 0-100. Compartments for grid leaks and findings. Space for soldering iron, tools and extra tubes. Everything at your finger tips. Nothing else to carry. Size closed 7 x 7½ x 14 inches. Order now and free your mind of the servicing problem.

READRITE METER WORKS
6 COLLEGE AVE. BLUFFTON, OHIO

25TH ANNIVERSARY

An Expression of Gratitude

A QUARTER of a century is a fitting period for an organization to take stock of itself. Happily, the Readrite Meter Works finds itself after this interval in a very augmented position, both in its facilities for production and in its standing with the users of its product.

With a trained personnel, housed in one of the most modern plants of its kind, with the finest tool room and production equipment, and independently financed, Readrite is in a position to make its product even better than in the past and at the lowest unit cost.

The Company wishes to acknowledge its indebtedness to its loyal friends, whose goodwill alone has made this possible; and to express its firm determination to step onward, with their assistance, to new heights and a larger field of usefulness.

Readrite



ELECTRAMUSE

OFFERS RADIO DEALERS
A NEW MARKET
AND PROFIT
That's WORTH GOING AFTER



Confectioneries



Dance Halls



Parks



Barbecues



Restaurants



Lunch Rooms



Drug Stores



Cafes



When you
are in
CHICAGO

Visit our Display — HEAR the Electramuse — have it demonstrated.

Suite 900
State-Lake
Building
190 N. State St.

Makes a Big Hit with Merchants in All Lines —Easy to Sell—Unlimited Prospects

ONCE IN A GREAT WHILE, dealers are given a real opportunity to branch out and lay the foundation for a more profitable business.

ELECTRAMUSE offers that opportunity now. A proven product—in use from coast to coast—nationally advertised to the trade—and past the pioneering stage. The market has been established—there is big business waiting in large cities—small towns and along the highways. ELECTRAMUSE the fastest-selling, coin-controlled, musical instrument is automatic—plays all makes of records—superb in tone—the music makes a hit. Merchants in all lines—restaurants—cafes—drug stores—lunch rooms—parks—hotels—recreation parlors are buying ELECTRAMUSE—it increases their business—attracts new trade—earnings average \$2 to \$7 per day. This makes it easy to sell.

**RETURN
the
COUPON**

Let us tell you how the other dealers are prospering with ELECTRAMUSE.

It will pay you to investigate.

Attractive Discounts that Make Real Profits Possible!

For 30 years Holcomb & Hoke Mfg. Co. have been manufacturing money-making equipment. ELECTRAMUSE is destined to be their greatest achievement. The same money-making possibilities that are offered merchants are now offered dealers. Discounts are large enough to make ELECTRAMUSE an impor-

tant part of your business and leave a profit after every sale. Direct selling methods can be adapted to ELECTRAMUSE with amazing results—eliminates house to house canvassing—gives the men an opportunity to call on business houses and that's what they want. Mail coupon today for full particulars.

HOLCOMB & HOKE MFG. COMPANY
INDIANAPOLIS, IND.

MAIL NOW!

HOLCOMB & HOKE MFG. CO.
Dept. W-506, Indianapolis, Ind.

Without obligation on my part, please send me the full data on your Electramuse Dealer Plan.

Name _____

Address _____

City _____ State _____

Finest Quality Tube Supplies

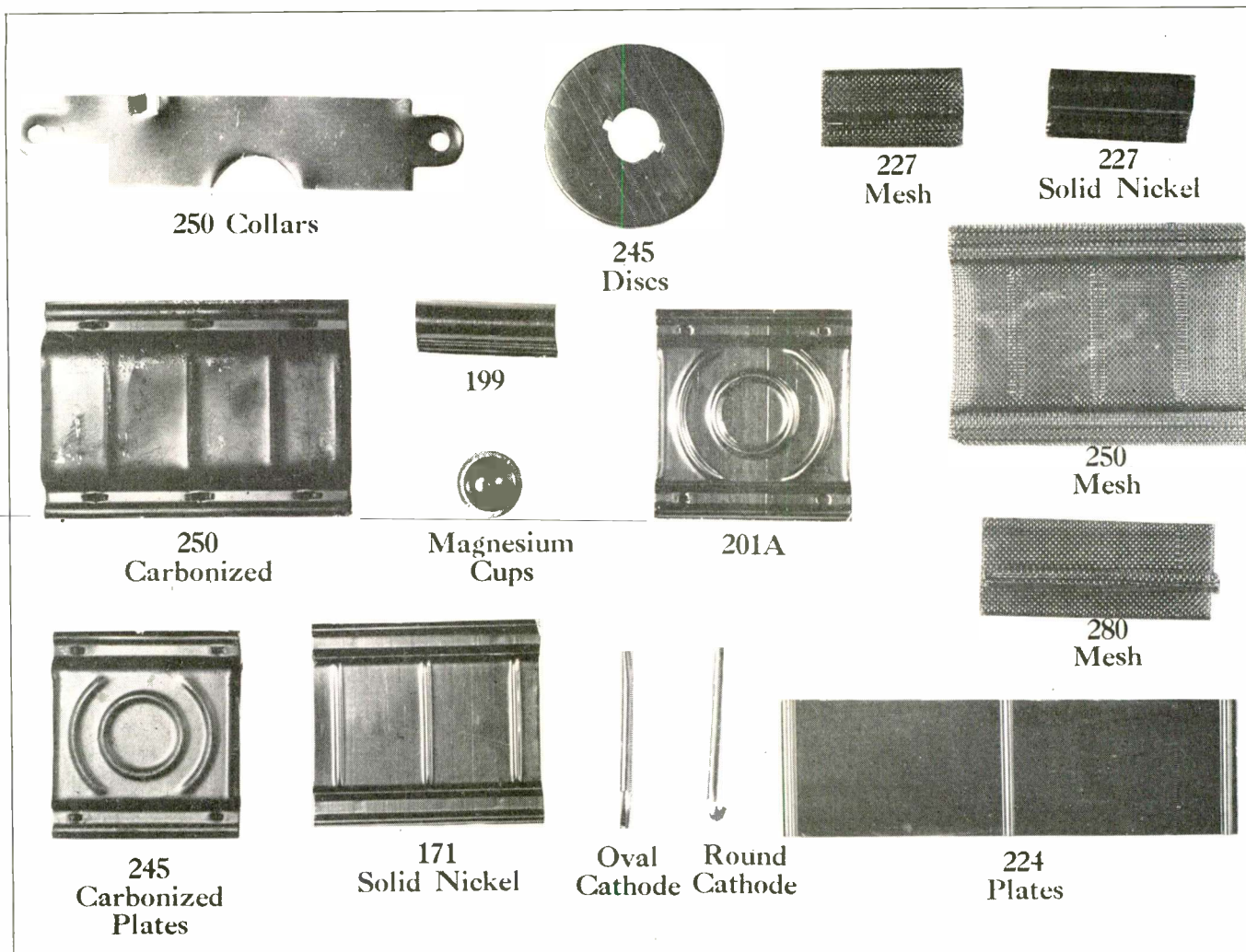

WE ARE equipped to furnish tube parts in any size or in any quantities—molybdenum filament hooks, tungsten filament hooks, screens, bolts and nuts, where necessary—in fact all of the various stampings used in the assembly of better tubes.

These tube supplies are manufactured from superior materials and with the utmost care and precision. Tubes that are assembled with Juno parts will stand the test of quality and service in any competition.

We will gladly meet your specifications or send any further information you wish.

JUNO FASTENERS, Inc.
 HILLSIDE, NEW JERSEY

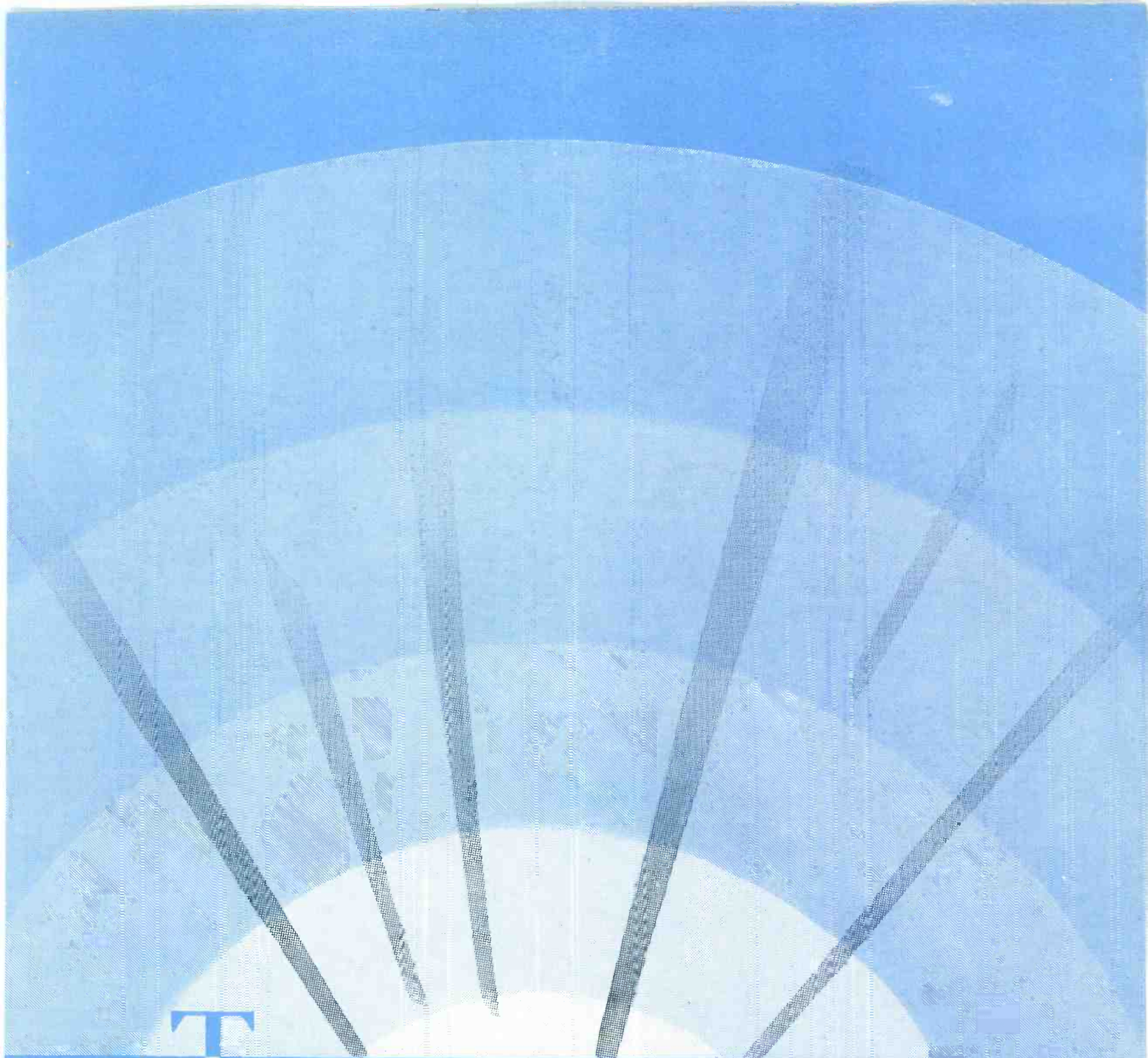

T
The new
Balkeit Radio

*At the R. M. A. Show—Booth 135-D and Room 561-A
Hotel Stevens—Chicago*



RADIO claims greater expression in this new Receiver—a quality so topping its price class that it *demands* attention.

Balkeit Model C bears a famous name to greater glory and goes to the radio public *only through you—direct, through the better dealers of the country.*

Because the Balkeit Model C is new—*brand new*—you won't find a single, crippling, out-of-date item about it. Five tuned stages with uniform sensitivity over the entire dial, operating through the UX-245 output tubes—that is typical of what we mean. This set has "It"—a jump ahead, in many ways, over the finest competition.

In tonal quality, in remarkable fidelity over an extraordinary range of low and high notes, this new set gives you something very real—to sell.

Because Balkeit National Prestige will be so profitably stimulated by this greater set, you, yourself, should seize the leader's benefit of quick and early action.

See and hear the Balkeit Model C at the Chicago Show—Booth 135-D and Room 561-A, Hotel Stevens

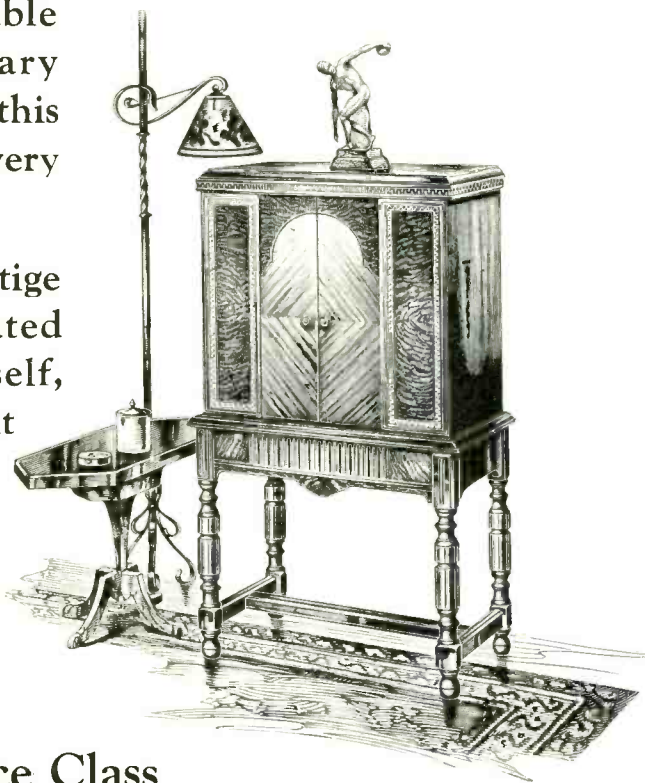

A Step Above Its Price Class

Salient Selling Points of Model "C" Balkeit Radio

1. Nine tube Super-Neutrodyne including the rectifier tube—no oscillation.
2. Five tuned stages. Selectivity, exactness of tuning, extraordinary resonance of tone achieved in a complete A. C. tuned radio frequency circuit through five tuned stages.
3. Uniform sensitivity on all wave lengths—a standard of selectivity new in radio, with a sensitivity performance that is surprising.
4. Two UX-245s in push-pull—the highest power-tube development—insuring long life—stability—superb tone quality—complete dependability.
5. UY-227 type tubes used in the four RF stages, power detector, and first audio stage result in colorful tone qualities found only in Balkeit Radio. A new type of audio amplification providing revolutionary tonal fidelity for low notes and high.
6. Exclusive features of design cut hum to an absolute minimum.
7. Single illuminated dial—accurate knob control.
8. Power detector that cannot overload.
9. Rugged, one-piece chassis construction.
10. Faithful ten kilocycle separation of stations—uniform distance getting ability over entire dial.
11. Sturdy and complete shielding.
12. Volume control that is smooth and positive—from a whisper to a full orchestra.
13. Filtered power supply for DC dynamic speaker. No external power devices to increase installation costs.
14. Licensed under R.C.A., Neutrodyne, and Balkeit patents—the dealer is fully protected.

Rich Dealer Territories are still open — write for complete information

Balkeit Radio Company
NORTH CHICAGO, ILL.



HOWARD A. GATES
Chief Research Engineer of

ZENITH
TRADE MARK REG.
says

"In my opinion, the performance of every radio set requiring an aerial is directly dependent upon and proportional to the type of aerial used and upon its insulation and installation. A good aerial, properly erected, is of prime importance."

H. A. Gates

LEADING Radio Engineers emphasize the need for reliable aerials. They know that today's crowded station channels and super-sensitive sets demand nothing less.

Successful dealers see to it that a durable, weather-proof aerial is a part of every radio they sell. For no other equipment is so essential to good performance. Excessive servicing . . . that radio profit-eater . . . has been largely eliminated with the passing of sloppy, make-shift aerials.

Most dealers now use and recommend Premax Aerials. For the Premax is wind-proof, rust-proof, easily erected, attractive and inexpensive. The collapsible tubular steel masts permit easy and safe erection while telescoped. The

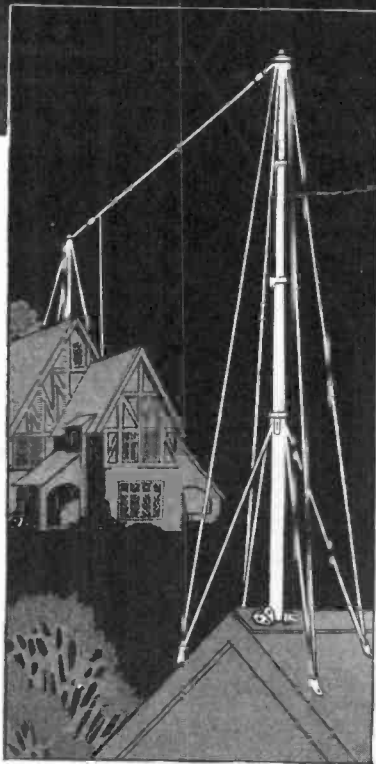

Illustrating typical Premax installation using 13 foot and 3 foot Premax Aerial Masts.

masts are then extended to the desired height and securely locked. Sold by good jobbers.

**NEW AERIAL BOOKLET
SENT FREE**

Our new booklet, "The Right Aerial and Easy Ways to Erect It," covers such important subjects as *Getting DX with the Right Aerial; How long Should My Aerial Be; What Has Aerial Height to do with Good Reception.* It explains and illustrates how to erect a rugged, well-anchored, properly proportioned aerial under every condition. Sent promptly on request. Premax Products, Inc., Niagara Falls, N. Y.

Jobbers: Write for profitable Premax proposition.

PREMAX AERIALS AND GROUND RODS

THERE IS A STANDARD PREMAX AERIAL FOR EVERY JOB!

ELECTRAD'S Remarkable New VOLUME CONTROL

U. S. Pats.
No. 1034103-
1034104 and
Pats. Pend-
ing.



Resistance element fused to enameled metal base. Smooth, pure silver, floating contact.

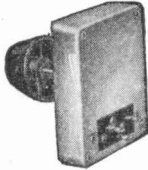

Neat, compact, firmly riveted. Practically all metal for rapid heat dissipation. Bakelite insulation.

Here is a new-type volume control with unusually long life and designed for the high voltages of modern receivers. It makes cheap, inefficient compromises unnecessary. Reduces replacement costs.

Dissipates a full five-watts at any position of the contact and gives a smooth current flow hitherto unknown in volume controls.

Laboratory tests, under load, prove it will stand more than ten years' average use, without appreciable wear or change in resistance value.

Not merely new in design and principle, but superior in every respect, thanks to the thorough research and originality of Electrad engineers.

Write for complete description.

If you are a progressive radio manufacturer, you need this better Volume Control. If you are a dealer, your customers will thank you for stocking it.

Electrad specializes in controls for every radio purpose, including Television. Also fixed and variable resistances of world-wide reputation for eliminators and power packs.

Dept.
R R 6.,
175 Varick St.,
New York

Send complete data on New Five-Watt Volume Control and other Electrad devices.

Name.....
Street.....
City..... State.....

ELECTRAD INC.

Your Coil Problem Solved!

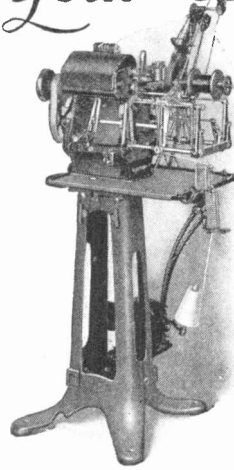

Install a group of "Universal" Coil Winding Machines

and insure uniform production of dependable coils at surprisingly low cost

or

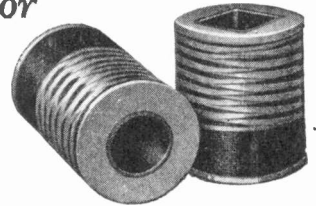

Purchase these same coils from us, carefully wound to your specifications and ready for application to your product

UNIVERSAL WINDING COMPANY
Lesons
BOSTON

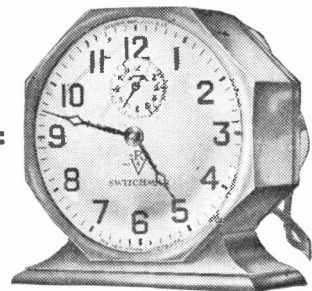

\$7.50

Liberal Discount

The RADIO SWITCHMAN Brings JOY to set owners— and PROFITS to you!

The R-V "Radio Switchman" makes set owners proud and happy. Imagine—retiring and gently falling asleep to the tunes of rhythmic music—or awakening at the sound of a snappy 1-2-3-4!

This small, attractive electric time-switch clock will turn on, or turn off, at any desired moment, radio, electric-fan, night light, heating-pad, etc. Its electrical rating is 200 watts, 110 volts, any frequency. Has six-foot cord with receiving receptacle and plug attached; no wiring required—"just plug in"! Finish dark brown; unbreakable crystal. Its good looks, and low price, and many uses should put more than one in many homes.

DEALERS, connect one on your demonstrator set and watch it go!
Radio isn't up-to-date without this "self-starter!"

R.-V. Mfg. Co., Marshfield, Mass.

One Year Unconditional Guarantee ON THIS AMAZING NEW GORDON MOTOR

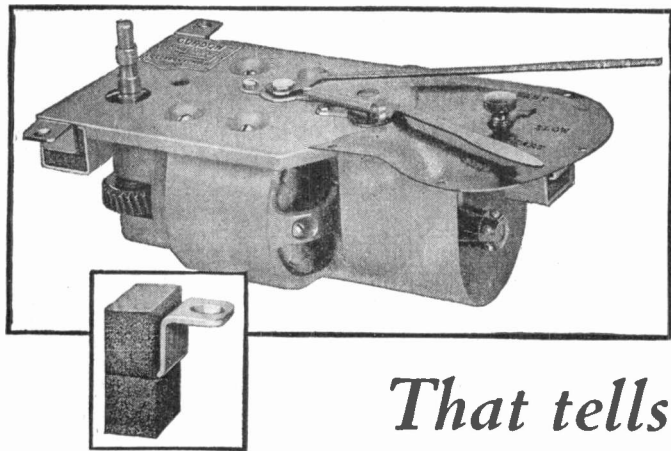

**SIMPLICITY
COMPACTNESS
PRECISION
SILENCE**

That tells the whole story!

WE HAVE built 2,000,000 phonograph motors. This one is the best! We know what it can do, its dependability, its permanence. That is why we can unconditionally guarantee it for one year!

There is only one gear wheel in the whole motor assembly. It is made of silent, frictionless Spanish felt, far surpassing fiber or composition gears. Steady and silent power is supplied to it by a worm of phosphor bronze. No lubrication is needed. All motor bearings are also of phosphor bronze. The motor is literally cradled on air by a three-point suspension on live sponge-rubber brackets which absorb the least vibration. The standard model is A. C. 110 v. 60 cycle. Other windings may be had on request.

All Gordon motors are complete with 12-inch turntable, automatic stop, speed control, and 8-foot extension cord and plug

The turntable, its felt cover tightly bound by an extra metal ring, revolves at perfectly constant speed on its tapered bearing, controlled by the

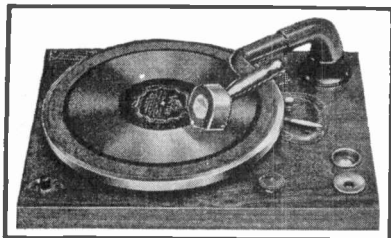

now famous Gordon precision governor, a development of our 20 years of manufacturing experience. There is also

lutely no "wailing" in reproduction when a Gordon motor furnishes the power.

The Gordon turntable motor is furnished with full panel assembly, if desired,

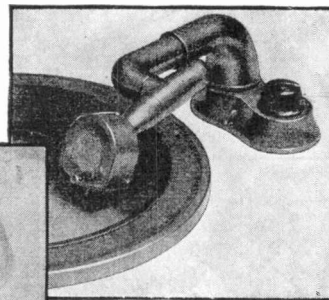
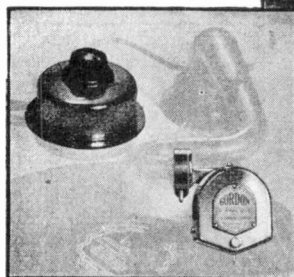

including counterbalanced tone arm, Gordon Pick-Up, "Radio-Phonograph" switch, automatic stop,

volume control, speed regulator, and needle cups. All parts handsomely finished in statuary bronze. Other finishes by special arrangement.

The Gordon Pick-Up, using the finest of cobalt steel magnets, is an electrically perfect mechanism, tested to the most minute degree for its ability to reproduce sound with fidelity. It is furnished for attachment to phonograph arm or with its own counterbalanced tone arm. In the latter style, the volume control may be had separately or as a part of the tone arm base. Each Pick-Up is sold on the basis of a guaranteed output performance curve.

ONE YEAR UNCONDITIONAL GUARANTEE

The new Gordon turntable motor is unconditionally guaranteed for one year from date of purchase against any defect in workmanship, materials or operation, and it is the only phonograph motor so guaranteed. This guarantee is only a suggestion of our confidence in the perfection and sturdiness of the motor, only a suggestion of the years of satisfactory and efficient service you may expect of it. Write or wire for further details and specifications.

L. S. GORDON COMPANY
1800 MONTROSE AVENUE, CHICAGO, ILLINOIS

STUDNER BROS., INC., National Sales Representatives, 67 W. 44th Street, New York, and 28 W. Jackson Blvd., Chicago
Export Agents: AD. AURIEMA, INC., 116 Broad Street, New York City
Cable Address: AURIEMA, New York

NEW! A GENERAL AMPLIFIER FOR \$85 USING THE NEW 245 POWER TUBES

New possibilities, in the field of sound reproduction, have been opened up by this latest development in power amplification. An amplifier employing the new type 245 tubes in a stage of push-pull. So designed and constructed as to offer the ultimate in quality "Sound Projection."

It is entirely self-contained in two drawn steel cases finished in black crackle and mounted on a metal base. The base also carries the four flush-mounting sockets, with identification buttons, as well as the small amount of sub-base wiring necessary. The contents of both cases are thoroughly impregnated, eliminating any troubles which might arise from moisture absorption. Handles are provided for convenience in carrying.

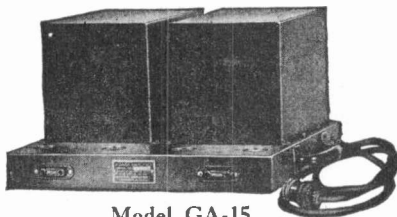

Model GA-15

A two-stage power amplifier employing one 227, two 245 power tubes in push-pull and one 280 rectifier. It will deliver approximately 1.5 watts of undistorted energy to the reproducer. Suitable for the home or other moderate sized installations.

Price (less Tubes)—\$85

Through the incorporation of such features as push-pull, the use of self-healing condensers in the power supply, and the use of capacity resistance filters in both the grid and plate leads of all tubes, a power amplifier of exceptional performance is assured. Tremendous volume and absolute fidelity is possible with this amplifier which has an essentially flat frequency characteristic over a wide range.

Our engineering staff is at your service at all times and desires to cooperate with you as fully as possible in all of your problems of power amplification. They are specialists in the design and manufacture of power equipment for specific purposes.

Bulletin RR-3, fully describing this and other General Amplifiers, will be sent on request.

GENERAL AMPLIFIER COMPANY

27 Commercial Ave., CAMBRIDGE, MASS.

Makers of High Grade Power Amplifiers

SEE AND HEAR

the new
WRIGHT-
DE COSTER

at the
R·M·A·
SHOW

Booth 65
Demonstration
Room 561
STEVENS HOTEL

WRIGHT-DE COSTER INC.
FACTORIES
SAINT PAUL, MINNESOTA

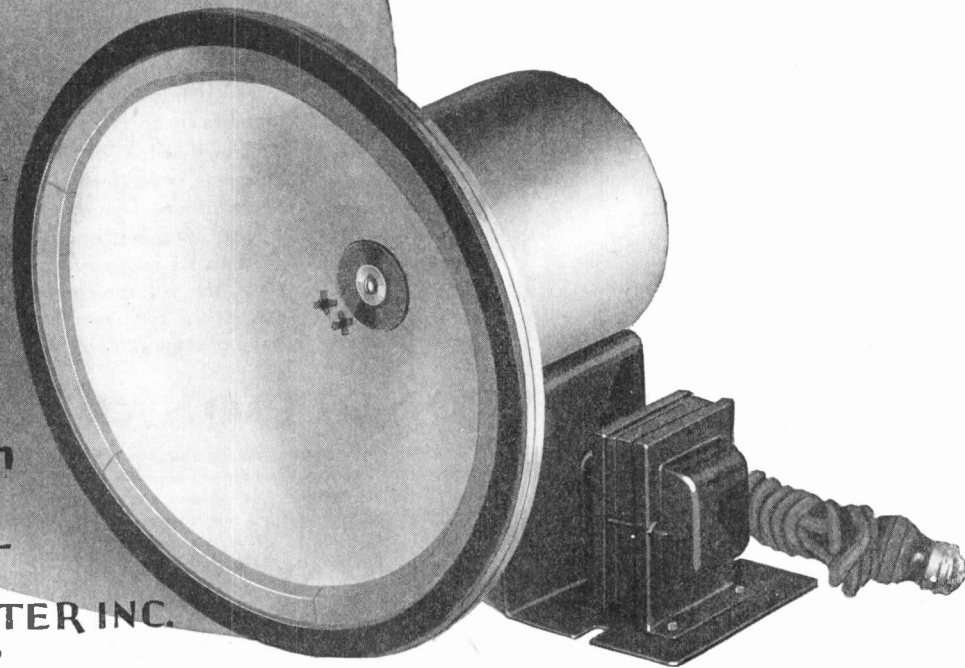

The Speaker of the year

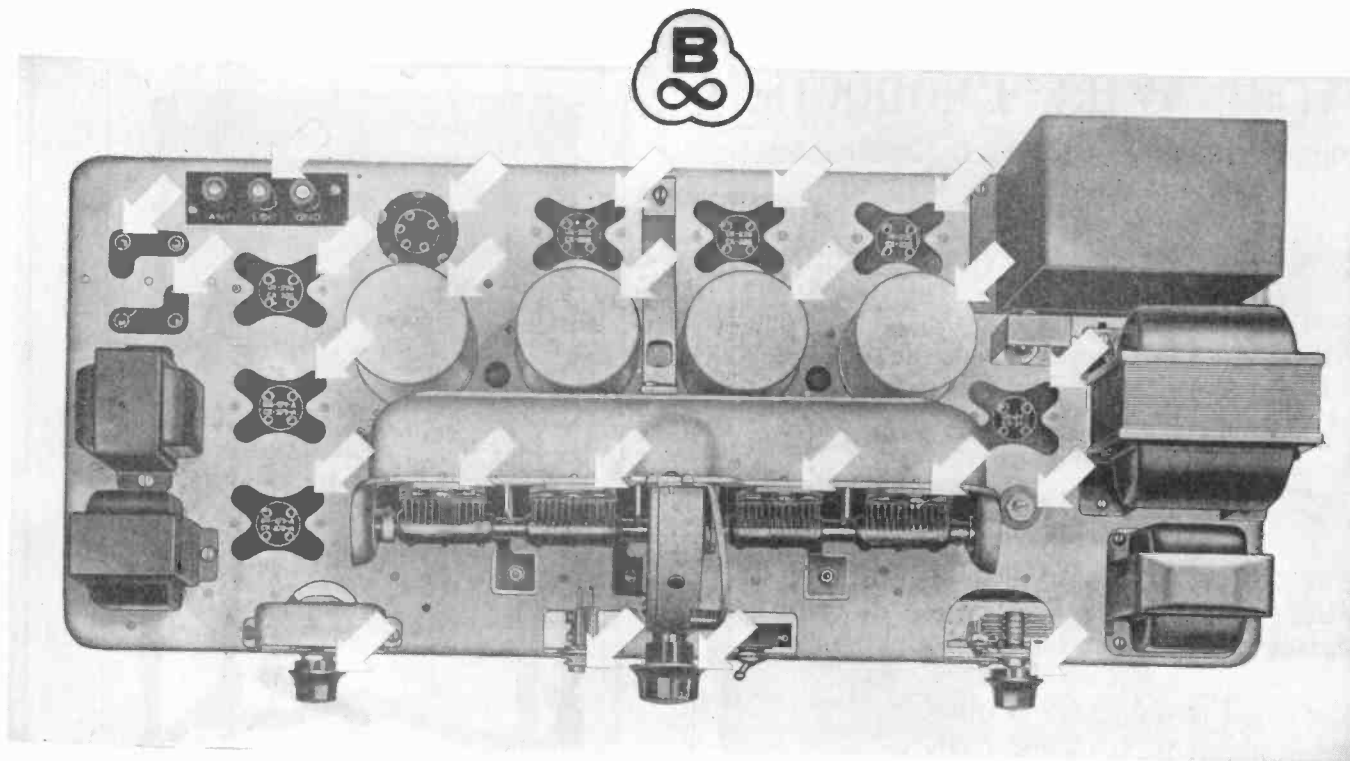

Chassis of Philco Radio Receiver showing many of the Bakelite Insulated parts. Made by Philadelphia Storage Battery Co., Philadelphia, Pa.

Philco superlative performance is protected by Bakelite Materials

NOTABLE selectivity and sensitivity, combined with undistorted volume and fidelity of tone are claimed for the Philco Radio Receiver. Throughout this finely designed and built set Philco relies upon Bakelite Materials for the effective insulation of the delicate electrical elements, under all operating conditions, and in all climates.

Dealers will find that radio receivers of the makes and types which have earned a reputation for exceptional performance are invariably



insulated with Bakelite Materials. These materials are standardized products, possessing known and uniform properties, assuring the manufacturer that the results obtained in the laboratory will be duplicated in service.

It is always a wise precaution to make sure that the radio sets and parts which you sell have Bakelite Insulation. It creates customer satisfaction through eliminating troubles caused by faulty insulation. Write for Booklet 39, "Bakelite in Radio."

BAKELITE CORPORATION

247 Park Avenue, New York, N. Y. Chicago Office, 635 West 22nd Street
 BAKELITE CORP. OF CANADA, LTD., 163 Dufferin Street, Toronto, Ont.

BAKELITE

REGISTERED



U. S. PAT. OFF.

THE MATERIAL OF A THOUSAND USES

"The registered Trade Mark and Symbol shown above may be used only on products made from materials manufactured by Bakelite Corporation. Under the capital 'B' is the numerical sign for infinity, or unlimited quantity. It symbolizes the infinite number of present and future uses of Bakelite Corporation's products."

ACME WIRE PRODUCTS

Parvolt Filter and By Pass Condensers
Coils—Magnet Wire Wound
Varnished Insulations

Magnet Wire . . . All Insulations

All products made to Recognized Commercial Standards, including those of:

National Electric Mfrs. Assn.
Radio Manufacturers' Assn.
American Society for Testing Materials

For 25 years manufacturers and suppliers to the largest and most discriminating users.

THE ACME WIRE CO.
NEW HAVEN, CONN.

Branch Offices

New York
52 Vanderbilt Ave.

Chicago
842 N. Michigan Ave.

Cleveland
Guardian Bldg.



Exhibit at
RMA
Trade Show
Room 421-A
Booth 136-D
Stevens Hotel

An ASTON Favorite

A rare treat for the discriminating purchaser. With an air of another period, it is nevertheless modern in feeling. Beautifully figured Burl Walnut doors with artistically colored center overlays. Entire cabinet 5-ply walnut lacquer satin finish. An ornament in any setting.

Write for Catalog

ASTON CABINET MANUFACTURERS
Distinctive originality in design of high grade Radio Cabinets
1223-1229 W. Lake St., Chicago, Ill.



DON'T fail to see this new model—acclaimed by all who have seen it to be the most clever, best proportioned radio cabinet yet offered. Equipped with our patented slide-door feature which will surely interest you. This is one of many we will display at the show.

CONGRESS HOTEL, Room B18
STEVENS HOTEL, Room 563

The success of the RADIO CABINET CO. has proven the design and quality of our merchandise, as well as our fair and square business ethics.

This season we find other cabinet manufacturers using our name and variations of it. Do not be misled; we are the original, and have thousands of our cabinets in the homes of satisfied users.

**RADIO CABINET
COMPANY**
GRAND RAPIDS

Proven demand assures rapid sales!

Save one-half of your salesmen's time in creating a market, sell an Excerciser and Reducer that is nationally wanted. The Tower name stands for the ultimate in mechanical perfection. Your customers look for it before buying. Nation-wide advertising has created this tremendous demand, you cannot afford to overlook it — your customers want the TOWER. To tie up with this advertising and stock the Tower is to take advantage of a thoroughly receptive market. Write us today for complete information on our dealers' discount plan — it will interest you.



Broad possibilities are assured Tower dealers through our liberal discount plan. Fast-moving sales are an actuality, as the Tower Excerciser and Reducer combines with its low price exceptional mechanical features. It may be used on its own stand (included in the price) or on any convenient desk or table. Its convenient size makes it easily portable. Wide and narrow belts, quiet operation, sanitary slip covers, adjustable vibration and the finest materials throughout make the Tower Excerciser and Reducer by far the better health machine. Stock it!

Send coupon today for complete information regarding our profitable merchandising plan. Our liberal dealer's discount arrangement will mean attractive profits to you!



Tower Manufacturing Corp.
122 Brookline Ave., Boston
Please send me complete information regarding your dealer's merchandising plan.

Name

Street

City and State

My Jobber is

TOWER MANUFACTURING CORP.
122 BROOKLINE AVENUE, BOSTON, MASS.



CONDENSER TISSUES

NO Radio set is any better than its weakest link, and the weakest link is very often a filter Condenser. No Condenser is any better than the thin strips of Insulating Tissue which separate the layers of metal foil. A pinhole or a speck of metal in the Condenser Tissue means a break down of the Condenser, with the entire set put out of commission.

DEXSTAR Condenser Paper is regarded by Radio experts as being the highest grade Insulating Tissue ever made—the freest from defects, the most uniform in quality, the most lasting under exacting and unusual requirements. DEXSTAR Condenser Tissue is the specialized product of a paper mill which has excelled in Tissue Paper production for three generations.

RADIO dealers and builders should have the assurance that Condensers which they use are made with DEXSTAR Condenser Tissues. It is insurance against many radio troubles. The leading Condenser manufacturers are now using DEXSTAR Condenser Tissues exclusively.

For Samples and Prices Address Dept. No. 3

C. H. DEXTER & SONS, INC.
Makers of Highest Grade Thin Papers
WINDSOR LOCKS, CONN.

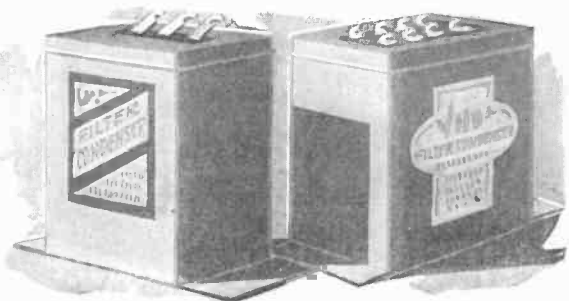

POWER AMPLIFICATION

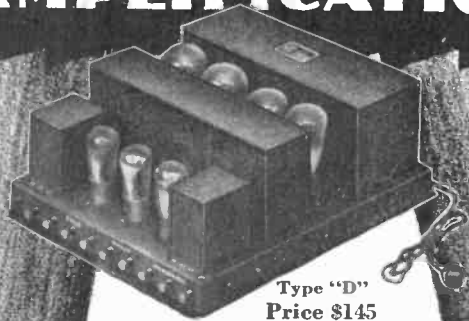

Type "D"
Price \$145
(without tubes)

Theatres
Auditoriums
Summer Resorts
Dance Halls
Factories
Clubs and Schools

are interested in bringing music or speeches to great crowds of people and should know about

WEBSTER
CHICAGO
POWER AMPLIFICATION

A WEBSTER power amplifier with a good radio or phonograph reproduces the voice or instrument, thru a series of speakers, with marvelous accuracy. Not a note or a syllable is slurred when WEBSTER amplifiers supply the power. These instruments are designed by engineers skilled in the science of audio amplification, who have had many years of practical experience in this field. The manufacture is done in a plant that has for years specialized in the making of power supplies for radio. The name WEBSTER is a guarantee of accurate design, dependable operation, and superior workmanship. Write for information about our complete line.

POWER Packs, Transformers and Chokes

The WEBSTER line includes complete power packs as well as component pack parts. WEBSTER power transformers and power chokes are standard equipment adopted by the manufacturers of the country's finest radio receivers.



In its Machine and Tool Division Webster manufactures RAULAND SUNSHINE, an ULTRA-VIOLET RAY LAMP of remarkable power. Absolutely harmless and a source of health and happiness for the whole family. A profit-maker for radio, hardware, department, or any retail store. Write for particulars.

WEBSTER
CHICAGO

The Webster Co. 850 Blackhawk St., Chicago



Visit BOOTH NO. 150
ROOM 515A
Hotel Stevens

Be sure to see the Webster Remote Control at the Show

NEW

insurance protection

on the

WIRT LIGHTNING ARRESTER

means more sales

Here is a Lightning Arrester that not only guarantees protection—but actually insures it—\$200 property damage, and from \$5,000 to \$10,000 personal injury. No other Arrester is insured for this much—no other Arrester gives as complete protection—no other

Arrester will be as easy to sell!

The Wirt Lightning Arrester is an air-gap type. Made of bakelite and brass—"petticoat" insures ample insulation in any weather. Terminals are extra heavy, and so arranged that aerial

can be connected without cutting it. This is much the best practice for better reception, as

well as for complete protection. The bracket gives a rigid fastening and the Arrester will last a lifetime.

Get going on this item now—this is the time of the year

when electrical storms are frequent. Push our Arresters, and watch them go! List price only \$1.00. Profitable discounts. Coupon below is for your convenience in ordering.

Send it in today!

\$5,000
coverage

WIRT COMPANY

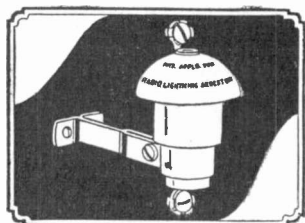

List Price
Only \$1.00

WIRT COMPANY

5221 Greene St., Philadelphia, Pennsylvania

R. R. 6-29A

Please ship by return mail:

.....display cartons of 10 Wirt Lightning Arresters, No. 200
 (Price list of other Wirt products)

Name.....

Address.....

NEW PROFIT MAKERS for YOU!

CORWICO VULCAN LIGHTNING ARRESTERS



LIST PRICE
\$1.00

The Corwico Vulcan Lightning Arrester is made to sell and perform. In addition to giving lightning protection this arrester also dissipates accumulated static charges. It sells because it has more eye value and is a bigger value than any other lightning arrester on the market. It's big and massive, it's colorful, being an attractive dark green, and it is packed in an eye-catching two-color box.

Its protection against lightning damage to radio receivers is guaranteed by a \$100 insurance pledge enclosed in each box. You can easily sell a Corwico Vulcan Lightning Arrester with every radio set, and this is the time of the year to sell one to every owner of a radio. List Price One Dollar.



LIST PRICE
\$2.50

CORWICO ANTENNA KITS

Now is the time of the year to tell your customers to overhaul their aerials. For better reception they should equip their receivers with a matched aerial kit such as the Corwico Antenna Kit No. 4, in which is included a Corwico Vulcan Lightning Arrester. List Price \$2.50.

Write for particulars regarding these two new Corwico Profit Makers. See them at the Chicago Show, Booth 130, Stevens Hotel.

CORNISH WIRE CO.
30 Church St., New York

MAKERS OF
CORWICO Braidite HOOK UP WIRE

List
\$1.85

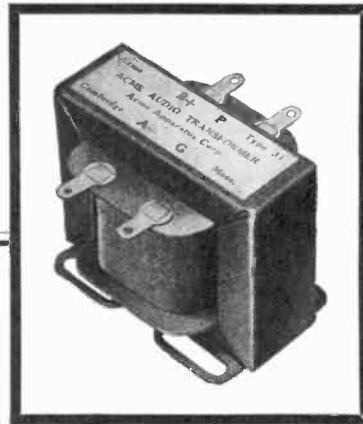

Fully
Guaranteed

Type 31 Ratio 3-1
Overall—2½ x 2¼ x 2

A New Acme Audio Transformer

—and a special trial offer

Dealers: It's a fact that your transformer replacement profits have been made on time and labor. But here's a chance to change that order a bit. The new Acme audio transformers are offered specially priced—a trial offer—at \$1.00 each—\$2.00 a pair—they list at \$1.85 each. It's time to cash in on this offer.

This transformer is built to fit at least two holes in any subpanel—it has four oblong mounting holes—the coil is mounted on a shell type of core which is particularly desirable when used in A.C. receivers.

The fact that we have effected savings in the assembly and mounting arrangement and that all parts are made in our own plant permits this offer.

Use the Coupon.

ACME for amplification

Acme Apparatus Corporation
Transformer and Radio Engineers and
Manufacturers
Cambridge, Mass.

Acme Apparatus Corp., 39 Osborne St., Cambridge, Mass.

Here is my check, money order, cash, for \$2, for which please send me two audio transformers which you guarantee in every way and you agree to allow me to return if they are not just as I expected them to be; in which case you'll refund my money. This will be sent postpaid.

Please send me free your bulletin No. 100 describing your VR2 Voltage Regulator.

Name

Street

City and State



KERSTEN'S

Don't forget to see our complete line of Radio Speakers at the R. M. A. TRADE SHOW, June 3 to 7, Inc., at the Stevens Hotel—Demonstrating Room 545; Display Booth 33-D.



KERSTEN TABLE SPEAKER No. 4

Also made in another decorative design, No. 3. These cabinets are of exceptionally attractive design, beautifully finished in walnut shade and are ornamental to any room in which they are placed. Equipped with Kersten D-221 ELECTRO-DYNAMIC UNIT for light socket operation.

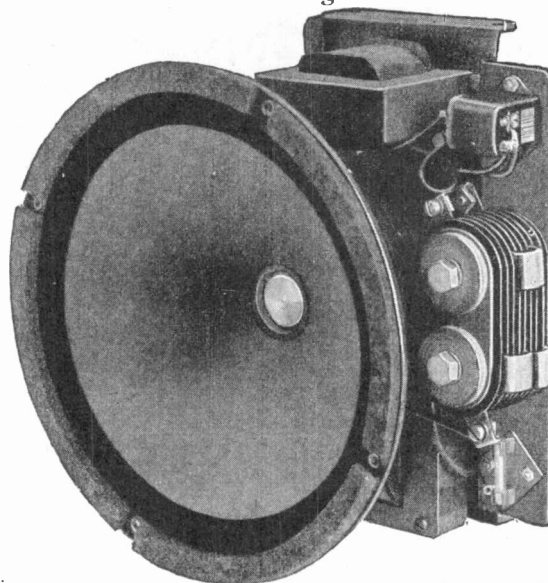

KERSTEN DYNAMIC No. D-221.

Built to handle even the greatest capacity. Brings out the most minute detail of tonal quality. So real that it rivals the original production. Field draws 45 milliamperes at 90 volts.

We manufacture a complete line of Radio Speakers, also horns and units for theatrical purposes.

Kersten Radio Equipment, Inc.
Kalamazoo, Michigan

See and hear first demonstration of Kersten Dynamic Exponential unit.

actron

ACE
of

RADIO TUBES

A COMPLETE LINE

Write for Specifications and Attractive Prices

THE ACTRON CORPORATION
123 Sangamon St.
CHICAGO

SHORT WAVE ADAPTER

\$17.50

to

\$27.50

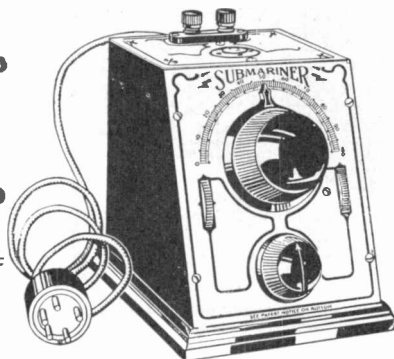

Attractive Dealer's Proposition

NO CUT RATE

NO CUT RATE

COMPLETE PROTECTION WHEN YOU SELL

THE PIONEER SHORT WAVE ADAPTER
THE SUBMARINER

Leading the world since 1926. Two years ahead of anything of its kind. Radio talks and magazine ads for the past three years have done the missionary work. The "Submariner" will prove its superiority in direct competition with any short wave system. AC and DC models for every requirement. Harmonize with the finest receivers. Write for attractive dealer proposition and latest data on the "Submariner" with the "J" feature. Patents Pending.

J-M-P MANUFACTURING CO., INC.
3332 FOND DU LAC AVE., MILWAUKEE, WIS.



LIST - - - - \$20.00
DEALER'S PRICE
\$12.00

BEEDE

introduces
an ideal instrument!

It's the new combination tube and set tester which every dealer, serviceman and set builder has been waiting for. It makes all ordinary tests on tubes and receiving sets—quickly and accurately.

There are real profits in selling this new Beede combination tube and set tester—a liberal discount—a healthy customer demand.

Every radio dealer, serviceman and set builder needs this instrument for his personal use.

Write for further information.

Beede Electrical Instrument Co.

*Manufacturers of Quality Battery Meters,
 Meters for Radio Use, Etc.*

PENACOOK, NEW HAMPSHIRE

Chicago Representative

S. B. DARMSTADER

326 West Madison St., Chicago, Ill.



Metal Cabinet Model

This beautiful metal cabinet is finished in a black rubberoid color and houses the chassis illustrated below. It employs two 245 tubes in the audio circuit, two 227 tubes for the detector and first audio, the usual 226 tubes in the R.F. circuit, and one 280 tube as a rectifier.

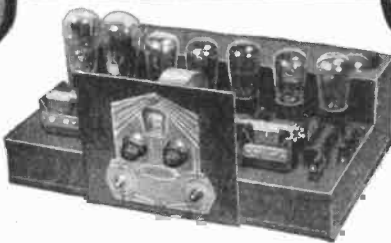

Chassis Model

The chassis is rigidly constructed of heavy gauge drawn and welded steel and houses all component parts including the power supply which is of liberal design and construction to stand heavy overloads. This Pierce-Airo Chassis fits any standard console.

Now! A New and Finer



ELECTRIC RECEIVER FOR A.C. OR D.C.
DYNAMIC RECEPTION

The 1930 Pierce-Airo uses the new 245 tubes. It is a perfect electric chassis manufactured in accordance with the most advanced scientific principles of radio reception. Among the features of the new Pierce-Airo are the provision in the chassis for the use of either A.C. or D.C. Dynamic Speakers, and the automatic phonograph attachment permitting the use of phonograph pick-up if desired. Provision is also made for the regulation of line voltages. The new Pierce-Airo's exclusive features in design and construction will instantly appeal to both expert and layman.

At the Chicago Trade Show.

See the New Pierce-Airo at the Stevens Hotel, Booth 135, Exhibition Floor, and on demonstration in Room 542-A.

PIERCE AIRO, INC.

113-R Fourth Avenue, New York City

When you sell a set sell
THIS to protect it!

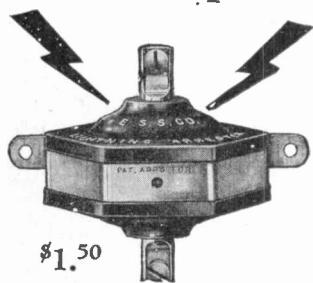

\$1.50

Every set you sell represents a costly investment to your customer! Here's a simple, proved device that will give absolute protection against the dangers of lightning. The price of a Keystone radio lightning arrester is consistent with its quality. Made of genuine Bakelite and heavy brass. It is reliable, safe and stays sold.

Manufactured by a company having more than thirty years' experience in the design and manufacture of lightning arresters.

Attention Live Jobbers and Dealers!

Also get details on our Protex arrester which retails at 75c.

ELECTRIC SERVICE SUPPLIES CO.

Home office and plant at 17th & Cambria Sts., PHILADELPHIA. District Offices at 111 N. Canal St., CHICAGO; 50 Church St., NEW YORK; Bessemer Bldg., Pittsburgh; 88 Broad St., Boston; General Motors Bldg., Detroit; 316 N. Washington Ave., Scranton.

KEYSTONE

RADIO LIGHTNING

ARRESTERS

Over 100

Janette

Rotary Converters

Used by Exhibitors at the Chicago Trade Show

32 VOLTS D. C.

The fact that many of your prospects have 32 volt D.C. lighting plants need not prevent you from selling them an A.C. radio. Now you can sell them an A.C. set and a Janette 32 Volt Rotary Converter too — 2 profits from one sale.

At the Chicago Trade Show, held in Chicago's D.C. district, Janette Rotary Converters were used exclusively to demonstrate A.C. radio equipment.

If you, too, are located in a D.C. district, a Janette Rotary Converter will enable you to demonstrate your A.C. radios right on your sales floor and should be considered a necessary part of your equipment.

Write for Bulletin 129-C

JANETTE MFG. CO., Dept. R.
556-558 W. Monroe St., Chicago

Singer Bldg.,
149 Broadway,
New York

Real Estate
Trust Bldg.,
Philadelphia



Condenser Performance

CONDENSERS play an all-important part in set construction. Modern A. C. sets demand trouble-free condenser performance. Sprague Condensers have been meeting the most rigid standards of the foremost set manufacturers . . . year after year.

And there's a reason why these manufacturers always depend on Sprague. For every condenser is tested and retested in the Sprague laboratories. Skilled engineers are working . . . always working to insure the perfect performance of every Sprague Condenser.

Condensers are made by Sprague for all standard circuits . . . and to your order if you wish. Send us your specifications and let us counsel with you. No obligation, of course.

SPRAGUE SPECIALTIES COMPANY
Quincy, Massachusetts

SPRAGUE

CONDENSERS

Maintains Its Leadership!
**MASTER
 VOLTAGE CONTROL**

Eliminates Free Service Calls

This amazingly simple device, soundly engineered from the start, has required no mid-season changes in its design or construction. Thousands in use and more going into service daily. The first *air-cooled* voltage regulator, variable, yet without any moving parts to get out of adjustment, it maintains its leadership as the best!

HEAVY DUTY MODEL
 Capacity 100 Watts

For use on AC sets with built-in dynamic speakers which draw 80 to 100 watts.

List Price \$3.00

STANDARD MODEL
 Capacity 60 Watts

For use on AC sets that use magnetic speakers which draw from 40 to 60 watts.

List Price \$2.50

Endorsed by Leading Tube
 Manufacturers

Visit our Booth 65-D
 Stevens Hotel

MASTER ENGINEERING CO.

122 So. Michigan Ave., Chicago, U. S. A.

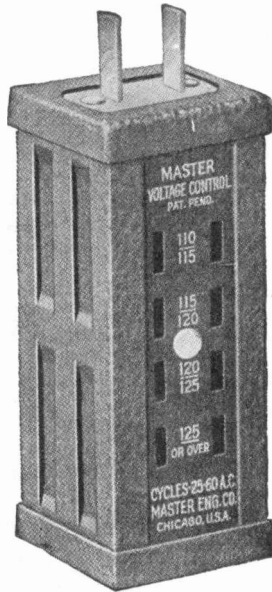

**Make More Money
 in Retailing**

In the last analysis there is only one reason for the existence of any store—the fact that the store makes a profit. But in a great many cases the profit is not as large as it might be, due either to faulty methods of management or to antiquated systems.

How this additional profit can be obtained and the steps which must be taken in order to realize it are given in:—

**Methods of
 Retail
 Management**

By **WILLIAM E. KOCH**

Business Counselor and Specialist in
 Modern Methods of Management
 272 pages, 6x9, 26 illustrations, \$3.00.

The book presents the essentials of business management as applied easily and profitably by the retail merchant regardless of the kind or size of store he operates.

It brings to the retailer valuable ideas and practical plans which could be otherwise acquired only through years of specialized effort.

It outlines rules of procedure which will not only result in greater sales but insure profit from these sales. The essentials are presented in simple language, easily read, easily understood and easily adapted to valuable application.

Greater profit from sales

Stock assortment—buying records—sales quota—the inventory—each has a definite place in retail operation. This book shows how best to utilize these and all related factors in formulating control methods that are applicable to every type of retail business.

A graphic study of the selling price centers attention on the important difference between "mark-up" and "margin."

The book does not attempt to tell any retailer how to run his business, but it does formulate and present to him principles which have proved to be fundamentally sound and effective in practice—principles that will make his selling efforts bring the maximum profit.

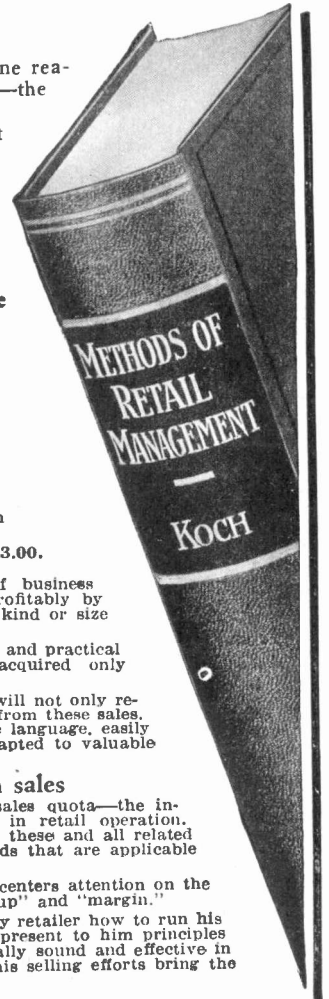

CONTENTS

- The Age of Management.
- The Profit-Making Program.
- What the Retailer Can Do with Sales Quotas.
- A Practical Basis for Positive Control of Retail Stocks.
- How Consistent Stock Assortments are Developed and Maintained.
- How a Simple Buying Record Guides Consistent Assortments.
- Other Simple Forms that Guide to Consistent Assortments.
- How a Better Expense Budget Leads to Greater Retail Profit.
- Gaging Profit by Lines.
- How Fast Should the Merchandise Move?
- A Study of Mark-up Percentages. Can the Inventory be Made More Helpful?
- What Should the Bookkeeping System Accomplish?
- More Profit Through Better Use of Figure Facts.
- High Lights in Buying.
- High Lights in Selling.
- High Lights in Controlling.
- A Study of the Selling Price.

Order a copy NOW—Use this Coupon

**McGraw-Hill
 FREE EXAMINATION COUPON**

McGraw-Hill Book Co., Inc., 370 Seventh Avenue, New York.

You may send me on 10 days' approval, Koch—METHODS OF RETAIL MANAGEMENT, \$3.00 net postpaid. I agree to remit for the book or to return it postpaid within 10 days of receipt. (To secure books on approval write plainly and fill in all lines.)

Name

Home Address

City and State

Name of Company

Occupation

(Books sent on approval to retail purchasers in U. S. and Canada only.)

R. E. 6-38

UP TO
 THE
 MINUTE



SCREEN
 GRID
 TUBES

**SCREEN GRID RADIOS
 UNDER YOUR OWN BRAND!**

Private brand radio is the answer to profitable merchandising. It enables you to set your own price on quality merchandise to meet your every trade condition—to get every possible price concession by buying direct from factory. It's the remedy for top-heavy inventories, restricted territories, insufficient markup and burdensome contracts. Most of all, it preserves your greatest asset—your trade identity and good will.

By purchasing Premier chassis, and cabinets, speakers and tubes direct from our co-operating associate companies, you are able to easily fabricate your own comprehensive line of complete receivers to meet any competition.

Illustrated is a typical private brand radio with Premier chassis installed in moderate priced yet extremely popular sliding door walnut cabinet—but one of many models available.

PREMIER HAS EVERY SALES FEATURE

Premier chassis have every desirable sales feature—eye value, tone, volume and distance—push-pull amplification—all metal, 100% shielded—phonograph pick-up—latest tube combinations. No. 227, 245 and 224 screen grid. Write for full details.

Come see us while at the show—20 minutes from the loop

PREMIER ELECTRIC COMPANY

3838 Ravenswood Avenue, Chicago, Ill. Established 1905

FLEWELLING PRODUCTS

The FLEWELLING ANALYZER meets the new demand



A.C.

Range 4-8-16
and 160 volts
Bakelite case
of sturdy design
and lasting
finish.

D.C.

Range 20-100-
200-600 volts
and 20 or
100 milli-amperes.
1000 ohms
per volt.

THE Flewelling Analyzer is designed to make complete tests on all receivers and accessories, including both A.C. and D.C. screen grid circuits. It is accurate to a degree possible heretofore only in the most expensive instruments. Equipped

with Weston or Jewell meters, (optional). Our new Tube Testers, Direct Reading Ohm-meters, Crystal Checkers and *The Short Wave Adaptor* will be on demonstration at the R. M. A. Show, Room 526-A in the Stevens Hotel.

Member
R.M.A.

The Radio Products Co.
Dayton, Ohio

FLEWELLING PRODUCTS

THERMATROL

announces

The New **FILTROL**

For Elimination of A.C. Line Noise

A specially designed and constructed filter that can be depended upon to quiet noise coming over the A.C. line. Just plug it ahead of the set.
No. 460.....Price, \$12.00

Motor Filtrol for direct application to oil burners and other interfering apparatus. Handles up to 1/2 hp. motor. Built to be wired into the circuit. No. 458... Price, \$15.00

Filtrol Jr.—Plugs ahead of household appliances such as vacuum cleaners, sewing machines, etc.
No. 450.....Price, \$3.50

For Protection of A.C. Tubes

Line Voltage Control—for sets up to 6 tubes. No. 200.....Price, \$1.75

Heavy Duty Voltage Control—For large sets with dynamic speakers. No. 210. Price, \$2.00

Compact, efficient, no moving parts. four separate outlets, stick tight in the outlet.

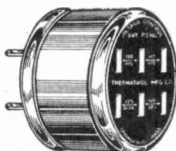

Voltage Control
No. 200

THERMATROL MFG. CO.
SPRINGFIELD, MASS.



Something
New!

at 612 So.
Michigan Ave.
(Between Stevens and
Congress Hotels)
(Main Floor)
CHICAGO

during trade show

See Speaker and Cabinet that make
every room talk from one set!

Columbia Woodturning Co.
1906-24 So. Western Ave., CHICAGO

The New and Marvelous "CLAR-A-TONE"



The New CLAR-A-TONE is an indispensable device for every radio set made. A combination

- Interference Eliminator (1)
- Tone Clarifier and (2)
- Volume Control (3)

INTERFERENCE ELIMINATOR—No. 1
A clever device which will reduce static to the lowest degree possible—enable you to tune out interfering stations—and bring the desired station in clearly.

TONE CLARIFIER—No. 2
All reception is brought in on the receiving set so clearly, that it is difficult to believe that the program is not actually in the home.

VOLUME CONTROL—No. 3
This device will bring in out-of-town stations by increasing the volume two-thirds above the normal ability of the set itself.

Beyond all semblance of doubt, no radio set owner should be without this device. It is priced moderately so that it is within the reach of everybody. Placed in the home in any room, will enable the owner to get reception lower or louder without interfering with the dials on the set. Beautiful in appearance—finished in Japan-Crystal Mahogany color—Packed in individual containers with full installation instructions. Unit packages of 24 and 36 CLAR-A-TONES.

List Price, \$3.00 each

Jobbers and Dealers—We will be glad to quote you our discounts, and also send a sample upon request—orders filled promptly.

GUARANTEE

We unconditionally guarantee this device against mechanical defects, and will stand by any claim that is made for it.

ESSENBEE RADIO DEVICES CO.

2016 W. Lake St., Chicago, Illinois

Michigan Sales Office:
Superior Sales Co., 51 E. Canfield, Detroit, Mich.

loud . . . clear . . . life-like . . .

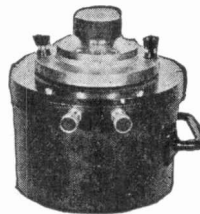

Type M-100
Dynamic Unit
5½ by 5½

that's **MILES**

NEW heights of reproducing power and realism, based on years of intensive research and development. Performance that has won leading dealers interested in attracting crowds into their stores . . . that will win YOU, by a single trial. Get in touch with us at once!

MILES MANUFACTURING CORP.

"Builders of Acoustical Reproducers Since 1923"

31 West 21st St. (Phone GRAMercy 5081) New York City

HOWLING — SCREECHING

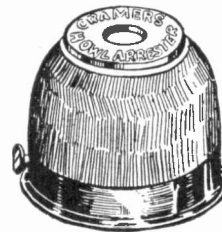

removed from any Radio set with this new, fast-selling item.

**CRAMER'S
HOWL ARRESTER**

LIST PRICE

75c

Get a good supply of this Howl Arrester in stock—cash in on a large volume of sales. WRITE FOR A SAMPLE TODAY. Test it—see its great sales value—Territory now open. Large discounts.

STANDARD RADIO CO.

NATIONAL DISTRIBUTORS:

520 S. State St.

Chicago, Ill.

We are NOT Radio Set Manufacturers

But we are specialists in cord sets for loud speakers and special harnesses for set manufacturers.

We make every kind of cord for loud speakers, —dynamic and magnetic.

We are now supplying dynamic speaker manufacturers with rubber insulated speaker cords in rayon and also mercerized cotton.

Some of the largest and best known manufacturers in the radio field are our customers and we have served them for years faithfully.

We are in a position to render quick service on quality products:—just the two items mentioned above. And we have the right prices.

Please let us quote on your requirements.

CRESCENT BRAID, Inc.
116 Elm St., Providence, R. I.

RADIO CABINETS BY UDELL



"55 Years
of Cabinet
Craftsmanship"

Fine radio engineering deserves a *Udell Cabinet*.

For 55 years the Udell cabinet craftsmanship has been recognized when fine woodwork is appreciated. Since the advent of the radio, "Cabinets by Udell" have come to signify quality and beauty.

See us at the
R. M. A. trade
show. Booth 72.
Demonstration
Room 512-A
Hotel Stevens

The UDELL WORKS, Inc.

28th St. and Barnes Ave.
INDIANAPOLIS, INDIANA

BUCK



Radio Tubes

Make more bucks with
"Bucks."

If you are interested in quick sales and big profits "Don't Pass the Buck"—"The Best for Less"—guaranteed for six months. Distributors from Coast to Coast. Write for the name of the one nearest you.

Buck up—
your sales
policy with

1. A unique original merchandising plan.
2. A complete line of Buck Tubes — all popular — A.C. and D.C. types.
3. Posters and sales boosters that "buck up" your trade.
4. The Buck Tube itself — "not a kick in a million."

Universal Electric Lamp Co., Newark, N. J.

Full, True, Rich Tones Without Distortion



Davis
DYNAMIC

Reproduces perfectly all the tones of the seven octaves of the orchestra range, without blare or distortion — mechanically and acoustically correct, whether the volume be adjusted to a whisper or to its maximum.

D. C. 6 volt
D. C. 90 to 120 volt
A. C. 105 to 120 volt

1930 Models

Manufacturer's Types

Designed for installation in all standard cabinets and suitable for all types of receivers. Our construction assures unequalled reproduction.

Write for circular and prices.

DAVIS INDUSTRIES, INC.

314 W. 43rd St. *Radio Division* CHICAGO, ILL.

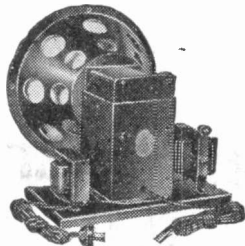



BUD
ANTENNA
ELIMINATOR
AND
SELECTOR

**BUD ANTENNA ELIMINATOR
AND SELECTOR**

Radio's Latest Contribution

The unsightly and troublesome aerial is at last replaced by the NEW BUD ANTENNA ELIMINATOR AND SELECTOR. This device will bring in distant stations on Electric Radio Sets with equal volume of a fifty foot Aerial. Will also improve the SELECTIVITY and cut down INTERFERENCE. Dealers and Jobbers are requested to write to us for additional information and discounts.

BUD
GROUND CLAMP

Attaches to water pipe by slipping the open jaws over pipe and screwing up on the bolt. No need of removing paint, rust or dirt from pipe as the jaws and the cone pointed bolt imbed themselves into pipe making a PERFECT ground connection.

BUD RADIO, INC.
Erie Building, CLEVELAND, OHIO

MARING

"The Nation's Finest Value In Magnet Wire"

Plain Enamel	Single Silk Enamel	Double Silk Covered
Single Cotton Enamel	Double Silk Enamel	Single Cotton Cov'd
Db'l. Cotton Enamel	Single Silk Covered	Db'l. Cotton Cov'd

ANACONDA WIRE & CABLE CO.
Magnet Wire Dept.
MUSKOGON, MICH., U. S. A.
Branches in Principal Cities

Symbol of
MARING
PROCESS
Quality

MAGNETWIRE

SEARCHLIGHT SECTION

EMPLOYMENT and BUSINESS OPPORTUNITIES—SURPLUS STOCKS—DISCONTINUED MODELS

UNDISPLAYED—RATE PER WORD:

Positions Wanted. 8 cents a word, minimum \$1.25 an insertion, payable in advance.

Positions Vacant and all other classifications, 12 cents a word, minimum charge \$2.50.

Proposals. 40 cents a line an insertion.

INFORMATION:

Box Numbers in care of any of our offices count 10 words additional in undisplayed ads.

Discount of 10% if one payment is made in advance for four consecutive insertions of undisplayed ads (not including proposals).

DISPLAYED—RATE PER INCH

1 inch\$7.50
2 to 3 inches..... 7.25 an inch
4 to 7 inches..... 7.00 an inch

Rates for larger spaces, or yearly rates, on request.

An advertising inch is measured vertically on one column, 3 columns—30 inches—to a page. Radio Retailing

POSITION VACANT

MERCHANDISING writer and editor wanted, with practical retail merchandising and advertising experience, and knowledge of radio or electrical trade. Unusual opportunity and adequate salary with strong publishing organization for man of ability and personality. Write fully, giving record of experience and stating salary expected. O. H. Caldwell, Radio Retailing, Tenth Ave. at 36th St., New York City.

POSITIONS WANTED

A young married man who has been a wholesale radio jobber's salesman selling sets and accessories to the radio trade in the state of Connecticut for the past three years, desires a position as salesman with some reliable manufacturer. Can furnish the best of references as to my character and ability. PW-97, Radio Retailing, Tenth Avenue at 36th St., New York.

RADIO department manager, now employed, desires to make change. Capable taking charge sales, service and repairs. Excellent references. PW-98, Radio Retailing, Southwestern Bell Tel. Bldg., St. Louis, Mo.

(Continued On Opposite Page)

To the Radio Industry

Advertising in connection with legitimate offers of surplus stocks and discontinued models of radio merchandise is acceptable in this section of *Radio Retailing*.

Extreme care will be exercised by the publishers to prevent the use of advertising in the Searchlight Section to encourage price cutting on current models of merchandise or equipment. Nor will advertising which invites violation of the dealer's contract with the manufacturer be acceptable.

All merchandise offered in the Searchlight Section must be accurately and fully described and must be available on order.

Surplus Stocks

Large or Small Quantity

Sell—

Argus Electric Sets
XL56 Console Grand
R.C.A. "B" Eliminators
245 Power Tube Adapter
Pooley Armchair Consolette
Large Patent Cone Speakers
3 Dial Freed-Eisemann Bat. Sets
A.C. Dayton Electric Table Model 63
Freed-Eisemann Large Cone Speakers
Federal All Electric Table Model No. H-10
XL50 Console with large Orthophonic Speaker
Freshman G4 Console 7x26 Table Type Cabinets

Buy—

We are ready to purchase Radio Sets, Parts and Speakers in any quantity.

**Bennie Ginsberg wants
to see you**

at the Hotel Stevens during the show.
Give him details of your surplus stocks, or
send them direct to our Brooklyn Office.

BROOKLYN RADIO
577 Myrtle Avenue Service Corp. Brooklyn, N. Y.

Mr. Manufacturer and Mr. Jobber!

We are outright cash buyers of surplus stocks of standard Radio Merchandise.

In fact we have cash resources that permit us to buy stocks of any quantity.

Before disposing of your next lot be sure to get our cash bid.

Upon receipt of complete details—such as make, models and amount of stock on hand—we will promptly submit our bid.

Write, wire or phone full details today.

Note: See our three pages following.

AMERICAN SALES CO., 19-21 WARREN ST., NEW YORK CITY

Ideal For Use With

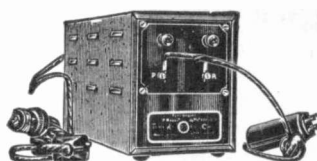

TIMMONS 210 Power Amplifier

Both of these high quality compact units use a 281 tube for rectifying and a U.X. 210 super power audio tube as an amplifier which gives distortionless and true natural reception with wonderful tone quality and volume.

Both instruments are identical in their performance as super power amplifiers. The Combination however is also a complete "B" Eliminator furnishing all the "B" current required by the regular tubes of the set.

List Price \$45.00
(without tubes)

Special **\$7.75**

Dynamic Speakers

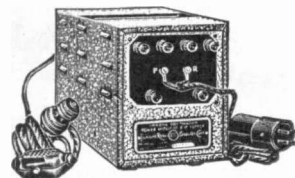

TIMMONS Combination 210 Power Amplifier and "B" Supply

No adjustments required and no output transformer or similar auxiliary equipment needed with either unit.

For use with alternating current 105-120 volts, 50-60 cycles. Every unit is brand new, packed in original factory sealed carton and fully guaranteed. They have been approved by Popular Radio and Popular Science Laboratories.

List Price \$70.00
(without tubes)

Special **\$14.50**

DeForest Output Transformer



1—1 ratio.

Improves tone and prevents burning out or demagnetizing of speaker unit from high voltage. Weight 1½ pounds.

List \$7.50

Special **95c**

TERMS: 20% cash with order, balance C.O.D. f.o.b. New York. (2% Discount for Full Remittance with order).

CABINET MANUFACTURERS Consoles Wanted

Large Department Store will purchase any quantity high grade cabinets. Highboy styles preferred . . . any style considered.

End stocks of previous cuttings . . . close outs in any quantities for immediate shipment.

Pictures, specifications and quantities should be submitted to:

W. P. SAUNDERS, Hotel Stevens, Chicago,
on June 4th, 5th and 6th.

Prompt and definite acceptance of propositions will be made if merchandise is offered at acceptable prices.

SALESMEN WANTED

Wanted

Salesmen on commission to sell radio cabinets. In your reply please state territory covered and lines carried. Premier Cabinet Corporation, Jamestown, N. Y.

Salesmen Wanted

To represent manufacturer of high-grade Radio cabinets selling direct to dealers, men of good standing and clean reputation able to sell merchandising as well as cabinets, commission basis with full protection, can be handled straight or as side line if not carrying cabinets. Some very desirable territory open. Call at room 421A, Stevens Hotel, during Radio show or write Aston Cabinet Manufacturers, 1223-9 West Lake Street, Chicago, Ill.

REPRESENTATIVES WANTED

Factory Representatives

New York manufacturer of condensers, resistances, transformers, desires factory representatives, experienced in selling manufacturers. Also a line for jobbers, such as replacement parts, line filters, 245 adapters, etc. Mayo Laboratories Inc., 281 E. 137th St., New York City.

REPRESENTATIVES AVAILABLE

EXPERIENCED manufacturers representative calling on the Cleveland radio trade. Wants to connect with good line. References and financially responsible. Address, WH 1028 E. 82nd St., Cleveland, O.

Manufacturers Agent and Representative ads on page 279.

PHENOMENAL!
Values

This radio equipment is KOLSTER built, packed in the original Kolster cases and cartons, shipped direct to us from the Kolster factory.

Every set and every Electro-Dynamic Reproducer is BRAND NEW; each bears the Kolster guarantee tag and original serial number.

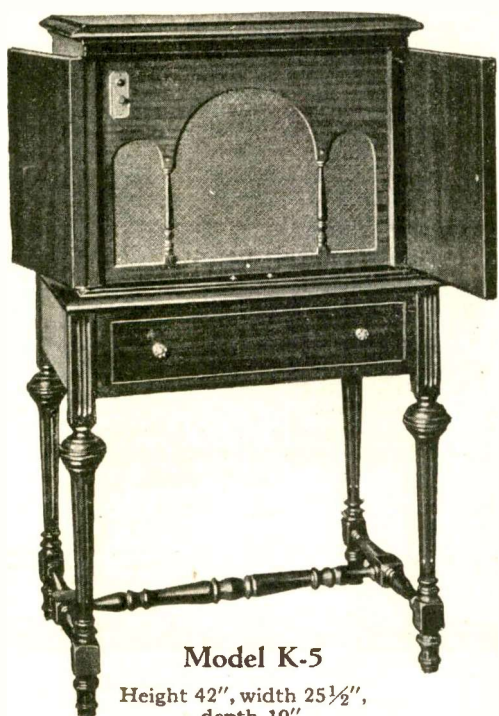

Model K-5

Height 42", width 25½",
depth 19"

~~List Price \$175.00~~

(Without Tubes)

\$33.50!

Lots of 5
or more **\$29.50** Ea.

FEATURES

1. Electro-Dynamic Reproducer (10¼-in. dia.)
2. 210 Power Amplifier. Fine tone quality.
3. Supplies "B" voltage, if desired.
4. Can be used with any electric or battery set.
5. Complete A.C. Electric operation.
6. Beautiful pencil-striped walnut cabinet.

GO!

K O L S T E R ELECTRO-DYNAMIC REPRODUCER

Combined with 210 Power Amplifier and "B" Supply Unit

THIS finely matched, rugged unit comprises a complete heavy duty Electro-Dynamic Reproducer, including a 210 Power Amplifier with "B" supply unit, all self-contained on a steel frame. It weighs 45 pounds without the cabinet. The cabinet itself is of pencil-striped walnut, beautifully designed with Cathedral grille. It is equipped with switch for control of house current to reproducer, power unit and amplifier. A pilot light indicates when the Reproducer is in operation.

If desired the 210 Power Amplifier will also supply 22, 67 and 90 volts "B" current, sufficient for any set using up to 8 tubes. An automatic voltage regulator tube, UX-874, maintains the "B" voltage silent and steady.

This Electro-Dynamic Reproducer can be used with any battery or A.C. set, replacing the last audio stage or be used with all tubes of the set. Wherever used, it will bring out every shading and range of tone; every note is reproduced with utmost faithfulness, pure and undistorted. It will modernize any radio receiver.

The following tubes are required for its operation: 2-UX-281 (for full-wave rectification); 1-UX-210 (for super power amplification); 1-UX-874 (for voltage regulation). For use with phonograph pick-up, one additional audio stage is recommended between the pick-up and this Reproducer.

A 20-ft. cable is included with each instrument. Operates direct from 50-60 cycle, 110-120 volt A.C. current.

Licensed Under Patents of the Radio

AMERICAN SALES COMPANY

TERMS: 20% cash with order, balance C.O.D. f.o.b. New

NO!

EXTRAORDINARY! Quality

By sending us your order today you take a big step toward eliminating the usual summer slump. In other words these Genuine Kolster Products will help make your summer business just as active as a peak period.

Our advice is to buy now, before the other fellow banks the money that should come into your store.

KOLSTER SIX TUBE CONSOLE RECEIVER With Built-in Kolster Electro-Dynamic Reproducer

THE entire set can be operated direct from the A.C. light socket, 50-60 cycle, 110-120-v., by simply adding any "A" supply unit and a small 4½-volt "C" battery. The built-in Electro-Dynamic Power Reproducer furnishes the "B" supply current to the set. A switch snaps the receiver in or out of operation and a pilot light tells instantly when set is in operation. The single dial control makes this the simplest of receivers to operate.

This receiver employs the famous Kolster T.R.F. circuit. It operates on either indoor or outdoor antenna using three stages of R. F., detector and two stages of A. F. The three point tap switch aerial adjuster operated from panel gives hairline selectivity. A loose coupled coil in conjunction with tap switch increases the distance getting value of the receiver. In addition, the 210 power amplifier built into the model K-5 Dynamic Reproducer, achieves remarkable tone quality. In this receiver is embodied everything looked for in modern radio.

The combination Kolster Set and Electro-Dynamic Reproducer is housed in a beautiful console of burled walnut with maple overlay. Full swinging doors found only in the finest cabinets add to its beauty.

The receiver uses 6-UX 201-A tubes and the Electro Dynamic Reproducer uses 2-UX 281, 1-UX210, and 1-UX 874 tubes.

Corp. of America and Lektophone Corp.

19-21 Warren St., New York City

York. (2% Discount for Full Remittance with order).

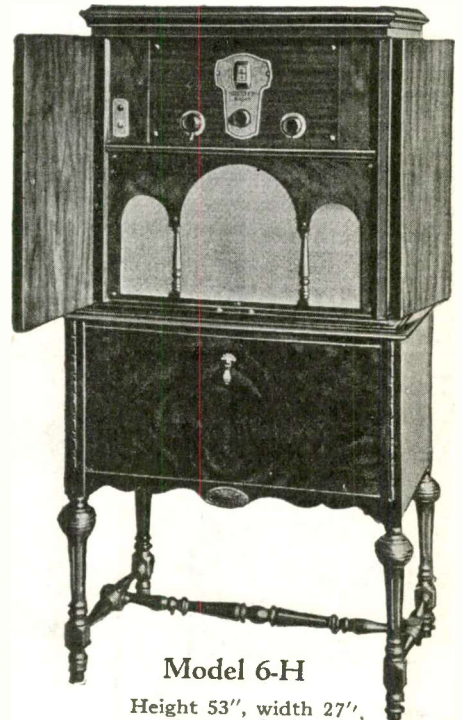

Model 6-H

Height 53", width 27",
depth 18½"

~~List Price \$295.00~~

(Without Tubes)

\$48.50!

Lots of 5
or more **\$44.50** Ea.

FEATURES

1. Beautiful highboy console of burled walnut with maple overlay.
2. Kolster K-5, Electro-Dynamic Reproducer with built-in 210 Power Amplifier included for fine tone quality (see opposite page).
3. Famous Kolster 6-tube T.R.F. circuit.
4. Hairline selectivity. Distance Reception.
5. Single dial control—simple to operate.

Another Page of Astounding Bargains

KOLSTER SIX TUBE CONSOLE RECEIVER

With Built-in Magnetic Cone Speaker
(for Battery operation)

This receiver employs the famous Kolster T.R.F. circuit. It operates either on indoor or outdoor antenna, employing three stages of R. F., detector, and two stages of A. F. The three point tap switch aerial adjuster operated from panel gives hair-line selectivity. A loose coupled coil in conjunction with tap switch increases the distance getting value of the receiver.

Either a 112-A or 171-A Power tube can be used in last audio stage.

This is the famous Kolster's battery outfit. It has won world-wide fame for selectivity, distance and tone quality. Single dial control makes this Receiver simple to operate.

Uses 5-UX-201A tubes and 1-UX-112A or 171A power tube.

The Kolster double magnet powerful Magnetic Cone Speaker built into this set insures wonderful tone quality.

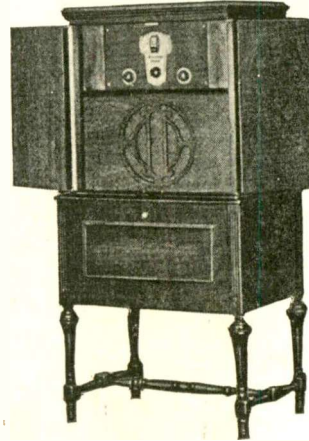

Model 6-G
Height 51 5/8", width 27",
depth 17 1/2"
List Price \$185.00
(Without Tubes)

FEATURES

1. Beautiful walnut highboy console.
2. Powerful Magnetic Cone Speaker. Fine tone quality.
3. Remarkable selectivity. Distance reception.
4. Famous Kolster six-tube T.R.F. circuit.
5. Uses a power tube (112-A or 171-A).
6. Single dial control; simple to operate.

\$35.50

THE NEW GOULD KATHANODE

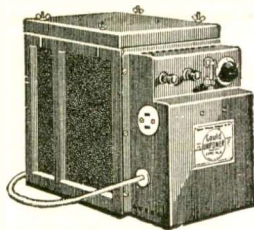

Unipower

GOULD PRODUCT

(With Built-in Relay)
AUTOMATIC

Radio "A" Power
From Light Socket

Model A.C.,—6 K (Six Volt)

Furnishes rich, smooth, unflinching "A" current, without any trace of hum. No rewiring necessary in your set. Equipped with a new noiseless Balkite Charging Unit which has four graduated charging rates and in addition one booster rate (1 1/2 amperes) for an emergency charge, which enables it to properly take care of all sizes of sets and conditions of operation. Operates on 110-120 V., 50-60 cycle A.C. current. Complete with extra fuse.

Can be used with Kolster Sets.

LIST PRICE \$39.50 EA.

Special \$9.75 Ea.

Lots of three, \$8.50 Ea.

Lots of six, \$7.50 Ea.



Dubilier

High Voltage Filter Condensers
(Newest Types Nos. 902 and 903)

These Dubilier Filter Condensers are tested from 3 to 5 times their rated value. Widely separated soldering lugs are provided to insure long leakage paths.

Each Condenser brand new and packed in individual carton.

Type 902. Rated D.C. Working Voltage 400 V.	Capacity	List price	Special
	1	\$2.50 ea.	\$0.50 ea.
	2	3.50	.70
	4	5.50	1.10

Type 903. Rated D.C. Working Voltage 600 V.	Capacity	List price	Special
	1	\$3.00 ea.	\$0.60 ea.
	2	5.50	1.10
	4	9.50	1.90

Genuine RCA UX200 Radio Tubes

These excellent detector tubes draw one amp.

SPECIAL PRICE 13^{c.} ea.

\$6.50 per Carton

Sold only in Carton Lots of 50

Due to the extreme low prices of these tubes, we cannot allow replacements. However, every tube is brand new and packed in the original factory sealed carton, we having purchased them direct from the Radio Corporation of America.



List Price \$1.75 ea.

MANUFACTURERS AND JOBBERS

We are prepared to offer cash for surplus stocks of Radio Merchandise. This means of course stock in first class condition and in such volume that insures a good value to our many established buyers. Send details of your offerings for quick action.

POWERIZER



PXY-1 MODEL R-20

Complete "A B & C" Eliminator
and 210 Power Amplifier

It is a "B & C" Eliminator furnishing "B & C" current to the entire Radio Set, also a Super Power Amplifier furnishing "A, B & C" current to the 210 power amplifying tube. Simple to connect, no rewiring necessary in the set. Comes equipped with an adapter plug which is inserted in the last audio tube socket. Has filament windings which will also supply A.C. current for the A.C. tubes, if desired. Uses the UX-210 super power and the UX-280 full wave rectifying tubes. Using this Powerizer with any Battery or Electric Set will bring out the finest tone reproduction and volume, comparable with the results obtained from any of the best modern receivers.

Operated direct from light socket; 110-120 V., 50-60 cycle, A.C. current.

LIST PRICE \$59.00 EA.

Special \$15.00

(Complete with Harness)

AMERICAN SALES COMPANY, 19-21 Warren St., New York City

Never before was there an offering like this

Chelsea All Electric Sets are all that any one could ask for. It is radio merchandise that builds good will for the progressive radio dealer.

It also helps build up profits! Just notice our special dealers price.

CHELSEA TREASURE CHEST
7 Tube All Electric

Uses 4—UX-226; 1—UY-227; 1—171-A and 1—UX-280 rectifier tube.

DIMENSIONS—24¾ in. wide, 12¾ in. deep, 12¾ in. high. Weight, 48 lbs. Shipping weight, 72 lbs.

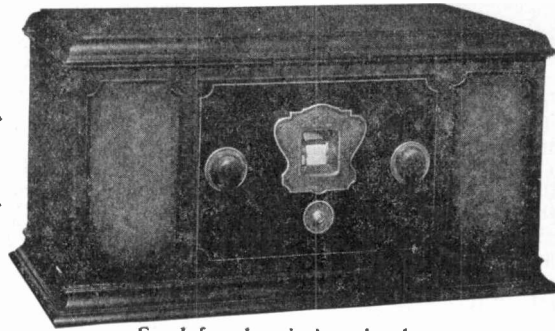

All these sales aiding features

Newly developed circuit.
One knob control, illuminated dial graduated from 0 to 100.

Popular style snap switch.

Jack for phono-pickup.

Built in hum adjuster.

Pressed Steel Chassis.

Exceptionally beautiful Cabinet made of selected woods, with Genuine Maple Burl panels. Lacquer mahogany finish.

Send for descriptive circular

Write, wire or telephone Astoria
your order today! 5492

List Price,
\$110.00
Special Dealers
Price

\$35.00

Special topless table for this set with built in 104A inductive dynamic speaker.
List price \$45.00 Special \$13.50

Makes an excellent combination with the Chelsea Set.

Jackson Radio Company

66-68 Patterson Ave., Long Island City, N. Y.

Terms: 3% discount on full remittance, or 20% with order, balance C.O.D.

FOR EVERY
BUSINESS WANT

"Think Searchlight First"

G-3

LOG BOOKS

RADEX calibrates any set. Just enter dial readings and you can see at a glance the wavelength you are tuned to. Users say it doubles their satisfaction. Sells everywhere 25c. Dealers \$2.00 a dozen.

THE RADEX PRESS
P. O. Box 143, Cleveland, Ohio

Lertzman Factory Sales

Manufacturer's Agent

Would like to take on radio lines, will be registered Stevens Hotel RMA Show.

510 Insurance Center Bldg.
Cleveland, Ohio

Get in Touch with
RAYMOND ROSEN
or **AL. J. SLAP**
Stevens Hotel, Chicago
(Week of Radio Show)
Final Disposal
Balance EXIDE and
WILLARD Power Units

FOR 25 OR 60 CYCLE CURRENT

If not attending the show write for special reduced prices to

RAYMOND ROSEN & CO.

49 N. 7th St., Philadelphia, Pa.

MANUFACTURERS REPRESENTATION
STONER & HEATH, Inc.

122 Greenwich St.
New York City

WESLEY W. S. SCHARP, Pres.
Manufacturers Agts.

Audak Co. Central Radio Labs
Bodine Elec. Co. Hygrade Lamp Co.

\$100,000

Ready for cash buys

Radio Sets Eliminators
Accessories Speakers, etc.

Write or Wire.

Perry Radio Corporation
79 Cortlandt St., New York City

MURDOCK AC Neutrodyne Receiver Model 1-A

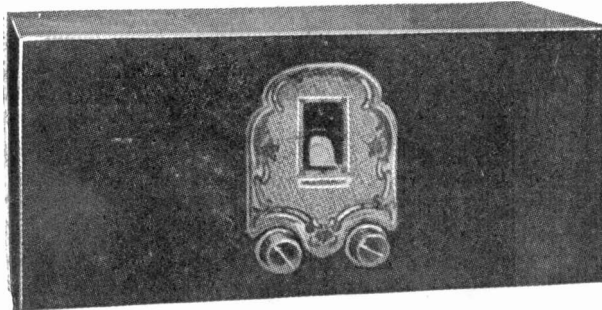

A compact seven tube all-electric receiver operating directly from the lighting current. Uses five AC 226, one AC 227, one AC 171A and one 280. It is completely shielded and all tuning is controlled by a single dial. Station settings are indicated by an illuminated rotating drum. Receiver is noted for its selectivity and tonal quality and is approved by the supercritical. Power pack used to operate this receiver is manufactured by the ACME MFG. CO., Cambridge, Mass. Overall dimensions: Height 9 in., width 20 in., depth 10 in.

List Price \$125.00

June Price \$25.00

MURDOCK Model 2-A

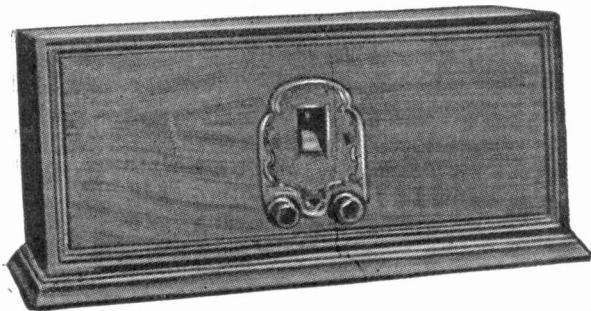

Same receiver as the Model 1A only it is enclosed in a genuine mahogany cabinet. Front panel is of the same wood finish as the cabinet and is equipped with knobs and richly embossed escutcheon plate, together with illuminated dial.

List Price, \$150.00

June Price \$27.50

MOHAWK NAVAJO



Six tube, one dial illuminated. Shielded R.F. with three audio and one output transformers. Which gives unequalled volume and tone quality. Battery operated.

List Price, \$75.00

Special June Price \$16.00

Clearance Sale

KING

Model FF ^{6 Tube} AC Electric

Genuine Licensed
All Electric
Neutrodyne

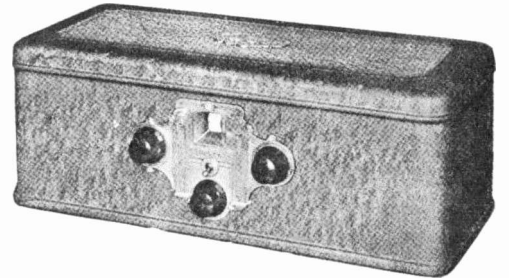

Here's a wonderful profit maker

at almost unbelievable low price. A result of a fortunate cash purchase of the manufacturer's entire supply, making it possible for us to offer this quality receiver at a price far below the maker's cost.

Every receiver packed in original factory sealed carton with a booklet of full instructions.

Just a few features of this receiver.

—employs six new type AC tubes.

- single drum control illuminated dial.
- marked in meters and kilocycles.
- beautiful brown bronze two-tone all metal cabinet.
- distance—selectivity greater than many high-priced sets.
- tone—deep, mellow and natural.
- compact—cabinet measures 19 in. long, 8 in. deep and 7 in. high.

List Price, \$110.00 less tubes

Special June Price \$27.50

A-C DAYTON
RADIO

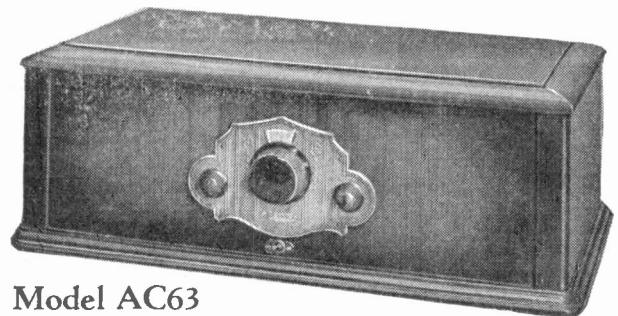

Model AC63

Complete for AC operation, uses four AC 226, one AC 227, one 171A and one 280. Has three stages TRF, tuned detector and two stages of 3 to 1 transformer coupled audio frequency amplification.

The set is enclosed in a handsome walnut cabinet with four way matched fancy veneer top. Size of cabinet overall, 19" long, 11 1/4" deep, 8" high.

List Price, \$115.00

Special June Price \$30.00

Model 65 This set has the same characteristics and design as the AC 63 except that it uses a 210 power amplifier in the last stage, utilizing 400 volts to operate this tube and giving the same results as the Panatropo or any electrical power amplifier. Size of cabinet same as Model 66.

List Price (less tubes), \$123.00

Special June Price \$32.50

Model 66 Utilizes the new No. 222 Shielded Grid Tube in addition to the new No. 250 —25 power watt amplifier, giving the latest word in sensitivity and volume with perfect tone quality.

Volume control, antenna vernier

List Price, \$143.00

Special June Price \$35.00

control and single large center tuning dial are mounted on escutcheon plate of antique bronze.

Handsome walnut cabinet with four way matched fancy veneer top is 24 inches long, 12 inches deep, 8 1/2 inches high with rounded corners.

See one of our three representatives at the Stevens Hotel—Harry Antin, Al. Rothenstein and Alexander Wellington. Will all be at the Chicago Show.

PARK RADIO SERVICE

Have your name put on

During June Only!

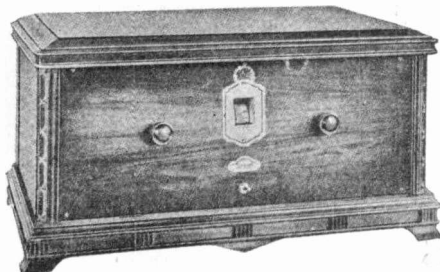

SLEEPER

All Electric Receiver

Monotrol, Jr.

Table Model

Uses 8 Tubes

Two UY227, three UX226 as amplifiers, two UX171A power tubes in push-pull, and one UX280 full wave rectifier.

The Monotrol, Jr., embodies the simple tuning efficiency demanded by the public today. It has one dial to rotate the electrically illuminated wave length dial—the other knob is for volume control to allow any intensity from great concert volume down to a whisper.

Special connection is provided for supplying the exciting current required by dynamic speakers.

The front panel of the Monotrol is of magnificently grained wood backed by metal to insure strength and permanence, as well as electrical shielding. Bronze escutcheon serves as complete control unit.

Unlimited reserve power and great distance getting ability are features of the new Monotrol, Jr. Receiver. Also has Phonograph Pick-up.

Special June Price \$35.50



FADA No. 7

Console Model

(Battery Operation)

Seven tubes, complete individual stage shielding, four stages radio frequency, detector and two stages of audio frequency amplification. Solid pressed steel chassis. Dual tuning control with "on-and-off" switch and volume control combined in one.

29 in. long, 50 in. high, 17 in. deep. Approx. weight 92 lbs. Cabinet of walnut.

List Price \$285.00

Special June Price,

\$57.50

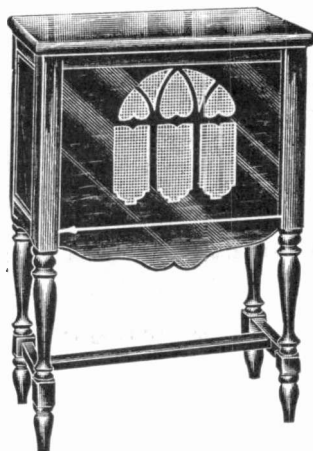

JENSEN DYNAMIC REPRODUCER

The Reproducer that has set a new standard of tonal quality in Radio reception. An unusual buy. Complete as illustrated. Only a limited quantity in stock. Sold subject to prior sale.

List Price \$62.50

Special June Price,

\$18.50

All units offered in this advertisement are BRAND NEW, packed in original factory sealed carton and fully guaranteed! TERMS: 20% cash with order, balance C. O. D. f.o.b. New York. (2% Discount for Full Remittance with Order.)

INC., 72 Grand Street, N. Y.

our preferred dealer list.

BROWNING DRAKE

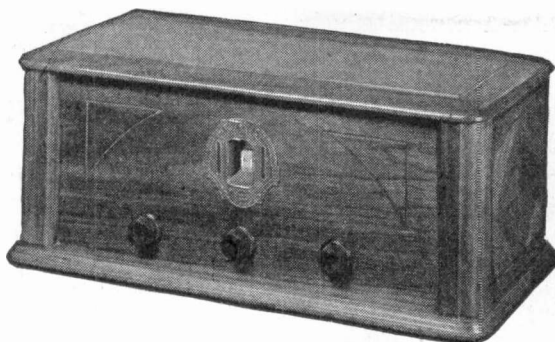

This is the greatest all-electric set ever designed in its class. Uses five 226 AC tubes, one 227 AC Detector, one 171 power tube and one 280 rectifier—eight tubes in all.

The Browning Drake has a built-in phonograph pickup attachment and works with either Dynamic or Magnetic Speaker. One Dial control beautifully illuminated.

List Price, \$135.00

June Price \$37.50

Model AC21

AMPLION

Lion Cone Speaker



A bronze finish Cone, 14 inches in diameter, mounted on an 18-inch walnut sounding board. Height 20 1/2 inches, including bronze moire base.

Armature unit used in the Lion is the latest and most scientific development in unit construction.

List Price, \$25.00

June Price \$4.50

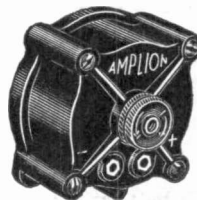

AU6X UNIT

with Cord

Designed for use on any phonograph or horn. It is an unusually powerful unit that will deliver great volume in all frequencies, even without a power amplifier. Amplion Model AU6X is the finest phonograph unit ever offered at any price. Sold only in dozen lots.

June Price, \$10.00 per dozen



FADA
CONE SPEAKER

List Price, \$35.00

Model 415B Table Model

June Price, \$9.00

Model W15B Wall Type

June Price, \$8.50

Quality Merchandise
at Low Prices such as
these never fails to
allure the cautious
buyer

R. C. A. Licensed

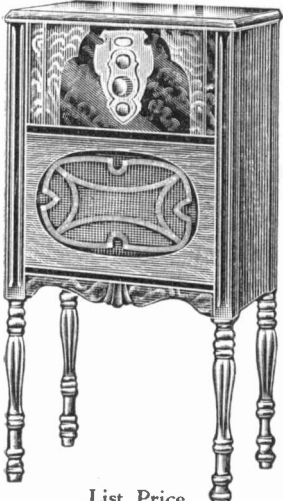

List Price
\$119.00 (Less Tubes)

Our Price
\$39.50

Uses 4—220, 1—227, 1—171-A
and 1—280 rectifier tube.

MOHAWK
Electric Set

An all-electric set that will enable you to combat the summer slump. Take advantage of this new low price. The tone and beautiful console will sell the set on sight. Remarkable built-in speaker gives clear undistorted tone.

Complete with Guaranteed
Air Hawk tubes \$46.50

RAMBLER
Portable Receiver

A portable job built by a well-known manufacturer. This portable is guaranteed and at the price could not be duplicated anywhere. June, July and August—months of sales and profits for you—order a sample today.

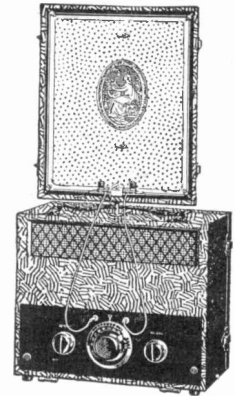

List Price
\$57.50

Our Price
\$29.50

Uses 5—UX199 tubes at 75c. ea.
2—45 volt "B" Battery, \$1.50 ea.
3—Dry cells at 25c. ea.
All guaranteed perfect in every respect.

Complete \$35.00
with Batteries and Tubes



Sell your customer *noiseless* electric set operation.

FILTERVOLT filters out the buzz, hums and noises that are so annoying in many electric set installations.

FILTERVOLT has taken the market by storm because it has lived up to every claim made for it.

Our Price
\$8.82

FILTERVOLT, JR.

For eliminating minor line noises caused by electric toasters, electric grills, small motors, switching on and off of lights, etc. Very effective as a light duty eliminator. Installs in the same simple manner as does large FILTERVOLT.

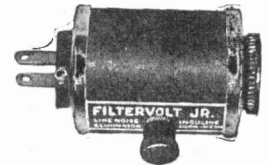

Our Price \$1.75

SELECTUNER

Reduces Static Interference... Separates Stations over the entire wave band... Cuts right through the locals... Enhances quality of reproduction... Installed without tools or circuit changes... For any set, anywhere... Write for details... This is a real seller.

A necessary summer item

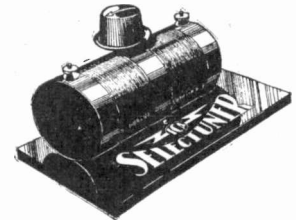

Our Price 88c.

Nathaniel
BALDWIN
MAGNETIC REPRODUCERS
ENCASED IN A BEAUTIFUL GOTHIC
CABINET
PROMPTLY FILLED

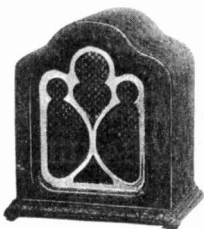

Our Price
\$6.75

SPEAKER COMPARATOR

In home or store you often want to operate two speakers together, or each separately, and this speaker switch does the trick! Enclosed in moulded Bakelite case.

Useful
Handy



No. 2 Relay. List price... \$2.50

Our Price
\$1.10

NOTE:
Write for our
Complete Price
List

VENUS RADIO CORP.

142 Liberty St., New York, N. Y.

RECTOR 7190-7191

TERMS:

20% with order
Balance C. O. D.
2% discount for
full remittance

SUMMER SALES BOOSTERS



Net \$7.50

Mayola Improvatore 245 Adapter

Will convert any electric or battery set into a modern receiver—the results of which will be the same as any of the new sets that are being put on the market at the present time. The 245 tube will produce more volume and better tone quality and outlast any 171 or 112 tube.

Dynamic Speakers require more power to operate them efficiently, even more than the 112 or the 171 tube will deliver. The new 245 Super Power tube is the last word in tube construction. The Mayola Improvatore 245 adapter makes it possible to replace the present 171 and 112 tubes. The Improvatore delivers the correct filament voltage and automatically regulates the C biasing. Modernize your customers' sets with the Improvatore and make extra profits during the summer months.

Mayola Line Filter



Net \$6.85

Takes the noises originated in the electric lines out of any electric or electrified set. It can be connected to the set and

will greatly improve reception, but if connected directly to the source of trouble such as oiled condensers, electric refrigerators, motors, etc., it will completely kill all noise. Line filter is a result of long months of experimenting, and is designed along the lines devised by the Bureau of Standards.

Mayola Combination B Eliminator and 245 Adapter

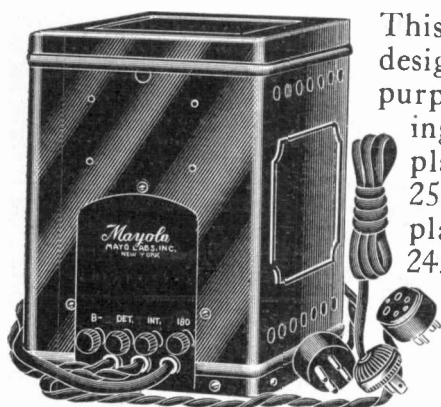

This unit has been designed for the purpose of supplying the correct plate voltage of 250 volts to the plates of 1 or 2-245 power tubes.

This unit also has taps for the detector and inter-

mediate voltages. It also supplies the correct C bias for 2-245 tubes.

It is unnecessary to make any changes whatsoever in the receiver, as each unit is furnished with 2 adapters which are placed in the power tube sockets of the set.

The net price is \$13.50

Mayola Majestic Eliminator Replacement Condenser Block

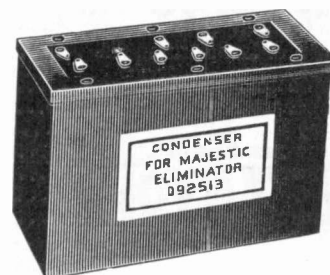

Net \$4.50

In lots of 6 \$25.00

A replacement block for Majestic eliminators, which is guaranteed by the Mayola Laboratories for a period of one year. The condensers in this block are all composed of high voltage condensers, and you can be assured that once this block is replaced it will last indefinitely.

Wire Wound Resistance on Baked Lava Tube



100 to 15000 ohms Variable Res.

This variable wire wound resistance designed for heavy duty work can be used on any radio circuit such as B eliminators, amplifiers, electric sets, etc. When the desired voltage is obtained it can be set and it will not vary due to the positive contact and absence of chemical properties such as used in other types of variable resistances. This unit aside from being electrically perfect, is low in price and will take the place from 2 to 4 variable resistances. List \$1.50.

Net price, each 75c. Net 65c. doz. lots

All of the above units are manufactured by the Mayo Laboratories of New York City, who are manufacturers of By-Pass Condensers, Filter Condensers, Resistances, Transformers, and who are supplying some of the prominent set manufacturers.

Federated Purchaser

A National Organization Serving Over 10,000 Retail Merchants

16-22 Hudson Street, New York, N. Y. Telephone Barclay 7583 7584

If you have not received our May 24th "Radio Bargain News," send for FREE copy today. It contains \$100,000 worth of radio merchandise at prices more than 75% off the regular list.

ALPHABETICAL INDEX
TO ADVERTISEMENTS

	Page		Page
A-C Dayton Co.	14-15	Radio Cabinet Mfgs.	33
Acme Apparatus Co.	266	Radio Corp. of America,	
Acme Electric & Mfg. Co.	237-238	102-103, Back Cover	
Acme Wire Co.	262	Radio Master Corp.	30-31
Actron Tube Co.	267	Radio Prod. Co.	271
Adler Mfg. Co.	27-183	Radio-Victor Corp.	54-55
Aero Prod. Co.	216	Readrite Meter Works	252
Allan Mfg. Co.	170-171	Red Lion Cabinet Co.	145
Allen Hough-Carryola	149	Rola Co.	138
Aluminum Co. of America	16	R-V Mfg. Co.	258
American Bosch Magneto Co.	172-173-191	Samson Electric Co.	140
American Furniture Mart.	34-35	Sentinel Mfg. Co.	147
American Reproducer Corp.	56	Shelby Co.	249
American Weekly	6	Shortwave Radio & Television Co.	233
Amrad Corp.	210-211	Silver-Marshall, Inc.	214-215
Anaconda Wire & Cable Co.	273	Sonatron Tube Co.	7
Andrea, F. A. D.	47-48-49-50	Sparks-Withington Co.	Front Cover
Arcturus Radio Co.	166-167	Sprague Specialties Co.	269
Aston Cabinet Mfrs.	262	Standard Radio Co.	272
Atwater Kent Mfg. Co.	21-22-23-24	Steinite Radio Co.	Inside Back Cover
Audak Co.	13	Stewart-Warner	176-177
Audiola Radio Co.	194	St. Johns Table Co.	36
Automatic Radio Mfg. Co., Inc.	65	Stromberg-Carlson Tel. Mfg. Co.	2
Bakelite Corp.	261	Sylvania Prod. Co.	76-202-203
Balkeitt Radio Co.	255-256	Temple, Inc.	217-218-219-220
Beede Elec. Instrument Co.	268	Thermatrol Mfg. Co.	271
Belden Mfg. Co.	195	Thordarsron Elec. Mfg. Co.	118
Best Mfg. Co.	192-193	Tower Mfg. Corp.	263
B-L Elec. Mfg. Co.	72	Transformer Corp.	154-155
Bodine Electric Co.	239	Trav-Ler Mfg. Corp.	43
Bohn Aluminum Corp.	46	Triad Mfg. Co.	161-162
Bond Elec. Corp.	174-175	Udell Works, Inc.	273
Brandes Prod.	146	Union Furniture Co.	32
Bremer Tully Mfg. Co.	212-213	United Radio Reproducers	
Brunswick-Balke-Collender Co.	208-209	187-188-189-190	
Buckingham Radio Corp.	240-241	United States Radio & Television Co.	
Bud Radio, Inc.	273	196-197	
Bush & Lane Piano Co.	160	Universal Elec. Lamp Co.	273
Cable Radio Tube Corp.	10-11	Universal Winding Co.	258
Capehart Auto. Phono. Corp.	204-205	Utah Radio Prod. Co.	3
Cary Cabinet Corp.	42	Vacuum Tube Prod. Corp.	52
Caswell Mfg. Co.	73	Valley Appliances	125
Caswell-Runyan Co.	29	Van Horne Tube Co.	53
Ce Co Mfg. Co.	62-63	Walbert Radio Corp.	178
Central Radio Lab.	51	Walker Co., Geo. W.	148
Champion Radio Wks., Inc.	126-127	Ward Leonard Co.	236
Colonial Radio Corp.	184-185	Wasmuth-Goodrich Co.	284
Continental Radio Corp.	164-165	Webster Co.	264
Columbia Woodturning Co.	271	Webster Elec. Co.	168-169
Cornish Wire Co.	266	Weston Elec. Instrument Co.	206
Crescent Braid Co.	272	Wirt Co.	248, 265
Crosley Radio Corp.	44-45	Wright De Coster, Inc.	260
Cunningham, Inc., E. T.	139	Zenith Radio Corp.	64
Davis Industries	273		
Day Fan Elec. Co.	158-159		
DeForest Radio Co.	228-229		
Dexter & Sons, Inc., C. H.	264		
Dooley Elec. Mfg. Co.	221-222-223-224		
Duovac Radio Tube Corp.	231		
Ebert Furniture Co.	28		
Eby Mfg. Co., H. H.	137		
Edison Co., Inc., Thos. A.	57-58-59-60		
Electrad, Inc.	258		
Electric Service Supplies Co.	269		
Emerson Radio Co.	68-69		
Erla Co.	163		
Essenbee Radio Devices	272		
Excel Phono. Mfg. Co.	243		
Excello Products Corp.	247		
Farrand Mfg. Co.	Inside Front Cover		
Findlay Mfg. Co., Inc., Robert.	207		
Fischer Furniture Co.	245		
Freed Eisemann Radio Corp.	116-226-227		
Freese & Sons Co., J. D.	246		
French Battery Co.	128-129		
Freshman Co., Inc., Chas. H.	116-152-153		
General Amplifier Co.	260		
Gold Seal Elec. Co., Inc.	156		
Gordon Co., L. S.	259		
Grebe & Co., Inc., A. H.	4-5		
Grigsby-Grunow Co.	12		
Gulbransen Co.	250-251		
Holcomb & Hoke	253		
Hygrade Lamp Co.	157		
Hyvac Tube Co.	234		
Insuline Corp. of America	198		
International Resistance Co.	61		
Janette Mfg. Co.	269		
Jensen Radio Mfg. Co.	130-131		
Jewell Elec. Instrument Co.	225		
J-M-P Mfg. Co., Inc.	269		
Juno Fasteners, Inc.	254		
Kellogg Switchboard & Supply Co.	134-135		
Kennedy, Inc., Colin B.	17-18-19-20		
Ken-Rad Corp., Inc.	136		
Kersten Radio Equip. Co.	267		
Knoxville Table & Chair Co.	25		
Kolster Radio Corp.	150-151		
La Salle Radio Corp.	8-9-230		
Lund Corp., I. A.	242		
Magnavox Co.	132-133		
Marvin Radio Tube Co.	199-200		
Master Eng. Co.	270		
McGraw-Hill Pub. Co.	270		
Miles Mfg. Corp.	272		
Mills Novelty Co.	235		
Munder Elec. Co.	232		
National Carbon Co.	66-67		
National Carbon Co., Raytheon Div.	37-38-39-40		
New York Times	41		
Operadio Mfg. Co.	186		
Oxford Radio Corp.	201		
Pacent Elec. Co.	74-75		
Perryman Elec. Co.	141-142-143-144		
Philadelphia Storage Battery Co.,	179-180-181-182		
Pierce Airo, Inc.	268		
Platt-Rubin Co.	244		
Pooley Co.	26		
Premier Elec. Co.	270		
Premax Prod. Inc.	257		
Quinn Tube	70-71		
Radio Cabinet Co.	262		

SEARCHLIGHT SECTION
Classified Advertising

American Sales Co.	276-77-78
Books and Periodicals	279
Brooklyn Radio Co.	274
Business Opportunities	274
Employment	274
Federated Purchaser	283
Jackson Radio Co.	279
Park Radio Service	280-281
Perry Radio Corp.	275
Radex Press	279
Rosen & Co., Raymond	279
Saunders, W. P.	275
Venus Radio Corp.	282

Attention . . .

Manufacturers Representatives

FOR the benefit of the industry, RADIO RETAILING'S market analysis department maintains an up-to-date list of manufacturers' representatives throughout the country. Information on agents, together with lines carried, is available to manufacturers without charge. To enable us to correct this list, RADIO RETAILING would appreciate hearing from agents handling radio lines giving information on products carried and territory covered.

Address: Market Analysis Department
RADIO RETAILING
Tenth Avenue at 36th Street, New York City

Fine Radio Cabinets fashioned by Master Craftsmen

Wasmuth-Goodrich Company
Peru, Indiana

In New York 103 Park Avenue



Sensation of the Show»»

Model 40→

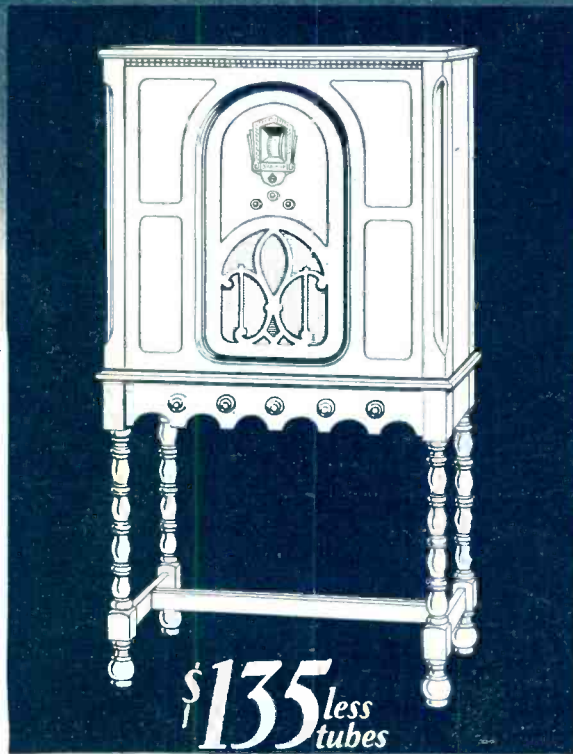

\$135 less tubes



Model 45
\$165 less tubes

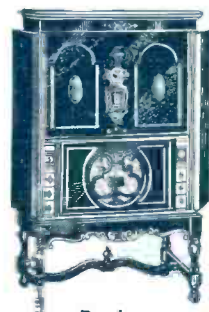

Radio
Phonograph
Combination
\$250 less tubes

Steinite

ELECTRIC RADIO

Dealers who have not yet seen and heard the new Steinite, will find it the sensation of the R. M. A. Show . . . Not only is each Steinite model supreme at its price; it is a triumphant competitor to radios of much greater cost. The cabinets are handsome in design, with rich, hand-rubbed finishes. The electro-dynamic speakers produce a tone of amazing fidelity. The coils are copper shielded and the rugged chassis is steel covered. Four condensers and five 227 tubes place the Steinite apart from older, obsolete types; and make possible unusual sensitivity and selectivity. Never before a radio like this at so low a price! Steinite Radio Company, General Sales Offices: 506 South Wabash Avenue, Chicago, Illinois.
EXHIBITION HALL, STEVENS HOTEL—SPACES 123, 124

America's Greatest Value»»» Radio's Greatest Thrill

Announcing—
a new RCA Radiotron
UY-224
SCREEN-GRID

The new A. C. Screen-Grid Radiotron is the creation of the associated Research Laboratories of RCA, General Electric and Westinghouse. It was years under test and development before the scientists and engineers were ready to release it to the public. UY-224 is an amplifier or detector Radiotron for use in specially designed radio receiving sets operated by alternating current.

Superior resources of research and manufacturing guarantee to RCA Radiotrons the finest quality in vacuum tubes. They are the standard of the industry—and are so accepted by the trade and public.



Look for this mark
on every Radiotron



RADIO-VICTOR CORPORATION OF AMERICA • NEW YORK • CHICAGO • ATLANTA • DALLAS • SAN FRANCISCO
RADIOTRON DIVISION

RCA RADIOTRON

RADIOTRONS ARE THE HEART OF YOUR RADIO SET