

# Radio Retailing

*The Business Magazine of the Radio Industry*

A McGraw-Hill Publication

JULY, 1928

## FRESHMAN PRESENTS

A NEW CONSOLE

A NEW COMPACT



A NEW SPEAKER



*That are not just New  
but Better!*

*and the  
mystery.....???*

With the "M" Models and the great Mystery, Freshman dealers have the best proposition in radio! The most complete all-electric line in radio history — and popularly priced! No slow-movers — rapid stock turnover!

**CHAS. FRESHMAN CO., Inc.**

Freshman Bldg., New York City

CHICAGO

LOS ANGELES

2626 W. Washington Blvd. 800 N. Spring St.



**D Y N A M I C**  
Model 70—Gothic table-type. Two-tone walnut cabinet, 12 inches in height. For A.C.—D.C.—or storage battery operation . . . . . \$50

Even if Farrand—recognized leader in the Speaker field—were

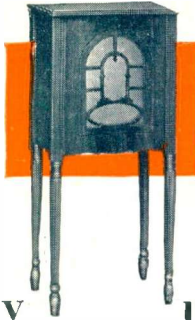

**D Y N A M I C**  
Model 74—Tiffany Table of two-tone walnut, 36 inches in height. For A.C.—D.C.—or storage battery operation. \$75

entirely unknown, the present Farrand line—standing on



*Balanced Armature*  
Model 64—Farrand Junior (Clock-type). Bronzed metal cabinet, 12 inches in height. Greatest speaker value ever \$19.50 offered . . .

its own feet, voicing its own outstanding merit—would instant-



*Balanced Armature*  
Model 62—Farrand Panel. Richly carved, two-tone walnut frame, 12 inches in height. \$25

ly establish Farrand supremacy. Eleven wonderful models.



*Balanced Armature*  
Model 60—Gothic table-type. Two-tone walnut cabinet, 12 inches in height. . . . \$35

# Farrand

FARRAND MANUFACTURING CO., INC. — LONG ISLAND CITY, N. Y.

Radio Retailing, July, 1928. Vol. 8, No. 1. Published monthly. McGraw-Hill Publishing Company, Inc., Tenth Avenue at Thirty-sixth Street, New York, N. Y. \$2 per year. 25 cents per copy. Entered as second-class matter, April 10, 1925 at the Post Office at New York, N. Y., under the Act of March 3, 1879.

EARL WHITEHORNE,  
Editorial Director  
RAY V. SUTLIFFE,  
Western Editor, Chicago  
HENRY W. BAUKAT,  
Technical Editor  
S. J. RYAN,  
Merchandising Counsellor

# Radio Retailing

The Business Magazine of the Radio Industry

WILLIAM ALLEY  
Managing Editor

Editorial Staff  
HARRY PHILLIPS  
LEWIS F. KENDALL, JR.  
OVID RISO  
C. GRUNSKY, San Francisco  
PAUL WOOTON, Washington

## Table of Contents, July, 1928

An Impression from the Trade Show.....	35
Factors to Keep in Mind when Placing Fall Buying Orders .....	36
Fine Furniture for Summer Sales.....	39
Dynamics Dominate Trade Show.....	40
"Atmosphere"—A Sales Asset.....	42
Music Industries Convene at New York.....	44
A Radio for Every Business Office.....	46
Jones Announces New Circuit.....	48
Patent Interchange Adopted.....	49
Keep a Written Record of Every Sale.....	50
Some Unusual New Radio Windows.....	53
Business Does Not Come to Him Who Waits.....	54
Are You Gaining or Losing on Service?.....	56
Practical Service Methods.....	58
Expressions of Opinion from Readers.....	61
New Radio Products Announced This Month.....	64
What the Trade Is Talking About.....	71
News of Jobbers and Distributors.....	75
New Dealer Help Material.....	78
Radio Pictures—a New Field for Parts.....	81
Permanent Directory of Parts and Manufacturers....	83
Manufacturers and Markets.....	87

Member Audit Bureau of Circulations  
and Associated Business Papers.  
All Materials in This Publication Copyrighted, July, 1928

## Catalog and Directory Number Next Month

THE August issue will be *Radio Retailing's* annual Catalog and Directory Number.

In the past, complete specifications of various types of radio equipment have been monthly features of *Radio Retailing*. This year, however, it is planned to publish specifications of the three major types of radio products—receiving sets, reproducers, and radio furniture—in the August issue, giving that issue the flavor of a buying catalog for the use of retailers and wholesalers when placing their fall buying orders.

In the next issue, therefore, the radio trade will have a ready reference guide to these three most important items and their manufacturers. All information germane to each product will be published so that complete information concerning them will be available for readers of *Radio Retailing*.

### In the Editor's Mail

"... I also want to take this opportunity to congratulate you on the excellent publishing job which your company is doing. "In my opinion, *Radio Retailing*, to date, has done the finest job of all radio magazines and our great industry is looking to you to continue this leadership in the future."  
HUGH H. EBY,  
Philadelphia, Pa. President, H. H. Eby Manufacturing Co., Inc.

"I subscribe to *Radio Retailing* to be sent to my residence so that I shall be sure to have time to read it, and now that I am actively engaged in running the merchandising end of our radio business, I appreciate more than ever that *Radio Retailing* is the best paper in the field, and I insist upon all our branch managers and salesmen reading it. "I wish we could get all of our dealers to read it also."  
MORRIS METCALF,  
Springfield, Mass. Vice-President, American Bosch Magneto Corp.

"The convention of the Federated Radio Trade Association was a very successful one and we are frank to admit that it was largely due to the wonderful co-operation we received in the way of publicity. "We wish to take this opportunity of thanking you very sincerely for your wonderful co-operation and the help you have given us."  
H. G. ERSTROM,  
Chicago, Ill. Executive Secretary-Treasurer, Federated Radio Trade Association.

"This is to express my appreciation of what you did to make the Trade Show a success. "The 'Trade Show Daily' was a knock-out and I am sure was appreciated by all. I want you to know that the R.M.A. Board of Directors as well as myself appreciate your good work. "I returned to my office this morning to find a good many inquiries from our ad in your last issue, showing that you have dealer interest. "Assuring you of our continued support of your paper, which we know to be the outstanding trade paper in the radio industry, Rochester, N. Y.  
A. T. HAUGH,  
Member, Board of Directors, Radio Manufacturers' Association. Vice-President, United Radio Corporation.

## McGRAW-HILL PUBLISHING COMPANY, INC., Tenth Ave. at 36th St., New York, N. Y.

NEW YORK DISTRICT OFFICE, 235 Madison Ave.

JAMES H. MCGRAW, President  
JAMES H. MCGRAW, JR., Vice-Pres. and Treas.  
MALCOLM MUIR, Vice-President  
EDWARD J. MERRIN, Vice-President  
MASON BRITTON, Vice-President  
EDGAR KOBAE, Vice-President  
C. H. THOMPSON, Secretary

Electrical World    Electrical West    Ingenieria Internacional  
Engineering and Mining Journal  
Chemical & Metallurgical Engineering    American Machinist  
Electrical Merchandising Power    Electric Railway Journal  
Bus Transportation    Engineering News-Record  
Coal Age    Construction Methods  
Copyright, 1928, by McGraw-Hill Publishing Company, Inc.  
Cable Address: "Machinist, N. Y."  
Annual subscription rate is \$2 in United States and Canada.

WASHINGTON, National Press Bldg.  
CHICAGO, 7 South Dearborn St.  
PHILADELPHIA, 1600 Arch St.  
CLEVELAND, Guardian Bldg.  
ST. LOUIS, Bell Telephone Bldg.  
SAN FRANCISCO, 833 Mission Street  
LONDON, E. C. 5 Boulevard St.





New

*There is nothing finer than a Stromberg-Carlson*

*No. 636 Stromberg-Carlson uses 7 Radiotron Tubes: 5 UY-227 A.C., one UX-17-1 A Output Tube, and one UX-280. Price, less Tubes and Speaker, East of Rockies \$245.00*

**CONSOLE model - A.C. Tube  
STROMBERG-CARLSON**

Low, perfect in proportion, of softly gleaming two-toned Walnut, this latest exquisite Stromberg-Carlson will be acclaimed enthusiastically by every Stromberg-Carlson dealer.

The operating unit of this new Receiver is identical with, and has all the magnificent tone quality of the No. 635 Stromberg-Carlson A.C. Tube Treasure Chest—the same extreme sensitivity, the same keen selectivity, *new Dual Circuit* volume control, one tuning dial, and phonograph jack for electrical reproduction of records. It is arranged for use with the Stromberg-Carlson external Cone Speaker (wall type or floor type)—so necessary for correct acoustical effects.

The cabinet itself is superb. Matched walnut butts give the top a rich beauty, while contrasting shades of paneling, delicate wood carved effects and an escutcheon of real bronze, lend it distinction. A Walnut slide which may be used as writing table acts as a cover to close the front. Easy access to the operating unit is provided at the back.

STROMBERG-CARLSON TELEPHONE MFG. CO., Rochester, New York

Other Models Range in Price from \$185 to \$1205, East of Rockies

*The Stromberg-Carlson Sextette Tuesday evenings at eight o'clock Eastern Daylight Time through the NBC and 22 Associated Stations*

# Stromberg-Carlson

*Makers of voice transmission and voice reception apparatus for more than thirty years.*



# Get it *Better* with a Grebe



## A New Complete Grebe Line

WITH the addition of the Grebe Synchrophase A-C Six, dealers are afforded a complete line which can be readily sold because of the nineteen-year-old Grebe reputation, and which will remain sold because of the minimum servicing required.

A tie-up with this complete Grebe Line will bring you those satisfactory profits that come only from satisfied customers.

**Grebe Synchrophase A-C Six** \$227.50  
List price, (less tubes)

An A-C operated receiver with distinctive Grebe improvements for better local and distance reception that will instantly appeal to the buyer.

**Grebe Synchrophase Seven A-C** \$195.00  
List price, (less tubes)

An A-C receiver of such superiority that it will always be an outstanding leader.

**Grebe Synchrophase Five** \$105.00  
List price, (less tubes)

A ready seller that offers unusual

opportunity for quick turnover and substantial profits.

**Grebe Natural Speaker** \$35.00  
List price,

A Grebe-made speaker that affords the final touch of perfect reception to any receiver.

**Grebe No. 1750 Speaker** \$17.50  
List price,

Grebe quality in a speaker that may be sold at a low price without sacrifice of volume or tone quality.



Grebe Natural Speaker

# GREBE SYNCHROPHASE

TRADE MARK REG. U.S. PAT. OFF.

## A-C Six RADIO

Send for Booklet RR



A. H. Grebe & Company, Inc., 109 West 57th Street, New York City  
 Factory: Richmond Hill, N. Y. Western Branch: 443 So. San Pedro St., Los Angeles, Calif.  
 Makers of quality radio since 1909

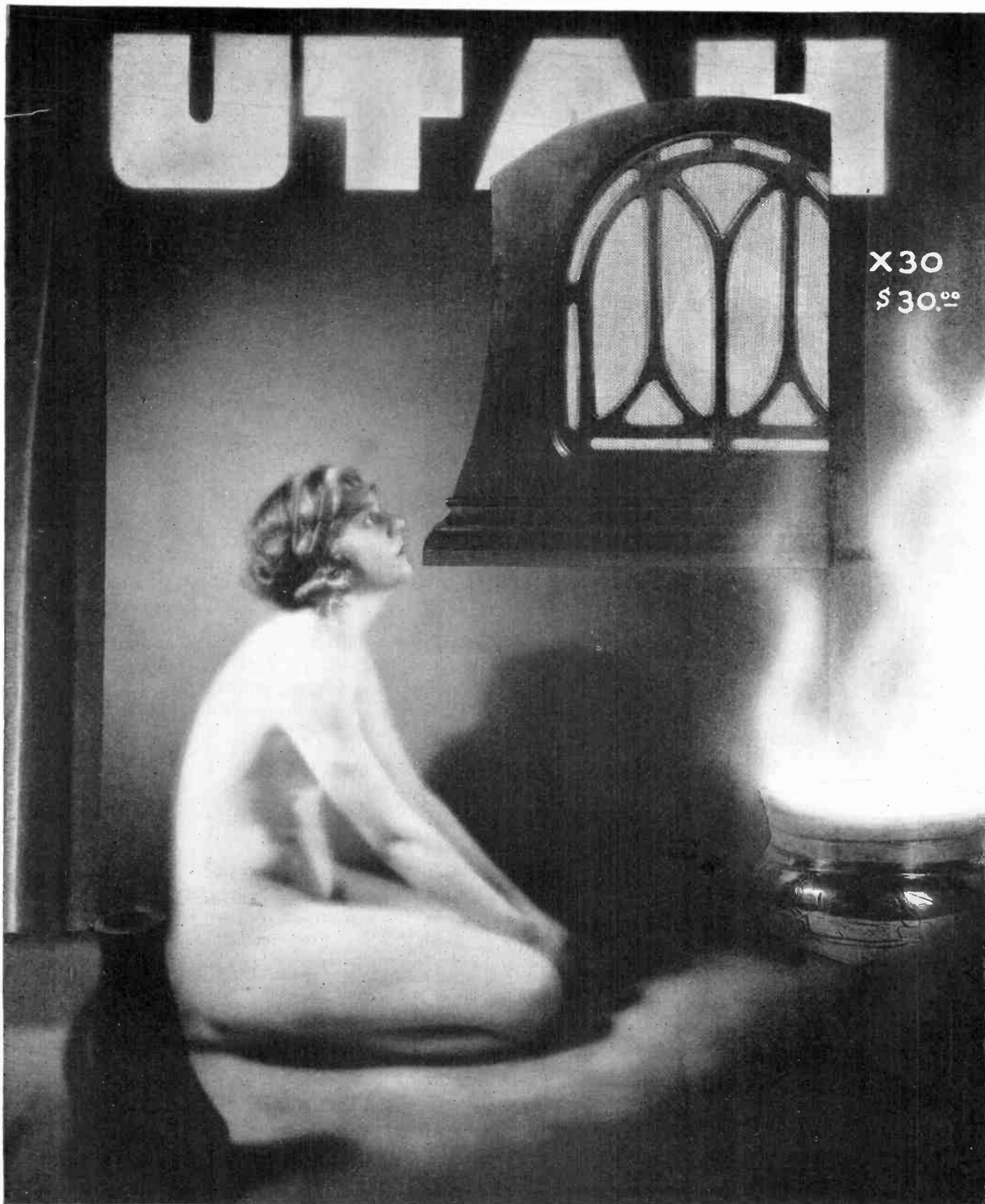

+ *mystic conveyer of melodious tone* +  
Utah contributes to the radio program tone qualities  
found only in *true* music. Attach a Utah unit and  
your set becomes a brilliant musical instrument.

WE ARE MANUFACTURERS, NOT ASSEMBLERS

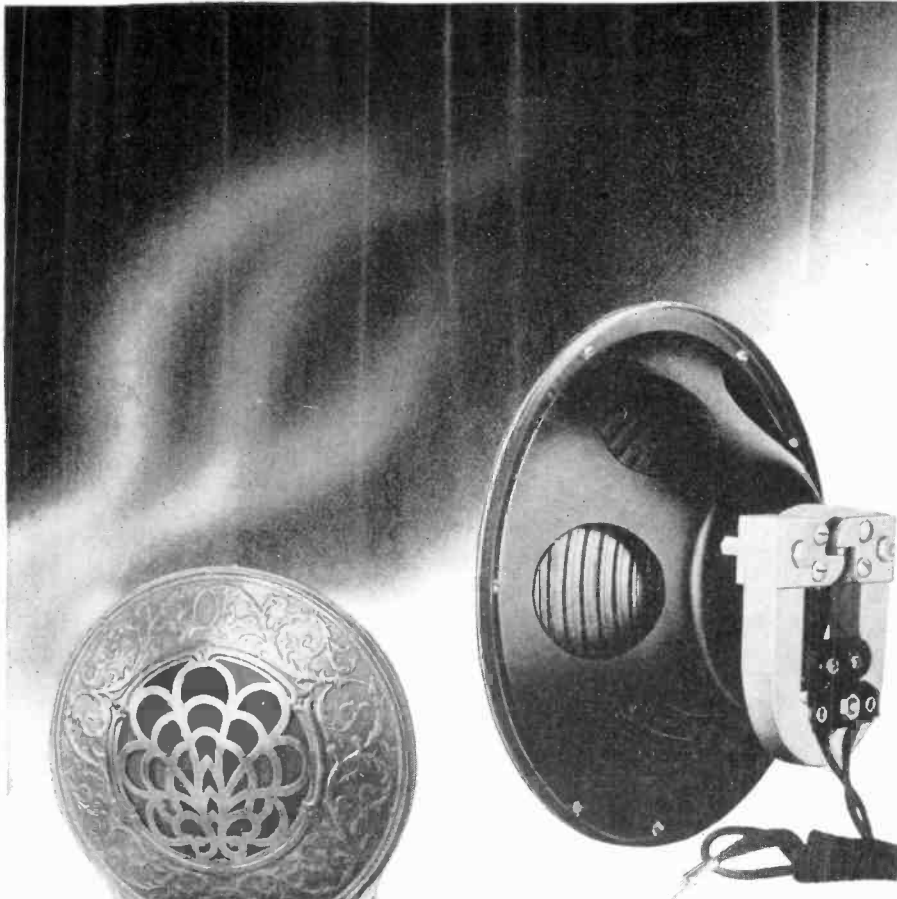

**Type X26—\$26<sup>00</sup>**

The new Italian Renaissance mahogany carved wood cabinet speaker equipped with UTAH Power Motor.



**Type X35—\$35<sup>00</sup>**

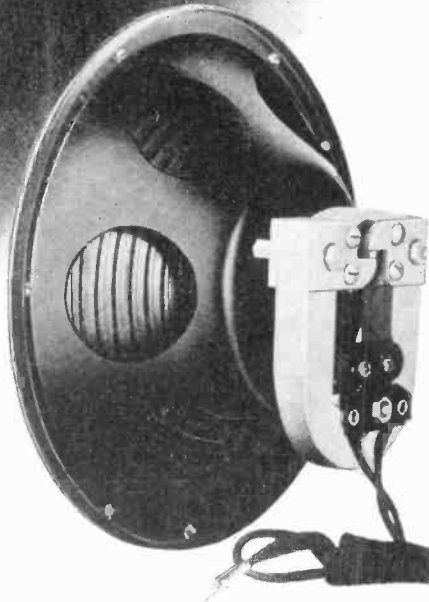

Utah Power Motor used in Utah Speakers with its nature-like voice coil an exclusive Utah feature—a lasting source of dependable Radio speaker power.

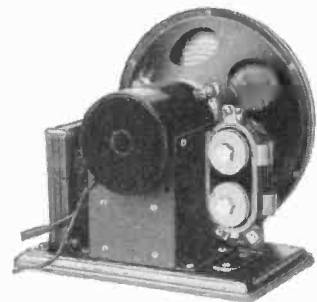

**A100—UTAH DYNAMIC UNIT**  
110 volt alternating current light socket supply for field excitation using Westinghouse dry rectifier. 9" high, 9½" wide and 7½" deep. Packed 1 to a wood crate. Weight 19 lbs. . . . **\$50<sup>00</sup>**

**R300—UTAH DYNAMIC UNIT**  
6 to 12 volts direct current for field excitation. Operates from A Battery. Current consumption .5 to 1 ampere. Packed 1 to a wood crate. Weight 14½ lbs. . . . **\$35<sup>00</sup>**

**D200—UTAH DYNAMIC UNIT**  
110 to 220 volts direct current for field excitation. Current consumption 45 to 90 milliamperes. 8½" high, 7" deep. Packed 1 to a wood crate. Weight 14½ lbs. . . . **\$40<sup>00</sup>**



**Type X30—\$30<sup>00</sup>**

Beautiful genuine brown mahogany cabinet speaker equipped with Utah power motor. One of Utah's leading new creations.



Utah Dynola Cabinet made of 5 ply walnut with genuine Burl walnut front finished in antique brown. This Cabinet is of nondirectional design having same grille and appearance both front and back. Dimensions: 12½" high, 15½" wide and 12½" deep. Packed 1 to a wood crate.

Utah Dynola Speaker equipped with "A 100" **\$75<sup>00</sup>**

equipped with "R 300" **\$60<sup>00</sup>**

equipped with "D 200" **\$65<sup>00</sup>**

**UTAH RADIO PRODUCTS COMPANY**  
1615 South Michigan Avenue . . . Chicago, Illinois





**PEERLESS  
POPULARITY  
CONTINUES**

**AS 75:15**

• • • • • **T**HE ever-growing tide of preference which last year made Peerless the biggest selling independent speaker in America, was again evident at the Chicago Trade Show in June

It is epitomized by the experience of one large cabinet factory making cabinets for radio manufacturers.

Of a hundred samples ordered by their trade, 75 called for Peerless Speakers, 15 for the second make, 5 for a third and the rest scattered.

The new Peerless line consists of the famous Peerless Magnetic in Built-in, Mantel and Table models; together with the Peerless Dynamic in Chassis, Mantel, and choice of Table Models.

If you haven't seen them — send for a broadside showing the entire Peerless line.

**UNITED RADIO CORPORATION**

25 Leighton Ave., Rochester, N. Y.



# SONATRON RADIO TUBES

THE WORLD'S LARGEST  
RADIO TUBE LINE





# Here's Performance that Really Protects Dealers!



THE WARWICK

This console promises unprecedented popularity. Its features are: compactness and accessibility; the last word in design—unrivalled tone. Height, 52-in.; width 26½-in.; depth 17½-in.; shipping weight, 120 lbs. Highest quality American Walnut with satinwood below. Reversible gunmetal hinges. Unequalled quality of reproduction.

### Combines These Distinctive Features

AC operation—Eight Tubes—Tremendous volume without distortion. Extreme sensitivity. Uses full wave rectification. Low power consumption. (Cost of operation is just equal to burning one 60-Watt Lamp at the time set is turned on.)—Exclusive cabinet designs. Latest creation in speaker construction. Licensed under RCA, Hazeltine and Hogan Patents.

THERE is no guarantee like satisfactory service when a product is put into use. And that's something that has to be built into a radio set. You can't just write it down on paper.

McMillan Radio, because it produces tone you cannot distinguish from the original—because it offers thoroughly dependable AC operation—and because it's enclosed in distinctly beautiful cabinets, exclusively McMillan in design—is a safe bet for live and far sighted dealers.

It is a radio with a generally recognized reputation for faithful performance. Radio at a price well within range of average pocketbooks. These two facts, together with liberal discounts and rapid turnover mean worth while profits.

The McMillan EXCLUSIVE FRANCHISE completes the protection to dealers. When you sell McMillan Radio, you know you are going to get all the dealer profits that are to be made in your territory.

Why not investigate today this stable line of quality radio receivers? There may be an opportunity open in the locality you serve. Address all inquiries to

McMILLAN RADIO CORPORATION  
1421 S. Michigan Ave., Chicago, Ill.

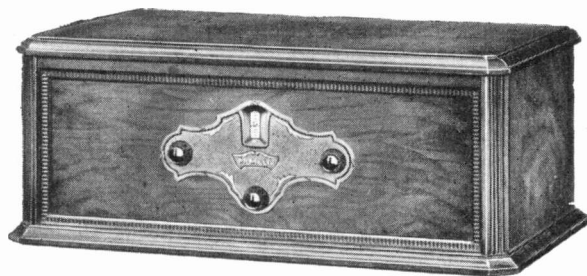

THE WESTCHESTER

Another exclusive model of finest American Walnut. Bevelled corners, exquisite shadings and a general note of richness combine to make it a striking piece of furniture. Height, 10-in.; width, 25-in.; depth, 16-in.; shipping weight, 40 lbs.

Prices range from \$160 to \$285

# Mc MILLAN

TRADE MARK REG. U. S. PAT. OFF.

# ELECTRIC THE LINE OF DISTINCTION



# O'NEIL DYNAMICS

*a sure fire hit*

*and the show proved it!*



*Clipping from the R.M.A. Trade Show Daily that indicates the trend and popularity of the Dynamic speaker.*

Hundreds—yes thousands—acclaimed this unusually attractive O'NEIL DYNAMIC TABLE SPEAKER the big hit of the show. Simply because it has exceptional "eye appeal" and to hear it means to want it. The price—only a few dollars more than the ordinary magnetic speaker—is an additional feature that made it so tremendously popular.

Using this model—No. DX 505—as your leader for the very complete line of the famous O'NEIL RADIO SPEAKERS you will be assured of a fine and fast selling line that will bring you a continuous volume of sales—and profits. It will also increase your present volume of speaker business. It just can't be helped! People will buy quality—even clamor for it as they did this model at the show. And every model in the O'NEIL Line has features to satisfy every demand.

It will pay you and pay well to inquire into the sales value of our complete line of dynamic and magnetic speakers. We should be pleased to answer your request for information regarding our proposition. If you are interested in making money you are interested in the famous O'NEIL Speakers. Better write today. There is a jobber near you.



**Model DX 505**—Fitted with our dynamic speaker, equipped with a standard dry disc electrifier and powerful transformer for operation from house current. No other auxiliary apparatus required, \$65.00.

## O'NEIL MANUFACTURING CORPORATION

—the famous O'NEIL Radio Speakers

West New York, N. J.



**Model DC 507**—Equipped with our dynamic unit. Finished in a beautiful two tone walnut to match the popular sets. Small in size, 13 1/4-in. high by 12 1/4-in. wide by 11 1/2-in. deep. Operates from 6 volt storage battery or 6 volt battery eliminator. List \$50.00.

**Model A 506**—Same cabinet as above. Ready to operate from any A.C. 110 volt 60 cycle lighting circuit. List \$60.00.

**Model A 508**—Like above except that it's made to operate from a D.C. lighting circuit.

O'Neil Speakers are licensed under the Lektophone patents—which is sufficient recommendation in itself.

We are prepared to make prompt deliveries on orders for dynamic speakers. Need we say more?

*this is a DYNAMIC year!*

# INSTANT ACCEPTANCE!

At the Crosley-Amrad Convention there was a spontaneous and enthusiastic interest in the all-electric models of the

## Symphonic Series

At the Chicago Trade Show thousands of retail dealers crystallized this enthusiasm by applying for the Amrad franchise



**The Opera**

Combination radio and electrical phonograph. Richly figured, hand-carved walnut. Both radio and phonograph are purely electrical, with built-in Dynamic power speaker and illuminated single dial.

Price \$875  
(without tubes)



**The Sonata**

Handsome console of walnut with decorative panels of satin-wood and zebra wood. The most modern purely electrical radio and finest type built-in Dynamic power speaker. Uses eight tubes.

Price \$475  
(without tubes)

You owe it to yourself and to your customers to see and to hear this line. Each model is all-electric; each has a built-in Dynamic Power Speaker; each is encased in a handsome cabinet—and the prices are amazingly low for radio sets of such outstanding quality and performance.



**The Nocturne**

Console model in walnut, built-in Dynamic Speaker. Purely electrical. Illuminated single dial control and bronze escutcheon plate enameled in color. Double shielded.

Price \$295  
(without tubes)

### SPECIAL FEATURES

The chassis includes a tone control in the rear of the Chassis, enabling the user to adjust the tone of the receiver to suit his taste, emphasizing either the high or the low notes.

It also has an electrical phonograph pick-up attachment which becomes effective by throwing a small switch, employing the audio amplifying system and electric dynamic speaker for phonographs of any type—giving the full richness and volume of tone, even in the case of small portable phonographs. One of the outstanding features is that which permits the use of the electrical connection for the receiver (through the lamp socket) as an antenna and ground, in which case neither outdoor nor indoor antenna is necessary. Best results, however, can be obtained by use of an outdoor antenna and ground wire. The principal use of the antenna plug-in is in demonstrating the receiver either in the home or in the display room.

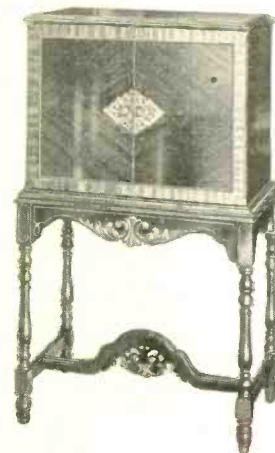

**The Concerto**

Beautifully proportioned modern cabinet of American and oriental walnut. Electric Dynamic power speaker built into cabinet. Purely electrical, single dial control.

Price \$320  
(without tubes)

## THE AMRAD CORPORATION

Medford Hillside, Mass.  
J. E. HAHN, President

2235 S. La Salle St., Chicago, Ill.  
POWEL CROSLY, JR., Chr. of the Board

# ATWATER KENT RADIO

◆

**A** RADIO RECEIVER is an instrument which gives you your choice of all the broadcasting stations within range.

When your radio receiver makes this selection quickly, brings in music and speech clearly, gives you no trouble at all—you have the best radio.

*A. Atwater Kent*

ATWATER KENT MANUFACTURING COMPANY  
4733 Wissahickon Avenue      A. Atwater Kent, President      Philadelphia, Pa.



# ATWATER KENT RADIO

## Still better for 1929



**MODEL 40 A. C.** The 1929 improvement on the famous Model 37, now in more than 200,000 homes. More powerful, more sensitive. New sealed power unit. FULL-VISION Dial. Satin finished in dark brown and gold or deep golden bronze and gold. Requires six A. C. tubes and one rectifying tube. For 110-120 volt, 50-60 cycle **\$77** alternating current.  
Without tubes,

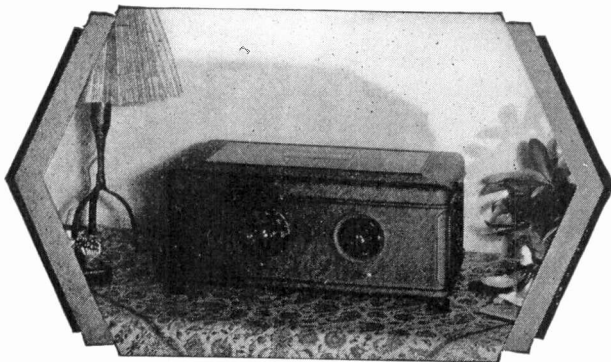

**MODEL 42 A. C.** Similar electrically to Model 40, with addition of automatic line voltage control. Many refinements in cabinet design—crowned lid, panelled corners, ball feet. FULL-VISION Dial with over-size numbers. Requires six A. C. tubes and one rectifying tube. For 105-125 volt, 50-60 cycle alternating current. Without tubes, **\$86**

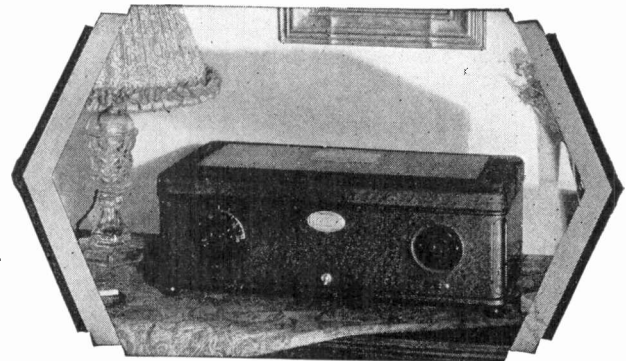

**MODEL 44 A. C.** Extra-powerful, extra-sensitive, extra-selective. Crowned lid. Panelled corners. Ball feet. Automatic line voltage control. Local-distance switch. FULL-VISION Dial with over-size numbers. Requires seven A. C. tubes and one rectifying tube. For 105-125 volt, 50-60 cycle alternating current. Without tubes, **\$106**

*Prices slightly  
higher West of  
the Rockies*

ATWATER KENT MANUFACTURING COMPANY

# ATWATER KENT RADIO

## Still better for 1929

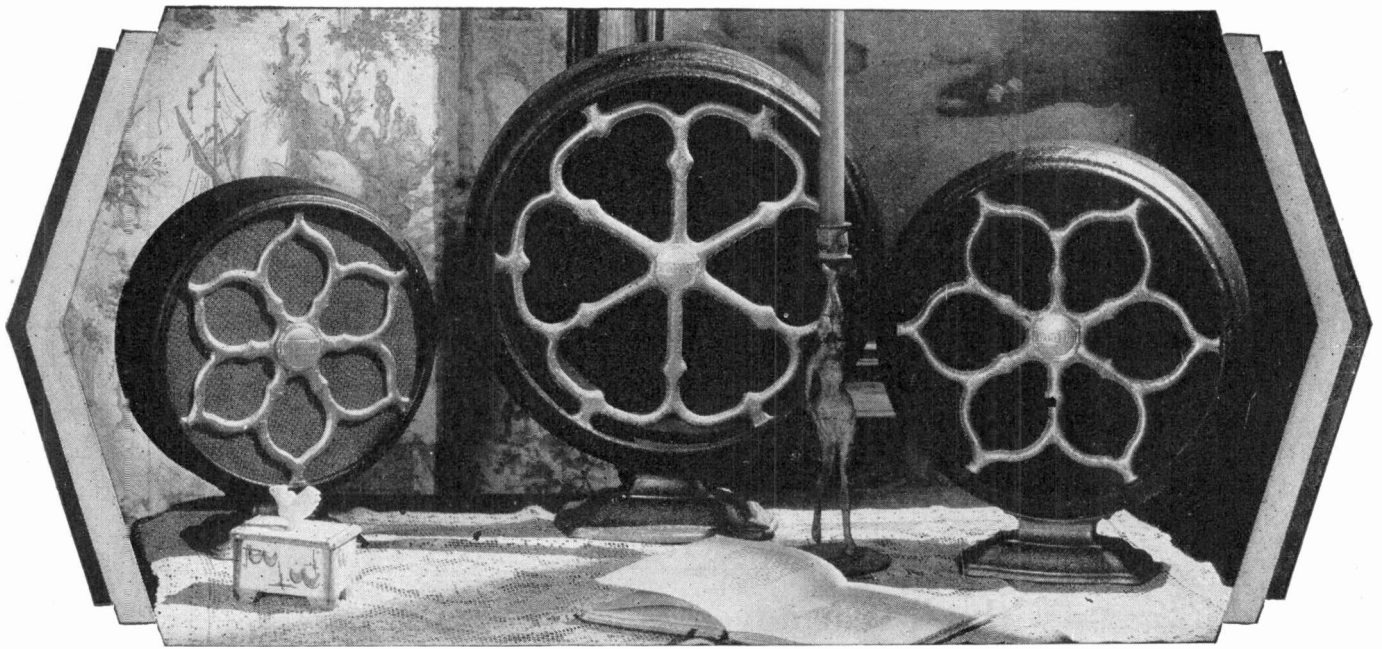

**"RADIO'S TRUEST VOICE."** Atwater Kent Radio Speakers: Satin finished—some in dark brown and gold, some in deep golden bronze and gold. Models E, E2, and E3, same quality, different in size. **\$20** Each

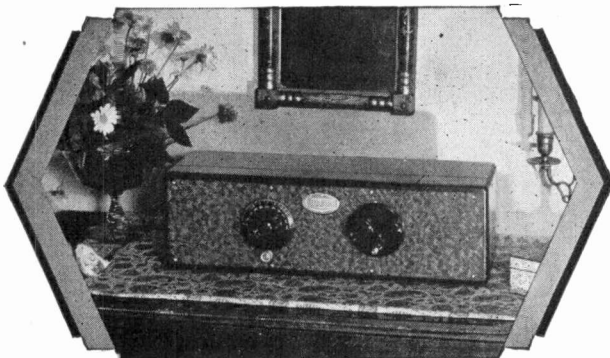

**MODEL 48** battery set. Solid mahogany cabinet. FULL-VISION Dial. Two stages of T. R. F. in conjunction with Atwater Kent coupling circuit, detector and two stages of A. F. Six tubes required. **\$49** Without tubes or batteries.

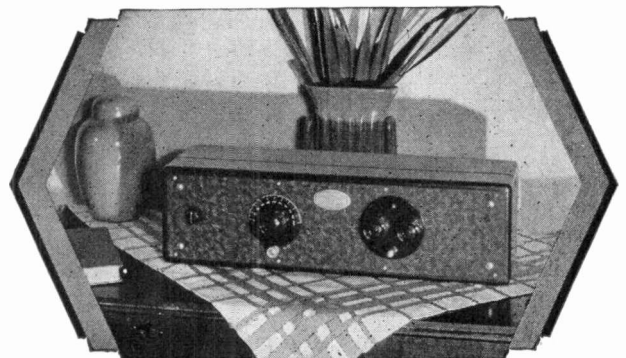

**MODEL 49** battery set. Solid mahogany cabinet. FULL-VISION Dial. Antenna adjustment device assures unusual selectivity. Three stages of T. R. F., detector, two stages of A. F. Six tubes required. **\$68** Without tubes or batteries.

*Prices slightly higher West of the Rockies*

4733 Wissahickon Avenue

A. Atwater Kent, President

Philadelphia, Pa.

# ATWATER KENT RADIO



## FIRST

- with compact sets.
- with true ONE-Dial sets.
- with shielding metal cabinets.
- with self-contained A. C. sets at a popular price.
- with 222 factory tests or inspections.
- with outdoor posters.
- with all-year advertising.
- with all-year broadcasting of famous artists.



ATWATER KENT MANUFACTURING COMPANY  
4733 Wissahickon Avenue    *A. Atwater Kent, President*    Philadelphia, Pa.



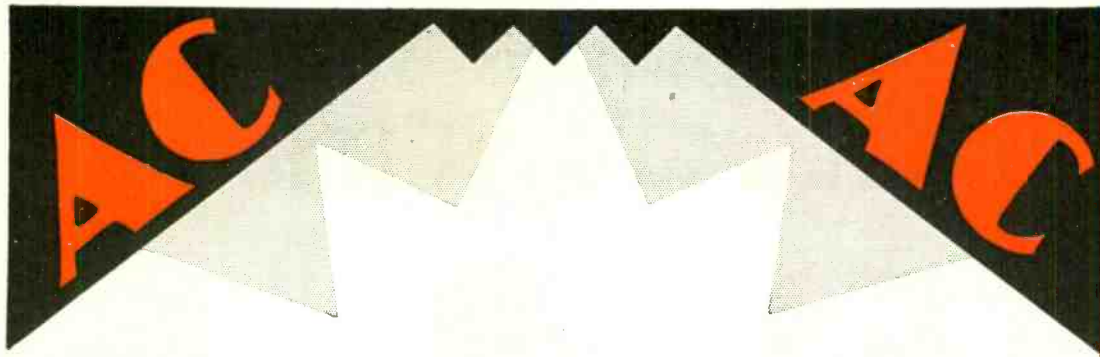

# MAGNAVOX DYNAMIC POWER SPEAKERS FOR EVERY SET

Seventeen years ago the first radio loud speaker was created. It was a Magnavox. It was a dynamic. Today the Magnavox Dynamic is in 400,000 homes, in the sets of America's fine radio manufacturers, in the stores of the country's best dealers.

Magnavox Dynamic "translates" the audio delivery of the power tube into a faithful reproduction over the full range of frequencies. It gives ample volume with studio realism.

*Write your name on margin of page below for speaker bulletins giving full information.*

**THE MAGNAVOX COMPANY**

Oakland, California

Eastern Sales: 1315 So. Michigan Avenue, Chicago

Magnavox Dynamic Speakers are protected by 13 U. S. and foreign patents. Infringements will be prosecuted.

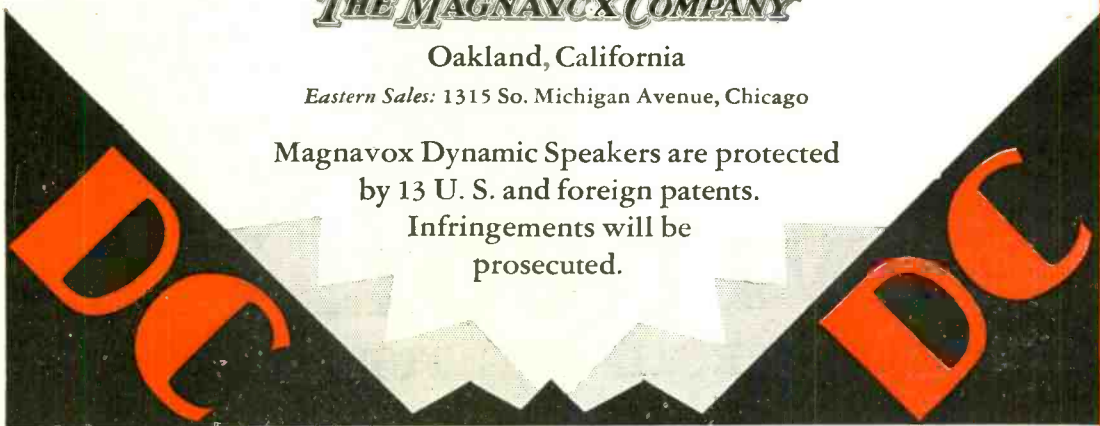

**ARISTOCRAT MODEL**

Beautiful butt burl walnut cabinet finished in two tones. It houses Dynamic 6, 7 or 80 unit. List prices:

*With—  
Dynamic 6, DC. \$70  
Dynamic 7, DC. \$75  
Dynamic 80, AC. \$85*



**BEVERLY MODEL**

Gracefully proportioned cabinet finished in light mahogany. For AC Operation, \$70 A-Battery Operation \$55

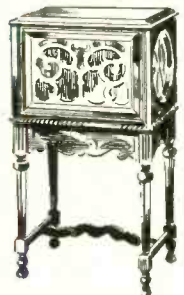

**CORDOVA MODEL**

With dynamic 700 unit, 110 volt, 60 cycle AC. Combining rectifier and power amplifier. Takes place of last audio stage in set. Handsome walnut cabinet. List \$175. Unit \$125

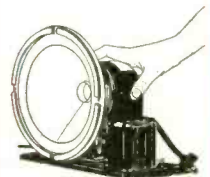

**DYNAMIC 80**  
110 volts AC. Has power transformer and dry rectifier. The most popular unit of the new line. Designed to operate with AC. sets. Unit, list \$50.

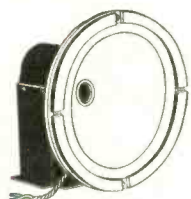

**DYNAMIC 6**  
6 volts DC. Field current consumption, .65 amperes. Operates from A battery. Unit List Price, \$35

**DYNAMIC 7**  
110 to 220 volts DC Field current consumption, .45 to .90 milliamperes. Unit, list \$40

# Millions of Eliminators Now in Use MUST Have Raytheon B-H for Replacements

Acme  
Acme Electric  
All-American  
Amplex  
Apco  
Apex  
Arbrophone  
Arco  
Batteryless  
Benjamin Electric  
Bosch  
Bremer-Tully  
Briggs-Stratton  
Buckwalter  
Buell  
Burns  
Bush & Lane  
Case  
Chamberlin  
Cloverleaf  
Colonial  
Consolidated  
Cornell  
Crosley  
Day-Fan  
Dongan  
Dragon  
Dubilier  
Durkee-Thomas  
Eagle Charger  
Electron  
Epom  
Erla  
Federal  
Ford Mica

Freed-Eisemann  
General Instrument  
General Radio  
Gilfillan  
Grant  
Grebe  
Greene-Brown  
Harold Herbert  
Jefferson  
Jordon-Carisch  
Kingston  
Knight

Majestic  
(Master, Super  
and Standard)  
Malone-Lemmon  
Martin-Copeland  
Mayolian  
Metrodync  
Midwest  
Modern

Mohawk  
Mu-Rad  
Muter  
National  
Nat'l Dead Battery  
Operadio  
Ozarka  
Paragon  
Pilot  
Pioneer  
Precise  
Precision  
Premier  
Prestolite  
Silver-Marshall  
Simplex  
Spartana

Sparton  
Standard Radio  
(Worcester)  
Standard Radio  
(Canada)  
Sterling  
Stewart  
Thordarson  
Timmons  
Triple A  
United Engine  
Universal  
U. S. Light  
Valley  
Varion  
Walker  
Warren  
Webster  
Webster Electric  
Wells  
White  
Wise-McLung  
Yale  
York  
Zenith



**T**HE Raytheon B-H is standard equipment on more than one hundred different makes of "B" Eliminators.

A radio used only 3 hours a day requires replacement of its Rectifying Tube once a year. 6 hours of service daily necessitates two replacements a year.

Raytheon B-H is the standard replacement

rectifying tube for millions of "B" Eliminators, now in use. Nothing else will do.

This ready-made demand must be filled. Why not by you?

Ask your jobber for the new Raytheon display carton. Every time that carton is emptied it represents a profit of \$7.20 for you.

RAYTHEON MANUFACTURING COMPANY, Cambridge, Mass.

# Raytheon

LONG LIFE RECTIFYING TUBE





# A Real Radio Tube Proposition for Real Dealers

- 1 A complete line of *standard quality* radio tubes—each tube *individually* tested—each tube *completely* degasified for longer filament life.
- 2 A broad adjustment policy that protects the dealer 100 percent. The customer must be satisfied—and he *will* be.
- 3 Profitable discounts—and an opportunity for wide-awake dealers to get protection against price declines—and obsolescence.
- 4 A well-rounded program of national advertising and effective merchandising helps.
- 5 All this backed up by a company which ranks as one of the three oldest radio tube manufacturers in business.



*Your jobber is ready to tell you all about the attractive Ken-Rad proposition—ask him for the details*

The KEN-RAD CORPORATION (Incorporated)  
Owensboro, Kentucky

# KEN-RAD

## ARCHATRONS

# FEDERAL'S new AC Models

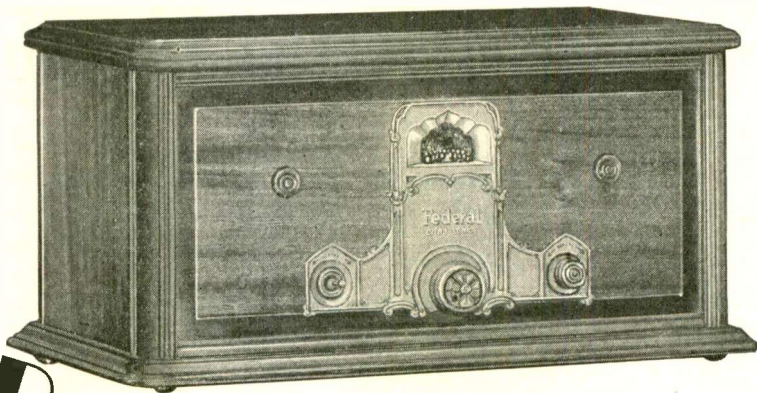

**OFFER**

## SENSATIONAL SALES FEATURES

AT \$ **130**

TO \$ **230**

# FEDERAL

ORTHOSONIC\*

Licensed under patents owned and/  
or controlled by Radio Corporation  
of America, and in Canada by Cana-  
dian Radio Patents, Ltd.



**FEDERAL'S** new all-electric sets using A. C. Tubes are the first really *fine*, popular-priced radio. Remarkable achievement by Federal engineers have made possible sensational performance, unusual selectivity and outstandingly supreme tone quality at a price within the reach of all. Never before has such a combination of sales-producing features been offered in any one radio.

*Seven tube receivers*, unusually selective.

*All metal chassis*, combines greatest of strength with light weight.

*Single Dial*—electrically illuminated—provides ease of operation.

*Two-way selectivity* makes receiver fit all conditions.

*All Self-Contained* in beautiful cabinets of genuine walnut and mahogany veneers.

*Push-pull Amplification* gives any desired volume.

*Full Ortho-sonic Tone*, that deep, rich, natural tone quality, possible only with Federal's exclusive, patented balanced circuit.

*Easily adjustable to line voltages* of

from 100 to 130 volts. This gives maximum performance with longest possible tube life.

*Unusual Compactness*—The table model, of small proportions, will tuck away in any one of dozens of places in the home. The Console model fits into the decorative scheme in the smallest nook or corner without rearrangement of the room or moving the furniture. Every woman will appreciate the beautiful compactness of these new models.

*Built-in Speakers* in the console model, especially designed to respond to the low frequencies with the greatest of clarity and naturalness. Also furnished with Dynamic Speakers.

**Price, without tubes and accessories:**

Table Model, 60 cycle, \$130; 25 cycle, \$140

Console Model, 60 cycle, \$220; 25 cycle, \$230

(Slightly higher west of Rockies)

The new Models are precision instruments of typical Federal standards thru-out. Featured at the remarkably low price, they are bound to mean a real flood of business for designated retailers this year.

*For Complete Information Wire, Phone or Write*

**FEDERAL RADIO CORPORATION, BUFFALO, N. Y.**

OPERATING BROADCAST STATION WGR AT BUFFALO

Federal Ortho-sonic Radio, Ltd., Bridgeburg, Ont.

# RADIO

\*Federal's fundamental exclusive development making possible Ortho-sonic reproduction is patented under U. S. Letters Patent No. 1,582,470

FEDERAL RADIO CORPORATION,  
1738 Elmwood Avenue, Buffalo, N. Y.

**P**LEASE send us complete details of the new Federal Models.

Name.....

Address.....

City.....



SPARTON  
*Absolutely and*  
The **EQUA**



**A**gain Sparton's pledge to maintain a position a year ahead of the radio industry as a whole has been fulfilled. After pioneering the development of All-Electric reception, Sparton introduces another and equally important innovation—the *EQUASONNE* circuit.

Radio engineers at the Chicago show acknowledged Sparton's new development to be, as great an advance as were the transitions from crystal to tube reception and from battery to light-socket operation. Experts unite in the opinion that another revolutionary forward step in radio design has been taken. And again Sparton is a year ahead of the entire radio industry.

Details of the new Sparton *EQUASONNE* are being widely published in radio publications and newspapers. In this announcement it is only neces-



PRESENTS

*Entirely NEW*

# SONNE

sary to say that the *EQUASONNE* circuit vastly increases the number of available stations by perfection of the reception in both the low and high wave lengths; that it greatly surpasses the remarkable tone quality for which Sparton always has been outstanding; that it practically eliminates alternating current hum; and that it makes any service a three-minute job.

Sparton's spectacular rise to its present high position in the radio industry is only the natural result of a superior product backed by a well planned and powerful merchandising and advertising program. Dealers interested in details of the much-discussed new Sparton *EQUASONNE* are invited to communicate with the factory without delay.

THE SPARKS-WITHINGTON CO., JACKSON, MICH.

Pioneers of Electric Radio without batteries of any kind (226)

# Again — Your Choice



Popular protest has corrected a situation, so that dealers are now in a position to use whatever tube equipment they wish.

\$77 Radio sets require TUBE equipment listing at \$22.50—30% of the selling price of the set.

Make the TUBE sales the most profitable part of your radio sales.

Sets equipped with CHAMPION RADIO TUBES are assured of maximum operating efficiency, and allow suitable TUBE PROFITS for you.

28 successful years of incandescent lamp manufacturing and a million-dollar company *positively* guarantee CHAMPION satisfaction.

*Dealers—Write us for booklet and more information about Champions and the set user's guarantee.*

## Champion

### RADIO TUBES

CHAMPION  
RADIO WORKS, INC.

144 Pine Street

DAN VERS  
Massachusetts

All Champion TUBES are packed individually in unique transparent display packages—six to a carton. It's what you show on your counter that makes for sales.

All  
AC and DC Types



The Guarantee of the Manufacturer Protects User and Retailer



Now that you have  
seen them all ~  
you can realize why

the

# SPLITDORF FRANCHISE

- ① with Duplex Receiver
- ② with Phonograph Jack
- ③ with Power Amplifiers (250" tube)
- ④ with Dynamic Loud Speakers
- ⑤ with Beautiful Cabinets - **and**  
**the biggest discounts!**

- is the most profitable **FRANCHISE**



- Did you get your copy  
of the new **Splitdorf** broadside?  
- write for it today -

SPLITDORF Radio CORPORATION

Subsidiary of Splitdorf-Bethlehem Electrical Company

NEWARK NEW JERSEY



# BOSCH

# 19



Bosch Radio Model 28 — for 110 volt AC operation using seven alternating current tubes and one power rectifying tube. Single tuning dial electrically lighted, solid mahogany cabinet.  
Price \$132.50 less tubes.

The Bosch Radio Dealer contract this season provides both profit and selling advantages unique in the radio industry. The new Bosch Receiver is far ahead in performance and appearance. Bosch Radio Dealers are backed by our new and sound merchandising policy which gives a more flexible inventory investment — a distinctly wider selling range than heretofore, a strong price position — all coupled with Bosch advertising. Dealer acceptance of the new Bosch Plans is verifying our assertion that the Bosch Radio contract will be the outstanding money maker this year.

A request will bring you the interesting details. Write the main office or our nearest branch today if you want to be included in our new plans.

Prices slightly higher west of Rockies and in Canada

THE  
BEST  
IN  
RADIO

BOSCH  
RADIO



AMERICAN BOSCH

SPRINGFIELD

MASSACHUSETTS



# RADIO

## 28

Authorized Bosch Radio Dealers are now showing Model 28A console illustrated, specially designed for them with the standard Bosch Radio Speaker. Console has fine selected and patterned woods, richly carved, beautifully finished. Bosch Radio Dealers are offering the console 23A with Bosch Radio Speaker and the Model 28 Bosch Radio Receiver for \$197.50.

Here are a few details of the Model 28 Bosch Radio Receiver—it has seven AC amplifying tubes and one power rectifying tube. There are three radio frequency stages — a detector stage and two audio-frequency stages, using three tubes. Two audio stage tubes are on the same circuit, employing "push-pull" amplification and permitting greater volume without distortion, achieving greater clarity and more faithful reproduction. Other important sales-getting features are single dial, electrically illuminated, grouped controls, shielded and armored; solid mahogany cabinets.

Bosch is backed by a fair and square selling policy, consistent magazine and newspaper advertising, Dealer cooperation. Bosch Precision Workmanship is an assurance of success.

Bosch Radio is licensed under patents and applications of R. C. A. — R. F. L. and Lectaphone

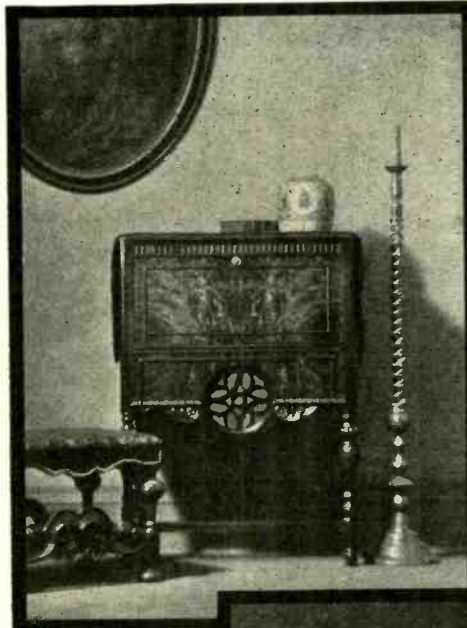

Authorized Bosch Radio Dealers are now showing the console Model 29B, specially designed for them with super-dynamic speaker and special high power speaker supply. Console has sliding doors, beautiful craftsmanship and selected woods. Bosch Radio Dealers are offering this console 29B with super-dynamic speaker and special high power speaker supply Model 28 Bosch Radio Receiver for \$255.00.

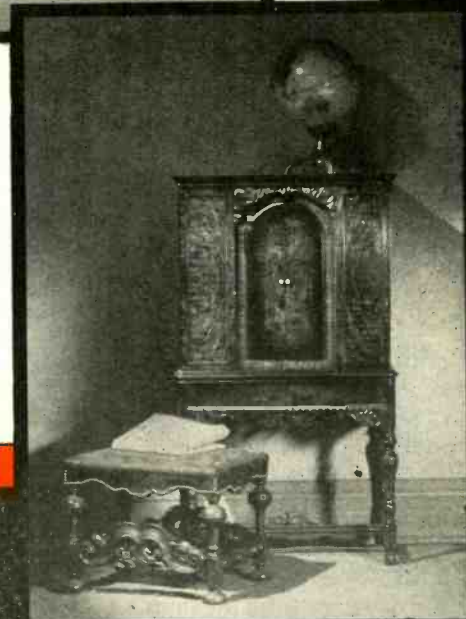

## MAGNETO CORPORATION

Branches: New York Chicago San Francisco

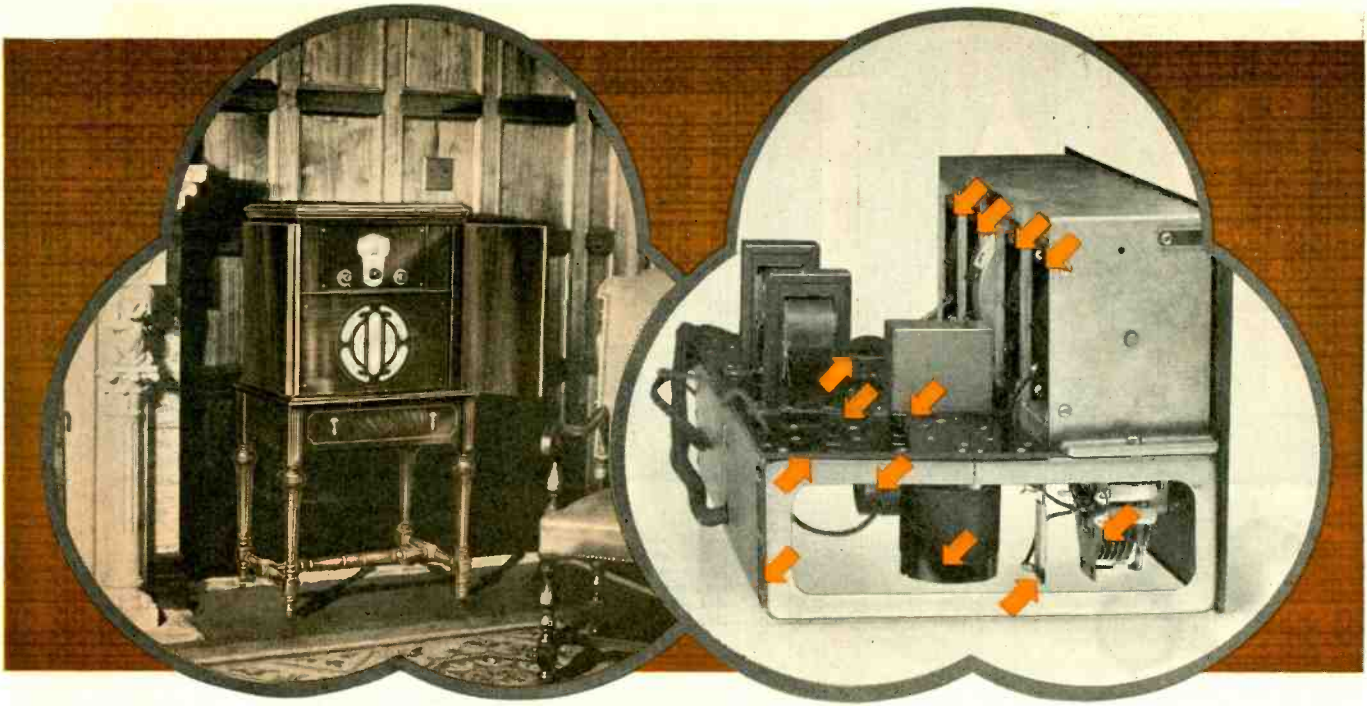

Kolster A.C. operated Radio Receiver and its chassis. Bakelite Materials are used in the construction of both. Made by Kolster Radio Corp., Newark, N. J.

## Bakelite Materials contribute to Kolster beauty and Kolster performance

**T**HE expert craftsmanship, and the beauty of Kolster Radio Receivers are obvious. In keeping with these is the harmonious color and rich permanent lustre of the Bakelite Molded Knobs on the panel.

It is within the receiver, however, that Bakelite Materials perform the most important service. No less than thirteen of the electrical elements essential to quality reception are Bakelite insulated. Through the use of this material the manufacturer is assured of unchanging

insulation value, for Bakelite Materials are unimpaired by age, use, or by exposure to climatic or temperature conditions which would ruin most insulations.

The advantages of Bakelite Materials which impel the leading manufacturers of radio equipment to standardize on it, provide equally important reasons for the dealer to make sure that the receivers and parts which he handles are Bakelite insulated. It is a practice which helps materially in assuring customer satisfaction.

### BAKELITE CORPORATION

247 Park Avenue, New York, N. Y. Chicago Office: 635 West 22nd Street  
BAKELITE CORP. OF CANADA, LTD., 163 Dufferin Street, Toronto, Ontario, Canada

# BAKELITE

REGISTERED

U. S. PAT. OFF.



THE MATERIAL OF A THOUSAND USES

"The registered Trade Mark and Symbol shown above may be used only on products made from materials manufactured by Bakelite Corporation. Under the capital "B" is the numerical sign for infinity, or unlimited quantity. It symbolizes the infinite number of present and future uses of Bakelite Corporation's products."



# SUPERBLY BEAUTIFUL

*A New Note in Artistic Appearance  
A New Standard in Realistic Tone*

**T**HE MARCO DYNAMIC REPRODUCER must not be confused with any other type of radio speaker, for, just as the ROLLS-ROYCE stands preeminent in the automobile field, so does this new reproducer stand apart from any reproducing device known in the field of radio.

Distinctly a quality product, the MARCO has been made expressly to the highest quality ideals and expressly for a class of buyers who not only seek a finer instrument but who can afford to gratify their desires.

In design, the MARCO DYNAMIC attains a totally new artistic plane—a combination of delightfully pleasing proportions and dignified simplicity—a beautiful case made of specially selected close-grained walnut and rubbed to a soft, semi-lustrous finish.

In tonal quality, the MARCO actually achieves the realism engineers have sought for years. Whether reproducing



the human voice, a single instrument or the full orchestration of symphonic compositions, this de luxe unit defies the descriptive power of mere words. We can only say that its new-idea chassis perfectly reproduces all frequencies in the audio spectrum, which literally means all frequencies within range of the human ear.

The New MARCO DYNAMIC is made in three models, which list at \$65.00, \$67.50 and \$75.00, respectively. Standard trade discounts. Literature sent upon request.

## The MARCO DYNAMIC CHASSIS

For radio and phonograph installation; sold without case.

Type DU-110 (110 v-60 cycles). List . . . \$50.  
Type DU-90 (110 volt D. C.). List . . . \$40.  
Type DU-6 (6 volt D. C.). List . . . \$35.

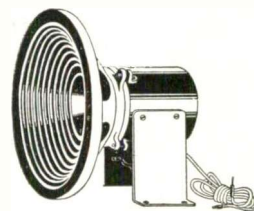

# MARCO

## DYNAMIC REPRODUCER

*“Superbly Beautiful”*

MARTIN-COPELAND CO.  
PROVIDENCE, R. I.



Radio Products  
ESTABLISHED 1880

# POWERIZER SOLVES AND MAKES GREAT

## *about those battery sets you take in trade . . .*

Powerizer helps you get more "new set" business because now you can make a profit on every set you take in trade—and, at the same time, make better allowances than competition can possibly offer—for you know how to turn these sets into cash. Instead of selling obsolete models, you will feature "all electric sets at an amazingly low price." The set you have taken in trade with "B" Eliminator, you turn into A. C. Electric with Powerizer "A," at \$12.00 list, and sets that come in without "B" Eliminators you turn into A. C. Sets with Powerizer Junior at \$35.00 list.

## *or the fellow who paid \$150 to \$300 for a battery radio . . .*

He will have to spend \$500 to \$800 to get an A. C. set that will give better tone quality—and you can't afford to give him much of an allowance if he buys an ordinary A. C. Set. Hook up a Powerizer—(Power amplifier, with complete A.B.C. supply) insert new A. C. Tubes in the set, and for approximately \$90, including tubes—you will have made his set an A. C. DeLuxe Power Amplified Set that will give him the tone quality of an \$800 Receiver.

## *and the family who has an \$80 Set and a "B" Eliminator . . .*

They, too, would like to have an A. C. All Electric. Hook up Powerizer "A" (\$12.00 List) with their present "B" Eliminator and install all new A.C. Tubes, and you make another profitable sale. Or, if he has no "B" Eliminator, better still—hook up Powerizer Junior, at \$35.00, and his set is ready for A.C. Tube operation.

---

---



# THE TRADE IN PROBLEM PROFITS FOR YOU!

A POWERIZER FOR EVERY PURSE AND PURPOSE

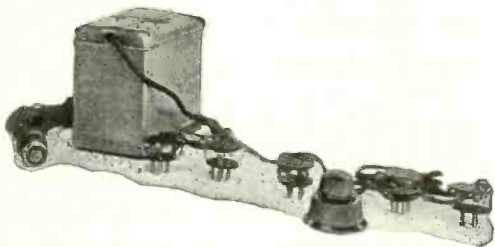

**POWERIZER A—**  
converts battery set to A.C. operation where "B" Eliminator is used. Supplies filament current and grid bias to from six to seven UX-226 Tubes, two UX-227 Tubes, and two 171 Tubes. Taps for the 226 and 227 and 171 Tubes, and also a "B" connection and "Hum control." Can be wired into set or we supply Harness and volume control.

**\$12.00**

**POWERIZER JUNIOR—**  
converts a battery set into the usual electric employing the 171 Radiotron in the last stage, such as the Atwater Kent or Radiola 17 or 18. Supplies current for six or seven 226 Tubes, two to three 227s, and 171s, Hum control—External on and off switch.

**\$35.00**

**POWERIZER—**  
A Powerizer that gives power amplification—finest tone quality in radio. General model for all standard sets. With A B and C Supply.

**\$54.00**

Special Powerizer and Power Pack designed for Radiolas 25, and 28.

**\$84.00**

**AMPLIFIER POWERIZER—Two Stage.**  
Two-stage amplifier, using UX-226 in the first stage and UX-210 in the second, used with radio set or phonograph pickup gives marvelous results.

**\$75.00**

Also Amplifier Powerizer—three stage UX-250 type.



**D. C. TUBE POWERIZER—**  
For those sets which operate only with the UX-199 Tubes UX-222 Screen Grid Tubes, Super Heterodyne 812, Radiola Grand, Radiola 26.

**\$80.00**

Now—your own dealer will make your battery set a power amplified A. C. DeLuxe with the famous

## POWERIZER

REG.

**\$12.00 up**

This amazing message will be broadcast to the millions of battery set owners throughout the country. The message will appear in dominant space in the country's greatest magazines and leading newspapers. People everywhere will be looking for the powerizer sales and service station that makes every battery radio an A.C. Electric for \$12.00 and up. Wire for Bulletin RR7, and complete details.

**RADIO RECEPTOR CO.**  
106 Seventh Avenue, New York City

Licensed by Radio Corporation of America and Associated Companies



# B-L RECTIFIERS

**Bone Dry · Noiseless  
Durable · Compact**

B-L Rectifiers embody a proved principle of rectification and are adaptable to all types of electrical equipment and apparatus requiring low voltage rectifiers.

They are made of metal and composition discs arranged alternately on a bolt and separated by metal plates which act as spacers and ventilating fins. They are compact, strong, rigid, durable and long-lasting. They are bone dry, contain no liquids, acids or bulbs—nothing to replace or repair.

B-L Rectifiers are furnished in standard sizes in single or full-wave units, or they are built to your specific needs.

### Some of the Many Uses for B-L Rectifiers

Battery chargers. · · Dynamic speakers.  
Radio "A" Power Units. · · Energize solenoids and magnets. · · Operate telegraph instruments direct from A. C. lines. · · Railway signal service. · · Telephone and telegraph circuits. · · Automatic train control equipment. · · Electric time clocks. · · Burglar and fire alarms. · · Electro-plating · · For experimental or laboratory work. · · Door-bells from A. C. lines. · · Damper and thermostat controls. · · Operation of electric toys. · · Automatic switches and controls. · ·

Electric Lighters direct from A. C. line. · · Spark coils; medical batteries. · · Relays. · · Electric locks. · · Small low voltage D. C. motors from A. C. lines, (automatic pianos, etc.) · · Traffic and crossing signals. · · Motor starting and control equipment.



### The B-L Booklet

Send for Booklet C-6, explaining the characteristics and application of B-L Rectifying Units. A postal card will bring it.

**THE BENWOOD-LINZE CO.**

"PIONEERS IN RADIO—FIRST IN MIDWEST"

1832 WASHINGTON AVE. · ST. LOUIS, MO.



# COMPARISON PROVED IT

THE **NEW ACME**  
WAS THE OUTSTANDING  
FEATURE OF THE  
R. M. A. TRADE SHOW



THE SET THAT  
SELLS THE  
MILLIONS

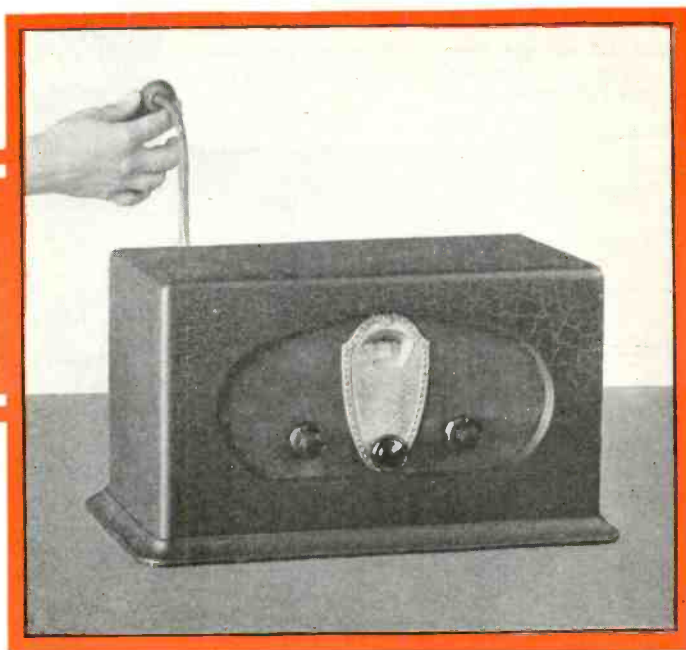

**D**EALERS came — saw — and ordered. The new ACME was truly the sensation of the R. M. A. show. This new ACME set has the features that sell the millions. They'll come to your store and buy as they never have before.

No batteries — no fuss — just plug into the nearest light socket. Illuminated, single dial control — perfect

LIST PRICE

\$ **65**

Complete with Tubes

reception, sharp tuning and attractive enough to be a suitable piece of furniture in any room.

This new ACME set is not a compromise, it's a carefully designed, thoroughly engineered, practical set. It's right! The profits will be big — the time to start is NOW. Everyone can afford this set — everyone will buy. Start selling the millions today. Write or wire at once for full details.

[[ Send for bulletins No. 100 to 104, describing the complete line of ACME power units. ]]

The ACME special set for distant stations uses A. C. tubes and lists at \$65.00, less tubes. Write for complete information.

The Acme Electric & Mfg. Company  
1446 HAMILTON AVE. CLEVELAND, OHIO

Established 1917

Representatives in principal cities.

Member R. M. A.



# More Beautiful Than Ever

**M**ASTER cabinets indeed—the Radio Master line for 1928 is more beautiful than ever before.

Lovely woods—touches of some rare ones almost unknown in American Furniture—wine mellow finish—design.

Oakley V. Weeks, one of the supreme designers of furniture, designs radio cabinets exclusively for Radio Master.

If you did not see these cabinets at the Radio Trade Show—by all means send for our splendidly illustrated catalogue.

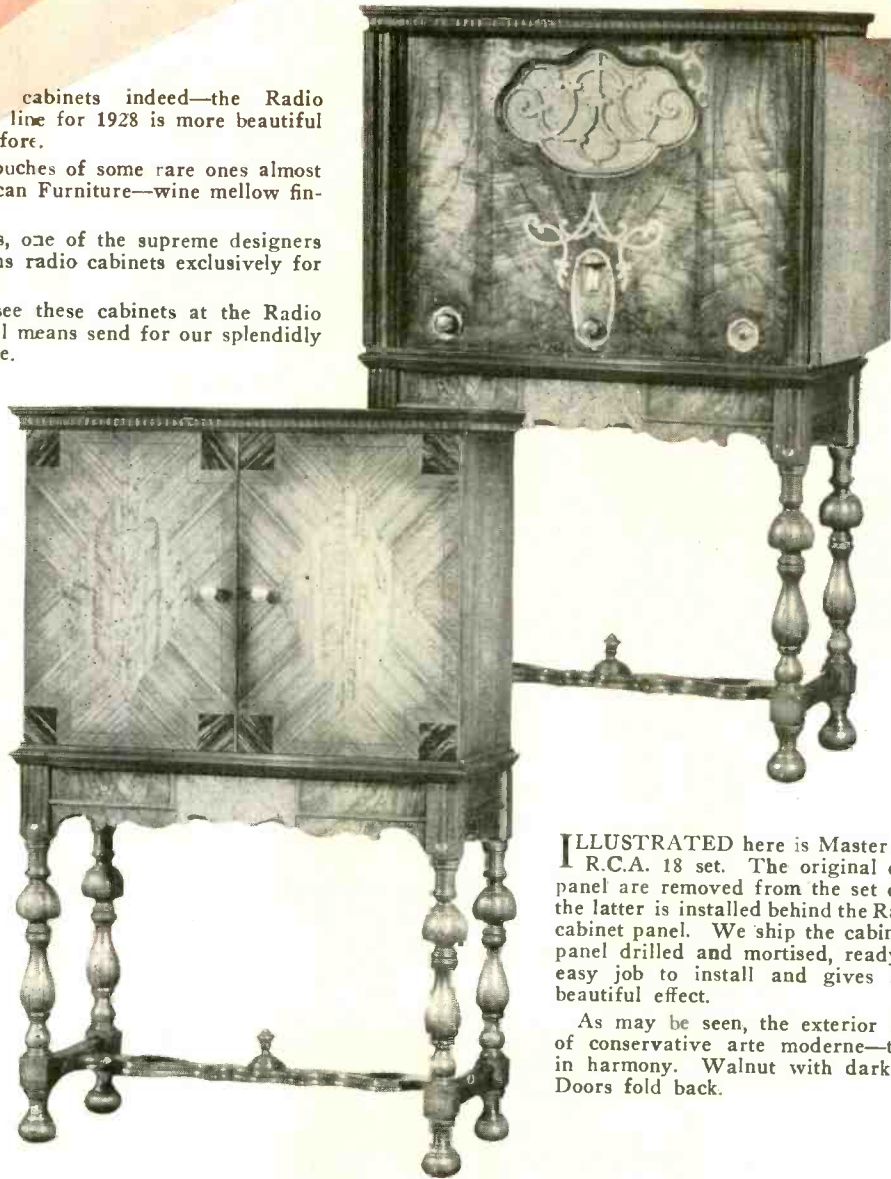

**I**LLUSTRATED here is Master Cabinet for R.C.A. 18 set. The original cabinet and panel are removed from the set chassis, and the latter is installed behind the Radio Master cabinet panel. We ship the cabinet with the panel drilled and mortised, ready. It is an easy job to install and gives a splendid, beautiful effect.

As may be seen, the exterior is a design of conservative arte moderne—the interior in harmony. Walnut with dark oak inlay. Doors fold back.

Send For Catalogue

# RADIO MASTER CORPORATION

BAY CITY, MICHIGAN

ONE OF THE WARD INDUSTRIES





# Yes, Thanks, Business is Fine!

## Read How You, Too, Can Make Real Money on Gold Seal Tubes

**W**HAT do you think of a tube manufacturer who made last year a net profit up in the hundred thousands—as you probably saw reported in the financial pages—on radio tubes alone?

Knowing what you do about the tube situation in radio—what do you think this means regarding the quality of Gold Seal Tubes?

What do you think it proves in the attitude of the trade? In the way Gold Seals sell?

This successful year means that the Gold Seal Electrical Company made their tubes right—packed their tubes so that they arrived right—and backed up their dealers on replacement, as any quality manufacturer should. It means that they allowed a

decent living profit to the trade, so that the man who took off his coat and sold Gold Seal Radio Tubes found something in the pocket when he put the coat back on again.

Always, in every industry, some leader arises who makes a success on the good old-fashioned principles of building a product right and treating his distributing organization squarely.

That's the only secret we have for our success, and that's the reason more dealers every day are carrying Gold Seal Tubes.

If you want to do business with a successful company, manufacturing in the newest, most up-to-date plant in the industry—

If you want to make money on radio tubes, as we do—

If you want satisfactory dealings with a manufacturer who knows he's got to make a success for you before he can make a success for himself—send the coupon and find out what kind of a proposition Gold Seal has been making to its jobbers and dealers which has built success for all concerned.

Let's have the coupon right away—and let's get together to your advantage, and ours, too.

# Gold Seal Radio Tubes

Every Type  
You Need—  
AC or Bat'y  
Made Right  
Packed Right  
Sold Right



## Find Out, Anyhow!

Gold Seal Electrical Co., Inc.,  
250 Park Ave., New York City, N. Y.

If you've found out how to make money in the tube business, I'm listening. Send me your proposition.

Name \_\_\_\_\_

Address \_\_\_\_\_

RR1

## *An* **I**MPRESSION *from the* **T**rade **S**how

LOOKING back at the R.M.A. Trade Show, what impressions stand out as the lingering memories? What do they mean? In addition to the value of the show as a marketplace, the opportunity it provides for a review and study of the drift of progress in the industry, is probably its most important contribution. And it is worth a bit of thinking.

THE most striking trends are not hard to set down. There were three of them—perhaps four—1. The growing prominence of the dynamic reproducer; 2. the increasing importance of furniture as a major element in radio, and 3. the growing number of combined radio and phonograph units. Then, as a secondary note, it might be well to mention, fourth, the introduction of color in the decoration of cabinets. All these factors stood out plainly, observable to all. Everybody recognized that here were new influences in the radio market, developments to be reckoned with, new opportunities that can be turned to profit in each town. Here were more changes in the rapidly evolving radio business. What does it mean?

IT MEANS above all that the cultural quality and character of radio is being steadily further refined and elevated. In the beginning it was all science and principles. The laws of sound, the theory of electrons, the study of electricity—these were the consuming interests.

Everybody was absorbed in perfecting better broadcasting and better reception. And now with the service of entertainment well assured, men begin to turn their attention first to beauty of tone and then to the beauty of the cabinet, to make it more worthy of a place in the modern home.

Radio men are recognizing that, after all, to John and Mary in their little cottage, radio is just two things—music and a piece of furniture. So to provide better music we see the dynamic reproducer forging to the front. And to provide a fuller service of music comes the marriage of radio and the phonograph. And to make radio a thing of beauty in home life, as well as entertainment, the classic art of the cabinet maker has been invoked and the furniture industry has brought to the support of radio the rich resources of its fine old craft.

IN A word, radio is now entering a higher cultural phase. To the public it is becoming less mechanical, less scientific. Beauty of tone and beauty of appearance, this is what will interest the customer. And the dealer of the future must know more and more of music and of furniture. He must have a higher sense of these two arts, a finer appreciation of beauty and what it means to men and women. It will be harder to be a radio dealer, but, by the same token, it will be more interesting and more profitable.



# When Placing Fall

—Keep These



*Appearance*

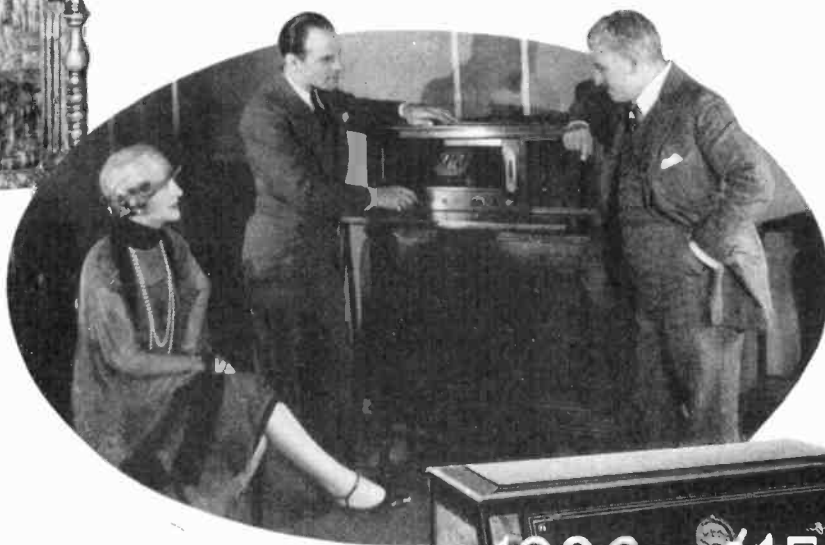

*Performance*

THE radio receivers offered for the 1928-1929 season represent a marked advance over those of the previous year in appearance, performance and quality of reproduction. Almost every manufacturer has made notable improvements in his line and, at the same time, many have achieved lower prices.

A careful analysis of the new wares displayed at the Trade Show in Chicago shows that the amount of radio value per dollar expended has doubled, this year over last. This is bound to result in a marked increase in the number of sets sold this year.

Many lines have been extended to cover wider price ranges, simplifying the dealer's purchasing problems, because the selection of two or three brands now enables him to meet demands for receivers in every price class. But generalities are of little help to the dealer planning his fall purchases. What new buying trends will the new season bring forth?

This is the year of beauty and technical refinement; we have passed the stage of radical changes such as last year's sweep of alternating current receivers and, the preceding year, of single control. Appreciation of eye value has at last arrived. Not only is radio furniture notably beautified and fine cabinet work become the rule, but new markets have been opened by attractive coloring and novel finishes. The black panel has passed into the land of the forgotten; green, blue, silver and white, though lacking in universal appeal, will attract many buyers who do not respond to conventional designs.

The table model is doomed to a gradually falling demand except in the under \$100 price class. It remains in the market only because of its economy but will continue to appeal to a purely price market.

The console, however, is now available in all price classes and it will be an increasingly big seller during 1928 and 1929.

A second definite trend will be toward the dynamic

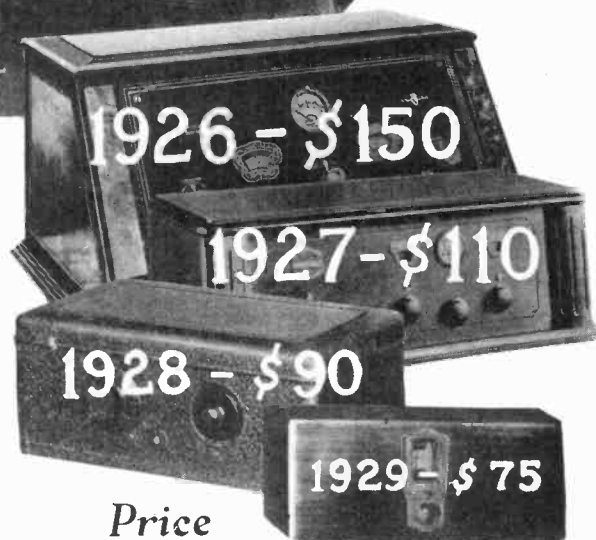

*Price*

speaker. Without considering its technical aspects and the question of its superiority over the cone type, it is an axiom that the public always prefers new departures in design. However, it is a generally admitted fact that the electro-dynamic speaker appeals because of its ability to handle considerable volume without tendency toward a marked resonant frequency. Moreover, its small physical dimensions particularly adapt it to embodiment in neater and more compact consoles on the part of manufacturers.

Several manufacturers are producing air-chrome speakers which together with cone speakers will find their market principally as adjuncts to table and console receivers requiring separate reproducers.

They will also find a market as replacements for archaic speakers, still serving their distorted output in tens of thousands of homes after three and four years of duty. Aggressive dealers will find profit in the replacement market for speakers which their less ambitious fellows will overlook.

# Buying ORDERS

## Points in Mind

A third trend, particularly in the more expensive lines, will be toward more powerful receivers. Four-stage radio amplifiers are embodied in numerous lines at surprisingly low prices while the type '50 power output tube will be demanded by the technically wise buyer. The public has become definitely responsive to factors which contribute to better tone quality. Now that transformers handling the entire tonal range with equal facility have become quite general, the only direction in which marked improvement may be expected is in the reserve power of audio-systems which enables them to handle volume peaks with ease.

Given a receiver with audio transformers passing large currents without saturation and a speaker not subject to overloading, a receiver equipped with the '50 tube is capable of magnificent volume. The swelling finale of symphony orchestras and the powerful low notes of the organ can truly thrill the listener with their majesty. A well engineered receiver with the '50 tube is the straight eight of the radio field.

The combined in-



*Radio-Phonograph Combinations*

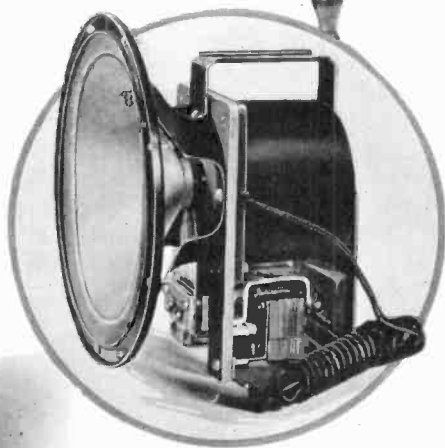

*Electro-Dynamic Reproducers*

fluence of fine furniture and more powerful radio and audio amplification systems will tend to make the unit of sale in the upper price classes higher than ever. Although the predominant trend is toward less expensive receivers, the elite will find magnificent phonograph-radio combinations ready to tempt them to five hundred dollar purchases. Intelligent selling in more prosperous communities will bring more fruitful

results than in past years. Many receivers, even in the lower price classes, are now equipped with input terminals for phonograph pick ups, doubling the utility of the radio receiver. By next year, the phonograph input will be standard.

In the lower price classes, cheap alternating current receivers will open up new quantity markets. Not only do low priced radio receivers vastly increase the number of prospects, but each such receiver sold paves the way for a resale within a year or two.

The resale market is becoming of increasing importance. In the end, the resale market will counterbalance the undesirably small unit of sale involved in the lower price classes. Design improvements have made hundreds of thousands of radio receivers obsolete and force attention to the establishment of organized channels for the sale of turned in receivers. The resale of second-hand receivers offers many pitfalls and the wise dealer will resist the temptation of excessive allowances. The only safe rule to follow is to place turn-in values low enough to assure resale without loss, even when the cost of advertising,



*Replacement Market*

merchandising and carrying is taken into consideration.

On every hand, there is indication of a year of greater opportunity and prosperity for the retailer. How this should be reflected in buying cannot be answered by a specific formula. Every dealer's problem is individual. The ratio which should be maintained between battery and alternating current receivers and how the dealer's purchases should be divided in the various price classes can be determined only by the demands of the dealer's individual clientele.

Mistakes of judgment in these matters have been made so generally in the past that hand-to-mouth buying has become the rule.

The writer, in preparing this article, examined the books of several prominent jobbers in order to analyze the buying methods of successful dealers. A majority of the orders placed, even by the most prosperous and well-financed dealers, are for small quantities. Those doing a reasonable volume of business frequently re-order as often as every other day and but comparatively few purchases of half dozen and dozen lots of radio receivers were noted. Everywhere the attitude is one of caution.

**B**UYING for the fall season appears to be a subject of small concern to the average dealer; he is satisfied with meeting the demand of yesterday and today. But what guide can be offered to make larger purchases safe? Every dealer should have a representative stock without taking on too great a burden. The question is, should larger purchases be urged because of their economy and sales advantage? The crux of the problem is to learn your customers' buying desires so that larger orders can be placed intelligently.

Begin your intensive selling earlier this year than ever before. Don't wait until the season pulls you to work. Get the public reaction early. Offer a wide range of products and sound out your buyers early. Then, before the peak of the season is reached, you will be in a position to supply the active fall demand with a minimum number of lost sales.

Two notes of warning should be sounded. The startling interest in the alternating current has unduly overshadowed the market for battery receivers. Dealers have concentrated on the alternating current receiver and tended to neglect the sales opportunity for the good battery receiver. We do not mean to predict a surprising revival of the battery receiver, but merely to warn against the general trend of the trade to forget the battery receiver entirely. It still has its field of usefulness.

In most instances, the problem of deciding the ratio of alternating current to battery sets offers little difficulty.

Obviously, the purchaser having alternating current available will prefer the power receiver. The dealer serving both rural and urban populations, however, may be deceived by the demand for alternating current receivers. Some of it may be due to novelty and last year's figures may therefore be illusive.

The total figures for the industry show that only a

fourth of last year's demand was for alternating current receivers. Inasmuch as production did not reach peak figures until the latter half of the season, the actual demand for a.c. and battery receivers was about evenly divided. In areas where rural electrification is progressing rapidly, a constantly changing proportion may be experienced. A house-to-house canvass where power lines have just been installed will reveal many new prospects for power line sets, but, by the same token, battery receivers can also be sold in those communities.

**A**TENTION is invited to an important and often neglected phase of the a.c.-battery set problem: the effect of changing ratios of these two classes of receivers upon the demand for auxiliary and maintenance accessories. Every battery receiver sold usually means the sale of a trickle charger or some other type of A power unit, a B power supply and speaker, or, in their stead, a power amplifier and speaker unit. It also means future sales of battery set maintenance accessories, such as rectifier tubes, battery tubes and B batteries. As the demand for battery receivers falls, it should be reflected by an immediate curtailment of these types of accessories.

The second point concerns the television flurry. The public is keenly responsive, particularly the set builder and constructor, who flourished from 1921 to 1925, for an opportunity to experiment. The public is always ready to grasp at novelty and the alert dealer never fails to be ready with merchandise having the impelling power of novelty to overcome selling resistance. Along television and picture reception lines, the dealer should acquaint himself fully with the performance qualities of what he offers, whether it be scanning disk, neon lamp or picture receiver. In the present development of the art of visual image transmission, the dealer sells experimentation, the lure which served as the introduction of radio entertainment as a major public service.

In selling visual reception, do not misrepresent. Exaggerated claims of performance will be made by a few over-enthusiastic sponsors of television. Set up and test every piece of equipment for radio image reception which you sell so that you can tell the experimenter, from your own experience, just what every device will do.

Dealers who have established parts clienteles will also find the screen grid tube the opening to a lucrative market. The parts business lives in proportion to the novelty of what it offers and the degree to which it is a departure from the conventional production type of radio. This year both the screen grid tube and visual broadcasting will help to make the parts business profitable.

Recapitulating, this year's offerings are possessed of greater diversity in price range, which should open new markets in both the low and high priced fields. There will be an increasing demand for complete console types gained at the expense of table models. Receivers using electro-dynamic speakers and '50 power tubes will be preferred by buyers able to afford them. Let the marked improvement in these respects be reflected in every purchase you make for the coming season.



## AND-Get Started Early



# Period FURNITURE for Summer Sales



*Featuring period furniture as a summer "buy" and working on the theory that customers wanted the best grossed an extra \$2,700 for this Illinois dealer*

THE fact that period radio furniture is not generally regarded as a warm weather sales item meant nothing to William Hedrick, manager of the radio department of Williams Sport Shop, Rockford, Ill., when, last summer, he informed his customers and prospective customers, that he had on display a selection of unusually attractive period cabinets, in authentic and exclusive designs, suitable as a life-long housing for their present sets or for a new outfit.

He announced, by telephone, personal calls and in two medium-space advertisements, that a liberal allowance would be granted on the old equipment. Nine substantial, profit-making, sales resulted from this effort. Four were replacement jobs; five sets and quality consoles went to new customers. Total gross volume added to the books, which otherwise would not have materialized, \$2,700.

In no instance did Hedrick allow more than 10 per cent of the list price of the new assembly for the the old set. And, since his average unit sale was slightly over \$300 and his average "mark-up" in excess of 100 per cent, and as three of these trade-ins were soon sold for their allowance price, each trade proved an exceedingly profitable one.

Mr. Hedrick sold his prospects on the wisdom of buying a *real* piece of radio furniture during the off season with the following arguments:

"Because the radio business is now at its lowest ebb I have been able to make an advantageous 'buy' in these custom built period pieces which you see here. This reduction I am passing on to you. Furthermore, I will be able to get more for your old set (or console) now than if it were to be turned in this fall, when all the newer models will be on the market; consequently I can allow you more at this time." It takes time, to sell quality furniture, which lists for \$175 or more, according to Hedrick. Family councils must be held and follow-up appointments arranged. Summer, with its larger proportion of leisure moments, is an ideal time, from the dealer's viewpoint, to put over a selling job of this nature.

Three sales to new customers were directly traceable to recent purchasers of these cabinets as a result of friends asking them where they obtained such beautiful radio sets.

When such a prospect comes into the store all thoughts of price bickering on the set itself, or of the particular make of set desired, are invariably submerged in the consideration of the quality of the set and the attractiveness of the piece of furniture which will house the sound producing mechanism. Mr. Hedrick never assumes that a customer wants a low-priced table model set without a cabinet. He works on the theory that the prospect wants a good radio chassis enclosed in as fine a piece of furniture as his pocketbook can stand.

Another advantage in talking fine furniture to your customers is that a cheap speaker is out of place in the company of a high-class piece of radio cabinetwork. With few exceptions Hedrick sold built-in reproducers of the \$30-60 price range with these "show" pieces.



# DYNAMICS *Dominate*

*New electro-dynamic reproducers and fine furniture among trade show features—other trends brought out at the show*

THE radio trade has been given four definite outstanding trends as a result of the second annual Trade Show of the Radio Manufacturers' Association, held last month at Chicago.

They are: first, the growing domination of electro-dynamic reproducers in the speaker field; second, the unprecedented popularity of fine furniture, with both the trade and the public; third, an unusual number of companies making radio-phonograph combinations, and, fourth, the use of bright colors which is rapidly coming to the fore, especially with the metal cabinets.

Incidentally, two opposite extremes in prices were noted at the show. "The rich get richer and the poor get poorer" is holding true in radio this year. The higher price ranges are going higher and the low-price sets are going lower. Briefly, the set situation for next season can be summed up as follows: beautiful period furniture for the highbrow market and tin cans for the rest of us.

In the console receivers, with fine wooden cabinets, the price trend is definitely higher, beginning at about \$135 and going on up into the thousands, with \$400 to \$500 a popular figure with several manufacturers. For table type sets below the \$100 mark, metal cabinets are the vogue, practically without exception. The grief in this price class is going to be heavy next season if the price war which seems imminent, materializes. There is a definite limit at which radio sets may be made and sold with a profit to the manufacturer and if the craze for "lower than \$75" continues, with its correspondingly steady price decrease, it does not need much imagination

to foresee the fireworks that are bound to occur.

And this word of warning is substantiated when the blatant announcements of this

By William Alley

year's production by many manufacturers are scanned. If the impending \$75-Price-War doesn't blow next season into a cocked hat, then overproduction will. That is, IF our best manufacturers adhere to their announced production schedules. And when one of the biggest says, "A million for me this year," the rest of the trade puts its tongue in its cheek and says, "Applesauce," but is willing to be convinced. In this industry, anything can happen.

## NUMBER OF DYNAMICS A SURPRISE

PERHAPS the biggest surprise of the whole trade show was the number of manufacturers who displayed an electro-dynamic reproducer in one form or another.

Out of a total of approximately two hundred exhibitors, exactly fifty-three, or more than 25 per cent, offered their unsuspecting trade one or more electro-dynamics. This startling, if not amusing, fact was brought out in a statistical review of the Trade Show, made by the editors of *Radio Retailing*, and published in the *Trade Show Daily*, the newspaper published on the floor of the convention each day by *Radio Retailing*.

This statistical survey disclosed that the number of electro-dynamics on display, by set manufacturers as well as speaker manufacturers, outnumbered the hitherto dominating cones, or magnetic type cones as they are now called, to distinguish them from the electro-dynamic type. Among the forty-eight exhibitors of receivers, thirty-two provided some sort of electro-dynamic speaker, as against twenty-eight supplying the ordinary cone, while only six are still adhering to the exponential or air column speaker. About the same ratio holds true among the speaker manufacturers themselves, twenty-one showing electro-dynamics, nineteen magnetic cones, and nine exhibited the exponential type of reproducer.

Thinking back to last year's show, it comes to mind that power units dominated the 1927 show almost as much as the electro-dynamic speakers dominated the one just closed, yet before six months had elapsed the separate power unit was a thing of the past. This year, only 13 of the 200-odd booths on the exhibition floor carried a line of independent power units for the retail trade. Out of the total of forty-eight receiving set manufacturers who exhibited,

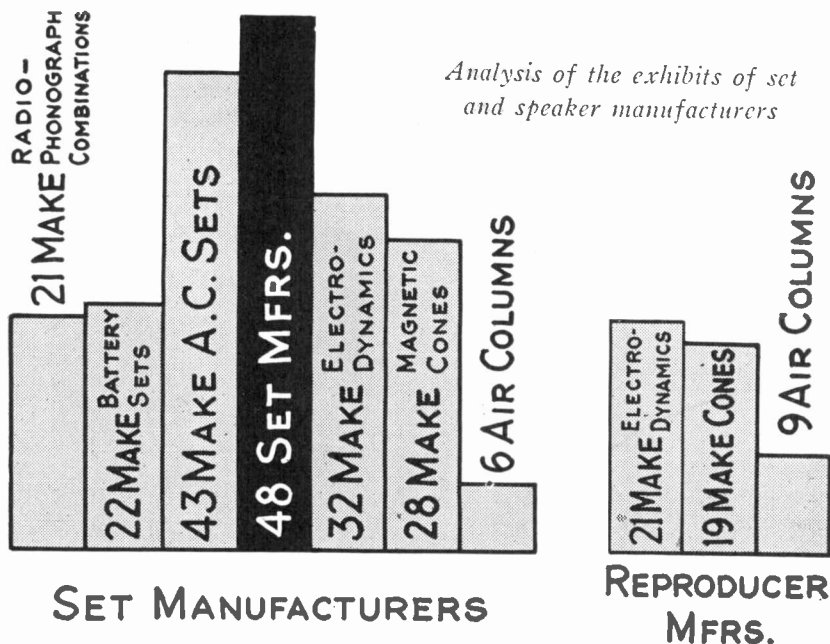

# Trade Show

forty-three carried a complete line of A.C.-operated sets, indicating beyond doubt, the permanency and popularity of A.C. tubes. Twenty-two of the forty-eight, however, still are keeping battery-operated sets represented in their lines, so that the rural trade need have no fear of not being able to obtain battery sets for those of their customers who want them.

Another surprising fact concerning set manufacturers, is that twenty-one, or almost 50 per cent of the set exhibitors, are including a radio-phonograph combination among this year's models. In many instances this type of instrument sells in the neighborhood of \$500 or over and thus carries an unusual margin of profit for the dealer. For several seasons, the radio trade has played around with this combination without any very great degree of success, but it would seem that the radio-phonograph is to come into its own this year, if the number of radio manufacturers making them is any criterion.

## FINE FURNITURE MUCH IN EVIDENCE

THE astonishing growth of the radio furniture branch of the industry is also proven by the 25 exhibitors who showed a complete line of consoles and tables for the retail trade. After looking over the quality of the cabinets these manufacturers had on display, and taking into consideration the brilliant colors which were so noticeable in the metal cabinet class, it can truthfully be said that beauty was the keynote of the show, and that the main consideration of the public next year will be the question of appearance.

Technically, in the receiver itself, outside of the dynamic speaker, there was nothing importantly new which would cause universal public interest and demand. Therefore, tone quality and appearance are the two major requirements, so far as the public is concerned. In the majority of cases, the tone quality is provided automatically, so that the appearance of the set—its exterior design—is the only remaining place where the individuality of each manufacturer can be expressed.

And when you look at some of the brilliant-hued new sets, you can see that they are certainly beginning to express themselves!

Every industry that appeals to the home has eventually come around to the use of bright colors in order to attract the customer's attention. Automobiles, furniture, electrical appliances, kitchen utensils, and now, radio. And, in each instance, the new colors have found ready public acceptance. The same may be so with radio.

In the lower price ranges, the brilliancy of the colors in which the receivers are sheathed, is dazzling. And even in the high priced cabinets, growing use of light and dark contrasts in the wood is noticeable, and, in many cases, colorful decorations add life to an otherwise dark wooden background.

Nowhere, perhaps, is the beauty theme better exemplified than in the quality furniture which set manufacturers and furniture makers alike had on exhibit.

From expensive cabinets in the most exquisite period design, to the latest severe lines in black and white in the

Major  
Herbert H.  
Frost  
vice-president of  
the Kolster Radio  
Corporation,  
was elected presi-  
dent of the  
R.M.A.



most up-to-date "art moderne" style, the radio furniture seen at the show provides for every possible decorative situation the public might call upon the trade to meet. The radio merchant who does not stock and sell a line of the modern radio cabinets this year will be overlooking an opportunity for specialty selling which will probably be at its peak during the 1928-29 season.

Parts and raw materials were also well represented, there being 41 exhibitors showing these types of products. No little interest was also shown in television parts and parts for the reception of still pictures. Both these new developments are expected to exert a beneficial influence on the parts market during the coming months.

Significant of the place which the Trade Show holds in the industry is the fact that approximately 21,000 radio men, according to official reports of the registration, crossed the threshold of the show during the five days of its life. This is an increase of about 4,000 over last year's registration.

## PATENT INTERCHANGE ADOPTED

OUTSTANDING among the events occurring at the fourth annual convention of the Radio Manufacturers' Association, held in conjunction with the show, were the adoption of a patent cross-licensing plan, reported elsewhere in this issue, and the election of Major Herbert H. Frost as president. Major Frost is vice-president of the Kolster Radio Corp., Newark, N. J.

This is the third term which Major Frost has served as president of the R.M.A. He was the first president of the organization, 1924-25, and was re-elected for the 1925-26 term. He is one of the founders of the R.M.A.

Arthur T. Haugh, vice-president of the United Radio Corporation, Rochester, N. Y., was the association's third president (1926-27) and C. C. Colby, president of the Samson Electric Company, Canton, Mass., is the retiring president.

Three vice-presidents were also elected at the meeting. Vernon W. Collamore, who has been for many years general manager of the Atwater Kent Manufacturing Company of Philadelphia, was named first vice-president. Morris Metcalf, treasurer of the American Bosch Magneto Corporation, Springfield, Mass., was chosen for the office of second vice-president. Lester E. Noble, president of the Federal Radio Corporation, Buffalo, N. Y., was selected as third vice-president.

John C. Tully, president of the Bremer-Tully Manufacturing Company, Chicago, was selected to serve as

(Please turn to Page 52)



# Atmosphere

## —a Sales

### ASSET

*Creating an artistic environment in which to display his merchandise proved to be the biggest selling influence for this California dealer*

By R. Randall Irwin



**W**OULD you invest \$20,000 in fixtures and decorations in a radio-music store in a new location, with no more of a guarantee that the investment would be returned other than your confidence in the additional business it would create? John T. Kelly of Los Angeles did and has succeeded in writing off \$5,000 of it the first year by running up \$75,000 in radio and phonograph sales with the assistance of only one salesman.

This outstanding sales record never could have been made, according to Mr. Kelly, without the help of the beautiful and artistic store which the investment made possible. "By putting \$20,000 into fixtures and decorations," he declares, "we produced our greatest asset—the store itself. Creating an artistic environment in which to display our merchandise, we produced the logical buying center for a large group of artists in all professions and of cultured business men and women."

"Before opening I decided that under no circumstances would I be 'just another radio dealer.' I wanted something in the way of a store that nobody else had. The location did not matter so much. We were after a class market that extends from San Diego to Santa Barbara, and the first year's sales show that we got it."

Does it pay?

Mr. Kelly wrote off \$5,000 in fixtures the end of the first year in business, and after charging off all expenses was obliged to pay a substantial income tax. Based on his sales figures so far, the second year bids fair to reach \$150,000 in gross sales.

**K**ELLY MUSIC as his palatial store is known, is located midway between Hollywood and the central business district of Los Angeles. When you enter you are met near the door by a charming hostess, who ushers you past a record and sheet music department into a

spacious ante-room where you are seated in an upholstered chair that puts you quite at ease. Beautiful pieces of furniture that hardly suggest radios or phonographs are set off against colorful Venetian walls. Here and there are inlaid bits of colorful tile.

Through the opening serving as a doorway, you catch glimpses of the main display room—Italian tapestries, carved woodwork and chairs, wrought iron lighting fixtures, and a brilliant-hued ceiling—all in keeping with the Mediterranean influence so evident at every turn. Such is the atmosphere in which Kelly Music presents its merchandise to its customers.

**T**HIS artistic atmosphere has in itself been an excellent advertisement for Kelly Music, and an expensive one. Twenty thousand dollars invested in beautifying the store does not sound so extravagant when considered in this light. It represents an expenditure of \$2,000 a year if the entire amount is written off in ten years. Not a large amount, certainly, for a store doing \$100,000 a year.

More intent on clean than on aggressive merchandising, Mr. Kelly and his salesman sell through skilled salesmanship, service and quality merchandise. Only one line of radio sets is carried, and that one is of good quality. Service is handled by the highest salaried technical men in the city. Salesmanship is based on making each prospect feel he is an honored guest. An example of this last point is given in the words of an attractive mailing piece issued by the store. It reads in part: "The delights of Kelly Music are offered you. We hope to have you for our guest of an hour—longer if you will."

That this method is practical if carried out intelligently is shown in the fact that Mr. Kelly and his salesman sell 60 per cent of all persons interviewed in



Left: View of main display room of Kelly Music, the beautiful radio-music salon of John T. Kelly, Jr., located at 122 S. Vermont Ave., midway between Hollywood and Los Angeles, Cal. Below: Another glimpse of the main display room, through the door of a large demonstration room, showing one of several Italian tapestries and an alcove faced with imported Lisbon tile.

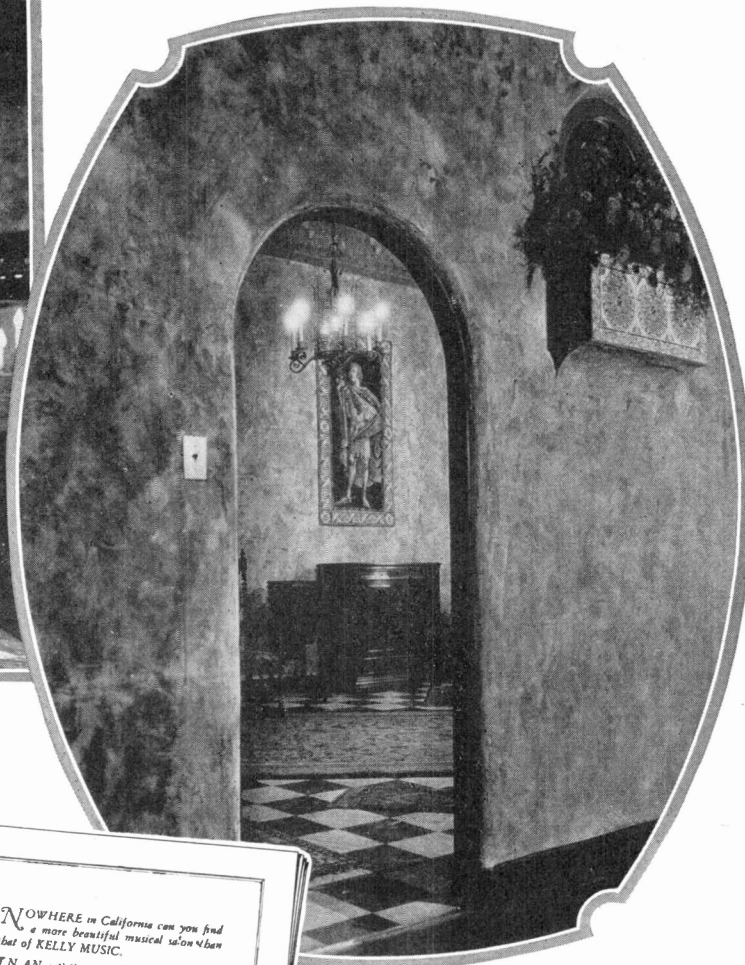

regard to radio. And one half of the sales are made on the first interview.

"The first step of a sale," declares Mr. Kelly, "is to engage a prospect in a conversation entirely foreign to radio in order that the salesman can get a line on his tastes, financial status and personal character. If the customer is artistic, the salesman asks how the home is treated, and suggests that they procure a cabinet that will fit in harmoniously with the rest of the furnishings.

"Women are primarily interested in furniture," he claims. "So, along with our exclusive line of distinctive and individual cabinets, we carry the type of furniture ordinarily carried by an average radio store. We point out the differences, and show prospects how a better type of cabinet will be valued all the rest of their lives.

"We ask why they should throw away their money on a cabinet that they would discard should they suddenly come into wealth."

Each cabinet placed in stock is altered so as to make it "the only one of its kind." This is done by applying hand carved pieces, painting artistic subjects, or carving the cabinets themselves. The art work is done by Mr. Kelly himself, who can assure each customer that his cabinet is truly different.

In building up confidence that enables him to close a deal on the first interview, Mr. Kelly puts this guarantee

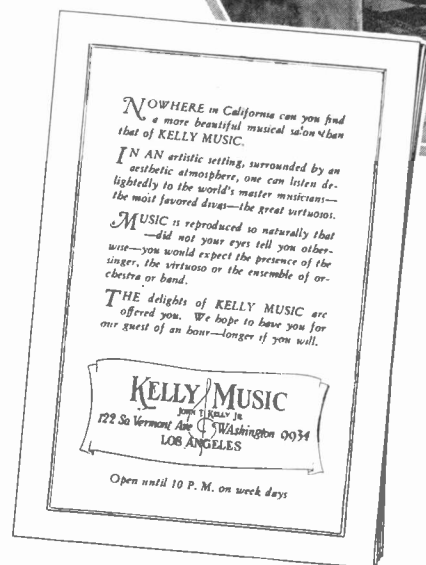

One of the attractive announcements mailed to the prospects of Kelly Music

on his merchandise, "If after 30 days the instrument does not come up to your expectations, your money will be refunded." In spite of this definite money back guarantee, the store has less than 2 per cent reverts.

What is very often the determining factor in keeping sets sold is the class of technical service rendered. Every set is carefully checked and balanced before delivery. After a set is installed, the same care is exercised in keeping it up to the customer's expectations.

Even with free service extending over the period of a year the technical department is now paying its own way with accessories sold and calls that are being charged for.

ALTHOUGH most people come into Kelly Music to look for a radio, the majority of them are sold the idea of a combination radio and phonograph instrument housed in an attractive cabinet. This boosts the average sale up to nearly \$500. "I always try to keep in the

(Please turn to page 60)

# Music INDUSTRIES



HERMAN IRION  
*Re-elected President of the  
Music Industries Chamber of Commerce*

CHARACTERIZED on all sides as the most successful gathering in the history of the music industries the 1928 convention of the Music Industries Chamber of Commerce came to a close with the annual banquet of the National Association of Music Merchants at the Hotel Commodore, on Thursday evening, June 7. The entire convention period of four days, beginning with the equally auspicious mass meeting and luncheon on Monday, June 4, was studded with many high lights, marking the convention as the most important gathering the music merchants have yet held.

Herman Irion, general manager of Steinway & Sons, New York City, was re-elected president of the Music Industries Chamber of Commerce and C. J. Roberts of Baltimore, Md., was re-elected president of the National Association of Music Merchants.

The Music Industries Chamber of Commerce indorsed the plan of continuing to hold a joint convention of all the manufacturers and dealers represented in the various bodies of the Chamber of Commerce.

The National Association of Music Merchants after some discussion at one of the meetings fell into step with this indorsement by voting to hold next year's convention in Chicago during the first or second week of June, to coincide with the other members of the Chamber.

The National Association of Music Merchants further voted to return to its former membership arrangement which will provide for three classes of membership, active, associate and honorary. It was felt that this step would permit a more representative association and work towards closer co-operation in the music trade.

This association also went on record as frowning upon

## *Prominent speakers and large*

the methods of manufacturers who dispose of their merchandise through loose jobbing channels when they passed a resolution urging that all manufacturers of radios and phonographs sell only to jobbers who in turn sell to legitimate dealers.

More than a hundred manufacturers had their merchandise on display at the Hotel Commodore during the convention, exhibiting everything in the line of music merchandise from instrument strings to grand pianos. Five radio manufacturers had their new models present and eight manufacturers exhibited combination radio and phonograph instruments, the latter instrument being one of the outstanding trends evident in this year's merchandise.

THE convention opened with a grand mass meeting and luncheon in the main ballroom of the Hotel Commodore at Monday noon, June 4. Herman Irion presided, and rendered his annual report on the activities of the Chamber of Commerce at this meeting. John Erskine, noted author and leader in musical education and president of the Juilliard School of Music, was the main speaker at this luncheon. He gave an exceptionally inspiring talk on the problems and possibilities in the musical education of America. The address was broadcast over WEAf and associated chain of stations.

The opening session of the Music Merchants Association was held Tuesday morning and several hundred members of the trade attended. Many prominent speakers appeared on the program, including Philip T. Clay, president, Sherman Clay & Company, San Francisco; Major Herbert H. Frost, vice-president Kolster Radio Company, Inc., and re-elected president of the Radio Manufacturers Association; F. E. Moskovics, president, Stutz Motor Car Company; and J. I. Burhans, manager of Credit and Collection Department, General Motors Acceptance Corporation.

President C. J. Roberts presided at the meeting and both he and Executive Secretary Delbert L. Loomis presented their reports on the activities of the Association for the year. In presenting his report Mr. Roberts brought out the music dealer's point of view on the relation of the radio and phonograph to the piano and other musical instruments in the home.

He stated that "while cordially granting that every American home should by all means have in it a radio set and a phonograph, we feel that there should also be in every home a piano and other musical instruments and that they should be played upon. While we are undoubtedly the most musical nation on earth, when measured by appreciation of music, and what is paid for it, we are by no means a nation of *makers* of music. To become mere listeners to music, neglecting to acquire real musical knowledge, the skill to play musical instruments and the cultivation of the voice, would be for us to become a musically degenerate nation.

"While sincerely and earnestly aiding in the promotion of music for itself we merchants must not overlook the



# CONVENE at *New York*

*attendance mark 1928 convention*

fact that the primary object of this Association, as such, is the promotion of the material interests of music merchants and that the sweetest note in music to the music merchant in his business capacity is that produced by the little jingling bell of the cash register. If, however, our altruistic objects are attained those of a material character will naturally follow."

**PHILIP T. CLAY**, president, Sherman Clay & Company, San Francisco, and a former president of the National Association of Music Merchants, next spoke on the subject of dealer operation and brought out some very interesting ideas on present-day musical instrument and radio merchandising.

"The music store today," said Mr. Clay, "must be an Emporium—an Emporium of Home Entertainment. We must sell those things that will amuse and entertain people in their homes. Before very long every music dealer will be selling a combination radio, talking machine and moving picture instrument.

"The automobile, the movie theater and the jazz bands have taken people away from the home because they offered more attractions. If the music dealers of the United States will combine with the one object in view of selling everything that will make the home more attractive, they will educate the people of the United States to an appreciation of what home really is.

"My advice to the Music Trade is to handle all kinds of musical merchandise. Be a complete music store. Make yourself the local headquarters for home entertainment, and if you are too old to learn this new phase of the business yourself, or too lazy, put a live one in to do the selling while you watch the financing."

Major Herbert H. Frost, vice-president of Kolster Radio Corporation and president, Radio Manufacturers Association, at the same meeting, spoke on the topic of "What Radio Means to Music Merchants," and stressed how well the set-up of the music dealer's store is adapted to the merchandising of radio sets.

Major Frost concluded his talk by asking for proper recognition of radio on the part of music dealers, and inviting them all to the R.M.A. Trade Show at Chicago next year while attending their own convention. The hope was expressed that the dates of both the radio and music convention in Chicago next year could be arranged so that the two would coincide, thus enabling the music merchants to cover the displays of both music and radio merchandise.

F. E. Moskovics, president, Stutz Motor Car Company, Indianapolis, and a nationally known merchandising expert, drew a close analogy between the problem of merchandising automobiles and those of merchandising musical instruments and radios.

At the Wednesday meeting of the National Association of Music Merchants, S. L. Rothafel, president, Roxy Theater Corporation, New York City, gave an exceptionally inspiring talk on the subject of "Music—An Inspiration to the Masses and to the Man Who Sells



C. J. ROBERTS  
*Re-elected President of the  
National Association of Music Merchants*

Musical Instruments." Homer McKee, president Homer McKee, Inc., Indianapolis, also contributed to the meeting with an interesting analytical talk on advertising.

At the same meeting Fred W. Shibley, vice-president Bankers Trust Company, New York City, who recently made an investigation of the financial situation in the piano industry, in a talk on "Merchandising the Piano," made the following interesting statements: "No single force is more important in the realm of music today, particularly in this country," declared Mr. Shibley, "than the radio and yet all the evidence I have been able to collect is to the effect that the radio will continue to enlarge the potential market of every music merchant, whether he is selling radios, phonographs, reproducing pianos, pianos, violins, or bass horns, for it is daily increasing the number who are interested in music."

**T**HE entire session of four days was punctuated throughout with meetings, luncheons and dinners of the various groups that are part of the Chamber of Commerce. Many manufacturers gave private dinners to their distributors and dealers. A banquet was given on Tuesday evening by the Associated Musical Instrument Dealers in New York City at which several hundred visiting musical merchandise men and women were entertained. Arthur J. Newman, president of this association, acted as toastmaster, and he, together with the excellent array of talent provided by the Musical Instrument Manufacturers, succeeded in making this banquet rival that of the music merchants on Thursday evening.

The latter banquet on Thursday evening officially closed

*(Please turn to page 52)*

# A RADIO

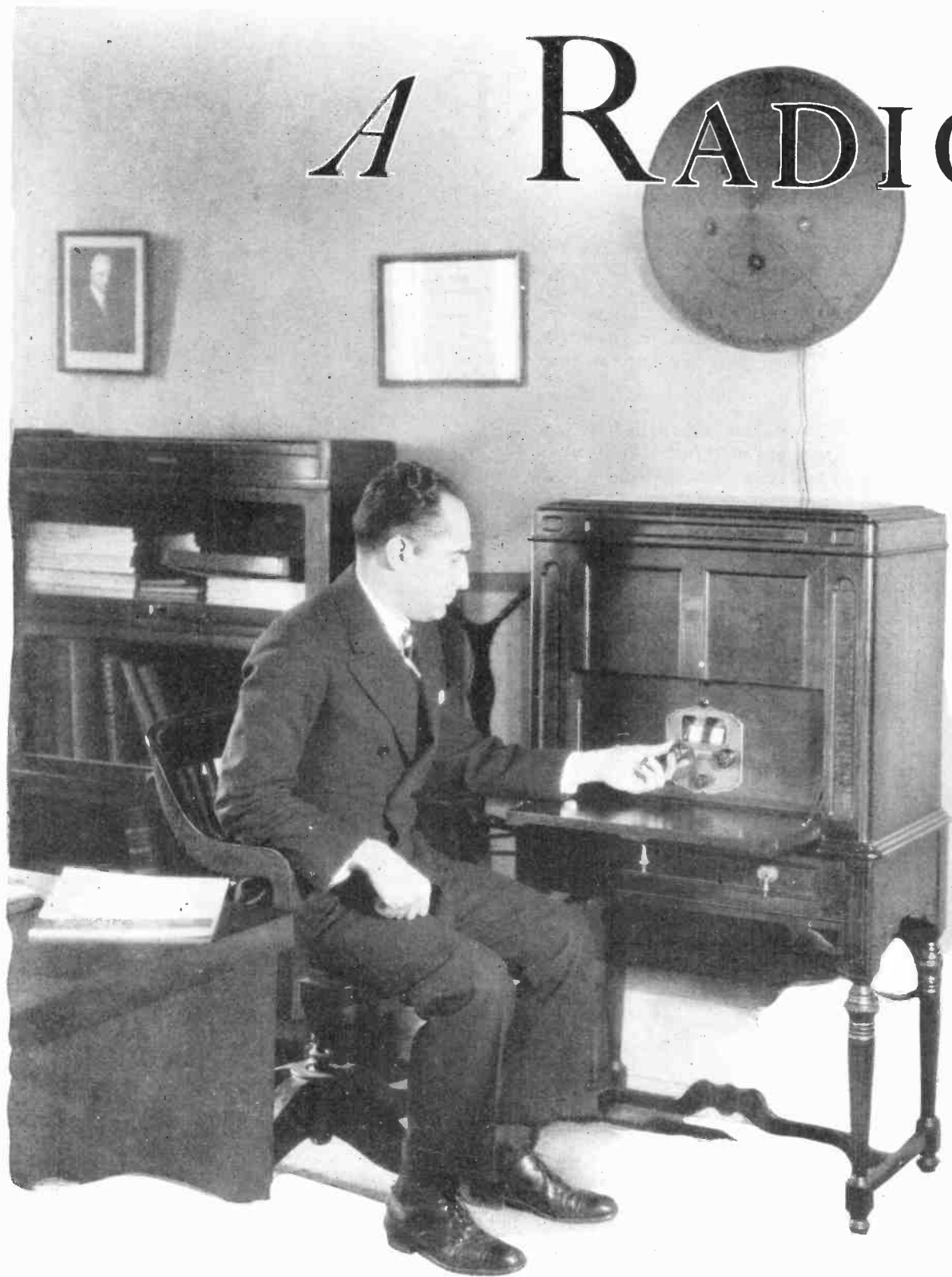

*Edgar Kobak, vice-president of the McGraw-Hill Publishing Company, found that a radio set, installed in his office, provided no information of value to him as a business executive. His suggested remedies are contained in this letter to the editor.*

# in Every OFFICE

*McGraw-Hill vice-president suggests a plan that opens up a new market for radio receivers among the nation's business men*

Editor, *Radio Retailing*:

EARLY one morning recently I tuned in my radio set at home and heard a summary of the latest news—events that had happened during the evening and early morning. It brought me right up-to-date so far as general world affairs are concerned.

This thought occurred to me—if radio can provide the average citizen with a quick, dependable summary of world news, why can't it provide a similar service of business and industrial news for the average business man and industrial executive?

So I had a radio set installed in my office with the idea that I would be able to pick up valuable information that could be used in the every-day conduct of business.

It was my impression that there were, during the week, periods of business news, industrial news, stock quotations, crop reports and so on. I thought I would have my secretary watch the published radio programs, and keep me advised whenever anything of interest to me was to be broadcast.

To date, however, I have been able to find no such service for business men. That expensive radio set in my office is absolutely useless to me in my day's work. Doesn't this suggest a natural opportunity for radio that should be developed?

I AM convinced that if the right kind of service is provided, radio can be made so indispensable to American industry that every business man would find it worth while and necessary to have a radio set installed in his office within easy reach of his desk. If business men, wherever located, could tune in every morning for a half hour or so at their offices and receive an up-to-the-minute review of business conditions, it would have tremendous value.

Reports on different industries or markets could be programmed in advance so that the busy executive could have those features of interest to him entered on his appointment pad. The time would be reserved for him to listen, and other members of his staff could be present. A stenographer could take down the pertinent information and it could be distributed in abstract to the organization. In this way radio would become a new resource of information, a new tool of business, that could be utilized to great advantage.

This service, I believe, would open up a vast new field for the sale of radio receivers. Business men would find radio of such practical value to them that

a radio set would prove as much of an investment to them as it is to the farmer.

I HAVE not given this subject mature thought. I have not worked out the details of how the idea should be developed. But it is easy to suggest a possible procedure.

1. The daily newspapers provide a wealth of current news of stocks, money rates, exchange, crop conditions, car loading and major news events that bear on industry and commerce. A properly interpreted digest of this material would give the business man a rapid panorama of the broad economic drift.

2. The business papers of the country might be called upon to supply broadcast stations with daily information concerning conditions in the key industries, such as steel, coal, electrical, copper, mining and so on, together with a review of the important events in the business world within the past several hours. These should be cold, dollars-and-cents facts concerning the movement of goods, buying orders, credit conditions, increase or decrease in activity, prices, and similar information, prepared as specifically and concisely as possible. The purpose would be to give the business man a quick picture of industrial conditions so that he could use the information immediately in his own business.

3. The leading stations could broadcast this business service daily during the early morning, between nine and eleven o'clock, scheduling short periods so that each man could tune in for what he wanted.

4. Using this program as a nucleus, the radio trade would be able to embark upon a concerted sales campaign with the object of selling a receiver to every business man for use in his office.

I am going to suggest that you present this idea to the radio industry and find out what the radio men think of it and then check up and see how it appeals to business men of various fields. Personally, I am sure that it opens up the possibility of a very practical service that will carry with it a vast new market for radio receivers. (It would probably save some of us some time in getting the baseball news and watching the stock market, but I won't mention this). The organized broadcasting of such business information, I believe, would be welcomed by business men everywhere.

Very truly yours,

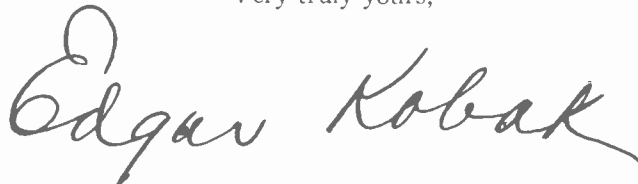

*Vice-President, McGraw-Hill Publishing Company.*



# New Circuit Announced

*Inventor claims non-infringement of patents  
in new receiving circuit*



LESTER JONES  
B.S. in E.E. and R.E.,  
consulting radio engineer.  
Fellow of I.R.E.

A NEW system of broadcast reception, known as the "Equase" circuit, which differs radically from existing types of circuits, has been developed by the Technidyne Corporation of New York City. According to Lester Jones, inventor, this new circuit is absolutely independent of all existing patents on radio circuits.

There are three U. S. patents already issued, two of which are circuits and one of which is a parts patent. They are U. S. Patent No. 1,581,900, April 20, 1926; U. S. Patent No. 1,620,661, March 15, 1927; U. S. Patent No. 1,673,287, June 12, 1928; and other patents. Patents have also been issued in Canada, Great Britain, France and the Argentine.

A selector circuit connected directly to antenna and ground permits only one broadcasting channel of ten kilocycles to pass through. It is composed of a recurrent network of inductances and capacities without any tubes. The bands of frequencies are selected by varying the capacities of a group of condensers, under one control, in the selector circuit. After selection, the signal passes into the amplifier unit. There it is amplified by a system of circuits with fixed adjustments which automatically tune themselves to the impressed frequency.

The relatively large amplifier gain impresses voltages on the detector far in excess of those ordinarily encountered so that plate rectification is employed. While somewhat less sensitive than the grid leak and condenser, this method handles large voltages without overloading. Any reduction in sensitivity is more than offset by the extreme sensitivity of the amplifier. In fact, the voltage output of the detector operates a 25-watt power tube without any intermediate stages of audio frequency. The elimination of one audio stage about pays the cost of licensing—an important consideration.

One of the most important features of this circuit is "flat-top" tuning. This makes station selection extremely easy. As the dial is revolved the signal suddenly comes

in completely. Also, there is enough leeway on the 10 kilocycle band so that absolute accuracy of dial adjustment is not essential to get full tone quality. This makes unnecessary the use of any verniers. The manufacturer benefits also by characteristics of this circuit; for with a given amount of high selectivity, more variation in the tuning is permissible than with the same number and quality of tuned radio frequency circuits.

The selector overcomes a bugaboo of the past in that it gives high selectivity of the right form without losing the signal. In the "Equase" selector we get at the output approximately seventy per cent of the voltage that exists in the input.

Five tubes employed in an amplifier give a voltage amplification of about 3,500 at 1,500 k.c. to about 15,000 at 550 k.c. The increased gain at the lower frequencies offsets the greater attenuation at the lower frequencies.

The circuit as shown below is divided into two parts: the selector unit and the amplifier-detector unit. In the amplifier-detector unit will be seen connections for an electric phonograph pick-up which is coming into popular use this season.

From a manufacturer's viewpoint, the "Equase" system is an efficient production proposition. The receiver proper divides into three main units: a selector device, a radio frequency amplifier-detector device and a power supply and audio device. Any one of these devices is interchangeable. From a service standpoint, this is very important. Each individual unit can be tested separately. A faulty unit can be replaced immediately by a spare.

This new circuit is being used at present only by the Sparks-Withington Company, which has taken out a license. This receiver is known commercially as "Equasonne."

In view of the patents which have been granted, the Technidyne Corporation will license reputable and reliable radio manufacturers to use this circuit.

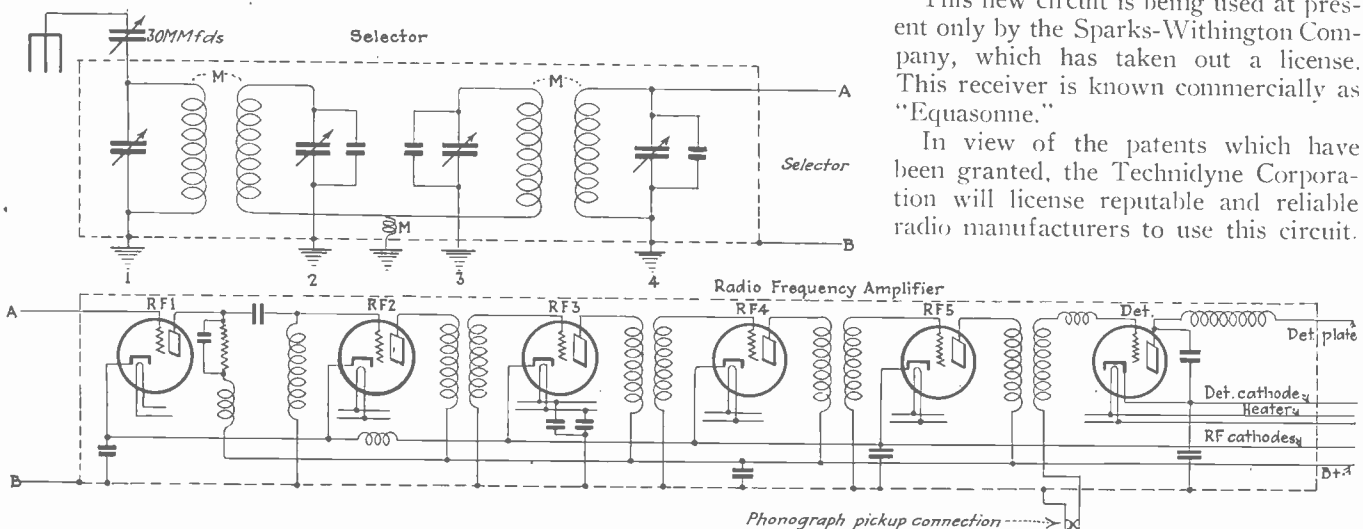

Schematic diagram showing the selector and amplifier-detector of "Equase" circuit

# Patent Interchange *Adopted*

*Radio Manufacturers' Association approves plan for cross-licensing of radio patents among R.M.A. membership*

WITH practically the complete roster of members present, the Radio Manufacturers' Association, at its annual convention in Chicago last month, approved the patent cross-licensing plan presented to the membership by the Board of Directors.

The cross-licensing agreement, which the R.M.A. Board of Directors has been preparing for the past year, will now be presented to the individual members of the association for signature and will become operative as soon as it has been signed by 51 per cent of the membership.

The patent interchange licensing agreement is designed to eliminate a great deal of patent litigation which, in the past, has been very costly to R.M.A. members.

It provides for the classification of patents held by members into two groups: Class A and Class B. Class A patents are those which are considered basic in nature and these do not come within the scope of the agreement. Class B patents are of the ordinary type, not displaying invention of a high order.

The association, under this plan, is given the right to license all the other members under these Class B patents without charge or royalty. Thus all of these Class B patents will be available to the R.M.A. members. Any patent owner may, however, himself license any one else he chooses. The agreement becomes effective only after 51 per cent of the membership of the Radio Manufacturers' Association have signed.

THE agreement does not contain any restrictions as to output, territory or price, nor in any manner as to trade activities. It is limited to patents of the United States, and for use only in radio devices, electrical phonographs and group address systems and in parts or accessories therefor.

Classification of patents is to be decided by the Board of Directors. If the member patent owner and the board of the R.M.A. are unable to agree, the question is submitted to arbitration. If the patent in question is decided to be in Class A, it does not come under the agreement, but each member is left free to deal with his own Class A patent in any way he chooses.

The adoption of the plan does not commit any individual member to sign the agreement. Only when 51 per cent of the members have signed the agreement does it become effective among the members who sign. It is believed that a very high percentage of the members will sign because of the unusual benefits to be derived.

According to Leroy Williams, patent attorney, and Judge John W. Van Allen, R.M.A. counsel, who collaborated in preparing the plan, the tremendous value of this agreement, to the radio industry and to radio fans, can hardly be overestimated. In addition to eliminating the great cost of patent litigation which has eaten into manufacturers' profits so radically in the past, the agree-

ment provides a patent clearing house where manufacturers may come for any number of patents which will enable them to make a complete and perfect product without recourse to expensive licensing procedure.

THE large number of patents which will undoubtedly be thrown into the pool will guarantee that signers will get out of it a lot more than they put into it. For every company that puts its own licenses into the agreement immediately has access to all the patents contributed by the other signers.

The reduced expense of patent litigation will also enable many manufacturers either to increase their net profits or to pass the saving along to the public in the form of lower prices.

The vote to adopt the plan was practically unanimous, there being but one unimportant dissenting vote. Makers of 90 per cent of the receiving sets and apparatus in this country were represented in the vote to accept the licensing agreement.

The action was characterized by President H. H. Frost of the R.M.A. as the most progressive step ever taken by the industry, and one which would enable it to go forward even faster than it has during the past four or five years.

During the discussion of the question it was pointed out by attorneys that the pooling arrangement did include television but not transmission of power by radio.

The agreement will continue until December 31, 1933, and for another five years thereafter unless a majority of the members withdraw.

THE R.M.A. has received an opinion from Silas Strawn, president of the American Bar Association, that the form and style of the agreement are wholly within legal boundaries. In addition it has met with no objections in Washington.

Adoption of the agreement made necessary several changes in the Constitution and By-Laws of the Association. These also were approved by the membership. The most important of these changes relates to dues, which have been revised so that association members pay annual dues according to the volume of their gross business. Most large trade organizations are conducted on this basis and the rapidly-expanding work of the R.M.A. made this procedure necessary.

In future, dues will be on a sliding scale, from \$200 a year for companies having a gross annual business under \$400,000, to \$5,000 a year for companies in excess of \$15,000,000 yearly.

By-laws giving the association the right to license its members under patents which may be turned over to it also were approved. The association approved a by-law giving it authority to participate in the defense of any patent action or suit brought against its members.

# Keep a Written Record

By Carroll  
Van Ark

# of Every



*"Statements and promises made at the time of a sale are too important to trust to memory," says Mr. Mayer. A written record of the transaction impresses the customer and prevents future arguments.*

*A. W. Mayer, Boston merchant, gives his business rules for running a successful radio store*

**K**EEP a written record of every sale and trust nothing to memory or chance." That is the foremost rule given by A. W. Mayer, of 147 Massachusetts Ave., Boston, Mass., for conducting a successful radio store. He owns one of the liveliest stores in New England, serving the radio fans of the aristocratic Back Bay district of Boston, and claims that his business has been successful mainly because he strictly abides by a few business rules.

A written record of every sale, Mr. Mayer went on to explain, means that when a set is sold he enters the details in a book having separate pages for each model, and the entries are numbered consecutively, so he can tell at a glance how many of each have been sold. Each entry gives the name and address of the customer, date of sale, whether sold complete with tubes and all other necessary equipment, whether a trade-in set was involved, whether the sale was for cash or time payments, and

what the model of the set and its serial number are. For quick reference a card file, arranged with the customer's name in alphabetical order, is also kept with the same data. In the sale of small articles over the counter, a sticker placed on the article is sufficient record in case it is returned, and eliminates a detailed account of minor sales. A service report card keeps a similar record in the file.

Again, whenever a set is left in a home for a trial, the customer is asked to sign a card stating that the set remains the dealer's property until the last payment is made. It is explained to the customer that it is usual practice to sign this printed card for a test of the set at home and thus not obligate the customer to buy the set.

**A**NOTHER precaution that Mayer takes on installment sales is to ask if there are any children in the family. The children of any family that moves away can be easily traced through their school certificates. If there are no children in the family it is wise to ask for the name of the family doctor and clergyman. If payments are late, the suggestion that their references might be willing to help is surprisingly effective.

Posting every article sold and writing the results in the sales record makes a good impression for the dealer and protects him against future arguments, states Mr. Mayer. In seven years, his annual sales have increased



A. W. MAYER CO.  
147 MASS. AVE., BOSTON  
KENMORE 2551

SOLD BY  
**A.W. MAYER CO.**  
SERVICED BY  
**A.W. MAYER CO.**  
BOSTON, MASS.

DATE RECD . . .	
STATUS	TEL.
WORKS	Parts Used
Customer's Property	Over
Service CHG. or PD.	

# Sale

Dealers  
Who  
Have  
Made  
Radio  
Pay—  
No. 18

NO.	NAME	LOCALITY	DATE SOLD	COMPLETE	TRADE-IN	TIME or CASH	MODEL
1	Mrs. G. M. Nowell	Boston	4-6-28	Complete	No	Cash	6-J
2	Mr. L. H. Corning	Brookline	5-8-28	Set: tubes	Yes	Time	6-D
3	Mr. Jno. Farragut	Jam. Plain	6-5-28	Complete	"	Cash	6-H

The details of every set sale are entered consecutively in a book having separate pages for each make of receiver. (Above) A service report card keeps a similar record in a handy card file. (Above, left) Stickers that are placed on tubes, batteries and inside the lid of every set sold.

five times the amount of his first year's business and the fact that he not only has specialized on testing tubes, batteries, speakers, and other equipment, but has kept records of these tests, and has advertised the fact, is given a major portion of the credit. The result has been that customers have told others of the reliability of the Mayer firm, and he now has an established reputation for thorough fairness and complete radio knowledge.

Another rule incidental to the first one is that of placing stickers on everything sold, whenever practical. "It is a constant reminder of your store and prevents complaints about another dealer's goods," states Mr. Mayer. "A good idea, in the case of batteries or tubes, is to write the test reading and place it on the sticker. That prevents later argument about its condition and how long the customer has had it. Accept no responsibility for goods without your sticker."

Mr. Mayer not only believes in identifying these small parts, but also the complete radio sets. A colored decalomania label is transferred to every set he sells. The label simply states: "Sold (or serviced) by A. W. Mayer Company, Boston, Mass." Anyone who is interested in radio and looks inside the set at the customer's home is bound to see this label. It tells him where he can get a radio like it, or have his present set repaired.

**M**AYER does not believe in adopting thirty or forty business rules, but does have a few strict rules that he adheres to religiously. His rules, like New Year's resolutions, will bring results if carried out. In

the following paragraphs are given the ones which he believes have contributed much to his success in Boston.

"Test every piece of merchandise before giving it to a customer. Then you are sure it's in first-class condition when it leaves your shop and you prevent many complaints that otherwise might come to you. Careless dealers don't build up a list of steady customers.

"Don't make extravagant statements to your customers which you can't easily prove. Wild claims about your merchandise give the suspicious prospect the impression that you're saying anything to make a sale, that you're looking out only for your own interests and that he can't depend upon anything you say.

**"B**E COURTEOUS at all times in your store and about. That applies to any salesman or service man who represents you. Serve your customers as if everything is done gladly, not grudgingly. Keep them friendly by doing all you possibly can to satisfy them, even if it means a little more trouble or expense. It pays in more business later, and they tell their friends.

"Have neatly dressed service men. Don't allow soiled clothing to enter a customer's home. 'Clothes make the man' is a good rule to remember in the radio business.

"Take advantage of popular broadcast features to demonstrate your sets before big crowds in theaters, club meetings and in your store. Don't be satisfied with one demonstration during the program. Send each service man or salesman out to a theater or hotel or club to take charge of a set, answer questions and perhaps

get the names of prospects who would like a demonstration at home. Always have a sign with the name of the radio set, and your name, within full view of the audience.

"Make a large number of acquaintances through social affairs and clubs. It is a big asset. All your friends will send you their friends, and that's a large field." A set in Mr. Mayer's cottage at a nearby lake, for instance, is used to demonstrate summer radio to acquaintances and several orders were taken there last summer by combining business with pleasure.

**"SELECT** a seasonal line of goods which is easily handled to balance the summer business. Be careful about selling heavy pieces which are hard to handle and which may require a great deal of service." Mr. Mayer's summer sideline of athletic goods is made a separate department and its sales curve shows that it balances the radio decrease in hot weather.

"Finally, remember your customer list with holiday greeting cards. It helps to promote that friendly feeling and again reminds them of your store at a time when they are all making purchases."

The store is divided into three departments—sets, service and parts. Each one must pay for itself and each one renders a weekly report. Mr. Mayer even has three special buttons on his cash register, marked "Sets," "Service" and "Parts," so that sales may be credited properly and a quick accounting made. He keeps a chart showing curves of sales by each department. The chart shows that recently sets have increased and service has decreased. The service decrease is due to the careful construction methods developed by the manufacturer, he believes.

**MR. MAYER** has an expert assistant in E. J. Maginot, who is in charge of the service department and testing laboratory. Both men have been associate members of the Institute of Radio Engineers since 1913. They have experimented with wireless since 1907 and because of their continued interest have "grown up with it," so to speak.

Their annual turnover is growing rapidly. So far this season, since Sept. 1, they have sold more sets than they did in the twelve months preceding that date. Their spring and summer business is always good because during those seasons they look for prospects instead of waiting for the prospects to seek them in the fall.

## Dynamics Dominate Trade Show

(Continued from page 41)

treasurer. He also is an organizer of the R.M.A. and his election brings two pioneers—Frost and Tully—together again.

Six new members of the Board of Directors were also chosen. They are: Captain William H. Sparks, president of the Sparks-Withington Company, Jackson, Mich.; M. Frank Burns, sales manager of E. T. Cunningham, Inc., New York City; George Kiley, vice-president of the Farrand Manufacturing Company, Long Island City, N. Y.; B. G. Erskine, president of the Sylvania Products Company, Emporium, Pa.; N. P. Bloom, secretary of the Adler Manufacturing Company, Louisville, Ky.; and Lloyd A. Hammarlund, president of the Hammarlund Manufacturing Company, New York.

## Music Industries at New York

(Continued from page 45)

the 1928 convention. C. J. Roberts presided and introduced Mr. Frederick Stief of Baltimore, who in turn introduced Governor Albert C. Ritchie, the main speaker of the evening. The entertainment of the evening was provided by several nationally known artists and was broadcast over a national hook-up of broadcasting stations. The banquet, as well as the convention, came to a close with dancing to music provided by the Hotel Commodore orchestra.

**THE** officers and directorate elected to the Music Industries Chamber of Commerce are as follows:

President—Herman Irion, of New York.

First Vice-President—Charles H. Yahrling, of Youngstown, Ohio.

Second Vice-President—William J. Haussler, of New York.

Treasurer—Herbert Simpson, of New York.

Secretary and General Manager—A. L. Smith of New York.

Directors at Large—Charles H. Yahrling, Mark P. Campbell, H. C. Dickinson, Louis Sterling. The following were elected to serve a one-year term: Max De Rochemont, Walter W. Clark, Herbert Simpson, R. E. Durham.

The officers and directors elected to the National Association of Music Merchants follow:

President—C. J. Roberts, Baltimore.

First Vice-President—Parham Werlein, New Orleans.

Second Vice-President—Charles H. Yahrling, Youngstown, Ohio.

Third Vice-President—Shirley Walker, San Francisco.

Fourth Vice-President—A. Z. Moore, Lancaster, Pa.

Secretary—Herman H. Fleer, Chicago.

Treasurer—Carl A. Droop, Washington, D. C.

Board of Directors—Otto B. Heaton, Howard Beasley, Jay Grinnell, W. Barry Hamilton, Edward A. Geissler, Frank J. Bayley, Alex McDonald, Alfred D. La Motte, George J. Winter, C. H. Yahrling, C. J. Roberts.

### Is the Music Trade Handling Trade-ins Profitably?

**THE** next article in the series of analyses of how the music trade is selling radio will appear in the August issue. The subject of this article will be a study of how the music trade is solving the problem of radio trade-ins.

C. L. Dennis, formerly manager of the Merchandising Service Bureau of the Music Industries Chamber of Commerce is making this series of studies exclusively for Radio Retailing. His analysis of the trade-in situation is expected to prove of outstanding interest to the radio industry.

# Some Unusual New WINDOWS

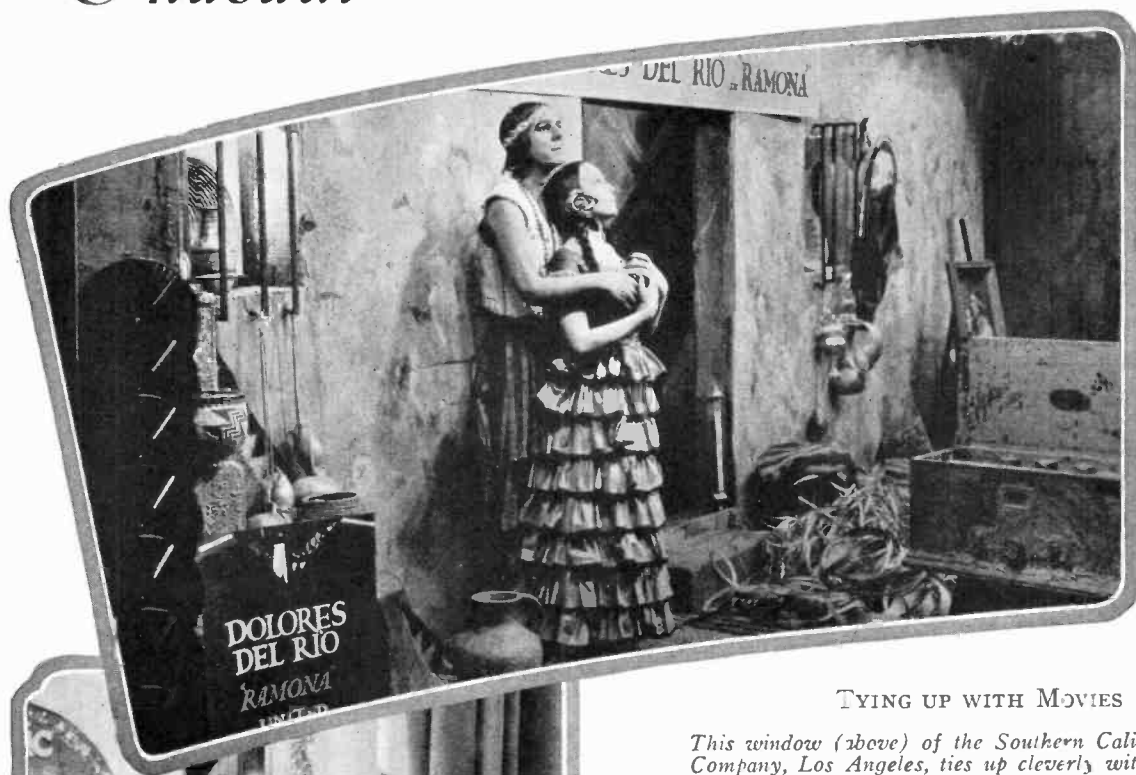

## TYING UP WITH MOVIES

This window (above) of the Southern California Music Company, Los Angeles, ties up cleverly with the motion picture, "Ramona." Added interest is given the receiver on display, as it functioned perfectly after surviving a California flood.

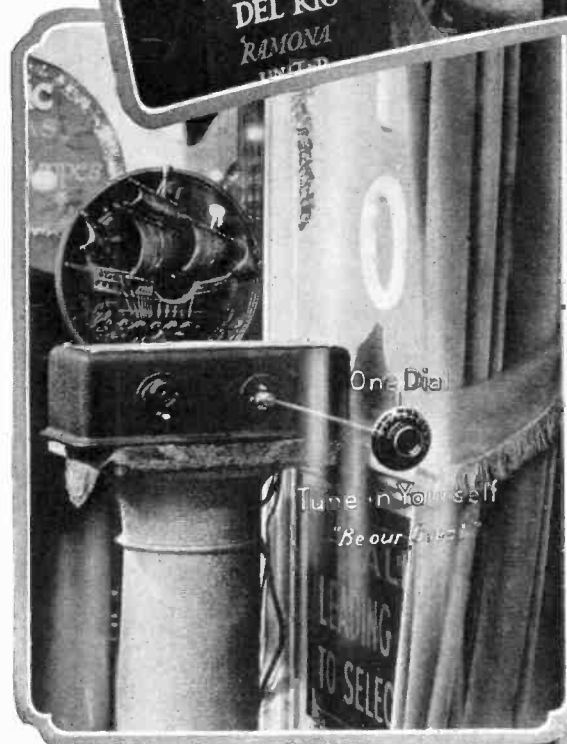

## TUNE IT YOURSELF

The Liberty Music House, Seattle, Wash., is responsible for this arrangement (left) which permits passersby to tune a set inside the window. A hole was bored in the plate glass, and a dial set on the outside of the window, connected with the tuning condenser by means of a rod. There was always a crowd around the window, taking advantage of the "tune it yourself" innovation.



## AVIATION AND RADIO

Tying up with the popular interest in aeronautics, Jerwyn Brothers, Scranton, Pa., recently featured this window cleverly tying in radio and aviation.



# BUSINESS

## *Does NOT Come to*

*Playing checkers is a great pastime while waiting for customers, but what if the customers do not come?*

By C. Grunsky

THERE are two major methods of merchandising radio sets and musical instruments, according to Mr. Daynes, of the Daynes-Beebe Music Company, Salt Lake City, Utah. One way is to stock up your store and wait for the customer to come in and buy; the other is to go out and sell your merchandise to the customer. The Daynes-Beebe Company chooses the latter method of merchandising and has built up a state-wide trade with its progressive policy of going out in the field to its customers.

Among the methods of "going out" which have been adopted with success in building up the radio department is a system of cold canvassing. To carry out this plan, twelve young men were hired with the definite understanding that this was the work they were to do. College men were preferred and married men were chosen above single. The qualification of a college education insured good presence and appearance and implied character and ambition. A married man who has a family to support is more of a sticker than his bachelor brother and puts through a difficult job with less chance of quitting. These men were paid \$15 a week, plus a commission on all sales made by the store to prospects whose names they furnished, the size of the commission depending upon the kind of merchandise sold.

Each canvasser was furnished with a portable phonograph, which, as a rule, gave him an entry into the home. Once in, he demonstrated the phonograph, to be sure, but he made no particular effort to sell it. Rather he directed the conversation to general musical lines, learning what instruments were already in the house and which the prospect contemplated buying in the near future. If possible he made a definite appointment for the prospect to go into the store or for a salesman to make a call at the home. It was not expected that he close the sale. Quite the contrary, it was preferred that this should be left to a more experienced salesman. This initial canvass was merely to sort out prospects and to take the preliminary steps.

The results from this scheme were excellent, even though a very small number of the young men survived

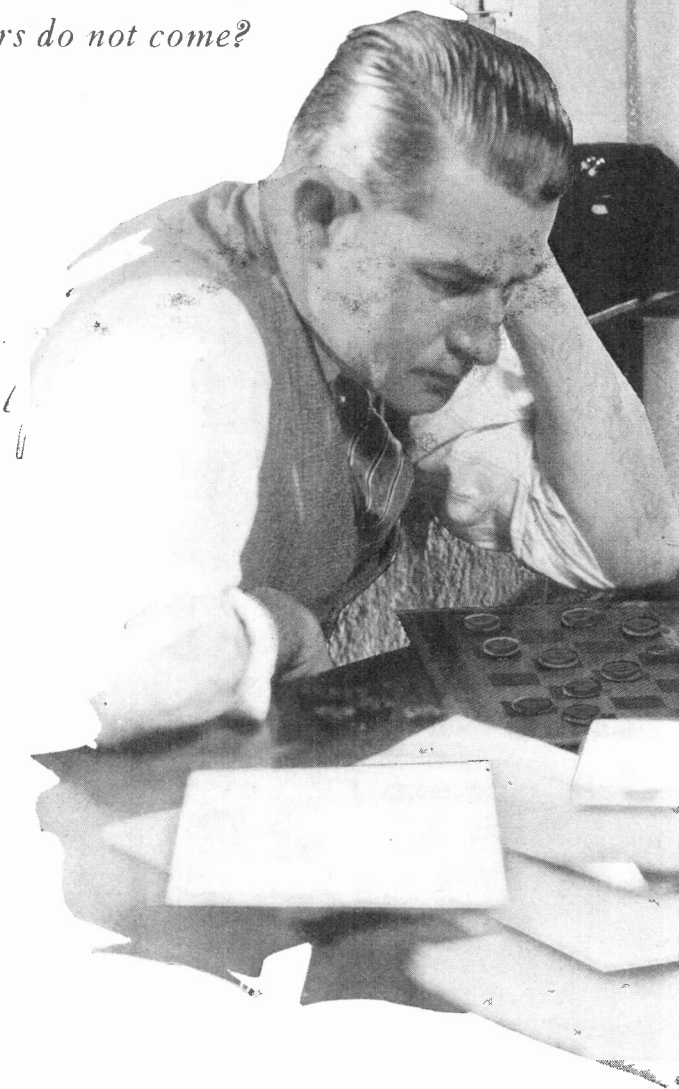

the ordeal of canvassing. The ones who did have stepped into the regular sales ranks of the store. Indeed, aside from the actual sales made as a result of this campaign, the system has proved such a satisfactory way of testing out applicants for salesmen's positions, that it is likely to become a permanent institution. This work is not seasonal, but has been found particularly effective in the summer months, bringing in prospects at a time when the season is otherwise dull.

ANOTHER efficient ambassador in the company's campaign of aggression is the man who is sent out with an automobile into the rural districts. He carries a radio set with him and demonstrates as he goes. Of course, he does not confine his work to the selling of

# HIM *Who* WAITS



radio alone, although it may be said that this is one of the most popular of musical instruments in the country home and often gives him an opening which later leads to sales in other lines.

The company issues a catalog once a year, listing such articles as seem particularly attractive from a price or other "bargain" angle, as well as standard stock. In addition the company does considerable advertising in the Salt Lake papers which have a state-wide circulation. This has led to the building up of quite an extensive mail-order business covering all sections of the state. Most of this business is on the time-payment basis, but no difficulty has been experienced with credits or collections. In the case of a new customer whose credit is not already established, bank and other references are

asked, including the name of a near relative and these are all checked up before delivery is made.

Through recommendation of church officials, representatives have been secured in practically all the small towns of Utah, some 600 in all. No salary is paid these young men, but they are allowed a commission on all sales made. They also prove a valuable source of information in the case of following up a matter of credit out of town. The recommendation of the local church authority insures the

character of the candidate and also makes for his local support and the interest of church members.

Trade-ins are also used by the store as a method of going out after business. That is to say, no effort is made to go out after second-hand sets, but these are taken in trade at a low figure where this seems advisable. As a matter of fact, not more than from 5 to 10 per cent of the sales involve trade-ins. Once on hand, they are allowed to collect until a feature can be made of them at a special sale. This is then made a feature in all advertising, with the result that the store is crowded. A larger attendance has been secured at these "used radio" sales than at any sale of first-hand material. All the trade-ins are sold on an occasion such as this and,

*(Please turn to page 60)*

# Radio Retailing

A McGraw-Hill Publication

JULY, 1928

Vol. 8, No. 1

# GAINING or

Are You

## *We Credit These Two to Duluth*

FROM Duluth, Minn., come these ideas for controlling service costs: Brander's Music Shop gives one free call per every \$50 unit of the total purchase price of the radio outfit. Thus if a sale comes to \$185 the customer is entitled to four free service visits. If the order totals but \$95 he gets two calls free. Trips due to a defective set are, of course, not counted.

E. W. Brander states that he figures he can afford three per cent of gross sales for free servicing. On the basis of a cost of \$1.50 per average trouble call, this equals one call per \$50 purchase.

The Kelly-Duluth Company attains the same objective but by a different route. This nationally known hardware store keeps a record of service car mileage. The customer is billed, at the rate of 10 cents a mile, for automobile mileage to and from the job. Inasmuch as each service man is required to own, or provide, his own car—for which he is reimbursed for operating expenses at the rate of 10 cents a mile—these charges and disbursements cancel each other and Kelly-Duluth's cost for service transportation is nil.

\* \* \*

## *A Good Service Department Pays*

A WELL set up service department should not only pay its own way but should show a profit. One way to insure this is to operate it entirely as a separate department. Keep the accounts relating to the service department entirely separate from the other accounts.

All merchandise sold in the course of servicing should be credited to this department as well as charges for service rendered. Against this should be charged the wages paid the service men, a portion of the rent, heat, light, etc., pro-rated according to the floor space occupied by this department. By this simple method, the most potent source of danger to your entire business is under complete control at all times.

\* \* \*

## *Greater Profits from Better Management*

RETAIL prices and dealers' discounts are gradually reaching a stable level. But every now and then is heard the feeble cry of a merchant for longer discounts. This is claimed necessary in order that the merchant make a fair profit.

But future profits in radio must come through better management rather than longer discounts or increased prices. It does not take a radio expert to sell radio sets, but it does take a merchant who understands thoroughly the problems of management and merchandising. Study ways to manage your business more efficiently and the profits will automatically result.

## *Radio and the Nation's Politics*

FOR the first time in the history of the nation the power of radio has been recognized to such a degree as to change a custom that has been fixed since the first national presidential convention. The keynote speech delivered at the Democratic national convention at Houston, Texas, which, under all tradition, should have been given at the opening of the first session, was postponed until the evening session in order that the entire nation could hear it over the great station hook-up. Thus is the far-reaching power of radio again emphasized and its importance to the country clearly set forth.

\* \* \*

## *Needed—a More Sympathetic Understanding*

THERE is much that warrants serious consideration in the recent statement of ex-Radio Commissioner Bellows that there exists a definite relationship between the radio manufacturer, jobber and dealer on the one hand and the broadcasters on the other hand.

"Suppose that those who are now providing more than 75 per cent of our programs should discover that the support of their listeners has flagged to a point where it is no longer even a remotely possible source of indirect revenue," Mr. Bellows says. "What would happen to radio manufacturing? The answer is clear enough: either the makers and merchandisers of radio receiving apparatus would have to take over the entire burden of our national broadcasting, or else their radio business would dwindle to negligible proportions.

"That is why the trade is, or ought to be, so vitally interested in the relations between the broadcaster and the public, as well as in their inter-trade relations. It is on the ability of the broadcaster to arouse, hold and increase the interest of the public, and to extend the value of his service, that the continued success of the radio industry depends."

*Radio Retailing* agrees with Commissioner Bellows when he enumerates further the two dangers that now face the broadcasters:

First, that public demand for quality and variety programs will progress so rapidly that the already strained finances of the broadcasters cannot keep pace with it.

Second, that the listeners will become surfeited with what they are now getting before the average station manager is aware of what is happening.

As he points out, the first of these difficulties can, to some extent, be averted by the radio manufacturers.

"A few of them now own and operate stations," he continues, "and it is worthy of note that these stations are among the very best in America. Others, who have



# LOSING Service?

on

Service Costs,  
Better Management, Sympathy,  
A Business Man in the  
White House,  
Disturbers of the Peace  
and other things discussed by the  
editors

leased the facilities of broadcasting plants for programs carrying their names are also putting out programs among the finest the listener has been privileged to hear.

"It may well be, however, that this type of service will have to be extended and that the radio industry will have to come to the assistance of the broadcasters with more commercial programs in order to maintain this service at a point where it will adequately stimulate the demand for receiving equipment."

The second danger is even harder to deal with. How is the broadcaster really to know what the public wants? Here is where the radio manufacturer, jobber, dealer and trade magazines must recognize their responsibilities. It should be their business to study public opinion in regard to programs and to see that the broadcaster serving their territory has the full advantage of their observations. This is no unreasonable demand. The very existence of everyone connected with the radio industry hangs largely on the progress of the art of broadcasting. If we of the industry are providing but 21 per cent of the broadcasting upon which every dollar of our income depends, we can at least help the broadcasters make their service, in type and quality, what it ought to be.

\* \* \*

## "Loud and Noisy" Reproducers

THE City of Detroit has passed an ordinance imposing a fine of from \$25 to \$100 on radio dealers who have "loud and noisy" sidewalk reproducers.

The purpose of a sidewalk reproducer is:

1. To attract the attention of the passing public to the place where radio sets are for sale, and,
2. The reproduction is a sample of what the buyer gets for his money.

Well, now, if the passing prospect hears a series of raucous noises, well mixed with portions of disagreeably loud conversation or jumbled with deafening crashes of jazz;—how can he be attracted?

It shouldn't be necessary for cities and towns to pass restricting ordinances. It is our own interest—in the interest of better radio and more sales—that we realize that loud and noisy reproducers are a detriment and not a benefit to our own business. Bring them in or tune them down.

\* \* \*

## Radio's Interest in Hoover's Nomination

HERBERT HOOVER'S nomination for the presidency of the United States is a matter of particular interest to the radio industry. For the years immediately ahead will see an increasing relationship between radio broadcasting and government, as radio becomes increasingly a medium of communication between Washington and the people. Meanwhile the influence of radio upon

commerce and industry will also grow and it will be fortunate indeed if in the White House we have a man with an intimate background of radio history and an intelligent sympathy with the orderly development of both the engineering and marketing phases of radio. Certainly Mr. Hoover as president would have a lively appreciation of the problems of the radio industry and the part which it is destined to play in the social and economic life of America.

The election of an engineer as chief executive of the nation, in itself would mark a new era in our political history that should be encouraging to every business man. In the past the lawyer has ruled us and the lawyer is a man trained to argument and skilled in the art of negotiation. Too often, however, he is a servant of expediency basing his judgment on political considerations. But industry and business are founded on economic factors and need the leadership of men who make their decisions in accord with cold facts. And what vaster business have we in this country than the business of our government? Hoover in the White House would mean not only an administration intelligently understanding the purposes and problems of industry but happily a first step toward an engineering approach in government.

## FORLORN FIGURES

By McBride

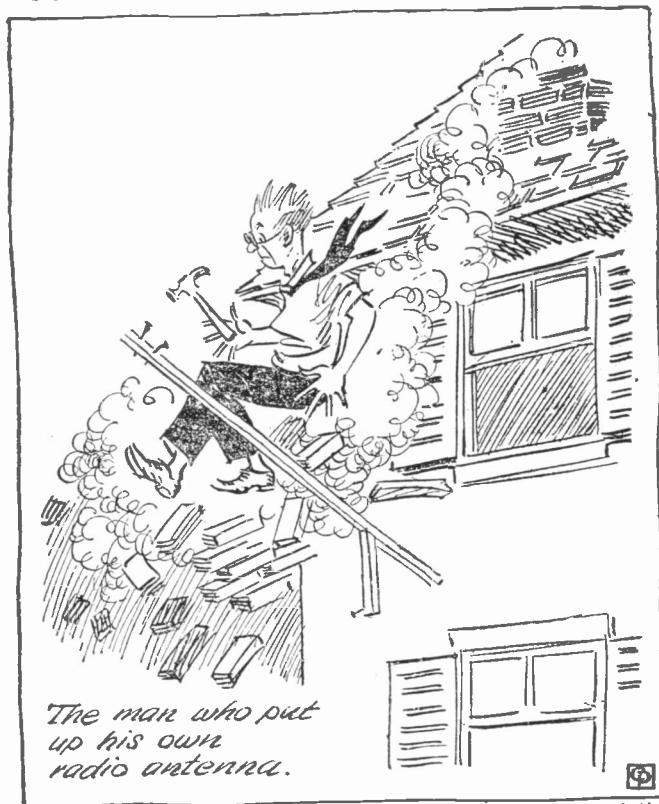

Copyright, Central Press Association

# Practical Service Methods

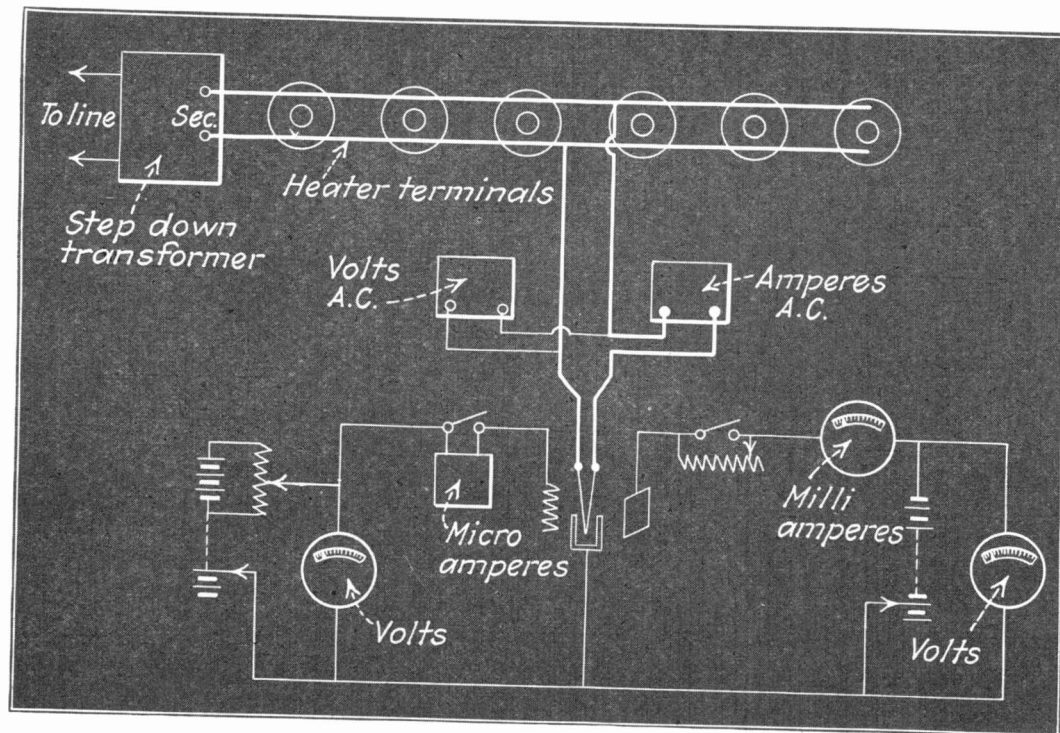

Circuit arrangement and meters necessary for testing A.C. tubes

## Testing A.C. Tubes

ALL the standards which have been applied to direct current tubes should now be applied to alternating current tubes without reservation.

It has been said that audio amplifiers should be built to cut off all frequencies below 100 cycles, because of the 60-cycle hum which it was believed was sure to accompany the use of alternating current tubes. Tubes are now available which do not produce a 60-cycle hum. Amplifiers should therefore be built to reproduce the full musical tone range up to the limit set by our present radio channel width; that is, 5,000 cycles. We certainly should not lose the deep 64-cycle pedal tones produced by our magnificent pipe organs, nor should we lose hope of faithfully reproducing the 32-cycle or even the 16-cycle tones sometimes played on the larger organs.

It has been a long step from the McCullough tubes marketed for the first time in 1925 to the better tubes of today. The 60-cycle hum was not the only difficulty which had to be overcome. There were soft tubes, and tubes which would scarcely pass any current in the plate circuit. There were tubes which worked for a short while, and there were tubes which performed remarkably well. This latter variety was nursed and petted until today it is possible to produce alternating current tubes in large quantities and having great uniformity in both physical and electrical characteristics.

Conducted by  
**H. W. BAUKAT**  
Technical Editor

THERE are two types of alternating current tubes; those in which there is a filament similar to that found in direct current tubes and those using an indirectly heated cathode. The filament is of course the cathode in a direct current tube.

A resistance must be connected externally in parallel with the filament, and a center tap on this resistance is used to make connection to the cathode when the cathode is the filament.

The '26 type is a tube of the filament cathode type, and the '27 and the Kellogg 401 or 403 tubes are of the indirectly heated type.

The indirectly heated type has gained favor because no center tapped filament shunting resistance is required for use with them, and because it has been possible to eliminate the hum which occurs when the cathode is the filament and is heated with alternating current. It is for this reason that the indirect heated type must always be used as a detector.

The indirectly heated cathode type of tube has a plate and grid assembly quite similar to a corresponding direct current tube. The electron emitted surface, however, is on a cylinder of small diameter. This cylinder is elec-

Editor's Note.—We are indebted to H. M. Armstrong, Research Engineer, Kellogg Switchboard & Supply Co., for the information in this article.

trically insulated by means of a refractory tube from the heater wires which carry the alternating current. The refractory tube must not only insulate the cathode from the heater wires, but it must also stand repeated heating and cooling from temperatures which make it incandescent.

It is very desirable from the standpoint of hum that the wires conducting the alternating current to the heater be as remote from the regular tube connections as possible. It is well to see that all heater wiring is external to the shielding.

The cylindrical cathode is metal, and will act as a shield to prevent the alternating electro-magnetic and electrostatic fields produced by the heater current from modulating the electron stream which flows from the outer surface of the cathode to the anode or plate. It is therefore desirable that the cathode should be closed as much as possible, and that it should extend well beyond the overall length of the grid and plate assembly. If the heater wire is shaped like a hairpin so that both terminals extend from one end, one end of the cathode may be closed.

**V**ACUUM tubes, whether of the direct or alternating current type should be tested when they are received, and again when they are sold. Rough handling will frequently produce internal injuries which will only be apparent when the tubes are given suitable electrical tests. Damage done while being shipped should be compensated for by the carrier. It is also possible that certain defects in manufacture will escape the attention of the most careful of factory inspectors. Reputable manufacturers will compensate for faults of this nature.

Sometimes vacuum tubes carry a code date of manufacture, but dealers should apply a sticker to each tube giving the date of sale, and the dealer's name. It is also desirable that the date of the first inspection be placed on this sticker. This data will enable the dealer to protect himself from unjust claims on returned tubes.

Tests should be made on each tube to see that the heater or filament voltage and current are correct, and that the mutual conductance and plate current are as they should be. Measurements of amplification factor, negative grid current, and plate impedance may also be made.

The same methods used for testing direct current tubes may be used for testing alternating current tubes. Of course alternating current meters must be used for measuring the heater or filament current and voltage, and the circuit may have to be altered to make proper connection to the cathode, but when this is done, the tests are identical.

In making tests, the heater or filament voltage is first adjusted to its correct value. The heater current is then noted. Alternating current tubes of the indirectly heated type will require from 30 seconds to a minute to warm up. It is therefore desirable, when many tubes of this type are to be tested, to arrange for the heating of a number of tubes at the same time. This may be done by connecting the heaters of several tubes in parallel, as shown in the diagram at the top of the preceding page. As the tubes are to be tested they are moved in and out of the socket in the test apparatus. An alternating current ammeter is connected to read only the heater current of the tube on test.

#### MUTUAL CONDUCTANCE

**M**UTUAL conductance is usually expressed as 1,000,000 times plate current change divided by the grid voltage change which produces this plate current change.

When testing for mutual conductance the tube is operated at certain specified plate and grid voltages which are normal for the tube. The grid voltage is varied and the change in the plate current is noted. A formula expressing this is

$$G_m = \frac{I' - I''}{Eg'' - Eg'} \times 1,000,000$$

- $G_m$  = mutual conductance
- $I'$  = plate current when the grid voltage =  $Eg'$
- $I''$  = plate current when the grid voltage =  $Eg''$

The mutual conductance of a tube will vary somewhat with the conditions of the test. These conditions must therefore be specified.

#### AMPLIFICATION FACTOR

Amplification factor is determined by comparing the change in plate voltage which will produce a certain change in plate current, with the change in grid voltage which will produce the same change in plate current. A formula representing this may be written

$$\mu = \frac{E_p' - E_p''}{Eg'' - Eg'}$$

where  $\mu$  = amplification factor

$E_p'$  = normal plate voltage

$E_p''$  = normal plate voltage (about 10% less than  $E_p'$ )

$Eg'$  = normal grid bias

$Eg''$  = grid bias which will reduce the plate current to its value when the plate voltage was reduced to  $E_p''$ .

#### GRID BIAS

Negative grid current is measured by means of a microammeter. This instrument is very delicate and should be short circuited until one is sure that no short circuits exist within the tube. Five microamperes—that is, five millionths of an ampere would be a maximum grid current in a properly biased tube.

Tubes of the indirectly heated cathode type may pass a higher plate current than would the older type tube. While this in itself may do no harm, a limit should be set, for most receiving sets employing alternating current tubes are operated from power units which will deliver only a limited current supply. Excessive plate currents mean correspondingly low plate voltages and consequently poorer reception. In some audio amplifiers the transformers are apt to be quite incapable of accurate reproduction if the direct current in their primaries is excessive. This is an additional reason for limiting the plate current of the radio tubes.

Of course there is also a lower limit of plate current for good radio tube operation. A tube is said to be 'hard' when it will not pass sufficient plate current. A hard tube is easily recognized while it is being tested electrically. A tube may become hard if the active material on the cathode loses its power to emit electrons. A hard tube will ordinarily cause distortion which may make radio reception not only difficult, but unpleasant to a trained ear.

#### PLATE IMPEDANCE

**T**HE plate impedance of radio tubes determines the impedance of apparatus associated with it. The plate impedance of tubes should therefore be held within certain limits. Usually if the mutual conductance of a tube is correct, the plate impedance will also be right. It is a simple matter to check this however while making the electrical tests.

At the time when the amplification factor was being determined the plate voltage was reduced perhaps 10 per cent. The voltage and current values obtained at this



time will serve for an impedance calculation. The formula is

$$Z = \frac{E_{p'} - E_{p''}}{I_{p'} - I_{p''}}$$

where  $Z$  is the plate impedance  
expressed in ohms.

Plate impedance varies slightly with the conditions of the test, but a test like the one suggested will give sufficiently accurate data for all practical purposes.

The distortion which may occur due to faulty operation of vacuum tubes has already been mentioned. The present demand for quality rather than for great distance or for tremendous volume has made it necessary to study distortion effects in vacuum tubes. This is of special importance in power tubes.

#### DISTORTION

It is not difficult to make electrical tests which will show very clearly the relative ability of various tubes to distort the signals which they receive. The procedure for tubes of the '71 type would be about as follows:

The tube would be placed in a circuit with suitable electrical measuring instruments and the plate current would be noted when the plate voltage was 180 and the grid was biased to -40 volts. A resistance of 4,000

ohms should then be connected in series with the plate and the battery voltage should be increased until the plate current had once more reached the same value which it had before. This battery voltage should be kept constant for the rest of the test. The grid bias should then be reduced to -5 volts. The plate current will increase, and this higher value should be recorded. The grid bias should then be increased to 75 volts. The plate current will decrease and this low value should be recorded.

$$\begin{aligned} \text{Let } I_{p'} &= \text{Plate current at } E_g = 40 \text{ volts} \\ I_{p'} &= \text{Plate current at } E_g = 5 \text{ volts} \\ I_{p''} &= \text{Plate current at } E_g = 75 \text{ volts} \end{aligned}$$

$$\frac{I_{p'} - I_{p''}}{2} = \text{Average change in plate current} = I_a$$

$$\begin{aligned} I_{p'} - I_p &= \text{Change in plate current for reduced bias} = I_r \\ \frac{(I_r - I_a) \times 100}{I_a} &= \% \text{ distortion} = D \end{aligned}$$

This value of  $D$  should be zero for a perfect tube, but may be quite high without spoiling radio reception for most of us.

The method which is given will merely give comparative results. A more elaborate test of this same nature is required if the full story of the tube is required.

## Atmosphere—A Sales Asset

(Continued from page 43)

customer's mind the thought that radio and phonographs are inseparable," states Mr. Kelly. "Radio is marvelous, but nothing can take the place of having music by the masters just when you want it."

"The woman is usually the hard one to sell," he added, "but she is the last one who would want to get rid of a fine musical instrument, once its possessor. She is also especially quick at grasping the significance of a beautiful piece of furniture, and largely through this ability to visualize an instrument in her home, we have sold 18 sets this year that we have only been able to describe."

The skill with which Mr. Kelly sells new instruments is secondary only to that with which he sells customers on the idea of keeping their old ones. In a section of the country where more than three-quarters of the homes already have radios, and nearly as many have phonographs, it is difficult to avoid trade-ins.

WHAT does Kelly do when a woman says, "We have a marvelous radio—everyone thinks it is just wonderful—and we paid \$300 for it only three years ago"?

This tactful salesman agrees with her in the following reply: "Yes, Mrs. Jones, no doubt you have a splendid instrument, but due to a poor condition of the market, it is worth only \$15. Now, rather than sacrifice so much and run the risk of your radio being placed in the hands of someone who will not appreciate it, let me suggest that you give it to a relative or friend."

This answer, when given with absolute sincerity and confidence, usually does the work. If, however, the prospect is still unconvinced, the salesman plays an even stronger hand. Supported by the evidence of new high grade stock on the floor, he conveys the idea that this is no place for second-hand merchandise. In fact, the store's clientele is such that there is no market for it.

### Rounding-up the "Think-It-Overs"

B. F. Carr and Sons, Chicago, employ a part-time university student to specialize on "rounding-up" that large percentage of prospects who drift into its radio store to look at sets but who desire to "look around" or "think it over."

"Eighty per cent of this type of buyer would undoubtedly get away from us," declares the junior member of this firm, were it not for the fact that I always make it a point to secure their name and address and to put our part-time salesman on their trail the following day."

Carr pays this student ten per cent of the gross amount of every sale which the latter closes himself and five per cent if the sale is eventually consummated by the proprietor.

The street address is obtained, without alarming the prospect, on the pretense of ascertaining the exact location where the set would be used "so that we can take into consideration local interference conditions, if any."

### Business Does Not Come to Him Who Waits

(Continued from page 55)

in addition, a great number of names are secured of people actively interested in securing a radio set. Many of them are sold new equipment before they leave the store and more of them later on.

Listed among the active salesmen of the Daynes-Beebe store are the display windows. Under the effective handling of Mr. Alston, in charge of window decoration, they have received numerous prizes in national and local contests. It is significant that they are among the windows used as models by the commercial department of the state university to illustrate the principles of business-getting to their students. The windows of the Daynes-Beebe Company reach out to the passers-by with their immediate claim for interest and get many of them, bringing them into the store. In fact, all the departments of the company are "go-getters."

# Ad Plan APPROVED — Other Letters from Readers

## Agrees that Co-operative Advertising is Needed by Industry

Editor *Radio Retailing*:

**I**N reference to your editorial in the June issue of *Radio Retailing*, I have a few observations that I would like to make.

During the past five years we have seen the rapid development and increasing use of group advertising. Some of these group association campaigns have been notably successful, while others have been of little value to the industries which they were supposed to benefit.

Without doubt, the outstanding co-operative advertising campaign has been that of the California Fruit Growers. Campaigns of the Lumber Association, the Brick Manufacturers, the Sauerkraut Makers, the Paint Manufacturers, the Oil Burner Industry, et al., have been more or less successful. Generally speaking, association advertising has proved very beneficial to the industries it has served.

But none of these various associations has ever had a greater need for co-operative national advertising than has the radio industry at this time. Right now the public of the nation is hungry for facts about the radio business, especially the kind of facts that will give them confidence in their radio purchases.

Radio manufacturers must remember that their chief competition does not come from other radio manufacturers. The whole radio industry is in competition with dozens of other industries for a share of the consumer's luxury dollar. Manufacturers of all luxuries and near-luxuries are giving radio manufacturers the stiffest kind of competition. Therefore, if radio manufacturers are to present a solid front in this battle for the consumer's luxury dollar, it is high time that they get into co-operative advertising action. Certainly much good will result from radio association advertising, provided it is intelligently planned and efficiently administered.

In the beginning any industry having as wide a popular appeal as radio, finds the demand greater than can be supplied. No outstanding sales ability is required to satisfy this spontaneous demand. The chief problem of producers is to keep up with orders. In the radio industry it is safe to assume that by this time the "spontaneous" demand has been practically satisfied. So producers are planning more intensive selling which, of course, includes more and better advertising. Such intensive sales and advertising effort necessarily must be directed toward that group of radio prospects whose desire for radio is lukewarm, or who may even be opposed to the use of radio in their homes. This group of radio prospects represents a vast section of the market. Most of the people in this group are ultra conservative in their purchases. They are the ones who never try anything when it is new.

Most of the people in such a group are confused by the various claims of radio manufacturers. Their natural conservativeness is heightened because of this confusion, so they do not buy. A campaign of association advertising setting forth, in a straightforward manner, the benefits of radio will do more to sell this group than all the advertising of individual manufacturers put together.

In addition to advertising the benefits of owning a radio set, there is a real opportunity for broadcasters to advertise their outstanding programs. Since the success of both broadcasters and set manufacturers is interdependent, it is logical to suggest that any campaign of group advertising should be financed by both. So it may be advisable for radio manufacturers and leading broadcasters to get together. We suggest a combination of the brains and resources of these two groups for the purpose of financing a campaign of national advertising to include magazines, newspapers and outdoor media.

MAC HARLAN, Advertising Manager,  
Kellogg Switchboard & Supply Co.

Chicago, Ill.

## A Pioneer in Industry Co-operation Voices Approval

Editor, *Radio Retailing*:

**P**ERMIT me to congratulate both *Radio Retailing* and yourself for the suggestion that the leading editorial in the June issue contains. It is a subject which, as you know, is very close to my heart as I believe that I was the first instigator of co-operative advertising in the radio field. The lines along which it was neces-

sary for me to work are not at all identical with the lines that you outline in that the scope of the advertising campaign that you suggest is broader than that which circumstances permitted me to attempt at the time our own co-operative advertising was brought forth.

It seems to me that one of the most successful co-operative campaigns ever launched in the radio business was the original Hammarlund-Roberts campaign in which a great many of the largest concerns in the business got together for the first time. You may remember that I brought these firms together at the first R.M.A. Convention held in Atlantic City. I hope that many manufacturers will see the significance of your editorial.

ARTHUR H. LYNCH, President,  
Arthur H. Lynch, Inc.

New York City.

## Finds Dealer and Jobber Are Waking Up

Editor, *Radio Retailing*:

**T**HE radio dealer and jobber are waking up. This was the outstanding impression which I received as a result of quite an extensive sales trip recently completed. At our local conventions, and elsewhere, I observed a growing desire, from both these members of the distribution chain, for modern merchandising knowledge—and a greater aptitude for using it. This eagerness to learn all about the products they sell cannot but help to make better merchants and improve the radio industry in general.

Dealers are realizing the value of co-operative advertising. They are using "helps" to better advantage than ever before. The hit or miss methods of retail selling is being replaced with carefully thought out sales campaigns that are bringing home a volume of sales never before attained.

The wait-for-them-to-come-in radio retailer is fast disappearing. He must go! Competition is too much for him. Active brains and willing, hard working, go-getting retail merchants are sounding his death-knell.

Furthermore, the much maligned jobber is helping the dealer become a better merchant. I noted with much pleasure the eager desire of the jobber to place at the dealers disposal every bit of sales information he could secure. Doesn't this willingness to co-operate with the dealer, by the jobber, knock the often expressed theory that the jobber is the parasite of the merchandising world?

But the jobber today, with the proper guidance from the manufacturer, can become an even more vital factor in the scheme of distribution. The proper training of his salesmen to help the dealer sell is very vital. He should do more of this. Also, the dissemination, by him, of educational information cannot help but redound to his own welfare inasmuch as he will be playing an essential part in business building both for his manufacturer and his dealer.

When he exercises his every opportunity of extending his services into creative selling channels no longer will those who disparage the jobber point to him as a parasite interested only in warehousing and billings.

The live jobbers who are making the most progress have come to get a clearer understanding of their part in the picture—and having attained that realization they are becoming indispensable.

We who travel among them must do our share by educating them to the better conception of modern merchandising. I am optimistic enough to feel that the job is not a hard one—that the jobber is seeking the guidance and aid of the manufacturer and feels secure. That with it he can build most substantially and permanently for a future that holds forth much promise of prosperity and profits.

OSCAR GETZ, Sales Manager,  
Steinite Laboratories, Inc.

Chicago, Ill.

## Thinks Dealers Need 50% Discount

Editor, *Radio Retailing*:

**M**AY we say here that we think your magazine is, without question, the best on the market. Your articles on cost are making them all sit up and take notice. I think the time is coming when not only dealers and jobbers, but manufacturers as well, will realize that to retail profitably, dealers must have at least 50 per cent discount.

J. N. FULKERSON,  
Fulkerson Music House.

Carbondale, Pa.

# This year's RCA sets are next year's standards of design in the American radio industry



**RCA RADIOLA 18—**  
Most popular of all RCA  
receivers—the biggest  
seller for "wired homes."  
Carefree operation from  
the lighting circuit—110  
volt 60 cycle, A.C. \$115  
(less Radiotrons)



*This sign marks the leading  
dealer in every community*



**RCA RADIOLA 51—**Combines the popular  
RADIOLA 18 with the famous RCA Loud-  
speaker 100A in a beautiful mahogany cabi-  
net, walnut finish. \$195 (less Radiotrons)

**RCA RADIOLA 30A—**The super-selective  
RCA Super-Heterodyne in combination with  
RCA Loudspeaker 100A. Custom-built cabi-  
net model. \$285 (complete)

RADIO CORPORATION OF AMERICA    NEW YORK    CHICAGO    SAN FRANCISCO

# RCA Radiola

MADE BY THE MAKERS OF THE RADIOTRON



*Sporting news - reported by experts - on this wonderful "Radiola 18" for less than a cent an hour*



The seven big Radiotrons in the new RADIOLA 18 use about as much electricity from your lighting current as an ordinary 30-watt lamp.

A snap of the switch turns them on selects the broadcasting station, and presto! you are in a ring-side or grandstand seat.

Without leaving your easy chair, you hear the round-by-round, play-by-play stories of the big sports events in distant cities, reported by experts that you have at your finger touch the finest music for dinner, or dancing, or an hour of reverie.

With an RCA Loudspeaker in the living room, or on the veranda, or out on the lawn, if you like, you can share your pleasure with a household.

A Radiola is as necessary today in a well-equipped home as the telephone and the newspaper. Radiolas are in daily use in nearly 2,000,000 homes.

RADIO CORPORATION OF AMERICA  
New York Chicago San Francisco

*There is a complete line of Radiolas for lighting current or battery operation ranging from \$50.00 to \$200.00*

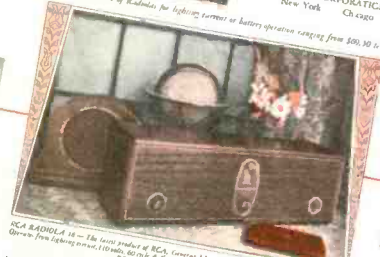

RCA RADIOLA 18 — The latest product of RCA, General Electric and Westinghouse Radio Laboratories. Operates from lighting current (110 volts), or from a C. Mackay's battery, or from four 1175's (see Radiotron). RCA LOUDSPEAKER 100A \$15

**RCA Radiola**  
MADE BY THE MAKERS OF THE RADIOTRON

Buy with confidence.  *Value lies in this sign*

# This is a big summer in radio

—and RCA is backing its dealers with the biggest campaign of sales promotion ever seen in the radio industry.

### MAGAZINE ADVERTISING

Color and black and white pages in *Collier's*, *Literary Digest*, *Liberty* and *Saturday Evening Post*.

### NEWSPAPER ADVERTISING

Big display copy for RADIOLA 18 and Loudspeaker 100A in leading dailies over the country.

### BROADCASTING

The new RCA Demonstration Hour every Saturday afternoon at 2:30 Eastern Standard Time.

### HOME DEMONSTRATION

A RADIOLA 18 demonstrated *in the home* by the dealer usually stays in that home.

### SALES HELPS

Dealer mats, descriptive literature, etc.

# RCA Radiola

MADE BY THE MAKERS OF THE RADIOTRON



# What's New in Radio and

This editorial section is prepared purely as a news service, to keep readers of "Radio Retailing" informed of new products.

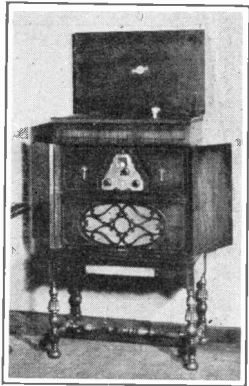

## Radio-Phonograph Combination

The Howard Radio Co., 4949 N. Crawford Ave., Chicago, is making a combination phonograph and A.C. radio console receiver with a '10 power tube in the last audio stage. Both radio reception and phonograph music are controlled by one switch. The intended retail price is approximately \$465.

Another model is an eight tube A.C. set, which will retail below the \$150 figure.—*Radio Retailing*, July, 1928.



## Receiver and Dynamic Reproducer

A dynamic reproducer of the end table type for placing beside an easy chair or davenport has been placed on the market by Wright-DeCoster, Inc., St. Paul, Minn. A receiver, if properly cushioned, may be set on top of the reproducer cabinet, which is made of finely grained solid walnut throughout. The amplifier uses two '81, one '74, and one '50 type tube and is constructed on a steel housing with concealed wiring. The complete reproducer unit and amplifier together weigh about 125 pounds. The intended retail price is \$275.

This company also makes a table type receiver using the t.r.f. circuit with six '99 tubes, one '20 power tube and a '22 radio frequency tube in the first stage of radio. The circuit consists of three stages of radio amplification, one detector and three stages of audio amplification. A meter on the panel shows the position at which to carry the A-current and a button is provided on the volt-meter for B-current reading. The cabinet is a black walnut with satin finish.—*Radio Retailing*, July, 1928.

## Receivers

Both A.C. and battery sets are included in the new Eveready line made by the National Carbon Company, East 42nd Street, New York City. A "shield within a shield" construction is an important feature of this new line. Each of the radio frequency stages is separately shielded, in addition to an outside over-all shield inclosing the entire R. F. amplifier.

The A.C. model is a seven-tube, single-dial, antenna-type receiver. The circuit consists of three stages of neutralized t.r.f. amplification, detector and two transformer coupled audio stages, ending in a push-pull power stage employing two '71A's, together with three '26 R.F. amplifiers, a '27 detector, a '26 in the first audio and one '80 full-wave rectifier. The volume control is accomplished by a high resistance potentiometer shunted across the input circuit of the detector. The power unit is complete within itself, and in addition to the A-B-C supply, it also contains the last audio stage and output transformer. The chassis and the power plant are separate, self-contained units. This set comes in two styles, both of which may be used as table models or placed on a special pedestal. One is of modernistic design, dark green in color with routed silver stripping and stands only 27 in. high with legs. The other has a natural-finish maple cabinet and is about the same height.

The battery set has six tubes and is a single-dial antenna type receiver. In general, it consists of three stages of high gain, neutralized, t.r.f. amplification, a high gain detector and two resistance coupled audio stages with a power tube in the output stage.

The tubes used are: 3 '40 R. F. amplifiers, one '40 detector, one '40 in the first audio and one '12A or '71A in the second audio. This receiver may be used as a table model or set on the special pedestal. It is finished in natural maple and measures 13½ in. square by 10 in. high.—*Radio Retailing*, July, 1928.

## A.C. Receivers

The new A.C. receivers made by the Kellogg Switchboard & Supply Co., 1066 W. Adams St., Chicago, Ill., include model 514, a walnut console with three control levers—group selector, station selector, and volume control. The circuit consists of four stages of inductively tuned t.r.f., a detector and two stages of transformer coupled audio. It is furnished with an enclosed sixty-inch air column reproducer. List price, \$495.

Model 515 is a two tone, warm brown metal table type receiver with the three control levers and illuminated dials. The circuit consists of two stages of inductively tuned, t.r.f., a detector and two stages of transformer coupled audio. List price, \$169.50.

Model 516 is a dark walnut console with the three control levers; an enclosed seventy-inch air column reproducer and the same circuit as the 514. A separate power unit is mounted in the back of the cabinet. List price, \$375.

Model 517 is a dark walnut, hand carved receiver with a burl walnut inlay lighted by lamps mounted in the rear of the controls. It has the regulation three controls; an enclosed sixty-inch heavy non-vibrating air column type reproducer and same circuit as the 514. List price, \$775.

Model 518 is a walnut console with a door which opens giving the appearance of a highboy secretary. It has three control levers; same circuit as the 515; and the power unit is part of the chassis. List price, \$225.

Model 519 is a dark walnut console. It has a special cone reproducer and the same circuit as the 515. List price, \$275.—*Radio Retailing*, July, 1928.

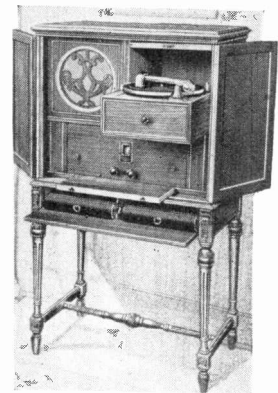

## Radio-Phonograph Combinations

The illustrated phonograph combination is being made by the All-American Mohawk Corporation, 4201 Belmont Avenue, Chicago. It includes the model 80 eight-tube chassis, R.C.A. electric pick-up, General Electric induction motor, concealed turn table, electro dynamic reproducer and two record albums and is 53 in. by 29½ in. by 18 in. in size. Intended retail price, for use on 110 volts A.C. 60 cycle, complete, less tubes, \$425.

Model 66, a phonograph combination, has the 60 chassis, spring motor and turn table, electric phonograph pick-up, magnetic reproducer and two record albums. Size, 47½ in. by 21 in. by 16 in. The intended retail price, complete, less tubes, \$245. With electro dynamic reproducer, \$35 additional.—*Radio Retailing*, July, 1928.

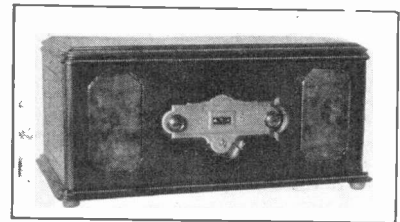

## Radio Receiver with Automatic Tuning

A new method of automatic tuning for radio receivers has been developed by the Marti Electric Radio Co., West Orange, N. J. This system does not limit receiver tuning to one or a small number of stations, but makes available the entire broadcast frequency spectrum. The system consists of a gear arrangement whereby a selecting system with indicating numerals, visible to the user, is adjusted to the desired wave length. The mechanism within the receiver automatically varies the tuned circuit so that it is resonant to the wavelength indicated by the automatic meter selector. This system is included on all Marti models, which include an A.C. operated console model with three stages of tuned radio frequency amplification, non-regenerative detector and three stages of resistance coupled audio with '10 type power tube output stage. The power plant consists of a '81 half wave rectifier with two section filter contained within the cabinet.—*Radio Retailing*, July, 1928.

# Where to Buy It

All announcements appearing on these pages are published without advertising considerations of any kind whatsoever.

Phonograph-radio combinations, complete television kits, a Neon lamp and photo cell, rectifying units for dynamic reproducers, and an automatically tuned receiver are among the items announced by manufacturers this month.



## Radio Cabinet

A burl walnut radio cabinet is being made by the Stettner Phonograph Corporation, 314 East 75th Street, New York City. This cabinet comes equipped with the R. C. A. 100A reproducer and will accommodate any standard set size 42 in. high by 27½ in. wide by 17 in. deep. The intended retail price, including reproducer, is \$75.—*Radio Retailing*, July, 1928.

## Reproducers and Sets

Five receivers and one reproducer constitute the 1928-29 line offered by the Crosley Radio Corporation, Cincinnati, Ohio. The "Gembox" is a shielded neutrodyne, six-tube, A.C. self-contained set which sells for \$65; the "Showbox" is an 8-tube neutrodyne, completely shielded, with two '71 push-pull output tubes, with 180 volts on plates, \$80; the "Jewelbox," which is now equipped with a new audio system, two '71 push-pull output tubes instead of one, and eight tubes instead of seven, \$95; the "Bandbox, Jr.," which operates from dry batteries and now has five tubes instead of four, \$35; the "Bandbox," which has been improved, \$55; and the "Dynacone" reproducer, a dynamic, \$25.—*Radio Retailing*, July, 1928.



## Cone Type Reproducer

A new reproducer, model X-26, has been added to the line of the Utah Radio Products Company, 1615 South Michigan Avenue, Chicago. This reproducer incorporates the X-Utah cone unit and is mounted in an attractively designed mahogany cabinet. Intended retail price, \$26.—*Radio Retailing*, July, 1928.

## Air Column Reproducers

Several new models of air column speakers are being offered by the Operadio Manufacturing Company, St. Charles, Ill.

The "New Senior" reproducer has a 54-inch air column and is 12 inches high, 14 inches wide, and 6½ inches deep. The familiar sunburst design of the Operadio has been carried out in this model which is obtainable in a crackle finish,—leatherized.

An entirely new model is the "Westminster," with a tone chamber 61 inches in length, and measuring 15½ inches high, 13½ inches wide, and 8 inches deep.

The "Junior" reproducer is a replica of the "New Senior" in general design, but smaller in size. The tone chamber has a length of 30 inches, but the reproducer is only 7 inches high, 8 inches wide, and 6½ inches deep. It may be had in bright colors.

This company also makes three new manufacturers' type reproducers with air columns varying in length from 30 inches to 84 inches.

Model No. 30 has a 30 inch air column and measures 7 inches high, 8 inches wide, and 7 inches deep, weight six pounds. Model No. 54-A has a 54 inch air column, measures 12½ inches high, 14½ inches wide, 7 inches deep, and weighs ten pounds, including bracket feet for mounting. Model 84-A has an 84 inch air column and measures 16 inches high, 20 inches wide, 12 inches deep; weight 24 pounds, including bracket feet. Models 84-A and 54-A are provided with lugs ready for lag screws or bolts, simplifying installation, and all models are designed to operate with or without power tube, and on A.C. or D.C. sets.

The tone chamber of all these reproducers is cast en bloc of an inert, light weight composition, giving a monolithic structure, which according to the manufacturer, prohibits absorption and side wall vibration, and changing weather conditions have no effect whatever upon the tone chamber.—*Radio Retailing*, July, 1928.

## Six Tube A.C. Receiver

The second unit in the new line being made by De Forest Crosley, Inc., 245 Carlaw Avenue, Toronto, Canada, is the "A. C. Console Six." This receiver uses a six-tube Neutrodyne balanced circuit, operates on either 25 or 60 cycle current supply, with 180 volts on the power tube. It is of cadmium plated all steel construction with complete individual shielding of coils, transformers, condensers and wiring. It has a special condenser gang for accurate maintenance of tuning alignment at all points. Among the other features of the set are a Mershon condenser, an accessible voltage control unit with voltmeter which governs all voltages, and a single-dial, illuminated control. It is housed in an attractive console cabinet.—*Radio Retailing*, July, 1928.

## A.C. Receivers

An electric set in several colors and finishes is announced by the Shamrock Manufacturing Company, 158 Summit Street, Newark, N. J. It is a seven-tube, single self-contained unit, including power pack, for 25 or 60 cycle use. It comes in the following colors: chinese green, mandarin red, ebony and gold, and ivory, which is especially adaptable for use in the boudoir. Each is hand rubbed with solid carved panels finished in antique gold. The overall size is 8½ in. high by 15½ wide by 11 in. deep. Intended retail price, \$95, less tubes.—*Radio Retailing*, July, 1928.

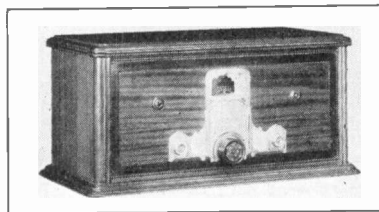

## New Kolster Line

A selection of sixteen models in electric and battery-operated sets is offered in the 1928 line of the Kolster Radio Corp., 200 Mt. Pleasant Ave., Newark, N. J. Both table and console models in artistic cabinets are included with a price range of from \$80 to \$750. In addition, separate magnetic and dynamic reproducers in both table and console styles, for use with type '10 or type '71 tubes, and a 60-cycle B-power unit are among the new products. The electric sets are four, five, six and seven-tube models. The four and five-tube sets are 60-cycle receivers of the table type in metal containers for insertion in book-cases, walls or special furniture, separate from the power reproducer, and list at \$80 and \$95. Both electric and battery sets are shown in the six-tube models with walnut cabinets of a new design. The console type receivers have magnetic cone reproducers. There are three different 60-cycle console sets using seven tubes and dynamic cone reproducers, one with a '71 type tube, another a '10 type tube, and a third, a '50 type tube. All have the single dial illuminated control and utilize the tuned radio frequency circuit with three stages of t.r.f., tuned detector and two stages of audio frequency, all coils being shielded.—*Radio Retailing*, July, 1928.



## Cone Reproducer

The B.B.L. Speaker Company, Inc., 101 West 31st Street, New York City, is making the illustrated end table model reproducer. This measures 29½ in. high, 28½ in. wide and 15 in. deep. It is made of walnut veneer wood with a walnut finish. The grill is made of turned solid walnut with gold cloth back of the grill. A magnetic type unit is used with a 24 in. cone mounted on a baffle board. It is equipped with a 20 ft. extension cord and is designed to be used as an end table accommodating the radio set if desired. The intended retail price is \$55. Other models of various design range in price from \$37.50 to \$95. There is also an improved 24 in. cone listing at \$25.—*Radio Retailing*, July, 1928.



## Receiving Tubes

Four new tubes have been added to the Ceco line offered by the C. E. Mfg. Co., Inc., 702 Eddy St., Providence, R. I.

The Hi-mu A.C. tube is especially adapted to resistance coupled audio amplification circuits. The filament is rated at 1.5 volts, 1.05 amps. and has the same general appearance as the M-26. The tube has an average amplification constant of 16. This type of tube should be used under conditions similar to those applying to the M-26 tube.

The A.C. shielded grid tube is of the heater type requiring 2.25 volts maximum, 1.5 amps and has a 5-prong socket. The control grid comes out through the top of the tube the same as in the D.C. shielded grid tube. It has characteristics which in many respects are claimed superior to those of the D.C. shielded type. Comparatively high mutual conductance has been secured and in general the inherent and recognized advantages of the shielded grid tube are made more available in this new type of A.C. tube.

The F-12A and the J-71A are actually the equivalent of the '12 and '71 in all characteristics, excepting the filament current consumption, which in the new types is  $\frac{1}{2}$  amp. current drain as against  $\frac{1}{2}$  amp. in the older types.—*Radio Retailing*, July, 1928.

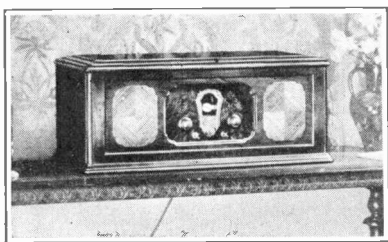

## A.C. Receivers

Two table model and two console model A.C. receivers have been added to the line of the Bremer-Tully Manufacturing Company, 656 Washington Boulevard, Chicago. Table model, 7-70, has seven tubes shielded, with four tuned stages and three audio, single illuminated control, 180-volt power tube output and dynamic drive. It uses five '26's, one '27, one '71A and one '80 type tube. The cabinet is 21 in. long by 10 in. high by 12 in. deep. The intended retail price, less tubes, is \$150. Table model, 8-20, illustrated, has eight tubes plus rectifier, is shielded, uses the Counterphase circuit, and has the single dial illuminated control, phonograph jack, 450 volt '10 type tube power audio and dynamic drive. The cabinet is of American walnut with matched inside panels. The tubes used are: five '26's, two '27's, one '10 and one '81. Retail price, less tubes, is \$230.

Model 6-40 has six tubes and rectifier, single dial illuminated control, 180 volt power tube output, dynamic drive and output transformer. It uses four '26 type tubes, one '27, one '71 and one '80. The intended retail price of this model, which has a mahogany finish cabinet, is \$130, less tubes.

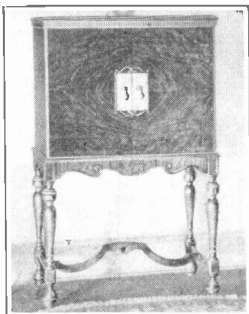

Console model, 8-21, illustrated, has the same specifications as the 8-20 table model and is equipped with a dynamic reproducer. The intended retail price is \$375, less tubes.—*Radio Retailing*, July, 1928.

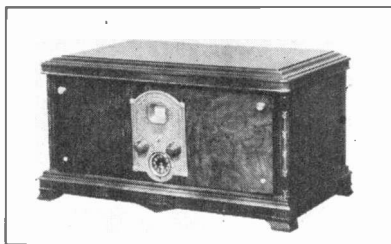

## A.C. Receiver

One of the models of the new line of electric "Monotrols" made by the Sleeper Radio Corp., Long Island City, N. Y., is a 7 tube single illuminated control, full wave rectification receiver. It has line voltage control, electric clock, local-distance switch, and is especially wired for dynamic reproducers. The price range of the complete Sleeper line is from \$140 to \$275.—*Radio Retailing*, July, 1928.

## Telephoto Kit

The Radiovision Corporation, 62 West 39th Street, New York City, is manufacturing a kit of parts for making radio picture recorders. This includes all the essential parts, except the items the set builder is likely to have in stock, such as switches, sockets, condensers, etc. The distinctive principle of the Cooley "Rayfoto" system is the employment of the corona discharge for exposing the picture. This makes special dark rooms unnecessary and makes it possible to use insensitive and inexpensive photographic papers. The Rayfoto recorder plugs into the output of any good radio set. It is a three tube unit of moderate proportions. The photograph is mounted on a printer unit, suitable for attachment to the phonograph. Included with the kit is a phonograph record of a transmission, enabling the making of pictures for experimental and test purposes at all times, regardless of the availability of broadcasting. The intended retail price is \$150.—*Radio Retailing*, July, 1928.

## Receivers and Reproducers

The Stewart-Warner Speedometer Corporation, Diversey Blvd., Chicago, has announced its new line to be known as the "800" series which will include both A. C. and battery models. Model 802, is a compact portable receiver with six receiving tubes and one rectifier tube, three tuned stages of r.f. amplification, with four tuned circuits, a built-in power pack, completely shielded, single dial control, a built-on reproducer, electrical phonograph pick-up and taps for connecting with either long or short outdoor aerial. A safety cartridge fuse completely protects the wiring of the set against burn-out through short circuit. The intended retail price, complete is around \$111.

Model 801 is the same as 802 without the built-on reproducer \$94.50; 806 is a battery operated model, identical in appearance with the A. C. model 801, and may also be had in console models with built-in reproducer. The new reproducer is of the magnet type, incorporating new developments, and has an intended retail price of \$16.50.—*Radio Retailing*, July, 1928.

## Voltage Regulator

The Simplex A.C. voltage regulator, manufactured by the Simplex Radio Co., 2000 St. Manayunk, Philadelphia, Pa., is made of heavy metal, with an olive color crystalline finish, and is equipped with an A.C. voltmeter and variable high grade resistance element for varying the voltage going into the receiving set. The list price is \$9.75. In many cases where short tube life is experienced with A.C. sets, the trouble is due to the excessive voltage from the house current supply. This voltage regulator is to protect the tubes against any high voltage and thus prolonging their life and allowing the set to function perfectly.—*Radio Retailing*, July, 1928.

## A.C. Receivers

Both console and table type receivers are listed among the new products of the All-American Mohawk Corporation, 4201 Belmont Avenue, Chicago.

The illustrated table model is an eight-tube set for either battery or A.C. operation, size 20 in. by 13 $\frac{1}{2}$  in. by 9 in. The intended retail price for A.C. operation is \$127.50, battery operation, \$95. Model 60, a six-tube set, slightly smaller in size, is \$65 for battery operation and \$92.50 for A.C.

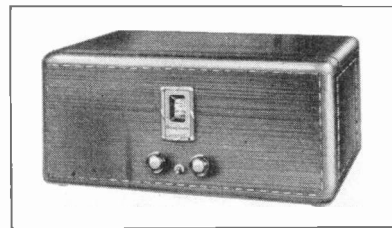

The console models include model 83, an eight-tube set with built-in magnetic reproducer for use on 110 volts A.C., 60 cycle, size 48 in. by 25 $\frac{1}{2}$  in. by 16 $\frac{1}{2}$  in., price, \$250 A.C., and \$217.50 battery operated; the illustrated model 86, which is also an eight-tube set with built-in magnetic reproducer, size 52 in. by 27 $\frac{1}{2}$  in. by 16 in., is \$235 A.C., and \$202.50 battery; model 85, same specifications as above and about the same size, \$195 A.C., and \$162.50 battery; model 61, which has six tube chassis No. 60 and built-in magnetic reproducer, slightly smaller than model 86, \$165 A.C., and \$137.50 battery; model 82, a highboy, has the six tube No. 60 chassis and built-in magnetic reproducer, \$172.50

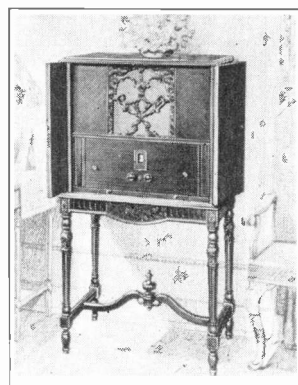

A.C. and \$145 battery; and model 65, with six tube No. 60 chassis and built-in magnetic reproducer, size 40 $\frac{1}{2}$  in. by 19 $\frac{1}{2}$  in. by 14 $\frac{1}{2}$  in. is \$137.50 A.C. and \$110 battery operated.—*Radio Retailing*, July, 1928.

## Radiola A.C. Kit

A new A-C kit, designed to convert with little or no alteration a regular Radiola Model 16 direct current radio receiver into an efficient A.C. outfit, using regular A.C. tubes, has just been put on the market by the Kingston Products Company, Kokomo, Indiana.

The power supply, wiring changes, etc., are all previously taken care of in the kit itself, so that the actual installation is very simple. A service man can make the desired change in fifteen or twenty minutes with nothing more than a screw driver.

The A-C kit is comprised of the following assembly, sold complete, ready to install: Kingston Type 2 B current supply unit. A special A-C transformer and C bias supply. Adapters. Volume control rheostat. Cable and approved A-C switch.

Adapters are used in the present sockets which isolate the existing filament circuit of the set. Connection is made to the filament and heater terminals of the A.C. tubes through a cable which connects the adapters together.—*Radio Retailing*, July, 1928.

## Short Wave Receiver Kits

The new 730 "Round the World" short-wave receiver kit, made by Silver-Marshall, Inc., 846 W. Jackson Blvd., Chicago, has one '22-type screen-grid tube in the R.F. stage, and employs the new 131 plug-in coils. It is assembled upon aluminum plates which, when erected, comprise the cabinet, size 14 in. long, 6 in. deep, and 6 in. high. Four separate coils provide a wavelength range of from 17.5 to 204.5 meters. Both a complete kit No. 730 and an essential kit No. 732 are provided. Or by dropping the 2-stage audio amplifier, a 2-tube short-wave adapter (kit No. 731) of remarkable efficiency is available. Intended retail price, including knock-down aluminum cabinet, \$49.50.

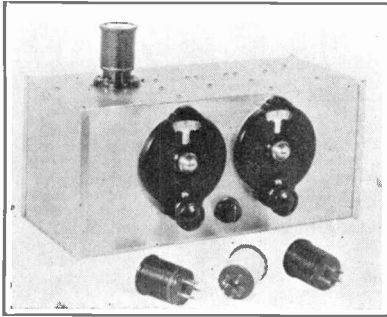

The "Screen-Grid Eight" is a custom receiver kit, which has five screen-grid R.F. tubes, employed ahead of the detector and a 2-stage audio amplifier. A steel cabinet, finished in rich coloring, is included. The intended retail price is \$79, including cabinet.

And, the No. 740 "Coast to Coast" screen grid A.C. receiver kit has one stage of '22-type screen-grid radio-frequency with '27-type detector, one '22-type screen-grid audio amplifier and '71-type second-stage power tube providing amplification and permitting complete light socket operation. Two drum dials and unusually large coils permit hair-line tuning and selectivity. Splendid tone quality is available by virtue of the 255 and 256 audio transformers. In conjunction with the 670-ABC power supply and No. 700 cabinet and chassis, a complete A.C. operated receiver is provided at a price of approximately \$89.—*Radio Retailing*, July, 1928.

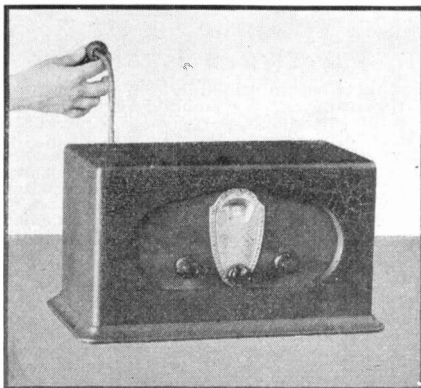

## Electrified Receiver

The Acme Electric and Manufacturing Company, 1444 Hamilton Avenue, Cleveland, Ohio, has entered the ranks of radio set builders. The first Acme set is a small, entirely self-contained table model receiver with the A and B-power unit built in. It uses D.C. tubes and may be plugged into the convenience outlet. It has the two-dial control and the cabinet is dark walnut with walnut panel set in and black dials. The intended retail price is \$65, complete with tubes.—*Radio Retailing*, July, 1928.

*Radio Retailing*, July, 1928

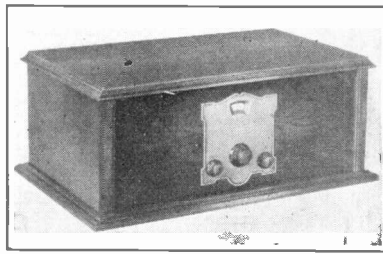

## A.C. Receiver

A seven tube, completely-shielded A.C. receiver consisting of three radio frequency stages, detector and two stages of audio amplification, has been placed on the market by the Pioneer Radio Corporation, Plano, Ill. The last stage is connected in push-pull, using two '71 power tubes. The chassis is made of cast aluminum with attachable power unit. The intended retail prices, complete with power unit, are as follows: Chassis, \$70 less tubes, metal cabinet model, \$77.50 less tubes, and walnut cabinet model, \$82.50 less tubes.—*Radio Retailing*, July, 1928.

## A.C. Receivers

The general specifications of the 1929 line of A.C. console receivers made by the Premier Electric Company, 3806 Ravenswood Avenue, Chicago, are as follows: single-drum control, t.r.f. circuit, consisting of three stages radio, detector, and two transformer coupled audio. A Premier 100-RAC power supply unit, placed in the cabinet back of the chassis, uses an '80 rectifying tube and is easily removed from the cabinet. The chassis is all metal and the sub-base is in box form made from heavy sheet steel  $\frac{1}{8}$  in. thick, and all wiring, transformers, etc., are in this metal box. All apparatus is totally shielded and the radio frequency transformers are individually and independently shielded in copper tubes.

Console model PC-2829-RAC, has the 2829-RAC chassis with the 100 RAC power supply unit installed in an attractive cabinet, equipped with Peerless reproducer; console model PC-2829-KAC has the 2829-KAC chassis with the 100-KAC power supply unit installed in the cabinet together with a Peerless reproducer; and console model PC-2829-RAC or PC-2829-KAC, has a solid walnut and veneer cabinet, size 26 in. by 40 in. by 16 in. deep. Weight packed for shipment, 100 lb.

The table model PT-2829-KAC, has the 100-KAC power supply unit, and is enclosed in a solid walnut cabinet with panel of natural wood mounted on a heavy steel back panel, size 22 in. by 8  $\frac{1}{2}$  in. by 12  $\frac{1}{2}$  in. deep.

This company also furnishes the chassis complete with power supply unit to those who prefer to use their own cabinets. The panel is 7 in. by 21 in. by  $\frac{3}{8}$  in., standard, or 7 in. by 18 in. by  $\frac{3}{8}$  in. special. Model 2829-KAC chassis is designed to operate with any make of No. 401 or 403 "overhead heater" type of A.C. tube, and model 2829-RAC chassis is designed to operate with the type '27 and '71 tubes.—*Radio Retailing*, July, 1928.

## Dynamic Power Reproducers

The Rola Company, Oakland, Calif., is showing a new dynamic power reproducer in both the table and console models. It reproduces with equal intensity, so the manufacturer claims, from below 30 cycles per second to 12,000 cycles per second, and is extremely rugged in construction. The diaphragm is corrugated and waterproofed by a new process and will not rattle or blast, it is claimed, at any power up to and including the output of several '50 type tubes in push-pull combination. A special development in the supporting spider insures positive and permanent alignment of the vibrating coil and eliminates any possibility of unstabling strains being set up in the torsional members. The console table model is \$110 for A.C. sets and \$95 for the battery type; the table model is \$75 for A.C. sets and \$60 for battery sets.—*Radio Retailing*,

## Electric Phonograph Motor

A "one-to-one" electric phonograph motor is now being marketed by the Sonora Phonograph Company, 50 West 57th Street, New York City, and will be included in the entire Sonora line for coming year. Due to its constructional features, this motor is quiet and produces no interference when working with electrical pick-up or in conjunction with audio-frequency amplification. The speed is controlled so as to maintain a constant rate by the standard three ball governor and by a torque absorbing device which is instantaneously operative in cases of load variation or voltage fluctuation. This motor requires lubrication but once a year and is wound for 110 volts A.C. 40 to 60 cycle. By the addition of a simple external resistance it may be used on 220 volts A.C. 40 to 60 cycle and 110 or 220 volts D.C. It requires but one-quarter ampere when running, and is supplied with turn-table, speed control parts, full non-set automatic stop and switch, or with pre-set automatic stop. In production quantities, any standard lacquer finish or plating can be supplied. The intended retail price, without accessories, is approximately \$45.—*Radio Retailing*, July, 1928.

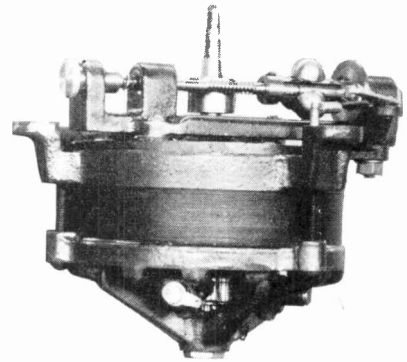

## Rectifying Units for Dynamic Reproducers

A new D-24 full wave rectifying unit, having a capacity of from 1 to 2 amperes at 8 to 10 volts D.C. output for supplying direct current to field coils for dynamic reproducers, has been added to the line of the Benwood-Linze Co., 1832 Washington Ave., St. Louis, Mo. This unit when used with proper transformer, and used with or without filter, supplies direct current to excite magnetic field coils of dynamic reproducers. The intended retail price is \$6 each.

They also make another model full wave rectifying unit with suitable transformer, cord and plug and mounting base, completely assembled, listing at \$15.—*Radio Retailing*, July, 1928.

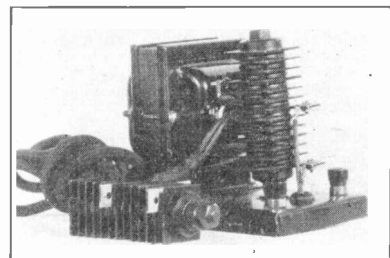

## A. C. Converter

For converting sets with D.C. tubes to electrified sets. The "Abox" converts 110-volt, 50-60 cycle current to 6 volts D. C., thus replacing the storage battery and charger. This is made by the Abox Co., 215 North Michigan Ave., Chicago, Ill. A receptacle for the B unit is provided and a master control switch is standard equipment. Output adjustable for sets using 3 to 8 tubes. Attractively finished in brown. Retail price not announced.—*Radio Retailing*, July, 1928.

## A.C. Receiver

A new model A.C. receiver, to be known as the "Synchrophase Seven A.C." utilizing five '26 type tubes, a '27 detector tube, a '71A power tube, and an '80 rectifier tube in a power unit which will be external, is being made by the A. H. Grebe, Inc., 109 West 57th Street, New York City.

The power supply components are divided between the receiver and an external power unit, whose overall dimensions are but 8 in. x 6½ in. x 5½ in. and is provided with a 36 in. connecting cable. Thus the unit may be concealed in an out of the way place.

The set has the single dial control, an "on-off" switch, a local-distance switch and a volume control. The volume control is of special design permitting very gradual control of volume from minimum to maximum, and is so located in the circuit that it affords complete control of the incoming signal. The intended retail price, including external power unit, but without tubes and reproducer, is \$195.—*Radio Retailing*, July, 1928.

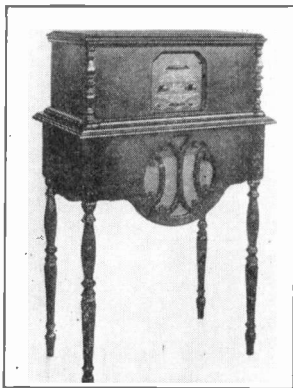

## Electric Turntable for Radio Phonograph Combinations

The Bodine Electric Company, 2256 West Ohio Street, Chicago, Illinois, announces the new Model RC 10 electric turntable which has been designed especially for use in radio phonograph combinations. The Model RC 10 unit is equipped with a single phase induction motor that has no commutator or brushes, and therefore cannot introduce interference in the loud speaker, usually caused by sparking at the brushes.

The modern trend to use an electric phonograph pick-up in conjunction with the amplifier in a radio receiver for electrical reproduction of phonograph records has created a demand for an electric turntable which will not create disturbances in the electrical circuit which operates not only the electric turntable, but also the radio amplifier and rectifier units. The new Bodine electric turntable will be furnished to manufacturers of electric phonographs and also will be merchandised through the regular jobbing channels.—*Radio Retailing*, July, 1928.

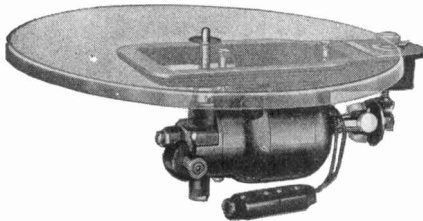

## Correction Item

In the June issue of *Radio Retailing*, on page 75, the console receiver made by the Day-Fan Electric Company was shown listed at \$200. This is in error, and the correct price is \$295 less tubes. Prices of the other models made by this company are now as follows: Table model, \$150; speaker table to accommodate the table model, \$205, complete.—*Radio Retailing*, July, 1928.



## Radio Phonograph Combination

The illustrated No. 960 radio-phonograph combination is being placed on the market by the Columbia Phonograph Company, 1819 Broadway, New York City. This instrument takes all of its power from the house current and has a six-tube Kolster radio set incorporated. The radio set has three stages of radio frequency tuned by means of a single control. All exposed metal parts in the turntable well are finished in lacquered bronze. The ornamental escutcheon plates on the control panel are a combination of walnut and bronze tone. At either side of the grille is a drop style record bin accommodating 15 records each. The cabinet is of walnut veneer shaded, toned and high lighted. The overall dimensions are: height 40 in., width 33 in., depth 22½ in. A switch is arranged so that the audio frequency amplifier may be conveniently used either for the radio receiving set or for the electric phonograph pick-up. Intended retail price, \$600.—*Radio Retailing*, July, 1928.

## Radio Tubes

The 1928 line of Buck radio tubes made by the Universal Electric Lamp Company, 26 Treat Place, Newark, N. J., includes the following: BX-227 a 2.5 volt, 1.75 ampere A.C. heater type tube, \$4; BX-226 a 1.5 volt, 1.05 ampere, A.C. filament tube, \$2; BD-11 a 1.1 volt, .25 ampere dry cell detector and amplifier, \$1; BD-12 similar to BD-11 but with the standard BX base, \$1; BX-201A a 5 volt, .25 ampere detector and amplifier, \$1; BV-199 a 3.3 volt, .063 ampere dry cell detector and amplifier, \$1; BX-199 the same as BV-199 but with a small standard base, \$1; BS-199 standard the same as BX-199 with the exception of the base, \$1; BX-112A a 5 volt, .25 ampere power amplifier, \$2; BX-171A a 5 volt, .25 ampere power amplifier, \$2; B-rectifier-85-MA a tipless tube, \$3; BX-200A a 5 volt, .25 ampere super-sensitive detector, \$2; BX-280 a 5 volt, 2 ampere full wave rectifier, \$4; BX-281 a 7.5 volt, 1.25 ampere half wave rectifier, \$6, and BX-210, a recent addition to the line is a 6.0 to 7.5 volt, 1.25 ampere (max.) heavy duty power amplifier, \$7.—*Radio Retailing*, July, 1928.

## Dynamic Reproducers

The Electrical Research Laboratories, 2500 Cottage Grove Ave., Chicago, has placed on the market what is said to be an exceptionally sturdy reproducer with only a very small number of parts. All coils are form wound to predetermined resistances and the voice coil is matched to the input transformer. This reproducer will be manufactured in several types, one for the retail trade which includes a dry rectifier and transformer so that it can be used with 110 volt A.C. current which will retail at approximately \$60; one for sale in those districts where the current is different than that mentioned above, in which case the field can be energized with a 6-volt storage battery; and another type which is to be sold only to phonograph manufacturers for use with our own or other makes of amplifiers. There is also to be a type for use with 110 volt D.C. current.—*Radio Retailing*, July, 1928.

## Receivers and Reproducers

The 1928-1929 line of the Freed-Eisemann Radio Corporation, Junius Street and Liberty Avenue, Brooklyn, N. Y., includes the following: the NR-80, using 1 rectifying and 7 A.C. tubes, three stages of neutrodyne t.r.f. with long wave equalizing antenna circuit, detector and two stages of audio frequency amplification and output transformer. The tubes used are: one '80 as a rectifier, five '26 A.C.'s for radio frequency and first audio stages, a '27 for the detector and a '71A for the output. For use on 110 to 120 volts 60 cycle A.C. supply. Intended retail price in either a steel or wood cabinet, 20½ in. x 8½ in. x 10½ in., \$215.

NR-80 for 110 to 120 volts D.C., same chassis as NR-80, with six '01A's for the radio frequency stages, detector and first audio stages, two '71A's connected in push-pull amplification in the second audio stage, in either a steel or wood cabinet, \$125.

NR-80 for 25 or 40 cycle A.C., same as NR-80 except that a special power transformer is used, steel or wood cabinet, \$135.

NR-85, same chassis as NR-80, with high power amplifier unit, automatic connection-jack built into set to accommodate F-E dynamic reproducer, and using the following tubes: one '81 rectifier tube, five '26's for radio frequency and first audio stages, a '27 for the detector and a '50 super-amplifier for the output stage, \$160. The reproducer line includes, the 300 dynamic, \$65; 300 chassis only, \$45; 345, a magnetic reproducer, in two different finishes, \$35; 345 chassis only, \$20; the 330 table model cone type, \$35; the 330 wall model, with 20 foot cord, \$35; and the 330 floor model, \$50.—*Radio Retailing*, July, 1928.



## Electrified Receivers

Included in the line to be offered to the trade for the coming season by the Radio Products Corporation, Inc., 3816 N. 28th Street, Birmingham, Ala., is model A, using the regulation battery equipment or the power case, which has no batteries, liquid, charger or switch and does not require the use of A.C. tubes or change in the wiring, intended retail price, battery operated, \$135, with unit, \$145; model C, the illustrated console, retails at \$181.75, battery operated, and at \$203.75, with power units; model D is a compact, self-contained electric, using same kit and standard '01A and '12 type tubes, with cabinet practically the same as model A, sold with unit only, \$150; model B is a portable with built-in reproducer, available for battery operation only, \$105.—*Radio Retailing*, July, 1928.

## Shielded Hookup Wire

A new wire has been placed on the market by the Belden Manufacturing Company, 2300 So. Western Avenue, Chicago, Ill., for use on the new shielded grid tubes. This wire consists of the Belden flexible color-rubber hookup wire, shielded with a braid of tinned copper. When the tinned copper braid is grounded, it provides a very effective shield for the grid wire.—*Radio Retailing*, July, 1928.



## "A" Filter Condenser

A condenser, for use in filtering 6-volt filament supply, and containing 3,600 mfd. within a space of only 5x5x1½ in., is made by the Tobe Deutschmann Company, 11 Windsor St., Cambridge, Mass. No attention or refilling whatever is necessary. The Tobe A-Block is just a condenser unit and once installed, it can be forgotten. The development of a condenser of this type makes possible the use of low-voltage rectified alternating current, for lighting the filament of ordinary battery type tubes from a lamp socket A.C. supply. By combining this device with a pair of chokes of suitable size, and a battery charger of the proper type, completely wired—reliable 6-volt, filtered, rectified current is available, for direct electrical operation of the filaments of battery type tubes. Intended retail price, \$7.—*Radio Retailing*, July, 1928.

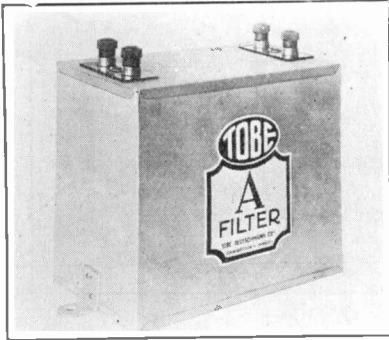

## Air Chrome Reproducer

A reproducer of the open radiator type with a large surface diaphragm but with the balanced tension principle, is offered by Temple, Inc., 1925 S. Western Ave., Chicago. The diaphragm is said to be so arranged that the larger or front half is tuned to the lower frequencies and the smaller or back half to the higher frequencies. The unit operates at the point where the two diaphragms come together—at the balanced center—and the response from the unit is impressed on the diaphragms without any loss, as there is no dead weight to lift before going into action. Model 20 Air Chrome, as it is called, is encased in walnut with sides of a grained leather effect. The intended retail price is \$35.—*Radio Retailing*, July, 1928.

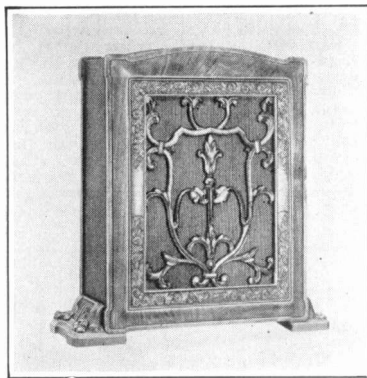

## A.C. Console Sets

Two console model A.C. receivers are being made by the Maxwell Radio Corporation, 103 Broadway, Brooklyn, N. Y. The set has five tubes, including a power tube, and two illuminated tuning controls. It operates from either A.C. or D.C. current. The "Louis XIV" model has a built-in reproducer and is 59 in. high by 31 in. wide by 20 in. deep. The "Coliseum" has the exponential type molded wood reproducer and is 47 in. by 31 in. by 20 in. Either "butt" or "diamond" design doors, so-called because of the design made by the wood, may be had in this model. Both are housed in an American walnut finish cabinet and have an intended retail price of \$375.—*Radio Retailing*, July, 1928.



## Dynamic Reproducers

The United Radio Corporation, Rochester, N. Y., announces several new models for the coming season. Foremost among these is the new dynamic reproducer incorporating several new principles of dynamic design. It is equipped with a rectifier element providing for light socket operation, and will handle the output of any tubes.

Model 17-A has a mahogany Gothic cabinet and lists at \$75. Model 19-T is a complete built-in reproducer table, listing at \$100. Finally, there is a manufacturer's model, 17-C, for built-in use in console sets.

In addition to these, a new model 7-T, (illustrated) which is a built-in reproducer table using the Model 7 cone-type chassis, is offered at a list price of \$50. Both this table and the dynamic reproducer table carry out in design the Gothic lines.—*Radio Retailing*, July, 1928.

## A.C. Receivers

One table model and three console models are included in the new line of the Steinite Radio Company, 506 S. Wabash Ave., Chicago. The table model has six tubes, as follows: four '26's, one '27 type detector, one '71A type power tube and one '80 type rectifier tube. The entire condenser assembly is protected by a steel cage. The cabinet is of Duco finished wood and the set has a built-in power pack which is readily adjustable for average line voltages. It also has a phonograph pick-up connection. A complete console model, the "Standish," retails for \$115. Besides this one-unit job, there are two other consoles which are so arranged that the table model receiver is dropped into the drawer of the console, making a complete piece of furniture. The "Rembrandt" cabinet is \$55 and the "Sevilla," in the Spanish style, \$75, both made of black walnut veneer.—*Radio Retailing*, 1928.

## A-B-C Power Unit

A Kuprox A-B-C combination power pack, for making any set an electrified set providing all A-B-C radio power, direct from the light socket; utilizing the efficient battery type tubes, is made by the Kodol Elec. & Mfg. Company, Cincinnati, Ohio. Kuprox rectifying element utilized throughout; operates power tube perfectly; and is free of hum, distortion or inconvenience of any kind. No water or attention necessary; contains no batteries. Simply plug into the light socket and forget it. Special model for Radiolas. Two models at \$65 and \$67.50.—*Radio Retailing*, July, 1928.

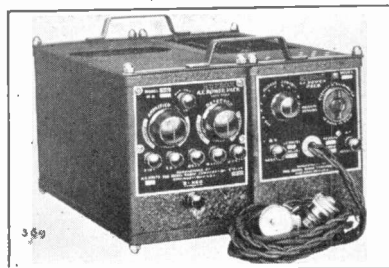

## Complete Television Kit

A television amplifier consisting of three stages of resistance coupled amplification, is being made by the Daven Corporation, Newark, N. J. The output of this is fed directly to the television lamp. The brilliancy of this lamp depends entirely upon the amount of current that the output tube will pass, hence the greater the consumption of the output tube, the greater the amount of brilliancy the television lamp will give. It is placed in the rear of the scanning disc, which is mounted on the spindle of a constant speed motor. The picture is viewed through the apertures in the disc and again through a small window placed either in the front or the rear of it. This constitutes the entire essentials to the assembly of a complete television receiver. Where signals are weak, and for receiving over great distance, two power stages of amplification are added to the above combination, supplied by efficiently rectified alternating current power supply.

A complete list of the television apparatus being made by this company follows: television essential kit, \$45 without tubes; television essential power kit, \$10; television scanning discs, \$5-\$7; special motor, \$15, and rheostats, \$3; television tubes, special television amplifier, \$12.50 without tubes; television resistance couplers, \$2.15-\$4.65; MU-20 tube for amplifier stages, \$2.25; AC-71 tube for output tube in series with television lamp, \$3.50; AC-10 tube for output tube in series with television lamp (bright illumination), \$9; television photo electric cell, \$25.—*Radio Retailing*, July, 1928.

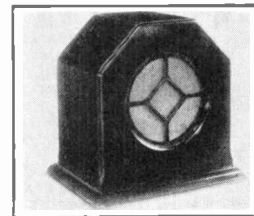

## Dynamic Reproducers

Three types of dynamic reproducers are included among the new products of the Martin-Copeland Company, Providence, R. I. They are enclosed in attractive brown mahogany cabinet of symmetrical lines and the manufacturer claims they will respond with equal fidelity and volume at any frequency between 50 and 6,500 cycles. Type D110, for operation on 110 volts, 50 to 60 cycle A.C., with the rectifier built in, is \$75, or chassis only, \$50; type D90 for operation on 90 to 110 volts D.C., as well as from the 90 volt tap of B-power units, is \$67.50, or chassis only, \$40; type D6, for operation on 6-volt storage batteries with a current drain of ½ ampere, is \$65, or chassis only, \$35.—*Radio Retailing*, July, 1928.

## A.C. Receivers

The Fansteel Products Company, Inc., North Chicago, Ill., is now making three models of A.C. receivers. The set itself has seven tubes and employs the neutrodyne circuit, using three stages of tuned radio frequency, a tuned detector and two stages of audio frequency, of which the last is push-pull. It uses the '27 type tubes in all stages except the last, which uses two '12-A's. In all models a dynamic drive is part of the power pack, so that no special equipment need be added for the installation of a dynamic speaker. In the console a dynamic reproducer is standard equipment. There are three controls, the tuning dial, a volume control and the switch—an arrangement to protect tubes and provide for satisfactory operation with fluctuating voltages. The set also uses the special Balkite condensers. The chassis, which is completely enclosed, is divided into two parts,—one the set proper, the other the power pack. These two parts are readily separable. The table model A-5, lists at \$235; the Highboy A-7, at \$487.50, and A-3, which is enclosed in a simple steel case, lists at \$197.50.—*Radio Retailing*, July, 1928.

## Neon Lamp and Photo Cell

The Raytheon Manufacturing Company, Cambridge, Mass., has placed on the market two new products—the Kino-Lamp and the Foto-Cel—to aid the radio amateurs, scientists, and other experimenters, in this development work. The Raytheon Laboratories are also closely following television developments. The Kino-Lamp, as will be seen from the accompanying cut, comprises two flat metal plates, placed parallel and very close together. Rigidity of the plates is obtained as a result of the novel system of bracing. The plates are approximately  $1\frac{1}{2}$  in. x  $1\frac{1}{2}$  in. and the glow over the cathode plate is exceedingly uniform. Either plate may be used as the cathode by interchanging the base connections.

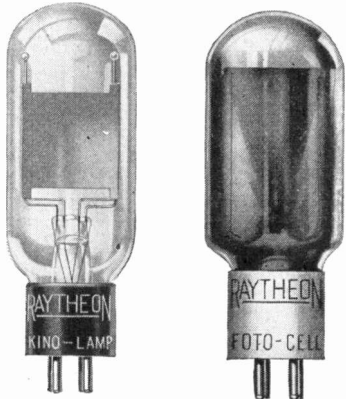

The tube has been so designed as to have a dynamic impedance of about 1,500 ohms in order to permit its operation directly in the plate circuit of an '71 Amplifier tube without resorting to the use of impedance adjusting transformers. The Kino-Lamp draws 15 M.A. at 222 volts.

The new Raytheon Foto-Cel is an improvement on former types of hard vacuum photo-electric cells, in that high sensitivity for this type of cell has been successfully combined with rugged construction and small size. This cell should not be confused with the gaseous type of photo-electric cells, which are also being developed, and in which the sensitivity can be increased many times. The uniform response of the hard vacuum Foto-Cel makes it the ideal type for television requirements.—*Radio Retailing*, July, 1928.

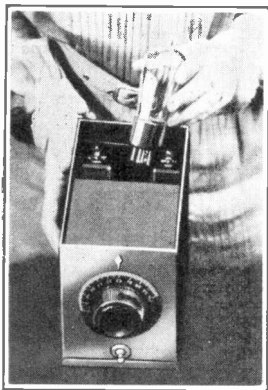

## R.F. Amplifier Unit

A "Pre-Amplifier," which makes possible the use of the '22 screen grid tube, is the latest product of the Sterling Manufacturing Company, 2831 Prospect Ave., Cleveland, Ohio. This device, as its name implies, is connected in ahead of any 6-volt or 4-volt D.C. receiver, without rebuilding or re-wiring, without changing any tubes, and without new batteries or socket power.

Model 375 is equipped with switch and power cable having marked leads. Easy to install. Two tone green-bronze case. Size  $7\frac{1}{2}$  in. x  $4\frac{1}{2}$  in. x  $5\frac{1}{2}$  in. The intended retail price of model R375 for 6-volt or R-374 for 4-volt without tube, \$15; with tube, \$21.50.—*Radio Retailing*, July, 1928.



## Carbon Grid Leaks and Resistors

The Ohio Carbon Company, Cleveland, Ohio, is now manufacturing a complete line of carbon grid leaks and resistors with the standard ferrule cap terminal or with the wire terminal, supplied either looped or straight. The wire terminal has an advantage in that it saves the cost of the clip fixture which is required in the ferrule cap type, is easy to apply and never corrodes. These resistors and grid leaks can be supplied in ranges from 200 ohms to 10 megohms. This carbon type is not inductive, has low temperature co-efficient and is non-hydroscopic. If desired can be supplied sealed with special enamels and may also be ordered in other sizes and types. Normal changes of temperature do not affect them.—*Radio Retailing*, July, 1928.

## Reproducers and Sets

Two new reproducers have been added to the line of F. A. D. Andrea, Inc., Long Island City, N. Y. The Fada-4 is a newly developed small cone reproducer housed in a die-cast metal case of the mantle clock type. The housing for this reproducer is of heavy die-casting of artistic design, approximately  $13\frac{1}{2}$  in. wide, 11 $\frac{1}{2}$  in. high and 9 $\frac{1}{2}$  in. deep, with an ornamental radio grille backed by a silk screen of unusual and beautiful design. The motor is of the balanced armature type with an extra large chrome steel magnet and improved bobbin winding which is rigidly mounted to a die-cast aluminum bracket fully protecting both the unit and entire cone mechanism. The 7 in. cone is driven by a rod direct from the armature instead of the usual driving beam, mechanical transformer and driving pin arrangement of the past. The price is \$30.

The Fada-14 is a dynamic cone reproducer. The entire power supply for energizing the field coil, the motor, and cone, are completely self-contained in one cabinet. The moving coil is  $1\frac{1}{2}$  in. in diameter and the entire mechanism is rugged in construction and protected to prevent damage by suitably designed die-cast brackets. The price is \$65.

The new receiver line includes the Fada 10, all electric, with a neutralized tuned radio frequency circuit utilizing five '27, one '71 and one '80 type tubes, three stages radio, detector, two audio, last stage a power stage, completely self-contained in a two-tone metal cabinet, single dial control, intended retail price \$110, without tubes; model 11 is a table model with same chassis as the 10 but encased in a burl walnut cabinet, \$135, without tubes; model 30, is a console model with the same chassis and a Fada 4-B cone reproducer. The cabinet is about 40 in. high by 25 in. wide by 16 in. deep and has matched burl walnut panels, \$187.50, without tubes. Model 31 is a highboy console of walnut with the same chassis and reproducer as the previous model. It is about 50 in. high by 17 in. wide by 29 in. deep and has a front drop lid covering the tuning panel and two swinging doors enclosing the built-in reproducer, \$235, without tubes. Model 50 is an all-electric set with a neutralized t.r.f. circuit, using six '27's, two '10's and one '81 type tube in four stages of radio frequency amplification, detector, one stage of straight audio frequency amplification and one stage of push-pull power amplification. The cabinet is of two-tone burl walnut, approximately 11 $\frac{1}{2}$  in. high by 27 in. wide by 17 in. deep with a loop of the disappearing type, automatically disconnecting and nesting inside the cabinet when not in use. The electric unit is a separate chassis although self-contained within the set. Intended retail price, \$225, without tubes. The 70 has the same chassis as the 70 and a dynamic reproducer. The Sheraton period cabinet is 41 in. by 29 in. wide by 19 in. deep, price \$340, without tubes.—*Radio Retailing*, July, 1928.

## A.C. Console Receiver

Responding to the public demand for a low-priced, socket-power receiver in a console cabinet with an enclosed reproducer, the Radio Corporation of America, 233 Broadway, New York City, announces the introduction of Radiola 51. This new model employs the radio circuit and power unit of Radiola 18 in combination with the 100-A cone type reproducer. One UY-227, a UX-171-A, a UX-280, and four UX-226 Radiotrons are employed. The receiving mechanism and reproducing unit are embodied in a console cabinet of matched walnut finish. Radiola 51 is priced at \$195, without Radiotrons.—*Radio Retailing*, July, 1928.



## Radio Receivers and Reproducers

The Atwater Kent line for the coming season includes three A.C. receivers, two battery operated sets, and three reproducers.

Model 40, illustrated, is the 1929 improvement on the 37, is all-electric and uses six A.C. tubes and one rectifying tube. It is made for use with 110-120 volt 59-60 cycle A.C. and is finished in dark brown and gold or bronze and gold. The intended retail price, less tubes, is \$77.

Model 42, is an A.C. set, similar to the above model but with an automatic line voltage control. For use on 105-125 volt, 59-60 cycle A.C. Intended retail price, choice between two cabinets, \$86, less tubes.

Model 44, is a more powerful A.C. set, with line voltage control. It has seven A.C. tubes, one rectifying tube and a local-distance switch. Uses same current as the 42. Intended retail price, less tubes, \$106.

Model 48 is battery operated with two stages t.r.f. in conjunction with A-K coupling circuit, detector and two stages of audio frequency. Six tubes required. Intended retail price in solid mahogany cabinet, without tubes or batteries, \$49.

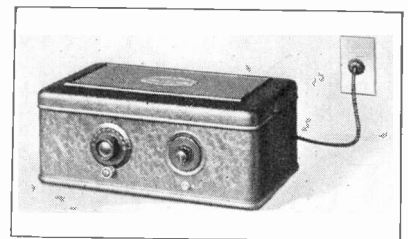

Model 49, is also battery operated with an antenna adjustment for selectivity. Three stages of t.r.f., detector and two stages of audio frequency. Six tubes required. Intended retail price, without batteries or tubes, \$68.

In the reproducer line is included the illustrated model E, the largest size, model E-2, medium size; and E-3, small size. They may be had in satin finish—dark brown and gold or bronze and gold. The intended retail price of each model is \$20. The Atwater Kent Manufacturing Company, Philadelphia, Pa.—*Radio Retailing*, July, 1928.

# What the Trade is Talking About

## Federated Unanimously Adopts New Constitution

Two events of major interest marked the Chicago convention activities of the Federated Radio Trade Association. These developments, according to President Harold Wrape, bode well for the future success of this national affiliation of radio dealers, wholesalers, manufacturers' representatives and local trade associations.

By a unanimous vote each of these four branches of Federated approved, on Wednesday morning, June 14, the revised Articles of Incorporation and By-Laws, as prepared and presented by A. M. Edwards, Detroit, chairman of the revision committee, and his associates, Harry Cory, Minneapolis, and Sidney Neu, Milwaukee.

The new constitution provides for a central governing board of twenty-four directors, six from each related organization. It provides also for a new schedule of dues, commensurate with the character of the participating members, and for the independent functioning of each group on matters relating to its own individual affairs.

These affiliated organizations will be known by the following names and be authorized to levy the following membership dues: National Radio Retailers Association, individual membership dues, \$5 per annum; Radio Wholesalers Association, yearly dues, \$100 per firm; Manufacturers' Representatives Section, dues, \$10 per agent; and the Association Section, with annual affiliation dues of \$1 per local organization.

The significance of this unique welding of all representative distribution groups, according to Mr. Edwards, is that, with centralized boards, the greatest possible weight will be given any concerted actions Federated may undertake. Retailers, jobbers and agents will be able to co-ordinate their objectives through a parent organization, thus eliminating cross-purpose policies.

With the election of Peter Sampson, president of the Sampson Electric Company, Chicago, to the presidency of the recently organized Radio Wholesalers Association, the fortunes of this rapidly expanding and important member of the F.R.T.A. received added impetus. Mr. Sampson's appointment was confirmed at the Wednesday meeting. J. F. Connell, of the Kruse-Connell Company, Indianapolis, Ind., and Charles Gomprecht, of Trilling and Montague Company, Philadelphia, Pa., were elected vice-presidents. Harry Alter, president of the Harry Alter Company, Chicago, will be treasurer.

Committees were appointed at this meeting to investigate the economics of the distribution of tubes, to recommend a practical code of ethics and to present, for adoption, standard forms of purchase orders and catalog sheets. A traffic committee was organized, under the chairmanship of R. C. Coleman, of the George Beckwith Company, Minneapolis, Minn., to co-operate with the Radio Manufacturers' Association for the purpose of reducing freight rates on radio goods.

One of the things emphasized at all group meetings, and that was clearly stated by David Burke, president of the Radio Distributing Company, Detroit, Mich., at the wholesalers' gathering, was that the influence of organization strength would

## FEDERATED RADIO TRADE ASSOCIATION — BOARD OF DIRECTORS 1928 —



not be used as a club over the head of any other type of radio industry member. "Rather," he declared, "we will attempt to solve our problems of trade relationships in a constructive and friendly manner."

In line with this thought, Martin Wolf, Electric Appliance Company, Chicago, speaking at the same meeting, dwelt on the vital necessity of co-operating with the R.W.A. relative to the tube situation and exorbitant freight rates. "In the future," he stated, "there will be an organized body of jobbers with whom the manufacturer should take council before launching policies inimical to the best interests of either wholesaler, dealer or consumer."

At the dealers' meeting, membership applications were received from Maine to California. Attendance was five times that of last year.

## Annual Convention Held by NEMA Radio Division

A large and successful series of meetings was held by the Radio Division of the National Electrical Manufacturers' Association during its annual convention the week of June 4, at the Drake Hotel, Chicago.

Addresses were delivered by a number of prominent men and many important decisions and recommendations on industry problems were made. One of the most valuable results of the convention is the decision to establish a training school for radio service men.

The wide resources of NEMA, embracing the leading radio manufacturers in the United States, is behind the service course and, through the co-operation of the Radio Institute of America, this course will soon be available for all radio dealers.

Within several months, also, the radio retailer in every part of the United States will have available the "NEMA Handbook of Radio Trade-In Values." Going back as far as 1924, this handbook will contain

George Riebeth, Minneapolis, Minn., lead the divisional meeting of the manufacturers' representatives. A gratifying interest was shown in the matter of perfecting a national organization for this branch of the industry.

It was decided to divide this association into territorial sections, the better to retain contact and promote local meetings.

A gratifying attendance characterized each meeting. "With the impetus gained during convention week," declared Harold Erstrom, executive-secretary of Federated and of each of its four affiliated associations, "there is every reason to believe that 1928-29 will mark the definite turning point, toward greater things, of this national amalgamation of dealer and jobber interests."

suggested trade-in values for used radio sets and will offer the radio dealer a useful guide in selling a new radio set to a customer who wishes to trade in his present used set for a new one.

This handbook will be prepared under direction of George Scoville, Stromberg-Carlson Telephone Mfg. Co., and head of NEMA Merchandising Council, and H. Curtiss Abbott, Vice-Chairman of Merchandising Council, and sales manager of Crosley Radio Company.

Two important recommendations were made by the broadcasting section. Stating that, in the present congested condition of the air, only those stations which serve the largest number of listeners should be permitted by the Radio Commission to remain on the air, the National Electrical Manufacturers' Association recommended to the commission "that greater consideration be given to those stations which broadcast programs satisfying a wide variety of interests or groups." Stations were condemned which "now act purely as house organs in selling merchandise for one firm or which exclusively broadcast programs devoted to furthering the interests of some



particular group, creed or class." This action was taken directly to condemn so-called direct-selling stations and those owned by a single political party, church or other sectarian group.

The association also strongly will urge to the Federal Radio Commission that the "Engineers' Plan" of broadcast allocation be put into immediate effect. The Engineers' Plan first proposed by an unbiased technical committee of the Institute of Radio Engineers in Washington several months ago, provides for reduction in number of stations and a maximum number of cleared channels.

During its annual meeting the Radio Division went on record as favoring the increased use of higher power by broadcasting stations. They also recommended to the Secretary of Commerce that the radio inspectors, working under the Secretary of Commerce be supplied with adequate apparatus for the accurate measurement of the carrier frequencies of broadcasting stations.

Saying that the predatory price-cutter of standard guaranteed merchandise is one of the greatest enemies of the public and manufacturer alike, representative Clyde Kelley of Pennsylvania and co-sponsor of the Capper-Kelley "Fair Trade Act" told the Radio Division of NEMA at the final session that, "The Radio business is a new and highly technical business and the public cannot know the quality of products except through identified goods which have the backing of the manufacturer for high quality at a fair price. When 'gyp' merchandise is substituted by predatory price-cutters, the public suffers. Cut-throat competition drives the independent out of business. Consolidations follow and the cycle is complete."

Representative Kelley stated that it was a widely held delusion that any contract expressed or implied between an independent manufacturer of a standard product and his distributors as to resale price is restraint of trade, a violation of the Sherman Anti-Trust Law and an injury to the public.

"The truth is," said Representative Kelley, "that such a contract tends to emancipate trade, to discourage monopoly and to benefit the public. The predatory price-cutter of standard guaranteed goods is the real offender. His unfair practices

injure the honest manufacturer, the honest dealer and the public. He is the 'gyp' business man who builds on fraud and deception. His system is to bring customers into the store through ruinous cut prices on well-known merchandise and then profit by excessive prices on unknown, unidentified goods."

Contending that this issue is the greatest involved in American business today, Representative Kelley declared that the Fair Trade Act, sponsored by himself and Senator Capper, is designed to permit the manufacturer of an identified product to contract as to its resale price. The Bill (H.R. 11) has been favorably reported by a Sub-Committee of the House and is up for consideration in the December session. The Bill is an enabling act to enforce a square deal price policy so that business can build not on a basis of jungle competition but on co-operation and confidence, both essential to the buying public.

Other addresses made at the meetings included one on television by Dr. Herbert E. Ives, of the Bell Telephone Laboratories, who said that practical television via radio is still a long way off due to the cumbersome equipment and high cost involved.

Benjamin Gross, president of Gross-Brennan, Inc., Stromberg-Carlson representatives in New York, outlined some of the ways in which manufacturers should co-operate with their dealers. Frederick P. Vose, of the National Electrical Credit Association, told of some of the credit problems confronting the radio industry, and how the N.E.C.A. is helping to solve them.

H. Curtiss Abbott, sales manager of the Crosley Radio Company, spoke on the subject of trade-ins, quoting many facts and figures from *Radio Retailing*, to substantiate his claims. Dr. Alfred N. Goldsmith, of the Radio Corporation of America, outlined the ways in which NEMA and the Institute of Radio Engineers might co-operate for the benefit of the industry.

The Radio Division has also announced the publication of "The Radio Market," which is a comprehensive study of the radio market based on statistics gathered by the Department of Commerce in co-operation with the National Electrical Manufacturers' Association. It was announced that this was the first issue of a similar study which would regularly be made.

Statistics heretofore available on radio stocks and radio sales have been largely estimates accompanied by deductions frequently drawn by statisticians not directly concerned with radio merchandising. The data offered in the "The Radio Market" are based on actual figures from the retail trade as a whole and since it is intended for the radio industry, deductions of doubtful value have been avoided. It has been prepared for the purpose of supplying each phase of the industry with facts which are readily available to those concerned in marketing a particular product. The 32-page publication, full book size was compiled under the direction of Major R. A. Klock, chairman of the NEMA statistical committee.

Copies of "The Radio Market" have been distributed to all members of NEMA and additional copies are available for non-members at a cost of \$2 each, from the association headquarters at 420 Lexington Avenue, New York City.

The results of balloting for officers of the radio division gave to Louis B. F. Raycroft, of the Electric Storage Battery Company, the vice-presidency and leadership of the radio group for another year. This is Mr. Raycroft's third term in office.

In the division dealing with trade and merchandising problems, George A. Scoville was re-elected chairman of the Merchandising Council, and H. Curtiss Abbott was chosen vice-chairman. Mr. Scoville is with the Stromberg-Carlson Company, and Mr. Abbott is general sales manager of the Crosley Radio Corporation.

In the important technical committee sections, L. W. Chubb of the Westinghouse Company was chosen chairman of the radio receiver section; George Lewis, Arcturus Radio Company, head of the vacuum tube section; H. L. Olesen, Fansteel Products Company, head of the power supply section, and Julius Weinberger, Radio Corporation of America, head of the radio transmitter section.

Huntington B. Crouse, president of the Crouse-Hinds Company, Syracuse, N. Y., was elected president of the National Electrical Manufacturers' Association at its annual meeting at Hot Springs, Virginia, the week of June 11, succeeding Gerard Swope, president of the General Electric Company, who retains membership on the Board of Governors and on the Executive Committee of the Association.

The following Vice-Presidents to head NEMA's various Divisions were also elected: Apparatus Division, N. A. Wolcott, Packard Electric Company; Appliance Division, M. C. Morrow, Westinghouse Co.; Policies Division, Clarence L. Collens, Reliance Elec. & Eng. Co.; Radio Division, Louis B. F. Raycroft, Electric Storage Battery Company; Supply Division, W. E. Sprackling, President, Tubular Woven Fabric Co., Pawtucket, R. I.

For a term of three years the following were selected to become members of the Board of Governors: H. B. Crouse, Crouse-Hinds Company, Syracuse, N. Y.; R. Edwards, Edwards & Company, Inc., New York City; A. L. Eustice, Economy Fuse & Mfg. Co., Chicago, Ill.; Otto H. Falk, Allis-Chalmers Mfg. Co., Milwaukee, Wis.; W. L. Jacoby, Kellogg Switchboard & Supply Co., Chicago; J. F. Kerlin, National Carbon Company, Cleveland, Ohio; D. H. Murphy, Wiremold Company, Hartford, Conn.; R. J. Russell, Century Electric Company, St. Louis, Mo.; Frank E. Wolcott, Frank E. Wolcott Mfg. Co., Hartford, Conn.

For a term of one year to fill an unexpired term, I. A. Bennett of the National Metal Molding Company of Pittsburgh was elected.

## Annual Shamrock Stag

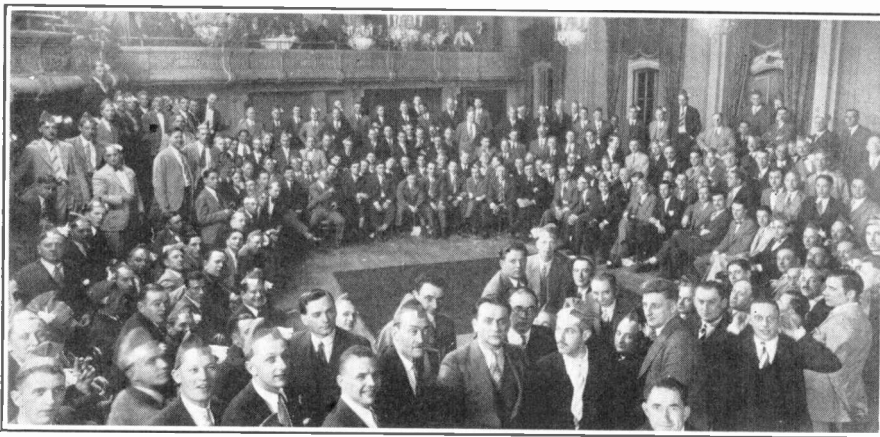

The dealers and employees of the Shamrock Manufacturing Company, Newark, N. J., recently held their annual stag party in the gold room of the Washington Restaurant in Newark. About three hundred were present. After the banquet, the guests were entertained with impromptu amateur wrestling and boxing matches and songs and dances by attractive young maidens, with Danny Sullivan acting as master of ceremonies. Herman Rose, president, introduced each member of his staff and Nate Hast, sales manager, addressed the group.

## McGraw-Hill and Shaw Companies Merge

A consolidation affecting two large publishing interests has just been brought about by the merger of the McGraw-Hill Publishing Company, Inc., of New York and A. W. Shaw Company of Chicago.

The Shaw organization publishes *The Magazine of Business, System and Industrial Distributor and Salesman*, while the McGraw-Hill organization is the publisher, either directly or through subsidiary and affiliated companies, of over twenty leading business papers, and of engineering and business books. Its magazines cover the electrical, mechanical, construction, mining, radio and chemical fields, and include such well-known papers as *Electrical World*, *Engineering News-Record*, *Power*, *American Machinist*, *Engineering & Mining Journal*, *Chemical & Metallurgical Engineering* and *Radio Retailing*. The two companies have had a close relationship since last fall when they jointly formed the McGraw-Shaw Company, which publishes *Factory and Industrial Management* and *Industrial Engineering*.

The A. W. Shaw Company will now be known as the "A. W. Shaw Company, a division of the McGraw-Hill Publishing Company, Inc." The McGraw-Shaw Company will also be operated as a division of the McGraw-Hill Publishing Company.

Two reasons for the merger are stressed by the officers of the merging companies. The magazines of the two organizations are complementary in character. The Shaw papers cover business broadly, giving the business man an understanding of what is going on in all branches of trade, industry and finance. Their service is extensive in character. The McGraw-Hill service, on the other hand, is intensive. Its magazines give a highly specialized service to given major industries and to related industrial groups. Thus the consolidated companies serve the business man in both his general and special business interests. The second reason is the very evident economy and increased effectiveness of consolidated operation, enabling a superior service to be rendered to the whole sweep of American business.

James H. McGraw, president of the McGraw-Hill Company, gave the following reasons for the merger:

"It was apparent that the McGraw-Hill group of industrial and trade papers would have a new way of carrying the message of common business problems if it was allied with papers like *The Magazine of Business and System*. At the same time these publications would be immeasurably strengthened by being tied in with and assisted by the great editorial staff of over one hundred and thirty industrial and business specialists who edit the McGraw-Hill papers. There were also conspicuous opportunities for more effective subscription and advertising work and for economies in every phase of publishing.

"The logic of these opportunities could not be escaped. The merger has been the result."

THE ALDEN MANUFACTURING COMPANY, Springfield, Mass., has moved to its new factory at Brockton, Mass. A substantial addition to the capital of the company has been made. The control, however, remains with Milton Alden, president, and there will be no change in the management. In view of this added capital and the improved manufacturing facilities, a line of electrical accessories will be made along with the radio products.

## W. R. McCanne Addresses Stromberg-Carlson Sales Group



A most successful two-day sales conference was recently held at the Stromberg-Carlson Telephone Manufacturing Company's plant at Rochester, N. Y. W. R. McCanne, president, welcomed the visiting salesmen and branch office forces, and Ray H. Manson, chief engineer, demonstrated the new line of receivers and reproducers. W. T. Eastwood, advertising manager, acted as chairman of the second morning session at which publicity, dealer co-operation and direct-by-mail literature were discussed and he was followed by George A. Scoville, sales manager, who addressed the group on servicing and merchandising the 1928-1929 line. The conference closed with a banquet at the Rochester Club.

## Industries Banquet Again Set for September

Although there has been some doubt as to whether the annual Radio Industries Banquet would be held this year, it has been finally decided to hold it as usual on Wednesday or Thursday evening during the week of the Radio World's Fair, New York City, September 17 to 22. The dinner will be participated in by a number of leading radio trade associations and will be broadcast by a large number of stations.

No speeches will be made with the exception of a ten-minute talk by some outstanding radio industry leader and the program will be confined to three hours in length. It was decided to announce the day of the banquet as "National Radio Day."

FRANK REICHMANN has joined the Joy-Kelsey Company, Chicago, where he will supervise the manufacture of a complete line of magnetic and A.C. and D.C. dynamic cone reproducers, as well as seven and eight tube radio chassis.

THE ARCTURUS RADIO COMPANY, Newark, N. J., has reduced the price of its 15 volt A.C. amplifier and power tubes to \$4.

### Correction

IN THE article entitled, "The Question—the Answer," on page 60 of the June issue, the first line of the fourth paragraph is in error. It reads, "The average price of the radio outfits installed by radio \$4,684.09 in radio, etc." The line should have read, "The average radio-music store is carrying a stock of \$4,684.09 in radio, etc."

Unless this line is read in its correct form, a correct interpretation of the paragraph cannot be made.

THE PHILADELPHIA STORAGE BATTERY COMPANY, Philadelphia, Pa., has commissioned three of its men to tour the country from coast to coast, outlining to dealers its merchandising, advertising and servicing plans. The "Three Musketeers," as they are called, are: Harry Boyd Brown, merchandising and advertising counsel; Sayre Ramsdell, sales promotion manager, and Robert F. Herr, service engineer. The itinerary of the group is:

Detroit, July 5	San Diego, Aug. 6
Indianapolis, July 6	Los Angeles, Aug. 7
St. Louis, July 9	El Paso, Aug. 10
Chicago, July 10	Dallas, Aug. 13
Minneapolis, July 11	San Antonio, Aug. 14
Des Moines, July 12	Houston, Aug. 15
Omaha, July 13	New Orleans, Aug. 16
Kansas City, July 16	Memphis, Aug. 17
Denver, July 17	Louisville, Aug. 18
Salt Lake, July 20	Cincinnati, Aug. 20
Spokane, July 23	Atlanta, Aug. 22
Seattle, July 24	Charlotte, Aug. 24
Portland, July 27	Toronto, Aug. 30
San Francisco, July 30	Montreal, Aug. 31
Sacramento, July 31	
Fresno, Aug. 2	

THE RAYTHEON MANUFACTURING COMPANY, Cambridge, Mass., has placed on the market 25,000 shares of its common stock. Application will be made to list this stock on the Chicago Stock Exchange. The audited balance sheet as of May 26, 1928, showed current assets of \$463,593.60, and current liabilities of \$85,000, and net tangible assets of \$622,333.60, including fixed assets of \$243,740, equal to \$8.30 per share of capital stock. The net earnings after all charges including Federal Income taxes were deducted, were: 1926, \$393,961.04; 1927, \$218,816.68, or an average of over \$4 per share of common stock for the two years of operation.

THE STANDARD STATISTICS COMPANY, New York City, has issued the following statement on the outlook in the radio industry:

"Reports from practically all of the principal retail markets advise that sales of radio receivers and equipment are reaching an unusually heavy volume for this season, and dealers express confidence that business will remain exceptionally active during the late summer and early fall. Several national exhibitions, featuring fall models, are scheduled during the near term, and trade is likely to be stimulated by this development. On the whole, the price sit-

uation is more stable than in many months. There is less wholesale dumping of obsolete sets, and, in consequence, buyer confidence in the market is gradually being restored. While many of the smaller concerns continue to experience difficulty in making adequate profits on operations, most of the well established, large scale companies should report satisfactory returns for the present half year."

## Two Reproducer Mfrs. Merge

A merger which combines two well-known reproducer companies has been effected. The United Radio Corporation, Rochester, N. Y., and Newcombe-Hawley, Inc., St. Charles, Ill., have joined hands under the name of the United Radio Reproducers, Inc.

While each company will retain its individual identity, the agreement just effected will give each company stronger patent, engineering and financial positions. With the United Radio Corporation licensed under Lektophone cone speaker patents, and the Newcombe-Hawley Company licensed under the Jensen electro-dynamic patents, it is now possible for each company to manufacture a complete line of speakers, according to Selden E. May, president of United, who engineered the combine.

Independent lines will be made and marketed by the two companies, each retaining its own manufacturing and sales divisions.

THE ALLEN-HOUGH MANUFACTURING COMPANY, Racine, Wis., has taken over the exclusive marketing rights in the United States and foreign countries for the "Phono-Link," an electrical pick-up device.

## Edison Enters Radio Field

As a result of arrangements recently concluded, Thomas A. Edison, Inc., Orange, N. J., and the Splitdorf Bethlehem Electrical Company, Newark, N. J., have pooled their radio patents, and manufacturing, research and laboratory facilities for the purpose of making and selling radio and electrical phonographs, reproducers and other radio equipment of a similar nature. The new line of radio sets and phonograph and radio combinations are already in production.

As a result of this agreement, Charles Edison becomes a member of the board of both the Splitdorf Bethlehem Electrical Company and its subsidiary, the Splitdorf Radio Corporation. Arthur Walsh, vice-president of Thomas A. Edison, Inc., and general manager of the division of radio and phonograph, also becomes a member of the board of the Splitdorf Radio Corporation. Edward H. Schwab is chairman of the Splitdorf Bethlehem Board, of which Charles M. Schwab is a member. Walter Rautenstrauch, president of the Splitdorf Radio Corporation, will be consulting engineer for Thomas A. Edison, Inc.

## Eisler Process Does Not Infringe G-E Patents

After many years of litigation in the courts and finally in the United States Circuit Court of Appeals, Charles Eisler has again won a victory against the General Electric Company, Schenectady, N. Y., who sued Mr. Eisler personally and his company, the Eisler Engineering Company, Newark, N. J., for infringing on one of their patents. It was ruled that Mr. Eisler's

machine for inserting wire into the glass does not infringe.

An abstract from the Judges' opinion reads, "Eisler has gone back to the old hand art and instead of discarding that art as the General Electric did, has utilized it and has simply transformed the method and means of that hand art and embodied that hand method in two separate, non-co-operating automatic machines." This is the third victory for Mr. Eisler. The first and second suits resulting in a decision that protected the Eisler patents on the tipless situation. Aside from the personal victory the decision emancipates tube and lamp manufacturers from the yoke that would otherwise bind them from carrying on their business.

## Sonatron Issues Stock

The Sonatron Tube Company, Chicago, has placed 29,000 shares of its common stock, no par value, on the market through C. L. Schmidt & Company, Inc., 39 South LaSalle Street, Chicago. Application will be made to list this stock on the Chicago Stock Exchange.

The following statement of the net earnings has been issued in connection with the floating of this issue:

	3 Mos. 1928	Year 1927	Year 1926
Profit before Special salaries of officers and Federal income Tax.....	\$106,863.80	\$123,877.51	\$89,993.40
Federal Income Tax at 13 1/2%.....	14,426.61	16,723.46	12,149.11
Profit after eliminating special salaries of officers and adjusting Federal Income Tax....	92,437.19	107,154.05	77,844.29

## H. T. Roberts Co. Merges With United Cabinet Mfrs. Corp.

A new company to handle the national sales of several well-known lines of radio furniture has been formed by the merger of the H. T. Roberts Company and the United Cabinet Manufacturers Corporation, both of Chicago. This new midwestern corporation has taken the name of the Radio Allied Manufacturers Corporation and has opened a sales office and display room at 1340 South Michigan Avenue, Chicago, where the Roberts company has been located for some time. H. T. Roberts is president; M. M. Scribner, vice-president and treasurer, and T. J. Shiltz, treasurer.

## Broadcast Radio Pictures

A program of motion pictures was broadcast from the Jenkins Laboratory, at Washington, D. C., on Monday, July 2, at 8 o'clock. The program lasted an hour and was sent through television on a wavelength of 46.7 meters, enabling amateurs in the United States and Canada to pick it up. The pictures were broadcast at the rate of fifteen a second and contained 48 lines to the picture. The performance will be repeated each Monday night.

THE KODEL RADIO CORPORATION, Cincinnati, Ohio, has changed its name to the Kodel Electric and Manufacturing Company and increased its common A stock from 55,000 to 100,000 shares.

THE UTAH RADIO PRODUCTS COMPANY, Chicago, has been licensed by the Magnavox Company, Oakland, Calif., under its electro dynamic reproducer patents.

## Radio Shows and Conventions

July 24, 25, 26 and 27: Radio Jobbers and Manufacturers' Representatives Club Trade Show, Book - Cadillac Hotel, Detroit, Mich.

August 18-25: Fifth Annual Pacific Radio Exposition, Civic Auditorium, San Francisco, Calif.

September 3-8: Sixth Annual Los Angeles Radio Show, Ambassador Auditorium, Los Angeles, Calif.

September 10-15: Second Annual Philadelphia Radio Rodeo, Commercial Museum, Philadelphia, Pa.

September 11-14: Fifth Annual Columbus Radio Show, Memorial Hall, Columbus, Ohio.

September 17-22: Fifth Radio World's Fair, New Madison Square Garden, New York City.

September 17-22: Fourth Annual Rochester Radio Show, Convention Hall, Rochester, N. Y.

September 17-22: Fourth Annual Southwest National Radio Exposition, New Coliseum, St. Louis, Mo.

September 24-29: Seventh Annual Northwest Radio and Electrical Show, Municipal Auditorium, Minneapolis, Minn.

September 24-29: Fifth Annual Montreal Radio Show, Windsor Hotel, Montreal, Canada.

September 27, 28, 29: Youngstown Third Annual Radio and Electrical Show, Rayen-Wood Auditorium, Youngstown, Ohio.

October 1-6: Eighth Annual Boston Radio-Aero Exposition, Mechanics Building, Boston, Mass.

October 1-6: Pittsburgh Radio Show, Duquesne Gardens, Pittsburgh, Pa.

October 1-6: Sixth Wisconsin Radio-Music Exposition, Milwaukee Auditorium, Milwaukee, Wis.

October 8-14: Sixth Annual Chicago Radio Show, Coliseum, Chicago, Ill.

October 15-20: Detroit Radio Show, Convention Hall, Detroit, Mich.

October 21-29: Fourth Annual New Orleans Radio Show and Exposition, New Orleans States' Building, New Orleans, La.

October 22-27: Norfolk Radio Show, City Auditorium, Norfolk, Virginia.



# News of Jobbers and Distributors

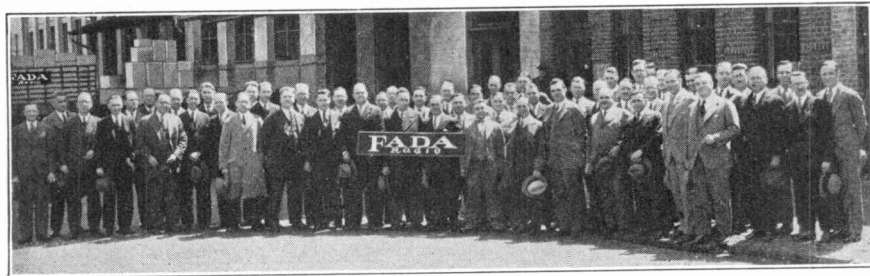

## Staff of New Fada Distributor Visits Plant

A group of sales representatives and branch managers of the Post and Lester Company, Boston, Mass., newly appointed distributor for F. A. D. Andrea, Inc., in the New England states, recently visited the Fada plant in Long Island City, N. Y. They inspected the factory thoroughly and saw radio receivers and reproducers in the various stages of manufacture. The Post and Lester Company operates eight separate units in various New England cities.

## Jobbers' Stocks Show Slight Decline

Nearly half a million radio sets were sold by one-third of the radio jobbers in the United States last year. According to figures compiled by the Electrical Equipment Division, Department of Commerce in co-operation with the Radio Division of the National Electrical Manufacturers' Association, sales of radio receiving sets by 326 American radio jobbers last year totaled 452,260 sets.

Returns from 36 per cent of the jobbers queried, placed sales of battery sets at 284,393 and of electric at 167,867. Average sale by each jobber reporting totaled 870 battery and 515 electric sets.

More A.C. sets than battery sets were sold in the Middle Atlantic states. In this group of New York, New Jersey and Pennsylvania, the average sale of jobbers reporting totaled 905 battery sets compared with 1,117 electric sets.

Although the percentage reply fell off somewhat, being 36 per cent on April 1; as against 40.5 per cent on January 1, rough comparison can still be made as to stocks on hand. The stocks in jobbers' hands of battery sets showed a decline from 50,228 on January 1, to 34,151 on April 1, while for electric sets the corresponding figures were 16,727 and 15,481, indicating on the surface a falling off but dealers stocks showed an increase.

Stocks of reproducers showed a decrease from 56,980 to 44,129. Storage battery holdings were less, being 9,988 against 15,129 on January 1, and B and C battery stocks were also lower, 45 volt batteries on the shelves of jobbers reporting totaling 95,702 as against 150,117 on January 1.

Socket power unit stocks showed a drop also, B units being 15,957 on April 1, compared to 24,897 on January 1, and A and B combined units being 7,406 as against 14,313.

As to receiving tube stocks, the A.C. variety on hand April 1 amounted to 112,666, as compared with 93,495 on January 1, whereas storage battery tube stocks were 193,993 and 394,227 respectively.

Rectifying tubes on hand remained about the same on April 1 as January 1 totaling 39,581 and 45,487 respectively.

JULIUS ANDRAE & SONS COMPANY, Milwaukee, Wis., has taken over the House of Downing, Des Moines, Iowa, radio and electrical supply dealers.

## Crosley-Amrad Distributors View New Line

Over 250 distributors from the United States and Canada recently met in Cincinnati for the sixth annual distributors' convention of the Crosley Radio Corporation, Cincinnati, Ohio, and the Amrad Corporation, Medford Hillside, Mass.

The new receivers and reproducers were demonstrated, and Powel Crosley, Jr., talked to the assembly on the plans for the coming season. One of the features of the two-day convention was the banquet and entertainment in the ballroom of the Hotel Gibson, with Mayor Seasongood of Cincinnati, as the guest of honor.

## New Sales Manual Shown at A-K Jobber Convention

The fifth annual Atwater Kent distributors' convention recently held at the Congress Hotel, Chicago, proved to be a most enthusiastic and successful pre-year get-together.

V. W. Collamore, general sales manager, presided over all the meetings; A. Atwater Kent introduced the new line; Mr. White of the Bankers Commercial Security Company, covered finance; and John McCoy, southern district manager, introduced a very complete sales manual which will be supplied to the trade within a few weeks. L. A. Charbonnier covered service and showed the delegates an elaborate binder to be used to hold all service data sent out this year, and Mr. Seacrist and Ben Stauffer exhibited the Red Lion and Pooley lines of cabinets.

M. H. Aylesworth, president of the National Broadcasting Company, was next introduced and spoke optimistically on the future of radio.

One of the outstanding addresses of the convention was that of P. A. Ware, merchandising and sales promotion manager, during which a series of charts were used covering some very interesting facts unearthed by a survey in various cities throughout the country. R. E. Smiley, assistant sales manager, gave the distributors several helpful suggestions to aid them in reaching their quota for the year.

The entertainment included theatre parties and two costume balls.

## All "Hopped Up" Over A-K



Atwater Kent wholesalers from San Francisco, St. Louis, New York and other remote parts of China, recently convened at the Congress Hotel, Chicago, for chow mein and a side order of business. One of the novelties was a Chinese costume ball. Here you see the pseudo-Orientals before the A-K joss house.

## New B-T Distributors

The Bremer-Tully Manufacturing Company, Chicago, Ill., has recently added several new wholesalers to its list. The Albany Hardware & Iron Company, Albany, N. Y., the Sprague Electric Company, Waterbury, Conn., and Renier Bros., Dubuque, Ia., will act as distributors in their respective territories.

HARDWARE AND ELECTRIC SPECIALTIES, LTD., 4 Frederick Street and 11 Henry Street, Port-of-Spain, Trinidad, British West Indies has been appointed distributor in the B. W. I. territory for the Bremer-Tully Manufacturing Company, Chicago.

Another foreign appointment by the Bremer-Tully Company, is that of the Eastern Electric and Trading Company, Bombay, India.

THE KEYSTONE RADIO CORPORATION, Pittsburgh, Pa., has been appointed distributor for the Steinite Radio Company, Chicago, in western Pennsylvania, eastern Ohio and northwestern West Virginia.

## Optimism Keynote of Schimmel Electric Supply Company Dinner



Over three hundred radio and electrical dealers attended the dinner-meeting recently given by the Schimmel Electric Supply Company, Philadelphia, Pa., at the Hotel Adelphia. The dealers came from eastern Pennsylvania, southern New Jersey and Delaware and the results of the meeting were said to be most successful. Samuel Schimmel, president, delivered an interesting talk on the responsibilities of a distributor to his dealers. Addresses were also given by Arch R. Strong of Temple, Inc., Chicago; Guy Elwell and Lester Abelson of the Steinite Company, Chicago; F. H. Breuning of the Westinghouse Acceptance Corporation, East Pittsburgh, Pa., and Mr. Gordon of the Public Ledger, Philadelphia.

## Co-operative Spirit Predominates at Sonatron Banquet



Among the sidelights of the recent radio trade show was the banquet given to distributors and dealers at the Hotel Stevens, Chicago, on June 13, by the Sonatron Tube Company, Chicago. There was an attendance of about two hundred. Nathan Chirelstein, president of the Sonatron Tube Company, Harry Chirelstein, vice-president, and Edward H. Weiss, of the Edward H. Weiss advertising agency in Chicago, addressed the group. An interesting talk was also given by Oswald F. Schuette, executive secretary of the Radio Protective Association. Following the dinner, there was a diversity of entertainment which drove the "13th" jinx away.

KNERR, INC., Harrisburg, Pa., a newly-formed organization, has been appointed Atwater Kent distributor for this section, replacing Fromar and Company. The officers are: President, C. G. Knerr; vice-president, W. G. Knerr, and secretary, G. R. Knerr. W. G. and G. R. Knerr have operated a retail store in Harrisburg for the past year, carrying the A-K line exclusively. New headquarters have been secured and made into what is said to be one of the most modern and complete radio distributing plants in central Pennsylvania.

THE JENSEN RADIO MANUFACTURING COMPANY, Oakland, Calif., has added the following jobs to its list: the K. W. Radio, New York City; The Wholesale Radio Equipment Company, New York City and Newark, N. J.; Lewis Radio Jobbers, Philadelphia; Detroit Electric Company, Detroit; Harry Alter Company, Chicago, and Benwood-Linze Company, St. Louis.

THE NEW SYSTEM TELEPHONE PTY. LTD., 280 Castlereagh Street, Sydney, Australia, has been appointed distributor throughout Australia for the Operadio Manufacturing Company, St. Charles, Ill.

THE DETROIT ELECTRIC COMPANY, Detroit, Mich., has closed a contract with the Jensen Radio Manufacturing Company, Oakland, Calif., for \$100,000 worth of dynamic reproducers. Under the agreement, the Detroit Electric Company is given distribution rights in Michigan and Ohio, as well as exclusive distribution in the lower Michigan peninsula.

THE EAGLE ELECTRIC MANUFACTURING COMPANY, Brooklyn, N. Y., with branches in San Francisco, Chicago and Boston, is publishing a house organ called the "Eagle News." There appears in the pages of this monthly, advance information regarding new Eagle numbers and items of general interest to jobbers.

THE CLEVELAND IGNITION COMPANY, Atwater Kent distributor in northern Ohio, will hereafter be known as the Cleveland Distributing Company, with new and enlarged headquarters at 5205 Euclid Avenue, Cleveland, Ohio.

DUNGAN-STERNFIELD RADIO SALES, INC., Chicago, has moved into new and larger headquarters at 1507 South Michigan Avenue.

## Freed-Eisemann Jobbers Meet at Briarcliff



Amid the unusually attractive surroundings of the Briarcliff Lodge and Casino, Briarcliff, N. Y., three groups of Freed-Eisemann distributors met for sales conferences with the executives of the company. Each group was in session two days, and business and pleasure were combined in smokers and dinners. The new line of receivers was demonstrated, and Alex Eisemann and Arthur Trostler, addressed the merchandisers. In the evening, everyone listened to a boxing contest received by one of the latest Freed-Eisemann models.

# Sylvania Policies

*Insure the Reputation of the  
"Tubes That Never Disappoint"*

## 1. *Manufacturing*

Build a complete line of standard tubes for every radio requirement—perfect each new type before announcing it to the trade—test each individual tube under rigid standards, with no deviation from this policy regardless of delivery demands.

## 2. *Selling*

Maintain uniform trade discounts and re-sale prices—provide full protection against price decline on all tubes in stock—replace returned tubes on basis of satisfaction to the customer.

## 3. *Advertising*

Influence every radio tube user with broadcasting programs—bring buyer to dealer with newspaper advertising and store display—keep the trade informed of latest developments through bulletins and trade-paper advertisements.

[ *Co-ordination of all Sylvania Policies to insure every Sylvania Dealer  
a steady, maximum profit from the "Tubes That Never Disappoint".* ]

SYLVANIA PRODUCTS COMPANY  
EMPORIUM, PENNA.

Tune in on the Sylvania Foresters' sparkling entertainment each Wednesday night at 8.30 (eastern daylight saving time) through stations WJZ, WBZ, WBZA, KDKA and KYW.

MEMBER  
RMA

# Sylvania

RADIO TUBES



# New Dealer Help Material

*Aids to greater profits provided by radio manufacturers for their dealers*

## "Not A Kick In A Million"

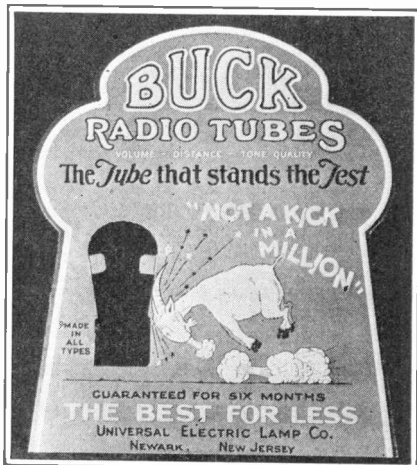

A counter card with a cut-out space for a Buck tube is being offered by the Universal Electric Lamp Company, Newark, N. J. This display stands 11 inches high, has an easel back, and is printed in green and yellow. This company is also offering a pamphlet describing in detail its full line of Buck tubes. Both will be sent to dealers without charge.

THE AMERICAN MECHANICAL LABORATORIES, 285 North Sixth Street, Brooklyn, N. Y., have issued a booklet containing a collection of practical radio circuit data under the title of "The Gateway to Better Radio." This 32-page booklet is generously illustrated and features receiving circuits, and socket power operation, including the making of B-power, A-power and C-power units, as well as amplifiers. The charge for this manual is 25 cents.

THE CHAMPION RADIO MANUFACTURING COMPANY, Danvers, Mass., has available a 24-page, pocket-size booklet on radio tube reception, describing and illustrating each of its tubes and containing some general information on tube construction and operation. This company also offers four-page tube catalogue sheets. Both will be sent without charge.

THE TOBE DEUTSCHMANN COMPANY, 11 Windsor Street, Cambridge, Mass., still has a supply of large-size business calendars for its dealers who have not as yet received one. These calendars carry this company's characteristic "Uniform—They Stand Up" illustration at the top.

THE SLAGLE RADIO COMPANY, Fort Wayne, Ind., is offering free to its dealers a heavy cardboard counter standard finished so as to give the effect of a bronze sign. It is 4 inches by 12 inches and carries the words, "Slagle Radio."

THE CRESCENT BRAID COMPANY, INC., Providence, R. I., has available a counter standard illustrating the convenience of its twenty-foot extension cord in moving a reproducer to the different parts of the room. Sent free to dealers.

THE RADIO CORPORATION OF AMERICA, 233 Broadway, New York City, is supplying to its dealers a four-page pamphlet illustrating and describing in full the new De Luxe Speaker 105. This folder can be obtained direct from headquarters at the rate of fifty cents per hundred, without imprint, or, seventy-five cents per hundred imprinted with the dealer's name and address.

THE BREMER-TULLY MANUFACTURING COMPANY, 656 Washington Boulevard, Chicago, Ill., is offering its dealers a metal sign, 20 inches by 50 inches, carrying the words "Bremer-Tully Counterphase Radio." The letters are red, outlined in black on a yellow background and the sign makes an ideal display for either outdoor or indoor use. It may also be used on the delivery truck. Free upon request.

THE SONATRON TUBE COMPANY, Newark, N. J., has available an envelope stuffer describing and illustrating its line of A. C. tubes. The leaflet also contains a radio-frequency circuit showing the use of the tubes in a typical circuit. There is space on the back for the dealer's business card. Free upon request.

F. A. D. ANDREA, INC., Long Island City, N. Y., offers its dealers several new window streamers and two posters on its A.C. receivers. The posters are designed for the Fada metal-frame holder. Free upon request.

THE KOLSTER RADIO CORPORATION, Newark, N. J., is furnishing window posters each week giving the current program for the Kolster Hour. Free to dealers.

## Display Carton



The Dubilier Condenser Corporation, 4377 Bronx Boulevard, New York City, is merchandising its light-socket aerials in the illustrated display carton as a sales aid to its dealers.

ELECTRAD, INC., 173 Varick Street, New York City, has just released a 31-page booklet entitled, "What B-eliminator Shall I Build?" giving instructions on the use of variable wire-wound resistances in several types of power supply units. Nine different circuit diagrams are shown, including several well-known makes, together with the arrangement of parts for each. Free upon request.

## Cut-Out With Stage Effect

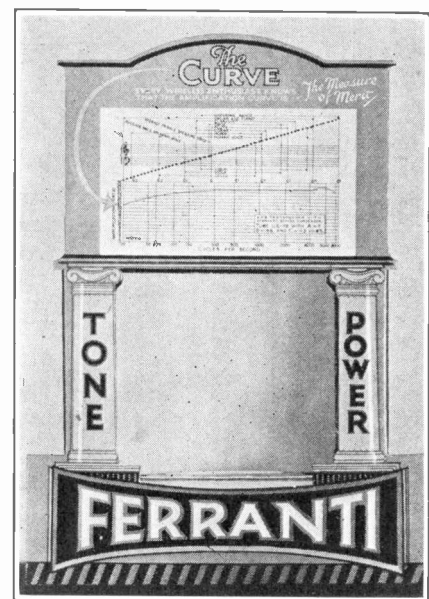

This counter or window cut-out is offered by Ferranti, Inc., 130 West 42nd Street, New York City, for displaying Ferranti transformers. It is made of heavy cardboard and so constructed that, when folded, it forms a stage, upon which is placed the transformer. A graph at the top shows the amplification curve of the instrument. The cut-out is printed in red, black and yellow and stands 12 inches high. Sent to dealers upon request.

THE FREED-EISEMANN RADIO CORPORATION, Junius Street and Liberty Avenue, Brooklyn, N. Y., has compiled a group of twenty-five letters complimentary to the new NR-60, electric receiver, and bound them together in the form of a booklet, size 8 inches by 11 inches. They will be supplied without charge.

THE AMERICAN MECHANICAL LABORATORIES, 285 North Sixth Street, Brooklyn, New York, has just issued a folder entitled "Radio Etiquette," which tells in picture and printed form how the usual radio set may be controlled as regards volume and tone. This booklet will be sent free upon request.

THE DIAMOND ELECTRIC CORPORATION, Newark, N. J., offers its dealers a supply of material for complete window displays. This material includes dummy cartons, which are exact replicas of B and C batteries, several easel-back counter cards and window streamers. Free to dealers.

# The Newest Creation in Radio Cabinet Design

*"The Popular Hit of the Chicago Show"*



*The Caswell-Runyan Company*

HUNTINGTON, INDIANA

*"Consoles with Personality"*

**Console Number 25**

**List Price \$112**

Beauty of design and finish—spacious stationary compartments and drawers—make this Radio Console most desirable, and its dual use adds an economy feature unexpected in a console of such superb design. Furnished with installation panels for any standard set.

**Sold direct to Jobbers**

Photos

Descriptions

Prices

of this and other Caswell-Runyan Consoles, Tables and Cabinets will gladly be sent you on request. Write for our booklet showing the entire 1928-1929 line of new "consoles with personality."

*The Caswell-Runyan Company*

HUNTINGTON,

INDIANA



## Please Note -

The wise dealer, in selecting his radio lines for this season, will choose the instruments that are Thordarson equipped. - The manufacturer who is far-sighted enough to specify "Thordarson" may invariably be depended upon to have the balance of his design in keeping with this high standard of performance. -

C. H. T.



# MERCHANDISING RADIO PARTS



A Section of *Radio Retailing*

July, 1928

## *Radio Pictures*

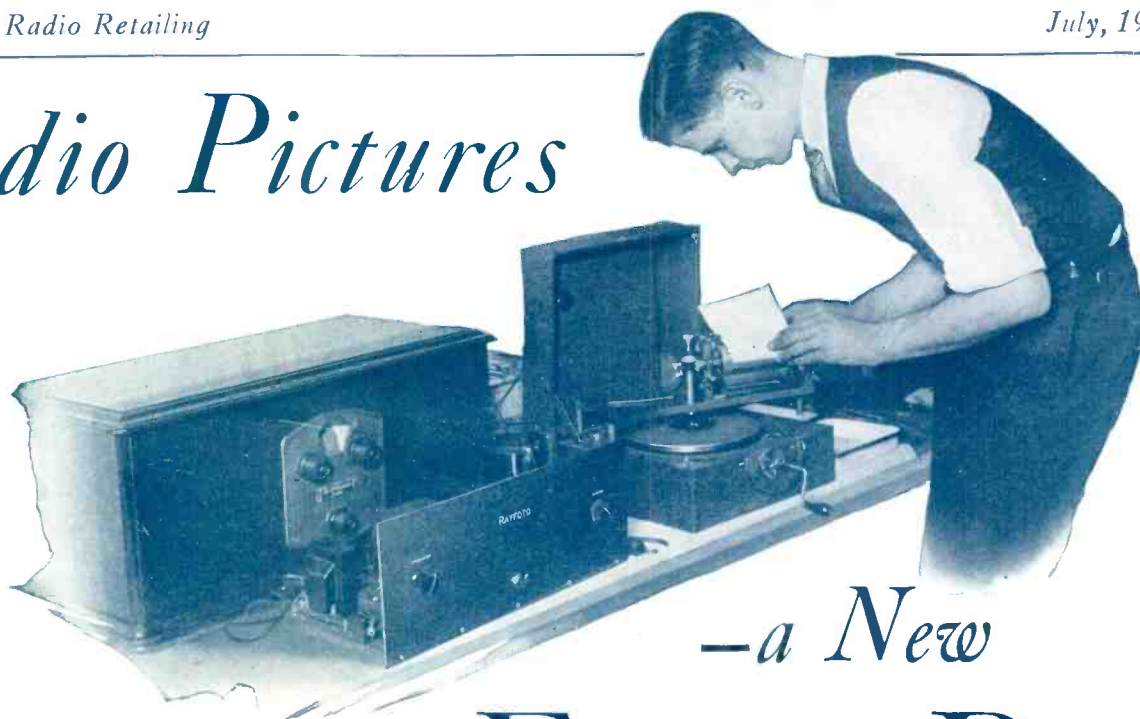

## *—a New Field for Parts*

**T**ELEPHOTOGRAPHY, or the transmission of still pictures, appears to have become established overnight. At this writing several stations throughout the United States are already maintaining regular schedules for broadcasting still picture impulses in addition to their aural programs, and others are taking up this feature every week.

Stations WMCA and WOKO, New York, are broadcasting this feature four times a week, station WTMJ, Milwaukee, nightly; while station KMDX is furnishing St. Louis with regular programs, and station WFI will be broadcasting for Philadelphia fans by the time this issue comes off the press. The activities on the part of these stations are rapidly creating an interest and a demand for apparatus that will receive still pictures.

Several manufacturers are working on various still-picture and television recorders to be merchandised in the form of kits and assembled by the fan.

One concern that is now manufacturing a still-picture recording outfit is providing an excellent opportunity for all parts dealers to take hold of this new broadcasting feature, in that this concern sells only the skeleton kit, consisting of those parts which are not available on the market. This means that the parts dealers must supply the other radio parts necessary to complete the picture recording attachment.

A glance at the circuit diagram of this recorder shows a large number of parts required for it which the average dealer carries in stock. Of the parts indicated in the circuit only the high-frequency corona coil (N, N<sup>1</sup>), the synchronizing relay (X), the corona modulation transformer (T 3), and the synchronizing filter transformer (T1), are included in the kit. All other radio instruments in the circuit are standard parts which are stocked by the average dealer. They are as follows:

- 1 200,000 ohm potentiometer—(R<sup>1</sup>)
- 1 500,000 ohm variable resistor—(R<sup>2</sup>)
- 1 Audio transformer—(T<sup>2</sup>)
- 3 Filament ballast resistances—(F<sup>1</sup>, F<sup>2</sup>, F<sup>3</sup>)
- 3 Sockets—(S<sup>1</sup>, S<sup>2</sup>, S<sup>3</sup>)
- 2 '01-A tubes
- 1 '12-A tube
- 1 Filament switch—(SW)
- 1 85 M. H. radio-frequency choke coil—(R.F.C.)
- 1 .0005 mfd. fixed condenser, with grid leak mounting—(C<sup>0</sup>)
- 1 .002 mfd. condenser—(C<sup>1</sup>)
- 1 .003 mfd. condenser—(C<sup>2</sup>)
- 1 .004 mfd. condenser—(C<sup>3</sup>)
- 1 1 mfd. condenser—(C<sup>4</sup>)
- 1 .002 mfd. condenser—(C<sup>5</sup>)
- 1 10,000 ohm grid leak—(R<sup>3</sup>)
- 1 0.0005 mfd. variable condenser—(VC<sup>1</sup>)
- 13 Binding posts and binding post strip

In addition to these parts and other set-building accessories such as panels, base-boards, cabinets and other things usual for building sets, another line is open to the

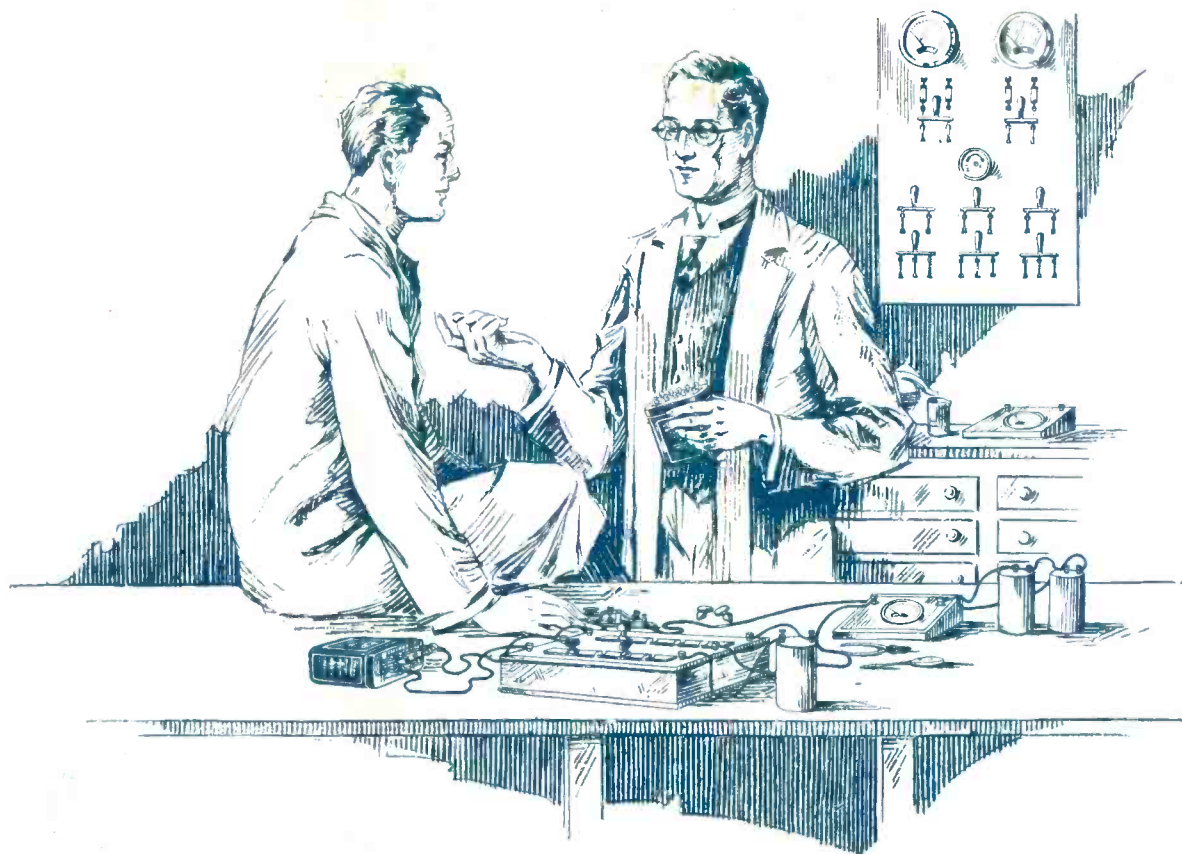

## And by Laboratory Test

In leading electrical laboratories from coast to coast Faradon Capacitors have proven their reliability. Their long life and dependability have won for Faradon acceptance by the quality radio manufacturers.

Be sure that the sets, kits and replacement parts you stock are Faradon or Faradon equipped.

WIRELESS SPECIALTY APPARATUS CO.  
Jamaica Plain, Boston, Mass., U. S. A.  
Established 1907

# Faradon

---

**Electrostatic Condensers for All Purposes**

---







Faithfully reproducing every note in the register — from the lowest to the highest — with all the accidentals. Any instrument — any volume.



## COILS for the NEW Dynamic Speakers

Again Dudlo keeps pace with Radio development in meeting the demand for special coils required by this latest trend in speakers.

All would to give that wonderful charity of tone characteristic of Dynamic type units.

Transformer Coils—Field Coils—Choke Coils

Superior insulation of Dudlo wire, highly skilled operators on the winding machines, trained engineers who are coil specialists, tremendous stocks and facilities—all contribute to make this the industry's headquarters for these new coils.

# DUDLO

DUDLO MANUFACTURING COMPANY, FORT WAYNE, INDIANA

56 EARL ST. NEWARK, N. J.    160 N. LA SALLE ST. CHICAGO, ILL.    Division of THE GENERAL CABLE CORPORATION    274 BRANNAN ST. SAN FRANCISCO, CAL.    4143 BINGHAM AVE. ST. LOUIS, MO.





**SPECIAL MENTION**

Stuyvesant Electric Co., New York, moved up from 15th place in May to 6th place in June.  
Hudson-Ross, Inc., Chicago, moved into 3rd place.

**—ARE YOU ON THE MAP?**

—IF SO, note your standing according to number compared with others in the distribution of

**TRAV-LE-R Portable Radio Receivers**

(They sell the year round)

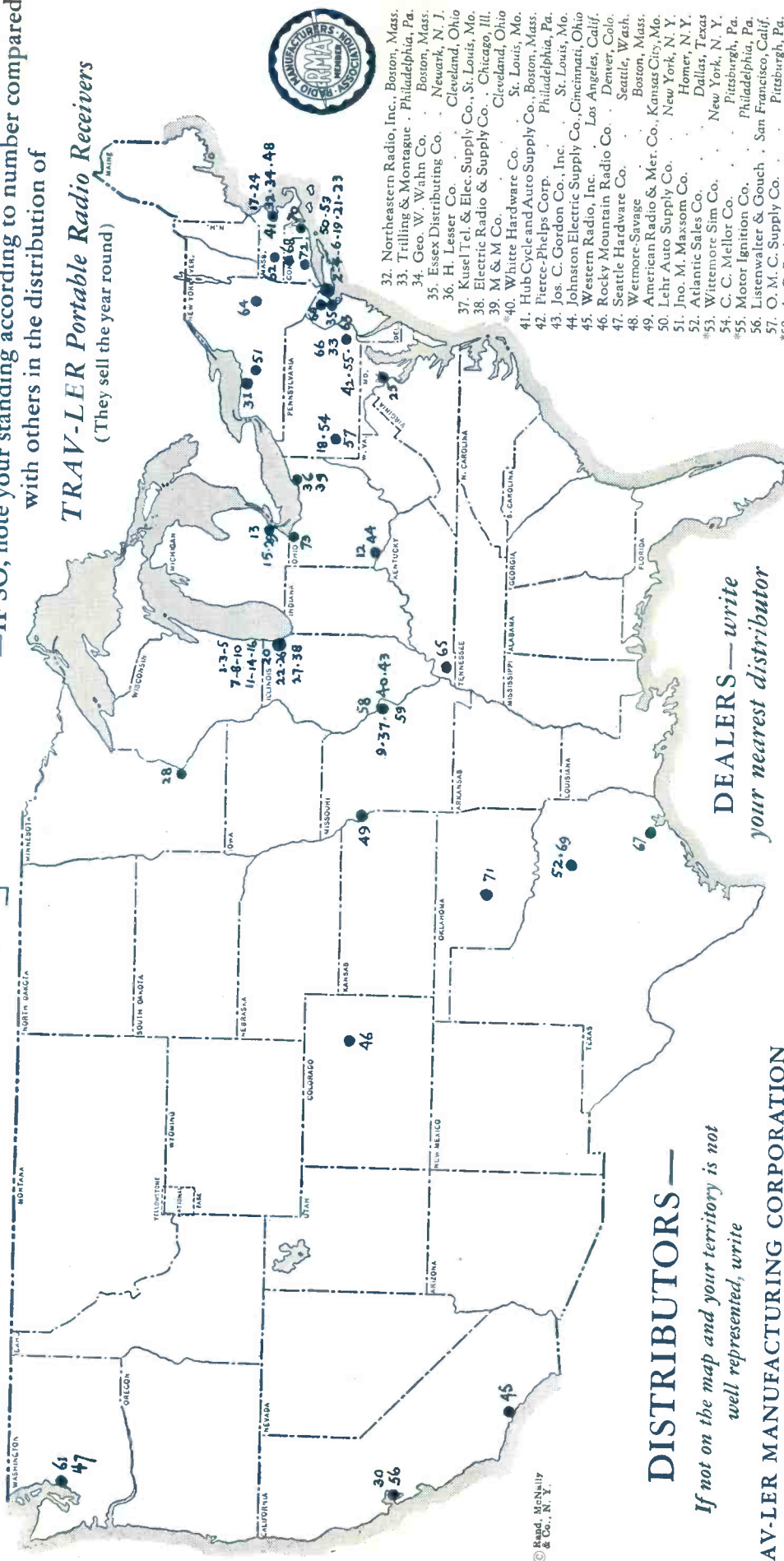

**DISTRIBUTORS —**

*If not on the map and your territory is not well represented, write*

**TRAV-LE-R MANUFACTURING CORPORATION**  
3401 North Halsted Street, Chicago, Illinois · Manufacturers of



ONE-MAN PORTABLE RADIO"

**LIST only \$ 57.50 East of the Rockies. \$ 60.00 West**

**DEALERS — write**  
*your nearest distributor*

1. Lyon & Healy Chicago, Ill.
2. Specialty Service Corp. Brooklyn, N. Y.
3. Hudson-Ross, Inc. Chicago, Ill.
4. Auto Hardware & Equip. Co., New York, N. Y.
5. Triangle Electric Co. Chicago, Ill.
6. Stuyvesant Electric Co. New York, N. Y.
7. Young, Lorish & Richardson Chicago, Ill.
8. Beckley-Ralston Co. Chicago, Ill.
9. Van Ashe Radio Co. St. Louis, Mo.
10. Telephone Maintenance Co. Chicago, Ill.
11. Western Radio Chicago, Ill.
12. C & D Auto Supply Co. Cincinnati, Ohio
13. Beckley-Ralston Co. Detroit, Mich.
14. National Radio Chicago, Ill.
15. Detroit Electric Co. Detroit, Mich.
16. Harry Alter Co. Chicago, Ill.
17. F. D. Pitts Co. Boston, Mass.
18. Beckley-Ralston Co. Pittsburgh, Pa.
19. R. H. McMann Co., Inc. New York, N. Y.
20. Wakem & McLaughlin Co. Chicago, Ill.
21. Triangle Radio Supply Co. New York, N. Y.
22. Chicago Auto Equipment Co., Chicago, Ill.
23. Mackenzie Radio Corp. Chicago, Ill.
24. Milhender Electric Supply Co., New York, N. Y.
25. Robert C. Rogers Co. Washington, D. C.
26. Manhattan Electric Co. Chicago, Ill.
27. New England Mills Co. Chicago, Ill.
28. Kern-O'Neill Co. Minnetonka, Minn.
29. Automobile Equipment Co. Detroit, Mich.
30. Coast Radio Supply Co., San Francisco, Calif.
31. J. Lawrence Hill Co. Rochester, N. Y.
32. Northeastern Radio, Inc. Boston, Mass.
33. Trilling & Montague Philadelphia, Pa.
34. Geo. W. Wahn Co. Boston, Mass.
35. Essex Distributing Co. Newark, N. J.
36. H. Lesser Co. Cleveland, Ohio
37. Kussel Tel. & Elec. Supply Co., St. Louis, Mo.
38. Electric Radio & Supply Co., Chicago, Ill.
39. M & M Co. Cleveland, Ohio
40. Whitte Hardware Co. St. Louis, Mo.
41. Hub Cycle and Auto Supply Co., Boston, Mass.
42. Pierce-Phelps Corp. Philadelphia, Pa.
43. Jos. C. Gordon Co., Inc. St. Louis, Mo.
44. Johnston Electric Supply Co., Cincinnati, Ohio
45. Western Radio, Inc. Los Angeles, Calif.
46. Rocky Mountain Radio Co. Denver, Colo.
47. Seattle Hardware Co. Seattle, Wash.
48. Wetmore-Savage Boston, Mass.
49. American Radio & Mer. Co., Kansas City, Mo.
50. Lehr Auto Supply Co. New York, N. Y.
51. Ino. M. Maxson Co. Homer, N. Y.
52. Atlantic Sales Co. Dallas, Texas
53. Wittmore Sim Co. New York, N. Y.
54. C. C. Mellor Co. Pittsburgh, Pa.
55. Motor Ignition Co. Philadelphia, Pa.
56. Listenwalter & Gouch San Francisco, Calif.
57. O. M. C. Supply Co. Pittsburgh, Pa.
58. A. C. Radio Co. St. Louis, Mo.
59. Campbell Iron Co. St. Louis, Mo.
60. Federal Radio & Electric Co., Paterson, N. J.
61. L. C. Werner Co. Seattle, Wash.
62. Tarbell-Watters Co. Springfield, Mass.
63. Keystone Radio Philadelphia, Pa.
64. Cortner Radio Corp. Schenectady, N. Y.
65. Clayton-Hughes Memphis, Tenn.
66. Radio Parts Co. Philadelphia, Pa.
67. Star Elec. & Engineering Co., Houston, Texas
68. Crown Light Co. Hartford, Conn.
69. Ferris-Simpson Co. Dallas, Texas
70. Waite Auto Supply Co. Providence, R. I.
71. Southern Sales Co. Oklahoma City, Okla.
72. H. M. Tower Corp. New Haven, Conn.
73. T. M. Cook Co. Toledo, Ohio.

\* NEW DISTRIBUTORS



# MANUFACTURERS and MARKETS

*Devoted to the Problems  
of the Manufacturer in  
the Design and Distribu-  
tion of Radio Apparatus*

A Section of *Radio Retailing*

July, 1928

## *Is LATIN AMERICA a Market for our A. C. Equipment?*

By JOHN F. RIDER

WHEN summer sales are mentioned to the radio receiver and parts manufacturers in the United States, all eyes turn towards the Latin American countries, such as South America, Central America and the West Indies. Because of the reversed seasons in North and South America, the peoples of the Latin American countries are buyers of radio products during our summer slump. South America as a unit, because of its response, has been considered a radio market, pregnant with tremendous possibilities. Some of these possibilities have been realized, as practically every reputable radio manufacturer of parts or receivers in this country is exporting a certain amount of his annual output.

The development of A.C. receivers and A.C. equipment in the United States, has however, introduced a new phase to the export business. Are the Latin Americas markets for A.C. receivers?

The past season demonstrated conclusively, that D.C. receivers are considered obsolete in this country, that only A.C. receivers can find a market. The result is self-evident. All receivers utilizing batteries have been recalled and redesigned for A.C. operation. All our manufacturing utilities are being utilized for the construction of radio equipment designed to operate directly from the alternating current house supply. Observation among some export men brings forth the fact that this change in our receiver design hinders the receiver export business, because the power supply systems in the Latin American countries appear to be in a chaotic state.

WHAT is to be done? . . . Must the radio manufacturer of A.C. radio equipment again manufacture D.C. units for export sale or must he forget his possible summer outlet because it is said that South and Central America are not yet prepared for A.C. receivers. A study of the power situation in our sister continent of the Western Hemisphere seems to indicate that the chaotic state is not as bad as it is imagined to be, that with judicious co-operation, A.C. receivers and equipment can find a ready market in Latin America. It may be necessary to design some new

accessories to be used in conjunction with the present A.C. electric receiver, but these specialties are by no means intricate or expensive.

As a concrete example, let us consider any one of the successful A.C. receivers, scientifically designed, equal in efficiency to some of the battery-operated receiver installations which have been exported during the past two or three years. Let us now go down to South America and examine the power available in the home and for use with radio equipment.

IN ARGENTINE, for example, in the city of Buenos Aires, we have both D.C. and A.C., the D.C. being supplied by one organization and the A.C. by another. This state is very similar to that existing in New York City. Here, too, we have both D.C. and A.C. With respect to the A.C. supply in Buenos Aires, we find that the frequency is 50 cycles. This frequency value is quite in accordance with the design of our A.C. equipment since our power transformers are usually designed to operate over a band of line frequencies, that is, from 25 to 40 and from 50 to 133 cycles, hence the frequency consideration does not introduce any complications. With respect to the voltage, however, we find that their supply is 225 volts instead of 110, available both in single-phase and three-phase supply.

As far as the phase of the supply is concerned, it is immaterial to the owner of the socket power receiver, he knows nothing about it and cares less. The use of 225 volts, however, introduces the need for voltage reduction but this problem is by no means difficult. The probability that the consumer's voltage supply in Buenos Aires will ever be reduced to 110 volts in order that he have correct supply for our A.C. receivers, is very remote, since the alterations necessary to effect this change in the power equipment of a city involves tremendous expense. For our radio receiver manufacturers to curtail the export of A.C. receivers until this change in power supply is effected, would certainly not be a business-like proceeding. We have to contend with a certain state of affairs and we might just as well settle down to the overcoming of this obstacle. As every engineer will

admit, the reduction of 225 volts to the 110 volts necessary for our receivers, is not a tremendous impediment. All that is required is a variable resistance of the proper ohmic value and wattage capacity. This offers the possibility of the sale of variable power resistances.

If two individual sales are undesirable, the receiver manufacturer can incorporate with his receiver the proper voltage reducing resistance. As far as frequency and voltage fluctuations are concerned, there is no real reason why this factor should be any greater than it is in this country, inasmuch as our power equipment manufacturers are supplying and installing the major of the power and lighting supplies in Latin America. Consequently, the equipment is of American design and possessed of American characteristics.

Passing through Argentina and visiting the various cities, we find that the lighting systems wherever A.C. is available, are usually of 220 volts and 50 cycles. This is found in Bahia Blanca, La Plata, Mendoza and other cities. Cordoba alone is equipped for 60-cycle, 115-volt supply. The difficulties in Argentina do not appear to be so great.

IN BRAZIL, we encounter more complications. Rio de Janeiro is equipped with both A.C. and D.C., the consumer lighting supply being both 125-volts D.C., and 125-volts, 50-cycle, A.C. In Para, we find 120 and 240 volts A.C. at 50 cycles, the 120 volts being the lighting supply and the 240 volts being the power supply. In Bahia the lighting equipment supplied is 220-volt, 50 to 60 cycles, A.C. In Santos, the lighting supply is available at 105 and 210 volts and 60 cycles.

In Bogota, Colombia, the lighting equipment voltage available for A.C. receivers is 60-cycle, 150 volts. The major portion of Chili is still D.C., although one or two cities are equipped with 220-volt A.C. supply at from 50 to 60 cycles. In Quito, the capital of Ecuador, the lighting supply is 110 and 220 volts at 60 cycles. In Lima and Calao, Peru, the consumer voltage for lighting equipment is 110 and 220 volts at 60 cycles. In Venezuela, the large cities furnish 110 and 220 at 50 and 60 cycles.

Judging from the above figure, South America is not in such chaotic state. If one studies compilations of the voltages available in every large city and the list includes the voltages at various substations, the method of transmission, the voltages available for the traction systems and heavy power machinery, the list appears complicated indeed, but if we select the values of interest to ourselves, as for example, the utilization of A.C. equipment including receivers, eliminators, etc., and compare these values as available in the various commer-



# ANNOUNCING



A  
New  
Electrad  
Money  
Maker!

## TRUVOLT DIVIDER

Reg. U. S. Pat. Off. (Patents Pending)

A Universal Voltage  
Separator

And Now Electrad's latest triumph—the Truvolt Divider! A product eagerly Awaited by Eliminator Builders, Experimenters and Dyed-in-the-Wool Radio Fans.

The new Truvolt Divider is a complete unit of wire-wound resistances so arranged with variable taps that proper voltages can be obtained with any set and eliminator combination.

By dividing the filter voltage into usable values, it eliminates all necessity of mathematical calculations in constructing a power pack. It does away with a great deal of wiring and the need of voltage regulator tubes. It makes it possible to build a power supply device which is universal in its application.

The Truvolt Divider provides the missing link in power plant construction and any power pack can be built around it. It is designed to take care of any desirable load with a generous factor of safety.

Made with genuine bakelite, it will add a smart appearance to any unit.

Five potentiometer type control knobs show values on a scale of high visibility. Can be mounted on baseboard or sub-panel, or used as the front panel on a metal cabinet, at the same time providing binding posts for all B and C voltages.

List Price \$12.50

TEAR OUT AND MAIL COUPON

Electrad, Inc., Dept. KA-7, 175 Varick St.,  
New York.

Gentlemen:  
Please send me FREE booklet which gives full description and information on the Electrad Truvolt Divider.

Name .....  
Address .....

# ELECTRAD

# FROST-RADIO

NOW OFFERS A COMPLETE LINE  
FOR THE SET BUILDER

FROST always has led the parts field in quality and production. Now it is again first with a COMPLETE LINE of parts—everything the set builder needs. Recent additions to the line include the following:

- Variable Resistance with A.C. Switch
- Approved A.C. Snap Switch
- Gem Hum Balancer
- Center Tapped Resistances
- Panel Brackets and Hook-up Wire
- Universal Resistance Kit
- Filter and By-Pass Condensers
- "B" Blocks
- Moulded Mica Condensers
- All-Bakelite Cable Plug
- Convenience Wall Outlets

Our new catalog of all these new Frost Parts, illustrating and describing our entire line, will be mailed on receipt of coupon. Write for this 16-page book today.

HERBERT H. FROST, INC.  
Main Offices and Factory, ELKHART, IND.

HERBERT H. FROST, INC., ELKHART, IND.

Send me your new Catalog of all Frost-Radio Parts, including the new items listed in Radio Retailing.

Name .....  
Address .....  
City ..... State .....

# CONDENSERS

for the Manufacturer

WE ARE equipped to produce in quantities, any type of paper condenser or any combination of capacities, for any working voltage up to 1,250 volts D.C.

We will be pleased to quote prices upon receipt of blue prints of your requirements.



2317 Calumet Avenue



## A. C. VOLTMETER

In the Jewell Pattern No. 77 the dealer is provided with an instrument that is very flexible in its adaptation to the problems arising with the increased use of A.C. radio sets and applied equipment. It enables checking filament and line voltages and all A.C. equipment and charging devices.



Pattern No. 77

It is one of the best additions that can be made to complete any service man's kit of service equipment.

Write for descriptive circular No. 1145.

Jewell Electrical Instrument Co., 1650 Walnut St., Chicago  
"28 Years Making Good Instruments"



cial centers, they do not appear so complex. We see a market for A.C. receivers and B-power units. Perhaps these markets are to be found only in the large cities, but they are there nevertheless.

**CENTRAL AMERICA**, particularly Mexico, approximates very closely the conditions existing in our own United States. Five large centers in Mexico are equipped with 60 cycle supply. Vera Cruz furnishes 127 volts, Tampico 125, Puebla 152, Orizaba 127, Monterey 110 and 220, Mexico City, Guadalajara and Morelia furnish 115 to 125 and 220 at 50 cycles. Guadalajara is changing its supply from 50 to 60 cycles. Panama City and Colon in Panama supply 110 and 220 at 60 cycles. In all of these instances, 220 is usually the power supply and 110 to 125 is usually the lighting supply. In the capital of Honduras, the lighting supply is 110 volts and 60 cycles.

The major cities in Guatamala supply 110 volts at 60 cycles. The same is true of San Jose, Costa Rica. Belize, the capital of British Honduras, is still equipped with 225 volt D.C. supply. San Salvador furnishes 110 and 220 volts at 60 cycles. The latter voltage doubtless being for power equipment. As in South America or even perhaps more so, the lighting equipment furnished and installed is usually of our own manufacture, that is, made by power supply manufacturers in the United States. As such, the equipment is very akin to that utilized here in our own country.

In the West Indies, we find a situation resembling our own. Bermuda supplies 110 volts at 60 cycles. Kingston, Jamaica is furnished with 110 volts at 40 cycles. Havana, Cuba with 115 volts and 60 cycles. Cernaquey, Cuba is equipped with 110 volts at 60 cycles. Cienfuegos and Cardenas, Cuba still supply D.C. at 120 and 240 although the latter is also equipped with A.C. Santiago and Santo Domingo in the Dominican Republic, furnish 110 and 220 at 60 cycles.

**T**HIS concludes the probable Latin American markets and one cannot deny that these countries are markets for our A.C. equipment. The situation is not as bad as many imagine. We must remember that these A.C. installations are modern. The cities mentioned in this text are all modern, in many instances, much more so than our own American cities. A.C. equipment furnishes convenience, and convenience is one of the most important factors in the existence of the Latin American. Many of our American manufacturers are entertaining the fallacious opinion that the Latin American is a slow moving, slow thinking individual; that the Latin American countries are purchasers of obsolete equipment. The sooner this opinion is corrected, the better for our manufacturers. Latin America as a unit, is open for immediate exploitation of our A.C. equipment.

With respect to the 110 and 220 volt A.C. supply mentioned as available in some of the cities, the 110 is invariably for the lighting system and 220 for small power work. This is very similar to the status in our own country. With respect to the frequency of the available supply, we do not find more variation in all Latin America than exists in our own United States. An analysis of the frequency of the line supply in the countries mentioned herein, shows use of 40, 50, 60 and 100, the last mentioned only in one instance. In United States we find 25, 40, 50, 60 and 130 cycle supplies. If these five do not offer any complications, there is no reason why the preceding four should involve any com-

plexities. It is true that international standardization of line voltages and frequencies would be of vital importance and effect tremendous advantages, but since it is not available, we must be content with what we have, particularly if the existing conditions do not offer any values.

## Trade Marks Relating to Radio Apparatus and Supplies

The following is a report of trade marks passed by the United States Patent Office during the past month for early registration unless opposition is entered by some other claimant to the trade mark within a limited time. In other words, any person who feels that his business would be injured by the registration of any of these trade marks may oppose it or seek its cancellation.

The editors of *Radio Retailing* have arranged with Lester L. Sargent, patent attorney, of 1115 K St., Washington, D. C., by whom this report is furnished, to make an advance search without charge on any trade mark any reader may contemplate adopting or registering by communicating either with the editors of *Radio Retailing* or directly with the attorney.

April 17, 1928

"Powerohm" for electrical resistance devices such as used in radio apparatus. Use claimed since April 1, 1927. International Resistance Company, Philadelphia, Pa. Serial No. 253,150, filed Aug. 6, 1927.

"B-D" (in monogram form) for radio receiving set and radio receiver construction kits and parts thereof, namely condensers, antenna coils, radio frequency transformers, dials, panels and foundation units. Use claimed since Aug. 17, 1927. Browning-Drake Corporation, Cambridge, Mass. Serial Number 254,790, filed Sept. 16, 1927.

"Universal" (written over the design of a heart printed in red) for socket power units for use with radio receiving sets. Use claimed since Aug. 1, 1925. Universal Battery Co., Chicago, Ill. Serial No. 256,754, filed Oct. 28, 1927.

"Champion Battery Clamp" (with picture of same enclosed within an ellipse, the words "Champion Battery Clamp" being in red and the ellipse colored blue) for storage battery clamps. Use claimed since Aug. 15, 1927. Taylor Bros. Mfg. Co., Los Angeles, Calif. Serial No. 258,890, filed Dec. 13, 1927.

"Penn Batteries" (enclosed within circles) for storage batteries. Use claimed since Oct. 15, 1927. Penn Battery Co., Lock Haven, Pa. Serial No. 260,463, filed Jan. 21, 1928.

"Kathanode" for storage batteries and parts thereof. Use claimed since Aug. 24, 1927. Gould Storage Battery Co., Depew, N. Y. Serial No. 261,876, filed Feb. 18, 1928.

April 24, 1928.

"Majestic" for radio receiving sets. Use claimed since Nov. 8, 1927. Grigsby-Grunow-Hinds Co., Chicago, Ill. Serial No. 258,688, filed Dec. 9, 1927.

"Remax" for electric batteries. Use claimed since Aug. 26, 1927. Bright Star Battery Co., Hoboken, N. J., doing business as Unedit Battery Co., New York, N. Y. Serial No. 260,552, filed Jan. 24, 1928.

"Air-Chrome" for radio reproducers. Use claimed since Sept. 15, 1927. Air-Chrome Studios, Inc., Irvington, N. J. Serial No. 261,855, filed Feb. 18, 1928.

"Red-Bar" (with picture of a bar shown in red on a round label) for storage batteries. Use claimed since Dec. 27, 1927. Red-Bar Battery Co., Dayton, Ohio. Serial No. 261,588, filed Feb. 11, 1928.

"Braidite" for insulated copper wire. Claims use since May 1, 1927. Cornish Wire Co., Inc., New York. Serial No. 262,598, filed March 5, 1928.

May 8, 1928.

"Pilot-Lite" for vernier dials and illuminating dials, particularly dials used in radio receiving apparatus. Use claimed since Nov. 17, 1926. The Pilot Elec. Mfg. Co., Inc., Brooklyn, N. Y. Serial No. 246,118, filed March 21, 1927.

"Chesterfield" for radio vacuum tubes. Use claimed since Aug. 1, 1927. Diana Radio Tube Corp., New York, N. Y. Serial No. 255,057, filed Sept. 22, 1927.

"Splitdorf" (arranged over five lines resembling a staff of music) for radio receiving sets, reproducers, condensers, ear phones, tuning coils, radio "pick-ups" for attachment to phonographs, "pick-ups" adapters, and "pick-up" volume controls since Sept. 22, 1927; and on radio tubes since Aug. 15, 1927. Serial No. 257,710, filed Nov. 17, 1927.

"SYD" for batteries. Use claimed since Aug. 1, 1924. Syd Radio Storage "B" Battery Co., Chicago, Ill. Serial No. 259,085, filed Dec. 17, 1927.

"Crosley" (with zigzag line extending through the word) for battery-operated radio receiving sets, A. C. operated receiving sets, A. C. power connectors (battery eliminators, reproducers and electrically operated reproducers for use with phonographs and parts thereof. Claims use since July 15, 1922. Crosley Radio Corp., Cincinnati, Ohio. Serial No. 260,261, filed Jan. 18, 1928.

"Merola" for electric phonograph reproducers and parts thereof. Use claimed since Dec. 30, 1928. Crosley Radio Corp., Cincinnati, Ohio. Serial No. 261,047, filed Feb. 2, 1928.

"Karas A-C-Former" for alternating current transformers. Use claimed since Dec. 6, 1927. Karas Elec. Co., Chicago, Ill. Serial No. 262,611, filed March 5, 1928.

May 15, 1928.

"Greif" for parts of radio sets, namely: panels, dials, sockets, plugs, knobs and insulating paper. Claims use since about 1920. Dr. Heintz Traum & Sohne, Vormals Harburger Gummi-Kamm, Hamburg, Germany, filed March 10, 1928.

May 15, 1928.

"Greif" for parts for radio sets, namely panels, dials, sockets, plugs, knobs and insulating paper. Use claimed since 1928. Dr. Heintz Traum & Sohne, Vormals Harburger Gummi-Kamm Campagnie, Hamburg, Germany. Serial No. 262,985, filed March 10, 1928.

May 22, 1928.

"Polymet" for radio parts and accessories, namely telephone plugs, rheostats, detectors, i.e. detector tubes, crystals and crystal detector units, potentiometers, condensers, leaks, batteries, ear phones and amplifier horns. Use claimed since March, 1924. Polymet Mfg. Corp., New York City. Serial No. 197,450. Filed May 22, 1924.

"Premier" for radio receiving sets adapted for installation in or for combination or association with pianos, piano players and player pianos and other combinations of radio sets and parts with pianos. Used since Feb. 1920 on pianos and parts thereof; since Sept. 12, 1923 on electrically equipped pianos, and since June 9, 1924 on radio sound reproducing means and parts combined and used with pianos. Premier Grand Piano Corp., New York, N. Y. Serial No. 210,924. Filed March 12, 1925.

"Majestic" for rectifying tubes. Use claimed since March 24, 1924. Grigsby-Grunow Co., Chicago. Serial No. 262,562. Filed March 3, 1928.

June 5, 1928.

"King Radio," the words being printed over the illustration of a crown, for radio receiving sets. Use claimed since June 1, 1926. King Mfg. Corp., Buffalo, N. Y. Serial No. 245,793. Filed March 15, 1927.

"Apex Lampspeaker" for combination radio speaker and electric lamps. Use claimed since Sept. 1, 1927. Wulkan-Fleming, Inc., New York, N. Y. Serial No. 258,927, filed Dec. 14, 1927.

"Dynamic" for receiving and transmitting sets for telephonic use and electrically operated radio speaking sound reproducers and parts thereof. Use claimed since Jan. 21, 1915. The Magnavox Co., Oakland, Calif. Serial No. 262,234. Filed Feb. 15, 1928.

June 12, 1928.

"Universal" for electric power plants, namely electric light and power units for generating electricity, consisting of gasoline engines directly connected to electric generators, together with generator and engine equipment used for any purpose requiring an independent source of electric light and power. Use claimed since Jan. 1, 1925. Universal Motor Co., Oshkosh, Wis. Serial No. 260,199. Filed Jan. 10, 1928.

"Dynatone" for radio speakers, use claimed since March 15, 1928. Ponspeaker Radio Co., New York, N. Y. Serial No. 260,293, filed Apr. 4, 1928.

"Blackhawk" for storage batteries. Use claimed since Aug. 1, 1927. Grant Storage Battery Co., Minneapolis, Minn. Serial No. 264,428. Filed April 6, 1928.



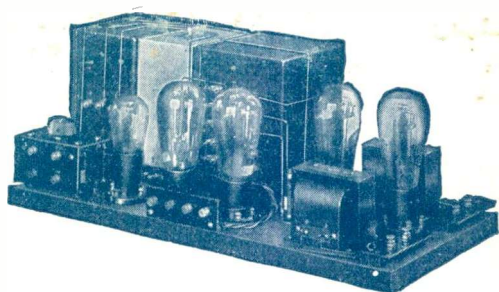

## New TCA AMPLI-PACK

Makes Any Radio a Real Musical Instrument

A complete A. C. Power Supply—"A," "B," and "C"  
—Makes any D. C. Set into a Modern A. C. Receiver  
—Uses 210 type tubes in push-pull or single 250 tube amplification. Gives complete power amplification. Assures full musical scale range found only in the most modern and expensive receivers.

### AMPLI-PACK can be assembled in one evening

Any set can be brought up to the most advanced engineering standards of reception by assembling an Ampli-paCk in the home. It can be done easily in one evening. A screw driver, pair of pliers, and a soldering iron are all the tools needed. We supply complete, simple construction diagrams. Standardized mass production methods reduce cost, improve quality, and give you advanced radio instruments at less cost than ever before offered.

Simple to install. Can be attached to set in three minutes. Consumes no more current than ordinary 50-watt light. Cool, quiet, and dependable in operation.

#### Send for Free Book

We have prepared a booklet giving the latest information on Power Amplification and A. C. Conversion. Your copy is ready for you, FREE. Write for it.

#### Manufacturers:

Send us your specifications on power packs, audio transformers, and chokes. We will gladly furnish samples together with quotations on your season's requirements.

### Transformer Corporation of America

1428-1432 Orleans Street, Chicago, Illinois

Manufacturers of the T. C. A. Line of Power Transformers, Audio Transformers, Chokes, Power Packs, and Power Amplifier Packs



## For High Volt A.C. Sets

The same craftsmanship that has made Sprague Midgets the choice of leading set manufacturers is evidenced in this new type condenser. Safe for continuous A. C. operation up to 550 volts, 60 cycles and up to 750 volts D. C. Waterproofed with asphalt covering and special process of triple impregnation. Capacities from .00007 to .1 MFD.

SPRAGUE SPECIALTIES CO.

Quincy, Massachusetts



## Tone and Volume Control

A MUCH needed radio accessory — A Volume control at the output of a radio receiver that will temper the volume to the exact tone desired without affecting the quality of tone. The ModuPlug is the ideal volume control for use with electrical phonograph pick-ups or controlling two or more speakers independently.

Write for Booklet.

# Centralab

CENTRAL RADIO LABORATORIES  
30 Keefe Avenue, Milwaukee, Wisconsin



# New Radio Patents

MAY 15, 1928

## PATENTS

- 1,669,502. High-Speed Radio Transmitter. Arthur L. Wilson, Hammond, Ind. Assor. to Westinghouse Electric & Manufacturing Company.
- 1,669,524. Speed-Control System for High-Frequency Generators. Samuel M. Kintner, Pittsburgh, Pa. Assor. to Westinghouse Electric & Manufacturing Company.
- 1,669,527. Method of and Apparatus for Producing Modified Currents, etc. Friedrich W. Meyer, Schenectady, N. Y. Assor. to The Cutler-Hammer Mfg. Co., Milwaukee, Wisconsin.
- 1,669,575. Radio Station-Finding Mechanism. Alfred F. Sanford, Knoxville, Tenn.
- 1,669,893. Radio Receiving System. Fred Parker Benjamin, Watsela, Illinois.
- 1,669,959. Radio Receiving System. Philip John Walsh, San Francisco, Calif.
- 1,670,004. Rheostat. George Rudolph Plovich, Benld, Ill.
- 1,670,149. Radio Receiving System. Christian W. Hanson, Chicago, Ill. Assor. to Zenith Radio Corporation, Chicago, Ill.
- 1,670,272. Radio Dial Construction. Adolph J. Neef, Brooklyn, N. Y.

MAY 22, 1928

## DESIGNS

- 75,200. Radio Dial Plate. William H. Anderson, Los Angeles, Calif. Assor. to Eclipse Manufacturers, Inc., Los Angeles, Calif.
- 75,204. Radio Cabinet or Similar Article. John M. Beach, Grand Rapids, Mich.
- 75,222. Candelabrum Radio Reproducer Stand. Isaac De Kaiser, Pittsburgh, Pa.
- 75,223. Candelabrum Radio Reproducer Stand. Isaac De Kaiser, Pittsburgh, Pa.
- 75,224. Candelabrum Radio Reproducer Stand. Isaac De Kaiser, Pittsburgh, Pa.
- 75,227. Radio Cabinet. Noel S. Dunbar, New York, N. Y. Assor. by mesne assignments to Splittorf Radio Corporation, Newark, N. J.

## PATENTS

- 1,670,356. Vacuum Tube. William T. Hawes, Montreal, Quebec, Canada.
- 1,670,375. Picture-Transmitting System. Henry Nyquist, Millburn, N. J. Assor. to American Telephone and Telegraph Company.
- 1,670,483. Electron Device and Method of Activation. Harvey Clayton Rentschler, East Orange, N. J. Assor. to Westinghouse Lamp Company.
- 1,670,487. Electron-Emission Material and the Activation Thereof. Thomas Philip Thomas, Bloomfield, N. J. Assor. to Westinghouse Lamp Company.
- 1,670,489. Radiogoniometer. Ettore Bellini, Paris, France.
- 1,670,497. Radio Transmission System. Thomas Lydwell Eckersley, Danbury, England. Assor. to Radio Corporation of America.
- 1,670,553. Wireless Antenna. Louis E. Sharp, Denver, Colo. Assor. by direct and mesne assignments to Sharp and Combs, Inc., Denver, Colo.
- 1,670,586. Compensating Means for Oscillating Radio Circuits. Walter Lytton, Chicago, Ill.
- 1,670,589. Crystal Detector. Fred J. Martin, Oakland, California.
- 1,670,760. Radio Receiving Instrument for Systems of Broadcast Distribution. Edward E. Clement, Washington, D. C. Assor. to Edward F. Colladay, Washington, D. C.
- 1,670,782. Radio Frequency Amplifier. Carl Pfanstiehl, Highland Park, Ill. Assor. to Pfanstiehl Radio Company.
- 1,670,888. Submarine Sound Receiver. Walter Hahnemann, Kitzberg, near Kiel, Germany. Assor. to the Firm Signal Gesellschaft m.B.H., Kiel, Germany.
- 1,670,951. Radio Receiving Set. Anthony Boedeker, Cincinnati, and Jesse S. Wentworth, Norwood, Ohio. Assors. to Grandtone Radio Corporation, Cincinnati, Ohio.

MAY 29, 1928

- 1,671,130. Grid Circuits of Electron Tubes. Samuel P. Shackleton, Wyoming, N. J. Assor. to Telephone and Telegraph Company.
- 1,671,146. Howler Circuits. Thomas F. Crocker, Chicago, Ill. Assor. by mesne assignments, to Automatic Electric Inc., Chicago, Ill.
- 1,671,204. High-Voltage Vacuum-Tube System. Arthur A. Oswald, Bradley Beach, N. J. Assor. to Western Electric, Incorporated, New York, N. Y.
- 1,671,262. Submarine Sound Reception. Robert Longfellow Williams, Newton, Mass. Assor. to Submarine Signal Corporation, Boston, Mass.

- 1,671,284. Radio Tube Socket. James E. Hanly, Uniontown, Pa.
- 1,671,292. Apparatus for Electrical Sound Reproduction. John J. Jakosky, Los Angeles, Cal. Assor. to International Precipitation Company, Los Angeles, Calif.
- 1,671,302. Electro-optical Transmission. Robert C. Mathes, Wyoming, N. J. Assor. to Belle Telephone Laboratories, Incorporated, New York, N. Y.
- 1,671,466. Radio System. Robert L. Davis, Wilkinsburg, Pa. Assor. to Westinghouse Electric & Manufacturing Company.
- 1,671,467. Modulation Meter. Robert L. Davis, Wilkinsburg, Pa. Assor. to Westinghouse Electric & Manufacturing Company.
- 1,671,478. Condenser and Grid Leaks. Ralph E. Marbury, Wilkinsburg, Pa. Assor. to Westinghouse Electric & Manufacturing Company.
- 1,671,519. Electrical Condenser. William Dubilier, New York, N. Y. Assor. to Dubilier Condenser Corporation, New York, N. Y.
- 1,671,543. Sound Amplifier. Orval R. Platter and Jasper T. Ball, North Vernon, Ind.
- 1,671,625. Universal Inductance Device for Radio Receiving Apparatus. Harry Wilbur Brown, Philadelphia, and Gordon O. Wilkinson, Ardmore, Pa.
- 1,671,639. Reproducer. William F. Hendry, Ossining, N. Y. Assor. to Manhattan Electrical Supply Company, Incorporated, New York, N. Y.
- 1,671,863. Sound-Reproducing Instrument. Alfred Herschel, New York, N. Y.
- 1,671,902. Radiographic Apparatus. Sidney Israel, Houston, Texas.
- 1,671,920. Instrument-Dial Illumination. Joseph Zubaty, Flint, Mich. Assor. to A. C. Spark Plug Company, Flint, Mich.
- 1,671,954. Rheostat. Henry J. Kasch, Dayton, Ohio. Assor. to The Kurz Kasch Company, Dayton, Ohio.
- 1,671,959. Means for Eliminating Reactive Coupling in Radio Circuits. Joseph David Roth Freed, Woodmere, N. Y. Assor. to Freed-Elsemann Radio Corporation, Brooklyn, N. Y.

JUNE 5, 1928

## PATENTS

- 1,671,969. Utilization of Alternating Current for Radio Signaling. Glenn W. Carpenter, Washington, D. C.
- 1,671,996. Electrical Condenser. Edwin L. Powell, Washington, D. C.
- 1,672,010. Amplification System. Albert H. Taylor, Washington, D. C. Assor. to Wired Radio, Inc., New York, N. Y.
- 1,672,018. Electrical Circuits. Louis W. Austin, Washington, D. C.
- 1,672,027. Radio Signaling System. Henry E. Hallborg, Washington, D. C.
- 1,672,037. Method of and Apparatus for Amplifying Electrical Currents. James E. Parker, Washington, D. C.
- 1,672,056. Translating Circuit. John R. Carson, Scarsdale, N. Y. Assor. to American Telephone and Telegraph Company.
- 1,672,057. Electrical Circuits. Alva Benson Clark, Brooklyn, N. Y. Assor. to American Telephone and Telegraph Company.
- 1,672,173. Electromagnetic Sound-Reproducing System. Charles R. Rowe, East Orange, N. J. Assor. to Brandes Laboratories, Inc., Newark, N. J.
- 1,672,233. Radio Grid and Filament Spacer. Walter J. Skinner, Bloomfield, N. J. Assor. to himself and Frank J. Kent, New York, N. Y.
- 1,672,290. Potential Control Apparatus. Henry J. Wiegand, Milwaukee, Wis. Assor. to The Cutler-Hammer Mfg. Co., Milwaukee, Wis.
- 1,672,367. Variable Air Condenser. Allen D. Cardwell, Rockville Center, N. Y.
- 1,672,370. Radio Broadcast Distributing System. Edward E. Clement, Washington, D. C. Assor. to Edward F. Colladay, Washington, D. C.
- 1,672,371. Subdivided Service System of Radio Broadcast Distribution. Edward E. Clement, Washington, D. C. Assor. to Edward F. Colladay, Washington, D. C.
- 1,672,372. Traffic-Control System for Radio Broadcast Distribution. Edward E. Clement, Washington, D. C. Assor. to Edward F. Colladay, Washington, D. C.
- 1,672,373. Subscriber's Instrument for Broadcast System of Distribution. Edward E. Clement, Washington, D. C. Assor. to Edward F. Colladay, Washington, D. C.
- 1,672,374. Traffic-Control System for Radio Broadcast Distribution. Edward E. Clement, Washington, D. C. Assor. to Edward F. Colladay, Washington, D. C.

## PATENTS

- 1,672,394. Fixed Radio Coupler. Martinus Sieveking, New York, N. Y.
- 1,672,407. Radio Broadcast Distributing System. Edward E. Clement, Washington, D. C. Assor. to Edward F. Colladay, Washington, D. C.
- 1,672,472. Acoustic Transformer. Percy A. Robbins, Highland Park, Ill.
- 1,672,493. Reproducer. Russell T. Kingsford, Wyncote, Pa. Assor. to Atwater Kent Manufacturing Company, Philadelphia, Pa.
- 1,672,568. Automatic Radio Switching System. James E. Hoge, Cleveland, Ohio, and Edward E. Clement, Washington, D. C. Assors. by direct and mesne assignments to Edward F. Colladay, Washington, D. C.
- 1,672,686. Attachment for Radio Receiving Sets. Peter Mertes, Jr., St. Paul, Minn.
- 1,672,796. Sound Reproducer. William B. Whitmore, Orange, N. J.
- 1,672,811. Electrical Amplifier Circuit. Lewis M. Hull, Boonton, N. J. Assor. to Radio Frequency Laboratories, Incorporated, Boonton, N. J.
- 1,672,855. Duplex Radio Communication. Paul Ware, New York, N. Y. Assor. to Ware Radio, Inc., New York, N. Y.

JUNE 12, 1928

- 1,672,916. Potentiometer. James C. Snell, Oak Park, Ill. Assor. to Premier Electric Company, Chicago, Ill.
- 1,672,968. Transmission Circuits. Homer A. Whitehorn, Port Washington, N. Y. Assor. to Western Electric Company, Incorporated, New York, N. Y.
- 1,672,975. Wave Transmission System. John Fish Farrington, Flushing, N. Y. Assor. to Western Electric Company, Incorporated, New York, N. Y.
- 1,672,995. Electric-Current Transmission. Donald F. Whiting, New York, N. Y. Assor. to Western Electric Company, Incorporated, New York, N. Y.
- 1,673,002. Control of Electric Waves. Justin L. Fearing, Jamaica, N. Y. Assor. to Western Electric Company, Incorporated, New York, N. Y.
- 1,673,006. High-Frequency Transmission and Reception. Raymond A. Heising, Milburn, N. J. Assor. to Western Electric Company, Incorporated, New York, N. Y.
- 1,673,008. Electron-Discharge Device. William A. Knoop, Brooklyn, N. Y. Assor. to Western Electric Company, Incorporated, New York, N. Y.
- 1,673,009. Antenna-Circuit Arrangement. Marius Latour, Paris, France. Assor. to Latour Corporation, Jersey City, N. J.
- 1,673,016. System of Electrical Conductors. Arthur A. Oswald, East Orange, N. J. Assor. to Western Electric Company, Incorporated, New York, N. Y.
- 1,673,023. Carrier-Wave Repeater. Francis X. Rettenmeyer, Montclair, N. J. Assor. to Bell Telephone Laboratories, Incorporated, New York, N. Y.
- 1,673,031. Wave Transmission System. Donald F. Whiting, Port Washington, N. Y. Assor. to Bell Telephone Laboratories, Incorporated, New York, N. Y.
- 1,673,079. Radio Tuning Control Device. Charles E. Kilgour, Cincinnati, Ohio. Assor. to The Crosley Radio Corporation, Cincinnati, Ohio.
- 1,673,173. Crystal-Calibrator Apparatus. Robert H. Worrall, Washington, D. C. Assor. to Wired Radio, Inc., New York, N. Y.
- 1,673,213. Variable Condenser. Thomas W. Sokumlyn, Los Angeles, Calif.
- 1,673,249. Loop Antenna. Frederick A. Kolster, Palo Alto, Calif. Assor. to Federal Telegraph Company, San Francisco, Calif.
- 1,673,287. Electron-Discharge-Tube Amplifier System. Lester L. Jones, Oradell, N. J.
- 1,673,443. Rheostat. Powell Crosley, Jr., Cincinnati, Ohio.
- 1,673,458. Antenna for Radios. Burle R. Jones, Tulsa, Okla. Assor. of one-half to George H. Lessley, Tulsa, Okla.
- 1,673,461. Reproducer. Arthur Atwater Kent, Ardmore, Pa.
- 1,673,560. Vacuum-Tube Structure. Hubert M. Freeman, East Pittsburgh, Pa. Assor. to Westinghouse Electric & Mfg. Co.
- 1,673,562. Method of and Multiplex System for Transmitting Radiant Energy. John Hays Hammond, Jr., Gloucester, Mass.
- 1,673,593. Radio Receiving System. Sheldon L. Sanderson, Wilkinsburg, Pa. Assor. to Westinghouse Electric & Mfg. Co.
- 1,673,661. Electromagnetic Sound Reproducing Apparatus. Cecil E. Brigham, East Orange, N. J. Assor. to Brandes Laboratories, Inc., Newark, N. J.
- 1,673,768. Sound-Reproducing Amplifier. Angus H. Gibson, Salt Lake City, Utah. Assor. to American Radio Products, Salt Lake City, Utah.



**The Standard  
of Comparison!  
ELECTRAD RADIO  
CONTROLS**

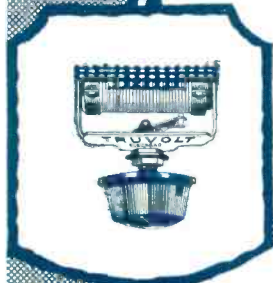

**T**HE goodwill which Electrad Products enjoys among builders of receivers and power devices is not the result of accident.

Rather it is the outgrowth of building year after year radio products of the highest quality — superior in performance, design and ability to meet every requirement in radio construction and operation.

**TRUVOLT**

Reg. U. S. Pat. Off.

**ALL-WIRE  
RESISTANCES**

Remarkably accurate and dependable due to unique air-cooled design, Truvolt Variables are potentiometer type, eliminating difficult calculations and permitting easy adjustment to receivers and tubes. Truvolt Fixed are adjustable to any set values desired by the use of sliding clip taps.

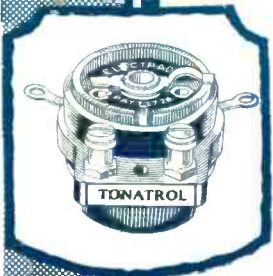

**TONATROL**

TRADE MARK

**A Complete Line  
of Volume Controls**

Tonatrol Volume Controls are designed in types to meet the specific requirements of all types of circuits. There are specialized volume controls for A.C. circuits as well as for the conventional battery type receivers. Furnished in standard types or with filament switch or power switch attached.

We specialize in a full line of Resistance Controls for all radio purposes.

**Tear Out  
and Mail  
This  
Coupon**

**ELECTRAD,  
Inc.,  
Dept. K-7,  
175 Varick Street  
New York**

Please send me FREE circulars on the Electrad line of resistances, also complete dealer information.

Name .....

Address .....

**ELECTRAD** Inc.

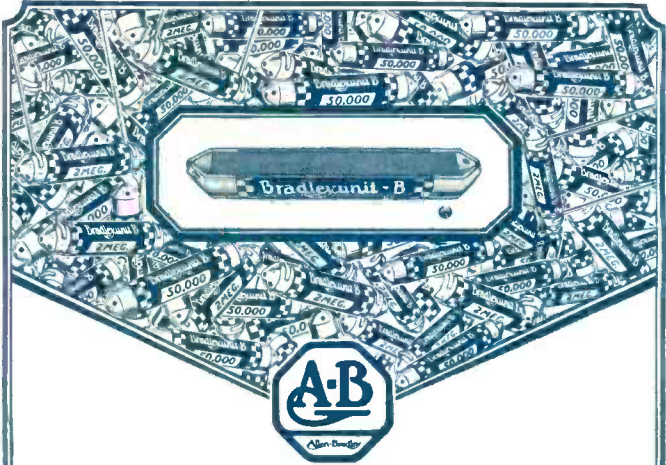

**No Grid Leak Interference  
with the  
Bradleyunit-B Resistor**

**B**RADLEYUNIT-B solid-molded resistors eliminate the noise and interference in radio circuits caused by inferior grid leaks. Oscillograph tests show the Bradleyunit-B to be remarkably quiet in operation.

The Bradleyunit-B Fixed Resistor is made of a special, uniform mixture, baked and solid-molded at high pressure. This creates a solid, uniform unit, providing a constant resistance regardless of voltage used.

Radio dealers are assured of an accurately calibrated resistor which will retain its initial rating indefinitely.

**For Radio Dealers**

These remarkable solid-molded resistors are practically unaffected by moisture, altho not depending on a glass enclosure for protection.

The Bradleyunit-B is furnished with or without tinned leads for soldering Made in values from 500 ohms to 10 megohms.

*Order your supply of  
Bradleyunit-B Resistors today*

Allen-Bradley Co., 489 Clinton Street  
Milwaukee, Wis.

**Allen-Bradley Resistors**



# 3 New Time-Saving and Money-Saving RADIO WIRE PRODUCTS

THROUGHOUT the radio industry—from novice builder to professional and actual manufacturer—Acme Wire is used by the thousands of feet for every radio hook-up requirement.

Now we announce the three new wire products shown and described on this page. As with all other products manufactured by The Acme Wire Co., these three new items have been made to meet actual existing needs—to simplify wiring operations, thus saving the time and money of the men who build and repair radio apparatus.

The quality of each of these three products is the same that has made the name Acme famous throughout the industry. Each can be relied upon to give perfect service for the individual purpose for which it has been designed.

Made by THE ACME WIRE CO., New Haven, Conn., manufacturers of magnet wire, varnished insulations, coil windings, insulated tubing and radio cables.

## ACME TWISTED A.C. CELATSITE WIRE

For A.C. Filament Hook-up. One strand of Red and one strand of Black 16/30 Flexible Celatsite twisted together. The two colors are used so that, if desired, the same sides of all filaments can be maintained at the same relative potential. Packed 25-ft. coil in individual carton.

## ACME PUSHBAK WIRE

This is the speediest hook-up wire for the Professional Set Builder—simply push back the insulation! No. 19 solid tinned copper wire covered with cotton wrap and braid, then thoroughly impregnated with wax. 25-ft. coil in individual carton. Six colors: black, yellow, brown, green, red, blue.

## ACME POWER SUPPLY CABLES

R-112 cable, illustrated, is universal for A.C. or D.C. use for 12 conductors or less. Has four twisted pairs and four single wires. One of twisted pairs has extra heavy current capacity. 100-ft. coils. Enclosed in full glazed cotton braid with rayon tracer. Cables containing 5, 6, 7, 8 or 9 conductors are also made for use in battery and power supply hook-up. 5-ft. and 100-ft. coils.



## ACME CELATSITE WIRE PRODUCTS

### ENAMELED AERIAL WIRE

Enameled copper wire in both stranded and solid types. Also Acme Lead-ins, Battery Cables, Indoor and Loop Aerial Wire.

### CELATSITE WIRE, FLEXIBLE and SOLID

For all types of radio wiring. High insulation value; non-inflammable. 10 colors.

### ACME COILS, MAGNET WIRE, & VARNISHED INSULATION

### ACME SPAGHETTI

A superior cambric tubing for all practical radio and other electrical requirements. Supplied in 10 colors.

Made by the Manufacturers of

## ACME PARVOLT CONDENSERS





## “A ROYAL

¶ Several dealers used this exclamation at the Show. ¶ The new Kolster merchandise looked like an unbeatable “hand” to them. ¶ Aside from thoughts of other merit, *distinction of appearance* was what stopped them. ¶ Such excellence of design acts literally like four wheel brakes upon passers-by, dealers or consumers. ¶ In the last twelve months the seed of



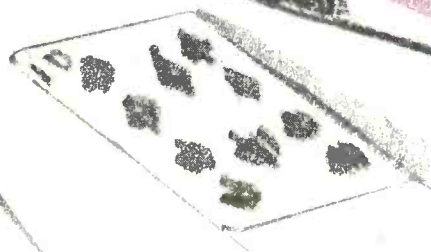
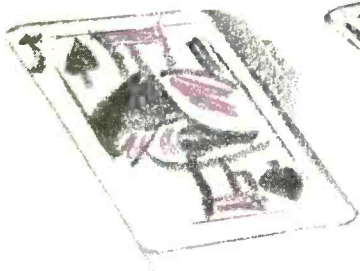

# FLUSH!"

Kolster popularity has been sowed so thickly everywhere that the season of 1928-9 *with this new and striking line* is bound to see a proportionate harvest. ¶ The blue chips are yours for the taking.

¶ Drop us a line today for pictures of the merchandise in a de luxe volume and details of the Kolster selling and advertising plans. ¶ You will then obtain a clearer idea of the coming radio season's possibilities.





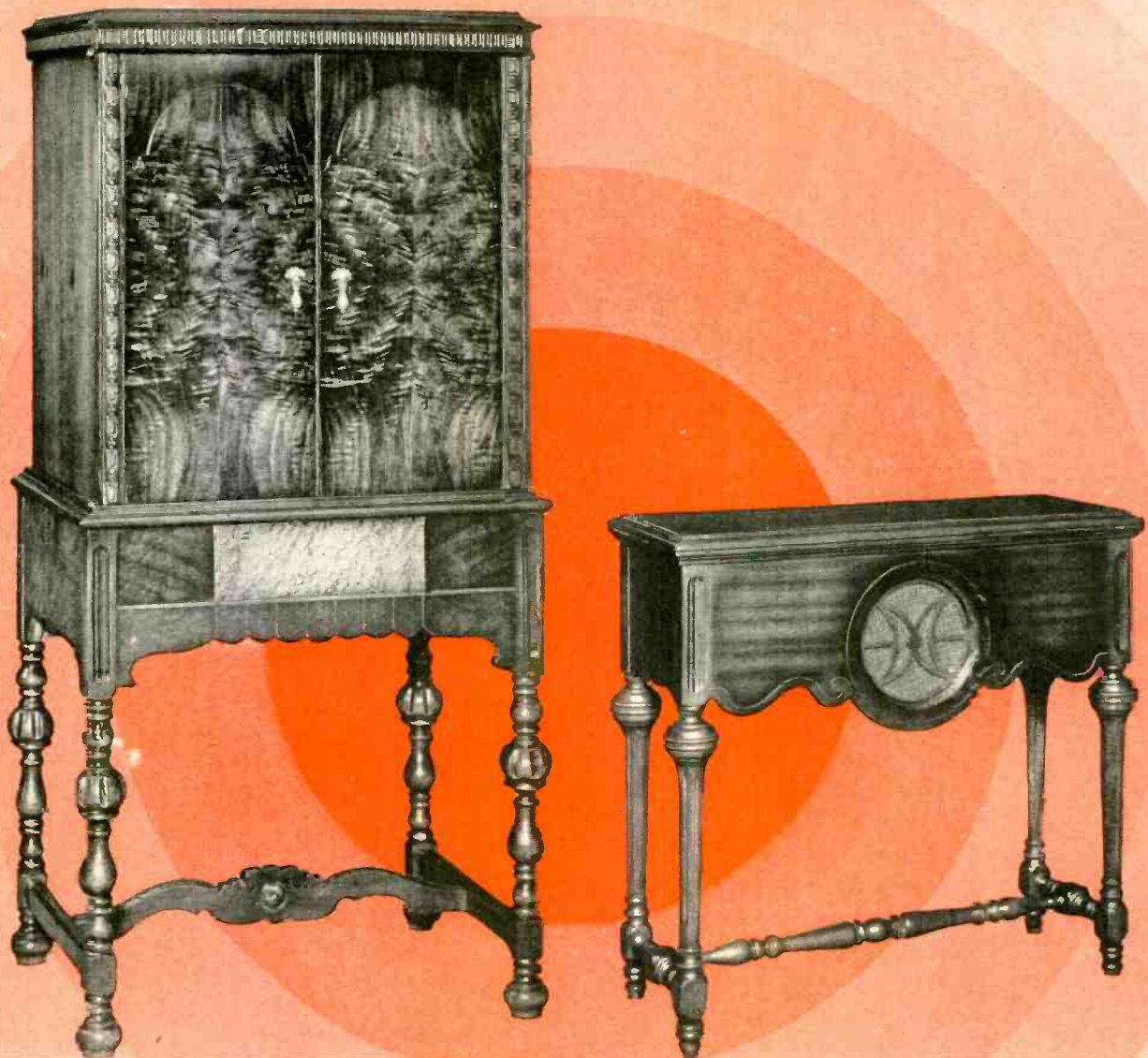

No. 95. Federal Cabinet—51" high, 24" wide, 18" deep—the de luxe piece of the season—built walnut veneer over 5-ply construction. Moulded decoration and maple overlay.

No. 1840. A very high class console table that can be sold at very low price. Fits all standard sets and speakers. Sold with or without the No. 100-A RCA Speaker.

Illustrative of a complete line of handsome radio cabinets and tables—last word in design—5-ply construction throughout—finest walnut veneers—beautiful finishes in the popular dull-rubbed style—all models made to accommodate popular receivers—unsurpassed acoustical qualities—sold with or without the No. 100-A R. C. A. speaker.



# FEDERAL

FEDERAL FURNITURE FACTORIES, Inc., 208 Lexington Ave., New York



No. 36-R Federal Console—31" high, 32" wide, 16½" deep—5-ply construction, matched walnut veneers. Doors made with matched walnut veneer.

No. 37-R. Federal Cabinet— a beautiful piece of furniture—46" high, 24" wide, 18" deep, 5-ply construction, matched walnut veneers, high quality marquetry.

The gigantic financial and manufacturing resources of the well-known Federal Furniture Factories are behind this new series of radio cabinets and tables—your guarantee of fine quality at a new low price scale which will have an important effect upon your sales and profits for the coming season. Don't order your radio cabinets and tables until you first get full particulars on the new Federal series.



# CABINETS

Irving H. Isaacs, President Ben Lauterstein, Sec. and Treas. David E. Kahn, Director of Sales





## STEWART-WARNER

### Model 802

Six receiving tubes. One rectifier tube. FOUR tuned circuits. ONE dial control. Calibrated wave-length dial, illuminated. Built-on reproducer. Built-in light socket aerial. Completely self-contained and portable.

Price of set, plus speaker,

**\$110<sup>50</sup>**

Without tubes

Prices slightly higher west of the Rockies.

# STEWART-WARNER AC All Electric RADIO

## Model 802, With Built-on Reproducer and Built-in Antenna

The outstanding sensation of the June Radio Show, this amazing new Model 802 has brought Realism to radio and unparalleled money-making opportunity to the radio dealer. Small, compact, self-contained, portable, strikingly beautiful in bronze Moiré finish, its many new unique features make it the preponderant value in radio today.

The new Stewart-Warner Reproducer is a built-on part of Model 802. Cabinet and reproducer perfectly harmonize in design and in operation. Here are beauty, performing efficiency, tone trueness and operating simplicity that delight the radio buyer, and make the Stewart-Warner dealer a leader in the retail radio field. The Reproducer is also sold as a separate unit.

### Other Features of Model 802

*Cabinet* entirely shields all working parts.

*Three tuned stages* of radio frequency amplification with *four tuned circuits*.

*Built-in power pack*. Taps for high or low voltage.

*Built-in light-socket antenna*, permitting reception of local broadcasts without any other inside or outside aerial.

*Taps* for connecting with either long or short outdoor aerial, insuring maximum efficiency.

*Safety cartridge fuse* protects wiring against burn-out through short circuit.

*One control* for tuning, one for volume.

*Gold-plated dial*, calibrated in wave-lengths.

*Electrical phonograph pick-up receptacles* for instant attachment.





STEWART-WARNER  
REPRODUCER

Model 435

\$16<sup>50</sup>—

A new type magnetic cone speaker  
with new tone depth and beauty

Prices slightly higher west of the Rockies

STEWART-WARNER  
All-Electric A. C.

Model 801

\$94<sup>50</sup>—

Without tubes

Same as Model 802, but without  
built-on reproducer  
The same style in battery-operated  
set, \$67.50



# The New Triumph REALISM in RADIO

The new Stewart-Warner "800" group will help you, Mr. Dealer, to establish a sound permanent business—with remarkable money-making opportunities—with selling co-operation that means constant growth.

REALISM is the word that sums up the performing quality of the new "800" group. The Stewart-Warner "Electrical Ear" test enables reproduction of music *exactly as played*. The "Electrical Ear" records minutest sound vibrations of music as played and of the same music re-created by the Stewart-Warner set. Comparison of the two records proves a fidelity of reception that means REALISM—and LEADERSHIP for Stewart-Warner Radio, and for dealers who handle it.

Model 802, with its built-on Reproducer, is one of the leaders of the All-Electric A. C. group. Model 801 is the same receiving set *without* the reproducer. Model 806 is a *battery-operated* set, with cabinet of same design as A. C. Model 801. There is also a complete line of *Consoles* approved for both the All-Electric and battery-operated sets. Consoles are of new design, of striking beauty—made by the Buckeye Cabinet Company, Springfield, Ohio, and sold through Studner Bros., Inc., National Sales Representatives. Here's a range of style and price that meets all radio demands. And back of every set is the guarantee of this 50-million-dollar corporation, with a 21-year record of success and 18 million products in use.

*If you can secure the Stewart-Warner Franchise you will have one of the most valuable business assets a radio dealer can own. An opportunity you can't afford to miss. Territories closing fast! Write or wire today.*

STEWART-WARNER SPEEDOMETER CORPORATION · CHICAGO  
22 years in business—World-wide service—50 million dollars in resources—1st successful radio year

**STEWART-WARNER** *The Voice of Authority*  
in RADIO

We do not consider a Sale Final until

## Elkon Believes in Doing its Part to sell Elkon Products to the Customer



**I**N the old Bowery days of the gay nineties it was considered progressive merchandising to pull the innocent passerby into the store, close the door and sell him something before he got out.

Not so long ago, it was considered by some companies quite the thing to load up the jobber and the dealer with tremendous stocks—and then let them sell the merchandise as best they could. Unfortunately that is still the policy of some companies.

We have a different idea about merchandising. We urge jobbers and dealers to buy carefully in quantities large enough to take care of their needs—but not to overstock. Then, we consider our job is only partially done.



We believe that it is just as much a part of our job to help move that merchandise off the dealers' shelves as his own.

We can't very well have a man stationed in front of every store to drag 'em in. But we can tell millions of people about our products. And we do.

Newspaper and magazine advertising, display cartons, window cards, booklets—every type of effective advertising and merchandising is part of our job—and we know it—and do it.



### SEND THE COUPON!

If you haven't tied up with the Elkon line of quality Radio Products—now is your time.

**ELKON, INC.**  
PORT CHESTER, N. Y.  
Division of  
P. R. Mallory & Co., Inc.

# ELKON RADIO

The Merchandise is in the Consumer's Hands



PRODUCTS

Radio Department,  
**ELKON, Inc.**  
 201 Fox Island Road  
 Port Chester, N. Y.

We are interested in handling the Elkon line for 1928-1929.  
 Without obligation, please send us complete information.

.....Jobber .....Dealer (Please check)

If you are a dealer, please indicate your favorite jobber.

..... Favorite Jobber's Name

Name.....

Address.....



# THERE HAS RADIO LIKE

Balkite, in designing its new line of AC receivers, has patterned after no existing radio.

It has produced instead a receiver unique in the field. A receiver that has achieved recognition over night.

A receiver that meets the demand of the public for radio that is a standard household necessity harmonizing with fine furnishings. The public will today pay more for radio if performance and appearance justify it.

A receiver as beautiful as it is possible to make it. Both Balkite A-5 and A-7 are housed by Berkey & Gay—one of the great furniture makers of the world. Noth-



The Balkite A-7

*Showing the finely carved cabinet with doors closed. A cabinet to meet the taste of the most exacting household—by Berkey & Gay*

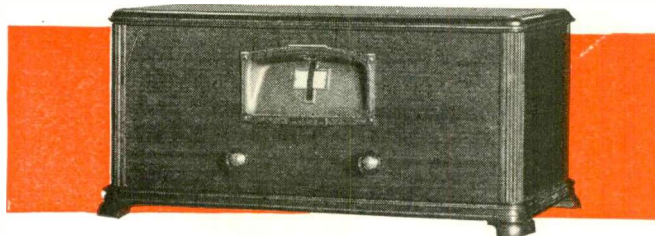

Balkite A-5

*Cabinet by Berkey & Gay. Complete except for tubes and speaker—\$230*

ing finer can be said.

A receiver matching in a simple commercial set performance hitherto available only in complex over-engineered radio. Every feature time has shown to be desirable is included, as are features never before existing on any receiver. Single-dial direct drive control. 7 tubes. Noise-free neutrodyne circuit. 227 tubes for stable performance. Push pull audio that reproduces every note sent out by the broadcasting station. A phonograph jack for reproducing records. A built-in power-supply for operating a dynamic speaker. Protection against fluctuating volt-

# Balkite Radio

*Cabinets by Berkey & Gay*

# NEVER BEEN THIS BEFORE

ages. Special noiseless Balkite condensers. Complete shielding.

A receiver built as only Balkite can build it. 80% less wire is employed. Power pack and set are easily separated. Every part is readily accessible for service. Construction is more like that of a battleship than that of the usual receiver, giving a set that will not only stand abuse in shipment, but give years of satisfaction.

*In short, a receiver that meets the need of the dealer for a higher priced unit of sale with fewer service calls.*

In addition the receiver will be backed by sound policies that will protect the trade. It



**The Balkite A-7**

*Cabinet by Berkey & Gay. Includes dynamic speaker. Complete but for tubes—\$487.50*

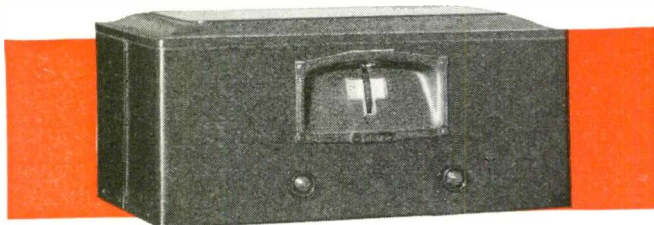

**Balkite A-3**

*For those who want all radio. Housed in a simple but slightly all-metal case. Complete but for tubes and speaker—\$197.50*

Prices slightly higher west of the Rockies

will be advertised in a typical Balkite manner. It is backed by the most thoroughly organized service system in the field.

Sell Balkite and you make money. See our jobber. Fansteel Products Co., Inc., North Chicago, Illinois.

HAVE YOU  
SEEN  
THE  
BALKITE  
SYMPHION



*It is the  
finest instrument  
in music*

# Balkite Radio

*Cabinets by Berkey & Gay*





DYNAMIC (Model 71) . \$50  
Balanced Armature—same cabinet (Model 61) . . . . . \$35



DYNAMIC—(Model 75)  
End Table . . . . . \$75



BALANCED ARMATURE  
(Model 63) Panel . . . . \$25



BALANCED ARMATURE  
(Model 65) Cabinet Junior \$19.50

# Low-tone Supremacy

When you consider that Sandar is the exclusive exponent of quality low-tone reproduction, it is easy to understand why Sandar Speakers are first in public demand. Radio buyers everywhere seek the rich, mellow, colorful bass effects—and Sandar alone can satisfy them. Feature Sandar—and cater to the wishes of your trade. But get in touch with your distributor *now*. Ten, wonderful, new models.

# SANDAR

SANDAR CORPORATION, LONG ISLAND CITY, N. Y. . . . Division of Farrand Mfg. Co., Inc.



Model No. 124 \$13.50 De Luxe Model with Counter-balanced Tone Arm

Model No. 105-A \$10.50 De Luxe Model without Tone Arm

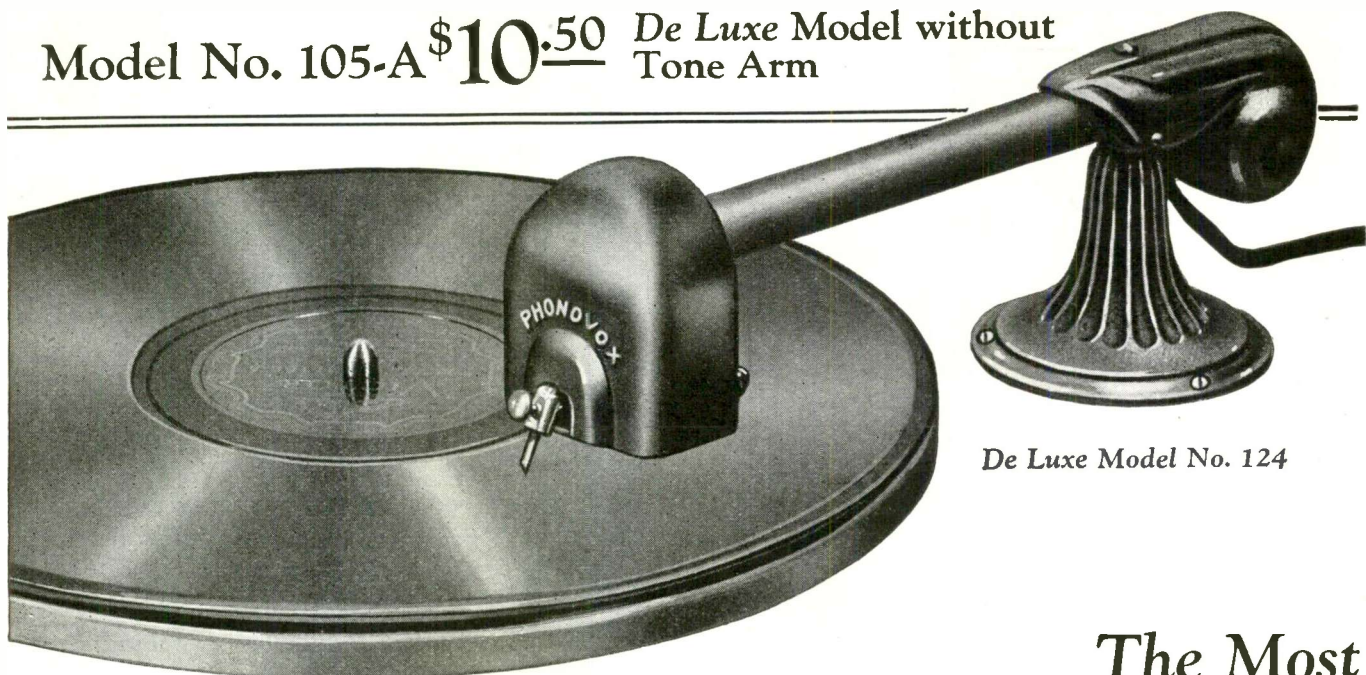

De Luxe Model No. 124



The two special Pacent adapters which are packed with each Phonovox. For battery operated sets, the one on the left is used. For A. C. sets, the adapter on the right is used.



# The Most Talked About Phonograph-Radio Accessory of the season The Pacent De Luxe Model PHONOVOX

THE Electric Pick-up

LIKE WILD-FIRE the outstanding performance of the new De Luxe Model Phonovox has spread from coast to coast, resulting in a trade demand far exceeding our estimated production schedule.

The superb reproduction of this year in advance electric pick-up is the result of many new and exclusive features—each a real sales-building talking point, not offered by any other pick-up—such as—changing from radio to phonograph reproduction without removing the detector tube; the greater musical range covered; for use in either A. C. or battery set; uses the fibre needle without appreciable loss of volume; the counter-balanced tone arm assures correct needle pressure on record and other equally important points.

Get on the Phonovox band wagon! Order a sample from your jobber and let results convince you. Right now is the big consumer Phonovox buying season. If unable to obtain one from your jobber—write us at once and we will see that you are supplied—promptly.

PACENT ELECTRIC CO., INC. 91 SEVENTH AVE. NEW YORK CITY

Makers of the famous Pacent Radio Speaker Manufacturing Licensee for Great Britain and Ireland Igranic Electric Co., Ltd., Bedford, England

For the AC Radio **PREFERRED** by Millions

# Super AC Reception

The **ULTIMATE** in Radio Power

—requiring **NO** change in Set or Tubes

7,500,000  
battery-type Sets in use

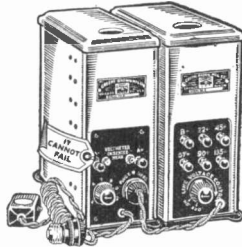

4,200,000  
prospects for Greene "AC" Units

**T**ODAY—Greene Leadership in the Radio Power field is more pronounced than ever. The 1928 RMA Trade Show proved it. Enthusiastic acceptance by jobbers and dealers, confirmed by hundreds of orders for the Great Greene Line for 1929, quickly became one of the most sensational topics of the show.

Consistently, Greene advanced engineering has kept step with each new DC and AC-tube improvement with important new power principles for minimizing AC hum-m and line-voltage noises so characteristic of modern AC receivers. Thus, again, Greene scientific research contributes advancements of price-less value to the industry by quickening general public acceptance of "all-electric" radio.

Here are batteryless AC-radio-converters for noiseless



reception of super-excellence utilizing the newest AC, or lower cost DC-tubes. Here is a special Dry-Electric "A"; "A-B" and "ABC" light-socket combination for receiving sets of every type meeting all voltage requirements (25-40, or 50-60 cycle) regardless of power-line variations.

Here is popular-priced "packaged-merchandise" for over-the-counter selling, requiring no service man to install, and no servicing-after-sale. Shrewd dealers will concentrate on this line—for the next two years—and, profit richly.

Now~ for "ALL-ELECTRIC"  
AC-or DC-RADIO

**GREENE**  
POWER AC UNITS  
Better than Batteries

Immediately request full descriptions and complete sample shipment to be billed through a nearby Greene Distributor. Then—subject these units to any test—let your own ears prove the indescribable superiority of AC-radio powered the Great Greene way.

## No More "AC" HUM-M!

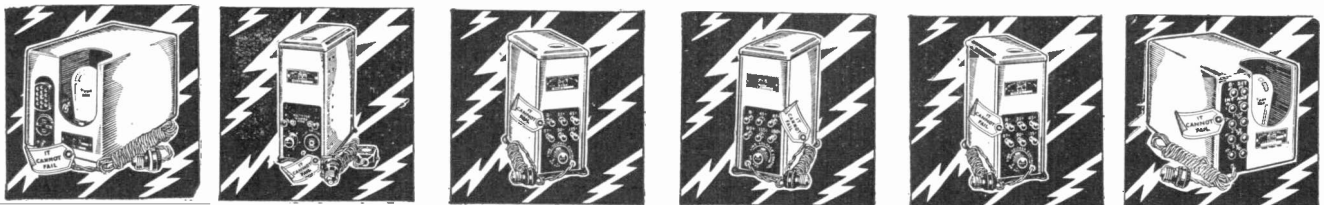

ATTACH THIS COUPON TO YOUR LETTERHEAD—MAIL TODAY

GREENE-BROWN MANUFACTURING COMPANY, 5100 Ravenswood Avenue, CHICAGO, ILL., U. S. A.

I am interested in the huge sales possibilities of the Great Greene Line for 1929. Please send full descriptions of your AC Units.

Name ..... Address .....

Dealer                       Jobber                       Manufacturer

If samples of A and B Units are desired, confirm by separate letter stating jobber's name.

Radio Retailing—July '28

# DIFFERENT!

**The JENSEN DYNAMIC  
SPEAKER is different and  
better because of the genius  
and experience of Peter L. Jensen**

**U**SE of the dynamic principle in speaker design is in itself no assurance of better and truer reproduction.

Correct use of this principle, however, means unqualified superiority. Such success can only come through experience and long research. As co-inventor of the dynamic principle, patents bearing Peter L. Jensen's name date back to 1912. Many thousands of dynamic speakers have been built under his direct supervision in the factories of the Jensen Radio Manufacturing Company.

Jensen superiority is fully acknowledged by the country's leading radio engineers, who depend upon laboratory tests for their opinion.

But by what standards will the public judge dynamic speakers? They will insist on distinctly better tone quality, dignified beauty in cabinet design, and unmistakable value for every dollar they spend.

And you as a jobber, dealer or manufacturer—what will you demand? It must be all these qualities which summed up mean *consumer preference*.

And in addition you should also insist on proven ability to maintain uniform quality in volume production, plus a practical advertising and merchandising policy.

Write or wire immediately for complete information and nearest distribution point.

Prices range from \$40 up.

**Jensen**  
**DYNAMIC SPEAKER**  
(Licensed under Magnavox Patents.)

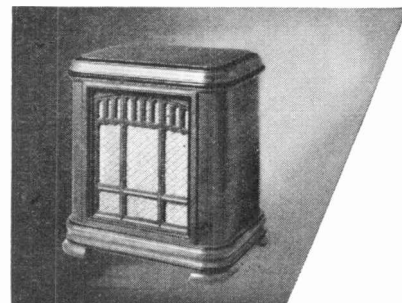

**Jensen Radio Manufacturing Company**

338 N. Kedzie Avenue

CHICAGO, ILLINOIS

212 9th Street, Oakland, California



# OPERADIO

**THE LINE COMPLETE!**  
*Dynamic and Air Column*  
**SPEAKERS**  
 \$15<sup>00</sup>~to~\$250<sup>00</sup>



**The Bloc-Type Tone Chamber**

Designed to give accurate reproduction. The tone chamber is an exponential air column cast in a solid monolithic bloc of a new light weight material, "Vocalite", which is absolutely inert, non-vibrating and unaffected by any climatic conditions.



**The Junior**  
 \$15.00

**New Senior**  
 \$25.00

The New Senior is last year's most popular model, improved in performance with many refinements of design and finish. Either will deliver satisfactorily the output of any set up to and including five and six tube neotrodynes, superheterodynes, etc. using the 201-A type tubes. Great volume, range and sensitivity. The Junior has a 30 inch air column, Senior, 54 inch air column.



**The Barcelona**

A very attractive speaker table of Spanish design equipped with 54 inch air column. A beautiful cabinet that is also designed to accommodate any standard radio set. **Price \$42.50**

Manufacturer  
**OPERADIO MFG. CO.**  
 St. Charles, Illinois  
 Greater Chicago District



**THE WESTMINSTER**

The newest and finest of the Operadio Air Column Speakers embodying all that is new and beautiful in design. May be connected to any set and will handle the output of any standard amplifier system up to and including the 171 tube [171 push-pull excepted]. Has a 61 inch air column. **Price \$35.00**



**The Bel Canto**

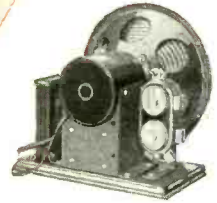

**The Operadio Dynamic Unit**

Incorporates decisive improvements in power reproduction. Manufactured under special Operadio designs to handle the output of the largest sets built regardless of the stages of power amplification used, without trace of distortion, blasting or rattling.



**The St. Charles**

A beautiful cabinet model Dynamic Speaker which will handle and give tremendous volume with undistorted tone fidelity. Recommended for sets employing power tubes or equipped with separate amplifiers using power tubes.

6 volt D. C. \$70; 110 volt A. C. \$90

**The Bel Canto**

Obtainable with an 84 inch air column or Dynamic unit, 6 volt D. C. or 110 volt A. C. [with or without an Operadio four or five tube amplifier]. Amplifiers may be used in combination with either air column or Dynamic units.

**Price Range, \$80.00 to \$250.00**

Sales Department  
**THE ZINKE COMPANY**  
 1323 S. Michigan Ave.  
 Chicago, Ill.

# 7 Reasons why YOU should handle CECO TUBES

## 1 A Quality Product

Scientifically made on the most modern tube making equipment in the largest plant devoted exclusively to Radio tube making. Rigid inspections and tests assure unvarying uniformity.

## 2 Consumer Acceptance

Known and accepted nationally as one of the three standard makes of tubes—a matter of great importance to the busy dealer.

## 3 More Profit

The only standard tube manufacturer offering greater profit-margin with its resultant greater profit making possibilities.

The additional profits you make on CeCo Tubes go a long ways toward helping to carry the load of operating overhead.

## 4 Complete Line

Every radio requirement is met with the CeCo line in both A.C. and battery types and rectifiers—a feature that eliminates duplication of stock and permits of sales concentration on one brand.

## 5 Special Type Tubes

CeCo exceeds all other manufacturers in the making of Special Purpose Tubes—both battery and A.C. types—for which a definite demand has been created—adding tube sales possibilities not offered by any other brand.

## 6 Liberal Replacement Policy

A CeCo dealer has the advantage, although seldom exercised, of making adjustments and replacements at the point of purchase.

## 7 Advertising

Ceco dealers will be supported by the Ceco Broadcasting each week over the 17 stations of the Columbia System, together with extensive newspaper and magazine advertising.

# LONGER LIFE



MEMBER  
RMA

PRONOUNCED  
SEE - CO

# Radio Tubes

*Repeat sales — the  
best evidence*

Legions of CeCo Tube users repeat on Ceco Tubes because of the improvement they give in reception—increased sensitivity—more volume—greater clarity, and, of prime importance—longer life—due in part to the exclusive CeCo process of evacuation.

Read at the left the seven reasons why you should handle CeCo Tubes! The CeCo is a tube proposition unequalled in sales and profit making possibilities.

*Ask us for interesting and unusual piece of printed matter entitled "Getting the most out of your Radio", also catalogue sheet.*

**CeCo MANUFACTURING CO., INC.**  
PROVIDENCE, R. I.



THE spacious and thoroughly modern All-American Mohawk Plant, operated under the strict supervision of eminent radio engineers, is adequately equipped with facilities essential to precision in every stage of production and the rigid maintenance of the highest attainable degree of excellence—assuring uniformity of quality and unfailing dependability.

# Centralization

of capital experience, manufacturing facilities

## Reduces Costs—Improves Quality

MERGER of two veterans in the radio field, The Mohawk Corporation of Illinois and the All-American Radio Corporation—trailblazers and originators of refinements that contributed to the advancement of radio, created a mighty organization comprised of well-qualified experts. Through the sound, scientific and unfailing principle of Centralization it has provided a line of Radios of unsurpassed sensitivity, selectivity, precision of operation, naturalness of tone, beauty of design and finish—yes—“Radio’s Realistic Close-up”—at prices never before approached for true economy.

Probably never in the history of Radio have dealers been extended values of so irresistible a character—so many selling advantages and buying appeals. Quality, variety, beauty, dependability, money-saving prices—every element essential to substantial business development!

The All-American Mohawk Corporation dealer franchise is worthy of investigation and serious consideration. It grants more than the mere privilege of All-American Mohawk Cor-

poration representation. In reality it is a definite trade treaty with a progressive, aggressive, thoroughly experienced and entirely capable manufacturing and merchandising organization that extends unstinted co-operation, assuring peak sales and increased profits. It embraces tested, highly productive plans for trade promotion. It is a pledge of the loyalty and support of a firmly established manufacturer—a guarantee of business permanency on a most satisfactory and profitable basis. Sign and mail the coupon for complete details. Let your own unbiased judgment weigh the worth of All-American Mohawk Corporation products and determine the many money-making advantages of our liberal dealer-franchise.

All-American Mohawk Corporation,  
Dept. 47, 4201 Belmont Ave.,  
Chicago, Illinois

Without obligation on our part send us complete information regarding your 1928-29 Dealer Franchise and profit privilege.

Name \_\_\_\_\_  
Street \_\_\_\_\_ State \_\_\_\_\_  
City \_\_\_\_\_

# All-American Mohawk Corporation

4201 Belmont Avenue    Department 47

CHICAGO, ILLINOIS



# Bremer-Tully Announces New and Improved Radio Models

A widely extended line of *amazing values*—sixes, sevens and eights—

Your supreme opportunity for *bigger profits* and *added prestige*.



**B-T 6-41**  
With  
Magnetic  
Speaker  
**\$190.00**

**B-T 8-21**  
With  
Dynamic  
Speaker  
**\$375.00**

**B-T 6-40** \$130.00

**B-T 7-71**  
With Magnetic  
Speaker **\$245.00**  
With Dynamic  
Speaker **\$280.00**

**B-T Speaker**  
Magnetic  
**\$35.00**  
Dynamic  
**\$65.00**

**B-T 7-70**  
**\$150.00**

**B-T 8-20**  
**\$130.00**

*Time  
Tried  
and  
Time  
Proved*

**Be There  
with BT**

Every feature of this bigger and better B-T line reflects the extensive radio experience of the manufacturer.

Seven years of outstanding achievement and success is behind it.

Furniture of surpassing beauty.

Performance beyond anything at equal prices.

Selling policies that consistently protect the dealer.

No essential to radio merchandising success has been overlooked.

Get the B-T line now!

*The coupon will bring further details.*

..... COUPON .....

Name .....

Address .....

City..... State.....

**Bremer-Tully Mfg. Company**  
656-662 Washington Blvd., Chicago

# POOLEY

## RADIO CABINETS

Approved for  
**ATWATER KENT RADIO**

The new Pooley Radio Cabinets are ready.

The Pooley distributor in your territory has the full line for you to see and hear.

Those who saw the line at the Trade Show realize that there is a big profit opportunity in it.

To those who did not get to Chicago—write or phone your Pooley distributor for photographs and full details. Better still, visit him and see what Pooley has to offer for 1928-29.



THE POOLEY COMPANY  
 1600 Indiana Avenue  
 Philadelphia, U. S. A.

Mr. Atwater Kent says:  
 "The new line of Pooley Radio Cabinets is certainly very interesting and should appeal to all those who want the highest type of modern radio furniture.  
 "For this reason, I heartily approve of their use with Atwater Kent Radio for 1928-29."

(Signed)

*A. Atwater Kent*

# Kellogg Radio

*The Line for Dealers Who Pick Their Manufacturers with the Same Caution They Pick Their Merchandise . . .*

Merchandise is important, of course. But the stability and the permanence of the manufacturer behind that merchandise is also of vital importance.

The institution behind the Kellogg line means everything to the dealer who looks to the future, as well as to the present profits. A third of a century of successful manufacturing experience; unquestioned financial stability; a record of genuine accomplishment in radio development; these are the things—in addition to merchandise—that have influenced far-sighted dealers and distributors to tie up to Kellogg.



A real price leader  
Model 518, \$225.00

## 6 Magnificent Models— Every One a Leader In Its Price Class

Models 514, 516,  
517, and 519  
have built-in  
speakers



Model 514, \$495.00



Model 519, \$275.00  
Model 516, \$375.00



Table Model 515,  
\$169.50



Model 517, \$775.00

### A Wide Price Range \$169.50 to \$775.00

This wide price range gives you a Kellogg set to meet every demand of your better class trade. It pays to push Kellogg because every sale means an *extra profit*—the difference between what you would make on a \$100.00 set and the profit on the Kellogg \$169.50 Model—or between a \$250.00 set and the Kellogg at \$375.00. You get these extra profits, not on one sale alone, but on every one of the future sales that a Kellogg Radio is certain to make for you.

All Models priced  
complete with  
Kellogg AC Tubes

The season is almost upon you. No time to delay! Write or wire us that you are interested and we will send a representative to give you full details concerning the Kellogg Line and Kellogg merchandising plans for Fall.

**Kellogg Switchboard & Supply Company**  
Dept. B-547, CHICAGO • Members R. M. A. and N. E. M. A.



# "I wish you could see how this Tube is made"

*Paul C. Wittman*  
President



I WISH that every radio jobber and dealer could visit our factory and see how carefully and conscientiously each La Salle High Vacuum Tube is built. You'd understand then why this tube requires from two to four times as much factory and laboratory time as is used to build the ordinary tube.

The superiority of the La Salle High Vacuum Tube—proven by matchless performance in the hands of users everywhere—is the result of a policy that demands the utmost in quality and in advanced methods of manufacture.

That is why we stand back of La Salle A. C. Tubes with a rigid guarantee. Jobbers who realize the importance—and profits—in handling high quality tubes are invited to write for complete information.

Manufacturers  
LA SALLE RADIO CORPORATION  
149 West Austin Avenue, Chicago, Illinois

Sole Distributors  
MATCHLESS ELECTRIC COMPANY  
143 West Austin Avenue, Chicago, Illinois



Two A.C. Types { I. S. 227  
I. S. 226  
Other Standard Types for Battery Power

# La Salle

## HIGH-VACUUM TUBES

# RED LION CABINETS

Built Exclusively for  
ATWATER-KENT-RADIO

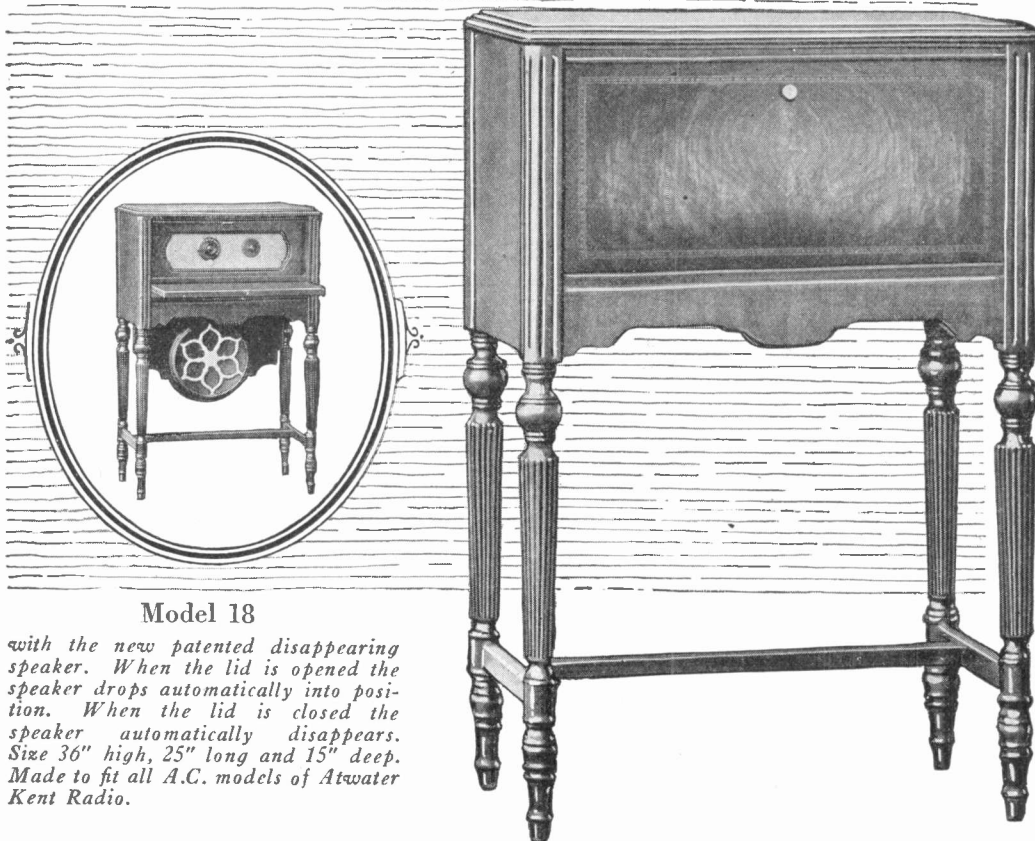

Model 18

with the new patented disappearing speaker. When the lid is opened the speaker drops automatically into position. When the lid is closed the speaker automatically disappears. Size 36" high, 25" long and 15" deep. Made to fit all A.C. models of Atwater Kent Radio.

## ANNOUNCING Another really exclusive RED LION Feature—the Patented Disappearing Speaker

For the past two years Red Lion Cabinet Company has specialized in producing radio cabinets of real individuality. As these cabinets have been made only for Atwater Kent Radio Sets, they have afforded Atwater Kent dealers an exclusive line of radio furniture.

This season Red Lion has gone a step further in offering the dealer a cabinet with a patented feature which *cannot* be duplicated by other manufacturers. This is the disappearing speaker as shown in Red Lion Model 18.

Red Lion Cabinets will be nationally advertised as usual.

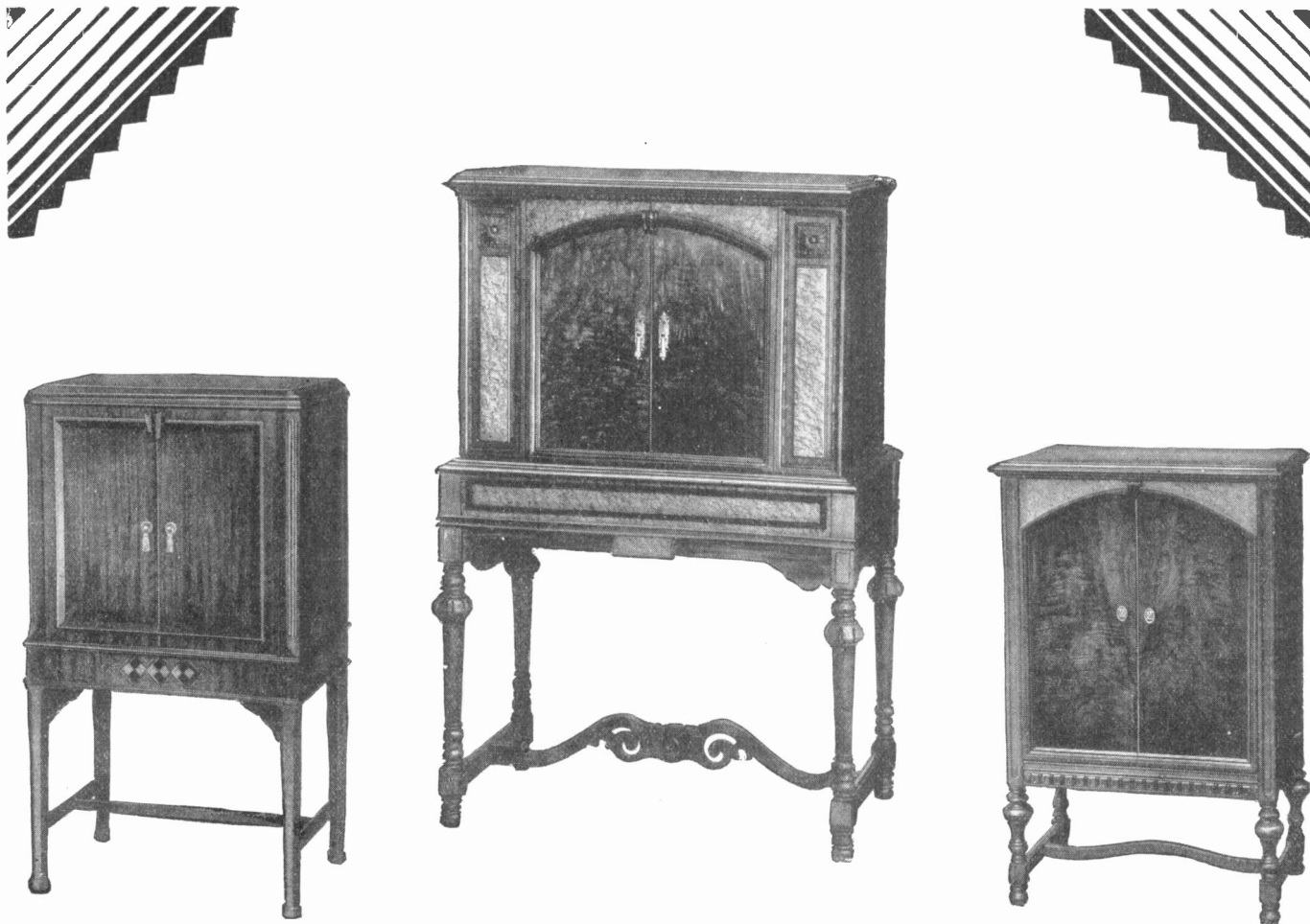

## ADLER-ROYAL RADIO CABINETS

At the R. M. A. Show in Chicago, shrewd buyers, with sensitive fingers on the pulse of public preference, bought these three models in solid carload lots—dozens of them.

Again the tireless efforts of Adler artisans to produce advanced creations—to keep abreast the remarkable improvements of radio—are crowned with the greatest acceptance in our history.

We thank the entire industry—manufacturer, jobber and dealer. More than ever before they know it speeds their sales to say, "Cabinet by Adler-Royal."

Write for copy of "The New 200 Series" just off the press—it will help you.

ADLER MANUFACTURING CO.  
Incorporated  
LOUISVILLE, KENTUCKY



# . . . . . The Flewelling Short-Wave Adapter Opens a Vast New Field for Immediate Radio Sales . . . . .

SHORT wave reception, heretofore impossible for individual set owners, is now an engaging reality—summer programs, usually spoiled by static, are picked up with amazing clearness—International programs become daily entertainment—London and other foreign stations are heard consistently—all made possible by the A-C DAYTON-Flewelling Short-Wave Adapter.

This remarkable device, invented by E. T. Flewelling, one of radio's foremost engineers, is far and away the most important radio development announced in 1928. It was the sensation of the R. M. A. Show in Chicago, last month, attracting the attention of all who are interested in the distribution and sale of radio.

The A-C DAYTON-Flewelling Short-Wave Adapter may be instantly attached to any ordinary radio receiver without additional wiring, adapting the set for

short wave reception. The retail price is only \$22.50, placing it within reach of all set owners, and opening up a vast new market for immediate sales. (Already twenty-six U. S. Stations are broadcasting on short wave lengths.)

In step with A-C DAYTON'S progressive policy and immediately following Mr. Flewelling's announcement that the Short-Wave Adapter had been perfected, negotiations were consummated whereby the A-C DAYTON Company acquired exclusive manufacturing rights and Mr. Flewelling was retained as Consulting Engineer.

Alert distributors and retailers the country over have quickly sensed the significance of these announcements—every mail brings urgent inquiries for territorial rights. The coupon below is for the convenience of those who wish to send for full particulars.

THE A-C DAYTON COMPANY  
DAYTON, OHIO, U. S. A.

### SPECIFICATIONS

Wave length range 18-80 meters, has 3 plug-in coils for 3 wave length ranges—17-29, 27-48 and 47 to 84 meters, which are the only active broadcast bands. Additional coils for other waves can be supplied, if desired. No additional tubes or batteries required. No wiring change in your set. Adapter comes complete, housed in a handsome cabinet which will harmonize with the finest of radio furniture.

©1928, T A-C D Co.



E. T. Flewelling, noted Radio Engineer and Inventor.

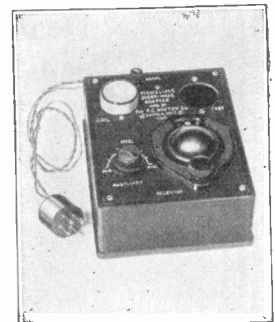

The A-C DAYTON-Flewelling Short-Wave Adapter—Retail price \$22.50

# A-C DAYTON RADIO

**Distributors**  
Many excellent territories are yet to be assigned. Wire or use the coupon today, requesting full particulars.

**Retailers**  
If your jobber is not already supplied, write direct, giving us his name and address.

The A-C DAYTON Company, Dayton, Ohio.  
Gentlemen:

I want more information about the A-C DAYTON-Flewelling Short-Wave Adapter and the new A-C DAYTON line of receivers. Please rush your reply to

Name .....Address .....  
City .....State .....

Please state whether jobber or dealer.



# Slagle Radio

To the same new and revolutionary circuit which made Slagle Radio so outstanding last year, valuable additions and refinements have been made, until the performance of the new Slagle challenges detection from the actual broadcast.

Naturally Slagle standards of quality cannot include the lower reaches of radio's price range, as almost every conceivable feature providing beauty, convenience, power, range, and richness of musical expression is abundantly supplied.

For the Nineteen Twenty-Eight and Nine season the trade mark above will identify five console models which we sincerely believe to be the finest built in quality radio today,—two of them including a phonograph combination.

If the June Trade Show in Chicago is a fair criterion, this season will show an unprecedented demand for radio of the higher type, for people are fast realizing how distinctly different good radio really is. This should be especially interesting to Distributors and Dealers,—it means real business, real profits, and fewer service calls.

*Write or wire us for complete facts  
on the Slagle line.*

## Slagle Radio Company

Fort Wayne, Indiana

*Division United States Electric Corporation*

*Licensed under patents of Radio Corporation of America and associated companies—  
also The Technidyne Corporation*



# FADA Radio



## THE FADA "10"

Operates from A. C. light socket (90-130 Volts, 25 or 60 cycle) — Single dial — Uses 6 tubes and rectifier — 7 tubes total — Illuminated Station Finder — Adjustment for long or short antenna — Smooth volume control — Completely shielded — Self-contained in handsome velvetex-finished cabinet.

WITHOUT TUBES

**\$110**

## IT'S HERE

THE BIG PARADE IN RADIO — BEYOND QUESTION — IS THIS NEW

## FADA "10"

A. C. ELECTRIC

An outstanding value — where price and precision meet —

**AT \$110**

Sales volume — Profits are yours — if you own the FADA FRANCHISE — Get in line early — join the PARADE OF PROFITS — Get in touch with your nearest Fada jobber — or write us — for open locations and the most profitable franchise in radio.

F. A. D. ANDREA, INC., Long Island City



# **The World over without exception**



## *leading manufacturers build* **LEKTOPHONE** *licensed speakers*

### **These are the LEKTOPHONE LICENSEES**

#### In United States:

*American Bosch Magneto Corp.  
Amplion Corp. of America  
Brandes Products Corp.  
Farrand Manufacturing Co.  
Marcus C. Hopkins  
O'Neil Radio Corp.  
Pathe Phonograph & Radio Corp.  
Radio Corporation of America  
Radio Foundation, Inc.  
Stromberg-Carlson Tel. Mfg. Co.  
J. S. Timmons, Inc.  
United Radio Corp.  
Utah Radio Products Co.*

#### Added since last announcement:

*Atwater Kent Manufacturing Co.  
Grigsby-Grunow Company*

#### Throughout Europe:

*Standard Telephones & Cables, Ltd.*

Joint Licensor

It is easy, more satisfactory and, in the long run, more profitable to sell standard products . . . built by standard manufacturers . . . licensed under recognized, meritorious patents.

Without exception, the leading loud speaker manufacturers have recognized the superiority of LEKTOPHONE construction. They manufacture under LEKTOPHONE licenses.

LEKTOPHONE licensed speakers are now produced by the fifteen foremost loud speaker manufacturers in this country, by the largest European companies, and are installed in the more expensive instruments sold by the three leading phonograph companies in America.

In the field of *dynamic drive* loud speakers, LEKTOPHONE licensees have the benefit of basic patents which are essential.

*You can depend on the products  
of LEKTOPHONE Licensees.*

**LEKTOPHONE CORPORATION •**  
**15 Exchange Place, Jersey City, New Jersey**

# Day-Fan RADIO

The New Standard for Radio of Tomorrow

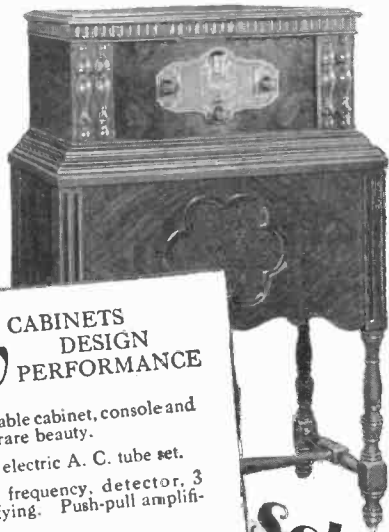
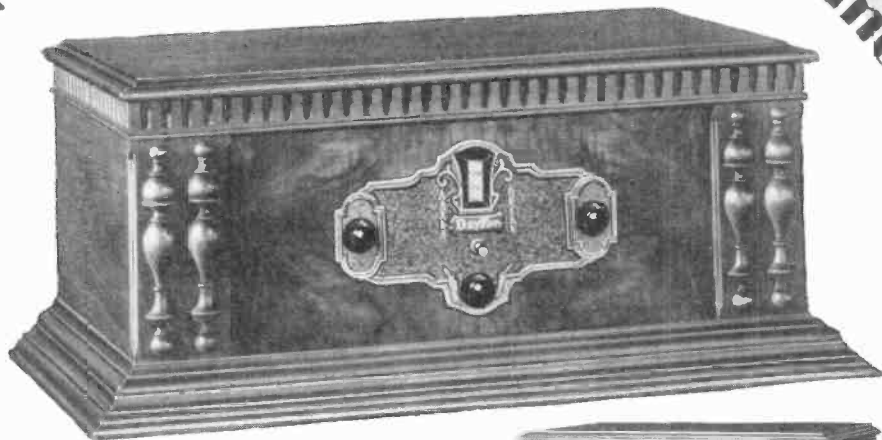

Tone

Selectivity Beauty

## New CABINETS DESIGN PERFORMANCE

American walnut table cabinet, console and consolette of rare beauty.

Self-contained all electric A. C. tube set. 8 tubes—4 radio frequency, detector, 3 audio amplifying. Push-pull amplification.

Complete shielding.

Single illuminated dial control.

Beauty of tone; increased selectivity; sensitiveness; full volume without distortion.

Table model, less tubes and speaker \$150.00

Console with built-in speaker, less tubes \$295.00

Consolette (table and speaker) \$55.00

Day-Fan Electric Co.  
Dayton-Ohio



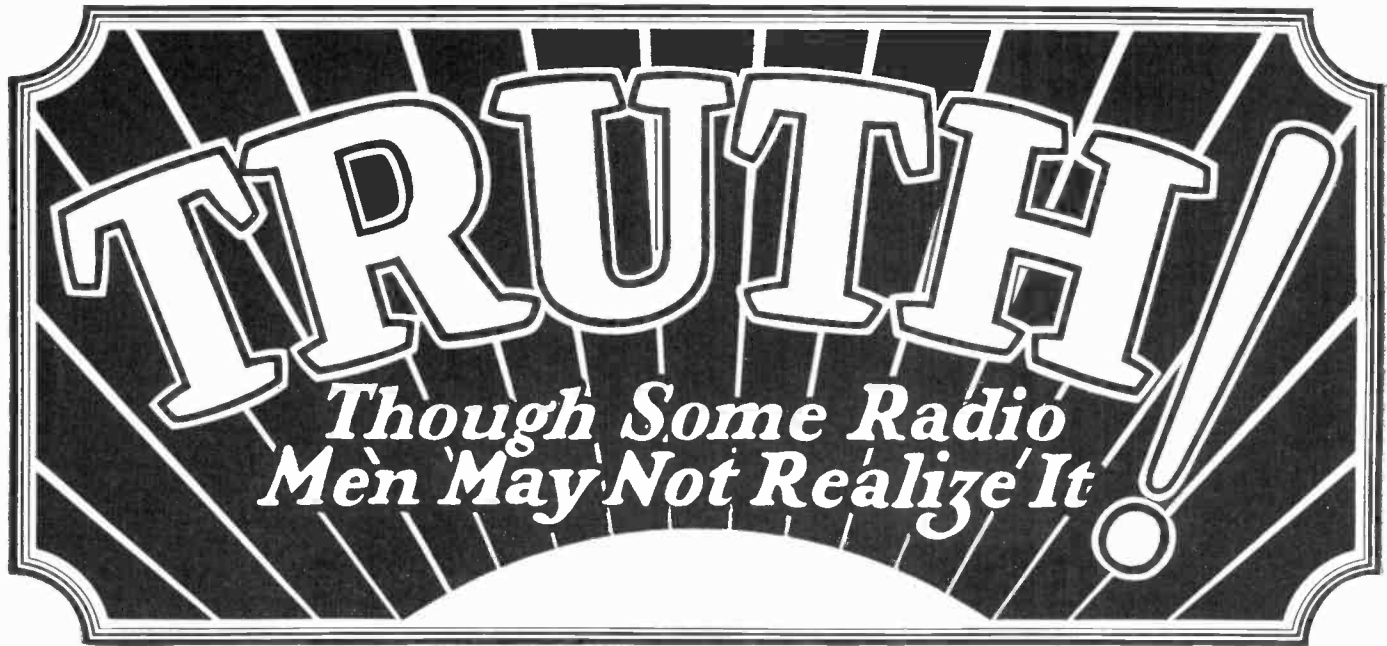

**W**HY will a sensible hard-headed radio buyer suddenly turn philanthropist under the influence of some genial, entertaining and clever talk?

Why will a radio man forget radio—forget the fundamentals of *performance*, perfect mechanism and eye value—and buy radio like the cowboy of years ago used to fight—“without fear or judgment.”

“I’ll take ten carloads,” he’ll say when his business judgment should prompt him to reply “tell it to Sweeney.”

Salesmen’s methods in selling radio are frequently 20 years behind the times. They still sell good fellowship, entertainment, “what my company will do,” etc. The last thing they think of is—*the radio set itself!*

If he could take a phonograph record of the conversation and play it to himself in his more reasonable moments perhaps the radio man would realize the truth of this.

Yet, after all, what brings in the profits and customer good will? What spreads the fame of a dealer? *The performance and reliability of the radio he sells!*

Shamrock has maintained this fact for years. Amidst a thousand conflicting claims we have merely said this:

“Here is a fine receiver—built by engineers, styled by artists. Here is a radio that gives all the necessary volume and distance plus unusual selectivity and tonal value. We believe it will stand up against any in the country. Let *performance* be the test.

“Now there are many good receivers on the market. *We know* that mechanically Shamrock ranks at the very top. *We know* that it has built customer good will for thousands of dealers throughout the country. *We know* that it will bring profits to you. Why not hear it demonstrated?”

*Shamrock Cabinets are available in finishes to accord with every color scheme—Antique Walnut, Chinese Green Lacquer, Mandarin Red Lacquer, Ebony, Ivory, and Crackle. Their beauty of design and decorative hand-carved wood panel make them effective on any type of table, cabinet, or console, yet they are modestly priced at only \$95 list*

**Everybody likes a Shamrock**

**SHAMROCK**  
ELECTRIC RADIO

LEADERS BY PROVEN PERFORMANCE  
SHAMROCK MANUFACTURING CO.

152 Summit Street . . . . . Newark, N. J.





**MODEL 109  
COMBINATION CONSOLE**  
With Dynamic Cone Reproducer, electric phonograph turntable, and space for radio receiver. Has radio-phonograph selector switch.



**MODEL 959 LARGE CONSOLE**  
Designed for large size A. C. receivers such as R. C. A. Model 18 and others. Equipped with Dynamic Cone Reproducer for light socket operation. Blank panel furnished, cut to fit any standard receiver.

# Radio Reproducers

## Dynamic, Magnetic and Air Column

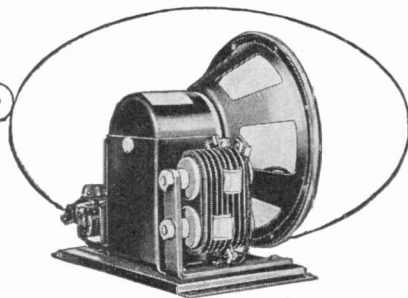

### HEART OF NEWCOMBE-HAWLEY DYNAMIC CONE REPRODUCERS

A remarkable free-floating cone unit of unsurpassed tone quality and plenty of volume. Furnished in chassis form if desired for battery or A. C. light socket operation. Special condition equalizer assures perfect reproduction.



**MODEL 929  
SMALL CONSOLE**  
Designed with compartment above reproducer grill to hold the average receiver. Blank panels cut to fit any standard receiver. Equipped with Dynamic Cone Reproducer for either storage battery or light socket operation.



**MODEL 969  
PORTABLE**

Equipped with D. C. Dynamic Cone Reproducer for Battery operated sets or A. C. Dynamic Cone Reproducer for light socket operation. Condition equalizer is provided for controlling quality of reception.

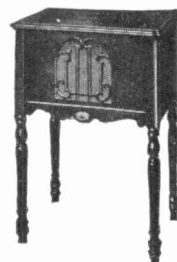

**MODEL 909 TABLE**  
With D. C. or A. C. Dynamic Cone Reproducer. Wide enough to hold most radio receivers.

## Newcombe-Hawley Air Column Reproducers

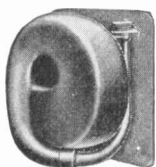

**MODEL 70  
AIR COLUMN UNIT**  
Has Baldwin Rival Unit and 86-inch air column. Furnished without cabinet.



**MODEL 73  
DRUM REPRODUCER**  
Equipped with genuine Nathaniel Baldwin Unit. Air column 54 inches long.

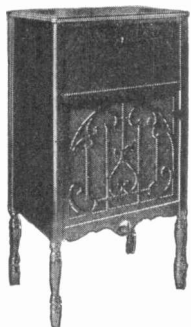

**MODEL 72 CONSOLE**  
Has 72-inch air column reproducer and Nathaniel Baldwin Unit. Accommodates popular radio sets.



**MODEL 71 TABLE**  
A popular table reproducer wide enough to hold most radio receivers. Equipped with Newcombe-Hawley 72-inch air column and genuine Baldwin unit. Cabinet in walnut with gold cloth grill.

Never before has such an outstanding and complete line of radio reproducers been offered to the radio trade by one manufacturer. The 1928-1929 line of Newcombe-Hawley Radio Reproducers includes the three most successful types.

Alert radio dealers and jobbers will instantly appreciate the enormous sales advantage of the complete Newcombe-Hawley line. Pave the way for profitable reproducer business by hooking up with Newcombe-Hawley.

Write for literature today

**Newcombe-Hawley, Inc.**  
201 First Ave., North  
St. Charles, Ill.



## Newcombe-Hawley Magnetic Cone Reproducers

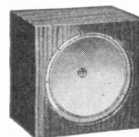

**MODEL 80  
MAGNETIC CONE**  
A powerful magnetic cone of exceptional tone quality. Furnished in chassis form with plain wood box.



**MODEL 83 PORTABLE**  
A beautiful portable reproducer with a high quality magnetic cone unit. Furnished in burl walnut cabinet with cloth grill.

### NEWCOMBE-HAWLEY MAGNETIC CONE REPRODUCERS

are popularly priced and meet the demand for a high grade radio reproducer that will give excellent results with practically any type of radio receiver.

Model 83 Portable lends itself readily to use with any interior appointments.

Model 81 Table will accommodate any radio receiver although it is designed particularly for all-electric sets.



**MODEL 81 TABLE**  
For large receivers such as R. C. A. Model 18 all-electric sets. Has magnetic cone reproducer under table.

# NEWCOMBE-HAWLEY

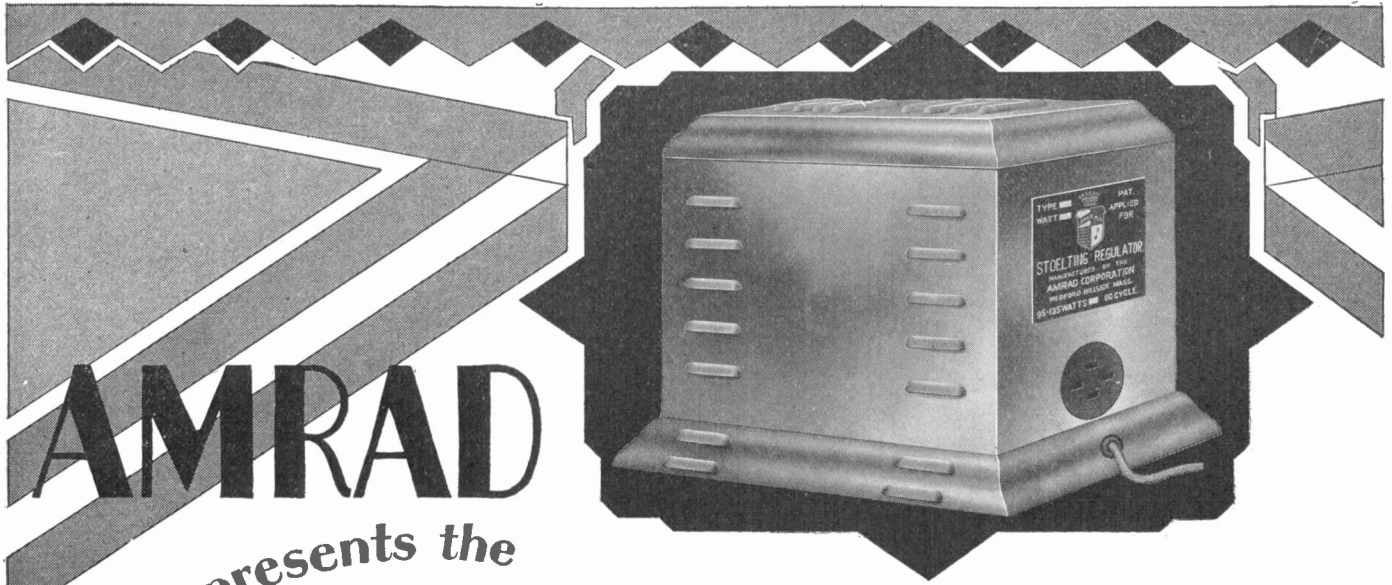

**AMRAD**

presents the

# Voltage Regulator

*Preserves and lengthens  
the life of A.C. tubes. . . . .  
Keeps the flow of current  
at one level. . . . .  
Requires no adjustment.*

- (1) Maintains practically constant voltage input to the receiver even though the line voltage fluctuates from 95 to 135.
- (2) The Stoelting Regulator functions in a manner to control or adjust the voltage applied to the receiver so that just the proper voltage is applied to the receiver at all times regardless of the line voltage at the light socket which enables the best operation on the receiver.
- (3) Very compact and simple to install.
- (4) Employs usual plug connection to lamp socket.
- (5) Very simple, nothing to get out of order, no replacements, will last a lifetime.
- (6) Made in following sizes:  
 Type A—60 watts—60 cycle  
 Type B—120 watts—60 cycle  
 Type C—60 watts—25 cycle  
 Type D—120 watts—25 cycle
- (7) The Stoelting Regulator will operate receivers regardless of the number of tubes employed. It greatly prolongs life of radio tubes.
- (8) A boon to owners of radio receiving sets in localities where line voltage is constantly either excessively high or excessively low.
- (9) The addition of the regulator adds practically nothing to the cost of operating the receiving set.
- (10) The Stoelting Regulator will operate all types of receivers which operate on lighting current from commercial light service.

If you want to eliminate most of your trouble with A.C. tubes—and at the same time have your customers get *better* radio results—you'll sell them the Amrad Voltage Regulator. It has no moving parts and is entirely automatic; functions permanently without a touch or a thought.

Type A . . . . . List \$18  
 Type B . . . . . List \$25

See your nearest Amrad Distributor—  
 he has them

**The AMRAD Corporation**

Medford Hillside, Mass.

J. E. HAHN, *President*

POWEL CROSLY, Jr., *Chr. of the Board*

Manufacturers of the Symphonic Series of Electrical Radio Receivers.

# Replace your old radio!

## Seven and a half million sets now obsolete

### 1928 Features

Few radios AT ANY PRICE combine ALL of these features which are essential to today's new radio reception.



**AMPLIFICATION**

Neutrodyne 10-10-10-1000  
Other systems 5-5-5-125

**Crosley Radios tune efficiently**  
Crosley Neutrodyne circuit is sharp, sensitive and selective. Distant stations are easily found. Local stations tune without squealing.



**Crosley Radios are shielded**  
Each element shielded from each other provides maximum selectivity and is featured in the most expensively made sets.



**Crosley Radios are selective**  
In crowded districts where many local stations fill the air you find in Crosley radio a means of listening to ONE at a time.

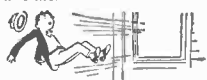

**Crosley Radios have volume**  
Volume may be increased to tremendous proportions without distortion. This provides plenty of volume for power speakers.



**Crosley Radios can be softened to a whisper**  
A positive volume control enables operator to cut any program down to faint and scarcely audible reception.



**Crosley Radios fit any kind of furniture**  
Outside cases are easily removable and chassis are quickly fitted into any type of shape console cabinet.  
**Crosley Radios have illuminated dials**  
The modern way enables you to see clearly in the dusk or in corners.

Your set has served you well *but you will not be satisfied with its strained stringy tones when you hear a new full toned power speaker Crosley set*

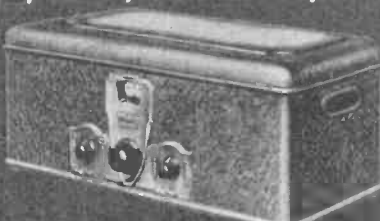

**\$25** New Dynamic **DYNACONE**  
Amazing Speaker

6 tube **GEMBOX** \$65  
AC ELECTRIC

### FIVE DAYS' FREE TRIAL IN YOUR OWN HOME

Crosley originated the idea of a national policy of home demonstration. Home is the place to buy a radio set. Compare a Crosley radio set with any other that you are contemplating buying and you will choose the Crosley. If you have electric current in your home, your set should be a modern, AC electric receiver. A converted battery set is out of date. If you pay more than \$65.00 for a radio set, it should have two 171 output tubes, push-pull instead of one, eight tubes instead of seven. To be up-to-date, your new radio set should be designed to take and supply the current for a power or dynamic type of speaker. Crosley sets are so designed. Other sets designed for power speaker use are much more costly. You should demand the tone quality and the performance resulting from high power output coupled with dynamic speaker. Your set should be completely shielded and incorporate the highly sensitive, genuine, neutrodyne circuit. It should have a modern illuminated dial. An examination of Crosley radio sets will show you many other modern exclusive features.

**\$25.00 NEW DYNAMIC DYNACONE AMAZING SPEAKER!**

The Dynacone is a new revolutionary speaker at a price less than many good magnetic speakers. The first minute you hear this new reproducer, it will thrill you to a new conception of what radio broadcast reception should be. Crosley manufacturing speed and straight line methods permit the extremely low price.

**WHY PAY MORE THAN CROSLEY PRICES?**  
We urge you to listen to a

Crosley radio set, try it, put it to any test you can think of. No sets that approximate Crosley prices can compare in performance. Why pay a high price for a set that can compare favorably with Crosley?  
**SIX TUBE GEMBOX AC ELECTRIC, \$65.00**  
Self-contained AC electric receiver. It utilizes two radio, detector, two audio and a rectifier tube—471 power output tube. Designed for use with the new Crosley Dynamic power speaker. Operates from 110 volts 60 cycle AC house lighting current.

*Crosley prices do not include tubes*

### 1928's greatest radio



**8 tube SHOWBOX \$80**

Genuine Neutrodyne, 3 stages radio amplification, detector, 3 stages audio (last two being 171 push-pull power tubes) and 280 rectifier tube.



**8 tube JEWELBOX \$95**

Genuine Neutrodyne 3 stages radio amplification—227 detector tube 3 stages audio frequency, and 280 rectifier. Shielded coils, modern illuminated dial, highly selective and powerful.



**6 tube BANDBOX \$55**

An improved model of the 1927 receiver that led the world to better radio. Genuine Neutrodyne—every modern fitting and refinement including illuminated dial. The set you can safely buy where AC current is not available.



**5 tube BANDBOX Jr. \$35**

Operates entirely from dry cells and is especially designed where no electric current is available either for AC radio or recharging storage batteries.



**Improved MUSICONE \$15**

The outstanding Magnetic type speaker available, still maintaining its leadership, today, as from its inception in 1925.

# CROSLEY



When the pennant winners meet...

*...You're there with a Crosley*

The Crosley Radio Corporation

Power Crosley, Jr., Pres.  
Cincinnati, Ohio.

Montana, Wyoming,  
Colorado, New Mexico  
and West, prices slightly higher.

Your name.....  
Address.....

**5 DAY FREE TRIAL COUPON**

Mail this coupon to the factory. Nearest dealer will bring you receiver checked.

Please let me try receiver and proper speaker. I have checked, in my own home without obligation for 5 days.

JEWELBOX  SHOWBOX   
GEMBOX  BANDBOX  BANDBOX JR.



# Music Trades Welcome these New Master Models



**CARRYOLA NO. 40—\$35**  
*Very handsome. All metal parts gold plated; Patented, exclusive Bakelite tone arm and reproducer; Patented diaphragm; velvet turntable and Automatic stop. This new design is also provided with a patented, built-in Wood Record Container—50-inch air column, new type horn chamber and a motor that plays three full selections without rewinding. Beautifully finished in heavy Black or Brown Fabrikoid. Weighs only 23 pounds.*



CARRYOLA is the center of interest wherever dealers come together in quest of money-making ideas.

They recognize in these new Master models quick-selling features never before incorporated in musical instruments selling at a low price. They welcome the Carryola Line of New Improved Portable Phonographs, however, not merely because they sell for so little money but, principally, because of their superior quality, purity and richness of tone, mechanical excellence and outstandingly beautiful appearance.

The all-important advantage of the Carryola line to you as a dealer is in its unquestioned popularity. Everybody knows Carryola. As the dominating factor in the portable phonograph business, Carryola sales will continue to give you prestige and leadership that attracts trade and increases profits for you the year round.

See and hear the marvelous new Carryola models at your Jobber's or write us direct.



**THE CARRYOLA COMPANY OF AMERICA**  
*The World's Largest Manufacturers of Portable Phonographs*  
 645 Clinton Street, Milwaukee, Wisconsin

**CARRYOLA NO. 30—\$25**  
*With long air column horn chamber of unique design; Patented, exclusive Bakelite tone arm and reproducer and Patented diaphragm. Motor will play three selections without rewinding. Velvet turntable—finished in new special design Fabrikoid, in Black, Blue, Green, Red and Brown.*

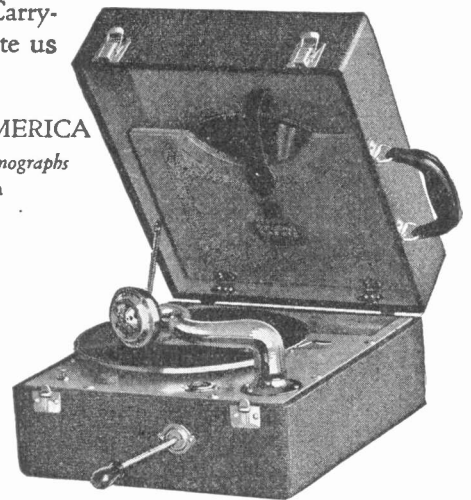

**CARRYOLA NO. 20—\$15**  
*New type air column horn chamber and other substantial improvements make this new model by far the greatest value ever offered below \$25.00.*

**CARRYOLA ELECTRIC PICK-UP**  
 replaces the reproducer of the phonograph

By inserting the Adaptor plug in the detector tube socket of the Radio Set—phonographic records played on any phonograph may be electrically reproduced through the Radio Loud Speaker, volume control being a mere matter of turning a single knob.

This attachment may be used with any standard Radio Set and any Phonograph.

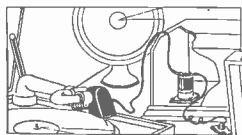

**CARRYOLA ELECTRIC PICK-UP**  
 for use with any radio set and any phonograph  
 \$7.50 list.

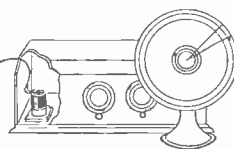

**CARRYOLA PORTO PICK-UP**  
 \$20.00 list, regular model  
 \$38.50 list, with electric motor

**CARRYOLA PORTO PICK-UP**

To attach, simply replace the detector tube of radio set with adaptor plug. Play records as usual—but thru the loud speaker with all the added volume and tone richness characteristic of electric reproduction.

The Carryola Porto Pick-Up is equipped with single-spring motor at \$20.00 list or with electric motor at \$38.50. The pick-up or electrical reproducer is attached to a curved throw-back arm which makes it easy to change needles. Volume control on motor-board regulates volume anywhere within limits of receiving set and speaker. Box beautifully finished in durable Fabrikoid, nickel-plated fittings.

# Carryola

BEYOND THIS YOU BUY FURNITURE

# AFTER ALL Isn't It Radio PROFITS That Count?

By C. R. STRASSNER, President and Treasurer



**Y**OU can't be eight years in the radio manufacturing business and not learn something.

We've learned what the permanent kind of radio dealer wants—and we've learned to want that kind of dealer. Our proposition is planned for him.

While we have been making money in radio for eight years we have also been seeing that our dealers made it too. That's why our company and our dealer organization are both strong today.

Point for point, you'll find the A-C DAYTON franchise a mutual profit maker, based on a

four model line that will go out and sell on straight competitive demonstration. It starts at \$65 list, has an up-to-the-minute all electric set for \$98, offers power amplifier performance for \$123 and ends with a de luxe model that amplifies 3200 times. That's exactly six times average efficiency.

Our distributors cover their terri-

tories closely, see you often and fill orders promptly. All our advertising is concentrated on our dealers' immediate markets - newspapers, sectional farm papers, displays and literature that go directly and specifically to the people you can do business with.

There's no guess-work about this. We've proved it out since 1921. *You'll find it more profitable to sell A-C DAYTON than to sell against it.*

Let us lay our full proposition before you. Clip the coupon to your letterhead and send it today. You'll get an immediate answer to consider and decide on.

## A-C DAYTON RADIO

THE A-C DAYTON COMPANY, Dayton, Ohio  
Gentlemen: Please send complete details about your dealer's franchise.

Name.....  
Address.....

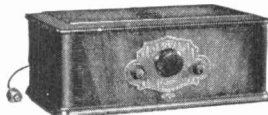

AC-63, SELF CONTAINED ALL-ELECTRIC: a 6-tube receiver complete for light socket operation except for tubes and speaker. May be used with any type speaker. Power tube takes full rated voltage. A reliable electric set listing \$98, except Canada and West. Model XL-61 listing at \$65, is same as AC-63, except that it is battery operated.

AC-65, at right, has same characteristics as AC-63 except that it uses 210 power amplifier in last stage, giving electrical power amplifier results. \$123, except Canada and West.

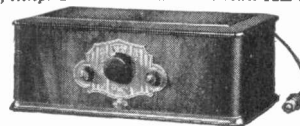

# Tables and Console Cabinets Specially Designed and Built for A-C DAYTON . .



*This handsome speaker table stands 34 in. high, 27 in. wide, 18 in. deep. Suitable for use with any A-C DAYTON model.*

Any 1929 A-C DAYTON Model is equally well adapted for this Table and Console. With only a small stock, dealers may offer eight different combinations of sets and furniture, complete with reproducers, in addition to the four standard cabinets produced by the

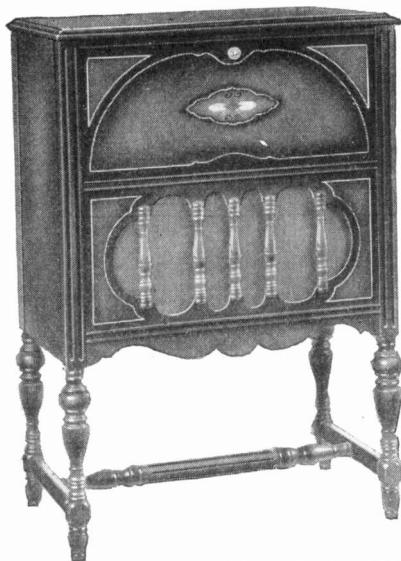

A-C DAYTON Company. Send for complete information and name of nearest distributor.

*Chillicothe Console, measures 42 in. in height, 28 in. in width, and 17 in. in depth—compact and graceful. The set compartment is 9 1/2 in. high, 25 in. wide and 13 in. deep.*

**CHILLICOTHE  
FURNITURE COMPANY  
CHILLICOTHE, MISSOURI**

Radio Furniture by  
Caswell-Runyan—  
*as fine in reputation as in  
workmanship!*

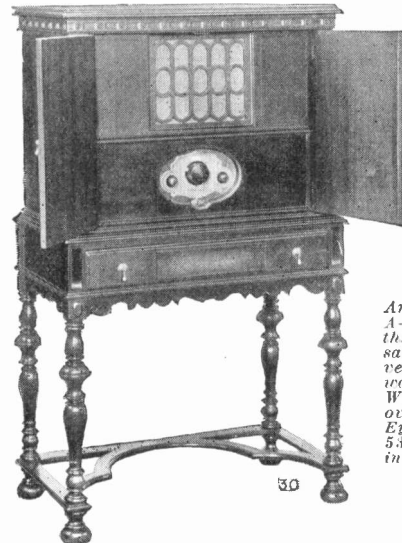

*Any new model A-C DAYTON fits this Console. Quarter sawed Red Gum, veneered with 4-way matched Butt Walnut; drawer overlaid with Bird's Eye Maple. Height 53 in.; width 32 1/2 in.; depth 18 in.*

A-C DAYTON dealers, in building permanent patronage, will consider two things: (1) that Caswell-Runyan designs and workmanship have earned their recognition as cabinet builders to America's finest makes of radio—(2) that this same excellence builds reputation for dealers who sell Caswell-Runyan cabinets.



*Top of 5-ply, 4-way matched Butt Walnut and Bird's Eye Maple overlay on drawer front are features of special beauty in this table. Walnut finish, durable, satin. Height 30 in.; width 32 1/2 in.; depth 18 in. Fits any 1929 model. (A-C 63 shown.)*

*For name of nearest distributor and other information address*

**THE CASWELL-RUNYAN CO.  
HUNTINGTON, INDIANA**



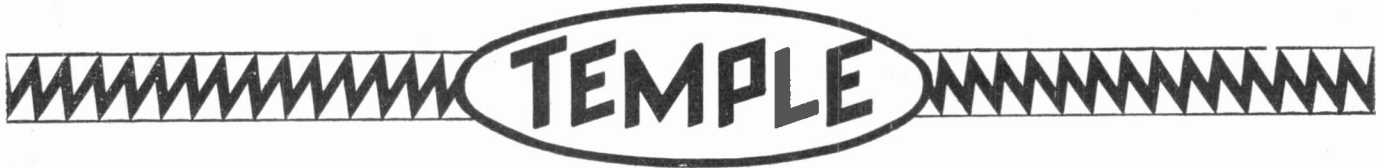

# New Temple Speaker

## Center of Attention at R.M.A. Show



U. S. Pats. Pend.

### Model 15 Air Column Speaker

Model 15 is the refined and improved air column speaker—the same type of speaker upon which Temple success was founded—but now better than ever. \$29.00.



U. S. Pat. No. 1,672,796

### Model 20 Air Chrome Speaker

Model 20 Temple Air Chrome represents a sensational new development in loudspeakers. The open radiator consists of two sections instead of one, driven by the powerful Temple Double Action Unit, thus substantially increasing the volume and tonal range. \$35.00.

**A** GAIN Temple engineering has set another standard. Again has Temple leadership in reproducer design been acknowledged by the trade from one end of the country to the other. 3,000 of the country's leading buyers—men who recognize and demand the finest in reproducer quality and workmanship—registered at the Temple exhibit—and bought. The Temple demonstration was easily one of the "high-spots" of the show—"Temple" was the talk of almost every gathering.

The new Temple line is more attractive than ever before. Two new table models are the major items—one, the famous Temple Air Column Speaker of new and improved construction, and the other, the new and sensational Temple Air Chrome Speaker. Both are outstanding for their faithful reproduction, response to all frequencies and ability for handling tremendous volume without distortion.

The refined beauty of their design, the genuine walnut panels lend an eye appeal which is bound to be a big sales factor.

These two speakers together with a complete line of both Air Column and Air Chrome models for cabinet installation offer you in one complete line reproducers that will meet every speaker requirement—all backed by Temple reputation, skill and manufacturing excellence.

*Write today for complete information.*

**TEMPLE, INC.**

1929 S. Western Ave., Chicago, U. S. A.

**LEADERS IN SPEAKER DESIGN**



# Busy Clerks mean Busy Cash Registers

**Y**OU are always trying to sell people the music in the air, yet, you know downright well the music sweetest to your ear is the ring of the cash register checking up another sale and the scurry of your clerk's feet as he hurries to wait on the next customer.

The busier your clerks are kept, the more merrily the cash register rings.

The best way to keep your clerks active making sales is to keep yourself and them absolutely up-to-date on everything in the radio line—and that is why you should subscribe for

## RADIO RETAILING

Every month it brings you the up-to-the-minute authentic information from the nation-wide radio market. Our editors covering all parts of the country bring to you all the most effective sales campaigns and cost saving plans, etc., used by both leading and smaller dealers.

Get Radio Retailing. Keep it for your clerks to read or even better, subscribe for individual copies for each man or woman on your sales force.

It will pay you to do this for this big magazine on yearly subscription costs less per month than you pay for a cigar. \$1 per year—less than 9c per month. Send the attached coupon now—and you will get July's issue, which will contain a complete report of the big Radio Trade Show.

Clip here

This space is the exact size of a one-dollar bill.

Get one and try it

then

—pin it on

—stick it on

—or send it loose with the coupon

to

**Radio Retailing**  
Tenth Ave. at 36th St.  
New York, N. Y.

6 Sp.



Name .....

Street .....

City.....

State .....

Name of Company .....

Besides Radio We Sell .....

For the dollar bill attached I want to subscribe to Radio Retailing for one year starting with the next issue.

This Special Offer is for cash with order only

# NEW BIRNBACH ACCESSORIES

## Birnbach Acid-Proof Battery Cables



For Every Circuit and Purpose

These Battery Cables are composed of Stranded Wires insulated with Colored Rubber and enclosed in an attractive Braid over all wires. For use in connecting A, B and C Batteries or Eliminator to Set. Furnished with brass soldered lug terminals on all ends for neat and quick attaching of cable to batteries or eliminator. Each wire of separate Solid Color. Made in 5, 6, 7, 8, 9, or 10 Wires.

110— 5 Wires, 54 inches	\$0.50
111— 6 Wires, 54 inches	.60
112— 7 Wires, 54 inches	.70
113— 8 Wires, 54 inches	.85
126— 9 Wires, 54 inches	1.00
119—10 Wires, 54 inches	1.15

## The New Birnbach 10 Foot Battery Cable

Now you can place the Batteries or Eliminator in the basement or in another room—away from the Set with the BIRNBACH 10 Foot Battery Cable. All ends of wires complete with Soldered Lugs for neat and instant attaching of Cable to the Set and Batteries or Eliminator.

114— 5 Wires, 10 foot	\$1.25
116— 6 Wires, 10 foot	1.55
117— 7 Wires, 10 foot	1.85
118— 8 Wires, 10 foot	2.15
127— 9 Wires, 10 foot	2.45
128—10 Wires, 10 foot	2.75

## Birnbach Riga Battery Cable



This Cable is made of flexible stranded wires, and insulated with Colored Rubber. The wires for the A Battery are made of heavier gauge conductors and assembled with storage battery clips. Other wires furnished with Soldered Lugs. A Battery Cable for Heavy-Duty Service.

100— 5 Wires, 60 inches	\$1.00
160— 5 Wires, 54 inches	.90
161— 6 Wires, 54 inches	1.05
162— 7 Wires, 54 inches	1.20
163— 8 Wires, 54 inches	1.40
164— 9 Wires, 54 inches	1.55
165—10 Wires, 54 inches	1.70
150— 5 Wires, 10 foot	1.60
152— 6 Wires, 10 foot	1.80
153— 7 Wires, 10 foot	2.25
154— 8 Wires, 10 foot	2.55
155— 9 Wires, 10 foot	2.85
156—10 Wires, 10 foot	3.15

## BIRNBACH Extension CORDS

ATTENTION! RADIO DEALERS

Hundreds of people who bought their Radio Sets from you last fall and winter need Birnbach Extension Cords and extra Loud Speakers that can be placed in any room or on the porch and lawn and be entertained.



## New Birnbach Moisture-Proof Extension Cord Units

You can move your Radio Speaker into any room desired—bedroom, kitchen, dining room, baby's room, or living room, by connecting the cord of your Speaker to the BIRNBACH EXTENSION CORD UNIT. Attaches instantly. BIRNBACH CORDS are made of Stranded Copper wires and insulated with rubber to protect the Copper Strands from moisture; which causes leakage from one conductor to another, and covered with a beautiful brown mercerized braid. All Cords furnished with Connectors.

166— 10 foot, complete	\$0.75
120— 20 foot, complete	1.00
121— 30 foot, complete	1.40
122— 40 foot, complete	1.80
123— 50 foot, complete	2.20
124—100 foot, complete	4.20

## Replacement Cords

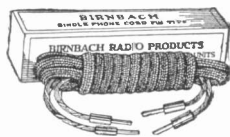

These Cords are used in replacing worn-out cords from head sets or loud speakers. Five feet long.

102—Speaker Cord with Pin Tips	\$0.35
103—Speaker Cord with Pin and Spade Tips	.35
106—Speaker Cord with Pin and Eye Tips	.35
104—Head Set Cord with Pin Tips	.50
105—Head Set Cord, Pin and Spade Tips	.50
107—Head Set Cord with Pin and Eye Tips	.50

## Birnbach Cords In Beautiful Silk Colors



Now you can select a BIRNBACH CORD to harmonize with the Color of the baseboard in the home.

Made in OLD GOLD, MAROON, and WHITE.

A Color to satisfy every possible taste.

620—20 foot White Silk Cord	\$1.50
621—20 foot Old Gold Silk Cord	1.50
622—20 foot Maroon Silk Cord	1.50
630—30 foot White Silk Cord	1.90
631—30 foot Old Gold Silk Cord	1.90
632—30 foot Maroon Silk Cord	1.90
650—50 foot White Silk Cord	2.75
651—50 foot Old Gold Silk Cord	2.75
652—50 foot Maroon Silk Cord	2.75

## Birnbach Cord Connector

Made in one piece. Built to withstand heavy wear and abuse. Neat in appearance—easy to use. Cord tips can be attached quickly without the use of tools.



151—Cord Connectors Only, each.....\$0.35

## Battery Connectors



Made of Stranded Wires insulated with rubber and covered with a distinctive braid. All ends assembled with brass soldered lug terminals to fit the binding post or clip on all batteries. A handy accessory for use in connecting Dry Cell "A" Batteries, B and C Batteries. Carton contains 25 of each size.

RC 3— 3 in. Connectors, each	\$0.04
RC 6— 6 in. Connectors, each	.05
RC 8— 8 in. Connectors, each	.06
RC12—12 in. Connectors, each	.07

"SOLD THROUGH YOUR FAVORITE JOBBER"

BIRNBACH RADIO CO., 254 West 31st Street, New York, N. Y.



For Conventions, Theatres, Schools, Athletic Contests, Races, Fairs, etc.

## Announcing a Larger Power Amplifier "Pam 19 or 20" to Supplement "Pam 16 or 17"

Type "PAM" 19 is for all ordinary types of loud speakers

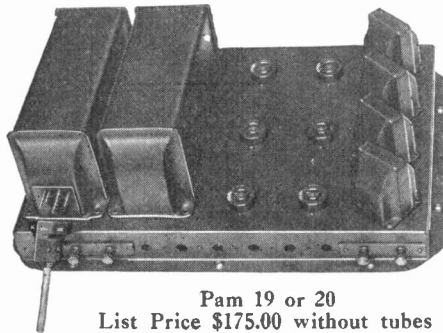

Type "PAM" 20 is for and supplies field current to dynamic type speakers

Pam 19 or 20  
List Price \$175.00 without tubes

Equal to two or three PAMS 16 or 17 in power output, this all-electric *three-stage* audio amplifier with the famous Symphonic and Symphonic Push Pull Transformers uses AC tubes and operates from 110 volt 50-60

cycle current. Compensation is provided for line voltage variation. It is designed to meet Underwriters and A. I. E. E. Standards. Tubes required are 2 UX250's, 2 UY227's, and 2 UX281's.

General Offices  
Canton, Mass.



Factories  
Canton and  
Watertown, Mass.

Send for Bulletin B1 descriptive of this amplifier and many others.

**BEEDE  
A-C LINE TESTER**

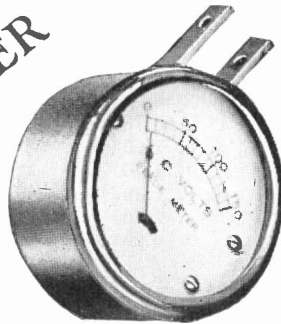

**A Fast Selling Necessity  
with a Good Profit**

Plug into any Electric Light Socket or Receptacle and know accurately your line voltage.

Every Electric Set owner should have one of these Testers. **SHOW IT AND SELL IT.**

Small in size but with a scale that can be easily read.

**LIST PRICE \$3.00      DEALERS COST \$1.50**

If your Jobber cannot supply you we will ship you direct. Six or more shipped prepaid—Less than 6 add 10c. each for postage and packing.

There's a Beede Meter for every Radio use.

**BEEDE ELECTRICAL INSTRUMENT CO.**  
136 Liberty St., New York



**JUNIOR, A.C. Chassis Only.....\$ 87.50**  
(7 tubes and one rectifier)

**STANDARD, A.C. in Cabinet.....\$132.50**  
(8 tubes and one rectifier)

**STANDARD DE LUXE, in Spinnet  
Table with Bench, Invisible Air-  
chrome Speaker .....\$195.00**

*Write for franchise—also for our agency for battery to A.C.  
conversion of radio receivers.*

**THE LANGBEIN-KAUFMAN RADIO CO., Dept. M.**  
62 Franklin St., New Haven, Conn.

**Only reliable products can  
be continuously  
advertised**

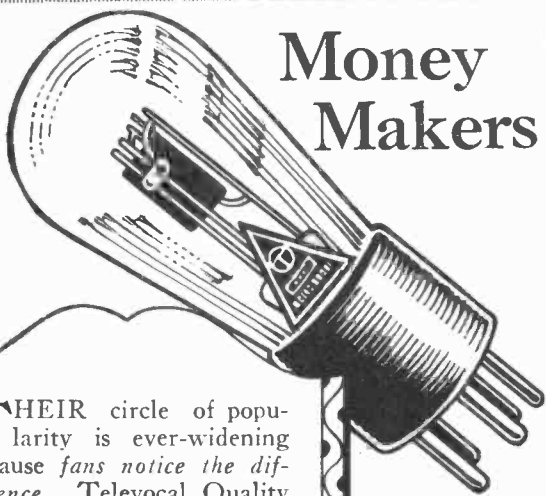

## Money Makers

THEIR circle of popularity is ever-widening because fans notice the difference. Televocal Quality Tubes are made in all standard types.

Write for full description and prices.

Televocal Corporation  
Televocal Building  
Dept. E-2, 588 — 12th Street,  
West New York, N. J.

# Televocal

## Quality Tubes

## You're the Goat

if you pass the Buck

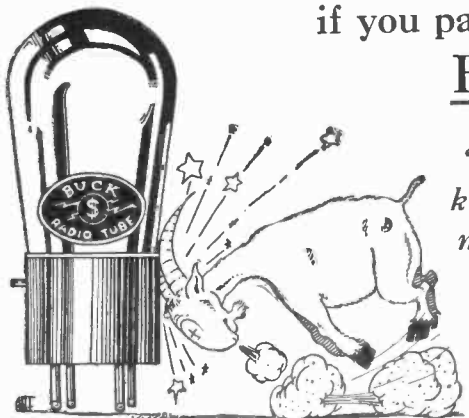

"Not a kick in a million"

"The Tube that stands the test"

YOU are missing hundreds of bucks that you could easily be gathering in selling these popular tubes.

Just think of it! The popular 201A retailing at \$1.00 or one buck, also the 199 (all types) at \$1.00 or one buck. Better look into this complete line of Buck Tubes. It includes all A.C. and D.C. types.

Buck up! Ask us for the details of our merchandising plan, featuring attractive and original posters and displays.

"Guaranteed for six months"

Distributors—Jobbers—Dealers

Write today.

UNIVERSAL ELECTRIC LAMP CO.  
Newark, N. J.

# TAKE TIME to investigate!

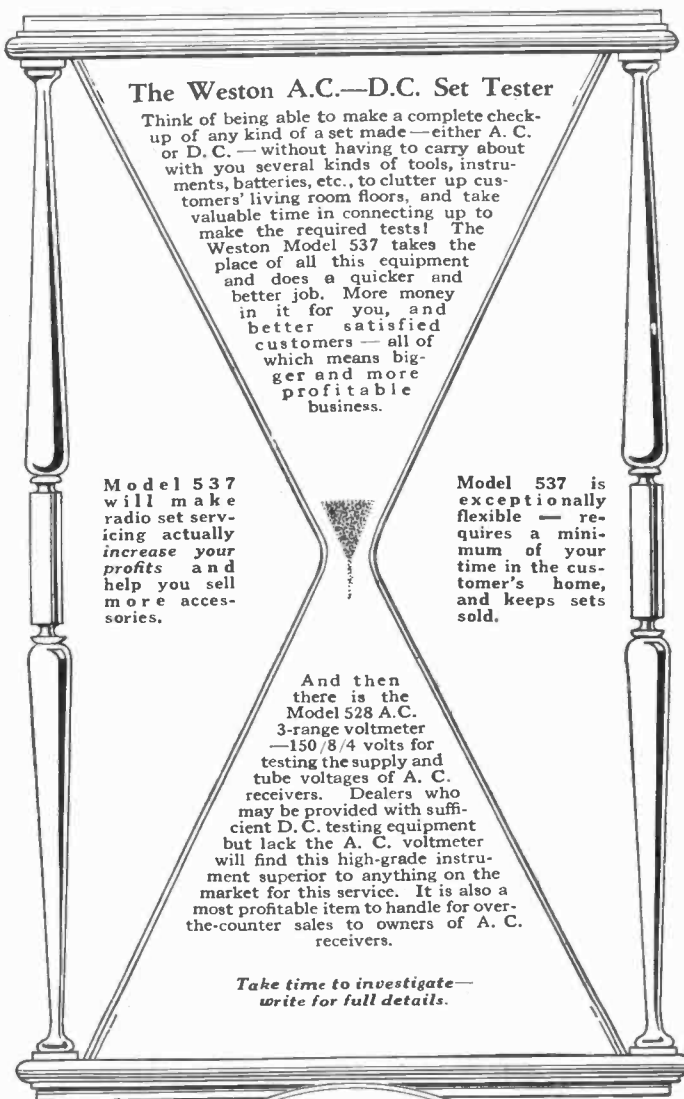

### The Weston A.C.—D.C. Set Tester

Think of being able to make a complete check-up of any kind of a set made—either A. C. or D. C.—without having to carry about with you several kinds of tools, instruments, batteries, etc., to clutter up customers' living room floors, and take valuable time in connecting up to make the required tests! The Weston Model 537 takes the place of all this equipment and does a quicker and better job. More money in it for you, and better satisfied customers—all of which means bigger and more profitable business.

Model 537 will make radio set servicing actually increase your profits and help you sell more accessories.

Model 537 is exceptionally flexible—requires a minimum of your time in the customer's home, and keeps sets sold.

And then there is the Model 528 A.C. 3-range voltmeter—150/8/4 volts for testing the supply and tube voltages of A. C. receivers. Dealers who may be provided with sufficient D. C. testing equipment but lack the A. C. voltmeter will find this high-grade instrument superior to anything on the market for this service. It is also a most profitable item to handle for over-the-counter sales to owners of A. C. receivers.

Take time to investigate—write for full details.

## Weston

PIONEERS SINCE 1888

## INSTRUMENTS



Model 537



Model 528

WESTON ELECTRICAL INSTRUMENT CORP.  
581 Frelinghuysen Avenue, Newark, N. J.

# Readrite

## UNIVERSAL TEST SET

*Tests A.C. and D.C. Circuits  
Quickly Locates Set Troubles*

Standard with No. 215 Tube Tester, list price \$12.50, and No. 346 Voltmeter, range 0-300 volts, list price \$5.00. Optional with No. 347 Voltmeter, 0-500 volts, for \$1.00 additional. Tube Tester plugs into socket from which tube to be tested has been removed. A practical outfit for service man or set owner.

### Readrite Meter Works

Established 1904

6 College Ave. Bluffton, Ohio

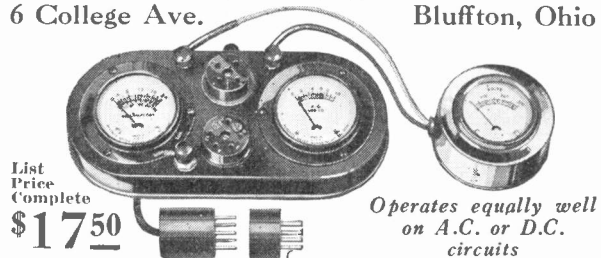

List  
Price  
Complete

\$17.50

*Operates equally well  
on A.C. or D.C.  
circuits*

## HIGH POWER CORDS & CABLES

Gavitt cords and cables are made to give unusually good service. They are moisture proof so that there is no loss in signal strength. Conductors are covered with rubber and a high grade mercerized braid to stand lots of rough usage. Conductors are twisted to eliminate induced AC hum. The Bakelite cord connectors are shock proof and each cord will stand up to 7000 volts.

Jobbers and Dealers will find an unusually good proposition in handling Gavitt products. We have the right product at the right price to assure your making a good profit—and we help you to sell. Better write and ask us about our Dealer proposition.

Manufacturers who want service as well as quality should know the Gavitt line. We can assure prompt deliveries during the busy season and are regularly supplying most of the Eastern manufacturers with our cords and cables. It would pay you to inquire into our prices so why not write to-day?

**GAVITT MFG. CO.**  
BROOKFIELD, MASS.

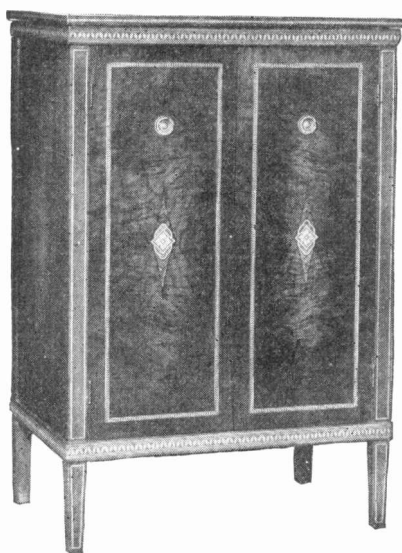

### Classic Beauty in ASTON Design

is uniquely displayed in this ideally proportioned cabinet. Full length doors of matched butt walnut are embellished with imported marquetry inlay in a distinctive motif at once rich and restrained. The entire cabinet is of 5-ply walnut. Interior grille polychromed. Learn all about the interesting Aston line. Write for our catalog.

### ASTON CABINET MANUFACTURERS

*Distinctive Originality in design of  
High Grade Radio Cabinet*

1223-1229 W. Lake St., CHICAGO, ILL.



The New

## Nassau

*Electric Power  
Receiver*

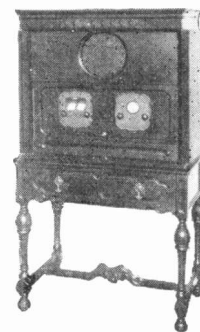

THE last word in radio—a custom-built receiver for those who want the best in reception and appearance.

Uses AC tubes with new 250 power output tube. Built-in dynamic speaker. Gives perfect reproduction of every tone.

The new Nassau is sensitive, highly selective with perfect control of line voltage. Provision for electric pickup.

Three Exquisite Cabinet Styles

Distributors—choice territory still open. Write for our new profit plan. Ask for circular "R."

**Nassau Radio Co. Inc.**

20-22 Bergen St., Brooklyn, N. Y.

Established in 1922 and makers of electric sets exclusively since 1926.



# Protects A-C Sets—Improves reception!

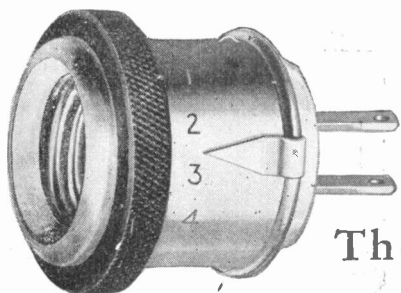

Sold in a display carton, 10 to a box. \$2.25 each list. 40% discount.

Excessive voltage harms A-C sets and ruins tubes. They are built to operate on a line pressure of only 110 volts. In many cities the normal line voltage is from 112 to 118 volts. In most cities, too, the voltage so varies that, at certain times of the day, it is high enough to burn out the tubes and seriously to harm the step-down transformers.

## The WIRT A-C Voltage Regulator No. 211

protects sets from "surges" and excess voltages. It prevents tubes and other parts from burning out. It banishes A-C "hum." At the same time, it enhances the tonal quality of the set and gives more perfect reproduction of music and speaking voice.

Assure satisfaction of installations, *save your service time*, banish customer troubles—*make added profits* by advising and selling the WIRT A-C Voltage Regulator No. 211. Standard discounts. All jobbers can fill your orders. Or write direct to:

Makers of  
"DIM-A-LITE"  
and  
"DIM-A-LAMP"

# WIRT COMPANY

5221 Greene Street

Philadelphia, Pa.

New York, N. Y.  
Hathaway & Co., Inc.  
16-22 Hudson Street

Chicago, Ill.  
Geo. Richards & Co.  
557 W. Monroe Street

San Francisco, Calif.  
James J. Noble Company  
915 Bryant Street

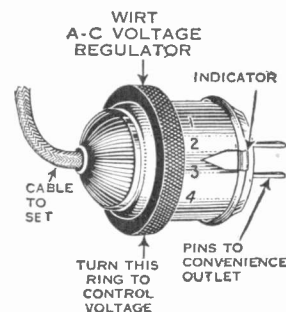

# No Set Is Better Than Its Aerial

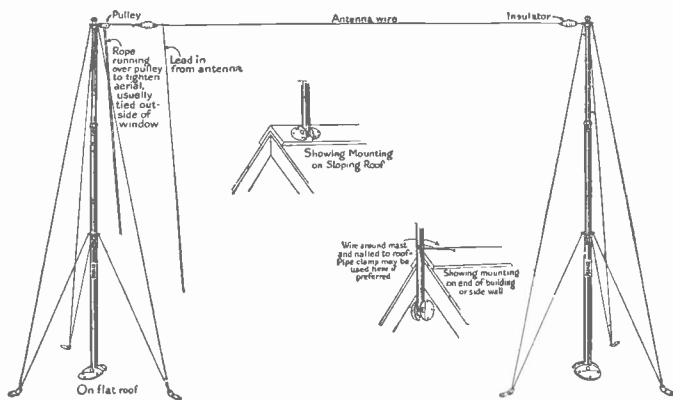

There's a neat, sturdy, easily erected Premax steel mast, umbrella aerial, spreader, insulator bracket or other convenient accessory for every occasion.

You'll save a lot of service calls and unreasonable complaints if you install the kind of aerials that meet the various conditions under which your sets operate.

The Premax Service Manual, illustrating and describing many practical methods of approved aerial construction, will be mailed promptly on request. Why not send for it today?

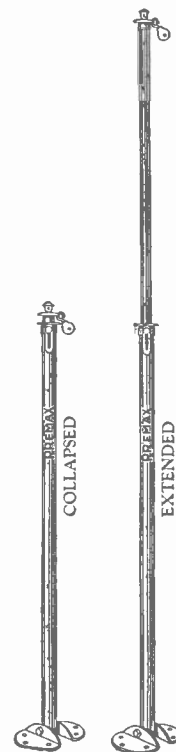

## NIAGARA METAL STAMPING CORPORATION

Dept. RR 7-28

Niagara Falls, N. Y.

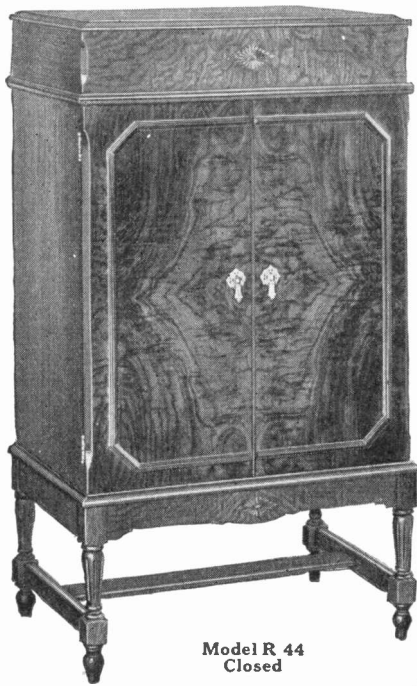

Model R 44  
Closed

# The New "Excello" Combination Phono-Radio Console

*Meets the most exacting demand  
for Beauty and Quality*

The very attractive model illustrated, No. R 44, is of highest grade cabinet work with selected matched butt walnut doors and rich piano finish. Sliding drawer accommodates any radio set up to twenty-four inches long. Equipped with phonograph turntable, G E Electric Phonograph motor, switch and adapter, volume control, electric pick-up with tone-arm and automatic shut-off attachment. Also Cone or Dynamic speaker.



Model R 44  
Open

Dealers and Distributors ask for particulars of Franchise Proposition.

## EXCELLO Radio Consoles

Nationally Advertised—Sell the Excello—Nationally Preferred

WRITE FOR CATALOG  
OF COMPLETE LINE

### EXCELLO PRODUCTS CORPORATION

4834 W. 16th St., CICERO, ILL. (Suburb of Chicago)

Pacific Coast Representative: Pacific Sales Corporation, 426 Larkin St., San Francisco, Calif.

## CASE RADIO

**A Complete Line  
of Fine Radio Sets  
from \$98 to \$500**

*With the Strongest Selling Feature in  
the Field—O. A. P.!*

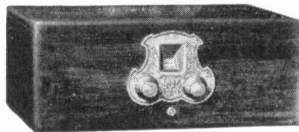

Model 67A

Seven tube A. C. Neutrodyne Receiver. Single Drum Dial Control; beautiful wood cabinet, including A. B. C. power supply built-in, but easily accessible. Price complete but less all tubes. . \$98.00  
O. A. P. Rating 620,000.

Here is radio value expressed in terms your trade will understand, appreciate and prefer. The new Case measures up to the most exacting 1928 standards of perfect radio reception.

It is the first set to be rated for O. A. P. (Over-All Power) an unbiased comparative test of radio set efficiency which gives the

actual amplification of an entire set, based upon N.E.M.A. standards created by the Institute of Radio Engineers.

No competing radio set anywhere near the price of the Case has greater power or beauty of design.

This season the public wants to know what it is paying for. O. A. P. will be the outstanding feature of the industry as a result of this demand.

Be the first in your community to introduce this big selling idea.

Send for a treatise on the O. A. P. theory

**CASE ELECTRIC CORPORATION**  
DIVISION UNITED STATES ELECTRIC CORP.  
MARION INDIANA

**POWER PROVES THE CASE**

# Jobbers and Dealers Agree:

*"The demand  
grows and grows  
—and seemingly  
is endless."*

## Majestic

**ELECTRIC RADIO**

GRIGSBY-GRUNOW COMPANY

General Offices

4540 Armitage Ave., Chicago, Ill.

## B.M.'S HOME BROADCASTER



fool your friends—

be your own broadcaster

**This is the product—judge its sales merits yourself:—**

An adapter plug that slips into the detector tube socket of any radio set, with a long extension cord that reaches into another room or closet, where you talk into a microphone and broadcast via the loudspeaker. Get some friends together, tune in on your favorite station, ease out of the room, to the Broadcaster microphone, and at an opportune moment, simply press the switch button, automatically cutting off radio reception—and make a station announcement from Paris or Shanghai, give a wrong time signal, make some intimate remarks about your friends—say anything! Then release the button and let the program continue. *It fools everybody!* . . .

**and sells in a steady stream wherever it is displayed.**

The Home Broadcaster can be left permanently connected to the set as it will not interfere with radio reception. It is absolutely noiseless and will give clear and undistorted reproduction. It is small, light and compact and can be easily slipped into the pocket to be taken to a party. It is unnecessary to change any of the set wiring or make changes in the battery connections.

Type UX, for sets using 4-prong Detector Tubes.

Write for descriptive circular.  
List Price  
**\$7.50**  
Complete

Type AC, for sets using 5-prong Detector Tubes.

**BROOKLYN METAL STAMPING CORP.**  
728 Atlantic Ave., Brooklyn, N. Y.

See our Exhibit at Chicago Trade Show, Booth No. 146

N. Y. Sun

One of the bright spots at the annual R. M. A. show at the Stevens Hotel in Chicago is the neon lighted filament on the giant A. C. shield grid tube at the Arcturus booth. Aside from the interest displayed in this novel exhibit, there is evidence at the show an undercurrent of serious thought directed toward

## ARCTURUS thanks the trade

THE talk of the R.M.A. Show—**ARCTURUS A-C Tubes.**

Many manufacturers are standardizing ARCTURUS in their sets; jobbers and dealers everywhere are handling ARCTURUS—the tubes with long-life, greater volume, better tone quality and absolute reliability.

Still a few choice territories open for the ARCTURUS 2-profit line. Write for the ARCTURUS proposition.

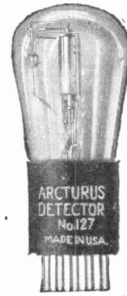

Write for details of the new low-voltage line of ARCTURUS A-C Tubes.

Booklet 20 sent upon request

ARCTURUS RADIO CO. NEWARK, N.J.

# ARCTURUS

A-C LONG LIFE TUBES

**For Real Radio Profits**

Sell **PREMIER AC RADIO**

**under your own private label!**

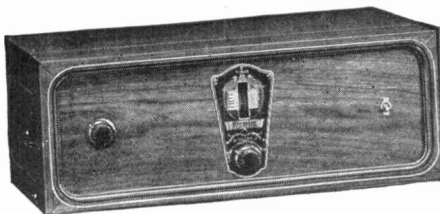
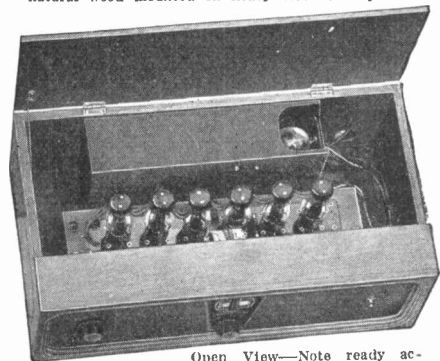

Table Model. Solid walnut Cabinet, front panel natural wood mounted on heavy steel back panel.



Open View—Note ready accessibility of tubes, power supply, etc.

A Quality Product—sold under Unconditional Guarantee—everything one can ask for in radio—Looks—Performance—Price. Table and Console Models.

Made for either type AC Tubes 5-No. 227 and 1-No. 171, or 5-No. 401 and 1-No. 403. Licensed under U. S. Navy Patents and Hogan Patent No. 1,014,002.

Send inquiries now. Line up for next fall.

**PREMIER ELECTRIC COMPANY**

Dept. 1124. 3800 Ravenswood Ave., Chicago, Ill.  
Established 1905—Radio Since 1920

## WASMUTH - GOODRICH Radio Furniture

is distributed only by

**Symphonic Sales Corp.**  
370 Seventh Avenue New York

# CORWICO

### A-C ADAPTER HARNESS

Converts all makes of battery receivers of six tubes or less to AC operation without re-wiring. Made for all types of AC tubes. Type "R" for R.C.A. tubes, \$8.00. Type "A" for Arcturus tubes \$5.00. Write for complete information.

How's your stock of "BRAIDITE"—radio's fastest selling hook-up wire?

**CORNISH WIRE CO.** 30 Church St. New York City



# SEARCHLIGHT SECTION

## SURPLUS STOCKS—BUSINESS OPPORTUNITIES

**UNDISPLAYED—RATE PER WORD:**  
*Positions Wanted*, 6 cents a word, minimum \$1.25 an insertion, payable in advance.  
*Positions Vacant* and all other classifications, 10 cents a word, minimum charge \$2.00.  
*Proposals*, 40 cents a line an insertion.

**INFORMATION:**  
*Box Numbers* in care of any of our offices count 10 words additional in undisplayed ads.  
 Discount of 10% if one payment is made in advance for four consecutive insertions of undisplayed ads (not including proposals).

**DISPLAYED—RATE PER INCH:**  
 1 to 3 inches.....\$6.65 an inch  
 4 to 7 inches..... 6.40 an inch  
 8 to 14 inches..... 6.20 an inch  
 Rates for largespaces, or yearly rates, on request.  
 An *advertising inch* is measured vertically on one column, 3 columns—30 inches—to a page.

Radio Retailing

### POSITIONS VACANT

IF you are not satisfied with your present position, why not begin to look for another one now? A small advertisement in the positions wanted column will be seen by the most important men in the radio industry. Maybe one of them is looking for a man with just your experience and qualifications. Write to-day to Searchlight Department, 10th Ave., at 36th St., New York City.

### POSITIONS WANTED

**SALES MANAGER** and executive—Engineer with extensive manufacturing, office and advertising experience, seeks connection with reliable manufacturer. Of mature judgment (41) having promoted and managed large companies—exceptionally resourceful and aggressive and familiar with radio merchandising. A forceful, productive correspondent able to organize and maintain an efficient sales force and get results at low cost. PW-74, Radio Retailing, Tenth Ave. at 36th St., New York.

**YOUNG MAN**, 25 years old, married. In retailing radio game since '22. Store manager at present. Would like to make connection with responsible manufacturing company, with opportunity for advancement. Can qualify at service, sales or executive work. PW-75, Radio Retailing, Tenth Ave. at 36th St., New York.

YOU can almost take it for granted, Mr. Employer, that a man who has enough initiative to advertise when he wants a better job is a good man for you to employ. Next time you have a vacancy in your organization, answer the advertisements in this column first. For further information on employment problems, address Searchlight Department, 10th Ave., at 36th St., New York City.

### SALESMEN WANTED

**Energetic Salesmen**  
 To sell an attractive line of radio cabinets on a commission basis. State experience and territory you cover. Premier Cabinet Corporation, Jamestown, New York.

### WANTED Surplus Radio Stocks HIGHEST CASH PRICES PAID

Write or wire  
**FULTON RADIO CO.**  
 218 Fulton St., New York City, N. Y.

### WE PAY CASH for your SURPLUS RADIO STOCKS

What have you for sale?

**AMERICAN SALES CO.**  
 21 Warren Street, New York City.  
 Established 1919

### WE HAVE CASH for Your Radio Surplus Stock

Write or Wire Immediately  
**VENUS RADIO CORPORATION,**  
 142 Liberty Street, New York City, N. Y.

### WANTED WIRE AND CABLE

of every description.  
 Surplus Electrical and Radio Material.  
 Send us your list.

**FISHER ELECTRIC CO.**  
 779 Coney Island Ave., Brooklyn, N. Y.

### TO HELP YOU

LOCATE SELLING OPPORTUNITIES

"Searchlight" Advertising

One Insertion

of a

"Searchlight" Ad

is often all that is necessary  
 to locate a buyer.

## Are You On the Preferential List?

Over 12,000 live dealers receive our BARGAIN BULLETINS regularly. We are the pioneer mail order radio house in the country. The national products sold by us at substantial reductions are the talk of the industry.

Let us put your name on our list. There is no charge for this service and no obligation, of course.

**RADIO CIRCULAR CO., INC.**  
 225 Varick St., N. Y. City, N. Y.

Gentlemen: Please place my name on your Preferential List to receive your BARGAIN BULLETINS.

Name .....

Address .....

City ..... State.....

Use this coupon today. We are always making good "buys" and this is our means of passing the news to you.

Keep Posted!  
 Radio "Buys"  
 Make More Sales!

Use the Coupon.

# DEALERS—

*here are real bargains*  
(NATIONALLY ADVERTISED ITEMS)  
*everyone a money maker!*



## UNI-RECTRON POWER AMPLIFIER

[Ideal for use with Dynamic Speakers.]  
(Model AP-935)



As the Uni-Rectron stands it is a super power amplifier, which can be used in connection with any radio set and loud speaker. Binding posts are provided for input to the Uni-Rectron and output to a loud speaker. Requires no batteries for its operation. It obtains its power from the 110 volt, 60 cycle alternating current house lighting circuit.

Radiotron UX-210 and Rectron UX-216-B or 281 Tube are used with this Amplifier. All that is necessary is to insert the plug into a wall or lamp socket and the R.C.A. Uni-Rectron, by means of the UX-216-B or UX-281 changes or rectifies the current so that the correct

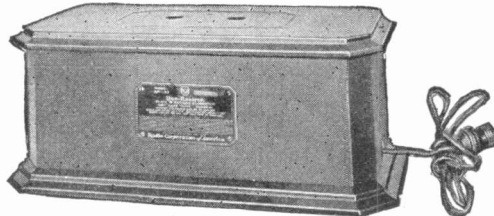

List Price \$88.50 each [without tubes]  
**Special at \$14.50 Ea.**

voltage will be delivered to the super-power amplifier tube, UX-210. The whole unit is enclosed in a metal cabinet which is small and compact and presents a good appearance.

This super power amplifier cannot overload. From the faintest whisper to the loudest crash of sound — R.C.A. Uni-Rectron amplifies each note at its true value. High and low notes are all treated alike.

Not only is its volume and quality a revelation but it lowers the cost of set operation, for when Uni-Rectron is used the drain on the batteries which operate the receiver is greatly reduced.



Former  
List Price \$30.00  
Reduced to \$15.00

## New *Algonquin* CONE SPEAKER

Will stand powerful or weak volume equally well and reproduce with wonderful tone quality and volume.

Has a full-floating large 18-inch Cone, brought to the highest point of perfection. Made of a special impregnated fabric (not paper) which is absolutely unaffected by moisture or atmospheric conditions.

Equipped with an extremely sensitive electro-magnetic Cone unit with direct drive to Cone and is exact to highest degree.

A beautifully designed Speaker with art metal scroll. Ship model. Finished in polychrome gold stipple.

**Special \$3.95 Ea.**

### NEW GOULD

The New and Improved Gould Kathanode Unipower type AC-6k (6 volt). Automatic "A" Power Unit with built-in relay. Throws the charger on and off and controls a "B" battery Eliminator if one is to be used.

Fundamentally different from any other automatic charging "A" power device on the market.

Its Kathanode construction insures longer life and is an exclusive patented feature being used by the U. S. Government in their submarine Batteries which are furnished by Gould. Its high capacity makes it especially adaptable to heavily worked or power tube sets.

### Automatic Radio "A" Power

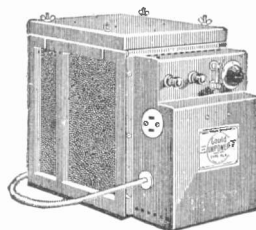

List Price \$39.50

### KATHANODE

## Unipower

Equipped with a new noiseless Balkite Charging Unit, which has four graduated charging rates and in addition one booster rate (1 1/4 amps.), which always keeps the battery fully charged.

Operates on 110-120 volt, 50-60 cycle A.C.

**Extra Special \$9.75 Ea.**

All units offered in this advertisement are BRAND NEW, packed in original factory sealed carton and fully guaranteed!  
TERMS: 20% cash with order, balance C. O. D. f.o.b., New York

**AMERICAN SALES CO., 19-21 Warren St., NEW YORK CITY**

*These items represent only a few of our real buys. Send for our latest complete Catalog just off the press.*

Buyers  
Everywhere  
know  
"Searchlight"  
Try an ad for what you  
wish to sell.

NEED DISTRIBUTORS?  
Advertise for them in the  
"Searchlight Section"

**Dealers !!!**  
Send for our catalog of radio bargains.  
*Every item a real money-maker*  
AMERICAN SALES CO.  
19-21 Warren St., New York City

## Wells "A & B" Eliminators

Especially Priced \$15.00  
to Dealers . . . . .

Less Tubes

LIST PRICE \$65.00  
20% with Order, Balance C. O. D.  
Each one guaranteed and in original cases

NATIONAL RADIO CO.  
123 N. 4th Street, Philadelphia, Pa.  
*Write for our Specials*

# KEYSTONE

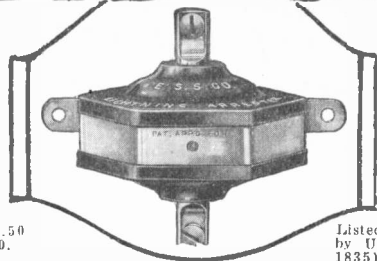

Retail price \$1.50  
In Canada \$2.00.

Listed as Standard  
by Underwriters (E-1835).

## Sell one with every set!

Every time you sell a radio set or some antenna material, you can easily sell the purchaser a Keystone Radio Lightning Arrester.

This proven protective device is made of genuine Bakelite and heavy brass and provides maximum protection always. It is reliable, safe and stays sold.

Manufactured by a company having more than thirty years' experience in design and manufacture of lightning arresters.

Jobbers and retailers—send for complete details of our attractive proposition.

**ELECTRIC SERVICE SUPPLIES CO.**

Home office and plant at 17th & Cambria Sts., PHILADELPHIA; District Offices at 111 N. Canal St., CHICAGO; 60 Church St., NEW YORK; Bessemer Bldg., Pittsburgh; 88 Broad St., Boston; General Motors Bldg., Detroit; 316 N. Washington Ave., Scranton.

# RADIO LIGHTNING ARRESTERS

The **CARAVAN**  
"Brings the World to YOU"

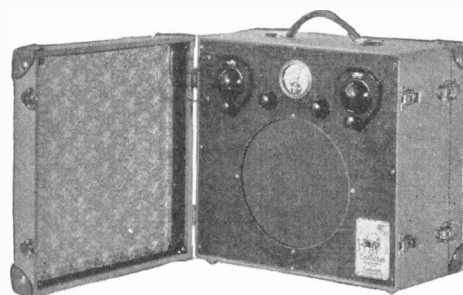

IF YOU didn't see the Caravan portable at the Hotel Stevens during the week of the Radio Trade Show or on Page 226 of the June issue of Radio Retailing, be sure to get acquainted with it now.

There's still time to "cash in" on this big Summer Radio feature and we have a few desirable territories open.

(Will also have something of interest for fall and winter trade.)

Write for descriptive literature and distributor offer.

**CARAVAN RADIO LABORATORIES**

4725 Clifton Ave., Chicago, Ill.

## ALPHABETICAL INDEX TO ADVERTISEMENTS

	Page		Page		Page
A-C Dayton Co.	117-127	Elkon Wks.	100-101	Radio Corp. of America,	62-63, Back Cover
Acme Electric & Mfg. Co.	31	Excello Products Corp.	136	Radio Master Corp.	32
Acme Wire Co.	93	Fansteel Products Co.	102-103	Radio Receptor	28-29
Adler Mfg. Co.	116	Farrand Mfg. Co.	Inside Front Cover	Raytheon Mfg. Co.	16
Air-Chrome Studios, Inc.	33	Federal Furniture Factories, Inc.	96-97	Readrite Meter Works	134
All-American Mohawk Corp.	110	Federal Radio Corp.	18-19	Red Lion Cabinet Co.	115
Allen Bradley	92	Freshman Co., Inc., Chas. H.	Front Cover	Samson Electric Co.	132
American Bosch Magneto Co.	24-25	Frost, Inc., Herbert H.	88	Sandar Corp.	104
Amrad Corp.	10, 124	Gavitt Mfg. Co.	134	Seachlight Section	138, 139
Andrea, F. A. D.	119	Gold Seal Elec. Co., Inc.	34	Shamrock Mfg. Co.	122
Arcturus Radio Co.	137	Grebe & Co., Inc., A. H.	3	Slagle Radio Co.	118
Aston Cabinet Mfrs.	134	Greene-Brown Mfg. Co.	106	Sonatron Tube Co.	7
Atwater Kent Mfg. Co.	11-12-13-14	Grigsby-Grunow Co.	136	Sparks-Withington Co.	20-21
Bakelite Corp.	26	Jensen Radio Mfg. Co.	107	Splitdorf Radio Corp.	23
Beede Elec. Instrument Co.	132	Jewell Elec. Instrument Co.	88	Sprague Specialties Co.	90
Benwood Linze Co.	30	Kellogg Switchboard & Supply Co.	113	Steinite Radio Co.	Inside Back Cover
Birnbach Radio Co.	131	Ken-Rad Corp., Inc.	17	Stewart-Warner	98-99
Bremer Tully Mfg. Co.	111	Kolster Radio Corp.	94-95	Stromberg-Carlson Tel. Mfg. Co.	2
Brooklyn Metal Stamping Corp.	137	Langbein-Kaufman Radio Co.	132	Sylvania Prod. Co.	77
Brown & Caine Co., Inc.	88	La Salle Radio Corp.	114	Symphonic Sales Corp.	137
Caravan Radio Lab.	140	Lektophone Corp.	120	Televocal Corp.	133
Carryola Co.	126	Magnavox Co.	15	Temple, Inc.	129
Case Electric Corp.	136	Martin-Copeland Co.	27	Thordarson Elec. Mfg. Co.	80
Caswell-Runyan Co.	79, 128	McMillan Radio Co.	8	Transformer Corp.	90
CeCo Mfg. Co.	109	Nassau Radio Co.	134	Trav-Ler Mfg. Corp.	86
Central Radio Lab.	90	Newcombe-Hawley, Inc.	123	United Radio Corp.	6
Champion Radio Wks., Inc.	22	Niagara Metal Stamping Co.	135	Universal Elec. Lamp Co.	133
Chillicothe Furniture Co.	128	O'Neil Mfg. Co.	9	Utah Radio Prod. Co.	4-5
Cornish Wire Co.	137	Operadio Mfg. Co.	108	Wasmuth-Goodrich Co.	137
Crosley Radio Corp.	125	Pacent Elec. Co.	105	Weston Elec. Instrument Co.	133
Day Fan Elec. Co.	121	Pooley Co.	112	Wireless Specialty Apparatus Co.	82
Dudlo Mfg. Corp.	84	Premier Elec. Co.	137	Wirt Co.	135
Electrad, Inc.	88, 92				
Electric Service Supplies Co.	140				



# Steinite

## ELECTRIC AC RADIO

Time Tested!



# \$75

A 6-Tube Set Using A C Tubes

## Again... America's Greatest Value!

WHAT Steinite dealers saw at the recent Trade Show assured them that Steinite was still America's greatest radio value. Their judgment received striking confirmation when other dealers by the score sought the Steinite franchise with eager enthusiasm.

Only Steinite could do what Steinite has done . . . thanks to masterful

engineering and "one-profit manufacture." There was never a year when the choice of the right set, and an early franchise meant so much as *now*. Mail the coupon below.

Beautiful Consoles—\$115 • \$130 • \$150

Polyphonic Speakers:

Table Model \$20 • Console \$40



The STEINITE RADIO COMPANY

506 S. Wabash Ave.

CHICAGO

Factories:  
Atchison, Kans.

Mail the Coupon

STEINITE RADIO COMPANY *Mail this Coupon TODAY!*

506 South Wabash Avenue, Dept. EG, Chicago

Please send me complete information on the New Steinite Line.

Name .....

My Jobber's Name and Address is

Street Address .....

City ..... State .....

A Radiotron  
for every purpose

**RADIOTRON UX-201-A**

*Detector Amplifier*

**RADIOTRON UV-193**

*Detector Amplifier*

**RADIOTRON UX-199**

*Detector Amplifier*

**RADIOTRON WD-11**

*Detector Amplifier*

**RADIOTRON WX-12**

*Detector Amplifier*

**RADIOTRON UX-200-A**

*Detector Only*

**RADIOTRON UX-120**

*Power Amplifier Last  
Audio Stage Only*

**RADIOTRON UX-222**

*Screen Grid Radio  
Frequency Amplifier*

**RADIOTRON UX-112-A**

*Power Amplifier*

**RADIOTRON UX-171-A**

*Power Amplifier Last  
Audio Stage Only*

**RADIOTRON UX-210**

*Power Amplifier Oscillator*

**RADIOTRON UX-240**

*Detector Amplifier for  
Resistance-coupled  
Amplification*

**RADIOTRON UX-250**

*Power Amplifier*

**RADIOTRON UX-226**

*A.C. Filament*

**RADIOTRON UY-227**

*A.C. Heater*

**RADIOTRON UX-280**

*Full-Wave Rectifier*

**RADIOTRON UX-281**

*Half-Wave Rectifier*

**RADIOTRON UX-874**

*Voltage Regulator Tube*

**RADIOTRON UV-876**

*Ballast Tube*

**RADIOTRON UV-886**

*Ballast Tube*

The standard by  
which other vacuum  
tubes are rated



Look for this mark  
on every Radiotron



A Radiotron  
for every purpose

RADIOTRON UX-201-A  
Detector Amplifier

RADIOTRON UV-193  
Detector Amplifier

RADIOTRON UX-199  
Detector Amplifier

RADIOTRON WD-11  
Detector Amplifier

RADIOTRON WX-12  
Detector Amplifier

RADIOTRON UX-200-A  
Detector Only

RADIOTRON UX-120  
Power Amplifier Last  
Audio Stage Only

RADIOTRON UX-222  
Screen Grid Radio  
Frequency Amplifier

RADIOTRON UX-112-A  
Power Amplifier

RADIOTRON UX-171-A  
Power Amplifier Last  
Audio Stage Only

RADIOTRON UX-210  
Power Amplifier Oscillator

RADIOTRON UX-240  
Detector Amplifier for  
Resistance-coupled  
Amplification

RADIOTRON UX-250  
Power Amplifier

RADIOTRON UX-226  
A.C. Filament

RADIOTRON UY-227  
A.C. Heater

RADIOTRON UX-280  
Full-Wave Rectifier

RADIOTRON UX-281  
Half-Wave Rectifier

RADIOTRON UX-874  
Voltage Regulator Tube

RADIOTRON UV-876  
Ballast Tube

RADIOTRON UV-886  
Ballast Tube

The standard by  
which other vacuum  
tubes are rated

RCA  
Look for this mark  
on every Radiotron

Every Radiotron is tested and inspected in 41 different ways before it is approved in the laboratories and factories of RCA, General Electric and Westinghouse.

The Radiotron is the joint product of RCA, Westinghouse and General Electric, developed and perfected in the same great laboratories which give you the Mazda lamp. They are the creation of the skilled radio engineers who made modern broadcasting possible. Equip your set with genuine RCA Radiotrons. Never use new tubes with old ones that have been in use a year or more. See that your set is completely equipped with RCA Radiotrons once a year at least.

**RCA Radiotron**

MADE BY THE MAKERS OF THE RADIOLA

RADIO CORPORATION OF AMERICA · NEW YORK · CHICAGO · SAN FRANCISCO

Back of RCA Radiotrons is a national advertising campaign that is larger and more impressive than that behind any other vacuum tube. Because the story is convincing and performance backs it up, RCA Radiotrons lead all other makes of vacuum tubes in volume of sales. Forceful counter and window displays, folders, etc., help you to get your share.

Every RCA Radiotron is inspected and tested in 41 different ways before it leaves the factory laboratories where it is made. Developed and perfected by the expert radio engineers of RCA, the Radiotron is accepted as standard by leading manufacturers of all receiving sets sold on a quality basis. There is a Radiotron for every purpose. Carry the complete line. Recommend them to your customers and watch your profits mount.



RADIO CORPORATION OF AMERICA · NEW YORK · CHICAGO · SAN FRANCISCO

**RCA Radiotron**

MADE BY THE MAKERS OF THE RADIOLA