

LIBRARY
JUN 16 1932
U
ENT

UTAH

CONE

SPEAKER

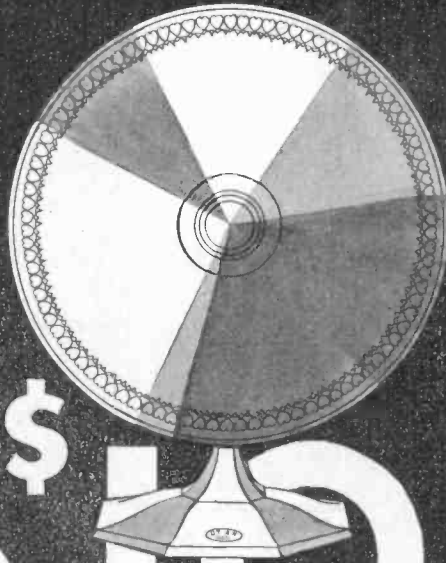

\$
10

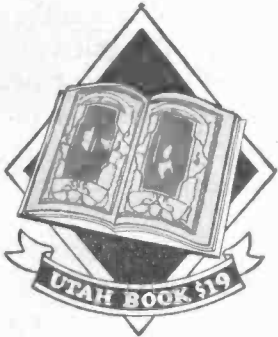

UTAH BOOK \$19



UTAH STANDARD \$22.50



REG. U.S. PAT. OFF.
SUPERFLEX \$10

**The JUNIOR CONE is the
Outstanding Speaker for 1927**

UTAH RADIO PRODUCTS CO., 1421 S. MICHIGAN AVE., CHICAGO

17½-in. Senior Cone \$16 13-in. Junior Cone \$10 14-in. Standard \$22.50 11-in. Junior \$12.50 17½-in. x 13½ in. Book \$19

Each One Guaranteed

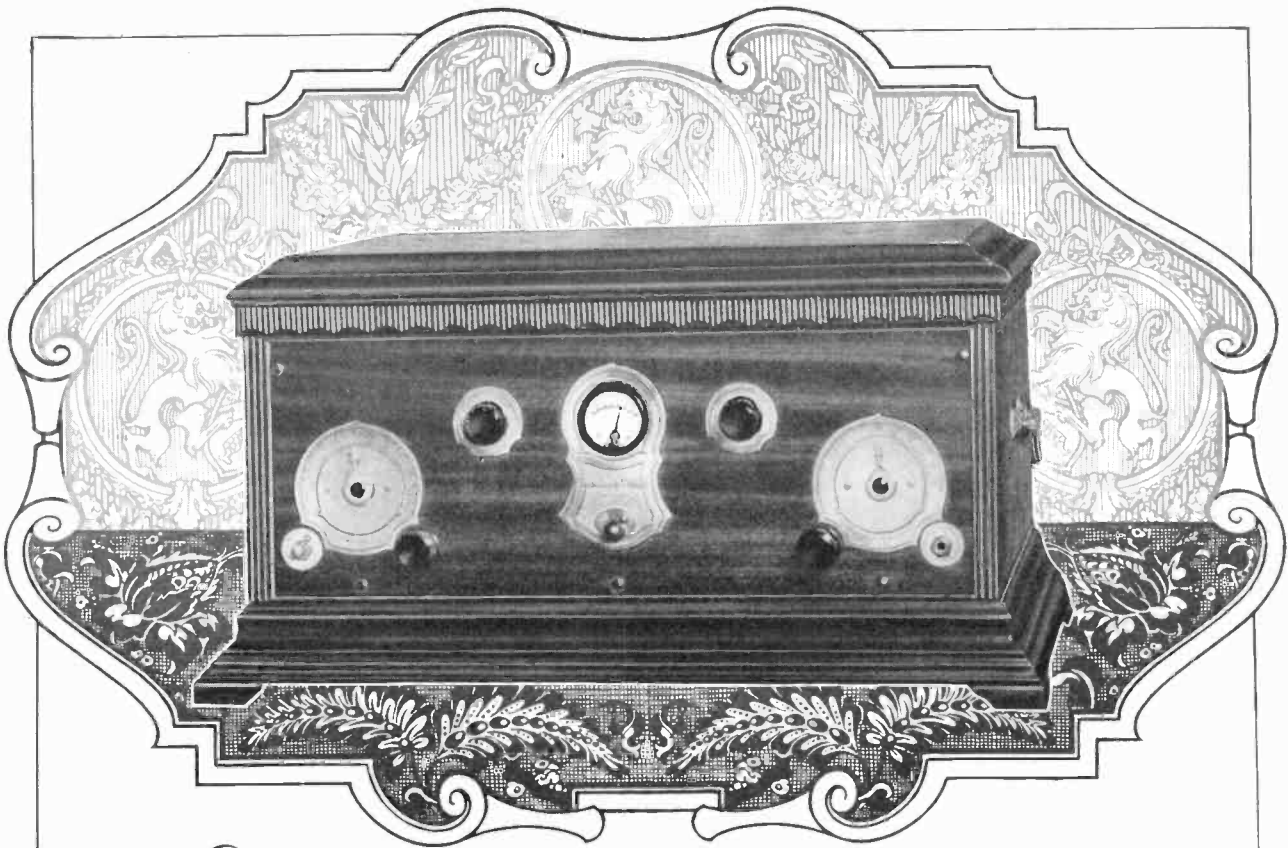

Stock the Receiver that helps—
YOUR WARM WEATHER SALES

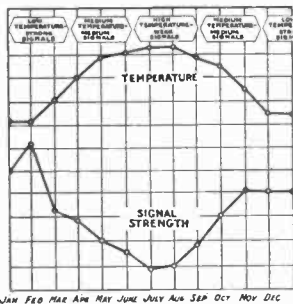

The air temperature has important influence on radio transmission. The illustration adapted from graphs prepared by Dr. L. W. Austin of the U. S. Bureau of Standards, shows clearly how the strength of the Radio signal decreases as the average air temperature rises. Only a receiver of ample power will give satisfactory results in warm weather.

MARCH—the first month of Spring—has held the record for Stromberg-Carlson sales for the past two seasons. This indicates a realization by dealers that when conditions are not at their best, the worth of these magnificent instruments becomes even more apparent. With a Stromberg-Carlson weakened signals may be amplified readily to needed volume, for there is always a surplus of power—made possible through total shielding. Stromberg-Carlsons are “summer-time” Receivers—“daylight” Receivers—Receivers that will stimulate your “after-the-peak-of-the-season” trade in radio.

Dealers can safely stock and push these Receivers in the Spring and Summer months.

STROMBERG-CARLSON TELEPHONE MFG. Co.
 ROCHESTER, NEW YORK



Stromberg-Carlson

Makers of voice transmission and voice reception apparatus for more than thirty years.

6

Tangible Reasons

why the Grebe Synchrophase Radio Sells Quickly and Stays Sold—

- One Dial Control
- Colortone
- Binocular Coils
- S-L-F Condensers
- Sound Construction
- Minimum Servicing

Booklet RR explains fully. Send for it.

A. H. Grebe & Co., Inc.
 109 West 57th Street New York City
 Factory: Richmond Hill, N. Y.
 Western Branch: 443 So. San Pedro St., Los Angeles, Cal.
The oldest exclusive radio manufacturer



The GREBE Synchrophase RADIO



The Synchrophase is also supplied in five console models.

Helping the Radio Dealer Buy goods that will Sell

How is the radio dealer to select his stock from the thousands of products offered by hundreds of manufacturers?

Which are good? . . . or bad? Which will sell?

Thousands of dealers turn to Popular Science Monthly for advice, as did Lyon & Healy, Inc. Why?

For this reason: When radio was an "infant", Popular Science set about to protect its 300,000 readers—those men who look to its pages (both editorial and advertising) for reliable information.

So the Popular Science Institute of Standards was established . . . to test radio products, and to approve those of merit.

Popular Science soon became the radio authority, a disinterested "third party" who had the facts.

In twelve months—8000 dealers and consumers wrote for information on what radio equipment to buy.

And many other thousands bought the sets advertised in our columns, because Popular Science guarantees those products.

The Popular Science readers in your community are those well-informed customers

Popular Science

MONTHLY

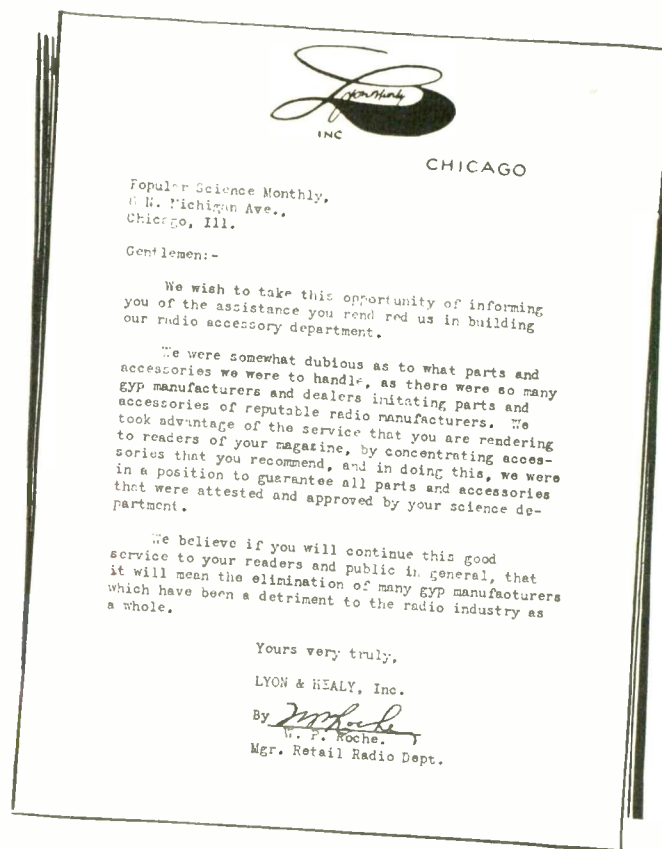

who know what they want themselves, and influence the purchases of their friends. Get their trade by displaying those approved products which they see advertised regularly in Popular Science Monthly.

FREE SERVICE

Buy goods that will sell! Write for facts about our Dealer Service which keeps you up-to-date on the radio products which have the Popular Science Seal of Approval. This service is free. Popular Science Monthly, 250 Fourth Avenue, New York City.

What is the Popular Science Institute of Standards?

The Institute is under the direction of Professor Collins P. Bliss, Associate Dean, College of Engineering, of New York University. Radio apparatus and tools are tested, and products of merit approved. This approval is necessary before such a product can be advertised in Popular Science Monthly. A Buying Guide of approved products is issued on request,—but the magazine itself is literally a buying guide.

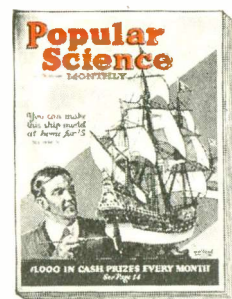

300,000 "interested" men readers pay 25¢ every month for the practical information contained in the editorial and advertising pages of Popular Science Monthly.

WORLD'S GREATEST LOUDSPEAKER VALUE

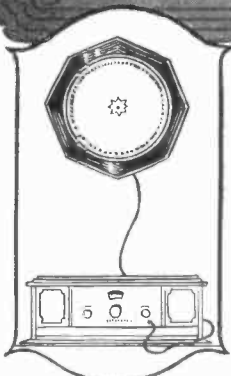
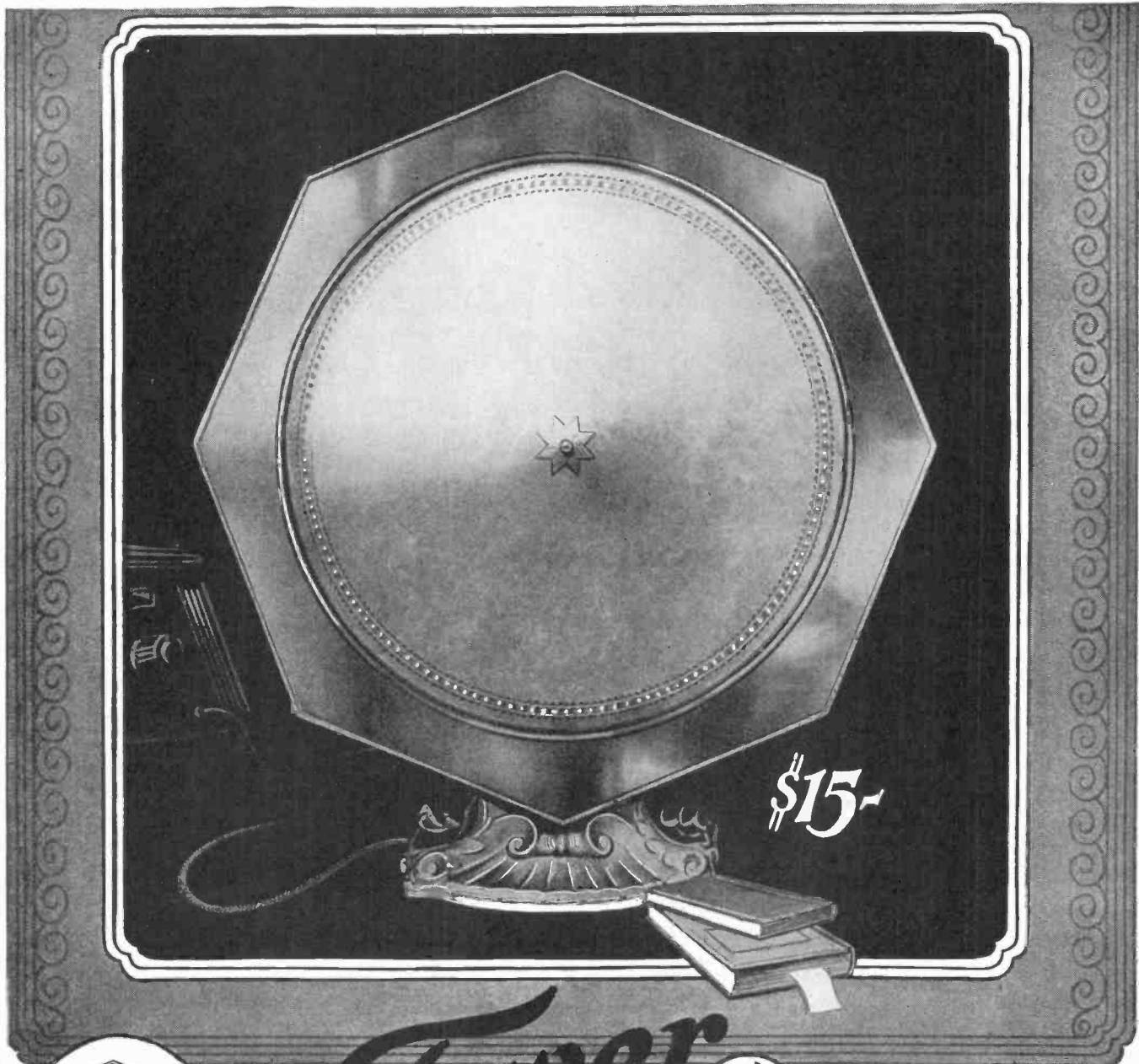

Both Wall and Table Model Combined
Use the Meistersinger as a Table Model or detach the art metal base and hang it on the wall. (15 feet of cord with each Cone.)

Tower
Meistersinger
CONE

Dealers tell us the Tower Meistersinger is the *easiest* selling Cone Speaker on the market. This is due entirely to its high quality, numerous popular features, and wholly satisfactory performance. It will handle the new power tubes, it is both a wall and table model, it is beautiful, rugged—in fact it takes the place of speakers costing twice as much. No wonder it is the *easiest* Speaker to sell!

Write us for your Jobber's Name

TOWER MFG. CORP. — Boston, Mass.

Wherever there are ears that hear there's a Tower Product to fit your taste and purse.

- Meistersinger Speaker (gooseneck type) . . \$15.00
- Scientific Cone 9.50
- Scientific Speaker (gooseneck type) . . . 8.50
- Little Spitfire 4.95
- Phonograph Attachment 3.95
- Scientific Headset 2.95
- Little Spitfire Headset 1.95

KOL

JUST mail the coupon for the Kolster Dealer Proposition. It gives all the facts regarding the Kolster Franchise as an asset—shows you, as it has thousands of progressive dealers, how to increase profits by the Kolster plan.

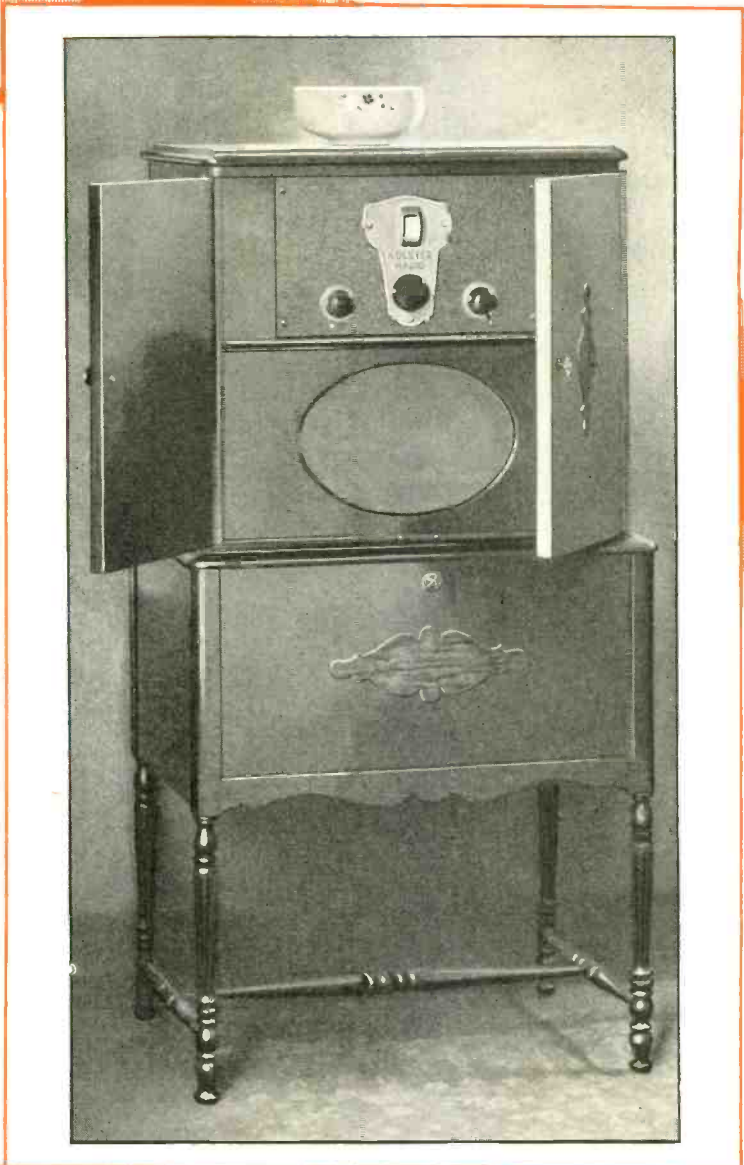

SUCH a beautiful cabinet—simple, aristocratic—fittingly encases such a fine set as the Kolster 6 G. In-built cone. Antenna operation. Ample space for batteries List, \$185

ster



SOME models are the result of public demand. Such is the new cabinet Kolster 6 G pictured here.

Its companion, the Kolster table model 6 D has proved itself such a winner that hundreds of buyers insisted upon a like set, but in a floor cabinet. The Kolster policy is to meet such demand quickly, so as to cooperate profitably with the Kolster dealer.

This new 6 G is winning friends fast. At its list price, \$185, it offers a distinct attraction, an exclusive value. In comparison with higher priced instruments, its *value* is an outstanding sales builder. A comparative demonstration nearly always results in a sale.

Complete descriptions of both the Kolster 6 G and 6 D—and of the other models—will be sent to all inquirers.

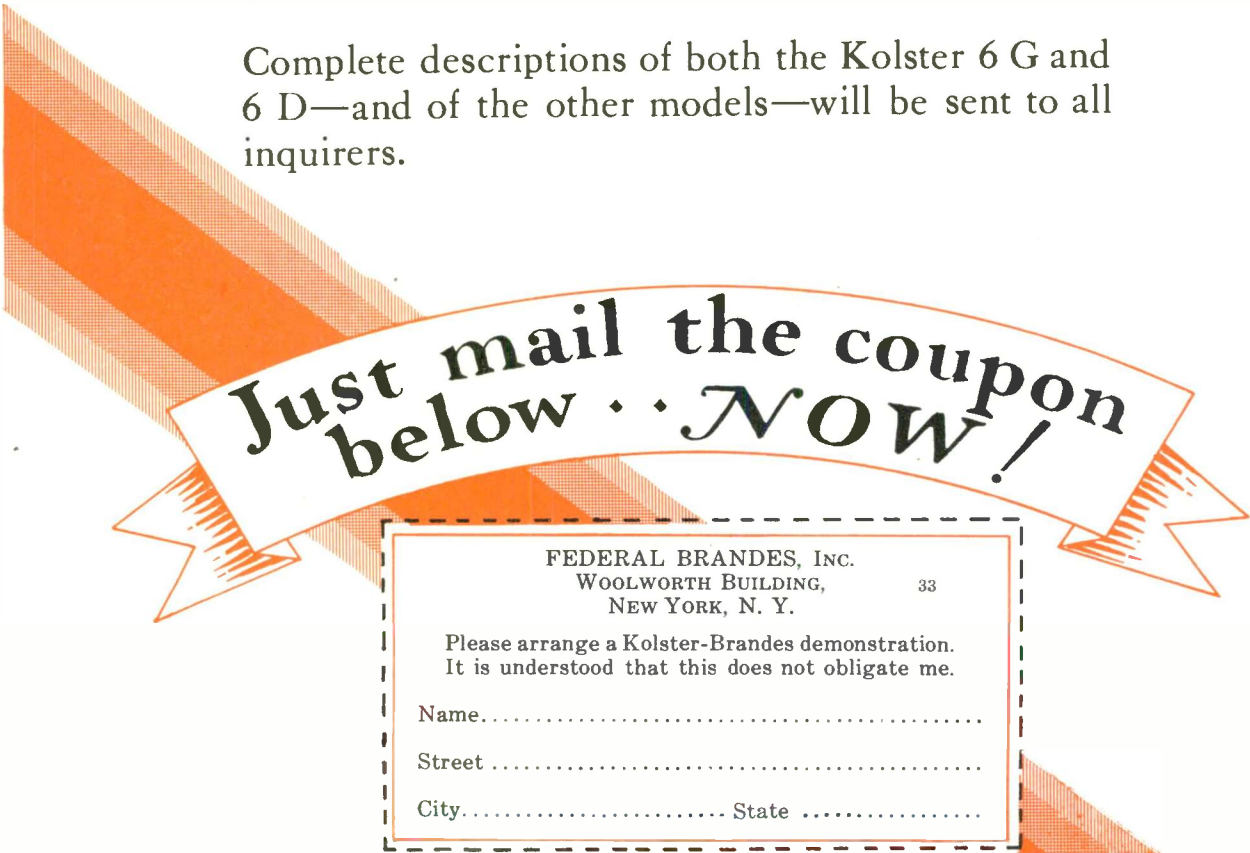

Just mail the coupon below . . . NOW!

FEDERAL BRANDES, INC.
WOOLWORTH BUILDING, 33
NEW YORK, N. Y.

Please arrange a Kolster-Brandes demonstration.
It is understood that this does not obligate me.

Name.....

Street.....

City..... State.....

**SANDAR
SPEAKER**

**SANDAR
SPEAKER**

**SANDAR
SPEAKER**

**SANDAR
SPEAKER**

**SANDAR
SPEAKER**

**SANDAR
SPEAKER**

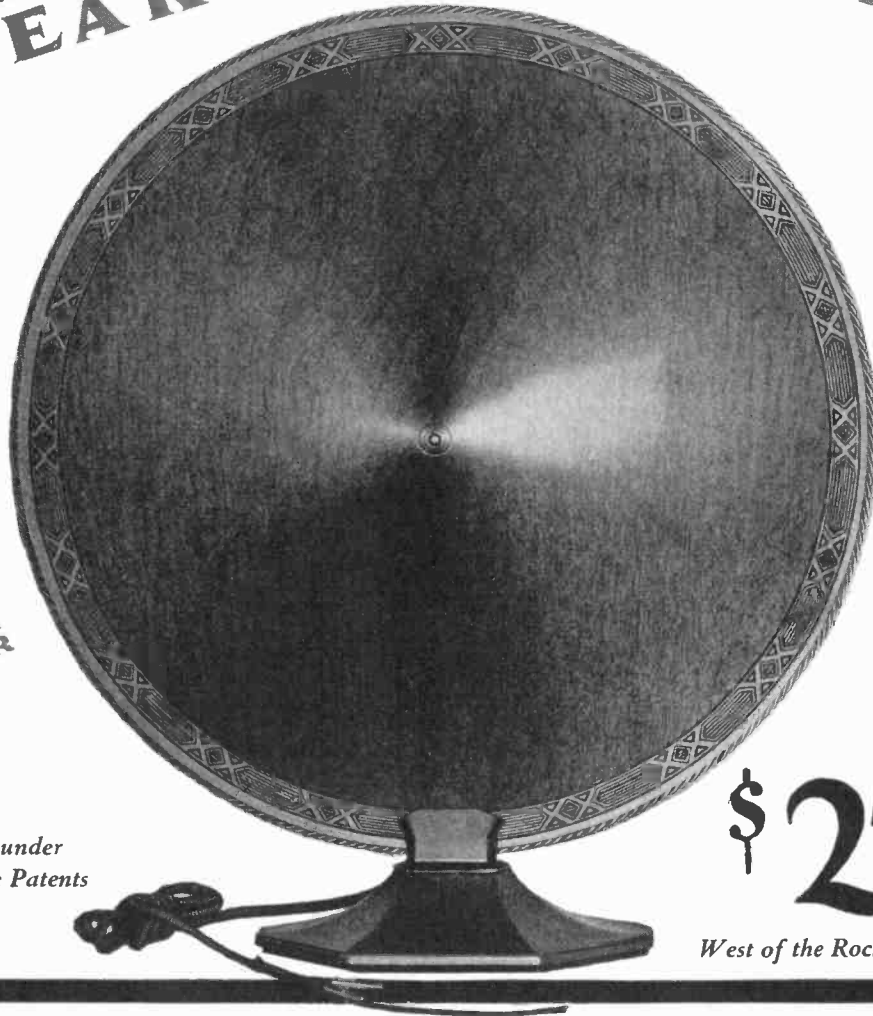

Licensed under
Lektophone Patents

\$ 27.⁵⁰

West of the Rocky Mountains, \$30

You hear it everywhere!

SANDAR is the speaker of its type. Ever since this new cone speaker was introduced some months ago, its success has been phenomenal, and every day shows a steady growth in the popularity of this outstanding achievement in the field of radio. The manufacturers are striving hard to fill the dealers' orders created by the fans' demands, and you hear Sandar everywhere!

Sandar's down-

right good looks, its mechanical excellence, and its remarkable price — lower than that of any other licensed speaker of its size on the market—readily explain the widespread approval it has won. There still remains an opportunity to cash in on the profits and prosperity of Sandar by negotiating for some of the limited territory still available. So write today for terms and full information.

**SANDAR
SPEAKER**

SANDAR CORPORATION • Crescent Plaza Building • Long Island City, New York



New!
Made to meet actual dealer requirements. Attracts attention, holds stock of same Durham Resistors now in sets you are selling.



Practical
Only 7 in. by 2 in. by 7 in. Takes little room. Modern in the way.

The Approved Resistor in the Approved Counter Cabinet

DURHAM Resistors are adopted by leading set manufacturers as well as professional and amateur builders. Now we offer you these approved Resistors in a beautiful mahogany and glass counter display cabinet which has also been approved by every dealer who has ordered it. If you haven't ordered one

for yourself, do so to-day while they last. Just order stock to fill—50 assorted Durham Resistors and each of the single and double mountings. List price \$30.75 less regular discounts. Case costs us nearly \$5.00, but no charge to you. Order direct and give us the name of your jobber.

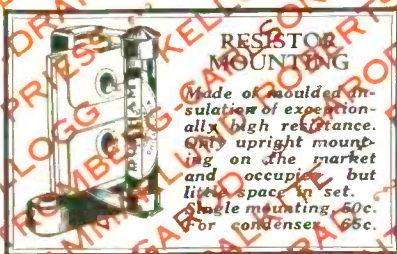

DURHAM
METALLIZED
RESISTORS

INTERNATIONAL RESISTANCE CO., Dept. J., Perry Building, Philadelphia, Pa.

VESTA

Quality Radio Units

Sell the Radio Units that Keep the Receiving Set Up to 100% Efficiency!

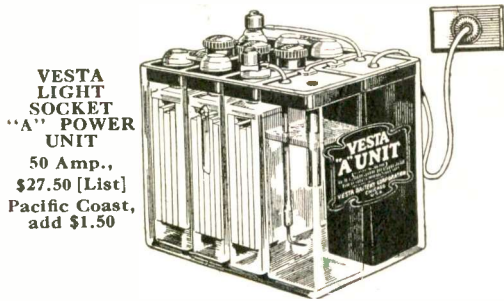

VESTA LIGHT SOCKET "A" POWER UNIT
50 Amp., \$27.50 [List] Pacific Coast, add \$1.50

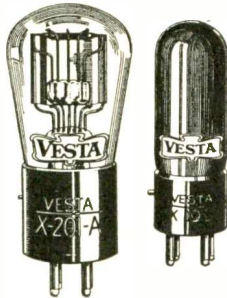

VESTA QUALITY TUBES
A remarkable improvement in Tube Construction. A quality that cannot be questioned.
X-201-A, \$1.75 199—\$2.25
Special Detector Tube for increased volume. No. X-250-A List \$3.00

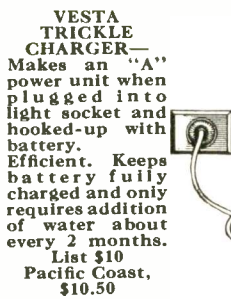

VESTA TRICKLE CHARGER—
Makes an "A" power unit when plugged into light socket and hooked-up with battery. Efficient. Keeps battery fully charged and only requires addition of water about every 2 months. List \$10 Pacific Coast, \$10.50



VESTA RADIO "A" BATTERY
The Highest type of battery quality. 25 to 125 amp. hour sizes for every radio need.

THE power units are the most essential parts of the radio. The satisfaction that the customer gets out of his set—depends upon the **QUALITY** of the power units.

If you are as particular about the quality of the accessories as you are about the quality of the set, you will standardize on Vesta Units.

The Vesta Light Socket "A" Power Unit is the most ideal—and satisfactory—method of obtaining constant, smooth flowing, full power **ALL THE TIME**.

It is a complete "A" Unit.

The Vesta Trickle Charger makes an "A" Unit out of any battery.

The Vesta Tubes—being non-microphonic—will create pleased customers for you.

Vesta Central Distributors in over 50 central distributing points can give you "minute-man" service on deliveries.

Try any of these Vesta Units yourself—that's the way to know the true facts.

Price Reduction —on Vesta Batteries

A very substantial reduction in price on ALL VESTA Batteries was announced Feb. 20 in 48 leading newspapers, and will be featured in The Saturday Evening Post, March 5, making the lowest prices in Vesta's 30 years of quality battery building.

It includes Vesta Radio "A" Batteries—both the high grade type with oversize plates and oversize separators—and the Vesta-Vaco Radio battery. 1926 was a record-breaking year for Vesta. 1927 production increase makes the new low prices possible and assures a still greater sales record. This will be another record-breaking year for Vesta dealers. Send the coupon for the New Prices and the Vesta dealer plan. It will not obligate you in any way.

VESTA BATTERY CORPORATION
2100 Indiana Ave., Chicago, U. S. A.
*Makers of Vesta Automobile Batteries—
Quality Products for 30 Years*

----- WRITE HERE -----

VESTA BATTERY CORP., 2100 Indiana Ave., Chicago.
Please have your Central Distributor near me present the Vesta
 Vesta Tubes Trickle Charger R. R. -
 "A" Unit Batteries March

Name

Address

City State

Tune in VESTA Broadcasting Station WFKB, Chicago—217.3 Meters

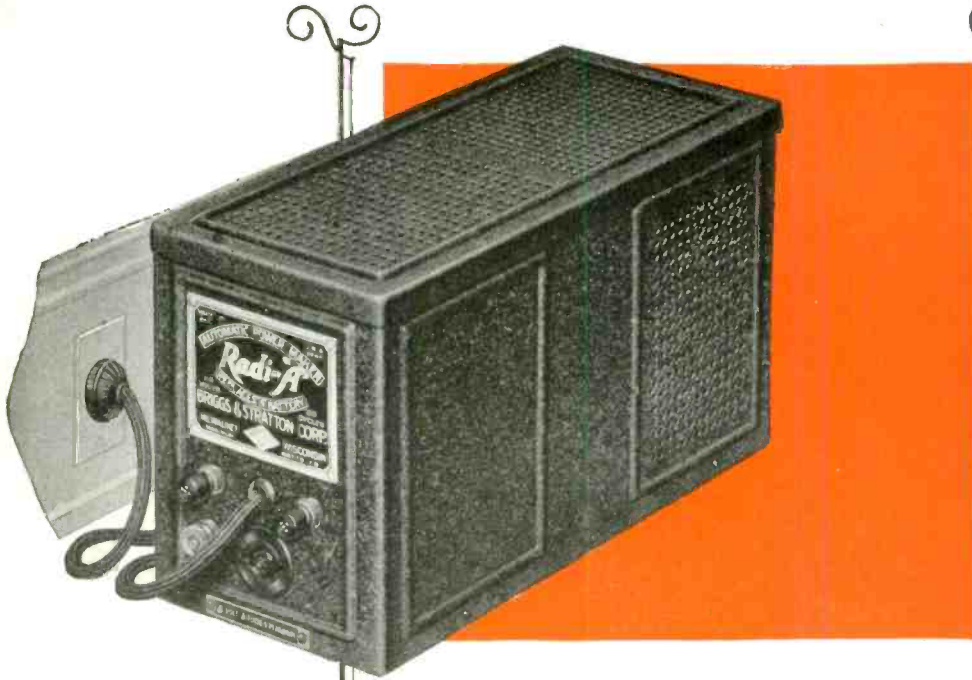

Radi-"A" operates without trickle charge—consumes power only while in actual use. Never runs down, no matter how long or how often it is used. Entirely automatic in operation. Makes "B" eliminator automatic also.

A Dependable Product backed by a Dependable Manufacturer

RADI-"A", the recently perfected light-socket power unit that replaces the "A" battery and charger, is guaranteed to give satisfactory performance, and the instrument itself is fully guaranteed as a mechanical device. It is *dependable*—far more dependable than any battery can be. You can give Radi-"A" your personal endorsement without any fear of a come-back, and with the knowledge that it is sponsored by a well-established manufacturer who has been serving the automotive industry for more than fifteen years.

"Basco" ignition and lighting switches are standard equipment on many of the country's finest cars. "Basco" Fullpower Gasoline Engines are standard equipment on numerous nationally known mechanical appliances and machines. Today Radi-"A" is already favorably known from Coast to Coast, just five months after its initial introduction to the radio trade.

Radi-"A"'s dependability is vouched for not only by the service it is giving in the hands of users, but also by the reputability of its manufacturer.

If you are not yet selling Radi-"A", it will pay you to investigate the profit opportunities it offers. Ask your jobber about Radi-"A". Descriptive circular on request.

BRIGGS & STRATTON CORPORATION
MILWAUKEE, WISCONSIN

Radi-"A"

Replaces "A" Battery and Charger

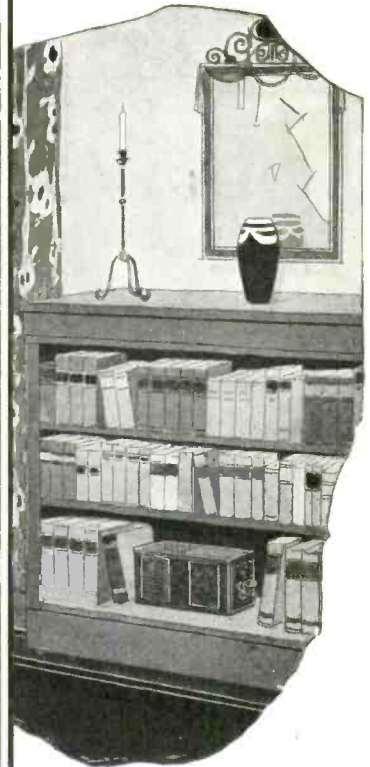

Three Styles Adapted to All Radio Sets:

Radi-"A" may be operated from any 110-volt A. C. 50 or 60 cycle electric power line.

Radi-"A" 6-Volt Standard is for use with radio receivers of 4 to 8 quarter-ampere tubes inclusive. It develops a 6-volt direct current of 2 to 2³/₁₀ amperes.

Radi-"A" 6-Volt Special is for use with sets of 8 to 10 quarter-ampere tubes inclusive only, and develops a 6-volt current with a maximum output of 3 amperes.

Radi-"A" 4-Volt is made for any set using up to 12 No. 199 UV tubes inclusive.

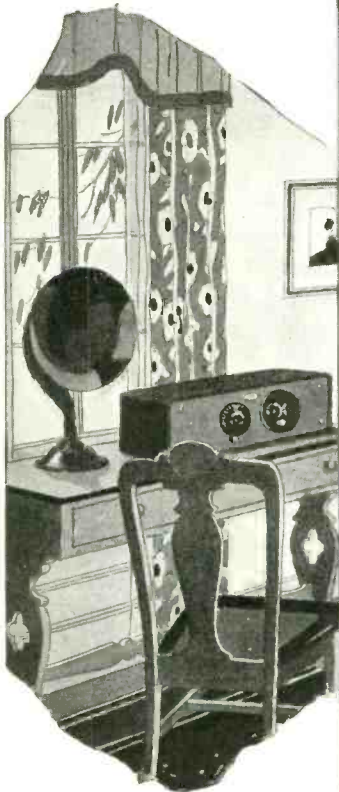

Why So Many Successful Dealers have Sought the Stewart-Warner Franchise

Why it will Interest You

Stewart-Warner Offers You these Advantages

A protective policy.

A complete line of cabinet and console one-dial and three-dial models.

A range of prices that will enable you to sell all prospects.

A "Matched-Unit" combination of Stewart-Warner Receivers, Stewart-Warner Reproducers, Stewart-Warner Tubes.

A name that is nationally known and nationally advertised.

A Stewart-Warner Wholesale Distributor organization (in 55 large cities throughout the nation) that will save you time and money on deliveries.



This beautiful walnut console is a recent addition to the Stewart-Warner line. One dial, six tubes.

STEWART-WARNER'S success in franchising thousands of successful dealers has been largely due to the fact that to these dealers the institution behind the product takes precedent over everything else.

They rightly reason that if the manufacturer is of long standing, is known to be reputable, has facilities for large production and prompt distribution, then its products, policy, prices and service are bound to be right.

These dealers are in business for the same reason that Stewart-Warner is—a reasonable profit this year, next year and for years to come. It is for this reason that they have become associated with Stewart-Warner. They wish to build up a business that will grow steadily and surely.

The radio business is no longer in a trial stage. It has firmly established itself as a big, profitable line of activity, ranking with the biggest industries in the country. In this business you want to build for permanency and profits.

Stewart-Warner is firmly established and an acknowledged leader in the field. A Stewart-Warner franchise is the one you want. A request for further details will bring an immediate answer.

STEWART-WARNER SPEEDOMETER COR'N
1820 DIVERSEY PARKWAY - CHICAGO, U. S. A.

Tune in the Stewart-Warner Air Theatre—WBBM—226 Meters

The
Inductively Tuned
RADIO
of Flawless
Reproduction



Kellogg

Again, We Stress PERMANENCE

A year ago we pointed out the importance to the retail dealer of tying up to manufacturers who may safely be considered Permanent fixtures in the radio industry.

Subsequent events have only served to stress this point—and the better radio dealers from Coast to Coast are showing their faith in Kellogg by adopting Kellogg Radio as their leading *Quality* line.

Kellogg Switchboard & Supply Co., Chicago

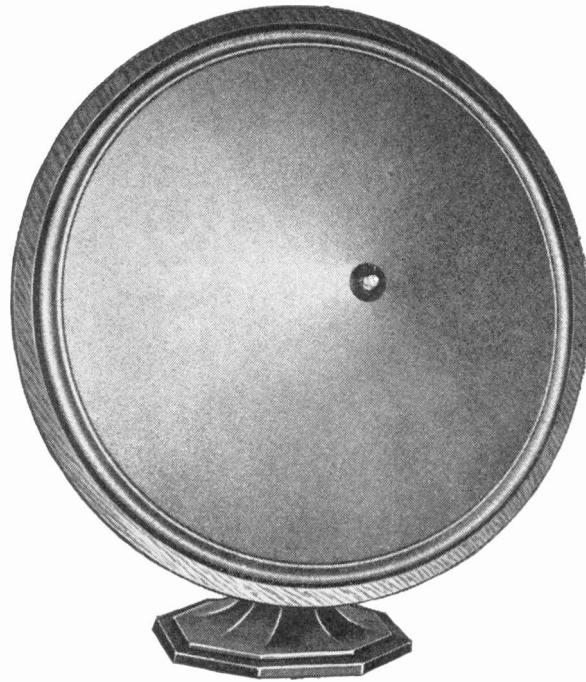

Licensed and Manufactured
under Patents 1414801

Slagle Speakers Say It All!

*Recommended by Hammarlund-Roberts
for use with their Hi-Q set Kits*

A high quality speaker improves even the best receiver. A Slagle Speaker makes any set better. But used with a Slagle Receiver, the result is all that any one could ask in the way of radio performance.

15 years is a long time in the radio industry but from the beginning the name of Slagle has stood for just one thing—the finest products that engineering skill, expert workmen, and painstaking inspection can turn out. No one need tell you what that means in the radio business.

SLAGLE RADIO COMPANY, Fort Wayne, Indiana
High Grade Radio Products Since 1911

Slagle Radio

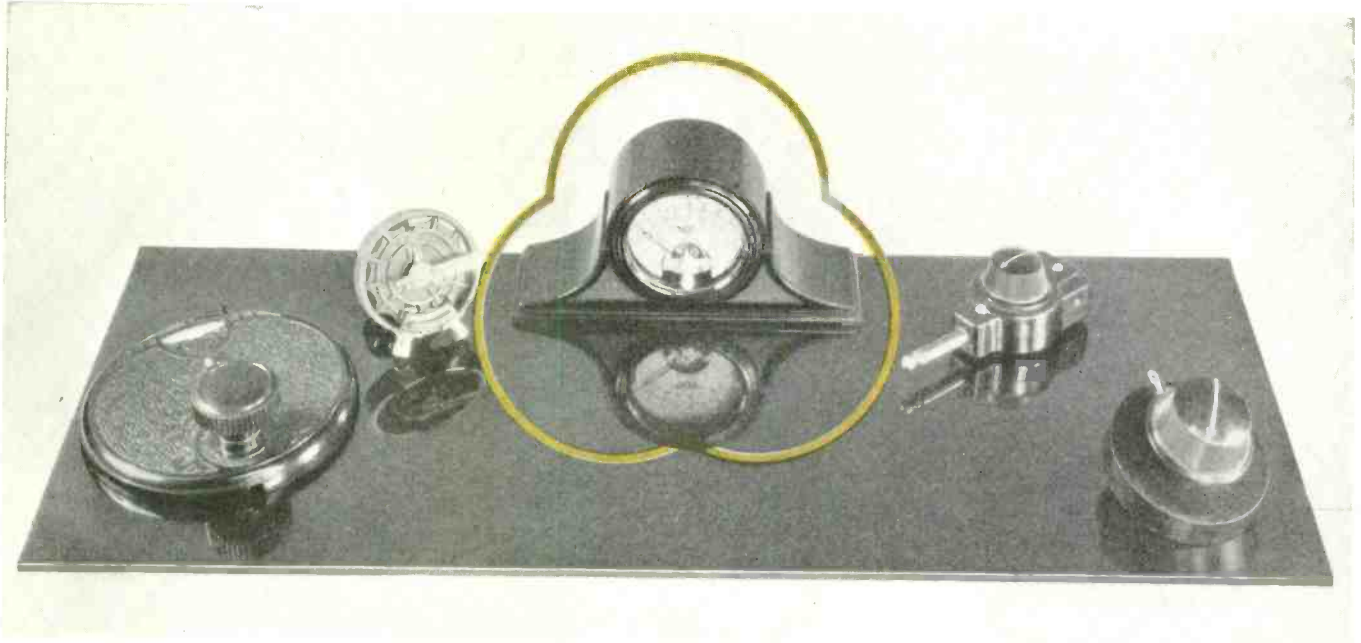

First impressions do count!

When you spread out before a customer a number of radio parts or accessories, be sure his first impression is one of "quality." If so, a sale is far more quickly made.

The rich color, high lustre and fine "modeling" of Bakelite molded parts, assure favorable first impressions. The knowledge of the radio public of the merit of Bakelite, of its permanent insulation value, helps still more in making sales.

It pays you well to handle radio parts and accessories that are plainly trade-marked "Bakelite" on article or carton, for only the genuine may bear it. Write to us for Booklet No. 39, telling of the many advantages of Bakelite for radio equipment.

BAKELITE CORPORATION

247 Park Ave., New York, N.Y. Chicago Office: 636 W. 22nd St.
 BAKELITE CORP. OF CANADA, LTD., 163 Dufferin Street, Toronto, Ontario

BAKELITE

REGISTERED

U. S. PAT. OFF.



THE MATERIAL OF A THOUSAND USES

"The registered Trade Mark and Symbol shown above may be used only on products made from materials manufactured by Bakelite Corporation. Under the capital "B" is the numerical sign for infinity, or unlimited quantity. It symbolizes the infinite number of present and future uses of Bakelite Corporation's products."

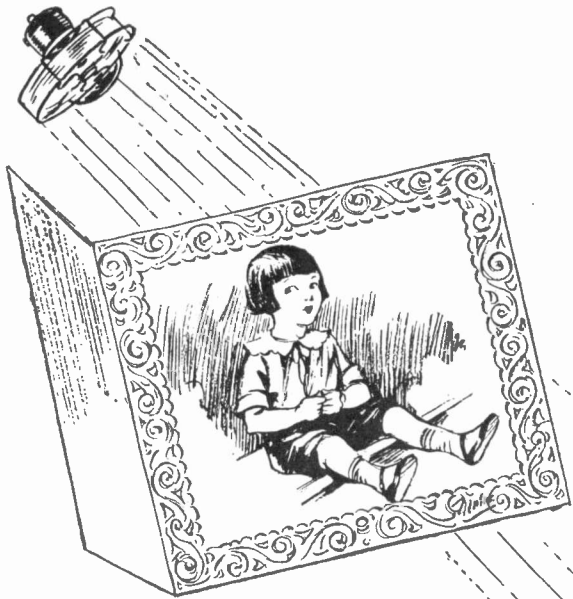

From Childhood to Manhood—This Day-Fan Fan Has Served Its Owner

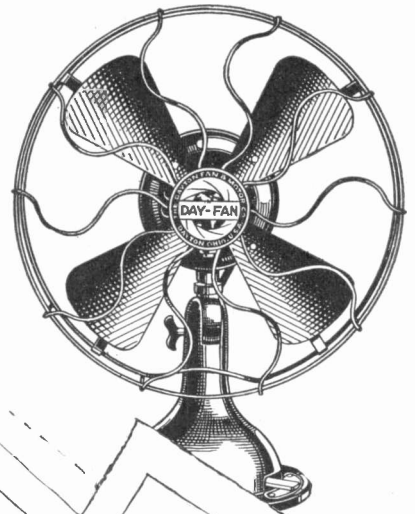

HERE'S an answer to that question any prospect might ask you about a Day-Fan Fan—"How long will it run?"

We heard of one Day-Fan Fan that ran for 26 years! Figure that from the standpoint of a man's life from babyhood to full grown manhood—and you'll better understand how many seasons that fan ran. The point of the story is that the fan is still running.

Day-Fan Fans have many features and many talking points. Long life is but one. Day-Fan keeps things cooler on a hot day, because it has "extra air delivery." It runs long with little attention because its windings are specially insulated—making it heat, dirt and dampness proof. It is economical—it saves on the current. Its quality is fixed and permanent, for it is made by a strong, 38 year old company.

As a result of these combined features—Day-Fan Fans help sell themselves. Make use of these talking points next summer, and you'll find they make selling work easier. They show a prospect that there is a difference in fans—and that it is Day-Fan that makes the difference.

DAY-FAN ELECTRIC COMPANY
Dayton, Ohio



DAY-FAN RADIOS
Nationally known as the radio receiver used by great broadcasting stations to listen to their own programs.

Day-Fan

RADIO • MOTORS • FANS
PRODUCTS

For More Than 38 Years Manufacturers of High Grade Electrical Apparatus.

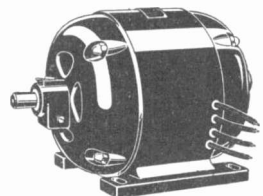

DAY-FAN MOTORS
Used as the standard equipment motor to drive the products of 15 leading manufacturers of labor saving devices.

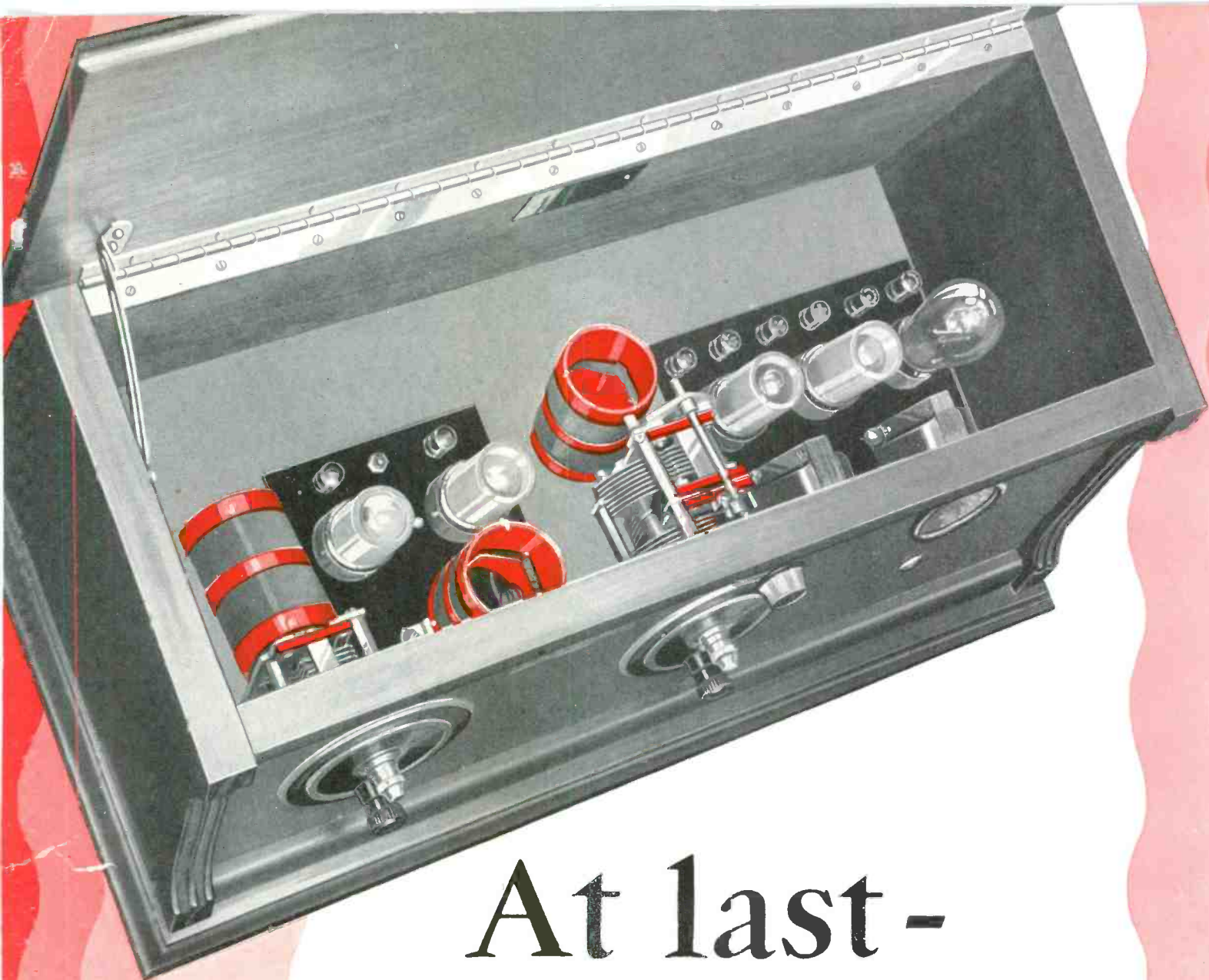

At last -

*An insulating material produced expressly
for the protection of delicate Radio Voltages*

Ordinary insulating materials, designed for electrical purposes, were never intended for radio use. Modern, high quality radio equipment demands an insulating material of its own—a material of clearly defined characteristics and produced expressly for the peculiar requirements of the radio industry.

Celoron Radio Insulation, the answer to this demand, marks a new era in radio manufacture. Produced in great quantity, yet definitely guaranteed to exacting laboratory specifications, it removes the guess work from the buying of radio insulation and assures uniform quality throughout volume production.

C E L O R O N

R A D I O I N S U L A T I O N



Follow the Lead of Successful Radio Manufacturers

Build this new Quality and Dependability in your Equipment

Celoron insulation has been adopted as standard by leading manufacturers and by the U. S. Navy and the U. S. Signal Corps.

As new as the power tube and just as essential for natural, undistorted quality reception, it offers the manufacturer a new, positive control of delicate

voltages throughout the radio receiver.

For instance—as a part of fixed condensers, its low power factor and dielectric constant prevent penetration by the current which would otherwise emerge, out of beat with the original pulsate transferred to the con-

denser, and hence cause the unbalancing of accurate condenser storage capacities. The improper insulation of this one vital factor in radio re-

ceivers is many times responsible for power loss, and, more important, for the distortion of desirable natural tones.

There are countless ways that Celoron can be used to improve the efficiency of your products—countless ways that this easily machined mate-

rial and the service policy behind it can speed up production in your plant. And it will cost you nothing to substitute Celoron since it costs no more than ordinary insulation materials. Write for the whole story of Celoron today, and ask us to tell you about the

fabricating service which is supplying innumerable parts, machined from Celoron, to many radio manufacturers.

*The Laboratory Test
Standard upon which*

CELORON
is GUARANTEED

over 100 meg. resistance after four days' exposure to humidity of 90% at 95°;

a dielectric constant below 6;

a tensile strength ($\frac{1}{8}$ " material) of 10,000 lbs. per square inch.

THE CELORON COMPANY

Division of Diamond State Fibre Co.
BRIDGEPORT, PA.

Laminated Products, Moulding Powders and Varnishes
Fabricating Service in New York City, Cincinnati, Chicago, Kansas City, San Francisco, Los Angeles, Bridgeport, Pa. In Canada, at 235 Carlaw Ave., Toronto.



CELORON

RADIO INSULATION

33% of ALL the RADIO ADVERTISING In New York Newspapers

World Leadership in Radio Advertising

FOR years radio advertisers have used more space in THE SUN than in any other newspaper in the world.

In 1926 THE SUN alone published 33 per cent of all the Radio Advertising placed in the twelve New York newspapers.

Manufacturers and dealers of radio sets and radio parts recognize THE SUN as the most powerful sales producer in the territory where the largest radio sales are available.

THE SUN's leadership in Radio Advertising is due largely to the superiority of its Radio news columns—and its unexcelled Radio Magazine—which have drawn to THE SUN a large body of people who are interested in radio and are responsive to radio advertisements.

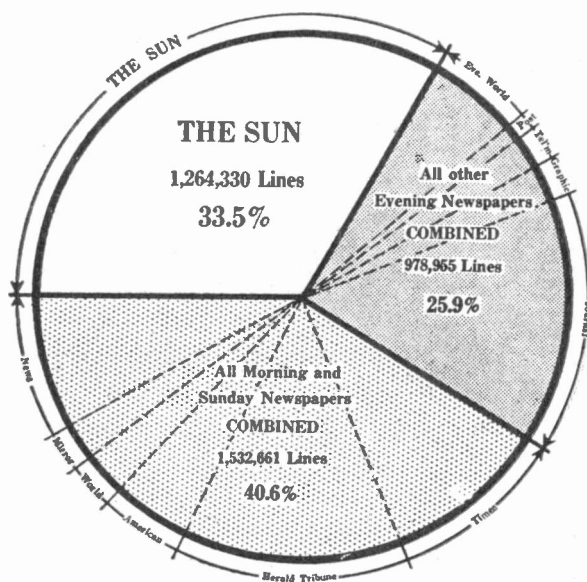

Evening Papers		Morning Papers	
THE SUN	1,264,330	Herald Tribune	463,181
Journal	580,728	Times	407,293
Eve. World	193,590	News	303,582
Graphic	100,056	American	175,031
Telegram	77,266	Morning World	95,521
Post	27,315	Mirror	88,053
Total	2,243,285	Total	1,532,061

THE SUN is New York's Market Place
for Radio Products

The



Sun

280 BROADWAY

NEW YORK



Your Opportunity for increased sales

SUCCESSFUL radio dealers are concentrating on the best in every line of radio merchandise. Customer satisfaction means increased sales.

Concentrate your loudspeaker sales on a quality speaker — for the success of the speaker is the success of the radio installation.

The new Rola Cone Speaker gives a quality of reproduction vastly superior to anything known in radio engineering — on all sets, regardless of make, type of tubes, or circuit used.

The Rola Speaker suppresses any distortion which may occur in the older or lower-priced sets—yet reproduces every shade of delicate tone coloring brought in by the finest sets built.

The Rola Cone is the latest development in speakers. The patented laminated armature; the cone material of remarkable acoustic properties—both are exclusive Rola features.

The Rola Cone is a speaker that actually sells sets. It is one on which you can concentrate all your selling efforts—with good profit to yourself.

Write today for information on the Rola line, and the Rola plan for helping you sell Rola Cone Speakers. . .



Pedestal Type
\$32.50

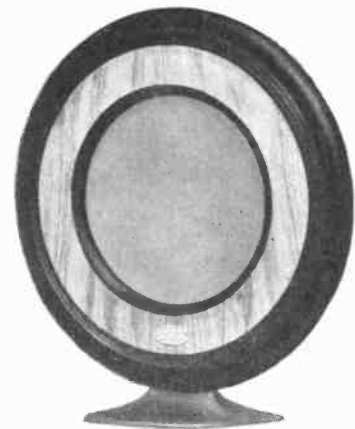

Table Type
\$28.50

The
Rola Company
Oakland, California
You may send me particulars

Name.....
Address.....
City.....State.....
Jobber's Name.....

Rola CONE SPEAKERS

Manufactured by
The Rola Company, Oakland, California

Raytheon Principle Employed To Best Advantage In The **ERLA** Big Ten "B" Power Unit



PRICE
Including
Raytheon
Tube \$45⁰⁰

*A Most Important Feature is the Tremendous Reserve Power—
more than ample to fulfill every requirement
of any set up to ten tubes, including Power Tube*

Due to its design and construction the Erla Big Ten "B" Power Unit is the outstanding source of "B" current on the market today.

Absolutely hum proof. Oversize parts of highest quality. Compact in size. Hermetically sealed filter system. Raytheon Rectifier. Controlable voltage output. Attractive in appearance. Long Life. Economical operation. Requires no attention.

Here is a "B" Power Unit that stays sold

and delights owners with the better reception and increased range resulting from its use. Operates from any light socket supplying 105-125 volts, 60 cycle, alternating current.

You can build a worth while business that pays real profits. Every set owner is a prospect. Do not lose a day; write for information regarding a dealership.

Address Department M50,
2500 Cottage Grove Avenue

ELECTRICAL RESEARCH

**ERLA
RADIO**

LABORATORIES, CHICAGO

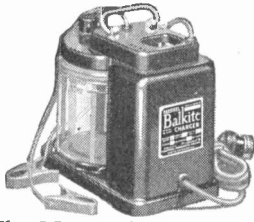

The New Balkite Charger

MODEL J. Has a low trickle charge rate and a high rate for rapid charging and heavy duty use. Can thus be used either as a trickle or as a high rate charger and combines their advantages. Noiseless. Large water capacity. Visible electrolyte level. Rates: with 6-volt battery, 2.5 and .5 amperes; with 4-volt battery, .8 and .2 amperes. Special model for 25-40 cycles with 1.5 amperes high rate. Price \$19.50. West of Rockies \$20. (In Canada \$27.50.)

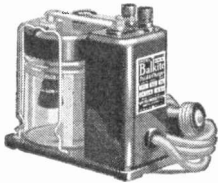

Balkite Trickle Charger

MODEL K. For those who require a charger of limited capacity only. Can be left on continuous or trickle charge thus automatically keeping the battery at full power. Converts the "A" battery into a light socket "A" power supply. Charging rate about .5 ampere. Over 350,000 in use. Price \$10. West of Rockies \$10.50. (In Canada \$15.)

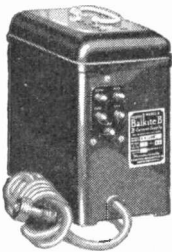

Three New Balkite "B's

Balkite "B" eliminates "B" batteries and supplies "B" current from the light socket. Noiseless. Permanent. Employs no tubes and requires no replacements. Three new models. The new popular priced Balkite "B"-W at \$27.50 for sets of 5 tubes or less requiring 67 to 90 volts. Balkite "B"-X, (illustrated) for sets of 8 tubes or less; capacity 30 milliamperes at 135 volts—\$42. Balkite "B"-Y, for any radio set; capacity 40 milliamperes at 150 volts—\$69. (In Canada "B"-W \$39; "B"-X \$59.50; "B"-Y \$96.)



Balkite Combination

When connected to the "A" battery supplies automatic power to both "A" and "B" circuits. Controlled by the filament switch on the set. Entirely automatic in operation. Can be put either near the set or in a remote location. Will serve any set now using either 4 or 6-volt "A" batteries and requiring not more than 30 milliamperes at 135 volts of "B" current—practically all sets of up to 8 tubes. Price \$59.50. (In Canada \$83.)

All Balkite Radio Power Units operate from 110-120 volt AC current with models for both 60 and 50 cycles. The new Balkite Charger is also made in a special model for 25-40 cycles.

Keep radio profits up by concentrating on lines that are selling now

Keeping your radio department operating at a satisfactory profit at this time of year is a matter of selecting the correct lines to push. Scatter your efforts on all lines, many of which are unsalable at this season, and your sales will drop. Concentrate them on the few lines that are good sellers now and they will keep at the maximum.

Balkite is one of those lines. In fact Balkite sales after the first of the year are greater each season than before the first of the year. When most lines are falling off, the Balkite season is just beginning. This is logical, for every purchaser of a radio set the early part of the season is now a Balkite prospect.

Balkite is the standard line in the radio power field. It is consistently advertised. The profit you make on it is clean, for every Balkite unit is a permanent piece of equipment, with nothing to wear out or replace. Get behind the line now, and get your share of Balkite volume and profit.

FANSTEEL PRODUCTS COMPANY, Inc.
North Chicago, Illinois

Balkite Radio Power Units

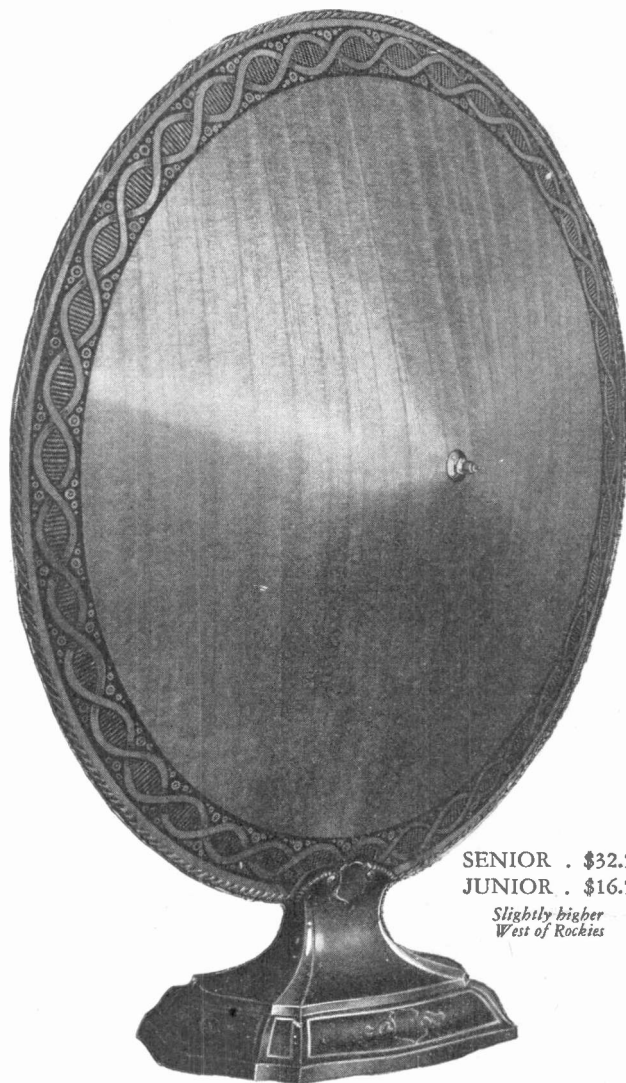

SENIOR . \$32.50
 JUNIOR . \$16.50

*Slightly higher
 West of Rockies*

THE Farrand Speaker commands the same price today that it did two years ago! Stop a moment and contrast this unbroken full-price, full-value record with that of any other speaker on the market. When you buy Farrand Speakers you not only know they will sell fast, and stay sold, you know they will *always* command their *full* value, *always*

assure you *full* profit. Furthermore, no reduction in price will *ever* be contemplated without first protecting you—the dealer—against

loss. This comes to you not only as a pledge from your distributor, but also as an absolute guarantee from the manufacturer. Farrand Manufacturing Company, Incorporated, Long Island City, N. Y.

Your Stock of
FARRANDS
is
VALUE—
INSURED!

Farrand
Speaker

ATWATER KENT RADIO

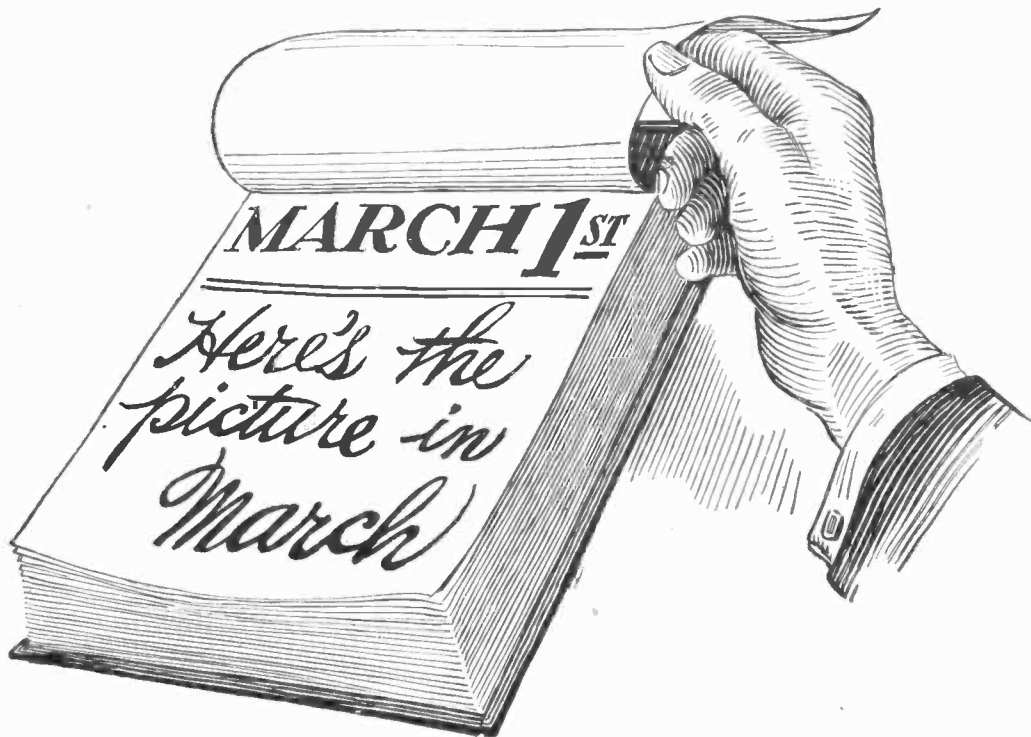

PEOPLE used to think that any radio set that would make a noise was wonderful. They know better now.

Quality is in such demand that a radio set has *got* to stand up and do its work or it isn't in the picture at all.

The picture isn't changing as rapidly as it did in the kaleidoscopic transformations of a year or two ago—but it's still changing.

And the more it changes, the stronger is Atwater Kent Radio's position with the public and the trade.

Every one of the more than a million owners is a walking advertisement of satisfaction. That's **NOW**.

Whenever any large group of people are

asked what radio they expect to buy—or buy next—more people say "Atwater Kent" than any other. That's the **FUTURE**.

The Atwater Kent Manufacturing Company will continue to offer its dealers and the public a product that sells easily and stays sold.

And, of course, its advertising (radio's greatest campaign) will continue through the spring and summer as it has done for the past two years.

MODEL 35, illustrated, 6-tube ONE Dial Receiver, less tubes and batteries, \$70. Speaker, Model H, \$21.

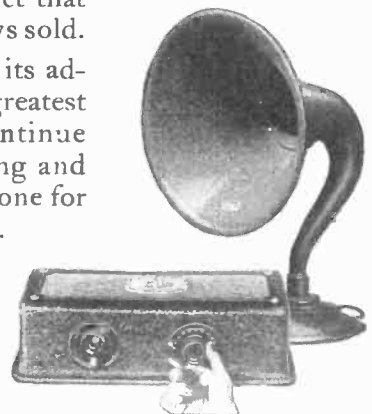

ATWATER KENT MANUFACTURING COMPANY

4733 WISSAHICKON AVENUE

A. Atwater Kent, President

PHILADELPHIA, PA.

Write for illustrated booklet of Atwater Kent Radio

Prices slightly higher from the Rockies west, and in Canada

EARL WHITEHORNE,
Contributing Editor
S. J. RYAN,
Merchandising Counsellor
L. E. MOFFATT,
Associate Editor
H. S. KNOWLTON, Boston
PAUL WOOTON, Washington

Radio Retailing

The Business Magazine of the Radio Industry

O. H. CALDWELL, Editor

WILLIAM C. ALLEY,
Acting Managing Editor
RAY V. SUTLIFF, JR.,
Western Editor, Chicago
HENRY W. BAUKAT,
Technical Editor
WILLIAM W. McDONALD,
Assistant Editor
C. GRUNSKY, San Francisco

Table of Contents, March, 1927

"Check Up Every Set in Town"	26
"Make Inspection Calls During Broadcasting Hours"	28
"Put the Postman to Work"	29
"Keep the Service Car Well Stocked"	31
"Your Territory Must Be Systematically Covered"	32
Radio Windows That Have Made Them Buy	35
"He Gets a Signed Order Before He Makes a Home Demonstration"	36
Trade Favors Speaker Separate	39
Merchandising the New Tubes	41
Radio Events of the Month	43
Radio Law Now in Effect	44
"Distinctive Advertising"	46
Reviewing Radio Export Conditions Abroad	49
Practical Service Methods	54
"How's Business?" Read the Market Barometer	56
Use Inspection Calls to Sell Accessories	59-61
A Store Layout That Is Good Looking and Practical	66
"Small Sets Are Profit-Makers"	67
Your Editors Have This to Say—	68
New Radio Products Announced This Month	70-74
What the Trade Is Talking About	75
News of Jobbers and Distributors	79
New Dealer Helps Offered by Manufacturers	80
How to Get Replacement Parts Business	83
Reviewing the New Circuits	87
New Radio Parts Marketed this Month	89

Not "Painting the Lily," But—

THE following communications received, unsolicited by the editors of *Radio Retailing*, are too significant not to publish. We don't like to throw bouquets at ourselves, but we don't want to keep any secrets from our readers, either.

So, at the risk of being accused of having swelled heads, here they are:

Communication signed by W. D. V. Hopkins, president, Hopkins Equipment Co., Atlanta, Ga.: "We are frank to tell you that of all the radio trade papers and magazines we have had the opportunity of studying to any extent, your paper known as 'Radio Retailing' is unquestionably, in our opinion, the best for the radio dealer. We are interested in having all our dealers subscribe to this magazine and are wondering if you would be good enough to get up a selling letter, place them in envelopes, stamped and sent to us in a package. We will address these envelopes and mail. Then we will follow up your letter with our letter, impressing upon our dealers the necessity of their learning more about the merchandising of radio and suggesting they subscribe to your paper."

Communication No. 1 from Parks and Hull, radio distributors, Baltimore, Md., signed R. B. Green: "We are planning to hold a meeting in the near future for all our dealers. I think it would be a good plan if we had a quantity of 'Radio Retailing' cards and circulars to give to these dealers."

Later—Communication No. 2 from Parks and Hull: "We distributed all of the subscription blanks at the meeting of our radio dealers and would suggest that you send us another quantity of these for future meetings."

BUT that isn't all. Read on—
Communication from A. Z. Heller, York Supply Co., Greenville, O.: "'Radio Retailing' would be a mighty fine thing for the 150 franchised King dealers whom we are serving. We would like to send our dealers one of your folders and solicit subscriptions for you by mail and through our salesmen, for we believe if we can induce our King franchised dealers to subscribe to 'Radio Retailing' they will become better merchants."

Here's one—short, but unusually sweet, from R. L. Roth, Roth-Downs Co., St. Paul, Minn.: "I wish there were some way I could force our 2,200 dealers to read 'Radio Retailing.' It is in a class by itself."

Last, but far from least—a letter signed by G. Dan Junas, radio manager, Times Square Auto Supply Co., New York City: "Herewith you will find a list of our branches. We request that you place our subscription for one copy of 'Radio Retailing' to be sent to each one of these stores and also three copies to our New York office, making a total subscription of 36 per month."

Member Audit Bureau of Circulations

Circulation of This Issue, 30,000 Copies

McGRAW-HILL PUBLISHING COMPANY, INC., Tenth Ave. at 36th St., New York, N. Y.

JAMES H. MCGRAW, President
JAMES H. MCGRAW, JR., Vice-Pres. and Treas.
MALCOLM MUIR, Vice-President
EDWARD J. MEHREN, Vice-President
MASON BRITTON, Vice-President
EDGAR KOBAK, Vice-President
C. E. THOMPSON, Secretary

Electrical World Electrical West Ingenieria Internacional
Industrial Engineer Engineering and Mining Journal
Chemical & Metallurgical Engineering American Machinist
Electrical Merchandising Power Electric Railway Journal
Bus Transportation Engineering News-Record
Coal Age Successful Construction Methods
Copyright, 1927, by McGraw-Hill Publishing Company, Inc.
Cable Address: "Machinist, N. Y."
Annual subscription rate is \$2 in United States and Canada.

WASHINGTON, D. C., Colorado Bldg.
CHICAGO, 7 South Dearborn St.
PHILADELPHIA, 1600 Arch St.
CLEVELAND, Guardian Bldg.
ST. LOUIS, 713 Star Bldg.
SAN FRANCISCO, 883 Mission Street
LONDON, E. C. 1, 8 Boulevard St.

Check Up

Within walking distance of your store or home are hundreds of radio sets that are out of date or giving poor service—

BUT THEIR OWNERS DON'T KNOW IT!

RADIO reception is getting better and better each year. In particular, the standards of musical reproduction have wonderfully improved. Many speakers and sets sold two and three years ago now sound tinny and terrible, compared with the splendid pure tones of modern equipment.

All over your town there are radio users who now in 1927, are really listening to "1925 radio,"— or "1923 radio,"—and don't know any better. They do not realize the tremendous progress in radio tone quality that has taken place. These good radio fans deserve better things. They should be shown what modern loud speakers, amplifiers, power tubes, new batteries and other accessories and parts can do to bring their old sets up-to-date. And in the cases where their own old receivers are "hopeless," they will need *new* receiving sets.

Here is the first great class of prospects, right in your own home town, who are waiting for you to sell them something.

They Want Lamp Socket Devices, Novelties, etc.

Second, there are hundreds of radio fans that would like the convenience of lamp-socket supply to replace their A and B batteries,—if someone would just make these devices "easy to buy" and would connect them up. *That means you.*

Third, there are hundreds of radio listeners with sets in which, without



where are prospects for the novelties and conveniences which are now offered in every complete radio stock. Dial lights, clock-switch controls, phonograph tone-arms, extra speakers with extension cords, outlets for antenna and ground, and so on. *This is all high-profit stuff.*

Thus, right within walking distance of your shop or your home, are hundreds of prospects for radio sales,—sales which can be made by going out after them!

You and Your Crew Can Start This Plan Now!

Here are sales awaiting calls from you, the boss,—from your salesmen,—from your service men.

You don't have to wait for anybody. You and your organization can start work today, tonight, tomorrow.

How? Every dealer undoubtedly keeps a card index of the customers to whom he has sold sets during the past few years. And most dealers have a name and address file in which are recorded all known set owners in his community. The first step in the "Check Up Every Set" campaign, then, is to write, telephone or *make a personal call on every known set owner, offering to*

the owners realizing it, the filament emission of tubes has become impaired and batteries have run down, making reproduction weak and "distance" reception almost useless. These users can be fitted out with complete sets of new tubes and new batteries, also, tube-testers, meters, and battery chargers. *You have these all in stock.*

And, fourth, radio fans every-

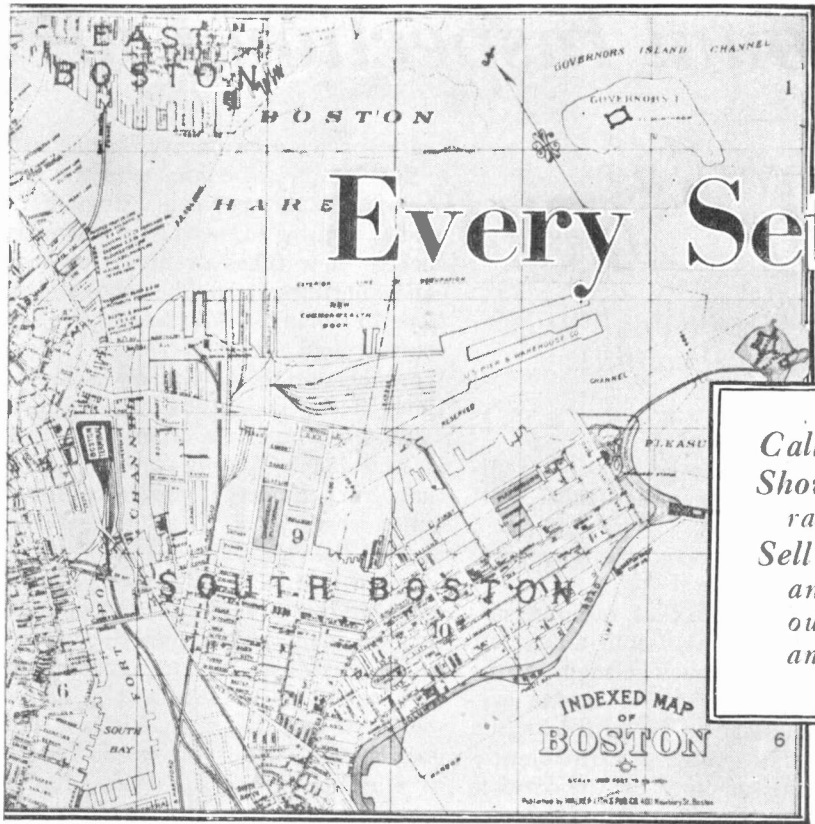

Every Set in Town

*Call on present radio owners
Show Them what good "1927
radio" really is, and you can
Sell Them new loud speakers,
amplifiers, lamp-socket-supply
outfits, tubes, batteries, parts
and even new sets*

check over his set for defects or loose connections and to tell him whether or not the set needs overhauling. This checking up service can be offered without charge to the customer, or a small sum such as \$1 may be asked.

The charge is not the important thing, however—the important thing is the opportunity thus created to get inside the customer's home, to talk with him about his installation and to sell him such accessories as you see he needs—perhaps getting him lined up for a new set if his installation is an old one.

This procedure is an accepted practice in the automobile trade, with this possible exception—that the automobile service stations have educated car owners to come to them for regular checking over of the automobile. Obviously the radio set owner seldom thinks of going to his radio dealer for such a service, so the dealer must go to the set owner.

And if a list of known set owners is not available, the dealer can resort to the simple expedient of ringing doorbells and inquiring whether the resident owns a set. If he does not, the dealer has one more prospect to add to his list, and if he does, getting inside to check over the in-

stallation depends on how good a talker the dealer is. Certainly such a procedure during the spring and summer is far better than sitting idly in the store from morning to night.

There are many instances on record of dealers who, a few short months ago, complained bitterly that service was eating up most of their net profits, but are now satisfied that service can be made to show a dollars and cents return. The secret, if there is any, lies in the ability of the dealer or service man to sell accessories at the time he makes his service call.

It seems appropriate, therefore, for the spring and summer months just ahead, that the trade embark

on an inspection campaign and adopt as its slogan—"Check Up Every Set in Town!"

On the following four or five pages is presented a series of three articles concerning dealers who have made service pay, and one dealer especially, whose entire business is composed of nothing else but radio service. These dealer experiences prove that radio service can be made to stand on its own feet and pay its own way. Putting into effect, now, as soon as it can be done, a campaign to "check up every set in town," will not only bring in many more dollars this spring and summer but will help the dealer establish his service department on a paying basis.

For full details of other men's experiences and methods which will help you this Spring in your own "Inspect-Every-Set-in-Town" Campaign,—be sure to read in this issue:

	<i>Page</i>
<i>"Call During Broadcast Hours," is Advice of Toronto dealer . . .</i>	<i>28</i>
<i>"How a San Antonio Dealer Started a 'Check Up' Campaign Through the Mails"</i>	<i>29</i>
<i>"Adapting the Service Car to Help the 'Check Up' Plan"</i>	<i>31</i>
<i>"Your Territory Must Be Systematically Covered"</i>	<i>32</i>
<i>"How to Sell the New Type Tubes on Inspection Calls"</i>	<i>41</i>
<i>"Use Inspection Calls to Sell Accessories"</i>	<i>59-61</i>
<i>"How to Get Replacement Parts Business"</i>	<i>83</i>

Make a Personal Inspection Call

"Call During Broadcasting Hours," Is Ratcliff's Advice

Dealer who makes radio service his entire business explains how he earns his living through calling on set owners

MAKE your checking-up calls on set owners during the hours when stations are broadcasting," is the advice given by J. H. Ratcliff, proprietor of the Ratcliff Radio Service, Toronto, Can., to dealers who contemplate instituting a plan to "check up every set in town."

Ratcliff's entire business is founded on service calls. His experiences in building a business out of radio service alone should prove extremely valuable to every dealer, particularly those who are seeking to increase their warm weather revenue and also to set up their service facilities as a self-supporting unit. The first step is to make a personal service call on every set owner. The second step is to sell accessories on these calls.

"Don't think that I wait for orders to come in," he says. "I go out after them all the time, but especially in summer when things are apt to be dull. I get all the names of set owners I can, and I write, phone, or call on each and every one of them. In this way I get not only servicing

jobs, but I make a lot of very profitable sales of accessories—tubes, batteries, amplifiers, power units, and other items, and not infrequently new sets."

Ratcliff believes that radio servicing is naturally a 14-hour-a-day job. Consumer calls must be made in the afternoon or preferably in the evening when stations are broadcasting. This indicates a very great limitation in the amount of the trouble work that can be done in one day.

Consumers are charged \$2.00 per call, under one-half hour, and at the rate of \$2.50 per hour thereafter. Special arrangements are made with dealers to handle their entire servicing business at a fixed price for each half hour of service. It is found that about six calls can be made by one man per evening as generally there is no objection by customers to calls made up to 11 o'clock. (A little sidelight on the type of man required for the work is furnished by the fact that a surprising amount of liquid refreshment is offered to

radio service men on evening calls.)

Revenue is not confined to the flat charge of \$2.00 per call. Customers often require renewal accessories such as new tubes or batteries, and can sometimes be sold better installations or aerials. Accessories are, of course, sold at full retail prices. Work on aerials or battery installations is charged at \$1.50 per hour.

That the business is not all velvet is revealed by figures which show that every time the service car goes out, a cost charge must be entered against the call. The operator's time is added to this.

"It might be said that the outside service man represents the whole radio business in the customer's eyes, and I do not think it is going too far to say that upon his tact and good sense depends the whole future of a radio service business. Radio knowledge is essential, but as between two candidates for a job, one knowing lots of radio and nothing of human nature, and the other a medium grade man but able to give people a good impression, the latter would be my choice. If the service man is absolutely stumped by the trouble, he can always make some excuse and take the set to the shop. The service man's prime duty is to keep the set sold, and to do that he has to be somewhat of a salesman."

Ratcliff believes, however, that the practice of picking up defective receivers and substituting others in their places will not do as a general system. He points out that a set should be installed and tested with the customer's own aerial, ground and batteries. Cases often occur where a defect exists among these items but it is not immediately visible. For instance, a B battery might give a good voltmeter reading but nevertheless have a high resistance joint that would prevent successful operation. Hence the importance of a thorough test on the spot. Customers will never get to the point where they will bring their sets into the service shop and it would not be desirable to do so.

One thing that is kept with meticulous care is the general log book, showing all calls for service and having space for entries giving particulars of what was done on each job. From this book the bills are made out.

Keep These Accessories in Mind to Sell on Service Calls

Adapters for power tubes
Aerial equipment
Ammeters and voltmeters
A, B and C Batteries
Hydrometers and similar meters
Cabinets and tables
Battery chargers
Trickle chargers and switches
Speakers
Socket power units, A and B
Battery connectors
Extension cords and connection blocks

Lamp socket antenna
Power amplifiers
Phonograph attachments
Lightning arresters
Plugs
Headsets
Time switches
Battery cable in place of loose wiring
Filter unit system for speaker circuit
Fuse block in A battery circuit to conform with new underwriter rules
New insulators
Tubes and power tubes

on Every Local Radio Set Owner

Put the Postman to Work

A direct-mail campaign to known set owners was used last year by a San Antonio dealer to start off his Spring service and sales plan

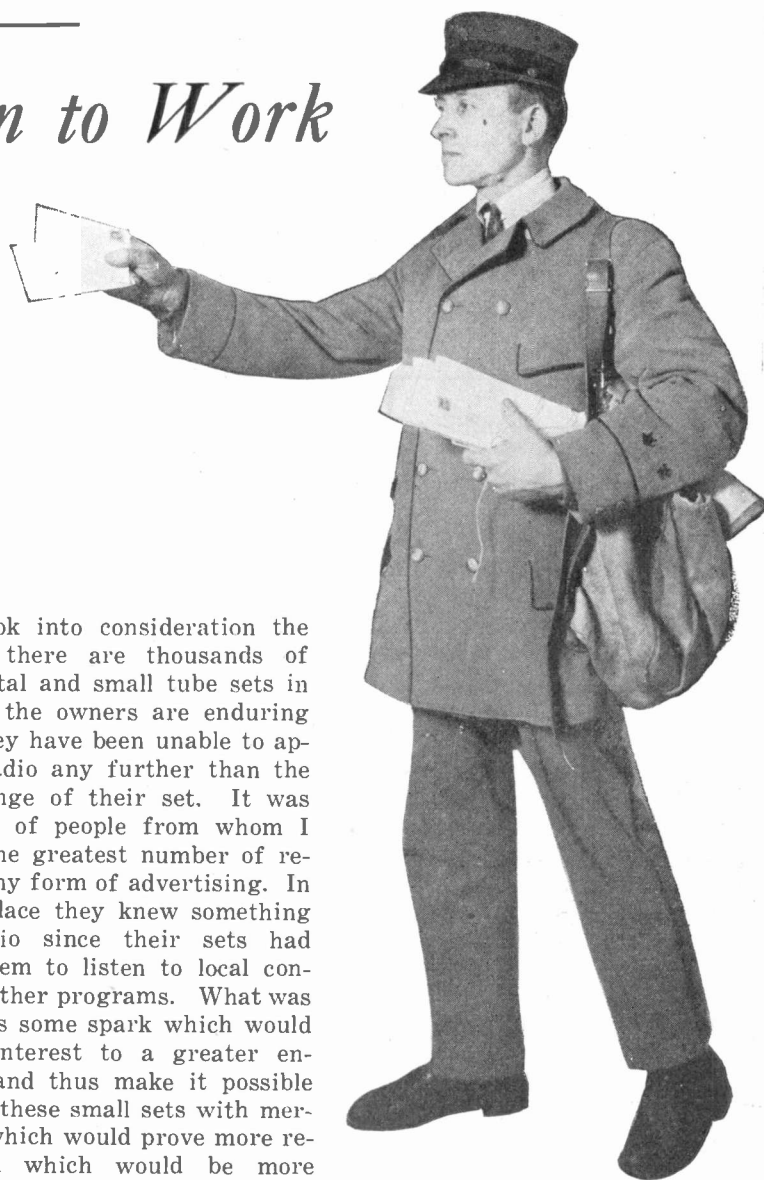

PLANNING for the spring trade is a problem which every radio dealer must work out each year. With a great many obstacles to prevent good business, he has to create means to keep his trade as nearly normal as possible.

In San Antonio, Texas, the Blanchard Radio and Typewriter Shop has effectively used personal letters with very gratifying results. How the plan was worked out, how it was put over, and the results attained are best told by G. C. Blanchard, the proprietor.

"With the coming of the hot summer months last year and the natural decline in radio sales," Mr. Blanchard explains, "I began to grope around for some means of offsetting this depression.

"I had used various forms of advertising and means of getting prospects, and while they all had their good features, nevertheless they did not bring in the results I had hoped for. It was evident, therefore, that some other form was needed. I began to look for some means of getting over my message to the greatest number of people with the smallest expense and assure myself of the greatest number of returns.

"To do this I placed myself in the position of a person who is a prospect for a radio set. I tried to picture just what sort of an appeal would affect me the most and what sort of an approach would cause me not only to become interested, but to buy.

"In working out this plan, how-

ever, I took into consideration the fact that there are thousands of cheap crystal and small tube sets in use which the owners are enduring because they have been unable to appreciate radio any further than the limited range of their set. It was this group of people from whom I expected the greatest number of returns on any form of advertising. In the first place they knew something about radio since their sets had enabled them to listen to local concerts and other programs. What was needed was some spark which would fire this interest to a greater enthusiasm and thus make it possible to replace these small sets with merchandise which would prove more reliable and which would be more greatly appreciated.

"I realized that it would not do to come right out and ask these people to throw away their sets and buy better ones from me, so I appealed to them from the repair and service

angle. To do this I wrote a letter which I felt would create the greatest possible amount of interest and at the same time would get results.

Mailed Letters to Set Owners

"As an experiment I mailed out a bunch of these letters to some people I knew who had small sets, but who could well afford to own something better. From these letters I got quite a number of replies, either asking about repair parts, or repair service, and in one or two instances about more expensive sets. Rendering the repair service gave me an opportunity to demonstrate a better set, and in this way I was able to sell quite a number of good

FREE inspection calls pay for themselves through:

1. Accessory and parts sales.
2. New leads on friends of the customer visited.
3. Paid calls from friends who bought elsewhere.
4. Paid inspection service in future.

Start Your Inspection Campaign Now

1. Divide your town into zones, giving each sales and service man a zone to cover.
2. Require the men to visit and report on a number of set owners daily.
3. Service men should check over each installation, informing the set owner as to his needs.
4. Call should be made without charge.
5. Small repairs should be made on the spot.
6. The service men should use the opportunity to sell the set owner such accessories as he may need, as pictured on Pages 59-61.

sets to replace the small cheap ones.

"I followed my first batch of letters with others and got similar results. By sending out more letters from time to time and taking advantage of every opportunity to replace a cheap set with a good one I have been able to increase my business and not only keep it normal but to bring it up to a point where it is showing a decided increase over other months. I have found that if you can create some means whereby you can reach the customer at his own request you are provided with an opportunity to give him a strong sales talk from which you are pretty sure of getting results."

A direct-mail campaign to set owners should offer—

1. To test and replace worn out accessories.
2. To install any desired additional accessories.
3. To test and repair antenna installation.
4. A monthly service call plan for so much per year.
5. To keep the set always in good condition.
6. To make a small allowance for the old set as a trade-in on a new sale.

The points brought out by Mr. Blanchard in this article are points which may be adopted by any dealer with profit both to himself and his business. The warm months are selling months for those who are willing to go to the customer with a definite plan in mind—to sell him either (1) a better set, (2) replacement and additional accessories, or (3) expert service.

Uses Service Testimonial in Advertising

Here is the text of "service testimonial" letter which was received, unsolicited, from a prominent thread manufacturer of Paterson, N. J.:

To H. M. Ash,
Radio Dealer,
Paterson, N. J.

Dear Sir:

This is to inform you that your service man called at my home last evening

and very quickly adjusted my radio set so that it now works to my entire satisfaction. I want to thank you for the prompt and expert attention I received.

Sincerely yours,

A— B—

Why not arrange to get a similar letter from someone in your town who has expressed his appreciation of your service? Then run this letter in your newspaper advertisements or reproduce it and circularize your prospect list.

The Real Function of Lightning Arresters

In each flash of lightning during a storm, there is a wide area of electrification. In every nearby radio aerial is induced an abnormal current which, in seeking ground, very frequently punctures the insulation of coils, condensers, grid leaks or other parts of the radio set, leaving a permanent damage to the set. This damage may not prevent the operation of the set, but it certainly affects the tone quality, quietness and the reception in general. Here is a good reason why every set should be checked over and a new lightning arrester installed.

The Letter Blanchard Sent to Set Owners

RADIO EQUIPMENT
PHONE CROCKETT 2046

BLANCHARD RADIO AND TYPEWRITER
REBUILT TYPEWRITER
112 NORTH ALAMO
San Antonio, Texas

RADIO SETS, SUPPLIES, SERVICE
BLANCHARD RADIO SHOP
SAN ANTONIO, TEXAS
1120 N. ALAMO
PHONE CROCKETT 2046

John S. White
845 North Main Street
City.

Dear Sir:

Super-Station W.O.A.I., in co-operation with the dealer members of the Radio Trades Association of San Antonio, has been broadcasting regular programs during the afternoon that are of interest to every member of the family. The Ed Fomby sport flashes, broadcasted on thirty minute periods, starting at three-thirty and continuing until all games have been played, will give you the Base Ball scores from the National, American, and Texas Leagues.

Is your set working at its best so that you and your family can enjoy these programs?

Are you listening to the night programs of this Super-Station that is fast becoming the talk of the Nation on account of the quality of its programs? Perhaps you have allowed your batteries to run down with the thought that Radio reception is no good in the summer. Why not let us inspect your Tubes and Batteries and put your set into condition so that you may enjoy these fine programs?

We maintain a service department that is equipped to take care of all your Radio troubles. We can supply you with batteries, tubes, and other accessories at a moment's notice. We refer you to any Radio owner who is acquainted with our service department. Phone Crockett 2046 and we will be on the job right now.

Place the enclosed card in your Radio set where it will be handy and the next time you need service give us a ring and we know that we can satisfy you.

Radioingly yours,
G. C. Blanchard.

GCB/#

Note that Blanchard offers to inspect the set and installation and put them in good condition for the warm weather. He also offers to test and replace worn out accessories and encloses his business card for future reference.

Building Good Will Through the Service Car

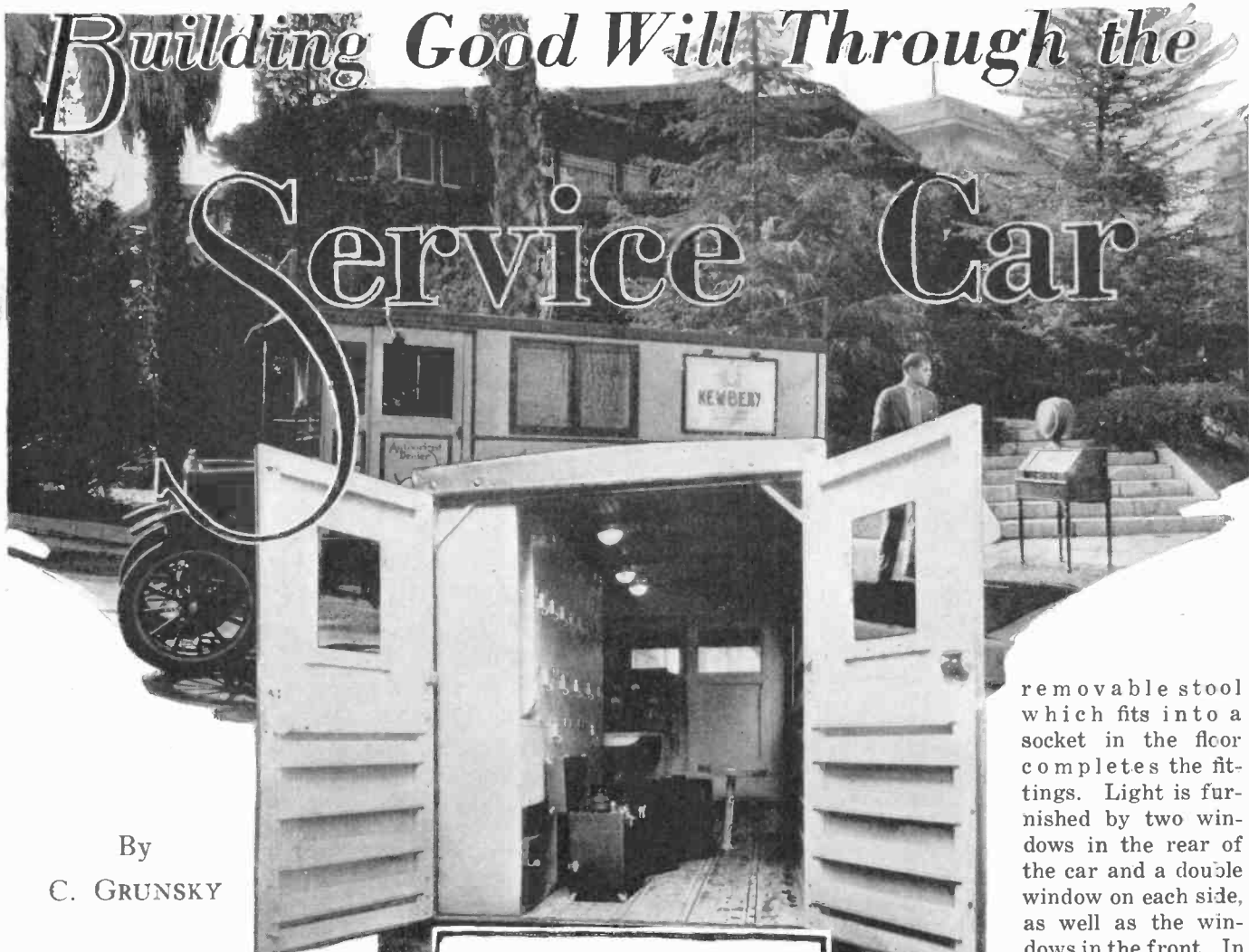

By
C. GRUNSKY

IN the process of making inspection calls on every known set owner, in an attempt to increase the sale of accessories, the service car becomes of immediate importance. The Newbery Electric Corporation, Los Angeles, Cal., has adapted its service car for use not only as a traveling workshop where minor repairs may be made on the set without taking it back to the shop, but the company has had the walls of the interior fitted out with shelves and compartments so that accessories and parts of all types may be carried. Thus sales of any kind of radio supplies can be made on the spot.

The interior is fitted up for greatest convenience both in delivery and service. The ample space of the interior means that double the number of sets can be handled as previously and also that they can be allowed individual space and handling. Quilted table packing is wrapped around each set so that no scratches will result from the transportation. The rear doors have been arranged

Keep the service car well stocked with accessories during inspection calls

to open full width. Steps bridge the gap from the floor of the truck to the street level. These lift up and slide under the car when not in use.

Besides being a delivery wagon, the car is outfitted as a complete work shop for handling service work. A cabinet, built into one side of the car, is made up of compartments and lockers of various sizes to accommodate tubes, batteries and accessories needed on the job. This eliminates the necessity of a return trip to the store for some small article which may have been overlooked when leaving, and lessens the overhead cost of servicing. A small work bench at a convenient height with drawers shares this side of the car. A

removable stool which fits into a socket in the floor completes the fittings. Light is furnished by two windows in the rear of the car and a double window on each side, as well as the windows in the front. In addition, three automobile dome lights

down the center of the ceiling give excellent light in the evening and add to the interior appearance. The windows are provided with prismatic glass which lets in the light, but does not show the interior from the outside. Ventilation is adequately provided for.

Three instruments are carried regularly, a tube testing instrument which is part of the equipment of the work bench, a directional interference locator and a set for wavelengths, etc. These are all portable, to facilitate moving wherever needed.

This car has proved a profitable investment. It has produced new business and has reduced the cost of servicing and delivery, according to the Newbery Company. The advertising value of the car was apparent from the time it was first used. The attractive color as well as the completeness and the conspicuous quality of the appurtenances arouses much comment, echoes of which drift continuously into the store. It is possible to check back and credit certain sales

(Please turn to Page 38)

Your Territory Must Be

Laying out the territory you serve into zones or routes and covering each one regularly is a tried and proved method of making radio sales to rural customers

By RAY V. SUTLIFFE

Editor's Note—The material incorporated in this article was originally prepared by Mr. Sutcliffe, Western Editor of "Radio Retailing," as a talk which he delivered before a series of radio trade meetings in the Northwest. The talk was such a

comprehensive survey of rural radio sales methods that the editors believe it worthy of more widespread consideration.

ACCORDING to figures collected by the Department of Agriculture, there are 6,371,617 farms in the United States. Of these 1,300,000 have radio sets. This leaves the interesting balance of 80 per cent yet unsold. The farmer needs radio. He needs it not only to tickle his ear, but to stimulate his business acumen. In other words, with the farmer, radio is a useful

tool. It is a utility as well as a pleasure-giving device. Every farmer and small town dweller is a prospect for a radio set. He does not have to have electricity on the farm in order to buy radio. If he is poor, he needs radio; if he is well-to-do he cannot afford to be without it. How to get your share of the farm radio business—that's the question uppermost in the minds of radio dealers in the



rural districts. You can get it I am convinced, after talking with countless successful dealers who have specialized on selling the farmer—by a thorough understanding of these three factors:

1. The "Buying Character" of the farmer;
2. Systematic methods for contacting him;
3. Sales promotional "Stunts" for directing his interest specifically to you.

Systematically Covered



Selling the farmer is 90 per cent psychology—get close to him—study him—understand that he will be led but refuses to be pushed—and you will be successful with this class that represents 60 per cent of the entire population of the country. “High-pressure” methods won’t do. Let him do the buying—when and how he pleases. Your job is to sell yourself to gain his confidence and then he will take your recommendations as to the set he should buy.

Tell the advantages of radio also, but don’t talk too much. Chat, rather than argue, and better still, act—turn to and help the farmer in his everyday problems whenever the opportunity presents itself. Above all, don’t patronize him. Don’t by the slightest hint, talk *down* to a farmer. He may not show his resentment, but you are “sunk” then and there.

But it is necessary not only to “cultivate the farmer” but to carry on this process continuously and consistently. In other words, *your territory must be systematically covered*. This is the more important, because, in a great majority of cases *the farmer is sold on the farm*. He is

hard to reach and this means that you must plan your trips in order to avoid waste of time and energy.

I find that dealers who have been most successful with the farmer do this: they survey their territory and lay it out in routes. They cover each route once a month. If your territory is so large that you cannot do this, then your territory is too big for economical selling purposes.

Call on Every Farmer

The experience of others has shown that it is advisable to call on practically every farmer along your route. Spasmodic selling will not do with the farmer. Do not be disappointed if you do not sell every one the first time. Remember that the law of averages is working in your favor. If you’re the fellow that gives the farmer the most attention, you’re the one that will get the business when the farmer is ready to buy.

I will now outline the two factors of personal selling, i.e., reaching the farmer, and cultivating him. There remains the third major consideration and that is—sales promotional stunts. This is a broader subject than mere newspaper advertising and a good-looking store. In the course of my travels I have uncovered countless clever and effective

devices for reminding the farmer prospect that you sell radio and that radio is an extremely useful and entertaining thing to have in his home.

Accordingly, I have prepared a list of the more practical methods dealers have used to get radio sets on the farms of this country. Check them over, one by one, and find out how many you can use and which ones you may discard. When you have outlined a program for yourself, then put it into practice. And always bear in mind this one thought—the farmer prefers to buy from the man he knows personally. And the only way to get acquainted with him is to pay him a personal call.

That is where the “systematic covering” of your territory is most important. Lay out your territory in zones or routes and visit every farm prospect on each route, not once but many times, until he begins to have a conception of you as an individual rather than just another salesman.

Carry latest farm reports with you—Get them over your radio before you start out in the morning on your round of calls. This puts you in a position to “talk shop” with the

farmer and incidentally to direct his attention to the use of radio in getting the very latest farm quotation news.

Leave a set with the farmer—If the farmer fights shy of the demonstration or the on-trial offer, leave a set with him on the assumption that it will accommodate you as you do not wish to carry it with you the rest of your trip and you will be coming back that way in a few days to pick it up.

Take along some accessory to show prospects and customers—This gives you something specific to talk about and increases your opportunity of making sales to present owners.

Make your store the headquarters for a class in cooking by radio—Lessons in cooking and in other subjects come over the air very frequently. Advertise your store as headquarters for those who wish to form a class and listen regularly and under organized auspices to these instructional domestic science lectures.

Run a radio column in the news section of the local newspapers—The small town papers cannot afford a radio editor and will gladly avail themselves of the service of a radio expert if he will write things which have a distinct news value and leave his own advertising out of the picture.

KEEP fully posted on new developments—and pass this information along to customers and prospects.

Community meetings—Group selling is frequently an economical and a practical way of interesting the most customers in the least time. It simply calls for arranging some attraction in advance and inviting the neighbors to attend. Furnishing light refreshments and some definite entertainment is usually sufficient inducement to do the trick.

Country Dealers Have Used Billboards Successfully

Billboards are inexpensive — if posted on country roads, and they work for you day after day. Dealers have reported very successful results from a limited number of billboard displays.

Salesmen on part time—In sparsely settled communities the cross-road salesman on part time is frequently the best bet. The foreman of a threshing machine crew, the bank teller, the grocery clerk, the mailman, etc., are possibilities in this line.

Telephone set owners when an unusual program is scheduled—Watch the papers for outstanding programs and pass this information along to set owners. The time it will take to do this will be well repaid in goodwill and in prospects which always result from this kind of owner-contact.

Get the prospect to admit he would like a radio set—This, as a rule, is not a difficult matter, but is generally followed by the statement, "but I can't afford it just now." This is your opportunity to install the aerial and ground connection "while my men have the time," on the understanding that when the farmer is ready, a telephone message will insure a quick installation job. Actually the sight of the aerial and the ground all ready for the set so works upon the prospect that, as a rule, in a short time a request comes to connect the set.

DIRECT by mail—This is the term that advertising men use to signify contacting the customer through the mails. It has been found that, as a general thing, a series of circulars or mailing pieces is better than one or two letters. A series of six postal cards, mailed at ten-day intervals, will certainly serve to register your company in the mind of every recipient.

The portable demonstration room—This consists, of course, of a radio set, aerial and other necessary apparatus, mounted on a small truck so that a demonstration may be given immediately and wherever the prospect happens to be.

A Prize for Prospects

The premium plan—High school students, set owners and merchants in other lines of business are good sources from which to obtain prospect leads. A standing offer of \$5 for every new prospect turned in who actually buys a set is money well spent, because the average cost per prospect sold runs more than this amount. This offer should be printed on a little coupon slip and freely distributed. Those who have agreed to work for you on this sub-salesman plan should be frequently reminded of the matter. In the washing machine and other major appliance businesses, this idea has always proved effective, but it is necessary, every week or so, to say to these prospect-getters, "How about a few names of prospects? Haven't received any from you the past few weeks."

Division of time—Many dealers have told me that for small town and country selling, they find their time is spent to better advantage on the outside than it is in the store, Saturdays excepted. In other words, they hire a young man to "keep store" while they are out doing the real selling which amounts to at least 65 per cent of their total sales.

NEWSPAPER advertising—You who do business in the smaller towns are fortunate that the newspaper rates are very much lower in proportion to their effective coverage than in the larger cities. This means that you can use sufficient space to get over a real message and you can advertise consistently and persistently. Actual check-ups of results show that testimonials are very good in the small town, because everyone knows everyone else and the testimonial means something. Write copy of your own wherever possible, even though it may appear crude. Talk to the people just as though you were meeting them face-to-face. Manufacturers' copy is good, but it should be diluted with home-made brew every once in a while in order to give you the intimate local contact. Write a little paragraph story about the experience of some pleased customer, about some distant station which he brought in, or some interesting concert that he told you he heard over his radio. Make frequent notes of anything that sounds like news and work these into your advertising.

IN CLOSING—there is one more important subject and that is—dealer qualifications. Analyze yourself and your business and see if you check with the following list of qualifications which have been compiled by the editors of *Radio Retailing*—after considerable thought—as representing those things a merchant should have if he is to make a success in the retailing of radio. They are as follows:

1. The merchant should not only be adequately financed, but should have established connections for financing the time payment paper which he cannot handle himself.
2. The dealer should have had experience in specialty selling.
3. He should have a reputation for square dealing in the community.
4. He should have an adequate knowledge of servicing.
5. He should have the necessary store facilities.
6. And he should have an inborn enthusiasm for radio.

Windows That Have Made Them Buy

"No Home Complete Without a Radio"

Radio is as much a part of the furnishings of the home as tables, chairs or lamps. That is the message this window, right, of the Stambaugh, Thompson Company, Youngstown, Ohio, carries, and repeats on the show card.



An Effective Use of Crepe Paper

Below is an effective and inexpensive display using strips of crepe paper in alternate black and white, centering on a map, showing leading broadcasting stations (Crouch Radio Co., Oneonta, N. Y.)

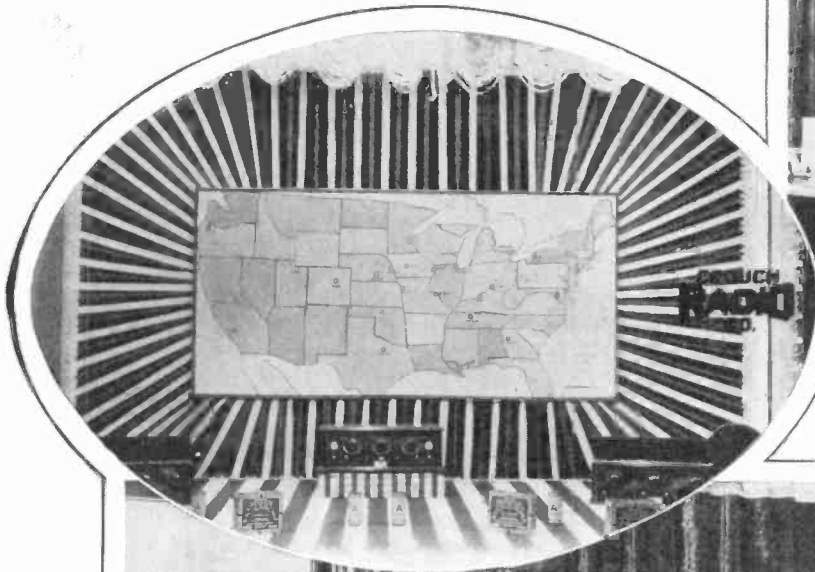

Ornamental As Well As Useful

The decorative value of a radio set is shown in the window, above, of the Worthington Radio Service, Coshocton, Ohio, dealer.



The appeal of this display of the John Wanamaker store, Philadelphia, is centered on one

receiver. It uses the raised platform idea to focus attention on the set that is featured.

He gets a Signed Order before he makes a

The Sage-Allen Company, Hartford, Conn., reduced its overhead \$200 a month by eliminating the expense of free demonstrations. A small part of the purchase price is asked before the home demonstration is made. Salesmen have not lost a single sale due to this policy.

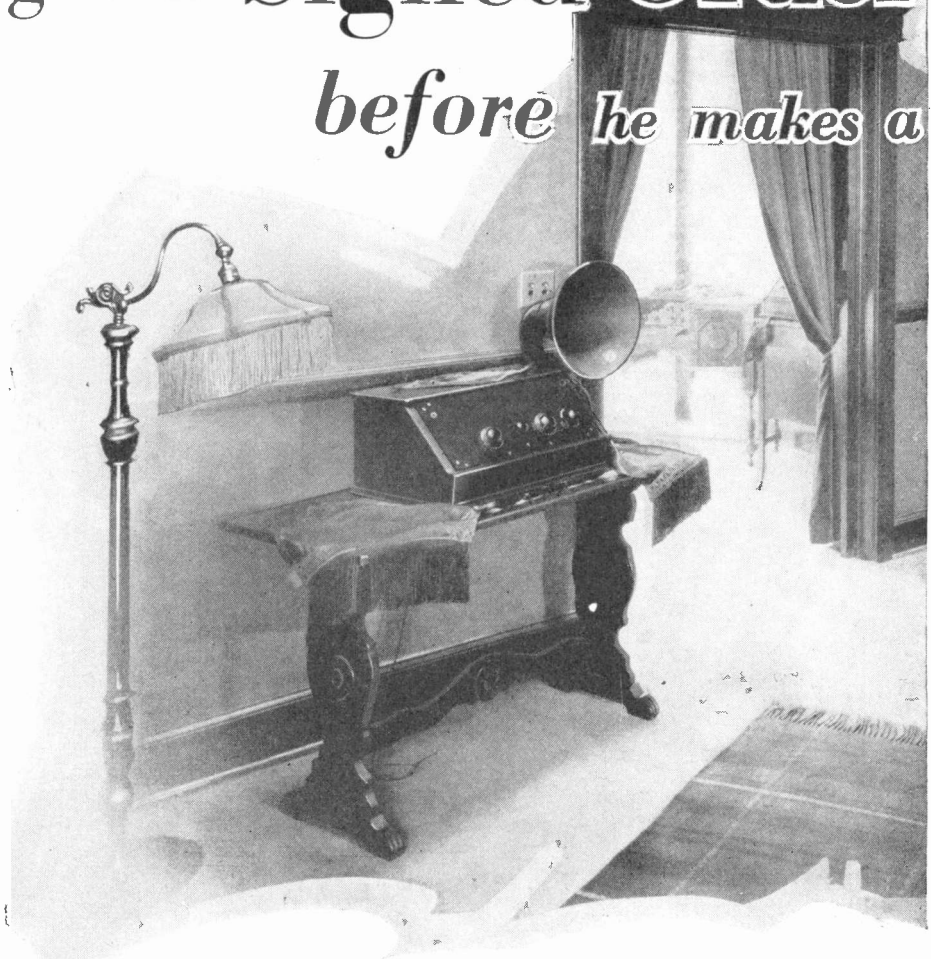

"I'D LIKE to see a good radio set." The speaker, a man with that undefinable air of one who has reached a decision to buy, advanced to the center of the Sage-Allen Radio Shop, glanced casually at an expensive console and waited for the salesman to answer.

"Certainly," came the reply, "step right this way."

Followed a rapid examination of several receivers, salesman and prospect going quickly from one demonstration booth to another until the former's attention seemed to focus on a small receiver of popular make. After a thorough examination of its cabinet, several twirls of the dial and a series of questions as to its distance-getting ability, selectivity, etc., winding up with the inevitable price quotation, came the matter-of-fact inquiry: "This one looks good to me—can you send it up to the house and let me try it for a day or two?"

The salesman hesitated. "Why yes. Just sign this conditional order blank and I'll have it sent up this evening."

The prospect's eyebrows lifted perceptibly. "Certainly you do not expect me to buy this set before hearing it in operation in my home, do you?" was the rather surprised question. "Any dealer in town would be only too glad to send one up on approval without any obligation to me."

The answer came immediately in the form of another query. "You've seen our entire line of receivers and it is certainly extensive enough to permit you to make a selection, isn't it?" The prospect thought a moment, then answered, "Yes, if they

sound as well at my home as they do here." The employee went on—"And if we can satisfy you, you intend to buy from Sage-Allen, don't you?" "If I can find the set I want at the right price, certainly," came the reply.

"Well then," the salesman played his trump card, "if you know that we carry a wide enough variety to satisfy you eventually, and if you really intend to buy from us, why not order the set, pay for it and have it installed in your home with the understanding that unless satisfactory it may be returned within 48

FREE demonstration of radio has admittedly exceeded reasonable bounds. Though a valuable aid to a sale if properly handled, its cost makes heavy inroads into profits. In many instances it has become a "white elephant," laying the

dealer open to attack by chronic "demonstration prospects." This article tells what happened when the free demonstrations were discontinued in a large retail store and contains a plan now in use for making this policy pay.

Home Demonstration

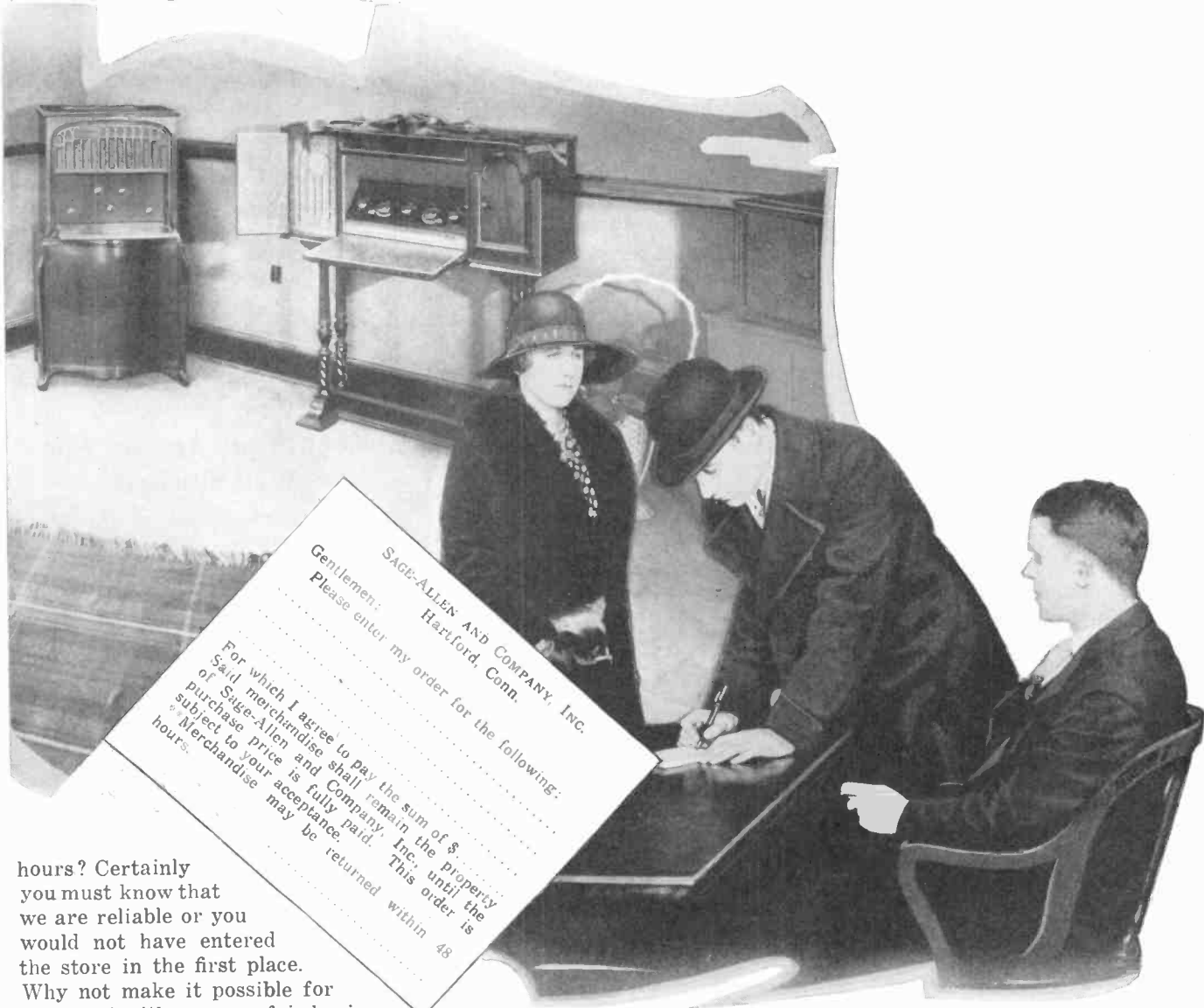

SAGE-ALLEN AND COMPANY, INC.
Hartford, Conn.

Gentlemen:

Please enter my order for the following:

.....

For which I agree to pay the sum of \$.....

Said merchandise shall remain the property of Sage-Allen and Company, Inc., until the purchase price is fully paid. This order is subject to your acceptance.

* Merchandise may be returned within 48 hours.

hours? Certainly you must know that we are reliable or you would not have entered the store in the first place. Why not make it possible for us to deal with you on a fair business basis?

"If you entered an automobile salesroom for instance, and asked the salesman on the floor to permit you to drive one of his cars for a few days before purchasing, he would immediately secure your signed order, with a similar understanding, I'm sure."

The prospect thought it over for a few moments, then apparently the logic of the salesman's statement struck home, and he smiled and answered, "Well, I guess you're right. I've seen many radio 'ads' featuring free demonstrations without any obligation to buy, but of course what I'm after is satisfaction—not just an instrument. Several

of my friends have told me of your excellent service and that is the reason why I came to you for a set in the first place."

Five minutes later he departed, leaving behind a signed order for the receiver to be delivered that evening, and a check for 25 per cent of the purchase price.

Secure the Order, Then Demonstrate

"There's an example of good salesmanship," remarked the store manager, J. Tarlow, turning to the writer who had been an interested spectator. "I estimate that we save at least \$200 a month by closing

sales here in the store—securing a portion of the purchase price and then demonstrating in the home. And what is probably more interesting to you, this policy has not to my knowledge caused the loss of a single sale!

"Prior to February 1st of last year, the sales policy of the Sage-Allen radio department was to interest the prospect who entered the store and then secure permission to demonstrate the receiver in his home, without entailing any obligation. It seemed to make it easier for the salesman—a sort of a short-cut to the sale. In this respect we followed a precedent established by

other dealers in Hartford. The theory of the home demonstration had often been expounded to me.

"I was told—and was thoroughly sold on the idea—that it is far easier to sell a set in the home of a prospect than to close the sale right in the store. First of all, according to 'high-powered' radio salesmen, the prospect, who has perhaps heard radio only in the shops, or in the home of a friend, may still be a bit skeptical. He wonders if a radio would work as well in his own home and hesitates to buy a 'cat in a bag.' Very often he is not certain that he can operate the new contraption. Next, the prospect is entirely at ease at home, amid familiar surroundings, and very often the fact that his wife is present to approve or veto his selection makes it possible to close the sale.

"I am still firmly convinced that the home demonstration has its place in the retail sales scheme. The theory holds water. Obviously it is better to make a number of demonstrations and to sell sets than to watch a bona-fide customer walk out of the store. For this reason the ruling should be flexible during the summer months. But there is one loophole in it. The expense of making demonstrations, unless a good number of them result in sales is absolutely prohibitive to the retailer. I estimate that, including transportation, the time of the installation man and depreciation of merchandise, the cost of making a single demonstration runs well into the neighborhood of \$8.

"When, as we did, the store makes as many as 75 to 80 demonstrations per month the overhead amounts to a considerable sum. Of these demonstrations, on the average of 25 were flat failures, which meant an expenditure of approximately \$200 without the slightest return. Very often the merchandise was out of the store on approval for several weeks, only to be returned. Now that I have definitely taken the step and placed 'thumbs down' on the home demonstration unless the prospect shows his sincerity by signing an order and paying a portion of the bill, I am confident that business *can* be done on this basis—and without loss of volume.

"On the first of February, 1926, we were up against it. The store auditor came to me with a statement of the amount of merchandise out of the department on demonstration. The figures were astounding, outstanding equipment running well

Tarlow's Success Formula Is:

SELL satisfaction, not the instrument.

Get a signed order from the prospect before making a home demonstration.

Secure a portion of the purchase price.

Send an experienced salesman to the home with the set and leave it there only one evening.

up into the thousands of dollars and I immediately advised all store salesmen that sales must in the future be closed in the store, or that failing this, a signed order must be secured accompanied by a reasonable deposit before making an outside demonstration. Naturally, the cancellation of the 'approval' privilege was resorted to with grave misgivings. Free demonstrations had been used as a 'closer' for so long that they had become a part of the sales system. Business was expected to fall off greatly in consequence.

Sales Remain Normal

"On the contrary, my sales figure for that month exceeded that during the same period of the year before. Gross sales for February, 1925 were \$9,243 as against \$10,300 for February, 1926. This in spite of the fact that it was necessary for the salesmen to secure signed orders before demonstrating during that month.

In order to reassure the prospect, an order blank, reproduced on these pages, is used, authorizing the return of merchandise within 48 hours of purchase if not satisfactory. This blank also serves another important purpose. The customer's signature gives you something definite to work on, as it is quite certain that he is in earnest. Though several sets were returned during February for exchange not one was sent back to the store for refund.

"The man who enters the store, we assume, has some intention of buying, or he would not have come in. If he is interested, if properly handled he will not object to paying a portion of the cost of the receiver before demonstration at his home. If he is one of those chronic offenders who go from store to store securing sets on approval without the

slightest intention of buying, on the other hand, a request for a down-payment and his signed order will discourage him.

"Not one of the store salesmen recalls losing a sale due to the cancellation of free demonstrations.

"When the order is finally signed, it is much better to send an experienced salesman with the set. It is seldom good policy to permit a set to be used for several days and our policy is to give the prospect a thorough demonstration on the first evening and then if he is not satisfied, try another receiver.

"The answer to the entire problem, as I see it, is to continue the present home demonstration plan, but be morally certain that the prospect is genuinely interested before installing the set. And the only way to do this is, I am convinced, to get his signed order."

Keep Your Service Car Well Stocked

(From Page 31)

definitely to the car, as customers have stated frankly in making their purchase that they had noticed the service wagon and had decided that a house which maintained equipment of this kind would maintain a satisfactory service after the purchase.

The exterior was painted a light blue with dark blue lines and lettering in red. In the panel on either side of the car were framed the name and trade mark of the store—a metal sign which is standard with the company—and on the sliding door of the cab was placed the authorized dealer trademark to tie up with the firm's advertising and window displays. An aerial was erected on the top of the car both for use and for ornament; and lengthwise on the black top of the car was painted the name of the firm.

Not only are the delivery trips reduced, but service calls as well, the stock of accessories in the car eliminating many return trips to the store. Many times the customer is not aware what is wrong with his set, but calls for help with the meager information furnished that "the set is not working right." In such cases it is possible to make the call with the truck, test the set with the instruments carried as part of the regular equipment, find the difficulty and replace the defective parts from the stock carried in the lockers.

Trade Favors

Separate Speaker

ELECTRICALLY, it is not always advisable to build the loud speaker inside the cabinet. From the standpoint of public acceptance, however, manufacturers believed the speaker as an integral part of the console was demanded. They are wrong.

To clear up this question—as to whether or not the public will accept its speaker separate in console models as well as in the table type sets—*Radio Retailing* asked 300 dealers what their customers are demanding. Of the answers, 63 per cent said their customers not only would accept the speaker and console separate, but prefer separate speakers due to the better reception obtained. Thirty-one per cent said their customers required a complete unit regardless of tone quality, while the other six per cent were non-committal, saying both styles can be sold satisfactorily.

Extracts from dealers' letters on the subject follow:

Favoring Separate Speaker

THE cone speakers of today, using the added power of the 171 power tubes, operate so much better about ten feet away from the receiving set that the real radio fan will not buy a console with a speaker combined. The public likes the idea of having the speaker separate so that it can be carried from room-to-room."—*J. C. Anderson, Strouss-Hirshberg Company, Youngstown, O.*

"In regard to speaker units being a part of the set in console models, I would rather see them built with the speaker as a separate unit as I believe that better reception will result.

"On the console sets that I am selling there is a phone jack where you can connect headphones or another loud speaker, which automatically cuts off the built-in speaker. In several cases I have sold separate speakers and the result has been a big improvement."—*S. F. Garber, Columbia City, Ind.*

"We do not now nor have we ever considered the built-in speaker successful. We have yet to hear a built-in speaker that equals an external one. In our three years of retailing radios we have purchased very few consoles with built-in speakers and had trouble disposing of them for the reason we could not conscientiously recommend them as highly as others. We find them particularly weak in transmitting voice

"Radio Retailing" asks dealers whether public will accept console with speaker separate. "Ayes" outnumber "Nays" two to one

tones and will not stand the volume of the horn or cone. We find the public looking for tone quality above all and we do not think it can be obtained with built-in speakers of the present."—*F. A. Gilbert, Gilbert Bros., Fowler, Ind.*

"We have found by comparison that when the speaker is placed 15 to 25 feet from the set that much better reception is the result. This is especially true of cone speakers. It seems to be the trend to want all units in one cabinet, but we believe the public should be educated along the lines of what constitutes the best reception and how to obtain it. The buying public is all from Missouri and wants to be shown. We do not try to sell any sets with built-in speakers."—*Blaine G. Sweet, Rome, N. Y.*

"Our experience has been that the general demand is for a neat console type receiver, with battery space but not necessarily a built-in speaker. The average customer realizes that much better results are obtained with the speaker away from the set and I believe the general public, at the present time, are demanding quality of tone more than any other one thing."—*M. H. Dutton, Smith-Dutton Company, Sanford, Me.*

"We believe a console with separate speaker will meet with the approval of 90 per cent of the public. In looking over our records, I find that during the present season, seven out of nine customers who bought sets with built-in speakers, have also purchased separate speakers which are being used in place of the built-in speaker with better results."—*R. J. Fischer, Regal Electric Co., Covington, Ky.*

"In my travels around Chicago, I have found the average person would just as soon, if not prefer, to have the speaker separate from the set, but manufacturers must put as much effort in beautifying the speaker as they have in beautifying the set itself.

"As an attractive addition to the home, most speakers wouldn't even get to first base, as far as appearances go. The people want furniture, that's why they buy the console type of set. Most of them prefer the speaker separate if for no other reason than portability, but they also want real tone and pleasing appearance in the speaker. If the manufacturers want a little advice on how to sell more speakers, they should

snap into it and design goodlooking speakers that combine beauty and tone."—*J. P. Willing, Berwyn, Ill.*

"The customer considers the built-in speaker a superior job at first and efforts to persuade him otherwise are looked on with suspicion. Yet, after using a radio for a while, experience proves the speaker at a distance to be the best and he regrets the original purchase.

"To our mind, a concerted advertising campaign, stating the opinion of experts in an unbiased manner, dealing with radios in general and not any special make, would enable the dealer to point out these things in his sales talk."—*W. Paulus, Paramount Radio Co., Atlantic City, N. J.*

"We find that, in some cases, the owner does not care to operate his set with sufficient volume to be audible in some desired part of the house. Then we find a detached speaker of value. With an extension cord of say, up to 50 feet, the radio set becomes a very flexible source of amusement or instruction.

"We suggest that each manufacturer, in advertising his product, include in the list price of the sets advertised, the speaker of his own manufacture or of some other manufacture which he considers best matched to the particular set."—*Grant W. Crotto, Crotto and Parker, Brandon, Vt.*

For Built-In Speakers

THE speaker of the future will be built as an integral part of the set along the same lines as the phonograph. The main difficulty at the present time with the built-in speaker is the fact that, with seven or more tubes, there is a tendency to microphonic noises which are very hard to overcome, but we feel quite sure that radio engineers will conquer this in the near future and then the fact that the set is in close proximity to the speaker will make very little difference."—*K. D. Ross, Main Auto Supply Co., Fort Wayne, Ind.*

"We believe the customers' choice will run to the built-in speaker unless they can be shown that the advantage of a separate unit is positive. In our experience, we have found the evidence of interference so conflicting as to make us believe it lies more in the construction of the set and cabinet than in the fact that they are close together."—*J. V. Lewis, Barnegat, N. J.*

"To put the speaker any place but in the console is an admission of defeat. If radio receivers are to take their place as musical instruments, by all means the unit must be complete in itself.

"Don't follow the path of least resistance. Give the public what they

want. Let the engineers overcome the obstacle of position." — *Richard R. Shick, Wolf and Lessauer, Fort Wayne, Ind.*

"Every set sold from the factory should be equipped with a loud speaker which meets the needs of that particular set. Correct reception depends a whole lot on whether the impedance of the speaker unit matches that of the transformers. All set manufacturers should at least mark the impedance on the set, or else recommend such speaker units as meet their requirements." — *Clare Grubb, The Electric Shop, Auburn, Ind.*

"If manufacturers would place a high-grade speaker in the set it would be the most desirable type of all. However, they most all try to cut expenses on this important item and bring nothing but trouble on the dealer and themselves." — *R. C. Myers, Myers Furniture Co., Piqua, O.*

"It is our opinion that the difference in reception of a speaker placed at a distance from the console will not justify the use of this method, as the console model with the built-in speaker will be the most salable merchandise of the two." — *H. C. Herda, Herda Electric Company, Baltimore, Md.*

"I believe that the speaker should be a part of the console and not a separate unit. But I also believe the manufacturers should retain the loud speaker jack so that a separate speaker may be used in any other part of the house, if desired. This jack should be in the back of the cabinet and controlled by a switch on the panel." — *L. W. Chapman, The Electric Shop, River Falls, Wis.*

"Personally, I would rather have the speaker outside of the set, but the public more or less demands built-in speakers, so why not have both?" — *Raleigh Brown, Brown Electric Shop, Thompsonville, Conn.*

Now Read What Some Manufacturers Have to Say

"THE reasons for divorcing the loud speaker from the radio set cabinet are not clearly understood by the radio public. It is the misconception on the part of nearly everyone discussing this subject that the loud speaker is removed from the radio cabinet to avoid electrical and mechanical couplings that interfere with good tonal reproduction. This is an incidental reason only and even though loud speakers can be built into cabinets successfully and so shielded that no mechanical or electrical couplings exist, the answer to this problem must be found in the results that we wish to produce from the standpoint of reproduction.

"The more we know about electro-acoustics and in particular the effect on acoustics of the room in which the speaker is located, the more forcibly is brought to light the fact that the speaker must be portable, or at least capable of being located where it will give the best tonal reproduction. If the speaker is the open cone type, there is more uniform spread to the sound and a large circle of listeners will obtain more satisfactory and uniform results than can be expected when the

speaker is built into the cabinet and has to operate through an opening in the side of the cabinet, thus having a pronounced directional effect. People located directly in front of such a speaker will receive a greater intensity of sound than those located at the side. The only reason why this effect is not more pronounced is the reflections from side walls, furniture, etc.

"It must be remembered that radio has long since passed the stage where it is a scientific toy, or an amusement device to encourage the picking up of many stations and stations that are difficult to bring in. This kind of amusement is only incidental to the real value of a high quality radio set. What the radio public will expect in the future from well-designed radio receivers is a reproduction of speech and music that is as natural as listening to the original speech or music before the microphone of the distant broadcast station. One way to create this illusion is to have the loud speaker or reproducer portable and so positioned in the room that it will give directly to the listeners the same sensation that the original would give if present.

Not Necessary to Copy Phonograph

"Personally, I believe that we have passed the stage in radio where it is necessary to copy the phonograph, as it has been demonstrated conclusively that radio has given to the phonograph industry a new lease on life. In the phonograph, it has been customary to build-in the loud speaker, primarily because the record must be connected mechanically through the sound box, tone arm, to the projecting horn. In radio, we make this connection electrically and the loud speaker can be located where it will give the most natural reproduction. In the end, the public will decide as to whether they prefer to listen to a band or soloist cooped up in a fancy cabinet or whether the more natural reproduction is an open loud speaker or reproducer that can be located where it will have free action in all directions to the group of listeners.

"It is safe to say that the correct positioning of the loud speaker with respect to the surroundings and with respect to the listeners, are factors which will receive more attention in the future." — *Ray H. Manson, Chief Engineer, Stromberg-Carlson Tel. Mfg. Co., Rochester, N. Y.*

"IT IS our frank opinion that the separate speaker is an anachronism harking back to the days of home-built bread board sets with their accessories scattered all over the place. There can be no doubt—for the demands of the modern housewife will allow no doubt—that as a musical instrument for the home, the radio more closely approaches the ideal in the built-in speaker console design. Further, we are convinced that the developments during the next year or two will make the separate speaker, be it horn or cone, as great a rarity, if not absurdity, as the talking machine horn pictured in the well-known trademark, 'His Master's Voice.'

"Radio manufacturers have no alter-

native. The console radio, self-contained with batteries and reproducing system, has so many obvious and distinct practical advantages that, from a utilitarian standpoint, its superiority has never been questioned. We must, therefore, accept the inescapable conclusion that only heretofore insurmountable engineering difficulties have thus far blocked the way to an attainment of the ideal self-contained console.

"Our own early pioneering in the console field has made us fully appreciative of the tremendous acoustical problems involved. Many months of research were forced upon us by the inexorable demands of the buying public. In our new sets, however, microphonic tendencies have been completely overcome." — *George A. Pearson, President, Electrical Research Laboratories, Chicago, Ill.*

"WE HAVE never heard an enclosed speaker or reproducer that was as clear or accurate as a good cone type reproducer of the non-enclosed type. This is a fact, and thousands approve that statement, but the public seems to want one thing from an eye point of view and still another from an ear point of view. That is to say, from my observations throughout the territory, the public seems to be more definite in their demands for more clear and perfect reproduction, but they are also rather definite in their demands—I say 'rather'—for an all-contained radio set.

"We believe in a separate reproducer, but we also believe in giving the public just about what they want, and so we shall endeavor to do the dual job of giving them what they ask for and, at the same time, try to educate them in accepting what we know they should have, for the present at least. We hope the trade will do their job in this educational work, for after all is said and done, radio will live longer and be more generally accepted as a universal household necessity, or I might say, a necessity of life, if its reproduction is accurate, and today I think 'those in the know' will agree that the unencumbered or unenclosed reproducer gives the most perfect reproduction of the human voice and of the musical instruments." — *A. H. Bartsch, General Sales Manager, American Bosch Magneto Corp., Springfield, Mass.*

"MICROPHONISM presents a difficult problem where a radio receiving set is incorporated in the same cabinet with the loud speaker, with the present day vacuum tubes. The difficulties are not insurmountable. Tube sockets may be cushioned and the tube shielded to prevent sound wave vibrations reaching the glass. Without doubt an easy way to prevent microphonic effects is to place the loud speaker away from the receiving set. The trend is, however, quite definitely toward the use of furniture to house the receiving set as well as the loud speaker unit. This will undoubtedly bring the use of non-microphonic tubes especially in the detector socket. Such tubes can readily be made and the great demand for them will undoubtedly very soon justify their production." — *Powel Crosley, Jr., President, Crosley Radio Corporation, Cincinnati, O.*

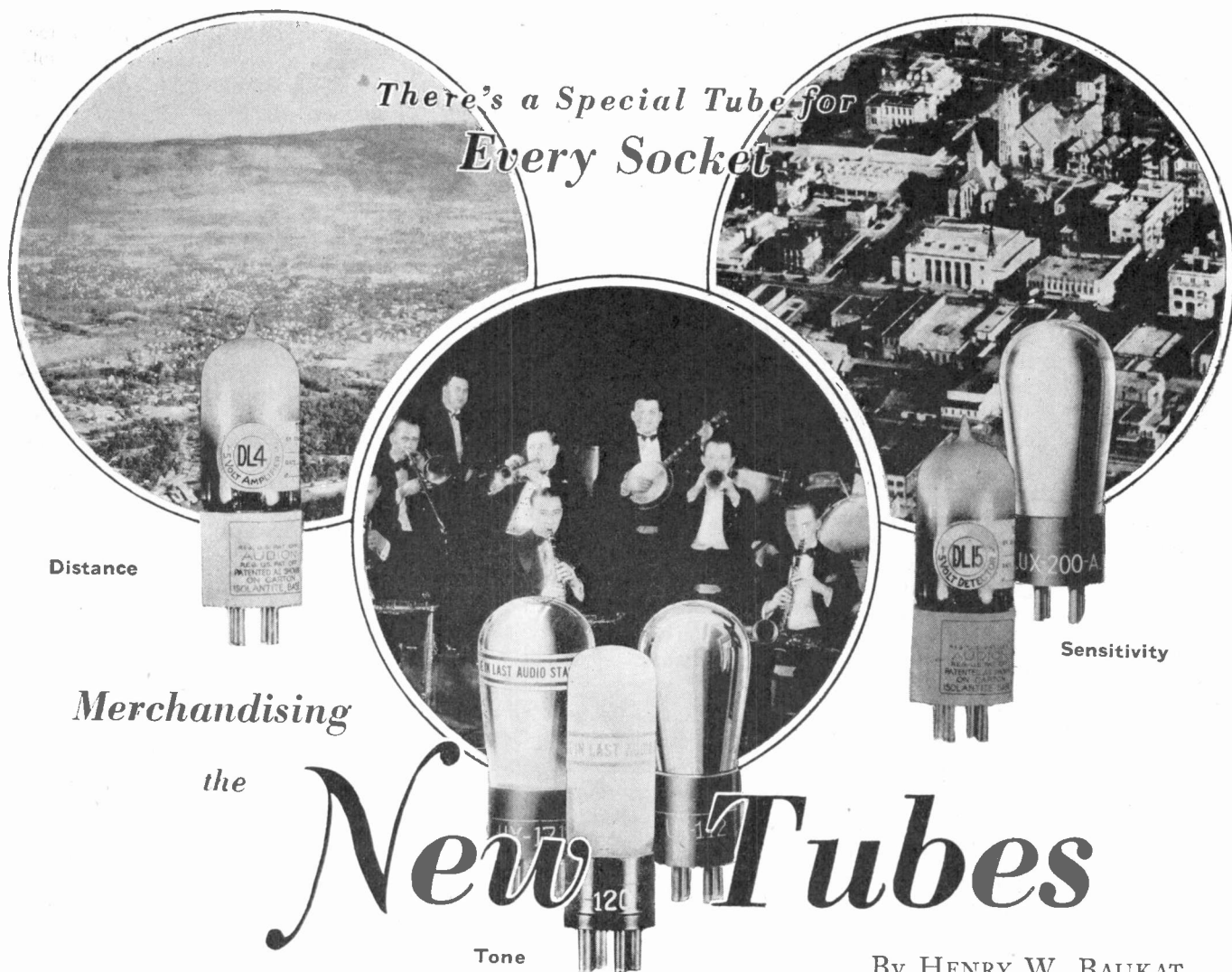

Merchandising
the

New Tubes

By HENRY W. BAUKAT

DURING the past year there have been marketed many new "special purpose" tubes. These tubes, used in the particular part of the circuit they were designed for, give results many times better than the old all-purpose tube. As the result of complaints about the operation of these tubes, *Radio Retailing* found, upon investigation, that both dealers and jobbers do not always understand how they are to be used.

It is unfortunate that the new tubes have become known to the public as *power tubes*. This name is misleading and in many cases results in the misuse of the tube. A much better term would be to call them "special purpose tubes."

The reason for the development of special purpose tubes was the demand for undistorted tones at a given volume. In attempting to reproduce this volume with the new type loud speakers which have been developed, it was found that the 201-A type tubes became overloaded and could

TONE quality in any receiver can be improved by the use of one or more "special purpose" tubes, commonly, but not altogether correctly, called "power" tubes. Unfortunately the use of these tubes is not properly understood by the public or the dealer, and consequently not so many are sold as there should be. The purpose of these tubes, and how they are to be used, are explained in this article.

not handle the energy. Therefore, tubes of greater capacity were designed.

The primary function of a special tube is to furnish *undistorted* volume to the loud speaker but not to give great added volume. In giving this undistorted output the tubes have

been designed to carry larger B battery current, necessary in order to give proper reproduction of certain frequencies. The bass notes previously neglected but now being reproduced, demand more energy than do the notes on the upper scale.

Placing a so-called power tube in the receiving set will not give any appreciable increase in volume although it will clear up a lot of distortion, thus bettering the tone quality of the receiver.

Higher Voltage Needed for Special Audio Tubes

To obtain full advantage of a special purpose tube designed for audio frequency amplification, it is necessary to add B and C battery voltage. The accompanying table shows in convenient form what these should be for the various types of tubes.

The C battery is a very important item with these tubes for it not only cuts down the plate current drain, which would be enormous without the use of the C battery, but also insures

that the grid of the tube will never become positive. By preventing the grid of the tube from becoming positive due to the impressed voltage, sound distortion caused by periodic changes of voltage direction in the grid is prevented. This is where a C battery proves its usefulness. Its primary purpose is to put an electric current in a negative direction on the grid element of the vacuum tube, thus preventing a flow of current from the filament to the grid. Also in reducing the B battery drain it reduces somewhat the noises in the set. A sound like that of flowing water may be due to an excessive flow of current in the tube. This will disappear when the filament current and the plate voltage are reduced when the C battery is used.

Radio Frequency Tubes

Tubes for radio frequency stages should have a low capacity effect between elements. The De Forest DL-4 tube is a special radio frequency amplifier, having been specifically designed for use in neutrodyne and other circuits of the finely balanced or bridged types. It is characterized by a very constant grid-plate capacity and high mutual conductance. These qualities result in greater distance reception than is obtainable with ordinary tubes. Greater control over the selectivity of the set is obtained by use of the DL-4, whose special design permits the operation of the R. F. rheostat over a very wide range of settings. For proper operation, 67 to 90 volts should be placed on the plate. This is the only tube of its kind on the

How Special Tubes Are Used

Detector	Amplifier	
	Radio	Audio
200-A Type B-6 Donle- Bristol	DL-4 De Forest	112, 120, 171 and 210 Types Also Hi- Mu Tubes

retail market at the present time.

The 200-A type tube is a special purpose tube designed for use only as a detector. It is intended to be operated from a 6-volt source, the filament drawing $\frac{1}{4}$ of an ampere at 5 volts. This new detector will give a clearer tone with increased volume on distant stations. It is not critical to B battery voltage and is usually found to operate best with 45 volts on the plate although in some circuits 22 volts will work very well.

WHEN the filament of this tube is first heated quite a loud hissing sound is heard in the loud speaker which gradually dies down to be replaced by a slight hissing sound which is present during its normal operation. Distant stations that before could barely be heard on the loudspeaker, can, by the use of this new detector tube, be brought in with good loudspeaker volume. The De Forest DL-15 which is of this same type has the additional feature of operating without any of the hissing noise. It is also non-microphonic. The Donle-Bristol B-6 is a supersensitive detector which can be

used in any standard type of receiving set and will greatly improve the quality of reception and the volume of weak signals. It has a 5-volt filament drawing $\frac{1}{4}$ ampere and operates on a B battery of from 22 to 90. This tube will operate in any detector circuit provided the grid return is connected to the positive terminal of the filament at the socket. This is the only particular requirement that must be observed. It is a detector tube of the gaseous type similar to the other two detector tubes described. This is a boon to the DX fan and a demonstration is usually a sale. It should be borne in mind, however, that where quality volume is desired from powerful local stations the general 201-A all purpose type tube is to be used.

Audio Frequency Amplifier Tube

Tubes for audio frequency sockets should have a high amplification factor. Development of these tubes has been quite extensive and there are several types available today, among which are the 120, 112, 171, 210 and the Hi-Mu type.

In choosing between the 112-type and the 171-type it should be remembered that the former is to be used in the first audio stage and the latter in the second audio stage.

This combination gives the proper balance for producing quality volume.

Although the 171 type will operate on a plate voltage up to 180 with a C battery bias of around 40 volts, it is recommended that this tube be used with a plate voltage not exceeding from 90 to 135 volts, with a corresponding correct C battery voltage. Operation at this voltage gives all the volume necessary for ordinary home use and makes operation more economical in that fewer B batteries are required. The current drain on the B batteries at this voltage is considerably less than that when it is used with a higher voltage. The 112 type is a 5-volt tube drawing half an ampere. This may be used in the last audio stage without a change of voltages if desired but the use of 135 volts on the plate with a negative grid potential of 9 volts is especially recommended. When used in combination with a 171-type tube, it should as stated before be used in a first audio stage.

Type 120 tube has been designed for those sets using dry cell or 199-type tubes and is to be used in the last stage of audio frequency ampli-

(Please turn to Page 51)

Proper B and C Battery Voltages for Power Tubes

Type	Use of Tube	A Battery Supply	B Battery Voltage	C Battery Voltage
120	Power Amplifier Last Audio Stage Only	4 volts D.C.	135	22.5
112	Power Amplifier	6 volts D.C.	90 135 157.5	6 9 10.5
171	Power Amplifier Last Audio Stage Only	6 volts D.C.	90 135 157 180	16.5 27 33 40.5
210	Power Amplifier Oscillator	6 volts D.C. 8 volts A.C.	90 135 157.5 250 350 425	4.5 9 10.5 18 27 35

The Month's Radio Events

Elusive Dark Rays Make Television Possible

Invisible rays operate this television apparatus, shown below with John L. Baird, of London, its inventor. In a recent demonstration before the Royal Institution it transmitted moving pictures through the air.

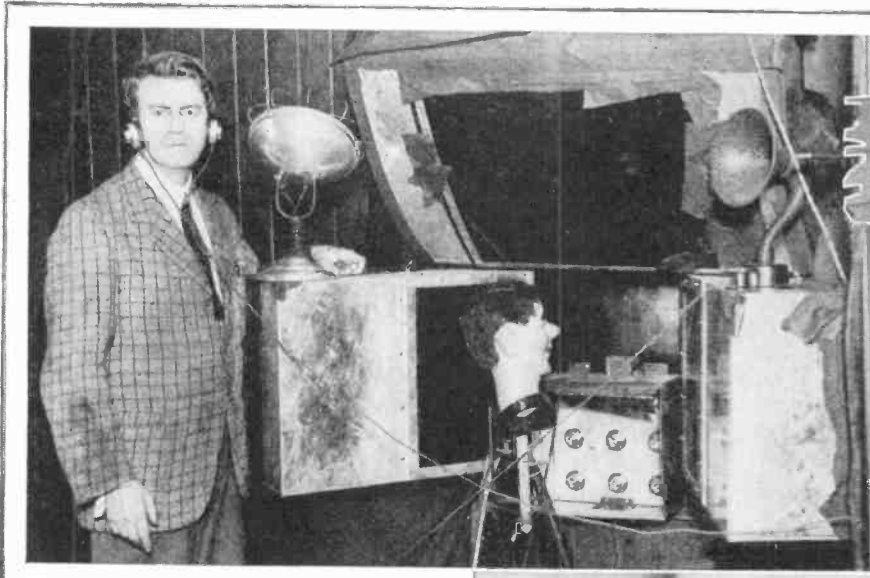

Detects Typhoons at Sea

The combined radio compass and weather radio recorder, right, determines the location and direction of storms and electrical disturbances.

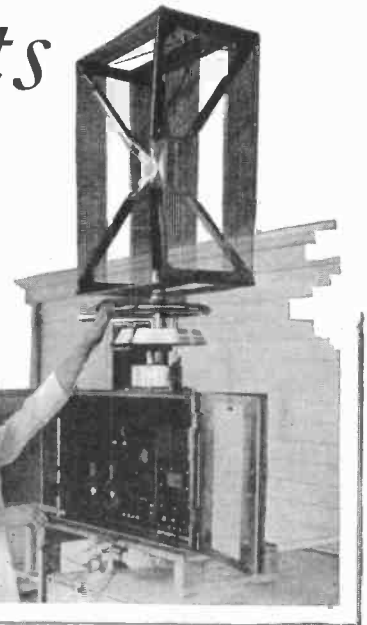

Both Hands Full

Freed-Eisemann executives (below) bid adieu to K. L. Aulcrdyce-Arnott, the company's manager in England, on his return home after a visit to this country.



Will Radio Police Warnings

The New York City police now receive alarms by radio. Radio sets, like the one above, are installed in all stations. The municipal station, WNYC, does the broadcasting.

How Your Voice Looks

The complicated apparatus, at the right, projects upon a screen the sound waves made by the human voice. In the inset is seen the word "radio" thus photographed. The device is used by General Motors, Detroit, for finding automobile motor noises.

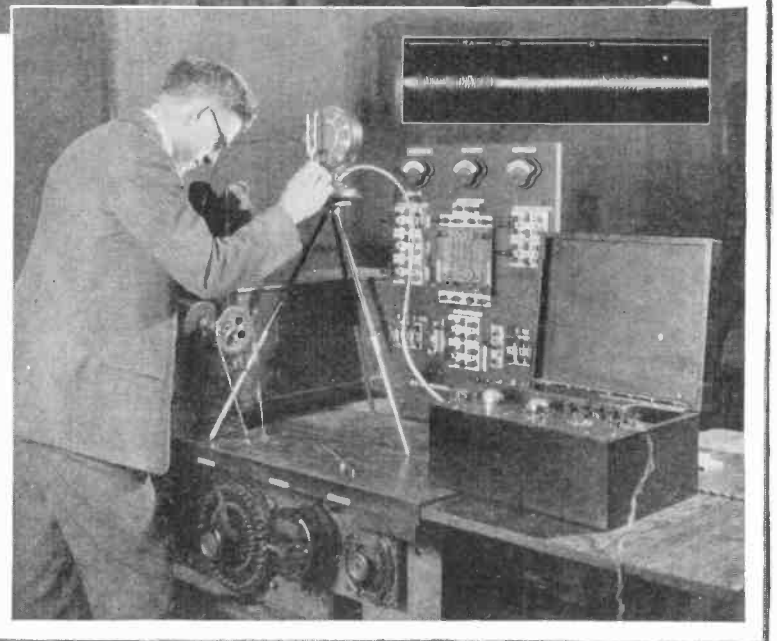

New Radio Law Takes Effect

"Service to the Listening Public," is defined by Congress as basis of permission to broadcast—Commission of five to rule for one year, then Secretary of Commerce

PASSED by Congress and approved by the President, the White-Dill compromise radio bill, reported in February by the joint Conference Committee of Congress, is now the radio law of the land.

Under its provisions, "public service" and the interests of the listening public are definitely made the legal basis for the *granting, refusing and revoking* of radio broadcasting licenses by the licensing authority. For the new law in exact terms specifies that licenses shall be granted *only "If public interest, convenience and necessity require."* Meanwhile the passage of the new measure and its signature by the President *automatically revoke all transmitting licenses* of all classes of station, some 18,000 in number, and places in the hands of the newly-created Radio Commission full authority to *renew only such licenses as it sees fit.*

This Federal Radio Commission of five members, appointed by the President, will have vested in it full control of radio transmission for one year. Following this first twelve-month period, during which it is ex-

pected that the present ether tangle will be largely straightened out, and principles of procedure established, direct control of radio will pass to the Secretary of Commerce, with the Radio Commission then continuing only as an advisory and appellate body which can be called upon to act in case of appeals from the decisions of the Secretary. During the first year when the Commission exercises its jurisdictional control of radio, the actual routine administration of licenses, regulations, etc., will be carried out by the Department of Commerce.

Duties of the Presidential Commission

The members of the Commission will be appointed by the President, one from each of the five zones. They will serve from two to six years, each receiving \$10,000 for the first year, and \$30 per day when called into session thereafter. Authority is granted to appoint a secretary, clerks, special counsel, experts, examiners and other employees. Following are the duties of the Commission, as defined in the new law:

Personnel of Radio Commission

As *Radio Retailing* goes to press, President Coolidge announces the following appointments to the Radio Commission:

Rear-Admiral W. H. G. Bullard, U. S. N., chairman;
O. H. Caldwell, New York, editor of *Radio Retailing*;
John Dillon, San Francisco, radio inspector;
Eugene O. Sykes, Jackson, Miss.; and
Henry A. Bellows, Minneapolis, Minn.

Section 4: Except as otherwise provided in this act, the Commission, from time to time, as public convenience, interest, or necessity requires, shall—

(A) Classify radio stations;
(B) Prescribe the nature of the service to be rendered by each class of licensed stations and each station within any class;

(C) Assign bands of frequencies or wave lengths to the various classes of stations, and assign frequencies or wave lengths for each individual station and determine the power which each station shall use and the time during which it may operate;

(D) Determine the location of classes of stations or individual stations;

(E) Regulate the kind of apparatus to be used with respect to its external effects and the purity and sharpness of the emissions from each station and from the apparatus therein;

(F) Make such regulations not inconsistent with law as it may deem necessary to prevent interference between stations and to carry out the provisions of this act; provided, however, that changes in the wave lengths, authorized power, in the character of emitted signals, or in the times of operation of any station, shall not be made without the consent of the station licensee unless, in the judgment of the commission, such changes will promote public convenience or interest or will serve public necessity or the provisions of this act will be more fully complied with;

(G) Have authority to establish areas or zones to be served by any station;

(H) Have authority to make special regulations applicable to radio stations engaged in chain broadcasting;

(I) Have authority to make general rules and regulations requiring stations to keep such records of programs, transmissions of energy, communications or signals as it may deem desirable;

(J) Have authority to exclude from the requirements of any regulations in whole or in part any radio station upon railroad rolling stock, or to modify such regulations in its discretion;

(K) Have authority to hold hearings, summon witnesses, administer oaths, compel the production of books, documents and papers, and to make such investigations as may be necessary in the performance of its duties.

Commission's Decisions Final, Except for Appeal to Court

As constituted by the new statute, the Commission is established to be wholly independent of any government department, and supreme in the matter of radio, for the first year. Following that, its jurisdictional functions will be taken over by the Secretary of Commerce, in which event any person or group feeling aggrieved by action or decision of the Secretary

"may appeal therefrom to the commission by filing with the Secretary of Commerce notice of such appeal within thirty days after such decision or determination or promulgation of such regulation. All papers, documents, and other records pertaining to such application on file with the Secretary shall

thereupon be transferred by him to the commission. The commission shall hear such appeal *de novo* under such rules and regulations as it may determine.

Decisions by the Commission in matters over which it has jurisdiction, either originally or on appeal, are specifically stated in the new law to be "final," subject to the right of appeal to the courts.

Broadcasting Licenses for Three Years

The new law limits the term of license for broadcasting stations to three years, and for other classes of stations to five years. Renewals can be issued for similar periods, but no renewal can be issued prior to thirty days before the expiration of the current license.

With the passage of the new law, all licenses of all kinds are automatically cancelled, but sixty days' operation without penalty is permitted present station operators to conform to the new regulations laid down by the Commission.

Very full details of the requirements concerning the licensing of new stations are laid down by the bill:

Section 21. No license shall be issued under the authority of this act for the operation of any station, the construction of which is begun or is continued after this act takes effect, unless a permit for its construction has been granted by the licensing authority upon written application therefor.

"The licensing authority may grant such permit if public convenience, interest, or necessity will be served by the construction of the station. This application shall set forth such facts as the licensing authority by regulation may prescribe as to the citizenship, character and the financial, technical and other ability of the applicant to construct and operate the station, the ownership and location of the proposed station and of the station or stations with which it is proposed to communicate, the frequencies and wave length or wave lengths desired to be used, the hours of the day or other period of time during which it is proposed to operate the station, the purpose for which the station is to be used, the type of transmitting apparatus to be used, the power to be used, the date upon which the station is expected to be completed and in operation, and such other information as the licensing authority may require."

The rights under any such permit shall not be assigned or otherwise transferred to any person, firm, company or corporation without the approval of the licensing authority.

Upon the completion of any station for the construction or continued construction for which a permit has been granted and upon it being made to appear to the licensing authority that all the terms, conditions, and obligations set forth in the application and permit have been fully met and that no cause or circumstances arising or first coming to the knowledge of the licensing authority since the granting of the permit would, in the judgment of the licensing authority, make the operation of such station against the public interest, the licensing authority shall issue a license to the lawful holder of said permit for the operation of said station. Said license shall conform generally to the terms of said permit.

Conditions under which political speeches and paid advertising may be

broadcasted are defined in the new law by the following paragraphs:

Section 18—If any licensee shall permit any person who is a legally qualified candidate for any public office to use a broadcasting station, he shall afford equal opportunities to all other such candidates for that office in the use of such broadcasting station, and the licensing authority shall make rules and regulations to carry this provision into effect: Provided, That such licensee shall have no power of censorship over the material broadcast under the provisions of this paragraph. No obligation is hereby imposed upon any licensee to allow the use of its station by any such candidates.

Section 19. All matter broadcast by any radio station for which service money or any other valuable consideration is directly or indirectly paid or promised to or charged or accepted by the station so broadcasting, from any person, firm, company, or corporation, shall, at the time the same is so broadcast, be announced as paid for or furnished, as the case may be, by such person, firm, company or corporation.

Full provision is made for the protection of ships' distress signals from interference by land transmitting stations. There is also a lengthy section of the new law defining the taking over or shutting down of private radio stations in the event of war.

The new Radio Law of 1927, as the act is called, took effect immediately upon its approval by President

Coolidge, but for sixty days no penalties under the act will be effective upon any station or operator who holds a license issued by the Secretary of Commerce under the preceding law.

Free Pencils Swell the Prospect List

J. E. Duer of Duer Electric Shops, Stoughton and Edgerton, Wis., bought a quantity of lead pencils, stamped on each and then secured permission to distribute one pencil to each pupil in the public schools within a ten mile radius of Stoughton. Each pencil was accompanied by a small card for the child receiving the pencil to fill out. On these cards the children were asked for their names and addresses, whether or not a radio was used in their homes, and, if so, what make. Duer's prospect list has become a pretty complete cross-section of the degree of radio saturation in the neighborhood.





Accounts for

DISTINCTIVE advertising is given credit for the tremendous increase in the volume of its radio business by Prest & Dean, pioneer Long Beach, California, dealers, whose sales have multiplied five times over in the past six years. Printer's ink is considered one of their best paying investments and they spend four per cent of their gross sales on it every year.

Direct mail advertising is one of their chief promotional aids. They mail several thousand form letters monthly to a list of names compiled from prospects who have called at the store, and from the records of service calls and repair cards. Besides these letters a special "thank you" letter is mailed out to each new purchaser of a set. This is designed primarily to create goodwill and show that the firm is as interested in the set-buyer after the sale as before.

The firm believes in making class as well as individual appeal. When the Congregational Church services were being broadcast each Sunday it got a list of members and circularized them, calling attention to the fact that they could stay at home and

Long Beach, Cal., pioneer radio company spends four per cent of its gross sales each year for publicity. This article tells how it attained its tremendously increased volume in six years.

hear the services. Demonstrations were made on Sunday nights when the services were being broadcast. Many sales resulted from this specialized appeal. A somewhat similar plan was employed in reaching members of the Optimists Club.

The unique part of the firm's advertising is its monthly house-organ: "Wave Lengths from Prest & Dean," which is sent to the entire mailing list. This publication is printed on cardboard stock, 5 by 8½ in., and can be mailed out as a postcard. On one side is space for the address, and a formal advertisement, while the reverse is used for the house-organ itself.

Ten or twelve short items consti-

tute the news published in a given issue. In a typical issue mention is made of one set owner receiving letters of verification from over 200 stations covering the United States, Canada, South America, Australia, and Japan. Of course the set owner's name is given, which makes the item a wonderful sales stimulator. Always there is mention of one or more broadcasting stations and other news of interest to fans, while interspersed here and there, are short notes about this or that receiving set.

In a recent number of the house-organ a contest, conducted by Prest & Dean, brought in several hundred letters, and incidentally built up a valuable mailing list. This contest was to select a name for a freak pictorial ad showing Millie Hart, a local stock company player, wearing the Radiola Hat. A \$5 prize brought a deluge of letters.

Freak advertising, as Fred S. Dean, one of the partners, calls it, is run continually by Prest & Dean in the rotogravure section of one of the Sunday papers. This invariably is illustrated by photographic work. One such advertisement featured a

Advertising

Prest and Dean's Rapid Expansion

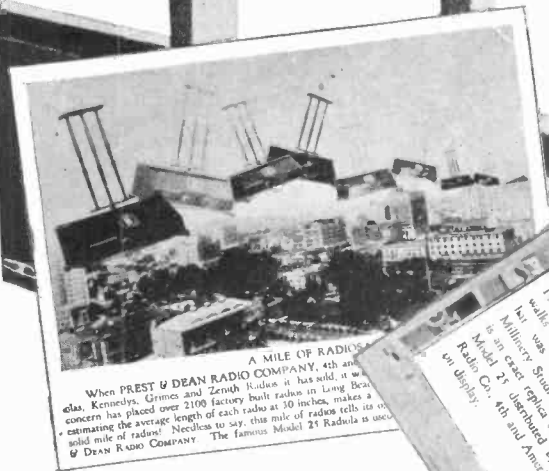

A MILE OF RADIOS
When PREST & DEAN RADIO COMPANY, 4th and American, Kennedy, Grimes and Zenith Radios it has sold, it was found that this foremost Long Beach Radio concern has placed over 2,100 factory built radios in Long Beach homes. This number, conservatively estimating the average length of each radio at 30 inches, makes a line more than 5,280 ft. long, or a solid mile of radiolas! Needless to say, this mile of radiolas tells its own story. The famous Model 25 Radiola is used in the illustration.

Dealers Who Have Made Radio Pay No. 3

photograph captioned: "A Mile of Radios!" A familiar downtown view of Long Beach was reproduced, with a never-ending stream of radiolas strung along the skyline. Beneath the picture appeared this text:

"When Prest & Dean Radio Company, 4th and American, figured the number of Radiolas, Kennedys, Grimes, and Zenith Radios it has sold, it was found that this foremost Long Beach Radio concern has placed over 2,100 factory built radios in Long Beach homes. This number, conservatively estimating the average length of each radio at 30 in., makes a line more than 5,280 ft. long,

Radio Retailing, March, 1927

or a solid mile of radiolas! Needless to say, this mile of radiolas tells its own story of the magnitude of Prest & Dean Radio Com-

pany. The famous Model 25 Radiola is used in the illustration."

"The next biggest factor in the business is the fact that we emphasize before a sale is made that service follows the placing of a set," says Mr. Dean. "Further, we try to live up to that sales argument." Therefore the service department is considered an important part of the business, from the standpoint of a good-will creator, alone. Of the men engaged in the service department one man is employed in the servicing of new sets, while two men in the shop divide their time between servicing sets that they are most proficient at. On the outside there is one man to install batteries and tubes, another installs aerials and delivers



The "Human Element" in Prest and Dean's Success



In this picture taken outside this pioneer Long Beach, Cal., radio store are the members of the firm, Fred S. Dean, left, and Ralph S. Prest, right, in doorway, and thirteen of their efficient office, sales and service employees.

sets, while a third man is used to relieve either outside specialist. A fourth man is used for special work and collections. Thus it is apparent that, in so far as it is possible, Prest & Dean make specialists of their service men.

Prest & Dean employs eighteen people. Four are engaged in selling; seven are in service work; and seven are in the office or do general work, in and out of the store.

All Salesmen Work on Commission Basis

In the selling branch of the business are four salesmen, all working on a commission basis. Mr. Dean explains that the day's schedule is so arranged that all salesmen have floor days, without any priority rights by any one, due to high sales volume.

"I have abandoned all theories about picking salesmen," admitted Mr. Dean. "The prime qualities are personality and willingness to work."

The firm's policy is to carry three or four lines of radio in stock regularly, in order to be assured of a wide price range, together with a variety of models. This obviates a lot of extra effort in selling the prospect.

Salesmen are permitted to have the exclusive on a prospect for twenty days after which another salesman is given an opportunity to close a sale. A record of all prospects is kept in the office, where they are circularized at regular intervals.

Seventy-five per cent of the Prest & Dean sales are on time payments. Mr. Dean says that the usual terms are a third down and ten or twelve months for the balance, though they

will let a radio go out on a twenty per cent down payment.

"We charge regular interest and insurance on time accounts," states Mr. Dean, "and carry our own paper. It's just like an auto contract. By carrying our own paper we have much less work. It does away with the necessity of making reports to finance companies. If we keep up the collections on an account we make a profit on the paper. If the set comes back we don't have the entire loss, as we have part of the profit from the insurance and interest."

Used-set problems, real or imaginary, do not worry this enterprising firm. On one occasion recently they moved one hundred used sets in thirty days. And they did not use any special direct-mail, newspaper, or other forms of advertising, special prices or inducements to accomplish this. There was no special feat in the moving of that number of sets, according to Mr. Dean, who thinks that it could be done right along, if that many sets were received on trade-ins.

"We moved these used sets simply by showing them, and proceeding to sell the prospects on them," he asserts. "We kept our windows full and put the best possible price we could on them. But we didn't sacrifice our rightful ten per cent over their trade-in value. Further we pointed out that the buyer was getting everything used, that he was buying the set 'as is.'"

Prest & Dean attribute part of their success to employees' efficiency meetings which are held twice a month.

"At these meetings, attended by

all service men and salesmen," states Mr. Dean, "they are given an opportunity to air any grievances they may have. It proves good for the men and for the firm, alike. Any one can voice an opinion on any problem affecting the individual or the business as a whole, and feel that he will be given a respectful, considerate hearing, and, if possible, a solution, from one of the firm or another employee. There's nothing like these meetings to cut out friction between various departments, personal back-biting and any general ill-feeling that might make itself felt in lessened sales or service effort."

Encourage Social Meetings of Employees

During the summer beach parties are arranged for the employees. These affairs are attended by the employees, their families and friends and are essentially employees' picnics from start to finish. The employees arrange the programs and details and select any entertainment talent they wish. They have a good many talented people in their ranks and the result is a real good time. About forty people attended the last such party.

The Prest & Dean partnership was started in 1918 by Fred S. Dean and Ralph S. Prest. At that time they were engaged in electrical retailing. Almost from the first they became interested in radio, and began pushing it. Within two years they had abandoned the electrical business and were concentrating on the sale of radios.

"Any success we have had," Mr. Dean declares, "has been because from the start we have made an effort to give the customer a square deal. We never promise anything we can't fulfill. We never sell a customer distance and do not make a guarantee. But we do give real service."

A New Use for Crystal Sets

When the Felt Radio Supply Company of Salt Lake City, Utah, opened its new store, a new use was found for crystal receivers. Felt gave away 1,000 of them to visitors during the first day and as a result sold 12 sets. In addition to these immediate sales he secured a prospect list which will probably net him 400 sales during the next year or two. The crystal receivers cost 38½ cents apiece.

Felt made sure the sets were of good value before giving them away.

Reviewing Radio Export Conditions in Foreign Countries

Department of Commerce officials co-operated with the editors of "Radio Retailing" in publishing this résumé of foreign radio trade—Second of three articles prepared exclusively for this publication by the U. S. Department of Commerce

IN 1918 the export of radio and telegraph apparatus from the United States amounted to less than \$400,000. Three years later, in 1921, the sales had risen to \$1,000,000. Then, came broadcasting. Export sales of radio apparatus alone in 1922 nearly tripled those of 1921, reaching \$2,987,799. In 1923 they rose to \$3,448,112 and in 1924 they reached the maximum figure of \$6,030,914. Export trade for the year 1925 reached approximately \$9,910,000—an increase of 6 per cent over 1924. In 1926 about \$8,500,000 worth of radio export business was done.

In 1927 radio exports from the United States may exceed those of either 1925 or 1926. This increase if it occurs, will be due to two things—more favorable radio broadcasting conditions in foreign countries, and, what is more important, greater sales effort on the part of the American manufacturers.

In the following paragraphs, each country that constitutes a market for American-made radio products is taken up, in alphabetical order, with an explanatory word about the radio situation in each country.

Argentina

Argentina has a population of over 10,000,000. Buenos Aires (2,750,000) is the principal city; others being Rosario (250,000) and Cordoba (105,000).

Radio reception is good throughout Argentina, especially from April to September.

Radio is controlled by the Government through the Chief of Naval Communications. Broadcasting is permitted freely, permits costing only a 1-peso stamp on the application. Receiving sets may be installed by anyone, the only requirement being that the Chief of Naval Communications be advised of the installation. There are no exceptional restrictions on importing, manufacturing, or merchandising.

A recent estimate places the number of receiving sets in use at 150,000. Some of these, in Buenos Aires, are crystal sets. The market for tube sets and parts is good.

American apparatus is almost universally used. A small amount of European materials is sold, and there is a limited domestic manufacture, but these do not seriously affect the market for American sets and parts.

Argentina has 9 broadcasting stations in Buenos Aires and one in Rosario.

Australia

Australia has a population of 6,000,000. The principal cities are Sydney (900,000), Melbourne (800,000), Adelaide (300,000), and Brisbane (200,000).

Regulations.—Broadcasting is under the control of the Postmaster-General. Stations are divided into two categories, high and low power. There is no restriction as to the number or location of low-powered stations, but high power is permitted to but one station in each of the States, except Victoria and New South Wales, each of which may have two.

Receiving licenses are required, the cost being determined by the distance of the set from the high-powered station for that State, a system of zones determining the rate. The fees range from 22½ shillings (\$5.36) to 30 shillings (\$7.30) per year, on sets for private use.

Statistics.—In September, 1926, 165,436 receiving sets were licensed. All kinds of sets are bought, but the best market is for parts, as the home construction of sets is popular.

Wavelengths up to 1,250 meters are used by Australian stations, but all except Perth are under 600 meters.

Broadcasting.—Australia has a number of excellent broadcasting stations. Stations are now operating in Adelaide, Bathurst, Brighton, Brisbane, Hobart, Melbourne, Mildura, Newcastle, Northbridge, Perth, Sydney, and Toowoombie.

Brazil

Brazil has a population of about 30,600,000. Rio de Janeiro, Sao Paulo, Pernambuco, Bahia, and Para, all seaports, are the principal cities.

The radio region of Brazil includes only

The World Market for American Radio Equipment

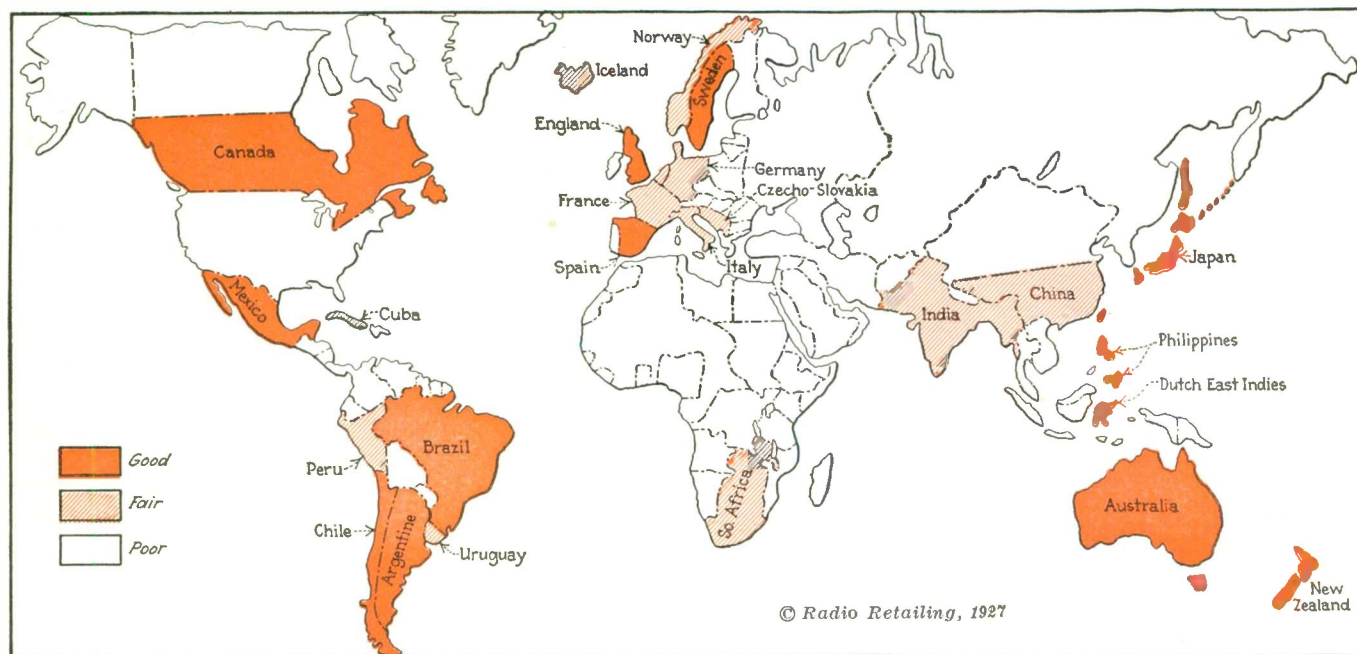

Where American radio exports go is shown by this map. The solid red portions indicate markets of over \$100,000

annually; the shaded countries, from \$20,000 to \$100,000, and the untinted sections, under \$20,000.

the truly coastal strip. The interior is sparsely settled and mostly heavily forested.

Climate.—In the north there are the usual atmospheric disturbances of the Tropics. Climatic conditions improve southward, though the extreme south is sub-tropical. Sets and parts should be protected against humidity, especially metal parts and transformers. The use of brass and bronze in preference to aluminum and nickel is highly desirable, and only enamelled wire should be installed.

Regulations.—Radio is administered by the Department of Public Works and Transportation, Department of Marine, and the Department of War. Concessions for the establishment of broadcasting stations are required. There is no monopoly. Receiving is permitted, registration being required. The registration fee is 20 milreis, there being no annual charge. Sets are subject to Government inspection.

Statistics.—Brazilian stations use wavelengths between 250 and 500 meters. Foreign stations received use from 40 to 600 meters. About 10,000 receiving sets have been registered, the number of unregistered sets being estimated at 5,000. All types of sets are in use. The building of sets at home is usual, hence the market for parts is good.

Broadcasting.—Brazil has broadcasting stations in 11 cities, and has made considerable progress in radio development during the past two years. Much has been accomplished through the excellent programs broadcast at Rio de Janeiro and Sao Paulo, which have been constantly improved since the inauguration of the stations.

British Isles

Climatically, the British Isles are ideal for radio reception. There is little atmospheric disturbance at any season, summer reception being nearly as good as winter.

Patents.—Many of the basic radio inventions are patented in the United Kingdom, the patent or an exclusive license being held by a British concern. American firms manufacturing apparatus under license will do well to investigate the status in Great Britain before exporting to that country, and thus avoid the possibility of expensive litigation. Certain British interests are at present actively attempting to collect royalties and it is believed that they may be at least partially successful.

Regulations.—Radio is controlled by the Post Office Department. Broadcasting is a monopoly vested in the British Broadcasting Corporation, which is a government body, and assumed charge Jan. 1, 1927. Its activities are supported by a portion of the license fees, 75 per cent of the total collected being available for this purpose, the remainder being turned into the general treasury.

Receiving licenses are issued to all applicants and cost 10 shillings (\$2.43) per annum. There are no other restrictions on the ownership and operation of sets, nor on importing, manufacturing, or merchandising, except the patent situation mentioned above.

Statistics.—Wavelengths of from 200 to 1,600 meters are used. Tube sets should be capable of receiving on wavelengths up to 3,000 meters, although most stations in England are now broadcasting within wavebands closely paralleling the American range. The population of the British Isles is 44,000,000.

Over 2,000,000 sets were licensed on July 1, 1926. These were principally of domestic origin, with some American, German, and French apparatus. All types of sets are in demand, and owing to the popularity of home construction, the market for parts is excellent.

American apparatus is considered to be very good, and in some sections is held to be superior to the British product.

Canada

The population of 9,000,000 inhabitants dwell in the southern one-third of the country. As in the United States, the greater part of the population is settled in the eastern half of this more temperate strip.

Regulations.—Radio is controlled by the Department of Marine and Fisheries. There are no exceptional restrictions on broadcasting, the only limitation being that broadcasters must be citizens of the British Empire. Receiving sets are licensed at the rate of \$1 per annum, the fine for operating without license being \$50. There are no other restrictions on receiving, nor are there any on importing, manufacturing or merchandising.

Exports Market Still Undeveloped

THE foreign market for American-made radio equipment has not been developed to its fullest extent, according to the Electrical Equipment Division of the Department of Commerce. Conditions in foreign countries show American manufacturers are not taking the best advantage of their export opportunities.

Statistics.—All Canadian broadcasting is done on wavelengths between 150 and 600 meters.

Information as of December 22, 1926, shows 300,000 receiving licenses in the Dominion. The U. S. exports nearly 50% of all sets sold and in use today in Canada. There are no exports of radio apparatus from Canada. All types of sets are in use.

China

China has a population of 400,800,000. Shanghai, Hankow, and Peking have populations in excess of 1,000,000 each.

The importation of radio apparatus is forbidden by the Government, being classed as munitions of war.

It is generally believed, however, that, although the restrictions might be lifted, the potential market is limited to the comparatively few foreigners and rich Chinese. A broadcasting station is operating at Shanghai.

Denmark

Denmark has a population of 3,419,095. Copenhagen (725,000), Aarhus (75,000), Odense (50,000), and Aalborg are the principal cities. About 57 per cent of the population is rural. Radio reception is good throughout the year, but is best from September to May.

Regulation.—Radio is governed by the State radio council. Broadcasting is supported by the proceeds from license fees, and all of the present broadcasting stations are Government owned. No restrictions, excepting the license requirements, have been imposed on the owners of receiving sets. Manufacturing, importing, and merchandising are permitted without restraint.

Broadcasting.—Denmark has broadcasting stations at Copenhagen and Sorø. All of the principal European stations are heard, as well as those less powerful in Sweden, Norway, Germany and the British Isles.

Parts.—Home construction is popular, resulting in a very good market for parts. The Danish market is principally for parts and accessories rather than for sets. It is probable that not more than 10 per cent of the sets retailed during the past year have been imported in assembled form.

Statistics.—All sets should be capable of receiving on wavelengths of from 200 to 3,000 meters, as some Danish broadcasting stations use very long waves. About 102,000 sets were registered in November, 1926. Slightly less than half of these are tube sets.

France

France has a population of about 40,000,000. The principal cities are Paris (3,600,000), Marseille (580,000), Lyon (560,000), Bordeaux, Lille and Strasbourg.

In the south radio reception is good during a limited season, while in the north reception is always good except during the hottest part of the summer. The best reception at Paris is from September to May.

There is no monopoly, though the majority of the stations are owned by the Government through the Ministry of Posts, Telegraphs and Telephones.

A receiving license fee of 1 franc per year is charged French citizens. Regula-

tions stipulate that foreigners shall pay 10 francs per year, but this requirement is often passed in particular cases. A luxury tax of 12 per cent on sets costing more than 500 francs and on parts costing more than 50 francs was instituted in January, 1926.

Statistics.—All sets should be capable of receiving on wavelengths of from 200 to 3,000 meters.

An estimate of February 12, 1926, places the number of sets in use at 800,000. This does not include any which may be operated without licenses. All types of sets are in demand. There is a good market for American sets and parts, and our radio exports to France are large.

Germany

Germany has a population of 62,500,000. There are 48 cities with populations in excess of 100,000, Berlin and Hamburg both running into millions. Radio reception is generally good, the season of best reception being from September to May.

There is a limited market in Germany for American radio equipment. Complete American radio sets are superior to German sets. American prices are high, however, and the sale is therefore considerably restricted.

Regulations.—Radio broadcasting is under the control of the postal authorities, who own the equipment of all stations. Broadcasting is done by corporations, which have monopolies in each section of the country. These corporations are supported from the proceeds of license fees.

Receiving licenses are freely granted to all applicants except Russians, Poles and Slavs. A fee of 24 marks (\$5.66) per year is exacted, for which a person is entitled to own and operate as many receiving sets as desired, provided not more than one is in use at any one time.

Cheap labor permits German manufacturers to supply the domestic market with sets at very low prices. The good distribution of broadcasting stations makes cheap sets quite satisfactory.

Statistics.—The wavelengths employed by broadcasting stations in Germany range from 200 to 600 meters, with the exception of the high-powered Königswusterhausen station, which relays Berlin (Vox Haus) programs on 1,300 meters. Crystal sets suitable to the American waveband might, therefore, be sold in some parts of Germany. Tube sets, however, must be able to receive on the entire European waveband of 200 to 3,000 meters.

On January 1, 1927, 1,200,000 sets were licensed in the country. An additional 200,000 were said to be operated without authorization. Practically all of the latter were crystal or one or two tube sets.

Broadcasting.—Germany has broadcasting stations in 19 cities.

India

India has a population of 318,900,000. The principal cities are Calcutta (1,300,000), Bombay (1,180,000), Madras, Hyderabad, Rangoon, and Delhi.

Radio reception is good from November to May in most sections.

Regulations.—Radio is under the control of the director general of post and telegraphs. A company which is to have a monopoly on broadcasting is being organized; meantime various interests control the broadcasting stations in operation.

Receiving licenses are issued to all applicants. These cost 10 rupees (\$3.50) per year.

The principal demand in broadcasting cities is for crystal sets. Tube sets having up to four tubes have a fair market.

Trade-marks.—The Indian law requires that trade-marks be accompanied by a similarly applied legend giving the country of origin. The words "Made in U. S. A." have been declared sufficient. This legend must be in characters as large and distinct as any word or line in the trade-mark. An expounder of this law may be had by communicating with the Commercial Laws Division of the Bureau of Foreign and Domestic Commerce.

Broadcasting.—India has broadcasting stations at Bombay, Madras, and Rangoon.

Italy

Italy has a population of about 42,000,000. The principal cities are Milan (700,000), Naples (700,000), Rome (600,000), Turin (500,000), Palermo (350,000), and Genoa (325,000).

At Rome the radio receiving season extends from November to June.

Regulations.—Radio broadcasting is under the control of the Ministry of Communication. A monopoly for broadcasting

has been granted to the Unione Radiofonica Italiana, a corporation organized for that purpose. Licenses costing 3 lire (12 cents) per year are required for the operation of receiving sets, the proceeds accruing to the national treasury. Subscriptions to broadcasting service are compulsory, the funds received being used for the purpose of supporting broadcasting stations and providing programs. Amateurs are required to pay 96 lire (\$3.75) per annum for this service. Receivers employed for commercial purposes are assessed at varying rates, sometimes as high as 3,000 lire (\$120) per annum.

No set may be installed unless approved by the Ministry of Communications. Samples of manufactured sets may be deposited by manufacturers and importers as a check against adherence to types, in lieu of individual inspection of sets, which is otherwise required. A sales tax is assessed, at the following rates: Tubes, 6 lire (\$0.25); crystal sets, 12 lire (\$0.50); loud speakers, 24 lire (\$0.95); tube sets, 53 lire (\$2).

Statistics.—Wavelengths of 324 and 423 meters are in use. Regulations prohibit the use of wavelengths under 300 meters or over 3,000 meters, either in broadcasting or receiving.

Broadcasting.—Italy has broadcasting stations at Rome and Milan.

Japan

Japan has a population of 80,000,000. The principal cities are Tokyo, Kobe, Osaka, Kyoto, and Nagoya. The climate is good for radio, reception being fair throughout the year and good from September to May.

Radio broadcasting is controlled by the Bureau of Communications, broadcasting permits being issued only to Japanese citizens. A single corporation has taken over the holdings of the companies which have been broadcasting, to effect economies in operation.

Broadcasting is supported from license fees. Receiving sets may be operated upon payment of the license fee of 2 yen per annum and a subscription fee of 1½ yen per month. Permits to install are required, and only sets approved by the Bureau of Communications may be used. Manufacturers and importers may deposit a sample set, the approval of which will serve for all additional sets of the same type so long as none of the specifications is changed. Wavelengths of from 150 to 400 meters may be used, but none other.

On June 1, 1926, 300,000 receiving sets were in use, an increase for six months of 50,000. About 78 per cent were crystal sets. The principal demand is for low-priced sets.

Japan has broadcasting stations at Nagoya, Osaka, and Tokyo.

Mexico

Mexico has a population about 15,000,000. Mexico City, Guadalajara, and Puebla are among the principal cities. The rainy season extends from May to October, and static is bad in all sections during that season. Reception becomes fair in all parts of the country during November, extending to February in the south and to April in the north.

Regulations.—Broadcasting is administered through the Department of Communications and Public Works. Permits to broadcast are required, and the Government reserves the right of censorship. Broadcasting is supported by the owners and operators of the stations. Licenses are required for receiving sets.

Statistics.—Between 15,000 and 20,000 receiving sets are in use. These are of all types and sizes, though there is very little demand for crystal sets. Three-tube sets are most popular.

Netherlands

The Netherlands have a population of about 7,500,000. The principal cities are Amsterdam, The Hague, Rotterdam, and Utrecht. Reception is good from September to May, and fair during the summer.

At present it is required that the postal authorities be notified of the installation of a set, but no fees are collected.

Crystal sets must be capable of reception on wavelengths of 1,050 meters and tube sets from 200 to 3,000 meters. About 25,000 sets are in use, about 75 per cent of these being of domestic manufacture. Most of the remainder are French and British. All types of sets are in demand, four-tube sets being the most popular. The market for parts is very good, as home construction is carried on to a considerable extent. Most of the tubes available are defective or of a poor quality, so a first-class tube should find a good sale.

The only broadcasting station in the Netherlands is in Hilversum. British, German, French, Belgian and other stations are received regularly.

Norway

The principal cities are Oslo (280,000), Bergen (100,000), Stavanger (46,000), Drammen, and Trondhjem. Total population 2,649,775. Radio reception is good throughout the year, but is best from September to May.

The control of radio broadcasting is vested in the telegraph authorities. The use of radio by amateurs is prohibited, and both of the stations at present operating are owned by the Government, though no monopoly has been declared. A license fee of 20 crowns (\$5.36) per year is collected from receiving-set owners, the proceeds being used to defray broadcasting expenses.

Wavelengths of 461 and 370 meters are used in Norway, foreign stations using from 200 to 3,000 meters being received regularly.

Norway has broadcasting stations at Bergen and Oslo. Swedish, Danish, and British stations, and the principal stations in other parts of Europe, are also received.

Spain

Spain has a population of nearly 22,000,000. The principal cities are Madrid (650,000), Barcelona (625,000), Valencia (250,000), Seville, Malaga, Merida, Saragossa, Cartagena, and Bilbao. Radio reception is fair from October until April.

Regulations in regard to broadcasting are liberal. Receiving licenses are required, and foreigners must obtain special permits. There are no restrictions on importing, merchandising, and manufacturing, except a requirement that salesmen be licensed.

Wavelengths between 300 and 500 meters are in use in Spain, and short-range sets capable of receiving on these lengths might be sold. Middle and long distance sets can be sold only when adjusted to a waveband of from 200 to 3,000 meters.

There is no reliable estimate of the number of sets in use at the present time. The market for crystal and for long-range sets is good. Parts sell fairly well, home construction being popular.

Spain has broadcasting stations in 13 cities. Other principal European stations

are received regularly. American apparatus is rapidly growing in popularity.

Sweden

Radio reception good throughout the year especially from September to May. Total population, 6,000,000.

Regulations.—Radio is under the control of the Telegraph Administration. A broadcasting monopoly has been granted to a corporation known as "Radiotjänst," but transmitting licenses are freely issued to amateurs, and the monopoly has provided facilities for the rebroadcasting of the programs of its stations by amateurs and radio clubs.

Permits to install receiving sets are issued at the rate of 40 crowns (\$10.72), while receiving licenses cost 10 crowns (\$2.68) per year. Manufacturing, importing, and merchandising are not subjected to any exceptional restrictions.

Broadcasting.—Sweden has broadcasting stations in twenty-seven cities. Danish, Norwegian, and Finnish stations, and the principal stations of other parts of Europe, are regularly received.

There was practically no market in Sweden for radio apparatus prior to November, 1923. The Government's restrictions and high license fees, together with the total lack of broadcasting, militated against any popular demand. At that time, however, the restrictions were abrogated, and subsequently the license fee was reduced and broadcasting stations established. The resultant development has been great.

The demand seems to be for cheap and medium-priced apparatus, about 80 per cent of the sets in use being crystal receivers. The competition between Swedish, American, and German sets is strong.

The Government, in conjunction with private industry, has proposed the erection of a super-power broadcasting station. It is expected that the construction of such a station would create a demand for between 80,000 and 100,000 new sets.

Statistics.—Some 208,000 receiving sets were licensed on Aug. 31, 1926. German, British, and American makes are imported, though considerable quantities are supplied by domestic manufacturers. Wavelengths of 196 to 1,350 meters are used by Swedish stations, while foreign stations are received on 200 to 3,000 meters. Home-built sets are very popular, and the demand for parts is therefore keen.

Merchandising the New Tubes

(From Page 42)

fiction in conjunction with a 4-volt supply. This tube operates with 22 volts of C battery when using 135 volts of B battery. It is equipped with a small push type base.

The 210 type is a heavy duty tube designed especially to operate large reproducers in halls and other places where great volume is desired. This tube may be operated from either a six-volt direct current source or an eight-volt alternating current source. When used in a B battery eliminator amplifier, raw or unrectified alternating current may be used to light the filament.

The Hi-Mu type tubes have an amplification factor of about three times that of ordinary tubes and are designed and recommended especially for use in resistance coupled amplifiers. The reason for this is that this type of amplifier depends entirely upon the amplification factor of the tube, there being no stepping up effect as with transformers. They may also be used for radio frequency amplifiers and as detectors.

There is no doubt that many sales are being neglected because the proper use of these special purpose tubes is not understood. Before the dealer should attempt to merchandise these tubes extensively he must thoroughly familiarize himself with the exact use of the tube and the voltage combination to be used with them.

When making a call a super-sensitive detector tube should be carried along. Install it and let the customer note the difference. No change in wiring is necessary and there is no doubt that the customer will be delighted with the results. Be sure, however, the proper value grid leak as specified by the tube manufacturer is used, for this has a marked effect on the tube's operation. After this, turn the set up to full volume and if this cannot be done without causing distortion, recommend also the use of power tubes in the audio stages. There is a widespread interest in these tubes and in the improved reception they afford, but also a great general lack of knowledge of their purposes, possibilities and method of installation. If the proper voltages are used with these tubes they will speak for themselves.

More Radiolas



LIVING ROOM—A MAN, A WOMAN, A CHILD—A RADIO

Why a Radiola is better value regardless of price

Some radio sets are bought on price alone—for they will always be people who think they get better value when they pay less money.

But every year, RCA Radiolas have proved by their outstanding leadership that it isn't the cost that counts—it's the performance, and the reputation for standing up under use.

Value is proved by comparison. People who learn and see and compare—buy Radiolas. Radiola 20, at \$18, has equipment that challenges comparison with any make—and proved its thousand uses that it is four times that any set of its type, regardless of price.

And many have bought the highest priced Radiolas.

It is the radio that meets every condition of modern broadcasting and matches every great musical program with reproduction that is vivacious. There is no finer instrument of musical reproduction today. That is its measure of value . . . and price!

An RCA Radiola is always "worth your money."

The price of RCA Radiolas not only covers maintenance of remarkably high quality—but exhaustive research, too. But the results of this research and this research, too. But the results of this research and this research, too. But the results of this research and this research, too.

Try it, and you'll be proved. It is the pioneer in "lightning bolt" radio—proved and perfected where others set their sights on setting. It sends an antenna—operates with a single control—meets our conditions in the most advanced cases.

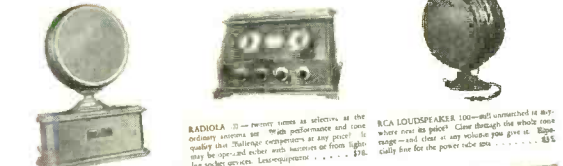

RCA LOUDSPEAKER 100—100-watt speaker with the addition of a power amplifier (RCA Loudspeaker 100) that puts great volume in your control. Complete . . . \$140. With tone bar in 100-watt. Complete . . . \$170. (Operates on 50-60 cycle, 110-volt A.C. in standard socket.)



RADIOLA 20—10-tube super heterodyne. As a portable it has a lamp in the cover, loudspeaker inside, plug in the back for small batteries. At home it has a fine walnut cabinet that holds six 250-volt batteries and a couple for an antenna. Case is richly grained walnut. With 6 Radiolas . . . \$225.

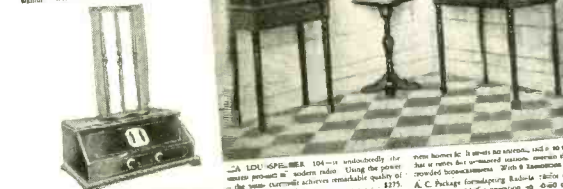

RADIOLA 21—10-tube super heterodyne with all the features of Radiola 20, but with a "cascading" tuning of the tuned circuits. Single connected. With 6 Radiolas . . . \$165.



RADIOLA 22—10-tube super heterodyne with all the features of Radiola 20, but with a "cascading" tuning of the tuned circuits. Single connected. With 6 Radiolas . . . \$165.

RCA Radiola

MADE BY THE MAKERS OF THE RADIOTRON

MILLION-FOLD CONSUMER APPEAL OF ADVERTISEMENTS LIKE THIS

The above advertisement appears in The Saturday Evening Post of March 12, 1927, selling the RCA product and the RCA dealer to the buying public. The RCA campaign, now in its eighth year, reaches into every field—general publications, women's magazines, class, radio, farm, boys', technical and trade publications, newspapers and billboards.

This sign marks the leading dealer in every community.



RCA Radiola

MADE BY THE MAKERS OF THE RADIOTRON

in use today than any other make

But this one fact is not by any means
the whole story of RCA Leadership

Other factors besides greatest number of receiving sets sold to date combine to make the RCA Authorized Dealership the most coveted radio franchise in America today. All of these facts are directly related to the individual prosperity of the RCA Dealer. To mention only a few of them, the RCA Dealer is the beneficiary of continuous RCA national advertising, now in its eighth year. Of RCA broadcasting activities, such as the National Broadcasting Company, and the ten stations controlled by RCA and its associates. And of the RCA engineering background, which, through the laboratories of RCA, Westinghouse and General Electric, has given radio every forward step since its beginning.

LIGHTING SOCKET OPERATION

RCA was the first to enable the radio owner to dispense with the antenna and to do away with batteries. Lighting socket operation is the uppermost thing in the buyer's mind today. And all Radiolas can be equipped to operate with batteries or with lighting socket devices.

HOME DEMONSTRATION

Complete demonstration of the set in the prospect's home has proved itself the outstanding thing in the methods of those RCA Dealers who have scored the most notable successes with the RCA line.

RADIO CORPORATION OF AMERICA



NEW YORK - CHICAGO - SAN FRANCISCO

RCA Radiola

MADE BY THE MAKERS OF THE RADIOTRON

Practical Service Methods

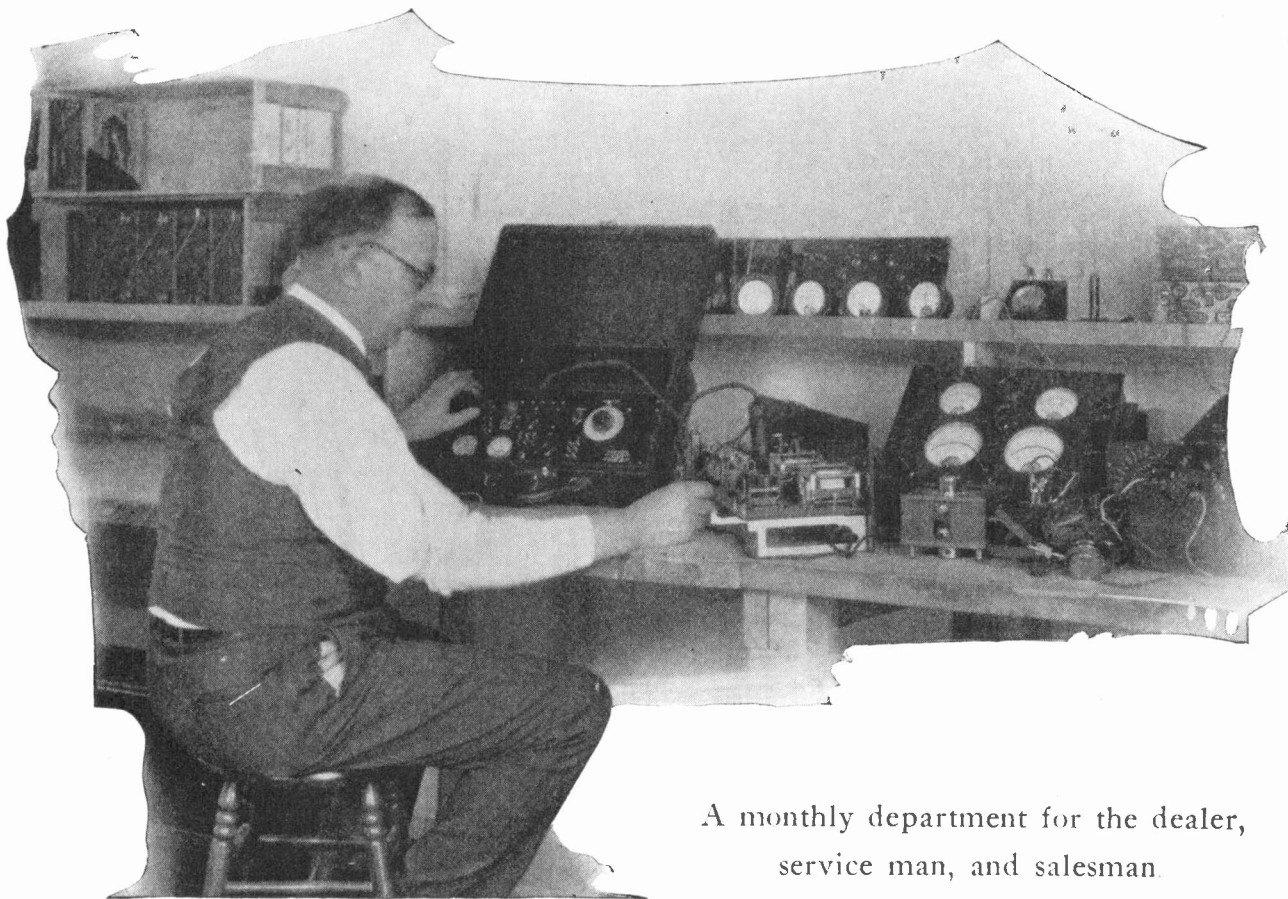

A monthly department for the dealer,
service man, and salesman.

Saving the Service Man's Time

New portable testing device quickly locates trouble in any tube, battery or circuit of any type of set—Disconnecting batteries or probing with test leads unnecessary.

THE chief cause of the high price that must be charged for service work is the amount of time that is usually spent in locating the trouble. Often, too, this time—which might almost be called time wasted—must be paid for by the dealer. This is doubly true when the work is done in the dealer's store and the customer is unable actually to see the amount of work "trouble shooting" is. Therefore the following information on an adequate system of "trouble shooting" should prove welcome to the entire radio trade.

With the portable testing device described in this article and used by the service school of the Michigan Radio Trade Association, faults in any tube, any battery and every cir-

cuit in any type of set are immediately indicated without making it necessary to spend time in disconnecting and re-connecting batteries or probing with test leads. This device has been so designed that both its construction and its operation are extremely easy to understand.

The minimum size panel that should be used is 6 inches by 14 inches, although a larger one may be used to fit the carrying case. On it are mounted:

- 1 nine point bi-polar switch;
- 1 anti-capacity double pole, double throw, twelve blade switch such as the Federal No. 1424;
- 3 battery switches marked "on" and "off";
- 2 double pole, double throw switches;
- 1 potentiometer (1850 ohms.);

- 1 high frequency buzzer;
- 1 open circuit jack;
- 1 0-25 milliammeter;
- 1 two scale (0-75 and 0-150) voltmeter;
- 1 UX tube base;
- 4 feet of 5 wire cable;
- 1 test clip;
- 1 phone plug;
- 2 test leads with probes.

A coil and condenser combination to cover the 200 to 600 meter band is used as the wavemeter. A 3 inch coil wound with 45 turns of No. 22 d s c wire and a .0005 mfd. condenser will do, and the use of a straight line wavelength condenser will simplify calibration.

All of the above material is standard except the 9 point switch. This can be made according to the specifications as shown, or may be pur-

chased for \$5 from the Duston Radio Lab. which will also be glad to send free blue prints of the entire layout.

The simplest instruction that can be given regarding wiring is to caution the constructor to use the utmost care in following the diagram, making connections only where indicated by a heavy dot at an intersection. Connecting wires must be insulated wherever there is any possibility of short circuit. The tube base takes four wires of the cable, the fifth being attached to a test clip. The other ends of this cable go to the five binding posts on the tester which are mounted facing the underside of the panel.

Process Is Simple

The operation is readily understood by looking at the completed set checker. However, it is really much more simple than it appears. For simplicity in the following instructions the nine point switch will be designated as SW, the anti-capacity switch as SW 2, potentiometer switch as SW 1 and the remaining D.P.D.T. switch as SW 4.

Open SW 1, to test for opens, shorts and grounds, turn MA off, pot. off, SW off, and SW 2 to plus. Remove all tubes from set and connect all batteries, loudspeaker, ground, and aerial or loop. Turn on "A" battery switch of the set to be tested. Connect test cable, as marked on wires, to the tester binding posts. Then plug in test cable to first socket on the set to be tested, and the extra red wire to the plus B battery post used with the socket being tested.

How Voltmeter Should Read

Now turn SW to "A." Closing SW 1 causes the voltmeter to read on the 0—7½ volt scale and should show full "A" voltage when the rheostats of the set are on full. In case the meter reads backwards turn SW 4 to the negative position. *If the voltmeter fails to read, the filament circuit is open.*

Next open SW 1 to make the meter read on 150 volt scale and turn switch SW to PS. This

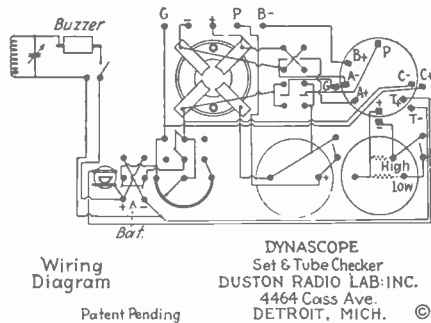

Above we have the actual wiring diagram showing the simplicity of the connections.

checks either the primary or secondary circuit for an open, short or ground, and the voltmeter should read less than the sum of the "A," "B," and "C" batteries combined. From the radio frequency sockets the change will be very slight; while from the audio frequency or detector sockets the change will be more pronounced. If the voltmeter does not read in the audio or radio frequency circuits, either the primary or the secondary is open. In that case proceed as follows:

Turn SW to P. *If the voltmeter now fails to read it is the primary circuit that is open.* If the voltmeter reads the full "B" battery voltage, the primary is short circuited or grounded between the primary and plate of the tube. This is barely discernible on radio frequency tubes.

Next turn SW to B. This will indicate the full "B" battery voltage and not the voltage actually on the plate. Now turn SW to G. Usually SW 1 should be closed so that the meter reads on the 7½ volt scale. If "C" battery is used its voltage minus the resistance drop of the primary will be indicated, plus or minus the "A" battery voltage. This depends on how the batteries are connected in

the set. *If the meter fails to read the grid circuit is open.* It should be remembered that detector tubes have the grid circuit broken by the condenser and therefore the voltmeter will not read until this grid condenser is short circuited. If it does read, the grid condenser or leak is shorted and should be replaced.

Dynamic Test of Tubes and Sets

After having repaired all trouble that has been located by the above tests, make the dynamic test as follows: Replace all the tubes in the set and tune in a station if one is on. If not, tune set to resonance by using the wavemeter in the set tester.

Remove the first tube in the set and replace it with the test plug of the set tester and place the tube removed from the set in the tube socket tester. Turn switch MA on. The milliammeter will now read plate current consumed by the tube under test. This should not be so high as when tested with a bench tester, since now there is a load in both the grid and plate circuit. This is what we mean by a dynamic test.

In radio frequency circuits the plate current varies with different sets. If it is exceptionally high or low another tube should be tried. When the set has a potentiometer it should be turned from the negative position towards the positive. Then note if the milliammeter reading increases. When the potentiometer is on the positive side the milliammeter should read from 4 to 6.

To Check Tube Characteristics

As a further test to check the dynamic characteristics of a tube, turn pot. switch on; SW 2 to positive or negative as required; switch SW on pot., and SW 1 on. Slowly turn the potentiometer and

note changes in the milliammeter reading corresponding to the various readings on the voltmeter. A dynamic curve can be drawn by plotting the voltage and milli-ampere readings on cross-section paper. These curves are never the same as grid-voltage plate-

(Please turn to Page 58)

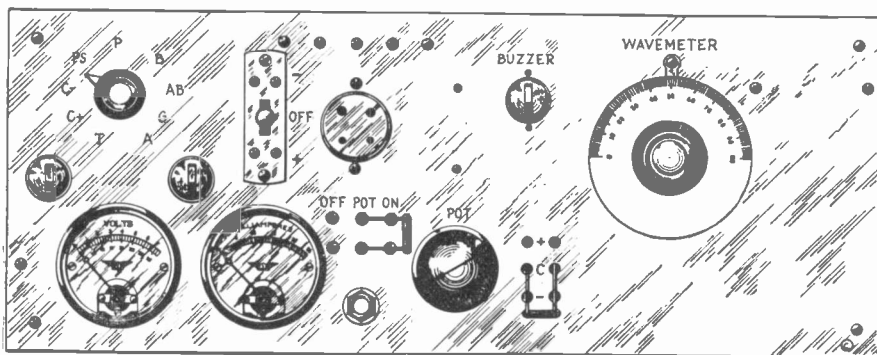

Panel Front Model L36

DYNASCOPE Set & Tube Checker DUSTON RADIO LAB. INC. 4464 Cass Ave. DETROIT, MICH. ©

Patent Pending

This panel front layout makes an attractive and easily operated testing instrument. The arrangement also facilitates wiring.

How's Business? —Read *Radio*

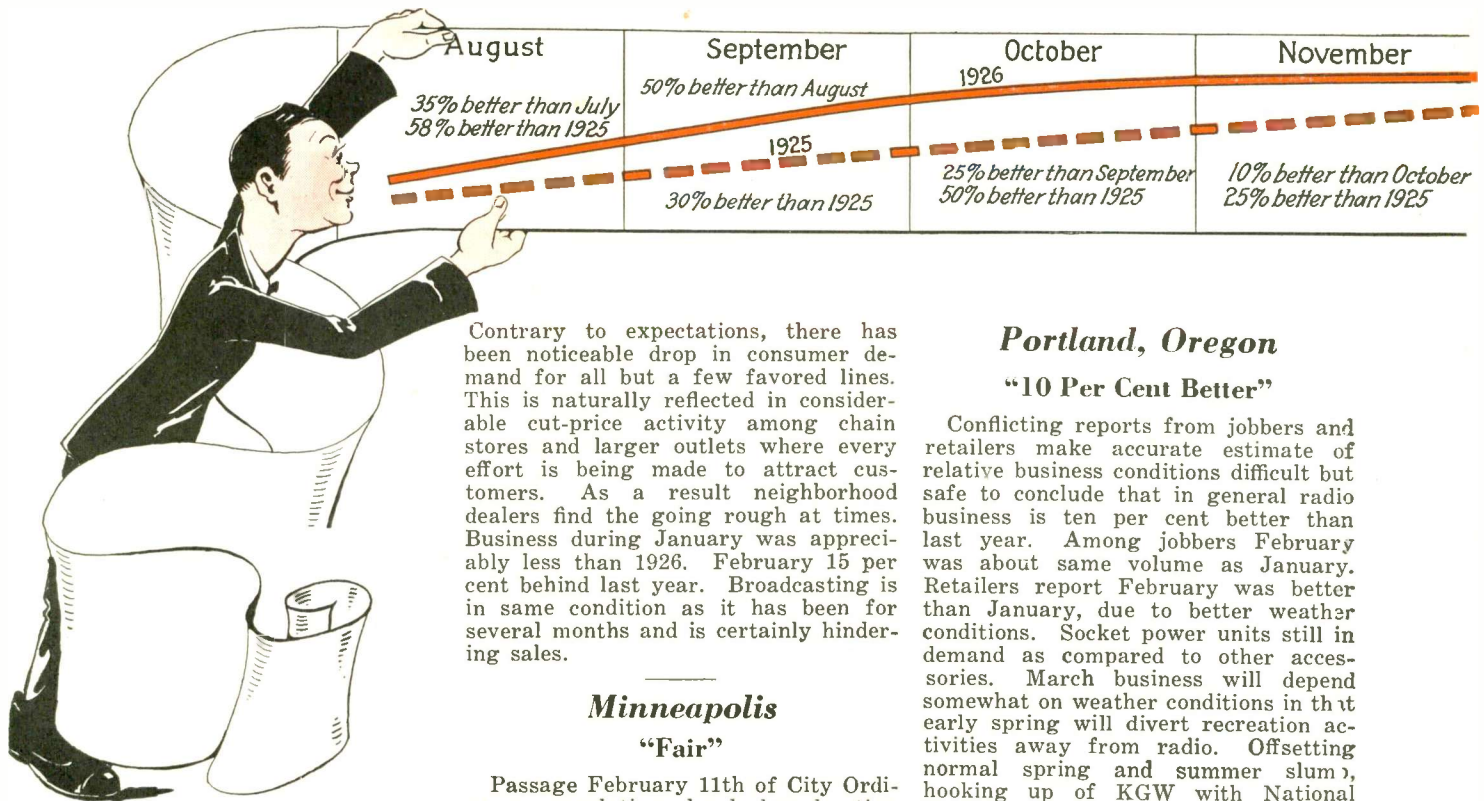

Los Angeles "Good"

February sales southern California showed fifteen per cent increase over January following comparatively quiet post-holiday season. Compared with February, 1926, sales were ten per cent greater. Jobber sales retarded due to slight retail overstock resulting from overbuying for anticipated Christmas rush that didn't fully materialize. Dealers report public holding back pending legal developments. Cluttered up ether renders all but most selective sets unsaleable. Power units moving rapidly with sales settling down to a few tried and true lines. Battery sales also holding up surprisingly well. More speakers than sets being sold indicating present set owners demand better tone quality. Alert dealers are following up speaker sales to sell new sets. Replacements of both sets and accessories constitute large part of business. Retailers find that more intelligent selling of better merchandise is necessary to meet demand of discriminating public.

New York "Behind Last Year"

Console sets with built-in speakers finding ready market New York City and vicinity. Manufacturers who brought out good models early this year are finding business satisfactory although considered as whole trade conditions not as healthy as expected.

Contrary to expectations, there has been noticeable drop in consumer demand for all but a few favored lines. This is naturally reflected in considerable cut-price activity among chain stores and larger outlets where every effort is being made to attract customers. As a result neighborhood dealers find the going rough at times. Business during January was appreciably less than 1926. February 15 per cent behind last year. Broadcasting is in same condition as it has been for several months and is certainly hindering sales.

Minneapolis "Fair"

Passage February 11th of City Ordinance regulating local broadcasting stations has helped trade here. Interference conditions between local stations hurting dealer sales. Listeners' League and Trade Association favored bill which restricts evening programs to twelve hours a week, no two conflicting stations to broadcast simultaneously. Blooper sets prohibited. City Attorney claims law constitutional under public nuisance act. Business has been fair with demand now better than last February. Season so far has not fallen below reasonable expectations. Accessories and also parts demand has been excellent.

Pittsburgh "Poor"

Radio business not as healthy as might be due to muddled condition in broadcasting. Radio fan at large complaining continually of poor reception and it is not unlikely this trend is having effect on purchases by new fans. Radio set-building contest inaugurated by Radio Council of Pittsburgh Chamber of Commerce is to some extent stimulating sale of parts and kits but not as much as expected. Substantial interest in building of home-made equipment is indicated but as yet effect of this interest has not been evidenced. Sale of sets has been confined largely to bargain sales of department stores at reduced prices but even here demand of former years is not in evidence. General attitude of fan is for equipment that will defeat present broadcasting conditions. With passage of radio legislation there should be regain in strength.

Portland, Oregon "10 Per Cent Better"

Conflicting reports from jobbers and retailers make accurate estimate of relative business conditions difficult but safe to conclude that in general radio business is ten per cent better than last year. Among jobbers February was about same volume as January. Retailers report February was better than January, due to better weather conditions. Socket power units still in demand as compared to other accessories. March business will depend somewhat on weather conditions in that early spring will divert recreation activities away from radio. Offsetting normal spring and summer slump, hooking up of KGW with National Broadcasting chain expected to have favorable effect on business. Federal regulatory legislation will improve conditions.

Chicago

"Holding Up Well"

Demand for sets holding up well in Chicago territory. Dealers notice growing interest in intelligent discussion of radio programs and set operation. Advertising of parts kits meeting with response. Dealers already discussing June Trade Show and look upon it as big step towards stabilization and advancement of season. Very little radical dumping compared with last year. Outlook is for steady demand for sets and accessories for next two months with good sale of quality accessories during summer.

San Antonio "Quiet"

Radio sales here quiet due to warm weather, although up to last year's volume with some dealers reporting slight increase. Outlook for spring and summer business uncertain. Radio Trades Association making plans for co-operative advertising campaign to continue through warm months educating people that radio is product for all seasons. Plans call for running advertisement each day announcing best programs. Fund will be raised by assessing each member of association. Some dealers planning addition of electrical lines and accessories to help out radio during summer.

Retailing's Market Barometer

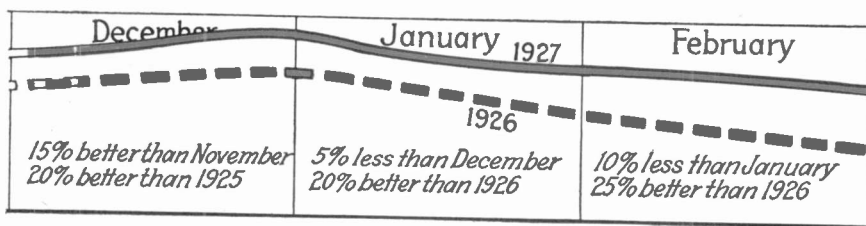

Toronto

"Good"

Earlier predictions of longer selling season being fulfilled in Toronto territory. Practically all radio men busy. Dealer buying largely on piece-meal basis but consumer demand remains active. Sales not up to exceptional January totals by 15 to 25 per cent but are ahead of last year. Some firms report increase of 25 per cent over last year's business. Everybody looks for this to be maintained during coming month and for general lengthening of season. Parts and accessories sales continue remarkably even, some firms reporting sales in these lines well up to pre-Christmas figures. Power units, chargers and general accessories in good demand. Some dumping by manufacturers but it appears there has been little over-production and no fears are felt. Observations of field show outlets are dividing broadly into price and quality types.

New Orleans

"\$4,000,000 Estimated Sales"

According to local distributors, \$3,661,934 worth radio merchandise at list prices was sold this territory last year. Their estimate for 1927 is \$3,767,500 at list prices. These figures do not include merchandise sold direct to the retailer nor storage battery sales. Total volume last year probably exceeded \$4,000,000. Nineteen twenty-seven estimate well in excess of \$4,000,000. Market here is stabilizing. Few new sets coming on market but socket power units doing very well. Retailers have not yet engaged in intensive radio selling here. Until trade is organized on more efficient basis manufacturers will have to continue paying for large part of selling cost. Unless such support is forthcoming, some of less experienced dealers will neglect radio for electrical lines during summer.

Detroit

"Sales Off"

Radio sales here off in January and off still more in February. All jobbers running behind same period last year 15 to 50 per cent. Slump attributed to considerable unemployment and chaos in air. Employment now on increase but not yet normal and work-

ers still cautious about spending. Stores featuring discontinued models and manufacturing overstock at cut prices also hurting regular trade. Cabinet models, unit-controlled and electrically operated, are favorites. Sales of accessories, particularly socket power units, have been good but now slow along with other radio business. Prospects for improvement fairly bright.

Boston

"Spotty"

Radio sales here spotty and uneven. Jobbers report falling off in trade last month though sales compare favorably with last year and three distributors of nationally known makes record average thirty per cent greater volume. Jobbers report slackening up in sales of sets due to unloading and dumping. Complaints widespread on this feature. Result, present market unsteady with some slashing and undercutting. Central stations report increasing sales charges and socket power units. Compared with last year opinion is that sets are in use one-third longer due to better programs, bringing greater demand for tubes, reconditioning batteries and turning in sets for new models.

St. Louis

"Bad Slump"

Majority of dealers and jobbers experienced bad slump first two weeks February. Condition now shows steady improvement, however, and with no further slump, month should show better business than February, 1926.

Philadelphia

"Conditions Satisfactory"

Although retail sales complete sets somewhat decreased, service on sets purchased through large department store sales is of great volume. Considering season, greater volume of business being transacted than last year. Good possibilities of season continuing through summer months with more stability than ever before due to improvements in sets and better broadcasting. It appears that situation concerning government control of broadcasting has little detrimental effect upon listening public. One large jobber reports shipping department still operating night shift. Cone speakers and power supply units continue to lead sales. Jobbers and dealers well pleased with busi-



ness transacted so far this season and look forward to steady volume through coming months.

Denver

"Very Good"

Post-holiday radio business Denver territory has not felt as great depression as in 1926. While manufacturers' sales to wholesalers tapered off, digest of reports from both wholesale and retail merchants shows January drop was only half as much as corresponding drop year ago. Relation of February about same. Altogether business about fifty per cent better than 1926 due to generally improved business conditions here. Evident that uncertainty of national radio legislation being felt keenly and it is opinion of trade that if legislation had gone through, February would have nearly equalled November. Continuation of business through spring months depends upon passage of national protective law.

San Francisco

"Improving"

Radio business San Francisco holding up well with February showing improvement over January and considerably better than last year. Outlook for next month bright. Socket power units and one dial sets most called for items. Suggestions made for improving conditions include careful study of service which should pay a profit, and merchandising of broadcast programs.

(Please turn to next page)

Saving the Service Man's Time

(From Page 55)

current curves as drawn from a tube tester on the bench, since here there is a load in both the plate and grid circuit. In general they are flatter. If any other characteristics of tubes are desired, they can be obtained by following the procedure outlined in any text book dealing with tube characteristics.

The first audio frequency tube will usually draw from 1 to 3 milliamperes if either 201A or 199 type tubes are used. The power tubes draw somewhat more current than this. If the set is receiving a signal, the needle of the milliammeter should remain very nearly stationary.

TUBES used in the second audio stage usually draw more current than those used in the first audio frequency stage. If the milliammeter needle moves up or down from its normal position, adjust "B" and "C" battery voltages in the same manner as for the first audio frequency tube.

In order to calibrate the wavemeter, tune the receiver to some station whose wavelength is known. Then turn on the buzzer and rotate the dial until the sound of the buzzer is

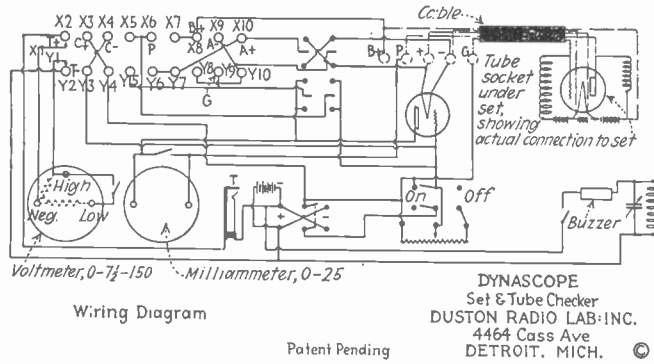

The entire circuit is readily traced on the above schematic wiring diagram. A high resistance voltmeter should be used so socket power supply device voltages can be measured.

loud and clear in the speaker. The wavelength to which the wavemeter is tuned is the same as the wavelength to which the set is tuned. Several points can be obtained in this way and the curve plotted on cross-section paper by using dial settings for the vertical spaces and wavelengths for the horizontal spaces. Draw a smooth curve through these points. This curve can be used to set the wavemeter to any wavelength.

To use the wavemeter close the buzzer switch and adjust the buzzer. Then rotate the dial until the buzzer is heard in the loudspeaker, when the set is tuned to resonance to some wavelength between 200 and 600 meters. If the set is working properly a loud, clear note should be heard in the loudspeaker when the tester is within a few feet of the set.

the terminals.

Barometer of the Market

(From Page 57)

Cleveland

"Outlook Encouraging"

Radio business Cleveland territory running practically same as last month and definitely ahead same month last year. Department store unloading sales having bad effect but not serious enough to worry most dealers. Prospects for coming month considered very satisfactory. Some of lower priced lines having more difficulty due to conflicting stations. Distributors of high priced lines report demand increasing as compared to other lines. Two distributors report increased sales parts and kits. General industrial conditions somewhat improved resulting in more buying power. With coming of spring navigation on lakes will start again and this usually reacts favorably on all retail trade here. Relayed programs from New York play important part in creating demand for good receivers, dealers report. General outlook considered encouraging.

Atlanta

"Unsatisfactory"

Sales unsatisfactory with all distributors called on. This condition reverses indications early December. Lack of activity unaccountable except general market conditions. There do not appear to be overstocks as existed at same time last season but cautious buying is prevalent generally. Sales approximately twenty per cent under last year. Trade expresses belief 1927 volume will be more evenly scattered throughout entire season and that summer business will balance off slump that occurred in January and February. Interest continues in elimination of batteries. Some attention given to entirely a.c. operated sets. Recent tie-in of four Southern broadcasting stations on chain programs will have much to do towards supporting sales throughout summer months. Dealers making preparations to retain radio interest during warm weather.

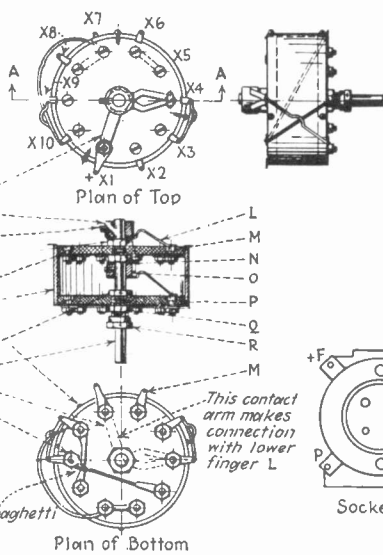

LIST OF MATERIAL			
LETTER	QUANTITY	MATERIAL	DESCRIPTION
A	2	Brass	Connection
B	2	"	Contact arm bushing
C	2	M.S.	" " locking screw
D		Brass	"
E	20	"	Contact points
F	1	Fiber	Casing
G	6	Brass	Securing screws
H	1	"	Shaft bushing
I	1	Bakelite rod	Shaft
J		brass	Contact connection
K	20	"	Nuts for contact points
L	2	"	Contact arms
M	20	"	Soldering lugs
N	1	Rubber	Insulating washer
O		brass	Contact arm bushing
P	2	Fiber	Top and bottom covers
Q	2	Brass	lock nuts
R	1	"	Panel bushing nut

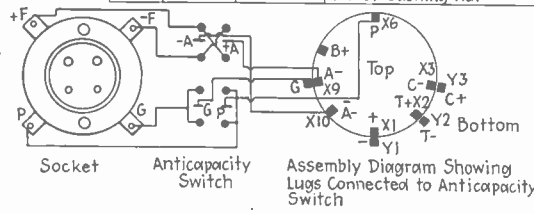

DYNASCOPE
Set & Tube Checker
DUSTON RADIO LAB. INC.
4464 Cass Ave.
DETROIT, MICH. ©

Patent Pending

The inductance switch we show in detail for those who may desire to construct their own. While this should not be difficult, extreme accuracy and care will have to be exercised.

This Spring—

*C*heck Up Every Set in Town

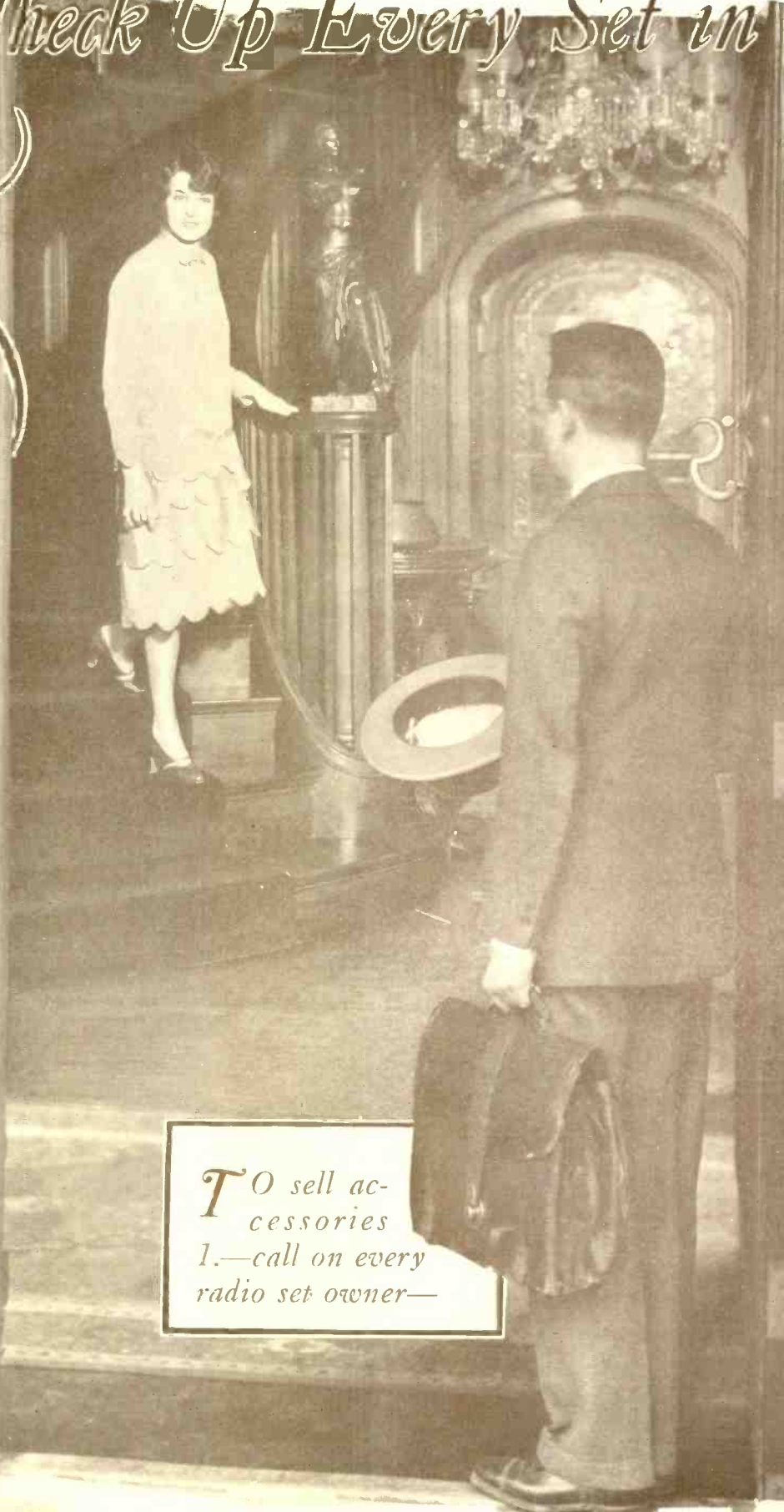

*To sell accessories
1.—call on every
radio set owner—*

*Follow this service man to the next page and
watch him sell \$100 worth of radio in 2 hours*

Inspect Every Installation—and



2 Check over and test the set and installation. Then take this opportunity to show how these accessories will improve reception—



3 New set of batteries—

4 New lightning arrester—



5 An A or B power unit, or amplifier, or a new cabinet or table for the set and supplies—

Use These Calls to Sell Accessories

6

New set of tubes and a power tube—

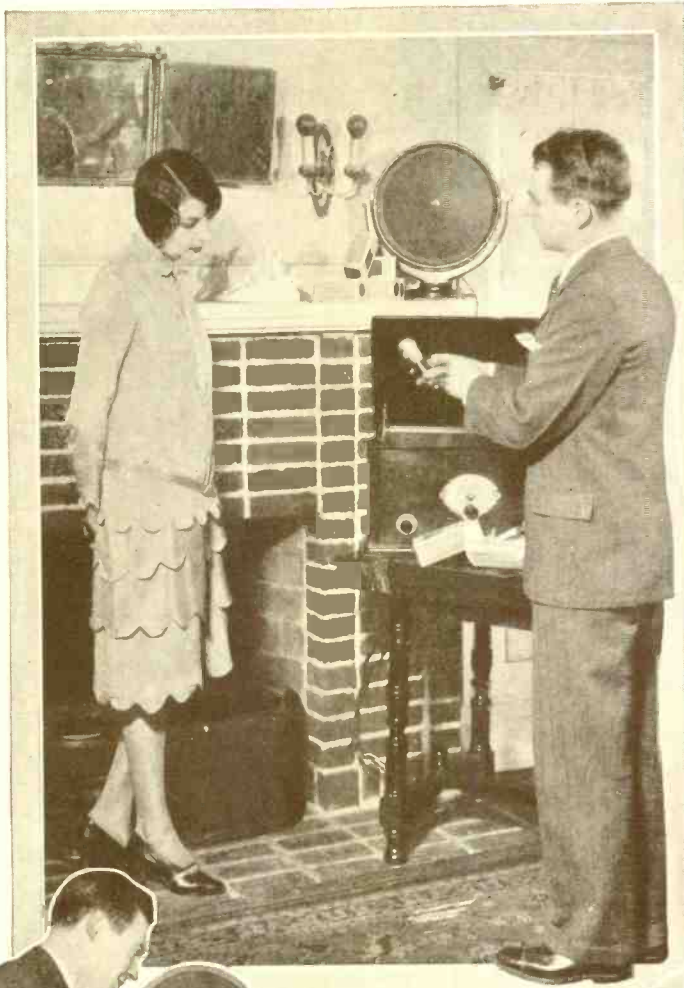

7 Battery charger—

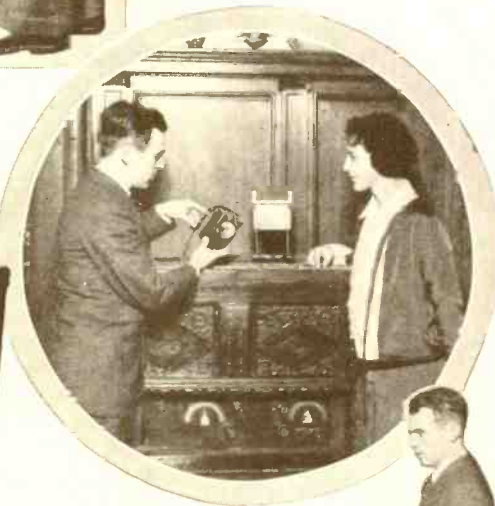

8 Time clock—



9 Volt-meter—

10 New type speaker, and many other similar radio products.

THE GREATEST STABIL THAT HAS COME



STABILIZING INFLUENCE TO RADIO

Radio Trade Show—Chicago June 13, 1927

When an epoch of development is crowded into a few short years, as has taken place in the Radio Industry, such an industry needs all the stabilizing factors it can get.

The Radio Trade Show, which opens June 13 in Chicago promises to be the greatest stabilizing influence Radio has ever enjoyed.

Every important manufacturer will exhibit his models for the year at this show, to be thrown open to the radio trade generally.

Jobbers and dealers may select their fall lines without having to wait until the last minute for possible new models.

Orders may be placed in time to avoid the 11th hour rush, when shipments are poor and factory inspection slack.

It will take some of the hump out of the manufacturing curve. The present enormous peak load which manufacturers carry two or three months of the year means gigantic overhead. Spreading the load out means less overhead—lower cost to YOU.

**RADIO MASTER
CORPORATION
BAY CITY, MICH.**

LOOK! EXTRA!!

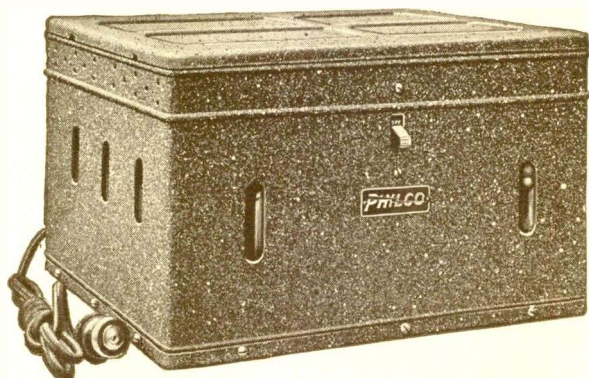

Here's Radio's The First All-Year-Round, Big-Selling and Big Profit- Making Radio Specialty

Talk About Sales! Read This

And this was in July!

A July campaign staged by Taylor Brothers, a small retail dealer in Philadelphia, sold \$3420 worth of Philco Socket Powers in what was supposedly the "dullest month" in the year! They spent \$50 in direct advertising and in seven days sold 38 Philco Socket Powers, then retailing at \$90!

\$70,000 Worth in 30 days

That's what the Philadelphia Electric Company did last March—1650 Philco Socket Powers in 30 days. And profits were \$26,000!

How's this for March?

Kaufman-Baer, Pittsburgh department store, put on a March campaign. Hundreds of Philco Socket Powers sold in 10 days! "Remarkable", said the store executives, accustomed to big-volume business.

\$40,000 Worth sold in Six Hours!

Evidence of sensational customer demand is strongly indicated in the success of a Detroit distributor who sold \$40,000 worth of Philco Socket Powers in 6 hours. And he ordered other carloads!

How Philco "ads" pull

1134 coupons from an advertisement in Philadelphia.

1803 prospects answered one advertisement in a Chicago newspaper.

2303 replies to a Philco advertisement in a New York newspaper.

753 coupons from an advertisement in a Boston newspaper.

... and hundreds more such instances, indicating public approval and consistent demand for Philco.

Here's the radio unit that killed the old belief about radio sales being "seasonal." You can sell Philco twelve months in the year! Spring and Summer as well as Fall and Winter! Philco has no "off season"!

Listen to this: We put on three retail test campaigns last March when everybody in the radio field was gloomy. What happened? The campaigns went over with a bang! Sales records everywhere were smashed.

1650 Units in Thirty Days

One retail outlet—the Philadelphia Electric Company—sold \$70,000 worth of Philco units in 30 days—1650 Philco Socket Powers! And in MARCH! Then, the retail price of Philco was one-third higher than it is now. That's only one instance. There are dozens more.

These sales kept right along during the Spring and Summer and these retail dealers—big and little—sold as many Philco Socket Powers and made as much money as during the previous so-called "peak months."

You can do the very same thing!

How? By tying up your store with the new Philco sales campaign that will sell Philco units as fast as you can deliver them. That's not theory, either. It's a fact. Hundreds of dealers have done it. So can you.

Millions of radio sets have been sold and *they'll be operated every hour, every night all-the-year-round.* Socket Power sales are going to be *tremendous* during the next six months. And remember this: Philco is the *only* Socket Power that furnishes *both* "A" and "B" power—the *only* one, enclosed in a *single* cabinet and operated from house current and controlled by the snap of one switch!

Philadelphia Storage

Ontario & C Streets, Dept. 5023
Manufacturers of the Famous Philco

Read This!!!

Best Seller!

~~PHILCO~~ Radio AB Socket Power

We Sell Your Customers for You

We're telling these set-owners in smashing, sensational magazine and newspaper advertisements the story of Philco prestige, Philco Quality and Philco Service. Full pages of this advertising are being run in the big national magazines. The big Sunday newspapers are carrying these tremendous, sales-producing Philco "ads." One hundred and thirty-four of the biggest newspapers throughout the country are repeating the Philco story—establishing in the mind of the set owner a determination to own a Philco AB Socket Power.

There will be no let-up in this advertising campaign. It will go through the Spring and Summer. It recognizes no "off season" and is working constantly for you.

Tell these prospects that *your store* handles the Philco AB Socket Power. Tell them about the exclusive Philco Free Installation feature and the Liberal Trade-in Allowance plan. And tell them they can buy Philco from you for a Small Down Payment. That's what they want to know now—*where* and *how* to get Philco!

And remember—there's *big profit* in Philco. It's sold to you on a liberal discount plan and it's backed by an established reputation and a campaign that will keep your sales force busy.

This FREE Sales Manual Tells You Exactly How

It's a mighty valuable book, chock-full of facts and all the details for a sensational, money-making Philco campaign. Thousands of dealers have already cashed in on it. *And you can do the same.*

First thing for you is to *get the book!* Nothing like it has ever been written. If you couldn't get another you wouldn't sell your copy at any price.

When you've read this wonderful book, get in touch with your Jobber and get on the band wagon. Use the advertising and display material we'll send you. Then tell your prospects that *your store* is ready to sell them the Philco they've been wanting.

Talk about sales! Your cash register will go on an "overtime" schedule. There's no obligation when you mail the coupon. But—do it today!

Battery Company

Philadelphia, Pennsylvania

Diamond Grid Batteries for Automobiles

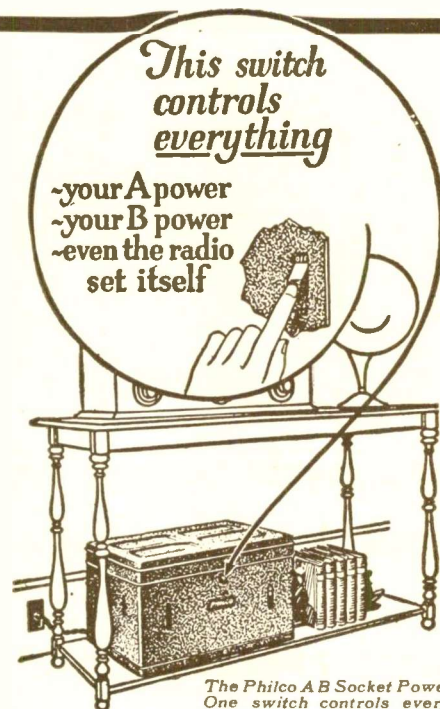

The Philco AB Socket Power. One switch controls everything — A power, B power, even the radio set itself!

A Sales Plan That Has Worked!

Every radio dealer should have the Philco Sales Manual. It tells how to plan sales that *will* move goods during the Spring and Summer. It gives you complete information about:

1. Trade-in allowance plan
2. Easy payment plan
3. Dealer collection plan
4. SPECIAL CAMPAIGNS
5. Direct mail advertising
6. Sales organization

You cannot afford to be without this book as the Spring and Summer months approach. Send for your copy TODAY. It's FREE. Use the coupon below.

SPECIAL COUPON

Philadelphia Storage Battery Co. Dept. No. 5023
Ontario & C Streets, Philadelphia

GENTLEMEN:

Please mail at once, without cost to me, the latest edition of your Radio Sales Manual. This request places me under no obligation.

Name.....

Street.....

City..... State.....

A Well Laid Out Store That Is *Goodlooking and Practical*

By careful planning the Dallas Radio Laboratories, Dallas, Texas, has succeeded in effecting an ideal store layout, that puts the customer at his ease and helps the salesman to close sales. The main display room is homelike and roomy. The floor is practically free, only a few consoles, easy chair and a divan are placed on it. Demonstrations are made in smaller separate room. A row of loudspeakers, equipped for quick switching, seen in lower picture, are always ready for use. The parts section is a gem of compactness. It is located under a small balcony on which the office is located.



Above: The main display room of the Dallas Radio Laboratories.



Below: Entrance to the demonstrating room. Loudspeakers ready for use with sets to be tried may be seen on the shelf.

Left: The parts section. Note how accessible all the items are.

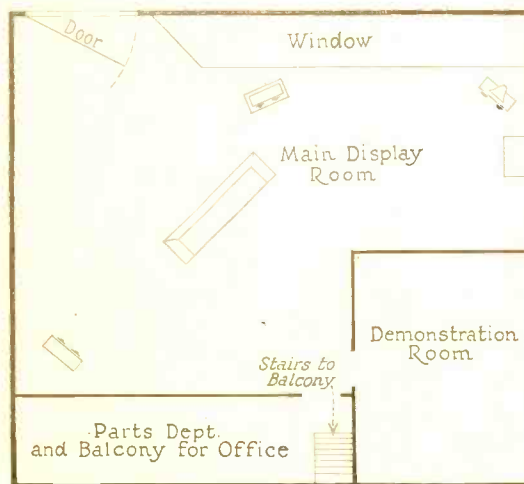

Above: The store floor plan of the Dallas Radio Laboratories. The parts section and demonstration room are at the rear of the store.

Small Sets Are Profit-Makers

Chicago dealer finds installations of \$100 and under pay big returns—Lead to sales of bigger sets and open wide field among poorer classes

IT PAYS to cater to the small-set buyer," says W. J. Leadinghouse, one of the owners of the S.L.S. Radio Store, 3412 North Clark Street, Chicago, Ill. Mr. Leadinghouse is emphatic about it. He has had a very satisfying experience with the small set as a business builder. He has expanded his entire radio sales volume by the proper use of the small-set "entering wedge."

The S.L.S. Radio Store is a comparatively small one. The firm started three years ago in the auto accessory business, but, entering radio, has been paying particular attention to the possibilities of the small set as a sales producer since November, 1924. The company's radio business has tripled in this length of time. This year it expects to do a gross of about \$25,000 in radio.

"Thirty-five per cent of my business, by volume, is in sets under \$100," he says, "and I find their aggregate profit well worth the time it takes to handle these popular-priced outfits. But over and above the increased total volume of business this line gives me, is the position in which it places me eventually to solicit higher price sales.

"I keep a careful record of the name and address of every purchaser. Thirty days after a small set has been sold I call on the owner and check up on the possibility of installing a bigger one. You see, we allow full credit for the first set—less tube and batteries—to apply towards the cabinet installation. You would be surprised how little depreciation there is on these smaller sets. We allow the full list price when we take them back unless they have been abused. Nine times out of ten the set looks like new and can be sold as such. Inasmuch as we sell one larger set in exchange for every third small set which we put out, we do quite an active business in both lines."

"When a prospect walks into my store, it doesn't take me long to find out what he wants, or rather, what he can afford to buy. If I see that it wouldn't be policy at the moment

for me to try and force the sale of a high priced set, I explain that really satisfying reception may be obtained from a two-tube with headphones or a four tube and a small speaker.

"Conditions in the Chicago district are particularly favorable for that kind of a talk. We have a dozen local stations, all with good programs and in great variety. Then, thanks to Silent Night, if the prospect is interested in DX, I tell him about Monday night—that our stations are off the air that evening. We all know, of course, that the modern two, three and four tube sets are great distance-getters if local conditions are clear, and I don't forget about the new power tubes, either. In my opinion, Silent Night and power tubes are putting this profitable sixty-to-ninety dollar business on the map."

Getting Prospects

Mr. Leadinghouse gets his prospects by the customary routes. He "uses the user" and hand-distributed circulars. This latter method he finds particularly productive. The

circular he has gotten up is quite simple. Nothing flashy about it. Just a few illustrations of popular priced sets, together with their specifications and list prices. To print and distribute five thousand of these costs him \$40. He hires boys to give them out.

"I know for a fact," he says, "that I sold at least seven sets of various sizes directly traceable to these little handbills. I am now at work on a new one. This time I will get out ten thousand."

This is a story of methods—not volume. Mr. Leadinghouse feels, however, that his system is absolutely right, because his business has shown such a rapid growth since he has been merchandising the "entire price range" line.

Regarding turnover he remarked, "Even during the busy season I find a thirty days' stock of small sets ample. This is because small sets are quickly obtainable from local jobbers or from the manufacturer's warehouse.

"Small sets require very little servicing," he concluded. "If the customer wants one of these sets installed, a charge of about \$5 is added. When the thirty day period has elapsed a service call is the pretext which leads to the bigger set conversation."



"Step In and We Will Tell You What \$60 Will Do," reads a sign in the window of the S. L. S. Radio Shop, Chicago, which has made a profitable specialty of small-set installations.

A High-Water Mark for Savings

THE following figures show the great increase in the amount of savings by the American people since 1914. In 1914 the annual life-insurance premiums were \$600,000,000; in 1925 they were \$1,750,000,000. In 1914 the new savings in savings banks decreased by \$200,000,000 under 1913. In 1925 the new savings during the year amounted to \$1,204,000,000. In 1914 the new savings in building-and-loan associations amounted to about \$30,000,000. In 1925 these new savings amounted to \$505,000,000. In 1914 the total accumulated savings of these three types totaled \$14,700,000,000. In 1924 these savings totaled \$38,660,000,000.

This extraordinary "savings surplus" of the American people shows the prodigious purchasing power that backs a popular interest in radio or any other product. The money is there!

* * *

Help Us Find

What It Should Cost to Retail Radio

THE editors of *Radio Retailing* have received repeated requests from retailers urging that a compilation be made, on a large scale, of the operating expenses and profits of successful retail stores. It has been brought to our attention that such an analysis would enable the radio retailer to determine just what costs might safely be, in proportion to gross sales, by permitting comparison with figures of successful merchants operating under similar conditions.

With its wide circulation, this publication is in a

position which makes the gathering of this basic data possible. We are taking it upon ourselves, therefore, with service to the industry firmly fixed in mind as a primary object, to obtain this data by mailing 5,000 data sheets to the most representative dealers in the country.

Will you contribute your share to the progress of the industry—help it make a tremendous stride toward more complete stabilization by filling out the blank when received, and returning it to us?

The identity of those firms which kindly assist us in this analysis will of course in no way be divulged, as the figures so obtained are to be used in a general sense only.

* * *

"Better Programs" a Reality

"BETTER PROGRAMS" is no longer merely a two-word phrase. The Chicago Civic Opera Company is planning to broadcast one complete opera a week throughout its next season. What a welcome change is this attitude from that of the Metropolitan Opera in New York which demands *double pay* before its artists may broadcast.

Broadcasting of concerts by symphony and philharmonic orchestras is already a common occurrence, notably New York, Boston and San Francisco. Such programs as these offer radio dealers the most ideal sales helps any trade could hope for.

The announcement by the National Electrical Manufacturers' Association that it will sponsor the "Nema Hour" through a nationwide chain on weekday afternoons also brings definite aid to dealers in providing them with a dependable daylight program which may be used as a demonstration period.

Summer and winter, eminent musicians give of their best talents for the radio audience. Thus, in a comparatively short time, operatic and orchestral music has been brought within easy reach of millions who, but for radio, would seldom have the opportunity of enjoying music of the highest type.

Practically speaking, there is no limit to the possibilities of radio in the vast field of musical art. Improvement in programs is bound to be constant and notable.

* * *

Broadcasting for Schools Opens New Merchandising Field

SCHOOLS throughout the country are looking with interest toward radio as a possible educational medium. From all districts come reports of radio equipment sold to high schools and grammar schools and many of the new buildings are provided with radio outlets in each room. The radio dealer who endeavors to extend this type of business, however, will find himself, in many sections, confronted with the difficulty that no broadcast programs of interest to schools are on the air during the school period.

Educational authorities would welcome this medium of conveying general information to their students at appropriate hours and much might be made of this

Toonerville Fights a Radio Duel



Fontaine Fox in The New York Sun.

This to Say—

**Radio
Retailing**
Vol. 5, No. 3

field, were such programs provided locally. What is needed are talks of an educational nature to be given at a convenient hour, preferably at 11 o'clock in the morning, or in the hour just before dismissal in the afternoon. Friday afternoons would be a suitable time for an entertainment program adapted to youthful listeners. It would be worth your while to look into the possibilities of the school market in your district.

* * *

The Value of a Fixed Sales and Service Policy

THE dealer who formulates a just and equitable sales and service policy and then gives this standard of good business practice wide publicity, will prosper in the radio game today. If he sticks to his colors he will succeed because the public likes to be led and he will be a leader.

In these days of semi-uncertainty in the merchandising of radio, the dealer who takes a firm position will stand out. The better class, the prosperous buyer, will be attracted to him. These people will recognize that back of this declaration of a specific sales and servicing policy there must be an individual of character and dependability.

* * *

A Fertile Field for Eliminator Exports

THERE is reason to suppose that light socket devices doing away with all radio batteries will meet with instantaneous approval in the large South American cities. Obviously such devices are of even greater interest to the radio receiver owners in the south than in the United States. Charging stations are few and far between. The humidity and excessive heat in cities situated in the lowlands are not conducive to long life of a battery, while in the mountainous regions abrupt temperature changes are especially detrimental to the life of dry cell batteries. Though electric generating plants in South American cities are small according to our standards, yet their equipment in most instances is modern, due to their recent installation. Almost without exception, alternating current of standard frequency is employed.

* * *

Radio Is Sound as Any Other Business

THERE'S nothing fundamentally wrong with radio. In spite of the continued failures and rumors of failures, big and little, there is no basic fault of the industry that can be blamed.

Rather the fault lies, in most cases, with a lack of appreciation of good merchandising practices on the part of radio executives.

The industry itself cannot be held accountable for the mistakes of individuals or individual companies. If a company does not, or cannot, adhere to good standards of practice in manufacturing, distributing, and merchandising, and finds itself in financial difficulties, the fault lies with itself alone and no odium can be attached to the "condition of the industry."

Radio Retailing, March, 1927

It Takes a Little Time to Learn a Bitter Lesson

AFTER four or five years of merchandising experience, a large part of the industry has not learned the bitter lessons that over-expansion and overproduction can teach.

Many, many radio manufacturers have built their factories and expanded their facilities to take care of the peak load on the assumption that the intense demand would last over a period of time. When the peak load got down to normalcy it left the manufacturer with the wheels running full speed ahead and no place to go. From plenty of merchandise and plenty of orders, he suddenly finds himself faced with plenty of merchandise but no orders. Then comes liquidation or bankruptcy. And often both.

The sensible system, other industries find, is to keep production going at a low, steady, year round level and store the summer surplus to take care of the fall demand.

The fall demand should be anticipated months ahead so that when the peak load comes, the manufacturer finds himself with enough merchandise to meet the demand without radically increasing his overhead.

Some Manufacturer Ought to Make This—

A Plug-in Condenser to Eliminate Interference

WITH the increasing interference created by all kinds of 110-volt electrical devices, especially with the new and sensitive radio sets, some simple and practical way of applying condensers across the supply wires of the offending appliances is needed. Obviously the simplest manner of connecting up a condenser to the 110-volt circuit is through a standard attachment plug and receptacle. The condenser could be connected to the plug by short wire leads, or could be built integrally with the plug.

Then to correct noises due to sparking commutators, thermostats, etc., it would be necessary only to plug in the condenser at the outlet feeding the appliance. And if a tap-plug were used on the condenser, the appliance feed could be taken directly out of the condenser plug.

As soon as the handiness and value of this device were understood, there would be a large demand for it as an accessory for the public to use to correct interference troubles.

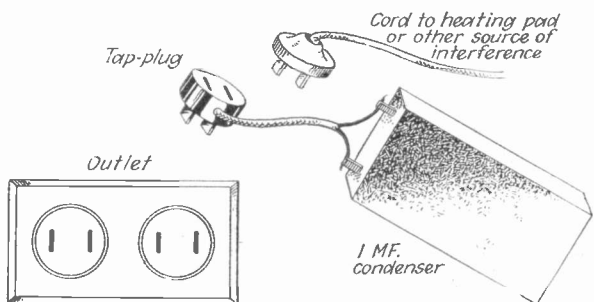



What's New in Radio and

This editorial section is prepared purely as a news service, to keep readers of "Radio Retailing" informed of new products.

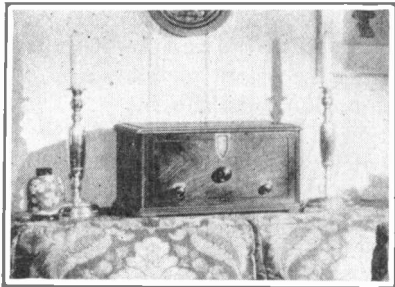

Five-Tube Table Type Receiver

Radio Retailing, March, 1927

The "Royal Cruiser" is the newest addition to the line of radio receivers made by the American Bosch Magneto Corporation, Springfield, Mass. This model is encased in a solid walnut cabinet has five tubes and the unified control which provides single dial simplicity of operation with two dial advantages. The intended retail price is \$110.

Oval Shaped Cone Reproducer

Radio Retailing, March, 1927

The Timmons Radio Products Corporation, Germantown, Philadelphia, is making a "Concert Grand" oval-shaped reproducer. Due to its design, it is said to give excellent reproduction over the entire musical scale. Another feature is that it is interchangeable from the pedestal type to the wall type. This change may be made in a few minutes without any additional equipment. It is decorated in such a manner that it becomes at once part of the drawing room. The intended retail price is \$56.

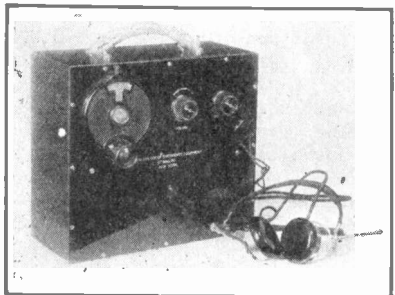

Radio Interference Finder

Radio Retailing, March, 1927

The illustrated portable trouble finder is being made by the Davis Emergency Equipment Company, Incorporated, 67 Wall Street, New York City. This outfit comprises a four-tube, TRF set, tuned by one dial and weighing only fifteen pounds complete with head phones. This makes a very light outfit to be carried by the trouble shooter. The loop and all batteries are inclosed in the case which measures 10 1/2 in. x 10 in. x 5 in. It also can be used as an ordinary receiving set having an approximate normal tuning range of from 275 meters to 925 meters, although it was not designed for this specific use. Here is a valuable instrument not only for radio dealers but for power companies as the smallest leak, which may develop into serious trouble can be easily located by this device which has an intended retail price of \$100 complete.

Two-Dial One-Tube Receiver

Radio Retailing, March, 1927

The Standard Radio Corporation, Worcester, Mass., is making what is known as the "Standardyne Multivalve" receiver which is equipped with the Emerson multivalve tube. The construction of this tube consists of one filament, three grids and three plates. The circuit of the receiver incorporates one stage of tuned radio frequency, detector and two stages of audio frequency. It is very compact, the panel being 7 in. x 10 in. Although the tube draws one-quarter ampere at five volts, it may be operated from dry cells. The intended retail price of set and tube, \$31.50.

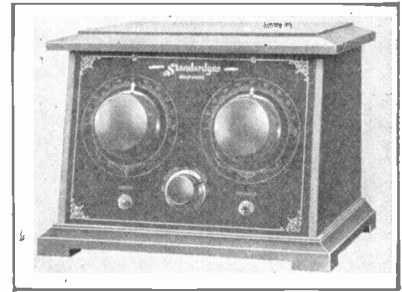

Six-Tube One-Dial Receiver

Radio Retailing, March, 1927

A one dial, six-tube receiver is the latest product of the Chelsea Radio Company, 179 Spruce Street, Chelsea, Mass. It is housed in a handsome two-tone mahogany finished cabinet with attractive plaque and illuminated window indicator in place of dials. This receiver includes an entirely new design of chassis, completely shielded. The tone quality, according to the manufacturer, is excellent, and the receiver has an intended retail price of \$65.

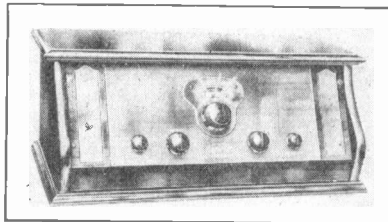

Five-Tube Two-Dial Control Receiver

Radio Retailing, March, 1927

The Modernola Company, Inc., Johnstown, Pa., makers of "Delano" Radio Sets, announce five new models. Three Highboy Models, the B1, B2, (illustrated) and B3 and three Sheraton Models, A1, A2 and Junior, make up the 1927 line. All are five tube sets having two main tuning controls. The first three models are installed in cabinets of solid mahogany, finished in two-tone blended effect, with a compartment under the set for accessories. All Highboy Models are equipped with a built-in-Delano loudspeaker and have intended retail prices of \$99.50. The Delano Sheraton A1 is contained in a mahogany cabinet, equipped with a Delano loudspeaker, the doors of which completely enclose the radio outfit and the loudspeaker. Intended retail price \$75. The Sheraton A2 in a specially constructed cabinet can be had in either mahogany or walnut finish. The set in this cabinet is installed in a drawer and can be removed for inspection. Loudspeaker is not included with this set. Intended

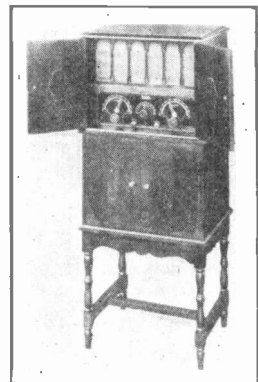

retail price \$50. The Sheraton Junior is enclosed in a cabinet of either mahogany or walnut and has an intended retail price of \$40.

Converts Phonograph Into Electrical Reproducer

Radio Retailing, March, 1927

The Crosley Radio Corp., Cincinnati, O., announces a new device which will convert any phonograph into an electric reproducer. This product is known as the "Merola." It is a substitute tone arm that replaces the diaphragm of the phonograph and is connected by a cord to the detector socket of a radio receiving set. In this way the music from phonograph record is reproduced with increased volume and without needle scratch through the radio loudspeaker. In order to install the Merola it is necessary merely to insert the plug on the end of the cord into the detector socket of the set and to place the Merola unit in position on the phonograph. Intended retail price, \$15.

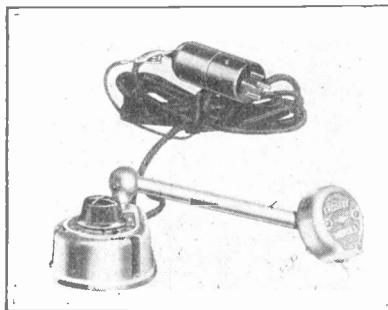

Where to Buy It

For Additional Information
on New Parts See Page 89

All announcements appearing on these pages are published without advertising considerations of any kind whatsoever.

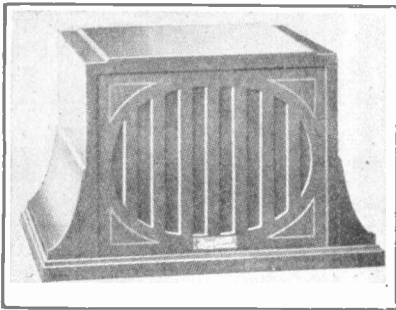

Cabinet Type Air Column Reproducer

Radio Retailing, March, 1927

The Armstrong Company, 1501 E. 55th St., Chicago, Ill., is making a specially designed air column reproducer said to be copied from the human mouth. Overall dimensions are 10 in. high, and 9 1/2 in. deep. It is made of selected walnut and has a hand rubbed lacquer finish. Intended retail price, \$35.

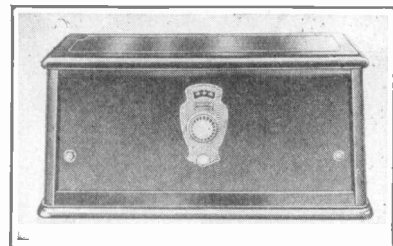

Six-Tube One Control Receiver

Radio Retailing, March, 1927

The Charles Freshman Co., Inc., 240 W. 40th St., New York City, has introduced a new six-tube, one control receiver. The panel is of metal finished in brown to harmonize with the cabinet. In the center of the panel is the dial, and beneath the dial is the combination switch and rheostat for volume control. Price range in console models is from \$75 to \$109.50.

Reproducer Unit Utilizing Piano Sound Board

Radio Retailing, March, 1927

The "Rotofor" radio piano speaker manufactured by the International Radio Corp., 145 Pacific Electric Bldg., Los Angeles, Cal., is equipped with a clamp by means of which the unit is fastened to the back of the piano, utilizing the sound board for reproduction in the same manner that a paper cone is used. The unit is easily attached and adjusted. Various parts of the sounding board will have to be tried out until the proper position is found for the unit. Intended retail price, \$25.

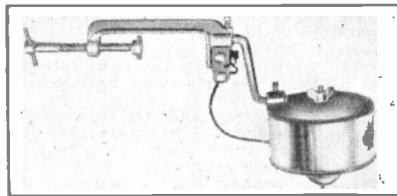

Electrolytic Filter Unit

Radio Retailing, March, 1927

The Abox Company, 215 N. Michigan Ave., Chicago, is making a filter unit which incorporates the Andrews Electrolytic Condenser. Two of these condensers are employed in the filter unit. The condenser consists of a series of plates immersed in an alkaline solution. When the plates are energized a film of hydrogen gathers upon their surfaces, which acts as the dielectric. Due to this large capacity the filter unit has been designed to be placed between an ordinary bulb type charger and the radio set, thus furnishing A battery current without the intermediate of a storage battery. This filter will handle up to 5 amp. and has an intended retail price of \$19.50.

Five-Tube Unified Control Receiver

Radio Retailing, March, 1927

The American Bosch Magneto Company, Springfield, Mass., has added to its line the "Imperial Cruiser" which is a cabinet type receiver. Simplicity of design is demonstrated in its colonial style which has two full length doors opening to the radio controls at arm chair height. A removable panel gives access to all batteries and power units. The cabinet is walnut throughout of matched grain and artistically high-lighted. Complete with the Library Arbotone reproducer, the intended retail price is \$147.50.

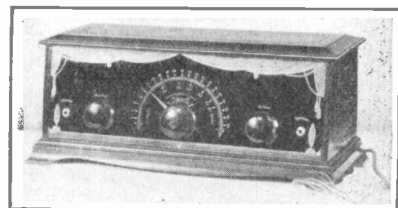

Four-Tube One-Dial Control Receiver

Radio Retailing, March, 1927

The illustrated receiver is being made by the Radio Products Corporation, Inc., 3816 N. 28th Street, Birmingham, Alabama. This is known as Model A-1021X. It is wired so that connections are brought out in a single cable suitable for using special purpose power tubes in all sockets. This receiver will work on a short antenna with extreme selectivity. With the circuit used four tubes are all that are necessary in order to please the most particular DX hound. All parts are protected beneath a sub-panel leaving only the tube tops visible. The cabinet is of two-tone walnut, hand-rubbed, piano finished. Straight-line frequency condensers are used. The filament circuit is controlled by the means of an extra set of contacts on the jacks and these jacks are so arranged that the loudspeaker may be operated at the same time that the phones are plugged in. The intended retail price is \$80.

Lamp Giving Proper Voltage for Receiver from Farm Lighting Batteries

Radio Retailing, March, 1927

The Jacob Radio Electric Shop, Morton, Ill., is making a lamp combination to be used in connection with farm lighting batteries for supplying current to the radio receiver. This is made in various combinations for both 32 volt and 110 volt systems. The proper voltages are given by the insertion of various size lights in the lamp. In some cases connections are provided for 6 volt trickle charging and in other cases (110 volt system) all batteries at the receiving set are eliminated. Another combination by means of which storage B batteries may be charged from 32 volt lighting plant is made. The intended retail prices of these lamp combinations run from \$10 to \$67.

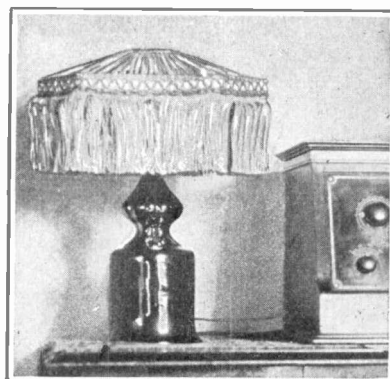

What's New in Radio and Where to Buy It—

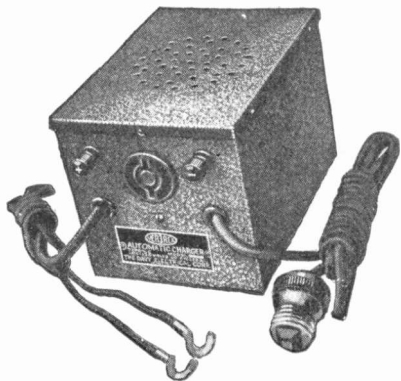

Automatic A Battery Charger

Radio Retailing, March, 1927

The "Vertrex" automatic charger is being made by the Davey Electrical Corporation, 505 Court St., Brooklyn, N. Y. This charger is absolutely dry and functions without heat or hum, according to the manufacturer. Its circuit is so arranged that if a B socket power unit is used in conjunction with the charger the operation of switching the radio receiver on and off will respectively bring the unit into operation or disconnect it from the receiver automatically. When the radio receiver is not in operation the storage battery is automatically kept fully charged. The charging rate is slightly above half an ampere and rises to almost one ampere if the storage battery is exceedingly low. It is designed to charge any 6-volt radio storage battery, and operates from 110-volt, 60-cycle current. Over-all dimensions 4½ in. x 7 in. x 5 in. Intended retail price \$17.50.

Six-Tube Console Receiver

Radio Retailing, March, 1927

The Buckingham Radio Corporation, 25 E. Austin Ave., Chicago, is manufacturing a model "P 500" console of American walnut. An attractive grill covers the speaker opening of a built-in Utah unit with a scientifically designed horn chamber. This is a six-tube, two-dial control receiver incorporating three stages of tuned radio frequency in shielded units, having one detector and two stages of transformer coupled audio. It is also equipped with nationally advertised parts. The height is 36 in., length 31 in., depth 13 in., weight 84 pounds. Intended retail price \$77.50.

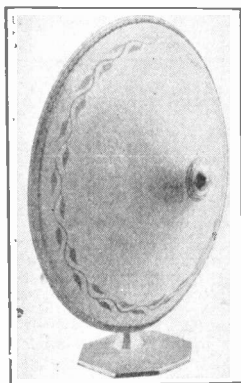

Cone Loud Speaker

Radio Retailing, March, 1927

The Radio Lamp Company, 254 W. 34th St., New York City, is marketing the Wheelan "Super-Tone" reproducer. This reproducer has a height of 18 in. and a width of 16½ in. The base is finished in bronze while the cone itself is finished in gold. The shipping weight is 11 lb. Intended retail price, \$10.

Power Unit For A Battery Supply

Radio Retailing, March, 1927

A combination storage battery and trickle charger is being made by the Radio-Rubr Storage Battery Corporation, 2012 Locust Boulevard, St. Louis, Mo. It is put up in a non-leakable rubber box with a convenient on and off switch located in the side. This unit is recommended for all sets using up to eight tubes. The 6-volt unit for 110 volts, 50 to 60 cycle operation has an intended retail price of \$27. The same unit, designed for 25, 30 or 40 cycle operation, retails at \$30. The 4-volt unit designed for 110 volts, 50 or 60 cycle operation, has an intended retail price of \$25. The same unit, designed for 25, 30 or 40 cycle operation, retails at \$28.

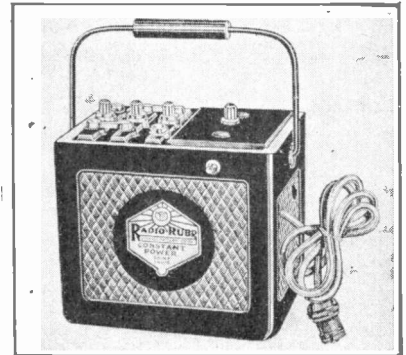

Combination Radio Lamp and Smoking Outfit

Radio Retailing, March, 1927

Perfect radio comfort is brought by the little Clown radio lamp and smoking set, made by the United Metal Art Manufacturing Company, 293 Wyckoff Avenue, Brooklyn, N. Y. The size of the outfit is 11 in. long by 5 in. wide. It is made of metal, hand-painted in four colors. The electric cigar lighter, which is a separate unit, resting on a round spring under the clown's feet, operates independently from the lamp, having its own switch. The swivel socket of the lamp enables the lamp to be turned upright for use on the table, at the bedside, etc. Included in the retail price of \$2.50 is the silk shield for the lamp, 3 ft. of silk cord for the lighter and 5 ft. of silk cord for the lamp.

A, B and C Battery Testing Meter

Radio Retailing, March, 1927

Burton-Rogers Co., Boston, Mass., is merchandising a new Hoyt switchboard-type voltmeter which is 5-in. in diameter. It is mounted vertically on a strong angle bracket, suitable for mounting on a wall or setting on top of a counter. The scale of the meter is large enough to be clearly read six or eight feet away. The B and C battery scale is marked in red at 22½ and 45 volts for easy reading and the scale reads from 0 to 50 volts. The A battery scale reads from 0 to 50 amperes. Two long rubber covered leads with prods clearly marked plus and minus are provided. The meter has a high-resistance moving coil, so the amount of current drawn is very slight. Intended retail price complete \$30.

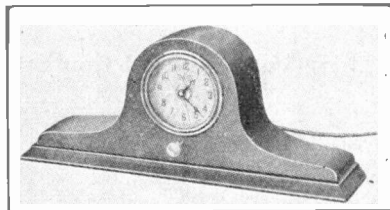

Radio Time Clock

Radio Retailing, March, 1927

The Time-Lite Clock Corporation, 182 Lafayette St., New York City, is making the illustrated time-clock for radio use. It is encased in a mahogany finish, wood mounting and will start or stop the radio set at any specific hour, or minute desired. It will also start, stop, and re-start the radio set. It is to be connected to the minus A lead and consumes no current.

Cabinet Cone Reproducer

Radio Retailing, March, 1927

Federal-Brandes, Incorporated, Woolworth Building, New York City, has made an addition to its line of speakers in a cabinet cone known as Model 1500. This has a double non-adjustable unit, using a choke and condenser for a filter system, and stands 13 in. high. The cone is elliptical and mounted in flexible rubber. The new unit, according to the manufacturer, is capable of great volume without trace of distortion or choking. Intended retail price \$30.

Six-Tube Receiver

Radio Retailing, March, 1927

F. A. D. Andrea, 1581 Jerome Avenue, New York City, announces a new Fada, six-tube radio unit. This consists of three stages of tuned radio frequency, detector and two stages of audio frequency amplification, with circuit arranged so that the last audio stage is adapted for a power tube. It is totally shielded. This unit has now been placed in the Davenport Table, Queen Anne Desk, Beethoven Grande and Console Model. Intended retail prices are respectively \$225, \$300, \$250 and \$275.

B Socket Power Supply Unit

Radio Retailing, March, 1927

A B socket power supply unit is being made by the Amrad Corporation, Medford Hillside, Mass., which incorporates the "Merston" condenser. Four voltage taps are arranged for 22, 45, 67, 90, 135 or 180 volts. The total capacity of the Merston condenser is 35 mfd. Once voltages are selected in this unit they remain constant due to the use of wire wound resistances. All parts are readily accessible and there are no variable adjustments. A steel black enameled finished case is used. The tube used is known as the Amrad S-1 tube and has an intended retail price of \$6. The intended retail price of the complete unit including the tube is \$35.

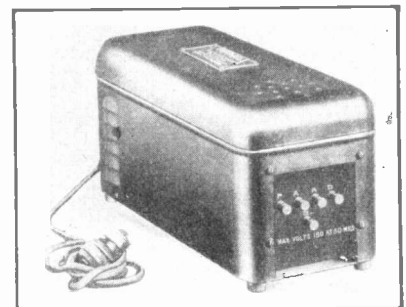

News of Latest Products Gathered by the Editors

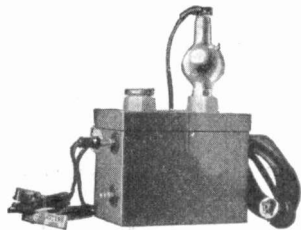

Trickle Charger

Radio Retailing, March, 1927

The Standard Transformer Company, Warren, O., is manufacturing a trickle charger having a maximum charging rate of 550 milliamp. for a 4-volt battery and 500 milliamp. for a 6-volt battery. It is designed for operation on 110 volt, 60 cycle current, has over-all dimensions of 2½ in. x 4 in. x 5 in. It may be used very conveniently with a storage battery for making up a power unit. Intended retail price complete with bulb, \$12.

Six-Tube Socket Power Receiver

Radio Retailing, March, 1927

A new six tube set operating direct from the light socket has been announced by The Crosley Radio Corp., Cincinnati, Ohio. This set, known as the "A-C-7," is supplied in the table cabinet at \$70 and a console with built-in speaker at \$85. The power supply unit which accompanies these sets and replaces A, B and C batteries lists at \$50. All the present Crosley models will continue to be manufactured, the new sets being merely additions to the line. With one exception the prices of older models will remain as before. That exception is the "R.F.L.90" a six tube set incorporating the R.F.L. circuit. This formerly listed for \$90 and now will sell for \$98.

Non-Adjustable Wave Trap or Station Selector

Radio Retailing, March, 1927

The "Centralab Station Selector" is the latest product to be made by the Central Radio Laboratories, 16 Keefe Ave., Milwaukee, Wis. This is a small compact non-adjustable device, designed to increase the selectivity of the average radio receiver within the range of from 220 to 325 meters. It is provided with a switch to cut it in or out of the circuit at will. The selector is connected permanently between the antenna and the receiving set, and although it will not separate stations sending on the same wave length nor those so close that they heterodyne, it does give a marked improvement in the selectivity of the receiver. Intended retail price, \$1.

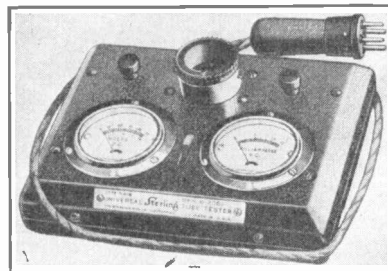

Universal Tube Tester

Radio Retailing, March, 1927

The illustrated "Servicer and Universal Tube Tester" No. R 408, is made by the Sterling Mfg. Co., 2831 Prospect Ave., Cleveland, O. A socket plug and suitable adapters are furnished so that all tests can be made directly in the tube sockets of the receiver without disconnecting any wires. It is equipped with a combination voltmeter, 0-150 volt scale for plate voltage, and 0-6 volt scale for filament. It also determines the amplification value of any tube, including the 120 or 171 power tubes at any B battery voltage. It shows whether a tube needs filament reactivation or not. Will test for open between grid and filament and locate the defect. It tests A and B battery voltages in the circuit. Many other uses may also be found for this instrument. It measures 7 in. long, 5½ in. wide and 2 in. high. Finished in dark green frostline, with nickel trimmings. The equipment consists of a 28-in. flexible cord with plug and suitable adapters for all sockets. Intended retail price, \$22.

A and B Socket Power Supply Unit

Radio Retailing, March, 1927

The Acme Electric and Manufacturing Company, 1444 Hamilton Avenue, Cleveland, O. is now making the "AB" socket power supply unit. This consists of a 6-volt storage battery, B power supply unit, two-rate trickle charger, and automatic control switch, all mounted in a steel case. All that is necessary for the radio fan to do is to connect the unit to some convenient base board receptacle and when the radio receiver is turned on the automatic switch within the unit will disconnect the charger from charging the storage battery and connect the B power supply unit to the radio receiving set. When it is desired to discontinue radio reception the switch on the receiver is turned off and the automatic switch will disconnect the B power supply unit from the receiver and connect the charger to the storage battery. The intended retail price is \$67.50 complete.

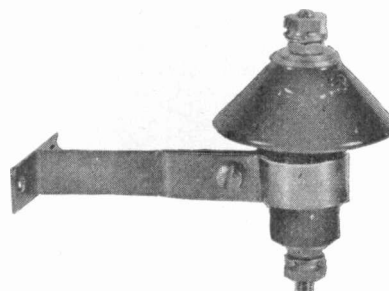
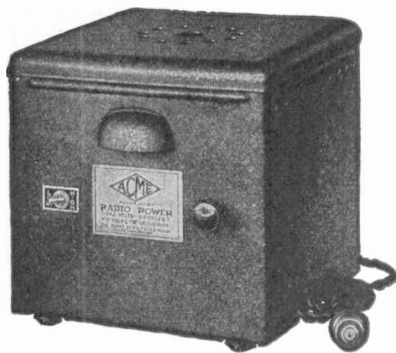

Lightning Arrester

Radio Retailing, March, 1927

The "Defender" lightning arrester is the latest addition to the line of M. M. Fleron & Son, Inc., 113 N. Broad St., Trenton, N. J. The body of this arrester is made of high-tension black porcelain and all the metal parts are of extra-heavy brass. The arrester is of the mineral gap type, which is said to assure operation without loss of radio current. Built to underwriters' specifications, with mounting screws furnished with each arrester. The intended retail price is \$1.50.

Radio Control Relay

Radio Retailing, March, 1927

The "Ruben" Relay is being made by the Electron Relay Company, 83 Fourth Avenue, New York City. Similar to an ordinary vacuum tube, this relay employs the effect of the bombardment of the electron stream from the filament upon the plate by its movement under the influence of the bombardment, to which it is sensitive and responsive. The grid serves to vary the intensity of the bombardment of the electron stream from the filament, thereby controlling the movement of the sensitive plate. The plate or anode element controls a local circuit by means of contacts, one of which is mounted upon it or moved by it, thereby making or breaking the local circuit. If this relay is placed in the usual tube socket in a standard set as in the radio frequency amplifier stage, with the necessary contact circuit attachment, it will operate any call signal, such as a bell, or lamp, at a predetermined wavelength. The contact capacity is one amp. and 110 volts. One use of this relay for broadcasting purposes is that it may be incorporated in a circuit in the receiving set and once

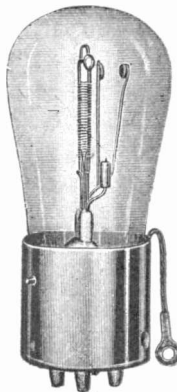

a receiver is tuned to a certain wave length or station, whenever that station is in operation a receiving set will also be automatically put in operation. This is but one of the many uses that can be found for this tube.

Console Containing Two Loudspeaker Units and Horn

Radio Retailing, March, 1927

Production has been started by the Day-Fan Electric Company, Dayton, O., on a new loudspeaker known as "Twin-Tone." It has two horns that are so adjusted that one brings out the high notes, and the other brings out the low notes. This loudspeaker is very similar in design to the table base which this company has been supplying with the Daycraft 7, and therefore a receiver can be placed on top of it. In its lower compartment there is sufficient room for A, B and C batteries. Intended retail price, \$115.

What's New in Radio and Where to Buy It

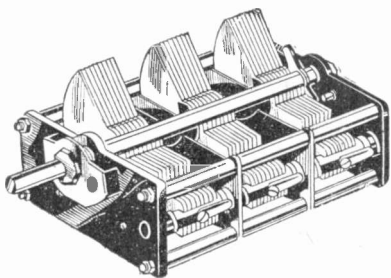

Three Gang Condenser with Compensating Verniers

Radio Retailing, March, 1927

The "Triplet," a three gang condenser manufactured by Amsco Products, Inc., 416 Broome Street, New York City, is equipped with three compensating capacity units with which circuit discrepancies may be adjusted to insure proper single dial control of multi-stage receivers. The tuning units are of the straight line wavelength type with insulated stator plates. The condenser is finished in lacquered brass and is provided with mounting brackets which permit it to be mounted parallel to the set panel, facilitating the use of "drum" tuning dials. The condenser may also be mounted at right angles to the panel, using a single hole mounting for this purpose. Made in maximum capacities from .00025 mfd., to .0005 mfd. Prices range from \$9 to \$11.25.

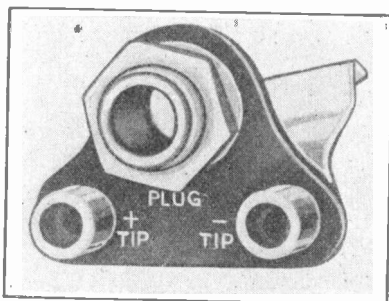

Combined Plug-tip Jack

Radio Retailing, March, 1927

By using a standard connection plug in conjunction with the illustrated "Duo-Jack," two loudspeakers or sets of phones may be connected in series or parallel. The unit is equipped with one standard phone jack and two tip jacks, and may be mounted on either a panel or a baseboard. Manufactured by the Wireless Radio Corporation, Varick Avenue and Harrison Place, Brooklyn, N. Y. Intended retail price, 25c.

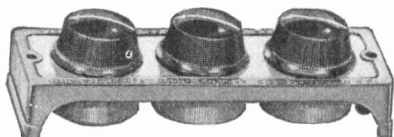

Rheostat Assembly

Radio Retailing, March, 1927

The assembly of rheostats shown in the illustration is manufactured by the George W. Walker Company, 6524 Carnegie Avenue, Cleveland, O., under the name, "Victoreen Audio Control Unit." It is designed to be placed inside the cabinet of a radio receiver to control the filament voltages of a detector and two audio amplifier stages. Type 3-R is assembled with three 30 ohm rheostats, suitable for use when detector and audio tubes are of the 201-A type. Type 3-R1 is equipped with a 10 ohm rheostat for use when a power tube is employed in the output stage.

Filament Rheostat

Radio Retailing, March, 1927

The Carter Radio Company, 300 South Racine Avenue, Chicago, manufactures the illustrated rheostat for baseboard mounting. The item is similar to the company's "Midget" resistances but is equipped with a short shaft and designed for adjustment with a screw driver in place of the customary knob. Use of a master rheostat to compensate for variations in battery voltage when

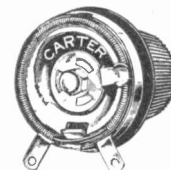

this resistance is employed is recommended. Available in sizes suitable for use with all standard tubes.

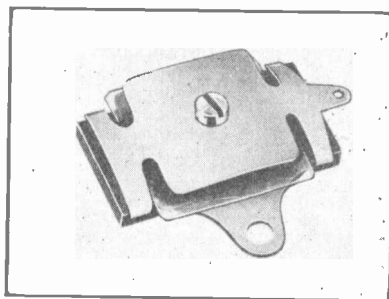

Variable Balancing Condenser With Mica Dielectric

Radio Retailing, March, 1927

The small balancing condenser, manufactured by the Hammarlund Manufacturing Company, Inc., 424 West 33rd Street, New York City, is variable from 2 mmfd. to 50 mmfd. It may be used either as a neutralizing condenser or a compensator in connection with gang tuning condensers and is easily mounted by means of small lugs. The base is of Bakelite, the adjustment screw and spring of phosphor bronze and the dielectric of mica, permitting the wide capacity variation. Intended retail price, 50c.

Wire Wound Rheostat With Single Hole Mounting

Radio Retailing, March, 1927

The Klosner Radio Corporation, 1022 East 178th Street, New York City, has released a line of rheostats which have as sales features single hole mounting, base of polished black bakelite, phosphor-bronze contact arm and a wire wound resistance unit which is said to maintain uniform resistance values regardless of temperature changes. The rheostats are obtainable in 6, 10, 20 and 30 ohm sizes and are intended to retail for 85c. complete with a bakelite dial or a knob of the pointer type; 350 ohm potentiometers of this same type, known as type A, are also obtainable. They are intended to retail for \$1.

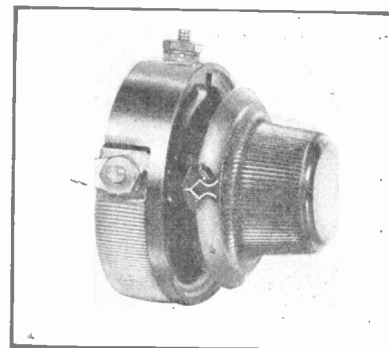

Spring Socket for UX or UV Tubes

Radio Retailing, March, 1927

The "Na-ald" silencer socket, manufactured by the Alden Manufacturing Company, Springfield, Mass., may be used with either UX or UV type tubes. The floating receptacle may be rotated or bent in any direction, insuring noiseless operation. Contact is made directly to the socket prongs by means of projecting lugs on the prongs themselves. Sub-panel mounting may be used, with connections projecting below the panel. The socket is known as No. 481 XS and is intended to retail for 50c.

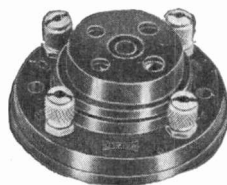

Variable Resistances

Radio Retailing, March, 1927

The Allen-Bradley Company, Milwaukee, Wisc., now manufactures a complete line of variable resistances for use as voltage regulators in B socket power units. Bradleyohm type E is made in the following ranges: E, 1 to 100 ohms; E-1, 100 to 5,000; E-5, 1,000 to 50,000; E-10, 10,000 to 500,000; and E-25, 25,000 to 1,500,000. Type E is intended to retail for \$2.25 and will dissipate 4 watts. Bradleyohm R is designed to pass 5 watts and is made in five ranges: R, 1 to 125 ohms; R-1, 100 to 7,500; R-5, 1,000 to 75,000; R-10, 10,000 to 750,000; and R-25, 25,000 to 2,000,000. The intended retail price of this type is \$2.75. Bradleyohm type X is the largest of the

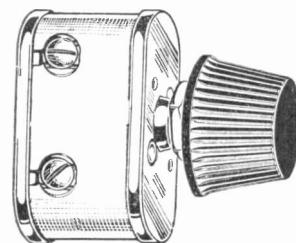

B power series, designed to dissipate 6 watts. Made in resistance from 1 to 2,500,000 ohms. Type X, 1 to 150 ohms; X-1, 100 to 10,000; X-5, 1,000 to 100,000; X-10, 10,000 to 1,000,000; and X-25, 100,000 to 2,500,000. Type X is intended to retail for \$3.25.

What the Trade is Talking About

To Hold International Radio Conference in October

The International Radio Conference, which was to have been held in Washington, D. C., early this spring, has been postponed until October. The Department of State, in a bulletin issued recently, states that it has been advised by the International Telegraph Bureau at Berne, Switzerland, that the book of proposals to have been considered at this conference cannot be completed for distribution to the various distant countries until late in February. It is expected that the conference will take place about October 1.

Window Display Week in May

The International Advertising Association urges retailers to compete in a national window display contest scheduled for the week of May 9. Management of the contest, the purpose of which is to stimulate interest in proper lighting and decorations, is to be under the direction of local advertising clubs. Co-operation of Boards of Trade, Chambers of Commerce and other merchant associations together with the Rotary, Kiwanis, Lions and similar organizations is suggested.

A complete hand book is being prepared for use of all local advertising clubs and full information may be obtained from the Association. Address Window Display Advertising Division, International Advertising Association, 383 Madison Avenue, New York City, for further information.

Business Bureau Censures Clumsy Broadcast Advertising

In a circular distributed to broadcast stations captioned, "The Goose That Lays the Golden Eggs," the National Better Business Bureau, Inc., 383 Madison Avenue, New York City, censures the clumsy efforts of advertisers who play up their products to the detriment of sponsored broadcast programs.

The release calls attention to the futility of combination "free lot and puzzle scheme" advertising via the ether to promote good will for a product. It continues:

"The clumsy broadcasting continuities of certain advertisers on the air, who have not learned the art and the manners of this means for building good will, may not only irritate radio listeners against those advertisers themselves, but provoke ill will toward all that broadcasting which produces revenue for the stations. This is, perhaps, much a matter of taste, but so is most effective advertising.

"Some recent programs have occasioned letters of protest to the National Better Business Bureau from broadcast listeners. Within the last week one New York station broadcast a period in which not only was the name of the advertiser repeated *ad nauseam*, but the advertisement was a combina-

tion of "free" lot and puzzle scheme. The highway of the air has a clean record. Broadcasting nuisances have been few. Radio has not served the blue sky promoter, the charlatan and fraud extensively as yet. This is perhaps one factor in its present effectiveness as a builder of public good will. Isn't it worth while to keep it that way?"

Here's the Saturation Picture For Your Own Town

Mary Sherman, president of the General Federation of Women's Clubs, quotes—in the *Woman's Home Companion*—the results of a survey to determine the saturation of home equipment in cities of various populations throughout the country. Every one of the 48 states figured in the survey. More than 8,000,000 American homes, representing over 32,000,000 people answered the questionnaire distributed by the Federation. The survey was completed in the fall of 1926.

Radio saturation, it is seen, is far less in towns of less than 1,000 inhabitants than in others. In towns of this size 18.7 per cent of the homes had radio sets while, in larger communities, those with populations between 1,000 and 2,500, this percentage is 19.9 per cent. In cities of 50,000 to 100,000 people, 26.6 per cent of the homes are radio equipped while this percentage drops to 26.1 per cent in cities over 100,000.

In the small towns, those with populations under 1,000, the state of California holds the record for maximum sales of radio in proportion to residents. In this state towns of this size have reached 33.8 per cent saturation. Vermont steps into the lead in cities

between 5,000 and 10,000, with a radio record of 50 per cent of homes sold, while in the 10,000 to 25,000 class Rhode Island towns have achieved a 75 per cent record.

New Jersey towns of populations between 2,500 and 5,000 have been sold radio sets up to 22.3 per cent of the total number of homes. In Iowa cities of the same size 26.7 per cent is the figure. California's sale seems uniformly high in cities of every size, for the figure is 36.6 per cent in cities between 5,000 and 10,000, while the state of Delaware lags behind with a total of 13.2 per cent in this population class. Indiana towns of between 10,000 and 25,000 are in the same boat with only 14.6 per cent saturation. Illinois towns of the less than 1,000 class, on the other hand, have reached 28.4 per cent sales.

134,486 Canadian Receivers Licensed

The Dominion of Canada has 134,486 licensed broadcast receiving stations within its boundaries, according to the annual report of the Radio Branch of the Department of Marine and Fisheries, issued for the fiscal year 1925-1926. During the fiscal year 1924-1925 the department issued 91,966 licenses of this kind. The increase this year thus represents 42,520 new receivers or 46 per cent more in use in the Dominion.

The report also states that on March 31, 1926, 55 commercial and 16 amateur broadcasting stations were in operation on wavelengths between 290 and 520 meters. Experimental amateur stations, operating on comparatively low wavelengths, totaled 482 at this time.

Corn Flakes Were Not on the Menu!



Chicago retailers are to be sold Kellogg receivers direct, according to H. C. Abbott of the Kellogg Switchboard & Supply Company, who outlined its sales plans for the season at a dinner, shown in the picture above, tendered to leading dealers of that city at the Hotel LaSalle. J. F.

Matteson of the company's advertising agency put over a forceful talk, bringing the remarkable possibilities for the sale of good radio merchandise to the attention of all retailers present with the aid of data compiled by *Radio Retailing* which may be seen in graphic form on the walls.

Electrifying the Old Phonograph

As the outcome of the developments lately made by the phonograph manufacturers in incorporating electrical amplifying systems and cone loud speakers for reproduction, a new device has recently made its appearance. It consists of three essential parts: first, a dummy base plug to be inserted in the detector tube of the radio set; second a resistance for controlling the volume; and third, an electrical pick-up which is to be connected to the tone arm of the phonograph.

The mechanical vibrations from the record are thus picked up through the usual needle converted into electrical energy, and passed through the audio frequency amplifying system of the radio set to be reproduced on the loud speaker. Thus, any old phonograph may be easily converted into an instrument giving the finest reproduction obtainable.

Those phonograph dealers who have combined radio with their business should find in this device a very profitable source of increased revenue. At this writing these devices cannot be found in stock in many phonograph or radio stores, but there is a market for them which should not be overlooked.

New Splitdorf Head

Walter Rautenstrauch, president of the Fred F. French Company, has been elected president of the Splitdorf-Bethlehem Electrical Company of Newark, N. J. Mr. Rautenstrauch succeeds M. W. Bartlett, who retired recently, and E. H. Schwab, chairman of the board, who served temporarily in this capacity. His retirement from the presidency of the company of engineers and builders was effective Jan. 1.

Fred W. Upton has been appointed vice-president in charge of engineering and inspection and George W. Lang vice-president in charge of manufacture. Both of the new officials have been associated with Splitdorf for a number of years, Mr. Lang being formerly factory superintendent of the company's Newark plant.

R.C.A. Reduces 201-A Tube Price

Effective February 1st the Radio Corporation of America reduced the list price of its 201-A tube to \$1.75 and that of type 213 to \$5. According to a release from the company, merchandise credits are being issued for tubes shipped to dealers during the month of January. The release also states that the Radiola "20" receiver has been reduced to \$89.50.

Radio Adds \$1,000,000 To Edison Power Sales

In a recent statement to the Public Service Commission, Arthur Williams, vice-president of the New York Edison Company, estimated that radio was directly responsible for an increase in

the company's annual income of more than \$1,000,000. In addition to the additional power consumed through the use of power units and chargers the lengthened hours of radio enthusiasts, who often listen to programs far into the night with consequent higher light bills, have a marked effect on the company's revenue. The New York Edison Company also maintains a radio department, selling sets and equipment to retailers under its customary arrangement.

Stymied!



The gentleman so ineffectively attempting to hide behind a sunny smile and a pair of golf socks is Arthur Moss, treasurer and general manager of Electrad, Inc., New York City.

Chart for Radio Circuit Calculations

A chart has been prepared by the radio section of the Bureau of Standards, Washington, D. C., for simplifying calculations of the relation between the constants of tuned radio circuits, i.e., inductance, capacity, and frequency. If two of these factors are known, the third may be found by inspection of the chart. Frequency and capacity values are plotted on logarithmic paper. Examples are given showing the use of the chart which gives results correct within a few per cent.

Stromberg Buys WHAM

Broadcast station WHAM, Rochester, N. Y., formerly owned by newspaper interests of that city, has been purchased by the Stromberg-Carlson Telephone Manufacturing Company. Under its new ownership the station will become affiliated with the National Broadcasting Company chain. The power of the station which has been 100 watts is to be increased to 1,000 watts.

The Sonatron Tube Company, 220 South State Street, Chicago, Ill., has reduced the list price of its 201-A type vacuum tube from \$2 to \$1.75 and the list of type 213 from \$6 to \$5.

Trade Association Holds 2-Day Meet

The fourth regular and the first annual meeting of the Federated Radio Trades Associations brought its two-day session at St. Louis to a close February 15 by electing the following officers for the ensuing year: President, Harold J. Wrape, St. Louis; first vice-president, Thomas White, Buffalo; secretary, Harry Cory, Minneapolis, and treasurer, A. M. Edwards, Detroit.

The first day's meeting was addressed by Paul Klugh, Arthur Haugh, president of the Radio Manufacturers' Association, and S. N. Clarkson, of the National Electrical Manufacturers' Association. Ray Sutcliffe, western editor of *Radio Retailing*, spoke on the subject of better business control.

The federation made definite plans to sell the many good programs now being broadcast to the non-listening public and to give nationwide publicity to the co-operation of retail trade associations with the broadcasters in the promotion of better radio entertainment.

In addition to 10 associations now members, Kansas City, Dayton, Columbus, Rochester, South Bend and Fort Wayne were elected to membership. Next meeting of this national association of dealers and jobbers will be held at the New Stevens Hotel, Chicago, June 14 to 16, at the time of the Trade Show.

Electrical Discoveries Shown to New Yorkers

Light rays employed to play tunes on a new kind of electrical organ; atoms shot out from radium and making loud thumps when they hit on little metal plates; beams of "black light" that make human teeth shine in the dark while false teeth are dead black; an instrument by which deaf persons can see the sounds of speech instead of hearing them; and a new electric lamp which is merely a glass globe suspended in space, without visible connection to the power wires; these were among the scientific novelties shown to the New York Electrical Society on the evening of Jan. 28, during a talk by Dr. E. E. Free of New York University on "Scientific Conquests of 1926."

In the new light-ray musical instrument rays of light from small electric lamps pass through tiny holes in a rotating disk of metal. These rays were then allowed to shine across the stage of the Auditorium, where they entered a photo-electric cell. This cell converted the light rays into electric impulses, which were amplified and transformed into sound by special loud-speaking telephones.

Ralph E. Tryon, manager of the radio department of Listenwalter & Gough, Inc., San Francisco, died at his home in that city on Thursday, the thirteenth of January.

Pacific Coast Stations to Join N.B.C. Chain

Seven broadcast stations located in California, Oregon and Washington are to be permanently linked with the present chain of the National Broadcasting Company which furnishes programs to listeners on the east coast and in the south, according to Merlin Hall Aylesworth, president.

Owners of KPO, San Francisco; KGO, Oakland; KFI, Los Angeles; KFOA and KOMO, Seattle; KGW, Portland, Ore.; and KHQ, Spokane, Wash., conferred in New York City recently and these stations will probably compose the Western chain. The extension of this network program service by the National Broadcasting Company establishes chain stations from Canada south to Atlanta, Ga., and from New York City west to the Pacific coast.

It will be possible through this new extended service to rebroadcast programs from any of the principal cities of the country.

The entire chain was in temporary operation on Washington's Birthday when President Coolidge's message, delivered before a joint session of the Senate and House in Washington was broadcast. The nationwide service will be officially inaugurated early in April from studios to be established in San Francisco for the Pacific and Northwest division. George J. Podyen has been appointed manager of this division and is at work with a staff of company engineers completing western organization.

Dealers Organize

The radio dealers of York, Pa., recently called a meeting to prepare plans for the formation of a radio trade association in that city. Will K. Robert was elected temporary chairman and instructed to proceed with an organi-

zation program for the association.

William C. Alley, acting managing editor of *Radio Retailing*, was the speaker at the organization meeting and told the dealers some of the fine things radio dealers in other cities have been able to accomplish through their organizations. E. A. Hirschmann, secretary of the York Chamber of Commerce, also addressed the meeting, urging the dealers to go on with their association plans and warning them not to become discouraged.

Crosley to Produce 10,000 De Forest Tubes Daily

Under the direction of Powel Crosley, Jr., the De Forest Radio Company's tube division is to produce 10,000 vacuum tubes a day, according to John R. Loofbourow. Meanwhile the receiving set division of this company, of which Mr. Crosley has acquired temporary control, is unproductive. It is considered likely that production of a high-priced receiver bearing the name "De Forest" will be resumed shortly.

Listeners' Club Formed in Salt Lake

The Salt Lake Radio Listeners' Club has been formed in Salt Lake City, Utah, for the purpose of bringing about better receiving conditions by tracing and eliminating interference. A. F. Palm has been elected president; Hugh C. Lewis, vice-president; A. J. Mechin, secretary; C. N. Douglass, treasurer; and K. M. Murphy, Dr. H. P. Kirtley and C. H. Simpson directors for one year. J. A. Bouford is chairman of the publicity committee. The association has appointed a committee of three to co-operate with the Mountain States Radio Trade Association and retailers are being enlisted to aid in a membership drive.

Mohawk Corporation Officials Confer



Pictured above are the officials of the Mohawk Corporation of Illinois in executive conference, while formulating ideas for the merchandising of new Mohawk single-dial receivers.

Left to right: Louis Frankel, treasurer, Otto N. Frankfort, general sales manager, Gustave Frankel, president and Douglas De Mare, chief engineer in charge of production.

It's a Tough Life

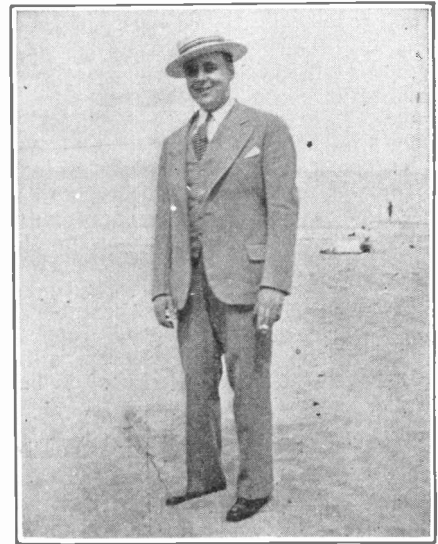

D. J. Quinn, Sonatron Tube Company of Chicago, is one of these envied sales managers who *must* visit southern distributors during the winter season. We can imagine him autographing duplicates of this photo "Weather in Palm Beach wonderful—Love," then shipping them back to friends in Chi. Gr-r-r!

New Philippine Radio Law

The Nieto radio bill affecting radio broadcasting in the Philippine Islands has become a law, according to advices to the Department of Commerce from Trade Commissioner M. Butler, Manila. In the past, broadcasting in the Philippines has been hampered because the stations had no financial support save that obtained from the sale of receiving apparatus, a portion of which accrued to the broadcasting concern. Hereafter, every owner of a receiving set will help to support the station whose broadcasting he receives.

The installation of a new transmitter at Manila Heights is being expedited. When completed this station will have 10 times the over-all efficiency of the present station. The new Radio Manila should be heard with reliability throughout the archipelago. At the same time that the transmitter is being installed arrangements are being made for new and improved studio facilities and an adequate staff is being organized to carry on the arrangement of programs and service.

King To Expand

The King Manufacturing Corporation, Buffalo, N. Y., manufacturer of King radio receivers, is increasing its production space and has made extensive alterations in manufacturing equipment in order to augment production for the new year. The company has appointed three new territorial representatives, W. C. Moore, N. M. Baker, and H. C. Goodrich.

B. W. Ruark has resigned as executive secretary of the Radio Manufacturers Association, Inc. Martin F. Flanagan has been elected temporarily to succeed Mr. Ruark.

Civil Service Exams Over March 22

Applications for the positions of Radio Engineer at \$3,800 per year, Associate Radio Engineer, \$3,000 or Assistant Radio Engineer, \$2,400, with the United States Signal Service and War Department, must be filed with the Civil Service Commission at Washington, D. C., not later than March 22. The work of radio engineers is in connection with the development, design, construction, installation and standardization of radio apparatus, such apparatus to include airplane and marine installations as well as portable and permanent land equipment. Applicants accepted by the department will be placed on a 6 months' probation basis.

R.M.A. Standards Committee Meets

The second Standards Committee meeting of the Radio Manufacturers' Association, Inc., was held at the Congress Hotel, Chicago, Ill., February 16 and 17. Wednesday, February 16, was occupied by registration, an introductory statement by Arthur T. Haugh, president of the R.M.A., delivery of a paper on vacuum tube developments, by Roger M. Wise, chief engineer of E. T. Cunningham, Inc., and an outline of committee activities by A. J. Carter, general chairman.

Thursday, the entire session was given over to an address, "Problem of Power Supply Devices as Applied to Radio," by R. M. Oberfeld, of the Underwriters' Laboratories, and "Audio Amplification and Sound Reproduction," by Professor Andres, chief engineer of Newcombe-Hawley, Inc.



Business is Business

Here we have a photograph of another gentleman in a sorry plight. C. L. Smith, president of the Diamond T Radio Manufacturers of South Bend, Indiana—the gentleman toting the straw—just had to visit a couple of Havana distributors. A. L. Wynston, manager of the Dominion Radio Sales, Toronto, Canada, is his little traveling companion on a pleasure jaunt. Smith looks a bit downcast about something—in Cuba of all places!

The Trav-Ler Manufacturing Corporation, 3337 North Halsted Street, Chicago, Ill., has appointed Richard P. Pickering sales manager. The company makes the "Trav-Ler" portable radio receiver.

Radio Corporation Markets Talking Picture

The new talking motion picture, "The Photophone," developed by the General Electric laboratories, is being marketed by the Radio Corporation of America, New York City. At a private showing early in February, the device showed perfect reproduction of sound in synchronization with the motion picture. The sounds to be reproduced by speakers placed in the theater, are photographed on the same film on which the visual action is photographed, assuring continuously perfect co-ordination between picture and sound.

In addition to providing motion picture theaters with the instrument, enabling small theaters to reproduce large orchestras with their films, the "Photophone" can be developed for use with motion picture machines in the home and the audio system of the radio set used for amplification. The instrument thus makes "talking motion pictures" available for everyone who owns a motion picture machine and a radio set.

G. Clayton Irwin, manager of the Radio World's Fair at New York and the Chicago Radio Show, has been retained by the Radio Manufacturers' Association to manage the details of the First Radio Trade Show to be held at the Stevens Hotel, Chicago, the week of June 13, in conjunction with the annual convention of the Radio Manufacturers' Association.

The Niagara Falls Radio Trades Association has been organized with membership of fifteen dealers and jobbers in Niagara Falls and LaSalle. Joseph A. Goldstein of the Music Shop, Niagara Falls, is president; R. D. Glenny, Falls Equipment Company, vice-president; Patrick J. Murphy, Murphy Battery Corp., secretary, and Jerome Brett, treasurer. Gabriel McGrath and W. R. McFarland of LaSalle head a committee on policy and program. Meetings will be held bi-monthly at the Hotel Niagara.

The Garod Corporation, Belleville, N. J., manufacturer of Garod electrically operated receivers, has appointed Leicester M. Mingins president, replacing I. P. Rodman in that capacity. Mr. Mingins is also president of the Twentieth Century Radio Corporation of Brooklyn, N. Y., Garod's largest distributor. Rodman has been appointed equity receiver for the company.

Diamond T. Radio Manufacturers held its midseason sales convention at the factory, South Bend, Ind. recently, attended by the various salesmen engaged in putting Diamond T. radio receivers over in the central states. C. L. Smith, president, delivered the principal address at a banquet held during the convention, and outlined the progress of the company.

The Radio Products Corporation, Inc., Birmingham, Ala., manufacturer of Superflex radio receivers, has increased its capital stock from 10,000 to 100,000 shares, par value to be \$100 each.

Radio Shows and Conventions

March 17-18: N.E.M.A., Policies Division, Briarcliff Lodge, Briarcliff Manor, N. Y.

June 6-11: Music Industries Chamber of Commerce Convention, Hotel Stevens, Chicago.

June 13-18: N.E.M.A. Convention, Homestead Hotel, Hot Springs, Va.

June 13-18: R.M.A. Convention and Trade Show, Hotel Stevens, Chicago.

August 20-27: Fourth Annual Pacific Radio Exposition, Civic Auditorium, San Francisco.

September 4-10: Fifth Annual National Radio Exposition, Ambassador Auditorium, Los Angeles, Cal.

*September 18-24: Third Annual Southwest National Radio Show, Coliseum, St. Louis.

September 19 - 24: Radio World's Fair, New Madison Square Garden, New York City.

September 26-October 1: Sev-

*Tentative

enth Annual Boston Exposition, Boston, Mass.

September 26-October 1: Sixth Annual Northwest Radio Show, Minneapolis Auditorium, Minneapolis.

*October 3-8: Salt Lake City Radio Show, Salt Lake City, Utah.

*October 3-8: Third Annual Indianapolis Radio Exposition, State Fair Grounds, Indianapolis.

October 3-8: Pittsburgh Radio Show, Duquesne Gardens, Pittsburgh, Pa.

October 4-9: Fifth Wisconsin Radio Exposition, Auditorium, Milwaukee, Wis.

*October 24-29: New Orleans Radio Show, New Orleans "States" Building, New Orleans.

*October 24-29: Dayton Radio Show, Dayton, Ohio.

*October 26-29: Third Annual Houston Radio Exposition, City Auditorium, Houston, Texas.

News of Jobbers and Distributors

Atwater Kent Distributors Active

Jobbers of Atwater Kent receivers have been unusually active these past few months.

Retailers from 26 central Ohio counties gathered at the Neil House in Columbus recently as guests of the Columbus Ignition Company, radio and automotive jobber. More than 150 dealers and the company's entire sales force listened to addresses on merchandising problems by Carl Wilkins of the Elite Music Company, Columbus; C. R. Williams of the Electric Shop of Delaware; Harry Humphries of the Pooley Manufacturing Company and Frank Foley, Atwater Kent district representative. W. W. Bennett, secretary and manager of the Columbus Ignition Company was in charge.

Down in Baltimore, dealers have been getting together with the local distributor.

One hundred and five Atwater Kent dealers in the state of Maryland sat down to an elaborate luncheon at the Belvedere Hotel, Baltimore, early in February as guests of Parks & Hull, Inc., the occasion being a sales promotion get-together.

Stewart G. T. Parks, president of the company, presided, introducing P. A. Ware of the Atwater Kent Company's merchandising division who delivered an illustrated talk. Miss May B. Columbo staged an impromptu play depicting the eccentricities of a good many radio salesmen and succeeded in driving home a number of important merchandising points in a laughable way.

The Braid Electric Company, wholesale distributor of Atwater Kent radio equipment in the states of Tennessee, Kentucky, and parts of Alabama, has obtained new and larger quarters at 107-9-11 Ninth Avenue South, Memphis, Tennessee. W. W. Gambill, Jr., has been placed in charge of the company's radio division.

Alter Co. Staged 50 Shows in Retail Stores

During 1926, the Harry Alter Company, Chicago, radio jobber, co-operated with approximately 50 retailers in putting over feature nights to attract radio set prospects. The company employed four popular radio entertainers to tour the territory and "broadcast" from retail stores. These entertainers made the rounds of small towns in the vicinity of Chicago, visiting moving picture theaters wherever possible before putting on their store exhibition, and attracted the attention of radio prospects throughout the section.

Programs were "broadcast" by means of a power amplifier, a microphone and a loudspeaker mounted outside the store. The real object was, of course, to get prospects to come into the store and listen. Radio set demonstrations were liberally sprinkled between selections by the artists.

Radio Retailing, March, 1927

National Radio Company is the name of a new Philadelphia, Pa., jobber of radio equipment. The company, formerly the Philadelphia Salvage Company, has obtained exclusive distribution rights for the Algonquin cone speaker and other popular apparatus. The company will handle a full line of high class console cabinets for radio sets. Its "surplus" division will handle overstocks of radio apparatus entirely separate from jobbing activities.

Sparks-Withington has appointed the following companies as distributors of Sparton radio: Clymer MacDonald Company, 4523 Shaw Boulevard, St. Louis, Mo., Perry B. Whitsit, Columbus, O., and P. J. Cronin, 10th and Flanders Streets, Portland, Ore.

Ernest Walker Sawyer, western representative of Silver-Marshall, Inc., and other radio manufacturers, has established permanent headquarters in the Chamber of Commerce Building, Los Angeles. Mr. Sawyer recently completed a 4,000 mile survey of Pacific Coast radio trade conditions and found exceptional activity in the Seattle section.

The Chadwin Radio Company's catalog of the various radio lines it distributes throughout eastern Pennsylvania is now available for the 1926-1927 season. The catalog is illustrated, contains prices at list with complete description of each item stocked. It may be obtained by writing the company at Broad Street and Ridge Avenue, Philadelphia.

The Wholesale Radio Equipment Company, Buffalo, N. Y., has been appointed a distributor of Kellogg radio receivers.

Lake States Supply Holds Sales Convention

C. M. Patterson, vice-president of the General Electric Company, was the principal speaker at a recent convention of retailers and salesmen sponsored by the Lake States General Electric Supply Company in Columbus, Ohio. "In spite of all opposition the jobber will remain in the picture as a distributor," according to Mr. Patterson. M. A. Pixley, president of the distributing company presided at the meeting and introduced F. W. Hall, sales manager; William J. Hanley, east central district manager; and W. H. Colman, Chicago district sales manager.

More than 150 dealers attended, coming from Cleveland, Toledo, Detroit, Akron, Cincinnati, Indianapolis, Dayton and Evansville.

The Ideal Manufacturing Company, Listowel, Ontario, Canada, distributor of radio and automotive supplies, has been appointed exclusive jobber of Showers radio receivers for western Ontario by Showers Brothers Company, Chicago. Arrangements were completed in Chicago recently when G. A. McDonald, general manager, and J. W. Bernie, sales manager of the company, visited the Showers plant.

Walter K. Badger has been appointed sales representative for the Stromberg-Carlson Telephone Manufacturing Company of Rochester, N. Y., in the Cleveland and Toledo districts. Mr. Badger comes to the Stromberg-Carlson Company from the Workrite Manufacturing Company of Cleveland, where he has been in charge of sales for the past three years.

How Harry Alter Co-operates with His Dealers

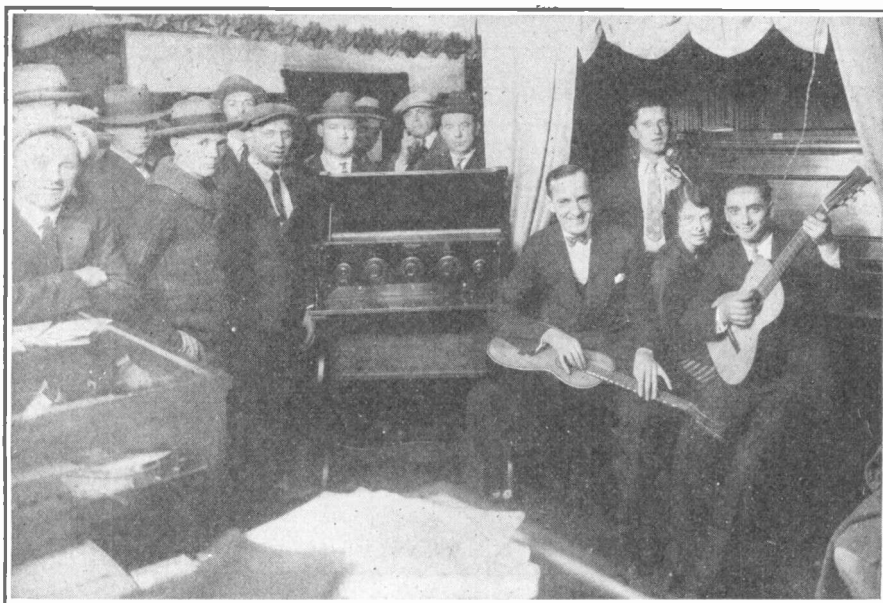

"Alter's broadcast quartet" was made up of Baltimore and Altimore, KYW stars, Ed Dempsey of WBCN and Miss

Peggy O'Neil of WSBC. In the photo, we have Ed Dempsey doing the announcing.

New Dealer Help Material

Aids to greater profits provided by radio manufacturers for their dealers

Eliminator Fuse Display



"Trico" fuses, manufactured by the Trico Fuse Manufacturing Company, Milwaukee, Wis., are furnished in the illustrated display carton. The fuses may be used in connection with battery eliminators and other power devices of the sort and are available in various standard sizes.

printed in red and black and contains a photo of Dr. Lee De Forest. The entire line of De Forest receiving tubes has been photographed and is arranged to form a border.

The Kellogg Switchboard and Supply Company, 1066 West Adams Street, Chicago, Ill., furnishes a series of small advertising leaflets which may be used in direct mail work for the sale of Kellogg radio equipment. The circulars are 3½ in. by 6¼ in. and may be mailed to prospects in standard size envelopes. Each one is devoted to a single Kellogg product. Form 455 describes the "Symphony" reproducer, form 478 the company's console type receivers, form 477 the "Wavemaster" and form 485 the "B Power Unit."

Four-Color Display

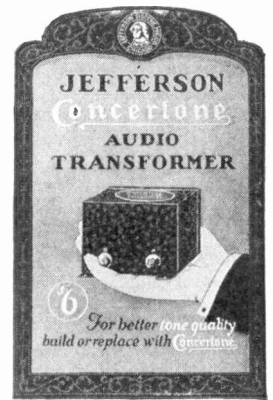

The hand and transformer in the latest counter display card distributed by the Jefferson Electric Manufacturing Company, 501 South Green Street, Chicago, are cut out and stand away from the rest of the card, throwing the Concertone transformer into relief.

De Forest's Tube Chart

The De Forest Radio Company, Jersey City, N. J., has prepared a card which may be hung on the wall of a retail store as an aid for the sale of De Forest vacuum tubes.

As a result of years of research, information on this chart enables the retailer to sell the exact De Forest tube best suited for a customer's needs. When a tube is to be used as a detector a glance shows the proper value grid leak, filament and plate voltage. Used as an audio amplifier the chart records necessary C battery biases for various plate voltages and for various audio stages. Similar information is available for the De Forest tubes to be used as power amplifiers and those suited for use in radio frequency stages.

The card is 10 in. by 13 in. over-all,

Durham Display

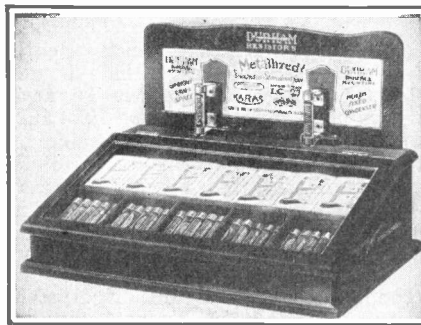

Durham upright resistance mountings are available, together with a supply of metallized fixed resistances, in the mahogany counter display case shown above. The display case contains 50 resistors and 9 of the new mountings, and may be obtained from the International Resistance Company, Perry Building, Philadelphia, Pa.

The Atwater Kent Manufacturing Company, 4700 Wisahickon Avenue, Philadelphia, Pa., has released an illustrated circular which is designed to induce the non-radio owner to part with a check and join the army of listeners. Among other pertinent questions asked by the set prospect this leaflet answers the prospect who is "waiting for the perfect set, the prospect who is waiting for radio to be simplified and the man who is waiting for better programs," carrying a sales message which is certain to be appreciated by non-owners. It contains photos of Atwater Kent receivers with list prices, and will fit a standard small envelope for mailing purposes. A space is provided on front cover for dealer's imprint.

The Bodine Electric Company, 2256 W. Ohio Street, Chicago, has just published two 8½ x 12½ in. data sheets, suitable for insertion in a loose leaf file of this size, which describe the Bodine De Luxe Loop Antenna and the Bodine Twin Eight R.F. Transformers, which the company manufactures. Both these items are illustrated and prices are listed.

Showers Brothers, Radio Division, 914 South Michigan Boulevard, Chicago, Ill., has available a quantity of small advertising leaflets describing one of its radio products, the Showers "Future Select Six," for distribution to retailers. The leaflet is designed to fit in a small envelope and contains a photo of the set showing its constructional features as well as a description of the set.

The Acme Apparatus Company's second edition of the booklet, "Power Supply for Radio Sets," is now available to retailers. It contains full data for the construction of the new Acme A battery eliminator employing two Tungar rectifying tubes as well as photographs of the company's new products and list prices. Copies may be obtained by addressing the company at Cambridge, Mass.

Sales Aids For Bosch Radio Dealers



The American Bosch Magneto Company, Springfield, Mass., furnishes the complete set of dealer help materials shown in the photograph, consisting of

counter cards, posters and transfers and circulars of every description as well as a metal holder for these circulars and an electric flashing sign.

*Long prophesied
Often attempted
Makeshifts frequently employed
Here at last!*

CROSLEY Radio Energy

*with only a
switch to snap*

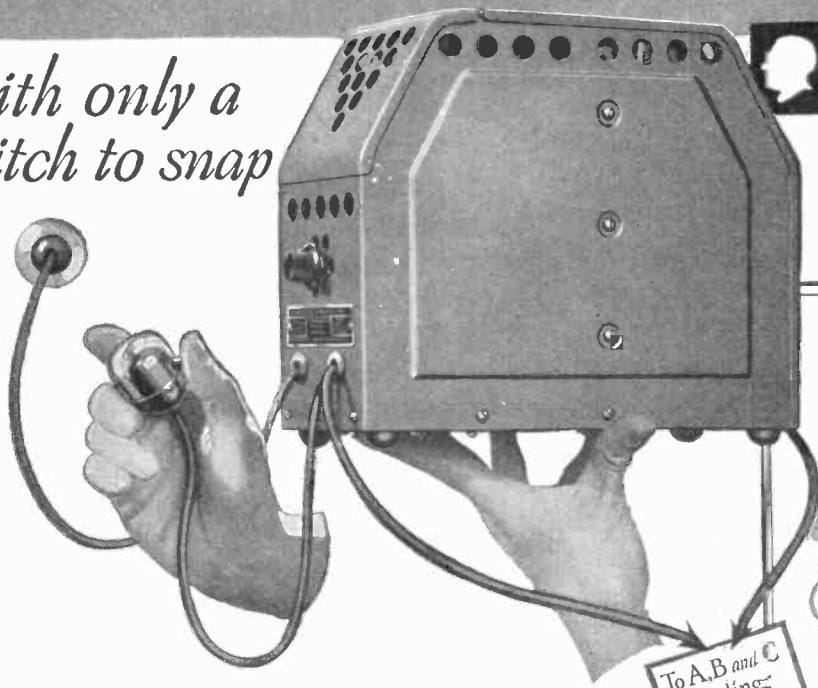

To A, B and C
Binding
Posts



A B and C Radio Power

from house current outlet direct into the radio with no more attention or thought than you bestow on a vacuum cleaner or your electric iron.

This wonder box weighs only 13 lbs., stands 9 inches high and is 4 inches wide, and is about half the size of an ordinary A storage battery. It is a mechanical device transforming ordinary 110 volt, 60 cycle house power into smooth, quiet radio energy for the new Crosley radios without slightest interfering hum and with the certainty of an electric motor.

PRICE \$50.

Crosley radios designed for use with this marvelous power supply are the AC-7, a 6-tube table model at \$70, and the AC-7-C, a 6-tube console at \$95. See these wonderful sets at any Crosley dealers, or write Dept. 130, for descriptive literature.

Crosley sets are licensed under Armstrong U. S. Patent No. 1,113,149, or under patent applications of Radio Frequency Laboratories, Inc., and other patents issued and pending. Prices slightly higher west of the Rocky Mountains.

- No more batteries to fuss with.
- No more more batteries or battery charger to water.
- No failure of the power plant just as you sit down to a fine program.
- No batteries to recharge.
- No batteries to renew.
- No apologies to make to callers because "the batteries must be getting low."
- No upsetting the house to have the radio serviced.
- NO MORE** annoyances from the vital power supply end of the radio. A snap of the switch is the only demand your radio makes upon you from **NOW ON.**

The CROSLEY RADIO CORPORATION
Powel Crosley, Jr., Pres. Cincinnati, O.

RAYTHEON IS THE HEART OF RELIABLE RADIO POWER



Do You Want More Spring and Summer Sales?

These Units Are

*Raytheon-approved
Raytheon-equipped
Raytheon-advertised*

ACME B-POWER SUPPLY
ALL-AMERICAN CONSTANT-B
BOSCH NOBATTERY
BREMER-TULLY B-POWER UNIT
BURNS B-BATTERY ELIMINATOR
CORNELL VOLTAGE SUPPLY
CROSLEY A, B & C POWER
ELECTRON CURRENT B SUPPLY
ERLA HUM-FREE B ELIMINATOR
GENERAL RADIO PLATE SUPPLY
KINGSTON B-BATTERY ELIMINATOR
MAJESTIC "B" CURRENT SUPPLY
MAYOLIAN "B" SUPPLY
MODERN "B" POWER
NATIONAL POWER SUPPLY
SPARTON RADIO B-POWER
STERLING "B" POWER
VALLEY B-POWER UNIT
WEBSTER B-POWER UNITS
ZENITH A, B & C POWER

**Western Distributors
Please Note**

We are opening a service branch in Chicago to take care of servicing and replacements in the Middle West. Address Raytheon Manufacturing Company, 2007 So. Michigan Ave., Chicago, Ill.

THE simple rule for building Spring and Summer sales is to make each radio owner in your neighborhood a radio enthusiast during those seasons. When a man is listening regularly to radio programs, talking radio to his friends, planning improvements to his own set, he is an active prospect for equipment from your store.

This is how it's done. B-battery sales are heaviest in October, which means that replacements are usually necessary during the Spring. As a replacement, sell your customer a Raytheon-equipped B-power unit. He will appreciate the economy of a source of supply that does not deteriorate when not in use, particularly at this season of the year. He will see the advantages of long life, reserve power, freedom from attention, and the finer reception made possible by a B-power supply that is always top-notch.

Once the unit is in operation he will be a rejuvenated radio enthusiast. The improved quality of reception will make him like a small boy with a new toy. The new possibilities of getting distant stations will again start him sitting up till all hours of the night "listening in"—and once he is in that frame of mind he will again be an active customer for you on other equipment, tubes, loudspeakers, even sets.

RAYTHEON MANUFACTURING COMPANY
Cambridge, Massachusetts

Raytheon

LONG LIFE RECTIFYING TUBE

Merchandising Radio Parts

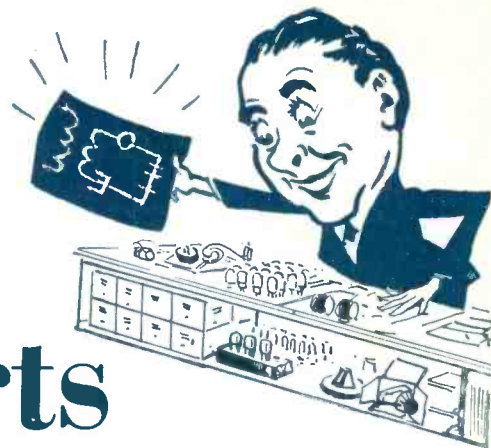

A Section of *Radio Retailing*

March, 1927

How a Parts Dealer Gets

Repeat and Replacement Business

The Radio and Electric Shop, Germantown, Pa., has built an outstanding parts business by getting customers—then holding them against all comers—Specializes in bringing old sets up-to-date by replacing old parts.

A MAN can make mousetraps far out in the woods, yet if it is a good mousetrap the world will beat a path to his door."

The Radio and Electric Shop, Germantown, Pa., is not located in the woods. It does not sell mousetraps. Yet, much like Emerson's manufacturer of superior hardware, its fame is widespread and parts buyers have beaten a path to its door at 12 East Armat Street, though the shop is half-a-block from the town's main street.

In 1926, 25 per cent of the Radio and Electric Shop's radio business was in parts. Fully 60 per cent of this business, according to J. Goldberg, the owner, was "repeat" business of steady customers. Full retail prices are maintained at all times, net profits are substantial enough to warrant a permanent investment of over \$6,000 at retail stock valuation and his parts business stands firmly on its own feet as a profitable source of income, particularly free from grief.

"If It's Radio We Have It"

Goldberg's success in the parts business is not dependent upon advertising expenditures—he does little direct advertising. It is not based on the "lowest prices in town," for the Philadelphia cut-price district is not far away and cheap merchandise is plentiful. His success is due rather to three established marketing principles, which are not merely set up as figureheads, but are actually carried out in his everyday flow of business.

The secret of the company's achievement in the parts game is contained in its proprietor's formula:

*Carry a complete stock—
Subjugate salesmanship to the best
interests of the customer—
Insure repeat business by offering a
replacement service.*

Printed on the shop's letterhead and on its display window is the slogan, "If It's Radio We Have It." This is no empty promise, for the shop carries a substantial stock of items which are likely to be used in the construction of most sets, such as transformers, condensers, sockets, resistances and similar units. In addition it covers the entire market by having on its shelves a "skeleton" stock of every other part for which there may be a call. He does not

attempt to carry every make but almost every type is represented.

A "skeleton" stock of odd items naturally calls for a more or less permanent investment in slow moving items. Goldberg has found it profitable to make this investment in order to hold every customer entering his store. If an item not on his shelves is called for he immediately 'phones his jobber and secures it.

He recalls making many sales in which he actually spent more money obtaining a small item than the profit on its sale warranted, in order to hold the customer for set, power supply or loud speaker sale later on. His salesmen have had this one thought driven home time after time, "When you have a customer, hold him at all costs."

The company's investment in radio stock totals about \$11,000, retail. Of this amount, \$6,000 is invested in parts, the balance in factory-made sets and accessories.

Sets valued at about \$2,500 are carried in stock until after the Christmas holidays when stock is reduced to about 75 per cent of this figure by curtailing orders until merchandise is actually sold. The parts stock is handled in practically the same way; permitted to drop from its normal worth, \$6,000 to about \$4,500 by not re-ordering non-essential items until the stock is entirely depleted. Transformers, condensers, coils and other items for which there is a more or less unfluctuating demand are kept up to normal and Goldberg does not resort to cut-price sales in order to prepare his shop for summer business.

During past years there has been a demand in Germantown during the

Can You Beat This Dealer's Replacement Business?

Every week he—

**Installs an average of 20
audio transformers.**

**Adds a stage of radio-
frequency to 2 three-circuit
tuners.**

**Changes tuning con-
densers in 4 old sets to
straight-line units.**

**Equips 3 sets with power
tube rheostats and voltage
taps.**

*“We’ve cut down our come-backs
with Faradon equipped sets!”*



MAKE sure that the sets you stock for next season are Faradon equipped. Do away with the complaints and returns caused by less durable condensers. The dependability of Faradon relieves you of much real annoyance.

Maintain the confidence of your regular customers and strengthen your prestige with prospective customers by selling only first quality stock—Faradon equipped.

WIRELESS SPECIALTY APPARATUS COMPANY

Jamaica Plain : Boston, Mass., U. S. A.

Established 1907

Faradon

Electrostatic condensers for all purposes

summer, for loud speaker extension cords and other items facilitating the placement of speakers in the open and the company's stock of such items is increased to take care of this demand.

Goldberg's stock in trade is to furnish the parts buyer with such outstanding service and construction advice that repeat business is a certainty. He has built a reputation for fair dealing by replacing all unsatisfactory parts without question and by being very careful that every part sold is suited to the customer's needs.

Rheostats, coils, transformers and condensers are not merely passed over the counter like so many pounds of nails, but are sold to fit the customer's exact requirements. The store salesmen always endeavor to find out what a part is to be used for and recommend a suitable unit.

A \$4,500 Replacement Business

Approximately \$4,500 worth of parts are sold per year, exclusive of normal parts business, through extra sales effort in inducing set owners to improve their outfits by installing improved equipment.

In 1926 the shop replaced an average of 20 audio transformers a week with new types designed to improve reproduction of high and low musical tones. Each week Goldberg's service man, on an average, added an extra stage of radio frequency to 2 receivers of the three-circuit type, embodying the sale of an additional tuning coil, a variable condenser, rheostat, socket and tube. Four tuning condensers of improved straight-line design were installed in sets which used comparatively inefficient types. *This was accomplished because of the service man's ability to take advantage of every opportunity on a service call.*

Salesmen have been instructed to mention new apparatus which may be installed in almost any set to improve tone, and Goldberg collects not only the full list price for all apparatus installed in this way but in addition \$1.50 per installation. This labor charge pays the salary of a man who is employed in the shop for such work.

Improvements of this nature are not confined to home-built sets, but include factory made receivers sold several years ago. Receivers are usually brought to the shop for repair, where every facility for replacing units is available. During the period when customers are without a radio the shop often loans an inexpensive set.

When a customer calls at the store for his set, or when it is delivered to him it is always hooked up and made to perform to his satisfaction. When a repaired set is delivered it is not merely "dumped on the front porch" but is hooked up and demonstrated much the same as a brand new one would be. The shop actually "sells" its work and in this way insures permanent satisfaction. Goldberg's repeat business is due largely to these little confidence-breeding services to the consumer.

In June of 1926, Goldberg bought 12 electric fans retailing from \$6 to \$35 apiece. These electrical items were obtained at discounts varying from 20 to 30 per cent from a local jobber who



Waste space due to excess spacing between shelves is reclaimed by making alternate shelves half width as shown above.

also furnished radio apparatus. During the summer months 143 of these fans, particularly those of the oscillator type, retailing for about \$25, were sold to companies located in nearby office buildings by merely calling them to the attention of radio customers. The "electrical experiment" netted \$715.

Waste Space Between Shelves Put to Work

In the majority of radio stores, small articles such as rheostats, condensers, tubes, etc., are placed on shelves built against the wall, back of the store sales counter. These shelves must be spaced about a foot apart in order that light may reach the parts and make them easily visible to customers.

The manager of the Shearn Radio Store, 8 East Fordham Road, Bronx, New York City, at one time used this conventional arrangement, but found that as the majority of parts placed upon these shelves did not usually stand more than three or four inches high, approximately four inches of display space was wasted between shelves.

By constructing narrower shelves, about one-half the width of the old ones and placing them half way between the original shelves, it is now possible to display another row of articles where formerly there was a blank, wasted wall surface. As these additions are placed back against the wall, the alternate shelves jut in and out in "zig-zag" fashion, thus allowing light to reach each article.

Date Stamp Sells B Batteries

Radio receiver owners usually purchase a B battery, hook it up and forget it until warned by weak and noisy reception that the battery is unfortunately not a perpetual accessory. The Fischer Radio Service, Larchmont, N. Y., fastens a small card, bearing the address of the store, to each B battery sold. The date of the sale is then stamped on the back of the card. This keeps the name of the store and the age of the battery before the customer.

The Salesman's Suggestions Help Sell Parts



The purchase of one part should naturally suggest some other associated article to the wide-awake salesman. In this instance the clerk is suggesting a 23 plate condenser to go with the customer's new three-circuit tuning coil. The next thing that will be suggested is probably a vernier dial to go with the new instrument. Price and quality being equal, the parts customer usually buys from the dealer who can give him authentic set building information. An efficient parts salesman keeps in touch with the latest technical developments.

SELL

the New
Official
BROWNING-DRAKE
Kit Set



THERE is now a standard Browning-Drake. The tremendous popularity of this receiver has caused many designs to be published by various writers so that it has been difficult for dealers to carry the necessary parts in stock. For this reason, Prof. Browning and Dr. Drake have designed a new assembly incorporating all the developments of the past two years. This assembly is marked "*Official*" and the inventors wish to emphasize that this design is intended as a standard, being the best all around Browning-Drake which their research has shown.

Hereafter, dealers may carry parts for the "*Official*" Browning-Drake with the knowledge that there will not be a number of designs called for by their customers.

Our distributors are now ready to make deliveries on the new Browning-Drake Corporation Kit and Foundation Unit. These distributors can furnish you with all of the other necessary parts which are being specified in extensive publicity.

Complete constructional booklets for resale to your customers at twenty-five cents, are now ready.

BRIGHTON BROWNING-DRAKE CORPORATION

MASS.

BROWNING-DRAKE RADIO

Reviewing the New Circuits



The Loftin-White Circuit

THE "Loftin-White" circuit, to be featured in the April *Radio News*, is a late development in combination inductive and capacitive r.f. coupling. It is said to provide uniform sensitivity and selectivity over the entire range of broadcast wavelengths with a minimum of controls. Parts used in its construction are:

- L, L1, L2—R. F. coils with automatic primary coupling.
- L3, L4—R. F. choke coils.
- C, C1, C2—Variable condensers, .00035 mfd.
- C3—Fixed condenser, .00025 mfd.
- C4, C5—Variable coupling or midget condensers.
- C6, C7, C8—Fixed condensers, .004 mfd.
- C9—Fixed condenser, .001 mfd.
- D, D1—Dial lights.

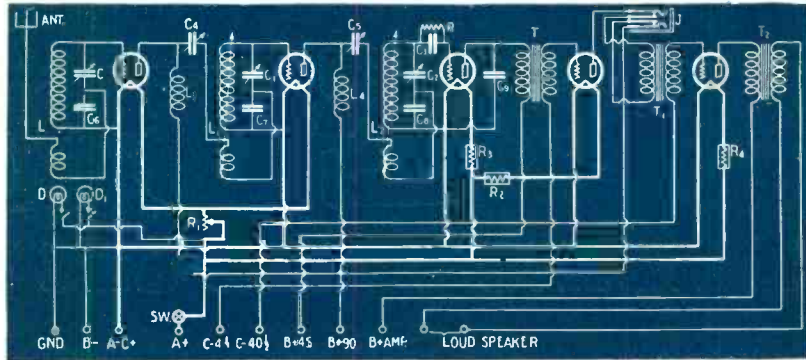

- R—Fixed resistance, 2 megohms.
- R1—Rheostat, 10 ohms.
- R2, R3—Resistances, ballast, 1 amp.
- R4—Resistances, ballast, 1 amp.
- T, T1—Audio transformers.
- T2—Output transformer.
- J—Double-circuit jack.
- SW—Switch.

Browning-Drake's Latest Offering

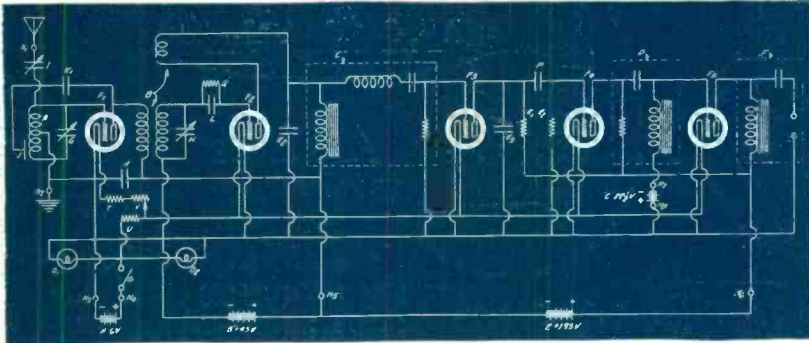

A NEW Browning-Drake receiver will be presented in the April *Popular Radio*. This offering embodies an audio amplifier which employs one stage of

resistance coupled audio, one of impedance and then a final stage of resistance with an output filter. The following units are used:

- A and G—Coil and variable condenser comprising antenna tuning unit.
- B and H—Coil and variable condenser comprising detector input stage with tickler control unit.
- C and D—Shielded impedance unit consisting of an audio choke coil, fixed condenser and resistance. C includes a small r.f. choke.
- E—Impedance output unit, shielded.
- F—Tube sockets.
- I—Variable midget condenser, .0001 mfd.
- J—Balancing condenser.
- K—Fixed condensers, .001 mfd.
- L—Fixed condenser, .000075 mfd.
- M—By-pass condenser, 1 mfd.
- N—Binding posts.
- O—Pilot lamps over tuning dials.
- P—By-pass condenser .1 mfd.
- Q—Resistance, 8 megohms.
- R1—Resistance, .1 megohm.
- R2—Resistance, .25 megohm.
- S—Filament Switch.
- T—Fixed resistance, 33 ohms.
- U—Automatic filament control, 1 1/2 amp.
- V—Variable resistance, 30 ohm.

The New "SC-11" Totally Shielded Receiver

THE "SC-11 receiver," also in the April *Popular Radio* is worthy of note. The set is completely shielded including the detector and one audio stage. All wiring is "bunched" in cable form and metal chassis, panel and sub-panel are recommended by the author, Laurence Cockaday, who developed the set in conjunction with McMurdo Silver. The parts necessary in its construction, keyed to the diagram on this page are:

- A, B, C—Variable condensers, .00035 mfd.
- D—Link motion control permitting two dial operation.
- E—Antenna coupling coil.
- F and G—Interstage r.f. coupling coils.
- I—Potentiometer and switch combined.

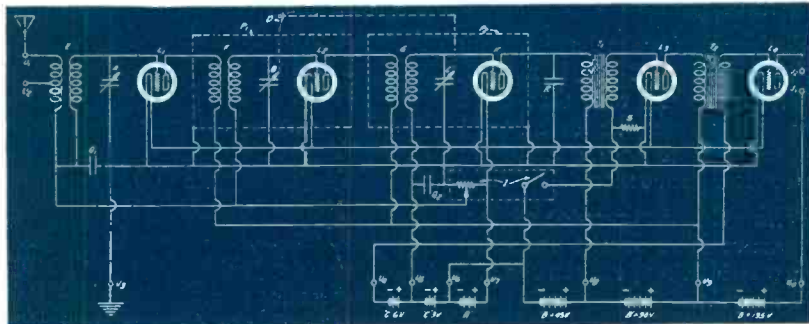

- J1 and J2—Tip-jacks.
- P1 and P2—Aluminum stage shields.
- Q1 and Q2—By-pass condensers, 1 mfd.
- R—Fixed condenser, .002 mfd.
- S—Resistance unit, .5 ohm.
- T1 and T2—Low frequency audio transformers.
- U—Binding posts.

The "R. B. Lab" Receiver in Its Latest Form

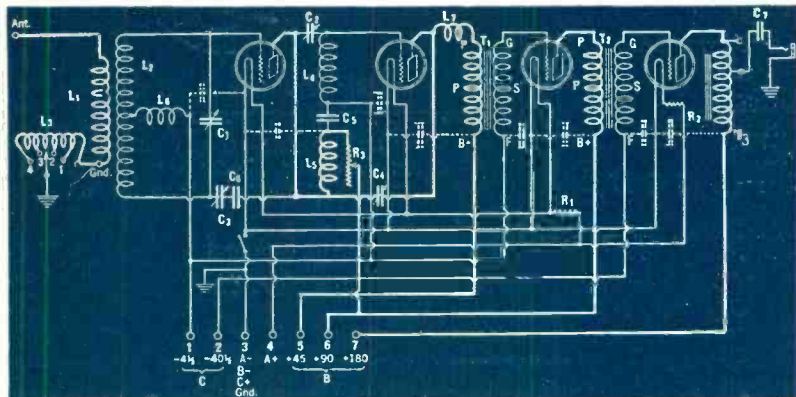

RADIO BROADCAST will feature the improved "R.B. Lab" receiver using a loop for an energy pick-up system, in its April issue. The set uses dry cell tubes if desired and is completely shielded. Parts necessary for the construction of the set are:

- L1, 2, 3, 4, 5, and 6—"R.B. Lab" coils.
- L5 and L7—R. F. choke coils.
- C1 and C4—Variable condensers, .00035 mfd.
- C2—Variable balancing condenser, .00001 mfd.
- C3—Variable condenser, .000055 mfd.
- C5—Fixed condenser, .01 mfd.
- C6—By-pass condenser, 1 mfd.
- C7—Output by-pass condenser, 4 mfd.
- T1 and T2—Audio transformers.
- T3—Output impedance.
- R1—Automatic filament control, 1/2 amp.
- R2—Automatic filament control, 1/2 amp.
- R3—Variable resistance, 0-500,000 ohms.

EBY

BINDING POSTS and SOCKETS—

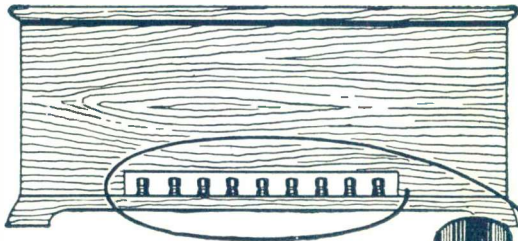

The Standard of All Radio!

From the beginning of Radio EBY Binding Posts have set the standard.

Engineers in great manufacturing plants and famous circuit builders, use and specify EBY exclusively.

Their experiments have proven that these fool-proof binding posts, with the tops that don't come off, are the surest and safest way to insure a perfect electrical connection.

With this unprecedented acceptance EBY is the one satisfactory binding post you can sell at a profit.

List Price, 15c.



Takes Any Type Connection

Straight wire, looped wire, pin or spade terminal—EBY Binding Posts takes any type equally as well.

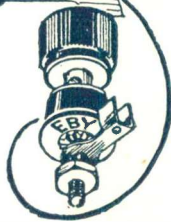

These Are Some of the Circuits Specifying EBY Binding Posts

(Complete sets are now furnished in separate packages)

Madison-Moore
Browning-Drake
Hammarlund-Roberts
Infradyne
LaCault LRA
St. James
Varion
Kenneth Harkness KH 27
Victoreen
General Radio 400
Henry-Lyford
Universal
Aero-Dyne
Premier
Thordarson (Power Amp. and "B" Elim.)
All American R.F. Set
Karas Equamatic
Daven
Samson TC DeLuxe
Aero Coil R.F. Set
AmerTran LC 27 Power Pack
Ultimax
Loftin White
S.C. 2
Cockaday LC 27

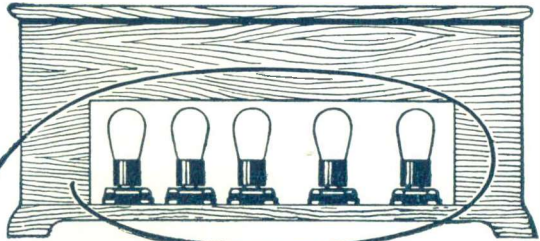

A Three Point Wiping Contact

Engineers have long since recognized the three point wiping contact as the ideal for electrical instruments.

Now EBY has brought this superior principle to radio in a socket that gives a three point wiping—the most perfect, positive and scientific type of contact known.

The ingenious construction of this new type socket eliminates microphonic noises and greatly minimizes the possibility of tube damage, when interchanging tubes.

EBY Sockets are made to take all tube types and sell at a profit.

List Price, 50c.



This Is Three Point Contact

Every time the tube moves in an EBY Socket the contact gets tighter and checks the jar. No wobbling, no noises—no losses.

THE H. H. EBY MANUFACTURING CO., Incorporated
4710 Stenton Avenue



Philadelphia, Pa.



New Parts Announced This Month

For additional new parts, sets and accessories see pages 70-74



Electrolytic Filter Condenser

Radio Retailing, March, 1927

The "Mershon" condenser, manufactured by the Amrad Corporation, Medford Hillside, Mass., is of the electrolytic type employing a harmless solution as its negative element or cathode and an aluminum sheet as its positive terminal or anode. Model D-15-30 contains two units of 15 mfd. capacity each and is especially simple to adapt for use in A and B voltage supply devices for filtering objectionable d.c. ripple. Model S-60 is a single unit with a capacity of 60 mfd. Either of the two units will operate satisfactory if the applied voltage does not exceed 300 volts d.c. Both are self-healing if the dielectric aluminum oxide which is formed at the factory is punctured. Intended retail price of either unit, \$8.



Vernier Dial With Friction Drive

Radio Retailing, March, 1927

The Pilot Art-Dial, manufactured by the Pilot Electric Manufacturing Company, Inc., 323 Berry Street, Brooklyn, N. Y., is of the friction vernier type and is said to eliminate back-lash and play in its operation. The dial is equipped with two tuning scales, one for use with instruments which must be turned clockwise and the other for counter-clockwise use. One scale is white with the indicating numbers from 0-100 in black while the other is black with white indicating figures. Intended retail price, 95c.

Intermediate R.F. Transformer

Radio Retailing, March, 1927

The Madison-Moore Radio Corporation, 2524 Federal Boulevard, Denver, Colo., manufactures an intermediate frequency transformer for use in connection with super-heterodyne receivers. Known as type HW, the unit is tuned to a frequency of 480,000 cycles and is said to prevent stations from appearing in more than one spot on the oscillator tuning dial throughout the broadcast range. The transformer is of the air-core type, enclosed in a nicked metal case and are 4 in. in diameter and approximately 1 1/2 in. thick. Sturdy metal mounting feet and well insulated and marked terminals are provided. Intended retail price \$11 each.

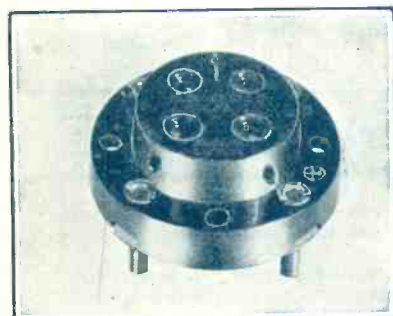

UX Socket for Sub-Panel Mounting

Radio Retailing, March, 1927

Type X tube socket, manufactured by the Klosner Radio Corporation, 1022 East 178th Street, New York City, is of bakelite and is designed to be used for sub-panel work. It is equipped with small terminal screws which perform the function of providing a means of fastening the socket to a sub-panel and at the same time provide convenient connection terminals. Designed for use with UX and large type UV tubes. Intended retail price, 40c.

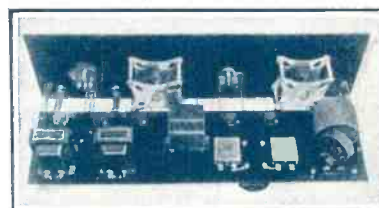

Henry Lyford Receiver Kit

Radio Retailing, March, 1927

The University Manufacturing Corporation, 50 Park Place, New York City, makes the illustrated complete set of parts, including drilled and engraved panel, plug-in coils, baseboard and a quality audio amplifier, for the Henry Lyford five-tube receiver. The circuit employed is a modification of the Rice system employing one stage of tuned radio-frequency. The set may be tuned over the broadcast band between 185 and 550 meters with the set of inductance coils provided. Other coils obtainable from the company, and easily substituted by means of plug-in terminals for those supplied with the receiver, permit its use on amateur bands down to 37 meters and on commercial high wavelengths. Intended retail price, \$69.50.

Triple Unit Gang Condenser

Radio Retailing, March, 1927

Variable condensers are available in all standard capacities, in the single-dial control or "gang" construction shown in the illustration, from the De Jur Products Company, 199 Lafayette Street, New York City. The end plates of the units are of buffed brass. All stator plate insulation is of Bakelite and is placed outside the electrostatic field to insure low dielectric absorption. The frame of the condenser unit is grounded to the common rotor by means of a

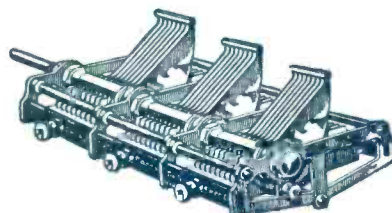

phosphor-bronze pigtail connection, thus eliminating body capacity effects.



30 Henry Filter Choke

Radio Retailing, March, 1927

The Jefferson Electric Manufacturing Company, 501 South Green Street, Chicago, makes the illustrated 30 Henry choke for use in standard filter circuits. The d.c. resistance of the unit, encased in a metal container, is 300 ohms. Equipped with two binding posts unless otherwise specified. Intended retail price, \$4.

High Voltage By-Pass Condensers

Radio Retailing, March, 1927

The Sprague "Midget" condenser is available in capacities of from .0001 to .02 mfd. Its manufacturer, the Sprague Specialties Company, Quincy, Mass., claims that it will operate on d.c. voltages up to 1000 safely and that every condenser is tested at 1500 volts d.c. before shipment. The condensers are exceptionally small and are molded into a mixture of paraffin and asphalt. Intended retail prices range from 35c. to 75c.

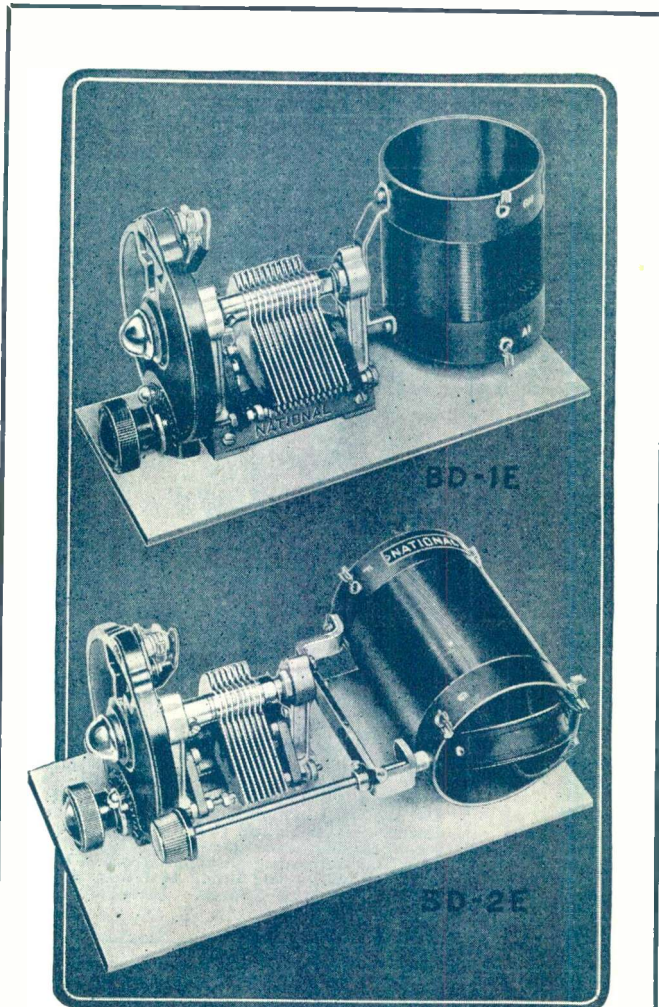

NATIONAL TUNING UNITS comprise the famous BROWNING-DRAKE Coils and R.F. Transformers with Slot-wound primary, and Space-wound secondary. These coils and R.F. Transformers were mathematically developed by Glenn H. Browning and F. H. Drake, at the Cruft Laboratory, Harvard University.

The coils are mounted on the new NATIONAL EQUITUNE Condensers, the plates of which are designed to space out stations evenly over 1/2 revolution. The rigid, structurally designed Girder Frame of the EQUITUNE Condensers occupy a minimum space and are extremely light in spite of their rigidity. NATIONAL ILLUMINATED Velvet-Vernier Dials are fitted to these tuning units. Each tuning unit is packed completely set up and may be used without change for experimental work or may readily be mounted on any kind of a panel.

DESIGNED AND OFFICIALLY APPROVED BY GLENN H. BROWNING

Price—BD-1E \$10.75
(with illuminated dial)

BD-2E—\$14.25
(with illuminated dial)

NATIONAL Tuning Units are standard for good Radio sets. So are NATIONAL Impedaformers for quality audio, NATIONAL Tone—Filters, for power tube output connection, NATIONAL heavy-duty B-Supply Units and 3-stage Power Amplifiers. Write National Company, Inc., W. A. Ready, Pres., Cambridge, Mass., U. S. A., for Bulletin 116-RK-3.

Be sure you get the genuine

**NATIONAL
RADIO PRODUCTS**

Follow the Buying Trend Electrify Your Sets



Today, the radio buying public looks upon battery operated sets like they do upon the one horse shay. The buying trend is decisively toward house current operated sets.

The Igrad "B" Unit is just what you want. Coupled with the proper choke coils, transformers, etc., it provides a smooth, humless power flow. The use of one Igrad "B" unit not only does away with many individual condensers, but it saves space and assembling time as well.

The season is just beginning—get your share of the profits. Our circular contains full descriptions and prices, sent on request. Also secure prices and information concerning the small type Igrad quality bypass condensers and high voltage units.

IGRAD CONDENSER & MFG. CO.
26 Avenue D Rochester, N. Y.

ACME CELATSITE WIRE



—a tinned, copper bus bar wire with non-inflammable "spaghetti" covering, for hook-ups. 5 colors; 30-inch lengths.

We also offer the highest grade of "spaghetti" tubing for Nos. 10 to 18 wires. 5 colors; 30-inch lengths.

Flexible Celatsite

Flexible, stranded wire for point-to-point and sub-panel wiring. Non-inflammable "spaghetti" covering.

In black, yellow, green, red and brown; a color for each circuit. Put up in 25-foot coils.



Celatsite Battery Cable

—a silk covered cable of vari-colored Flexible Celatsite wires, for connecting batteries to set. Prevents "blowing" of tubes; gives your set an orderly appearance.

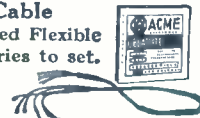

Stranded Enameled Antenna

Best outdoor antenna you can buy. 7 strands of enameled copper wire; maximum surface for reception. Prevents corrosion and consequent weak signals.



Dealers Write for Acme Wire Products Folder E

THE ACME WIRE CO. - New Haven, Conn.

ACME WIRE
MAKES BETTER RADIO

THE WORLD'S LARGEST PRODUCERS OF DIE-CASTINGS

Doehler Die-Cast Aluminum Horn for Radio-Phonograph Cabinets.

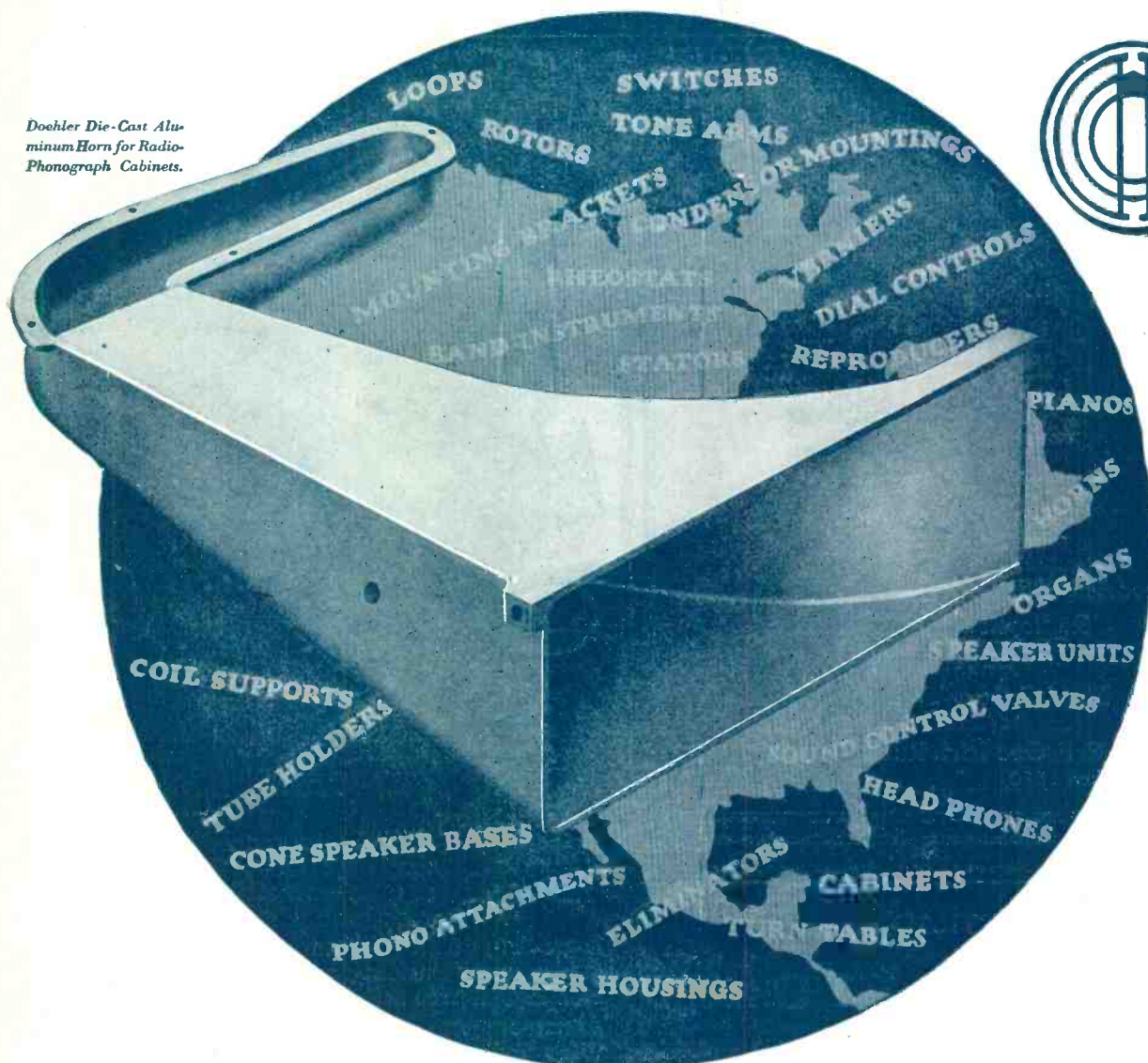

ASK! *ASK* the big users of Die Castings! *ASK* the manufacturer of precision products! *ASK* the manufacturer who demands prompt delivery. *ASK* us to show YOU how the facilities of the Doehler organization with its four great plants . . . with its 20 years experience and its resourceful engineering and metallurgical departments can serve your Die Casting needs . . . **Q**, Consult with us on your new project . . . Our Catalog should be in your files. A copy will gladly be mailed on request.

DOEHLER DIE-CASTINGS

Also designers & manufacturers of DOEHLER Vending Machines for selling, sampling and advertising purposes.

Goodrich Silvertown

The Radio Panel Supreme!

- 1 Easier to drill and machine.
- 2 Better color, lasting lustre.
- 3 Lower free sulphur —no discoloration.
- 4 Higher softening point—no warping.

Goodrich V.T. Sockets Spaghetti Tubing
Radiophone Ear Cushions
Battery Mats
Hard Rubber Tubes for Coils

The B. F. Goodrich Rubber Company
Established 1870 Akron, Ohio



ALCOA ALUMINUM Box Shields



THE Dealer cannot afford to pass by any opportunity for the improvement of radio—whether he sells sets or parts, or both.

A growing public demand, through the new hook-ups, insists upon shielding to prevent the constantly increasing external interference.

Aluminum was first used successfully for an Alcoa Wing Type interstage shield. This new Box Shield, a further development, gives total shielding in an adaptable, easily-worked material, of great durability, lightness and shielding performance.

Manufactured by the Aluminum Company of America in its own plants, its high standard specifications cannot be excelled.

Alcoa Aluminum Box Shields

are shipped knocked-down. Of heavy sheet, about the thickness of a half-dollar, (.080"—No. 12 B. & S.) to be completely effective for shielding. Consists of: Top, Bottom, Sides, 4 Extruded Corner- Posts, 8 Aluminum Screws. Assembles 5" x 9" x 6". Easily modified. Write us for complete dealer information.

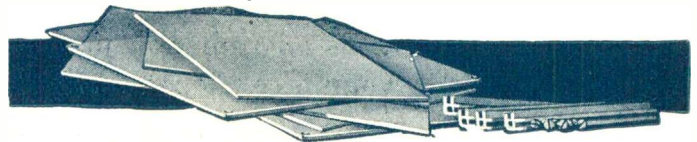

Here are some of the other Radio Applications: Alcoa Shields, Box Shields, Cabinets, Panels, Variable Condensers, High-purity Rods, Foil for Fixed Condensers, Die-Castings, Screw Machine Products.

ALUMINUM COMPANY of AMERICA
2322 Oliver Building, Pittsburgh, Pa.



The New ELECTRAD Product—

‘Phasatrol’

Licensed by
Rider Radio
Corporation

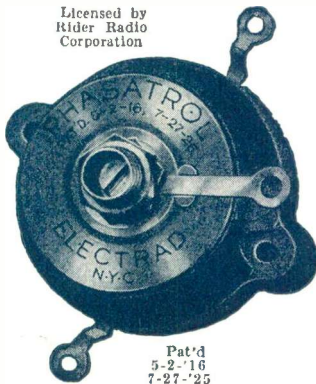

Pat'd
5-2-'16
7-27-'25

Destined to find a place in every set using radio frequency amplification.

A true balancing device for radio frequency amplifiers.

An extensive advertising campaign, technical articles by various radio authorities in newspapers and radio publications, display cards, posters and an aggressive sales effort are boosting the sale of

this new ELECTRAD product by leaps and bounds. PHASATROLS can be installed in any set and take the oscillations out of radio frequency amplifiers. The fans are demanding them and YOU should be selling them. They are packed six individual cartons to a display container and retail at \$2.75 each. You are losing money if you have none in stock, but that can be easily remedied if you send your jobber an order TODAY.

175 Varick Street, New York, N. Y.

ELECTRAD



The Coils the thing!

that makes Radio

No Radio Unit is any better than its coils---true of all electrical apparatus where coils are used, but most true of Radio.



EVERY step of Radio progress calls for more and better coils. The strong trend this year toward "B" power units, "A" battery chargers and other devices to use light socket power, makes the coil of greater importance than ever. Ordinary coils produce only ordinary quality of reception and make a mediocre out of an otherwise fine set.

It is therefore important for radio manufacturers to buy the *best coils* wound from the *best magnet wire*.

It is equally important for every jobber and dealer to *know* what kind of coils are used in every radio unit he sells to his customers. In other words,

Good Coils Make Good Radio Units

DUDLO

DUDLO MANUFACTURING CORPORATION, FORT WAYNE, INDIANA

412 Chamber of Commerce Bldg.
NEWARK, N. J.

160 North La Salle Street
CHICAGO, ILL.

4153 Bingham Ave.
ST. LOUIS MO.

274 Brannan St.
SAN FRANCISCO, CALIFORNIA

"Windham" Condensers

Conserve
Your
Working
Capital

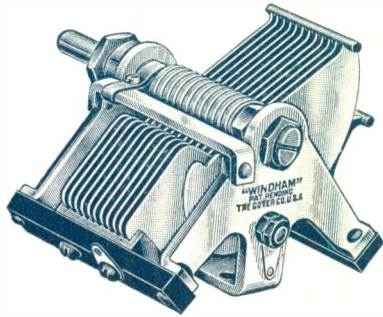

DO NOT fritter away your working capital by purchasing goods below the standard demanded by the trade. It costs money to trade an old customer for a new one.

"Windham" condensers are low in price when you consider durability and efficiency. They will retain the good will of your customers.

Manufactured by

THE GOYER COMPANY
Willimantic, Conn.



It's a Winner!

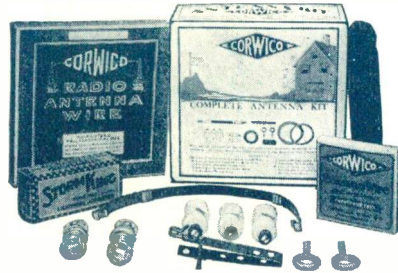

Our
Complete
Line
of
Complete
AERIAL
KITS

"Just what is needed" is the verdict of dealers, jobbers and the radio public—for the new Corwico Aerial Kits include everything necessary for aerial, ground and hook-up, making antenna equipment easy to buy and easy to sell. Prices list from \$1.75 to \$4.50, the higher priced kits including Storm King Lightning arresters.

TO DEALERS AND JOBBERS
Write or wire today for full particulars.

CORNISH WIRE COMPANY
30 CHURCH STREET, NEW YORK CITY
BOSTON 80 Federal St. CHICAGO 326 W. Madison St. KANSAS CITY 208 Baltimore Bldg.
SAN FRANCISCO: 585 Mission Street

Your Name

in this space in all issues where larger display space is not used backs up your advertising campaign and keeps your name in the alphabetical index.



THE PANEL OF BEAUTY AND SERVICE

No Finger Prints or Smudges.
Distinctive Appearance—Very Popular.
Plain Finish on Reverse Side.

Quick Turnover—Highest Quality—Low Price

HOOD RUBBER CO., WATERTOWN, MASS.

Efficient Service on Molded Parts



BAKELITE AND MOLDED MATERIAL
MADE TO YOUR SPECIFICATIONS

American Insulator Corp.

52 Vanderbilt Avenue, New York City



TRADE MARK REG'D U. S. PAT. OFFICE

SHORT-PATH CONDENSERS

Fixed paper condensers are made in two ways. The most usual method employs two terminals, one at the end of each winding. The winding therefore becomes inductive in effect. The other method ties together the two plates or windings in such a way that there is no flow of current around and through the plates. This is the non-inductive or short-path type of condenser.

Tests by reliable authorities indicate an improvement of efficiency in filter circuits of as high as 20% through the use of Short-Path or non-inductive type condensers.

Tobe Deutschmann Company makes and sells Short-Path type condensers.

The TOBE 400 line for 400 volts D.C. continuous operation has this more efficient construction. They are designed for use in the new Raytheon BH Tube. The TOBE BH BLOCKS contain groups of Short-Path condensers for convenient use with this new high capacity BH Tube. So does the new TOBE B BLOCK Type R-171, for use with the Thordarson 171 Power Compact.

(Dealers and jobbers write us for price-list and for full information.)

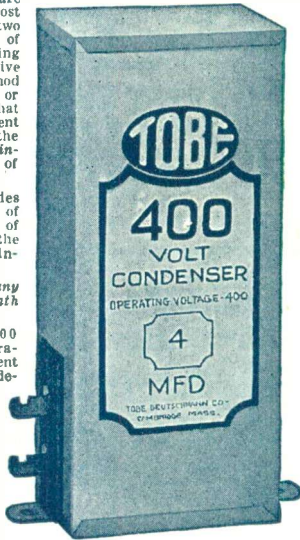

Tobe Deutschman Company

Engineers & Manufacturers of Technical Apparatus
Cambridge, Mass.

Now, Another Winner! The New Constant-coupled LOFTIN-WHITE RECEIVER

is one of the outstanding successes of the season. Designed by well known engineers, along distinctly new, scientific lines, it has unusual power, selectivity and tone that appeal strongly to the "build-your-own" fan.

It is going BIG. Are you stocked to supply the demand?

We can now supply the complete L-F Kit at a popular price that sells. Descriptive literature on request.

The Loftin-White is one of seventeen new circuits for which Hammarlund Precision Products are officially specified.

HAMMARLUND MFG. CO.

424-438 W. 33rd Street, New York



FROST-RADIO

Ask Your Neighbor

Type 880 Super Variable

List: \$1.25

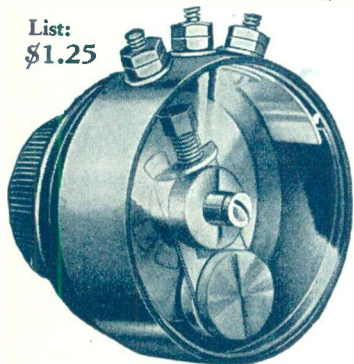

FROST-RADIO



The Gem-Jac is small and compact—a wonderful space saver. Projects only one inch behind panel. Springs have self-cleaning-sterling silver contacts and the frame is nickel plated brass. A fast-selling little item.

Prices 40c to 50c, list

Resistance

A new FROST-RADIO precision unit made to meet the demand for variable high resistance in receiving sets. Works smoothly and noiselessly. Does not heat up to any extent due to large area of resistance element. Movable arm makes smooth, positive contact without causing wear. It is finely made, like a good watch, and all metal parts are nickel plated and hand buffed. Knob is genuine Bakelite.



Pan-Tab

The Pan-Tab is without a doubt the DeLux radio jack. It has heavier springs, more positive contacts and a finer finish than you will find in other jacks of lesser quality. Arranged for panel or table mounting.

List prices, 65c to 90c

HERBERT H. FROST, Inc.

New York 160 North La Salle Street, CHICAGO Los Angeles

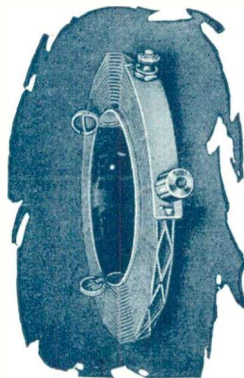

Set Manufacturers!

Standards of radio reception are becoming higher with each new year. 1927 models must be an improvement over those of 1926, and they will be.

Correct coils are vital to good reception. We specialize in such coils. We are producing regularly the most advanced types, built with the famous "Diamond-weave" construction.

Write us concerning your own requirements. We are prepared to furnish better coils for the new sets.

THE F. W. SICKLES COMPANY
140 Union St., Springfield, Mass.

SICKLES DIAMOND-WEAVE COILS

The St. James Transformer

The highly efficient vacuum-treated, dehydrated air core transformer which has been so successfully used in the well-known St. James Super-Het.

A mighty good article with good profits for parts dealers. Very complete and simple working plans available.

Send for our Folder

St. James Laboratories, Inc.
845 Washington Blvd., Chicago, Ill.

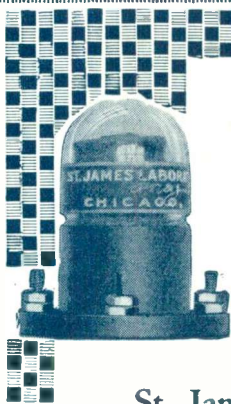

Again by Sprague

Since the first electric car in 1888—a Sprague invention—many electrical engineering advancements have been given industry—by Sprague.

No wonder that the latest—the SPRAGUE MIDGET fixed condenser—is attracting such widespread set-builder interest.

For the MIDGETS are factory tested at 1500 volts—have higher uniform breakdowns—constant capacities—insulated casings—quarter the weight—half the size; in short, they are midgets with electrical hearts of giants. Their new flexible lugs—pre-soldered—short-cut assembling expenses; saving screws, nuts, bolts, drillings and wire, too.

Just your address will bring you samples and all the reasons why Sprague Midgets will improve and economize in your set construction.

SPRAGUE SPECIALTIES COMPANY
Dept. N
QUINCY, MASS.

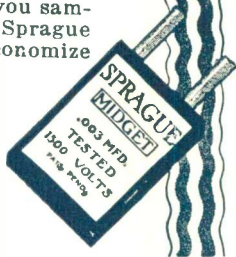

QUALITY in This Audio Frequency Transformer



Quality in reproduction and construction alike are found in Ferranti Transformers. And the fan knows it! That's why you'll find that prestige and profit can be gained by stocking Ferranti Transformers.

FERRANTI, Inc.
130 West 42nd Street
New York, N. Y.

Ferranti, Ltd., Hollinwood, Eng.
Ferranti Electric, Ltd., 26 Noble St., Toronto, Canada.

Ferranti Transformer, Type A.F. 3, \$12.00—the best transformer at any price. The next best—A.F. 4, \$8.50.



More Radio Cabinet Sales

This Standard No. 401 Radio Cabinet was designed to be highly attractive and to be most practical. Users find that it fully meets their needs.

A number of features including wood horn, make this a cabinet you should consider at once.

Made in Antique Brown Mahogany or Antique Burl Walnut finish. Write for dealers' transportation allowance and discount list.

STANDARD PIANO BENCH MFG. CO.
1221-1227 W. Lake St.
Chicago, Ill.

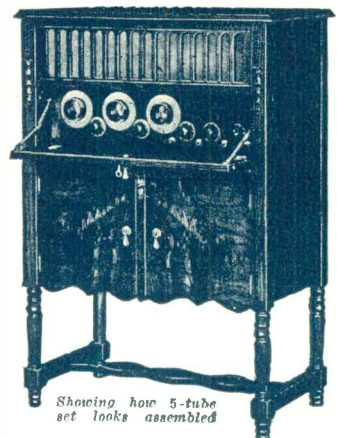

Showing how 5-tube set looks assembled

Metal Panel and Sub-Panel

FOR THE
S. C. II RECEIVER
SILVER COCKADAY

Price of complete unit—including all necessary screws, nuts, bolts and bushings, individually packed in convenient container

\$5.00

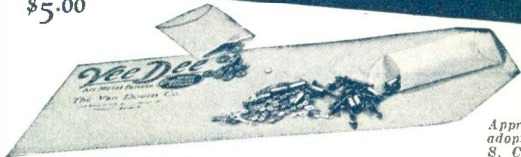
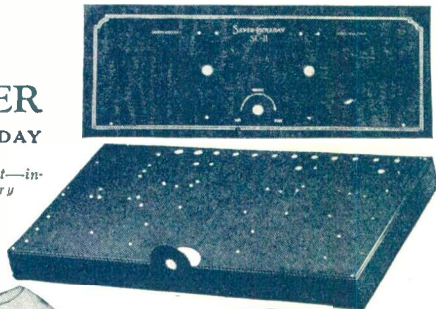

Approved and adapted for the S. C. II Receiver

VEE DEE METAL PANELS for Nationally Famed Kits—Drilled & Decorated
L. M. Cockaday LC-27. \$3.70
Browning-Drake Improved. \$3.05
Hammerlund-Roberts Hi-Q. \$2.70
Karas Equamatic \$3.50
Infradyne-Remler Type. \$3.75
Bremer-Tully Power Six. \$3.05
Citizens Super \$3.25
Write for Discounts



Metal Panels—Chassis—Shielding

We carry stock metal panels in all standard sizes, beautifully finished and decorated. Easy to drill. Prices, \$2.15 to \$3.55.

Vee Dee Metal Panels, Sub-panels and Shielding are being adopted as standard equipment by America's foremost set and kit manufacturers.

We invite correspondence from manufacturers who want special designs worked out. Write for details

The Van Doorn Company
160 North La Salle Street - Chicago, Illinois
Factory, Quincy, Illinois

CARTER

Rheostats—Switches—
Jacks—Resistors
—as usual—

Specified in
SILVER MARSHALL SC-II
(Popular Radio for April)

- 1—No. M-200-S "Midget" Potentiometer with switch and insulators.
- 2—No. 10 Tip Jacks with Insulators.
- 1—No. H 1/2 Fixed Resistor (1/2 ohm).

LOFTEN-WHITE
(Radio News for April)

- 1—No. M-10 "Midget" Rheostat.
- 1—"Imp" Battery Switch.
- 1—No. 102-A Jack.

These circuits pre-viewed in this issue.

Stock up:

Mr. Dealer, this advance information enables you to check up on your stock, become familiar with parts specified and have parts ready when these circuits appear and the consumer demand commences.

CARTER RADIO CO.
CHICAGO



Plate Voltage Aplenty for Big or Little Sets



Type 405
PLATE SUPPLY

Write for Bulletin 926 containing full information and prices on all G-R parts and accessories.

GENERAL RADIO CO., Cambridge, Mass.

The Type 405 Plate Supply delivers ample plate power to permit its use with multi-tube sets where there is a heavy current drain as well as with receivers having small current demands.

The Type 405 Unit operates on 110-volt (60 cycle) A.C. and provides voltages of 45, 90, 130, and 200.

Voltages are readily adapted to plate requirements of standard tubes in popular use by means of fixed resistances. These resistances are tightly sealed from dust and moisture, thus eliminating bothersome and noisy tendencies of variable resistance voltage controls.

The Unit is contained in a metal case with attractive black crystalline finish and has a conveniently located A.C. switch.

Price with type BH Raytheon Tubes \$46

Type 400 Power Amplifier and Plate Supply \$68.

Power Amplifier and Plate Supply Kits

Type 390 for UX-213 or CX-313 Tubes \$47.50

Type 395 for BH Raytheon Tubes \$50.

GENERAL RADIO PARTS and ACCESSORIES

SM

Increased Profits!

652 B Eliminator

The new S-M 652 B kit includes all parts to build a "B" supply with constant voltage output and absolute freedom from hum, "motor-boating," or other common troubles. Price \$34.50 less CX313 and CX374 tubes.

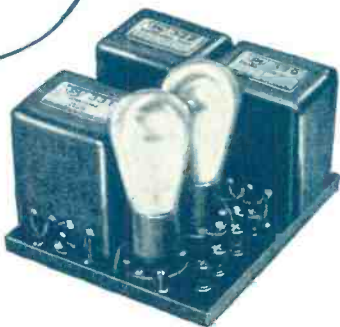

Effective April 1st, a new selling plan goes into effect on S-M products, carrying larger profits for you. Write for data! Be sure to read about the new Silver-Cockaday receiver, the S-C II, described in April Popular Radio. It too, will mean parts sales during your dull months!

SILVER-MARSHALL, Inc.
870 W. Jackson Blvd., Chicago, U. S. A.



THE extreme care used in assembling and testing Reliable Automatic Power Control Switches, makes it good business for radio dealers to recommend them with every Trickle Charger or B Eliminator.

A Reliable Automatic Power Control Switch is always positive acting, automatically turning on or off either or both the Trickle Charger and B Eliminator, as required. The illustration shows the Convenience Model with cord and plug and receptacles for quick connection. Convenience models retail at \$3.50 and \$3.75. Utility models (connected at binding posts) retail at \$2.00 and \$2.50.

Write for details and dealers prices.

THE RELIABLE PARTS MFG. CO.
WELLINGTON, OHIO

RELIABLE Automatic Power Control Switch

—and now the First Radio Trade Show

FOR THE FIRST TIME in its history, the radio industry will have an opportunity to see and study under one roof all that is new and saleable in radio sets, accessories and parts for next season.

During the annual convention of the Radio Manufacturers Association in June, when the entire industry assembles, the First Radio Trade Show will be held in the Hotel Stevens, Chicago, from June 13th to 17th inclusive.

Those manufacturers whose names appear on this page have already applied for exhibit space and with others will display their merchandise for the 1927-1928 season at the Radio Trade Show.

Plan now to attend the First Radio Trade Show. Dealers, jobbers and distributors only will be admitted. For full particulars write to

G. CLAYTON IRWIN, JR.,

Radio Manufacturers Association Trade Show

Room 1800, Times Building

New York City

Hotel Stevens, Chicago, June 13-17

Manufacturers Who Have Already Made Space
Applications for the First Radio Trade Show →

Allen-Bradley Co.
The Abox Co.
Acme Apparatus Co.
Acme Wire Co.
Adler Mfg. Co.
Aero Products, Inc.
Aerovox Wireless Corp.
All-American Radio Corp.
Aluminum Co. of America
American Bosch Magneto Corp.
American Elec. Co., Inc.
Amplion Corp. of America
Amsco Products, Inc.
F. A. D. Andrea, Inc.
Apex Elec. Mfg. Co.
Atwater-Kent Mfg. Co.
Audiola Radio Co.
Belden Mfg. Co.
Benjamin Elec. Mfg. Co.
Borkman Radio Corp.
Bosworth Elec. Mfg. Co.
L. S. Brach Mfg. Co.
Bremer-Tully Mfg. Co.
Briggs & Stratton Corp.
Brooklyn Metal Stamping
Brown & Caine, Inc.
Buckwalter Radio Corp.
Burgess Battery Co.
Camfield Radio Mfg. Co.
Carter Radio Co.
C. E. Mfg. Co., Inc.
The Celoron Co.
Central Radio Labs.
Compressed Wood Corp.
Continental Fibre Co.
Cornish Wire Co.
Crosley Radio Corp.
Crowe Name Plate & Mfg. Co.
E. T. Cunningham, Inc.
Daven Radio Corp.
DeForest Radio Co.
DeJur Products Co.
Tohe Deutschmann Co.
Diamond Elec. Specialty Corp.
Diamond T Radio
Diamond Vacuum Prod.
Dongan Elec. Mfg. Co.
Dubilier Condenser Corp.
H. H. Eby Mfg. Co.
The Ekko Co.
Electrad, Inc.
Elec. Research Lab.
Fansteel Prod. Co., Inc.
Farrand Mfg. Co., Inc.
Sandar Corp.
Federal-Brandes, Inc.
Federal Radio Corp.
Forest Elect. Co.
Freed Eisemann Corp.
Chas. Freshman Co., Inc.
Herbert H. Frost, Inc.
General Radio Co.
Gold Seal Elec. Co., Inc.
Gould Storage Bat. Co., Inc.
Greene & Browne
Grigsby Grunow Hinds Co.
Howard Radio Co.
Imperial Molded Prod.
Indiana Mfg. & Elec. Co.
International Resistance
Irrington Varnish & Insul.
Jefferson Elec. Mfg. Co.
Howard B. Jones
Hoyt Elec. Inst. Co.
Jewell Elec. Inst. Co.
Karas Elec. Co.
Kellogg Switchboard
Keystone Radio Labs.
King Mfg. Corp.
Kodel Radio Corp.
The Lignole Corp.
Arthur H. Lynch, Inc.
The Magnavox Co.
Marling Wire Co.
Martin Copeland Co.
Mohawk Corp. of Ill.
Leslie F. Muter Co.
Murad Radio Corp.
National Carbon Co., Inc.
Newcombe-Hawley, Inc.
Perryman Elec. Co.
Pamstiehl Radio Co.
Philadelphia Storage Batt.
Platter Cabinet Co.
Polymet Mfg. Corp.
Pooley Co.
Potter Mfg. Co., Inc.
Premier Radio Corp.
Prest-O-Lite Co., Inc.
Radio Corp. of America
Radio Master Corp.
Raytheon Mfg. Co.
Reichmann Co.
Runzel-Lenz Elec. Mfg. Co.
Samson Elec. Co.
Sangamo Elec. Co.
Seville Mfg. Co.
Shamrock Mfg. Co.
Slagle Radio Co.
Sonora Phonograph Co.
Sparks-Withington Co.
Spittdorf Elec. Co.
The Sterling Mfg. Co.
Stevens & Co.
Stewart Battery Co.
Stewart-Warner Speed. Corp.
Timmons Radio Products
Tower Mfg. Corp.
Trimm Radio Mfg. Co.
Utah Radio Products
U. S. Tool Co., Inc.
United Radio
The Van Horne Co., Inc.
W-K Elec. Co.
Walbert Mfg. Co.
Geo. W. Walker Co.
The Webster Co.
Webster Elec. Co.
Wells Radio Mfg. Co.
Westinghouse Union Batt.
Weston Elec. Instr. Corp.
The Workrite Mfg. Co.
Zenith Radio Corp.
Yaxley Mfg. Co.

Why hunt big game with a shot gun?

How do you go after big radio business? Are you still using shot gun methods—scattering your recommendations over so many lines of radio that you can do justice to none of them?

Or are you one of those clear-thinking progressives who in rifle fashion have "sighted" on one, possibly two, well known lines, and are able to concentrate all your recommendations on these lines, and bring down game at almost every price range?

Federal makes it easy for the retailer both to concentrate and be consistent in his claims. For so wide is the assortment of Federal Ortho-sonic models that it meets the needs of nearly every prospect. And every set is Ortho-sonic.

To offer so comprehensive a line of radio, the manufacturer must assume much added cost and expense. But Federal is convinced that such a policy is the one solution of the problem of the ineffectual retail marketing inevitably arising from too great a diversity of recommendations to prospects.

Besides completeness of line Federal offers the retailers all the advantages of a line that is utterly distinctive and outstanding. For Federal is the only Ortho-sonic radio—the only radio with the patented Ortho-sonic circuit.

Distinctive beauty of tone and of cabinet design, a vigorous policy of national and local newspaper advertising, liberal profit margin, protection from excessive competition, no signed contracts or red tape—these are just a few of the features of the Federal Retailer designation which have appealed so tremendously to the better class of retailers.

Get in touch with your Federal wholesaler. If you don't know who he is, write us—promptly.

The sign of the
Designated Federal Retailer



FEDERAL RADIO CORPORATION, Buffalo, N. Y.
(Division of Federal Telephone and Telegraph Co.) Operating Broadcast Station WGR at Buffalo

ORTHO-SONIC*

Reg. U. S. Pat. Off.

Federal Radio

* The fundamental exclusive circuit making possible Ortho-sonic reproduction is patented under U. S. Letters Patent No. 1,582,470.

Reduced!
The Perfected
Single Dial
SHAMROCK
now retails at

*Only Shamrock economies
 make it possible!*

\$ **75**

THE *Perfected* One Dial Shamrock, pioneer of single dial control sets, has been reduced to retail at \$75! In accordance with the Shamrock policy of dealer protection every distributor received notice of this reduction 30 days in advance of its going into effect. At this price the Shamrock Model A has no peer for eye-value, volume and perfect performance. Let every dealer do his duty —say it with orders!

*Slightly higher West of
 the Rocky Mountains*

SHAMROCK
 RADIO SETS
 PIONEERS IN ONE DIAL CONTROL
 SHAMROCK MANUFACTURING COMPANY
 195 WAVERLY AVENUE NEWARK, N. J.

AMRAD *Neutrodyne*

Serve Your Community Completely with this Complete Line ~ priced* far below competitive quality



3 Dial, 5 Tube, Batteryless No Batteries Needed

AC-5-C—This type of control is preferred by many experienced radio owners. All necessary power direct from light socket. No batteries, no trickle charger. Housed in a beautiful two-tone mahogany cabinet with genuine Crosley Musicone skilfully built in.

Receiver \$115 **\$175**
Power Unit \$60

AC-5—This is the table model of the console pictured to the left. The Amrad power unit has been tested under home conditions for more than a year and a half. Operates from A.C. current delivering 100-120 volts, 60 cycle. Power unit is shown behind table model set.

Receiver \$65 **\$125**
Power Unit \$60

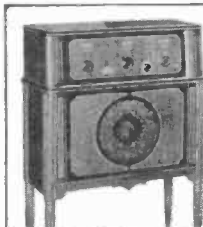

CONE TABLE

A mahogany cabinet finished in two-tones with the genuine Crosley Musicone cleverly concealed — the Musicone that won universal praise. Cone table matches Amrad table model receivers in design and finish. **\$32**

3 Dial, 5 Tube Models Battery Type

S-522-C—Beautiful in appearance, a wonder in selectivity and performance. Console model—two-toned mahogany—with Crosley Musicone skilfully concealed behind silk screen. Delicate vernier controls make tuning extremely easy and efficient.

\$110

S-522—Amrad quality is again exemplified in this beautifully made and proportioned set. The simple, elegant lines of this set win the admiration of all. The first of a line that has kept production at peak in the Amrad factory ever since.

\$60

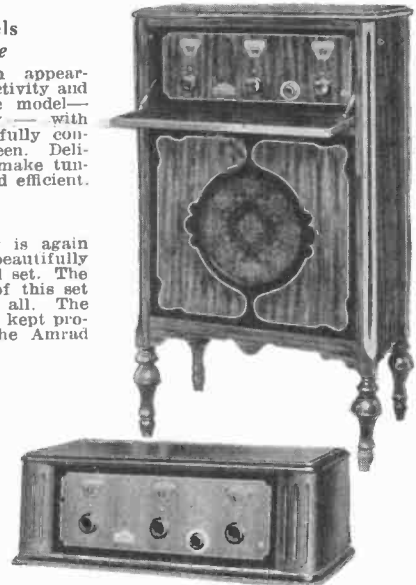

* Amrad low prices reflect the influence of the Crosley purchasing power and the Crosley resources. This, coupled with Amrad engineering skill and the technical achievements of Amrad laboratories, is a wonderful combination.

Write for sales franchise at once. Many desirable territories still open.

7 Tube S-733 Models Battery Type—2 Dial

S-733-C—This exquisite model is a handsome piece of furniture to grace any home. Delivers the utmost in radio enjoyment at a very reasonable price. Crosley purchasing power and Amrad engineering skill is reflected in this set. With the simplified 2 dial control, it becomes a super value **\$127** at

S-733—Owners of this Amrad Neutrodyne report complete satisfaction. High ratio vernier controls make tuning easy. Sockets are mounted on rubber cushioned base. Volume is controlled by a single adjustment. Two-toned mahogany cabinet, a wonderful value **\$77** at



7 Tube, 2 Dial Batteryless No Batteries Needed

AC-9-C—This radio is designed especially for A.C. power. It is designed for use with the Amrad power unit—a thoroughly tested batteryless power supply of great efficiency. The value of this set will be appreciated by many.

Receiver \$132 **\$192**
Power Unit \$60

AC-9—This set is similar in construction to the console. Two dials simplify tuning. The elegant lines of this model—two-toned mahogany—will harmonize with the surroundings in any home. Receiver **\$82**. Power Unit \$60 **\$142**

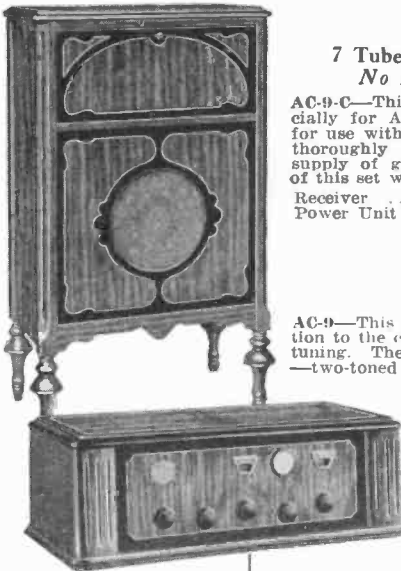

"B" Eliminator

The famous "Merston" Condenser in the design of this "B" eliminator makes possible a source of "B" power supply with finest TONE QUALITY. The unit is housed in a metal cabinet and finished in black enamel. All parts are easily accessible, in plain view and not covered with a compound. No variable controls. Furnished with the Famous Amrad S-1 Tube, Voltages—22½ or 45; 67, 90, 135 or 180. Max. volts at 50 mls.

\$35



Amrad consistently offers the greatest Neutrodyne values on the market. Ever since the S-522 models were offered at \$60. Amrad production has been at peak. Every succeeding model has been as great a value.

Altogether it makes a wonderful line—easy to sell and easy to service.

Write Dept. 8c7 for descriptive literature.

THE AMRAD CORPORATION

Harold J. Power, Pres.
Medford Hillside, Mass.

Voltage Regulator

Will feed a steady current no matter how badly the line voltage wavers. Many homes can now operate Amrad Batteryless Lamp Socket Sets. Heretofore many could not enjoy the convenience of lamp socket power because of badly fluctuating electric currents, causing broadcasts to swing in and out, or fade. Requires 1 UX—876 Ballast Tube. For complete satisfaction a voltage regulator should be included when sets are sold.

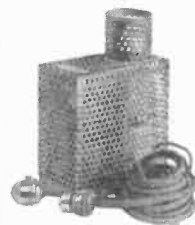

\$15

Here's a brand new selling point!



Ever since the beginning of the radio industry, Tungar has been the most popular battery charger. And now here's just one more selling point to add to your list.

The two-ampere Tungar will *trickle charge* a 6 volt "A" battery or give it a full rate boost—depending on the post that is used.

It will also charge 2 or 4 volt "A" batteries, all "B" batteries—and automobile batteries as well.

Just tell your customers the whole Tungar story. Let them know the full value of this remarkable charger, that is produced by General Electric.

This post —
trickle charge
to a 6-volt
battery . . .
Also charges
2- or 4-volt
batteries . . .

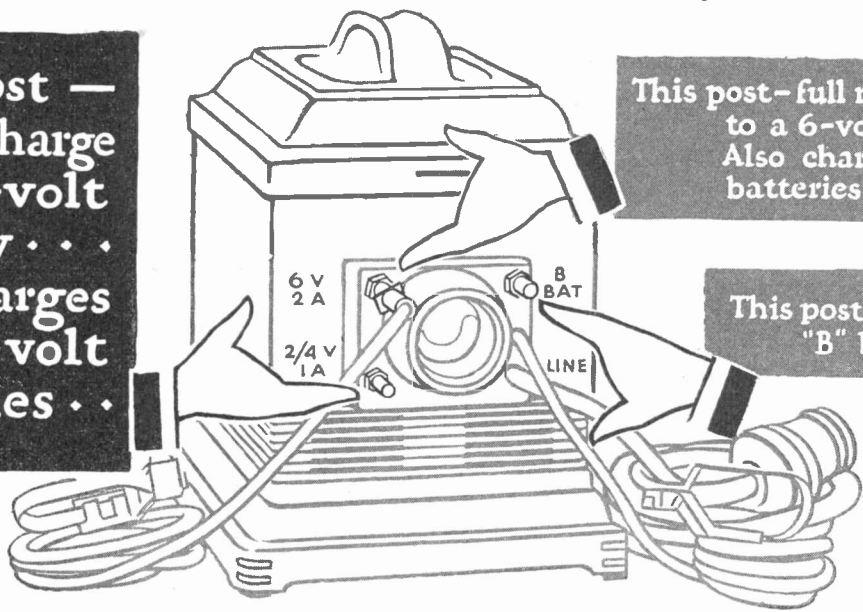

This post—full rate charge
to a 6-volt battery
Also charges auto
batteries

This post—charges all
"B" batteries

East of the Rockies
2 ampere Tungar - \$18
5 ampere Tungar - \$28
Trickle Charger - \$12

 **Tungar**
REG. U.S. PAT. OFF.
BATTERY CHARGER

Tungar—a registered trademark—is found only on the genuine. Look for it on the name plate.

GENERAL ELECTRIC

GENERAL ELECTRIC COMPANY MERCHANDISE DEPARTMENT BRIDGEPORT, CONNECTICUT

JOBBERS

- Baltimore, Md., American Sales Corp., 24 West Biddle St.
- Binghamton, N. Y., L. C. Grummond Co., 16 Morgan St.
- Buffalo, N. Y., Vim Cycle Hardware Corp., 137 Bway.
- Brooklyn, N. Y., McPhillben-Keator Inc., 68-34th St.
- Cedar Rapids, Ia., Main, W. F. Co.
- Chicago, Ill., Monarch Electric Co., Adams & Desplains Sts.
- Cincinnati, Ohio, Creaghead Engineering Co., 325 Main St.
- Cincinnati, Ohio, Stanley A. Morsbach Co., 132 E. Court St.
- Dallas, Texas, Atlantic Sales Co.
- Dallas, Texas, Automotive Appliance Co.
- Dallas, Texas, Higgenbotham, Bailey, Logan Co.
- Dallas, Texas, Moore Bros. Electric Co.
- Dallas, Texas, Schoelkopf Co.
- Davenport, Ia., Horst & Wilkinson
- Davenport, Ia., Sickles & Preston Co.
- Detroit, Mich., K. O. Tire Stores, 2144 Grand River Ave.
- Detroit, Mich., R. W. Kumler, 13186 Pinehurst St.
- Fort Madison, Ia., Perfection Sales Co.
- Fort Worth, Texas, Gogdell Auto Supply Co.
- Fort Worth, Texas, Nash Hardware Co.
- Grand Island, Neb., Plank Products Co.
- Kansas City, Mo., Standard Laboratories, 1406 Walnut St.
- Keokuk, Ia., Smith-Meyling Battery Co.
- Kansas City, Mo., Richards & Conover Hardware Co., Fifth & Wyandotte Sts.
- Kansas City, Mo., Gustin-Bacon Manufacturing Co.
- Minneapolis, Minn., Automotive Supply Co., 124 Washington Ave., N.
- Minneapolis, Minn., Plant Auto Equipment Co.
- New York City, Sanford M. Bookey, 221 Fulton St.
- New York City, Mackenzie Radio Corp., 1225 Broadway
- New York City, Parsons & Whittemore, 299 Broadway
- Oklahoma City, Okla., Self, J. M. Supply Co., 511 No. Broadway
- Okmulgee, Okla., Moore, John M., Co.
- Omaha, Neb., National Accessories, Inc., 2051 Farnam St.
- Petersburg, Va., Charles Leonard Hardware Co.
- Philadelphia, Pa., Lockwood Radio Co., Inc., 637 Market St.
- Pittsburgh, Pa., Wireless Electric Co., 206 Stanwix St.
- Reading, Pa., Geo. D. Barbey, 5th & Walnut Sts.
- Rochester, N. Y., Sternberg, H. D. Corp., 152 Broad St.
- Rock Island, Ill., Beardsley Specialty Co.
- St. Louis, Mo., Rice-Stix D. G. Co., Dept. No. 62
- St. Louis, Mo., Straus Co., The, Locust & 27th St.
- St. Louis, Mo., Wholesale Radio Co., 211 No. 10th St.
- Sherman, Texas, Hardwicke Etter Co.
- Sioux Falls, S. D., L. & L. Auto Supply Co.
- Washington, N. C., Harris Hardware Co.
- Washington, D. C., Potomac Battery & Electric Co., 1627 14th St., N.W.
- Wichita, Kans., Seesholts Fowler Radio Co., 113 No. Market St.
- Xenia, Ohio, Famous Auto Supply Co.



Announcing the new
**ZETKA PROCESS ZP
201 A POWER TUBE**

Just introduced! The new clear glass Zetka Process ZP 201 A power tube meets a definite demand for an "all-stage" power tube.

ZP. 201 A triples the best performance of any regular 201 A type tube. Designed for use in all stages it is capable of bringing every set up to its peak operating capacity, assuring a hitherto unknown degree of volume and tonal richness.

The regular power amplifiers Z 112, Z 171 and special detector Z 200 A are daily increasing in popularity with the

customer who purchases with discretion. With this new oxide filament, ¼ ampere clear glass ZP 201 A tube added to your Zetka stocks, you may expect a substantial increase in business.

And—to assure "volume sales," the price of this revolutionary new clear glass ZP 201 A power tube is not \$4.50— but \$2.50.

See your jobber for the facts on the Zetka tube meter display—a sales proposition worth considering.

ZETKA
The Clear Glass Tube

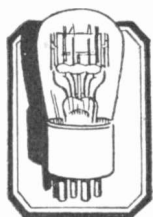

Z 171

A specially designed superior power amplifier. Plate voltage up to 180 volts.

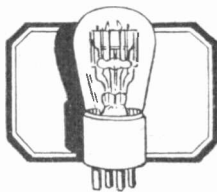

Z 112

Another exceptional power tube for voltages up to 135 volts. Designed for superior power performance.

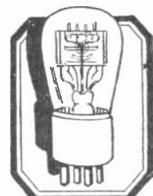

Z 200 A

A super-sensitive ¼ amp. oxide filament detector. Absolutely quiet, extremely sensitive, longer lived.

ZETKA LABORATORIES, Inc.
73 WINTHROP STREET
NEWARK, N. J.

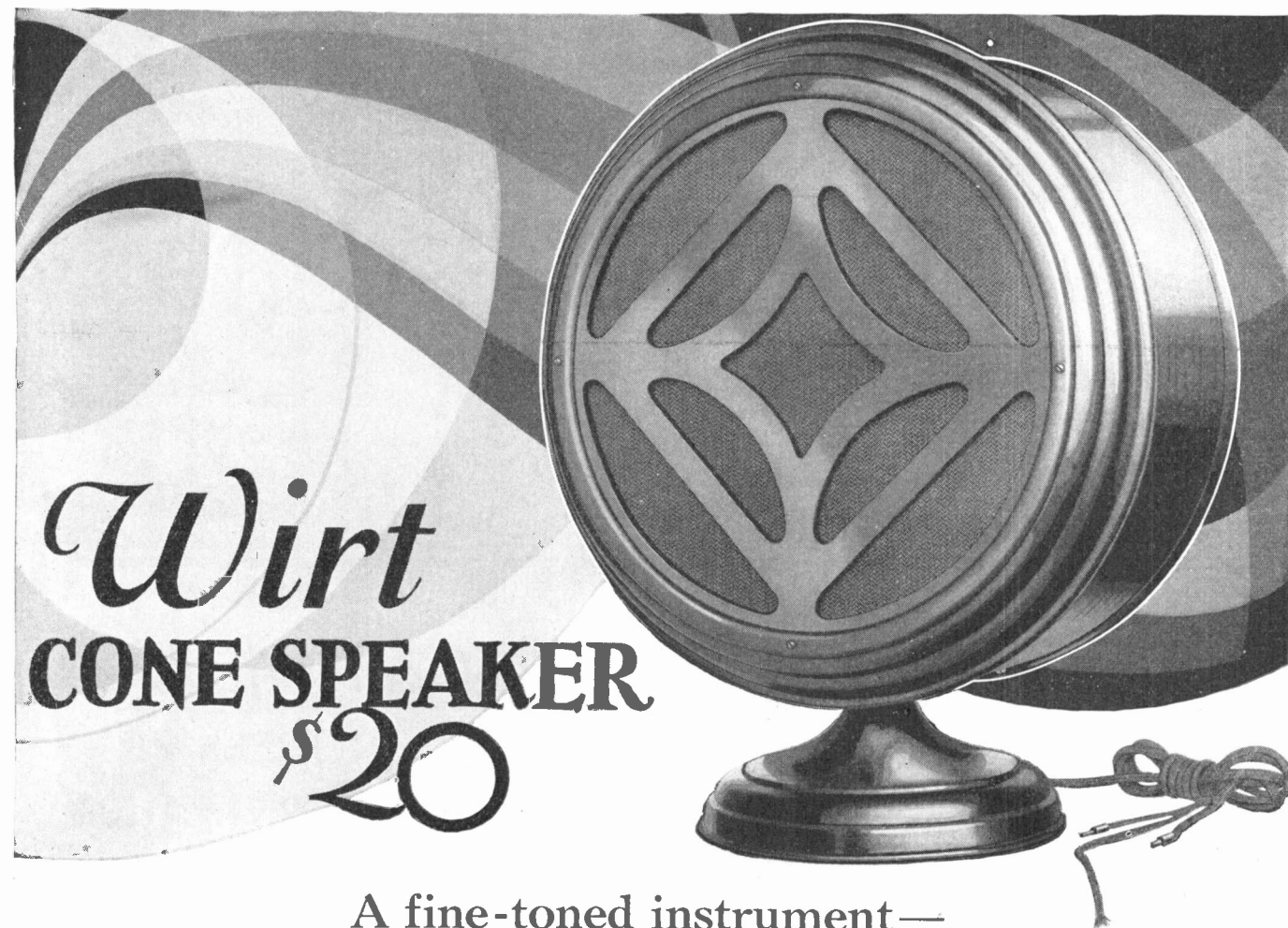

A fine-toned instrument—
of exceptional volume—
at a popular price

You'll like the Wirt Cone Speaker. It is an item that you can sell with unreserved enthusiasm, certain that it will give perfect reproduction and that it will stand up well in service.

It has good looks to commend it. Its tone is mellow, resonant and wonderfully clear. And it has sufficient capacity to deliver—without blast or distortion—the full volume of the set.

The highly sensitive unit is wholly the creation of Wirt engineers, as is every other part. Electro magnetic and extra large, it is capable of reproducing the

full range of audible sound from the deepest tones to the highest.

The cone is the free edge type and of a size and design to give best results under all conditions. A special feature is the adjusting knob at the back, a slight turn of which will correct any variation in the armature, thus eliminating the need of dismantling.

And the price, \$20, is low enough to make practically every set owner a likely buyer. You are authorized to stand back of the Wirt to the limit, for the Wirt Company will stand back of you. That has been its policy for years.

*Get in touch with your jobber at once.
He will allow you the usual radio discount.*

WIRT COMPANY

5239 Greene St., PHILADELPHIA, PENNSYLVANIA

Makers also of Wirt Radio Lightning Arrester, Wirt Radio Wall Insulator and the Wirt Dim-a-lite

Now SHOWERS 1927 Creation

DEALERS:

You can sell this set, and cabinet with speaker enclosed, for less than \$100.00.

Showers Brothers announce the La Phonic, a highly developed radio product, destined to be a favorite for 1927.

The La Phonic was created for successful Radio Merchants in every section of the country who qualify for our "one dealer in a town policy" with exclusive protected Franchise. La Phonic will meet the demands of the popular market for quality and new merchandise at the right price.

The Showers Brothers La Phonic is a six tube, single control, metal shielded, tuned radio frequency set. The cabinet finished in walnut, is full-sized, measuring 42-in. high, 28-in. wide, and 18-in. in depth, and contains the new 1927 Utah 22-in. cone speaker.

The La Phonic model cabinet is particularly suited for use with the Atwater-Kent and many other radio sets. Showers cabinets can be bought without Showers Sets and ready for use with other makes of radio.

It will pay you to investigate the Showers Brothers Cabinets.

59 years of successful manufacturing experience is your assurance of satisfactory business relations with this old established and reputable organization.

Write promptly for literature and details.

SHOWERS BROTHERS COMPANY

Established 1868

Radio Division

914 South Michigan Boulevard, CHICAGO

Factories: Bloomington, Ind.

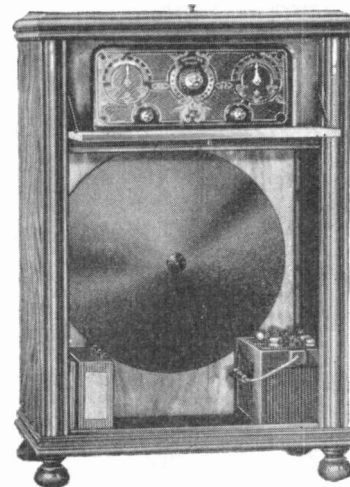
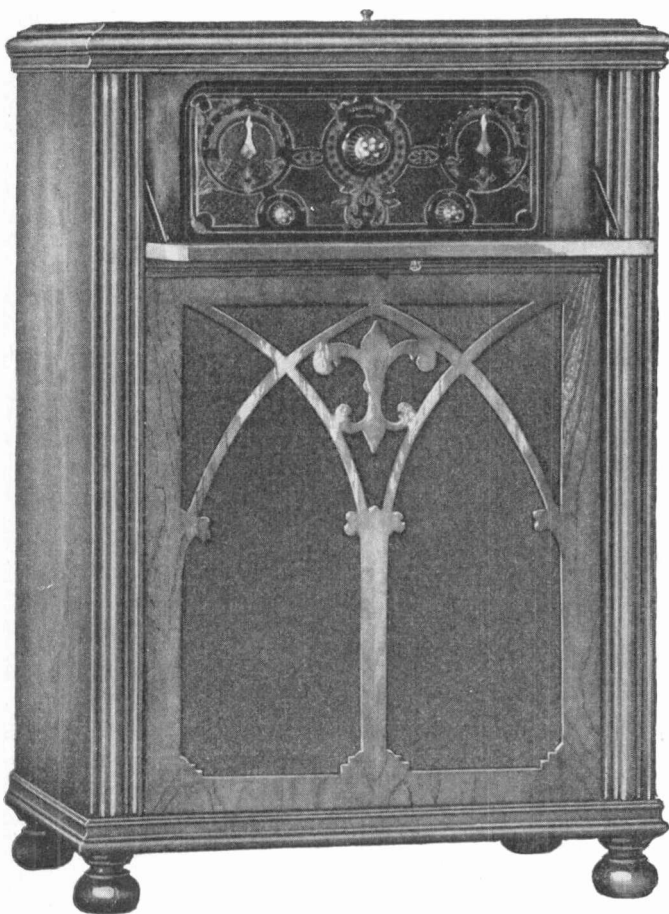

There is plenty of cabinet space for accessories and it is easy to locate and reach them when attention is required.

THE LA PHONIC RADIO

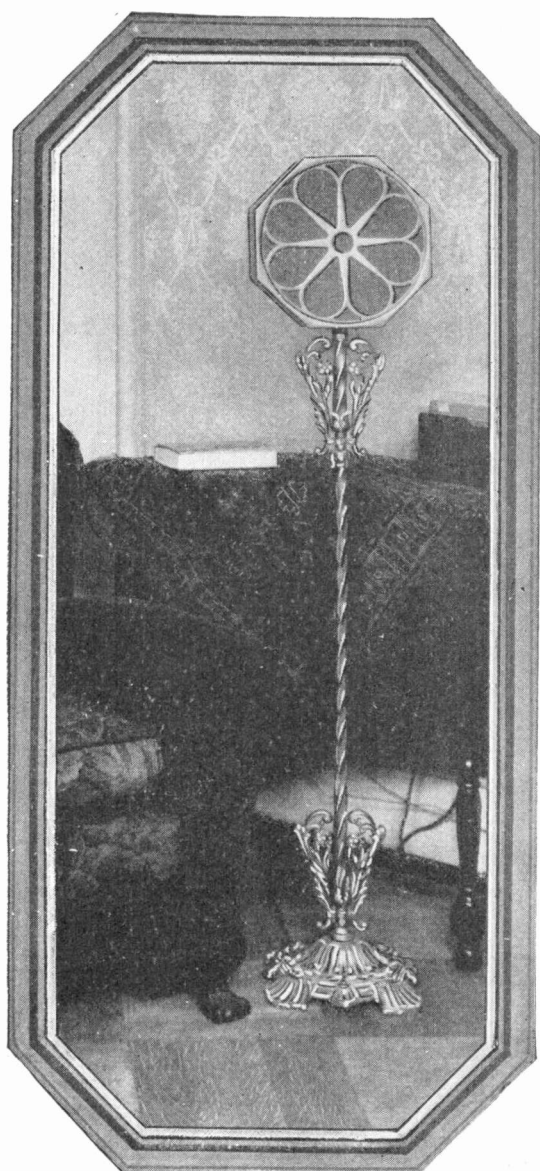

New *Pedestal* Model

\$34⁵⁰
*Slightly higher
 West of the Rockies*

The famous Pausin OCTACONE "accurate as the human ear," mounted on a handsome pedestal, elaborately carved and finished in Antique Gold, harmonizing with any surroundings.

EXQUISITE!

And its *performance*
 matches its beauty!

THIS newest Pausin Speaker permits you to offer your customers the marvelous OCTACONE reproducing powers, the mellow tone, the liquid sweetness, the accuracy surpassing any other speaker in its price class. Moreover it possesses a beauty of form that makes it a genuine addition to the furnishings of the most luxuriously appointed home.

Get acquainted with OCTACONE convenience and exquisite beauty as represented in this new Pedestal model. It will appeal not only to the new buyer, but to the man who already owns one speaker—a double market.

The PAUSIN OCTACONE

Pausin Engineering Company, 727 Frelinghuysen Ave., Newark, N. J.

Power Tubes
Require a "B" Power Supply
Specially Designed to handle them

Here it is!

The
Kellogg

"B"
power unit



Guaranteed to deliver 180 volts with 40 milliamperes draw and 100 volt, A. C. Supply

Here, at last, is the "B" supply unit that fills the crying need created by the 171 Power Tube.

It will deliver the necessary 180 volts at a current draw equal to the most extreme conditions.

Don't trust your reputation to the rated volt capacities of Eliminators! Check them with a high resistance volt meter with the supply unit in actual operation on the set with which it is to be used. Be sure you are selling a unit that will enable the set you sell to perform at its best when equipped with 171 Power tubes. The Kellogg "B" Power Unit will stand up to this test

on any factory built set now on the market not drawing over 40 milliamperes, and will furnish more than 40 milliamperes at corresponding voltages. The vital importance of adequate "B" voltage is apparent to every dealer concerned with giving satisfaction to his trade—and in reducing service expense to the minimum.

The Kellogg "B" Power Unit produces a remarkably FLAT curve. The voltage holds constant within narrow limits during the varying conditions of set operation. Beautifully pure, undistorted tone is the result. Here is something essential to the well being of Your Radio Business.

Dealer and Jobber Franchises Now Open to Aggressive Merchandisers
 Write us at once for details of the distribution plan for Kellogg "B" Power Units. This unit fills a need growing greater and greater every day. Be prepared!

The coupon will bring you full details—Mail it at once.

Kellogg Switchboard & Supply Co.

Dept. R. R. 3, Chicago, Ill.

KELLOGG SWITCHBOARD & SUPPLY CO.,
 Dept. R. R. 3, Chicago, Illinois.

Please send me full details concerning your "B" Power Unit, designed especially for supplying adequate voltage for high current consuming sets equipped with 171 Power Tubes.

Name

Address

For sure-fire selling

You will find that there's nothing in the "A" power line that can beat this as a sure-fire seller—the Prest-O-Lite Trikl-Auto-matic "A" Power Unit. The low prices to you, combined with a number of unusual features, make this unit extremely profitable and fast selling.

Made in two types. Type AX supplies "A" current and has automatic relay, turning charger off when set is turned on. In addition, it has connection for "B" power, making radio set 100% automatic power operated when used in conjunction with any "B" power device.

Type A—supplies "A" current only.

Each unit has 40 ampere-hour

Prest-O-Lite Radio Battery, 6 volts, specially designed to carry a large volume of electrolyte, eliminating the necessity of frequent watering, and a built-in hydrometer. A full-wave charger, silent, without liquids, bulbs or moving parts, indestructible and highly efficient, with adjustable charging rate. Built in a compact durable metal case attractively finished in maroon and with handle.

Prest-O-Lite also makes standard radio "A" batteries, 60, 80, 100 and 120 ampere-hour capacities. These, with the new Trikl-A units, make the Prest-O-Lite contract more profitable than ever before. Write for full details!



\$34⁵⁰

TYPE AX

\$29⁵⁰

TYPE A

Prices slightly higher west of Rockies

THE PREST-O-LITE CO., INC., INDIANAPOLIS, IND.
New York San Francisco
Unit of Union Carbide and Carbon Corporation

Prest-O-Lite

A Real Sales Maker

Made of selected genuine Mahy. or Amer. Walnut Plywood. Finished two tone Antique Brown Mahy. or American Walnut. Battery Compartment. High grade Loud Speaker Wood Horn and 'TAH-LOW' SPEAKER UNIT COMBINED. 30-in. High, 32-in. Wide, 15-in. Deep. Average shipping weight 62 lbs. Price Antique Brown Mahy. \$36.00. Price, Antique Amer. Walnut \$36.75. Write for liberal jobber and dealers discounts.



Radio Console No. 505

Exclusive United States Sales Representatives

SANFORD BROS.

CHICAGO, ILL.
30 W. Walton Place

CHATTANOOGA, TENN.
615 Broad St.
SAN FRANCISCO, CAL.
311 Minna St.

SEATTLE, WASH.
Amer. Bank Bldg.

Business Wants

THE *Searchlight* Section of this paper represents a meeting place for men and concerns who have immediate business "wants" to fill—the section covers

- Agencies Wanted
- Agents Wanted
- Books and Periodicals
- Business Opportunities
- Civil Service Opportunities
- Contracts Wanted
- Desk Room for Rent or Wanted
- Educational
- Employment Agencies
- Employment Service
- Foreign Business
- For Exchange
- For Rent
- For Sale
- Franchises
- Labor Bureaus
- Miscellaneous Wants

- New Industries Wanted
- Office Space for Rent or Wanted
- Partners Wanted
- Patent Attorneys
- Patents for Sale
- Plants for Sale
- Positions Vacant
- Positions Wanted
- Property for Sale
- Representatives Wanted
- Salesmen Available
- Salesmen Wanted
- Spare Time Work Wanted
- Sub-Contracts Wanted
- Tutoring
- Vacation Work Wanted
- Work Wanted

CLIP TIME OFF WIRING JOBS BY USING



Approved by the Underwriter Lab.
Cartons of 100 — Standard Package 1000

For Free Working Samples Sign Below and Mail

Name _____

Address _____

COLT'S PAT. FIRE ARMS MFG. CO., HARTFORD, CONN.



An Insulating Cap with a split screw that bites twisted wire ends.

"SEARCHLIGHT"

Outlasts
6 to 8 ordinary
dry "B" batteries ~ ~ ~
can be recharged 6 to 8
times at the cost of 1½
cents for current ~
and retails

at \$4.50

45 volts
 30 cells



Why TAB "B" Batteries Sell!

TAB is the only *rechargeable* dry "B" Battery. It retails for little more than the ordinary dry battery, yet it gives six to eight times longer service. In addition to having an extremely long original life, a TAB can be recharged to full strength 6 to 8 times with any standard "B" battery charger.

For noiseless, dependable reception the TAB battery has no equal.

Is it any wonder that a battery like TAB has established such a sales record?

Announcing!

TAB "A"—
 1½ Volt Dry Cells

For Radio—Ignition and
 All General Purposes

The TAB No. 6A—1½ Volt Dry Cell enjoys the same rechargeable features as the now famous TAB "B" Batteries. Full information will be sent on request.

Patented and Manufactured Exclusively by
 DRY STORAGE BATTERY CORPORATION, 213 So. Broad St., PHILADELPHIA



Service Set and Tube Checker
 — Locates Trouble Instantly —
 "Saves an hour per job."
 Tests every circuit in any set. Un-
 necessary to disconnect batteries or
 probe with test leads. Tests tubes
 for dynamic characteristics.
 Built-in wave meter. Weighs
 only 9 3/4 lbs. complete in
 handsome carrying case with
 tool and tube compartment.

Net \$90.00 complete set

Net \$60.00 complete kit

Write for free blueprint and full details.

DUSTON RADIO LABORATORIES, Inc.
 4464 Cass Avenue DETROIT, MICHIGAN

You Can Sell One to Every Battery User

Beede Pocket Voltmeter

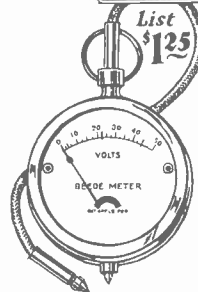

Recommend and Make a Friend!

The B Battery buyer will appreciate your advice . . . "test the Batteries, insure against poor or interrupted reception likely to happen just when you're all ready to tune in on some special program. Use a Beede Pocket Voltmeter—convenient and accurate."

There's a Beede Meter for Every Battery Need!

Beede A Battery Tester, \$1.50

Clean and convenient way to accurately test A Batteries—tests all or any single cell—indicates when to charge—when to stop.

Beede Midget Swivel Jack Voltmeter, \$2.50

A snug, fitting instrument for Radiola, Victor and Brunswick superhets—white on black dial makes easy reading. Like all Beede Meters guaranteed for accuracy.

FREE We Furnish Dealers With Special Labels to Help Educate Battery Buyers to Use Meters FREE

ASK FOR CATALOG BUY FROM JOBBER

BEEDE ELECTRICAL INSTRUMENT CO.
 FACTORY, PENNACOOK, N. H.
 N. Y. Sales Office: 136 Liberty St., John L. Madsen, Manager

ACME ENAMELED ANTENNA



Best outdoor antenna you can buy. 7 strands of enameled copper wire; maximum surface for reception. Prevents corrosion and consequent weak signals.

The Original Celatsite

—a tinned, copper bus bar wire with non-inflammable "spaghetti" covering, for hook-ups. 5 colors; 30-inch lengths.

We also offer the highest grade of "spaghetti" tubing for Nos. 10 to 18 wires. 5 colors; 30-inch lengths.

Flexible Celatsite



Flexible, stranded wire for point-to-point and sub-panel wiring. Non-inflammable "spaghetti" covering. In black, yellow, green, red and brown; a color for each circuit. Put up in 25-foot coils.

Celatsite Battery Cable

—a silk-covered cable of vari-colored Flexible Celatsite wires, for connecting batteries to set. Prevents "blowing" of tubes; gives your set an orderly appearance.

Dealers Write for Acme Wire Products Folder E

THE ACME WIRE CO. - New Haven, Conn.

ACME WIRE
 MAKES BETTER RADIO

\$10 Loud Speaker

You can sell, at \$10, the most satisfactory loud speaker that money can buy—the perfected Dulce-Tone, the nationally accepted radio-talking-machine-speaker. Set the talking machine needle in the Dulce-Tone reed, plug in, and you have the full volume, the beautiful clear tone that only Dulce-Tone and a talking machine can give.

THE GENERAL INDUSTRIES COMPANY
 Dulce-Tone Division
 Formerly named THE GENERAL PHONOGRAPH MFG. CO.
 26 Taylor St., Elyria, Ohio

Fully guaranteed to you and your customers. Nationally advertised and universally approved.

Write for sample and dealer's prices.



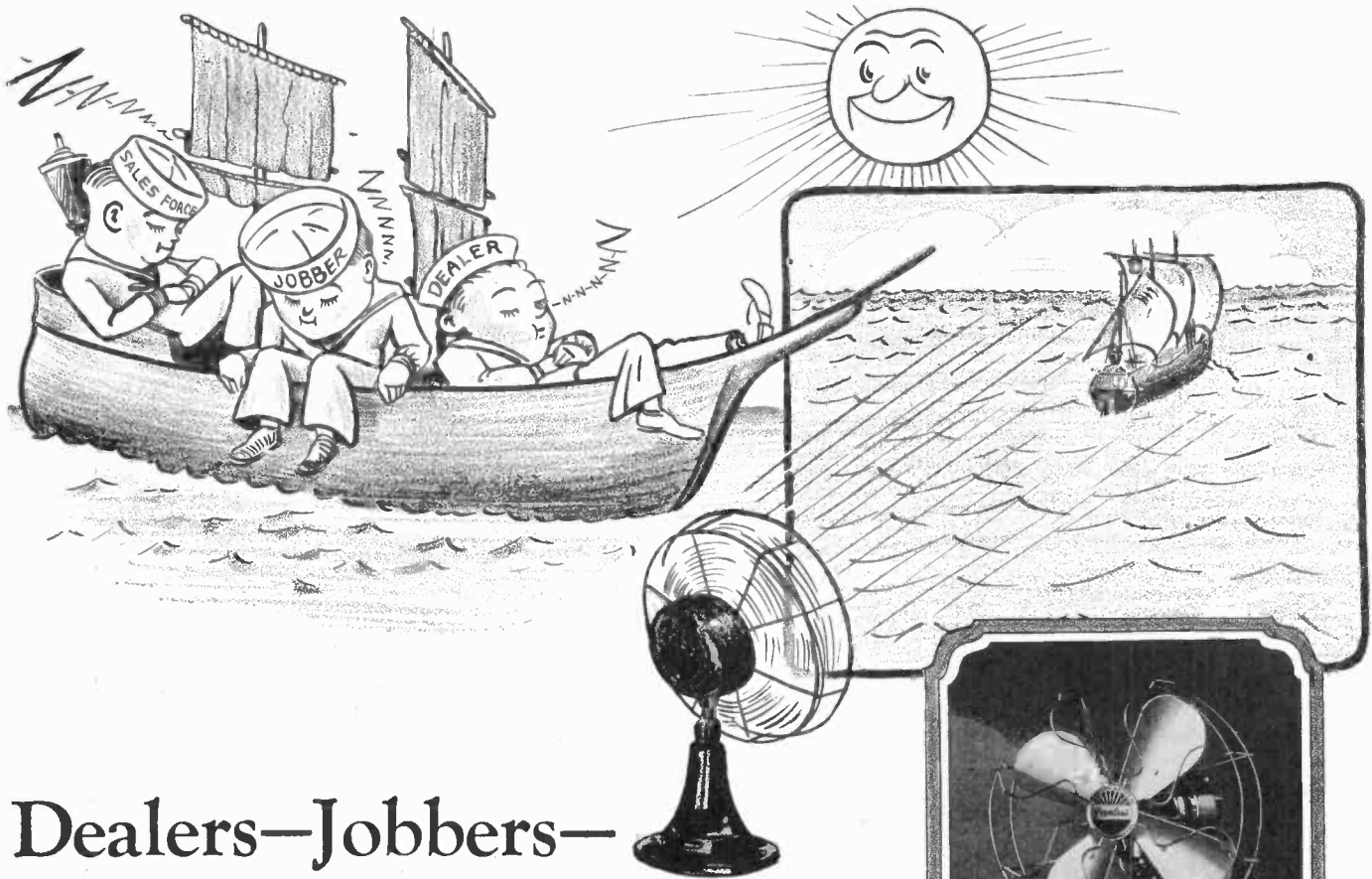

Dealers—Jobbers— Becalmed for Summer

The dead summer calm of radio business—scarcely a breath of breeze to move the business ship. Both dealer and jobber faced by the necessity of either carrying an expensive sales force over profitless months, or letting them go, and going through costly rebuilding in the autumn—

Floor space eating its head off in rent—windows that aren't worth a nickel—the fact that dealers and jobbers are able to survive at all is a tribute to their business ability.

But why try to just survive under such circumstances? There is a way to get some wind in your sales—Peerless Fans. They'll move the business ship.

The same sales force you have built for radio distribution can handle fans in volume. Profits are good, servicing negligible, stocks easy to carry and—

As Old Man Winter Sells Radios Ole Sol is Peerless' Best Salesman.

Send for our proposition. Let us tell you of Peerless' wonderful quality and sales appeal.

THE PEERLESS ELECTRIC CO., WARREN, OHIO

The Silent
Peerless Fan

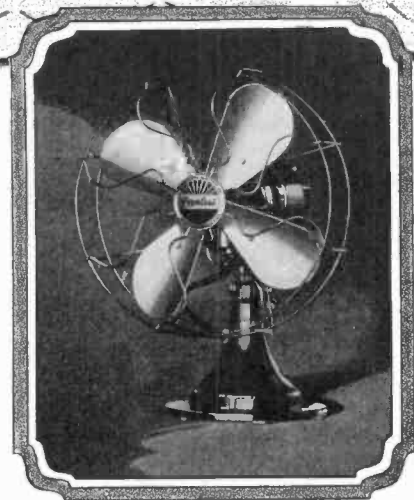

*Radio for Winter
Peerless Fans
for Summer*

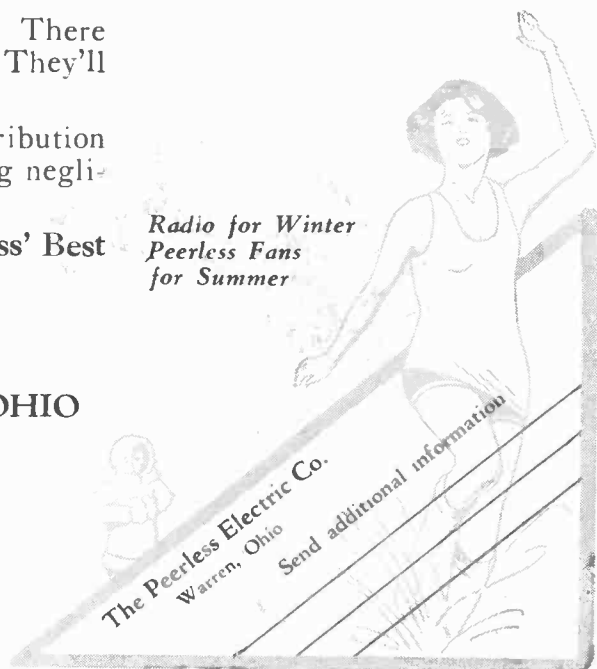

The Peerless Electric Co.
Warren, Ohio

Send additional information

Measurement of Battery Eliminator Voltage

REPUTABLE DEALERS are glad to know the truth with regard to new radio products, quick to discard those which do not perform, and eager to push those they know will be successful. ¶ Here is a new Weston Quality Radio Instrument which will show the actual performance of a battery eliminator to you and to your customers. It is a scientific instrument beautifully made with marked advantages over other types for this purpose. It gives you an accurate reading of the actual voltage being delivered by the battery eliminator—because of its high internal resistance of 1,000 ohms per volt, consequently its low current consumption of only one milliamperere for full scale deflection! ¶ You can use Weston Model 489 Battery Eliminator Voltmeter on your counter to advantage, showing your customer the quality of the battery eliminator you sell him. ¶ Knowing Weston instruments, their high standard of perfection, you will also have numerous requests for purchase of the instrument itself. ¶ For complete information address---

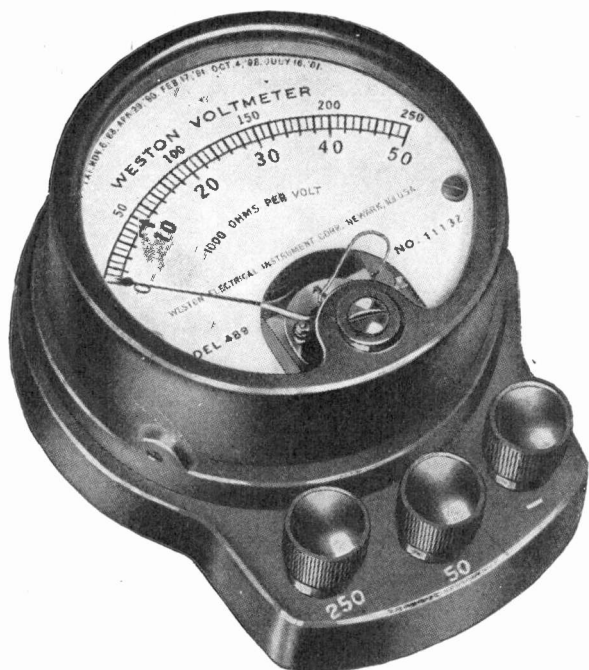

WESTON ELECTRICAL INSTRUMENT CORPORATION
25 Weston Avenue, Newark, N. J.



The **HANDY** "A" Power Unit

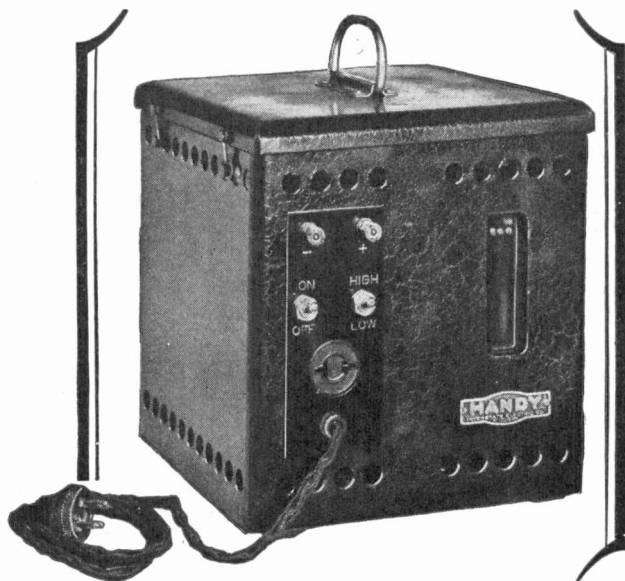

Dependable Power

THE HANDY "A" POWER unit is made up of two well-known and reliable units. First, the Willard glass 40-ampere hour capacity advanced design storage battery with visible indicators of strength of charge and visible solution gauge. Second the ever reliable HANDY TRICKLE BOOSTER bulb type charger to insure a fully charged battery regardless of how much you use your Radio and a means to eliminate the sulphation of your battery. These two units and the necessary switches and connections are all encased in a substantial and beautiful steel case finished in leather green crackle and nickle trimmings. We also equip this unit with an automatic control which cuts off the charging unit and eliminates any possibility of hum and furnishes power to the "B" Eliminator where one is used. This is a profitable unit, fully refined in all details to insure absolute satisfaction. Write for discounts and further information.

\$40⁰⁰
COMPLETE
with Willard glass
battery. \$42.50 with
automatic relay.

INTERSTATE ELECTRIC COMPANY
4351 Duncan Ave. St. Louis, U. S. A.

INTERSTATE

The following fourteen manufacturers are the only ones licensed to manufacture Neutrodyne receivers and the protective policies maintained by the Hazeltine Corporation and Independent Radio Manufacturers, Incorporated, apply only to the Neutrodyne receivers made by them:

THE AMRAD CORPORATION
Medford Hillside, Mass.

F. A. D. ANDREA, Inc.
New York City

CARLOYD ELECTRIC & RADIO
COMPANY
Newark, N. J.

EAGLE RADIO COMPANY
Newark, N. J.

FREED-EISEMANN
RADIO CORPORATION
Brooklyn, N. Y.

GAROD CORPORATION
Belleville, N. J.

GILFILLAN RADIO
CORPORATION
Los Angeles, Cal.

HOWARD RADIO COMPANY,
INC.
Chicago, Ill.

KING-HINNERS RADIO
COMPANY, INC.
Buffalo, N. Y.

WM. J. MURDOCK CO.
Chelsea, Mass.

STROMBERG-CARLSON
TELEPHONE
MANUFACTURING COMPANY
Rochester, N. Y.

R. E. THOMPSON
MANUFACTURING CO.
Jersey City, N. J.

WARE RADIO CORPORATION
New York City

THE WORK-RITE
MANUFACTURING CO.
Cleveland, Ohio

HAZELTINE CORPORATION
(Sole owner of "Neutrodyne" patents
and trade-mark)

INDEPENDENT RADIO
MANUFACTURERS,
INCORPORATED

(Exclusive licensee of Hazeltine Corporation)
Look for this trade-mark

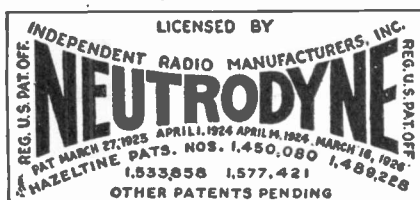

It is your protection against patent infringement
liability

This stabilizing influence — NEUTRODYNE

ONE question about radio is being asked on every hand: "What is a good set to buy?"

That is what the public asks of those who are supposed to know the fundamental facts about radio.

And more and more is the public being told just this: "Get a Neutrodyne."

For Neutrodyne the reliable, Neutrodyne the non-interfering, Neutrodyne the simple to operate, Neutrodyne the unique and inimitable, sets a standard of performance for home radio. Engineers knew from the beginning that without the Neutrodyne principle, Neutrodyne results—which mean the best possible results—would not be had. The public, through bitter experience, has learned this at first hand.

So, when you ask yourself "What is a good set to sell?" you can make yourself the answer: "Get a Neutrodyne."

For Neutrodyne has demonstrated, in the laboratory, in the shops of the nation, in homes everywhere, and even in the courts, that it is unique not only in principle, but in permanence. Designed solely for broadcast reception, kept in the forefront of the art by thirty radio engineers, Neutrodyne has never known a setback. It is here "for the duration of broadcasting"—and for the profit of dealers and the pleasure of listeners.

"GET A NEUTRODYNE"

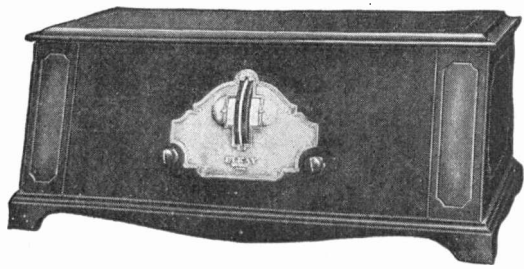

Licensed Under Patents Granted and Pending.



Truphonic Senior "6"

THE Senior renders in true tone and color all the notes of the scale, from bass to treble. It brings in the voice in natural, human quality; particularly women's voices! This remarkable fidelity is due to its Truphonic Audio, plus uniform precision engineering.

Besides remarkable tone, the Senior has:

The Elkay (patented) Synauto R. F., which tends to smooth out the tuning over the entire dial, from 200-580 meters.

Complete shielding against outside strays and inter-stage coupling; a quieter "background."

Uni-Control; the flexibility of three dials under your thumb, but with fine adjustments for selectivity.

The Elkay system of interchangeable cartridge rheostats, permitting instant change to any combination of tubes without alteration of wiring.

Handsome, sloping cabinet of antique, natural grain mahogany, Duco finished, \$125. Write for franchise.

The Senior will be completely described in technical detail in the editorial section of the April issue of Popular Radio, on sale about March 20th.

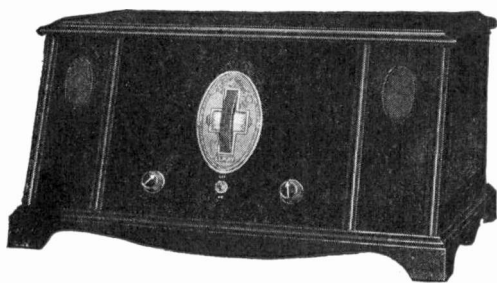

Elkay Junior Six

The "Junior" is Elkay quality through and through. It is a T. F. R. receiver built after the most approved practice of the day. Shielded coils, cushioned detector, simplified dual thumb dial tuning, combined transformer and resistance coupling. Designed for those who want Elkay quality and precision engineering but who cannot afford to invest more than \$80, which is the price minus accessories. Write for folder.

THE LANGBEIN-KAUFMAN RADIO CO.
Dept. M, 62 Franklin St., NEW HAVEN, CONN.

Profits for You Satisfaction for Your Customers

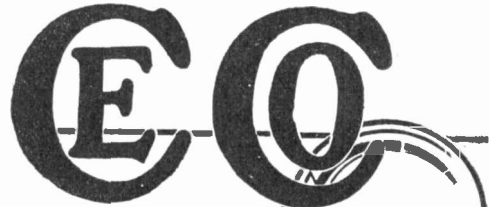

Surely it is safe for you to recommend CeCo Tubes, which are endorsed by Brown, Lynch, Cockaday and other famous radio authorities.

*The Tube
of
Longer
Life*

*A Type
for Every
Radio Need*

Makes a Good Receiver Better
Write for Complete Data Sheet
C. E. MFG. CO. Inc. . . . PROVIDENCE . R. I.

The Enchanter Radio Cone Speaker

A RICHLY decorative radio cone speaker capable of reproducing the entire tonal scale with true, full fidelity. Operates equally well without or with power tube.

THIS strikingly beautiful radio cone speaker makes an instantaneous appeal to the eye. The cast metal galleon is hand decorated in polychrome colors of silver grey, green, yellow and red.

Sells at \$30 list.

National Distributors
Baker-Smith Co., Inc.
Call Bldg.,
San Francisco, Calif.



Height 15 in., Diameter 13 in.

NEW!

*Eveready Layerbilt
"B" Battery No.
486, the Heavy-
Duty battery that
should be specified
for all loud-speaker
sets.*

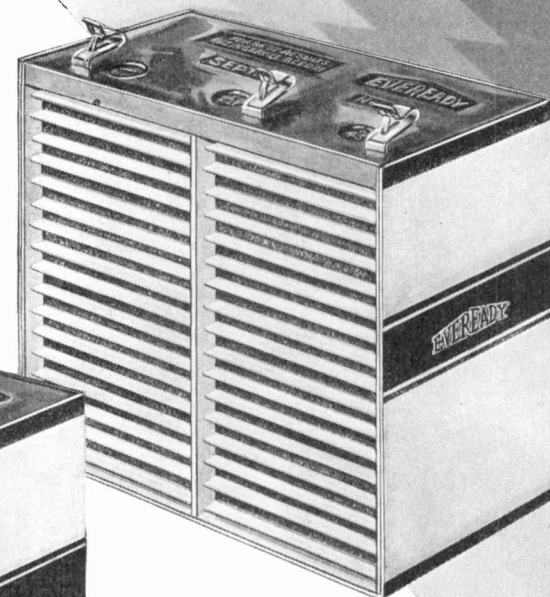

*The Layerbilt pat-
ented construction
revealed. Each layer
is an electrical cell,
making automatic
contact with its
neighbors, and fill-
ing all available
space inside the bat-
tery case.*

DIFFERENT!

This, the most economical "B" battery to use, is the most satisfactory to sell

OUT of the murk of contrasting claims in radio one thing stands clear: The Eveready Layerbilt "B" Battery No. 486 is, without doubt, the most economical of "B" batteries. It is, therefore, beyond all question, the preferred battery for dealers who are creating and holding their trade by selling satisfactory merchandise only. There is a decided swing of public demand to the Heavy-Duty size "B" battery, and that swing is going to be more and more pronounced as people learn that only from Heavy-Duty Layerbilts can they secure real economy on loud-speaker sets. In the Eveready Layerbilt you have the

longest-lasting of all Heavy-Duty batteries. It costs the consumer 25 cents more, but the increase in service is much greater than the slight addition to the price.

Eveready Layerbilt's surprising performance is due to its construction. It is built in layers of flat current-producing elements, which make connection with each other automatically, and fill all available space inside the battery case. Layer-building packs more active material in a given area and makes those materials produce more electricity.

Radio users will get maximum satisfaction from their loud-speaker sets, maximum "B"

battery economy, and you will build your reputation to greater heights, if you sell this, the greatest dry cell "B" battery ever built. Order the Eveready Layerbilt from your jobber.

NATIONAL CARBON CO., Inc.
New York San Francisco
Atlanta Chicago Kansas City
Unit of Union Carbide and Carbon Corporation

Tuesday night is Eveready Hour Night—
9 P. M., Eastern Standard Time.

- | | |
|------------------|--------------------|
| WEAF—New York | WGN—Chicago |
| WJAR—Providence | WOC—Davenport |
| WEEL—Boston | WCCO—{ Minneapolis |
| WTAG—Worcester | { St. Paul |
| WFI—Philadelphia | KSD—St. Louis |
| WGR—Buffalo | WRC—Washington |
| WCAE—Pittsburgh | WCY—Schenectady |
| WSAI—Cincinnati | WHAS—Louisville |
| WTAM—Cleveland | WSB—Atlanta |
| WWJ—Detroit | WSM—Nashville |
| | WMC—Memphis |

A Challenge

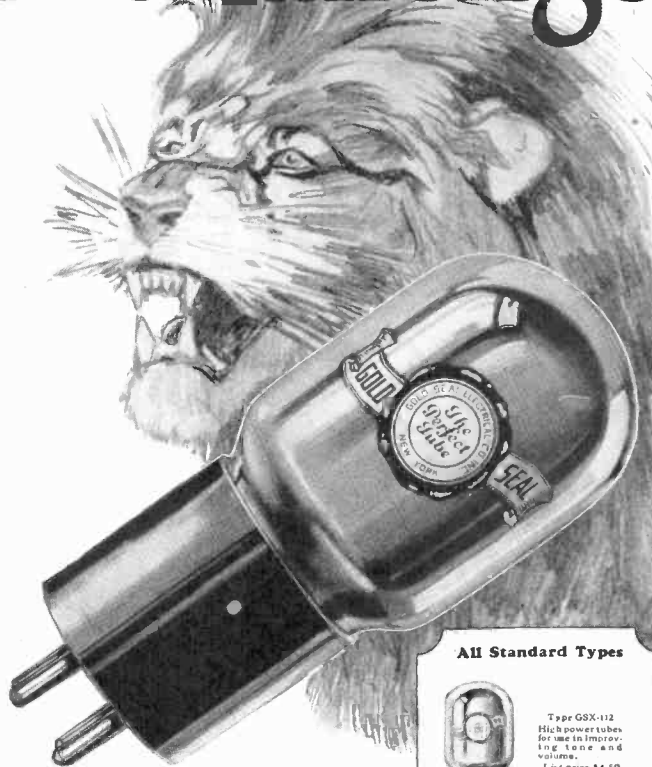

Gold Seal Challenges the Radio Tube Field

1. **PRODUCT**—for uniformly highest quality; superior tone; and longer life.
 2. **PACKAGE**—for attractiveness of container; convenience in handling, test and demonstration; and freedom from breakage.
 3. **DEALER HELP**—for literal co-operation and substantial aid—a square deal to all.
- PROFIT**—for unprecedented rise to quick-selling popularity.

Backed by a large national advertising campaign and the straight-forward guarantee of a strong company, the Gold Seal line offers many advantages to jobbers and dealers. [Mail coupon today for full details.]

GOLD SEAL ELECTRICAL CO.
Incorporated
250 PARK AVE., NEW YORK

Gold Seal Radio Tubes

Jobbers—A few attractive territories still open—write for details—at once.

COUPON
GOLD SEAL ELECTRICAL CO., Inc.
250 Park Avenue, New York, N. Y.
Gentlemen:—Please send me full particulars of the Gold Seal line and your attractive proposition to
 Jobber Dealer

Name _____ Address _____ City _____

All Standard Types



Type GSX-112
High power tubes for use in improving tone and volume.
List price \$4.50



Types GSX-201a and Gs-201a
The popular general purpose type for amplifier or detector. Long life and high efficiency.
List price \$1.75



Type GSX-216B
For use in battery eliminators to rectify alternating current—advantageous in supplying the higher current required by power tube equipped sets.
List price \$7.50



Type GSX-171
High power tubes for use in last stage of audio amplification give increased volume.
List price \$4.50

THE HYATT 6-TUBE PORTABLE RADIO RECEIVER—NEW MODEL



A portable radio receiver of highest quality and substantial construction for the home, hotel, club, hospital.

Selective. Long Range. Tone Quality and Volume.

Employing 6-C 219 or UV 199 Tubes. 3 Standard Dry Cells. 2 Burgess No. 4308 "B" Batteries and 1 No. 5360 Burgess "C" Battery.

Equipment includes Loop. Aerial. Inbuilt Speaker with Unit. Single Dial Control.

Enclosed in Black Leatherette Covered and Well Built Cabinet 15-in. wide, 11 1/2-in. high and 9 1/4-in. deep. Wt. 14 lbs. less tubes and batteries. 28 lbs. fully equipped.

LIST PRICE
Less Accessories
\$85.00
F.O.B. CHICAGO, ILL.
LIST PRICE WITH FULL EQUIPMENT
\$105.00

Jobbers and Distributors
Join us in the distribution of this Wonderful Receiver.
Write for our Plan and Discounts

Dealers
If your Jobber can not serve you, write us for our Circular and Discounts.

THE ELECTROPHONE CORPORATION
109 NO. WABASH AVE., CHICAGO, ILL.

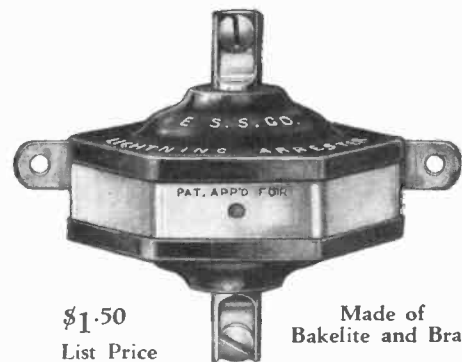

\$1.50
List Price

Made of Bakelite and Brass

Keystone is the one lightning arrester the radio public knows by name and relies upon for performance.

You can sell Keystone profitably at the nationally advertised price of \$1.50.

ELECTRIC SERVICE SUPPLIES COMPANY

Philadelphia 17th & Cambria Sts. New York 50 Church St. Chicago Illinois Merchants' Bank Bldg.

KEYSTONE RADIO LIGHTNING ARRESTERS

Radiola 20 with its new price is sweeping the country.

People everywhere are talking about this big "buy" in radio.

With the special Watsontown proposition, here is an opportunity never before approached for big cabinet sales at a real profit.

The greatest cabinet selling opportunity you have ever had!

The greatest value in radio today



\$78

Radiola 20. de...
PC...

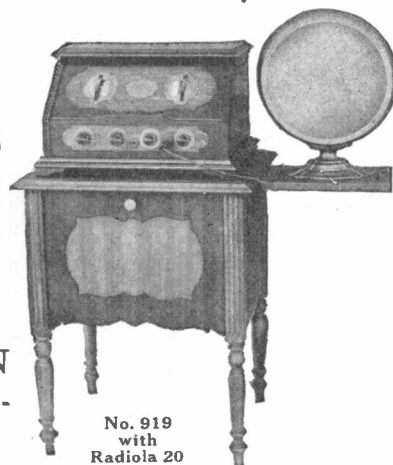

No. 919 with Radiola 20

GET THE SPECIAL WATSONTOWN PROPOSITION THAT ENABLES YOU TO OFFER THIS FINE CABINET AT ASTONISHING PRICE AND PROFIT.

A fine cabinet to match the Radiola 20!

It not only matches it . . . here is a cabinet that stands out for its workmanship and finish, and solid construction.

Watsontown never has and never will turn out a cabinet that does not pass the most critical and rigid in-

spection. This policy has made friends and has built up a splendid volume of sales.

Remember! . . . the people who are buying Radiola 20 are just the kind of customers to whom the Watsontown proposition appeals most strongly; critical customers who appreciate values!

Get this Watsontown proposition. Let us give you details of this cabinet and its astonishing price and profit.

Watsontown Table & Furniture Co.
Watsontown, Pennsylvania
Established 1893

ARE YOU TAKING ADVANTAGE OF HOMMEL'S DEALERS' SERVICE AND REPAIR DEPARTMENT ?

THE House of Hommel maintains a dealer service unexcelled if even equaled by any other radio jobber. In addition a complete repair and inspection department takes care of all sets needing minor repairs, thus saving the time and trouble of sending them to the factory. Hommel's Catalog No. 27-R will be sent on request.

WHOLESALE **LUDWIG HOMMEL & CO** EXCLUSIVELY
929 PENN AVENUE PITTSBURGH, PA.

CASE
SIX TUBE SETS

Indiana Mfg. and Electric Co.
Marion, Indiana

You BENEFIT

EVERY person in industry and trade who answers a McGraw-Hill questionnaire contributes directly to the welfare of the particular business with which he is identified.

McGraw-Hill makes it a rigid policy not to send you a questionnaire unless the information which you possess can be made of vital interest to American business.

The success of McGraw-Hill Publications in obtaining basic information is due to general recognition of the fact that a McGraw-Hill questionnaire is accepted in this spirit everywhere in industry and trade.

THE PUBLISHERS

MAGNAVOX

Cone Speaker Units Improve any set

Little but loud—
fits your hand
and your cabinet

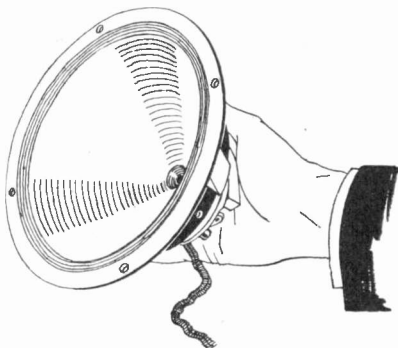

Best known and most readily accepted speaker.

Only 8 5/8 in. in diameter—fits any cabinet. Simplest to install—only 4 screws to turn.

Covers wide range of frequencies. Passes bass notes wonderfully clear.

Beautiful tone quality with volume for largest residence use. Takes the wallop from biggest sets.

Surprisingly low list price and liberal discount.

Send coupon right now for proposition that means money to you.

THE MAGNAVOX COMPANY

General Offices and Factory: OAKLAND, CALIF.
Chicago Sales Office—1315 South Michigan Ave.

To get an idea of how the Magnavox Cone Speaker Unit fits your cabinet, cut out a circle 8 5/8 in. in diameter and use as a template. Mounting screws are 8 3/16 in. apart.

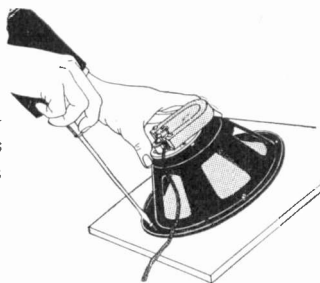

Turn only 4
screws — takes
only 4 seconds

Send this coupon now to nearest office.

THE MAGNAVOX COMPANY

Send full details of cone speaker unit proposition.

Name

Address

City

THE STERLING \$27⁰⁰ RT-41, now



—the low priced “B” Eliminator that sells— and stays sold!

HERE is the right “B” Eliminator to sell to owners of moderate sized sets—those who have two to five large tubes or more than five peanut tubes. And you can sell it, too, because of its remarkably low price and because of its Sterling features which put it in a class with “B” Eliminators selling at far higher prices.

Adjustable detector and amplifier voltages controlled by knobs. Supplies up to 130 volts at 20 milliamperes. Uses standard UX-213 or CX-313 tube. Shielded—absolutely free from hum.

The Sterling RT-41 is no larger than a 45 volt “B” Battery, yet it gives three times the power. You can safely guarantee the permanency of its operation. It is a Sterling product backed by 20 years of electrical specialization.

The Sterling RT-41 is the ideal installation for Radiolas 25 and 28. Your customers can install it themselves without your help. Instructions complete.

Also Raytheon Tube “B” Power Units
R-97, for “B” & “C” Power.....\$55.00
R-99, for “B” Power..... 45.00

Sterling

“B” ELIMINATORS

Write for information about Sterling's comprehensive line of battery chargers and other accessories that meet every Radio buying need.

The Sterling Mfg. Company
2831 Prospect Ave. Cleveland, Ohio



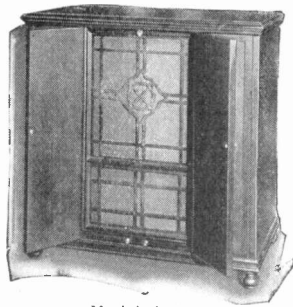

Model AC 15

The Amplion Grand

List Price \$135

This remarkable instrument utilizes a new principle of radio reproduction—a combination of soundboard, air-column and cone, in a handsome walnut cabinet 34-in. x 33-in. x 18½-in.

Every Amplion Grand is a laboratory model, personally tested and approved by Amplion's Chief Engineer.

Another Noteworthy Success!

The Amplion Cone
Model A.C. 12 \$30

A proven success because it has established a new standard in radio reception!

Amplion Reproducers from \$12 to \$135
Place an order with your jobber today.

THE AMPLION CORPORATION
of AMERICA

Suite E, 280 Madison Ave., New York City
The Amplion Corporation of Canada Ltd., Toronto, Ont.



Unipower AC-4 (\$33.00)
with Radiola 20.

Unipower AC-6-HA, for
201-A tubes or their equivalent, \$42.50.

Power Operation for RADIOLAS

*Now you can meet the demand
for powerizing Radiola 20*

YOUR Radiola customers are a made-to-order market for Unipower. And Unipower AC-4—especially designed for Radiola operation—furnishes the ideal "A" current for these sets.

The use of Unipower in Radiolas means simple one-switch operation of set and power combined—whether a "B" eliminator or batteries are used. It has its regular trickle charge rate, plus an extra, rapid charge to take care of emergencies.

Unipower is easy to install—far easier than complicated battery-charger-switch combinations. In Unipower these elements are concentrated in one compact unit—especially designed to fit in the restricted space of Radiola consoles.

A special connection on Unipower makes it possible to attach a "B" eliminator, so that both "A" and "B" power may be controlled by the Unipower switch which also takes the place of the Radiola set switch.

Unipower AC-4 operates all Radiolas except Radiola 30. Just now it makes a particularly attractive combination with Radiola 20.

Write us or your jobber for full details. Gould Storage Battery Co., Inc., 250 Park Ave., N.Y. C.

Unipower is manufactured by the makers of the famous Gould Batteries for automobiles, submarines, railways, farm-lighting, fire alarm service and emergency city-power

Unipower

A GOULD PRODUCT

AUTOMATIC "A" POWER WITH "B" POWER CONTROL

Eagle Multiple 16B Gang Charger

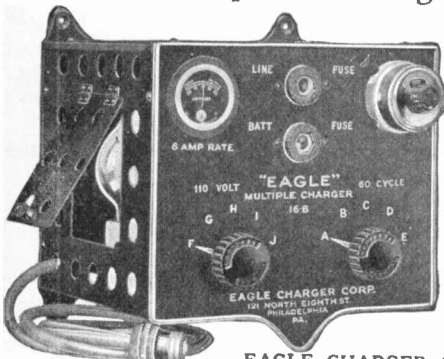

Tube type rectifier for service station work. Charges one to sixteen auto or radio batteries at six (6) ampere rate.

Will charge sixteen batteries in same length of time as one. Equipped with accurate ammeter showing charge and discharge, double pole, double throw switch and is fused in the A.C. line and in battery circuit.

110 volts—60 cycle
NET price, \$85.00
with bulb.

220 volts—60 cycle
NET price \$105.00
with bulb.

EAGLE CHARGER CORPORATION
121 N. Eighth Street, Philadelphia, Pa.



Radio Instruments

Jewell Radio Instruments are well made and have all been designed especially for their particular service. They are universally known and used.

Be sure that you carry Jewell instruments in stock as your customers will be asking for them.

Write for our prices and discounts

JEWELL ELECTRICAL INSTRUMENT CO.
1650 Walnut St., Chicago

"Twenty-seven Years Making Good Instruments"

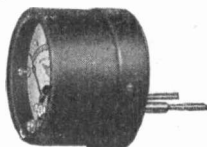

Pattern No. 135-A
Tip-Jack Voltmeter
—a special instrument for checking filament voltages.

Investigate This Profit Maker!

The  "A" Power Unit

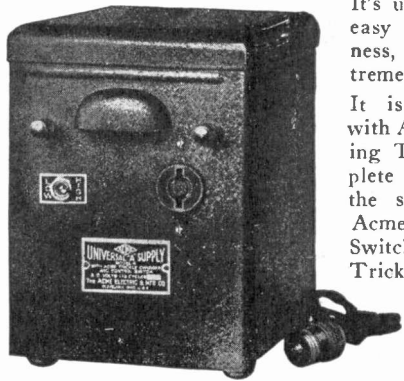

It's unique in its efficiency, easy operation, compactness, long service and extreme reliability.

It is furnished complete with A Battery and Rectifying Tube, making a complete unit and consisting of the six volt battery, the Acme Automatic Control Switch, the Two Rate Trickle Charger and sockets for connection with the B Battery Supply Unit at only

\$35.00 Complete with bulb.
List East of the Rockies

The case is so designed that any standard make of battery can be used in the extra compartment and it will be furnished where desired without the battery and rectifying tube still containing the Acme Two Rate Trickle Charger and the Acme Automatic Control Switch at the list price of only

\$19.00 East of the Rockies

This New Acme "A & B" Power Unit

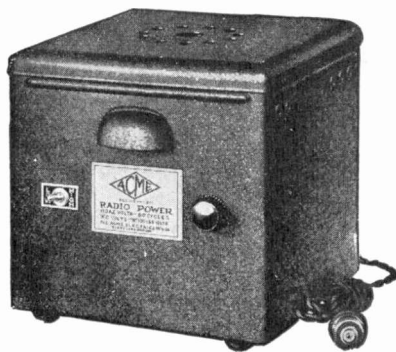

Consists of a six volt storage battery with a capacity of sixty ampere-hours; also an Acme B Supply Unit, a Two Rate Trickle Charger giving 1/2 and 1 1/2 amperes (this being controlled by a toggle switch), and the Acme Automatic Control Switch.

Attractive Container

These units are enclosed in a permanently attractive steel case finely finished with crystalline lacquer. Bulbs for both the charger and B Eliminator together with the necessary cord and sockets are included.

It is the most efficient unit on the market.

Price **\$67.50** East of the Rockies

Ask your Jobber or write us for complete information on our entire line of Acme Charging Equipment

THE ACME ELECTRIC AND MANUFACTURING CO.

1435 Hamilton Avenue, CLEVELAND, OHIO

A NEW SONATRON for B Eliminators



Type SH-85

Surface-Cooled Gas-Filled Full Wave Rectifier Tube. No Filament.

A great new field of sales is opened to the Sonatron dealer by this Gas-filled Rectifier Tube, designed to give superlative service in any B Eliminator. Maximum output 85 milliamperes, 200 volts.

Leadership!

Sonatron manufactures the world's largest tube line—over 30 distinct tubes—one for every radio need. Tie-up with Sonatron in 1927.

Write for the Sonatron Proposition.

Sonatron Tube Co., 108 W. Lake St., Chicago
New York, Newark, N. J., Detroit, Windsor, Ont., Can.

SONATRON
Nationally Advertised  Standard Quality

HARTUNG CLIPS
Continuous Circuit - Bulldog Grip

This clip will sell itself to your customers

just as it will to YOU

It is so much better than others that the difference never fails to draw attention.



If you are building for your store a reputation as the place where the better parts will always be found, you will find here a clip that is just what you want.

One piece construction allows continuous current flow. Super-coat of lead prevents deterioration. A handy assortment comes to you in a striking counter display—at quantity prices. By taking advantage of this assortment you get the same price that you would if you bought a carton of each size.

Order through your jobber or write for a sample direct.

C. F. HARTUNG CO.
728 E. 61st St., Los Angeles, Cal.

MAGNAVOX

MONEY-MAKERS

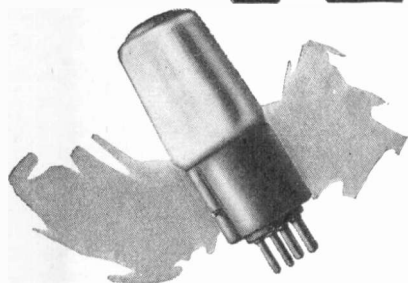

—for
distributors
and
dealers

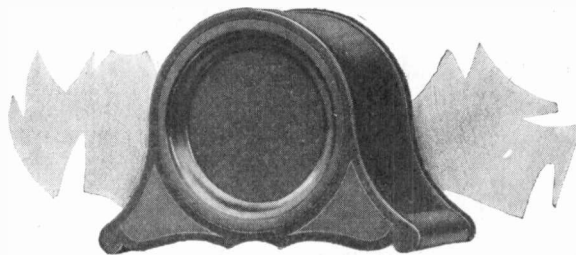

For more than a year we have been oversold on Magnavox Tubes. We are now increasing production and can accommodate more outlets.

The Magnavox line now includes:
201A—171—150D—200A—210—216B and Kathion gas filled rectifier.

They have many advanced selling features that insure a growing business—non-microphonic, anti-noise, sustained quality of reproduction over an extra long life, uniformity, unique filament construction adding to power and quality, standard "X" base, no solder on prongs.

Magnavox Tubes are sold at standard list prices. They have been tested and proved in the crucible of public service for two years. The percentage of returns is remarkably low.

Magnavox Cone Speakers offer a ready made business. Magnavox created the first radio loud speaker and has made nearly a half a million since. No loud speaker name stands higher in public good will. Over a million dollars have been spent in advertising it.

Two models of cone speakers cover all demands of the low and medium price market. The Stanford (above) lists at \$23.50 and the Cornell at \$16.00. These prices represent reductions from 1926 prices of \$11.50 and \$6.50 respectively—they open up a new wide market.

Quality of tone, range of frequencies, volume and eye value of Magnavox cone speakers keep you well in advance of the crowd.

Write for details of our proposition.

General Offices and Factory, Oakland, California — THE MAGNAVOX COMPANY — Chicago Sales Office, 1315 South Michigan Ave.

SIXTEENTH ANNIVERSARY OF MAGNAVOX PROGRESS IN RADIO

SEARCHLIGHT SECTION

SURPLUS STOCKS—BUSINESS OPPORTUNITIES

UNDISPLAYED—RATE PER WORD:
Positions Wanted, 6 cents a word, minimum \$1.25 an insertion, payable in advance.
Positions Vacant and all other classifications, 10 cents a word, minimum charge \$2.00.
Proposals, 40 cents a line an insertion.

INFORMATION:
Box Numbers in care of any of our offices count 10 words additional in undisplayed ads.
Discount of 10% if one payment is made in advance for four consecutive insertions of undisplayed ads (not including proposals).

DISPLAYED—RATE PER INCH:
1 to 3 inches.....\$6.65 an inch
4 to 7 inches..... 8.40 an inch
8 to 14 inches..... 6.20 an inch
Rates for larger spaces, or yearly rates, on request.
An advertising inch is measured vertically on one column, 3 columns—30 inches—to a page.

Radio Retailing

CASH

We want your SURPLUS RADIO STOCK

Send us your list and lowest cash price

EMPIRE RADIO CO.
216 Washington St.,
Boston, Mass.

CASH

BAKELITE PANELS

Make offer, all or part of 9000 Bakelite panels 3/4x8x21, one side standard Black finish, other side dull black finish. Box

FS-31, Radio Retailing
7 So. Dearborn St., Chicago, Ill.

WE PAY

Liquidate Your Surplus RADIO STOCK

Highest prices paid for surplus radio cabinets, sets and parts. Any quantity.

What have you to sell?
GENERAL RADIO SET CO.
74 Cortlandt St., N. Y. C.

CASH

Surplus Radio Merchandise Wanted FOR CASH

Console Cabinets, Eliminators, Sets, Loudspeakers, Etc

We will pay no attention to any offerings made to others at the same time when offered to us.

RESIDENT RADIO BUYERS

82-84 West Broadway, New York City
The largest Radio Surplus Stock operators.

FOR SALE

Electrical Contracting Business

Total sales over \$120,000, has radio department, motor rewinding and retail section, radio sales approx. \$40,000 annually, located in Carolinas City, population 85,000 paying well established business, owner expects to enter into manufacturing business.

BO-30, Radio Retailing
1600 Arch St., Philadelphia, Pa.

PERRYMAN RADIO TUBES

Here are the NEW PERRYMAN DISPLAYS



Individual figure, size 5 x 8 inches, with easel.

Window card, size 11 1/4 x 15 inches, with easel. Counter display, size 8 x 10 1/2 inches, with special easel to hold 3 radio tubes.



Individual figure, size 5 x 8 inches, with easel.

As has always been the policy of the Perryman Electric Co. to give retailers the utmost co-operation in the merchandising of their tubes.

Everything worthwhile is done to make Perryman Radio Tube sales easy. The new Perryman displays are just another step in that direction. They are lively, colorful and convincing. Seven colors are used and the bulbs of the tubes are silvered, giving a beautiful natural effect. Properly used, they will sell Perryman Radio Tubes for you.

You can use these Perryman Displays to dress a complete window or any part of it. You can use them around the store. They consist of window cards, counter displays, which support three tubes, large streamers and small figure cards, each with a small, peppy bit of copy on it.

The counter display is especially effective. It works all the time, displaying three Perryman Tubes, and demonstrating their superiority to all your customers.

Order the new displays from your distributor or send us your requisition direct.



Window streamer, size 9 1/2 x 30 1/2 inches, with metal hangers.



PERRYMAN ELECTRIC CO., INC.
33 West 60th St., New York

LABORATORIES and PLANT, NORTH BERGEN, N. J.

INDEX TO ADVERTISEMENTS

	Page	Page	
Acme Elec. & Mfg. Co.	120	Kellogg Switchboard & Supply Co.	13, 107
Acme Wire Co.	90, 110		
Aluminum Co. of America	92		
American Insulator Corp.	94		
Amplion Corp. of America	119	Langbein-Kaufman Radio Co., The	111
Anrad Corp.	101		
Atwater Kent Mfg. Co.	24		
		Magnavox Co.	118, 121
Bakelite Corp.	15		
Baker-Smith Co., Inc.	114		
Beede Elec. Instr. Co.	110	National Co.	90
Briggs & Stratton Corp.	11	National Carbon Co., Inc.	115
Browning-Drake	86	New York Sun, The	19
Carter Radio Co.	118	Pausin Engineering Co.	106
Celeron Co., The	17-18	Peerless Electric Co.	111
C. E. Mfg. Co.	114	Perryman Elec. Co.	122
Colt's Pat. Fire Arms Mfg. Co.	108	Philadelphia Storage Battery	64, 65 (Pictorial Section)
Cornish Wire Co.	94	Popular Science Monthly	4
Crosley Radio Corp.	81	Positions Wanted	121
Cunningham, Inc., D. T.	Inside Front Cover	Prest-O-Lite Co., Inc.	108
Day-Fan Elec. Co.	16	Radio Corp. of America,	52-53 Back Cover
Deutschmann Co., Tobe	95	Radio Master Corp.	62-63 (Pictorial Section)
Doehler Die-Casting Co.	91	Raytheon Mfg. Co.	82
Dry Storage Battery Corp.	109	Reliable Parts Mfg. Co., The	97
Dudlo Mfg. Corp.	93	Rola Co.	20
Duston Radio Labs., Inc.	110		
Eagle Charger Corp.	119	Sander Corp.	8
Eby Mfg. Co., H. H.	88	Sanford Bros.	108
Electrad, Inc.	92	Searchlight Section	121
Electric Service Supplies	116	Shamrock Mfg. Co.	100
Electrical Research Laboratories	21	Showers Bros. Co.	105
Electrophone Corp.	116	Sickles Co., F. W.	95
		Silver Marshall	97
		Slagle Radio Co.	14
Fansteel Products Co., Inc.	22	Sonotron Tube Co.	120
Farrand Mfg. Co., Inc.	23	Sprague Specialties Co.	96
Federal-Brandes Corp.	6-7	Standard Piano Bench Mfg. Co.	96
Federal Radio Corp.	99	St. James Lab. Inc.	95
Fervanti, Inc.	96	Sterling Mfg. Co.	118
Frost, Herbert H., Inc.	95	Stewart Warner Speedometer Corp.	12
		Stromberg-Carlson Tel. Mfg. Co.	2
General Electric Co.	102	Sylvania Prod. Co.,	Inside Back Cover
General Industries Co.	110		
General Radio Co.	97		
Gold Seal Electrical Co.	116		
Goodrich Tire & Rubber Co.	92	Tower Mfg. Corp.	5
Goyer Co.	94		
Gould Storage Battery Co., Inc.	119	Universal Winding Co.	96
Grebe, A. H. & Co., Inc.	3	Utah Radio Products Co.	1
Hammarlund Mfg. Co.	95		
Hartung Co., C. F.	120		
Hazeltine Corp.	113	Van Doorn Co.	96
Hood Rubber Co.	94	Vesta Battery Corp.	10
Hommel & Co., Ludwig	118		
Igrad Condenser Mfg. Co.	90	Watson Table & Furniture Co.	117
Indiana Mfg. & Electric Co.	118	Weston Elec'l Inst. Corp.	112
International Resistance Co.	9	Wireless Specialty Apparatus Co.	84
Interstate Elec. Co.	112	Wirt Co.	104
Jewell Elec. Instrument Co.	119	Zetka Laboratories, Inc.	163



