

Radio Retailing

The Business Magazine of the Radio Industry

Carried Like a Suitcase

Marvelous Tone and Distance

Instantly Available Anywhere

No Wires or Connections Required

Six Tubes and Speaker in Case

Dry Cell and Loop Operated

Everything Contained in the Case

Sell the World's Most Popular Portable

More Operadios have been sold than all other self-contained portables combined. That fact alone should convince you that this is the *one* sure-fire set for you to concentrate on right now and during the coming months. A powerful receiver, with six tubes (including power tube), loudspeaker, extra large batteries, loop and all parts contained in the attractive and compact carrying case. The only portable which is a proven national success on the market. Easy to demonstrate—known everywhere—economical to service. Let us send you full information.

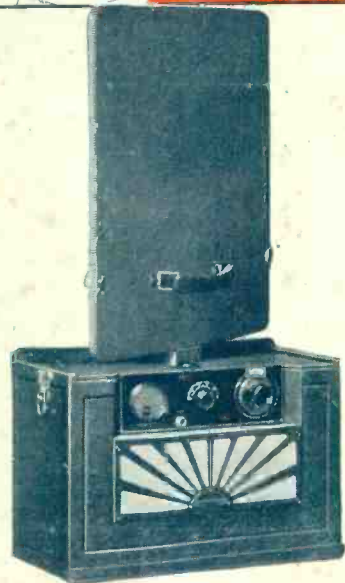

OPERADIO

The Original Self-Contained Radio

THE OPERADIO CORP., 8 So. Dearborn St., CHICAGO

Give Customers a Chance

Let them hear a Brandes Cone!

First hear it *yourself*. Make a personal comparison.

Learn how 18 years of acoustical experience result in a new-type cone in a beautiful cabinet.

Order only *one* cone if you wish. Hear it. Let others hear it.

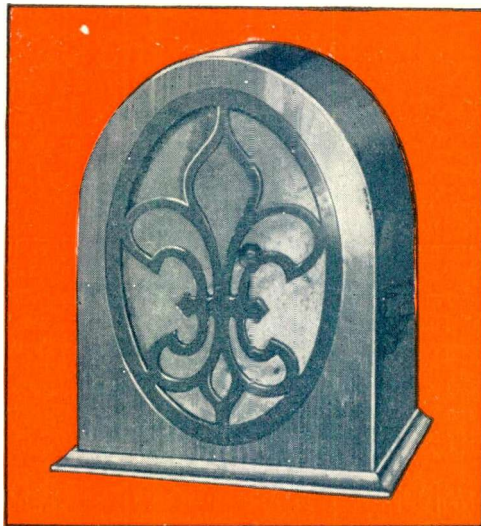

The Brandes Cone—a truly decorative bit of furniture that conceals a remarkable speaker.

Let the super-reproducer build quick, profitable sales for you.

Note the other Brandes products—each a final refinement.

For 18 years the Brandes staff has specialized in acoustics—it is inevitable that such experience should develop fine radio specialties.

Acoustics by Brandes

means the ultimate in reproduction



The Adjustable Table-Talker. Gooseneck horn. Finished in brown — felt-padded base. Adjustable. An excellent buy.



The Superior Matched Tone Headset is now, as always, ideal to tune in with—to listen undisturbed and undisturbing.

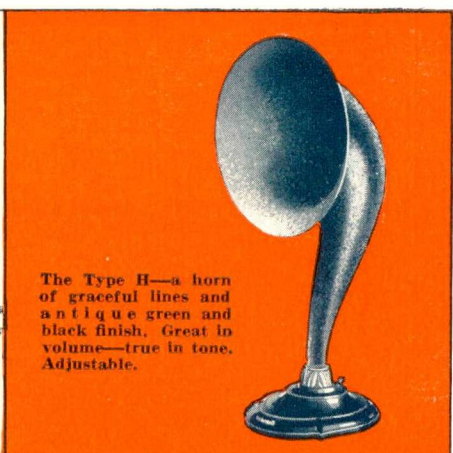

The Type H—a horn of graceful lines and antique green and black finish. Great in volume—true in tone. Adjustable.

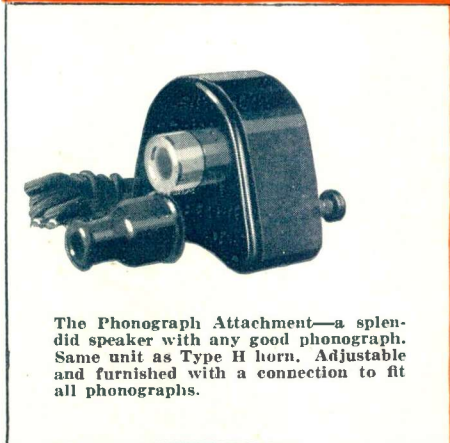

The Phonograph Attachment—a splendid speaker with any good phonograph. Same unit as Type H horn. Adjustable and furnished with a connection to fit all phonographs.



The Brandes Cabinet of mahogany, finished in walnut brown. The same unit, quality of tone and even greater volume than the Type H Speaker.

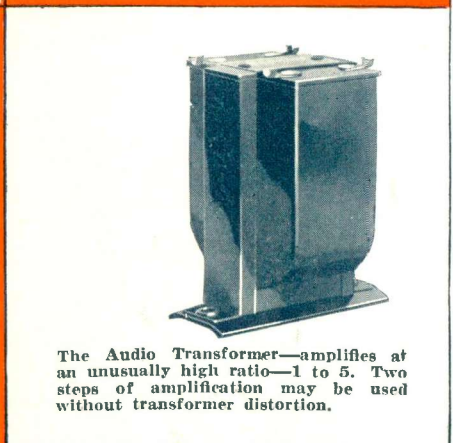

The Audio Transformer—amplifies at an unusually high ratio—1 to 5. Two steps of amplification may be used without transformer distortion.

Brandes Products Corporation, 200 Mt. Pleasant Avenue, Newark, N. J.

Radio Retailing, April, 1926, Vol. 3, No. 4 Published Monthly, McGraw-Hill Publishing Company, Inc., Tenth Avenue at Thirty-sixth Street, New York, N. Y. \$2 per year, 25 cents per copy. Entered as second-class matter, April 10, 1925, at the Post Office at New York, N. Y., under the act of March 3, 1879.

You Hit the "Bull's-Eye" With



Trade Mark Registered

Utah Superflex

Reg. U. S. Pat. Off.

No other manufacturer makes such guarantee



The Superflex has a tone chamber equal to that of the usual horn type. Stands but 8½ inches high by 6 wide. Finished in a harmonious brown. Weight 3 lbs. Packed 1 in a carton, 12 in a crate.

\$12.50

Utah Standard

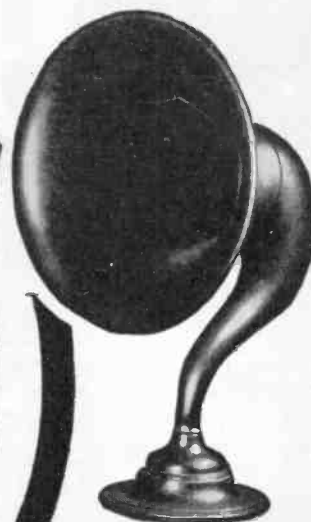

Horn is finished in a rich semi-dull black Morocco leather finish; 14-inch bell; weight 11½ lbs. Packed 1 to a carton.

\$22.50



GUARANTEE

Buy a **Utah** and use it for two weeks. Compare its tone with the best the others are able to produce. **If the Utah does not give better reception** return it to your dealer and **he will refund your money.**

Utah Phonospeaker



Handsomely finished in black rubber. Furnished with base to rest on turntable of talking machine, or without.

With Stand
\$10

Without Stand
\$9.50

Finished in a soft antique mahogany, designed to please both eye and ear. Measures 10½x8x7½. Weight 8 lbs. Packed 1 in a carton, 3 in a crate.

\$25

Utah Supreme

Reg. U. S. Pat. Off.

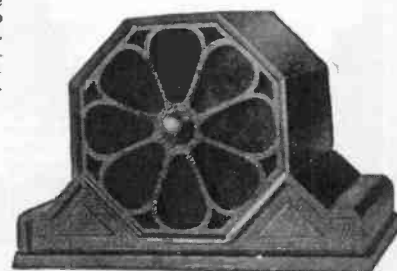

Utah Radio Products Co.,
1421 So. Michigan Ave., Chicago

We are manufacturers—Not assemblers

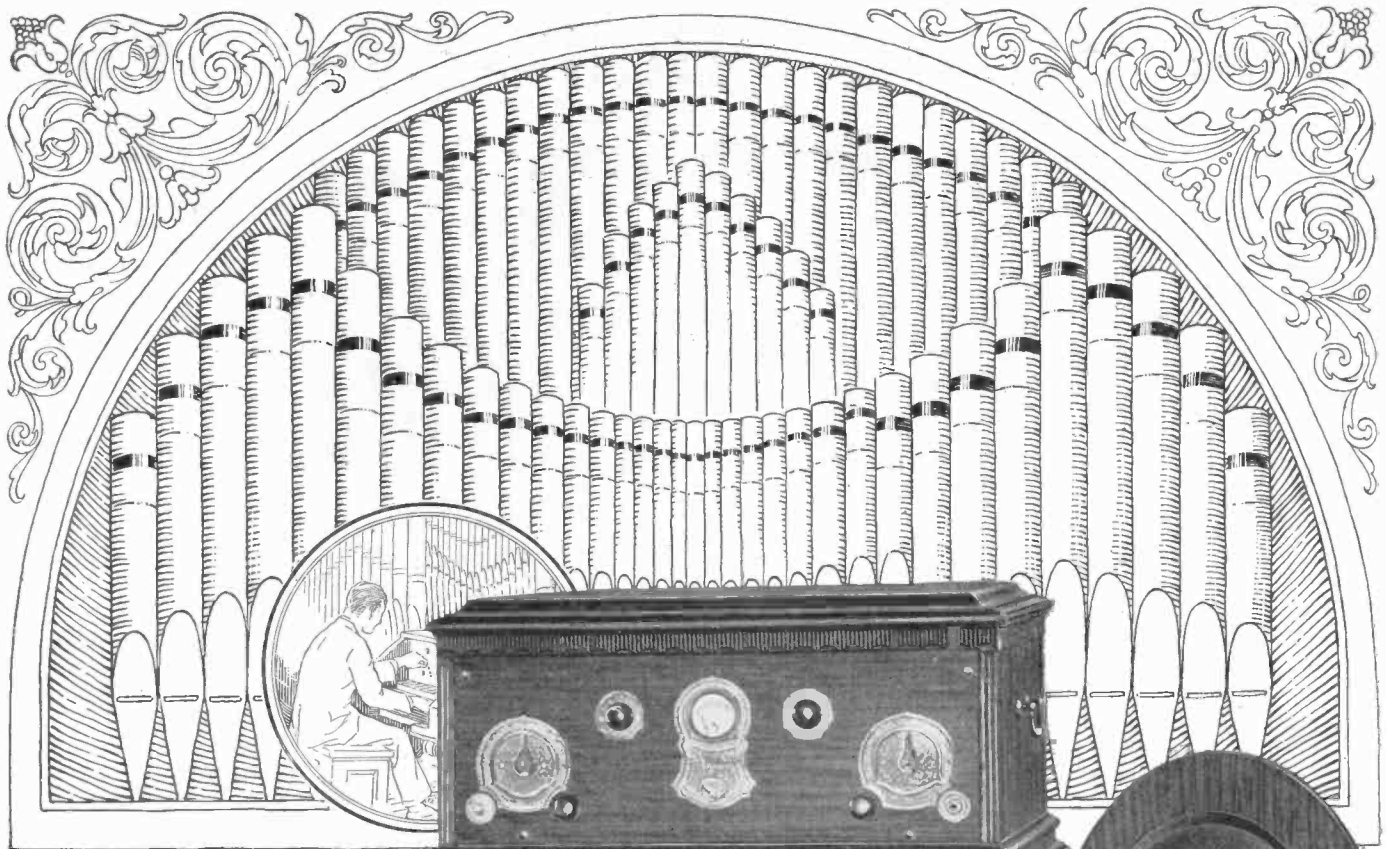

No. 601. treasure chest type, 6-tube, totally shielded. Equipped with volt meter. Solid Mahogany. Prices, without accessories: East of Rockies, \$210; Pacific Coast, \$225; Canada, \$200.

A New Cone Speaker Companion to the No. 601 Receiver

To the epic achievement of Stromberg-Carlson's No. 601 Receiver is added that of their announcement of the New Cone Speaker. Produced after exhaustive research and experimentation, this speaker embodies an idea, old to the master creators of musical instruments, but new to the radio trade—that of a soundboard.

The soundboard which functions the same on the new cone speaker as on piano or violin—accomplishes the same purpose—that of giving true pitch and modulation to notes over the entire musical register. Whether it is reproducing the majestic roll of the organ, or the piping of the flute, this soundboard liberates the true beauty of intonation and phrasing which the music lover desires and appreciates.

Authorized Stromberg-Carlson dealers will find that this Cone Speaker gives added saleability to the Stromberg-Carlson No. 601 Receiver and new prestige to the entire line. Merchants who have not a Stromberg-Carlson franchise will find in this new cone speaker an additional incentive for seeking one.

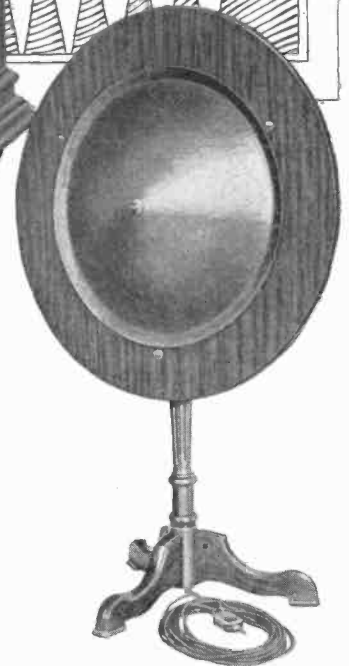

The New Stromberg-Carlson Cone Speaker

A magnificent instrument, with a soundboard which retains the timbre and beauty of the original notes. Standing unobtrusively against a wall or in a corner it so fills the entire room with music that it is difficult to tell from where the sound is coming. In addition, it is as ornamental as a Mahogany Tip-top Table which it so closely resembles.

Height 34½ inches over all; diameter 22 inches. Equipped with a 20-foot cord and plug. Soundboard and pedestal finished in Mahogany. Used with any Receiver which has semi-power tubes. Prices: East of the Rockies, \$35; Pacific Coast, \$40; Canada, \$49.

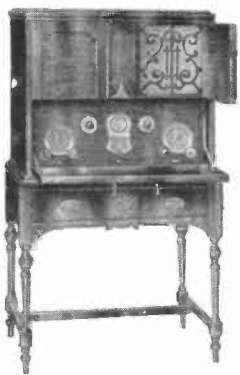

No. 602 Receiver, art console type, American Walnut Cabinet. Built-in Loud Speaker: 6-tube. Price without accessories: East of Rockies, \$340; Pacific Coast, \$360; Canada, \$470.



Stromberg-Carlson Telephone Manufacturing Co.
Rochester, N. Y.

Stromberg-Carlson

Makers of voice transmission and voice reception apparatus for more than 30 years.

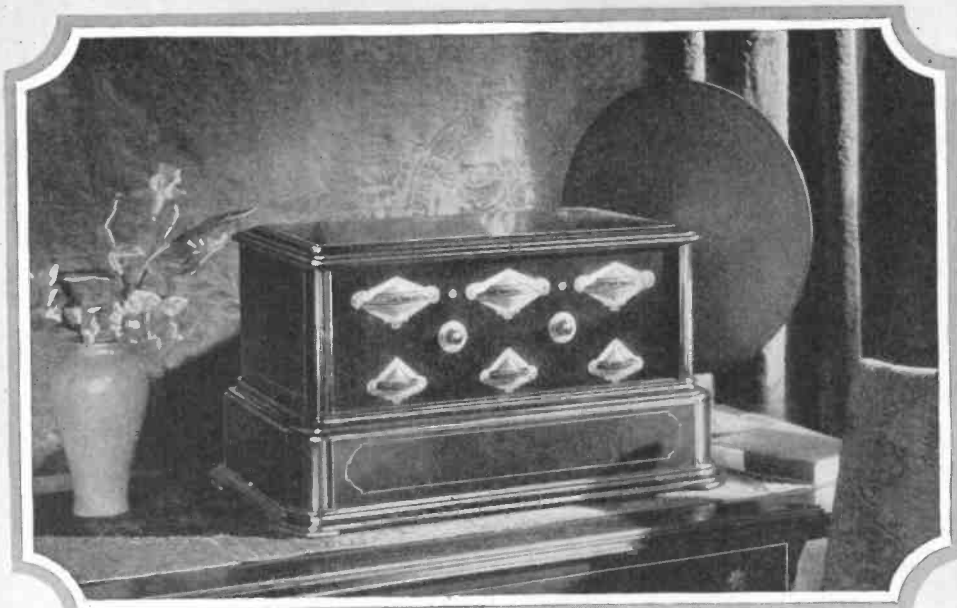

Grebe Always Protects the Dealer

OUR policy, restated again and again, will be maintained as always: viz.,

1. We will not cut prices nor permit dealers to do so.
2. We will not "unload", "dump", nor throw our sets on the market under any subterfuge.

On this policy the dealer can depend; on it he can, with confidence, buy the Synchronphase and offer it to his customers.

The Synchronphase is a set of the first quality as to construction, reception and the resulting satisfaction that they guarantee. On the Synchronphase, therefore, the dealer can build sound business and reputation, and enjoy a steady profit for years to come.

Write for full particulars.

A. H. Grebe & Co., Inc., 109 West 57th St., New York
 Factory: Richmond Hill, New York
 Western Branch: 443 So. San Pedro St., Los Angeles, Cal.

This Company owns and operates stations WAHG and WBOQ; also low-wave re-broadcasting stations, mobile WGMU and marine WRMU.

Flexible Unit Control

Grebe Binocular Coils
 Reg. U.S. Pat. Off.

and

Low-wave Extension Circuits

Usual Dial

Grebe Dial

Grebe S-L-F Condenser

Grebe "Colortone"

All Grebe apparatus is covered by patents granted and pending.

THE GREBE SYNCHROPHASE

TRADE MARK REG. U.S. PAT. OFF.



It is written:
 "Winnow while the wind is blowing."
 The wise man never ceases his endeavors to sell while the opportunity exists.

Doctor Myer

Sales With Profit

AT this time all dealers are considering the amount of profit to be derived from their merchandise on hand.

This profit will be controlled largely by the policies of the manufacturers they represent.

The fundamental policies of Kolster Radio are based upon sound merchandising principles of proved worth.

Dealers are given exclusive territory and protection against price decline and obsolescence.

Kolster Radio is technically correct and fully guaranteed.

These policies are simple and effective. They are and must be the basis of good merchandising.

The Kolster franchise is a valuable asset to dealers. It is an acknowledgment of Kolster's faith in the dealer. It is the dealer's assurance of assistance, protection and sales with profit.

We invite interested dealers to communicate with us concerning the Kolster franchise for reliable dealers.

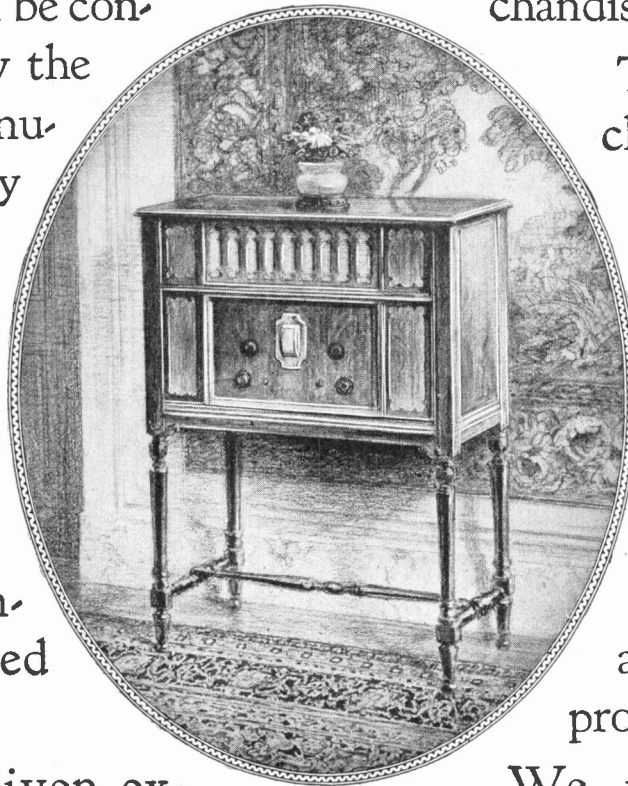

FEDERAL TELEGRAPH COMPANY
(OF CALIFORNIA)

Woolworth Building, New York City

KOLSTER RADIO

Record Breakers

Get Aboard the Gold Seal Quick Profit Line!

RECORD breaking sales of Gold Seal tubes show that the tubes are right and the sales policy is right. Are you sharing in this outstanding success? You can!

A Real Dealer Policy

Gold Seal dealers are happy because they are backed up by the Gold Seal policy of a square deal for everybody and real, aggressive selling help—national advertising, displays, improved testing container, price protection, prompt shipments, and a replacement guarantee that means what it says!

March 9, 1924, a special train left Los Angeles and arrived at Chicago in 49 hours, 17 minutes. Here another special train took up the race and covered the 961.5 miles to New York in 19 hours, 54 minutes, thus establishing the record time of 69 hours, 11 minutes for the trans-continental distance.

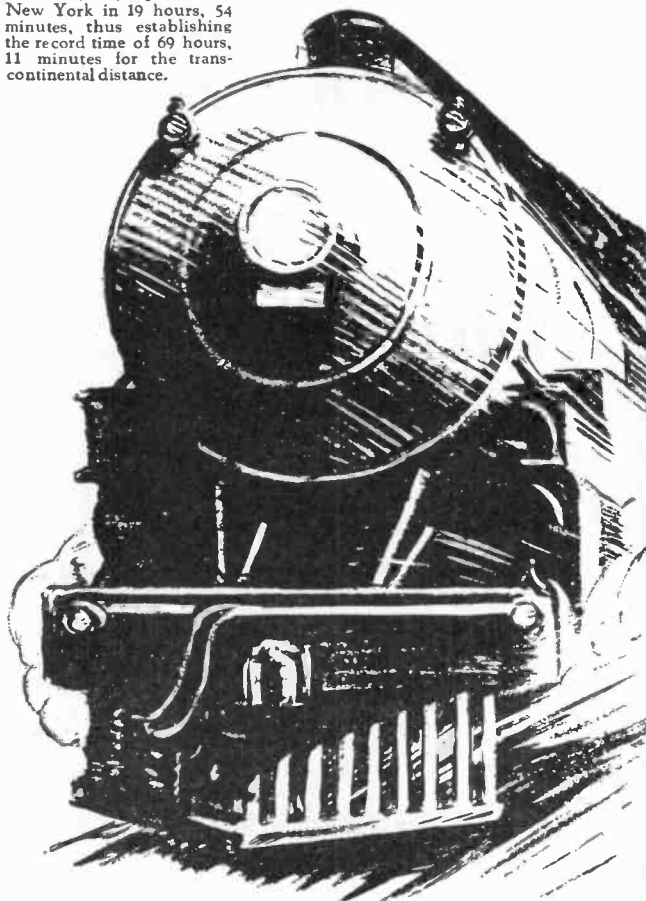

ALL TYPES
 GSX and G.S. 201-A
 List Price - \$2.00
 GSX and G.S. 199
 List Price - \$2.25
 GS 199 Large Base
 List Price - \$2.25
 GSX and G.S. 120
 List Price - \$2.50
 HIGH POWER
 GSX - - - 112
 List Price - \$6.50

Gold Seal tubes have broken all records because the public instantly recognizes their superior quality, uniformity and doubled life. Test them in comparison with any others—and they cost no more! A complete line of all standard types.

Write today for full details of this unusual merchandising policy—of particular interest to jobbers, distributors and dealers.

GOLD SEAL PRODUCTS CO., INC.
 250 PARK AVENUE, NEW YORK

Gold Seal Radio Tubes

Gold Seal Tubes last twice as long

You can read
THE
between the lines
EAR
why Farrand Speakers
SAYS
are replacing other
BUY
speakers everywhere

Everywhere,
 over and over again—
 “The Ear Says Buy!”
 whenever the Farrand
 Speaker is demonstra-
 ted. Re-orders are the
 order of the day from
 every section of the
 country. Are YOU
 cashing in?

*Farrand
 Speaker*

SENIOR MODEL
 \$32⁵⁰
 JUNIOR MODEL
 \$16⁵⁰

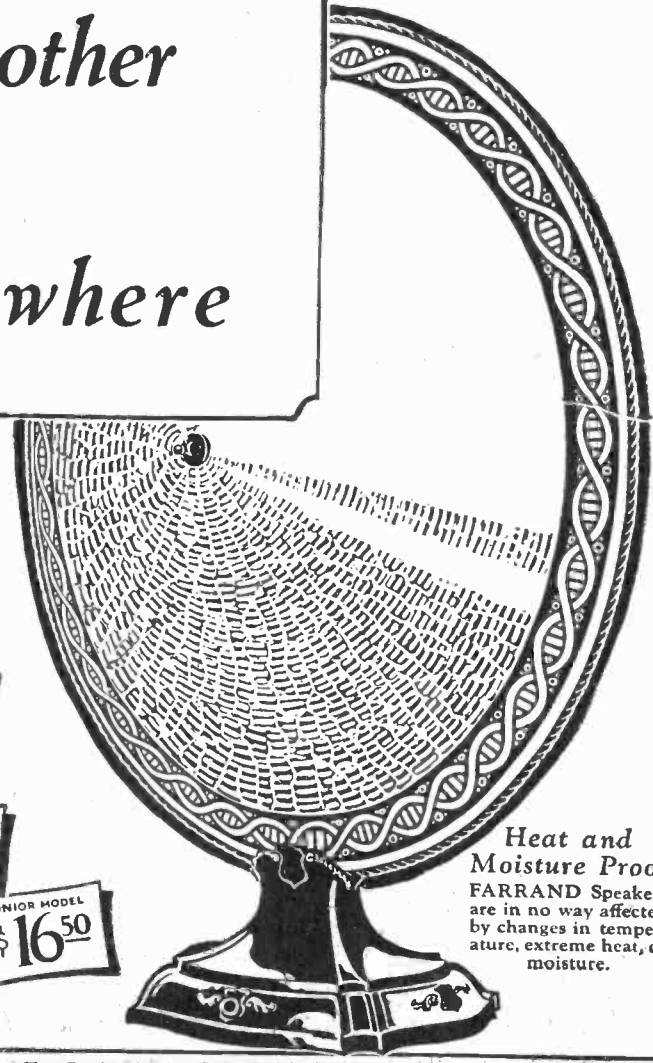

*Heat and
 Moisture Proof*
 FARRAND Speakers
 are in no way affected
 by changes in temper-
 ature, extreme heat, or
 moisture.

HANDS OFF!

Cone Speaker Patents Sustained

"Patent No. 1,271,527 is valid and infringed"

"Patent No. 1,271,529 is valid and infringed"

SO says the U. S. District Court for the Eastern District of New York in its decision recently handed down in a suit brought against a dealer and defended by the manufacturer. The dealer is not only enjoined from selling speakers infringing the Lektophone Patents, but is also required to account for damages and profits.

The trade at large is advised that the Lektophone Corporation has granted licenses under its Patents Nos. 1,271,527, 1,271,528, and 1,271,529 of July 2, 1918, and pending applications, to *none* but the following manufacturers:

American Bosch Magneto Corp
Springfield, Mass.

Pathe Phonograph & Radio Corp.
Brooklyn, N.Y.

Radio Foundation, Inc.
New York City

R. E. Thompson Mfg. Co.
Jersey City, N.J.

Farrand Manufacturing Co., Inc.
Long Island City, N.Y.

Radio Corporation of America
New York City

Stromberg-Carlson Telephone
Manufacturing Co.
Rochester, N.Y.

J. S. Timmons, Inc.,
Philadelphia, Pa.

Titanafram Corp.
Jersey City, N.J.

Speakers embodying the basic features of the Lektophone patents which come from sources other than these, are distinct infringements, and their manufacture and sale subject both maker and seller to immediate prosecution.

LEKTOPHONE CORPORATION
15 EXCHANGE PLACE, JERSEY CITY, N.J.



Radio marked Bakelite

IT IS a profitable practice to point out the trademark **BAKELITE** when selling Radio parts or accessories. Manufacturers recognize the prestige of Bakelite with the radio buying public and capitalize it by plainly marking their products **BAKELITE**.

You, too, can benefit by the publicity which Bakelite is constantly getting in the editorial pages of the radio papers and by the Bakelite advertising in the leading radio magazines. Many of your customers know the satisfaction that Bakelite gives through actual experience, and the others have learned through reading and hearsay.



BAKELITE

REGISTERED U.S. PAT. OFF.  A THOUSAND USES

The registered Trade Mark and Symbol at the top of this page are used only by products made from materials manufactured by Bakelite Corporation. Under the Symbol at the bottom of each product is a number, or numbers, or quantity, which symbolizes the infinite number of present and future uses of Bakelite Corporation's products.

Parts sell more easily

In selling Bakelite insulated sets and Bakelite panels and parts, you are building business on the sound basis of customer satisfaction. Bakelite is used by prominent makers of the radio parts and accessories listed below.

Adapters—Binding Posts—Coils (Forms, Varnish Impregnated Coil Mounting Brackets)—Condenser (Fixed, Variable, Grid Condenser Mountings)—Connecting Shafts—Contact Strips—Crystal Detector Mountings—Dials—Grid Leak Mountings—Head Sets (Caps, Diaphragms, Housing, Spools)—Jack Ferrules—Jacks—Knobs—Lightning Arresters—Loud Speakers (Bases, Cones, Horns, Spools)—Panels—Phonograph Attachments (Diaphragm, Housing, Spools)—Plugs—Potentiometer Bases—Rheostat Bases—Sockets—Sub Panels—Tube Bases—Variocouplers—Variometers.

Write for Booklet 39

BAKELITE CORPORATION

247 Park Avenue, New York, N. Y.
Chicago Office: 636 West 22nd Street

BAKELITE CORP. OF CANADA, LTD.

163 Dufferin Street, Toronto, Ontario, Canada

Great names become real folks
BAKELITE
THE MATERIAL OF A THOUSAND USES

Enchanting Radio Nights for Everyone
BAKELITE
THE MATERIAL OF A THOUSAND USES

Health and happiness through radio
BAKELITE
THE MATERIAL OF A THOUSAND USES

Radio drafted Bakelite
so all could listen-in
BAKELITE
THE MATERIAL OF A THOUSAND USES

It's mahogany to the eye
but in fact it's Bakelite
BAKELITE
THE MATERIAL OF A THOUSAND USES

Radio tested all insulations
and adopted Bakelite
BAKELITE
THE MATERIAL OF A THOUSAND USES

This is Station 2-L.O. London—12 Midnight
BAKELITE
THE MATERIAL OF A THOUSAND USES



BAKELITE

THE MATERIAL OF  A THOUSAND USES

The registered Trade Mark and Symbol above may only be used upon products made from materials manufactured by Bakelite Corporation. Under the capital 'B' of the numerical logo is the number of units per quantity. The symbol below the figure number represents and identifies the Bakelite Corporation's products.

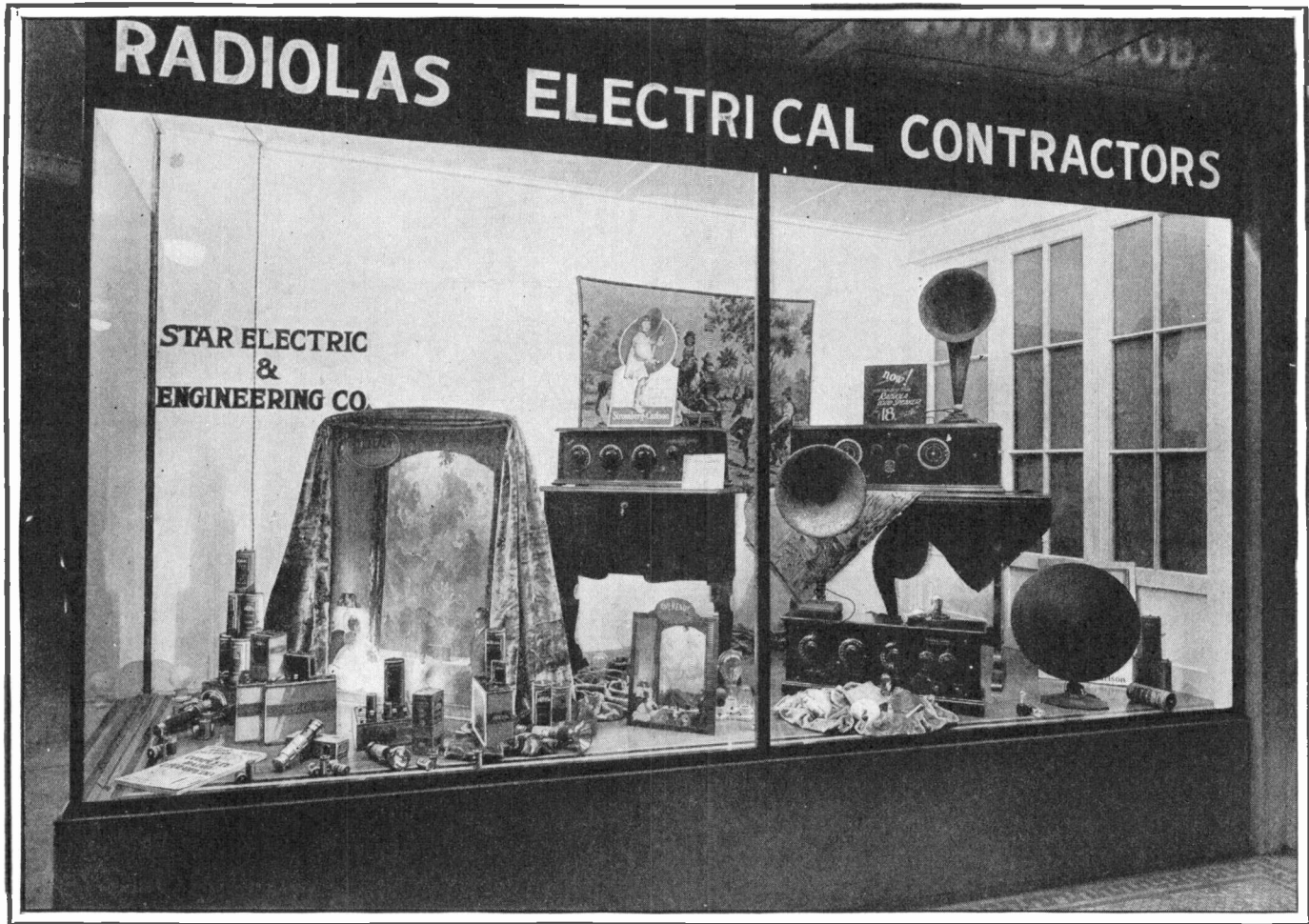

Because of popular demand

THE Star Electric & Engineering Co., Inc., Houston, Texas, first added radio as a side line. To their surprise a large volume of business was done the first year and a substantial increase has been experienced each succeeding year.

From the start in radio, the Star Electric & Engineering Co., Inc., has handled Eveready Radio Batteries, and they still continue to sell ever-increasing quantities of Evereadys, stating that it is "because of

popular demand, because they give better service and because our source of supply is sufficient to meet our needs."

Eveready Radio Battery business will bring profits to you and satisfaction to your customers. Order a stock of Eveready Radio Batteries from your jobber.

Tuesday night means Eveready Hour — 9 P. M., Eastern Standard Time, through the following stations:

WEAF—New York	WGR—Buffalo	WGN—Chicago
WJAR—Providence	WCAE—Pittsburgh	WOC—Davenport
WEEL—Boston	WSAI—Cincinnati	wcco { Minneapolis
WTAG—Worcester	WEAR—Cleveland	{ St. Paul
WFI—Philadelphia	WWJ—Detroit	KSD—St. Louis

Pacific Coast, Eveready Program
KGO—San Francisco—8 to 9 P. M.

*Manufactured and
guaranteed by*

NATIONAL CARBON Co., Inc.
New York San Francisco
Atlanta Chicago Dallas
Kansas City Pittsburgh
Canadian National Carbon Co., Limited
Toronto, Ontario

EVEREADY
Radio Batteries
—they last longer

Are you the man to sell BOSCH RADIO?

*The Radio Policy Bosch Announced
at the start of its Radio Program
is the Policy in effect today.*

BOSCH RADIO POLICY

1. BOSCH PROTECTION FRANCHISE
NO DISCOUNTS TO OTHER THAN
AUTHORIZED DEALERS HOLDING
THE BOSCH FRANCHISE.
2. BOSCH TERRITORIAL PROTECTION
TERRITORIAL FRANCHISE DEFINED
AND ALL RIGHTS PROTECTED
3. BOSCH PRICE GUARANTEE
THE DEALERS PROFITS ARE PROTECT-
ED BY GUARANTEE AGAINST PRICE RE-
DUCTIONS UNLESS DEALER IS REBATED
4. BOSCH RATIFIES DEALER CONTRACTS
ALL CONTRACTS MUST BE RAT-
IFIED BY THE MANUFACTURER.
5. BOSCH CO-OPERATION
EXTENSIVE CONSUMER AND TRADE
ADVERTISING IN NATIONAL PUB-
LICATIONS. CLOSE LOCAL NEWS-
PAPER CO-OPERATION.
6. BOSCH STABILITY
THE BOSCH RADIO POLICY MAIN-
TAINS THE SAME ETHICAL STAND-
ARDS WHICH HAS BEEN THE BOSCH
PRACTICE FOR 15 SUCCESSFUL YEARS
7. THE BOSCH DEALER
THE BOSCH FRANCHISE IS A MAN
SIZED, TWO FISTED OPPORTUNITY
FOR ONE RECOGNIZED BUSINESS
MAN IN A LOCALITY -- WHO IS
ABLE TO CONDUCT AN INTELLI-
GENT SUCCESSFUL BUSINESS
OVER A COURSE OF YEARS.
ARE YOU THE MAN?



When Bosch started to build radio, many radio merchants wondered what the distribution policy would be. They now know that Bosch conducted one of the most constructive radio sales campaigns in the history of the radio industry. They know that the Bosch Radio Policy announced at the outset has been adhered to in every one of its points. Bosch Radio Dealers have been protected on discount, on territorial rights, and their profits have been protected by the Bosch Price Guarantee.

Bosch, in line with its policy of "controlled merchandising" founded on its experience of so many successful years, followed a sane production program based upon a definite "absorption knowledge" of territories. This has been adhered to month after month. Dealers were not stampeded into any unwise purchases because of an unwise production program, nor was there any let down in policies through pressure of a momentary necessity. Bosch production followed a definite and orderly campaign which built satisfied radio merchants.

The Bosch Radio Program for this year and next, proceeds on the same constructive lines. It calls for an expansion of its radio line and its production and merchandising plans, just as Bosch has expanded so successfully in all its activities year after year.

The Bosch Radio Program, profitable in its original set-up, will be even more profitable in its expanded form. The expansion program affords greater opportunities for profits on the part of the present Bosch merchants and will take in additional merchants whose Radio Experience, whose Financial Backing, whose understanding of service and knowledge of merchandising is substantial enough to fit into the big things Bosch has planned for the coming months.

Are you ready to advance your business along the lines of a sane, sensible and constructive radio merchandising program? If so, tell us who you are, what your business is, the territory you can cover profitably, your financial position and your merchandising background. This will be held in extreme confidence. We will tell you then, through a visit or by letter, how Bosch has provided for the All-year-round success of Bosch merchants and of the benefits to be had through years of association.

AMERICAN BOSCH MAGNETO CORPORATION

MAIN OFFICE AND WORKS: SPRINGFIELD, MASSACHUSETTS
Branches: New York :: Chicago :: Detroit :: San Francisco

GENERAL RADIO

INSTRUMENTS
for the Scientist or Set-BUILDER

are
the

UNIVERSAL Standards of Precision

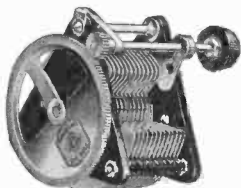

Type 247-H
Geared Condenser
Price \$5.00

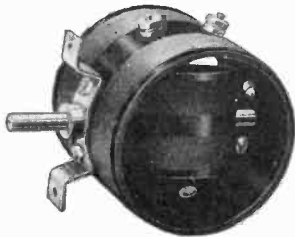

Type 268
Vario-Coupler
Price \$2.75



Type 277-D
Coupling Coil
Price \$1.50



For over a decade General Radio instruments have been universally recognized as the standards of excellence.

They are manufactured by a company which has contributed more laboratory equipment for radio research than any other one company in the history of radio. Nearly all the leading commercial and technical school laboratories throughout the world are equipped with General Radio scientific apparatus.

The same outstanding craftsmanship and materials are embodied in all General Radio parts for use in the construction of broadcast receivers.

Through the merits of design, performance, and price General Radio instruments for the scientist or set-builder are the accepted standards of quality.

Write for our latest catalog 924-R

GENERAL RADIO Co.
Cambridge 39,
Mass. U.S.A.



Type 285
Audio Transformer
Price \$6.00



Type 301
Rheostat
Price \$1.25



Type 349
Ux-Tube Socket
Price 50c.

Behind the Panels of Better Built Sets

STEWART-WARNER

Matched-Unit Radio

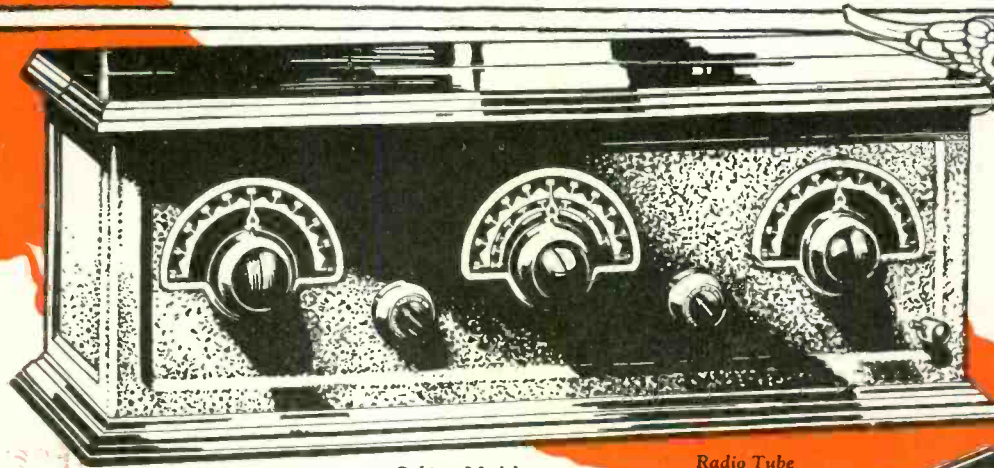

Instrument
plus Reproducer
plus Tubes plus
Accessories

Cabinet Models
Model 300 (as shown) \$65
Model 330 (for dry cells) \$65
Model 325 \$80
Model 340 (for dry cells) \$80
Model 305 \$95

**Radio Tube
Model S-W**
501-A \$2.00
499 (for dry cells) \$2.25



Model 400
Reproducer
\$25.00
Model 405
\$19.50

No Yearly Models

There are no yearly models of Stewart-Warner Matched-Unit Radio.

There will be none.

Think what that means to you as a dealer—

- 1 Full protection against being caught with obsolete stock on your shelves!
- 2 Full protection against the grief of trying to dispose of dead stock!
- 3 Positive assurance that your stock of Stewart-Warner Radio is *always saleable!*

Stewart-Warner is in the radio business "with both feet." *We're here to stay.* And we are pledged to a policy of 100% protection for every Stewart-Warner dealer every step of the way.

No other radio manufacturer can guarantee an equal measure of protection for the dealer—for none other has such complete control of distribution. We sell *only* through our own established Central Distribution Stations, never through jobbers.

Our Policy is Progressive and Protective

Our ample financial and engineering resources enable us not only to *keep abreast* of the latest developments in radio, but to *keep ahead of the field.*

Improvements will be made, of course. However, they will not be made at the dealer's expense, but in a way that will *protect and benefit* him.

The saying "A man is known by the company he keeps" is nowhere more evident than in the radio industry. Sound, reliable dealers naturally want to become identified with substantial, responsible manufacturers. Last year more than 3,000 dealers of this type were granted Stewart-Warner Radio Franchises.

Not every dealer can qualify for an exclusive Stewart-Warner Franchise. We want only dealers of unquestioned ability and integrity—men who want to achieve *permanent success*, not alone the quick profits of the hour.

If you think you can qualify, write us *immediately.* Do not delay, for only a limited number of Franchises are still available.

STEWART-WARNER SPEEDOMETER COR'N
1820 DIVERSEY PARKWAY - CHICAGO, U.S.A.

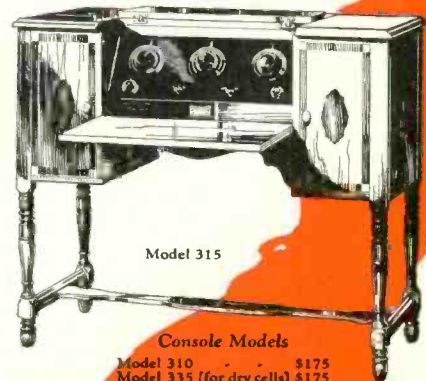

Model 315

Console Models
Model 310 \$175
Model 335 (for dry cells) \$175
Model 315 \$285
Model 320 \$450



Tune in
STEWART-WARNER
Station WBBM, 226 Meters

Mon. - 12-3 a.m., 6-7 p.m.
Tues. - " " " 9-12 p.m.
Wed. - 8-10 p.m., 12-2 a.m.
Thur. - " " " 8-10 p.m.
Fri. - " " " 8-10 p.m.
Sat. - 8-9:30 p.m., 11-2 a.m.
Sun. - 4-6 p.m., 8-10 p.m.

CENTRAL STANDARD
TIME

TWELVE MILLION PEOPLE ARE TODAY USING STEWART-WARNER PRODUCTS

ATWATER KENT RADIO

“Are you running a store
or a museum?”

THAT'S what the caustic stranger said to the radio merchant.

The merchant started to flare up, but thought better of it. Instead, when the visitor departed he spent a profitable half-hour with his own thoughts.

Had he taken on too many lines? Had he selected them indiscriminately? Didn't unsalable reminders clutter his shelves? Obsolete models, discontinued by the manufacturer in the middle of the year? Orphan sets—maker gone out of business?

Those job lots he had bought to “move quickly”—weren't they still hanging around? Yes, and good sets, but without the necessary advertising to make people want them? And sets that looked good but ate their heads off in service calls? Sets that had come in with drums beating—and stayed while the parade passed on?

“It is a museum,” said the merchant. “I only *thought* it was a store.” Whereupon he cleared out the relics as best he could, concentrated on the merchandise his customers really wanted, and lived happily ever after.

* * *

Has the Radio *you* handle commer-

cial value? Is it a good product, nationally advertised, and fairly priced? Has it a record of consistent sales and assurance of permanence? Does it sell easily—and *stay sold*, enabling you to turn your capital often with a minimum of overhead? In short, is it *profitable*—over a period of time?

If April is your month for mental stock taking—for figuring what you have been doing, where you stand and whither you are bound—isn't this a good time to look around, see what the Atwater Kent Radio merchants have done and what *they* think of the radio business?

Perhaps you would fit into the picture, too.

EVERY SUNDAY EVENING

The Atwater Kent Radio Hour brings you the stars of opera and concert, in Radio's finest program. Hear it at 9:15 Eastern Time, 8:15 Central Time, through:

WEAF New York	WFI } Philadelphia
WJAR Providence	WOO } alternating
WEEL Boston	WCAE Pittsburgh
WSAI Cincinnati	WGR Buffalo
WCAP Washington	WOC Davenport
WCCO Minn.-St. Paul	WTAG Worcester
WEAR Cleveland	KSD St. Louis
WLIB Chicago	WWJ Detroit

Write for illustrated booklet of Atwater Kent Radio.

ATWATER KENT MANUFACTURING CO.
A. Atwater Kent, President
4733 WISSAHICKON AVENUE, PHILADELPHIA, PA.

J. ANDREW WHITE,
Contributing Editor
S. J. RYAN,
Merchandising Counsellor
E. E. WHITEHORNE,
Contributing Editor
L. E. MOFFATT,
Associate Editor
PAUL WOOTON, Washington

Radio Retailing

The Business Magazine of the Radio Industry

O. H. CALDWELL, Editor

WILLIAM C. ALLEY,
Associate Editor
H. W. BAUKAT,
Assistant Editor
OVID RISO,
Assistant Editor
RAY SUTLIFFE, Chicago
H. S. KNOWLTON, Boston
C. GRUNSKY, San Francisco

Table of Contents April, 1926

What This Industry Needs <i>The editors of "Radio Retailing" call attention to several outstanding "dealer grievances."</i>	345
In Florida—Sales Must Be Forced! <i>Selling radio in perpetual summer is not so easy—but house-to-house canvassing is doing it.</i>	347
"Stock Control" <i>Keeping profits ahead of expenses is largely a matter of controlling stock—by J. Andrew White.</i>	351
"The Gyp Is Doomed!" <i>The Vim Electric heeds the "handwriting on the wall" and decides to quit price-cutting.</i>	356
Make Every Prospect a Sale <i>California dealer has an efficient system of recording information about prospects.</i>	359
"Good Will" <i>Customer satisfaction is the merchant's greatest asset—a timely tip from S. J. Ryan.</i>	361
Merchandise Leaks That Eat Up Profits <i>A few of the ways in which stock leaks out of the store, and how to stop them.</i>	362
That Last Ounce of Effort— <i>How one Massachusetts dealer made his net profit last year reach 9.5 per cent.</i>	364
Watch Your Selling Costs <i>Unique chart enables this Dayton dealer to keep sales and expenses always in mind.</i>	367
Demonstration Kinks to Help Close Sales <i>A variety of hints and suggestions on selling radio in the prospect's home.</i>	370
How the Canadian License Law Works <i>The benefits and disadvantages of licensing set owners as experienced by our northern neighbor.</i>	372
A Comfortable Store That Wins Friends <i>Attractive layout and tasteful decorations bring business to this New Jersey store.</i>	373
<i>Departments</i>	
The "Beauty Appeal" in Radio Window Displays	350
News of the Month in Photo Form	355
Servicing Helps and Suggestions	376
New Tools for the Service Department	379
"The Editors Have This to Say—"	380
New Merchandise for the Dealer to Sell	382
Dealer Helps Offered by the Manufacturers	388
What the Trade Is Talking About	389

"Spring Cleaning"

How Radio Retailing's 65 Field Men and 15 Correspondents Are Fine-Combing the Radio Trade

IN THE early stages of growth of every new industry, selling activities are largely experimental. Ready-made sales outlets do not, as a rule, exist.

But eventually the new industry enters a second period. Time and experience take a hand in determining dealer policy. "Fringe" dealers either quit voluntarily or are dropped by the manufacturer—the final result being a smaller group of dealers operating on a much more efficient basis.

The year 1925 was the last of the first period in the development of the radio industry and the first year of *Radio Retailing's* service. In 1925, *Radio Retailing*—at great expense—through the efforts of sixty-five field men and a large office force gave to its advertisers mass circulation—every known dealer outlet was covered. Not only was this what the manufacturer wanted but we could not then be sure in any other way that every worthwhile dealer was included.

The year 1926 ushers in a new era of better merchandising in the radio industry. "Fringe" dealers, particularly those who are dabbling in radio with small stocks—usually under \$250—are being eliminated. A dealer is no longer just a dealer. His financial resources, merchandising ability, and adaptability to the radio business now determine his value to the radio manufacturer and jobber.

Checking 8,000 Newspapers Weekly—Also 1,800 Telephone Directories

Radio Retailing has anticipated this condition and for some months has been carrying on a careful survey, the purpose of which is to determine the relative buying power and merchandising ability of all radio outlets.

Engaged in this tremendous task are fifteen correspondent compilers and sixty-five field subscription men. Eight thousand different newspapers are read and clipped each week. Also 1,800 telephone directories and many other lists are checked for new dealers.

Every dealer outlet, whether new or old, is subjected to the same close scrutiny either by personal call of a field subscription man or by a chain of four questionnaires with stamped return envelope. When this survey is completed every radio outlet in the country will be classified.

The circulation policy and distribution plan of *Radio Retailing* is being based on this continuous checking of names. This survey has made possible the remarkable growth of *Radio Retailing's* paid subscription list—now 16,717. In future issues, we plan to give further details regarding this survey.

McGRAW-HILL PUBLISHING COMPANY, INC., Tenth Ave. at 36th St., New York, N. Y.

JAMES H. MCGRAW, President
JAMES H. MCGRAW, JR., Vice-Pres. and Treas.
MALCOLM MUIR, Vice-President
EDWARD J. MEBREN, Vice-President
MASON BRITTON, Vice-President
EDGAR KOBAK, Vice-President
C. H. THOMPSON, Secretary

Electrical World Journal of Electricity Ingeniería Internacional
Industrial Engineer Engineering and Mining Journal-Press
Chemical & Metallurgical Engineering American Machinist
Electrical Merchandising Power Electric Railway Journal
Bus Transportation Engineering News-Record Coal Age
Copyright, 1926, by McGraw-Hill Publishing Company, Inc.
Cable Address: "Machinist, N. Y."
Annual subscription rate is \$2 in United States and Canada.

WASHINGTON, D. C., Colorado Bldg.
CHICAGO, 7 South Dearborn St.
PHILADELPHIA, Real Estate Trust Bldg.
CLEVELAND, Guardian Bldg.
ST. LOUIS, 713 Star Bldg.
SAN FRANCISCO, 883 Mission Street
LONDON, E. C., 8 Eouverie St.



New Models Once a Year!

Starting the Radio Selling Season in May or June

Would Stabilize the Business

Encourage Summer Selling

Reduce Overstocking and Dumping

Develop Public Confidence in Radio



1. The Manufacturer

Would be helped by:

- Stabilizing his production
- Stimulating summer volume
- Eliminating odd-lot buying
- Evening up manufacturing schedules

2. The Radio Dealer and Jobber

- Would be enabled to: Compare lines offered
- Get behind a line for 12 solid months, without fear of disruption by new models
- Have new goods to offer during the summer season to stimulate buying

1926 MAY 1926						
SUN	MON	TUE	WED	THU	FRI	SAT
1	2	3	4	5	6	7
8	9	10	11	12	13	14
15	16	17	18	19	20	21
22	23	24	25	26	27	28
29	30	31				

1926 JUNE 1926						
SUN	MON	TUE	WED	THU	FRI	SAT
1	2	3	4	5	6	7
8	9	10	11	12	13	14
15	16	17	18	19	20	21
22	23	24	25	26	27	28
29	30	31				

May or June have been suggested as the months to bring out new radio models. What do you think? As dealer, jobber or manufacturer, write your opinions to "Radio Retailing."



3. Customers Would Be Pleased—

- Knowing the new purchases would not soon become obsolete
- Being guarded against price cuts on purchases for which full list was paid
- Having greater confidence in radio

Radio Retailing

With Which Is Incorporated *Electrical Retailing*

VOLUME 3

APRIL, 1926

NUMBER 4

What This Industry Needs

The Editors of "Radio Retailing" Point Out Industrial Quicksands as Seen by the Dealer Trade—"Dealer Grievances" and Their Remedies—The Demand for Bringing Out New Models in Early Spring

THE radio industry, under present trade conditions, leaves room for a great deal of improvement. Dealers, jobbers and manufacturers will agree on that. It is admitted, also, that no trade so embryonic as radio can hope to win prosperity and perfection in distribution in the short time radio has been in existence.

But there are many things—many glaring faults—that can and should be corrected. Should be corrected for the good of every one in the trade and can be corrected by concerted, co-operative action by the trade. Personal visits made by the editors of "Radio Retailing" to every branch of the industry have shown everywhere the present great need for both understanding of "the other fellow's position" in the manufacturer-jobber-dealer chain—and a more sympathetic appreciation of the other man's problems.

That's dealer grievance Number One—that some manufacturers don't seem to give a hang so long as they get theirs. Which may or may not be true, but has a foundation of fact as past history has proven—particularly the history of "dumping and department-store bargain sales." And that brings us to dealer grievance Number Two.

The sale of large lots of receivers to big department stores enabling them to buy and sell far under the usual prices, admittedly demoralizes the market in the

locality where it occurs. It does not seem possible or even probable that dealers hundreds of miles away from the scene of this particular form of price-cutting should be affected by it. BUT THEY ARE!

Many a small dealer in a tiny hamlet is just as bitter about such "bargain sales" as is the man who happens to own a radio shop right next door to a store that holds them.

Local Dealer Gets Grief of "Bargain Sales"

The small-town man's argument is this—"Our customers see this big-town advertising of sets at prices way below what they paid for theirs. Who gets the bawling out? The dealer who sold them their set at the list price, of course. He has no argument, no comeback, and an enemy is made out of a man who was formerly a friend and booster. That attitude holds good, also, even if the set advertised in the sale is not the same make of set the customer has, but if it merely approximates his set, or has one more tube than his set, for which he has possibly paid twice as much, then he gets sore just the same and who can blame him? The trouble is, though, that we local dealers are the ones who get the grief."

The manufacturers' first thought in answer is this—"It's the dealer's own fault. Don't buy the products of those manufacturers who dump." That's all very

"Dealer Difficulties" as Told to the Editors of Radio Retailing

In constant contact with the radio trade in each of its three branches, and particularly with the retail trade, the editors of this publication have learned many things about radio trade conditions as seen through the dealers' eyes. Dealers have many

difficulties and are not hesitant about giving voice to them. Here are a few "dealer complaints":

1. Lack of consideration for "the other fellow's position" in the manufacturer - jobber - dealer chain.

2. The sale of large blocks of

receivers to large retail outlets for sale far under the market value.

3. The need for general trade announcements of new set models at one time only during the year, —in the early Spring or Summer.

well and the editors offer it for what it's worth. But that argument is shot full of holes when it is remembered that sales of dumped sets ruin the sale of ALL sets as well as those of the same make.

The manufacturers' second thought, however, is this—"Suppose I should bring out a new model making a previous model obsolete? Suppose I should take back from my dealers all their old models? Then, the only way I can liquidate them quickly is to sell them in a lot for whatever I can get. Having given credit to my dealers for their old sets, I wonder if they would stand for it if I dumped them to some department store?"

The answer, emphatically, is "NO!" Why the answer is so decidedly and instantaneously, "NO!" may be somewhat incomprehensible to a manufacturer who, feeling that he has protected his trade by extending credit for the old models, also feels that he is entitled to some return for his generosity. Nevertheless the dealers' answer remains a firm and undoubted negative, which brings us to dealer grievance Number Three.

Dealer grievance Number Three is that manufacturers bring out "too d— many new models during the course of a year."

R. B. Aldrich, one of the owners of the South Carolina Radio Shop, Charleston, S. C., reputed to be one of the first radio shops in the Carolinas, echoes the opinion of many radio dealers when he says, "Manufacturers should find some way to stop making frequent changes in design."

"The greatest bugaboo in the customer's mind is the fear that if he buys a radio set today, something revolutionary is bound to come out tomorrow which will make his set a back number. That fear of 'something revolutionary' has been planted in the public's mind by the manufacturers themselves who have advertised their new sets as 'revolutionary' and throwing into discard every other radio set that was ever made.

"That fear has already taken root and grown to alarming proportions. It is the one sales resistance argument that I get thrown at me by customer after customer and it takes some tall selling to overcome it.

"And these frequent changes in design, either in the circuit or in the appearance of the cab-

inet, are keeping alive this fear of purchasing radio now. I have many prospects who would buy a set today, but every time a new model comes out—and that happens regularly every few weeks from one manufacturer or another—they get the idea that it is a radical departure from the older sets, so they say they're going to wait until the final 'revolution' occurs before they buy.

"Now you know and I know that that's a lot of applesauce. But try and convince the public that there aren't going to be any more radical changes. No sir, they've read the ads in the newspapers and thus-and-so has a brand new set that's going to be a knockout and change the whole idea of radio reception so they'll wait and buy one. And when the set does come out they find it has possibly one more tube, or pretty pictures on the panel, or a different-sized cabinet from the old model and there the 'radical change' ends.

"There's one remedy and only one, as I see it, and that can be done only if manufacturers will forget their petty differences for a moment and as has often been proposed, bring out their whole new line all at once at one definite, certain time of the year.

"The most appropriate time for this, from the dealer's standpoint and I don't doubt, from the jobber's and manufacturer's viewpoint as well, is about the first of June, in my estimation. This will give us something to get behind and push during the summer months when, otherwise, things slow up. One of the reasons why summer is as slow as it is in radio is because it's the tag end of the radio buying season."

An Ohio dealer in a letter to the editors of *Radio Retailing*, emphasizes the same theme. He says:

"Make the summer the START of the radio buying season by bringing out all new models the middle of May or the first of June and then watch that summer sales curve climb.

"If dealers could be confident of being able to get behind the manufacturer's line with the assurance that nothing new was to come out for another twelve solid months, we would find one hundred per cent more effort on the part of dealers to sell radio."

And this from Portland, Ore.:

"Nothing is more urgently desired and needed in radio than co-operation

*Continued on
Page 392*

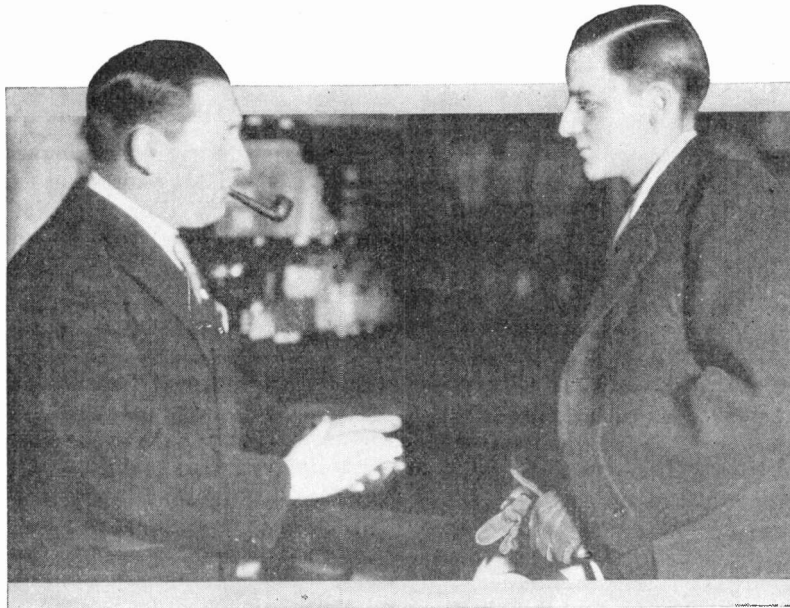

Radio Dealers Speak Their Minds—

when visited by the editors of *Radio Retailing*. They pound the desk—hit out straight-from-the-shoulder in voicing their thoughts about the radio industry—its faults and flaws, and what should be done to bring about increased prosperity for everyone.

The editors cannot visit every radio dealer, or every jobber and manufacturer—but the

pages of *Radio Retailing* are thrown open to the entire trade as a public forum for the discussion of radio trade problems and their remedies—You who haven't had a chance to tell your thoughts to the editors in person—SIT DOWN NOW AND ADDRESS A LETTER to the Editor, *Radio Retailing*, 36th Street and 10th Avenue, New York City.



In Florida—

Sales Must Be Forced!

Where Dealers Face Perpetual Summer—Southern Florida—Radio Is Up and Coming.—In the Policies and Methods of This Miami Retailer May Be Found Many Lessons on “How to Sell Radio in Hot Weather”

By WILLIAM C. ALLEY
Associate Editor, *Radio Retailing*

MIAMI, in the “golden” state of Florida, is fondly termed by its Chamber of Commerce, “The Magic City.” Also, its advertising slogan is, “It’s Always June In Miami.” June, as is well known in the radio trade, is not such a good month for radio sales. So the editor of *Radio Retailing* conceived the idea of sending me to Florida to find out how they sell radio in a climate where it’s “always June” and often August, figuring, no doubt, that if radio can be sold in a climate where it’s hot twelve months a year, it certainly ought to be easy to sell in the dear old North where summer is only three months long, praise be to nature.

The first three important things I discovered about radio conditions in Florida and particularly in Miami are that radio reception is as good in

the summer as it is in the so-called winter, that the “summer slump,” therefore, is something that is yet to be experienced, and that practically all selling is done outside the store.

“Radio can be and is being sold in Miami, let there be no mistake about that. But salesmen working outside the store and home demonstrations of sets are absolutely essential. Sales must be forced, let there be no mistake about that, either.” The gentleman talking is K. G. Mengert, secretary of the Mengert-Mann Corporation, of which R. G. Mann is president and Francis A. Kelly vice-president. The Mengert-Mann Corporation retails the Atwater-Kent line in Miami.

“It isn’t exactly a hard job to sell radio here,” Mr. Mengert continues, “but it isn’t easy, either. We’ve got to keep plugging, day and night.

We’ve got to tuck each little set under our strong right arm, pack it carefully in one of Henry Ford’s masterpieces and take it right into the patio of each little Spanish bungalow and then demonstrate it and sell it. Once the set is taken into the home, there it stays and the Mengert-Mann Corporation deposits another check in the bank.

95 per Cent of Sets Demonstrated are Sold

“Ninety-five per cent of the sets we have taken into Miami homes and demonstrated, have stayed there and resulted in sales. It’s all a question of shoving the set right up under their noses and letting them twiddle the dials themselves. The rest is easy. The check follows.

“Of course, the check may have to be put through the bank four or

five times before it turns out to be good, but that's simply a local situation due to the unstable real estate conditions. People have so much money down here and use so many different banks to keep it in, that they forget how much they have in any one certain bank and so overdraw their accounts. The checks almost invariably are good eventually, but like everything else in Miami, it takes time. Three N. S. F.'s per check is about the average and the fourth time it stays."

Five Outside Salesmen On 15% Commission

Five outside salesmen are traveled by the Mengert-Mann Corporation and they are instructed never to make a sale until after the set has been demonstrated in the prospect's home. Because of the distance from the large Northern broadcasting stations and uneven reception conditions, no demonstrations are made in the store. "We want every customer to feel we have a personal interest in him and taking the trouble to install the set in his home for the demonstration has clinched many a sale for us that otherwise might have been doubtful."

"Where do you get your salesmen?" I asked.

"Advertise for them," said Mengert. "There are probably some of the best salesmen in the United States starving to death in Miami. They swarmed down here confident in the belief they could clean up mil-

lions selling real estate. Well, some of them did, but for every one that did, there are a hundred who didn't. Men who have made tremendous successes as salesmen up North, stranded down here, are glad to take 15 per cent commission selling radio for us.

"True, we have a tremendous turnover in salesmen but that doesn't mean anything. As I said before, you've got to keep plugging. We don't let frequent salesmen changes discourage us. It's one of the griefs of any business, and as they go, we get others, preferably experienced salesmen. Also, they have to measure up, in ability, appearance and personality, to the standard we have set, which is a high one. Our market consists mostly of northern people who have come to Miami either to make it their home or to engage in business and as a class they are well enough off to appreciate quality—both in the radio set they buy and in the man who sells it to them."

Store Overhead Is Kept to Minimum

Store overhead is kept to a minimum by that policy of "all sales in the customer's home" and also because of the fact that the 15 per cent commission paid the salesmen includes all their expenses in making the sale. The commission includes the salesmen's expenses in getting the prospect, selling him, and servicing the set for sixty days.

Two salesmen combine to hang the aerial when a sale is made, under the supervision of Mr. Mann, who is an expert radio technician. All sets are sold complete for a definite price which includes the cost of installation, and for which a charge of \$25 is figured. That is, after the cost of the set and accessories is added up, a \$25 additional charge is totaled in. The customer, of course, is quoted only the final price, completely installed. Out of this charge, the salesman also receives \$7.50 for hanging the aerial, which he splits with his helper. So far this has worked out successfully.

Thus, on an Atwater Kent compact, the price with complete accessories and installed, is \$197. The salesman's 15 per cent commission amounts to \$29.55, and the \$7.50 extra for the aerial makes a total of \$37.05, out of which the salesman's expenses must be paid. The better salesmen's average earnings are close to \$100 a week, Mr. Mengert states.

The outside salesmen are wholly "on their own" in the matter of digging up prospects and selling them.

"How do you get your prospects?" was the next question I asked concerning "how to sell radio in Florida."

Prospects Obtained by House-to-House Canvassing

"Salesmen get their own prospects," was the answer, "by simple house-to-house canvassing. We give them every co-operation from the store whenever they need it, but so far they have been successful in finding enough prospects of their own to keep busy.

"We don't make any attempt to route them or confine them to any given territory and we have found that a new man, after the first few weeks, doesn't need to resort to 'bell-ringing,' and here's the reason: Suppose he selects a certain block that looks pretty free of aeri-als. He calls on every house on the block and say there are fifteen houses. Out of those fifteen calls he finds one good prospect, and that seems to be the average number of calls before the first sale is made.

"He makes a sale to that prospect. Then he goes back over the other fourteen neighbors and uses his customer as a reference. Invariably, on the strength of the neighbor's installation, he is able to make one or two, and often three, sales to the

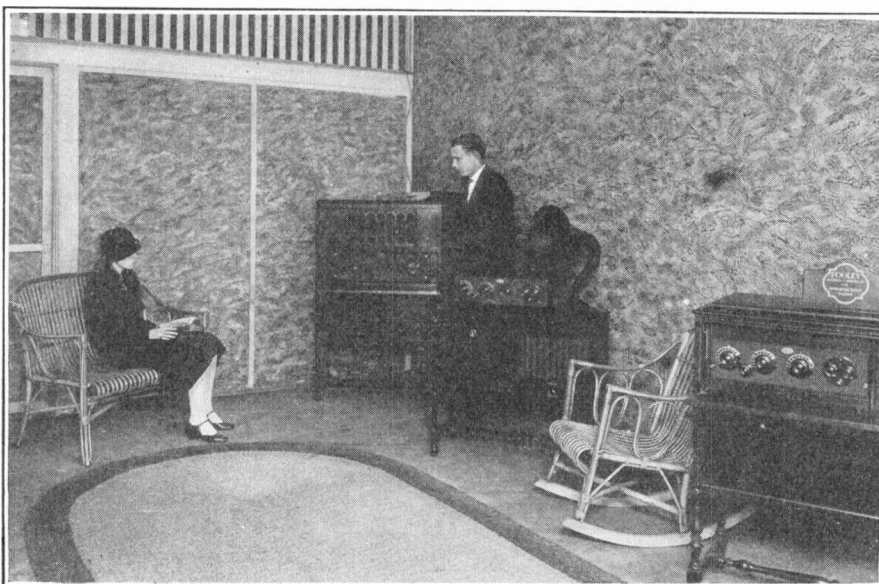

Despite the fact that few sales are made in the store, the Mengert-Mann Corporation's store interior presents a very attractive appearance. Although the left hand wall has been knocked out a few times due to

the fact that a new building is being erected next door (a condition peculiar to Miami) at least the appearance of completeness is preserved. The interior is finished in true Floridian style—blue Spanish stucco.

houses where he had failed in the first attempt.

"After that, after he gets two or three sets in a certain neighborhood, friends of those owners keep him busy with orders. Then friends of those friends are solicited, so that there is an ever-increasing circle of friends-of-owners for the salesman to concentrate on. Admittedly the first sales are the hardest, but they are bound to come if the salesman sticks to the job and keeps plugging.

"One sales idea that we have found an excellent one is to play upon the homesickness of the prospect. More often than not, he is not a native Miamian, so we find out what city he hails from. Then we attempt to tune in a station somewhere near his home town which always brings on a pleased, enthusiastic mood. We put across the idea that he can 'take a trip back home every night' and if the station is one that he has heard, or heard of, back home, he is ready to sign on the dotted line right there.

"Another thing we have found that might be of interest to other radio dealers is that it doesn't pay to let the salesman have too many sets out on demonstration at the same time. We limit them to two sets, and possibly three if conditions warrant it, and insist on having a decision in three days unless reception is so poor that a fair test of the set cannot be made in that time.

Where It's Summer Twelve Months a Year

radio is "not so hot." But it can be sold, and it is being sold, in ever-increasing quantities in Miami and throughout Florida.

The experiences and the policies of the Mengert-Mann Corporation, formerly the Francis A. Kelly Company, of Miami, in selling radio where summer is eternal demonstrate that the only reason why radio is not sold in colder climates during the summer is because the Northern public has been "mis-educated" to believe radio is useless in hot weather.

"Also we require that the salesmen make a service call every week for the first month the set is in operation. This checks up possible defects or dissatisfaction and not only creates good will for the store, but gives the salesman an opportunity to get names and addresses of friends of the set owner who have heard the set and liked it.

"Much of our business has been

built up because of the service we have given our customers after the sale was made. You must remember that radio is just getting started in Florida. Its stage of development has only now reached the point where it was up North three or four years ago. That is, so far as sets go. There is practically no parts trade because of our distance from broadcasting stations and it takes a very good, selective, powerful set to get satisfactory results—better sets are needed here than the average amateur set-builder could probably build himself.

Was an "Over-the-Counter" Business

"Therefore, service, in the past, has meant very little to Miami radio fans. Those few who were interested in radio, went into the shop, carried the set out under their arms, installed it themselves and the dealer promptly forgot all about it. It was an 'over-the-counter' business.

"Now, however, all that has changed. With the influx of northerners, many of whom were already well-versed in radio, there began to grow a demand for good sets and expert service. Service is unquestionably one of the prime requisites of any radio store and this holds good particularly so in Miami and probably the rest of Florida as well.

Continued on page 392



"We build buildings overnight" is a Miami, Fla., boast that comes almost near to truth. The construction era Florida is passing

through is illustrated by this photo of the store front of the Mengert-Mann Corporation, where a new structure is going up

next door. There is hardly a street in the city that does not present a similar view of scaffolds and building material.

These Windows Are Sales Producers—Are Yours?

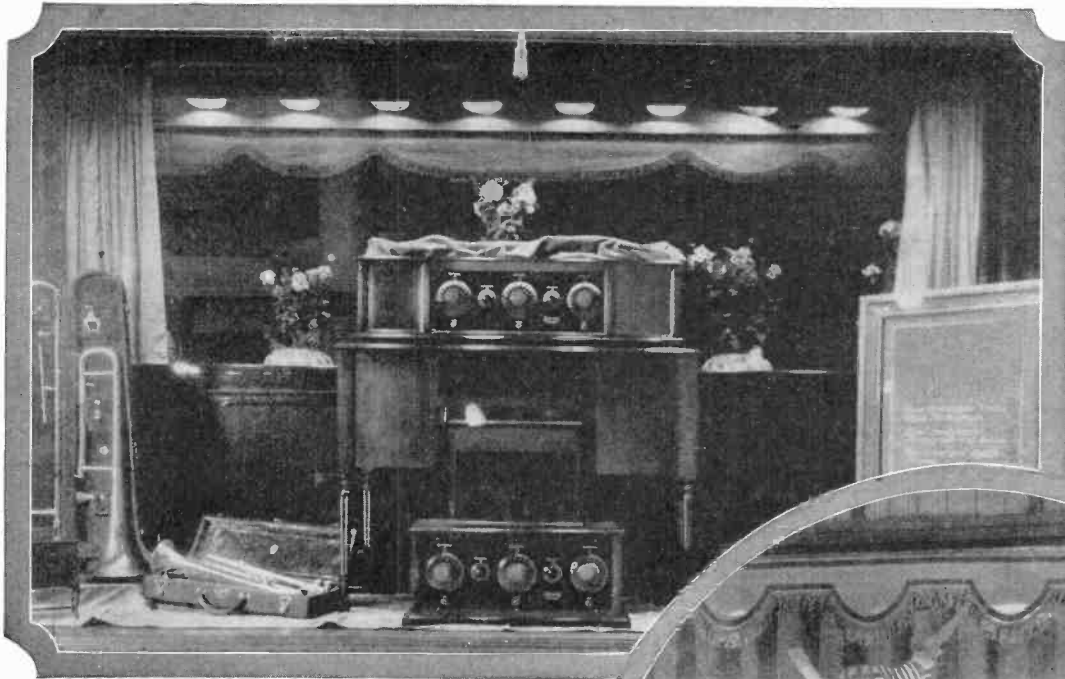

Illustrating the Use of the "Beauty Appeal" Versus That of "Action"

This window of the Foyal Music and Radio Company, Denver, Col., is a good example of the proper use of drapings and flowers for decorative effect. The window is not overdone and is well balanced.

This window, right, capitalizes a recent song hit. In it the Brunswick Shop, 3206 W. Lawrence Ave., Chicago, Ill., has presented an irresistible sales message. The snow and skiing figures create the right atmosphere for the song "I Miss My Swiss" and carry the suggestion that it sounds well "in the air." The sheet music strengthens the main idea and the receiving sets as much as to say "We are the means whereby you may enjoy this lively music."

Below: Another "atmosphere" window. The insertion of a comfortable arm chair in the picture is a clever touch. It breaks the monotony of the trim.

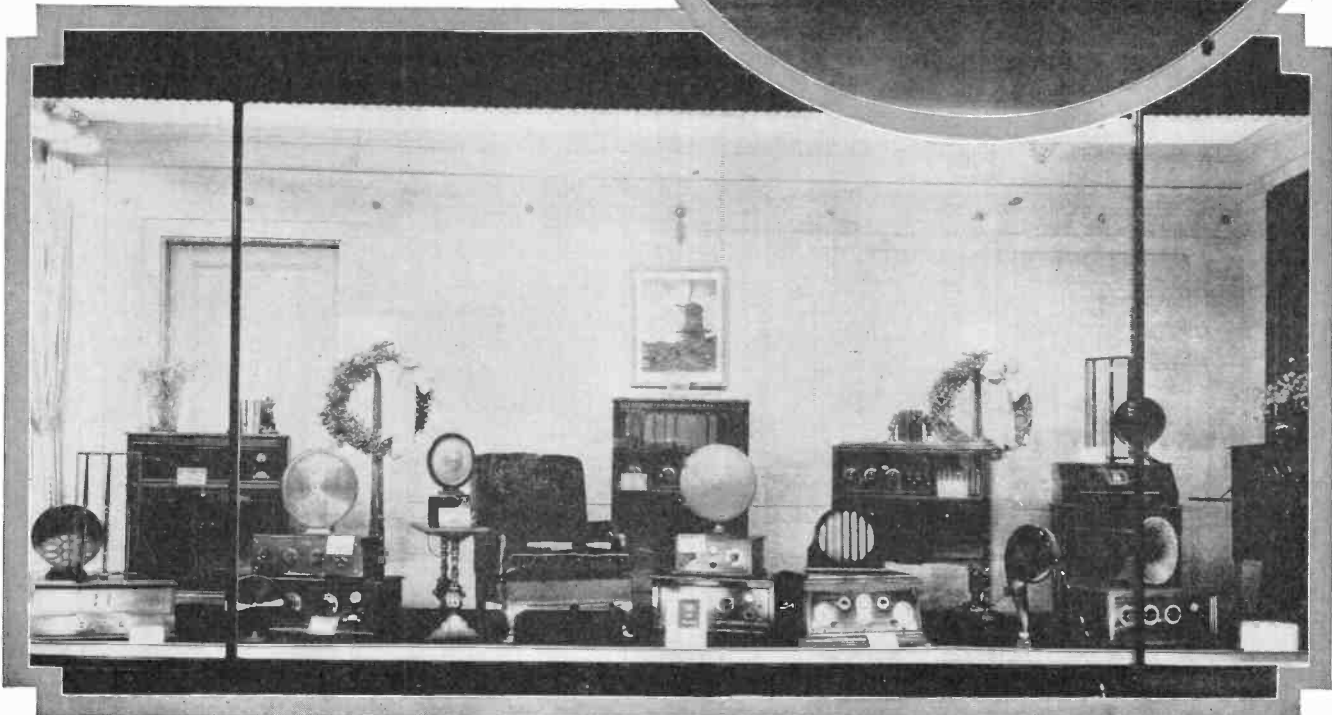
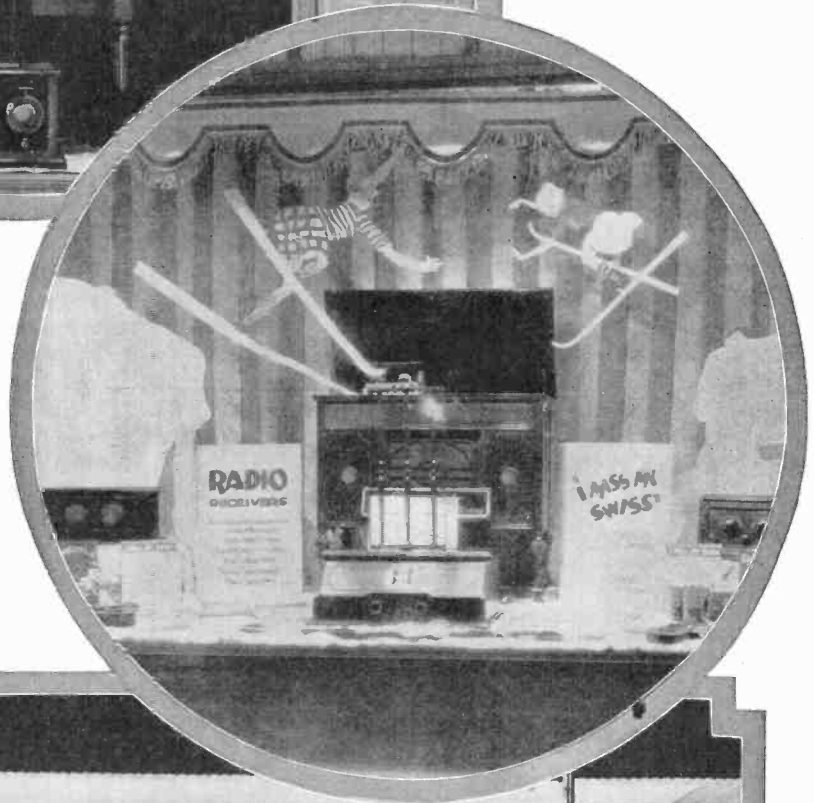

Stock Control

Daily Check-up Keeps Salesmen Acquainted with Shelves

Analyzing Buying Trends and Changes in Demand

The Importance of Accurate Weekly Inventories

"The Secret Is to Have What Is Wanted When It Is Wanted"

By J. ANDREW WHITE

MY ARTICLE in the March issue dealt with sales as the vital spark in the retail radio business. It discussed the direct relationship of sales volume to the training of sales personnel. That's about half the story. Now for the other half—

Not a single experienced radio retailer is going to give me an argument, I know, when I say that having the merchandise the public wants, when it wants it, is the very foundation of money-making in this particular branch of the business.

Talk all you want about price. That's flash-in-the-pan stuff; one sensational sale is a success; the next one is likely to be a failure. And when a sale doesn't "go over," the expense of the special advertising and the elaborate set-up and preparations run up a cost that comes mighty near wiping out all the gain of the previous success. Or take price-cutting as a regular thing, an everyday, year-round matter; a fixed policy on which certain stores base their entire operations—if this thing is to be done brilliantly it means buying in large quantities to get a low price. That is fine, if you can buy the right thing, always. Obviously, that can't be done. So what happens is, the bulk of the stuff that is bought at the abnormally long discount is made up of items "dumped" by manufacturers; dead

merchandise that hasn't moved fast enough. Or, if it is merchandise active in current demand which is bought "through the back door" because somebody's creditors are howling for money, the quantities thus secured are so small the "buy" doesn't really count for anything on the balance sheet.

Looking at it from any angle, therefore, the real Utopia seems to be best envisioned in a stockroom comfortably filled with the sets, parts and accessories of which there is a scarcity because of an insistent public demand, and practically no stock at all of the stuff that customers no

KEEPING abreast of the swift and sudden changes in the public's buying demands is the primary duty of the radio retailer, Major White believes.

"Too much importance cannot be laid upon the necessity—not of a large stock—but of a complete stock," he says. "No sixth merchandising sense is needed—only a consistent, daily routine of stock checking and weekly inventories."

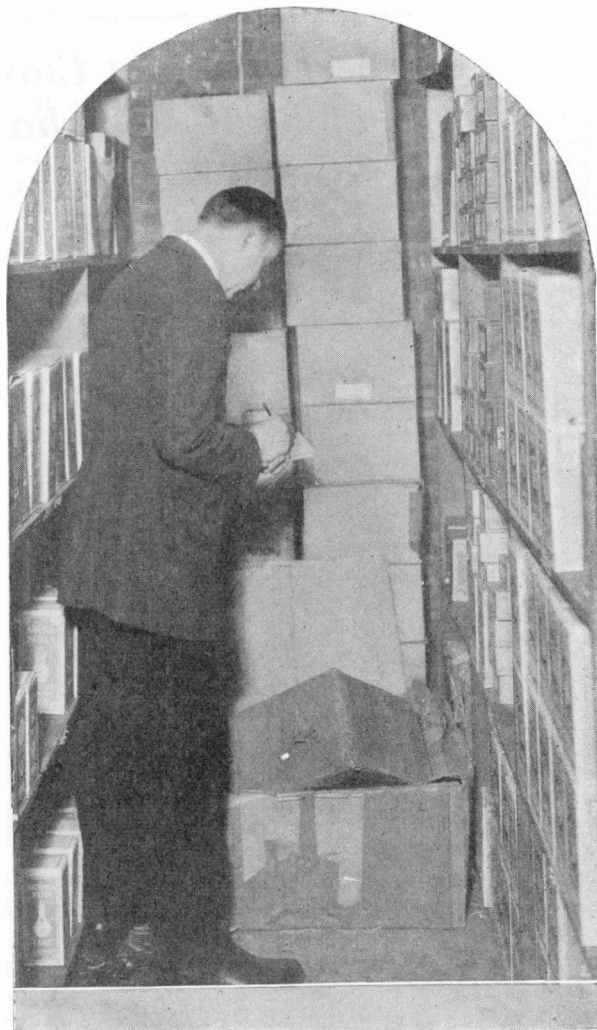

longer call for. Then it isn't necessary to cut prices; in fact it is foolish to do so.

By hearsay at least, it is known that there are retail radio stores which maintain this condition and operate successfully and profitably, because of the large volume of business which can thus be done in goods sold at the full list price. I am going to tell you how it is done, but I want first to emphasize this—the firm stock control which makes it possible is not a hit-and-miss matter, nor does there enter into it any suggestion of an eerie sixth sense or "merchandising instinct" — whatever that is—but rather it is due to strict observance of an unflinching routine which operates every day, irrespective of rain or sunshine or the state of anybody's health.

The "stock control" job takes up twenty minutes of the beginning of each business day, and no matter what comes up it has to wait that twenty minutes. For this is no different from any other system in the one particular that it must be rigidly adhered to; it accomplishes seeming

The Seventy-eight Classifications of Radio Merchandise

- | | | |
|----------------------|-------------------------|-------------------------------------|
| 1. Adapters | 28. Condensers—variable | 55. Plugs |
| 2. Ammeters | 29. Cords | 56. Potentiometers |
| 3. Amplifiers | 30. Cords—Phone | 57. Reactivators |
| 4. Arresters | 31. Crystals | 58. Resistances and Grid Leaks |
| 5. Amperites | 32. Cushions | 59. Rheostats |
| 6. Attachments | 33. Dials | 60. Sets |
| 7. Base Boards | 34. Eliminators | 61. Signal Lights |
| 8. Bearings | 35. Fuses | 62. Sockets |
| 9. Batteries | 36. Hydrometers | 63. Solder |
| 10. Binding Posts | 37. Insulators | 64. Spaghetti |
| 11. Bind Post Strips | 38. Irons | 65. Speakers |
| 12. Bradleyohms | 39. Jacks | 66. Switches |
| 13. Bradleystats | 40. Kilts | 67. Switch Stops and Points |
| 14. Brachstats | 41. Knobs | 68. Tables |
| 15. Brackets | 42. Lamps | 69. Tape |
| 16. Bulb Chargers | 43. Lead-ins | 70. Templates |
| 17. Bus Bars | 44. Levers | 71. Tools |
| 18. Bushings | 45. Loops | 72. Transformers |
| 19. Chargers | 46. Lugs | 73. Tubes |
| 20. Cabinets | 47. Mats | 74. Tubing |
| 21. Cables | 48. Mountings | 75. Tube Testers |
| 22. Catswhiskers | 49. Packs | 76. Victrola and Radio Combinations |
| 23. Clamps | 50. Panels | 77. Voltmeters |
| 24. Clips | 51. Panel Lights | 78. Wire |
| 25. Coils | 52. Phones | |
| 26. Compounds | 53. Phone Tips | |
| 27. Condensers—fixed | 54. Phone Units | |

miracles because it functions with positiveness each day in the year, but if it was once neglected or slurred over or allowed to get behind, it wouldn't be worth a darn. I'll show you that, later.

But first, so that I make clear what is meant by "stock control," let us view what goes on in the average retail radio store.

Keep Stock Up-to-Date

A customer comes in and wants to buy a certain article, an Iwanta Dingbat, we'll say. The clerk has heard of it; he is not at all sure that there is one in the store; it's not on the floor or counters or on the shelves or certainly he'd know it—maybe in passing through the stockroom he saw one sometime, or maybe he has just read the advertising somewhere; anyhow, it bothers him; he asks the Boss. Yes, the chief knows of the article; lemme see; bought a sample order several weeks ago, two or three of 'em; showed them to pet customers and they took them along with them; meant to order more, but something came up; must look into that. . . . So the clerk goes back to the customer and is sorry the store's out of them at the moment; get him one in a day or so. But the customer goes somewhere else to find it.

That is typical in scores of instances and with many and varied

products. Sometimes it applies to an item which once sold fairly well but never in sufficient quantity to attract especial attention, so when the last one left was sold, re-ordering seemed unimportant; more often does it occur with a really meritorious product which is in the early stages of distribution. But in either case, or in any of many variations of the situation which might be cited, the customer has gone; a sale has been lost, and possibly future patronage; and then along comes another inquirer for an Iwanta Dingbat, and another, and another. It is realized then that this is something the store must have; the Iwanta people have broken out with a special advertising campaign, or somebody has written an article or two, or a few highly enthusiastic radio fans have been tipping off their neighbors to a discovery—anyhow, there's a demand; and none in stock. So, the *At Once* order to the jobber and a long wait, because a lot of other stores want the same thing at the same time.

That's radio, as every retailer knows it. Fads and fashions and fancies, in the main, whether it's sets, accessories or parts; and every so often a product that creeps up from being a fairly slow mover into a standard article that sells in quantity every day in the selling season.

"Now," thinks the harassed proprietor who is caught in a shortage

and unable to get delivery of the one item that is selling when things otherwise are quiet, "they won't get me next time." But they will.

Because in the average retail radio store which has come under my observation the whole system provided for carrying a stock of merchandise rests upon some individual's memory or one or two or more persons' impressions of how this-and-that is moving, has moved, or is likely to move. If the store is a live one, the buyer ordinarily is almost exclusively engaged in scrambling about to get quick delivery of the stuff that is in demand and trying to ward off the importunities of salesmen who want him to consider something he hasn't the slightest interest in at the moment. The selling season is short, and *the whole trick is to have what is wanted when it is wanted.*

Keep the Right Proportions

Further to complicate the task is the necessity of keeping up the right proportions of stock on the staple items, if the store is truly representative of radio and carries the hundreds of small items wanted by the various classes of fans. As a matter of fact I cannot think off hand of a single item in radio which rightfully could be called a staple, yet there are countless items such as bus-bar and insulators and binding posts which must be ordered in considerable quantity; and not too voluminously, for even here fads and fancies crop up; yet they cannot be bought too conservatively because some of these items are sold both singly and in combination in making up kits or complete parts for the set builders. The mere contemplation of the task that confronts the man who expects to do a real job of stock control is enough to make one dizzy, for it is evident that the only solution rests in taking a physical inventory each day of the year. With hundreds of items in stock, that appears to be next to an impossibility. I'll go further and say that it is an impossibility; the economic waste it represents, alone would rule it out.

Resolve the whole problem into this, then: The man who does the buying must know what is on hand, what is selling, what is "dead," what new items are being offered, and their possibilities and potentialities—and although his knowledge must be exact on each point there are not sufficient hours in the day for him to examine into each item personally and attend to the regular business

of the store, in addition to which his picture of the business should be viewed in panoramic form, taking in everything singly and in detail but also in each one's relation to the other component parts. This can be done in but one way—by a system of salesmen's reports made daily, wholly comprehensive of the entire business and yet so simple in form that only a few minutes are required to make them out.

An Efficient Control System

One system of stock control of which I have first-hand knowledge and which is of proven effectiveness in producing the merchandise wanted when it is most in demand, as well as keeping "dead" stock to a minimum, is the one employed by the Haynes-Griffin stores. It was devised by the buyer—who in this instance is the president of the company, Mr. Griffin—and it is a house rule that the reports must come to his desk every business day of the year, and at the same hour.

Basically, there is a card record which is a complete inventory of every single item in the store. The merchandise is divided into seventy-eight classifications, and the supplies of each article are arranged in the stockroom in exactly the same relative physical position they occupy in the store. An actual physical count is taken once a week, but this

is more in the nature of a check-up or verification of the daily reporting done by those who are responsible for keeping the buyer posted on sales and supplies.

When the store opens at eight-thirty each morning, the very first duty of the five salesmen who are assigned to this task is to call for the cards, which have been assorted and allocated in advance to each individual. Each man immediately goes then to the stockroom and checks up on those items which are called for by the cards he holds, and makes the necessary entries, reporting the exact condition of these particular articles of merchandise. The job is proportioned to a nicety so that the burden falls equally. The man who has to report as to the number of binding posts, for example, is not required, too, to check up a binfull of grid leaks; where one classification is comprised of a large number of units, that is offset by a card of a certain type of radio receiver of which possibly only five or six are carried in stock. That is accomplished by taking originally the grand total of items of merchandise, numerically, and dividing the whole into twenty-five equal classifications, and in turn dividing these into five groups each for the five salesmen.

Twenty minutes each morning has been found adequate to clean up the whole job. This is done unflinchingly

for five days of the business week, and on the sixth day an actual physical count of the stock is taken. So that errors cannot creep in through this daily routine becoming monotonous to the men by the familiarity of reporting the same merchandise constantly, the assignments are switched each day and the man who reported on this certain group yesterday finds himself reporting an entirely different one today. Errors thus correct themselves within twenty-four hours at the most, and when the cards reach the buyer's desk at nine o'clock in the morning they present an amazingly accurate picture of the complete merchandising situation at that very hour.

Reports Studied and Analyzed

By ten o'clock the analysis and study of the reports has been completed and the buying for the day begins. Reorders can be taken care of in twenty minutes, for the record is 100 per cent clear on the current sales of any individual item, by day, week and month for several months back. The quantity to be ordered is jotted down on the record with a green pencil, governed of course by the previously entered green numerals which are an unflinching indication of what the normal sales have been for that particular item over any given period. The actual orders are made out by a clerk and the

National Music Week—and Its "Music Memory" Contests

NATIONAL Music Week, this year, will take place May 2 to 9. Each year, interest in music is stimulated by this special period of concentration on things musical, and to instil in the public a desire to hear better music—to acquaint them with better music—educational authorities in many communities conduct "Music Memory Contests"

in the schools—that is, selections are played and the students required to name the selection.

What better tie-up with "Music Week" can radio dealers have than the fact that—"A Radio Set Brings You Better Music Every Night!" Appeal to the parents' desire to educate their children by putting across the idea that their children stand a better

chance to win the "Music Memory Contest" if they are constantly hearing the best in music by means of a radio. Pound home the fact that radio, bringing the best music into their homes every night, will slowly but surely educate the growing generation to know and love the compositions of the world's great composers.

Special concerts, musical features and broadcast programs have been arranged for this period and music and radio dealers will feature the week in their advertising matter.

Cash in on the interest thus stimulated in music by tying it up directly with the definite sales appeal that radio brings better music into the home with greater ease and pleasure than any other musical instrument. Upon investigation, individual dealers can undoubtedly find many ways to capitalize on "National Music Week."



buyer is free then for the hour reserved for examining new merchandise offered and considering the various propositions presented by callers and through the mail.

Appraising this system of stock control, these merits are immediately obvious: First, the tremendous saving in time effected by dividing the work and responsibility among a half-dozen people. Buying radio merchandise in quantities that represent a daily average of three thousand dollars would not only occupy every second of a man's time but would keep him constantly working nights and so bound up in a maze of detail that he would have no opportunity for calm reflection and study of the trend of sales, and a fair proportion of his purchases would be based upon impressions or instinct or something equally hazardous. On "off days," with minor mistakes either at the inventory end, or in ordering too much or too little, an opportunity for a nice profit slips away, or overstocking later develops here and there.

Next in importance is the valuable knowledge to be gained from the reports as to which are the slow-moving items. The buyer puts in only twenty minutes a day going over these reports, but the mere fact that it is a *daily* job and that he is ex-

amining and studying cold figures rather than glancing up and down a line of stock shelves—"dead" stuff hasn't a chance in the world of escaping notice, whether the slowing up is a current matter of a few days, or a week; or longer; for the history of both its previous sales and current inactivity is there clearly on the record. The danger signal sets itself thus on any item, with the obvious remedy lying in pushing the

receivers, or loud speakers, or parts, or accessories, or it may be a sales plan, or a window display, or a newspaper ad, or a mail campaign, but it must have a particular purpose—to boost hot weather sales.

Be sure your name and address are clearly legible and bear in mind that, if accompanied by a photo—even a snapshot—it will make your contribution much more desirable.

Address, The Editor,
Radio Retailing,
Tenth Avenue at 36th Street,
New York City.

Your Summer Sales Experiences Are Worth Five Dollars Each

EVERY dealer has had some experiences or ideas on how to push radio in the summer-time—how to increase the hot weather sales volume. Every such idea that has produced sales and profits is worth Five Dollars to the editors and readers of this publication. Sit down now and write us about that little scheme you did last summer, or the plan you have in mind to do this summer, and if it will be of aid to other dealers and is suitable for publication, *Radio Retailing* will forward you immediately a check for \$5. It may be an idea to sell radio

Summer Sidelines to Beat the Slump



Appropriate sidelines that will help pay the rent during the hot weather are being taken on by radio dealers in increasing numbers. Something icy seems to be the most popular, including vacuum ice cream freezers and electric refrigerators. The Whiting Radio

Service, Bridgeport, Conn., is among the stores that are selling electric ice-boxes, and above is a view of how the Whiting shop looks with refrigerators "on the side." An intensive outside selling campaign is used to push the sale of the refrigerators.

sale of the "sleepers" until they disappear from the inventory or reduce themselves to negligible proportions. It is thus that heavy accumulations are avoided and the necessity for clearance sales kept to a minimum.

The remaining advantage is, the opportunity for concentration of thought on sales. With buying problems resolving themselves into chart form, there is plenty of time and opportunity available to place the maximum effort on selling. Integral with the stock control system, you will notice, is the fact that the daily reports of stock are taken by salesmen. Also that the arrangement of the stockroom calls for each item to occupy the same relative position that it is given in the store. The result is, that each salesman learns by absorption the approximate stock of any item which is on hand each day. When a customer asks for a certain article and a glance at the store shelves shows a vacancy at the particular place, a picture of that relative spot in the stockroom flashes into the salesman's mind and he knows whether the article in demand can be supplied. There is no hesitancy and if you know anything at all about selling, nothing more need be said on that point. Furthermore, since these salesmen have to report a different group of merchandise each morning there is no such thing as specialized knowledge; each man has equal familiarity with all the hundreds of items and knows each day the quantities, approximately at least, in which any item is selling, whether or not he has personally sold a single one himself.

Radio Events Recorded by the Camera

"Antinoe" Heroes Given Set

Among the gifts showered upon Captain George Fried and Chief Officer Miller of the S.S. "President Roosevelt" for their heroic rescue of the crew of the foundering "Antinoe," was a complete radio receiver. Captain Fried (seated) divides his time in mid-Atlantic between ZLO and WJZ.



Preserving Radio Programs

Francis R. Hoyt (below) is responsible for an invention which records broadcast programs as received by an ordinary set. A recent test was successfully conducted.



"The Book of Regrets"

J. E. Downey, assistant radio supervisor, is looking over the Department of Commerce's book in which are listed the 400 applications for broadcasting licenses denied for lack of wavelengths.



For English Kids

Sir Harry Lauder recently visited the Cheyne (England) hospital for children and found the kids listening in.



*The Handwriting
on the Radio Wall
Says—*

The Gyp Is

SLOW music during this scene. Slow music and soft drums—"Alas poor Yorick" and so forth. Because this scene, you see, heralds the doom of something whose doom has been prayed for by the radio trade for many moons.

The scene is laid in a graveyard—Cortlandt Street, New York—the graveyard of radio. On one side of Cortlandt Street, No. 66 to be exact, we find a typical Cortlandt Street radio store—the Vim Electric Company—windows plastered up with cut price signs and "big bargains in radio," interior the usual thing, counters and shelves, shelves and counters, dirty floor, cluttered up with boxes and strewn with paper.

A few doors away, No. 70, we find one of the classiest storefronts we have yet encountered. Take a look at it down there in the right hand corner of these pages. Nifty, isn't it? And the expensive electric sign above it reads, "Vim Radio." The same, unbelievable as it may seem, as the dilapidated dump down the street.

Sam Kassover, president of the company that operates both stores, explains the reason for this astounding move—a classy radio store on Cortlandt Street—a move that shook the "price-cutters' paradise" to its very foundations. Highbrow stuff on Cortlandt Street? Kassover's crazy.

Crazy like a fox, maybe. Kassover is nobody's fool. He's cut prices. He admits it—forced to, of course—competition and so forth. But he's made money, which is the important thing, apparently, and he's had seven years' experience selling radio, most of which was spent in the midst of his playful, cut-throat, boy friends in Cortlandt Street. So it may be said with a fair degree of truth that he has an inkling of what this radio business is all about.

And when we say that price-cutting and gypping, and two-by-four radio stores, stores of the unprepossessing type that radio began with four or five years ago, are on the way out, we are simply taking Kassover's word for it.

"He Must Quit Price-Cutting"

If we remember rightly, Walter Nussbaum—head of the Walthal Electric Company, also Cortlandt Street—made a similar prediction in the pages of this publication last November. "It can't last," said Nussbaum. "It will all work itself out under the force of competition. As lines become more and more stabilized, the supply of merchandise will be cut off and reduce the gyp's volume. When he realizes what is going to happen to him, he will know that he must quit price-cutting and sell at list."

That's a warning that should be written in flaming letters across the horizon of the radio industry. This heralding of the passing of the gyp is being borne out in actuality. The Vim Electric Company, ladies and gentlemen, the Vim Electric Company, of Cortlandt Street, New York City, is the first to take heed.



From this lowly, unattractive radio store at 66 Cortlandt Street, New York City, the Vim Electric Company has soared to—

Doomed!

From the lips of one of them is sounded the death knell of gyps and gypping practices. "The old order changeth" and, due to the natural evolution of the radio industry, the era of price-cutting and other merchandising evils is about to end. Gather close, and listen!

Sam Kassover took the bull by the horns and put into practise what all of the cut-price artists must eventually realize—that price-cutting and all that goes with it is unsound, uneconomical and doomed to failure from its very inception because of the dangerous ground—narrow margins—on which it is built.

"Gypping is *done!*" declares Mr. Kassover, emphatically. "The natural evolution of radio will take care of that. By that, I don't mean that all price-cutting and all dumping is going to stop immediately. It may take one year, or two years, but sooner or later it must die out.

The Dumping Evil

"I believe that dumping by foolhardy manufacturers, with consequent 'bargain sales' will cause much more grief in the future than the so-called gyp price-cutting.

"I'm not going to close up my other little store right away, either. But close it I must some day in the very near future. The cut-price trade is decreasing every day and one of these days it will be gone altogether, but just as long as there are other cut-price stores on Cortlandt Street doing business and just as long as my other store does enough trade to keep it open, I'll keep it open. But no longer. It'll have to close eventually and that goes for every other cut-price store in this district as well."

So that's that. Sam Kassover and the Vim Electric foresaw their fate and set out to save themselves. The

Radio Retailing, April, 1926

lifebelt is this beautiful new radio salon at 70 Cortlandt Street, photographs of which you see on these pages.

Now the question is, "How does an ex-gyp set about to build up a full-price, legitimate, confidence-inspiring, radio business in high-class sets?"

Mr. Kassover's answer is—First, by getting a store large enough to meet his requirements and transforming it into a well laid out, expensively appointed, attractively decorated radio demonstration salon,

Dumping—Not Gypping—Is Future Evil

"Dumping by foolhardy manufacturers is going to cause more disruption in the radio industry in the future, than price-cutting by so-called gyps.

"The day of the gyp is passing and soon he will be gone altogether," says Sam Kassover, who admits he has been a Cortlandt Street price-cutter, and who practises what he preaches by opening a store where radio sets are sold at full list prices.

with deep and tastefully dressed windows; and second, by conducting his business with customer satisfaction as the policy and service as the keynote.

High-class atmosphere is what this new Vim store ain't got nothin' else except. The windows compare favorably with the windows of the wealthiest department stores and in them are displayed the latest products of some of our best and most reliable set manufacturers.

No parts are sold in this new wonder of Cortlandt Street's—only sets and accessories. Parts are easily slashed in price and no doubt it would be too great a temptation.



—This imposing radio salon at 70 Cortlandt Street. What it foretells about radio's future is interestingly told in this story.

So, immediately upon opening the door, the customer is confronted by a wide space in which is a display of the latest console type radio receivers. The tiled floor is carpeted, and the walls are of stone. Curtains and tapestries are hung prominently and the customer has a sense of richness and comfort. He feels it would be a very great pleasure, indeed, to buy a radio set in such delightful surroundings. Neatness and order are everywhere apparent.

Atmosphere, therefore, putting the customer in a pleasant buying mood, is one of the first requisites of the radio shop of the future, in Mr. Kassover's opinion—which opinion he has had the courage to put into actual practice.

Next, the customer, having been greeted courteously, presumably, by a radio salesman, walks up two short steps and passes beneath an arch attractively curtained with velvet draperies. Here, in the rear of the store, is a fairly long aisle, lined on each side by three demonstration rooms, each with its quota of radio receivers and speakers, grouped according to price range, each room being devoted to sets within a certain price limit.

Then as the customer is leaving the store after hearing the demonstration, he passes, on the way out, and in the open space between the demonstration rooms and the door, the desk where contracts of sale are signed.

There is a psychological reason for this. The customer, as he leaves, may witness the purchase of a set by another customer, creating the same desire within himself, to also sit at that elaborate mahogany desk, sign a paper, and become the proud owner of a radio set.

So much for the physical aspects of this astounding new Vim radio store. But history has shown that a king can sit in regal robes and still be a thorough scoundrel, so let's find out how the business behind this elaborate store is being run.

Building a Reputation

"My business," Kassover declares, "is being built up on one thing—service. Complete, thorough and satisfying radio service. I don't expect to make a cent this year. Every penny goes back into the business to build up this store's reputation for service to the customer until every customer is satisfied. I want to sell sets. And most sets are sold through mouth-to-mouth advertising from one man to another—'How do you like your set? Where'd you buy it? Satisfied with it?'—I want every one of my customers to say, 'It's perfect. I bought it at Vim Radio; they've treated me right and that's the place where you should buy your set.'"

"You can't give service like that and cut prices. You can't build up a reputation like that in five minutes. You can't do that kind of a radio

business and make money at the very start and you can't stay in the radio business unless you make up your mind to give that kind of service."

Therefore, to begin with, Kassover's rejuvenated Vim Radio has a service department of nine men working under a radio engineer. "The successful radio merchant of the future will base his competition on the service he gives rather than on the merchandise he sells," Kassover says—a statement which will be disputed by a good many radio men who believe that the successful radio merchant of the future will be known equally by the kind of merchandise he sells as by the kind of service he gives. "Good merchandise and good service" is the goal on which radio retailers must set their eyes.

"I am not trying to sell radio today," Kassover goes on. "I have all I can handle without pushing sales. What I am doing is making good will and customers for the future. Therefore I consider my service department my most important item."

This "most important service department" is the acme of efficiency. It makes all installations and the nine men work as a group—not individually. Deliveries are made in one section of the city at a time, the service men following the next day to install them, also cleaning up any other service calls that may have to be made in that territory.

Elastic Service Charge of \$1

As Kassover's main idea now is to build up a clientele, and not to make money on service, the charge per service call is only \$1. And that is very elastic as, for instance, when the trouble is found to be merely a rundown battery, no service charge is made. "Building good will," is the explanation.

A ticket record is kept of all service calls, with full explanation of the trouble, the work done and the time spent, so that service costs and income can be calculated. A fully equipped auto follows the group of service men, and is used as their traveling headquarters, containing tools, parts and accessories that might be found necessary while on installation or service calls.

So much for Sam Kassover's ideas on reliable service as the means of building up a satisfied radio trade. Now let's look over what he has to

Continued on Page 392

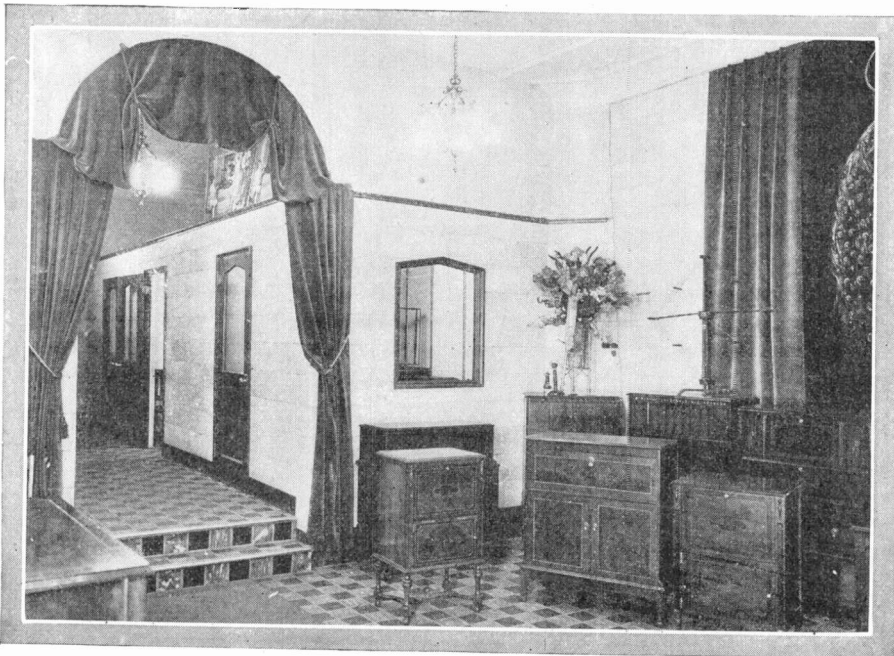

The main display space of the new Vim store presents this roomy, inviting appearance. Here are displayed the large console models. In the background are the demonstration rooms where sets are ranged ac-

ording to price, each room containing only sets within prescribed price limits. This results in less confusion in the customer's mind and fewer demonstrations for each sale.

Efficient System of Recording Information Helps This Dealer

Make Every Prospect a Sale

"Estimate Cards" Are Given to Each Inquirer, Listing the Equipment Asked About—Information Kept in Duplicate and Quickly Followed Up

EFFICIENT recording of prospects and of accurate information concerning them is responsible for many sales that would otherwise be lost. The Radio Electric Company, South Pasadena, Cal., has a very thorough and workable system of keeping track of all customers and prospects.

Each salesman, for instance, according to H. E. M. Reach, owner of the company, is equipped with small estimate cards on which are listed vertically, "Set, A bats., B bats.," etc. and space for number, name and price of the equipment. At the bottom is space for the name of the prospect and date.

This detailed information which is written down and handed to a prospect at the time of his first inquiry eliminates possibility of dispute as to price or nature of equipment quoted, and gives an air of authenticity to the initial negotiations.

If a prospect walks out without buying on the first call, as is usually

the case in radio, duplicate of the information given the prospect on the estimate card is immediately placed on a prospect card. If the prospect does not call again in a few days, he is followed up by the same salesman. Until the prospect is sold or proved to be "dead," the card is kept in a "live" file.

Care is taken to sell a customer just the right set for his purpose. Only when a salesman is thoroughly convinced that a prospect is ripe to purchase a set will he take one out on a demonstration. An average of 90 per cent of the sets demonstrated in homes is sold.

No Guarantee on Distance

At the bottom of the sales contract in bold face type appears the item: "I hereby declare that no promises, agreements, or guarantees, verbal or written, express or implied, were made to me as to the performance on distance reception of the said instrument and it is understood by me that only workmanship and material are guaranteed for a period of ninety days from date. This guarantee, however, does not include crystals, tubes or batteries, headphones or loud speaker."

Although the contract calls for only 90 days' free service, one year is actually given, except when calls are necessitated by fault of customers, low batteries or burnt-out tubes. In order to avoid controversy as to whether a set is working right when installed, Mr. Reach personally inspects all sets before they leave the shop.

Salesmen are paid on a salary and commission basis, \$125 a month and 2½ per cent on sales up to \$1,000. On sales over that figure, there is paid a commission of 12½ per cent.

Because of the nature of the community, bad credit risks are low. Although 75 per cent of the business

ESTIMATE	
THE RADIO ELECTRIC	
Set <i>Supina #25RCA</i>	<i>165.00</i>
6 A Bats.	<i>3.00</i>
2 B Bats.	<i>7.70</i>
3 C Bats.	<i>1.65</i>
1 Plug	<i>.60</i>
<input checked="" type="checkbox"/> Tubes	<i>included</i>
1 Loud-speaker #100	<i>35.00</i>
<input checked="" type="checkbox"/> Aerial, ground	
<input checked="" type="checkbox"/> Phones	
1 Booster <i>Tally's</i>	<i>10.00</i>
1 Stand <i>NS 25</i>	<i>11.75</i>
Extras <i>1 Volt unit</i>	<i>12.50</i>
Total	<i>253.20</i>
Name	<i>Geo Armstrong</i>
Date	<i>1-21-26</i>

Before quoting a price on a set, a Radio Electric salesman fills out this card, asks the bookkeeper to add up the figures on the adding machine, and hands the card to the prospect with the slip from the adding machine. This system immediately instills confidence in the store's methods and eliminates future controversy over price and equipment.

Upon receipt of a "lead," a salesman immediately makes out a prospect card which is kept in "live" file until set is sold or prospect shown to be "dead." If prospect calls at store, card is filled out immediately after his departure.

is done on credit, the Radio Electric has lost only \$78 in bad debts in four years. Special care is taken in renters, those living in apartments and bungalow courts. As a protection against loss due to fire or accident, all sets sold on time are covered by insurance. The premiums are included in the carrying charge.

Mr. Reach takes advantage of all opportunities to build good will. One evening a man entered his shop and explained that his house was dark. Although Mr. Reach had no extra fuses, he gave the caller one out of his own fuse box. A few weeks later he sold this man a set. Children, likewise, are extended courtesy. They are often given old batteries which have enough juice to supply small sets. This, he figures, is good publicity.

The Radio Electric books show

Improving the Customer's Memory

The Radio Electric Company, Pasadena, Cal., puts down in black and white the articles the prospect inquires about, together with prices. This card the prospect keeps so that, in case he does not buy at once, he will know just what the Radio Electric Company has told him about the installation he wants.

The information is kept in duplicate, the prospect's name and address filed and followed up, if no immediate sale results.

that the expenses are lower than those of the average radio store, the margin is higher, and likewise the profits. Publicity expense is practically nothing. Very little has to be marked off in stock shortage. Careful check is kept on all stock. A balcony above the repair shop accommodates reserve stock. Nothing goes down the stairs without being checked out. "Attention to minute details means profit in the end," says Mr. Reach. Maintained gross margin is about 30 per cent.

Record Kept of All Service Calls

Careful check is also kept on all service. When a customer calls for a service man, the name, address, telephone number, name of set, complaint, and time and date when the customer will be at home are entered on a service card provided with carbon and copy. The original is filed in the office and the duplicate goes to service man.

Before going out on a call, the service man transfers the name, address, telephone number and name of set on a memorandum card to take

with him, stamps the service card on a time clock, files it, and goes on his call with the memorandum card and such equipment as may be needed to put the set in working condition.

After making the repairs and before leaving the home of the customer, the service man notes the material used and service rendered on the memorandum card. On his return to the shop, he again stamps the service card on the clock, lists the material already noted on the memorandum card, and turns the service card into the office.

The material and service charges are then transferred to a sales (or cash) slip, from which they are entered in the ledger and journal. The number of the service card is entered on the sales slip and of the sales slip on the service card.

If a customer is not at home at the time of the first appointment, the service man leaves a card bearing the suggestion, "We called but found no one at home. Please phone us." If the service man is not too busy, he does not wait for a phone call, but takes the initiative, phones the customer later in the day, and makes another trip on appointment.

Time is charged for at a rate of 30 cents for every ten minutes, from the time the service man leaves the shop until his return. This corresponds to about \$1.75 an hour, which is about an average for radio stores. Seventy-five cents is the minimum charge for a call. If a customer is not at home at the appointed time, a regular charge is made for the time taken on the call.

It took a little time and study for Mr. Reach to attain efficiency in his methods, but by combining the advantages of personal contact held by a community merchant, with efficient big-store methods, he has effectively met the

**"Radio Retailing"
Helps This Dealer
Conduct His Business**

A sincere and unsolicited compliment was paid Radio Retailing, while its representative was interviewing H. E. M. Reach, owner of the Radio Electric Company, Pasadena, Cal.

"Without Radio Retailing," said Mr. Reach, "I should never have made the success, nor would I have been as enthusiastic about radio as I am now."

competition of city stores and lower prices.

Just as an example of the way he works, Mr. Reach thoroughly reads *Radio Retailing*, carefully weighs the ideas presented, and applies those that harmoniously fit into his scheme of doing things. He then reverses the process, checks his methods and the conditions of his business against the methods and statistical matter presented in this magazine, separates the tares from the wheat in his own field; then goes back to work with renewed confidence.

"Without *Radio Retailing*," Mr. Reach said, "I should never have made the success, nor would I have been as enthusiastic about radio as I am now."

"Courtesy and Efficiency"

"Courtesy and efficiency" is the motto of his business. Starting with the buying end, he practices courtesy. "There is much to be gained by treating manufacturers' and jobbers' salesmen right," he says. "They can help a dealer in many ways, assisting in demonstrations and service, giving information on the market, and helping get rush orders through quickly. By being sure we can get sets on rush orders, we can keep our stock down to a minimum of good practice. Last year the stock turn was eight times, not exceptionally high, but slightly higher than that of the average radio store, as shown by recent figures published in your magazine."

The efficient recording of prospects and a consistent system of following them up are the outstanding factors in bringing this store to a "higher-than-average" level.

Tel. ELIot 3307

THE RADIO ELECTRIC
1165 Fair Oaks, SOUTH PASADENA

I,, the undersigned, hereinafter called Purchaser, have received from THE RADIO ELECTRIC, hereinafter called Seller, in good condition:, with the following equipment:

..... which I agree to buy and to pay for to Seller, or its assigns, \$..... in hand and \$..... per week, month, for months, weeks, on the day of each month, week, with interest on each past due payment at the rate of one per cent per month, payable on demand.

All appliances, tubes, batteries and addition that may be made to said property, shall become a part thereof and be covered by this contract.

Title to said property shall remain in Seller or assignee until all payments, including collection and attorney's charges, of every kind, are paid in full, at which time ownership shall pass to Purchaser.

If Purchaser fails to make any payment the Seller may incur such expense as it deems necessary to collect the same, and all such expenses shall be paid by Purchaser and be covered by this contract, and Seller or Seller's assignee shall be the sole judge as to what expense is necessary by way of collection charges or attorney's fees. Purchaser shall not assign this agreement.

If Purchaser fails to make any payment as called for herein, the Seller, or Seller's assignee, may, without demand or notice, exercise either of the following remedies:

(a) Declare all unpaid amounts and installments hereunder immediately due and payable and sue thereon.

(b) Take immediate possession of said property, terminate this agreement, and thereupon Purchaser shall have no further right to said property, and all sums theretofore paid by Purchaser shall be retained by Seller.

In event Seller elects to declare all sums and amounts due and payable, it is nevertheless expressly agreed that no title shall pass to Purchaser until all such sums have been fully paid.

Seller may at all times inspect and examine the property.

Seller or assignee may at their option insure said personal property against fire and theft for an amount equal to purchase price and Purchaser agrees to pay on demand the premium for said insurance.

Purchaser agrees to take good care of said instrument and accessories and to be responsible for its loss by or through any reason and not to remove it from unless the written consent of the Seller, or its assigns, is first obtained.

I hereby declare that no promises, agreements or guaranties, verbal or written, express or implied, were made to me as to the performance on distance reception of the said instrument or otherwise, and it is understood by me that only workmanship and material are guaranteed for a period of ninety days from date. This guarantee, however, does not include crystals, tubes or batteries, head phones or loud speaker.

.....

THE RADIO ELECTRIC Purchaser
By Address.....

Time payment contract used by the Radio Electric Company of Pasadena, Cal.



Good Will

Fair Dealing and Courtesy Are the Twin Factors Which Build That Great Intangible Asset—Good Will

By S. J. RYAN
Merchandising Counsellor

GOOD WILL is the invisible dividend of fair dealing; the interest on intelligence in business; the product of courtesy; the reward of service to your customers. *Good Will* is the essential link between a business and its clientele; it is the unseen asset that measures real success.

Good Will is difficult to acquire and still more difficult to retain over a span of years. The dictionary defines it as "the established popularity of a business" but it is not so much that as the established confidence of the public in your honesty, intelligence and courtesy.

Good Will may prove to be a transient asset but it is not an intangible one. It is frequently—all too frequently—merged as an asset in the balance sheet and has many times been used as the vehicle for conveying a business from one owner to another.

Good Will may be personal, as in the case of an enterprise built upon the acts of an individual, or impersonal as in the case of an intelligently directed corporation. Invariably, however, it is the reflection of a personality. One of the best recent illustrations of this was the comment of Arthur Brisbane upon the offering for sale of a great newspaper. He said millions could now buy it but millions could not have built it.

THE qualities that build good will for a business are the same qualities that make for success in any enterprise. There is every conceivable kind of good will as there is every conceivable kind of business—and there are varying degrees of good will.

Fair dealing and courtesy are the greatest builders of good will; next a broad-gauged policy of service; an equality of price; completeness and assortment of stock. Personality is a tremendous factor in the smaller businesses. But these qualities alone will not build good will. It is the *intelligent application* of these common virtues that creates good will.

As we analyze good will we find no one thing accounts for its presence, rather it is a *composite* of intelligent merchandising. As buyers or sellers, we experience its effects daily in our habits. The mere peddling of merchandise, as in a 5 and 10 cent store, is a crude form of merchandising. Yet these institutions enjoy a tremendous good will. As we go higher up the scale of merchandising our opportunities for building good will increase.

Radio, with all its unsolved problems, offers the most interesting field of speculation in modern merchandising in this matter of building good will.

Merchandise Leaks

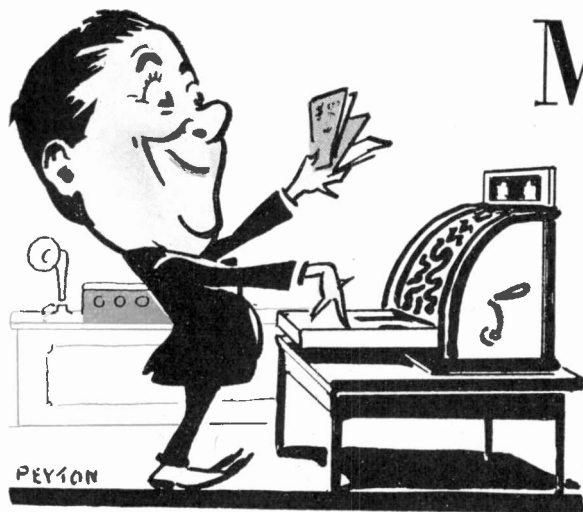

Do you check sales slips against the cash register?

Channels Through Which Stock and Indirectly Profit, Slip Out of the Retail Radio Store Without Making the Slightest Impression on the Cash Register —How Dealers Prevent These Leaks

TO RUN a retail radio store profitably, it is necessary that overhead expenses be kept at a minimum. By overhead expenses, we mean those expenses which are necessary in the running of the business, such as store rent, employee salaries, and advertising expenses.

These expenses are readily seen and kept down by the dealer and have in most cases already been reduced to the lowest practical figure. There is, however, one expense coming under this classification of overhead, that is not so readily seen, and in many instances is overlooked entirely. This expense is called the "merchandise leak." Although, in most cases small, this illegitimate and unnecessary item is sufficiently damaging to the profit margin to

warrant consideration by every merchant.

There are many channels through which merchandise may disappear, the most common of which we shall endeavor to list, together with possible remedies. In the elimination of this form of waste, the old maxim "An ounce of prevention is worth a pound of cure" is the keynote of success.

Probably the most common "leak" is the—

1

Leak Through Employees

Probably the greater number of losses through clerks or employees are due to carelessness or negligence, rather than to actual dishonesty. By installing the proper checking systems

and carefully selecting employees, the dealer can reduce loss from this source to a point where it is no longer important.

Employees often unintentionally lose money for the store by undercharging for merchandise. Rather than rely on the memory of the salesman, it is better, therefore, to mark prices plainly on the articles.

2

Outside Salesmen

Salesmen who make the store's home demonstrations often forget to return all equipment to the shop. These demonstrations are usually completed late in the evening and in the hurry to get through and return to the store, a battery or tube is easily forgotten.

One Canadian dealer has had a printed form made, upon which outside salesmen must list all equipment

Mr. Dealer—

Are you losing money through any of these channels?

Check them off one at a time and see if they can be "plugged."

Do you mark prices plainly on merchandise, or do you leave it to your salesman's memory?

Do you check merchandise received against your order, or do you take your jobber's word for it?

Are you making refunds and



Do you watch for thefts?

replacements on merchandise bought elsewhere?

Are you making it easy for customers to steal in your store?

Do you place temptation in the way of your employees?

Does your store checking system prevent losses through carelessness or negligence of employees?

That Eat up Profits

removed from the shop. The salesman is held responsible for the return of all the equipment listed on this sheet. This slip also acts as a convenient accessory check for the salesman and in many cases, a glance over it before leaving for the evening demonstration saves a long trip back to the store for a forgotten accessory.

3

Dishonest Employees

A prominent New York City dealer tells us that the solution of this rather unpleasant problem in his store has simmered down to just two things. The careful selection of employees and his willingness to pay salaries that will keep these employees satisfied. In this dealer's store, when a position is open, the preference is given to married men, or single men with some responsibility; to quote this dealer, "men of the old school."

Unfortunately, this method of employee selection does not entirely stop losses, and it is therefore necessary to take other precautions.

4

Store Checking Systems

One of the easiest checks for the dealer to make is by means of the sales slip. These slips should be made out in duplicate, for all sales, regardless of the amount involved, and should in all cases, bear the signature of the salesman. Periodically, they should be checked against the cash register.

A common channel through which merchandise "leaks," is the giving of "extra measure" by salesmen to their friends. In other words, by the salesman wrapping a number of unpaid-for articles in his friend's package.

One large radio dealer who has had this experience in his store, uses a method which makes this impossible. The package wrapping for the entire force of salesmen is done by one man. The salesman selling a quantity of parts makes out his sales slip, receives the customer's money and passes the merchandise together with the duplicate sales slip to the wrapping counter.

Here, the slip and merchandise are compared and the package wrapped and given to the customer.

During "rush hours," this method also saves considerable time.

5

Service Men

The service man usually has more opportunities for petty pilfering thrown his way than any other employee in the organization. It is quite common for this man to take a transformer, socket, or other replacement part out on a repair call, and falsely report to the store manager that this instrument was used on the call.

Service men should be required to sign a requisition for all parts removed from the store, and if this part is used to replace some defective instrument, the defective part should be returned to the shop.

6

Thefts by Customers

Pilfering by customers is an extremely delicate "leak" to handle. Systematic prevention, such as is possible in the case of employees is impractical, the only solution being to



Do you check incoming stock?

arrange counters, show cases, etc., in such a way that pilfering is made difficult.

Several dealers have told us that the loss of tubes from sets on demonstration has been the chief form of customer pilfering.

In the store of one large dealer, the favorite stunt of "off color" customers was to ask the store salesman to show them an article, and while retaining this article, ask for another of different make in order that they might compare the two. When the salesman's



Do you take frequent inventories?

back was turned for the second article, the "customer" faded out of the picture. Since this occurrence, the store has made a ruling that only one instrument at a time be shown to a customer.

The layout of the store is the most important thing in the prevention of pilfering by customers. Shelves and high show cases should not conceal parts of the shop from employees, counters should not be piled high with merchandise and above all, small parts and accessories should not be left where they may be easily reached by so-called customers.

In one large radio store, all packages are wrapped in brightly-colored paper. All customers carrying packages of other colors therefore become noticeable. Of course it is impossible to stop the taking of small articles in this way, but all obstacles placed in the way of the thief help to stop leaks.

7

Returned Goods

Returned goods should not be accepted unless accompanied by the sales slip. Many so-called "customers" try to return to a dealer batteries, tubes, etc., which they bought elsewhere, or found around the house, in hope that by working on his good nature, a replacement or refund can be secured. The radio dealer is usually intent upon making many friends, and is easily "taken in" in this way.

8

Checking Incoming Stock

All stock received from the jobber or manufacturer, should be carefully compared with the invoice or bill. Some time is taken up in this way, but in the end the dealer is well repaid for his trouble. Particular care should be taken in the count when the order includes a large number of small items.

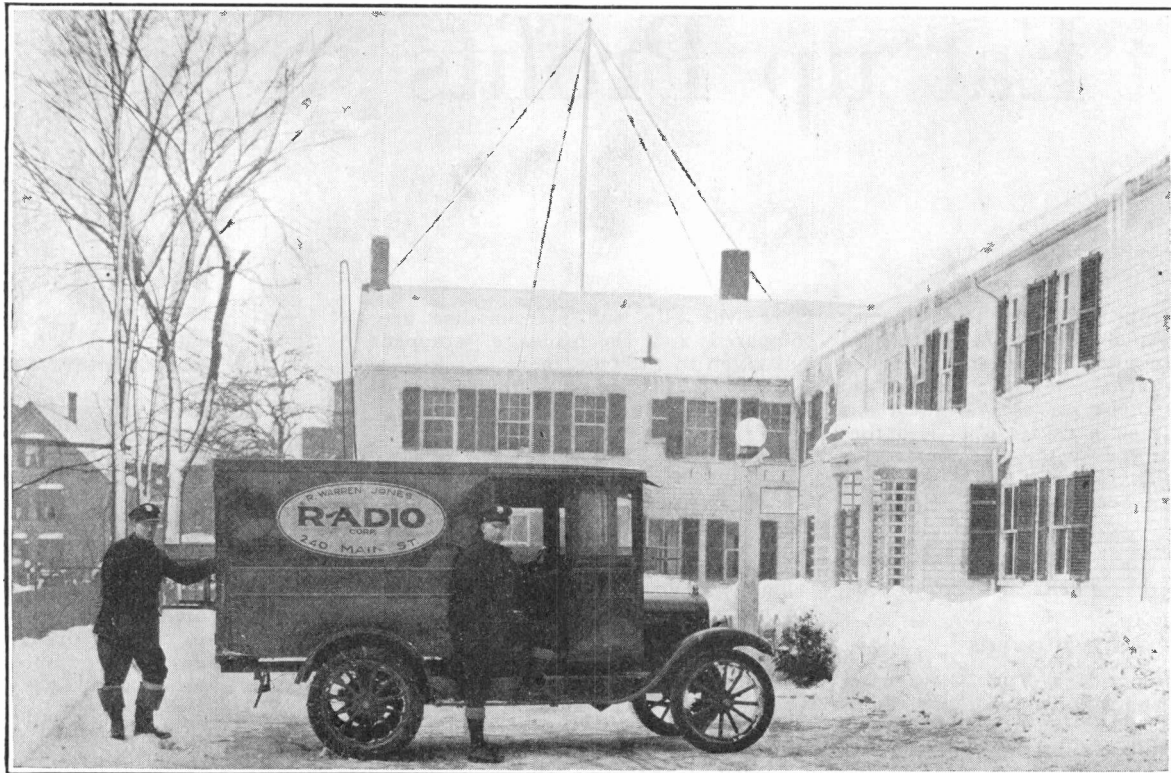

If it took four men two hours to erect this "umbrella" antenna, Jones says it gives greater volume and is non-directional. He pushes this \$20 item as an "off season" special and has sold 100 to date. Note the

service men's uniforms. These outfits cost \$40 each. Jones supplies each of his service men, six in all, with these publicity-creating and morale-building uniforms. When Jones makes a particularly fine set-installation

he photographs it—and uses the photograph to sell the next job of a similar character. He brings his wires into the room at the baseboard and through "jacks" whenever possible.

That Last Ounce of Effort—

Built a \$95,000 Radio Business for This Massachusetts Dealer—Keeping One Jump Ahead of His Competitors in Sales Promotion Stunts
Made \$9,000 Last Year for H. Warren Jones

IT'S that last ounce of effort that wins the foot race. So it is in the world of business. The merchant who works just a little bit harder, who puts that "extra ounce" of sales promotional effort into his business, is the one who reaps the rich reward.

Given two stores with equally attractive merchandise, selling at about the same prices, which one will get the business? The store that uses some out-of-the-ordinary method to attract attention unto itself, of course. Now it's this extra business that spells p-r-o-f-i-t for the retailer. It's the last ten thousand dollars gross that represents the "velvet" because overhead and selling costs remain practically the same. That is why it pays to exert extra effort to get that twenty per cent increased volume you've been dreaming about.

Lieutenant-Commander H. Warren

Jones, of Brockton, Mass., is doing just that. He must have solved the problem, because the Jones Radio Corporation sold the people of this New England shoe city \$95,000 worth of radio—and at a net profit of 9½

per cent, during its fiscal year just closed. The year runs from April to April. Lieutenant Jones serves a population of 95,000. He succeeded therefore in extracting the equivalent of \$1—even money—from every man, woman and child within the range of his four flivvers.

Brockton is a typical shoe city, and the shoe business hasn't been any too good in Massachusetts these last two years. Jones was operating, therefore, in territory of less than average sales productivity. He was able to build a radio business of this satisfactory volume and profit in spite of local conditions because he used all the standard, time-tested methods of creating radio sales—and in addition, he did a number of things that the other fellow neglects to do, which accounted for that large gross. It meant the difference between just a "good business" and an

Five "Efforts" That Made Money

Jones—

1. Taught radio to factory employees.
2. Pushes "specials" during off-season.
3. Has uniformed service men.
4. Trains employees systematically.
5. Has established "borrowing credit" at the bank.

"outstanding" one, between a possible loss or a substantial net profit. It put him in good standing with his local bank. In short, it spelt success. Let's take a detailed look, therefore, at just what this man Jones, who was a lieutenant-commander in the navy during the war, in charge of radio communication at Brest, France, has done and is now doing to get that extra twenty or thirty per cent sales volume.

Taught Radio in a Shoe Factory

Here is the first instance. Brockton is the home of the George E. Keith Company, manufacturers of the "Walk-Over" shoe. This concern employs 5,000 workers. It maintains, for these employees, a well-equipped clubhouse. In this clubhouse are conducted classes in self-improvement. Now Jones is an expert radio technician. He conceived the idea, therefore, of organizing a class in radio, and he put it over. It at once became the most popular class in the building. Forty men, all that Jones and two of his store assistants could take care of, enrolled. So great was the enthusiasm and so rapidly did the idea "catch on" that a second class of forty members was organized and started just as soon as the first class finished.

There were ten lessons in the course. Each lesson was divided into two parts, one hour of theory and an hour and a half of the practical application of this theory—set building. The "Walk-Over" people paid Jones \$10 a lesson. Here was \$200 "velvet" to begin with. The real profit, however, was in the \$6,000 worth of parts and accessories that Jones passed out over the counter of his store to these eighty "students," an average of \$75 per individual. Jones estimates that he also sold another \$4,000 in finished sets to other "Walk-Over" employees. Ten thousand dollars from one source, to begin with, to say nothing of the advertising value and indirect sales obtained.

Gets Radio Trade of 5,000 Wage-Earners

There is another interesting angle to this factory contact which Jones established. Before he taught radio at the "Walk-Over" plant he was unable to sell its employees any radio equipment whatsoever—they were buying through the purchasing de-

**He Borrows Money
When He Doesn't
Need It**

To establish his credit as a good risk at his local bank, this Brockton, Mass., dealer has formed the habit of borrowing a thousand dollars or so every once in a while, whether he needs it or not, paying it back promptly when it's due.

Why? Because he is building up a reputation for prompt pay which will stand him in good stead if he should ever be pressed for cash.

partment of the George E. Keith Company—at a ten per cent discount. Jones was obliged to grant this same discount—"To radio class members only," but his position as instructor in radio was the point of the wedge which made it possible for him to swing the purchasing power of 5,000 wage earners in his direction

There are one or more good-sized factories in almost every town and the majority of radio dealers know enough about radio to teach it. Here is how Jones arranged his lectures:

Lesson 1

Part 1. Meaning of names and symbols,

such as wavelength, heterodyne, ohm, ampere, volt, etc.
Part 2. Laying out a radio set (the panel).

Lesson 2

Part 1. Reading radio diagrams, reading electrical diagrams.
Part 2. Drilling the radio panel.

Lesson 3

Part 1. Explanation of radio circuits—the advantages and disadvantages of all types of circuits.
Part 2. Mounting apparatus on panel.

Lesson 4

Part 1. Formulae and calculation of radio circuits. Finding the capacity of condensers and the inductance of coils; wavelength of circuits.
Part 2. Wiring set.

Lesson 5

Part 1. Battery chargers; B battery eliminators, etc.; theory and operation.
Part 2. Continuation of set wiring.

Lesson 6

Part 1. The antenna: its capacity, inductance and wavelength. The construction of various types. The advantage and disadvantage of each.
Part 2. Continuation of set wiring.

Lesson 7

Part 1. The spark transmitter; theory and operation.
Part 2. Testing of sets built by students.

Lesson 8

Part 1. The radio telephone transmitter. Theory and operation.
Part 2. Checking troubles on radio sets.

Lessons 9 and 10

Parts 1 and 2. General theory and practicable experiments.

General Instructions

It is proposed that the students build a three-tube, three-circuit radio set, under the instructor's supervision.

The parts for this radio set will cost in the neighborhood of \$33. A reasonable discount will be allowed students on this price.

All instruction papers will be given students at first lesson.

All students should supply themselves with the following material:

- 1 notebook.
- 1 1-pt. rule of calibrated straight edge.
- 1 prick punch (small).
- 1 pair small pliers.

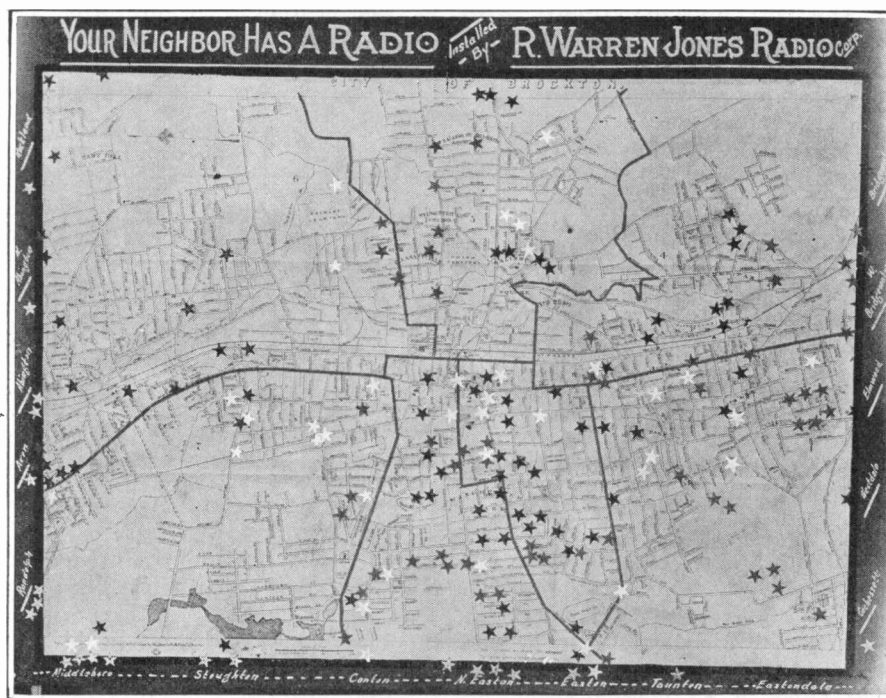

"What does that little red pin on my street stand for?"
"That represents Mrs. Smythe who purchased a Blank set from me last May," replies Mr. Jones, after consulting his records.

"Oh, yes! I know Mrs. Smythe, so she has a Blank outfit also—they must be pretty good then." This "radio pin map" helps sales by creating just such conversations as the above sample.

All heavy tools, such as soldering irons, hammers, etc., will be supplied by the instructor.

Expert radio wiremen will instruct the students in wiring of radio sets.

The second "money-getter" for Jones is his practice of always having a "special" item for those who can afford it. Last year it was a basket aerial. This season he has found the "umbrella" type of antenna to give better results than any other type, and has been recommending them in every instance where a customer, or a prospect, wants more volume and non-directional reception.

He sends out four men to install this kind of a job. It takes them, all told, just about two hours to complete the installation. They erect a 20-ft. mast at a central point on the ridge of the house. Four insulated antenna wires run from the tip of this mast to the four corners of the house at the eaves. The insulated portion of each wire is 28-ft. long. These wires are connected at the top of the mast and a fifth, or lead-in, wire runs from this point, by the nearest direct line, to the set.

Makes Nearly 50 Per Cent Profit on Installation

Jones gets \$20 for a job of this kind. His labor and material costs him \$10.50. He makes \$9.50 per installation. He has installed over 100 of these "umbrellas" since last June. He is even prepared to mount a weather-vane on top of the mast if the customer desires it.

"The only difficulty I have with this item," he says, "is convincing people that this kind of an installation does not detract from the appearance of their house. It is surprising, however," he continues, "how many really want the work done. It's something to show their neighbors. It's an appeal to the natural desire that most of us have to go the other fellow just one better, I guess."

This spring and summer Mr. Jones will conduct a telephone canvass of his owner list. He will suggest this type of aerial equipment, and also will endeavor to sell replacement batteries and improved loud speakers. Last summer he "broke even" by running a somewhat similar campaign.

Jones spends two per cent of his

JOB ORDER	
R. WARREN JONES RADIO CORPORATION 240 Main Street	
Date <u>Feb 20</u>	Whom <u>"Bill"</u>
Via <u>Auto</u>	Time <u>3:30 P.M.</u>
Name <u>Mr. G. Grigaly</u>	
Address <u>75 Salt Springs Rd</u>	
Job <u>Installing "Umbrella" aerial.</u>	
When Promised <u>Tuesday the 23rd</u>	
Ant <u>100</u>	14 <u>50</u> CC <u>30</u>
Hardware <u>20' mast</u>	Strap <u>3</u>
Arrester <u>1 LX</u>	Knobs <u>12</u>
	<u>Special ground clamp</u>
Workmen <u>Tom & Bill</u>	
Time Arr. <u>2 P.M.</u>	Time Lv. <u>4 P.M.</u>
Notes <u>Charge for extra lead-in.</u>	
USE OTHER SIDE IF NECESSARY	

This "job order" ticket is the source of information from which Jones keeps his service accounts. It tells the service men where to go and what to do. It gives them a definite form on which to record all material used and time expended.

gross income on newspaper advertising. He advertises regularly using one and two column copy. His advertisements are good, but not exceptional. Here is one advertising stunt he does, however, that is out of the ordinary—he uniforms his men. Jones operates two Ford service trucks and two Ford sedans. He



Jones taught radio in a shoe factory to boost the sale of parts

has an outside force of 6 service men. Each service man is required to wear the following uniform which the boss supplies at a cost of \$40 each:

High leather boots, corduroy breeches and jacket, soft brown shirt, and a corduroy cap. The cap bears a neat badge which reads "The H.

Warren Jones Radio Corporation."

"Of course it's impossible to trace any direct results to these uniforms," says Jones, "but I do know that my trucks and my uniformed men practically 'blanket' every other radio dealer in town, as far as publicity is concerned."

Being a trained man himself Mr. Jones believes that his men should be well versed in at least the fundamentals of radio. When he hires a man he takes time to teach him the theory of radio and how to repair sets. The successive steps in the progress of an employee, from tyro to finished outside salesman, are as follows: Replacing transformers and other defective parts; simple repairs; store man; service man; salesman.

This former lieutenant in the navy pays his men well—from thirty to fifty dollars a week, he says.

"When I started in business for myself two years ago," explained Mr. Jones, "I at once established a \$5,000 line of credit with my banker. Now it so happens that there have been very few times since then that I really needed extra capital, even for a short period. I make it a point, however, to apply for a loan of \$1,000 or \$1,500 about every three months. This keeps me 'acquainted' at the bank. I pay these loans back very promptly, and thus maintain my credit standing. Now if the time ever comes when I need money and need it in a hurry, I am positive that I will have no difficulty in obtaining it."

Jones marks the location and type of every set he sells on a large map of the city of Brockton. This new kind of "radio map" not only gives him, at a glance, the complete picture of the wards where he is doing the best selling job but it provides him with a very effective means of influencing the prospect to buy.

He is always able to "spot," on this map, some set owner living near the residence of the person with whom he is talking. "Oh yes!" a customer will exclaim, "I know Mrs. Barnes—so she has a set like the one you are showing me—you seem to have sold quite a lot of them in my vicinity, too." Jones has also used this map as the central feature of a number of window trims.

Charting Sales and Expenses Enables This Dealer to

Watch Selling Costs

By RAY V. SUTLIFFE

IN these days of rapidly changing business conditions and keen competition, what does the retail radio dealer need to do if he would keep abreast of the first situation and "lick" the second one?

Out in Dayton, Ohio, there is a man who has more than doubled his radio business within the past year. He attributes a goodly portion of his success to these two facts: First—he has set up a system which enables him to keep all vital, pertinent, up-to-the-minute facts about his business before him in such a way that they may be quickly grasped and analyzed. He is able to observe "trends" in local business conditions and to govern his decisions accordingly. This is how he meets the first condition. Second—he went on a determined search for customers. "A

sure way to get your share of the business," he says.

C. J. Linxweiler graduated from Ohio State University with the degree of Electrical Engineer. Mr. Linxweiler is part owner and is the manager of the C-L Radio Company of Dayton. The gross business of this concern for the year 1924 amounted to \$38,545. For the year 1925 its total sales grossed \$89,885, with a net profit of slightly over seven per cent. The outstanding reasons for this satisfactory showing are outlined in the following story.

One of the best ways to obtain a

complete mental picture of a group of related facts or figures is to plot these statistics from week to week or month to month on a sheet of graph paper. By connecting each succeeding point on the cross-section paper, as they are located by the values of the weekly or monthly amounts, it is possible to determine at a glance, buying trend as well as present and past facts.

All Sales and Expenses on the One Chart

Linxweiler keeps six separate "curves" of this nature on one large sheet of cross-section paper. Fur-

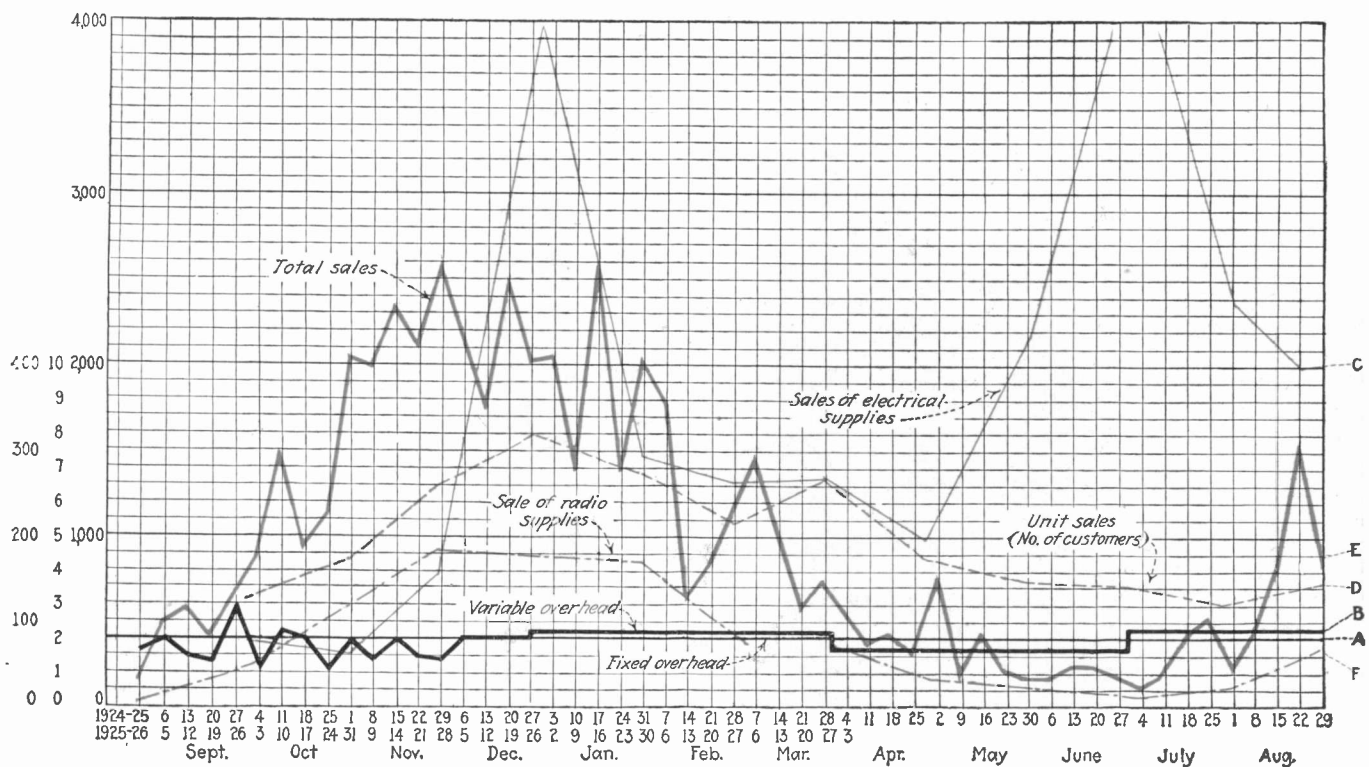

On the sales chart kept by this company, there are twelve curves—six each for the seasons 1924-5 and 1925-6, enabling the owner at a glance to compare sales and expenses for this year and last.

However, for purposes of simplification, only the curves for one year are reproduced above, to serve as a guide for other dealers who may wish to chart out their business in a similar way. Key—

"A"—Fixed overhead. "B"—Variable overhead. "C"—Sales of electric supplies. "D"—Unit sales (number of customers). "E"—Total sales. "F"—Sales of radio supplies.

thermore he has drawn his 1925 curves on the same sheet of paper that he used for the 1924 graphical presentation of the progress of his business. This enables him to compare not only six different sets of related figures for this year, but he can compare these with last year's records of the same subjects.

Here is some of the information he is keeping in this manner:

- Fixed overhead charges.
- Variable overhead charges.
- Electrical supplies sales.
- Customers; i.e., unit sales.
- Total weekly sales.
- Total monthly sales.

An Analysis of Some of These Curves

The sheet of curves maintained by Mr. Linxweiler is a bit too elaborate for the requirements of the average dealer in radio. Some of the information Mr. Linxweiler keeps in this manner is so plotted as to be understood only by himself. This "graph" sheet is reproduced in *Radio Retailing* not because of the information it gives concerning the business of the C-L Radio Company or because this visual analysis of the sales season of one concern may be used as a basis from which to draw deductions to apply to the industry as a whole, but rather to show how easily vital records may be kept in this manner and how quickly they may be interpreted.

One of the first things a man

should know about his business is the amount of fixed overhead charges. These consist of rent, heat, light, taxes, interest on capital invested, insurance and depreciation. Mr. Linxweiler has taken this unvarying total and represented it by the straight horizontal line "A." Fixed overhead is about the only straight "curve" in business.

Variable Overhead Is Charted

The next general classification of expense is called "variable overhead." Under this title are to be found such items as: salaries and wages, advertising, window display, office expense, losses from bad debts, and collections. This total expense is represented by curve "B." Notice how it rises and falls with the volume of business curve "E." This indicates that Mr. Linxweiler has succeeded in keeping his controllable expenses in proportion to his sales.

The C-L Radio Company also handles a small line of minor electrical appliances and supplies. The 1925 sale of electrical goods is represented by the curve "C." This curve registers two distinct "peaks," one at Christmas time and another in July when C-L sold a lot of electric fans.

In studying these curves allowance should be made for the fact that they are not all plotted on the same scale. At the extreme left will be seen four vertical rows of figures. Only Mr. Linxweiler knows the true

values that these figures represent and which set of figures to use with each curve.

Curve "D" is the record of sales by transactions. Mr. Linxweiler points out that, as was to be expected, his customers dropped off right after Christmas and continued to grow less each day until January 31, 1925, but that the number of sales per day remained practically constant through February. The sales volume curve for February shows a marked decline. He feels that this indicates that his store is holding its trade even though people are naturally buying less per transaction.

Linxweiler plots his record of weekly sales ("E") on one sale and his monthly record on another. These two curves show very clearly the period of public demand for radio apparatus. By watching the progress of curve "E" Mr. Linxweiler was able to anticipate stock requirements far enough ahead so that he could buy closely. This permitted him to turn his complete stock nine times during the year.

How This Information Is Obtained

Every sale, it matters not how small it may be, is recorded on a duplicating register at the time the clerk completes the transaction. The customer gets the original but the carbon goes to the bookkeeper. It is from this carbon copy that the bookkeeper makes up the weekly statement of electrical sales, radio sales and unit sales. It is a matter of but a few minutes once a week for Linxweiler to locate the values on his graph and continue his curves to meet them.

"A man does not have to be a graduate of an engineering college to run a set of simple curves of this nature," says Mr. Linxweiler.

The Radio Census

Last July and August Linxweiler conducted a "radio canvass." One reason why he did this was to give his best men something to do so he wouldn't have to let them go. It proved to be a real sales producing idea, however. Linxweiler has direct knowledge of at least ten sets sold out of his store in the early Fall due to the direct mail campaign that he released to 3,700 selected prospects picked from the "radio canvass" cards. Here is how he worked the canvass:

Ten high school boys were hired. These boys were paid \$2 per day

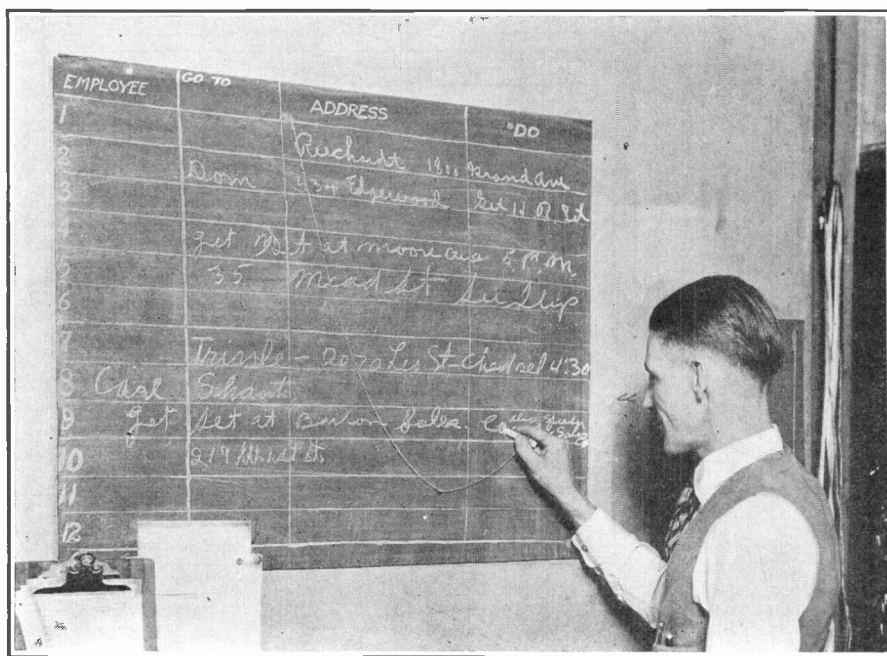

This service schedule board speaks for itself. The call is first written up on the register sheet. The service-man's copy of this record may be seen at the lower left

hand corner of the blackboard. This sheet gives all detailed instructions and provides a place for time and material to be entered by the serviceman.

apiece. They were given a quota of 125 cards to turn in every evening. These ten lads practically covered the better residential parts of Dayton in three weeks. Total cost \$360 for the following first-hand information about 19,400 of the best families in town: Name and address; phonograph and make; washing machine and make; radio and make.

How the Information Was Used

As fast as the cards were turned in they were sorted by the store salesmen into two groups. Those that represented families in the better neighborhoods were again divided according to whether or not there was a radio set in the home. Thirty-seven hundred of the best, hand-picked prospects, were then circularized by first-class mail, with consumer literature provided by the manufacturer of a well known radio set. Linxweiler states that his direct inquiry returns from this mailing numbered about 25. These were all personally followed up and enough sales closed to more than pay the cost of the canvass.

"The advertising the firm received as a result of our ten boys making these 21,000 calls and the follow up with a mailing of 3,700 pieces helped us, I know, to get off to a quick start last Fall," says Mr. Linxweiler.

"Why did you ask the housewives whether they owned a phonograph and a washing machine?" he was asked.

"Two reasons," he replied. "We didn't want to make the real reason for the canvass too obvious and we wanted the other information for our own benefit. Truth of the matter is we sold a list of washing machine prospects to a washing machine agency for \$85," he concluded with a smile.

Policies Developed from Twelve Years in Radio

It is the intention of this company to circularize another portion of this card list early this Fall.

To supplement the summer canvass Linxweiler contracted for seven large highway signs. These were erected on the seven main arteries of travel leading into Dayton, one board on each road. They cost \$700 and remained up from May until October.

Linxweiler belongs to that group of young Americans who started "fooling around with spark gap transmission," as he puts it, long before the days of radio telephony. His

Know Your Costs

LINXWEILER keeps his low set of business curves. This gives him control—saves money.

He advertised his store and obtained a good prospect list by running a radio census. Following this up increased sales—made money.

company wisely capitalized on this fact. "Twelve Years' Radio Experience" is its slogan. Naturally, when people set out to buy radio they prefer to do business with a dealer who is also a technical expert on the subject. Linxweiler is fully aware of this tendency. That is one reason why he has instructed his salesmen to never "over talk" the capabilities of a set. He and his men are just as frank in explaining its limitations as they are to dwell upon its good points. "It is surprising the confidence in us that this policy has created. People from all over Dayton and vicinity tell me how much they appreciate this kind of salesmanship," states Mr. Linxweiler. "Another advantage of this policy is that when the set goes out there is less chance of a disappointed customer or of a return," he says.

The C-L Radio Company gives one

year free service. It charges only for replacements of worn out tubes and batteries or for a serviceman's time when the customer is plainly at fault.

Here is a ruling Linxweiler has laid down that has prevented countless returns—exactly how many he was unable to estimate. The following clause is the last paragraph of a letter of thanks and instruction which is mailed to the purchaser the day the set is delivered. This letter is not sent, of course, to people who have a set "on trial."

"It is understood that all claims for adjustments or returns shall be made within five days from the date the set is delivered to your residence. It is mutually agreed that absence of complaint within that period will be construed as your final acceptance of this material. This clause is in accordance with a ruling of the Dayton Chamber of Commerce—Merchants' Association Department."

Linxweiler demonstrates in the home but always charges \$8 for the erection of a permanent aerial. If the set is delivered before the salesman arrives he holds back the tubes. These are taken out by the man who is to give the demonstration.

Linxweiler features the fact in his advertising and in his window trims that he is prepared to give eight or ten months' terms. Seventy-five per cent of his business in sets is on the partial payment basis which he finds a profitable policy.

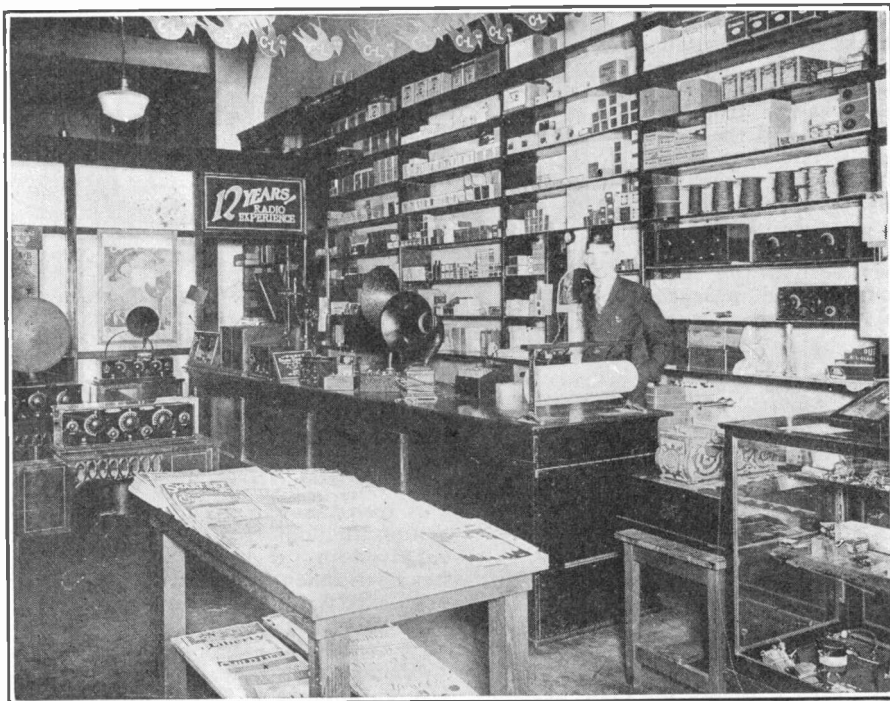

This store did a \$90,000 business last year. The magazine table, foreground, is good for \$50 a month and attracts trade besides. Linxweiler features his engineering knowl-

edge by displaying a large show card over the rear door. This reads "12 Years' Radio Experience." The magazine table has led to many larger sales.



Pave the way with a mail campaign

Demonstration Kinks

Selling Sets in the Prospect's Home Will Be Responsible for the Greatest Number of Sales in Future—Here Is a Variety of Ideas and Actual Dealer and Salesman Experiences in the "House-to-House" Method

Pick Any Good Block and "Dig In"

"Just pick a good-looking block anywhere and 'dig in' is the advice of a particularly successful upper New York state radio salesman.

He says— "Everybody is interested in radio today; therefore if you simply start at one end of a prosperous-looking street, and make a few calls, you will soon find a lady who can be persuaded to let you demonstrate your set. Don't waste time on the tough cases because, this year, there are too many people who are just waiting to be sold to bother with the other kind."

"Keep the Howls to Yourself," Bailey Advises

"When giving a demonstration always 'tune in' with the head phones on," is the advice of D. A. Bailey, in charge of the radio department for the Twin City Electric Company, Troy, N. Y. Mr. Bailey thinks it good policy to keep as many as possible of the static noises away from the prospect and the prospect's friends. When the proper reception has been obtained and a good program located, he then switches to the loud-speaker and proceeds with the demonstration.

If a second man is along to talk radio and so occupy the time of the audience until the man at the set is all ready to "shoot," so much the better. In this way, also, the quality of reception from various stations may be ascertained and the best one selected.

Rebates Part of Customer's Bill for Live Tips

Ray Blanchard, Woolworth Building, Providence, R. I., allows his customers a rebate on their accounts for every prospect they turn in, provided this prospect buys a radio set from Blanchard. This credit equals

four per cent of the total amount of the prospect's purchase.

This plan not only has kept Blanchard supplied with all the leads he could possibly follow up but also enables him to keep "every customer a satisfied one," as he phrases it. If a customer doesn't send in a new prospect's name for two months, Blanchard calls on the customer to see what is the matter.

Push the Button Once —Then Wait

"When calling on a prospect give the front-door bell button one push then step away from the door, turn your back and wait two minutes before ringing again" is the advice a successful house-to-house crew manager gives to his men. It applies just as well to the radio salesman.

A series of quick "buzzes" aggravates the housewife and, if she sees that the callers back is turned, her curiosity will prompt her to open the door.

of any article simply because it is free. Even where the intention to purchase is a bonafide one, interest sometimes lags for the simple reason that nothing is at stake and it is too easy to let the matter drop. If an antenna has actually been installed, it is almost certain that some sort of radio set will be purchased—and it is in the hands of the individual dealer to see that it is purchased from him.

The essential corollary to this initial agreement is the further stand taken by the Portland dealers that no antenna shall be installed free of charge, but that a minimum payment shall be made even for a trial installation, the customer agreeing to pay for the antenna whether a radio set is purchased or not. This arrangement has been readily accepted by the public.

Lets the Customer Compare Loud-Speaker Quality

One dealer in the New York metropolitan district is selling loudspeakers in the following novel manner and having considerable success.

When a customer comes in and seems interested in a speaker he is courteously asked what type of set he is using and what make of speaker. The dealer suggests that he be allowed to send up one of the new speakers to the customer's home, where it may be heard under actual operating conditions.

It is said that the average human ear cannot carry a note more than a few seconds and consequently if two speakers are compared even by connecting and reconnecting the wires and perhaps changing the plug, the full value of the comparison is lost.

To make the test easy for the customer, therefore, this dealer provides a single-pole double-throw switch by means of which one or the other speaker can be thrown on almost instantly,—even changing in the middle of a note. This permits the customer to make a very good comparison and it certainly shows up a poor speaker.



"Pick any good block and dig in"

No Demonstrations in Portland Without Antenna Installed

A movement in the direction of lessening the number of lost motions now involved in the selling of radio sets has been taken by the radio dealers of Portland, Oregon. Under the auspices of the Radio Trade Association of that city, the radio dealers have agreed not to demonstrate radio in any home unless an antenna is installed.

This insures the good faith of the prospect and eliminates that group of economizers who send for free samples

That Have Helped to Close Sales

"Keep the Customer Interested in the Demonstration" Is a Sales Commandment Every Dealer Should Heed

Care should be taken to connect the red cords properly, as this will make a big difference in some types of reproducers. A switch of the ignition type is used, but any type of quick-throw single-pole double-throw switch can be employed.

Following a successful demonstration the old speaker is often "traded in," but if possible the dealer shows the customer how it can be attached to a long cord and placed in a different room; this effecting a "clean" sale of the new speaker.

This same dealer makes it a point to send out at least two speakers with every set he sells, and allows the customer to choose the one which he prefers. In some cases the customer has kept both speakers or bought two of the same kind, for use in different rooms.

Why Not Apply This Demonstration Idea to Radio?

A manufacturer of a well-known line of electric refrigerators uses the following method to pave the way for his salesman's initial calls on prospects:

Three to five days before the salesman calls on a prospect the latter receives, by parcel post, a very elaborate treatise on the subject of electric refrigeration. That same day there is also delivered at his home, by first-class mail, a personal letter from the company. This letter informs the recipient that "Owing to the limited supply of these rather expensive books, our Mr. Lenox will call for it within the next five days."

This handsomely bound booklet and the first-class letter serve, of course, to prepare the way for the visit of Mr. Lenox—whose real objective is to sell the prospect an electric refrigerator.

This idea could be applied to the demonstration and sale of radio sets. Mail an elaborate catalog, a book on radio or some other piece of radio literature to a likely prospect. Follow this up with a personally signed letter reading somewhat as follows:

Dear Sir:

We are sending under separate cover a very complete catalog which illustrates the line of quality radio sets we handle. Unfortunately, because of our

limited supply it will be necessary for us to ask that we may have this particular catalog back. With your permission, therefore, we shall have our Mr. Lenox call for it at your home sometime within the next few days. We trust that you will enjoy looking over its pages.

Very truly yours, etc.

This letter not only directs attention to the mailing piece but it gives the salesman, who follows it, an excellent reason for his visit and naturally leads right into the subject of a radio set for that particular home.

Handles But One Line, to Concentrate Customers' Attention

"We believe in handling but one line of radio sets," says H. M. Ash, Jr., of the firm of H. M. Ash, Paterson, N. J., "because we have to first sell ourselves that a certain one manufacturer's product is the best on the market before we can talk convincingly to our trade and how could we do this if we carried three lines." Mr. Ash states that he has seen many cases where both salesman and prospect were so confused by a multiplicity of makes to choose from that the customer finally gave it up and drifted out of the store. "We, therefore, specialize on



Tune in with the earphones first

one line and concentrate our entire selling talk and demonstration, as well as the attention of the prospect, on that line," he concludes.

Make Store Demonstrations Away from Windows

Just as getting the customer to the point where he consents to a demonstration is a science, so also the successful demonstration and the eventual closing of the sale depend largely upon the method of handling the prospect.

If the demonstration room is

SALES campaigns carried on in "enemy territory"—the prospect's home—is the big thing that will sell radio sets from now on, winter or summer. Dealers who neglect the great unsold market for radio that the 24,000,000 American homes constitutes, by remaining in the store when they could be calling upon the residents of their city, are losing an untold number of valuable sales.

located in the front of the shop, visible from the street, do not place chairs or lounges facing the window and the street. The prospect's attention is much easier to hold if he is not continually distracted by those passing the shop and by other customers entering. Always face the customer to the shop interior.

If the prospect is a woman, it is a well known fact that if not seated immediately upon entering the store, she will invariably wander from set to set and make it impossible for the salesman to concentrate on his talk, resulting often in his complete undoing. Comfortable chairs or settees for women customers are requisites in every radio shop.

Value of Home Demonstrations

Robert Himmel, president of Hudson-Ross Corp., 116 South Wells Street, Chicago, Ill., has this to say about the subject of outside selling and demonstrations in the home:

"I have found that there are very few radio merchants who have taken advantage of the possibilities of personal solicitations

and my observation has been that where the merchant, or his trained representatives, have called on prospects, that his business has grown and that he is a real factor in the radio business in his city. He is the one who is most widely known.

"I am thoroughly convinced that the greater part of future sales in radio will come through comparison of sets and through the house solicitations of the wide-awake radio merchant. There is a broad difference between that title and the title 'radio dealer.' The former is a real salesman, the latter waits for business to come to him."

In Canada, Every Listener Must Have a License

How Dealer Is Affected—Inspection Reduces Interference
Troubles—Right of Entry into Listeners' Homes

EVERY owner of a radio set in Canada is required to purchase a government license. Such a license costs one dollar and is valid for one year from April 1. There were 96,254 of these radio receiving licenses issued by the Department of Marine and Fisheries between the first of April and the last day of December, 1925.

How does this measure affect the popularity of radio in the dominion and does it influence, in any manner, the radio dealer's business? These are the first questions that naturally arise in the minds of American readers when they consider the operation of this phase of governmental control of radio. The general feeling seems to be that the radio receiver licensing law is a practical act, easily enforced and gladly obeyed, and that a considerable amount of beneficial results should be credited to it.

Cleaning up local interference is, of course, the big thing that government radio inspectors do which directly profits both dealer and set-owner.

Inspectors in Every City

There is a government radio inspector in every sizable city and these men respond to calls for assistance from the "fans" to as full an extent as their time and facilities will permit.

This interference hunting service benefits not only the listener, but the radio dealer as well. More than one dealer has solicited the aid of the department, stating that unless inductive interference in his district were cleared up, he would have to go out of the radio business altogether. In every instance his troubles were remedied.

The department now maintains interference investigation cars in the largest cities in Canada. These cars are fully equipped for the work in hand.

The first of these cars, which by way of experiment, made a 4,000-mile tour of eastern and central Ontario, cleared up 75 per cent of the interference encountered on the

trip. Most of the balance will be cleared up as the result of intensive research work and experiments now being carried on at department headquarters. The department has received many letters of appreciation from various dealers and broadcast listeners, for clearing the air of inductive interference.

How Licenses Are Distributed

Licenses for "private receiving stations" may be obtained from the postmasters of the larger towns and cities in the dominion, from departmental radio inspectors, and from radio dealers authorized to sell such licenses.

The majority are issued by the dealer who sells the set and at the time the sale is made. The government permits the dealer to deduct ten cents as his commission on every license he issues. The dealer simply buys a book of serially-numbered licenses from the nearest radio inspector and fills in the purchaser's name on the line provided. These

license blanks come in triplicate. The owner gets the original, the carbon goes to the district radio inspector and the dealer keeps the third copy.

As the dealers' sales are largely dependent on clear reception, they stand to gain more than the private broadcast listener from the department's activities.

The license fees are forwarded to the department headquarters office at Ottawa. The local inspector receives his pay from headquarters and is not dependent on local license collections. The local inspector is also responsible for the supervision of radio-telegraphy. Not all of his time, therefore, is available for the betterment of radio reception conditions.

Radio Inspector Has Right to Enter Any Home

How is the law enforced? Quite simple! The dealer is the first check. And then the inspector has the right to enter a person's home and demand to see his radio license. When the inspector is "shooting trouble" he generally takes this opportunity to make a few calls in the immediate vicinity. Any set owner who cannot produce a license is liable, on summary conviction, to a penalty not exceeding fifty dollars and costs, or to imprisonment for a term not exceeding twelve months.

W. 68. (En'd May 1922.)

Radiotelegraph
Branch

CANADA

DEPARTMENT OF MARINE AND FISHERIES YEAR 1926.-1927..

License to Operate a Radio Receiving Equipment
(Issued under the Radiotelegraph Act, Statutes 1918, Chapter 43.)

John Stanley Browning
(Christian name in full) (Surname)

is hereby licensed to operate a radio receiving equipment at

225 Grace Avenue
(Street and Number)

London Ontario
(City or Town) (Province)

This license to be in force from the day of the date hereof, until
31st day of March next, unless sooner forfeited.

Received the sum of one dollar (\$1.00) license fee, this *25th*
day of *February* A.D. 192*5*.....

ORIGINAL
To be handed
to Licensee.

J. S. Browning
Deputy Minister, Department of Marine and Fisheries.
Countersigned *J. S. Browning*

Nearly 100,000 of these radio receiving licenses were issued to Canadian set owners, from April to December, 1925. They cost \$1 each. On the back of each certificate appears this suggestion: "When using

a receiver of the regenerative type, please avoid increasing regeneration to the point where the receiver begins to oscillate, otherwise you will cause interference with neighboring receiving equipments."

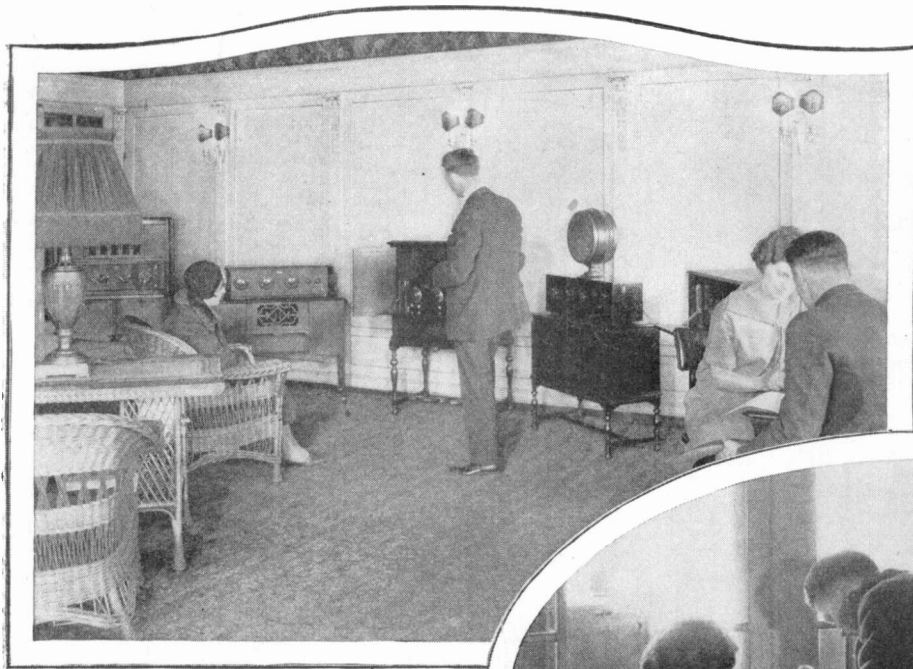

Left: The salesroom of the Hyde Music Company, 366 Central Avenue, Jersey City, N. J., is comfortable—yet businesslike.



Right: A desk near the front door insures maximum attention to customers—as they enter—and when they depart. Window shoppers, as well as prospects in the store, are influenced to buy if they see someone else “signing up.”

A Comfortable Store That Wins Friends and Business

HOW it is possible to combine the advantages of a “home-like” atmosphere in a radio shop and yet not permit the customers to forget what they came for, is well illustrated in the furnishings and equipment of this radio store in New Jersey.

When a customer enters the richly appointed sales room of the Hyde Music Company, 366 Central Ave., of Jersey City., one of the first objects he sees is a business-like, flat-top desk. There is generally a young lady attendant seated in front of it. This desk is located right near the front door and directly behind a large, open back, show window. This location for a desk appears, at first glance, a little odd because the rest of the store is furnished more like a

living room than a place of business. A beautiful soft carpet covers the entire sales floor. Half-a-dozen easy chairs and a good looking table occupy the center of this valuable space.

“But will your prospects get down to business when it comes time to ‘close’?” we asked R. A. Hyde, the store owner.

“That’s just the reason I put the desk where it is,” Mr. Hyde replied. “I want the public to feel that this is a business institution and that we are here to sell radio sets and to get the ‘signature on the dotted line.’ I have often observed,” Mr. Hyde continued, “that people passing the store will stop, and then come in, if they see a group of customers in the fore-part of the store. This desk

helps accomplish this objective. I have further noticed that it is much easier to persuade a prospect to ‘sign up’ if this prospect sees someone else signing for a set right under his eyes. That is why we believe in transacting the final step in the sale right out in front for the whole world to see.”

In addition to the psychological effect of having a business desk right near the front door this location also permits the young lady who keeps the books and answers the telephone to wait on customers as well. She is instructed to see that everybody who comes in is given immediate attention and that nobody goes out “with a grouch” if she can help it. This rarely happens and the store has made many friends.



Radiola 28, (at right) eight-tube Super-Heterodyne, including eight Radiotrons. . . \$260

RCA Loudspeaker 104, (at left) with power amplifier and battery eliminator, operates the set entirely without batteries—on any 50-60 cycle, 110 volt lighting circuit. Complete in its cabinet. . . \$245

A. C. Package, adapting the Radiola for use without A, B, or C batteries, \$35



Get a whole orchestra at actual volume

RCA Radiolas achieve reality by duplicating volume as well as tone

HERE is radio dance music that you can dance to in a great hall. It is loud and full as the orchestra itself—talk or dancing cannot drown it out. And with all its tremendous volume, each note is clear, each instrument true!

Even in a small room where you would not turn on all the volume, half the illusion of reality in listening to music depends on having reserve power. But this was never possible before. An ordinary radio set has a definite volume limit for clearness. Too often it is operated beyond that limit and it is always on the verge of distortion. Because

it has no reserve power, the ordinary set renders a sudden fine climax of music with a crash!

But now you can turn up the volume as loud as you please, and the voice is still true and undistorted. In the new RCA Radiolas, new vacuum tubes and power amplifiers give power enough and to spare. There is no more straining to get the quietly spoken word. There is no more need to call on the imagination to supply tones lost to the ear. Low notes are mellow and full. High notes are sweet and clear. Music and speech are *real and actual in tone and volume!*

Radiola 28 is an eight-tube Super-Heterodyne that needs no heralding of its performance. With all its delicate accuracy, it is operated with a single control! With the new RCA Loudspeaker 104, it is operated entirely without batteries—just by plugging in on the house current.

This new loudspeaker, with its power amplifier and battery eliminator, employs an entirely new principle of reproduction. With the Radiola 28 beside your chair, and this remarkable new loudspeaker in a distant corner of the room, tune in to new thrills in radio!



RCA Radiola

MADE BY THE MAKERS OF RADIOTRONS

RADIO CORPORATION OF AMERICA · NEW YORK · CHICAGO · SAN FRANCISCO

RADIO CORPORATION OF AMERICA

Quality of tone —
quality with volume
—the permanent quality
of the eight-tube
Super-Heterodyne
...with single control
and no batteries!



RCA  Radiola

MADE · BY · THE · MAKERS · OF · RADIOTRONS

NEW YORK · CHICAGO · SAN FRANCISCO

Servicing Methods and Trouble-

Switchboard Connects Sets to Common Battery Supply

According to P. E. Hawley, proprietor of the Electric Shop, Westfield, N. J., the switchboard shown in illustration has proven to be a great aid to him both in selling and in testing sets. As soon as a receiving set is unpacked it is immediately equipped with a battery cable. This immediately standardizes all connections. The two sets of switches, one on each side of the switchboard, are equipped with spring-clips which makes it possible to connect up a set for demonstration in a few moments.

Use of this arrangement also makes it very easy to test a set that that is brought into a shop for repairs. For this purpose each cell of the 6-volt storage A battery, located on a shelf directly beneath the panel, is tapped in order to provide current for any style of tube with which the set may be equipped. This connection, which goes to a single pole double throw switch, is kept in the form of a flexible lead. For plate voltage, either dry cell B batteries or

an eliminator may be used. This comparative demonstration Mr. Hawley has found to increase his B battery eliminator sales.

In making up the panel, ordinary porcelain base, double pole, double throw switches were used. After demounting the switches the bases were used, templates for drilling the Bakelite panel which measures 7 in. x 18 in. x $\frac{3}{8}$. In remounting the switches, of which seven double pole double throw and two single pole double throw are used, it is to be noted 1 in. $-8/32$ round thread machine screws will have to be used.

All Wires Cabled

Wooden strips one inch square run the length of the panel, one on each side, which provide enough space, from the back of the panel to the wall, for all wires. These wires are cabled into two groups which are brought through the wooden strips on either side of the panel. Two antennas are connected to the top switch, one of which is a straight wire about 50 feet long, the other a loop running around the edge of the building. As the building measures

22 ft. x 14 ft. the latter gives practically the same results as an inside antenna running around the molding of a room.

Charges Battery Every Night

Another feature about this arrangement, and a very important one, is the fact that a charger is connected to the A battery switch. A double wall plug, located conveniently to one side furnishes 110 volt 60 cycle current for both the B battery eliminator and the charger. At night when closing up the store Mr. Hawley puts all the switches in a neutral position except the A battery switch which he throws over on charge, then turns on the charger. In this manner when the store is opened the following morning a fully charged A battery is always to be had for the day's demonstration.

Free Monthly Inspection of Sets Made Profitably

A regular, free inspection of all receivers sold, in the customer's own home, is made by the R. & R. Radio Company, 1418 Broadway, Brooklyn, N. Y. This convenient service plan, W. J. Romani, the store manager, tells us, has not only kept his customers "sold" but has made such a favorable impression on them, that they recommend his store to all their friends.

A small record card is attached to each set sold, and serves the triple purpose of—a guarantee for one year against defects of all kinds,—a record of inspection card,—and keeps the dealer's name always before the customer. Service men who are furnished with suitable identification cards, for the customer's protection, make these service calls monthly, for the period of one year without charge. If it is necessary, during the first year or two that a customer has a set, to make a reasonable number of calls for instruction, etc., these calls are also made without charge.

Defective transformers, sockets and other parts of the set itself, are covered by the guarantee, and are replaced free. Batteries and tubes, if in perfect condition when installed, are charged for (being accessories which wear out under normal use).

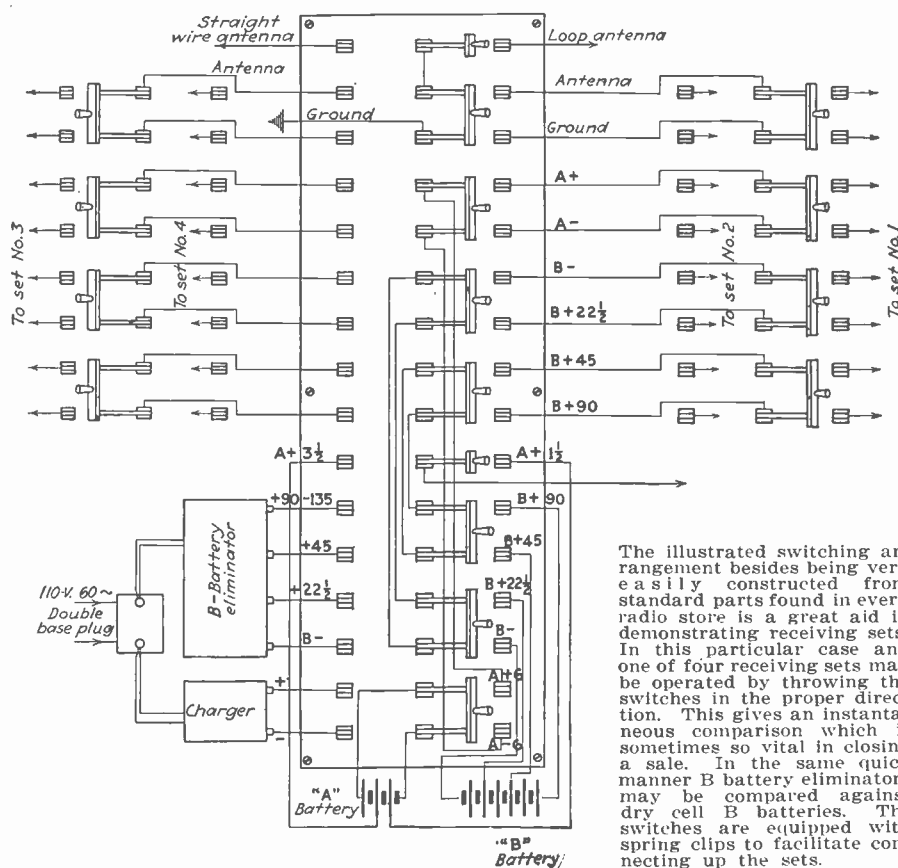

The illustrated switching arrangement besides being very easily constructed from standard parts found in every radio store is a great aid in demonstrating receiving sets. In this particular case any one of four receiving sets may be operated by throwing the switches in the proper direction. This gives an instantaneous comparison which is sometimes so vital in closing a sale. In the same quick manner B battery eliminators may be compared against dry cell B batteries. The switches are equipped with spring clips to facilitate connecting up the sets.

Shooting Helps

A monthly department for the dealer, serviceman, and salesman. For practical ideas in 200 words—if acceptable for publication—two dollars will be paid

Headphone with Battery Aids in Testing

A small flashlight battery used in series with a headphone makes an excellent instrument for checking circuit continuities. The illustration shows such a combination with the battery mounted on the side of the phone. It is common practice among service men to use a C battery in making tests of this kind. This, however, is not always convenient so it can be easily seen that by carrying the battery mounted on the earphone the work is greatly simplified and facilitated.

A resistance mounting, such as is used with amperites, will be found to be just the right size for holding an Everyready flashlight cell No. 935. The mounting can be fastened to the shell of the earpiece by means of a small screw. A pick made from fiber tubing, about the size of a pencil, and having metal ends to which the cords from the phone are connected will be found of great help in making test connections. The metal end of each pick should be filed to a sharp point in order that it will penetrate insulated wire when testing radio frequency coils.

Breaks in either the primary or secondary of audio frequency transformers can also be very readily found by placing the contacts across the winding under test. When connected this way, the primary of an audio frequency transformer should give a sharp click in the phone and the secondary a dull click if it is O.K. This is due to the high and low resistance of the respective windings. Variable condensers may be also tested for shorts by placing the contacts on the terminals, then rotating the condenser. A sharp click will be heard at the point where the plates touch. The service man will soon find many other places where this useful device will aid him.

Keeping Tube Information

A record of meter reading on tubes that have been tested may be kept very conveniently in the following manner—cut a piece of cardboard, such as is used in file cards, to dimensions of approximately 1 in. x $\frac{1}{2}$ in. It will then be found that this can be

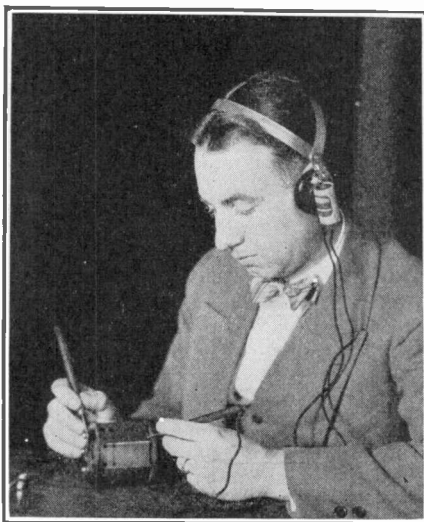

By use of a small flashlight battery in series with a single headphone, having two picks connected to the cord ends for convenience, various circuit conditions may be tested for. The illustration shows a radio frequency coil being tested for a break in the wire. The battery can be easily taken from the clips for replacement.

jammed between the prongs at the base of the tube firmly enough to insure permanence. Being very thin it will in no way interfere with the insertion of the tube in the socket. Information can be jotted down with a fine pointed pen and kept this way for reference.

Kit Prevents Loss of Tools

Service men have a bad habit of leaving their tools on the job when they are out and the percentage of recovery is very small indeed. Even when the tools belonged to the service man the same trouble was experienced.

One firm in Buffalo, N. Y., solved the problem in a very simple way. A standard tool case was furnished to each man with a list of the tools on a typewritten sheet pasted in the top. A tool role was made which had a compartment for each and every tool. Instruments such as voltmeters, etc., were placed in pockets in the case so that they would not be damaged by contact with any loose parts that might be carried.

When the job was finished, all the service man had to do was to look about and note whether any compartments were empty. If there was, he knew immediately that there was still some tool left out and he could look for it.

Resistance Coupled Amplifier Trouble

Some two years ago a push-pull amplifier was built for a man who wished the very best obtainable as far as volume and quality were concerned. As he had considerable trouble with his tubes burning out rather frequently a 25-watt electric light was placed in the B battery lead so that an accidental short of any kind would not cause the tubes to blow. Not so long ago resistance coupled amplifiers came into vogue and of course this same man wished to try it out. The new amplifier was hooked up in the same position as the old, using the same B batteries except for the addition of an extra 22½ volts to the 90 already in use.

Light Bulb Causes Trouble

It was then found that the new amplifier would work all right for a time and then start to block. The repair man thought that perhaps the interstage condensers were too small and larger ones were substituted. This did not help in the least and finally in desperation a full set of new B batteries were hooked in direct. The amplifier worked perfectly. The new batteries were then put in place of the old one with the protective lamp in place, and the blocking started in again. After a few further tests it was found that the 25-watt lamp was causing all the trouble.

Apparently even a small resistance in the B circuit has a very detrimental effect on the action of this type of amplifier. It was also found that the storage B battery gave better results than any other type, probably due to the lower internal resistance of the cells.

Sharpening the Tuning of Crystal Sets

In radio receiving circuits employing a crystal detector, if the detector is shunted across approximately $\frac{1}{2}$ the inductance coil, the sharpness of tuning and selectivity of the set in broadcast reception will be greatly improved, according to a statement recently issued by E. B. Judson of the Radio Laboratory of the Bureau of Standards, Department of Commerce, Washington, D. C.

Detrimental Effect of Long Battery Leads

Not so long ago, a peculiar complaint came in from an owner of a six-tube, tuned radio-frequency set located several miles distant from the nearest broadcasting station. Without the antenna connected the set functioned fairly well, but with no startling volume. When the antenna was connected the receiver refused to work and the stations could barely be heard on the phones. After a careful check up of the tubes, B batteries, antenna, etc., it was found that the owner had located his storage battery at least a hundred feet away in a small shed. The reason for this was that it made it easy for him to charge it on the Delco system which was used for lighting.

After some argument, the battery was brought into the house and connected directly to the set. The volume came up to what it should be and the antenna functioned perfectly. Apparently the long battery leads were acting as an antenna which was opposed to the regular antenna on the set and the signal from the station was wiped out.

Clean and Inspect Socket Prongs

Most of the trouble with radio sets can be traced directly to little things that go wrong. The tube socket is a concrete example of this. From the time that radio started, a great deal of trouble has been experienced with poor contacts made between the tube prongs and the socket springs. Noisy reception, fading signals, and poor volume can usually be traced directly to socket trouble.

The prongs of the tubes are composed of brass, with a lump of solder at the tip. Most socket springs are phosphor bronze, designed to bend upward and make contact against the soldered tip of the tube prongs. As the soft solder of the tube prong tips wears off the socket contacts are coated with a lead oxide, making a very poor electrical connection, and consequently a noisy set. The spring loses its resiliency and fails to exert sufficient pressure upwards against the prongs of the tubes, and then real trouble begins. When dirty socket contacts are encountered they should be cleaned until bright metal shows. If the spring is very weak, it is best to install a new socket rather than try to bend it up. Be

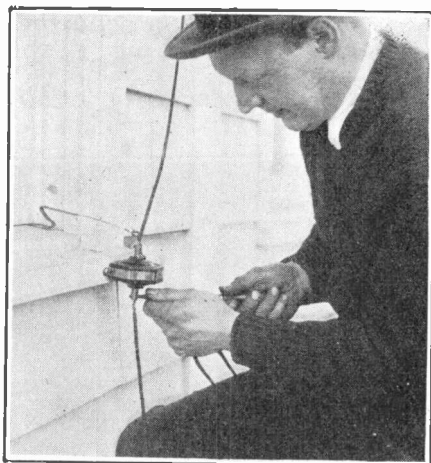

With the approaching summer months comes the usual supply of lightning and rain-storms. In order to be prepared for these conditions, now is the time to go over antenna equipment. Make sure customers have an efficient, approved lightning arrester such as is shown in the illustration, and that all the insulators are in good shape. You may think that your arrester is O. K. but "it is better to be safe than sorry."

sure to disconnect the batteries before working on the sockets otherwise damaging short circuits will result.

Test Batteries Frequently

All dry cells should be tested by the dealer before reaching the customer's hands. This should be done with a volt-meter while the battery is connected to the tubes and the current being drawn. The voltage of batteries, especially dry cells, falls considerably when current is being drawn, due to the dissipation of energy within the cells and to certain internal chemical actions. Therefore, if the "open circuit" voltage is read it may be quite deceiving, being considerably higher than the actual total voltage delivered when the set is in operation.

When dry-cell A batteries total less than 1.4 volts per cell and dry-cell B batteries less than 21 volts per 22.5 volt unit or 32 volts per 45-volt unit, they are in no condition to be sold. After the voltage of dry-cell A battery falls below 1.1 per cell and that of dry-cell B batteries falls below 17 volts per 22.5-volt unit or 34 volts per 45-volt unit they should be discarded.

Small Insulation Strip Useful when Testing Sets

When the service man tests a set which has been returned to the shop, he usually turns it on and gropes beneath the sub-panel for a loose con-

nection. When this is necessary, all too often a screw driver or metallic object is used as a "probe," greatly endangering the tubes because of short circuits with high voltage. A very handy and efficient instrument for this work, which also has many other uses, is a small strip of bakelite or hard rubber about five inches long and a half-inch wide.

Determining Polarity with a Glass of Water

In the case of a direct-current lighting system, it is often desirable to make a quick check on the polarity. No devices for this purpose being available, the service man will find the following a very simple and effective means of determining which side of the line is positive and which is negative.

All that is necessary is a glass of water in which a spoonful of ordinary table salt has been dissolved. The ends of the two wires coming from the light socket attachment plug are scraped clean of insulation, for about an inch, and dipped into the salt water with the wires held just as far apart as they can be in the glass. When the wires are dipped in the salt water one of them will give off a great many more bubbles of gas (hydrogen) than the other. The wire from which most of the bubbles come is the negative.

Order Used in Testing Sets

It is always best in testing sets to have a regular routine to follow. Then nothing is overlooked which might cause trouble later and better satisfaction will result from the service rendered. It does not matter a great deal just what order of inspection is taken, but several service men use the following: First, aerial and connections; Second, ground wires; Third, batteries, both A and B; Fourth, the receiver itself, and Fifth, the speaker.

This is a casual inspection and if the trouble is not located the set is taken out of the cabinet and gone over thoroughly.

Some types of sets have certain peculiarities which make trouble shooting easy and it is not always necessary to go through the whole process. However, it cannot be over-emphasized that a regular system, when followed, will save time in the end and perhaps an extra call at a later date.



New Service Tools and Equipment for the Radio Dealer's Use

Battery Charger With Full-Wave Rectification

Radio Retailing, April, 1926

The illustrated battery charger is known as "Quill" and is manufactured by Hanson & Van Winkle Company, Newark, N. J. The rectifier consists of a synchronous $\frac{1}{2}$ hp. motor, a pole changer and a transformer. In addition to these, there are ammeters-voltmeters, and the necessary relays and switches to give the operator a perfect understanding and control. In case of power failure or drop in line voltage, the motor circuit is automatically opened. Instantly with the opening of the motor circuit the battery circuits are open, making it impossible to drain the batteries or injure any apparatus. On return of power everything automatically starts up again. The three wire system is used for charging 6- or 12-volt batteries.

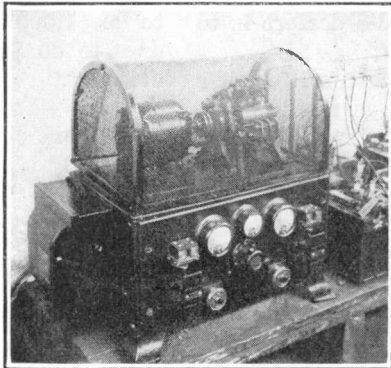

Honeycomb Coil Winding Machine

Radio Retailing, April, 1926

Illustrated is a honeycomb coil winding machine being made by the Morris Register Company, Twenty-ninth and Broadway, Council Bluffs, Ia. Widths from $\frac{1}{2}$ in. to 1 in. may be wound. The diameter may be varied by putting different size wooden spools on the winding spindle. It also has a recorder for counting the number of turns which is equipped with an adjustable pointer. Each machine is finished in black enamel and packed in an individual carton. The intended retail price is \$6.

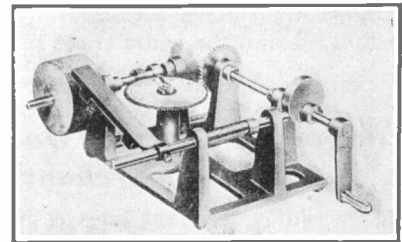

Spring Holder for Hydrometers and Tools

Radio Retailing, April, 1926

The illustrated holders are manufactured by the National Specialty Company, 35 Warren Street, New York. These are designed to be used in the shop where it is desired to place the tools above the work bench. They may be fastened in place by means of the wood screw which is fitted in a square hole and riveted in place. The use of this device gives the work bench a neat and orderly appearance in addition to having the tools easily accessible at all times. A holder, made of lighter tension spring, is also offered for use with a hydrometer. It will be found that this forms a very convenient method of keeping the hydrometer in place and at the same time the tension is not heavy enough to break the glass. Intended retail price of both sizes 10c. each.

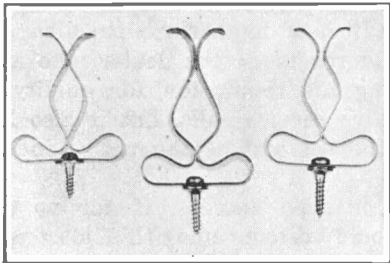

Testing Instruments

Radio Retailing, April, 1926

The Gray Instrument Company, 64-70 West Johnson Street, Philadelphia, Pa., is the manufacturer of "Queen" instruments. Complete portable testing outfits are made designed to meet every requirement. Some of the measurements made by these instruments are, for resistances, location of crosses and grounds, insulation, capacity, etc. Information and prices may be had by writing the above company for bulletin E-6.

Motor Driven Coil Winder

Radio Retailing, April, 1926

The Radio Production Machinery Company, 212 Centre Street, New York, is the maker of the illustrated coil winding machine. It is fully automatic, stopping after the required amount of wire is put on and will wind up to No. 44 enamel wire. While the winding takes place automatically, the operator takes place on the leads; one to the idle spool supply to make ready and one to the finished coil put into the idle chuck for that purpose. This machine makes 10,000 revolutions per minute. The intended retail price is \$165.

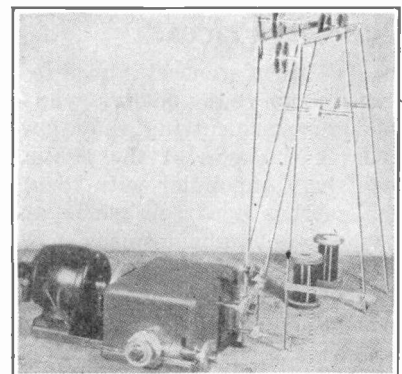

Long Nose Plier and Wire Cutter

Radio Retailing, April, 1926

Made by the Crescent Tool Company, Jamestown, N. Y., is the illustrated long nose plier designed especially for radio use. Wire can be bent into any desired shape by use of this tool which is also equipped with a strong wire cutter. The edges are sharp but are not the knife edge style which are so easily broken. Intended retail price, 75c.

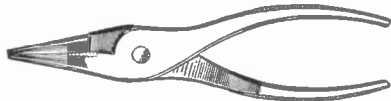

Wrench Set

Radio Retailing, April, 1926

The illustrated wrench set has been designed by Stevens and Company, 375 Broadway, New York, for the mechanic who prefers wrenches with separate shanks and a universal handle. It consists of a number 3, 4, 5, 5 $\frac{1}{2}$, 6, 7 and 8 wrench. It is put up in a neat, flexible tool roll which may be carried in the pocket or bag. With this set, every machine screw nut used in radio may be handled. The universal handle has a positive catch which keeps the bits from slipping, but at the same time, permits the bits to be changed quickly. This is known as "Spintite Set, T-74R," weighs 12 oz., and has an intended retail price of \$2.50.

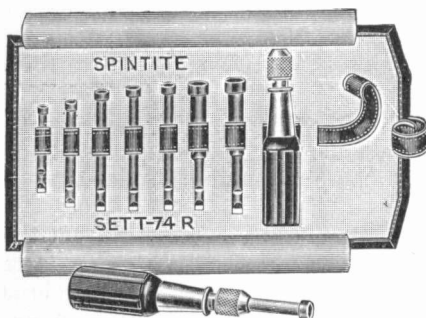

Proof That Super-Power Boosts Sales

SUPER-POWER needs no defense. But the attack by the New Jersey State Legislature on WJZ's 50,000 watt station at Bound Brook, N. J., cannot be justified in any way whatever, if the ultimate good of the vast majority of radio fans and radio dealers is to be considered.

WJZ's super-power transmission has been a life-saver for the radio trade in the entire South, as far down as southern Florida. That is the opinion of radio dealers all along the line from New York to Miami. Dealers report its reception as excellent and their customers enthusiastic about it. WJZ's new station, dealers say, is responsible for renewed life and activity in radio sales throughout Dixie. If its power is curtailed through legislative action, it will be a serious blow to radio fans and the radio trade in all the Southern states.

The Jobber's Invoice Doesn't Cover All the Costs of Merchandise

IF A radio merchant does a good volume of business and yet makes no money, the only answer is—something is out of proportion. His gross margin may not be large enough, or his overhead expense may be too heavy. Yet obvious it is that if these can be held at a fixed level, there is a point at which sales volume will turn a loss into a profit. Any competent accountant can show the puzzled retailer just what has to be done in his particular business to push it over into the profit column, or to increase the percentage of profit. It is all a matter of fixed rules, a mathematical certainty. The man who is skilled with figures has the set rules to guide him unfailingly; he doesn't fall into the common error of believing that buying at a price and selling for a higher one makes a profit. To him, the jobber's invoice doesn't represent the whole cost of the merchandise; there are lots of expense items to be added up and the proper proportion tacked on to each particular item before the selling price that will make a profit is affixed to the goods.

When Does It Pay to Cut Prices?

IN SPITE of general advice to the contrary, there are still some radio dealers who cling to the idea that although price-cutting may lower the value of their goods in the eyes of the public, and although it may make them unpopular with their fellow merchants, still such cutting does sell goods and as a money-making method is not to be despised.

Here are a few figures which come from the Los Angeles office of a well-known firm in another line of business which indicate how frequently this impression of making money through cut prices is only illusion—and a costly one.

On a 25 per cent margin of profit, a cut of 5 per cent

requires 19 per cent more volume to bring equivalent returns.

An 8 per cent cut requires 35 per cent more volume.

A 10 per cent cut requires 50 per cent more volume.

A 12½ per cent cut requires 75 per cent more volume.

A 15 per cent cut requires 112 per cent more volume.

In other words, it does the dealer just as much good to do \$1,000 worth of business at regular prices, as it does to do \$2,125 worth of business at a 15 per cent discount.

It is well to think this over before setting out to raise the volume of sales by cutting prices.

It Endangers the Good Reputation of Both Set and Dealer

THERE is a prevailing practice, among certain dealers, of advertising nationally-known sets, "completely equipped," at prices so low that, in the eyes of the bargain-hunter, they seem like a real "buy."

Of course it is well understood that the dealer endeavors to satisfy his need for a living margin of profit, in cases of this kind, by equipping these standard sets with low-priced tubes, batteries, etc. But this is a boomerang policy. It is a temporary expedient—one that not only quickly reacts on the dealer who makes the sale, endangering his reputation for quality and necessitating expensive service calls, but it also hurts the good name of the set and of the entire industry as well.

For their own continued success, if for no other reason, dealers should discontinue this destructive practise.

Tie Window Displays to Current Events

"A STORE window, decorated or arranged, so that it is in tune with some special broadcasting feature, is one hundred per cent more effective than one that is just well decorated," says the manager of the Radio Engineering and Repair Company, 380 E. 149th St., New York City.

"For instance:—For some time I had had a number of multi-tube radio sets in the shop, about which very few inquiries were made. Just as soon as the date of the international broadcasting tests was announced, I placed four of these sets and a sign in the window all by themselves. The sign read: 'Did You Hear Europe Last Year?'"

"These sets are well suited for the international tests.

"Since then my shop has been headquarters for all the neighborhood distance fans, and I have sold several of these receivers.

"International tests happen but once a year, but there is always some radio news event, popular artist, orchestra, concert, presidential speech, or novel broadcasting stunt around which an interesting window display can be built."

This to Say—

Radio Retailing

They've Never Heard of the "Summer Slump" in Florida

RADIO dealers in Miami, Fla., recently organized an association one of the primary purposes of which was to hold a radio show during the Spring season. This may sound daring to those who have had experience with off-season radio shows in the North, but there is a significant reason behind this apparent defiance of precedent.

Radio, in Florida, is several years behind the rest of the country in development. In fact, this past season was really the first radio season deserving of the name that Florida has yet had. Therefore, Floridians, and particularly Miamians, are not laboring under the misapprehension that radio is something to be put up in mothballs during the summer.

It was to acquaint their as yet "uneducated" radio market with the fact that radio can be, and is, a year-round recreation, that it was decided to hold a radio show at the beginning of the so-called slump period. Realizing the havoc created by the "summer slump" in other sections of the country, these dealers banded together and by advertising and publicity are determined to keep the hot-weather crash in radio sales away from their section of the country.

It is simply a matter of educating the public—food for some heavy thinking on the part of every manufacturer, jobber, and dealer.

Use "Community Programs" to Increase Sales

"COMMUNITY Programs" from broadcasting stations are becoming more numerous every day. That is, an hour or so, or perhaps an entire evening program is dedicated to some one community and the artists participating are residents of that community, and perhaps the Mayor makes a speech and altogether a fine spirit of civic interest is aroused.

How many dealers take advantage of these "home town" programs to sell radio receivers? It is, at the least, a great opportunity for personalized sales talks and demonstrations. On April 30th, the city of New London, Conn., is to broadcast a "New London Night" from WTIC, Hartford, from 8.15 to midnight. It will be interesting to learn whether the radio dealers of New London use this sales help and what success they meet.

Radio Sets for Lighthouse Keepers— A Worthy Cause

IN THE recent appeal of Secretary Hoover for radio sets for the government lighthouse keepers, opportunity is presented to the radio industry to express its appreciation of the invaluable services of these men who sacrifice their liberty, and if need be, their lives, that those who sail the seas may do so in safety. The nature of their duties separates these men from the rest of the world for months at a stretch, and makes entertainment

or news of the "outside" practically impossible to obtain. To this group, radio will bring both these things. A more worthy cause is difficult to conceive.

Ignorant Competition— the Worst Menace of All

COMPETITION in retail business has been compared to arsenic's effect on the human system. A little of either—competition or arsenic—will stimulate activity and improve the general tone. But *too much* of either may kill the patient!

Competition is the pace-maker of the merchant. And it is the safeguard of the customer, insuring him of fair "market values." When competition is intelligent and based upon knowledge of costs and merchandise, it is to be welcomed.

But ignorant competition is today the most menacing influence in radio or any other line. In radio particularly such competitive businesses spring up, expand, falter, and then crash down into the morass of their own making. But as they topple, they wreck values around them, and may endanger even the soundest members of the business community.

Radio Beneficial, Not Detrimental to Plays

THE controversy as to whether or not the broadcasting of copyrighted selections and plays is detrimental or beneficial in actual monetary returns is of long standing. From time to time there are fresh outcroppings of woe from various quarters.

It is significant, in view of this seemingly endless discussion, that the Messrs. Shubert, producers of the "Student Prince," broadcast last fall, saw fit also to broadcast their new operetta, "Princess Flavia." According to a recent statement, the Shuberts believe radio a worthy and profitable adjunct to the theater. So that settles that!

Concerted Action Needed on Service Policies

"THE time is rapidly arriving," comments a prominent radio dealer in a mid-western city, "when the radio dealers of this country will have their own city, state and national organizations. One of the main things I look for from such associations is the working out of demonstrating and servicing policies for the purpose of giving the dealers and their men a little more independence. As the situation now stands, the dealer is at the beck and call, day and night, of any customer who takes it into his head that he would like a little attention."

United action by a group of dealers in a declaration of fixed policies as to when and how demonstrations and service will be rendered, will go a long way toward permitting those dealers and their helpers to get at least one good night's rest a week, and still make a fair return on the capital each has invested in his business.



What's New in Radio and

This editorial section is prepared purely as a news service, to keep readers of "Radio Retailing" informed of new products.



Seven-Tube Receiver Having Built-in Reproducer

Radio Retailing, April, 1926

The illustrated receiver is being manufactured by the Federal Radio Corporation, Buffalo, N. Y. Known as the C-30, it contains four stages of radio frequency amplification and two stages of transformer coupled audio frequency amplification. Each individual part of the circuit is heavily shielded being enclosed again in a main shield, which takes in the entire receiver. All wires which run outside of this shield go through flexible metal covers. Overall dimensions are approximately 39 in. x 16 in. x 21½ in. The loop shown on the side may be taken off and housed in the rear of the set, provision having been made for this. It may also be used to operate the set from this position but is not recommended. Binding posts are also provided so that aerial and ground may be used if desired. Furnished with each set is 40 ft. of silk wire cut in 20-ft. lengths so that one-half may be used as antenna and the other for counter-poise.

On the front brass panel, which has a crackle finish, are the two tuning controls and battery switch. This receiver covers a wave band from 200 to 550 meters. Inside the set is ample room for storage battery, charger and all B batteries or a B battery eliminator, if desired. The cabinet is of mahogany finished in Adam brown. Intended retail price less accessories \$200.

Log Sheet Lists Station Schedules

Radio Retailing, April, 1926

Station log-sheets provided for imprinting the radio dealer's name and address for advertising purposes are not unusual, but here is an idea in log-sheet design that appears to be a distinct improvement.

On the cover of a new log record printed by the Henry Advertising Company of New York City, stations broadcasting weekly features are listed, showing at a glance the day-by-day entertainment high-lights. In the log sheet itself, not only are the principal broadcasting stations, their locations and wavelengths listed, but a column is provided for the evening schedule for each station.

A space is provided on the cover for the dealer's imprint which is included in the price of \$20 per thousand.

Eight-Tube Receiver With Built-in Cone Reproducer

Radio Retailing, April, 1926

The "Novadyne" radio receiver is manufactured by the Novadyne Radio Corporation, Battle Creek, Mich. The set which employs 8 tubes in a combination tuned and untuned radio frequency circuit is equipped with two stages of audio frequency amplification. A cone loudspeaker mounted in its lower compartment is said to be extremely large in circumference. Straight-line frequency tuning condensers are used and but 90 volts of B battery is necessary. This circuit uses a ground connection only—no antenna or loops being necessary for operation according to the manufacturers. Intended retail price, equipped with loudspeaker and walnut console cabinet, \$330, table type cabinet without speaker, \$205.

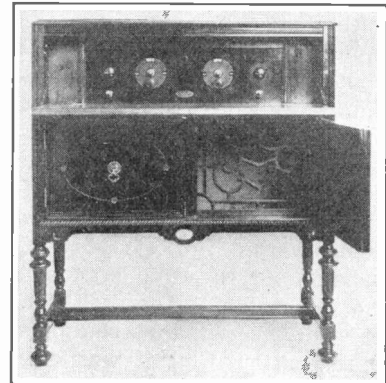

Six-Tube Receiver With Tone Regulator

Radio Retailing, April, 1926

The Malone-Lemmon Products, Incorporated, 130 Waywood Place, Plainfield, N. J., is making the illustrated six-tube receiver. This is said to be a perfectly neutralized circuit having resistance coupled amplification and a custom-built mahogany cabinet which measures 21½ in. x 12½ in. A tone regulated dial controls the tone at all volumes. Vernier hair-line dials greatly facilitate tuning. The set is easy to install as all connections are conveniently made with a multi-colored cable connected by a single plug at the rear of the set. Intended retail price, less tubes or batteries, \$140.

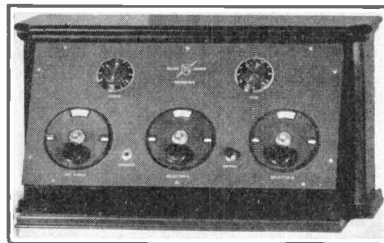

Cone Reproducer on Pedestal

Radio Retailing, April, 1926

The illustrated cone reproducer, known as No. 5-A, is made by the Stromberg-Carlson Telephone Manufacturing Company, 1060 University Avenue, Rochester, N. Y. A soundboard is incorporated in the speaker in order to reinforce the low notes. It consists of an annular ring of specially selected wood 3-in. wide, on the inner edge of which is mounted the cone. The cone itself is made of heavy material embossed and finished to represent Spanish leather and is treated so as to be impervious to climatic changes. The cone, unit and soundboard are mounted on a solid mahogany pedestal, the whole being fashioned after the style of the tip-top table. A 20-ft. cord is supplied so that the speaker may be moved about the room for best position. Intended retail price \$35.

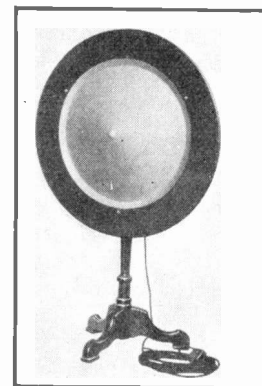

A Battery Eliminator

Radio Retailing, April, 1926

The A battery eliminator illustrated, made by Joyce Brothers, 71 Chestnut Street, Boston, Mass., is said to be noiseless and humless. It is designed to be attached to house lighting circuit and will run from four to twelve tubes. It is also claimed, by the manufacturer, to be inexpensive to operate and made to fit all types of radio sets. Intended retail price \$40.

Where to Buy It News of Latest Products Gathered by the Editors

All announcements appearing on these pages are published without advertising considerations of any kind whatsoever.

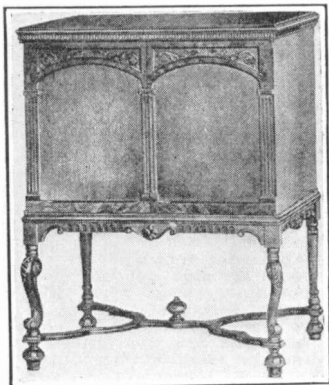

Power Amplifier and Reproducer

Radio Retailing, April, 1926

Known as the "Panatrop" is the illustrated instrument being manufactured by the Brunswick-Balke-Collender Company, 629 South Wabash Avenue, Chicago, Ill. This operates from 110-volt a. c. house lighting current, using radio power tubes for amplification of sound. This is to be used as a power loud speaker when connected to any radio receiving set. There is a volume control on the instrument which allows full control of sound from minimum to maximum. Intended retail price of style P-3 in a cabinet of Adam brown mahogany or two-tone walnut, \$600.



Five-Tube Receiver With Strip Wiring

Radio Retailing, April, 1926

The Kardon Radio Corporation, 294 East 137th Street, New York, is making the illustrated radio receiver, known as "Kardonstrip." By means of its construction, in which the strips are riveted together, all soldered connections—which are sometimes broken in shipment—are eliminated. Three dials are used for tuning and the rheostat control instead of being by means of a dial is a small lever. Intended retail price \$35.

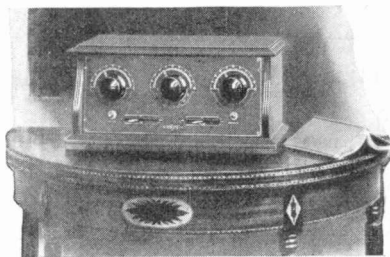

Five-Tube Receiver Equipped with Accessory Maintenance Units

Radio Retailing, April, 1926

The Aristocrat radio receiver, manufactured by the Radiocompak Company, Bradley Beach, N. J., is a complete radio installation in itself. Housed in a duo-tone cabinet of either mahogany or walnut, the set is equipped with apparatus for its complete maintenance, containing a battery charger, tubester, tube-rejuvenator and distilled water for the storage A and B batteries. The set, which is also equipped with an internal loudspeaker is attached to the electric lighting circuit by means of a cable and plug supplied, and maintenance of tubes and batteries is thereafter controlled from a small power panel mounted to the left of the five-tube radio frequency receiver. Meters are provided by which condition of batteries may be easily ascertained and a master switch mounted on this small panel controls the operation of the receiver and the charging of batteries. All equipment is mounted permanently within the cabinet. The circuit incorporates two stages of tuned radio frequency amplification, detector and two stages of audio frequency amplification.

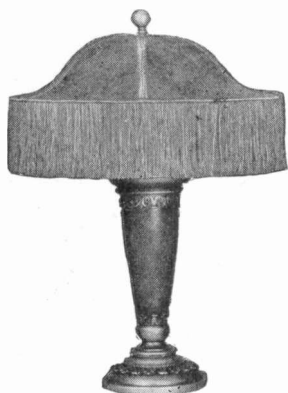

Table Lamp with Reproducer in Base

Radio Retailing, April, 1926

The illustrated lamp which has a reproducer unit incorporated in the base, is being made by the Malone-Lemmon Products, Incorporated, 130 Waynewood Place, Plainfield, N. J. The base is polychrome and the shade of iridescent, amber-colored pressed mica, measuring 26 in. The lighting fixture is adapted to take any standard electric light bulb up to 50 watts. The hollow wooden base performs the function of a horn and casts the sound waves up to the mica shade where they are reflected evenly throughout the room. The shade fringe is multi-colored and of fine silk thread. Intended retail price \$37.50.

Low Loss Coils for Short Wave Reception

Radio Retailing, April, 1926

The Hammarlund Manufacturing Company, Incorporated, 424-38 West Thirty-third Street, New York, N. Y., is manufacturing the illustrated low-loss solenoid coils which are designed to be used in short wave receivers. These are wound with No. 16 single cotton covered wire, the spacing between being the diameter of the wire. They are to be used on wave lengths of from 10 to 200 meters. They are very rugged and the losses are too low to be measured. Although supported by a thin film of the dielectric material, they are as rugged as a coil wound on a solid form.

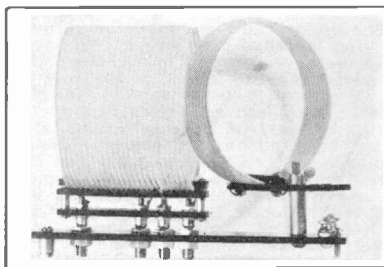

Tube for Last Audio Stage

Radio Retailing, April, 1926

The Connewey Electric Laboratories, Hoboken, N. J., have released the DC-112, a super-volume tube for use in the last audio stage of radio receiving sets. This is a special tube throughout, and can be used with plate voltages up to 157½. While it is said to improve the quality of reception possible with any set even though no provision is made for extra plate voltage, this tube is at its best when plate voltages in excess of 90 volts are used. The external appearance of the DC-112 closely resembles the standard DC-201A. The bulb is the same size and shape, and the base is also the same. The prongs in the base are the new long prong style.

What's New in Radio and Where to Buy It—

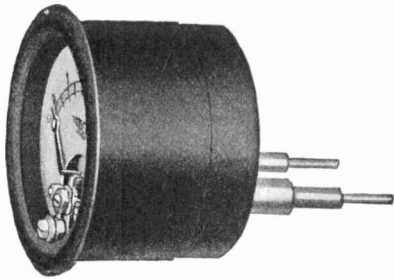

Voltmeter

Radio Retailing, April, 1926

No. 135-A is a 2 in. diameter Voltmeter reading from 0 to 5 which is being made by the Jewell Electrical Instrument Company, 1650 Walnut Street, Chicago, Ill. It is of the D'Arsonval, high resistance type and is finished in dull black with silver etched dial and black characters. All the moving parts are silvered, giving a very neat appearance. This instrument is equipped with special prods for plugging into cord tip jacks. Intended retail price, \$7.50.

Socket for UX Tubes

Radio Retailing, April, 1926

Designed to accommodate the new UX style tubes is the socket being made by the Cutler-Hammer Manufacturing Company, Milwaukee, Wis. The base is of heat-proof "Theraplast" which will not burn nor melt under heat of the soldering iron. This insures that the terminals cannot loosen when making soldered connections. The contacts are of one piece and silver plated for low loss. Double grip contacts firmly hold the tube prongs insuring perfect contact. The lugs at the end of the contacts are designed for easy soldering and may be bent down for under-wiring. Slots are provided in the hex nuts in order to permit tightening with screw driver or wrench. Intended retail price is 40c.

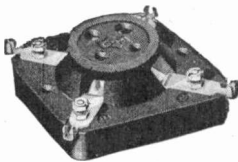

Hydrometer

Radio Retailing, April, 1926

"Ayanbee" is the name of the new hydrometer being made by the Scranton Glass Instrument Company, Incorporated, Scranton, Pa. It is small in size and only a teaspoonful of solution is required for a test. The nozzle is of red, hard rubber which has a large opening for quick flow of solution. It can be inserted in the smallest B battery vent hole. The prong float prevents sticking and leaning. It is $7\frac{1}{2}$ inches in length and has a straight glass barrel which is heavily walled and can be easily cleaned. A square collar is also provided so as to prevent rolling and breaking. The intended retail price is 75c.

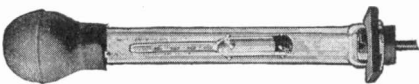

Reproducer Unit

Radio Retailing, April, 1926

The Electrical Products Manufacturing Company, 69 Sprague Street, Providence, R. I., has designed a loud speaker unit that can be attached to a phonograph tone arm or used with a horn. It is equipped with a special micrometer tone adjustment and is said to reproduce faithfully with quality of tone. The finish is of polished nickel and the unit is furnished with a 5-foot, 18-strand "Dymac" tinsel cord with standard tips. Shipping weight is 12 ounces. Intended retail price, \$5.

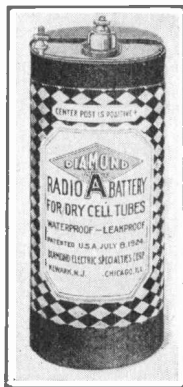
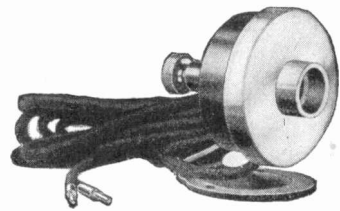

Dry-Cell Batteries

Radio Retailing, April, 1926

The Diamond Electric Specialties Corporation, 101 South Orange Avenue, Newark, N. J. is making dry cell A batteries designed especially for radio use. These batteries are so constructed, by an allowance for dead air space of $\frac{1}{8}$ " between the zinc cell and the waterproof container, that when the electrolyte eats through the zinc it goes into this second space and is held there. These batteries are guaranteed waterproof and the manufacturer states that each and every ingredient is thoroughly tested before being used.

Cartridge Resistance Mounting

Radio Retailing, April, 1926

A convenient unit for grid leaks and plate resistances used in resistance-coupled amplifiers is being made by C. E. Mountford, 465 Greenwich Street, New York. Two sets of clips hold the resistance and leak in position, as shown in the illustration. The stopping condenser can be connected directly across the terminals at one end. The clips are of phosphor bronze, heavily nickel plated. Brass binding posts also nickel plated form the terminals of the unit and bakelite is used for the base. Intended retail price, 60c.

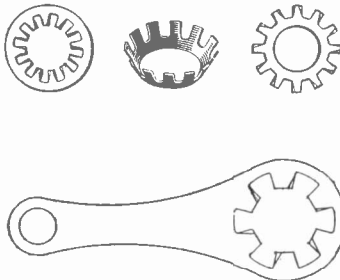
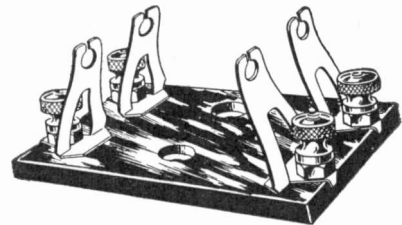

Lock Washers

Radio Retailing, April, 1926

The Shakeproof Lock Washer Company, 2501 North Keeler Avenue, Chicago, Ill. is making locking wire terminals and washers. The washers are made of the best clock spring steel, tempered bronze and in sizes from No. 4 nominal diameter to $\frac{3}{4}$ " diameter. These are made internal locking, counter sunk, and external locking. The terminals are of most interest in radio as binding posts, nuts, etc. can be tightened down, firmly locked and the connections made to the lug which extends.

Snap Terminal

Radio Retailing, April, 1926

The illustrated terminal is being made by the Rajah Auto Supply Company, Bloomfield, N. J. This is furnished with a molded bakelite ferrule made in either black, red or green. A perfect electrical contact, although solderless is made by baring about $\frac{1}{8}$ -in. of wire which is inserted into the knurled sleeve. This is then screwed on to the connector end. This terminal is especially recommended for use with antenna, ground and battery connections. It is substantial, easy to handle, and may be mounted in a variety of positions. Intended retail price complete with connector 20c. Additional base studs may be had for 6c each.

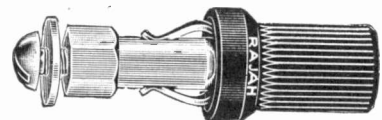

News of Latest Products Gathered by the Editors

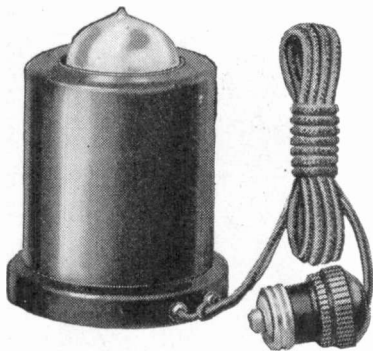

Tube Rejuvenator

Radio Retailing, April, 1926

The Aetna Machine & Manufacturing Company, Chicago, Ill., is making a tube rejuvenator designed to re-activate either 201-A or 199 type tubes. This device operates on any 100-120 volt house lighting circuit, and is equipped with a plug and cord as shown in the illustration. It is said that a tube may be rejuvenated in approximately ten minutes by use of this device at a cost of less than $\frac{1}{10}$ of a cent. The tube is inserted in a shell like receptacle containing an additional heating element, which bakes the tube from the outside. Intended retail price, \$3.75.

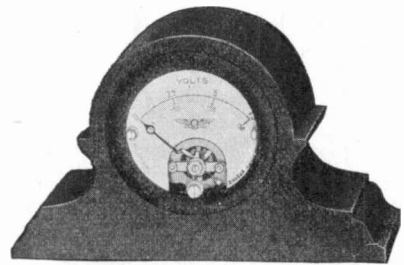

Portable Voltmeter De Luxe

Radio Retailing, April, 1926

"No. 135-C" is a double scale voltmeter being made by the Jewell Electrical Instrument Company, 1650 Walnut Street, Chicago, Ill. It measures 5 in. wide and 3 in. high and reads up to 7.5 volts on one scale and 150 on the other. Two cords are supplied with phone tips which are especially intended for plugging into the jacks of radiola receivers. This instrument is designed and finished to harmonize with the most artistic radio sets and furniture. The intended retail price is \$10.

Horn Type Reproducer

Radio Retailing, April, 1926

The Globe Phone Manufacturing Company, Reading, Mass., is manufacturing a horn type reproducer shown in the illustration. This has a silicon steel diaphragm, extra large drop-forged magnet with balanced coils mounted on a sound bridge having a special tone pocket beneath. This is said to give a very smooth tone and faithfully reproduces music or voice. A vibrationless horn is used which is claimed to eliminate all unpleasant overtones. The solid base is oblong in shape, and the unit itself is adjustable. Intended retail price, \$12.

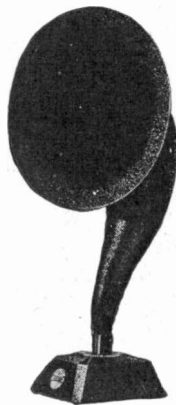

Audio Frequency Transformer

Radio Retailing, April, 1926

The Wagner Radio Company, 643 Washington Boulevard Chicago, Ill., has introduced a new audio frequency transformer, designed to give undistorted amplification on all frequencies. It is claimed by the maker, that all transformers produced are tested to meet a certain standard, which allows substitution of transformers any time without affecting the circuit. These are made in ratios of 1.4:1, 2.4:1, and 4:1. Every instrument is guaranteed for one year. The cases are finished in either crystal, black enamel or nickel.

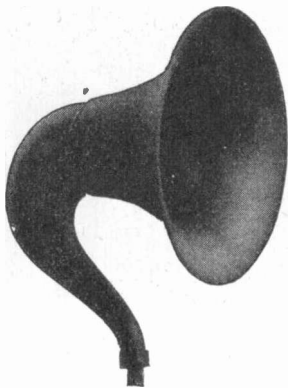

Rubber Composition Horn

Radio Retailing, April, 1926

A goose-neck type horn made of rubber composition is being offered by The Miller Rubber Company, Akron, Ohio. It is made in two pieces to facilitate shipping, and has a tight screw joint which eliminates danger of rattles. The finish is a rich, subdued, black velvet—special finishes may be had if required. These horns are fitted with a standard ferrule $\frac{1}{8}$ in. O. D. and $\frac{3}{4}$ in. long. These may also be had in special sizes if desired. As these horns are molded they are uniform so that no variations in air column space occurs. They are also said to be sufficiently inert to eliminate practically all horn distortion and vibration. Heat and moisture do not affect them.

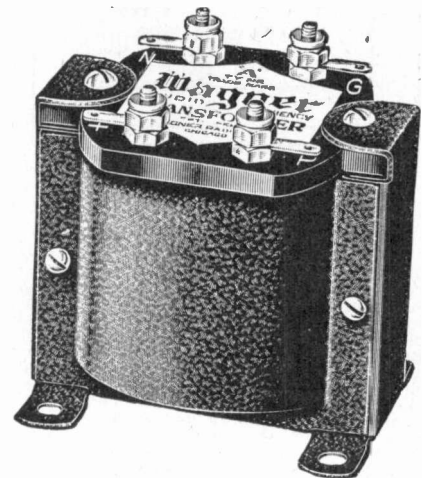

Rheostat

Radio Retailing, April, 1926

Using Manganin wire with double the number of turns usually found, the rheostat being made by the Victoreen Radio Incorporated, Cleveland, O., is said to permit very fine adjustment. Another feature pointed out by the manufacturer is that it has zero temperature coefficient which means that no matter how warm the unit may become the resistance remains constant. A third terminal is also incorporated. These rheostats are made in the sizes of 6, 10, 20 and 30 ohms. The intended retail price is \$1.20.

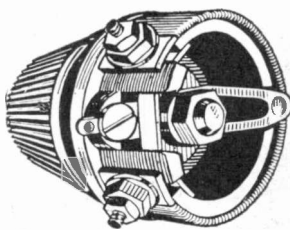

Horn Type Reproducer

Radio Retailing, April, 1926

"Temple" is the name of a reproducer being marketed by Parcells & Company, 68 West Washington Street, Chicago, Ill. The horn is made of ceramic material whose period of vibration is outside the range of human ears. There are no joints to become loose or rattle as it is made in one piece. The unit is adjustable by means of a lock thumb screw and the diaphragm is protected against damage from over adjustment by means of a suitable stop. The unique design has made possible a horn which stands only 14 in. high but has a 12 in. bell and an air column 26 in. long. The intended retail price is \$21.

What's New in Radio and Where to Buy It—

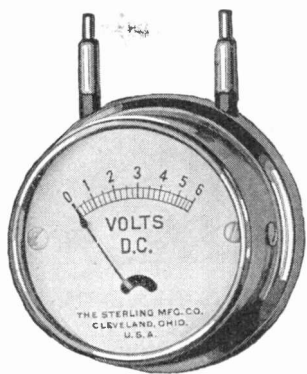

Voltmeter for Filament Control

Radio Retailing, April, 1926

The "R25-28" filament volt meter is the latest instrument to be made by The Sterling Manufacturing Co., 2831-53 Prospect Avenue, Cleveland, O. This has a silver etched dial with a black scale in relief. The nickel plated case is 2½ in. in diameter, 1½ in. thick and 3½ in. long, which includes the cord tip leads. The scale is graduated in ¼ volt divisions. This meter is of the high resistance type having 90 ohms per volt at 3 volts. Each instrument is packed in a gold stamped, maroon box. Intended retail price, \$7.50.



Tinning and Soldering Compound

Radio Retailing, April, 1926

The Soldo Company, Sicilian House, Southampton Row, London W. C. 1, England, is making a non-acid tinning compound. This is in the form of a powder, with solder, finely divided, mixed up with it. Upon inserting a hot soldering iron into this, the iron is not only cleaned but tinned and contains enough solder to make a secure joint when wiring up a radio set. This compound will be found to work on all metals except aluminum. Its use will facilitate wiring besides leaving a non-corrosive joint.

Five-Tube Receiver

Radio Retailing, April, 1926

Designed to cover a wave band range of from 200 to 600 meters is the five-tube receiver being made by the Trego Radio Manufacturing Company, 1427 Chestnut St., Kansas City, Mo. The cabinet is made of hard wood with an ebony duco finish having overall dimensions of 7 in. x 8 in. x 8 in. It is also equipped with a sloping panel. Three main tuning dials are used, and the insulation throughout is of bakelite. All wiring and coils are concealed beneath a sub-panel. Intended retail price, \$45.

Electrolytic B Battery Eliminator

Radio Retailing, April, 1926

Illustrated is the "B" battery eliminator being made by the Pep Manufacturing Company, Incorporated, 33 West Forty-Second Street, New York. This is designed to operate on 110-volt, 60-cycle house lighting current. It is said that there is no hum present during operation. Eight large size electrolytic cells are used which are always under-loaded and the only attention necessary is to add a little water once or twice a year. Voltages supplied are 45, 67, 90 and 135. There are no adjustments whatsoever to be made on this device. Intended retail price is \$33.

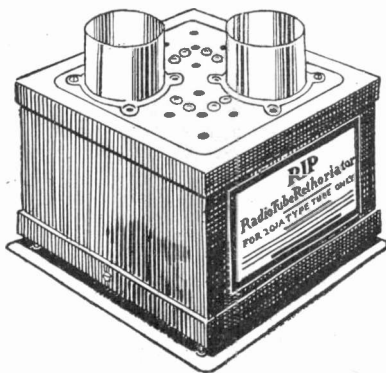

Tube Rejuvenator

Radio Retailing, April, 1926

The "Rip Rejuvenator" is being made by the Radio Institute, Incorporated, 40 South Clinton Street, Chicago, Ill. This instrument is designed to be used on 110 volts, either a.c. or d.c. Two sockets are furnished, one for high voltage and the other for low voltage. Three styles of instruments are made, known as No. 100, 102 and 103. The first is for 201-A type tubes, and has an intended retail price of \$3. The second is for 199 type tubes and also retails at \$3. The third is designed for both types of tubes and has an intended retail price of \$5.25.

Radio Frequency Transformer

Radio Retailing, April, 1926

The "Lennis-Coil" is a product of the General Winding Company, Incorporated, 214 Fulton Street, New York. In external appearance this coil greatly resembles a binocular coil, but in actual internal construction it is said that it is very much different. There is only one coil of wire, but it is wound by automatic machinery in such a fashion that the effect of two coils, side by side, is created. This it is said eliminates all external fields. It is designed to be used in any tuned radio frequency circuit with standard .00035 mfd. variable condensers. The coil is encased in a colored bakelite shell which is sealed air-tight and dust-tight.

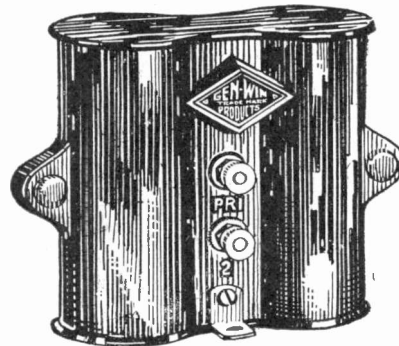

Roof Type Aerial Mast

Radio Retailing, April, 1926

S. W. Hull & Company, Cleveland, O., have placed on the market a roof type aerial mast, which may be had from 20 to 120-ft. high. Special high strength steel angle construction is used which affords ample strength and at the same time light weight—simplifying erection. The steel roof adaptor is so designed that it can be placed on a peak or a flat roof. Earth installations are made without the use of concrete. All sizes of masts are tested at the factory to withstand a 500-lb. pull at the top, which makes them ideal for supporting a heavy transmitting antenna as well as the standard aerial used with radio receiving sets, according to the manufacturer.

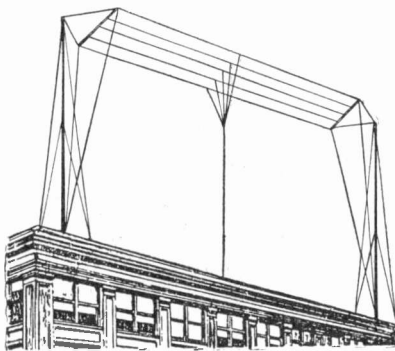

News of Latest Products Gathered by the Editors

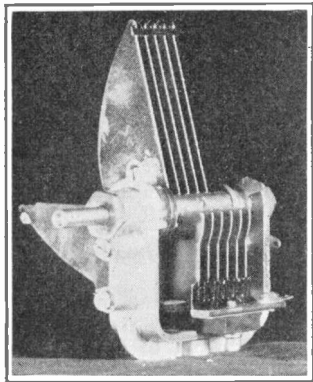

S.L.F. Condenser for Low Wave Receiver

Radio Retailing, April, 1926

A special straight line frequency condenser designed for receiving sets operating below 200 meters is being made by the Hammerlund Manufacturing Company, Incorporated, 424-38 West Thirty-third Street, New York, N. Y. Contact to the rotor plate is made by means of a bronze clock-spring pig-tail which prevents contact losses. The plates are hard brass, chemically treated against corrosion and securely soldered in individual slots. Permanent alignment is insured by sturdy tie-bars. The plate spacing is unusually wide which reduces to a minimum the losses countered by dust collection. Maximum capacity .0015 mfd., minimum .000004 mfd. As can be seen in the illustration the condenser has nine plates. Intended retail price \$4.50.

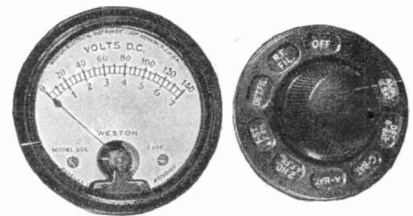

Voltmeter and Universal Radio Switch

Radio Retailing, April, 1926

Illustrated is the universal switch and voltmeter being made by the Weston Electrical Instrument Corporation, Newark, N. J., by means of which all voltages in the set may be checked. By turning the knob so that the desired circuit is indicated, A, B, or C battery voltages may be instantly measured regardless of the type of set or what its internal connections may be. If the disks furnished do not contain a desired designation, they may be reversed and any desired index written on the reverse side. The switch is mounted on the panel by means of two screws, similar to the customary method of mounting rheostats. Intended retail price, in combination with a single range Model 506 voltmeter, with scale figured 140/7 volts, \$13.

A Battery Eliminator Using Tubes

Radio Retailing, April, 1926

The Davy Electrical Corporation, 505 Court Street, Brooklyn, N. Y., offers the illustrated A battery eliminator, which operates with two Rectigon tubes. Both halves of the a. c. cycle are rectified and it is said that the unit has the new filter circuit incorporated in it. A regulator allows a variation of voltage from zero to 6 volts. It is said that receivers with from 4 to 6 tubes, using the 201-A type, may be successfully operated from this unit. It is rugged in construction and is claimed to contain no condensers, liquids or moving parts. Overall dimensions are approximately 12-in. x 6-in. x 8-in.

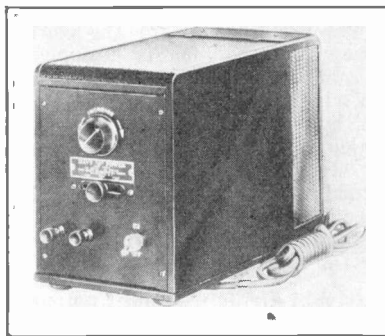

Crystal Receiver

Radio Retailing, April, 1926

A small compact crystal receiver is being produced by the Cherington Radio Products, Incorporated, Waukegan, Ill. It is 3 1/4 in. high to the top of the terminals. The metal case, which is nickel plated, is part of the circuit and it is claimed by the manufacturer that this set will receive stations operating on from 220 to 550 meters. Intended retail price \$1.75.



Trickle Charger Using Two Ampere Tungsten Bulb

Radio Retailing, April, 1926

The Acme Electric and Manufacturing Company, 1500 Hamilton Avenue, Cleveland, O., is now making type AT-1 Trickle Charger. Using a 2 amp. tungsten bulb, with a special transformer having independent windings, this charger delivers from 1/2 to 1 amp. of current continually and consumes 25 to 40 watts during operation. The case is made of sheet steel finished with crystallizing lacquer, mounted on rubber feet and presenting in whole a very neat appearance. Intended retail price, with the extension cord attachment, but without bulb, \$6.

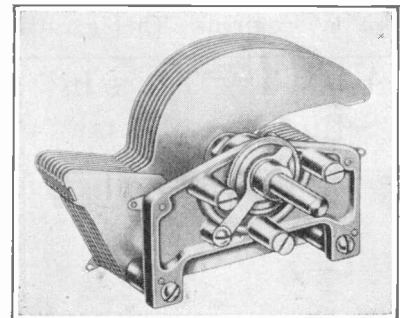

Straight Line Frequency Condenser

Radio Retailing, April, 1926

The Benjamin Electric Manufacturing Company, 120 South Sangamon Street, Chicago, Ill., has perfected a straight line frequency condenser. Broadcasting frequencies are spread in even steps over the entire range of the dial, making tuning easier and more precise.

The brass, die stamped, rotor and stator plates are solidly braced to the cast aluminum frame to give perfect alignment and rigidity. A thumb nut which does not loosen nor throw rotor plates out of alignment adjusts turning tension of the rotor. Cone bearings allow rotor to turn easily but firmly and help keep it perfectly true to line. Rotor plates and frame are grounded to eliminate body capacities. The condenser is finished in unpolished silver plate and adaptable to any type of set. Furnished in .00025, .00035 and .0005 mfd. capacities.

Modulator Plug for Volume Control

Radio Retailing, April, 1926

The Centralab "Modulator Plug" made by the Central Radio Laboratories, 16 Keefe Avenue, Milwaukee, Wis., is a unique device that can be quickly attached, without tools, to any radio receiver having one or more jacks, and provides gradual control of tone volume from a whisper to maximum. In appearance it is slightly larger than the average phone plug, with a small Bakelite knob on one side. Turning the knob through an arc of approximately 300 degrees varies a smooth graphite resistance in the plug base. This in turn controls the tone and volume. The Modulator Plug now enables radio owners to install this modern feature on their old set at small cost, simply by substituting the new plug for their old one. Intended retail price, \$2.50.

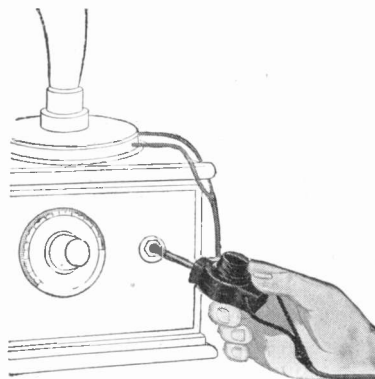

How Manufacturers Promote Dealer Sales

New "Dealer Helps" Offered to the Radio Retailer by the Manufacturer to Increase the Merchant's Radio Profits

How the Operadio Corporation Helps Retailers

A fine example of the co-operation between manufacturer and dealer which is so necessary if business is to continue profitable to both is the new broadside of dealer help material furnished by the Operadio Corporation, Chicago, manufacturer of self-contained radio receivers. This new broadside consists of a large 10 x 40 in. poster for the dealer's window, several 14 x 17 in. news posters featuring photographs of current events, a large wall poster attractively colored, several different folders fitting in small envelopes which are suitable for circularization purposes and a set of three-easel-backed cards particularly useful for window trim and on the counter.

A limited amount of this material is furnished to dealers at first and they are asked to fill out a requisition if more is required. This greatly

Dial Display "Tunes-In" Selling Arguments

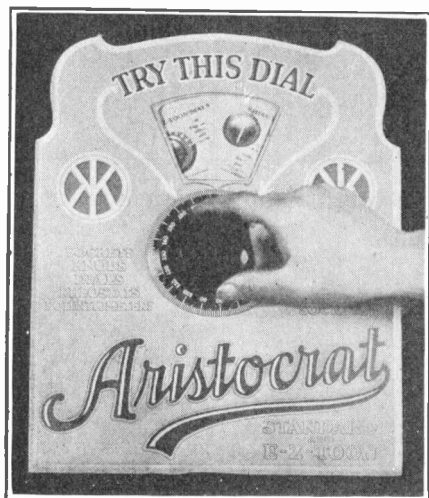

When a customer accepts the challenge offered by this display card to "try the dial," a number of sales arguments appear successively before his eyes in the slot above the dial. This attractively colored card is equipped with an easel back and is furnished dealers by the Kurz-Kasch Company of Dayton, Ohio.

reduces the loss through non-use of material on hand. Newspaper cuts in all usual sizes may also be obtained free of charge from the manufacturer.

The Burton-Rogers Company, Boston, Mass., manufacturer of the Hoyt line of radio indicating instruments, publishes a unique eight-page folder to be used in connection with a rotary meter which it has just brought out for the use of retailers. This booklet is unique in that it not only illustrates the many ways in which the new instrument may be used, but it is virtually a text book of incalculable value to every radio service station, explaining in easily understood form, methods by which sets may be tested and adjusted, and containing much other useful information for the man who repairs receivers.

The Grigsby-Grunow-Hinds Company, Chicago, Ill., manufacturer of the Majestic line of loud-speakers and battery eliminators, has issued an illustrated catalog listing its products and new prices. In this catalog, full instructions for the operation of the battery eliminator are given.

The Crosley Radio Corporation, Cincinnati, announces that the paper mache model of "Bonzo," the popular pup associated in the minds of many people with the Crosley line of radio apparatus, is now available to dealers at a cost of seventy-five cents. The company believes that this amusing little earphone enthusiast will also have a ready market as a curio and is available in any quantity.

The Dayton Fan and Motor Company, Dayton, Ohio, manufacturer of the Day-Fan radio receiver, issues monthly a small pamphlet called, "The Day-Fan Dial." With the February issue of this booklet, dealing with sales and service problems, comes a small form upon which the retailer is asked to list a few subjects which he would like to see discussed in the next issue. In this way a "question and answer" service between the dealer and the manufacturer is maintained greatly simplifying the problems of both.

Electrad, Incorporated, 428 Broadway, New York City, supplies twelve lamp socket antennas in an attractive colored counter display carton from which these accessories, which are also packed in individual boxes, may be sold. When the cover of this carton is raised it forms an effective background for the merchandise.

Merchandising Helps for Willard Dealers

In a new advertising plan, inaugurated by the Willard Storage Battery Company of Cleveland, Ohio, the company supplies all its dealers with motion-picture slides, cloth banners, window display signs, attractive counter cards, newspaper advertising mats and a series of "follow up" postcards. With each broadside of advertising material sent to dealers, a small instruction book for his guidance is included which explains the way in which material should be used for best results. This advice is based on the wide experience of the company in such matters and should be very helpful in securing more storage-battery business for the retailer.

The Stromberg-Carlson Telephone Manufacturing Company, Rochester, N. Y., announces the completion of a 250-page catalog in which all merchandise it manufactures is described.

"What good is a long nose?," is the title of a small leaflet furnished to dealers carrying the long-nose pliers manufactured by the Crescent Tool Company, Jamestown, N. Y. This little leaflet is attractively illustrated in colors and may be used by dealers as a "throw-around." The company also furnishes six pliers attached to a 8½ x 11 inch card for counter display.

Counter Case Shows All Value Grid Leaks

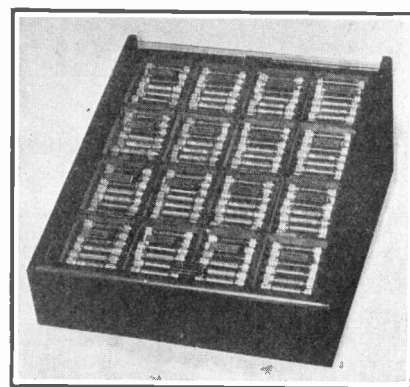

Grid leaks manufactured by the Aerovox Wireless Corporation, 489-493 Broome St., New York City, are available to the consumer in various values. The above illustration shows an attractive display of these leaks which is furnished to dealers. This display case is available when ordered with the resistances used for \$1.25, or separately for \$3. Each resistance is individually tested and is said to be accurate within 10 per cent of its rated value.

What the Trade Is Talking About

March Radio Show of Fort Wayne Dealers Proves Successful

Why hold a radio show in the early spring—right at the end of the buying season? What will be the public's response to such an innovation? Herbert C. Wall, president of the Fort Wayne Radio Trade Association, furnishes us with answers to both these questions. His organization has just held its first radio show. It ran for three days, March 6-7-8, and was staged in Elk's Hall, Fort Wayne, Indiana.

"We wanted to prolong the buying season for radio another month if possible. We wanted to extend it well into early spring," he says, "so nineteen of the boys, out of a dealer membership of twenty-four voted to exhibit and paid fifty dollars apiece for the privilege. The total attendance was 1,566. Admission cost twenty-five cents. Our total receipts therefore were \$1,340."

Mr. Wall states the expenses ran as follows: Rent \$120; Advertising \$300; Decorations \$250; Music \$90; Miscellaneous \$170; Grand Total \$930. Each exhibitor, therefore, received a refund of \$21.57.

The radio dealers of Fort Wayne feel that their first radio show was an unqualified success not only from an attendance and financial standpoint but from the more important angle of accomplishing the real purpose for which it was held. Live prospects, from 15 to 25 per exhibitor, were reported. Public interest was, at all times, not only keen but sincere. "People wanted to know all about summer reception, about tonal quality and loop reception developments and particularly were they interested in the subject of changes in models," explained Mr. Wall.

One dealer was of the opinion that those exhibitors who had nothing new whatsoever to show were "holding the bag" for their fellow members who were fortunate enough to get in one or two new 1926 models.

Radio Corporation of America dealers will in the future be designated by signs in the fronts of their stores. Seven radio merchants in Columbus, O., have been selected by the corporation to represent it in that city. Erner & Hopkins, Inc., authorized distributors, will supply RCA equipment to the following licensed dealers: Heaton Music Store, Radio Electric Company, Carl Seaman, Sells Electric Company, Bower Hardware Company, F. & R. Lazarus & Company, and Harold Day.

Floyd C. Best, president of the Chicago Telephone Supply Company, Chicago, Ill., formerly known as the manufacturing division of Herbert H. Frost, Inc., and his associates, have purchased the Frost company in order to consolidate the sales and manufacturing divisions under the direction of the same interests. The officers of the *Radio Retailing*, April, 1926

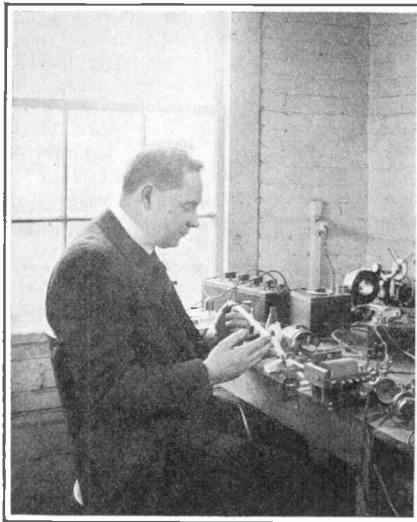

No, that isn't a stock ticker. H. B. Richmond, treasurer of the General Radio Company of Cambridge, Mass., is here shown studying some amateur high-frequency transmission records. Treasurer or no treasurer, Mr. Richmond is apparently no more immune from the bite of the "radio bug" than the rest of us.

new concern are F. C. Best, president and treasurer; D. S. Hill, vice-president, and W. A. Nicely, secretary. No change in merchandising policy due to the consolidation is contemplated. Major Frost, former president, will, in future, devote all his attention to his Cunningham tube interests.

Miami Dealers Organize to Help Trade in Florida

The radio dealers of Miami, Fla., some fifteen in number, recently organized an association to further the development of the trade in that city. Officers elected were: F. J. Reynolds, president; Harry B. Peacock, vice-president; Howard Henshaw, secretary; Claude de Bower, financial secretary, and Paul Penny, treasurer. Two committees were appointed, one to draw up by-laws, consisting of L. D. Kent, J. E. Henshaw and Frank Hoselton, and one to plan a radio show, consisting of Claude de Bower, Howard Henshaw and Arnold Kent.

William C. Alley, associate editor of *Radio Retailing* was present at the meeting and gave a short talk. In addition to those already mentioned, others at the meeting included, J. R. Hyatt, J. L. Causey, F. R. Clark, Jr., H. Barclay, Larry J. Moore, Jr., R. G. Mann, and N. S. Noble of the *Miami Herald*.

The Sleeper Radio Corporation at a meeting of the newly elected board of directors re-elected Gordon C. Sleeper president of the company, elected Fred A. Klingenschmitt vice-president, Harold C. Doyle treasurer, John J. West secretary, and Kenyon W. Mix assistant secretary. The board of directors is made up of the above mentioned officers and Robert W. Perkins.

Dayton Radio Dealers Form Trade Organization

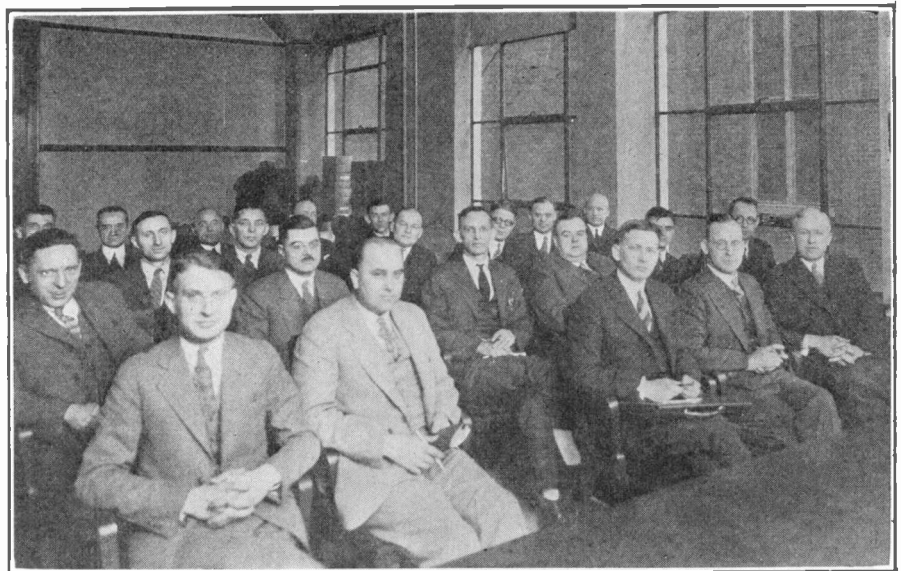

The radio dealers of Dayton, Ohio, have organized. Detailed plans for perfecting their association were completed at a meeting March 5. This activity is the outgrowth of a preliminary meeting held in the Chamber of Commerce Assembly Room, February 26. At that time R. V. Sutcliffe, associate editor of *Radio Retailing* addressed twenty-three of the leading radio dealers of Dayton on the subjects, "Adopt a Policy and then Stick to It," and "The Need for Radio Dealers to Organize." At

the March 5th meeting, officers were elected and it was decided to send a delegation to the first meeting of the new Federated Radio Trade Association at Chicago, April 15, 16 and 17. Forty-four radio dealers of Dayton were present. The officers elected were: John Saum, president; Frank Breidenbach, first vice-president; Carl Linxweller, second vice-president; John Becker, treasurer, and S. C. Davis, secretary. W. G. Biddle and A. F. Apple were elected directors.

Plans for a National Dealer Organization

A Statement by H. H. Cory, Secretary and Treasurer, Federated Radio Trade Association

The Federated Radio Trade Association is the name chosen to identify a proposed national organization of retail radio dealers and distributors. It was selected by the presidents and secretaries of the four pioneer radio trade associations of the Middle West when they met in Minneapolis, Minnesota, February 15, to discuss ways and means for amalgamating the various local radio dealer associations into one compact, functioning, national body. At that preliminary meeting, it was felt by the officers of the four radio organizations represented, that what the radio business needed, just at this stage in its development, was a group of volunteer leaders to sound the assembly call and to raise the banner of a genuine national organization—by the dealers, of the dealers and for the dealers. A general invitation is now extended through the kindness of *Radio Retailing*, to all radio associations to send two delegates to our Chicago meeting as the result of that preliminary "get-together." This will be held April 15, 16 and 17 at the Hotel Morrison.

26 Associations Invited

The radio trade associations who sent their officers to meet in Minneapolis cover these states: Michigan, Illinois, Missouri, Minnesota, Iowa and Wisconsin.

Twenty-six trade associations in various states from New York to California have been invited to date to send two representatives each to the Chicago meeting. Ten of them have already voted to send their delegates and meetings of many of the others will be held within a few days and the

matter taken up. Field workers are busy organizing trade associations of dealers, jobbers and manufacturers in the states where no organizations now exist so that by the first of April, eight or ten more associations are expected to be under way. Very little publicity concerning the movement has been given out, but the leaders of it have been working on it for more than a year. The size of the membership and the financial stability of the associations which have already joined the movement guarantees its future success. Each local organization will have a representative on the governing board of the national body.

The officers of the Federation, elected at the conference, are: president, H. J. Wrape, St. Louis Trade Association and owner of the Benwood-Linze Company; secretary and treasurer, H. H. Cory, Northwest Trade Association; first vice president, A. M. Edwards, Michigan Trade Association, and connected with the Wolverine Radio Company, Detroit; second, third and fourth vice-presidents were elected in the following order: N. C. Beerend, Milwaukee; G. H. Riebeth, Minneapolis, and R. W. Bennett, St. Louis.

In the three-day meeting in Chicago in April every problem confronting the radio industry of today will be brought up for discussion and the sentiment and action of the "Federation" recorded. A permanent Constitution and By-Laws and Articles of Incorporation will be adopted.

F. A. Klingenschmitt, for some time past connected with the Sleeper Radio Corporation, is now in executive charge of the Radio Service Division of Stanley & Patterson, Inc., 150 Varick St., New York City.

The Magnavox Company, Oakland, Cal., announces that the list price of Magnavox tubes has been reduced to \$2.50 and distributors have been instructed to protect dealers' purchases.

House Passes White Radio Bill—Awaits Senate

The House of Representatives has passed the White Radio Bill by an overwhelming majority and the bill now awaits action by the Senate. Public hearings have already been held by the Senate Committee on the Dill bill, the main provisions of which parallel the White bill.

Whether or not the Senate will enact radio legislation at this session seems to rest with Senator James E. Watson of Indiana, who is regarded as one of the Senate radio authorities. At present, there is a controversy between Senators Watson and Dill as to whether radio authority should be vested in the Department of Commerce or the Interstate Commerce Commission. Unless this can be amicably settled, great delay will probably ensue.

New Freed-Eisemann Plant

The Freed-Eisemann Radio Corporation has announced plans for a new factory to be located at Liberty Avenue and Junius Street, Brooklyn, N. Y.

Space for manufacturing purposes will be tripled in its removal to this new seven-story plant from its former location in the Sperry building, Brooklyn. The new plant is to be furnished with the most modern equipment, including a belt conveyor system, and will greatly facilitate increased production. A siding, running from the main line of the Long Island Railroad to the company's property, will reduce shipping costs and create more speedy delivery of merchandise.

Northeastern Radio, Incorporated, formerly of 99 Bedford Street, Boston, Mass., announces its removal April 1, to larger quarters in a more convenient section of the city at 269 Columbus Avenue. The company distributes several well-known lines in this section, including Hammarlund condensers and Ceco tubes.

L. Woodruff, formerly manager of the automobile department of C. S. Mersick and Company, New Haven, Conn., has started a business of his own which will specialize in radio and automotive equipment, known as Woodruff, Incorporated, 74-76 State Street, New Haven.

Fay Keyler, after four years with the Rickard Advertising Agency, New York City, has resigned to become sales promotion manager of *Radio Merchandising*. Mr. Keyler was assistant to W. L. Rickard, president of the agency.

H. H. Roemer, director of sales promotion for the Zenith Radio Corporation, Chicago, Ill., is still acting in that capacity, he declares, in spite of rumors that he had resigned.

John R. Patterson, 1176 Walton Avenue, New York City, announces that he has taken over the metropolitan territory as factory representative for the Fishwick Radio Company, Cincinnati, Ohio, manufacturer of the Effarsee indoor antenna.

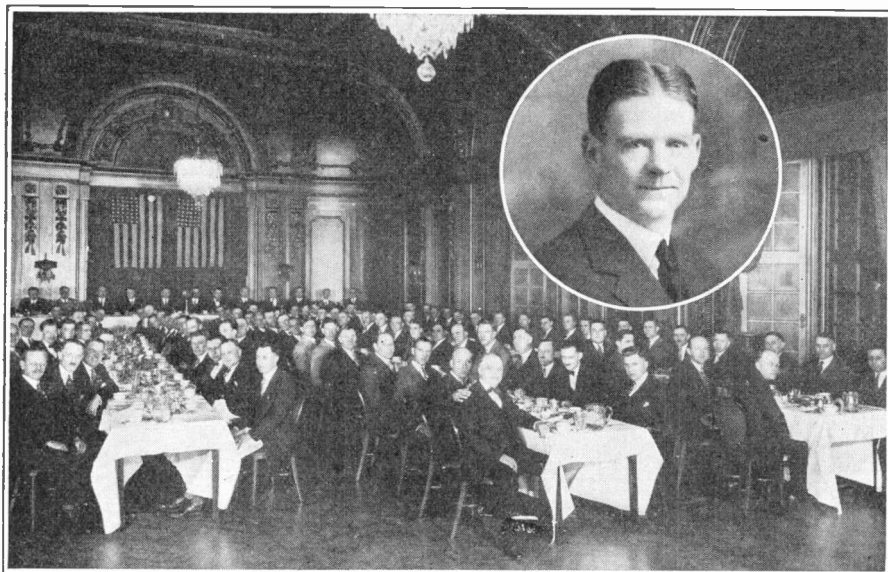

The above is a photo of the banquet given on the evening of February 15 in the Radisson Hotel of Minneapolis, Minn., by the Northwest Radio Trade Association in honor of the new Federation of Associations formed. At the speakers' table at the rear of the ballroom were N. C. Beerend, H. H. Reinhard, F. Hannaford, Mayor

Leach, G. H. Riebeth, H. H. Cory, W. C. Leingang, A. M. Edwards, H. J. Wrape, R. W. Bennett, L. O. Patterson and J. O. Maland.

Harold J. Wrape, newly elected president of the Federated Radio Trade Association and treasurer of the St. Louis Radio Trade Association, is seen in the insert.

Four New Radios

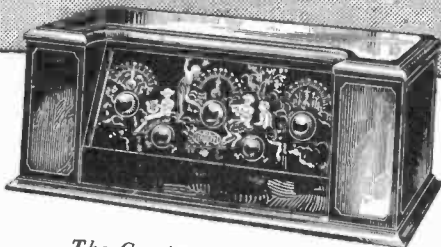

The Crosley 5-Tube RFL-75
 Absolutely balanced radio frequency amplification. Non-oscillating under any handling. Exquisite two-tone mahogany cabinet—satin finish. Decorated panel with rose-gold metal fittings. Cabinet holds necessary dry cells. Price without accessories. **\$75**



The Crosley 5-Tube RFL-60
 Same as RFL-75 but in compact cabinet only 17½ inches long. Truly marvelous selectivity, sensitivity and purity of tone. Art panel—solid mahogany cabinet—rose gold fittings. Price without accessories. **\$60**

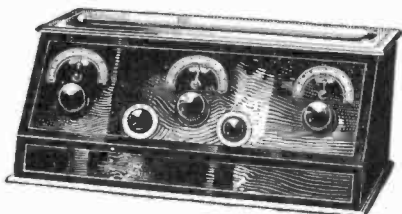

The Crosley 5-Tube 5-38
 All the volume, selectivity, sensitivity and fine tone in the best 5 tube set you've heard—plus the CRESCENDON. Two toned mahogany finished cabinet—daintily striped in gold. Price without accessories. **\$38**

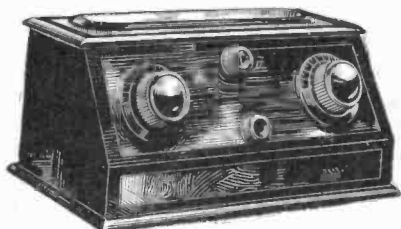

The Crosley 4-Tube 4-29
 A beautifully designed set—both to ear and eye. Crescendon equivalent to one or more additional tubes of radio frequency amplification. Two toned mahogany finished cabinet. Price without accessories. **\$29**

Prices slightly higher west of the Rockies

“If inexperienced in radio, be sure your first set is a Crosley”

It takes neither practice nor mechanical skill to tune in stations all over the country. Children and old people operate Crosley radios easily. They are fool proof.

They are inexpensive. They don't tie up a lot of money. They have proven their efficiency over a period of years. Thousands of letters report remarkable demonstrations. Hundreds of thousands of sets sold substantiate all claims to excellence.

They are made by a reliable, well known and financially strong concern, that guarantees them absolutely.

The easy operation, tone and volume of these four new Crosley sets delight, not only the expectant beginner; they arouse the most confirmed radio lover to realization that Powel Crosley, Jr., has again made a revolutionary improvement in radio.

And the RFL sets possess *true* cascade amplification. For Crosley has utilized an entirely new patented circuit which achieves cumulative amplification, actually approaching the theoretical maximum efficiency per tube.

The Crescendon

In the 4-29 and the 5-38, the introduction of the Crescendon enables these two highly efficient radios to give almost unbelievable results and has lifted them away and beyond all competition.

The Crescendon is an exclusive Crosley device for increasing the weak signals of distant stations to full volume tones without distortion. Yet with these sets, loud nearby stations can always be softened practically to whispers.

Their striking beauty will please your eye, and your ear will introduce to you new qualities in radio, which you are sure to pronounce a revelation.

Write Dept. 130 for complete details of Powel Crosley, Jr.'s latest and greatest triumph and of the Crosley dealer franchise.

Crosley manufactures radio receiving sets which are licensed under Armstrong U. S. Patent No. 1,113,149, or under patent applications of Radio Frequency Laboratories, Inc.

THE CROSLLEY RADIO CORPORATION
 Powel Crosley, Jr., President
 CINCINNATI, OHIO

Owning and Operating WLW, first remote control super-power broadcasting station in America

CROSLLEY RADIO

BETTER—COSTS LESS

FOR THE ENTERTAINMENT CORNER

What This Industry Needs

Concluded from Page 346

between manufacturers in bringing out all their models once a year and giving their dealers the opportunity to really feature the line for a solid year, the way it should be done, without breaking up our entire selling plan by frequent changes."

Plan Change for 1927

These expressions of dealer opinion concerning style changes, represent dealer grievance Number Three—without doubt the most important one for the advantage of the trade as a whole. The change cannot be made this year, that's true, but it can be planned for 1927 and for subsequent years, and this publication courteously advances the sincere hope that the majority of large set manufacturers will heed their dealers' desires in this matter. If *Radio Retailing* can help, the services and facilities of this publication and of our entire organization are at the disposal of the trade.

There are other dealer grievances but the foregoing are those of the greatest importance. One other specific one that should be brought to light and given an airing, is the laxity on the part of not a few manufacturers in the inspection and shipment of their product. Dealers

claim sets arrive inoperative and carelessly put together, increasing their service costs and causing much inconvenience and expense.

Many sets must be practically rebuilt upon arrival and all of them must be carefully checked over for defects. Sets that are tagged and signed by several inspectors at the factory, have even been found to be wired completely backwards. Also, many are not packed with proper care, with the result they are damaged and broken in shipment. And four out of five tubes, dealers claim, must be replaced.

These things may seem of minor importance but they all add up and increase dissatisfaction with the present situation. Their remedy lies in patient effort on the part of both manufacturer and dealer in a mutual co-operation.

"The Gyp Is Doomed"

Concluded from Page 358

say about radio selling methods and the radio industry in general.

The Vim Radio is a specialist on time payments, carrying its own paper without interest charges, thereby getting an edge under competitors who make the usual charge.

He handles twenty to twenty-five different makes of receivers and will

continue to do so until manufacturers put a stop to it and tighten up their distribution system. Kassover believes no dealer should handle two competitive lines and that dealers should not be permitted by manufacturers to handle too many makes. He also believes that dealer and manufacturer co-operation in advertising is of vital importance and that dealers should take more advantage of this opportunity than they now seem to be doing.

"Price stabilization must come," was Kassover's concluding thought. "The time when the radio industry is going to settle down into a legitimate business and an honorable institution is approaching with great rapidity—a year or two at longest. And when that time comes, take it from me, price-cutting is done, through, out. The day of the gyp is passing and sooner or later he'll have to mend his ways or go back to the clothing business."

"Sales Must Be Forced!"

Concluded from Page 349

"Our best stations, of course, are those in the South and in the southern portion of the Middle West. KDKA at Pittsburgh is excellent, and WJZ, at New York, when it is on 50,000 watts, comes in like a local station. WJZ's super-power station and the fine programs it has been putting on have contributed greatly to the radio boom that is just getting started in Florida. It is a good, steady, reliable station to fall back on when the customer wants DX and I want to say right here that we radio dealers down in southern Florida certainly appreciate WJZ and its super-power."

One of the most gratifying things about radio conditions in Florida, according to Mengert, is the fact that "time payments" haven't yet begun to invade the clear field of cash sales. The reason is that no time-payment company will take a risk on a resident of Miami because of the unsettled real estate conditions.

"However," says Mengert, "the time will come, of course, when we will have to sell on the contract basis. But the saturation point hasn't begun to be reached as yet. It seems Miami can only stand one boom at a time and now that the real estate boom has passed into history, the next craze that will hit town is radio. It's just getting started, and brother, watch it grow!"

Emphasizing "Quantity Production"

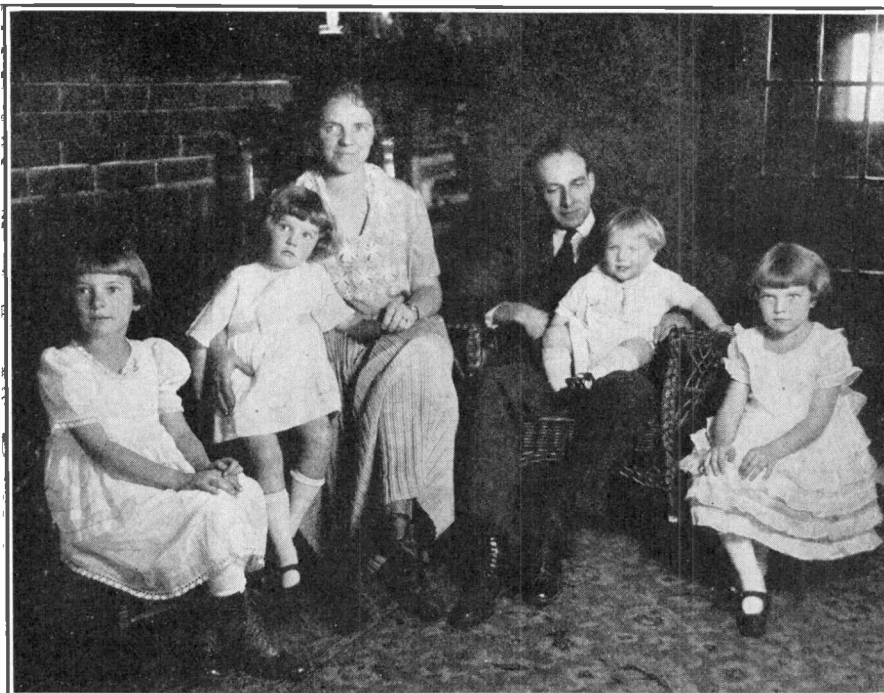

In "System" for January there is an article by Milton Alden, president of the Alden Manufacturing Company of Springfield, Mass., in which he states very clearly his

policy of quantity production. It requires no hypercritical judge to decide that quality is as much a characteristic of the product as quantity.

How will you fill in - the APRIL to SEPTEMBER GAP?



MAKE THIS CHART YOUR GUIDE

[RADIO SALES,
by months, compiled
by Radio Retailing]

We may as well face the facts: Radio sales *do* slump in hot weather.

But you simply cannot let summer slumps eat up winter profits.

Protect your business—not by changing the character of your store—but by adding a good, strictly summertime seller, to *balance* radio!

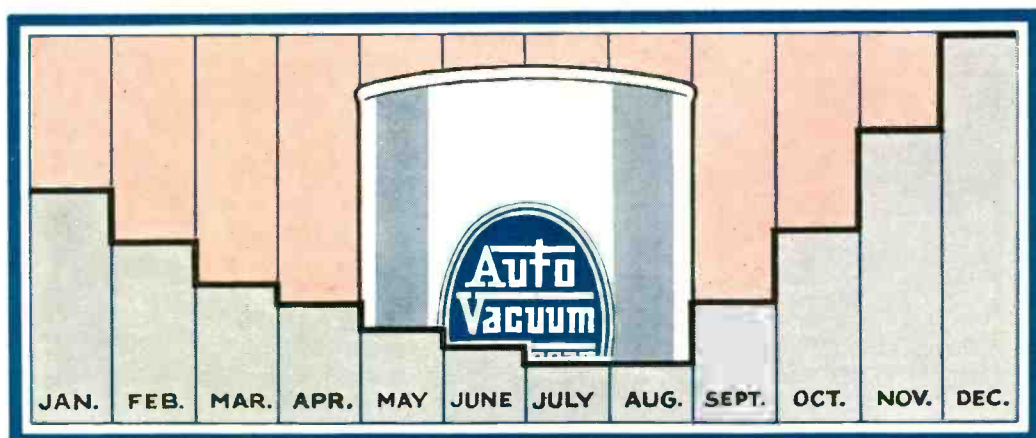

This summer - Sell a summer seller

BALANCE radio with Auto Vacuum—the nationally advertised home necessity that sells steadily from April to September. It requires no change in your store policies ... it needs NO servicing ... it

takes only a small investment —but it fills in the summer gap! It gives you something you can sell *easily*—when you need sales most!

Auto Vacuum Freezer Co., Inc.
220 West 42nd St., New York

AUTO VACUUM

The "NO CRANK" ice cream freezer

NOW
TURN
OVER



How to make money this summer



"Take it along in the car"

Auto Vacuum is the one freezer that can't leak, can't spill. Load it in the car when you start... enjoy delicious ice cream whenever you stop.

Used as a portable refrigerator (simply leave out the salt) Auto Vacuum keeps salads, sea foods, vegetables, etc. crisp and fresh for 48 hours.

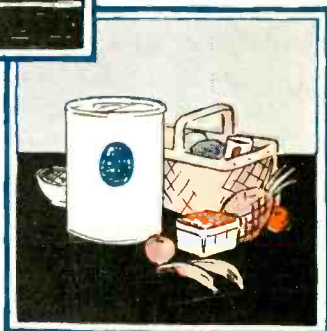

The dullest months for radio, are the height of the season for Auto Vacuum! People *want* Home-Made ice cream...but they *will not* crank! Auto Vacuum makes the creamiest, smoothest ice cream you ever tasted—with NO cranking. Pack in the ice and salt · pour in the cream · it freezes in 30 to 45 minutes. Thru 5 years of national advertising, Auto Vacuum's fame has mounted swiftly. Like radio, it appeals to every home. Like radio, it excites immediate interest. But unlike radio, it needs NO servicing. Your Auto Vacuum profits stay with you.

The coupon below points the way to a *profitable* summer. Will you send it in NOW... or will you spend June wishing you'd acted sooner?

Nationally advertised—guaranteed—endorsed by Good Housekeeping and New York Tribune Institutes, Priscilla Proving Plant, and other similar authorities.



Auto Vacuum

The NO CRANK freezer for a profitable summer

Only 3 Parts
the freezer itself,
and two covers.

LIST PRICES:

1 qt. \$5	2 qt. \$6
3 qt. \$8	4 qt. \$10

This striking window display and scores of other well-designed sales helps, are ready for the radio dealer who really wants to make money this summer.



Auto Vacuum Freezer Co., Inc. R
220 West 42nd Street, New York R

Yes, I'm looking for something that sells easily in summer. Send me the plans for making money with Auto Vacuum—the "NO CRANK" freezer.

Name _____

Firm _____

Address _____

Preferred Jobber _____

Hazeltine Licensee Sales Show Decrease

The financial report for 1925 of the Hazeltine Corporation, owner of patents covering the inventions of L. A. Hazeltine, shows a drop in gross sales of concerns licensed to manufacture under these patents, of \$907,721, under the 1924 figures. As reported, the figures for the year 1925 show total sales by the distributing section of \$11,895,339. These figures, presented quarter by quarter, as against those during the same periods in 1924 are as follows: First quarter, 1924—\$3,610,375 against \$3,114,298 in 1925; second quarter, 1924—\$616,245 against \$1,228,030 in 1925; third quarter, 1924—\$1,157,215—1925—\$1,734,750; fourth quarter, 1924—\$7,419,225—1925—\$5,818,261.

The corporation, which does not engage in any manufacturing activities, shows a net profit for the year, after providing for the Federal Income Tax but not for amortization of patents, of \$436,058.51.

Stockholders were notified that the corporation had purchased 80 per cent of the capital stock of the Latour Corporation, owner of titles, interests and rights in the United States and Cuba on the inventions of M. C. A. Latour, also that the company is the owner of the patents of J. S. Taggart in Great Britain, Canada and the United States.

R. M. A. to Convene

The annual convention of the Radio Manufacturers' Association will be held at the Ambassador Hotel, Atlantic City, N. J., the week of May 10th to 15th, inclusive. Addresses on topics of interest to the industry are scheduled by J. M. Arvey, of Chicago; W. H. Lynas, of Great Britain, and Major-General C. M. Saltzman, U. S. Signal Corps. Further information may be obtained from the executive offices of the association, 123 Madison Street, Chicago.

William R. McElroy, of the William R. McElroy Company of Pittsburgh, Pa., has been ordered by the War Department to attend the Infantry Training Course to be held at Fort Benning, Ga., for National Guard and Reserve officers, of which he is a first lieutenant. The company represents the Fansteel Products Company, Trimm Radio Manufacturing Company, Andrews Radio Corporation and the L. S. Brach Manufacturing Company in Pittsburgh and surrounding territory. During Mr. McElroy's absence until May 31, the Pittsburgh office will be left in charge of his brother, Frank N. McElroy, formerly of the Music Master Corporation and at present, sales manager of the company.

The Udell Works, manufacturer of radio cabinets, will be represented at the furniture show to be held from April 5 to 17 at the New York Furniture Exchange, 206 Lexington Avenue, New York City. Its Eastern representative, M. Kroll, will be in charge of the company's exhibit.



Steps in the development of the Rice hornless loudspeaker unit. Chester Rice, inventor of the unit that bears his name, and S. W. Kellogg putting on the finishing touches in the laboratory of the General Electric Company at Schenectady, N. Y.

Radio Foundation, Inc., licensee of the Lektophone Corporation patents governing cone-type speakers was omitted in the March issue of *Radio Retailing* under the list of Lektophone licensees.

The Pacent Electric Company, 91 Seventh Avenue, New York City, holder of a basic patent on radio connection jacks employing the spring pressed connection feature, announces that the Weston Electrical Instrument Company of Newark, N. J., has been licensed to manufacture jacks of this type.

1,000,000 Sets on Farms at Latest Count

In a report issued by the Department of Agriculture it is estimated that nearly 1,000,000 radio sets are now in use on farms throughout the country, based on investigation reports compiled during the last five years. The Department estimates that in 1923 approximately 145,000 sets were in use, 365,000 in 1924 and in early 1925 about 553,000.

Farmers have bought during this period, the report says, sets selling at around \$175 complete, with the tendency swinging to the lower-priced models because of improvement in this type.

The demand for market reports and other agricultural broadcast programs has so greatly increased that arrangements have been made for the regular broadcasting of these features from about sixty stations since the first of the year. This increases the number of stations co-operating in the farm programs to about 160.

The American Bosch Magneto Company, Springfield, Mass., announces the following changes in its branch office personnel: C. L. Shedd, former manager of the Detroit branch, has been appointed manager in Chicago, to be assisted in this territory by E. H. Marsh, formerly cashier of this office. E. S. Hanson, of the Chicago office, will go to Detroit as manager. W. R. Cogger is now assistant manager in Detroit, where he has held the position of cashier.

What's Powel Winking At?

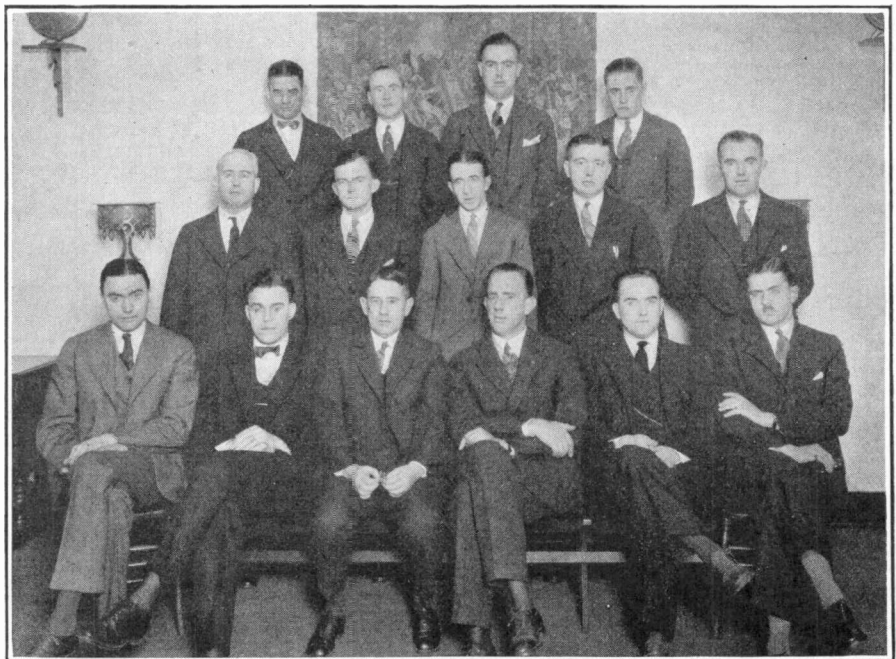

No, radio readers, this is not a picture of Powel Crosley, Jr., in the bosom of his happy family. It is simply a group of the Crosley Radio Corporation's field representatives on a recent visit to the Crosley factory at Cincinnati. Naturally, the boys would have been broken-hearted if they hadn't had their pictures taken with the big boss so they could show it to the home folks and say, "Oh yes, I had my picture

taken with Mr. Crosley. That's me up there in the top row and there's Mr. Crosley down in the middle of the front row—the fellow with the long legs." Walter B. Fulghum, sales manager (left of Mr. Crosley), was tendered a surprise dinner on the evening of the convention to celebrate his first anniversary with Crosley. As is usual with "surprise dinners," everybody was surprised except Walter.

A tip on CONSTRUCTIVE SELLING

*How to gain a new customer's
confidence and his steady business*

THE great majority of radio owners have to trust you implicitly when they come to buy equipment, because they know very little about it.

Here lies your chance to turn casual purchasers into steady customers. If you sell them only the type of radio equipment which you know will give them the best possible service, you can't help build up their lasting confidence in your judgment.

For this reason more and more dealers are finding Exide Radio Batteries profitable. Exides, with their steady, powerful flow of current and long life, always fulfil the claims you make for them.

And from a sales standpoint, Exide Batteries have the additional advantage of bearing a name that is world-famous. Most people you show an Exide to will have heard of it favorably—and that means your sale is already half made.

Exide Radio Batteries are made in different sizes and types to meet the requirements of every type of radio set. When a customer asks for "A" or "B" batteries, recommend the type of Exide he needs.

THE ELECTRIC STORAGE BATTERY COMPANY
PHILADELPHIA
Exide Batteries of Canada, Limited, 153 Dufferin Street, Toronto

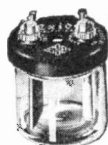

RECTIFIER

Exide Rectifier for economically recharging "B" Battery from your own house current.

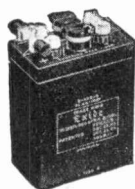

4-VOLT "A" BATTERY
Compact Exide "A" Battery for low-voltage tubes. Also made in 2-volt size.



6-VOLT "A" BATTERY
The rugged, good-looking Exide 6-Volt "A" Battery, in the one-piece case.

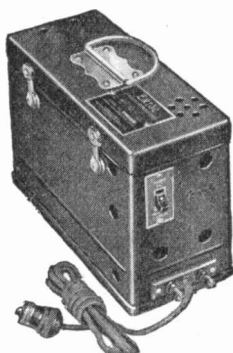

EXIDE RADIO
POWER UNIT

(Combination "A" Battery and Charger.) To be kept connected to both light socket and radio set. When switch is raised, radio set is connected; when lowered, battery is automatically placed on charge. Made in two sizes—for sets using 4-volt and 6-volt tubes.

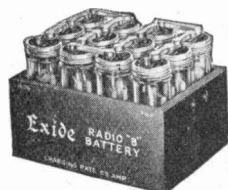

24-VOLT "B" BATTERY
In Glass cells, 6000 milliamperes hour capacity. Also made in 48-volt size.

Exide

RADIO BATTERIES

FOR BETTER RADIO RECEPTION, USE STORAGE BATTERIES

SINGLE DIAL CONTROL

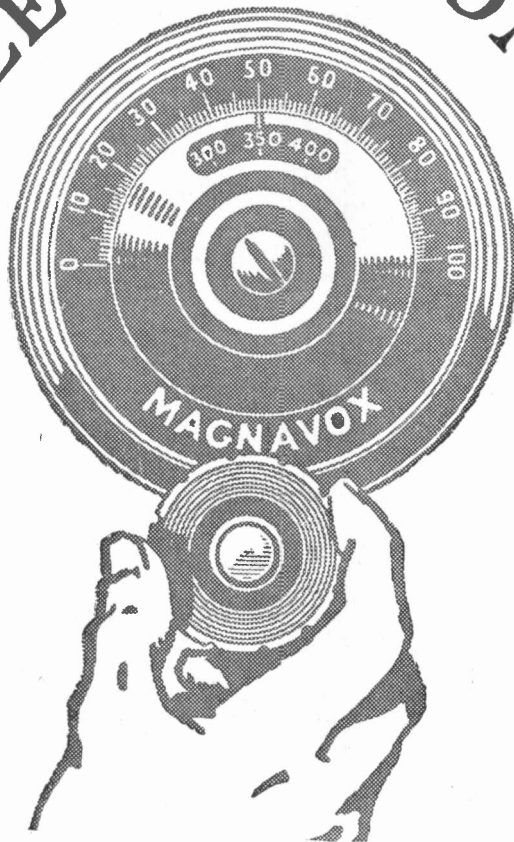

*It simplifies selling and service
just as it simplifies operation*

"No more three-dial sets for me" writes a dealer in Gardner, Mass. In those few words he sums up the trend of the whole radio world.

And why not? Magnavox perfected single-dial control has—

Convenience value—it is unquestionably easier and quicker to operate.

Ear value—it brings in better reception because tuning is not left to the operator.

Eye value—it makes the Magnavox set look like a musical instrument and not like a switchboard.

And when you've covered these three major points you've about covered the whole radio selling story.

While many sets are adopting single dial control remember that Magnavox has perfected it. No Magnavox dealer has to pass through an experimental stage. He has, relatively, no service problem and much less resistance in selling. Magnavox sets are dependable in performance—they make good and stay sold.

In the interests of better profits and less grief why not ask for all the facts.

MAGNAVOX

Radio Sets • Speakers • Tubes

24 D9

© 1926

THE MAGNAVOX COMPANY • OAKLAND, CALIFORNIA • Makers of Radio Products since 1911

To distributors in foreign countries:—Reputable concerns in the following countries with established selling organizations and good bank references are invited to correspond: Norway, Sweden, France, Brazil, Italy, England, Portugal, Russia, Switzerland, Egypt, Turkey, Philippines.

The MAGNAVOX line is complete

- a wide range of prices, \$75 to \$200 list.
- a quality standard that matches the highest.
- backed by 15 years' experience in making radio products.
- sold under a fair-square protective dealer policy and with a discount that dealers like.
- distributed through accredited channels.
- supported by liberal national advertising.

All Magnavox models have mahogany cabinets—all have the same identical new Magnavox tube circuit—all [except Junior] have interchangeable circuit assembly drawer.

Model D and PM-4

Convert any phonograph into a combination radio-phonograph.
Model D, \$75
PM-4 \$12.50.

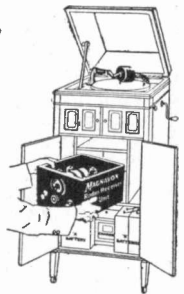

Magnavox Junior

Competes with anything in the \$100 class; price \$85.

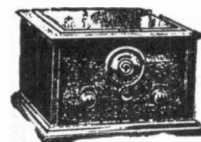

Magnavox 25

Built-in speaker. Encloses B batteries; price \$145.



Magnavox 75

Built-in speaker. Enclosing all batteries; \$200.



New Magnavox Tube

The non-microphonic wonder tube; \$2.50.



ANNOUNCING THE NEW
**FROST-RADIO
GEM-JAC**

The Jewel of all Radio Jacks

IT had to come, and it remained for FROST-RADIO to do it! Here it is—the smallest and most compact jack ever offered the set-builder—the new FROST-RADIO GEM-JAC. AN ENTIRELY NEW JACK—AN ENTIRELY NEW PRINCIPLE OF SPRING DESIGN—GREATER THROW—MORE POSITIVE CONTACT.

The GEM-JAC projects but 1 inch back of panel where old-type jacks project from 3 inches to 3½ inches. The GEM-JAC gives more space for other parts—may be placed in a very confined space—makes set much more compact.

List:
50c

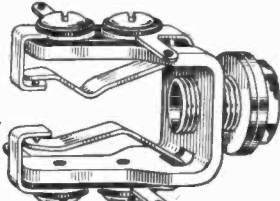

**FROST-RADIO No. 951
DOUBLE CIRCUIT GEM-JAC**
This and the cuts below are actual size. Note sturdy spring construction made possible by new GEM-JAC design.

List:
45c

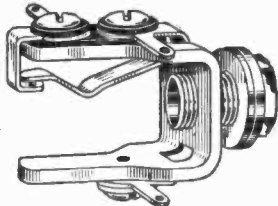

**FROST-RADIO No. 954
CLOSED CIRCUIT GEM-JAC**
All GEM-JACS have tinned terminals drilled for bus bar wiring. Insulation is genuine Bakelite.

List:
40c

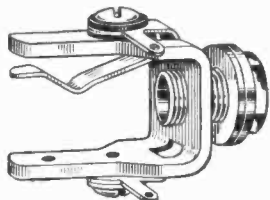

**FROST-RADIO No. 953
OPEN CIRCUIT GEM-JAC**
Remember that the length over all of GEM-JACS frame is but 1 inch. It is the smallest, most compact jack made. "NO OTHER RADIO JACK CAN EVEN COMPARE WITH IT"

**Note These Other
GEM-JAC Advantages**

- extremely low capacity effect.
- springs cannot get out of adjustment.
- positive inside contacts, with "under-pressure wipe" that eliminates dirt and makes the GEM-JAC positively self-cleaning.
- holds plug firmly. More force required to withdraw plug than to insert.
- U-shaped frame protects springs from any conceivable injury.
- tinned terminals drilled to take square bus bar wiring, if desired.
- BAKELITE insulation throughout, insuring low dielectric losses.
- mounts on 1/8 or 3/16 inch panel. Spacer washers provided for panels of varying thicknesses. Thimble fits 11/32 or 3/8 inch hole.
- sterling silver contacts; nickel plated brass frame; nickel silver springs; hand-buffed thimble and washers.

WRITE YOUR REQUIREMENTS ON THESE THREE TYPES

- No. 953
Single open circuit
List, 40c
- No. 954
Single closed circuit
List, 45c
- No. 951
Double circuit
List, 50c

**HERBERT H. FROST
(Inc.)**
314-324 W. Superior St.
CHICAGO, ILL.
New York City Cleveland
Kansas City Los Angeles
Export Office:
314 W. Superior St., Chicago



**DeJUR
AMPLIFIER**

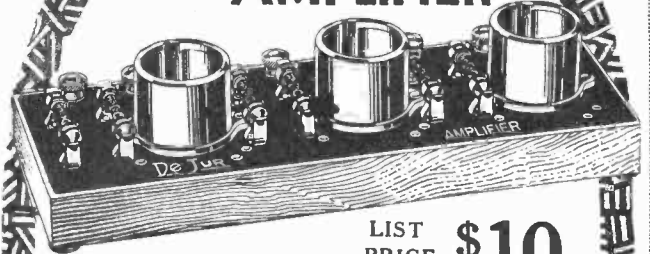

LIST
PRICE \$10

Distortionless Amplification

Equipped throughout with DeJur quality parts. Genuine Bakelite sockets which will take standard or new UX tubes. DeJur Grid Leaks with soldered caps used as resistors. Genuine Bakelite panel mounted in a mahogany case which sets into any type set.

No bus bar in wiring. All metal strip connections are riveted. No screws, nuts or bolts to get loose. The only Amplifier insuring permanent, positive contact and distortionless amplification.

BIG SELLER

Here is one of the biggest values in radio to meet the big demand for R. C. Amplifiers. Backed by the known DeJur guarantee.

Write for full particulars and discounts.

DeJUR PRODUCTS Co

The World's Largest Manufacturers of Rheostats
199 LAFAYETTE ST. NEW YORK CITY

Sales have so far exceeded our expectations that we are now able to give the dealer the advantage of the lowest price on any instrument in its class.

\$5
LIST

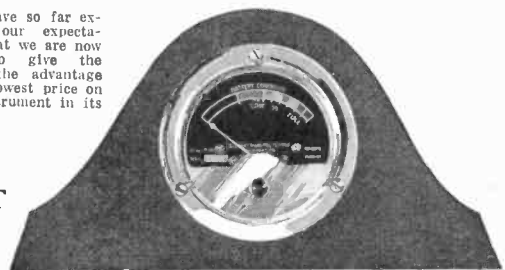

A little battery knowledge is a dangerous thing!

CELLO-METER

tells you *instantly* more about your battery than hydrometer, voltmeter and ammeter combined. Gives the exact amount of electricity stored in your battery.

**Use Its Splendid Features
To Keep Your Summer Sales Up**

The compact little Cell-O-Meter tells you as much in an instant as a whole laboratory full of equipment could. Just press the button.

It is very simple to connect, whether the instrument is set into the panel or whether mounted in the attractive wood base furnished. The wood mounting makes it possible to have a real instrument of this character without boring holes in the panel, and without making the radio front look like a switchboard.

Not only is the Cell-O-Meter accurate, it is made of the materials necessary to keep it accurate after continued use. We have refused to compromise on workmanship or quality of materials in order to put it in the cheap instrument field.

Dealers write for literature

CELLOKAY MFG. CORP.

Sales Office—1705 Flatiron Bldg., NEW YORK

Tungar is the name they know!

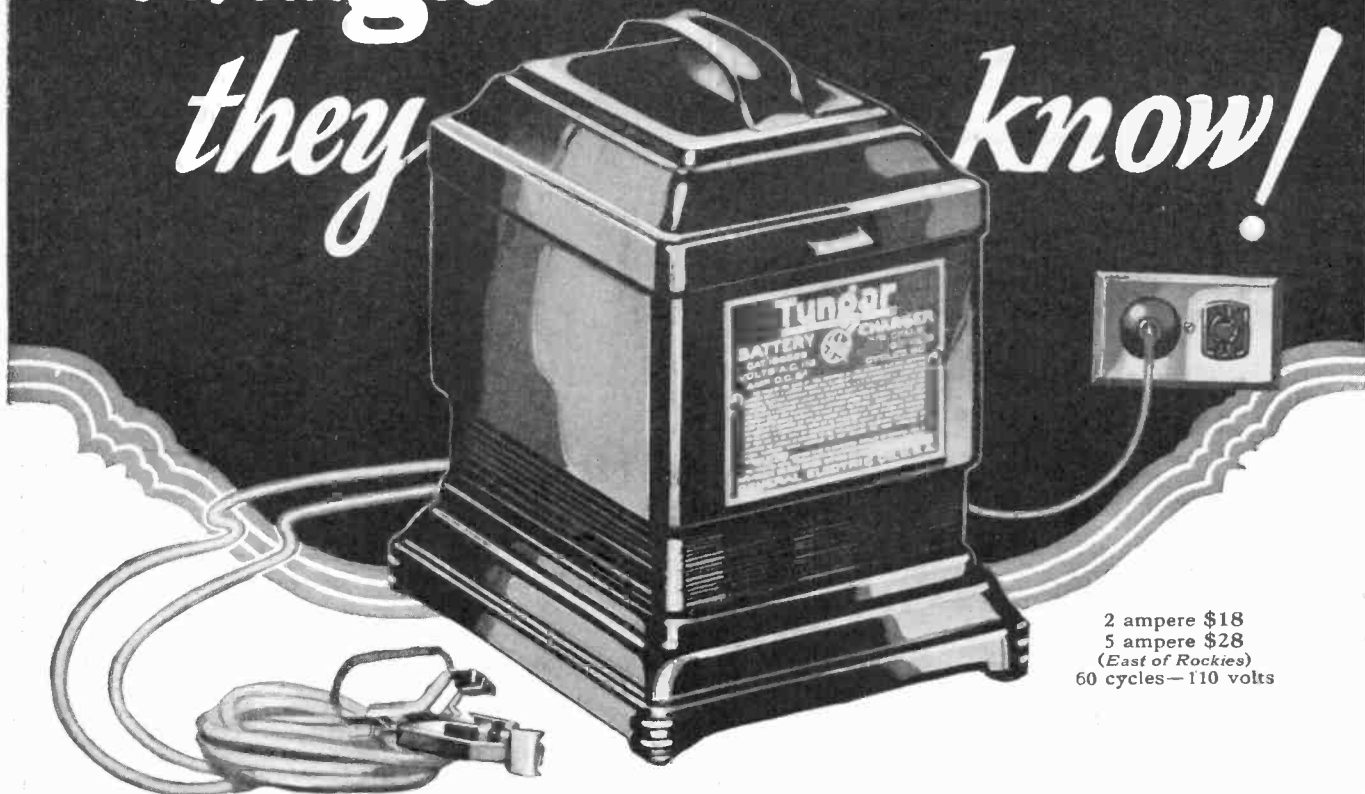

2 ampere \$18
 5 ampere \$28
 (East of Rockies)
 60 cycles—110 volts



Use this simple wiring diagram to help sell Tungars.

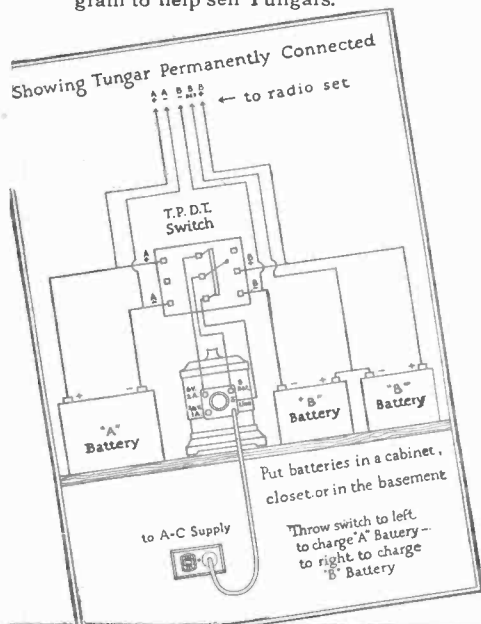

Boost the charger they *know*. Push the charger that sells.

Tungar is the original bulb charger—made by General Electric. It charges all storage batteries, “A” and “B”, causes no radio interference, and will not blow out Radiotrons. It is the trouble-proof, easy-to-use charger, and economical, too—an overnight charge costs less than a dime.

In addition to the profit you make on Tungars, you can, if you wish, make another profit by wiring them up for permanent installation. The diagram shows how easy it is.

Tungars can be sold right through the summer!

Tungar

REG. U.S. PAT. OFF.

BATTERY CHARGER

Tungar—a registered trademark—is found only on the genuine. Look for it on the name plate.

GENERAL ELECTRIC

GENERAL ELECTRIC COMPANY MERCHANDISE DEPARTMENT BRIDGEPORT, CONNECTICUT

HARTUNG CLIPS

*Continuous Circuit
-Bulldog Grip*

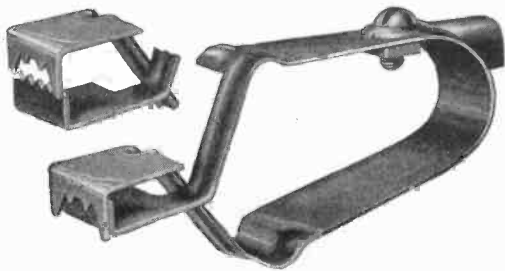

Three New Clips for Radio Use

Three special radio clips are included in the new and improved Hartung line. They are all designed alike—with strong, positive grip; continuous current path (no springs to crystallize and break, or joints to increase resistance); and heavy lead coating which insures long life. No. 16 has a capacity of 10 amps; No. 14, 20 amps; No. 25, 35 amps.

We will gladly send you a free sample and descriptive price list. Write to-day!

C. F. HARTUNG CO.
732 East 61st St.
Los Angeles, Calif.

The New Battery **TITAN**



For
Fords, Buick,
Studebaker
and other cars of
this class

Type 3—RF 11

also ideal for
RADIO

Sell CAPACITY— not size of box or weight

THERE'S more net profit for you, more satisfied customers and repeat business, when you sell batteries on the basis of *true rated capacity* instead of bunk about weight and size.

Every TITAN Battery is built to give its true rated capacity. Size and weight are unreliable indications—tell your customers so, and tell them about TITAN true rated batteries.

Show them, for example, the new

TITAN Type 3—RF 11

DOUBLE DUTY for Automobiles
for Radio

Sturdy rubber case—heavy connectors between cells. Long life, because assembled with heavy duty automobile starting and lighting plates—11 to the cell.

Gives a smashing surge of power for automobile starting, or steady full voltage current hour after hour for lighting or radio use.

Made by men who know how and who combine their years of successful experience with a determination to maintain the highest standards of quality.

And a square deal to every Dealer and Distributor—long profits, quick sales and satisfied customers.

Write for descriptive literature and net prices.

GENERAL LEAD BATTERIES COMPANY

8 LISTER AVE.

NEWARK, N. J.

The Home
of TITAN Batteries

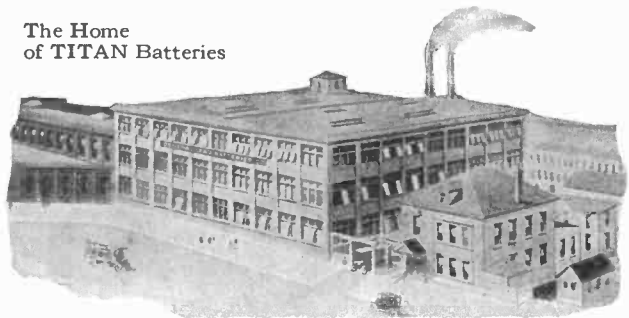



More than a quarter of a million watts have rallied to your assistance

More than 250,000 watts have been added to broadcasting power throughout the country since a year ago.

The addition of this enormous amount of electrical energy means in effect that the majority of stations have been brought considerably closer to radio users in your district.

As a consequence, an ever increasing number of stations have all the power necessary to maintain a signal noise ratio sufficient to be heard with entertainment value during the transmission conditions of the next few months.

Conditions for radio reception were very poor during January and February of this year, and yet radio was sold in quantity. It is doubtful if average summer conditions during any month period will show more atmospheric interference than we have had this past winter.

Moreover, the character of entertainment now being broadcast is far superior to that of previous years. This tends to satisfy the

new purchaser of radio with stations readily available.

There is no pleasure in touring on a cold, wet, stormy day, but this does not prevent people from buying motor cars for touring and recreation. Automobiles are sold as readily during the bad weather as in fine weather.

Many thousands of homes appreciate the entertainment that radio can give during the summer months. Even when the desire for long distance reception cannot be satisfied because of insurmountable atmospheric conditions, you are not justified in failing to give these people an opportunity to hear and buy Ortho-sonic.

Federal Ortho-sonic Radio Receivers are daily giving thousands of users the utmost in receptive qualities.

Join the Federal Retailer Organization. If you do not know the Federal Wholesaler for your territory, write and ask us to tell you how you may join us and receive the advertising and sales helps given preferred retailers on our S & S list.

FEDERAL RADIO CORPORATION, Buffalo, N. Y.

(Division of Federal Telephone and Telegraph Company)
Operating Broadcast Station WGR at Buffalo
Cable Address: "Fedtel" Buffalo

ORTHO-SONIC

(Reg. U. S. Pat. Off.)

Federal Radio

"Rivaled Only by Reality"

Concesionarios: Quedan disponibles buenos territorios en todas partes del mundo. Ofrecemos absoluta protección a los concesionarios, mayoristas y revendedores, activos e idóneos. Los Receptores Federal *Ortho-sonic* presentan una excepcional oportunidad para ganar dinero. Pidanse, por carta o cable, los detalles completos.

Distributors: Desirable territories open in all parts of the world. Full protection given to live, responsible distributors, wholesalers and retailers. Federal *Ortho-sonic* Receivers offer an unusual money-making opportunity. Wire or cable for full particulars.



**No Aerial!
No Ground!**

The all year 'round set

Whether in Maine or Florida, the Priess Straight Eight is an all year 'round set—a set that you can sell twelve months out of the year.

It's loop operated and semi-portable and can therefore be operated anywhere.

Go after summer sales! There's little competition and the business is most profitable!

Write us to arrange for an immediate demonstration by our distributor in your territory.

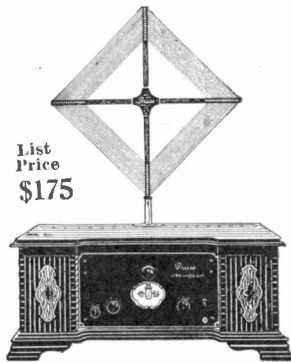

List Price
\$175

Priess
TRADE MARK
STRAIGHT EIGHT
It's loop operated!

PRIESS RADIO CORPORATION
697 BROADWAY NEW YORK, N.Y.

Hoyt
RADIO ROTARY METER

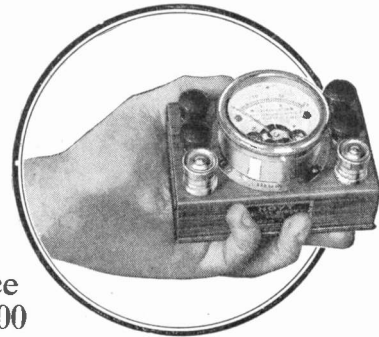

Price
\$24.00

THIS is a unique 5-range precision, moving coil voltmeter, made specially for the Radio Service Man, Dealer and Owner. It will make all tests necessary on Radio Receiving Sets, tubes, batteries and battery eliminators. It is rugged and will last a lifetime, yet will retain its extreme accuracy. Operation is simple and accident-proof.

BURTON-ROGERS CO.

26 Brighton Ave., Boston, Mass.

NATIONAL DISTRIBUTORS

Hoyt makes a complete line of Radio Meters. Send for booklet "HOYT Meters for Radio."

Dealers!

REAL PRICES

We carry in stock at all times the following merchandise—

- | | |
|---------------------|---------------------|
| Electrical Supplies | Chinaware |
| Furniture | Hardware |
| Radio | Musical Instruments |
| Automotive | Leather Goods |
| Equipment | Sporting Goods |
| Aluminum Ware | Jewelry |
| Novelties | |

FREE! 1926 complete illustrated catalog just off press. Write for a copy at once. Supply limited.

GENERAL MERCHANDISING CO., INC.
818 Walnut St., Philadelphia, Pa.



HIGHEST QUALITY HARD RUBBER

The Panel of Beauty and Service

Shows No Finger Prints, Smudges or Scratches

HOOD RUBBER CO., Watertown, Mass.

Hard Rubber Dept.



Scranton Glass Instrument Co., Inc.
SCRANTON, PA.

Manufacturers of

Battery Testers

A Size and Type for Every Purpose and Every Price

Descriptive information on request

**"Unless the Float Is Right
The Reading Is Wrong"**

DIATRON

Radio Tubes

are good because Walter Armstrong made them good.

Ever dependable. The result of 38 years unparalleled experience.

DIAMOND VACUUM PRODUCTS CO.

4049 Diversey Avenue, Chicago, Illinois.



RADIO'S LATEST DEVELOPMENT!
The Poly Claro-Plug



Trademark Registered

*"Clarifies and Harmonizes
Loud Speaker Reception"*

Improves the tone quality of every loud speaker. Removes "scrapy" sounds from loud speaker. Broadens the range; brings out bass and high tones. Adds body, detail and definition to the tone. Vastly improves Summer reception. No wires, no adjustments—simply plug in or attach to binding posts and enjoy the results.

Polymet has scooped the entire radio industry! The Poly Claro-Plug will be the big seller of 1926! Every radio owner is a sure sale. A big national advertising campaign is telling them about the Claro-Plug. Be the first in your territory to sell this profit making reception clarifier! Get in touch with your jobber today.

POLYMET MANUFACTURING CORPORATION
599C Broadway, New York City
"World's Largest Manufacturers of Radio Essentials"

POLYMET PRODUCTS

**SATISFIED
DEALERS
BECAUSE —
WE HELP THEM**

*Catalog
466-R
is free
to dealers.*

WHOLESALE EXCLUSIVELY
LUDWIG HOMMEL & CO
929 PENN AVENUE PITTSBURGH, PA.

"It Separates the Stations"

ONE DIAL (One Condenser—Pat. P'nd'g)
Volume—Clarity—Distance—Ruggedness—Beauty

S
U
P
E
R
F
L
E
X

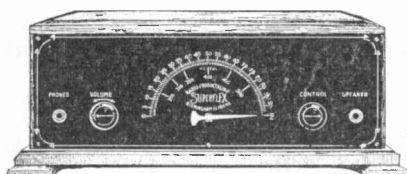

LIST
\$80.00
BARE

DEALERS:—Don't believe US—test one

RADIO PRODUCTS CORPORATION, Inc.
3816 N. 28th St., Birmingham, Alabama
Hemlock 4158

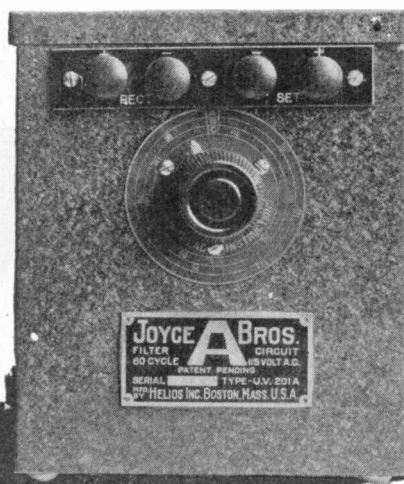

*At last!—the device millions of set
owners have been waiting for. And
1926 will surely prove it!*

**JOYCE BROS.
FILTER CIRCUIT**

It runs the radio set right from the lighting circuit!
Simple; Easy to operate; Fool proof; No hum; No
bother; No care.

*More Volume—More Distance—
More Clarity*

Think of it!

**Balkite, Tungar and Rectigon
Distributors, Jobbers
and Dealers!**

An-opportunity to make an additional sale wherever
you have sold these chargers! (And it gives you an
additional sales advantage on those chargers.)

Write for literature!

Helios Co., Inc.
71 Chestnut St., Boston, Mass., U. S. A.

Factory Representatives of Helios Products:

Wm. H. Kreeb, 2505 Union Central Bldg., Cincinnati, Ohio. Leonard C. Kohn Co., 917 Phoenix Bldg., Minneapolis, Minn. Leonard Kohn Co., 625 Security Bldg., Omaha, Neb. Strimple & Gillette, Corbett Bldg., Portland, Oregon. Strimple & Gillette, 169 Jackson Street, Seattle, Wash. Stephen Brown, Ft. Smith, Arkansas. Park Co., 128 No. Wells St., Chicago, Ill. William Reed Sales Co., 308 E. 17th St., Kansas City, Missouri. I. D. Livingston, 1529 Hutchinson St., Montreal, Canada.

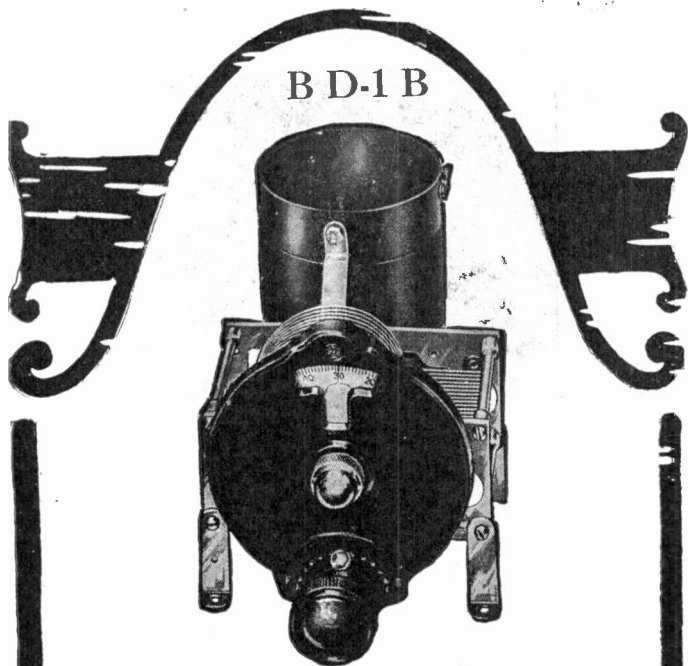

BD-1 B

The New
NATIONAL Tuning Units
 including the Genuine
BROWNING-DRAKE
Space Wound Transformer
 and the
NATIONAL Equicycle
(S. L. F.) Condenser

are now in the hands of your jobber. Their efficiency and beauty will greatly surprise you. Our advertising in the leading radio publications is directing customers to your store for these and other NATIONAL radio products.

Send for Bulletins 105 and 110 RR

NATIONAL COMPANY, INC.

W. A. READY, President
 110 Brookline Street, Cambridge

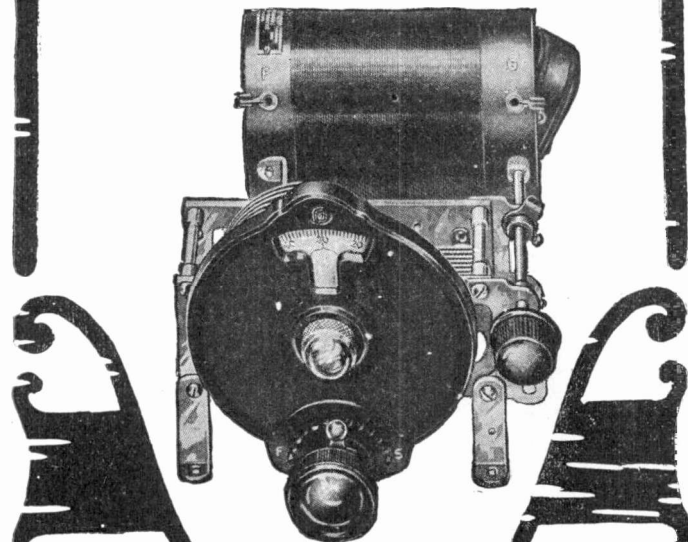

BD-2 B

The Reason
 THE TUBE WITH A SENSIBLE GUARANTEE

REG. U.S. PAT. OFF.
SUPERTRON
 A GOOD TUBE

Quality!
Performance
Dependability

are the factors which made Supertron the foremost Independent Tube in America !!

Supertron promises the Radio public and the Radio trades a revelation in the art of making tubes—a new reinforced interior construction that will positively cure the present tube ailments non-microphonic—uniform—better and a complete line.

Write for Complete Details

All Types \$2.00 Each (Canada \$2.75)

SUPERTRON MFG. CO., Inc., Hoboken, N. J.

Export Department, 220 Broadway, N. Y. City.

SUPERTRON

A SERIAL NUMBER GUARANTEE

Branch offices in principal cities throughout the United States

Get 2 Profits Instead of 1

When a Customer buys a **WIRT LIGHTNING ARRESTER**

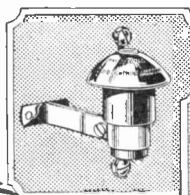

-sell him also a **WIRT INSULATOR**

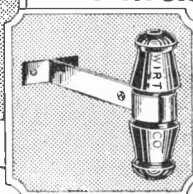

The **WIRT Lightning Arrester**

is the improved air-gap type.

Listed as Standard by Underwriters Laboratories

The protection is absolute. Made of bakelite, with bakelite "petticoat" which keeps out rain and dust. Brass terminals moulded in bakelite are far enough apart so that there is no leakage. Lasts a lifetime. Sells easily.

WIRT INSULATOR should be installed at the same time. ANOTHER SALE—ANOTHER PROFIT. Push them both.

Wirt Lightning Arrester..... \$1.00
 Wirt Insulator..... .35

The Wirt Lightning Arrester is Listed as Standard by Underwriters Laboratories

WIRT COMPANY
 PHILADELPHIA PENNSYLVANIA
 MAKERS OF DIM-A-LITE

Goodrich Silvertown

The Radio Panel Supreme!

- 1 Easier to drill and machine.
- 2 Better color, lasting lustre.
- 3 Lower free sulphur — no discoloration.
- 4 Higher softening point—no warping.

*Goodrich V.T. Sockets Spaghetti Tubing
Radiophone Ear Cushions
Battery Mats
Hard Rubber Tubes for Coils*

The B. F. Goodrich Rubber Company
Established 1870 Akron, Ohio

Fleron "HOME GUARD"

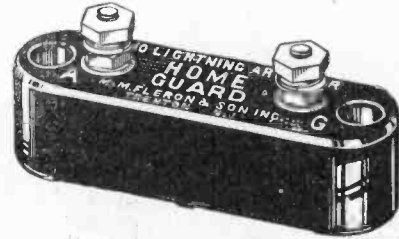

A New Standard of Lightning Arrester Value

Fleron Home Guard Lightning Arrester sets a New Standard of Lightning Arrester Value by giving a full size \$1.00 arrester for 50 cents.

Built entirely to the 1925 specifications of the Underwriters' Laboratories with all brass parts extra heavy.

Waterproofed for outdoor as well as indoor use.

Three separate arcing areas are provided so as to insure operation under all conditions.

Each Home Guard packed with two screws in a separate carton on which is printed directions for installing.

OTHER FLERON SPECIALTIES
Glass Insulators Lead-in Bushing
Stand-Off Insulators Complete Aerial Outfits

The Fleron Line of Radio Set Accessories is sold by all leading jobbers. Write for folder.

M. M. FLERON & SON, Inc.
TRENTON, NEW JERSEY

Who is to get the advantage of the **AMERTRAN** policy in your town?

In May, 1925, AMERTRAN inaugurated a new policy to protect and help the dealer, and to increase his profit.

The former jobber discount is now given to Authorized AMERTRAN Dealers. New plans to increase the sale of parts are being passed on to those dealers, constructive "brass tacks" methods which you can use.

No quantity requirements are imposed. No price cutting advertising. All sales for cash—fresh merchandise direct from the factory, fully guaranteed.

Let us send you literature outlining the Authorized Dealer Plan and what the dealer gains! Let us tell you about the important new AMERTRAN developments.

AMERTRAN Radio products are favorably known to every radio fan—known for their uniformity of performance (made possible and insured by electrical tests before packing).

AMERTRAN has some big things for its dealers this year! New products, and new ways to help you sell parts at a profit! Write for complete literature on the 1926 plan—now!

**This coupon will
bring you**

full particulars. You want
this advantage for your store.
Apply without delay!

**AMERTRAN
SALES CO.,
180 Emmet St.,
Newark, N. J.**

Tell me about the Authorized Dealer Plan and the AMERTRAN developments for 1926. I request first opportunity for the AMERTRAN franchise in my territory, if still open.

Name of Store

Name of Owner

Address

Territory Wanted

RADIO PEP

B-BATTERY ELIMINATOR

NO TUBES

NO HUM



Buy no more B-batteries!

USE the unlimited supply of cheap, dependable electricity right at hand in your house-lighting circuit.

This can be done with *permanent* satisfaction with RADIO PEP.

RADIO PEP is the **FIRST** eliminator to completely solve the problem, as it is the only one made with **EIGHT PERFECTED ELECTROLYTIC CELLS**, replacing tubes and doing away with all the familiar tube troubles.

Two or four cells *overloaded* will not give **PERMANENCE** and **POWER**—the outstanding characteristics of RADIO PEP.

135 VOLTS are called for by the modern sets and tubes; here you get it year after year without weakening.

For 110-125-volt, 60-cycle alternating current.

Send for particulars and name of our nearest distributor. Price \$38. Money-back guarantee.

PEP MFG. CO., Inc.
33 W. 42nd St. New York

New Sales Policy (direct from the factory to the dealer)
Enables you to sell this tube at a profit

for \$1



By eliminating wasteful distributing methods we have greatly reduced the selling cost of this standard tube, thus getting the price of tubes down to where it belongs.

Naturally the plan was an experiment at first—but it has met with such an immediate response that its success is definitely established!

ALADDIN

Type 201-A

"A tube of tubes"

DETECTOR AND AMPLIFIER

A Real Deal for the Dealer

These are standard tubes. Perfect tubes backed by an iron clad guarantee. There are no seconds.

Try these tubes. Put them to the test. To offer your trade such a tube at this price is the best kind of merchandising. It is good advertising. Good selling strategy which attracts new people to your store.

Take advantage of this introductory offer below. Mail your order today.

ALADDIN MFG. CO.
55 Hoyt St., Newark, N. J.

Special Offer to dealers only

Standard 201-A sold in 1 doz. lots, \$12.00 per doz., less 30% discount, \$8.40 net. Mail check with order or sent C. O. D.

Quality and Value Stand Out—

Look at any Standard Cabinet or Table and you see the very finest products of their kind. This means added sales for you.

This No. 303 Table is 30 inches high with 12x33 inch top and ledge. Finished Antique Brown Mahogany or Walnut. Ample shelf room for batteries.

Write for liberal dealer discounts.



One of our complete line.

STANDARD PIANO BENCH MFG. CO.
1221-1227 W. Lake Street, Chicago, Ill.



The quality and price for biggest sales

1.95 LIST

There's a big field among distance bounds, and where the rest of the household doesn't want to be disturbed.

The famous Superette at this price makes it easy to sell headphones to people who only occasionally use them.

Write for literature!

NEWTON PRESSED STEEL COMPANY
13 Hawthorne St., NEWTON, MASS.
Also manufacturers of the NEWTON Headset, which lists at \$3.00.

Now—tables designed and finished to match the sets!

Now you can feature tables to match the more important sets you sell!

Watsonstown has developed this plan to such a scale that we are able to offer the dealer a proposition far more attractive to him than any such plan has been before.

Incidentally, there's no need under this plan to carry a large stock in order to make a good profit.

Write for literature

WATSONTOWN TABLE & FURNITURE COMPANY, Watsonstown, Pa.

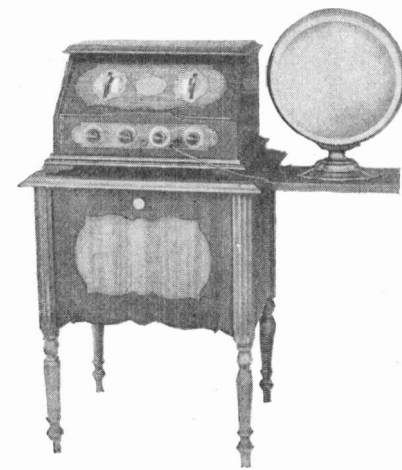

FOR RADIOLA 20
Finished in lacquer to make them heat, acid, and water proof.



FOR RADIOLA 25

Furniture Manufacturers for Thirty Years

Hook up with UNIPOWER

*—and be carried along
on the current of its
progressing sales.*

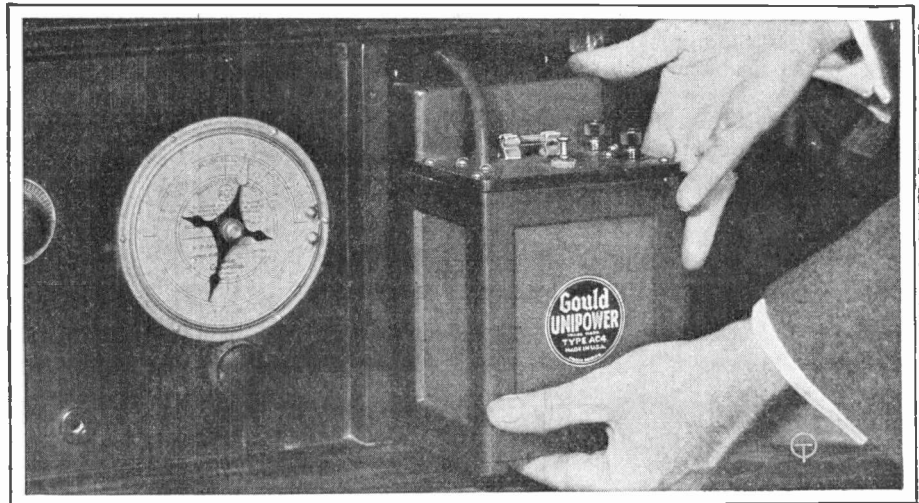

SINCE Unipower was first introduced, sales have climbed continually. Enthusiastic fans everywhere are buying this perfect "A" power unit.

Dealers all over the country are cashing in on the growing demand—a demand created by intelligently advertising a sound, practical product. Write today for the special "Dealers' Folder". Let it show you how to make sizeable profits and satisfied customers.

Unipower is supplied in two models for use with 110-125 volt A.C. only. Standard models are for 60-cycle. (Special models, 25-50 cycle, are available at slightly higher prices.) All are equipped with special Balkite rectifying element. The 4-volt model is for 199 tubes or equivalent and retails

for \$35; the 6-volt, for 201-A tubes or equivalent, retails for \$40. (West of the Rockies, prices are \$37 and \$43.)

THE GOULD STORAGE BATTERY CO., INC.
250 Park Avenue New York
Branches: Chicago, Kansas City, San Francisco

Unipower

Off when it's on—On when it's off

A Great Radio Contribution—WESTON

Model 506 Voltmeter and Universal Bi-Polar Switch—

FOR unusual radio results, for economy and for positive set control. ¶ Just a twist of the Bi-Polar Switch and you instantly and accurately make a complete electrical check on a radio set regardless of make! ¶ Obvious operating advantages lie in quick and positive knowledge of all voltage conditions as read on this double scale (140/7 volts) Voltmeter. ¶ By placing a Weston Model 506 Voltmeter and a Multi-Point Switch on the panel you insure the use of tubes at proper filament voltages, you can constantly check battery conditions and get the best results. ¶ Typical of its value is its use on a five-tube neutrodyne—you can regulate the filament voltages of: the Radio Frequency Tubes, Detector Tube, the First and Second Audio Frequency Tubes, and check the voltage of the "A" and "C" Batteries, the detector "B" and Amplifier "B" Batteries. ¶ Weston quality Radio Instruments lead in this new field, as they do in every other electrical outlet in commerce, industry, and research.

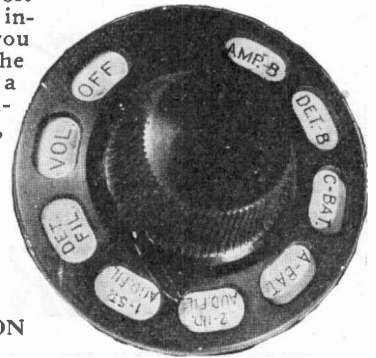
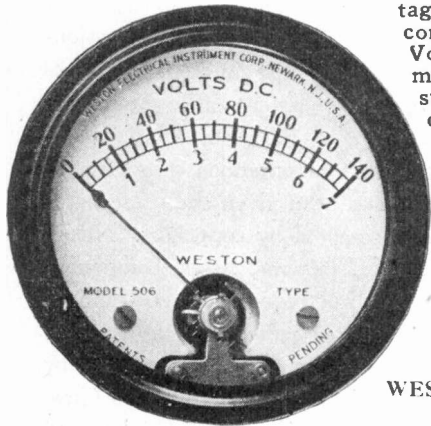

WESTON ELECTRICAL INSTRUMENT CORPORATION
25 Weston Avenue, Newark, N. J.

STANDARD THE WORLD OVER WESTON

Pioneers since 1888

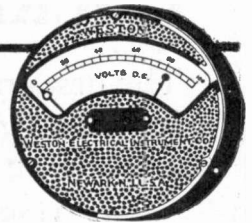
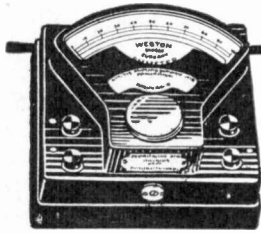

Get in the Big League at RADIO CENTER

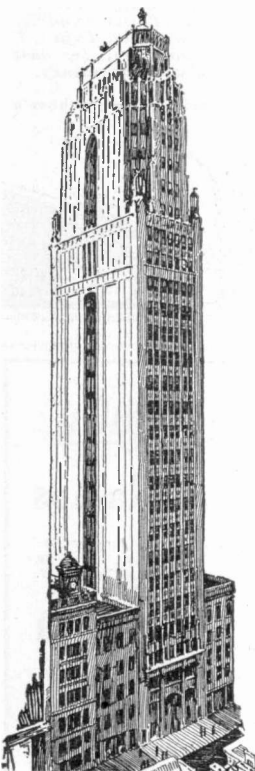

REQUESTS from dealers and jobbers for passes to Radio Center are pouring in from all over the country, indicating the keenest interest in this great cooperative time-saving sales enterprise which brings together under one roof the leading manufacturers and distributors.

Here are just a few selections from hundreds of similar letters:

- ROCHESTER, N. Y.—"Radio Center is a capital idea."
- PITTSFIELD, MASS.—"We are very much impressed with Radio Center, it will be valuable to all radio buyers."
- PHILADELPHIA—"Radio Center is a logical proposition, it will lead to big things."
- MIDDLETOWN, N. Y.—"Radio Center will be of great assistance."
- NEWPORT, VERMONT—"Radio Center will be most valuable to the manufacturer and the trade."
- FORT WORTH, TEXAS—"Radio Center will be a great asset."

MINNEAPOLIS—"Radio Center will be of big benefit to the trade."

GILBERTSVILLE, N. Y.—"Radio Center will be a wonderful help to out-of-town buyers."

Radio Center is the protected headquarters of the entire radio industry. It provides sound-proof offices and demonstration rooms of special construction, with unusual service and splendid year-round sales facilities to the trade alone.

Occupying two floors of more than twenty thousand square feet in the Bush Building, Radio Center is located at the heart of the world's greatest radio market—New York City—and the foremost manufacturers and distributors in the industry are rapidly making it the nation's main radio mart.

There is still excellent space available—for those who act quickly. Wire or write for full information and a copy of the big Radio Center Book—if possible, call in person. Don't delay—join the leaders at Radio Center, it's the big move of the year in radio.

RADIO CENTER, S. Herbert Mapes, President
Bush Building, 130 West Forty-Second Street, New York City

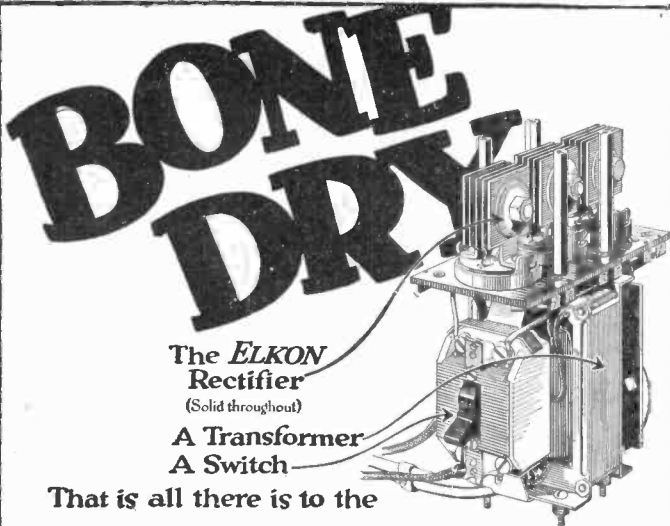

The **ELKON**
Rectifier
(Solid throughout)

A Transformer
A Switch

That is all there is to the

ELKON TRICKLE CHARGER

The first practical device for charging radio "A" batteries direct from alternating current *without*

ACIDS ALKALI
WATER TUBES
MOVING PARTS
CORROSIVE VAPORS

Noiseless. Does not interfere with other sets. Keeps "A" batteries replenished automatically, tapering down, or increasing as needed, *without attention of any sort.*

SOLD UNDER AN UNQUALIFIED
2000 HOUR GUARANTEE

Operates from 105-125 volt 50-60 cycles, charges both 4 and 6 volt batteries.

This represents the perfection of "bone-dry" rectification after a generation of experiment.

Complete **\$15⁰⁰** with switch

Set it — Install it — Forget it

ELKON WORKS
Subsidiary of P. R. Mallory & Co. Inc.
Weehawken, N. J. Inc.

Sole licensees under patents pending to Samuel Ruben
Also manufacturers of
Elkon Contact Points of Tungsten, Silver, Platinum, Special Alloys
"ELKONITE" Welding Electrodes and Dies
Molybdenum Sheet Metal Products



Warning

The Super-Ball Antenna Co., Inc., of Green Bay, Wis., is the owner by assignment of patent applications filed in United States patent office April 6th, 1925, Serial No. 21053, covering an improvement in antennas consisting of a metal ball to which has been given the trade name Super-Ball Antenna protected by copyright. Notice is further given that all persons, firms, companies, and corporations who directly or indirectly engage in the manufacture or sale of radio antennas as above protected will be prosecuted to the full extent as by law provided. All infringements upon the protected use of said name will be prosecuted by such legal redress as the law of the United States will permit.

Super-Ball Antenna Co., Inc.
Green Bay, Wis.

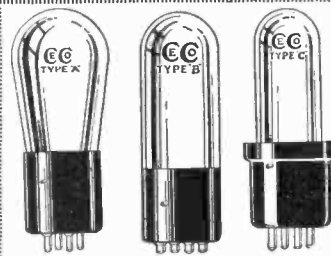

YOU sell radio satisfaction when you sell CeCo Tubes.

Now ready! CeCo Tubes with new type Long PRONG BASES. Also, Power Amplifier Tubes, E (Dry Cell Type), F (Storage Battery), for last stage of Audio Frequency.

Dealers write giving jobber's name.

	"A"	"B"	"C"
Filament Volts.	5.0	3.0	3.0
Filament Current	0.25	.06	.06
Plate Voltage...	20 to 120	20 to 80	20 to 80
Made with Brass and Bakelite Bases			

C. E. Mfg. Co., Inc.
702 Eddy Street,
Providence, R. I.

CECO
TUBES

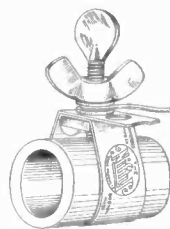

Hook up with **Nifty** Ground Clamps

No tools required—no soldering necessary. Made of tinned copper and brass. Easily adjusted to pipes most commonly used. Retail Price 20c. each. 50 in a Nifty Box.



Nifty Lead-ins

Completely weatherproof—pliable—and insulated. No holes to bore. Fits under windows and doors tight closed. 50 in a Nifty Box.

Amoroso Manufacturing Co.
75 High St., Boston, Mass.

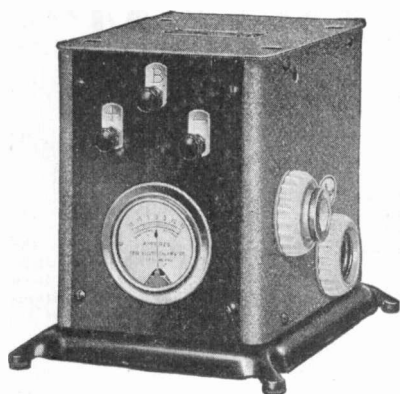

MASTER FORE

Charges both A and B Batteries

Every Radio owner wants the best reception possible. Weak A or B batteries are annoying to say the least. Sell him a Master Fore Battery Charger and win the good will of another customer.

Fill in, clip and mail the coupon now—
TODAY

Manufactured by
Fore Electrical Mfg. Co.
5255 N. Market Street, St. Louis, Mo.

RADIOGRAM

Fore Electrical Mfg. Co.,
St. Louis, Mo.

Send me free of charge complete information on how to make more money with the Master Fore.

Name

Address

City

State

More Radio Cabinet Sales

This Standard No. 401 Radio Cabinet was designed to be highly attractive and to be most practical. Users find that it fully meets their needs.

A number of features including spruce wood horn, make this a cabinet you should consider at once.

Made in Antique Brown Mahogany or Antique Burl Walnut finish. Write for dealers' transportation allowance and discount list.

STANDARD PIANO BENCH MFG. CO.
1221-1227 W. Lake St.
Chicago, Ill.

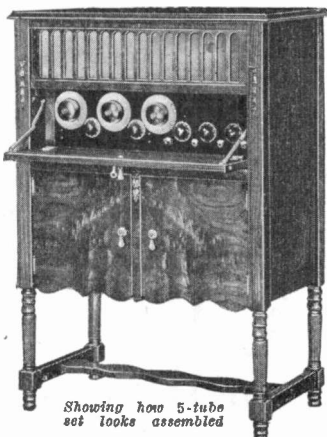

Showing how 5-tube set looks assembled



King Cole Aerial Wire

Many aerials, made of inferior wire, now need replacing.

Now is the time to sell King Cole enameled aerial wire to these and new customers. It insures permanence and satisfaction.

Write for our latest prices

Anylite Electric Co., Fort Wayne, Ind.

Speed Up

WITH THE 12 HOUR CHARGER

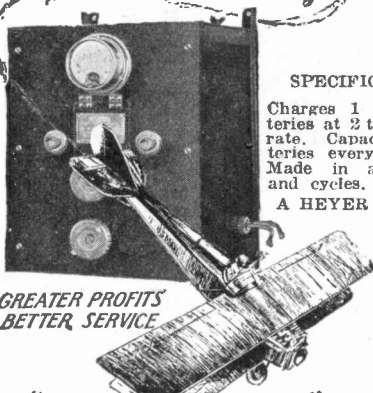

GREATER PROFITS
BETTER SERVICE

SPECIFICATIONS:

Charges 1 to 15 Batteries at 2 to 12 ampere rate. Capacity 15 Batteries every 12 hours. Made in all voltages and cycles.

A HEYER PRODUCT

"TWIN SIX"

THE "Twin Six" Charging System is a new application of an old theory except that two bulbs are utilized to give two-wave rectification. The resultant powerful 12 ampere current charges batteries in 10 to 12 hours without overheating at a cost of 8 to 9 cents apiece at 10 cents per kw.-hour.

This machine has all the advantages of the Bulb type charger combined with FAST SERVICE to meet the pressing demands of the public.

Simple in construction, the "Twin Six" sells for a very moderate price.

SALES DEPARTMENT:
CONSOLIDATED EQUIPMENT CORPORATION
160 Grand Street, New York, N. Y.
Write for catalog, terms and prices

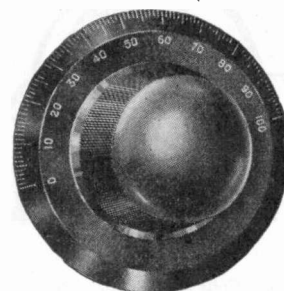

Efficient Service on Molded Parts

BAKELITE AND COLD MOLDED MATERIALS
MADE TO YOUR SPECIFICATIONS

American Insulator Corp.
52 Vanderbilt Avenue, New York City

Radio Parts
of Reliability
At Prices That Are Right
"Megohmo" Insulation
Metal Parts

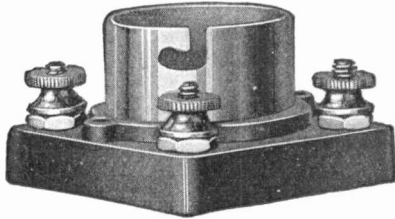

- | | |
|---------------|---------------|
| Sockets | Terminals |
| Dials | Eyelets |
| Insulators | Battery Clips |
| Adapters | Brackets |
| Binding Posts | Ground Clamps |

Special Moulded or Metal Parts
From B/P or Samples

SEND FOR OUR RADIO CATALOGUE

WATERBURY BUTTON CO.

Manufacturers Since 1812

WATERBURY, CONN., U. S. A.

Cable—Mattatuck

"WINDHAM"
Radio Products

The "Windham"
Air Cooled
Rheostat

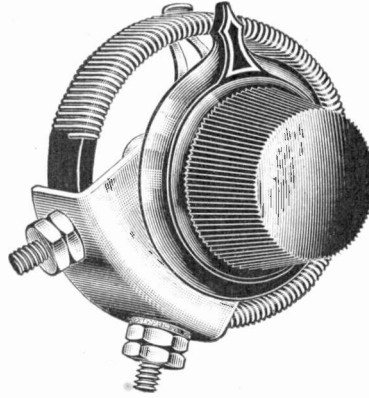

Designed to regulate the current within very close limits. They have been used under all conditions in a wide variety of receivers.

Six standard resistances—6, 10, 20, 30 ohms, and 400 ohm potentiometer.

Bakelite knob. Single hole mount. May be mounted on sub panel, independent of front panel.

"Windham" Wire Former

It will accurately form loops or eyes for No. 4, 6, 8 and 10 screws, make easy radius and sharp right angle bends, has flat jaws and wire cutters.

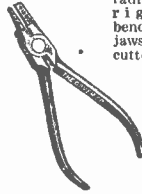

"Windham" Condensers

Small and has the characteristics so necessary for low radio frequency losses, easy tuning and selectivity.

Adjustable brake permits adjustment of bronze cone bearings without altering balance or alignment.

Practical separation on the short wave stations.

One hole mount. Holes for Sub-Panel Mounting. Six standard capacities.

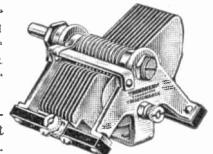

All Goyer products are rigidly guaranteed

THE GOYER CO., Manufacturers
WILLIMANTIC, CONN.



Toroid Coils and Complete Receivers
Rauland-Lyric: An Audio Transformer for the Music Lover
Constant-B: The Permanent B-Power Rectifier
ALL-AMERICAN RADIO CORPORATION, Chicago, U.S.A.
Radio Built for the Years to Come

Engrave Panels for
Set Builders

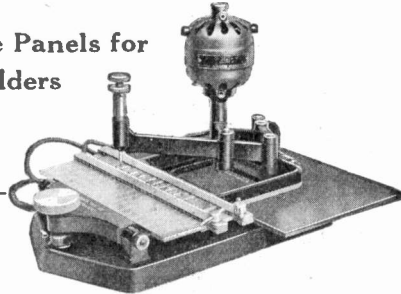

You can earn several dollars an hour engraving panels for amateurs building their own sets.

A low price engraving equipment for engraving the words used on radio panels, trade-marks, and border and corner designs. Will engrave on Hard Rubber, Bakelite, Aluminum and other soft metals. PRICE OF COMPLETE EQUIPMENT \$135.00.

Branch Tool Co., Dept. P, Forestdale, R. I.

Patent Applied for

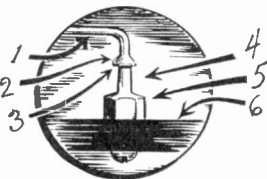

Bus wire (1), solder (2), soldering flange (3), tube (4), hexagon base nut (5), instrument or panel (6).

A Lastite can be a binding nut, a lock nut and soldering terminal—all three at once!

Lastite

terminals lock all circuit connections permanently.

They finish the job, save time and labor

Manufactured by

William Stevens Co.,
27 Hammatt Road
Roslindale, Mass

CRUWALD ANT-TERRA

The Super-Ground for
Radio Receivers



It eliminates static and power noises. Increases Signal Strength. Improves Selectivity and quality of reception. Can be used in place of an antenna or as a ground booster, and can be installed in 10 minutes.

Price \$6.50

Jobbers and Distributors Wanted
Factory Representative

BERNARD KRUGER

500 North Huntley Drive
West Hollywood, Calif.

THE HOUSE of SUPER-SERVICE

Just Out!
HARRY ALTER'S
RADIO
CATALOG

A New, Big Edition
 Dealers; Write for a Copy

The Harry Alter Co.
 ELECTRICAL and RADIO SUPPLIES
 Ogden at Carroll Ave.
 CHICAGO ILL.

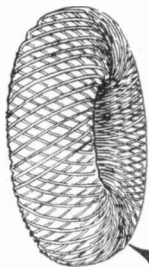

COILS
for
RADIO

- Balloon Honeycombs
- Wave Wound Spirals
- Transformer Windings
- Honeycomb Inductances

*We Wind For The
 Manufacturer Only*

COTO-COIL CO.
 PROVIDENCE
 R. I.

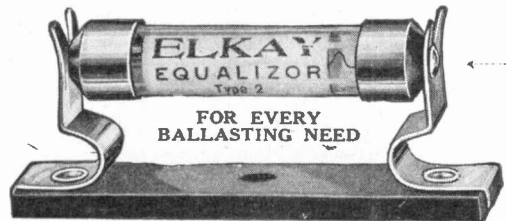
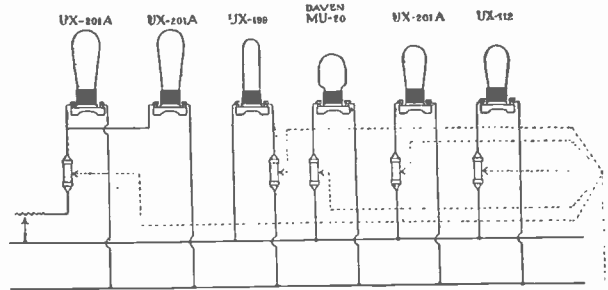
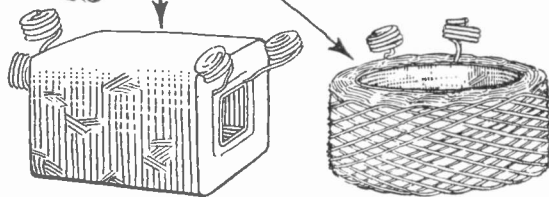

TUBE EQUALIZER SYSTEM

permits use of any combination of tubes in the same set

This System comprises a wide range of flexible filament control Equalizers to slip into spring clips. Equip a set with these clips, and ANY TUBE + THE CORRECT EQUALIZER = 6 VOLTS! With exception of the R. F. stages, no other filament control is needed. A set can be changed instantly from dry cell tubes to big tubes, for instance; and, in these days of UX tubes, the System is ideal. Shown above is a standard tuned R. F. circuit filament line, with four different kinds of tubes equalized to 6 volts. Price of Equalizers, 50c.; with clip, 75c. Write for complete folder on the Elkay Tube Equalizer System.

MANUFACTURERS! With this System you can eliminate at least one adjustment, perhaps two, and save from 10c. to 20c. a set. Write for low quantity prices.



ELKAY 5-TUBE SUPER-SELECTOR, \$80
 (Equipped with Equalizer System)

Compares favorably in appearance, selectivity, volume, distance and tone quality with sets at twice its price. Has one stage R.F. detector, one stage of transformer coupled amplification and two resistance choke permits same smooth operation on low or high wave lengths. Control over selectivity a distinct departure—an ELKAY invention.

The Langbein-Kaufman Radio Co., Dept. M.
 511 Chapel St., New Haven, Conn.



A Comparison

of the advertising pages in the March, 1925 and March, 1926 issues of five trade magazines featuring radio, shows

Magazine "A" with a loss of 49%

Magazine "B" with a loss of 74%

Magazine "C" with a loss of 54%

Magazine "D" with a loss of 60%

and "*Radio Retailing*" with a GAIN of 13%.

"*Radio Retailing*" is the only radio trade magazine to show a gain in number of advertising pages over a year ago.

Radio manufacturers spent more money for advertising in March "*Radio Retailing*" than in the two next largest papers combined.

The *Paid* circulation of "*Radio Retailing*" is 16,717,—more than twice that of any other radio trade publication.

Radio Retailing

—a McGraw-Hill Publication

473 Tenth Avenue, New York City

SEARCHLIGHT SECTION

SURPLUS STOCKS—BUSINESS OPPORTUNITIES

UNDISPLAYED—RATE PER WORD:
 Positions Wanted, 6 cents a word, minimum \$1.25 an insertion, payable in advance.
 Positions Vacant and all other classifications, 10 cents a word, minimum charge \$2.00.
 Proposals, 40 cents a line an insertion.

INFORMATION:
 Box Numbers in care of any of our offices count 10 words additional in undisplayed ads.
 Discount of 10% if one payment is made in advance for four consecutive insertions of undisplayed ads (not including proposals).

DISPLAYED—RATE PER INCH:
 1 to 3 inches.....\$6.65 an inch
 4 to 7 inches..... 6.40 an inch
 8 to 14 inches..... 6.20 an inch
 Rates for larger spaces, or yearly rates, on request.
 An advertising inch is measured vertically on one column, 3 columns—30 inches—to a page.

Radio Retailing

Sale of Navy Radio Material

BY SEALED PROPOSALS

To be publicly opened by the

**CENTRAL SALES OFFICE, NAVY YARD,
 Washington, D. C.**

at 11 A. M. (Eastern Standard Time) 7 May, 1926

The following approximate quantities of material, located at the various navy yards and naval stations throughout the United States, will be offered:

308 Receivers; 622 Transmitters, 1/4 to 5 kw.; 503 Transformers; 221 Motor Generators; 42 Gas Engine Generating Units; 191 Spark Gaps; 206 Wave Meters; 16 Booths; 28 Switchboards; 189 Vacuum Tube Detectors; 3,096 Crystal Detectors; 6,221 Vacuum Tubes; 35 Wave Changers; 28,070 Insulators.

Also Many Other Miscellaneous Radio Items

Catalog 279-B, containing all available details of description and Terms of Sale, can be obtained from any navy yard or station or the

**CENTRAL SALES OFFICE
 NAVY YARD, WASHINGTON, D. C.**

POSITION WANTED

PAUL STANTON, of Vermillion, Kansas, would like to secure a position with a reliable radio company or radio store; not particular about wages but wish position where there is chance of advancement; have had two years' experience building, repairing, installing and selling radios; I am twenty-four years old and willing to work; if you haven't a place for me please show this to someone who has or give me their address. Thanks! All letters promptly answered.

RADIO expert, high school graduate, aged 21 years, eight years' experience, desires position with reliable radio company; references if necessary. PW-10, Radio Retailing, Guardian Bldg., Cleveland, Ohio.

BUSINESS OPPORTUNITIES

Manufacturers and Wholesalers
 Desiring disposition of unsold radio merchandise, communicate with me; odd lots bought or sold on commission. Walter M. Braun, 123 Grand Ave., Milwaukee, Wisconsin.

FOR QUICK SALE

Copper Magnet Wire

300 lbs. net weight, Beldenamel, diameter 40, on spools net weight 2 to 8 ounces.

HARRY W. DePREZ, Shelbyville, Indiana

Think "Searchlight" First

"SEARCHLIGHT" Service Is for You, Too

IT is to help you whenever you have a business want. It insures you, at an extremely small cost, the quickest and most effective delivery of your message to the men in this field who are most likely to be interested in your needs. Try it. Learn what "SEARCHLIGHT" really means to YOU.

Agencies Wanted
 Agents Wanted
 Auction Notices
 Bids Wanted
 Books and Periodicals
 Buildings For Sale
 Business Opportunities
 Civil Service Opportunities
 Contracts-to-be-let
 Contracts Wanted
 Desk Room For Rent
 Desk Room Wanted
 Educational

Employment Agencies
 Foreign Business
 For Exchange
 For Rent
 Franchises
 Help Wanted
 Industrial Sites
 Labor Bureaus
 Machine Shops
 New Industries Wanted
 Partners Wanted
 Patent Attorneys

Patents For Sale
 Plants For Sale
 Positions Vacant
 Positions Wanted
 Property For Sale
 Proposals
 Receivers' Sales
 Representatives Wanted
 Salesmen Wanted
 Specialties
 Sub-Contracts Wanted
 Water Front Property
 Work Wanted

For Every Business Want
Think "SEARCHLIGHT" First

0170

When Writing Your Ad

Provide an indexing or subject word.

Write it as the first word of your ad.

If it is a Position Wanted or Position Vacant ad, make the first word the kind of position sought or offered.

This will assure proper classification in the column. The right is reserved to reject, revise or properly classify all Want Advertisements.

*Proper Classification
 increases the possibility of
 Prompt Returns*

Last call

April 15 /



The special subscription rate of only \$1 a year for *Radio Retailing* expires on April 15. On that date the regular rate of \$2 a year goes into effect.

Radio Retailing is the biggest value for a single dollar ever offered in radio!

Right now — fill in the coupon below, attach a dollar bill to it and send it back to *Radio Retailing*.

It will bring you *Radio Retailing* for a whole year and prove a profitable investment all around! Also, you'll save \$1!

But get the coupon back at once — the special \$1 rate expires on April 15.

Return the coupon without delay

The special \$1 offer expires on April 15

Radio Retailing

Tenth Avenue and 36th St.,
New York, N. Y.

Attached is \$1. Send me *Radio Retailing* for a year. Start the service with the next issue, please.

Name

Street

City State

Name of Company

Besides *Radio* we sell

4-26

Don't delay— return the coupon with \$1 now. Get in on the special subscription offer of \$1 a year — it expires on April 15. There's no time to lose!

AMPLION

The Product of 38 Years' Experience

Due to supremacy of performance this creation of Alfred Graham & Co., England leads in sales throughout the world. Six models, including phonograph units, equipped with cords and plugs, \$12 up. Nationally advertised. Write for "Amplion Pedigree" and proposition to trade.



THE AMPLION CORPORATION OF AMERICA
 Executive Offices: Suite E, 280 Madison Ave., New York City
 Chicago Branch: 27-29 No. Morgan St.
 In Canada: AMPLION CORP. OF CANADA, LTD., Toronto

Set Manufacturers!



Standards of radio reception are becoming higher with each new year. 1926 models must be an improvement over those of 1925, and they will be.

Correct coils are vital to good reception. We specialize in such coils. We are producing regularly the most advanced types, built with the famous "Diamond-weave" construction.

Write us concerning your own requirements. We are prepared to furnish better coils for the new sets.

THE F. W. SICKLES COMPANY
 140 Union St., Springfield, Mass.

SICKLES DIAMOND-WEAVE COILS

No. 401 for large tubes \$8.50
 No. 399 for small tubes \$10.00

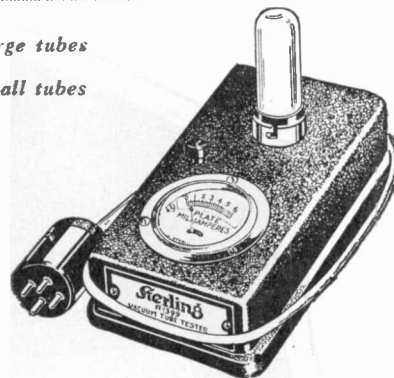

Sterling "HOME" TUBE TESTERS

More popular now than ever!

Right from the start the Sterling "Home" Tube Tester made a hit with the radio owner, but it took time for the demand to reach such huge proportions as now exists!

Set owners are now giving more attention to their tubes. Are they still good?—must they be replaced?—which is the poor one?—these questions must be answered and the Sterling Tube Tester answers them all.

Dealers—Send for diagram showing how this Home Tester can be wired up for counter testing.

Sell them and increase your profits.

**THE
 STERLING MANUFACTURING
 COMPANY**
 Cleveland, Ohio

ALPHABETICAL INDEX TO ADVERTISEMENTS

Page	Page	Page	Page
Aladdin Mfg. Co. 406	De Jur Products Co. 398	Hartung Co., Charles F. 400	Radio Centre 409
All-American Radio Corp. 412	Diamond Vacuum Products Co. 402	Helios Co., Inc. 403	Radio Corp. of America,
Alter, Harry Co. 413		Hommel & Co., Ludwig. 403	374-375, Back Cover
American Bosch Magneto Corp. 339	Electric Storage Battery Co. 396	Hood Rubber Co. 402	Radio Products Corp. 403
American Insulator Corp. 415	Elkon Works, Inc. 410	Kruger, Bernard 412	Scranton Glass Inst. Co., Inc. 402
Amertran Sales Co. 405		Langbein-Kaufman Radio Co. 413	Searchlight Section 415
Amoroso Mfg. Co. 410	Farrand Mfg. Co., Inc. 334	Lektophone Corp. 335	Sickles Co., F. W. 417
Amplion Corp. of America. 417	Federal Radio Corporation. 401		Standard Piano Bench Co. 406-411
Anylite Electric Co. 411	Federal Telegraph Co. 332	Magnavox Company 397	Stevens Co., William. 412
Apeo Mfg. Co. Inside Back Cover	Fleron & Son, M. M., Inc. 405	National Carbon Co., Inc. 338	Sterling Mfg. Co. 417
Atwater Kent Mfg. Co. 342	Fore Electric Mfg. Co. 411	National Company, Inc. 404	Stewart-Warner Speedometer
Auto Vacuum Freezer Co. 393-394	Frost, Herbert H., Inc. 398	Newton Pressed Steel Co. 406	Corp. 341
Bakelite Corp. 336-337	General Electric Co. 399	Operadio Corp. Front Cover	Stromberg-Carlson Tel. Mfg. Co. 330
Benjamin Electric Mfg. Co. 420	General Lead Batteries Co., Inc. 400	Pep Mfg. Co., Inc. 406	Super-Ball Antenna Co. 410
Branch Tool Co. 412	General Merchandising Co. 402	Perryman Elec. Co. 407	Supertron Mfg. Co. 404
Brandes Products Corp.,	General Radio Co. 340	Polymet Mfg. Corp. 403	
Inside Front Cover	Gold Seal Products Co., Inc. 333	Prest-o-Lite Co., Inc. 407	Utah Radio Products Co. 329
Burton-Rogers Co. 402	Goodrich Rubber Co., B. F. 405	Wartburg Radio Corp. 402	Waterbury Button Co. 412
Cellokay Mfg. Corp. 398	Gould Storage Battery Co., Inc. 408	Watsontown Table & Furniture	
C. E. Mfg. Co., Inc. 410	Goyer Co., The. 412	Co. 408	
Consolidated Equipment Co. 411	Grabe, A. H. & Co., Inc. 331	Weston Electric Inst. Co. 409	
Coto Coil Co. 413		Wirt Company 404	
Crosley Radio Corp. 391			

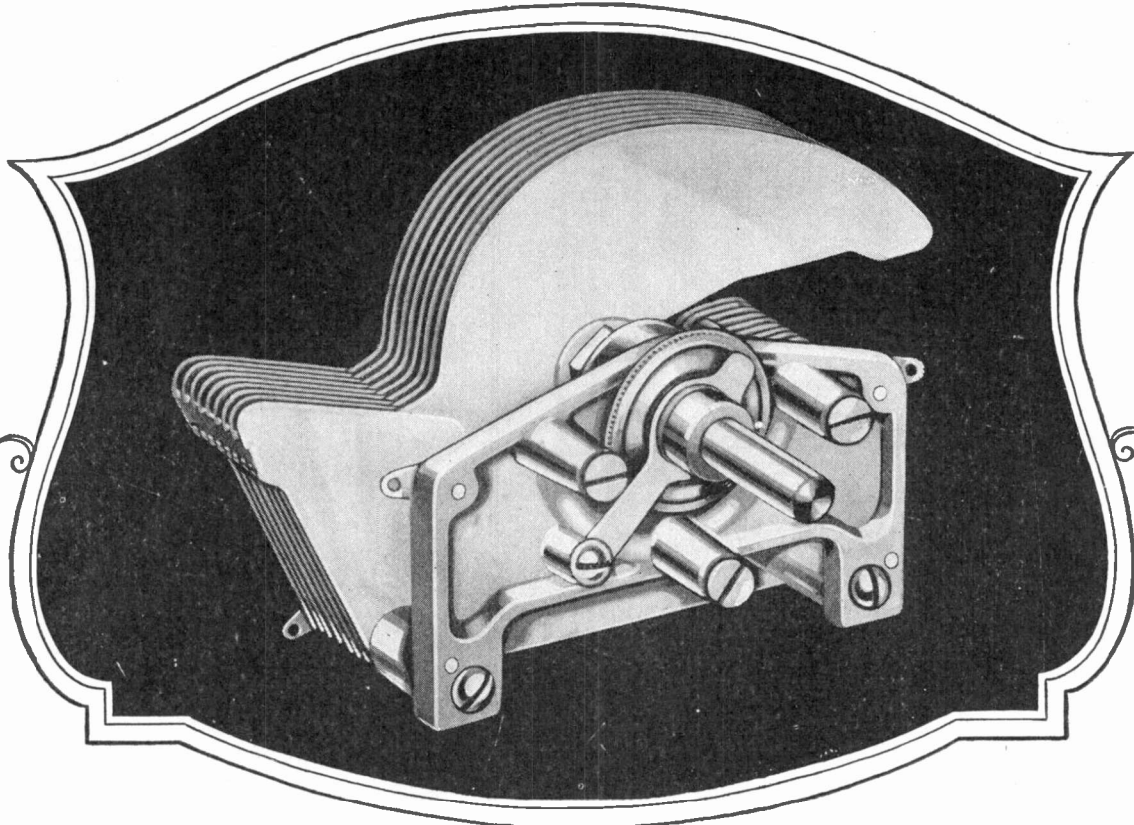

The Benjamin A REAL Straight-Line Frequency Condenser

The key to finer radio. Easier tuning—better selling. Backed by generous national advertising. Logs evenly over the sweep of the dial in exact ratio with the broadcasting frequency spectra. Eliminates bunching

of stations and increases selectivity and sensitivity. No body capacity effects and no absorption losses. A beautiful instrument in unpolished silver plate, made with the precision of a watch, to last a lifetime.

Cle-Ra-Tone "Push" Type Radio Socket

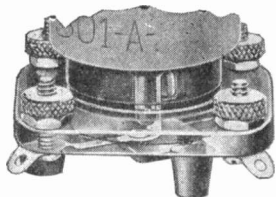

Pat. July 25, 1925; May 2, 1911

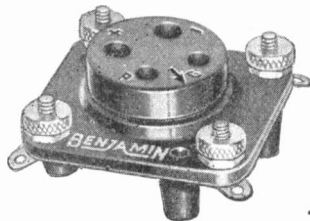

The Benjamin Radio Socket of many distinctive and individual features. The suspension spring and contact member are made in one piece, eliminating high resistance joints. Side wiping contacts insure perfect electrical connection to the tube prongs. Tube noises are stopped by preventing transmission of outside vibrations into microphonic disturbances. For standard UX tubes.

The Benjamin "Lekeless" Transformer

A few of the characteristics which make this a "Lekeless" transformer are: [1] A closed field which prevents power leakage and feed-back, making neutralization easy. [2] A minimum amount of supporting insulation lowers power loss. [3] Extremely low distributed capacity, low resistance and high inductance. Each turn of wire placed with perfect mechanical accuracy, resulting in uniformly high inductance and low losses.

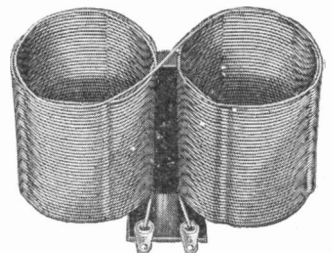

Patents Pending

Send for full information on Benjamin
Super Radio Parts for Better Radio Sets

Benjamin Electric Mfg. Co.

120-128 So. Sangamon Street, Chicago

New York: 247 West 17th Street

San Francisco: 448 Bryant Street

Manufactured in Canada by the Benjamin Electric Manufacturing Company, of Canada, Ltd., Toronto, Ontario

A recognized product to meet a recognized need

APCO Super "B" Battery Eliminator

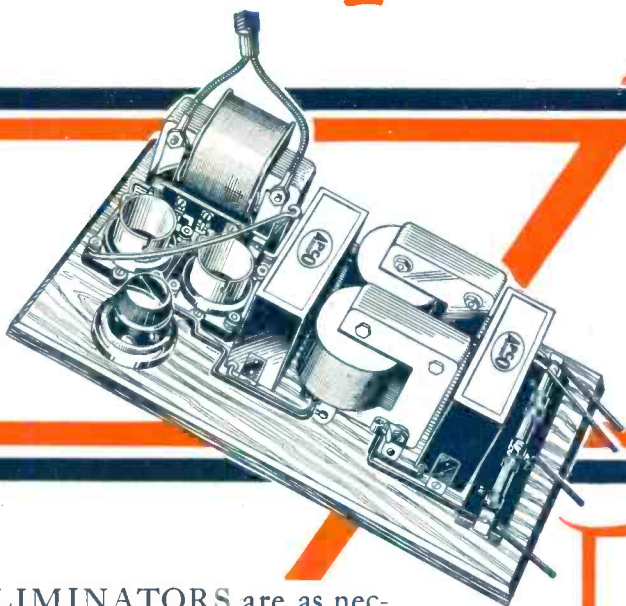

"B" ELIMINATORS are as necessary to radio as a self-starter to a car.

For two years, APCO "B" Battery Eliminators have been recognized as standard by practically every radio expert in the country.

The APCO Super "B" Eliminator is the highest development of that two years' experience.

Complete in open mounting, as shown. Ready to use except tubes. Delivers up to 135 volts and 40 milliamperes. Two standard 201-A tubes or one 213-X tube may be used. Comes ready to attach to lamp socket. List, \$36.00.

Apco Manufacturing Company
1247 Eddy Street, Providence, R. I.



APCO Rectodyne, No. 66.
List, \$44.00

APCO "A" Charger, No. 77.
List, \$18.50



APCO "A" Charger, No. 79.
List, \$12.50

APCO "B" Charger, No. 89.
List, \$4.00

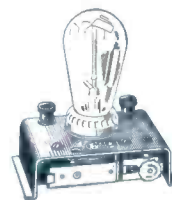

Radiotron UX-199
dry cell tube for both de-
tection and amplification.

Radiotron UV-199
is exactly the same but
has the old type base.



A sales leader that never fails—that produces profits twelve months a year—the “*bread-and-butter*” of the reliable radio dealer:
RCA Radiotrons.

RADIO CORPORATION OF AMERICA
New York Chicago San Francisco

RCA Radiotron

MADE BY THE MAKERS OF RADIOLAS