

Radio Retailing

The Business Magazine of the Radio Industry

making
profits
easily

YOUR customers are always influenced and often sold by your recommendations. It is equally true that radio buyers — your customers — know the General Electric Company and have faith in the quality of its products.

In this issue is described a radio product with which you are acquainted. Its reputation is also known most favorably by radio owners everywhere. It is a product needed by millions of radio users — highly profitable and half-sold when its well-known name is mentioned. A sale can be completed 9 times out of 10 upon your recommendation.

Read about it on pages 436 and 437

GENERAL ELECTRIC

Order just one!



HERE'S a straight-from-the-shoulder proposition. You want to stock the fast-selling speakers—you want to sell the best. You can't know the remarkable tone—the range and volume of the new Brandes Speakers unless you hear 'em.

So order just one—any one—cone,

cabinet, or horn. Test it thoroughly. Try it on any good set. Compare it with other speakers.

Each is a beauty of its type—but the tone is of Brandes quality. Hear one Brandes speaker—and let your customers hear it. That's all we ask!

Select a speaker and ask your Brandes jobber to send it to you for test. Or send your request to us and we will forward it to the jobber.

Brandes Products Corporation
200 Mt. Pleasant Avenue Newark, N. J.

Brandes

EXPERTS IN RADIO ACOUSTICS SINCE 1908

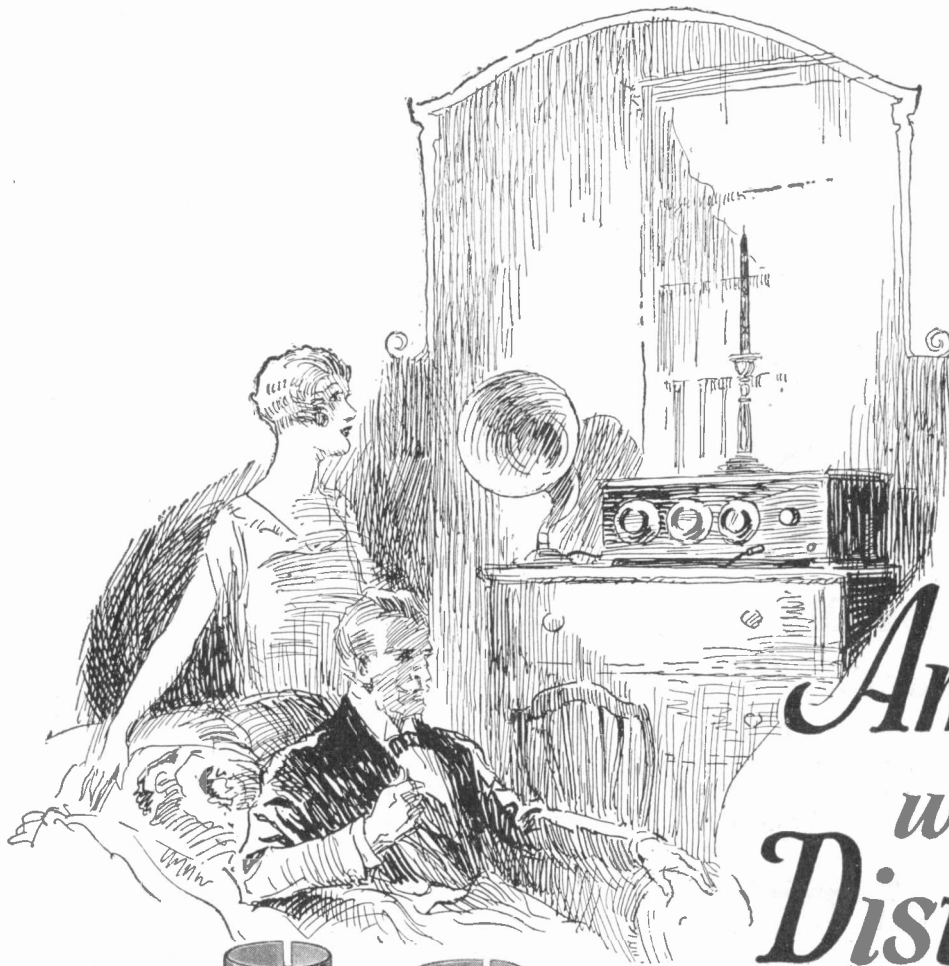

Amplifies without Distortion

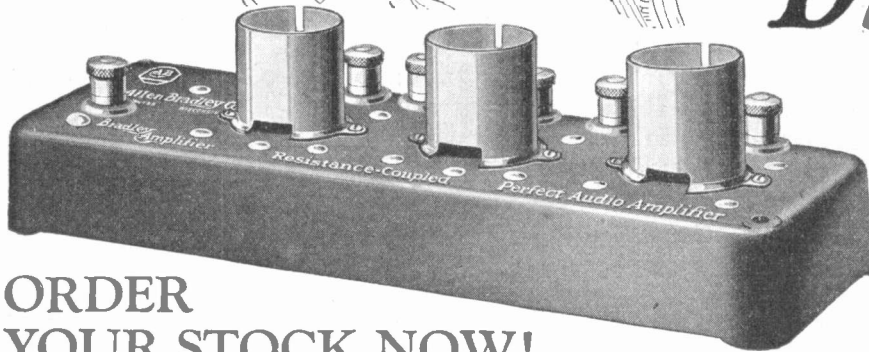

**ORDER
YOUR STOCK NOW!**

SET owners, as well as set builders, are interested in the Bradley-Amplifier. It is so compact that it slips easily into any set. It is wired, ready for instant use, and requires no rewiring of the set. It may be installed outside the set if desired.

The resistance coupled amplifier is a big seller, this year. Get your share of Bradley-Amplifier sales by entering your order now. Write for latest literature today.

ALLEN-BRADLEY CO., 489 Clinton St., Milwaukee, Wis.

THE latest Allen-Bradley contribution to better radio is the new Bradley-Amplifier, a marveously compact three-tube audio amplifier of the resistance coupled type.

Aside from its faultless tone quality and perfect reproduction, the Bradley-Amplifier is amazingly small in size. All circuits, resistors, and condensers are securely soldered within the base, leaving no exposed parts.

Another outstanding feature is the use of Bradleyunits (Molded Resistors) which do not deteriorate with age, nor are they affected by temperature and moisture. The Bradley-Amplifier requires no attention or adjustment.

Bradley-Amplifier

Resistance-Coupled

PERFECT AUDIO AMPLIFIER

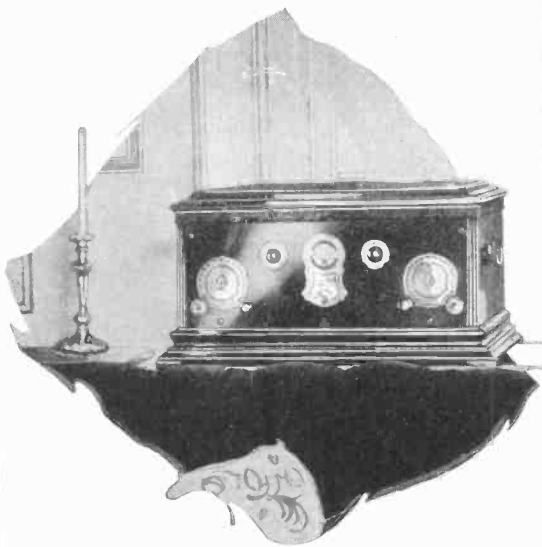

Stromberg-Carlson, again sets Radio's Standards of Sensitivity, Tone Purity, Selectivity and Beauty of Design

The new 6-tube, dual control, Stromberg-Carlson Receivers, with three totally shielded stages of radio frequency and detector, a volt meter and perfected audio amplifier, revolutionizes even Stromberg-Carlson standards of owners' results.

The table and floor cabinets in which this advanced example of radio engineering is contained, set new standards for radio even if regarded wholly as "Fine Furniture."

Other Stromberg-Carlson models, with their celebrated range and tonal beauty, have been perfected along the lines of the most advanced engineering principles and are being retained at full former prices, making a complete quality line.

Stromberg-Carlson policies, which have established radio merchandising standards, remain in as full force as ever.



Stromberg-Carlson Telephone Mfg. Co.,
Rochester, N.Y.

No. 601 Table Model; 6-tube; totally shielded; dual control; equipped with voltmeter; takes new tube bases; operates either horn or cone type loud speaker; perfected audio amplifier. Mahogany finish. Price \$210.

No. 1 Type Table Model: 5-tube; shipped arranged for five 201-A type tubes, also can be arranged for UX-112 type power tube and 135 volt "B" Battery for second stage of audio frequency amplifier. Has antenna coupling switch; also key for switching from first to second audio frequency amplifier. Mahogany finish. Price \$180.

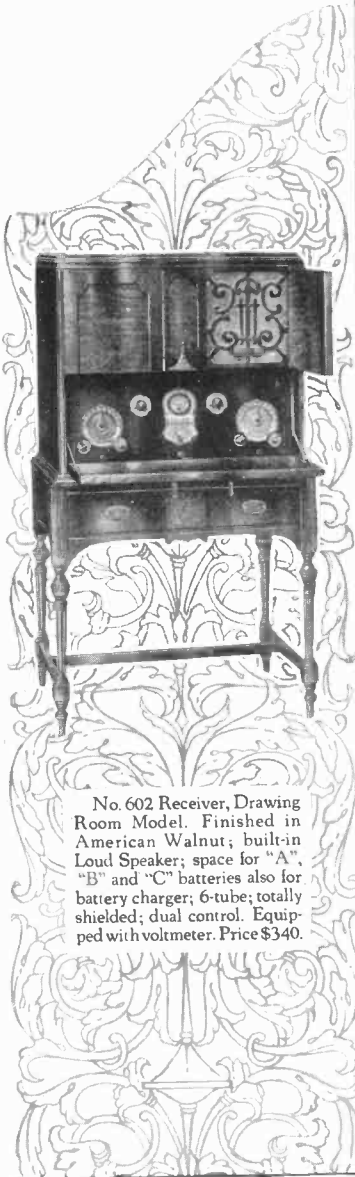
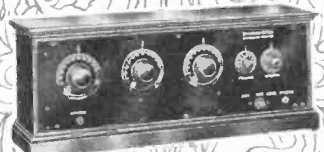

No. 602 Receiver, Drawing Room Model. Finished in American Walnut; built-in Loud Speaker; space for "A", "B" and "C" batteries also for battery charger; 6-tube; totally shielded; dual control. Equipped with voltmeter. Price \$340.

Stromberg-Carlson

Makers of voice transmission and voice reception apparatus for more than thirty years

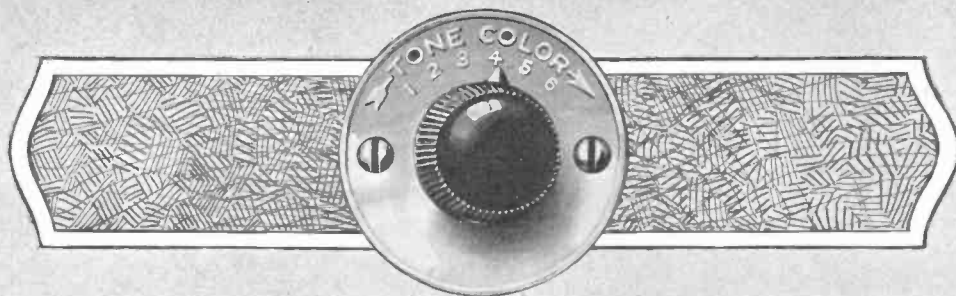

What this Grebe Invention Will Do for Your Sales

THE Grebe "Colortone" will remove at once the objection of thousands to the purchase of a radio set.

The listener may alter, to his taste, the quality of speech or music from high, thin pitch to deep, round tones with all the variations between.

As the Synchronphase makes reception independent of the loud speaker's characteristics, you can sell, with this receiver, any good speaker with the assurance that it will give satisfactory results.

The "Colortone" makes it possible to suppress considerably the high pitch frequencies caused by heterodyne interference of one station with another and also to reduce, to a great degree, disturbances due to static.

Grebe has thus removed some of the most serious obstacles to the development of your business. You ought to learn more about this remarkable invention.

Write for full details

A. H. Grebe & Co., Inc., Steinway Hall, 109 West 57th St., N. Y.

Factory: Van Wyck Boulevard, Richmond Hill, N. Y.

Western Branch: 443 So. San Pedro Street, Los Angeles, Cal.



"It is only he who possesses absolute truth who can create."

— Confucius

The constant seeking for truth has created the "Colortone" and other Grebe advances in radio reception.

Doctor Tzu

The GREBE SYNCHROPHASE

TRADE MARK REG. U.S. PAT. OFF.

This company owns and operates stations WAHG and WBOQ; also mobile and marine low-wave rebroadcasting stations.

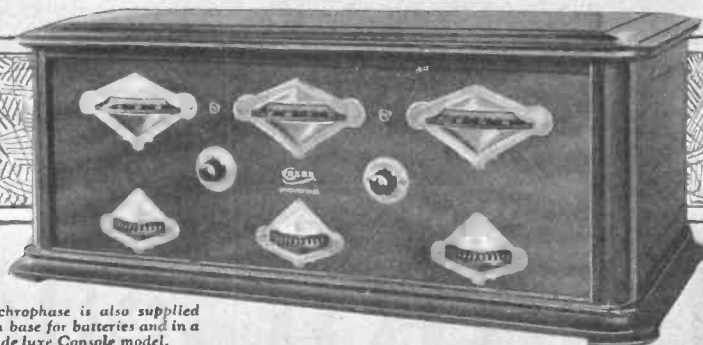

Synchronphase is also supplied with base for batteries and in a de luxe Console model.



All Grebe apparatus is covered by patents granted and pending.

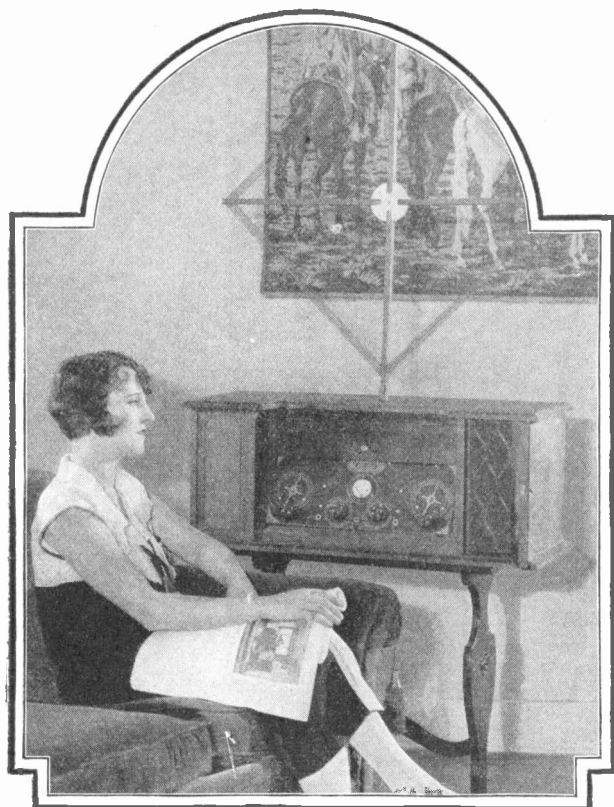

Easy to Sell Easy to Service

Cleartone complete radio sets can be demonstrated anywhere because they require no ground wire or outside antenna. They get away from service troubles because all tubes, batteries, loud speaker and loop are tested at the factory and the outfit is shipped complete to sell at one price.

CLEARSTONE offers this year a proposition that was designed to make life easy for the dealer. It is a seven tube loop set of wonderful tone that will readily sell itself when demonstrated. Operates on dry cells.

The factory selects and tests all batteries, tubes and other equipment. Each set is actually used with the exact equipment that you will deliver before it is shipped. That is the end of troublesome comebacks.

The set is removed from the fierce competition on five tube sets—and every dealer no matter what the rest of his line has a profitable place for it in his business. It is a splendid set for anyone, and it has unusual possibilities with the farm and apartment house trade.

Cleartone complete radio sets are the product of a reliable long established company that has introduced many important improvements into radio, such as metal panels, and the use of pointers instead of dials for tuning.

Model 90 Complete with Detached Loud Speaker.....\$185
 Model 91 Complete with Built-in Loud Speaker.....\$200
 Model 92 Console with Built-in Loud Speaker.....\$275

Our Selling Plan will interest any dealer. It does away with most of the troubles you have previously had. Write for it.

The Cleartone Radio Company
 2429 Gilbert Avenue, Cincinnati, Ohio

Accessories Furnished with Cleartone Sets

7 Radiotron Tubes
 9 Ray-O-Vac Dry A Batteries
 2 45-volt Ray-O-Vac B Batteries
 1 Cleartone Loop Antenna
 1 Cleartone Loud Speaker

CLEARSTONE *Complete* RADIO SETS

Phenolite panels and tubes combine perfect insulation with great physical strength, uniformity and fine machining quality!

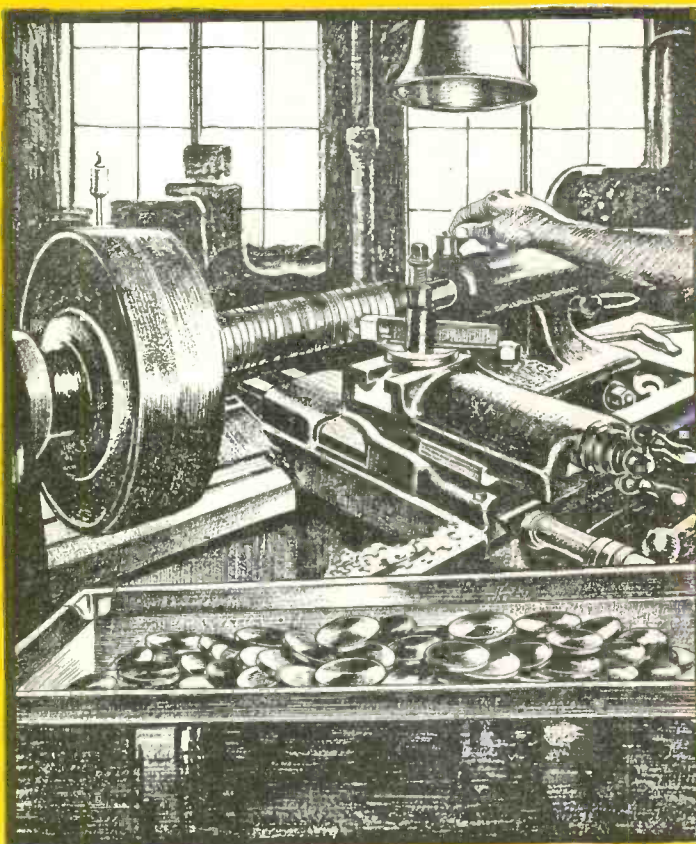

—sell machining quality!

PHENOLITE can be machined in precisely the same manner as wood and steel are machined. It can be milled, punched, threaded, turned, tapped, sawed, drilled, bored, ground . . . And you will find Phenolite of *unvarying* quality—no soft spots; no hard spots; no splitting; no cracking! Whether you are buying completed sets or panels and tubes, Phenolite is the standard of *unvarying* quality . . . Your jobber will supply you—or write us.

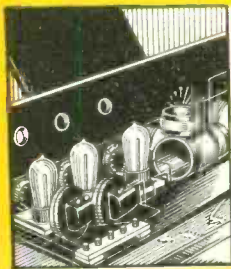

Insulation—it is the basis of all electrical control! . . . America's leading manufacturers of radio receiving sets are paying a premium to insure perfect insulation. Phenolite meets their most exacting requirements.

National Vulcanized Fibre Co.
 PHENOLITE PRODUCTS DIVISION, WILMINGTON, DEL., U.S.A.
 We operate six great plants and maintain sales and service offices at New York, Chicago, Boston, Philadelphia, Pittsburgh, Cleveland, Milwaukee, Los Angeles, San Francisco, Detroit, Rochester, Birmingham, Denver, Seattle, Toronto, Greenville, St. Louis, Baltimore.

PHENOLITE
Reg. U.S. Pat. Off.
 Laminated BAKELITE
 SHEETS : RODS : TUBES : SPECIAL SHAPES

Made by the makers of National Vulcanized Fibre

Everybody knows the Tungar

REG. U.S. PAT. OFF.

BATTERY CHARGER

The original bulb charger

There are nearly three million radio storage batteries in use that need a partner. They are not complete without a charger. You can safely stake your reputation on your claims when you recommend a Tungar. The Tungar stands out in the public mind as the *original* bulb charger — the best known — a dependable performer — a G-E product. With a word from you, it easily *sells*.



GENERAL

MERCHANDISE DIVISION

EVERYBODY knows the G-E Tungar. Half the people you meet talk about "Tungars" whenever they mean battery chargers. There is profit in this fame for every man who sells the *genuine*.

Big Selling Points

- It makes no disturbing noise
- It cannot create radio interference
- It cannot burn out tubes if battery is left hooked to set while charging
- It charges any make and size of storage battery: radio "A" and auto batteries, and "B" batteries as high as 96 volts in series.

In choosing a particular type of charger, a buyer considers all these points. He considers, too, the reputation of the charger, as an indication of performance—the name of the maker, as a guarantee of quality—and *your recommendation*, as the last word that closes the sale.

To dealers everywhere—

The profit possibilities of the Tungar are tremendous. Its prestige, backed by your recommendation, guarantees big sales. Our window displays, folders and extensive advertising are at your service.

Mail this coupon for details.



Merchandise Division,
General Electric Company,
Bridgeport, Conn.

Please send me full details of your Tungar dealer plans, prices, discounts and sales helps, also address of distributor.

Name _____

Address _____

City _____

State _____

E L E C T R I C

BRIDGEPORT, CONNECTICUT

BOSCH

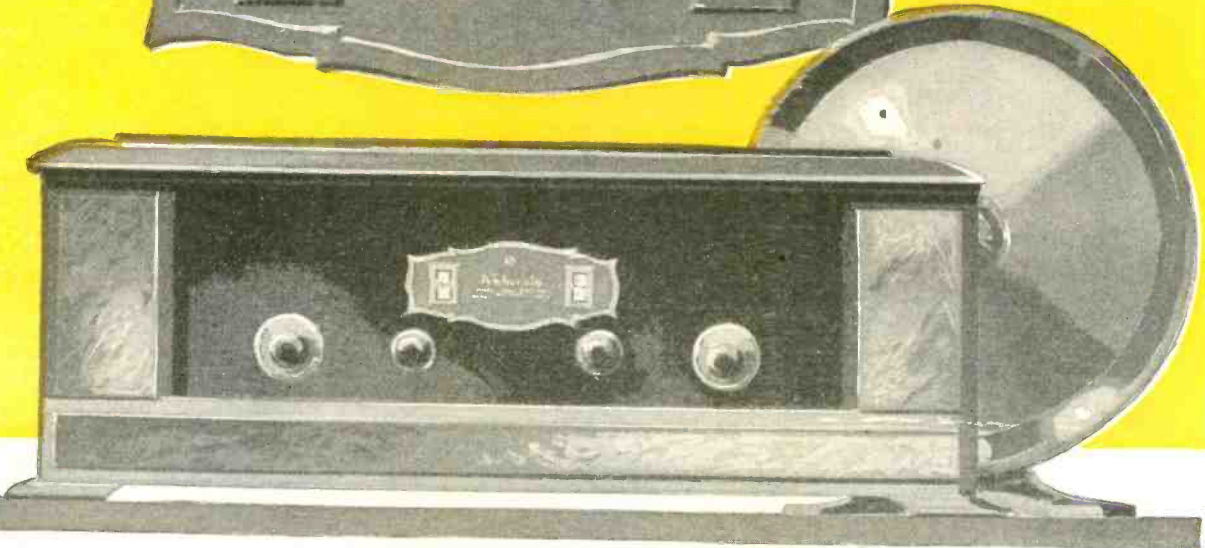
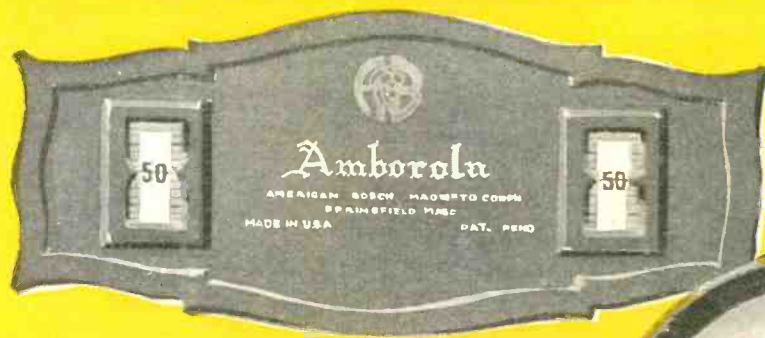
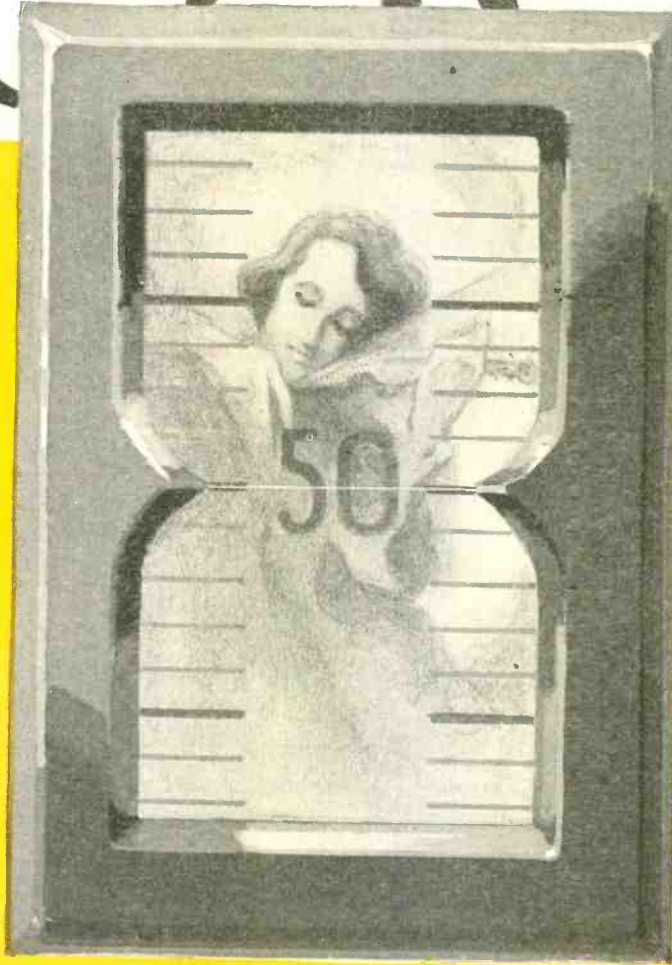

May 1934

RADIO

BOSCH RADIO BACKGROUND

The American Bosch Magneto Corporation is in position to build radio products of unapproachable quality. This organization comprises skilled electrical engineers, workmen experienced in precision manufacture, a world-wide service and distributing organization all backed by plant, tools and equipment especially designed for the manufacture of precision electrical apparatus.

Bosch quality is world famous.

This is the incomparable background of Bosch Radio Products—the Amborola Receiving Set, the Ambotone, and the Junior Ambotone Reproducers—all reflecting Bosch quality in design, manufacture and performance.

AMERICAN BOSCH
MAGNETO CORPORATION
SPRINGFIELD . . . MASSACHUSETTS



PERRYMAN

Here are Sales Helps that actually **SELL** for you **\$2.50** All Types

A handsome Window Display, better than any you've seen for tubes, that not only sells Perryman Tubes but sells your store too.

A Counter Display featuring a clear glass demonstrating tube, that enables you to show your customers why Perryman Tubes are worth \$2.50 down to the last penny.

An Authorized Dealer Transfer for your window.

Booklets for counter use, written so a novice can understand why his money ought to go into Perryman Tubes.



A Carton of striking appearance. Easy to look at. Your customers will instantly locate the Perryman Cartons on your shelves.

IMPORTANT

We want all jobbers and dealers to know that The Perryman Electric Company is ably financed and thoroughly equipped to deliver the goods. Our laboratories and plant in North Bergen are the last word in equipment. We will gladly refer you to our banks for information concerning our financial strength and the character of the men behind the company.



Perryman Type R. H. 201-A Amplifier and Detector



Perryman Type R. H. 199 Standard Base Amplifier and Detector

GEORGE H. PERRYMAN has been making vacuum tubes for ten years during which time he has directed two of the largest plants in the country. He has built four tube-making plants. He knows the faults and virtues of practically every tube on the market. He knows tubes as few know them.

These Perryman Tubes—the first to which he has given his name—are the result of an experience in tube making second to none.

They actually *are* superior to the tubes you've been handling. You can see their advantages immediately through the clear glass of the demonstrating tubes that we supply every dealer free of charge to show customers exactly what they're buying; exactly why they are superior; why they will stand the gaff indefinitely, and why they are worth \$2.50 down to the last penny.

PERRYMAN

LABORATORIES AND PLANT—NORTH BERGEN, N. J.

RADIO TUBES

\$2.50
All Types

You can see the difference at a glance



Perryman
Type R. H. 199
Miniature Base
Amplifier and Detector



Perryman Rectifier

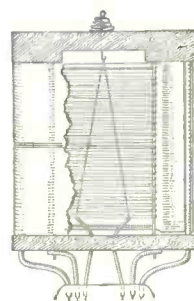

Tube Assembly of Perryman
Type R. H. 201A
and Perryman Rectifier

Notice this new type of tube assembly. The filament, plate and grid are held in permanent parallel alignment at the point of greatest efficiency by two bridges. You can't shake them apart.

These Perryman Tubes not only deliver the greatest efficiency possible, but deliver it for the longest possible period of time.

PERRYMAN Radio Tubes are made in the latest and most modern plant in the country—with George H. Perryman watching them at every step.

You've never seen better built, better looking, nor better operating tubes than the Perryman line. You've never seen more complete, nor more helpful sales support than we give you for use in your own shop. Every Perryman Authorized Dealer receives free display material that is as good as the tubes—and that's saying a lot. Not only does it sell Perryman Tubes—it sells the shop.

Perryman Authorized Dealers get price protection, territorial protection, and the right to sell a line of tubes that has the most interesting sales story in the industry behind it.

We cordially invite Jobbers and Dealers to write us for information concerning Perryman Tubes.

And here's the GUARANTEE

This Perryman Vacuum Tube is guaranteed to be perfect in every respect and to conform with the Electrical Specifications as printed on the carton. We agree to replace it free of charge if it ever fails because of defective material or workmanship.

George H. Perryman

ELECTRIC CO., INC.

SALES AND EXECUTIVE OFFICES — 33 WEST 60th STREET, N. Y. C.

tone

TONE—and tone only is the final point which decides the radio sale. When your customer walks out, it is the faithfulness with which your speaker reproduced the broadcasted program which has or has not clinched the sale.

How vastly important tone is in your business—how vastly important it is to have a speaker which gives real tone.

The Snyder Speaker is that kind of a speaker. Of course it's mechanically right. It will sell speakers *and sets* for you.

Get in on a good thing—*IT SPEAKS FOR ITSELF.*

Distributed by good jobbers at a price which gives you a good money profit. Send for the facts.

HOMER P. SNYDER MANUFACTURING
COMPANY, Inc.
Little Falls, N. Y.

Snyder

FOR FAITHFUL

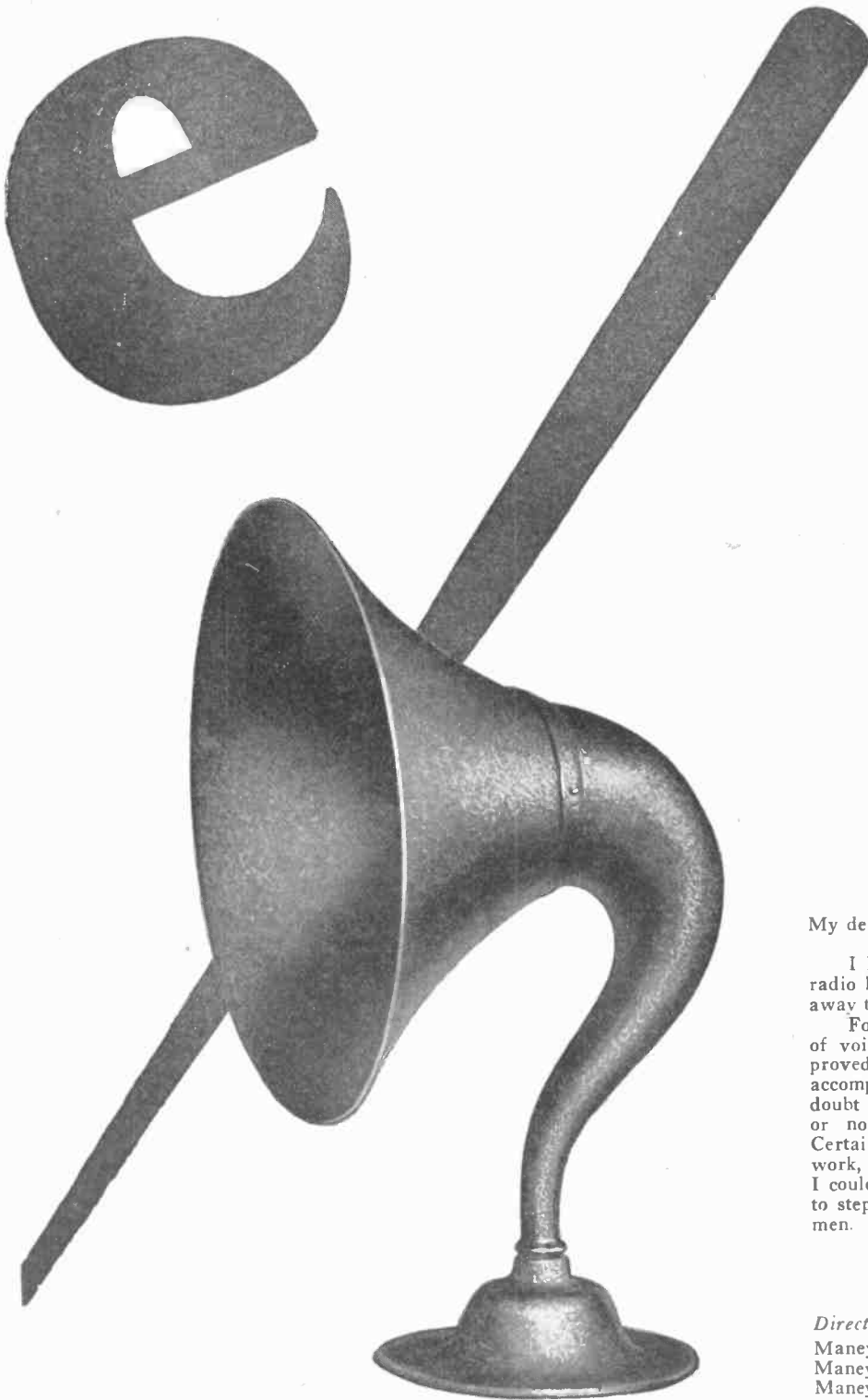

August 19th, 1925

My dear Mr. Snyder:—

I had the pleasure of listening to your new radio horn, last Sunday night, and it is far and away the best I have ever heard.

For depth of tone—richness and naturalness of voice, it is hard to say how it can be improved. I heard Godfrey Ludlow and his accompanist, from the room adjoining, and I doubt if the *person lives* who could tell whether or not the performers were actually there. Certainly *I* could not—and I have been in music work, listening to tones of all kinds, all my life. I could have sworn that it was possible for me to step into the room and shake hands with the men.

Sincerely with best wishes for your success,

JOHN ARTHUR MANEY

Director
Maney's Concert Band
Maney's Symphony Orchestra
Maney's Music School

Speaker

RE — CREATION

Just out-



-the **NEW**
URECO
GOLDENTONE
Power Tube

*the tube
with the
golden color*

LIST \$ **6 50**

URECO GOLDENTONE sets a new standard of power and tone

Cut down on your complaint department right now. You can *double* the efficiency of any set you sell! It's as easy as snapping the fingers to do it. Just prescribe the URECO GOLDENTONE Power Tube for the last audio stage. Result—

1. Coast-to-coast range
2. Heretofore unheard sweetness of tone —
3. *Absolutely free of distortion.*

Why the GOLDENTONE builds up volume

The inside of the GOLDENTONE is *different*—not only different in construction, but additional elements and greater capacities, to increase the flow of plate current to almost twice as much as in the 201A. That means amazingly increased volume—*clear loud-speaker volume on far distant stations.*

Why the GOLDENTONE eliminates distortion

That last tube in the radio set has been heretofore like a man's voice—past a certain range, falsetto, distortion. GOLDENTONE is like *a voice of unlimited range*—no forcing necessary to produce each tone, true and clear. The extra plate current gives it the power to build up the signals *smoothly.*

Not words, but PROOF is what you want. Put the URECO GOLDENTONE in the last audio stage of your own set and you will never take it out.

THE UNITED RADIO & ELECTRIC CORPORATION
418-426 Central Avenue Newark, New Jersey



Eveready Radio Batteries build business and reputation

"SINCE my start in business twenty years ago," says Mr. L. C. Blundin, of Philadelphia, Pa., "my policy has been to handle first-class merchandise only, and give every customer value received for his money." I can't think of another article in my store that fulfills that better than Eveready Radio Batteries.

"Such lines as Eveready Radio Batteries help build a merchant's reputation."

Evereadys are the choice of dealers everywhere, who

are selling satisfaction as well as batteries, and banking confidence as well as profits.

One of the sensations of the year is the great growth in Eveready popularity, manifest to dealers by their increasing sales.

Order from your jobber.

EVEREADY HOUR EVERY TUESDAY
at 9 P. M.
Eastern Standard Time
For real radio enjoyment, tell your customers to tune in the "Eveready Group." Broadcast through—

WEAF New York	WSAI Cincinnati
WJAR Providence	WWJ Detroit
WEEI Boston	WCCO Minneapolis
WFI Philadelphia	WOC St. Paul
WGR Buffalo	WOC Davenport
WCAE Pittsburgh	

Manufactured and guaranteed by
NATIONAL CARBON COMPANY, Inc.
New York San Francisco
Atlanta Chicago Dallas
Kansas City Pittsburgh

Canadian National Carbon Co., Limited
Toronto, Ontario

EVEREADY

Radio Batteries

- they last longer

Rapid Turnover and Greater Profit Available by Concentration on NA-ALD Sockets and Dials

◆◆◆
THE IMPORTANCE OF YOUR JOBBER
 ◆◆◆

THE jobber is an essential factor in successful radio retailing. You can make a larger percentage of profit on your stock investment by making your jobber's warehouse your store room. Because, being able to replenish your stock promptly, you can buy in small quantities, tie up but little capital and turn your stock over rapidly.

Jobber is an expert

By close contact with both retailers and manufacturers, your jobber has an insight into present and future business conditions. He knows what other retailers are doing. He is well acquainted with the requirements of your particular locality.

Your interests are his

This knowledge is a direct aid to you if you will use it in governing your stock purchases. Remember when consulting your jobber that your interests are his interests, because your growth is essential to his success.

When properly used the jobber is far more than a mere connecting link—he is factor of economy, convenience and protection—for both the retailer and the manufacturer. Use your jobber to increase your profits and to speed your business development.

One measure of a good jobber

You may be sure that any jobber handling Na-Ald Sockets and Dials is a leading factor in the Radio business in your section. His methods are sound, his service efficient, and his line full value. The fact that a jobber handles Na-Ald proves him worthy of close cooperation. Make such a jobber not only your source of supply for Na-Ald products but also consider him your "partner." He will help increase your profits and your sales volume.

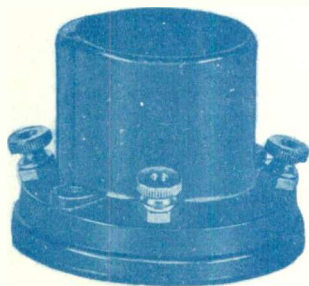

Constructive suggestion

ONE difficulty of radio retailing is due to the initial purchase by the dealer of too many brands of sockets and dials; too much stocking of sockets and dials that are perhaps different in a minor degree in construction or price but which duplicate in their uses; and too little consideration for the healthy sales advantage which concentration upon a carefully selected adequate stock gives you.

Whether or not you standardize on the Na-Ald line, we urge you to select your sockets and dials with an eye to concentration on the fewest adequate number of sockets and dials—and the efficient use of your jobber as a reserve stock depot.

Some Na-Ald products in most stores

Now, frankly, we can suggest this sound procedure freely because as specialists in sockets and dials, and the largest manufacturers of them, we have discovered that few radio stores can get along without some portion of the Na-Ald Socket and Dial line. Good judgment suggests, consequently, that Na-Ald is a profitable line for you to standardize upon for all socket and dial requirements.

Smallest stock needed for Na-Ald line

CANDID investigation will show you that the Na-Ald line is skilfully designed to give the retailer completeness within the smallest possible stock requirements—and in addition unique merchandising and profit opportunity.

Unique features

NOWHERE else can you secure in sockets and dials what the Na-Ald line offers. Check the following points for completeness—and yet remember that the line and its distribution is so planned that only a minimum stock investment is necessary.

Sockets

For every tube—new and old. Cushion mounted. For small space. For sub-panel mountings. Adapters for all requirements of new and old tubes. Priced to produce greatest sales volume. The only socket with side-scraping, self-cleaning double contact. By test, the lowest loss and the lowest capacity.

Dials

A NEW and unique vernier. A massive five-inch dial. Handsome two, three and four-inch dials. Mahogany finished dials. Dials in a variety of colors for better selling and display—separately, and in sets, with generous profit margin. Dials reading counter clock-wise and clock-wise. The only dial scientifically designed and "stop-watch tested" for easiest and quickest operation.

While all this is fundamental in the insurance of minimum carry-over and greatest net profit, the most vital factor remains.

Na-Ald known as standard

RADIO users know Na-Ald as the leading socket and dial line. Anyone who knows the name of any socket or dial knows Na-Ald. Advertising, wide distribution, attractive packages, unique display and quality insure this.

You can properly standardize on Na-Ald because it is already standard in the minds of the radio public. Na-Ald is the fastest selling brand of sockets and dials.

Stock investment in Na-Ald is like money in a good security—sound, on all the markets, and readily salable.

Concentrate on Na-Ald Sockets and Dials. Use your jobber. Mail the coupon.

ALDEN MANUFACTURING
COMPANY

Dept. A-9

Springfield, Mass.

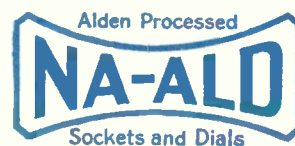

ALDEN MANUFACTURING COMPANY
Dept. A-9, Springfield, Mass.

Send list of Na-Ald jobbers in my vicinity and full information on Na-Ald sockets and dials; also prices, and advertising and dealer helps.

Name _____

Firm _____

Street _____

City _____ State _____



No. 400
75 cents

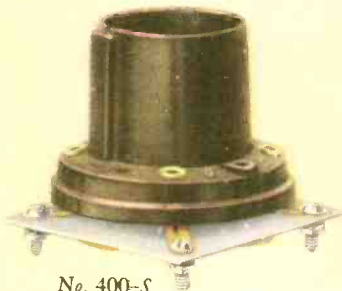

No. 400-S
75 cents



No. 419-X
35 cents



No. 401-S
50 cents



No. 481-X
35 cents



No. 481-XS
50 cents



No. 499-S
50 cents



No. 429
75 cents

Now color adds its charm to the miracle of radio

LET the beautiful warmth and mellowness of blending hues and harmonies of color add to your enjoyment of the miracle of radio. How fitting that the turning of harmoniously colored dials should release the kindred harmonies of sound, which your radio brings you—the thunderous notes of the distant organ, the crashing ensemble of the symphony, mad bursts of passion; all the myriad voices of music that stir the emotions of the heart and uplift it with happiness.

Let color make your set more than an instrument of mechanics and currents. Let it blend in beauty with the most exquisite furnishings of your home. Express your individuality in radio's latest creation — Na-Ald Colored Dials.

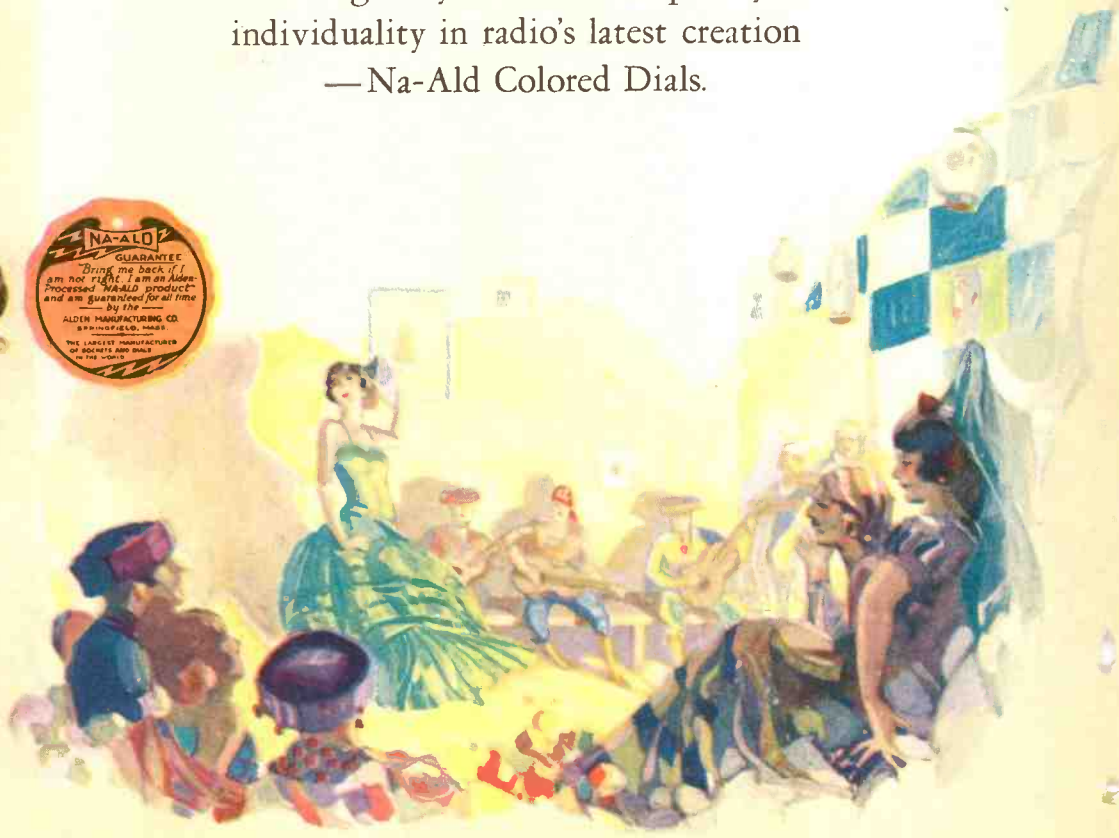



*and behind the mystery
lies technical perfection*

AND behind the Na-Ald colored dials, in the hidden mysteries of the set, have the proper Na-Ald Sockets, so that the delicate unseen currents may do their full work without loss. And when corrosion, at the contact points of tubes and sockets, chokes the voice of your radio, let your hand pass from tube to tube without removing them. Give each a few turns back and forth and clean away this corrosion, which is the enemy of pure reception. Na-Ald sockets, and *only* Na-Ald sockets, with patented duo-pressure scraping contacts accomplish this important work in this simple way. Send today for Na-Ald literature that your radio may have added beauty and perfection.

ALDEN MANUFACTURING COMPANY
Makers of the famous Na-Ald Sockets and Dials
Springfield, Mass.

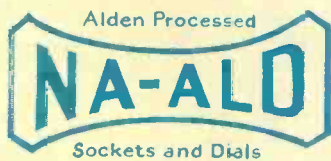

\$5
The SET

Na-Ald de Luxe Dial Set
in all colors.



Malachite-green No. 3054
\$2.50



Garnet No. K3674



Brilliant Tortoise
No. 3044



No. K3844



Mahogany No. 3034



Black No. 3044

Here's Profit Talk!

**You and your jobber's
salesman are talking**



You: "I'll admit, friend jobber, that these Na-Ald colored dials certainly are attractive. And they will sell because they are a novelty—"

Jobber: "But their novelty isn't the half of it! The important thing about them for your profit is that you can sell them in attractive boxed sets of three matched dials and two knobs at \$5.00—a worth while sale with a generous margin. Also, of course, one at a time—an entirely additional piece of business. To be sure, merely by carrying Na-Ald colored dials you show your customers that you're up to the minute in new stock."

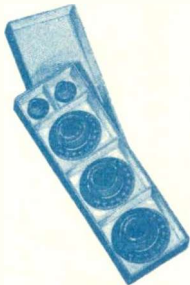

Boxed set of three matched dials and two knobs in choice of colors: brilliant tortoise, malachite-green, garnet, or grain mahogany, \$5.00. The individual Super-de-Luxe Dials 4 inch, No. 3044, in any color, \$1.50 each; knob set No. K3844, in any color, 50c. each.

You: "Who'll buy them?"

Jobber: "Radio owners you thought you'd never sell anything more than tubes to are again your customers for this new distinctive accessory—Na-Ald colored dials. And you know how women like color! Interest women and get them coming in here and you've doubled your business opportunities. Put colored dials on a set and it looks like a new one. It's like putting a big flower garden around a house and making it the show place of the town. You've made your profit on the black dials already—now sell em a new colored set. Colored dials are the rage in radio—like colored stockings for women."

No. 481-X-S Cushion Socket for all new tubes, 50c; with binding posts and without cushion, 35c.

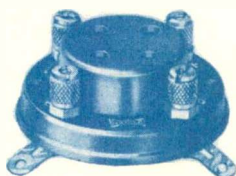

You: "Another thing I can do is to move some of my old stock of sets—by dolling them up with your colored dials!"

Jobber: "You bet—and when you find a prospective set buyer hesitating—just slip on a group of colored dials—and see him decide to buy. Also when you are on a service job, or some one brings in a set for repair, replace the dead black dials with color and make a \$5.00 additional sale."

No. 419-X adapter permits the use of new UX-120 and UX-199 tubes in old sockets, 35c.



You: "Sounds good. Send some along. Now, it seems to me there is a natural big business coming on adapters, with all these tube and set changes. What have you got?"

Jobber: "You can't get ahead of this Alden outfit. Not only has the Na-Ald line been complete—but they have now come out with a complete set of adapters and a new socket that opens up a whale of a business for you. Our Na-Ald line is right up to the minute."

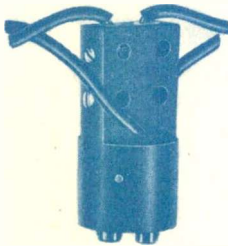

No. 420-X adapter—\$1.25. This adapter is for use with the new UX-120 tube, particularly in RCA Super-heterodyne Sets. It is designed to conform to the limited space available, and to provide connections to B and C batteries for the extra voltage necessary.

You: "Have they a socket for the new tubes? How much?"

Jobber: "Yes. Number 481-X, genuine bakelite, 35c. With cushion mounting, 50c. Everybody who is rewiring for new tubes or building a new set will want it. And here is the adapter story. There is a 419-X adapter at 35c for fitting new tubes to old sockets. There are a lot of people who will do that. Second, the Super-Het No. 420-X adapter, \$1.25, equipped with cables for connections will be snapped up by the owners of Radiola Super-Het, Radiola-Super VIII, and the owners of other sets using UV-199 tubes—in order to get the great increase in volume

and clarity the new UX-120 tube develops. This 420-X will help you sell a lot of tubes you otherwise wouldn't. Finally, there is a new adapter No. 421-X at 75c for use in making the shift from WD-11 to UX tubes. It is especially designed for Radiolas II, III, and III-A. The tremendous army of users of these popular sets are going to get the additional volume the new tubes provide—and buy this 421-X adapter. You will need a good stock of them."

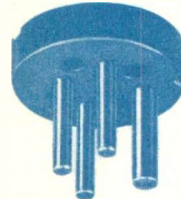

421-X adapter, 75c; last stage \$1.00.

You: "With the three Na-Ald adapters and the new Na-Ald socket I will be able to meet every new tube requirement."

Jobber: "Yes. Better use this coupon now."

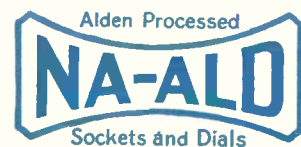

Coupon to your Jobber

Jobber's Name _____
 Name _____
 City _____ State _____
 Send us _____ boxes Na-Ald 4 inch colored dials
 (3 dials, 2 knobs) assorted colors; _____ 481-X,
 _____ 481-X-S (cushion) Na-Ald sockets; _____
 419-X, _____ 420-X, _____ 421-X adapters.
 Also send complete information and display material.
 Name _____
 Dealer _____
 Street _____
 City _____ State _____

See coupon on page 1 for general information. Orders may be sent to the Alden Mfg. Co., Dept. A-9, Springfield, Mass., for shipment through any Na-Ald jobber you select.

Preliminary Announcement

ALL-AMERICAN RADIO RECEIVERS

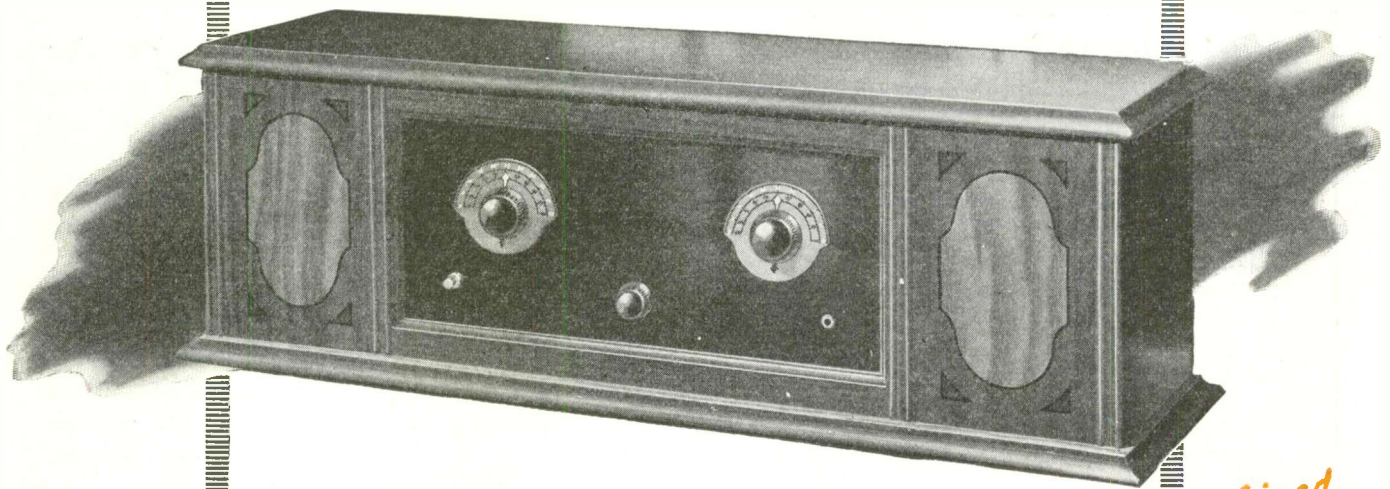

Look at the Set— Then look at the Price— Then look at the Maker's Name. Is there anything on the market to equal it?

Model R: Price \$90.00

There will be available this fall a limited number of radio receivers, produced and wired complete in the new ALL-AMERICAN factory, and bearing the name ALL-AMERICAN.

Many hundreds of sets have been constructed in the ALL-AMERICAN laboratories. Most of them have performed in a manner which, in less experienced factories, would have caused the most joyful excitement. A few of these sets have shown results truly remarkable even when measured by the ALL-AMERICAN standard; but E. N. Rauland, pioneer in radio and severest critic of ALL-AMERICAN products, shook his head and said "Wait."

And he was wise. If this achievement had not come until next year, it would still have been worth waiting for. But it is on view at the shows.

Last year it was our pleasure to add to the family of the "World's Largest Selling Transformers" an audio amplifying instrument embodying features hitherto considered impractical,

outside the laboratory, on account of their high cost. This transformer, Rauland-Lyric, has in one season revolutionized the tone-amplifying art. And now, in the same spirit, we offer the ALL-AMERICAN Receiver.

ALL-AMERICAN Receivers embody, necessarily, all the genuine improvements of the past year in radio reception—many of them the especial product of the ALL-AMERICAN laboratories. Multistage control through two 360° dials, without gears, the elimination of "body capacity," the extreme of beauty in tone through Rauland-Lyric, and of distance, power and selectivity through ALL-AMERICAN Straight-Line-Frequency TUNING—these are combined with the utmost beauty and permanence in external appointments.

And yet, ALL-AMERICAN Receivers are not high-priced. This is due to the fact that, although only a small number will be produced this fall, the price has been set on the basis of next year's extensive production.

This ad. in Popular Science Monthly, Radio News, Radio, Popular Radio, Popular Radio Mechanics, Radio Digest, Radio Broadcast and Q.S.T. will be backed up with heavy advertising, keeping pace with factory production.

Dealers who realize the significance, for future growth, of handling merchandise of this character, are invited to **write their jobbers** or the factory for full information, or to visit our booth at the Chicago or St. Louis radio shows.



ALL-AMERICAN RADIO CORPORATION, E. N. Rauland, Pres., 4207 Belmont Ave., Chicago, U. S. A.



OWNING AND OPERATING STATION WENR—266 METERS

ALL-AMERICAN
Pioneers in the Radio Industry

By Radio Retailing's Own Check,* See Where Premier Stands

What is the 1925 Customer asking for?

"Radio Retailing" asked 100 dealers in ten States what their prospects were demanding of radio sets and also what the trend in buying factors has been since radio's inception in 1922. The answers, given * * * below, will be of inestimable value to the buyer in choosing his merchandise for the Fall market and to the salesman in selling "customer satisfaction."

1. Tonal Quality.

is the first requisite. Customers are demanding faithful reproduction and clarity. To win the women to radio, the raspy note of a year ago must give way to a mellow and pleasing sound.

2. Selectivity.

In centers like Chicago and New York this factor is of paramount importance. Stock and sell only sharp-tuning sets so that customers will not be disappointed by over-lapping of stations.

3. Appearance.

"Radio is style merchandise." Very shortly this factor will head the list. This is a desired evolution if the radio set is to get the premier position in the living room of every home.

4. Price.

Low-priced sets are in demand, but salesmanship and convincing demonstrations can shift sales to a quality basis. Sets and loud speakers made solely for a "price" market are a menace to radio's future.

5. Distance.

The ranks of DX hunters are thinning rapidly. The potential buyers, upon which a sound market must be built, will be satisfied with a dependable local program.

6. Loop Reception.

Self-contained units without unsightly wires are coming more and more into popular favor. While outside antennae are giving more all-round satisfaction, the dealer should stock both types.

7. Volume.

could be considered a prerequisite. But since a set which has not got loud speaker volume could hardly be called a standard article of merchandise, this element is no longer a factor.

SINCE its beginning, Premier has stressed its surpassing tone, a tone of such clear acoustic beauty that it did not seem to be radio at all, as radio was generally known. NOW the reward is being reaped.

While Premier's chief distinction and most salable feature is its clear tone, its general salability will check, item for item, with the points the 1925 customer is asking for, as reported to Radio Retailing.*

So well does it have the essentials for a high average of salability that Premier dealers report, almost invariably, "a demonstration means a sale."

Isn't this the kind of radio you want to handle? An uncommonly generous discount and exclusive sales franchise are other Premier advantages. It will pay you well to send in the coupon and find out more about Premier. Do it now.

**From a check of radio dealers as reported in Radio Retailing for August*

The Premier Radio Corporation

Defiance, Ohio

COUPON

The Premier Radio Corporation,
Defiance, Ohio

Without obligating me kindly send complete description of Premier radio and details of dealer agreement.

Name

Company

Address

TIMMONS B-Liminators

STAY SOLD

Right now there are thousands and thousands of B-Liminators in daily use. The people who own and use them are enthusiastic about their performance. They are telling their friends about getting away from the annoyance and expense of B batteries.

These personal endorsements, together with the approval of eighteen or more radio publications and newspapers, mean that thousands more B-Liminators are going to be sold this year.

—And they will stay sold.

For B-Liminators had to pass more severe tests in the laboratories of radio publications and newspapers than they will ever be called upon to pass in actual use. There is no servicing to a B-Limiter, and you sell it complete with special tube. The new price is \$28.50.

This low price also will be a factor in the big sale of B-Liminators. At new discounts which you can get from your jobber, this means big money from B-Limiter sales.

Our advertising is just getting under way in newspaper and radio publications. We also have B-Limiter literature, window and counter signs, all of which help you to sell B-Liminators.

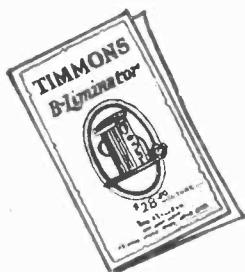

**TIMMONS RADIO PRODUCTS
CORPORATION**

Germantown, Philadelphia



Standardyne

OFFERS YOU 3 THINGS!

AN ABSOLUTELY PROTECTED EXCLUSIVE FRANCHISE.
 AN ADVERTISING CAMPAIGN NATIONAL AND LOCAL.
 A RECEIVER OF ESTABLISHED QUALITY AND POPULARITY.

Our dealer's Franchise insures you a product of established sales value, an advertising campaign designed to bring the customer to your counter and an exclusive territory positively protected, supplemented by a wonderful array of selling helps in the form of advertising supplies.

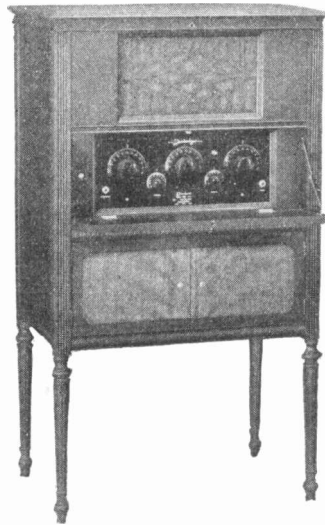

**CONSOLE MODEL
 BH**
 LIST PRICE \$135.00

Model B5 and Model BH Standardyne Radio Receivers present the ultimate in radio at popular prices. Model BH is a magnificent mahogany console type with built-in loud speaker, while Model B5 is the de luxe cabinet type.

5 Tubes
 Tuned Radio
 Frequency

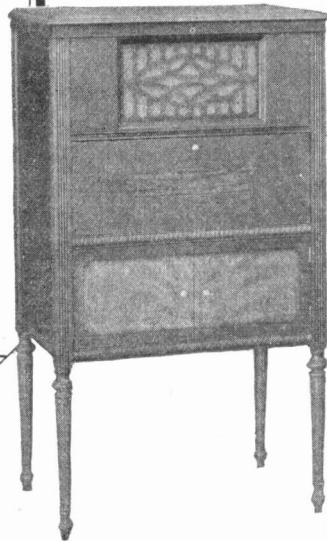

Pacific Coast and Mountain States Prices:
 Model B-5 \$65.00
 Model BH \$160.00

MODEL B5
 LIST PRICE \$60.00



DEALERS - Have You Secured Your Standardyne FRANCHISE?
 Apply to **BEN W. FINK** *Sole World's Distributor for*
 1123 Broadway, New York
 The Standard Radio Corporation
 Worcester, Mass.

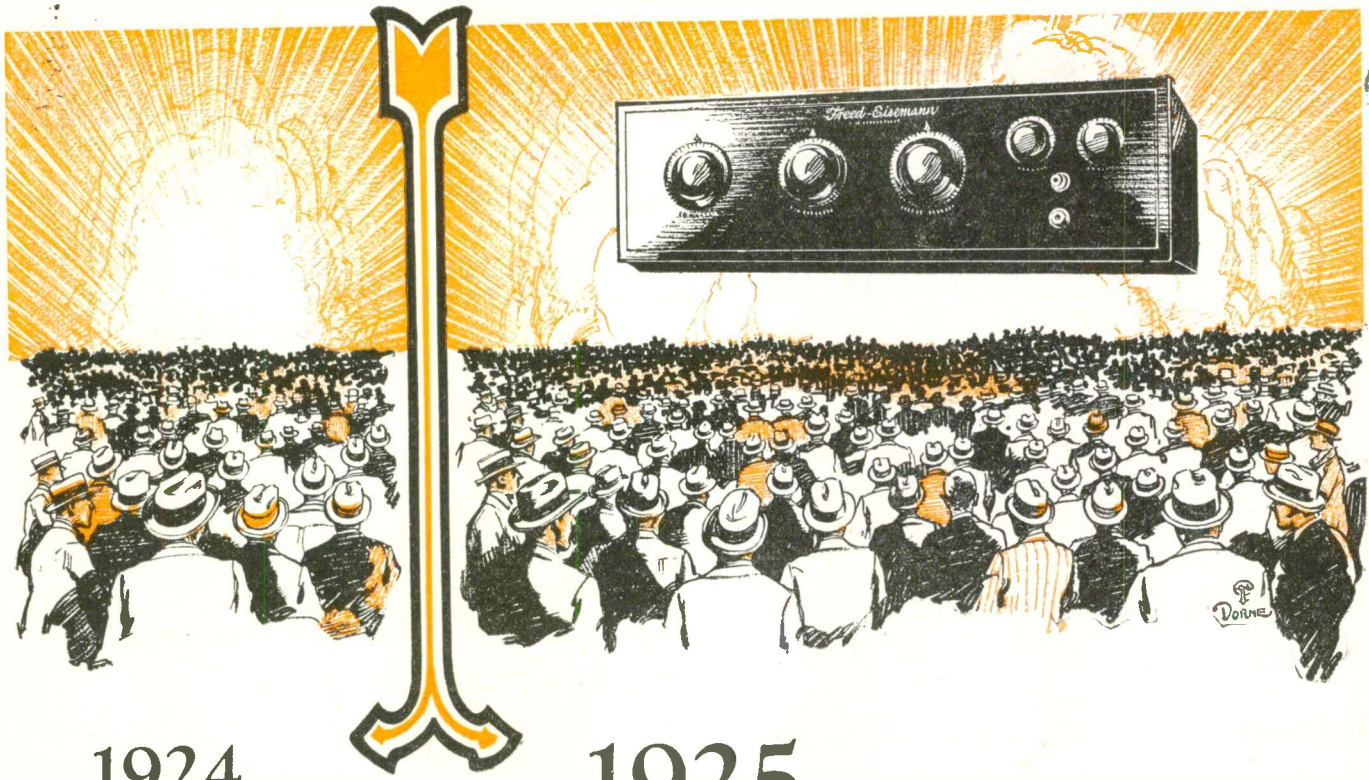

1924

1925

Four times as much business as the same period last season!

The reason why dealers are so eager for the Freed-Eisemann franchise is best expressed by the voluntary statement of a Cleveland dealer at a large dealer meeting.

He arose and said to his fellow-dealers:

“I am sold on the Freed-Eisemann proposition because Freed-Eisemann is the first big company to recognize that a dealer, in order to

make money, needs 40% and 10% on the majority of sets he sells.

“Freed-Eisemann has a fine line of radio receivers and they give us a franchise contract that has teeth in it and that really means something.”

Get full details! Write to the Freed-Eisemann exclusive territorial jobber, or write to us and one of our executives will reply personally.

Licensed
under
Hazeltine
Patents

Freed-Eisemann Radio Corporation
MANHATTAN BRIDGE PLAZA, BROOKLYN, N. Y.

Licensed
under
Latour
Patents

FREED-EISEMANN

MASTERY IN RADIO

Kolsters Anticipate

Kolsters satisfy every requirement of the CONSUMER

The public demands reality in tone—
tonal perfection.

It demands easy tuning—preferably
single control.

It demands a quiet set with no back-
ground noises.

It demands selectivity—no interference.

It demands ample sensitivity.

It demands beautiful cabinets harmo-
nizing with fine furniture.

It demands service based upon a re-
liable guarantee from the manufacturer.

Kolster Radio satisfies all these reason-
able demands of the public.

Because of this, Kolster Radio is a
money maker for progressive dealers.



Kolster Eight. Single control. Internal
loop. Provisions for external loop or
antenna. Built-in reproducer.



Kolster Six. Dual control for
antenna. Built-in reproducer.

Public Demand

Kolsters satisfy every requirement of the DEALER

Federal Telegraph Company,
(of California)
Woolworth Building, New York, N. Y.

Please send me particulars regarding Kolster Radio and the Kolster dealer proposition.

Name _____

Street _____

City _____

State _____

Progressive dealers must have, in addition to a set which satisfies public demand, territorial protection.

They must have a substantial margin of profit.

They must have protection against obsolescence.

They must have protection against erratic price fluctuations.

They must have aggressive advertising

support. Kolsters more than satisfy these reasonable demands of progressive dealers.

Because of all this, Kolster Radio is the line for you to handle.

Write, wire or mail the coupon for complete information.

FEDERAL TELEGRAPH COMPANY
(of California)

Woolworth Building, New York City

Kolster Eight. Single control. Enclosed, rotating loop. Also provision for antenna. Built-in reproducer.

Kolster Six. Dual control for antenna. External reproducer.



We tell them-



\$35 The new

you sell them

What is already the talk of radio engineers
we are now making the talk of radio fans—
and that's where you can profit!



MILLIONS of owners of multi-tube radio sets are being told and sold Unipower through a national advertising campaign in *The Saturday Evening Post* and the radio magazines. Every one of these advertisements is in full page space telling a complete and convincing story.

This advertising is thorough. It is extensive and intensive. It is concentrated in the best buying months of the year. It reaches millions of prospects and does this persistently with page after page, month in and month out.

Thousands of the fans this advertising is selling are right in your territory. Many of them are already your customers. And those that are not, you want, and we have a plan that will help you get your share of them.

But first find out what Unipower is

Now, for the first time, the radio owner may have complete, continuous "A" power supply in a single compact unit always at full voltage and completely controlled by a master switch which operates both radio set and Unipower—and all this at an operating cost of only a few cents a month.

Note that Unipower is *not* a so-called battery eliminator and should not be confused with any other radio power device.

For the first time owners of R. C. A. super-heterodynes and other cabinet sets with limited battery space may have a permanent "A" battery supply which can be *safely* put inside the cabinet.

Unipower is unique. When the radio set is on, the house current is off. When the set is off, Unipower is automatically replenishing itself from the house

current. These and other advantages, together with Unipower's low price, make for quick, easy sales—and your profit on each sale is large!

Here is a means of getting many new customers

If you want to cash in on this latest sensation in radio, if you want to hold old customers and attract new ones, if you want to increase your sales and profits immediately, then get behind this advertising by stocking Unipower at once. (Order from your jobber.)

Then put our dealer plan to work for you. It is simple but effective. It provides a means of attracting customers and prospects into your store through sales helps we supply, *free*; booklets, counter display and newspaper advertising.

Write for folder!

Send right now for "Special Dealer's Folder." It tells the complete story of the big advertising campaign behind Unipower. It explains how you can quickly and easily cash in on this advertising. Write today and the complete dealer plan will reach you *promptly!* Gould Storage Battery Co., Inc., 250 Park Ave., New York, Chicago, Kansas City, San Francisco.

Unipower is supplied in two models for 60-cycle, 110-125 volt A. C. Each model is equipped with a Balkite charger of special design. The four volt type is for UV-199 tubes or equivalent and retails for \$35; the six volt, for UV-201-A tubes or equivalent, retails for \$40. (West of Rockies prices are \$37 and \$43.) Special models, 25-50 cycle, are available.

Unipower

TRADE MARK

Off when it's on ~ On when it's off

Manufacturers: If They Left You Out

THINK of the inconvenience you would be caused and the sales you would lose if the telephone company left you out of the phone book. Your business would go to other companies in your line—manufacturers who were listed in the directory.

Yet how much more important it is for your company to be properly represented in a directory that is used not in your city alone but in every community in the entire country in which radio is sold—"The Radio Trade Directory."

This is the Directory that contains complete, classified lists of manufacturers of all products sold or used in the radio industry. Radio dealers, jobbers and manufacturers refer to it for sources of supply, names, addresses and other "necessary-to-order" data, whenever they are in the market for material of any kind. "The Radio Trade Directory" is always referred to for buying data before an order is placed.

All known manufacturers are listed in "The Radio Trade Directory." But it is only natural for buyers to place their orders with those manufacturers whose products are *cataloged* in the Directory as well—who give all the necessary buying data on their products.

Cataloging your products in "The Radio Trade Directory" is advertising. So is inserting your name in the phone book or issuing a catalog. But all of these are *reference* advertising—advertising that is vitally necessary if *educational* advertising is to be properly supported.

of the Phone Book???



Every recognized radio dealer who sells something more than sets alone, every radio jobber and every radio manufacturer—over 20,000 of them in all—get each issue of "The Radio Trade Directory" which is issued quarterly by the world's largest business publications house.

The radio manufacturer who wants to lay a solid foundation for his publicity invariably catalogs his products in "The Radio Trade Directory," the Catalog Carrier of the Radio Industry.

Cataloging your products in the Directory, where they will be seen before an order is placed, is a surprisingly inexpensive investment, too.

The Radio Trade Directory

Carrying "where-to-buy-in-a-flash" information to the radio industry

McGraw-Hill Company, Inc., 475 Tenth Avenue, New York

KODEL RADIO

The Emblem of  Worth in Radio

The Best that Radio Offers



LOG·O·DYNE
"BIG FIVE" **\$90⁰⁰**

Five tubes, self-balanced tuned radio frequency; sloping panel gold engraved; beautiful, massive, Adam brown mahogany cabinet; compartment for batteries; stations already logged for easy tuning.

If the LOGODYNE Big Five excelled only in performance it would not be a KODEL RADIO.

But combining as it does the ultimate in good performance, a tone as mellow and true as a rare old music instrument, a cabinet artistry worthy of the old masters the LOGODYNE Big Five expresses the perfection required of the entire KODEL RADIO line—the best that radio offers.

Free Send for the new edition of our free booklet "The Secret of Distance and Volume in Radio". Gives helpful interesting information on radio operation.

THE KODEL RADIO CORPORATION
503 East Pearl Street Cincinnati, Ohio

WKRC
Owners of Kodel Broadcasting Station WKRC on the Alms Hotel. Send for program.



LOGODYNE "Big Five" Console Model—the Aristocrat of Radio; built-in loud speaker; compartment for batteries and charger a masterpiece in furniture design. **\$275**

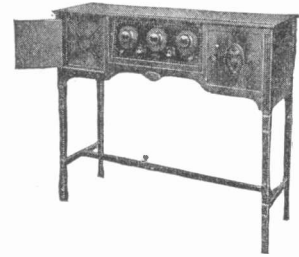

LOGODYNE "Standard Five" Console Model—beautiful brown mahogany; built-in loud speaker; compartment for A and B batteries and charger. **\$165**

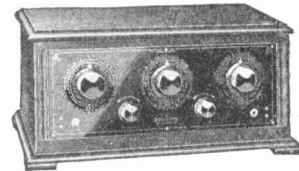

LOGODYNE "Standard Five"—five tubes self-balanced tuned radio frequency; gold engraved panel and sub-panel; battery compartment; handsome brown mahogany cabinet. **\$70**

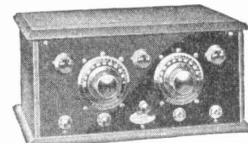

KODEL "Gold Star" Models—Radio's greatest set values:
Three Tube "Gold Star" Model. **\$30**

Two Tube "Gold Star" Model. **\$20**

One Tube "Gold Star" Model. **\$12**

"Gold Star" Crystal Set. **\$ 6**



THE NEW LOW WAVE 1926 ECHOPHONE RECEIVERS NOW READY



"R-3" \$48.00

Tube, 3 Circuit, Non-radiating regenerative receiver

Buy for the future

The outstanding feature of the 1926 Echophone line is its provision for a low wave tuning range from 550 to 150 meters. The use of low waves is inevitable. Echophones give you an enormous sales advantage in that they reach stations that can't be tuned in on other sets.

Tone Quality, Selectivity and Beauty

The design of our cabinets has reached a high degree of perfection. The most critical customer will be convinced upon seeing them. We seek comparison with all other sets on the market in the above three features. Tone quality and selectivity are attained with—SINGLE and DUO-DIAL CONTROL—which permits of simplicity of operation formerly not thought possible.

Echophone policies guarantee PROFIT—PROTECTION— PERMANENCE

1. Profit for both distributor and dealer through liberal discounts offered.
2. Protection against price reduction and by exclusive dealer sales franchise.
3. Permanence by the good will established through extensive advertising in national publications and local newspapers.

We stand behind the dealer at all times with our SERVICE and COOPERATION.

Write for detailed information and give us the name of your distributor; or better, order now.



Console \$200.00

R-5 Console with built-in Loud Speaker



"R-5" \$85.00

5-tube Tuned Radio Frequency
Solid Mahogany Cabinet

Echophone Radio, Inc.

1120 N. Ashland Ave., Chicago, Ill.

Echophone Sales Co.
San Francisco

Echophone Radio Shop
Long Beach, Calif.

ECHOPHONE



POOLEY
RADIO CABINETS
with
ATWATER KENT
RADIO

POOLEY
RADIO CABINETS
with
ATWATER KENT
RADIO

Model 1120-R-2
Stuart Style. Walnut or Mahogany. Price complete, less tubes and batteries. \$225.
Model 1110-R-2, with open receiving set. \$210

Model 1100-R-2
Italian Style. Walnut or Mahogany. Price complete, less tubes and batteries. \$200

Pooley saw what women

WHEN the Pooley Company turned their attention to radio, they saw what women wanted—radio made more beautiful.

For 42 years Pooley had designed and made to "special order", much of America's finest furniture. You may see it in the Plaza, Waldorf-Astoria, Bellevue-Stratford, St. Regis, Fairmont, Ritz-Carlton hotels—in distinguished clubs and mansions.

For 25 years Pooley had put phonographs into cabinets of arresting beauty and out of resonant woods had built a concealed horn of luscious tone.

To Pooley craftsmen, a radio or radio-phonograph meant

a musical instrument. Their conceptions arise with orders.

Now, six new Pooleys are presented—built-in Pooley flared (according to model). All mechanism is in gems in walnut, Stuart, Italian or

To adorn a lover's dealer show you.

The new Pooley model and described in a



Closed view of Model 1120-R-2

Prices slightly higher west of the Rockies and in Canada

Leave nothing to desire— but possession

LET radio bring beauty into the home. Let the classic furniture periods lend their exquisite lines and details to cabinets of rare woods. Let the top be convenient for flowers. Let the radio and its accessories be concealed yet immediately accessible. All this Pooley makes possible.

Radio has made an immense advance. You see it in Pooley Radio Cabinets with 5-tube Atwater Kent receiving set and built-in Pooley floating horn. They leave nothing to be desired by lovers of radio and of beauty—except possession. Visit the Pooley dealer near you.

Six beautiful, new Pooley Radio and Radio-Phonograph Cabinets, priced from \$75 to \$205, are shown and described in a booklet that is waiting for you. Send for it

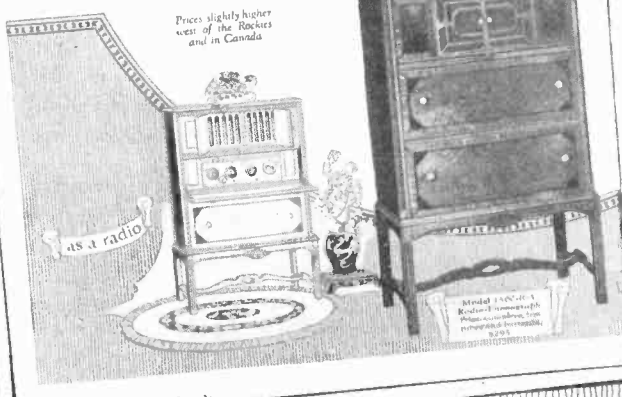

Prices slightly higher west of the Rockies and in Canada

Saturday Evening Post, Oct. 31

In addition to these Saturday Evening Post advertisements, you will see Pooley advertising in the October numbers of Good Housekeeping, Vogue, Vanity Fair and House & Garden.



Console Model 1400-R-1
Louis XVI Style—English brown mahogany only. Height, 2 ft. 7 1/2 in.; length, 2 ft. 10 in.; depth, 15 3/4 in. The top of Console on which a set can be placed is 28 1/2 in. long by 10 in. deep. Accommodates any Atwater Kent Receiver. Price, less Set, tubes and batteries—\$75.



THE POOLEY COMPANY
1646 Indiana Ave., Philadelphia, U.S.A.

Model 1400-R-1
Louis XVI Style
Mahogany. Price complete, less tubes and batteries. \$75.

Open view of Model 1120-R-2
Stuart Style. Walnut or Mahogany. Price complete, less tubes and batteries. \$225.

Model 1100-R-2
Italian Style. Walnut or Mahogany. Price complete, less tubes and batteries. \$200.

Saturday Evening Post, October

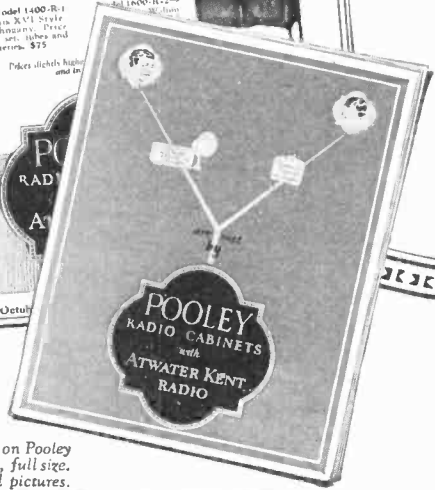

Have you seen the new sales and advertising portfolio on Pooley Radio Cabinets? Shows 1925 fall and winter advertising, full size. Packed full of Pooley selling features, in words and pictures.



See how
Pooley advertising
tells your story in
your community

REMEMBER this about national advertising—it goes to the best buyers right in your town. Two and a quarter million American homes get The Saturday Evening Post every week. These two October Pooley advertisements in the Post will go into nearly every home in your sales area where a Pooley can be sold. Pooley advertising is planting new ideas about radio in those families, arousing their curiosity and interest. Now let them know that you can demonstrate Pooley models.

Your own local advertising brings right into your store, your full share of benefit from our national advertising. We will gladly furnish mats or electros of newspaper advertisements and cuts, ready to use at once.

Have you protected yourself with orders to your distributor for your Pooley needs? Do so without delay. All we have said about heavy demand is already more than true. It's a great big Pooley year.

THE POOLEY COMPANY
Radio Sales Department E

1602 Indiana Ave., Philadelphia, U.S.A.



Model 1600-R-2
Italian style—English brown mahogany or American walnut, duotone. Height 3 ft. 5½ in.; length 2 ft. 10½ in.; depth 16¾ in. Equipped with the Atwater Kent Model 20 Compact, 5-tube Panel Type Receiving Set. Price complete, less tubes and batteries—\$200.

Model 1120-R-2
Stuart Style—English brown mahogany or American walnut, duo-tone. Height 4 ft. 4½ in.; length 2 ft. 9 in.; depth 15½ in. Equipped with the Atwater Kent Model 20, 5-tube Panel Type Receiving Set. Price complete, less tubes and batteries—\$225.

Model 1110-R-2
is the same except equipped with Model 10 Atwater Kent 5 tube Open Set. Price complete, less tubes and batteries—\$220.

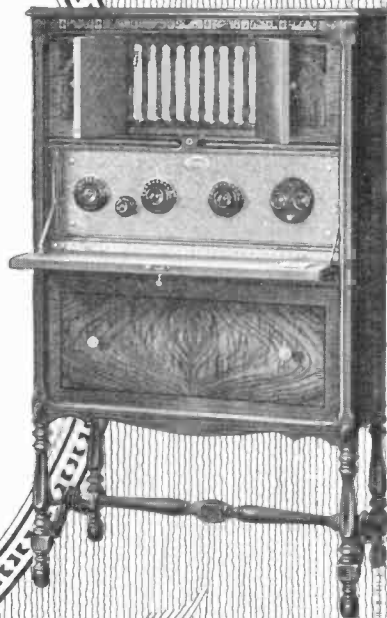
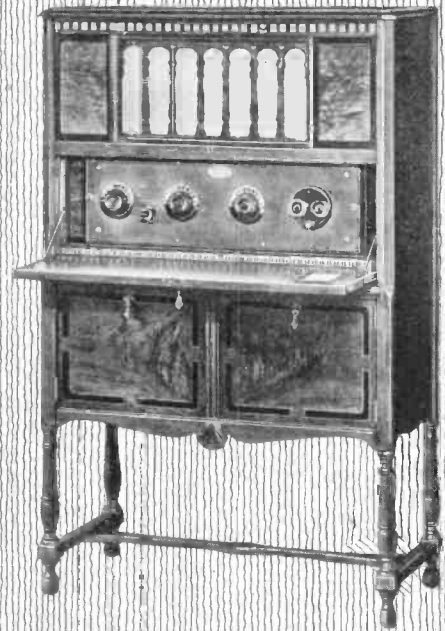

Model 1320-R-2D
(Same as Model 1320-R-2, but with doors covering grille.)
Stuart Style—English brown mahogany or American walnut, specially selected Oriental burl, rosewood and walnut inlays. Height 4 ft. 2¾ in.; length 2 ft. 5¼ in.; depth 15½ in. Equipped with Atwater Kent Model 20, 5-tube Panel Type Receiving Set. Price complete, less tubes and batteries—\$265.

Model 1320-R-2
Stuart Style—English brown mahogany or American walnut, specially selected Oriental burl, rosewood and walnut inlays. Height, 4 ft. 2¾ in.; length 2 ft. 5¼ in.; depth 15½ in. Equipped with Atwater Kent Model 20, 5-tube Panel Type Receiving Set. Price complete, less tubes and batteries—\$260.

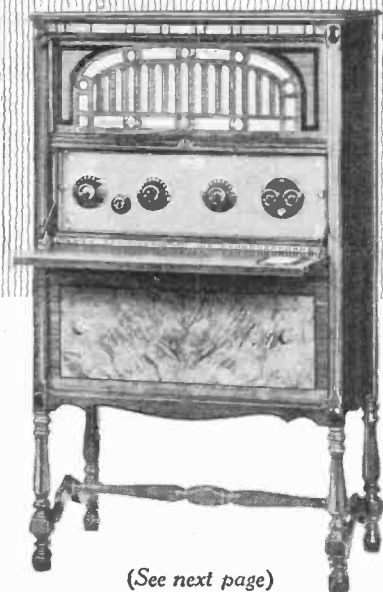

(See next page)



POOLEY
RADIO-PHONOGRAPH
with
ATWATER KENT
RADIO

As a Phonograph

**A lovely adornment
— an unrivalled
entertainer**

BEFORE you is a lovely Chippendale cabinet—more lovely in its graceful lines and exquisite woods than any picture can reveal. It is Pooley's conception of a radio and phonograph combined in a piece of beautiful furniture.

Just such a gem as you should expect from Pooley's forty-two years of "special order" furniture making for the finest mansions, clubs and hotels of America.

With all its beauty, here is an unrivalled entertainer. A 5-tube Atwater Kent Receiver—a superbly toned Pooley Phonograph—a built-in Pooley floating horn whose mellow clarity is a revelation—are all there. Everything hidden, including batteries and wires. Everything accessible and the cabinet top stationary. A lovely adornment in your home—an unrivalled entertainer.

The Pooley dealer will demonstrate.

THE POOLEY COMPANY
1644 Indiana Ave. Philadelphia, Pa.

BESIDES the Radio-Phonograph, beautiful new Pooley Radios are priced from \$75 to \$150. They are described in a separate booklet. They are equipped with 5 tubes and the latest batteries. \$225

Model 1310-R-2
Grand Style Walnut or Mahogany. Price complete, including tubes and batteries. \$760

Model 1120-R-2
Grand Style Walnut or Mahogany. Price complete, including tubes and batteries. \$225



POOLEY
RADIO-PHONOGRAPH
with
ATWATER KENT
RADIO

Chinese Chippendale Style
Model 1500-R-3

The Pooley Radio-Phonograph, American Walnut or English brown mahogany, duospace, selected burr wood. Height 50", width 30", depth 18". Equipped with Atwater Kent 5-tube Model 10 Receiver. Built-in Pooley horn with Phonograph in an adjoining chamber. Plays all standard records. Price complete, including tubes and batteries. \$295

POOLEY
RADIO-PHONOGRAPH
with
ATWATER KENT
RADIO

Price slightly higher west of the Rockies and in Canada

POOLEY
RADIO - PHONOGRAPH
with
ATWATER KENT
RADIO

**On the eye no less than the ear. If the
can be accomplished, Pooley and
have done it.**

**combined in a lovely Chippendale cabinet—here
entertainment. A superbly toned Pooley Phono-
floating horn whose mellow clarity is a revelation
all here. Everything is hidden, in-
stantly accessible. The cabi-
nity and art.**

**ey Radio Cabi-
a booklet that**

The Pooley Radio-Phonograph is featured in the Saturday Evening Post of Sept. 19, half page, and October issue of Good Housekeeping, 2/3 page, out Sept. 25.

October issues of Vogue, Vanity Fair, House & Garden, whose readers will like the Pooley Radio-Phonograph and the full page style of its presentation here.

We believe in Advertising

POOLEY dealers have ordered a lot of Pooley Radio-Phonographs. We have been shipping them fast for weeks. This rapid development proves we are right in nationally advertising them.

Here are two of the advertisements.

The best people in your market will know about Pooley Radio-Phonographs with Atwater Kent radio. Will they know that you have them? Pooley Radio-

Phonographs are a hit and deserve to be. It looks as if our big problem will be to make enough of them.

If you have stocked them, advertise the fact in your local papers. We are sending you a catalog of handsome newspaper advertisements and cuts, ready to use at once. If you do not get yours, write us.

If you haven't stocked them, see your Pooley distributor. We can send his name to you.

The POOLEY COMPANY

1602 INDIANA AVENUE
PHILADELPHIA, U.S.A.

See preceding page

ATWATER KENT RADIO

*Are you
ready for
the rush*

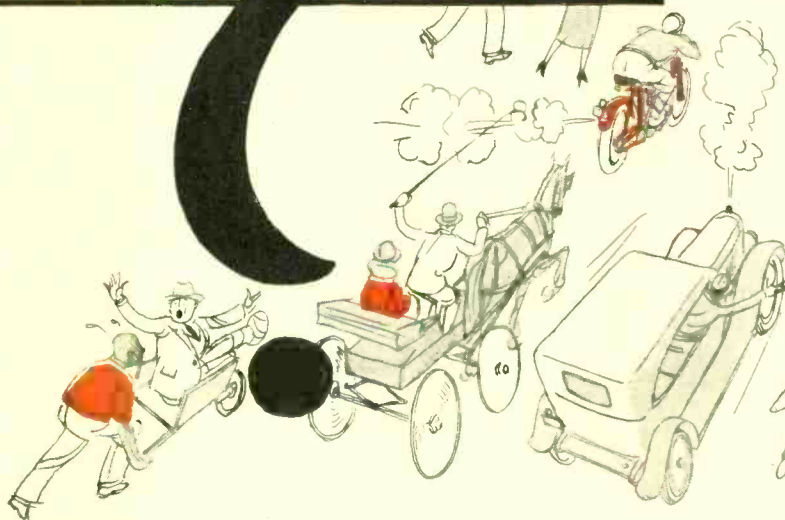

ATWATER KENT RADIO

*Are you ready
for the rush?*

OCTOBER BUSINESS is opening with a rush that we did not anticipate even in August, when we made our predictions of a big fall market. This activity is reflected in every phase of Radio.

It is a situation for earnest consideration by radio distributors and dealers who are seriously in the business.

The time has nearly passed in Radio, as it passed years ago in the automobile business, when a dealer carried an assortment of several competing makes so that he "wouldn't miss a sale." Shrewd merchants have found out that the radio buyer nowadays doesn't take what is urged upon him, but buys what he knows.

This fall, as never before, Atwater Kent is known favorably to the country. For during the past summer there was no let-up in Atwater Kent sales effort. Many powerful national magazines carried the Atwater Kent message. Billboards in unprecedented number flashed their message to the passing motorist and pedestrian.

Hundreds of thousands of prospective buyers have been convinced by this steady activity through the hot months, that Radio has at last produced a year-'round set—and that it is the ATWATER KENT.

ATWATER KENT RADIO

Atwater Kent enjoys national recognition. Atwater Kent and very few others must supply the bulk of the demand. Our new twelve-acre factory enables us to meet a record-breaking increase in business, but there is a bottom even to the ocean!

What Radio are you going to offer to *your* customers this fall?

Is it known to everybody?

Is it backed by a strong manufacturer?

Is it built right?

Is its price right?

Are you ordering it before the rush comes?

Will it sell; and *will it stay sold?*

Something to think about and something we will gladly talk over with the right kind of merchants in territories where we may still need additional representation.

ATWATER KENT MANUFACTURING COMPANY

A. Atwater Kent, President

4733 WISSAHICKON AVENUE

PHILADELPHIA, PENNSYLVANIA

*Write for
illustrated
booklet*

telling the complete story of Atwater Kent Radio.

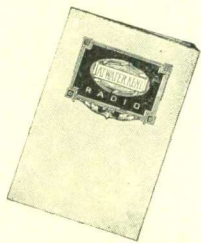

Every Thursday Night—

the potential audience of the Atwater Kent Radio artists, who broadcast from ten stations every Thursday evening from 9 to 10 o'clock (eastern standard time), is estimated at more than 10,000,000. These are the stations:

WEAF . *New York*
WJAR . *Providence*
WFI . . *Philadelphia*
WEEI . *Boston*
WSAI . *Cincinnati*

WCAE . *Pittsburgh*
WGR . . *Buffalo*
WWJ . *Detroit*
WOC . . *Davenport*
WCCO . *Minneapolis-
St. Paul*

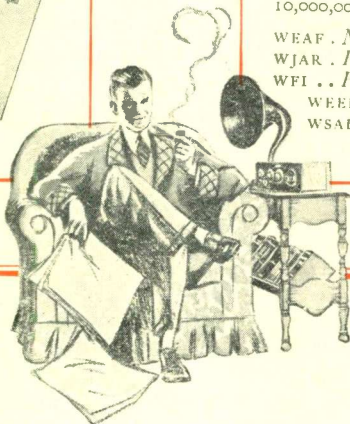

ATWATER KENT RADIO

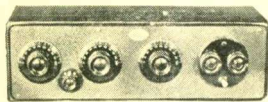

Model 20 Compact, including battery cable, but without tubes, \$80

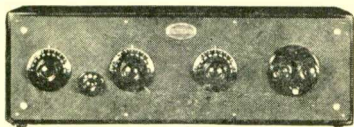

Model 20, without tubes, \$80

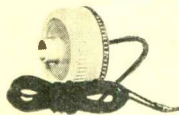

Phonograph Attachment, with 9' flexible cord, \$8

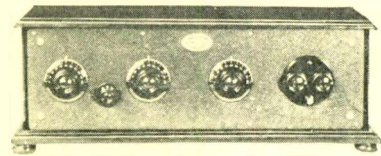

Model 24, without tubes, \$100

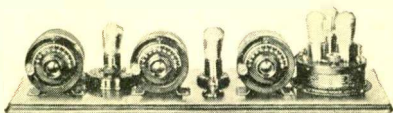

Model 10, including battery cable, but without tubes, \$80

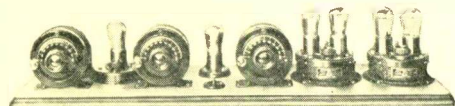

Model 12, built on special order, including battery cable, but without tubes, \$100

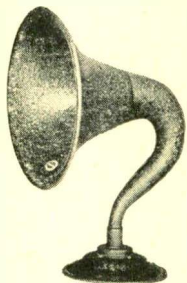

Model H, with 9' flexible cord, \$22

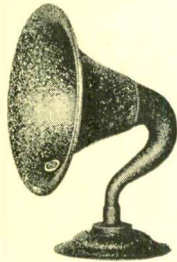

Model L, with 9' flexible cord, \$17

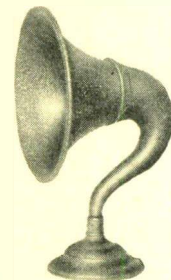

Model M, with 9' flexible cord, \$28

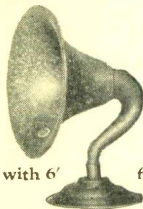

Model R, with 6' flexible cord, \$12

Prices slightly higher from the Rockies west, and in Canada

J. ANDREW WHITE,
Contributing Editor
S. J. RYAN,
Consulting Editor
E. E. WHITEHORNE,
Contributing Editor
L. E. MOFFATT,
Associate Editor
PAUL WOOTON, Washington

Radio Retailing

The Business Magazine of the Radio Industry

O. H. CALDWELL, Editor

M. CLEMENTS,
Managing Editor
WILLIAM C. ALLEY,
Associate Editor
H. W. BAUKAT,
Assistant Editor
H. S. KNOWLTON, Boston
C. GRUNSKY, San Francisco
RAY SUTLIFFE, Chicago

Table of Contents

October, 1925

Extend the Buying Season Into the Spring	472
Service Is Foundation for Future Sales	474
Every Farmer Needs a Radio Set	477
"The Farmer Must Be Shown"	479
News of the Month in Photo Form	481
"Straight Line" Is 1926 Style in Condensers	483
"Getting 'em Into the Store"	485
Action Windows Make Passersby Stop	487
"What Kind of a Merchant Are You?"	488
Who Is Jobbing Radio Today?	490
Interesting the Women in Radio	491
"Lamp Socket Radio" Here to Stay	493
Selling to the Business Man in His Office	494
Radio Programs from Dawn to Dawn	495
Enjoyment Is the Year-Round Keynote	496
The Editors Have This to Say—	502
New Radio Products Seen at Shows	504
What the Trade Is Talking About	514
Dealer Helps the Manufacturers Offer	521
Specifications of Batteries	522

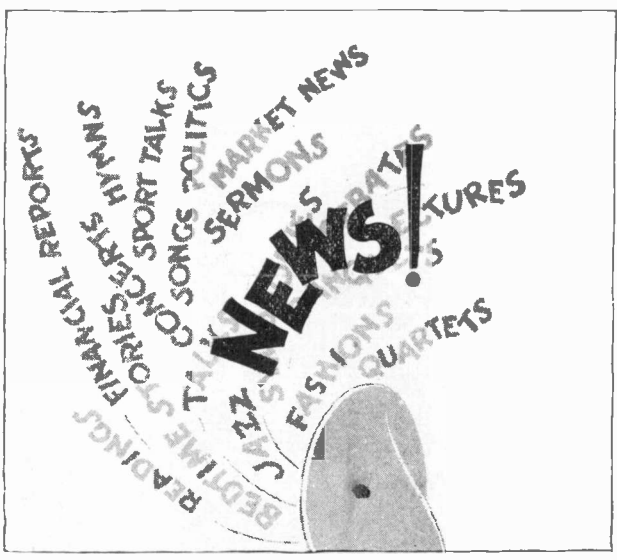

Broadcasting of News May Prove Radio's "White Hope"

RADIO is a public utility only to the farmer. He uses it for weather and market reports. With him it is in a class with transportation, telephones, newspapers, etc. Its service appeal is on a par with its enjoyment or luxury appeal.

To the city dweller, radio as a public utility is still a misnomer. It is only a few laps ahead of the phonograph or player piano. Generally speaking, the public thinks of it solely in terms of entertainment.

Can this conception be changed by making radio an adjunct of the newspaper? Brief, last minute news reports "on tap" at definite periods throughout the day, including the time when the head of the home is at his breakfast table, offer a means of keeping listeners-in interested in radio all year 'round.

* * * *

A discussion of this subject from the viewpoint of the trade, newspaper publishers and broadcasters will appear in an early issue.

McGraw-Hill Company, Inc., Tenth Avenue at 36th Street, New York, N. Y.

JAMES H. MCGRAW, President
ARTHUR J. BALDWIN, Vice-President
MALCOLM MUIR, Vice-President
EDWARD J. MEBREN, Vice-President
MASON BRITTON, Vice-President
JAMES H. MCGRAW, JR., V.-P. and Treas.
C. H. THOMPSON, Secretary

Electrical World Journal of Electricity Ingenieria Internacional
Industrial Engineer Engineering and Mining Journal-Press
Chemical & Metallurgical Engineering American Machinist
Electrical Merchandising Power Electric Railway Journal
Bus Transportation Engineering News-Record Coal Age
Copyright, 1925, by McGraw-Hill Company, Inc.
Cable Address: "Machinist, N. Y."
Annual subscription rate is \$2 in United States and Canada.

WASHINGTON, D. C., Colorado Bldg.
CHICAGO, 7 South Dearborn St.
PHILADELPHIA, Real Estate Trust Bldg.
CLEVELAND, Leader-News Bldg.
ST. LOUIS, 713 Star Bldg.
SAN FRANCISCO, 383 Mission St.
LONDON, E. C., 8 Boulevard St.

Use Today's Buying Crowds as a Basis

1925 OCTOBER 1925							1925 NOVEMBER 1925							1925 DECEMBER 1925							1926 JANUARY 1926						
Sun	Mon	Tue	Wed	Thu	Fri	Sat	Sun	Mon	Tue	Wed	Thu	Fri	Sat	Sun	Mon	Tue	Wed	Thu	Fri	Sat	Sun	Mon	Tue	Wed	Thu	Fri	Sat
				1	2	3	1	2	3	4	5	6	7			1	2	3	4	5						1	2
4	5	6	7	8	9	10	8	9	10	11	12	13	14	6	7	8	9	10	11	12	3	4	5	6	7	8	9
11	12	13	14	15	16	17	15	16	17	18	19	20	21	13	14	15	16	17	18	19	10	11	12	13	14	15	16
18	19	20	21	22	23	24	22	23	24	25	26	27	28	20	21	22	23	24	25	26	17	18	19	20	21	22	23
25	26	27	28	29	30	31	29	30						27	28	29	30	31			24	25	26	27	28	29	30

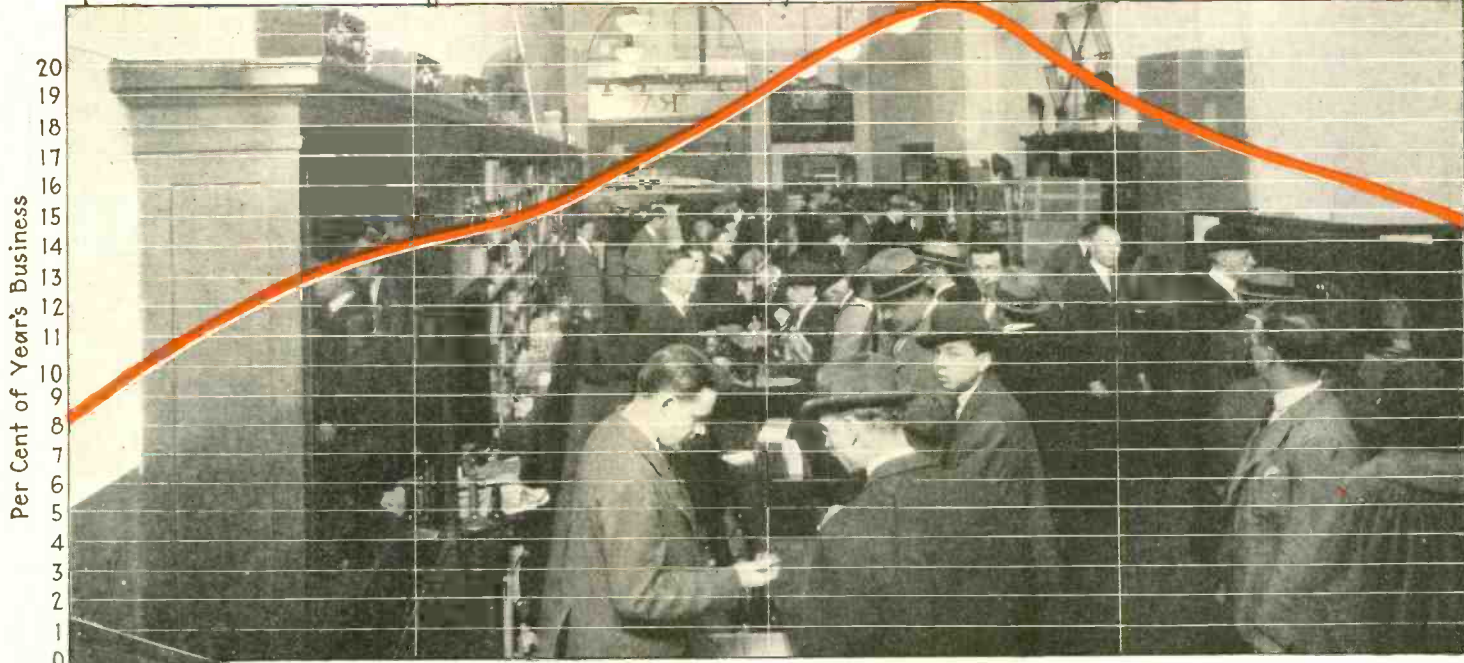

Between Now and January Radio Is a Four Months' Shopping Business

By M. CLEMENTS
Managing Editor, "Radio Retailing"

BETWEEN now and January, 70 per cent of the year's radio business will be done. During these four months radio has all the zest and excitement of a bargain sale rush. Little merchandising knowledge is needed to handle the shopping crowds. Generally speaking, all the dealer has to do is to stock the right merchandise and pass it over the counter—slot machine selling some call it.

But after January sales narrow off rapidly, leav-

ing dealers to gaze at their empty stores, unable to adjust themselves to a new condition. The potential market for sets remains unchanged, but the desire of possession on the part of the public no longer leads them into the store to plank down their money. Radio right then changes its plumage and becomes a household specialty and requires the type of merchandising muscle that is used to sell electrical appliances, sewing machines, etc.

The appliance salesman has to "plug" all year 'round. His life isn't sweetened with a shopping season, or "openers" such as

Build a prospect list and wrap good will into every package during the present "red letter" selling season

for Your Spring and Summer Business

1926 FEBRUARY 1926							1926 MARCH 1926							1926 APRIL 1926							1926 MAY 1926						
Sun	Mon	Tue	Wed	Thu	Fri	Sat	Sun	Mon	Tue	Wed	Thu	Fri	Sat	Sun	Mon	Tue	Wed	Thu	Fri	Sat	Sun	Mon	Tue	Wed	Thu	Fri	Sat
	1	2	3	4	5	6	7	8	9	10	11	12	13	4	5	6	7	8	9	10	2	3	4	5	6	7	8
7	8	9	10	11	12	13	14	15	16	17	18	19	20	11	12	13	14	15	16	17	9	10	11	12	13	14	15
14	15	16	17	18	19	20	21	22	23	24	25	26	27	18	19	20	21	22	23	24	16	17	18	19	20	21	22
21	22	23	24	25	26	27	28	29	30	31				25	26	27	28	29	30	%	%	25	26	27	28	29	
28																											



20
19
18
17
16
15
14
13
12
11
10
9
8
7
6
5
4
3
2
1
0

Per Cent of Year's Business

From February On It's An Eight Months' Specialty Business

broadcasting features and service calls offer. However, he's getting the job done through mastery of specialty selling technique—efficient leg work, home demonstrations, easy payments and trade-ins.

The first step in applying this sales philosophy to radio is to start today in building a customer and prospect list. On each prospect's card jot down the name of the party giving the lead, as the name of a friend who is a satisfied customer makes the entree easier.

After the first of the year, when sales start to lag, an inspection call should be made by

an intelligent salesman on every customer who was sold a set during the boom. This inspection call can be the basis of a friend-to-friend canvass—the customer being the nucleus for each neighborhood.

Every sale made now should be the basis of two or at least one other next year. The retailer is on the front line and if he remains on the offensive both he and the wholesaler will profit, factories would keep running all year round and radio could join the ranks of the nation's stabilized industries.

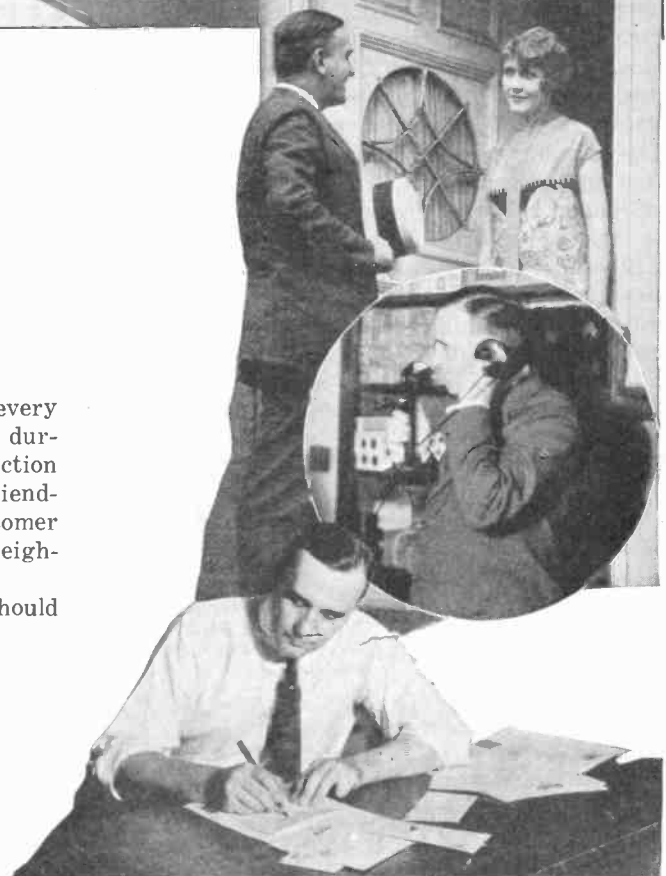

After February, use "negotiation selling," the telephone and letters to reach prospects and to boost this sales curve

“Radio Retailing’s” Nationwide Survey of Radio Service Is Solid Foundation

One Thousand Stores of All Types Form the Basis of a Comprehensive Study of Radio Service Plans and Costs Conducted by This Publication

By WILLIAM C. ALLEY
Associate Editor “Radio Retailing”

FREE service for a limited time” has been voted for overwhelmingly by radio dealers from Maine to California as the best policy to be followed in the matter of servicing radio receivers.

The question as to whether “free service” pays for itself in added trade, both in accessories and in securing the names of prospects, and also in the good will it generates, or whether a charge should be made for every service call after the installation of the receiver, is one that has been troubling radio dealers ever since “the days of ’21.”

So this publication, for the past several months, has been conducting a nationwide study of 1,000 representative outlets selling radio, divided among radio stores, music stores, electrical stores, department and furniture stores, and miscellaneous stores, which includes auto supply, sporting goods, hardware stores, etc.

The results of the survey, presented on these pages, will prove of inestimable value to everyone who sells radio,—dealer, jobber and manufacturer alike.

Department stores, as a class, were found to have the highest service expense per set sold, amounting to \$8.75, although their average length of free service per set was smallest—

4½ months—and their average remuneration for every paid call the highest—\$1.44. The percentage of department stores reporting they believed “free service for a limited time” the best policy, was also lowest, only 69 per cent answering this question favorably. Department stores were next to the lowest in saying that their service department paid for itself, 77 per cent answering yes. In this respect, the music store was lowest, 60 per cent reporting their service on an independent financial basis.

Perhaps the reason for the department stores’ service showing the poorest return is the fact that their percentage of sales attributed to service was also lowest, amounting only to 19 per cent, whereas electrical stores reported 47 per cent due to their service, the general average for all stores being a trifle under .375.

Who’s Doing Best Job?

The electrical stores were found to be doing an excellent job in using service calls to sell accessories, the percentage saying that their service thus paid for itself being 83 per cent. This was topped only by radio stores which reported 92 per cent of their service departments on a self-paying basis. Music stores reported the fewest number of self-paying service departments, the percentage here being 60.

Generally speaking, radio stores were found to be making the best of their service facilities, and music stores the poorest. Despite the fact that radio stores gave the longest average period of free service—seven months—their percentage of self-paying service departments was highest, as reported above, and 81 per cent said they believed a limited period of free service essential. This shows the ability to take excellent advantage of free calls to sell accessories and get leads for new sales. Also, 18 per cent of radio stores use an annual service call policy, that is, one call a month for a stipulated yearly sum. This was more than double the number of other types of stores using this plan.

Music stores reported only 21 per cent of their sales can be attributed to service and the service cost per set sold was \$7.75, next to the highest. Miscellaneous stores, such as auto supply and hardware, had the lowest service expense, \$4.16 for every set, due, it appears, to the fact that in most cases the proprietor himself did the servicing, eliminating the service man’s salary.

Analyzing all the various types of stores together, the averages are as follows: .07 per cent give no free service, 18 per cent give one month’s service free and 38 per cent for one year. The total average length of the free service period is a trifle over

Dealers Attribute Thirty per Cent of Total Radio Receiver

Type of Store	Giving No Free Service, Per Cent	Giving 1 Month, Per Cent	Giving 2 Months, Per Cent	Giving 3 Months, Per Cent	Giving 6 Months, Per Cent	Giving 1 Year, Per Cent	Average Length of Free Service, Months	Saying Service Pays for Itself, Per Cent	Charging 50c. an Hour, Per Cent	Charging 75c. an Hour, Per Cent
Radio.....	0.04	0.14	0.07	0.15	0.19	0.41	7.00	0.92	0.04	0.08
Music.....	0.06	0.19	0.18	0.07	0.13	0.37	6.00	0.60	0.00	0.14
Electric.....	0.05	0.26	0.13	0.20	0.07	0.29	4.75	0.83	0.08	0.16
Department.....	0.14	0.27	0.15	0.07	0.08	0.29	4.50	0.77	0.00	0.00
Miscellaneous.....	0.05	0.06	0.08	0.15	0.13	0.53	6.20	0.78	0.00	0.02
Total averages.....	0.07	0.18	0.12	0.13	0.12	0.38	5.69	0.78	0.02	0.08

Service Policies Shows That for Future Sales

Seventy-Eight per Cent of Radio Dealers Say Their Service Department Pays for Itself

5½ months. Seventy-eight per cent say that service is made to pay for itself, and the average price paid for non-free calls is \$1.32. Thirty-two per cent of all stores selling radio charge \$1 an hour, and 26 per cent charge \$1.50 an hour.

Service accounts for 30 per cent of the total set sales and \$6.15 is the average cost of free service for every set sold. Only .07 per cent use a yearly service plan and .06 per cent give their service men commissions on sales they make. Forty per cent of the total number of service calls are free calls, and the average store makes 28.8 calls weekly. The average service man gets \$32.98 a week.

Finally, 83 per cent of the radio dealers reported that free service for a limited time has been found, by actual experience, to produce the best results, both in additional sales and in good will.

Exclusive Radio Stores

A "radio service agreement," signed by the customer and the shop, is the feature of the service policy of Henkel's Radio Shop, Lansing, Mich. With every set sold, an agreement is signed and six months' free service given. After that period, a charge of \$1 per call is made. The charge for service calls on sets not sold by the shop is \$1.50 per call.

Any set owner may take advantage of the "service agreement" by signing a contract with the shop and designating the period of time he wants the service. Henkel's employs two service

men, paying one \$40 and the other \$30. They make an average of five calls a day, and do all delivering, installing and inside repairing. About 40 per cent of the calls are free calls. On the back of the contract, space is marked off for each call, where the date, condition of receiver and work done may be reported.

"Our service department loses money in actual dollars and cents," according to Herman Henkel, proprietor of the shop, "but sells enough supplies to more than break even. We believe our service pays and that a good service department sells as many sets as any other one influence. Free service calls for a limited time we have found to be the best policy to follow."

The Grid Leak Radio Store, Utica, N. Y., has a similar service contract, which customers sign, providing a year's service for \$10. The contract reads as follows:

"The Grid Leak Radio Store..... agrees to render radio service to..... for the period of one year. This service shall consist of a monthly visit by our trained service man who will thoroughly clean the customer's set, test the batteries and connections, ground and aerial, and vacuum tubes, and rejuvenate any tubes which can be restored to normal condition.

"The customer agrees to pay the sum of \$10 for the entire yearly service to be paid as follows: \$5 upon signing this agreement and \$5 upon the commencement of the second six months.

"Finally, the customer is requested to sign a service ticket at the termination of each inspection signifying his or her satisfaction with the work performed, and to enter all complaints directly to a member of the firm."

Signed..... Accepted, the Grid Leak Shop.

The Average Radio Store's Service Plan Is as Follows:

- Gives 5½ months' free service.
- Gets \$1.32 an hour for paid calls.
- Sells 30 per cent of sets through service.
- Has \$6.15 service expense per set.
- Makes 28.8 service calls a week of which 40 per cent are free calls.
- Pays service man \$32.98 weekly.

"We pay our men \$35 a week," says A. E. Shrock, treasurer of the company. "We make no free service calls, but include the \$10 fee in the completely installed price, letting the customer know that we are giving him the year's service but that he is paying \$10 for it.

"We are not in favor of rendering free service nor do we believe that with the tremendous amount of service involved in the radio business, a dealer can stand up under the free service policy. We feel that by our rendition of 100 per cent paid service, we are making satisfied customers for accessories and sets."

William R. Osborn, radio dealer of Croton-on-Hudson, N. Y., makes three free service calls, one a month, after the set is sold. He has figured the cost of "free service" to be about \$3.50 per set. At the expiration of the "free service" period, \$1.50 per hour is charged, with a minimum charge of 75c. On sets sold by other dealers, he makes a charge of \$2 an hour, with \$1 the minimum. Osborn is a firm believer in the system of free service calls for a few months.

Twelve dollars a year is the cost of the radio service of the United Radio Maintenance Company, New York City. This entitles the subscriber to call on the service department any time between 10 a.m. and 10 p.m., in case the

Sales to the Policy of Giving Free Service for Limited Time

Charging \$1 an Hour, Per Cent	Charging \$1.25 an Hour, Per Cent	Charging \$1.50 an Hour, Per Cent	Charging \$2 or Over an Hour, Per Cent	Average Price per Hour	Average Per Cent of Sales Attributed to Service	Average Cost of Service per Set Sold	Per Cent Using Yearly Service Plan	Average Number Service Calls Weekly	Per Cent Free Service Calls	Average Salary of Service Man	Per Cent Giving Service Man a Commission	Per Cent Believing Limited Free Service Best
0.24	0.12	0.36	0.16	\$1.28	0.31	\$5.26	0.18	26	0.25	\$30.80	0.07	0.81
0.49	0.21	0.09	0.07	1.32	0.21	7.75	0.07	44	0.28	30.66	0.08	0.91
0.19	0.11	0.31	0.15	1.27	0.47	4.83	0.06	25	0.43	39.82	0.08	0.96
0.19	0.31	0.27	0.23	1.44	0.19	8.75	0.04	24	0.43	33.40	0.05	0.69
0.48	0.13	0.25	0.12	1.27	0.30	4.16	0.00	25	0.60	30.10	0.00	0.78
0.32	0.18	0.26	0.14	\$1.32	0.30	\$6.15	0.07	28.8	0.40	\$32.98	0.06	0.83

receiver is found to be out of order. The service also permits the customer to have the storage battery re-charged and delivered, and the use of rental, for 75c.

Three months free service is given on new sales and the charge for service calls to non-subscribers is \$2.50 an hour. Service men are paid \$35 weekly and they average 70 calls a week, of which ten or fifteen are free. This service department has been put on a self-supporting basis and about ten per cent of the sale of sets can be attributed to it.

Of the remaining stores devoted exclusively to radio, 22 per cent give free service for thirty days, 11 per cent for sixty days, 11 per cent for 90 days, 16 per cent for six months, and 40 per cent give a full year's free service.

The Cleveland Radio Supply Company, Neal Cochran, owner, Oakland, Cal., one of the stores that reported 30 days free service, makes a \$1 charge for other calls and declares his service department does not pay and accounts for very few new sales.

On the other hand, O. D. Fincher, proprietor of the Central Radio Company, Fresno, Cal., declares his service department does pay for itself and attributes ten per cent of his sales to his free service. Fincher also gives thirty days free service but makes a \$1.50 per hour charge on other calls.

Cochran pays his service man \$25 a week and half his calls are on the free list. He figures his free service costs him \$5 per set, or about three calls. Contrast this cost, over a period of only one month, with the cost reported by Osborn of Croton-on-Hudson, N. Y., who declares three months' free service only costs him \$3.50 per set.

Fincher pays his men 75c. an hour—half of the charge made for service—and says one-quarter of their calls must be paid for out of his own pocket. Most men, however, believe free service must be given for at least a month.

The Pacific Coast Radio Company, Pomona, Cal., pays its service man on a commission basis, thus reducing the service cost to a minimum. For service calls, the service man is given the entire charge for the calls—\$1—and a commission on all the sales of sets and accessories he makes. Ten per cent commission is given on supplies and 15 per cent on sets.

Music Stores

Of the music stores surveyed, 36 per cent said they give free service for a year, 13 per cent for six months, 21 per cent for two months, 23 per cent for one month, and 7 per cent made a charge for every call.

The Shore Radio and Phonograph Shop, Brooklyn, N. Y., is one of the music stores that adheres to the policy of giving a year's free service on the sets it sells. However, it has a service plan whereby, on payment of two dollars for two months, or five dollars for six months, any set owner may have his set serviced in his home every two weeks. To put this idea across, a direct mail circular, with a return coupon, was sent to a mailing list of set owners in the vicinity.

The Shore Shop charges \$1 for indi-

Of the Country's Radio Dealers—

- 7 per cent give no free service.
- 18 per cent give one month's free service.
- 38 per cent give one year's free service.
- 78 per cent make service pay its own way.
- 32 per cent get \$1 an hour for paid calls.
- 26 per cent get \$1.50 an hour for paid calls.
- 7 per cent use a yearly service plan.
- 6 per cent give service man a commission.
- 83 per cent believe limited free service best.

vidual service calls and has found that its service department pays for itself. \$25 is paid the service man who makes approximately forty calls a week, of which one quarter are free calls. Free service costs this shop 2 per cent of the price of the set. The paid service plan and remuneration from the consequent sale of supplies and accessories enables service to be taken off the "red ink" side of the ledger for this concern. In addition, the service policy is responsible for 20 per cent of the sale of new sets.

A practice of stamping all supplies with the store label enables Stocker's Music Shop, Bradford, Ohio, to follow a policy of giving indefinite "free service" as long as the customer buys his accessories from Stocker's. If the customer does not buy his supplies from the store, a charge of \$1 per call is made.

As Bradford is a small town, 2,500 population, Stocker does his own servicing and declares his service costs, thus being low, are equalized through the accessory sales. Stocker also uses his service calls to get leads and has secured 25 per cent of his new sales in that way.

Conversely, the Clark and Jones Piano Company, Birmingham, Ala., declares its service facilities do not pay and that very few new sales are secured through free service. One month's free service is given on new sales, which, it is estimated, costs \$10, with an average of three trips. The service man receives \$35 a week. The calls after the free period expires, are charged for on a time basis.

Although they each give a full year's free service, both the Benedict Piano Company, Clarina, Ind., and Bauer's Music Shop, Astoria, N. Y., believe the ideal service system is to give only six months' service without charge and to get \$1 an hour after that time.

The Astoria store pays its service man \$29 a week, and he averages between thirty-five and fifty calls weekly.

The cost of "free service" is said to be only \$1 per set, which seems to establish a new low record. We know many radio dealers who'd like to be in business in Astoria!

M. L. Decker, music dealer of Cortland, N. Y., finds his service costs him 50 per cent of the profit on the sale and believes a charge should be made for every call after the first one. Decker's service, if his figures are accurate, bid fair to turn out similar to the worm that was swallowed by a little boy. The worm kept on gnawing, so the story goes, until it had swallowed the boy. A service cost of one-half the profit, is one of the worst worms this particular radio business ever swallowed.

A striking similarity can be discerned between the Mitchell Phonograph Company, Detroit, Mich., and the Morris Music Shop, Fordham, New York City, so far as their service is concerned. The Mitchell Shop gives free service for a year, pays its service man \$42 a week, finds that its free service costs \$5 per set sold, says that its service department does not pay for itself, but attributes 10 per cent of its new sales to its year's free service policy. This shop makes no charge for any service call, which may be the reason why the department is not on a self-supporting basis. Either that, or because its service man is a poor accessory salesman.

The Morris Shop also gives a year's service, pays its service man \$40 a week, has a per-set-sold expense of \$10 for service and also reports its service department does not pay its own expenses. Perhaps a shorter period of free service, then a yearly service plan for a fee of ten or twelve dollars, might do the trick.

Electrical Stores

Late in August, the Craig Electric Company, of Gastonia, North Carolina, sent out a circular letter to all known set owners, along the following lines—"Welcome home from your vacation. The old daily grind begins again, but you still have your radio set to relieve the monotony. With fresh batteries, and perhaps a new tube, your reception will be better than ever.

"Cold weather is just around the corner and you can begin to reach out for distance. A new set of batteries now will last you until late in the Spring or Summer, and one cannot estimate the life of a tube. Don't put off fitting up your set or you may miss many of the fine broadcasting features planned for the Fall.

"What we want to bring home to you is this—We are going to service your set, purchased from us or not, absolutely free. Give you prompt, efficient and courteous service, and charge you only for the new accessories which your set may need. We want you to call telephone number 93 for all your radio troubles and tell your friends about our service."

The purpose of the free inspection was, of course, to boost the sale of accessories, and this, according to J. L. Rudisill, radio manager, resulted in returns that exceeded expectations and got the Craig Electric Company's radio

(Continued on Page 499)

Every Farmer Needs a Radio Set

Few Radio Dealers Are Making Any Effort to Sell Receivers to Farmers, Government Report Shows—Agricultural Programs Should Be Basis of Sales Talk

By J. C. GILBERT

Marketing Specialist, U. S. Department of Agriculture

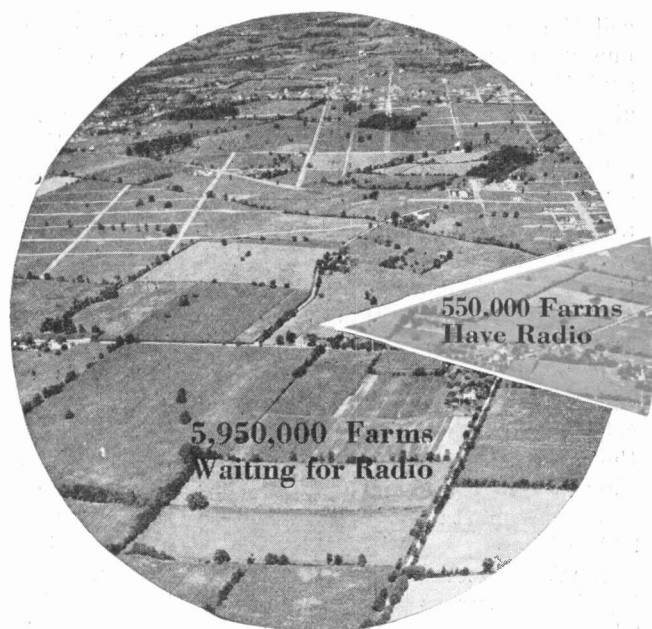

The Farm Market Is Only 8½% Sold

WHEN it was decided to ask the County Agricultural Agents for the third time to answer some questions about the use that farmers are making of radio, several new questions came up for consideration.

On several occasions before the questionnaire was prepared the question had been asked if the dealers were really making an effort to sell radio equipment to farmers. No definite answer could be given, as the department had no facts or results of observations on which to base an answer.

With this in mind a question was prepared and included in the list sent to the county agents this year: "No. 8—Are radio dealers making any conspicuous effort to sell radio sets to farmers in your county?" We did not want to know if they were selling sets to farmers. We knew that they were. The estimates of the number of sets on farms would indicate that farmers were buying sets. What we wanted to know was this: Were the dealers making any outstanding effort to attract the farmer's attention to the advantages to be derived from the ownership of a good radio set on the farm? Or in other words, we wanted to know if the dealers were looking into the future to the time when radio broadcasting would be universally recognized as a great benefactor of agriculture; to the time when, in the words of President Jardine of Kansas Agricultural College, now Secretary of Agriculture, "Its influence on agricultural betterment will

be, perhaps, its greatest contribution to civilization."

Now, the County Agent is about the best informed man in the county on things agricultural or affecting the farmer. It is his business to know what is being done in his county that has any affect on the farm life of the community. If the dealers in radio equipment were making any kind of a campaign to get farmers interested in buying radio sets, he would know about it as soon as it started, if not before.

Little Dealer Effort Found

To date, 60 days after the radio questionnaires were sent out we have answers to this question from 1,033 counties. Some from each of the 48 states. In 558, or 54 per cent of the counties replying, no effort of any

kind had been made to interest farmers, as farmers, in the purchase of a radio set. If the farmer bought a set he did so not because its value to him as a farmer had been emphasized, but only as anyone might be attracted to buy. Of the remaining 475 counties, 46 per cent of those replying, less than half reported any effort to attract farmer buyers.

In some of the counties, however, the agents reported that the dealers were applying for permission to demonstrate their sets at farmers' meetings, others were sending their salesmen out to the farm homes where they would install a set and demonstrate it in the farmers' living-rooms and leave it on a partial payment plan if desired. In a few locations the dealer in radio equipment has had also a broadcasting station. By securing and broadcasting information of interest to farmers and by having the County Agent broadcast to those farmers who owned sets considerable interest has been created and the sale of sets has increased.

A few concrete instances of the growing interest on farms is indicative of what might occur in any agricultural county in the country. From replies sent in by 52 out of 86 County Agents in the State of Indiana we have made a comparison with the returns for last year and have estimated that there has been an increase of 120 per cent in the number of radio sets on farms in a year's time.

Twenty-seven of the 52 counties in Indiana reporting, mention some

Radio Means More to the Farmer

than to any other class of people. Realizing that radio is an actual necessity to the farmer in conducting his business, the U. S. Department of Agriculture is paving the way for radio dealers right up to the farmer's door by broadcasting crop service, market and weather reports, commodity prices and other programs of direct, material benefit to farmers.

kind of effort made by the dealers to sell the farmer. Carroll County is one such county and is fairly representative of the results of an aggressive campaign to interest the farmer folks. In 1924 the County Agent estimated that there were 45 radio sets in farm homes. This year there are 300 sets on farms and the interest is increasing. In Harrison County, another of the 27, 1924 saw 150 sets on farms; this year there are 600.

It must be remembered that the set the farmer buys must be a good set. It must be capable of getting the distant stations. That means four or five tubes and loud speaker reception on stations within 150 to 200 miles.

What inducement has the dealer to offer to farmers to buy radio sets? There are many more reasons why the farmer should have a radio set than the man who lives in the city or even the modest-sized town. Taking the purely recreational side of the matter first, the man in the town or city has every sort of entertainment available in the original form. Band concerts, orchestra concerts, choirs, soloists both instrumental and vocal, speakers, lecturers and entertainers of all kinds are available in the towns and cities. The greatest reason for the growth of cities is that they give people these advantages. The farmer who lives only a few miles away from a town or city has to make a special effort to enjoy its attractions. He must take his family to town for an evening and the homecoming is always late. The regular schedule is interrupted and he has to pay much more than the city dweller in time, effort, and money to get the same pleasures.

Radio a Utility to Farmer

From the practical side there can be no argument as to the advantage that radio has for the farmer. Practically all of the utility broadcasting that is being done in this country is for the benefit of the farmer. Let's consider weather first.

Slowly but surely the various factors in the production of farm crops and livestock are coming under control. Weather, however, is the greatest factor in the farming business and it cannot be controlled or influenced. The best we can do is to try to understand its vagaries and to learn its habits and moods. The U. S. Weather Bureau is able to forecast with a high percentage of

accuracy the possible changes in the weather. This foreknowledge of even a day in advance is of inestimable value to the farmer. Weather reports are now a regular scheduled part of the broadcasting programs of more than 100 of the more powerful broadcasting stations in the United States. Practically every farmstead in the whole country is within the broadcasting range of the weather service by radio. This service alone is sufficient inducement for thousands of radio sets to be installed on farms.

In the past few years more and more attention is being directed toward the problems of marketing the farmers' crops and livestock. Supply, demand, movement, price trends, all are engaging alike the attention of the farmer, the traffic man and the student of economics. Every

Make an Effort to Sell to Farmers

The latest farm survey conducted by the U. S. Department of Agriculture included the question, "Are dealers making special efforts to sell radio to farmers?" Fifty-four per cent of the replies were, "No!" That proves conclusively there is still room for aggressive salesmanship in reaching the farm market.

source possible is being combed for information. Agencies both public and private are issuing reports for the information and guidance of those who are financially interested in the distribution and sale of the several billion dollars worth of farm products that are produced each year in this country. Recognizing that this kind of information would be appreciated by the many listeners, farmers in particular, the radio stations almost without exception have sought to secure some marketing information for broadcasting. The types of broadcasting mentioned in the applications for broadcasting licenses has almost invariably included market and weather reports.

The U. S. Department of Agriculture maintains the largest and most elaborate market news service in the world. It has a private telegraph system consisting of 7,500 miles of wire lines and 34 branch offices.

Daily more than 100,000 words are sent flashing back and forth between the offices. In 84 cities the crop and market reports are released to radio broadcasting stations. The map shows that almost all of the agricultural sections of the country are served with marketing information.

Agricultural Schools Help

Have we any evidence that this broadcasting is appreciated? Thousands of letters have been received both by the Department and by the stations that broadcast the reports, attesting to the value of the service. Not only that it was interesting but that the information which radio alone made available had enabled the farmer or shipper to take advantage of the best marketing conditions and make more money by using the information gained.

Is this any inducement for the dealer to hold out to the prospective farmer-buyer of a radio set? No one could even suggest a negative reply.

Nor is this the only reason that can be advanced for a radio set on the farm. The United States Department of Agriculture, in co-operation with the Agricultural Colleges in the 48 states, has developed a great extension organization which serves as a channel through which the knowledge gained by research, experiment and exploration is passed on to the farmers. Every known means of making the information available is used by these tireless workers; demonstrations, lectures, short courses at the colleges in the winter, bulletins, correspondence courses, stereopticon slides and lectures to accompany them, exhibits at state and county fairs, moving pictures and now radio.

At 25 of the Agricultural Colleges broadcasting stations have been erected. Several of the colleges are co-operating with privately-owned stations. At each of these college stations and the co-operating stations, more or less regular schedules of agricultural lectures, talks, and at some of the colleges regular extension courses are being broadcast. Radio is thus, through the American Government, taking directly into farm homes the best and newest information available about the farmer's business and his mode of life. Is this any argument in favor of a good radio set on every farm? Let dealers themselves answer the question.

The Farmer Must Be Shown

Home Demonstrations, Free Movie Shows and an Annual Radio Exhibit Are Methods Used to Convince Farmers That "No Farm Is Complete Without a Radio Set"

SELLING radio successfully in a town of 10,000 population, with four competitors also in the field, may be regarded as somewhat of an achievement. The Universal Car Company, of Centerville, Ia., local headquarters for Ford automobiles and Kennedy radio sets, sold just two sets over the counter last year. But the number of sets it sold by home—or rather, farm—demonstrations, is the interesting part of the story.

There are several plans the Universal Car Company uses to tell the farmer what he is missing if he lacks a set. First, is the peculiar habit H. H. Payne, president of the company, has of becoming violently annoyed when he sees a set on a shelf doing nothing but eat up its value in rent. So he packs it into a delivery car and tells the chauffeur to take it up to some certain farmhouse out in the country and leave it there. The usual outcome of this procedure is that Payne eventually deposits another check in the bank.

Payne a "Go-Getter"

Payne is a born showman. If the automotive and radio games ever give up the ghost, Payne would make a whale of a success as ringmaster in a circus. He has the ability to get

Selling Two Sets a Year

over the counter is not much of a record. But the Universal Car Company, of Centerville, Iowa, takes the set out to the farm and lets the farmer sell it to himself.

Most farmers are "from Missouri" and want to be shown why and how a radio set should be included in the parlor furnishings. So the Universal Car Company adopted the simple plan of showing them.

people excited. Even Iowa farmers are susceptible to his personality.

He has a policy of holding a "radio show" in his display rooms at the beginning of each season. Small exhibits like that are usually dull affairs, mechanically conducted but not so the Universal Car Company's. This one is ballyhoo-ed and shouted about and heralded for weeks in advance as the biggest event of the year. The entire block is decorated and the countryside takes a holiday to come into town and see the latest

in radio. Admission is free and local talent supplies musical entertainment to supplement the radio programs. The visitors are asked to register and enough live leads are obtained in a few days to last the rest of the year.

Free Movies Bring Crowds

And as if that weren't enough, Payne has made his agency the entertainment headquarters of the community by giving free motion picture shows every Saturday night! Having also the Ford auto agency, he has quite a large garage which is used as the auditorium. Films likely to interest farmers, are shown, and often a local talent contest is held, the winner being accorded the privilege of broadcasting from a station in a nearby town. Payne estimates the average attendance is well over a thousand.

In return for the free entertainment provided, the guests are asked for the names of prospects, each person handing in a name being given a free ticket in a lucky number contest, the duplicates being put in a hat and two drawn. Holders of the numbers drawn are awarded prizes.

Besides all these various activities,

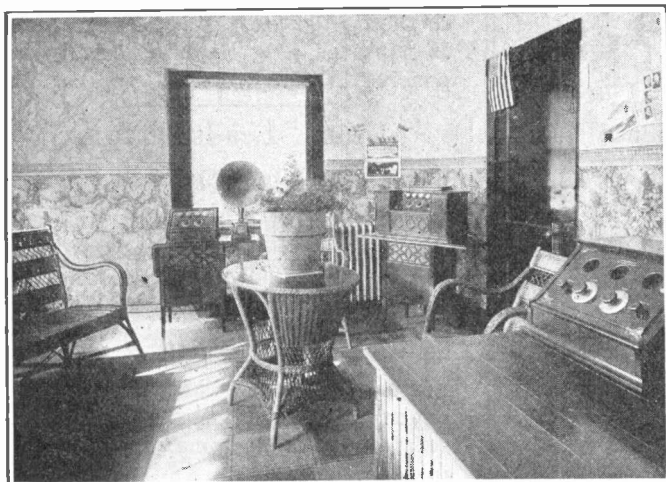

A service car is a fundamental necessity in reaching the rural radio market and when one firm combines a Ford agency with a radio shop it makes an economical tie-up. The Universal Car Company, of Centerville,

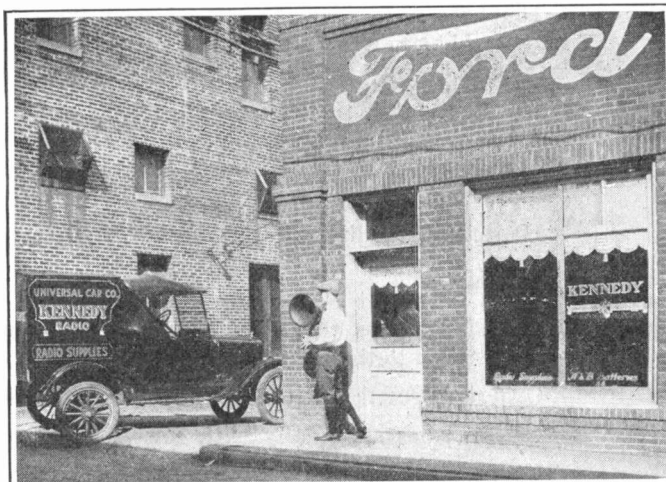

Iowa, discovered that farmers wouldn't come in and buy radio so it took radio out and sold it to them. This neat, but unprepossessing storefront leads to the prettily arranged radio display room at the

left. On the evenings when free movie shows are given in the adjoining garage, this radio room is always crowded with prospective purchasers whose names are obtained for future sales.

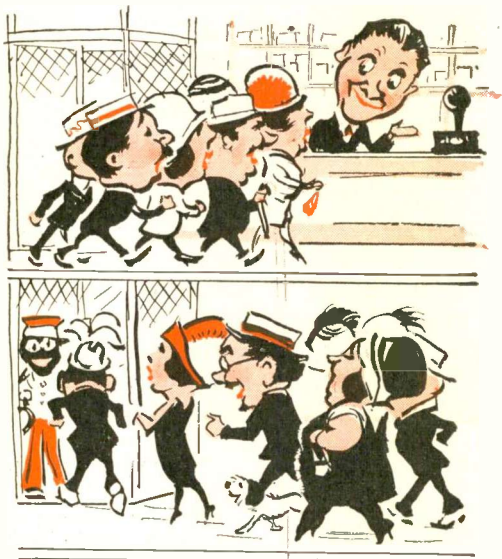

Upstairs Store Ignores Cut-Price Competitors

HARRY TILLEY, president and general manager of the Tilley Radio Corporation, on the third floor of the Woolworth Building, Providence, R. I., is a radio merchant who has built up such an excellent reputation in his home town that an average of two hundred customers a day took the elevator to Tilley's third floor location and spent \$100,000 on radio last year. Why? Because Tilley:

Maintains full list prices regardless of competitors' price-cutting. He would rather not sell, than resort to cutting.

Was the first exclusive radio dealer in Providence and gives a complete radio service, selling transmitting equipment as well, making Tilley's the amateurs' headquarters.

Features parts by taking popular circuits as they come out and pushing them.

Employs radio experts as salesmen "because they know what they're talking about." And gives them small salary raises every six months.

Has one outside salesman, on fifteen per cent commission, whose sales average one a day, usually obtained by a house-to-house canvass and giving a home demonstration.

Has every facility for service and charges \$1.25 an hour for it.

Picks out what he believes is the best of the new sets and features them, one at a time, devoting his entire energy to the one make until the demand changes.

Orders in small quantities and never gets overloaded.

Checks sales slips daily with inventory.

Keeps overhead absolutely to rock-bottom by paying personal attention to every detail of his business.

Payne shows his versatility by writing a column for the local newspaper, called the "Universal Radio Column." Putting all these things together, it is not surprising that the Universal Car Company, of Centerville, Iowa, is known far and wide as radio headquarters. An interesting sidelight on the radio situation in Centerville is that the five radio dealers of the town work hand-in-hand in the matter of home demonstrations. If a dealer makes a home demonstration and puts up an aerial, and the prospect buys a set from some other dealer, the dealer who gets the sale pays five dollars to the dealer who put up the aerial.

What a Time-Clock Will Do for Your Customer

Radio controlled by a time-clock is something new, indeed. In one of the Fifth Avenue homes in New York this novel installation has just been made, and now Mrs. Manhattan can look over the programs of various broadcasting stations in advance, decide what she does or doesn't want to hear, then simply set the wise little timer, which proceeds to turn the concert on without further effort on the part of any of the family, writes Mrs. Lillian Cassills in the *Electrical News Letter*, a New York dealers' publication.

This ingenious little time-clock—with which we are all more or less familiar, as it is used widely to turn lights on and off—may be set at the time it is desired to tune in and also at the time one wants to tune out on any program. It is simply connected in series with the A battery, and it acts exactly as it would in the control of lighting equipment. It runs ten days, and is not an expensive affair.

Gets "Leads" from Marriage Licenses

An enterprising dealer in the Bronx, New York City, has hit upon the idea of following up those who take out marriage licenses. He gets the addresses from a local newspaper which publishes them, and makes a personal call upon likely brides-and-grooms-to-be, and suggests a radio set for the new home, sold on the installment plan.

A surprising number of sales are made in this way, not all of them at once, but the missionary work done leads to many future sales.

News of the Month in Photo Form

Exploiting Radio News

The first news of the wreck of the Shenandoah reached New York via radio and the practical value of news through the air was demonstrated by one of the Liberty Radio Stores when half-hourly bulletins were pasted on the window.



Woman Leader Broadcasts

Another broadcast tie-up was made possible recently when Mrs. Carrie Chapman Catt, honorary president of the National League of Women Voters spoke over station WEAJ, New York. It was to hear this address that many groups of women within hearing of the station held "radio teas."

Radio Show in Armory

Here is a general view of the Second RadioWorld's Fair held last month in the 258th Field Artillery Armory, New York City. The armory is said to have more space on one floor than any other building in the world that is available for expositions. The photo shows only about half of the armory's floor space.



Exposition Takes Three Floors

At the right is a close-up of a section of the exhibits at the Fourth National Radio Exposition held in September at the Grand Central Palace, New York. Three floors were required for the show, which was visited by more than 250,000 people.

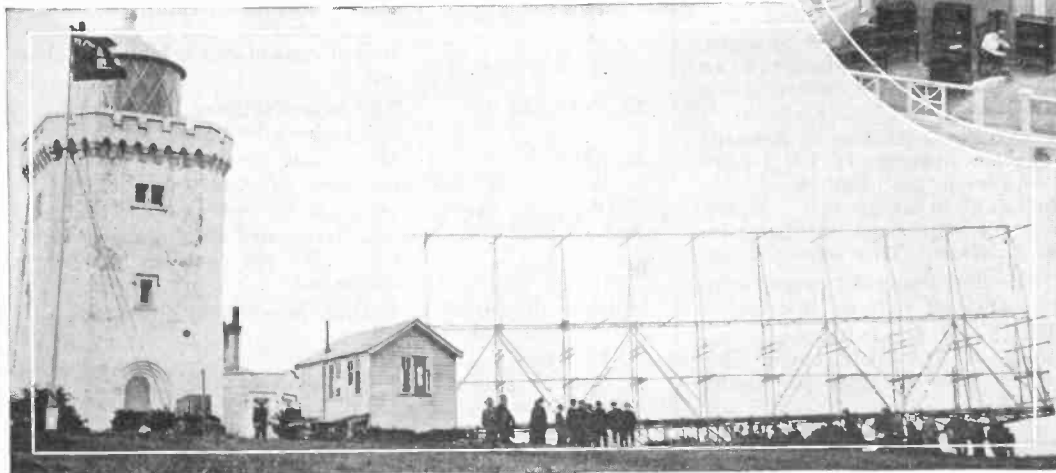
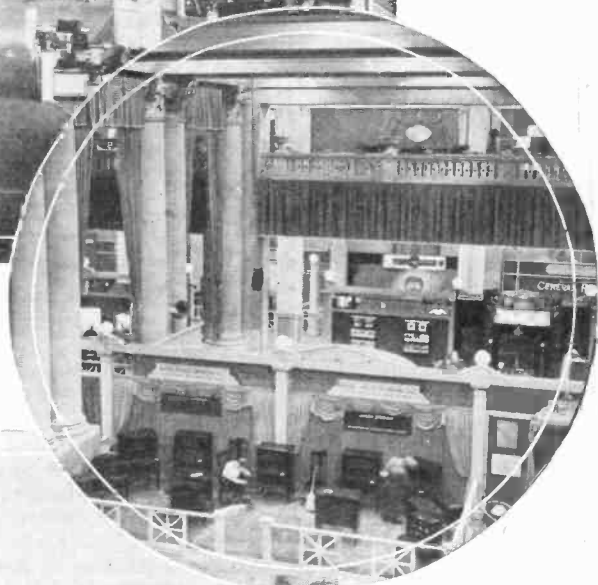

A Radio Lighthouse

A radio lighthouse is the latest invention of Signor Marconi. Built on the rocks of the English coast at South Foreland, this lighthouse sends out wireless signals enabling ships to know their exact position in the densest fog.

Ask These 27 Questions When Buying Condensers

Questions to rate condensers as desirable or undesirable	Comment intended to guide buyer in a general way	Questions to rate condensers as desirable or undesirable	Comment intended to guide buyer in a general way
1. What is the price of the condenser?	Above \$5—go slow in stocking. Below \$3—look to its design.	13. Is the spacing of the plates too close for practicality?	Some types use thin plates and if one becomes bent, the instrument is rendered practically useless. Too close spacing makes it a jeweler's type and mainly for portables; it invites losses from dust.
2. What is the range in the capacity of the condenser?	Less than .0003 means may not go high enough. Over 15 MMF minimum is too high for average tuned radio frequency. Seventy-five per cent of sales will be for tuned radio frequency (220-550 meters).	14. Are the plates thick?	Usually should be thick and heavy or will eventually be bent and condenser is useless.
3. Is it straight-line?	Claims of "straight-line" are being grossly exaggerated. Demand curves and literature that is verified by experts. SLF is ideal (see below). SLW is satisfactory. SLC may be used with dials.	15. What set screws or nuts are apt to loosen?	If they do, can they be tightened without dismantling?
4. Is it good mechanically?	Will plates touch if frame is pressed by hands across corners? Will pressing on shaft cause short circuiting? Can plates be tapped loose by a pencil? Are plates well supported by design to stay in line? Is the bearing adjustable? If SLF or SLW is the counter-balance or tension going to slip? Will the insulation crack with temperature or use? Is there any end-play? Can anything wear and cause back-lash? (Important in cog-turned types.)	16. Are soldering lugs attached?	This is desirable.
5. Who recommends it?	Many writers specify anything and recommend nothing. Demand the opinions of competent experts before buying in quantity. These opinions must be recent. (Not older than August 1, 1925.)	17. Is it low-loss construction?	This is generally considered to be so if it uses parallel insulation supports for stators rather than insulation ends or bushings.
6. In what circuits is it used?	Unless it is a standard unit applicable to the various circuits in vogue, avoid heavy stock. Keep a scrap book or table of parts for reference. Note values for super-het, regenerative (Reinartz) Roberts, Cockaday, TRF, neutrodyne, etc.	18. Is the condenser dust proof or covered?	This is desirable but not entirely necessary if the plates are well spaced.
7. Is it clockwise or counter-clockwise in action?	This will bear upon your dial orders.	19. Is the condenser tested for lint, metallic dust, etc.?	The manufacturer should subject all condensers to a 500-volt a.c. test to be sure. Peculiar circuit troubles are often caused by stray objects getting into condenser.
8. Is it big?	Beyond a 4 inch x 4 inch overall, you exceed standard dial limits and exact big panels and cabinets.	20. Is the discount high?	Don't expect good quality with high discount. List price on this basis means nothing. Remember, it is hard to put anything in a package and call it a good condenser for less than \$1 to the manufacturer. If you are offered the condenser at \$1 or \$1.25, etc., do you think you will be aiding parasitic conditions or building up the trade on a basis of fair play? Cheap junk is the bane of the trade. Avoid concerns which pirate, dump, job cross-shipped equipment, or in any way play the game on a basis of unfair competition. You need the support of manufacturers of reputation.
9. How long has it been on the market?	Never hurry on new designs. Let the demand simmer down to a proven type before going too heavy.	21. Does it look like a good condenser?	Merchandise appeal is common sense.
10. Can it be mounted easily?	Fussy panel drilling is detested by parts buyers. If it is 3-point suspension see that there is a template in every box. Watch out for odd sized shafts— $\frac{1}{4}$ -in. is standard. This affects dials.	22. Will it be dumped?	Too much production or too little working capital at the manufacturing end are suggestive of season-end sales. Watch out.
11. Is it heavy?	This affects portability and kind of panel as well as thickness.	23. Who jobs it?	The manufacturer is known by the jobbers he keeps.
12. Is it large with plates out?	Watch out for inter-stage coupling of SLF-SLW types with plates passing close to nearby parts.	24. What kind of insulation is used?	Watch out for mud, cheap composition, or too thin Bakelite.
		25. Will it tarnish in stock?	If brass is not treated, watch out. If impure aluminum, watch out. If not evenly nickled, watch out.
		26. Can dust or dirt get into bearing or cogs?	Rather important, obviously.
		27. Has it adequate rotor connection?	Look carefully. It pays.

Condenser Trends—
 1923—“Insulation End”
 1924—“Low Loss”
 1925—“Straight Line”

**1926 Demand
 Will Be for**

“Straight Line” plus Quality

“Straight Line” Demand Puzzling Dealers—Parts Buyers Beginning to Look for Quality in Condenser Construction as Well as Even Calibration—How to Detect Good and Bad Craftsmanship

By EDWARD R. DOYLE

THE radio parts market is perhaps more whimsical,—although rationalized,—than the women’s apparel trade. The Poirrets, Henris, Jaquets, etc., are repeated in the houses of radio design which feel apparently that every year they must out-think each other in the on-sweep of revolutionizing designs.

This is exemplified to a remarkable degree by the condenser market. Three years ago all condensers were “insulation end” types with a few “die cast.” Two years ago in swept the “low loss” era using metal ends, etc. Last year a rumble of “straight-line” was heard which this fall has burst with more fury than sanity upon the parts dealer to add to his perplexities.

“Straight-line” is the vogue of the hour in condensers, and losses are now relegated to a subsidiary position of importance, while proper mechanical design is temporarily forgotten in the pell mell rush to get into the fray with a design that is straight-line frequency or straight-line wave length. Veritably a “condenser war” is on which is as bitter and endlessly tangled up in claims, patents and values as the allocation of broadcasting stations.

How to Judge Quality

However, merely to cite the historical background of today does not shed illumination on the dealer’s problem. He wants to know what constitutes the condenser “you will eventually buy” (during the season) and how its “earmarks” can be uncovered.

Losses. The market factor on losses is somewhat changed today from last year. New combinations of high-powered stations make dis-

...tance less essential than formerly. Consequently a natural relaxation on losses standards has set in. On the other hand, with the spreading of stations more uniformly over the broadcast band, there is a greater invitation to the expert and connoisseur to seek for greater logging laurels. The practical result as far as publicity will affect the market seems to be that losses should be restricted reasonably but ultra low losses are not entirely the factor in selection. In some tuned radio frequency circuits which are proving popular, losses are consciously introduced to beat down oscillation. This may be a temporary situation which will be altered the moment a practical type of neutralizing circuit appears. If it does, and it is logical to expect it, the loss element will be more important than ever.

Curve. The public are asking for “straight-line” condensers without understanding exactly what it is all

about. They are told by editors and writers that straight-line frequency is the ideal, and to have that as the means of separating stations. These emphasize that separation is more a factor of losses than of condenser shapes and unless a good electrical design is used, straight-line frequency type means nothing, any more than vernier ratio. Straight-line frequency is a new way of saying “vernier where you need it without a fixed ratio vernier dial.”

Already several condenser manufacturers have felt that to shift from standard designs of proven mechanical and electrical excellence over to a straight-line frequency or straight-line wave length design is unnecessary and are resorting to auxiliary dials which will “compensate” for straight-line condensers and “convert” it into straight-line frequency or straight-line wavelength.

Whether the straight-line frequency or wavelength condenser or the dials will answer the situation, is too early to say. Generally, a straight-line condenser avoids the cost of the compensating dial but it usually introduces higher costs in one form or another for the buyer. If he owns a set, the dial saves replacing the condensers. If he starts building a set, the straight-line condenser saves the dial.

Sizes. There are today three sizes of variable condensers which are enjoying special favor. These are

A. .0003 Used for tuned radio frequency

B. .0005 Used for superheterodyne

C. .00005 Used for regeneration or stabilization.

Should the Department of Commerce drop the minimum wavebands

“Straight Line” Is Vogue of the Hour

in condensers and losses are now relegated to a subsidiary position of importance.

Proper mechanical design also is temporarily forgotten in the pell mell rush to get into the fray with a design that is straight line frequency or straight line wave length.

During this condenser “style” war a few suggestions on buying by an authority on sizing up quality are in order. Here they are.

below 200, as is indicated to be forced upon it, it will cause a peculiar situation in the condenser market. Immediately, the tuned radio frequency condenser must become one of unusually low minimum and afford a maximum wavelength (with its coil) in short making a greater span than the standard or average .0003.

This would suggest that a well-designed coil and condenser will be in demand shortly covering 150 to 550 meters using a condenser with minimum of about 8 MMF and maximum of about 240 MMF. These are not easy to find and the coils almost unheard of. They can and may be on the market later in the year and will affect what condenser stock the dealer has at that time.

Rating condensers by the number of plates is today a happily extinct or dying practice. With many "jack-

knife" straight-line types coming out, the platage means nothing in terms of capacity and the dealer must always remember that inductance design will affect the stock more than any predetermined publicity on average capacities.

Verniers. Aside from the curve factor in selection, the built-in vernier may be considered as a condenser consideration. The trend seems to be away from the built-in vernier. All indications suggest that the vernier dial, if any vernier, will be the accepted practice. Vernierized condensers (outside of straight line curve effects produced by plate shapes) are likely to slumber peacefully on the shelves.

Prices Being Reduced

Prices. Competition among manufacturers is causing a net reduction in condenser prices. The current

market at this writing shows some \$3 condensers begging on the bargain counters at 75c. Popular designed types, however, hold their list fairly well between \$4 and \$6. Above or below these prices suggests a tendency either to sacrifice quality and serviceability to get the price down or to over-elaborate the design to a value that is not commensurate with public requirements.

Good-looking condensers (merely package and design psychology) easily command \$5 while obvious quantity production designs are acceptable at about \$3 and \$4. Temporarily, straight line calls for about \$1 additional on either grade.

Multiples. The effort to get "unicontrol" sets has affected and created a market for combination condensers affording either dual or triple tuning. These types, however call for some general system of adjustment of each circuit to a common resonance. Some types have small vernier devices built in and other do not. Experimental work thus far has not verified the complete popularity of the multiple type but it will unquestionably be a factor, particularly in the dual .0003 and the triple .00035 sizes.

Broadcasting Complications

Broadcasting. Comment was made on the possible spread of stations over 150 to 550 meters instead of 220 to 550 as at present. It may be pointed out that if many of the small stations decide to give up their licenses rather than to compete with the "national" broadcasters, straight-line, and low loss will probably be less in demand. Unicontrol or multiples will then assume an unusual importance. Today, the trend is toward monopolization of the air by big interests, not through a special license but through power-rating—a simple process of drowning out small stations with both energy and quality of program. In this, however, there will probably be plenty of "localization" effect because most broadcasting is for relatively local advertising purposes. The linking up of the "big twelve" or "big twenty" as it may be, suggests simultaneous broadcasting for major events which will revert the demand for good mechanically designed condensers and less consideration of intensive straightline or vernier.

Mechanical. With some fifty condenser designs to select from, it is not illogical to expect that mechanical designs vary tremendously. The

(Continued on page 519)



La casa della felicità.

Radio Outlets Cross the Rubicon

An example of America's influence on the European radio industry is reflected in the cartoon above, reproduced from "Radiofonia," an Italian publication. "Happiness in every room" is the title of this modern dwelling, which was adapted from the January issue of "Radio Retailing."

every now and then. He tells about a typical experience of this sort in this way: "I had taken a set out to a man's house and given him a fine demonstration. The prospect was tickled to death and declared he'd probably buy the set eventually but in the meantime wanted to try out some others.

"Well, that's up to you," I told him, "but why waste any more salesmen's time? You've tried all the best known makes already, according to what you've told me. You've been telling me this evening that none of the other sets you've tried has brought in as many different stations or brought them in as clear as this one. It won't be fair to other salesmen simply to try out their sets, if you know, in your own mind, that you are really going to buy this one eventually."

"That was pretty strong talk, of course, and I couldn't have given that line of talk to most of our prospects but I could give it to him because he was a plain-speaking man who always advocates frank, straight-from-the-shoulder talk in his own business.

"This line brought the man up with a start and made him rather angry for a moment or two. Then he

saw the point and the upshot of the matter was that I put the sale across.

"Every now and then I find that it is mighty good business for me to talk plainly with people, especially with people who look as though they are trying to put something over on radio dealers in the way of getting free entertainment on the plea of trying out different sets. We radio people can't afford to let the public put things over on us that way."

Fusing Would Have Prevented This A Battery Fire

BY H. W. GOODRICH

Electrical Inspector, Iowa Insurance Bureau
(Member N. F. P. A.)

With the increasing number of radio sets in use, this fire in a Des Moines residence is of particular interest.

In the basement was a wooden shelf on which was placed a large-sized storage A battery and a battery charger of the vibrator type. The charger was connected to the house lighting circuit and was protected by its branch fuse. Fuse protection was also built into the charger on the low voltage side and this circuit was carried to one side of a double pole double throw switch

also on the floor above. Leads from the radio apparatus were connected to the other side of the above switch. The storage battery leads were connected to the neutral switch points and so far as can be ascertained consisted of stranded wire, one lead with asbestos and braided covering, the other of rubber. The leads in going to their switch position were run in loose contact with a hot-water pipe of the heating system.

The apparatus was last observed before the fire about 11:00 p.m. and the rectifier was charging the battery in a satisfactory manner. The fire was discovered about 2:00 a.m. and had become so severe that the occupants were forced to leave the building by ladders from a porch roof.

It is probable that the fire started from the short circuiting of the battery leads at the point where they were against the hot water pipe. The apparatus had been installed about one year and the pipe, when the investigation was made, was too hot for the hand to touch it for more than a short time. This condition having existed for some time, the insulation on the battery leads probably deteriorated gradually until the short circuit point was reached. Damage done will probably amount to about \$20,000.

This fire emphasizes the fact that particular care must be given to the installation of the leads from the storage A battery and that fuse protection for them is desirable.—From the *National Fire Protection Quarterly*.

Radio "Penny Arcades" Found in Italy

An unusual way of capitalizing radio receivers is being used in Rome, Italy, according to Dr. Lee DeForest, who has just returned from Europe. Fashioned after our own "penny arcades," these "radio receiving stations" offer a pair of earphones for about one cent, which allows the listener to hear one selection.

"There is just one master receiver," Dr. DeForest says, "and many pairs of earphones, but the listener must be content with just what the operator tunes in. The owner of a powerful set can, by establishing a 'listening post,' make considerable money, as there are very few privately-owned sets in Italy."

Sell Them What Radio Has to Offer

For a few months in the Fall—this month and next—the inter-collegiate football contests are among the most popular broadcast features and offer exceptional means of exploiting the service a radio receiver can give. Also, it opens up a ready-made, specialized market—alumni of the competing colleges who may be appealed to through newspaper advertising. Window posters such as the one pictured here were distributed last year by the Pacific Radio Trade Association to its members as a dealer help in putting over the broadcasting of football.

NEW YEAR'S DAY
EAST vs WEST FOOTBALL GAMES
WILL BE BROADCASTED BY
RADIO

Hear the Games Play by Play on Your RADIO SET

Hear the Rooting Sections and College Songs on Your RADIO SET



UNIV. of PENNSYLVANIA vs. UNIV. of CALIFORNIA
At MEMORIAL STADIUM, BERKELEY
Broadcast by Station K L X "THE TRIBUNE" (Oakland) - - Announcer at Microphone at Field

NOTRE DAME vs LELAND STANFORD UNIV.
At the ROSE BOWL, PASADENA
Broadcast by Station K P O "HALE BROS." (San Francisco) - - Received Over Lamhore by Plays
Broadcast by Station K H J "THE TIMES" (Los Angeles) - - Announcer at Microphone at Field

Pacific Radio Trade Association - Poster Service

Action Makes Passers-by Stop, Look and Listen

Another adaptation of the "Tune it in yourself through the window" idea, which appeared in the July issue of *Radio Retailing* is illustrated in the photo at the right. The Radio Service and Lighting Company, Pittsfield, Mass., worked the scheme out a little more intricately, however, by gearing all dials together and having but one master control on the outside window ledge. Also, the outside dial was arranged as a filament switch, which when pushed in, lit the tubes.

A set revolving on a table formed the central point of interest in a recent window display in one of the Liberty radio stores in New York City. The background of the window as a whole is decorated to resemble an arbor and the draperies forming the background for the set is a dark velvet. The fore part of the window is taken up with a display of other sets and parts. Effective colored lighting made the display still more attractive. A time clock controlled the turning on and off of both the lights and the revolving table.



With the advent of the hunting season, the Smith Winchester Company, Jackson, Mich., presented the camp-radio scene shown below. The background was a painted canvas of a woodland setting, the hunter and his tent are displayed at the left, his campfire at the right and his radio receiver in the center.

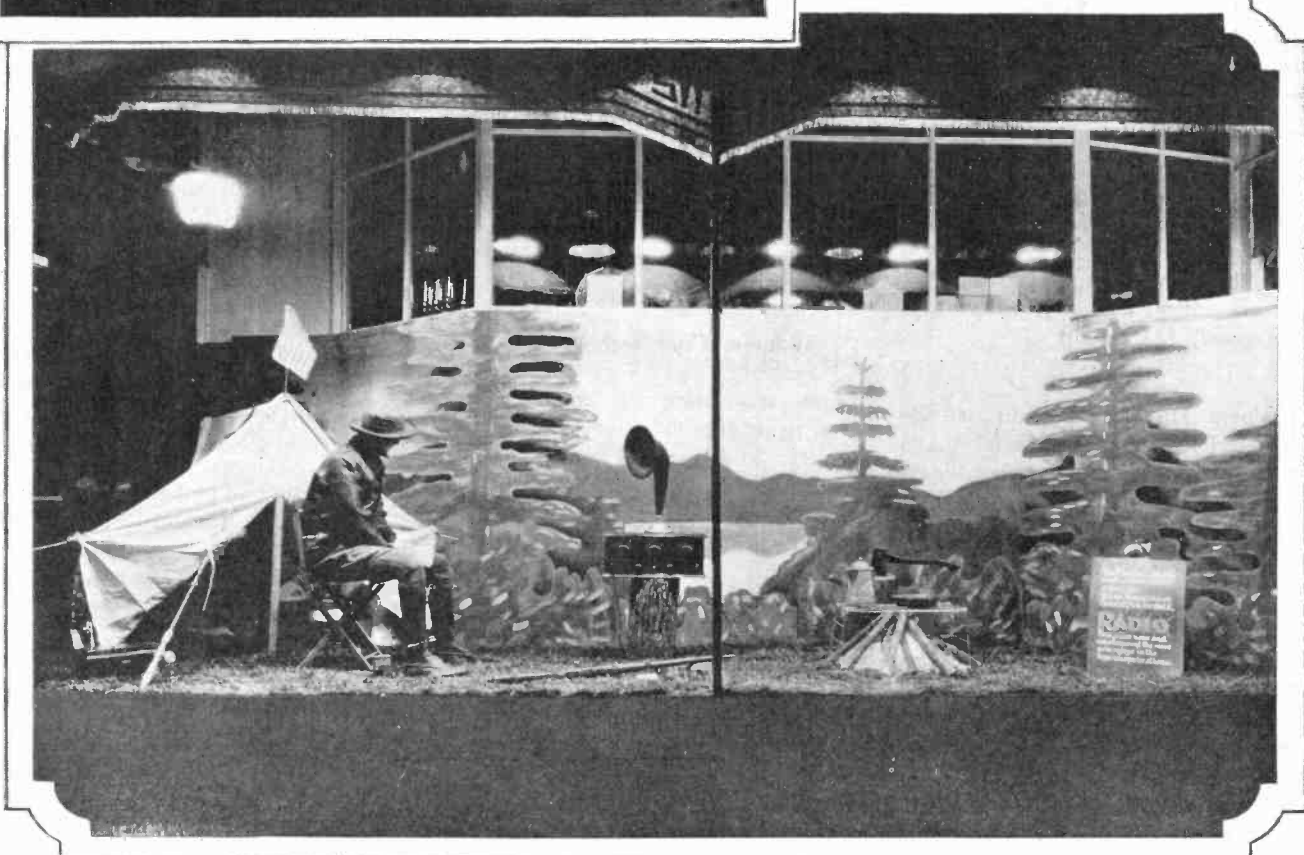
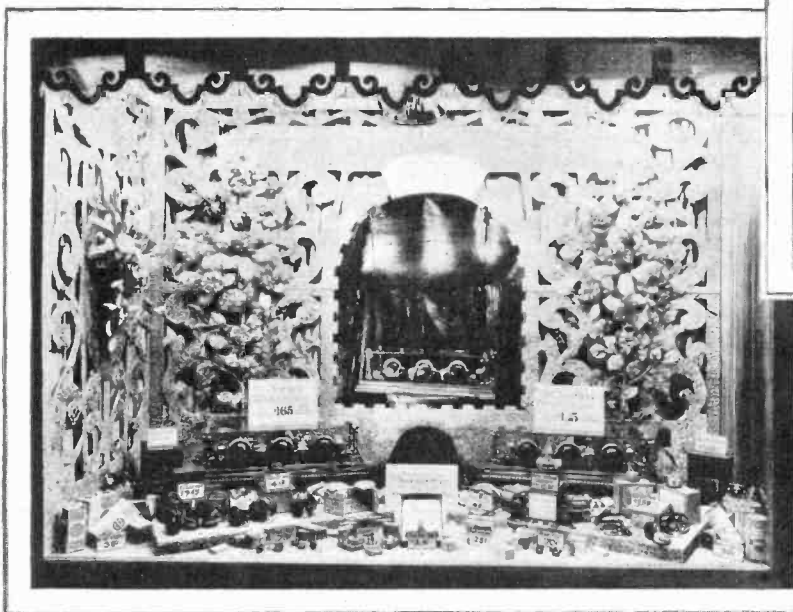

What's Your Rating as a Merchant?

How Many of These Profit-Getting Ideas Can You Check Off () as Being Used in Your Business? And How Many Can You Cross Off (X) as Having Been Tried Out and Found Impracticable?

- Service Calls.** Have you a definite program for making periodic visits at the homes of customers to see if their sets are giving complete satisfaction, and if any accessories are required? (For articles relating to this subject, see February issue, Page 173; March, 261; May, 452; June, 538; July, 46; September, 265, and this issue, Page 474.)
- Trade-Ins.** Are you holding your older customers who have equipment to turn in for more up-to-date sets by keeping a fair trade-in schedule posted in your store? (March, 260; June, 552; September, 283.)
- Operating Costs.** Are you protecting your profits by the use of a set of books that will show you at any time whether you are making or losing money; and if there is a loss, where it is? (February, 131; April, 354; June, 540; September, 296.)
- House-to-House Sales.** Do you and your salesmen spend all available time during slack periods ringing the doorbells of a selected list of prospects, which you have gathered from friendly customers? (January, 52; February, 142; July, 18; August, 144.)
- Farm Market.** If you are located near rural districts, are you stressing the utility broadcasting service of weather reports and market data in your sales talk? (January, 69; April, 349; May, 438; June, 530; September, 286, and this issue, Page 477.)
- Boy Trade.** Have you tried out the idea of a radio school or club with a technical youth in charge, to help the rising generation "roll their own"? (January, 44; June, 526 and 543.)
- Accessories.** Are you displaying prominently and asking your customers to buy, specialty accessories such as time switches, tube testers, voltmeters, battery chargers, eliminators, extension cords, etc.? (July, 22 and 28; September, 288.)
- Time Payments.** Are you posted on all the intricacies of the partial payment plan, and are you using a fair contract (which does not call for exorbitant interest charges) to break down sales resistance? (April, 339.)
- Store Arrangement.** Wouldn't a re-arrangement of your store — cases, counters, tables, demonstration booths—make a better impression on customers and also facilitate handling crowds during rush hours? (January, 40; March, 245 and 264; April, 367; May, 447; June, 535.)
- Advertising.** Have you made an effort to key your newspaper advertisements, and also check up on returns from circulars, letters and other means of publicity to see which is the most economical medium to use? (January, 48 and 62; March, 274; May, 435; July, 50; August, 144 and 147; September, 302.)
- Women Customers.** Are you making an effort to attract women customers by means of a pleasing store exterior, store personality, and courteous clerks, and also by stocking style merchandise? (January, 47; April, 342; July, 46, and this issue, Page 491.)
- Seasonal Slump.** Are you keeping in mind that the shopping season is only of four months' duration, and therefore, you must wrap good will and confidence into each customer's package in order that he will come back to your store? (May, 428 and 430; June, 523 and 526; July, 22, 25, 32 and 35.)
- Broadcasting.** Do you get advance programs of features from your local broadcasting stations and use them as sales helps and advertising copy? (March, 246; June, 529; September, 275; and this issue, Pages 481 and 486.)
- Turnover.** Are you speeding up stock turn to seven times or better by buying more carefully and more frequently? (See Operating Costs.)
- Telephone Sales.** Is your telephone (and telephone directory) being used to get in touch with prospects for afternoon and evening demonstrations? (January, 49; February, 137; June, 533.)
- New Apparatus.** Are you keeping posted on the eighty or ninety new radio devices brought out each month by manufacturers, and described and priced in the new merchandise pages of Radio Retailing? (Every issue.)
- Community Leadership.** Are you active in civic movements, clubs and fraternal organizations, thereby assuring yourself of attention and esteem of "key" citizens? (February, 180; June, 561.)
- Prospect List.** Are you constantly adding names to your prospect list gathered from news items, directories, real estate reports, and friendly customers? (March, 256, 271 and 275; April, 347; May, 443; July, 25, and this issue, Page 472.)
- Buying.** Are you gaging your stock requirements by a practical inventory system and also by anticipating changes in style trends and hookups? (January, 64; June, 552; August, 130, 137 and 141.)
- Bonus for Sales People.** Have you used a bonus plan of remuneration as an incentive to bigger volume on the part of your sales people? (February, 135.)

A Check List of Sales Subjects

Each One of These Basic Subjects Has Been Indexed so That Readers Can Refer to Their Back Issues of "Radio Retailing" for Information Bearing on Practically Every Function of Retailing

Publicity Stunts. Are you as original and aggressive as your local movie owner in getting your name and your products before the community? (*April, 379; June, 542; July 24 and 29; August, 136 and 140; September, 290, and this issue, Page 485.*)

News Service. Are you demonstrating the utility service of radio by making your window a bulletin board when news of national importance, football scores or election returns are being broadcast? (*This issue, Page 481.*)

Price Maintenance. Are you keeping faith with your public, your manufacturers and yourself by establishing prices on the basis of a fair profit rather than on your competitors' guesswork? (*January, 31; February, 145; July, 33.*)

Mark-ups. Do you know that it takes a 25 per cent mark-up on the cost price to equal a 20 per cent mark-up on the sales price? (*See Operating Costs.*)

Courtesy Discounts. Do you know that in giving a courtesy discount to a friend, you are not only robbing yourself of a profit but are weakening the whole merchandising fabric of radio as well? (*February, 180; March, 279; September, 309.*)

Window Displays. Are your windows attractively decorated and well lighted so that sidewalk traffic has a tendency to slow up when passing your store? (*Every issue.*)

Home Demonstrations. Do you know that the automobile salesman clinches the deal through a demonstration on the highway, and that your "sales highway" is in the prospect's home? (*January, 52; February, 142; April, 345.*)

Shop Equipment. Is your service department equipped with essential repair parts and up-to-date tools and instruments for facil-

itating repairs? (*July, 41; September, 305.*)

Bargain Table. Have you a "pick-up" counter near the front of your store where slow moving, damaged, and obsolete merchandise may be displayed? (*January, 36; August, 167.*)

Training Sales People. Do you know that five or ten minutes spent each day in instructing your sales force may increase your sales ten or fifteen per cent? (*February, 138; March, 240; April, 368; July, 27; August, 150.*)

Cash Discounts. Are you building up a balance by taking all those two per cent discounts for cash in ten days offered by your jobbers? (*For articles pertaining to jobbing, see May, 456; July, 68; August, 178; September, 280.*)

Radio Outlets. Are you sponsoring the "radio in every room" idea by telling architects, builders and home owners the value of this convenience feature? (*January, 51 and 61; February, 160; May, 458; August, 149.*)

Trade Associations. Are you doing your part in bettering local merchandising conditions by helping to build a strong radio association? (*May, 480; June, 575; September, 176 and 178.*)

Management. Are you dividing responsibilities so as to relieve yourself of details and gain more time for thinking and planning and applying methods other dealers use? (*Every issue.*)

Dealer Helps. Are you utilizing in your store the valuable sales helps being furnished by manufacturers and described monthly in *Radio Retailing*? (*Every issue.*)

Location. Are you overcoming the handicap of a poor location by giving customers unusual service and attention, assuring their return again and again? (*January, 35; March, 263; September, 281.*)

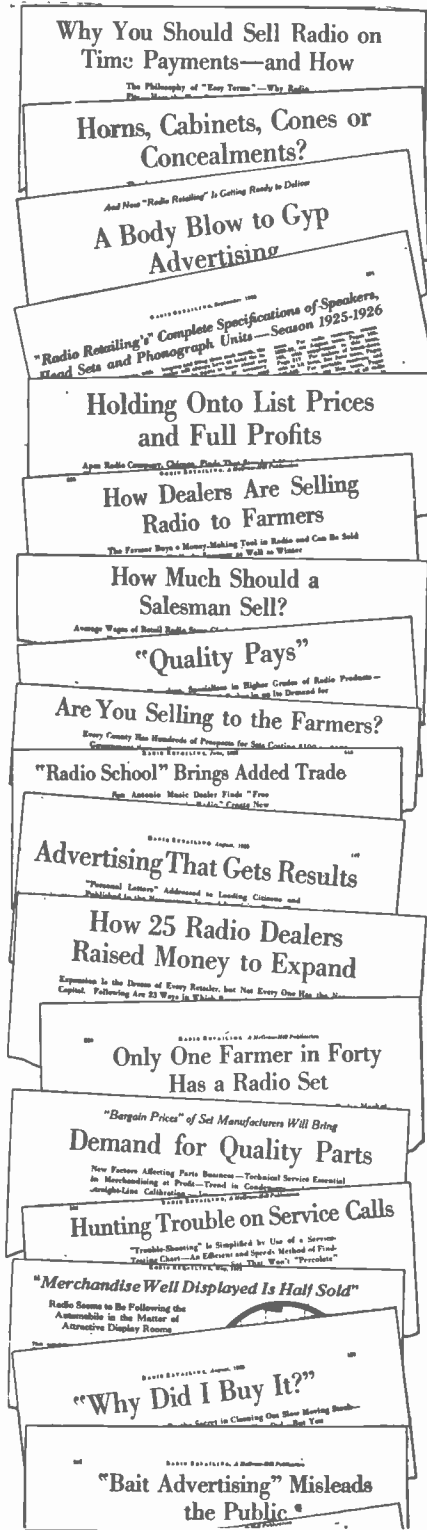

Every issue of "Radio Retailing" contains more than 20 major articles such as these—each one bearing directly on some phase of selling radio, each one containing information useful to the man who sells radio. Are you reading and profiting by every one?

Radio Reception Good in Bank Vault

Front page publicity in the local newspapers was recently obtained by the Earl G. Wilson Company, Napa, Calif., when a completely self-contained radio receiver was taken into a local bank, inclosed in a big steel vault, and a radio program received.

Wilson invited bank officials and the editors of the local papers to witness the demonstration and be convinced that radio reception is possible almost under any conditions. Of course, the sole purpose of the stunt was to get publicity and create interest in a new portable set.

Newspaper Censors Radio Advertising

In an effort to co-operate with the radio trade in achieving stabilized retail conditions, the *New York Sun* has adopted a set of rules to which radio advertisers must conform. The rules are as follows:

1. Fraudulent or misleading advertisements are not accepted.
2. A sufficient supply of the article advertised must be on hand to satisfy a reasonable demand. When only a limited number of the article advertised is on hand the advertisement must say so, or give the number to be placed on sale.
3. When only a limited number of the article advertised is to be sold each customer, the advertisement must say so.
4. An accurate description of merchandise advertised must be presented so that the reader will know the true nature of the article advertised.
5. When an article is on sale for a limited time only, the advertisement must say so.
6. The merchandise described must be sold at the prices named in the advertising copy.
7. If the article advertised is a discontinued model or a second, the advertisement must say so.
8. The use of cuts and illustrations taken from competitive advertisements will not be permitted.
9. No advertisement should reflect discredit on competing products or services.
10. Any advertising that in the opinion of *The Sun's* Advertising Censorship Committee would injure the confidence of *Sun* readers or be injurious to reputable advertising will not be inserted.

The following additional rules have been suggested:

- a. The degree of selectivity and the distance of reception, if stated, must mean radio broadcast station-entertainment programs.
- b. The degree of selectivity and distance of reception, if stated, must not imply that every purchaser may expect the same results as given in a statement

of another user of the same set or device advertised.

c. The word *complete* must not be used in any advertisement of a set unless every accessory (A batteries, B batteries, tubes, head phones or loud speaker, and either loop or antenna) necessary for the complete reception of broadcast programs is included for the price stated in the advertisement.

d. When a set is advertised and not meant to be complete then the word "only" must follow the word "set," and then such accessories as are included for the price must be enumerated in full.

e. The word "guaranteed" shall not be used in an advertisement unless a full and complete statement is given as to what the guarantee includes and means.

f. The word "service" must not be used and implied as being included with a set or a device unless a full and complete statement is made of the amount of service and the time limit stated within which the service is included.

Who Is Wholesaling Radio Today?

BY G. A. E. AHRENS
Statistical Bureau, "Radio Retailing"

An analysis of *Radio Retailing's* list of radio wholesale houses in the United States shows a total of 571 jobbers selling radio sets. Of this total 245 or 42.9 per cent are primarily electrical jobbers, 173 or 31.5 per cent are exclusive radio jobbers, 37 or 6.4 per cent do a miscellaneous jobbing business, 57 or 9.9 per cent are primarily auto accessories jobbers, 41 or 1.9 per cent are hardware jobbers, 11 or 1.2 per cent are music jobbers, and 7 or 1.2 per cent are sporting goods jobbers.

The accompanying table shows the analysis by states.

Analysis of Wholesale Radio Supply Houses in the "Radio Wholesalers' List"

State	Electrical	Radio	Music	Hardware	Auto Accessories	Sporting	Miscellaneous
Alabama.....	2
Arizona.....
Arkansas.....	1	1	1
California.....	15	16	..	2	1	1	1
Colorado.....	1	4
Connecticut.....	7	2	6	..	1
Delaware.....	..	1
D. C.....	4	1	1	..	1
Florida.....	4
Georgia.....	3	1
Illinois.....	14	17	3	..	4	..	2
Indiana.....	6	5	..	3	1	..	1
Iowa.....	9	5	..	3	1
Kansas.....	3	1	..	1
Kentucky.....	1	1	..	1	..	1	2
Louisiana.....	5
Maine.....	..	1	..	1	3
Maryland.....	3	3	1	..	2	..	1
Massachusetts.....	13	10	6	..	4
Michigan.....	9	3	..	2	1	..	1
Minnesota.....	9	2	..	1	1	..	1
Missouri.....	10	7	2	4	5	2	2
Montana.....	3	1	..	1	2
Nebraska.....	5	3	..	4	2
New Jersey.....	1	6
New York.....	36	33	4	5	7	2	2
North Carolina.....	2	2	..	1
North Dakota.....	1	2
Ohio.....	16	10	..	2	6	..	4
Oklahoma.....	4	1
Oregon.....	3	2	..	1	1
Pennsylvania.....	20	16	1	1	4	1	2
Rhode Island.....	1	2	2	..	1
South Carolina.....	2	1	1
South Dakota.....	1	1
Tennessee.....	4	1	1
Texas.....	7	3	..	4	1	..	3
Utah.....	1
Vermont.....	..	1	..	1
Virginia.....	3
Washington.....	6	3	..	1	1
West Virginia.....	3	1	1
Wisconsin.....	7	5	..	1	1	..	1
Total 571.....	245	173	11	41	57	7	37
Per cent.....	42.9	31.5	1.9	7.2	9.9	1.2	6.4

...ly recovering at his home.

**RADIO TEAS WILL
BE GIVEN BY LEAGUE
OF WOMEN VOTERS**

Mrs. Carrie Chapman Catt
Will Broadcast on World
Court Aug. 29—Local
Women Interested

A series of Radio Teas will be given throughout Westchester County on Wednesday afternoon, August 26th. Members of the League of Women Voters are planning these neighborhood gatherings to listen to Mrs. Carrie Chapman Catt, whose address in commemoration of the 5th anniversary of the ratification of the Suffrage Amendment will be broadcast by WEAJ at four precisely. The title of Mrs. Catt's address is "The Next Step" and she will deal with women voters.

"Radio Retailing" Starts a Campaign to

Interest Women in Radio

Programs by Local Women's Organizations from Nearby Broadcasting Stations—and "Radio Teas" to Hear Them—Will Go a Long Way Toward Attracting the Attention of Women to Radio

ONE of the most direct and forceful ways to interest the women of the nation in radio is the broadcasting of programs of particular and intense appeal to women.

This was established recently when Mrs. Carrie Chapman Catt, an outstanding figure among American women, broadcast a talk from WEAJ, New York, to which hundreds of women's clubs and branches of the League of Women Voters within hearing of the station, listened. In many instances, "radio teas" were held by groups of women in their homes and in clubrooms, and the address received via radio.

Radio Retailing believes this plan of broadcasting programs by and for women and women's organizations and then holding "radio teas" so that groups of women may hear the programs, presents a great and important opportunity for the radio industry to accomplish a long-desired aim—to get women equally as interested in radio reception as are men.

Therefore this publication has prepared and is putting into operation a nationwide campaign to coordinate local women's clubs and organizations of all kinds, with their local broadcasting stations, thus paving the way for radio dealers from coast to coast to capitalize upon the interest created among women in radio.

The co-operation of the National League of Women Voters has been secured and this organization,

through its executive secretary, Miss Gladys Harrison, at Washington, D. C., has expressed its determination to make every attempt to have its local branches supply women's programs to broadcasting stations and urge their members to listen-in via radio.

League Is Non-Partisan

The League of Women Voters is a national, non-partisan organization, countrywide in its scope, having local branches in many cities and towns in practically every county in every state in the Union. While political

in name, it is purely educational in its work. It is not affiliated with any of the parties and the reason for its existence is to urge women to take an active interest in national and local-civic affairs.

The League does not spread political propaganda. It makes its appeal directly to women and its membership numbers millions, its national officers including such prominent women as Mrs. Carrie Chapman Catt, Mrs. Caspar Whitney, Miss Ruth Morgan, Mrs. Mary O. Cowper, Mrs. William G. Hibbard, Miss Belle Sherwin and many others whose

Get Local Stations to Broadcast Women's Programs

then secure the co-operation of the prominent groups of women in your town and urge them to prepare programs—an hour a week—for the station.

Women's organizations that are prominent in almost every town include the following: Women's Club, League of Women Voters, Eastern Star, Daughters of the Revolution, Daughters of the Confederacy, Women's Auxiliary of the Knights of Columbus, Daughters of Isabella, women's auxiliaries of fraternal orders,

Order of Rebekah, women's auxiliaries of charitable institutions, Catholic Big Sisters, Protestant Big Sisters, Jewish Big Sisters, groups of women affiliated with churches and synagogues, Parent-Teachers' Associations, and women's auxiliaries of hospitals.

There is only a partial list of the feminine groups who have enough active members in each town to get up a weekly "women's hour" program. But it is the dealer who must get them started.

Help Prepare Programs for Women

After the dealer has secured the co-operation of the broadcasting station and the women's organization to send out a weekly "Women's Club" hour, or whatever the name of the organization may be, he should help prepare the program. Here is a sample, as used by a leading station:

4 p.m.—Talk by well-known woman or club officer on a matter of local interest. Alternate weeks on subject of national or international importance.

4.10 p.m. — Instrumental selections, piano, violin or banjo.

4.20 p.m.—Talk on household economics, giving cooking recipes, or sewing, child hygiene, or other household lessons.

4.30 p.m.—Vocal selections.

4.40 p.m.—Talk on latest fashions. Alternate weeks on subject pertaining to literary world.

4.50 p.m.—Combined vocal and instrumental concert.

standing among the women of the nation is high.

Mrs. Caspar Whitney, first vice-president of the National League of Women Voters, has been appointed to supervise the radio activities of the League.

No broadcasting station need hesitate to accept the programs offered by the League. Such programs are entirely non-political and non-partisan. Many branches, particularly in New York State and Minnesota have been broadcasting regularly for several years. Last year, the New York Branch of the League, under the direction of Mrs. R. T. Oliver, supplied weekly talks from WEA, and this year they are going out through WGBS, both of New York City.

Some of the speakers and their non-partisan subjects included: Miss Mary Garrett Hay, "Women and the Parties"; Judge Henry E. Curran,

"Recruits, Salute"; Mrs. Franklin D. Roosevelt, "Why Register and Enroll"; Senator Nathan Straus, Jr., "Citizens and Slackers"; Mrs. Caspar Whitney, "The Primaries, One-Half the Battle," and others equally prominent whose talks were directed especially to feminine listeners, urging them to exercise their right to participate in civic affairs.

However, it is *Radio Retailing's* hope and plan that weekly "women's hours," including musical concerts as well as talks will be supplied to many local broadcasting stations by members of League branches and other local women's clubs and organizations.

And our plan to co-ordinate women's organizations and broadcasting stations for the purpose of arousing radio interest among the vast feminine market does not end there. Other nationwide women's clubs and associations are taking the

campaign under advisement and within a short time, we hope a comprehensive program can be arranged and announced that will react not only to the great benefit of radio as a whole, but also to the direct material benefit of radio dealers.

For every women's program that goes out over the air, there will be thousands of opportunities for dealers to give demonstrations at that hour, permitting those women who want to hear the programs and who have no other means of doing so, to listen in. Dealers can readily see the sales opportunities thus put within their grasp. Demonstrations not only in private homes may be given, but also in the store and in women's clubs and meeting rooms where "radio teas" can be held.

The scarcity of good programs for and by women leads the editors of this publication to believe that radio broadcasting stations must give serious attention to programs of that nature. Contact is now being made with the directors of the 600 stations in the United States, urging them to send out the programs supplied by women's organizations. And contact is also being made, with the co-operation of the National Headquarters of the League of Women Voters, with its local branches, urging them to prepare interesting addresses and musical selections for their nearest stations.

The active co-operation of other women's groups is also being sought, and if broadcasting stations will lend a hand as well, *Radio Retailing* believes a plan can be worked out that will be the biggest step yet undertaken to get American women interested in radio and acquaint them with the incomparable service that radio can render them.

Sell Customers Equipment for a "Home Service Department"

THERE is a large group of radio fans who take a keen delight in "tinkering" with radio sets.

Even those who are not rabid set-builders often feel the urge to fix up their own sets when something goes wrong. Therefore, a radio workshop in the home is a possibility for added sales to the "tinkerers." Sell them the idea of their own repair shop, equipped with such articles as a soldering iron, busbar and spaghetti, solder, a hydrometer, a voltmeter, small wrenches and screw drivers, short and long nosed pliers, tube tester and reactivator, battery charger, scissors, distilled water, earphones, ground clamps, insulators, extra aerial and ground wire, and a supply of extra batteries, tubes and parts of all kinds.



Every man has an urge, at one time or another, to fix things himself. Capitalize on it by selling home repair tools

"Lamp Socket" Radio to Have Important Place

Many Efficient Receivers Designed Especially to Operate from A.C. or D.C. House Current Have Been Announced

On this page is a review of the leading "batteryless" radio receivers which were on exhibition at New York's radio shows last month. It is the consensus of the radio trade that battery elimination will rapidly grow in popularity as the degree of perfection in this field is reached and that radio dealers should give it serious attention this season.

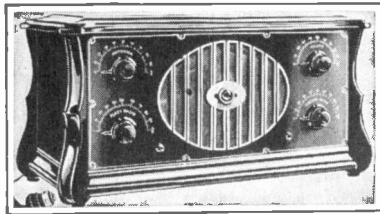

Miessner Radio Corporation, Brooklyn, N. Y. A.C.—\$175

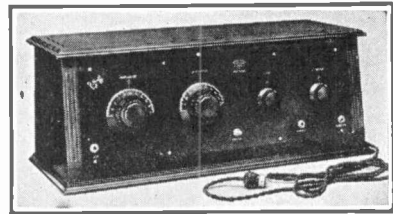

Radio Receptor Company, New York A.C.—\$185 D.C.—\$135

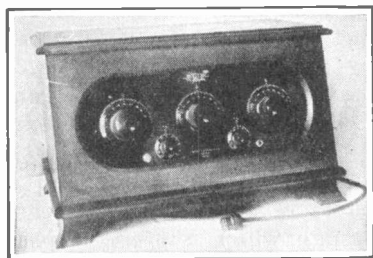

Batteryless Radio Corporation, New York, N. Y. A.C.—\$200 D.C.—\$140

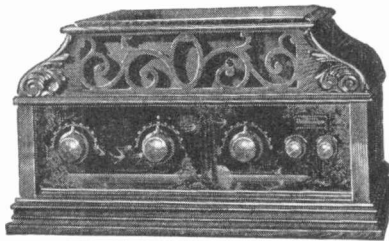

Andrews Radio Corporation, Chicago, Ill. A.C.—\$365

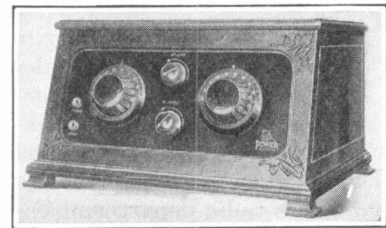

Argus Radio Company, New York, N. Y. A.C.—\$160

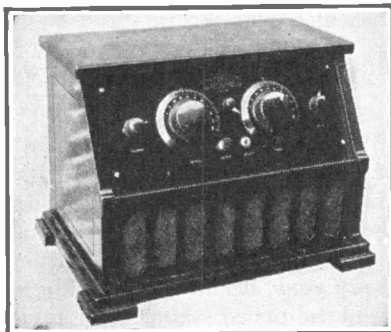

San Pedro Radio Laboratories, San Pedro, Cal. A.C.—\$100

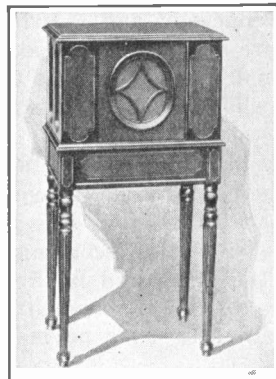

Radio Corporation of America, New York, N. Y. A.C.—\$245*

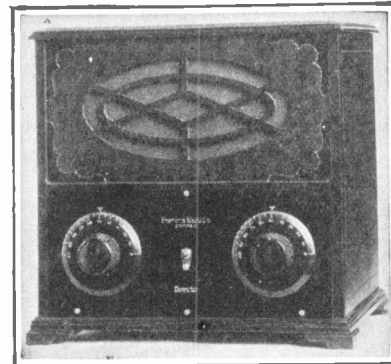

Peerless Radio Corporation, Chicago, Ill. A.C.—\$125



Radio Corporation of America, New York, N. Y. A.C.—\$575

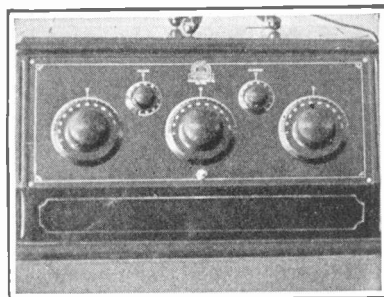

Powerola Radio Corporation, New York, N. Y. A.C.—\$165 D.C.—\$115

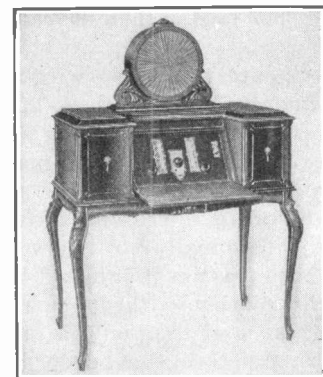

Music Master Corporation, Philadelphia, Pa. A.C.—\$400

*This is a speaker operated from 110-volt, 60-cycle house current which, when used with a Radiola 25 or 23, replaces all batteries, and when used with any other set, supplies the B battery voltage.

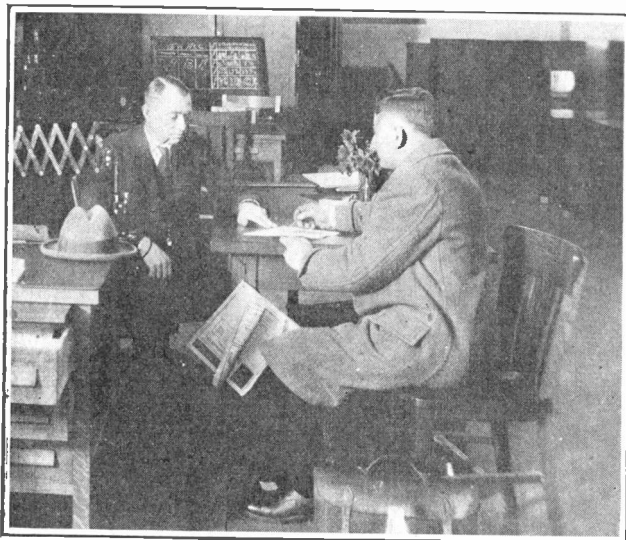

Sell to the Business Man in His Office

Oregon Concern Uses Office Supply
Salesmen as "Points of Entrance" to
Interest Business Owners in Radio

GET to the business man in his office" is the radio sales policy of the J. K. Gill Company, Portland, Ore. The Gill Company is a large book, stationery and office supply store and the success achieved by its radio department entitles its radio sales plans to be worthy of attention.

The Gill Company's office supply salesmen are used to get leads for radio prospects. True, they already have an entree to the business man's office because of their connection with Gill's, but the idea of selling the business man in his office is one that radio merchants may study with profit.

Other Salesmen Pioneer for Radio

When Gill's salesmen visit a business man with regard to his office supplies, radio is always brought into the conversation. If it develops he has no set and might be induced to buy one, the lead is turned over to the radio department for future follow up. The lead is then developed in two ways.

Further contact is made with the business man in regard to a home demonstration and if that meets with no enthusiasm, the business man's better half is brought into the picture. By direct mail, personal letters, telephone, and finally, by personal calls, the radio serum is injected into another happy home through Mrs. Business Man and it is only a question of time before they drop into the store "to hear the set you've been talking about so much."

Radio merchants, in general, may profit considerably by taking a tip from the Gill Company. While every radio merchant may not have the "point of entrance" the Gill Com-

pany salesmen have, still it is possible to see the average business man in his office, if the way is carefully prepared by mail or phone, or both.

Then, taking another tip from Gill, don't try to take a set under your arm and demonstrate it in the office. Give him literature to read about the set you think he ought to have—seeing and hearing the set is the next step. The first interview ought to take about five minutes at the most. Present your proposition quickly, concisely and clearly—then exit before an anti-climax occurs.

The final follow-up comes through the chancellor of the family exchequer—she is told the advantages a radio set will bring—music, entertainment, opera, recipes, household economies; she is made to see how indispensable a receiver is in the economical conduct of the home and finally she is told the set may be purchased on credit, either by time payment con-

tract or on a thirty, sixty or ninety-day charge account. Thus, every possible obstacle to a sale is removed.

Follow up cards are kept by Gill's, of every radio prospect that comes to the store's attention and a full history of the stages of development through which a prospect passes is kept in a special file. The cards are followed up at consistent intervals, and by reference to the cards, the status of every "near sale" may be seen at a glance.

Rents Sets to Prospects for Month's Trial

"I am opposed to the 'on trial' plan of selling radio," declares H. P. Harrison, manager of the radio department. "Thousands of dollars are lost by radio dealers of this city every year, because of placing equipment in private homes on trial. If a high-priced machine is left in a home for a try-out for a week or more, there is a 90 per cent possibility that the people know nothing about handling a set and will not be able to get anything even approximating good reception from it.

"The Gill plan of selling radio is this: If a man decides to place a machine in his home on trial, we install it there on a rental basis for one month at a charge of \$25—a \$10. service charge and \$15 for tubes, batteries, etc. If he decides to purchase the instrument, he is credited with the \$15 accessory charge. In any event, we keep the \$10 service charge as payment for time and material.

"In addition to our charge account system, Gill's accepts time payment contracts of one-third down, with the balance in ten installments at six per cent interest, which, we have found, works out very satisfactorily for both ourselves and our customers."

Salesmen for Office Supply Houses

have entree to most of the business offices in the city. A profitable working agreement is possible between these salesmen and radio merchants. Seek out these men and pay them a commission for every set of yours they sell to their office supply customers.

The Gill Company, of Portland, Ore., successfully uses its office supply salesmen to sell radio to business men. They have the "point of entrance"—the rest is easy.

Sell in Terms of 16-Hour, Daily Service

**Class B Stations in Broadcasting Programs from 8 A.M. Until 12 P.M.
Give Radio Dealers Sales Support Unsurpassed in
Any Other Field of Merchandising.**

Morning

Left—Father and the children use radio as a tonic, the first thing in the morning. Setting-up exercises to the accompaniment of lively music is helping hundreds of thousands of families to start the day healthier and happier.

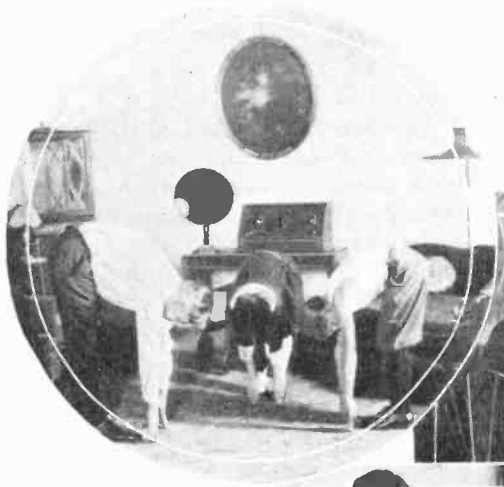

Forenoon

Left—Morning broadcasting of recipes, domestic science talks, sewing hints, etc., brings the housewife to her new "helpmate"—radio.



Noon

Right—At midday, when the kiddies are home for lunch, soft music subdues their restlessness and pranks. "Radio is the background of every meal," says mother.



Afternoon

Above—In the afternoon, radio is on the job playing "hostess." "Radio Teas" are quite the vogue, and rightly so, for what other form of entertainment is at hand so readily?



Evening

Right—Before supper, father gets stock reports and news items and is also refreshed with the strains of syncopation. There is no evening dullness, for radio brings a new interest and animation into the home.



Night

Left—Radio is hard on the parlor carpet, for the young folks now prefer to stay home and dance to the tune of "Vincent White-man's" orchestra, rather than go to where jazz may be a misnomer.

Lights Out

Right—Father tunes in on his favorite station, sets the time switch and goes up to bed. Radio puts the family to sleep and then turns itself off automatically.



Enjoyment Is the All-Year-Round

¶ *When Winter Comes, Remember Summer Follows*

¶ *Constructive Selling Will Extend the Season*

By J. ANDREW WHITE

This Business of Ours

A Department of Retail Radio Comment

WE ARE busy again in the retail radio field and all the worries of surviving the Summer slump are rapidly receding into those recesses wherein unpleasant memories hide themselves. Hide themselves—but not for long. Let's not forget that.

The human mind bounces quickly back out of states of depression and nothing so markedly aids that resiliency as the merry ring of the cash register and the call of customers for the things that are new. Yes, it's great to be busy again, and the natural thing is to be unthinkingly joyous with the relief that the dark days are over. To be engaged in profitable activity in itself is a form of celebration.

So this reminder—the whole thing is going to be pretty transient if in the present month and the few "fat" ones to follow we skim the surface and neglect the substance.

AN ante bellum anecdote seems to fit the situation. It is the one about the weebegone private, a little fellow, bowlegged and water-eyed, an enlisted man in a colored stevedore company working on the docks at Brest, and the reaction that hit him when he heard the news of the armistice. Immediately he was homesick and miserable, and he went to his sergeant, a powerful raw-boned yellow boy from Texas. "Sarge," says he, "I done hear how dis wahr is over and if you isn't mindin' I wants to git back home to Alabama. A long time now I been totin' dese here boxes from de ships to the cyars and all de meat on my bones is jes worn ragged. So ef it's all de same to you I'll jes be moseyin' along, dis mornin', or termorrer, maybe. I 'listed for de duration of de wahr, an' now de wahr is done over, an' I wants ter git on back home." The sergeant looked slantwise down at him, a murderous glint in his eye. "Nigger," he said, "git yourself back on dat job. 'Listed for de duration

of de wahr, eh? Well, de wahr am over...dat's right... but de duration, dat am jes started!"

THE STORY seems to fit in. Here is the festive Fall, after the Summer slump, and we just want to stop toting heavy burdens and project ourselves into the happier environment of getting what's coming to us. Which is right and proper and natural, too, but something has got to be done to hold captive two opposing forces we encountered last year, wobbly Winter and skidding Spring. The Summer slump isn't the whole story by any means, and well we know it . . . when we stop and think.

If there is a key to the situation of extending the selling season for radio I wish the fellow that has it would bring it forth. Thousands of hours of thought and study have brought me just about nowhere in the attempt to fix on one bright idea which will sustain the buying urge with Mr. and Mrs. Public the year round. All I have managed to gather together are a few merchandising principles which will help the situation somewhat if they are embodied in toto and stuck to. But they are things that I know, not from consultation or observation, but by actually putting them into practice in the retail stores with which

I am associated. And since it appears that some retailers, and perhaps many, are even more foggy on the subject than I am, I am inclined to set down here what I have learned for the general good of the cause, and with the hope that these fundamentals will be adopted widely in the trade and, what is more important, supplemented by better ideas from other retailers.

So, without expectation of saying a thing that is new, but in the hope of co-ordinating constructive thought on the problem and suggesting standards of practice, the following things I feel are worthy of consideration by every retailer who feels the necessity of extending the selling season.

ENJOYMENT is the most forceful keynote to strike. Our salesmen, our show windows, our advertisements haven't done all they could to focus attention on this one thing—and to me it is the one unanswerable argument why everybody should have a radio set. That's the important matter, the creation of a desire for ownership because he is missing something good. Tell him that steadily and interestingly and he'll make up his mind to buy. Which is the one thing the radio industry needs now more than anything else. Millions of potential buyers are still holding back.

And why? Well, we've talked a lot about price slashing having destroyed confidence. Unquestionably it has; and the indications are that the lesson has been learned, and there will be a lot less of this particular evil. It is perfectly evident, though, that price stabilization alone won't restore confidence without long and patient waiting. Something more is needed.

Quality is the thing to shout about. For the past year there have been any number of radio sets which have been giving more faithful reproduction of sound than the phonograph accomplished in twenty years, and the radio industry has been blabbling about dynes and trons and super this's and ultra that's, a lot of

Start Stabilization While We Are Busy

The dark days of radio are not over. They're momentarily eclipsed by a shopping season. The buying days will be pretty transient if we skim the surface and neglect the substance.

Only through adapting and applying successful merchandising principles will we succeed in taking radio out of the "straw hat" or seasonal industry category.

Keystone to Strike in Selling Radio

Put Entertainment and Dependability to the Fore
 Keep Customers Listening Twelve Months a Year

confusing technical terms and exaggerated claims about distance and quantity in reception and the superiority in electrical properties of this tongue-twisting circuit over the other fellow's. As a result, when two fans discuss their sets in front of a person who is uninitiated, the newcomer doesn't know what it is all about. If radio looks pretty technical to him and he decides to defer his purchase until sets have arrived at a point where a technical education is not required to make them percolate, then we have no one to blame but ourselves. Not a minute should be lost in dropping all this jargon out of both printed and verbal sales talks. And the hokum, too. The salesman who has said, "Yes, there are a number of sets which are simple to operate and sound pretty good, but wait till you hear *this* one—" he has done a real selling job.

A GOOD part of the job of selling has been done when the dealer puts entertainment to the fore. But not all. Dependability is a requisite to enjoyment. Nothing dampens the buying urge more with the novice than to have his neighbor alibi that the set was working perfectly just before the visitor arrived but it won't behave now that company has come. Invariably the receiver is compared to the behavior of a small child under the same circumstances. It's a standard gag—and yet to this particular bromidom can be laid the loss of a mil-

lion sales at least. Radio should be yanked out of the small child classification, and the one way to do it is by putting the emphasis upon dependability.

In nine cases out of ten the set is inoperative when on hearthside display because of the batteries being run down. That is something the dealer can remedy; and as a matter of fact, whatever the trouble is, very rarely is it anything but some minor ailment that has nothing to do with the intrinsic merit of the set itself. How glaringly apparent it is then that the dealer is the very foundation of any impressions the public may hold of temperamental uncertainties of radio sets. That's part of the job for this season—emphasis upon the satisfaction that is built into the merchandise, quality first with price secondary, for after all price is merely a standard for measuring the relative value obtained. A sale that is made wholly upon

satisfaction to the purchaser naturally carries with it the dealer's determination to keep it operative, which is another way of saying, Service.

OF COURSE, no observations on the subject of dependability would get anywhere without stressing the importance of service. Nobody expects an automobile to run without fuel yet the average radio set owner is either chagrined or mildly surprised when his set becomes inoperative because his neglect of renewing current supply. Why?—because he hasn't been told what to expect; he knows a lot about the number of miles to the gallon of gas and when to add a quart of oil, but in radio we've been too busy talking about plate potentials and what-nots to ground the pur-

The image features a central black and white photograph of a group of people in a room, likely a radio listening party. The room contains a radio set, a piano, and a framed portrait. Overlaid on the photograph and scattered around it are numerous orange theater tickets from the 'Orchestra' company. The tickets display various seat numbers and prices, such as \$3.85, \$4.40, and \$5.50. Some tickets also specify dates like 'MAY 7 1925' and 'AUGUST 14 1925'. The overall composition suggests a connection between the entertainment value of radio and the entertainment value of theater.

Sell the entertainment value of these stars—Schumann-Heink, Emilio de Gorgoza, Feodor Chaliapin, Anna Case, Frieda Hempel, Louise Homer, Reinald Werrenrath, Paul Althouse, Mischa Elman, Josef Hofmann, Mario Chamlee, Lucrezia Bori and Florence Easton, all of whom are to broadcast a series of concerts. (See page 514).

chaser in the very fundamentals of radio reception.

What a mockery of the term service it is to sell a set and merely say, "Yes, we stand back of that; if anything goes on the blink we'll fix it up."

Plainly it is the duty of the retailer to make it very clear to his customers how long the batteries should last and how to tell when they are running down, so they can be renewed by recharging or replacement before the set goes dud. Voltmeters, hydrometers, battery chargers, extra batteries and tubes can easily be included in the original sale, in most cases. In any event, the installation man can put these items across, or someone from the store calling at the customer's house at the end of, say, a week, under the guise of seeing that everything is working O.K. can explain their utility and desirability as accessories. When customers really understand how simple it all is, the inclination is offset to let the set lie idle during the outdoor months rather than be bothered with calling on the retailer to fix up things.

WHEN we learn to keep our customers listening all year round—a proportion of them, anyhow—or when we make it easier to have the set operating continuously, an important step will be accomplished in extending the season. Initially, it may mean only the sale of accessories, but these sales help materially in carrying the overhead in the dull season, and who can tell but what concerted effort on the part of broadcasters and dealers might convince a sizable proportion of the audience that radio is entertaining any and every night, with the ultimate result of selling some, if not as many sets in the heated term, too. Tougher tasks than that have been accomplished in other industries.

Before this particular subject can be dismissed, let me mention again something that works out well with those who have tried it out; that is, the service plan which gives the customer a monthly inspection, with a man from your store calling at the house to look things over. In my experience they are glad to pay twelve dollars a year for this service, aside from which we sell accessory replacements or renewals bringing in twenty-five dollars more, on an average; we are sure of this much business at least from each customer and, best of all, it is distributed over twelve months!

They Photographed the "Static," Too



When this portrait of Captain Rogers, the temporarily-lost Hawaii flyer, was being radioed 5,116 miles from Honolulu to New York in September, severe static conditions prevailed about the receiving antenna, with occasional lightning flashes. This "static interference," so familiar to radio listeners, made itself evident on the received radio photograph in the form of occasional dots in the white spaces, as shown in this unretouched reproduction of the incoming picture.

Some retailers omit the twelve dollar charge if the set is purchased at their store. All right, if they want to; take your choice. But don't think you are servicing sets if your policy is to sit back and await the call for help. It may not come. The other fellow may get it. Or, lacking a call, then the set may be standing idle, which is no way to extend the selling season.

AND now, to tie things all together.

Public confidence in radio has been destroyed; otherwise buying would not have stopped almost completely last spring. We are out to head off a repetition of that now. Well, let's not have any doubts about values. Cut out the discounts! This has been one of the greatest evils in the electrical industry.

The other important thing about wrecking values is price slashing that results from too heavy an inventory. Sacrifice sales in almost every case can be traced to trying to take on everything there seems to be a demand for, instead of concentrating on the fewest possible number of lines, whether sets, parts or accessories. Capital tied up in bulging storerooms tends to unstabilize values as quickly as anything I

know. If nothing else it makes the dealer jumpy and nervous over each day's volume of business and turns thoughts that might otherwise be buoyant toward quick reduction of stock even if at a sacrifice. There are habitual price slashers. Nothing here said is intended for them. This article's sole purpose is to coordinate thought on lengthening the selling season. We can expect nothing from them. I have no quarrel with the cut-raters, those that do business with the penny-pinchers and sell everything at a slight reduction from list prices. They have their place in the scheme of things and will make money or lose it according to their merchandising ability. But the slashers—they are nothing but parasites. Forget them. They'll kill off themselves. They were attracted to radio because it was new. They'll be passing along to something else — Florida real estate or some other sensational field for opportunism. I feel that we are just about rid of them; many itching fingers were burned in the past few months. Yet that must not interfere with the sense of obligation imposed upon the legitimate radio retailer that so sure as he starts slashing prices public confidence in values goes to pieces and business stops.

ANOTHER thing which will help to make radio less of a seasonal business is the time payment proposition. Don't be afraid of it. The procedure is well standardized, losses are infinitesimal, and besides it's here to stay. Get a third down on the initial payment if you can; don't accept less than one fourth; a year to clean up the transaction should be the absolute maximum and the bulk of the business should be on a six months basis—that's all there is to it.

As for trade-ins, I cannot help but feel that the time has come when we will just have to take in old sets, whether we want to or not. A second-hand market may not be a bad thing after all if it brings the skeptics into radio initially at a low cost; most of them will develop into fans and later buy real stuff at a regular price. It has worked out that way in other lines of luxury business. Adoption of a trade-in policy can be guided by the simple rule of allowing about fifty per cent of the profit on the new purchase. You can be more generous if you

(Continued on page 519)

Service Is Foundation for Future Sales

(Continued from Page 476)

buying season off to a flying start. Here is an idea that is good right now and can be used by any dealer.

Despite the fact that the Craig Electric Company gives free service indefinitely on the sets it sells, Rudisill declares it pays its own way through the sale of supplies, as well as accounting for 40 per cent of the total set sales. The service man gets \$35 a week and the service cost is about \$1 per trip.

The Enterprise Electrical Company, Middletown, N. Y., uses a card index system to keep track of its service calls. A card, 9 in. x 13 in., is filed for each customer, with his name, address and description of receiver. When a customer asks for service, his card is taken from the file and placed in a rack. Space is provided on the card for a description of the work to be done. After the job is completed and the charge made, the card is filed away until needed. This gives a complete record of all servicing and is of great aid to the service man.

Three months free service is allowed on new sets, after which a service charge of 50c. is made. On receivers not sold by the Enterprise Electric Company, \$1 is the minimum charge. Because of these well-prepared service plans, this department supports itself, although but a very small percentage of new sales can be traced to it. An average of three service calls is made on each receiver, at a cost of \$3. The service man receives \$40 a week and does the shop repairing, as well as being used to help out behind the counter when necessary.

T. R. Cornick, proprietor of Cornick's Electrical Shop, Petaluma, Cal., makes his radio service pay by doing all service calls himself. "This," he says, "gives me contact with purchasers, from whom I secure my new leads, as well as selling them on other electrical needs. It pays big. I make my free radio service calls pay for themselves in good will and added business. Seventy-five per cent of my new sales are brought about through taking the service calls myself."

Cornick makes two free calls, and changes the batteries without charge the first time, provided the new batteries are purchased from him. Other calls are charged for at the rate of \$1.50 during the day and \$2 at night.

J. C. Halvey, proprietor of The Electric Store, Cooperstown, N. Y., puts forth the belief that lax instruction at the time of installing the set is responsible for many unnecessary service calls. "The instruction period really determines how many future calls have to be made," Halvey says. "This is handled in a very slipshod way by most dealers and means many free calls. I believe giving free service calls is necessary for a limited time, yet it is profitable, because almost always they will buy anything that is recommended. But in the case of a man who imposes on us, we charge as much as we can."

Department Stores

The Shepard Store, Boston, Mass., according to A. R. Whitcomb, manager of the radio department, gives no free service, except to remedy defects in the set. This service department is put on a matter-of-fact basis and must show a profit just as any other department in the store. Therefore, a charge is made for every call. The service costs and income figures are kept in a daily accurate record. Whitcomb believes a charge for every call is the best plan.

That policy is practical for a large store in a big city, which is not dependent entirely on radio, but dealers in the smaller towns are overwhelmingly in favor of giving a limited amount of free service and getting back the cost in good will, sale of accessories and leads on new prospects.

The extent to which the Shepard Store has put its radio service department on a business basis, may be gleaned when it is learned that the city has been divided up into zones and the service calls charged for accordingly, from \$2 to \$3.50. Five dollars is charged for half a day's work and \$8 for a full day. In addition, the customer pays the expenses of the service man in making the trip. "We have no kicks on our system," Whitcomb says, "and break better than even."

Written orders must be issued before the service men leave the store on a call and they are routed by districts on a planning board, so that, when a call comes in, the location of the nearest service man can be ascertained.

The radio department of Macy's, Brooklyn, N. Y., of which W. L. Fraser is manager, gives twelve months free service on sets it sells. On others, a service charge of \$1.25 an hour is collected. If the call comes from out of

town, carfare is also added to the bill. By making an installation charge, and through the non-free service calls, the department pays for itself, the installation charge, of course, being credited to the service department.

Twenty-four dollars to thirty dollars a week is paid the service man, and it has been figured out that it is necessary to make an average only of four free calls per set during the year. It is the policy of Macy's to call back about a week after each set is installed, check it over for faults and answer any questions that may have arisen in the owner's mind concerning the operation of the set.

Service is almost, but not quite, a self-paying feature for the American Supply Company, Worcester, Mass. Here, thirty days free service is given and a charge of \$1 an hour made after the first month. The service man gets \$25 a week, and to interest him in making additional sales, both of sets and supplies, he is given a small commission on all sales he makes. Or if he turns in a lead that later results in a sale, he also receives the commission. This has resulted very satisfactorily, according to H. F. Reilly, manager of the radio department.

At least half of the calls made are free calls, although the average free service cost on each set ranges only from \$3 to \$7. The service policy accounts for 15 per cent of the total set sales and Reilly adheres to the belief that free calls for a limited time is the best system to follow.

With every set sold, the purchaser is asked to sign a service agreement, telling in just how much and what kind of service to expect. This avoids all misunderstanding and both the store and

(Continued on Page 520)

"The Happiness Boys"—"Al" Smith and Major White



The awarding of a silver loving cup to Major J. Andrew White, contributing editor of *Radio Retailing*, was one of the events of the opening of the Radio World's Fair at New York during the week of September

14. Major White is a pioneer broadcaster in radio, and in the presence of a vast audience, the cup was handed him by Governor "Al" Smith of New York (right), who officiated at the opening ceremonies.

Stewart-Warner

100% Protection

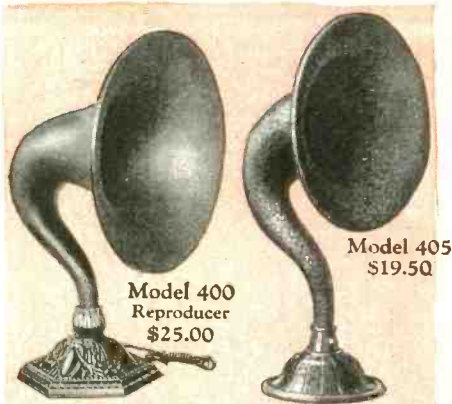

Model 400
Reproducer
\$25.00

Model 405
\$19.50



Model 300
\$65.00



Model 325
\$80.00



Model 305
\$95.00



Model 510
Antenna Kit
\$4.50



Model 320
\$450.00



Model 310
\$175.00



Model 315
\$285.00



Model 410
Radio Table
\$65.00
Console Table including
Built-in Speaker
and Battery Compart-
ment, without Radio

The important factors governing your success are:

First: A complete line of highest grade radios fulfilling every demand.

Second: Built and guaranteed by one of the largest and most progressive manufacturers of today.

Third: Absolute protection guaranteed by a "Dealer-made" plan.

Fourth: Only one dealer in each locality.

Fifth: No jobbers.

Sixth: A large advertising program that will create an unusual demand.

Seventh: A price and style to suit every radio buyer.

Eighth: A personal service that guarantees complete radio satisfaction.

Stewart-Warner Matched-Unit Radio offers you all of these things and more.

Prices slightly higher West of the Rockies

Matched-Unit Radio

For The Radio Dealer *of of of*

RADIO SUCCESS hinges on many things, but the greatest of all is worth while profit.

You, as a Radio dealer in your locality, in order to attain success must sell a radio set that will satisfy your customers, and at the same time prove a profitable transaction to you. Stewart-Warner has invested thousands of dollars in developing and perfecting a high-class set which you, as a dealer, will be proud to sell.

Stewart-Warner engineers have gone one step farther. They have matched each unit, the Instrument, the Tube, the Reproducer, the Accessories for perfect functioning with each other, enabling you to offer to the buying public a radio set that is unsurpassed.

You, as a dealer, are entitled to a fair profit and absolute protection. We guarantee both. Our "Dealer-Made" plan assures you every avenue to success.

There will be no bargains in Stewart-Warner Radios. They will be sold by authorized dealers only.

No individual can buy Stewart-Warner Radios at dealer's prices. He must buy from an authorized Stewart-Warner Dealer.

Stewart-Warner Matched-Unit Radios are distributed direct from our own central distribution stations. Ninety-six all over the world—sixty-two in the United States and in Canada.

Stewart-Warner Dealer Policy guarantees every dealer abso-

lute protection. You get all the profit, because there are no other dealers handling Stewart-Warner Radios in your immediate locality. No possibility of the Drug Store down the street selling the same line or some other store around the corner stepping in on a share of your profits.

In the same way you receive full benefit from the extensive advertising campaign now appearing in the National publications.

Stewart-Warner has gone into radio in a "sure-footed" way, and their success is already evident. Their name is already known from coast to coast through the high quality products now used by over ten million people, and when tied up with radio, instantly carries home the thought of another quality product.

Radio sets are today bought in much the same manner as motor cars—that is, the buyer wants to know who is back of the article he is purchasing and whether they will be in business next year or the year after.

For this reason it will be well worth your while to consider a Stewart-Warner Dealership now because next year one may not be available in your locality.

If you are a live-wire dealer, you can build up a radio business that will give you prestige, profit, protection and permanence, through our "Dealer-made" plan of radio merchandising. Send in the coupon below and we will have our representative call and explain its many advantages to you.

STEWART-WARNER SPEEDOMETER CORPORATION
CHICAGO · U. S. A.

Stewart-Warner

Matched-Unit Radio

INSTRUMENTS

TUBES

REPRODUCERS

ACCESSORIES

COPYRIGHT 1925 BY S.W.S. COR'N.

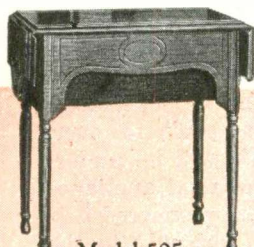

Model 505
\$22.50

Radio Table with storage space for batteries



Radio Tube
Model S.W.
501-A
\$2.50

Radio Division
Stewart-Warner Speedometer Corporation
1820 Diversey Pkwy., Chicago, U. S. A.

Gentlemen:—I want to be considered in connection with a Stewart-Warner Radio Dealership and to discuss the details with your representative.

Date _____

Name _____

Address _____

City _____ County _____ State _____

Your Editors Have

Radio Is Bringing Contentment and Stabilization to Farm Life

THE cities are claiming fewer and fewer of our farming population due to the beneficent effect of radio, which is successfully combating the roving spirit inspired in part by the automobile and motion pictures. No longer does the younger generation want to rush off to town after the day's chores are completed. Radio is bringing to their fireside better things than the average town has to offer. A Kansas postmaster writes this to the *Rural New-Yorker*:

"The automobile was largely instrumental in demoralizing farm help and the residents of farms, in that it took them away too often hunting pleasure when they should have been at home at work. I feel from conversation with farmers who come to the windows on Saturday afternoons after their mail that radio is going to change all that, for they can have much of their entertainment at home in the future. On the whole farmers are better off than for the past several years, and more content."

Continue the Buying Season Into the Spring

IF THE radio industry is going to be faced with another session of overproduction, the only legitimate way to absorb the superfluous sets is to continue the buying season long after the holidays, in fact, right up to early summer. In previous years of radio selling, this was done. Buying did not begin to drop off radically until warm weather set in. The public can be educated to return to its old habits and buy radio consistently from September to June.

This can be done only by advertising and publicity. Spread the propaganda that radio is a public utility and its usefulness is just as great every day of the year, regardless of the season or weather. Start the radio season now and keep it going indefinitely, by advertising and by word-of-mouth. "Radio Week," the last week of January, will do its share to keep post-holiday business up to a sane level. Do your share to continue it throughout the Spring and Summer.

Don't Let the Musical Octopus "Touch" Your Cash Register

THERE is no reason why the Society of Authors, Composers and Publishers should make the exorbitant demands it does for broadcasting songs composed by its members. The Society is making radio the goat and is milking the goat to the death and will continue its parasitic methods until someone calls a halt.

Radio popularizes any song given repeated hearings over the air. Radio sells that song to the public. The Society should pay radio stations rather than extort ludicrously high license fees from an institution whose very existence is of inestimable material benefit to composers of musical selections.

The National Association of Broadcasters has gone on record as favoring legislation in Congress that would

put radio broadcasting of copyrighted selections in the same class as mechanical reproductions—that is, to pay the owner of the copyright a stipulated sum each time a song is broadcast. This is a fair and equitable arrangement. It would pay the composer an adequate royalty, would continue the popularization of his songs and would insure broadcasting stations of an even flow of musical numbers at a reasonable figure in payment.

This question directly concerns every radio dealer, jobber and manufacturer. Great harm would be done to radio if it was choked off from any type or group of songs. Therefore, every reader of this publication should make it a personal obligation to bombard his congressmen with demands that radio broadcasting of music be put on the same payment basis as mechanical reproductions, and dealers should make it their business to see that set owners send letters to Washington at once advocating that plan.

Why Make Time Payments a "Three-Ball" Deal?

TWO of the largest automobile companies have cut red tape and handling charges on time payment sales. Radio must fall in line also. The legitimate merchandising world should not be handicapped by having to pay exorbitant interest charges. Credit should be a tool to help move merchandise, not a mill-stone around its neck. What we need are better acceptance houses closely associated with radio manufacturing and mercantile activities rather than merely side-line outlets for surplus commercial credits.

Buy More Credit with a Sales "Plan"

RADIO has financial interests puzzled. Bankers are still to be convinced that radio is permanent and not a fad. This was made plain at the Radio Industries Banquet held in New York City last month, where *Radio Retailing* invited a group of bankers to show them the substantial calibre of the men behind the industry.

One of the bankers present in discussing the problems of radio financing, stated that radio dealers and manufacturers who approached him for loans or extensions were sadly lacking in a "plan" for getting out of their difficulties, brought on as a rule through the seasonableness of their product. Loans in many cases, he maintained, could be appreciably increased if the borrower had a definite program for moving merchandise in the off season.

The sales philosophy of radio being a "specialty" after the "four months' shopping season" is over, described on page 472, is a plan which will be understood by bankers everywhere. For electrical appliance dealers and sewing machine dealers have pioneered this "specialty selling" highway for years, not only to the housewife's doorway but to the inner sanctum of the banker's office as well.

This to Say—

Trade, Not Laboratory, Must of Necessity Censor New Products

CENSORSHIP of advertising is a pre-requisite of publishing ethics. In stabilized fields of merchandising and manufacturing, rash claims and exaggerations are easily rooted out of copy. But in radio with its present transient stage of unprecedented inventive development there are times when only the trade itself can establish what constitute the commercial limitations of new devices.

Granted that a manufacturer has a reputation of integrity and financial means to back up his advertising, no individual can take unto himself the arbitrary powers of putting thumbs down on an untried product. A publication is a common carrier and is used to build up a common law of practice. It cannot in every case set itself up as a jury to decide what is or what is not truth in advertising in terms of *new* devices.

A commercial test must be given to a manufacturer before making him a defendant. Readers are intelligent judges and quick to detect misrepresentation and bad faith on the part of manufacturers. Therefore the editors of this publication solicit the criticism of readers. We'll stand by their decision.

"Wire-for-Radio" Booth at Radio Expositions

IT IS much easier to sell a radio receiving set to the owner of a building where the wiring already installed makes its connection and use easily accomplished. The lessee of a home which is wired for a radio connection in every room will not long remain without a set which will enable him to take advantage of this convenience. The public is appreciative of the benefits of radio-wired homes, but they do not know what is necessary to have done nor what expense would be involved. An educational effort is required before this idea can become widely disseminated. There are some twenty-five radio expositions planned within the next few months. Why not devote the space of one booth in each to selling the idea of wiring the home for radio to the radio fan? The instruction will be of benefit to radio dealers and to electrical contractors as well as to the general public.

Radio Almost of Age—Cite Stability to Encourage Buying

BECAUSE radio has become commercially practicable only within the past few years, the impression prevails in the public mind—and in too many dealers' minds as well—that it is something new, something undeveloped and something that may undergo radical changes at any moment.

This uncertainty in the mind of the purchasing public unquestionably has delayed a fuller acceptance of radio, at least insofar as immediate buying is concerned. Unfortunately many, if not most, dealers are not sufficiently versed in the history of radio to speak

authoritatively to their prospective customers and thus allay this fear.

One of many significant facts that should be given greater publicity is that many of the basic patents on radio have already expired and the life of a patent is seventeen years.

Use Your Users—Get Their Profitable "Repeat" Purchases

WHAT is or should be one of the greatest assets of a merchant? Satisfied customers, of course. And yet how few of us know whether our customers are satisfied or not—whether they are living advertisements of our business, or apathetic, or even antagonistic?

A simple way and a very profitable way is to keep a record of your sales. There must have been some reason for the initial sale. Why just leave it to chance that you will secure the profitable repeat business? Most merchants do so leave it, and yet *they* appreciate courtesy and thoughtfulness and intelligent aggressiveness in others with whom they deal.

"Profits Are Lost on Leftovers"

"PROFITS are made on turn-overs; profits are lost on left-overs." That was the poignant phrase of a wise merchant, long before the day of radio, but its lesson applies to the radio dealer and his 1925 wares, no less.

If the radio merchant will tuck those ten words away in his mind and use them as a guide in his buying, he will be better able to hold onto the "net" he earns but which is too often lost again on the "sticker" merchandise.

Merchandise must be purchased only in accordance with what a careful study of the business shows is required to fill the needs of the business.

Buying on this principle is buying for a profit.

Don't Be Afraid to Repeat If It's Successful

SO MUCH has been said from time to time about changing window displays and advertising copy in order to keep interest fresh that many radio dealers find themselves in the position of an author who has said all his finest things. They feel that they should not repeat and yet they have nothing left but mediocre things to say. After all there is but one best way to present a sales argument. An advertisement is not intended as a masterpiece of poetry but as a tool. Why not use it again if it is successful? This does not mean that a merchant should not be open to new ideas—should indeed, not originate them; but there is no reason why he should be afraid of old ones. Do not be afraid to repeat occasionally, if you find something worth repeating.

New Sets, Accessories, and Parts Seen

This editorial section is prepared purely as a news service, to keep readers of "Radio Retailing" informed of new products on the market.

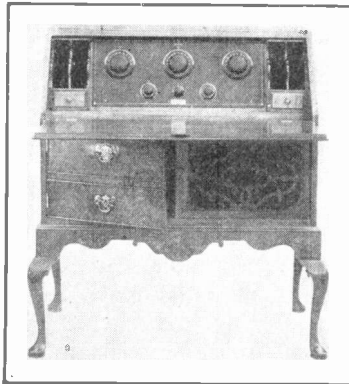

Five-Tube Receiver

Radio Retailing, October, 1925

The Queen Anne period walnut desk, shown in the illustration, is a new radio model made by F. A. D. Andrea, Incorporated, 1581 Jerome Avenue, New York, which incorporates the 170-A five-tube neutrodyne panel. Ample space is provided for both batteries and loud speaker and when closed looks like an ordinary writing desk. Compartments are furnished on each side of the panel so that when the front is lowered it may be used for keeping records of the radio set or it may be used as a writing desk. A door at one side of the bottom opens, allowing access to the batteries, while the other side has a grill work where the loud speaker may be placed. The intended retail price is \$300.



Six-Tube Receiver

Radio Retailing, October, 1925

The "W-6" radio receiver is the latest product of the DeForest Radio Company, Jersey City, N. J. An entirely new circuit is used to prevent a tube from oscillating due to its internal capacity. It is also said by the manufacturer, that the new tubes being made by this company are partially responsible for the excellent results obtained by this set. These tubes are used in the fifth and sixth sockets. The electrical unit is housed in a beautifully designed and carved cabinet as shown in the illustration, with a special cone reproducer being placed on top of the receiver. The intended retail price is \$450.

Six-Tube Receiver

Radio Retailing, October, 1925

The William J. Murdock Company, Chelsea, Mass., is making a six-tube shielded neutrodyne console type receiver as shown in the illustration. Three stages of tuned radio frequency amplification are used with two dial control. The batteries, loop and reproducer are self-contained thereby eliminating all outside wires. The electrical unit is shielded in a heavy aluminum casting thereby giving the receiver greater selectivity and volume. Vernier dials are also used. Intended retail price of this model is \$350. Other new models have intended retail prices of \$92.50, \$100, \$110, and \$140. Of these latter, the first two are five-tube receivers.

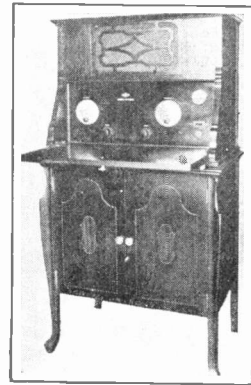

Six-Tube Receiver

Radio Retailing, October, 1925

The illustration shows the new "King Six" radio receiver being manufactured by the Workrite Manufacturing Company, 1812 East Thirtieth Street, Cleveland, O. This is a neutrodyne receiver utilizing resistance coupled amplification. It covers wave lengths of from 200 to 550 meters and these are carefully graduated on the panel over the center control. The cabinet is of genuine mahogany, 22 in. x 14 in. x 20 in. with a built-in reproducer. A switch on the panel enables one to change instantly from soft to loud as desired. The intended retail price is \$170. Other new models have intended retail prices of \$80, \$120, \$125 and \$275.

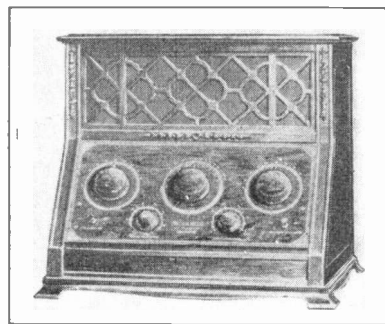

Radio-Phonograph

Radio Retailing, October, 1925

Model 1500-R-3, radio-phonograph is included in the new line of the Pooley Company, 1604 Indiana Avenue, Philadelphia, Pa. At the top are sliding grilles which give access to the phonograph. Below this the radio set is placed and at the bottom is a compartment for batteries and shelves for record albums. The style is Chinese Chippendale with a duotone finish furnished in either American walnut or English brown mahogany. Overall dimensions are 50 in. x 30 in. x 18 in. A model 20 Atwater Kent five-tube set is used with a built-in Pooley horn. Intended retail price complete, less tubes and batteries, \$295.

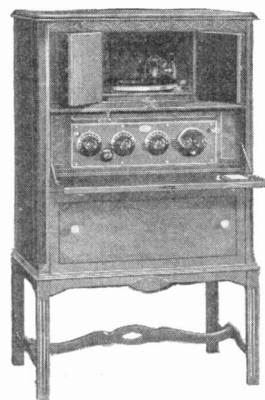

Five-Tube Receiver

Radio Retailing, October, 1925

"Valleytone" is the name of the radio receiver being made by Valley Electric Company, St. Louis, Mo. It is a five-tube, tuned radio frequency receiver, using the potential balance method of suppressing oscillation. In addition it also uses the "Toroidal" coils. It is said that the set is very selective and has good volume and tone. The panel is mounted in a solid walnut cabinet, finished in two tones with inlaid gold stripes. This set may also be secured in a console model. The intended retail price of the set is \$115.

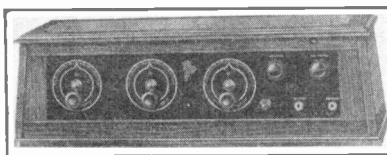

at Two New York Shows Last Month

It should be noted that all announcements appearing on these pages are published without advertising considerations—Most of the products were at N. Y. shows.

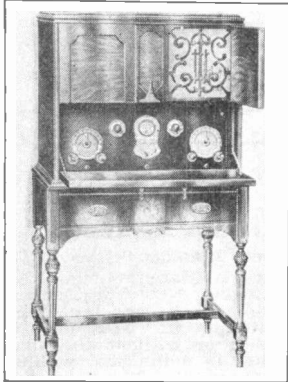

Five-Tube Receiver

Radio Retailing, October, 1925

Two new models of five-tube receivers and two of six-tube receivers have been brought out by the Stromberg-Carlson Telephone Manufacturing Company, Rochester, N. Y. The 5-tube models, known as No. 1 and No. 2 incorporate the same circuit, consisting of two stages of neutralized radio frequency amplification, detector, and two stages of audio frequency amplification. The receivers are said to possess great selectivity and cover a wave band of from 200 to 550 meters. In the six-tube receiver, three straight stages of neutralized radio frequency amplification have been incorporated. Only two tuning controls are used and the sets are equipped with a volume control.

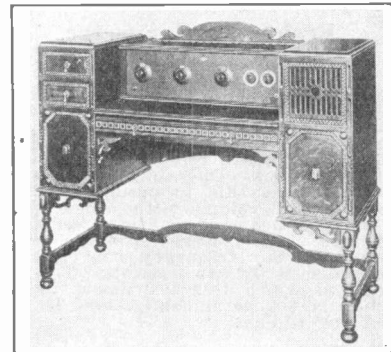

Five-Tube Receiver

Radio Retailing, October, 1925

The "Nocturne," as shown in the illustration, is one of the latest five-tube tuned radio frequency receivers to be manufactured by the Splitdorf Electric Company, 392 High Street, Newark, N. J. This receiver has been designed for those who desire a set with a built-in reproducer, together with provision for concealing the batteries. It is equipped with the new electric-lighted, enclosed dial, type of panel. The cabinet is of American walnut matched and paneled, and finished in natural grain. The intended retail price is \$150.

Five-Tube Receiver

Radio Retailing, October, 1925

H. W. Harmon & Sons Company, 418 Poplar Street, Grove City, Pa., is marketing a five-tube receiver shown in the illustration. Incorporated in this are two stages of tuned radio frequency and two stages of audio frequency amplification, the tuning being done by a single slow motion knob. An antenna compensator for proper adjustment of the antenna circuit is also used. The receiver is equipped with a metal panel, and the built-in reproducer employs a Kellogg unit with a volume control. It can be had in either a walnut or mahogany cabinet of which the over-all dimensions are 14 in. x 14 in. x 33 in. Automatic filament control is also a feature of this receiver. The intended retail price is \$175.

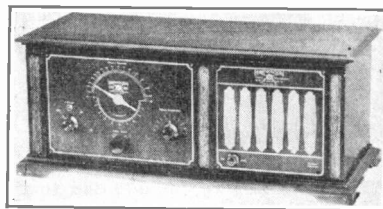

Six-Tube Receiver

Radio Retailing, October, 1925

"Model VI" is a six-tube reflex receiver with resistance coupled amplification being made by the Biltmore Radio Company, Boston, 30, Mass. It will receive wave lengths of from 150 to 550 meters, using either standard 6-volt tubes or 199 tubes, and has over all dimension of 30½ in. x 15½ in. x 9½ in. The intended retail price without accessories is \$115. A five-tube receiver is also made by this company using a reflex circuit and having the same specifications as the above receiver. The intended retail price of this without accessories is \$100.

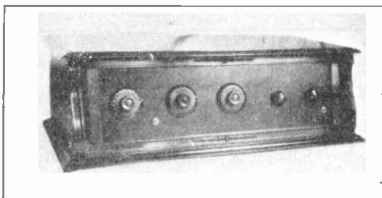

Five-Tube Receiver

Radio Retailing, October, 1925

The Eagle Radio Company, 16 Boyden Place, Newark, N. J., has a five-tube neutrodyne receiver with several new features. The coils are wound on thin cylinders of cellulose acetate, which is said to give a lower high-frequency resistance and distributed capacity. Resistances are also placed across the secondary of the second audio frequency transformer, allowing gradual volume regulation. The dials, which are of bakelite, have been changed to the concealed type and geared down to a 5:1 ratio, in order, to facilitate fine tuning. The panel which is 22 in. x 8½ in. is finished with gold trimmings and lettering. Intended retail prices of the various models are \$125, \$150, \$235, \$250, and \$275.

Five-Tube Receiver

Radio Retailing, October, 1925

The Marathon Radio Corporation, 133 First Street, San Francisco, Cal., is manufacturing a 5-tube receiver incorporating two stages of tuned radio frequency amplification and two stages of audio frequency amplification. The receiver uses standard tubes, operating on a storage battery and has three tuning controls. The illustration shows the MX model, which has an intended retail price of \$100. Its overall dimensions are 27 in. x 10 in. x 9 in. "MP" is another new model which has over-all dimensions of 33 in. x 13 in. x 10 in. and an intended retail price of \$200. The fundamental circuit is the same in both sets.

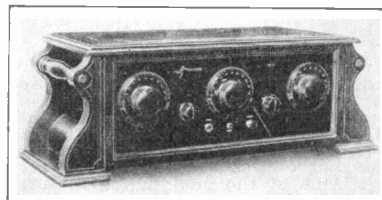

What's New in Radio and Where to Buy It—News

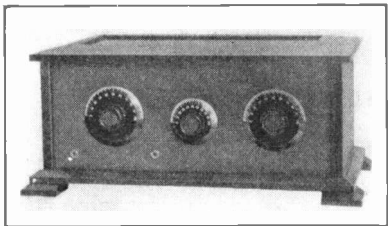

Frequency Converter

Radio Retailing, October, 1925

The "Amaco" frequency converting heterodyne unit is made by the American Apparatus Company, American Building, Richmond, Ind. It is used ahead of standard receivers of any circuit or design. Operating on loop or antenna, it is said to produce greater distance and volume with a minimum of interference. It converts ordinary receivers into superheterodynes, and tuning on the frequency converter is accomplished by two controls. The receiver to which this instrument is attached is set permanently, and is not used for tuning.

Vacuum Tube Mounting

Radio Retailing, October, 1925

A vacuum tube mounting which will accommodate tubes with any length prongs is being manufactured by the Strable Radio Manufacturing Company, 102 Van Ripen Street, Jersey City, N. J. This mounting is in two sections and to use, it is first necessary to screw the bottom section to the sub-panel and fasten all wires, then the top section of the mounting is placed in position and held by two nuts. The tube is then placed in the holder by inserting the four prongs in the hole provided and the set screws are then fastened down. This mounting not only makes it possible to use either the old or new tubes, but eliminates loose space contact. The intended retail price is \$1.

Reproducer Unit

Radio Retailing, October, 1925

No. 120 Concert Model is a new type of reproducer unit being manufactured by the American Electric Company, State and Sixty-fourth Streets, Chicago, Ill. This unit is equipped with a convenient tone adjuster on the back of the mechanism case and is arranged with connectors in order that it may be fitted to any standard make of phonograph. It is said by the manufacturer to obtain pleasing mellowness of tone combined with sensitivity.

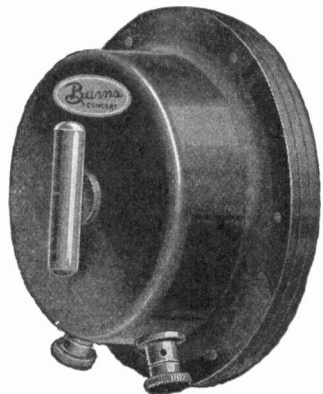

Cone Reproducer

Radio Retailing, October, 1925

The "Mu-Rad Gloria" reproducer is being manufactured by the Mu-Rad Radio Corporation, Asbury, Park, N. J. The reproducer consists of an elliptical gunmetal hoop held in a vertical plane by a heavy base. At the center of the top of the hoop is a housing for the driving unit. The stylus of the unit drops down from the housing and on its end is suspended the vibrating surface centrally located with respect to the hoop. This vibrating surface consists of two heavy paper cones about 16 in. in diameter cemented together at the edges. The lower cone has a hole cut in it so that there will be no cushioning effect due to the trapped air. The intended retail price is \$25.

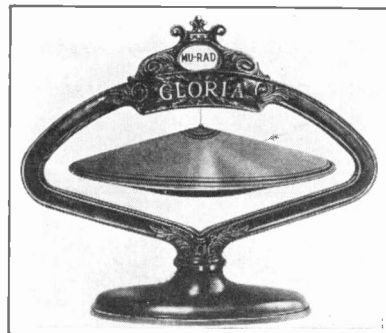

Lamp Reproducer

Radio Retailing, October, 1925

The Oracle Manufacturing Company, 35 Wall Street, New York, is making a table lamp with a cone type reproducer incorporated in it. This may be purchased with or without the shade and is furnished in mahogany, walnut, polychrome or metal. The lamp unit has place for two lights while the reproducer is non-directional and adjustable. The intended retail price, without the shade, is \$42.50. Other types of both floor and table lamps are made by this company, having intended retail prices of from \$37.50 to \$75.



Six-Tube Receiver

Radio Retailing, October, 1925

"Model 6" is a recent addition to the Mecc radio receivers manufactured by the Metropolitan Electric Company, 811 West Twenty-fourth Street, Des Moines, Iowa. The lower compartment contains a 6-tube dry cell receiver, and the upper compartment contains a built-in reproducer with space for both A and B batteries. The overall dimensions are 15 in. x 21 in. x 29 in. The set is controlled by use of two tuning dials and is balanced to operate on a 100 ft. aerial. The intended retail price is \$125.

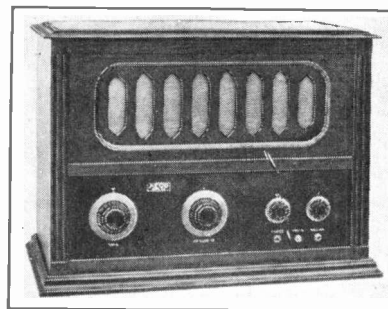

B Battery Eliminator

Radio Retailing, October, 1925

The Acme Electric and Manufacturing Company, 1444 Hamilton Avenue, Cleveland, O., now offers a B battery eliminator which will operate from 110-120 volts, 60 cycle, a.c. The detector voltage ranges from 0-50 and the amplifier voltage from 0-120. It is designed to serve a set of 8 tubes or less with an upkeep of approximately 1/3 of a cent an hour. A vacuum tube is used to accomplish rectification. The intended retail price, complete and ready to operate, is \$28.50.

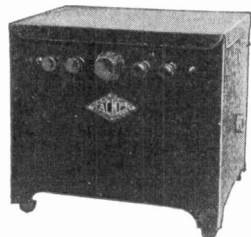

Resistance Amplifier

Radio Retailing, October, 1925

Allen-Bradley Company, 492 Fulton Street, Milwaukee, Wis., is manufacturing a resistance couple radio amplifier unit. This unit is ready for instant use and it requires no wiring outside of input and output and battery connections. One of the outstanding features is the use of molded resistors which are said not to deteriorate with age or be affected by temperature or moisture. This unit may be installed either inside or outside the set.

B Battery Eliminator

Radio Retailing, October, 1925

The "Sylvan" B battery eliminator is being made by the Baker-Smith Company, Incorporated, New Call Building, San Francisco, Cal. Operating on 110 volts, 60 cycles, it supplies 45, 67 1/2 and 90 volts for the amplifier, while the detector voltage is variable to 22 1/2 volts. It carries an unconditional guarantee for one year from date of purchase, and has no tubes to burn out or any liquid to spill. The intended retail price is \$25.

of Latest Products Exhibited at New York Shows

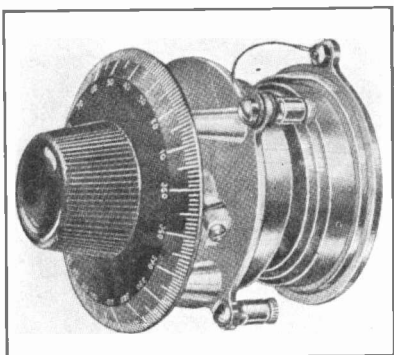

Variable Condenser

Radio Retailing, October, 1925

The Furnell Manufacturing Corporation, 889 Broad Street, Newark, N. J., is manufacturing a new variable condenser known as a 360° "Evolute Taper" coil condenser. It is entirely enclosed, which makes it dust proof, revolves through 360° and the moving parts are completely balanced. It is claimed by the manufacturer that due to the very rigid construction, rough treatment will not easily upset its capacity. The intended retail prices vary from \$2 to \$7 depending upon the capacity.

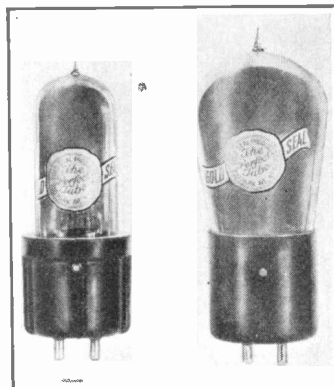

Tube

Radio Retailing, October, 1925

The "Gold Seal" vacuum tubes are being manufactured by the Gold Seal Products Company, 250 Park Avenue, New York. Type 201-GS is equipped with a standard base and has a 5-volt filament drawing 0.25 amp. It will take up to 130 volts on the plate. Type 199-GS is a 3-volt tube furnished with either small or standard base, draws 0.06 amp. and takes up to 90 volts on the plate. These tubes are very well made, are equipped with bakelite bases and have intended retail prices of \$2.50 each.

Five-Tube Receiver

Radio Retailing, October, 1925

A five-tube tuned radio frequency receiver, known as "Hetrola," is being manufactured by Charles A. Branston, Incorporated, 815 Main Street, Buffalo, N. Y. The illustration shows the electrical unit itself which is sold separately in order that it may be placed in any desired cabinet. The battery terminals are all located at the rear and the wiring is concealed beneath a sub-panel which measures 17 in. x 18 in. The panel on the front is artistically engraved and measures 7 in. x 18 in. Two tuning controls are used in conjunction with doughnut type coils. The intended retail price is \$55.

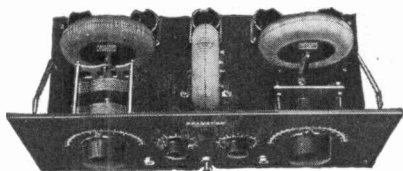

Tube Socket

Radio Retailing, October, 1925

The Alden Manufacturing Company, 52 Willow Street, Springfield, Mass., is manufacturing a socket known as 481-X which will take all the new Radio Corporation's tubes. This socket is made with either spring cushion or standard binding post for the amateur constructor, and rivet mounting for the regular set manufacturer. In order that the new UX-120 and UX-199 tubes may be used in the old style sockets an adapter known as 419-X, is being made to fit these tubes to any of the UV-201-A sockets. The adapter consists of a bakelite fitting which clamps tightly over the tube base and contains a bayonet pin to hold the tube in place in the socket. The intended retail prices of the first two types of sockets described are 35c. and 50c., while that of the adapter is 35c.



Insulating Tubing

Radio Retailing, October, 1925

The Bentley-Harris Manufacturing Company, Elm and Ash Streets, Conshohocken, Pa., makes tubing (spaghetti) of woven cambric, which is said to have great tensile and dielectric strength. Six coatings of varnish dipped by hand and naturally dried give it durability and also make it water and oil proof. This tubing is guaranteed not to crack.

Time Clock Switch

Radio Retailing, October, 1925

A time clock switch called "Radi-O-Larm" is being made by Herbert M. Hill, 117 Highwood Avenue, Leonia, N. J. Connected with the filament circuit this clock will turn the radio set on or off at any specified time, thus eliminating the possibility of leaving the tubes on all night. All that is necessary is to break the filament circuit, connecting the wires to the terminals on the clock, and then use the clock as you would an ordinary alarm clock. The intended retail price is \$4.50.

Panel Light

Radio Retailing, October, 1925

The Yaxley Manufacturing Company, 217 North Desplaines Street, Chicago, Ill., is manufacturing a panel light, using a special 6-volt bulb drawing .1 amp. This light is nickel plated, highly polished, with a hood similar to the one used on automobile dashboards. It is mounted to the panel by means of a single hole method. This makes a very neat and effective means of lighting the panel of a radio set and will also furnish enough light on the table to enable the operator to see to write.

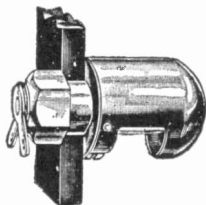

Tube

Radio Retailing, October, 1925

The De Forest Radio Company, Jersey City, N. J., is making a new type of transmitting tube for amateur use known as type "H." The specifications for this new tube are as follows: 750 to 3,000 volts on the plate, 50 to 500 volts grid bias, 10 volts filament, 2.75 amperes filament, plate current up to 1,600 volts—110 milliamperes, 250 watts, maximum output, 170 watts maximum plate dissipation. The grid leak value when used in a plate of the Hartley type is from 10,000 to 100,000 ohms.

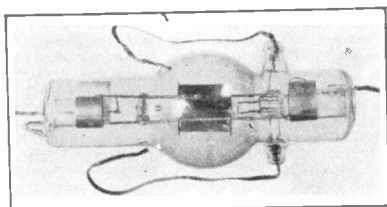

What's New in Radio and Where to Buy It—News

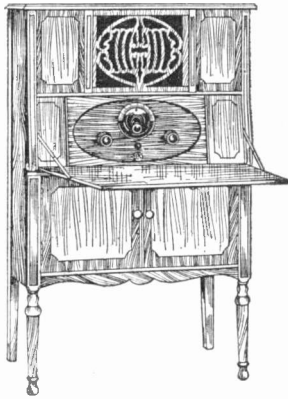

Five-Tube Receiver

Radio Retailing, October, 1925

The Brandeis Electric Manufacturing Corporation, 1841 Broadway, New York, is offering a table, console, and grand model of its five-tube, one dial control receiver. The panel is of figured parchment, transparent when in operation and the B batteries are self contained. In the two console models the reproducer is built-in. Intended retail prices are \$100, \$150, and \$200 respectively.

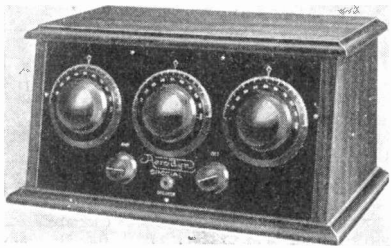

Five-tube Receiver

Radio Retailing, October, 1925

The Acrodyne Company, 1780 Broadway, New York City, is offering a five-tube radio frequency, non-oscillating receiver, having a tuning range of from 200 to 600 meters. The cabinet is of mahogany finish, having overall dimensions of 16½ in. x 9½ in. x 8½ in. Tuning is accomplished by means of three bakelite dials. The intended retail price, less accessories, is \$38.75.

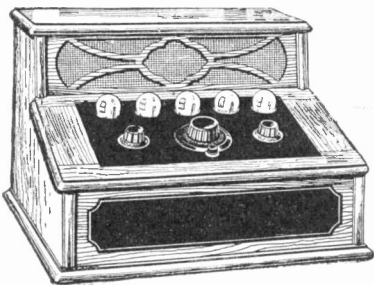

Five-tube Receiver

Radio Retailing, October, 1925

A single control five-tube tuned radio frequency receiver is being made by the Chieftain Radio Corporation, Diversey Boulevard, Chicago, Ill. A loud speaker is built in the receiver and there is also space provided where all the batteries may be placed. The over-all dimensions are 16½ in. x 23 in. x 21½ in. The intended retail price is \$135.

Five-Tube Receiver

Radio Retailing, October, 1925

"Torodyne" is the name of a new five-tube tuned radio frequency receiver employing doughnut type transformers made by the Ainsworth Radio Company, 308 Main Street, Cincinnati, O. Three major tuning controls are used and ample space is provided in the cabinet, which is of Adam brown mahogany, for the necessary B and C batteries. Standard tubes are to be used with this set although special models for the McCullough A.C. tubes can be had. The intended retail price, without accessories, is \$100.

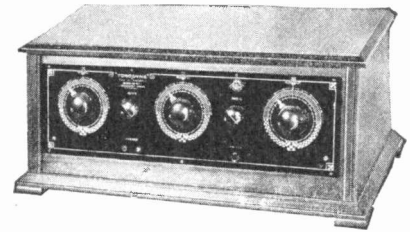

Five-Tube Receiver

Radio Retailing, October, 1925

"Melody" is the name of the five-tube receiver being manufactured by the Better Radio Products, Incorporated, Muncie, Ind. The circuit is modified tuned radio frequency using two main tuning controls. It is said that equal amplification is obtained over the entire wave band. The overall dimensions are 20 in. x 11½ in. x 9½ in. and the intended retail price of the model shown is \$51.

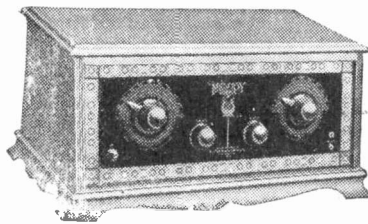

Five-Tube Receiver

Radio Retailing, October, 1925

The United Engine Company, Lansing, Mich., is now manufacturing several types of five-tube receiving sets. The cabinets are finished in either mahogany lacquer or two-toned walnut finish. A new type of coil called "Hexaircoil," derived from the fact that the coil is hexagonal in shape, is used. This is an exclusive feature.

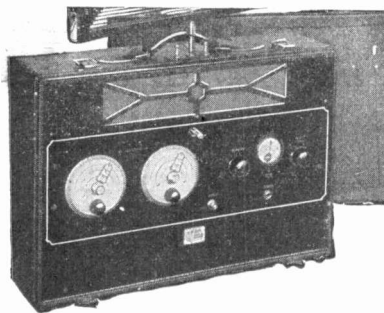
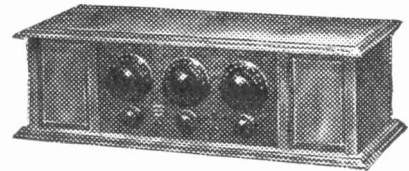

Kit for Portable Set

Radio Retailing, October, 1925

The "Erla" Supereflex Cir-Kit K-7, portable kit, is now being made by the Electrical Research Laboratories, 2500 Cottage Grove Avenue, Chicago, Ill. A pictorial diagram, with template for the base is supplied with this kit, which forms the basis of a five-tube reflex receiver. The panel is 7 in. x 18 in., and the total weight of the outfit is 13-lb. Also furnished, are drawings for a portable cabinet. The intended retail price is \$49.50.

Six-Tube Receiver

Radio Retailing, October, 1925

The "Page-6" is the latest addition to the radio receivers made by the R. B. Radio Company, 117 West Fifty-first Street, New York. It consists of two stages of tuned radio frequency amplification and three stages of resistance-coupled audio frequency amplification. The battery switch is provided with a lock in the form of a removable plug. The intended retail price, less accessories, is \$37.50. This company is also making the "Belle Claire" six-tube receiver which has a single dial control. Three stages of resistance coupled audio frequency amplification are used in this receiver also. Space is provided for two large upright B batteries in the piano finished mahogany cabinet which houses the set. The intended retail price is \$135.

Five-Tube Receiver

Radio Retailing, October, 1925

Model 8 receiver made by the Pfanstiel Radio Company, 11 South La Salle Street, Chicago, Ill., incorporates several new features in design. It is a five-tube, non-oscillating, tuned radio frequency set and uses a two-gang condenser which makes two-dial control possible. There is also a small orange light on the sloping panel which is connected to the battery switch and this will burn as long as the set is in operation. Either an indoor or an outdoor antenna may be used. The set is 22 in. x 10 in. x 14 in. and is encased in a solid walnut cabinet. Intended retail price is \$85.

of Latest Products Exhibited at New York Shows

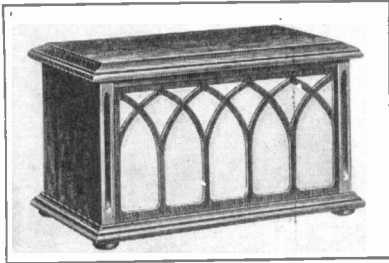

Console Reproducer

Radio Retailing, October, 1925

The "Console Entertainer" has recently been placed on the market by the Apex Electric Manufacturing Company, 1410 West Fifty-ninth Street, Chicago, Ill. It is made entirely of wood and is claimed to give accurate reproduction of sound. There is a grill which extends over the entire front of the console cabinet as can be seen in the illustration. The intended retail price is \$27.50.

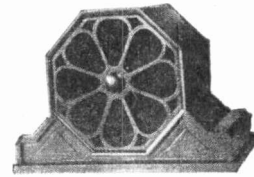

Reproducer

Radio Retailing, October, 1925

The Utah Radio Products Company, 116 Pierpont Street, Salt Lake City, Utah, is manufacturing a cabinet type reproducer made of semi-hard rubber, as shown in the illustration. The overall dimensions are 7 3/4 x 11 1/2 in. x 7 in. It is shaped somewhat on the style of a mantel clock and equipped with a regular Utah speaker unit. The retail price is \$25. The "Super-flex," a bell-shaped reproducer is also manufactured by this company. It is of semi-hard rubber, with the Utah speaker unit and is non-directional due to its unique design. It stands 8 in. high and is 6 in. in diameter. The intended retail price is \$14.

Cabinet Reproducer

Radio Retailing, October, 1925

"Operola" is the name given the cabinet speaker made by the Inter-Ocean Radio Corporation, 205 Tenth Street, Jersey City, N. J. It is constructed of a rich seal-brown fabrikoid leather, fitted with a special adjustable unit and a genuine fiber horn. Good quality of tone and volume are claimed for this instrument. The illustration shows clearly the grill-work and style of cabinet. Intended retail price is \$18.

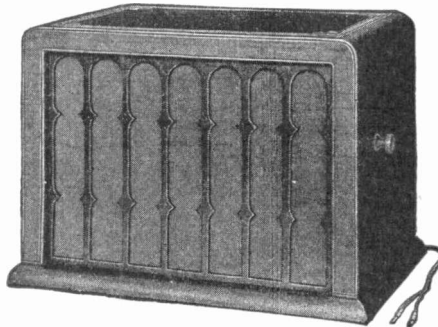

A and B Eliminator

Radio Retailing, October, 1925

The Cooper Corporation, Cincinnati, O., has just announced an A and B battery eliminator operating from 110 volt 60 cycle house current supply. It is claimed that there is absolutely no hum or other power line noise in this eliminator as all such disturbing factors have been effectively disposed of by a series of patented filters. Once the rheostats are set for a particular current, according to the requirements of a set, no further adjustments have to be made for either A or B battery voltages. It is estimated that to run a five tube set for an entire evening with this device costs approximately only five cents. The entire apparatus is housed in an attractive dark metal case. The intended retail price complete with the three tubes that are used, is \$97.50.

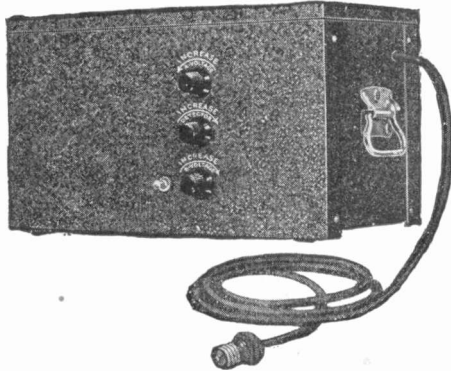

Reproducer Horn

Radio Retailing, October, 1925

The American Hard Rubber Company, 11 Mercer Street, New York City, is making a small "Radion" horn designed for use in portable sets. It stands 9 in. high with a 4-in. bell opening. The cap and unit adds only about 2 1/2 in. to its height. The cap is made to fit a Baldwin or similar unit. This horn is very suitable for those who wish to incorporate their reproducer within a portable set. The intended retail price, with the cap, is \$3.

Five-tube Receiver

Radio Retailing, October, 1925

A five-tube radio receiver known as "No-Dial" is being manufactured by the Ohio Stamping and Engineering Company, Dayton, O. The circuit used is a combination of tuned radio frequency and resistance coupled amplification. The set is made in circular form, which entirely incloses all the apparatus, the case having a bronze crystalline finish. Tuning is done by rotating the cover, which is also provided with a space where the stations may be marked as they are received. The exposed metal parts are finished in 22-karat brushed gold. Each set is also accompanied by a written guarantee. This set can be had for use with either storage battery or dry cell tubes at an intended retail price of \$98.

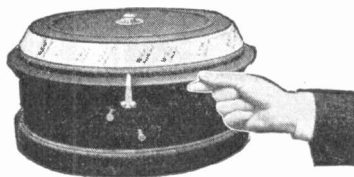

Cabinet Reproducer

Radio Retailing, October, 1925

The Timbre-tone Manufacturing Company, Hoosick Falls, N. Y., is manufacturing a cabinet type reproducer, 18 in. x 8 in. x 4 in. made entirely of wood. Acoustically it is said to be the same as the older horn type, the only difference being that it is made in a more convenient shape, being only 4 in. high, so that it may be placed either above or beneath the radio set. The intended retail price is \$30.

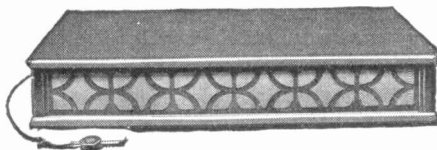

Five-Tube Receiver

Radio Retailing, October, 1925

Exclusive with the Mary-O-Dyne receiver is the "Fil-a-meter," which, the Amber Manufacturing Corporation, New York City, manufacturer points out, keeps the tubes operating always at the point of greatest efficiency. A push switch has been provided so that the B battery voltage may be read directly on the Weston meter used with the Fil-a-meter. The receiver is of the five tube tuned radio frequency type, using straight line condensers, and bakelite for insulating material. Incased in a solid mahogany cabinet the receiver has an intended retail price of \$110.

What's New in Radio and Where to Buy It—News

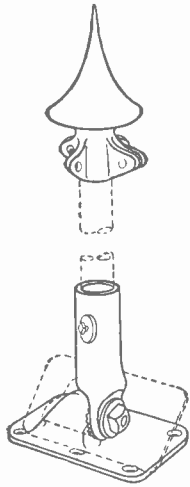

Antenna Mountings

Radio Retailing, October, 1925

A series of "Universal" antenna mountings are being manufactured by Brown, Strickler & Brown, Incorporated, 108-128 North Jefferson Street, Chicago, Ill. The roof bases are designed to fit any shape of roof and may be mounted in any position. They are made for either 1-in., or 3/4-in. pipe to be used for a mast. Use of this type of antenna mounting not only provides for a neat, attractive and efficient antenna system, but one that will comply with the fire underwriters' laws as well. Intended retail price range from \$1 to \$3.50 and all models are furnished complete with top, base, and center collar piece for guy wires.

Compression Rheostats

Radio Retailing, October, 1925

New types of compression rheostats known as the C-35 and C-700 are being made by the American Apparatus Company, Richmond, Ind. Both rheostats incorporate a 5/16-in. single hole mounting feature. The former is intended to carry filament voltages from 1 to 6 tubes, of any type, and is made up of a series of carbon disks and convex springs controlled by a knob in the conventional manner. This instrument has retail price of \$1. The same features are incorporated in the C-700, with the exception that a much higher resistance is used in order that the potential on a detector line of a B battery eliminator may be controlled by use of this device.



Resistance

Radio Retailing, October, 1925

The Arbee Manufacturing Company, 68 Springfield Avenue, Newark, N. J., is manufacturing a hermetically sealed moisture proof resistance. The resistance medium is melted in the inside of the glass in such a manner as to insure even current flow. It is noiseless in operation and guaranteed against any climatic changes. The range in size is from .005 to 10 megohms. Type 3 has soft copper extension lugs, while type 2 fits all standard mountings for resistance coupled amplifier sets. The intended retail price of all sizes is 75 cents each.

110-Volt Tube

Radio Retailing, October, 1925

The Lestein Corporation of America, 2 Broadway, New York City, is offering a tube, equipped with a standard base, which is said to operate equally well on any 110 volt supply of either a.c. or d.c. characteristics. It contains two electron emitting surfaces and the filament, which is lighted directly from 110 volt supply, also functions as a heater for an additional element, which when heated emits electrons. The general size and appearance of this new tube is the same as that of the ordinary 201-A type. The intended retail price is \$6.



Radio Cabinet

Radio Retailing, October, 1925

The Stettner Phonograph Corporation, New York City, is making radio cabinets of the style shown in the illustration. The upper tier contains a specially designed horn made from wood and metal. The cabinet may be had either in duo-tone butt walnut with a wax finish or in mahogany with a varnish finish. The overall dimensions are 52 in. x 34 in. x 17 in. and the radio set tier is 10 1/2 in. x 30 3/4 in. x 14 1/2 in. There is also space for batteries that measures 12 in. x 30 3/4 in. x 14 1/2 in. and in the back there is a center panel that is removable. The intended retail price is \$125.

Tube

Radio Retailing, October, 1925

"Marathon" radio tubes of type, M-199 and M-201-A are being manufactured by the Northern Manufacturing Company, 365 Ogden Street, Newark, N. J. According to the manufacturer, these tubes are made only of selected and tested materials in order that the finished tubes may be of uniform quality. All tubes are guaranteed to give full and complete satisfaction in operation, and have an intended retail price of \$3 each.

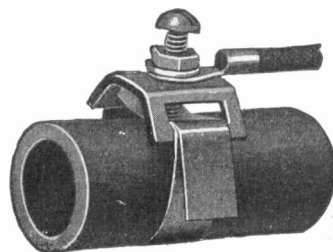

Ground Clamp

Radio Retailing, October, 1925

The "Saddle" ground clamp is the latest product of the Mertz Specialty Company, 206 West Tenth Street, Wilmington, Del. It is very readily adapted to any size pipe, as all that is necessary is to pull the strap through the saddle and tighten the screw. The strap is of phosphor bronze while the saddle, screw, washer, and nut are made of brass. Three different sizes are made, which take care of from a 1-in. to a 3-in. pipe. The intended retail prices are 5 1/2c., 6 1/2c., and 7 1/2c. each.

of Latest Products Exhibited at New York Shows

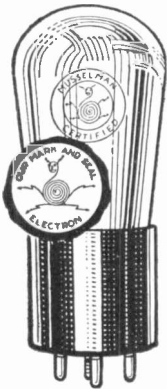

Tube

Radio Retailing, October, 1925

A certified radio tube is being marketed by A. J. Musselman, 549 Washington Boulevard, Chicago, Ill. Each tube carries with it, its characteristic curve, marked and sealed in the factory, so that the buyer may know he has a perfect tube provided the seal on the carton is unbroken. These tubes are made in both the 5-volt and 3-volt sizes, equipped with standard bases. A replacement guarantee against defects also accompanies each of these tubes, which have an intended retail price of \$3.50.

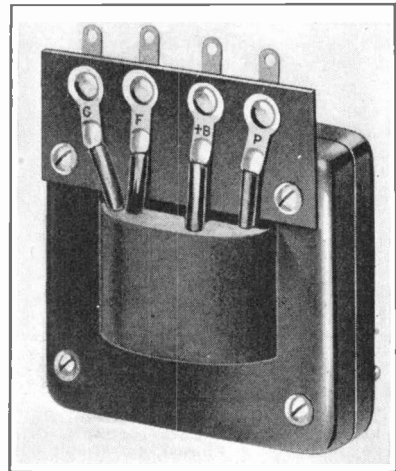

Audio Frequency Transformer

Radio Retailing, October, 1925

The Keystone Radio Laboratories, 4245 Lincoln Avenue, Chicago, Ill., are now marketing a new type M audio frequency transformer. The design of this instrument has been carried out with the purpose of facilitating, assembling and saving time. The current capacity of these transformers is 10 milliamperes, which is sufficiently large to care for any reasonable overload as 2 milliamperes, properly modulated flowing through the coils of an average loud speaker will yield a volume equal to the playing of a phonograph. Having all the terminals together on a flat plane makes it much easier to wire, and also makes shorter plate and grid leads. The intended retail prices are as follows: 2:1 ratio \$4; 3½:1 ratio \$3; and 6:1 ratio \$3.50.

Coil

Radio Retailing, October, 1925

Radio frequency coils of the toroid or endless field forms are now being made by the All American Radio Corporation, 2650 Coyne Street, Chicago, Ill. The advantages of this type of coil are due chiefly to its magnetic field being circular and endless, so that it is self-contained within the turns of the coil and does not spread itself all over the surrounding space, as the field of ordinary coils does. This company is making these coils in two types—one to be used as an antenna coupler, the other as a radio frequency transformer. The frame of the coils is finished in a glossy black which makes a neat appearance besides embodying high electrical efficiency. In the radio frequency transformer the primary is wound inside the secondary, and is entirely suspended in air. The intended retail price is \$3.50 each, while the set of three packed in a box has an intended retail price of \$10.50.



Panel Volt Meter

Radio Retailing, October, 1925

The Beede Electrical Instrument Company, 98 Park Place, New York City, is manufacturing a radio volt meter to be used on the panel of a receiving set. This meter is a double scale instrument reading 0-10 volts and 0-100 volts, which enables a set user to tell instantly the condition of both his A battery and B battery supply. On the top of the instrument is mounted a switch with the zero position in the center. By moving the switch to the right the 10-volt scale is connected and by moving the switch to the left the 100-volt scale is connected. The meter is supported from the back of the panel so that no screw holes are necessary. The intended retail price is \$4.

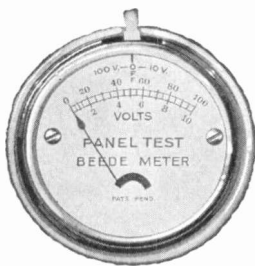

B Battery Eliminator

Radio Retailing, October, 1925

A small compact B battery eliminator is now being made by the Epom Corporation, 114 East Forty-seventh Street, New York City. An exclusive feature is the tube which has no filament to break or burn out. When this tube is in operation the space in and around the electrodes is filled with a pale glow, which serves as a convenient indicator that the tube is operating properly. The two stage filter used in this instrument eliminates the 60 cycle hum and line disturbances to a remarkable degree so that no hum can be distinguished in the loud speaker. A self contained push button switch installed in the top cover allows the instrument to be connected to the lighting socket at all times. The detector voltage is adjustable, by means of a compression type rheostat, from 10 to 40 volts. An amplifier tube voltage adjustment is mounted within the case directly underneath the cover. This device rectifies both sides of the wave and uses only one tube, which is filled with the gas argon. Intended retail price of the complete outfit is \$40 and additional tubes may be obtained for \$4.50.

Coil Winder

Radio Retailing, October, 1925

An adjustable coil winder for winding both flat and vertical coils of any diameter from 2 to 5 in. is being made by the Visto Products Company, 92-14 One Hundred and Fiftieth Street, Jamaica, N. Y. With this winder, either basket weave or Lorenze style of winding, the Lo-loss Figure 8 as well as the pickle bottle coil may be made. The winder is made entirely of metal and is very rugged. After a coil is wound, every part of the winding fixture can be removed but the pins which may be left in place until the coil is bound with cord, thus securing the winding. The intended retail price is \$2.50.

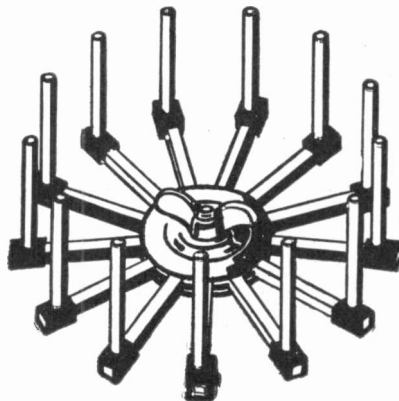

What's New in Radio and Where to Buy It—News

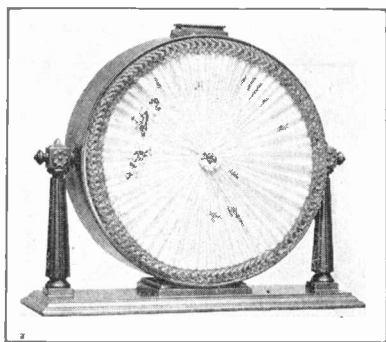

Drum Type Reproducer

Radio Retailing, October, 1925

The Music Master Corporation, Philadelphia, Pa., is manufacturing a drum type reproducer known as Model XII. This model, as shown in the illustration, is mounted on a stand, supported from the side with the face covered by a rosette sheered and drawn to the center. The overall dimensions are 19 in. x 6½ in. x 16½ in. The intended retail price is \$35.

Tube

Radio Retailing, October, 1925

Known as "Sylfan" are the radio tubes being manufactured by the Baker-Smith Company, Inc., New Call Building, San Francisco, Cal. Type 501-A is a 5-volt tube drawing 0.25 amp. The 499 and 499-A are 3-volt tubes drawing 0.06 amp. The only difference between the latter two being that the 499-A type is furnished with a standard base. The intended retail price of all types is \$2.50. This company also makes other tubes known as "Sylfan Blue Special," which are matched and have intended retail prices of \$2.75 each.

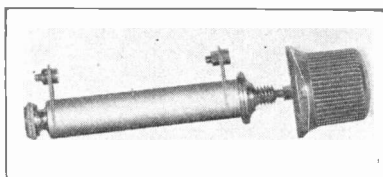

Variable Grid Leak

Radio Retailing, October, 1925

The North American Bretwood Company, 1505 Broadway, New York City, is importing a variable grid leak from England which is said to give absolutely uniform variations of resistance. A special composition is used inside of a tube in which a shaft is inserted, controlled by means of a knob. The grid leak is mounted by the single hole method and projects 2½ in. behind the panel.

Knockdown Receiver

Radio Retailing, October, 1925

The Mohawk Electric Corporation, Mohawk Building, Chicago, Ill., is marketing a knockdown set known as "KU 51." This contains all the necessary parts together with the cabinet for constructing a one dial receiver. The intended retail price is \$75. The "KU 54" is a special kit which consists of the Mohawk balanced three gang condenser and three radio frequency coils. This is to form a basis for the one dial control, five-tube receiver. The intended retail price is \$23.50. The three gang condenser alone has an intended retail price of \$15.

A Battery Supply

Radio Retailing, October, 1925

The Electric Storage Battery Company, Philadelphia, Pa., is bringing out a compact A storage battery and charger. This unit is assembled in an attractive metal case and is at all times connected with the house current as well as to the radio set. A key is on the side of the case and when in the up position the battery is connected with the radio set. When the key is thrown down the battery is automatically placed on charge. The unit is furnished in two sizes, one for 4-volt tubes and the other for 6-volt tubes with intended retail prices of \$28 and \$38, respectively.

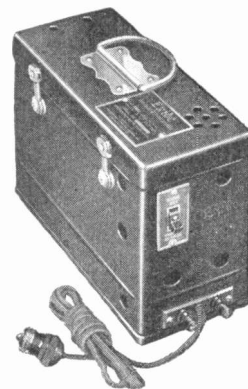

Modulator

Radio Retailing, October, 1925

A non-inductive, variable, high resistance, to be used as a volume control is found in the Centralab modulator, manufactured by the Central Radio Laboratories, 16 Keefe Avenue, Milwaukee, Wis. The total resistance is 500,000 ohms, smoothly variable from zero. It is connected in the grid side of the secondary of an audio frequency transformer, as shown in a diagram which is furnished with each instrument. This not only gives any desired volume but also improves the quality of the reproduction. It is designed for single hole mounting and has an intended retail price of \$2. Another new product is the Radiohm, which is made like modulator and is furnished in four different sizes. These have maximum resistances of 2,000, 50,000, 100,000 and 200,000 ohms, respectively and intended retail prices of \$2 each.

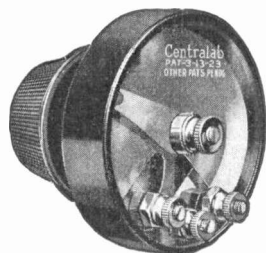

Variable Condenser

Radio Retailing, October, 1925

The Fett & Kimmel Company, Bluffton, O., is making a new "Craftsman" condenser of the low loss, straight line wave type. The rotor is grounded and Pyrex is used for insulation in order that the dielectric losses may be brought to a lowest possible minimum. Sharp turning and even distribution on the lower wave lengths are features claimed by the manufacturer of this condenser. Sizes furnished are .00025, .00035 and .0005 mfd., with intended retail prices of \$4.50, \$4.75 and \$5.

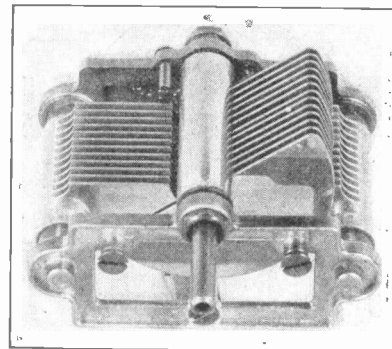

B Battery Eliminator

Radio Retailing, October, 1925

A B battery eliminator for use on 110-volt 60-cycle alternating current is being made by Ford Radio & Mica Corporation, 111 Bleeker Street, New York. A special rectifier tube is furnished with the B eliminator, although a Type 201-A tube can be used but is not recommended as it does not supply sufficient current. The eliminator has two controls, one for detector and one for amplifier voltage. A small lamp is mounted inside the case which shines through a jewel, as indication as to whether the current is on or off. The intended retail price is \$32.

Variable Loop Antenna

Radio Retailing, October, 1925

"Tun-A-Loop" is the name of the loop being manufactured by the English-Whitman Products, 120 Broadway, New York. It is made of genuine bakelite with a spider web wound with silk over phosphor bronze wire. It is very compact and is recommended for practically all types of sets. It really consists of two loops whose angular displacement to each other is controlled by the means of a knob. This gives very fine tuning and is said to increase signal strength.

of Latest Products Exhibited at New York Shows

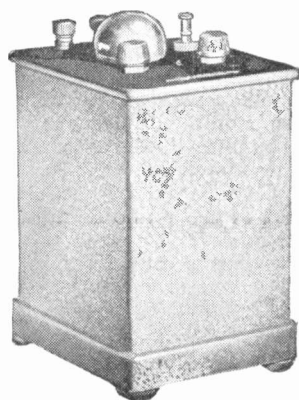

B Battery Eliminator

Radio Retailing, October, 1925

The "Aero-B" B Battery Eliminator is being manufactured by the Glenn L. Martin Company, Cleveland, O. It has two knob adjustments permitting voltage regulation and employs an ordinary 201A type radio tube for rectifying purposes. The detector voltage is variable from 0 to 75 while that of the amplifier is from 90 to 150. It is said by the manufacturer that an ordinary tube will have a life of from 600 to 1,200 hours used in this eliminator. The overall dimensions are 5½ in. x 4½ in. x 8½ in., and it will operate with equal efficiency in any position. The intended retail price is \$4.



Cone Type Reproducer

Radio Retailing, October, 1925

The "Ambotone" reproducer is made by the American Bosch Magneto Corporation, Springfield, Mass. This has a wood cone which is said to give a very mellow tone and accurate reproduction over the full range of music or voice. The intended retail price is \$27.50. The Bosch Junior Ambotone, which is similar in construction to the above but smaller, has an intended retail price of \$14.50.

Adjustable Crystal Detector

Radio Retailing, October, 1925

The United Metal Stamping & Radio Company, 410 East Pearl Street, Cincinnati, O., is making an adjustable crystal detector, to be controlled from the front of the panel by a small black knob and utilizing single hole mounting. As the knob is rotated, the threaded shaft to which it is connected, moves in or out depending upon the direction of rotation. At the same time the cat whisker is moved up and down by means of a cam arrangement thereby picking out new spots on the crystal. Any type of crystal may be used in the cup of the detector and held in place by means of a set screw. In construction, this detector is neat, solid and substantial. The intended retail price is \$1.50.

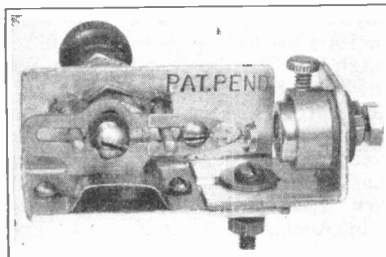

A and B Battery Charger

Radio Retailing, October, 1925

The Gold Seal Electric Company, 2110 Woodland Avenue, Cleveland, O., is offering the "Duplex" battery charger as an improved design over its previous model. It charges both A and B batteries without extra attachments and operates on 110-volt, 60-cycle current. A safety fuse is incorporated, and the instrument carries a two-year guarantee. The charging rate is 2 amp. Intended retail price, less tube, is \$6.

Storage Battery

Radio Retailing, October, 1925

The Helios Battery Company, Incorporated, 71 Chestnut Street, Boston, Mass., manufactures the Joyce Bros. "Wonder-Cell" battery. This is a storage battery having the plates cast and rolled in circular form and the bottom of the positive tube or plate closed up, eliminating wear caused from charging and discharging. This is said to give the battery a long life and a great amount of power. The acid that is used in this battery is gelatinized so there is nothing to spill. Cedar wood separators curled in a circular shape are used. Made in 2, 4 and 6 volt sizes it is suitable for any radio set.

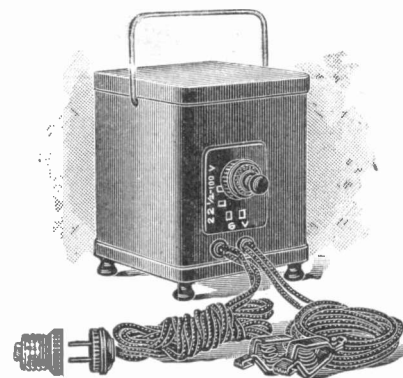
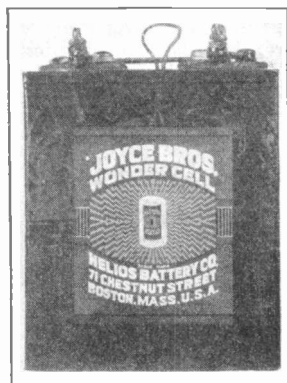

Variable Condenser

Radio Retailing, October, 1925

The Haig & Hair Manufacturing Company, Incorporated, 25 South Water Street, Rochester, N. Y., is now manufacturing a straight line frequency condenser. This condenser is said to facilitate tuning as the calibration curve is always a straight line in relation to the dial settings. Incorporated in this condenser is a compensator, the purpose of which is to equalize the fixed capacity of the circuit with that of the tuning unit. The end plates of this condenser are grounded, and the rotor is of ball-bearing construction, also the stator plates are securely anchored in die-castings firmly attached to rubber insulating bars. Capacities of .00025, .00035 and .0005 Mfd. may be had.

Vernier Dial

Radio Retailing, October, 1925

A vernier dial finished in a rich glossy black and gold is now offered by the Bremer-Tully Manufacturing Company, 532 South Canal Street, Chicago, Ill. The dial numbers are read from a scale passing under a window at the top of the instrument. The use of a special vernier device provides accurate readings to the fraction of a degree, if desired. Dial graduations read 0 to 100 over 180 degrees on one side and 100 to 0 on the other. This feature protects the purchaser who might wish to change from right hand to left hand condensers or vice versa. The large rotating pointer indicates wave length readings. Mounting is made by a single hole through the panel which eliminates all strain on the condenser shaft.

Storage B Battery and Charger

Radio Retailing, October, 1925

A combination storage B battery and charger is being manufactured by the Aidifen Battery Company, 68 East McMiken Avenue, Cincinnati, O. A paraffin oil is used on the cells instead of rubber corks, which keeps the acid from creeping and also from spraying while the battery is on charge. An electrolytic charger is built in the same cabinet with the battery, which is furnished in two sizes, one of 1,700 milliamperes and the other at 3,000 milliamperes, with intended retail price of \$35 and \$45 each. This battery is designed and constructed so that the user can remove any part in order to repair it.

What the Trade Is Talking About

Hoover Radio Parley Set for November

This year's radio conference probably will be held in November. Commerce Secretary Hoover thinks it will be better to delay the meeting until Chief Inspector Terrell can be present. Mr. Terrell is one of the American delegates attending the international conference at Geneva which is considering problems of electrical communication. He will return to Washington early in November.

The principal question to come before the conference, Secretary Hoover points out, will be the matter of dividing time among broadcasting stations. The point has been reached, he admits reluctantly, where steps must be taken to allot a larger proportion of time to the stations furnishing superior programs. Federal legislation must be secured before any such regulation could be undertaken.

Famous Artists Signed for Radio Programs

An announcement of primary importance in broadcasting circles was made late last month by the American Telephone and Telegraph Company, concerning the fact that a coterie of world-famous operatic and concert stars are to broadcast through the courtesy of A. Atwater Kent, president of the Atwater Kent Radio Manufacturing Company.

Thirty Sunday evening concerts, beginning October 4, will go out through WEAF, New York, and allied stations.

Some of the artists already under contract to participate in these concerts include Mme. Louise Homer, of the Chicago Opera; Edward Johnson, Metropolitan Opera; Mabel Garrison; Reinald Werrenrath; Maria Kurenko; Salvatore de Stefano; Alexander Brailowsky; Leo Luboshutz, Russian violinist; Charles Hackett; Anna Case; Frieda Hempel; Hulda Lashanska; Florence Austral; Albert Spalding; Eva Gauthier; Paul Althouse; May Peterson; Mischa Levitsky.

Negotiations are also going forward with the following: Mme. Schumann-Heink, Margaret Matzenauer, Emilio de Gorgoza, Cecilia Hansen, Kathryn Meisle, Dusolina Giannini, Feodor Chalipin, Mischa Elman, Allen McQuhae, Josef Hofmann, Mario Chamlee, Lucrezia Bori, Florence Easton, Merle Alock, Marion Telva, and Joan Ruth.

The General Electric Company, Schenectady, N. Y., reports excellent results from its short-wave transmission tests through WGY. All programs from WGY have been transmitted on 41.88, 109, 379.5 and 1,560 meters. The lowest wavelength was found to carry farthest and to push through best in daylight. It has been heard in Pretoria, South Africa, 7,988 miles from Schenectady, and in Auckland, New Zealand, a distance of 8,850 miles.

More than 400,000 people visited the two radio shows held in September in New York City, it is estimated. The Fourth Annual National Radio Exposition at Grand Central Palace accounted for 250,000 of this figure, and the Second Radio World's Fair at the Two Hundred Fifty-eighth Field Artillery Army was seen by 150,000.

Trade Association to Convene Next May

The National Radio Trade Association, at its annual meeting in New York last month, decided that the annual convention of the association will be held the week of May 10, 1926, at Atlantic City, N. J., at the time of the convention of the Radio Manufacturers' Association.

The convention committee, present at the meeting, was as follows: D. W. May, Joseph M. Zamoiskie, Max L. Haas, J. C. Fischel and E. F. Potter, chairman.

Break Pending Between Broadcasters and Publishers

A fight seems imminent between broadcasting stations and the Society of Authors, Composers, and Publishers over the right to broadcast music of association members without payment of the annual license fee imposed by the Society. Several stations have always disputed the right of the Society to demand that stations take out these licenses and this year the exorbitant demands made by the Society are forcing many broadcasters to consider not renewing their licenses and bring the matter into the courts.

At the recent annual meeting of the National Association of Broadcasters in New York, it was decided to favor a policy of extending the copyright laws covering the mechanical reproduction of songs, to apply to radio broadcasting. This would give the

Radio Industries Banquet at New York City Ushers in New Season—Attendance 1,500

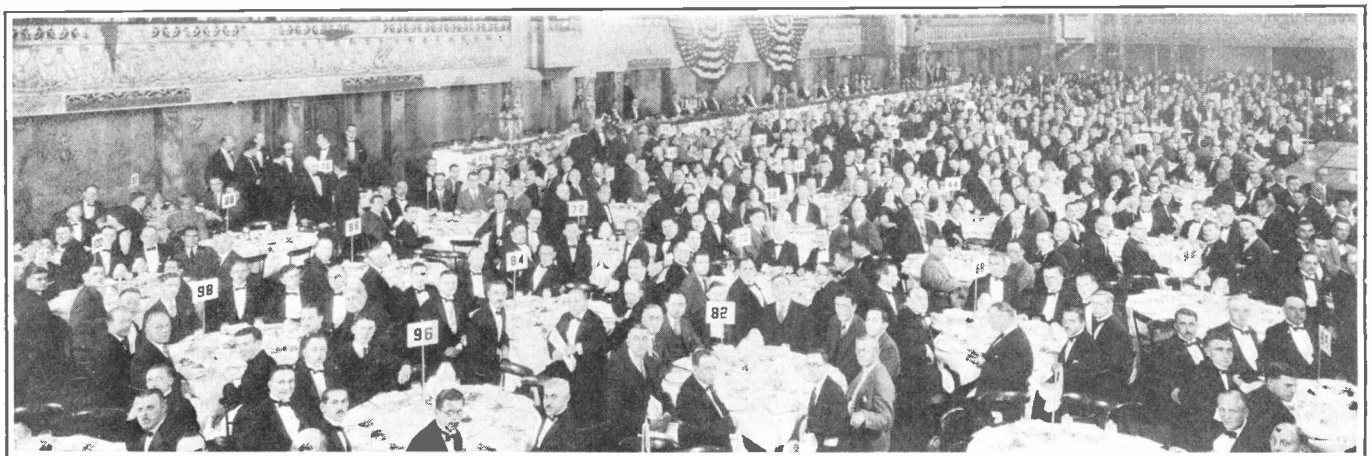

The second annual Radio Industries Banquet, held September 16, at the Hotel Commodore, New York, proved an outstanding success. But perhaps the most successful part of the entire evening for a majority of those present were the individual parties held after the dinner in various suites scattered throughout the Commodore.

Addresses were made by E. J. Cattell, Senator C. C. Dill of Washington, and Will

Rogers. Paul Klugh, chairman of the National Association of Broadcasters, presided. This organization and sixteen other radio groups, sponsored the function.

Will Rogers scored the biggest laugh of a night of laughs by declaring he didn't know what the banquet was all about but evidently somebody must have sold a set and wanted to celebrate it. Besides the Broadway cowboy, an evening of splendid

entertainment was prepared under the supervision of Major J. Andrew White, consulting editor of *Radio Retailing*. The program included the Happiness Boys, Major Bowes and his Capitol Theater gang, artists from the Eveready and Atwater Kent hours, and Vincent Lopez and his orchestra. The largest chain of stations that have ever been linked together broadcast the entire program.

composer a stipulated sum, amounting to a few cents, every time his song was sung over the air. It would also eliminate the extravagant fees now exacted by the Society.

Co-Operative Broadcasting Station for St. Louis

The St. Louis Radio Trades Association, St. Louis, Mo., through its manager, Thomas P. Convey, has succeeded in having a five thousand watt broadcasting station underwritten for St. Louis. \$150,000 has been subscribed and the order for Western Electric equipment has already been placed.

E. Lansing Ray, president of the St. Louis Globe-Democrat, has been elected president of the board of trustees who will guide the destinies of the new station, with Mr. Convey as general manager. It is planned shortly to secure a corporation charter under the laws of Missouri.

Radio Station WNYC, the municipal broadcasting station of New York City, has been enjoined from permitting partisan political propaganda to be sent out. The Citizens' Union, backed by the great majority of broadcast listeners, raised strenuous objection to the fact that the station was being used by candidates for election to further their own campaigns. After much controversy, an injunction was secured prohibiting political propaganda from this station.

The Diamond Vacuum Products Company, 4053 Diversey Blvd., Chicago, makers of "Diatron" vacuum tubes, has in charge of its manufacturing processes Walter R. Armstrong, a pioneer in incandescent-lamp making. Mr. Armstrong started with the old Swan Lamp Manufacturing Company in 1887, and later produced X-ray tubes. In 1897 he built the first vacuum pump for the Shelby Lamp Company, and in 1907 was general manager of the Federal Miniature Lamp Factory. Entering business for himself as a lamp manufacturer, he sold out his interests in 1923. The general manager of the Diamond company is George Loring, who started in the incandescent lamp business in 1901, with the Shelby company, continuing with the National Lamp Works until April, 1916.

Heckert L. Parker has resigned as secretary-treasurer of the Pacific Radio Trade Association, San Francisco, Cal., and, it is said, will represent the Magnavox Company in New York City.

The Crosley Radio Corporation, Cincinnati, Ohio, announces a reduction in prices of several models. Model 50, a one-tube receiver, has gone down from \$14.50 to \$12; the same model portable from \$16 to \$14. Model 51, two tubes, from \$18.50 to \$14.75, and the same model portable from \$23.50 to \$20. The three-tube receiver, Model 52, has been reduced from \$27.50 to \$25, and the portable from \$32.50 to \$30.

The World Series, beginning October 7, between Pittsburgh and Washington, will be broadcast through a number of stations, some through microphones

Broadcasters Re-elect Same Officers

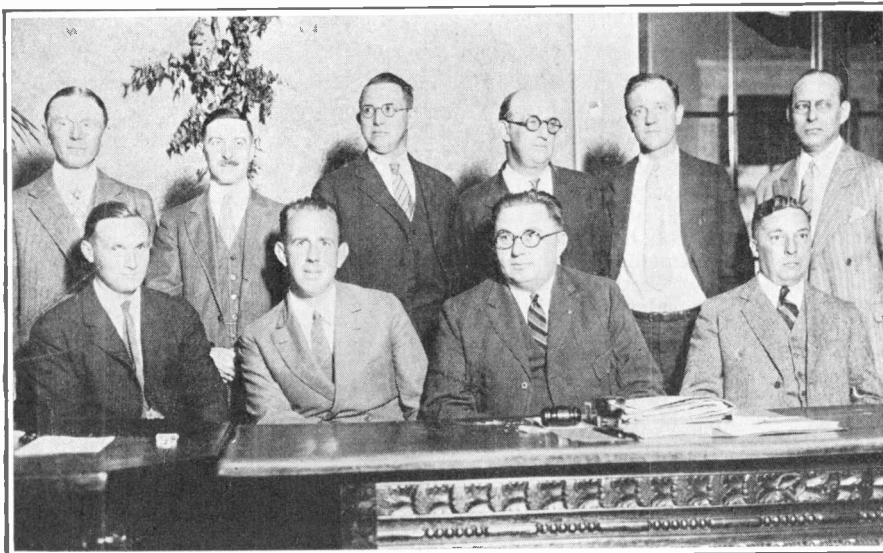

At the annual meeting in New York last month, the National Association of Broadcasters re-elected for another term the same officers who served last year. From left to right in the photo are: Seated—A. H. Grebe, WAHG, New York, re-elected Atlantic regional chairman; Powel Crosley, Jr., WLW, Cincinnati, vice-president; Frank W. Elliott, WOC, Davenport, Ia., president; Paul B. Klugh, executive chairman. Standing—Judge Charles H. Tuttle, legal adviser; H. J. Powers, WARC; W. A.

Heinz, WHO, Des Moines, Ia., vice-president; John Shepard, 3rd, WNAC, Boston, treasurer; George Morris, WGN, Chicago, and S. S. Marko, WJAZ, Chicago. Others elected were: A. F. Kales, KFI, Los Angeles, secretary; W. G. Cowles, WTIC, Hartford, Conn., New England regional chairman; E. H. Jewett, WJR, Pontiac, Mich., Great Lakes chairman; George Kuhns, WHO, Des Moines, Ia., Central States chairman, and Earle C. Anthony, KFI, Los Angeles, Pacific chairman.

placed actually on the field. A great many stations will send out play by play descriptions of the games as received over the press wires.

J. H. McCullough & Son, are distributing the "Kennedy" Radio line for the district of Eastern Pennsylvania, southern New Jersey, from Trenton south, and the state of Delaware. A demonstration and showing of the complete line of Kennedy radio was held at their place of business, 257-59 North Broad Street, Philadelphia, Pa., from September 21 to 25, inclusive.

The Timmons Radio Products Corporation, Philadelphia, Pa., has appointed the Hal Taylor Company, 1601 South Michigan Avenue, Chicago, sales representative for most of the Middle West territory. N. David Thompson, 308 Central National Bank Building, St. Louis, has been appointed sales representative for Wisconsin, Arkansas, and Southern Illinois.

The Radio Manufacturers' Association through its president, Herbert H. Frost, has announced that the official shows of the association in 1926 will be the Third Annual Radio World's Fair in New York, to be held at the new Madison Square Garden, on September 13, and the Fifth Annual Chicago Radio Show, to be held October 11 at the Coliseum in that city. Both shows will be under the direction of Messrs. U. J. Herrmann and G. Clayton Irwin, promoters of the Second Radio World's Fair, which closed on September 19 after a very successful week at the Two Hundred and Fifty-eighth Field Artillery Armory, New York City.

The Atwater Kent Manufacturing Company, Philadelphia, Pa., has appointed D. M. Bauer, formerly district sales manager, to the position of adver-

tising manager, succeeding F. W. Kulicke who has become affiliated with the Budd Wheel Company of Philadelphia and Detroit.

The Naxon Electrical Laboratories of Chicago have combined their sales offices with the general offices at 4526 Cottage Grove Avenue, having vacated their old location at 28 South Wells Street.

The Football Season gets officially under way this month and a number of stations are making preparations to broadcast them direct from the field. Stations WJZ, New York, and WGY, Schenectady, have already announced their schedules, as follows: October 3, Amherst at Princeton; October 17, Army-Notre Dame, at New York; October 24, Penn-Chicago, at Philadelphia; October 31, Penn-Illinois, at Philadelphia; November 7, Harvard at Princeton; November 14, Yale-Princeton, at New Haven; November 21, Yale-Harvard, at Cambridge, Mass.; November 26, Cornell-Penn., at Philadelphia; November 28, Army-Navy, at New York.

The Radio Industries Corporation, New York City, has elected Benjamin Gould president and general sales manager. Mr. Gould was formerly treasurer of the corporation. Hugo Gernsback, former president, tendered his resignation, effective September 1. A new line of radio sets and kits will be marketed by the corporation under the trade name of "Ricodyne."

The Sager Electrical Supply Company, Boston, Mass., conducting an exclusively wholesale business, opened two branch offices September 1, one in Springfield, Mass., and one in Worcester, Mass. Due to a misunderstanding, this company was wrongly termed a retail organization in the September issue.

Tests of International Reception Arranged

Actual reception in America of radio programs from Germany and their re-transmission to set owners of this country is assured, if coming international tests prove satisfactory, according to a statement issued by Dr. Hans Bredow, State Secretary of the Reichspost, the German post office department which has control of broadcasting in Germany. Arrangements for the tests were completed by Dr. Bredow and David Sarnoff, general manager of the Radio Corporation of America, on his recent visit to Europe. Likewise, broadcasting of American programs and their reception and re-transmission in Germany will also be tried, when the new 50,000-watt WJZ is ready at Bound Brook, N. J.

"Broadcasting has a mission to perform for the whole of civilization," Dr. Bredow declared, "and it will contribute to mutual understanding among all people. Therefore I lay great stress upon the importance of publishing American programs in Germany and German programs in America. Mr. Sarnoff and I agreed that Germany would attempt to receive American programs at a station especially equipped for the purpose, and to rebroadcast them from the central station of Königswusterhausen near Berlin.

"If these tests are satisfactory, Germany will provide the necessary funds to increase the power of one of our broadcasting transmitters so that it, in turn, can be well heard in America. Thereafter, at certain intervals, American programs specially arranged for America will be transmitted by this station to be received and rebroadcast by the Radio Corporation of America in the United States. The Radio Corporation will also prepare German programs which will be received by the Reichspost and transmitted to the German broadcasting companies.

"In Germany, there is a tax on every receiver, collected by the Reichspost,

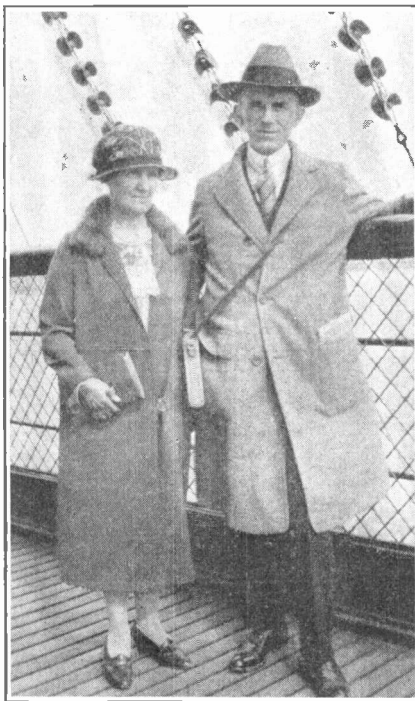

Ray H. Manson, chief engineer and member of the board of directors of the Stromberg-Carlson Telephone Manufacturing Company, together with Mrs. Manson, were recent visitors to Europe, and, of course, inspected the broadcasting station in the Eiffel Tower at Paris, England, France and Belgium. Mr. Manson said upon his return, are far behind the United States in radio development, due to the use of plug-in honeycomb coils, made necessary by the wide range of wavebands used by European stations, ranging from 300 to 1,600 meters, and the lack of multi-tube receivers. Owing to the tax placed on the number of tubes in a set, mostly crystal sets, or sets of one or two tubes are used.

of which sixty per cent goes to the broadcasting companies to pay for their upkeep and programs. The most prominent artists co-operate in the broadcasting, for which they are paid from the revenue received from the listeners. The performances of the Opera Houses in Berlin, Munich and Frankfurt-on-Main are transmitted regularly."

Electric Club Advocates Federal Radio Commission

The Radio Section of the Electric Club of Chicago has jumped into the radio broadcasting controversy with both feet. In a resolution just adopted the club goes emphatically on record as advocating a Federal Radio Commission to supervise broadcasting.

The resolution, in full, follows:

Whereas, It appears that the fundamental problem in radio today is not one of technical advancement but is one of the proper regulation and control of broadcasting; radio reception is becoming increasingly unsatisfactory to the general public because of constant interference between stations and heterodyne whistles due to fluctuations in wave length; there is a vast and costly duplication of effort in the same locality; hundreds of new stations are now being planned and will demand licenses to operate in an already congested band of wave lengths; with the stations now operating and those known to be in contemplation, the situation next winter will be nothing short of chaotic and will threaten an industry and a public service which, properly regulated and controlled, should be one of the most enlightening and progressive influences in modern life—

Radio today has become a vast public service; the number of wave-lengths is definitely limited and the number of desirable services by radio is circumscribed; paralleling of services and duplication of effort are undesirable and tend to add to the congestion; for this reason it is imperative that the control of radio as a public service be recognized—

Mature and wise review of these conditions and circumstances has been taken by the Councils of the Radio Section of the Electric Club of Chicago, an organization representing the best interests of radio broadcasters, radio listeners, radio manufacturers, jobbers and dealers therefore, in behalf of these,

Sampson Electric Company Conference Brings Out 400 Dealers



The Sampson Electric Company, Chicago, Ill., Atwater Kent and Pooley distributors for Northern Illinois and Northwestern

Indiana, held a sales conference and banquet for their dealers August 26 and 27 at the Congress Hotel, Chicago. More than

four hundred radio dealers heard the Fall Atwater Kent line of radio receivers and Pooley cabinets explained.

the above named Radio Section in meeting assembled, with a view to improving these conditions and circumstances, it is—

RESOLVED: That the Honorable Secretary of the Department of Commerce be respectfully urged to present before the Fourth National Radio Conference the outline of the circumstances and conditions pointed out in the foregoing, and be it further—

RESOLVED: That such conference debate and discuss and by the actions of committees or otherwise lay the groundwork for legislation to establish a Federal Radio Commission, composed of men familiar with the peculiar needs of radio, functioning along the lines now well established by Public Service Commissions now in existence and with such powers as will enable it to cope with new situations as they may develop, empowered to grant or withhold licenses for broadcasting radio programs, to establish and uphold minimum standards of service for the retention of such licenses, to suspend, revoke or transfer such licenses as the needs may arise, and otherwise to regulate broadcasting for the benefit of the public.

Dealers' Group Amends Radio Resolutions

The Talking Machine and Radio Men, Inc., New York City, held its September meeting on the 16th, at which Ray H. Manson, chief engineer of the Stromberg-Carlson Company explained the company's Fall line of radio receivers.

The organization recently adopted amendments to its resolutions on radio merchandising practices, which were published in detail on Pages 575-6 of the June issue of *Radio Retailing*. The amendments put the association on record as favoring a manufacturers' policy of selected dealers rather than exclusive franchises; that sets be advertised and priced as "stripped" only, unless the accessories are made by the same company. When advertising "complete sets," all necessary accessories should be listed with the manufacturer's name and model number.

"One discount to all dealers" is also recommended, the association recognizing, however, the right of a jobber to receive slightly more on broken packages. Manufacturers are also urged to protect dealers in the event of price reduction either by sixty days' advance, confidential notice, or by rebating dealers for stock on hand at time of announcement.

The Radio Telephone and Telegraph Corporation, New York City, has appointed Nathan Hast general sales manager. This company manufactures "Kismet" radio products.

The Beacon Radio Company, Brooklyn, N. Y., announces the appointment of E. J. Totten as radio sales manager. It is planned to market shortly a radio receiver under the trademark of "Trinity."

Radio Convention Held by Nebraska Jobber

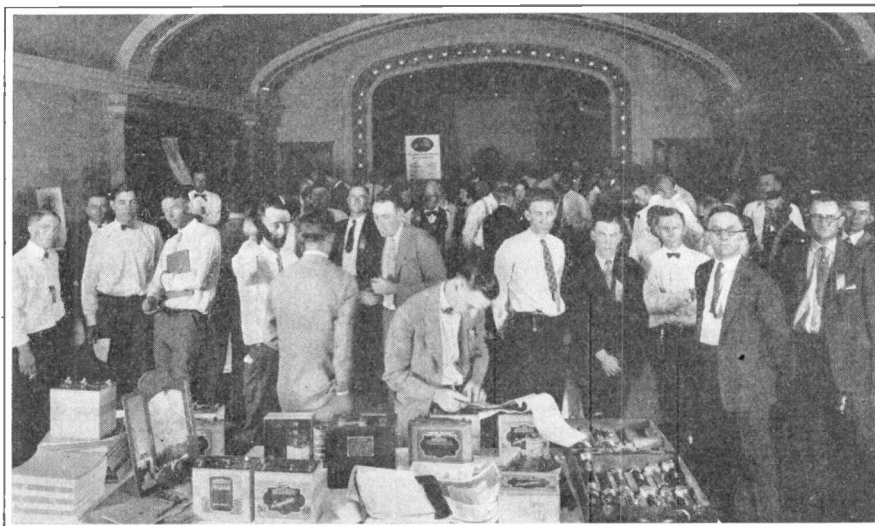

The ballroom of the Hotel Clarke, Hastings, Neb., was crowded to capacity each day of the five-day radio convention and sales conference held by the W. M. Dutton and Sons Company, radio jobbers of Hastings, August 24-28. It is estimated more

than 600 dealers attended and a number of manufacturers had exhibits. The Dutton Company reports that this season will exceed all others in gross business as five hundred dealers placed orders during the convention.

The Kodel Radio Corporation, Cincinnati, O., has acquired from the Secretary of the Navy, complete U. S. Navy licenses to manufacture radio apparatus under the confiscated German patents. The seventy-six patents involved cover almost every phase of tuned radio frequency sets. In return, Clarence O. Ogden, president of the Kodel Company, turned over to the Government, the thirty-two basic radio patents he holds in his own name, for use by the Government in case of emergency.



Active service in the field throughout the Mexican Border and A.E.F. campaigns, in every rank from private to Captain and, finally Major in the United States Signal Corps, is the unique war record of the president of the Radio Manufacturers Association, H. H. Frost, here pictured in his Florida retreat. Incidentally, it should be remarked that the real size of these fish is considerably dwarfed in the photo by Mr. Frost's own six-foot-two.

"Radio Week" Set for January

"International Radio Week," this season, will not occur until the week of January 24, it was decided at a meeting of the executive committee, held in New York, September 15. Powel Crosley, Jr., chairman of the committee, presided. As usual, the week will be featured by international radio broadcasting tests, and dealers will be supplied with window display material announcing the week.

It was decided to tie up "Radio Week" with the sale of American-made radio apparatus in foreign countries, manufacturers believing the test programs from America will create foreign interest in this country's radio equipment. Radio stations in the United States will remain silent during the tests, as has been the custom in the past. Broadcasting stations will also be asked to present exceptionally good programs during "Radio Week" and will be requested not to send out foreign language programs at the time of the tests, so that listeners will not mistake them for European stations.

George Furness was appointed chairman of the radio programs committee. L. A. Nixon and H. H. Eby head the finance committee, Powel Crosley, Jr., was re-elected chairman of the general committee and L. A. Nixon secretary. Arthur Lynch was reappointed chairman of the international tests committee.

Station WGY, Schenectady, N. Y., has been given permission by the Department of Commerce to broadcast regularly, on Saturday and Sunday evenings, on a power of 50,000 watts, beginning October 3.

The Fishwick Radio Company, Cincinnati, O., has moved its factory into new quarters at Central Parkway and Elm Street.

Read Contracts Carefully

Radio dealers should read very carefully the contracts they sign. Leon Carlin, of Southampton, Pa., was recently "caught" shrewdly by a so-called radio concern, a representative of which induced Carlin to accept \$700 worth of radio receivers "on consignment," and Carlin signed what the salesman assured him was simply an agreement to take the sets on a consignment basis.

However, shortly after the arrival of the receivers, Carlin was billed for the goods, and upon reading over the paper he had signed, found, in very small type, a clause which stated he was to pay cash for the order.

After long-winded law proceedings, it was found the "radio company" had practised fraud, so that Carlin was not forced to pay for the receivers and returned them.

The Adler Manufacturing Company, makers of the "Adler-Royal Radio" receivers, has appointed Everybody's Talking Machine Company, Philadelphia, Pa., as distributors for Eastern Pennsylvania, Southern New Jersey, Maryland, Delaware, District of Columbia and Virginia.

The Electric Store, Saranac Lake, N. Y., under the ownership of Philip A. Siebel, is a new store which plans to merchandise radio actively in the Fall.

The Electrical Research Laboratories, Chicago, Ill., has appointed Harry H. Hayden to the position of eastern sales manager of Erla products. Mr. Hayden was formerly manager of the Chicago office of *Popular Science Monthly*. His new office will be in New York City.

The Clyde-Washburn Company, Memphis, Tenn., has been appointed distributor of "Erla" products by the Electrical Research Laboratories, Chicago.

The Mackenzie Radio Corporation, New York City, was incorporated September 2, 1925, in the State of New York, with a capital of \$50,000. The corporation has bought the W. Mackenzie Company, formerly of 534 Sixth Avenue, New York, Zenith jobber in New York and New Jersey. The office of the new corporation is at 35 West Thirty-first Street, New York. The company will continue as radio jobbers, specializing on the Zenith line. The officers are: R. Corwin Klugh, president; M. E. Shaefer, vice-president; Irvin C. Gareverick, Jr., secretary and treasurer. M. E. Craddick is general manager.

The Sterling Radio Company, St. Louis, Mo., Kolster distributor, has just occupied a new three-story building at 1515 Grand Avenue, which will be devoted exclusively to wholesaling radio.

The Electrical Supply and Equipment Company, Albany, N. Y., has been appointed exclusive upper New York state distributor for Kolster radio sets, made by the Federal Telegraph Company. Branch offices are maintained in Elmira and Buffalo.

The Supertron Manufacturing Company is moving into its new plant at 222 Washington Street, Hoboken, N. J. The entire plant and offices will occupy 20,000 square feet. New and additional machinery in these quarters will give Supertron an output of 10,000 tubes daily, it is announced.

The Peerless Radio Company, San Francisco, Cal., plans shortly to open its third store, located at 254 Powell Street, it is announced by Joseph Rosener, general manager.

The True and Blanchard Company, Northern New England distributor of Atwater Kent radio products, held a well-attended sales convention August 3 and 4 at the State Armory, Newport, Vermont.

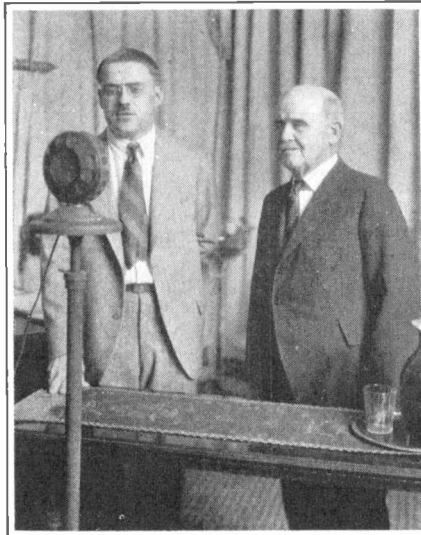

"The ears of the world are upon you," said E. N. Rauland, president of the All-American Radio Corporation, Chicago, to Senator William B. McKinley, of Illinois, at the dedication of the corporation's new broadcasting station, WENR. The senator is said to have replied that the world should have worn earmuffs. In his serious moments he is an active member of Congress and friend of radio, having been instrumental in killing the bill that would have imposed a ten per cent tax on radio apparatus.

The Stromberg-Carlson Telephone Manufacturing Company, Rochester, N. Y., held its annual conference for salesmen and branch office managers at the main offices September 1, 2 and 3. W. Roy McCanne, president of the company, and other officials addressed the sales force and explained the company's policy for the season. A feature of the conference was a banquet and entertainment at the Rochester Club.

The Federal Telegraph Company, San Francisco, has appointed H. H. Southgate as assistant sales manager of its Kolster Radio Division with headquarters in the Woolworth Building, New York City.

The American Bosch Magneto Corporation, Springfield, Mass., announces the resignation of G. W. Sherin, who has been advertising manager for six years.

The F. A. D. Andrea Company, New York City, has appointed the Essex Storage Battery and Supply Company, Newark, N. J., exclusive Fada distributors in Northern New Jersey.

The Aero Products, Inc., Chicago, Ill., manufacturer of Air Dielectric Coils,

has appointed Peter C. Cordell as production manager. Mr. Cordell formerly held the same position with the Electrical Research Laboratories, also of Chicago.

The Gleason Corporation, Chicago, manufacturer of straight line frequency condensers, has appointed H. J. Zbinden production manager.

The Morrison Laboratories, Detroit, Mich., have been taken over by R. R. Paul, also of Detroit. The list price of the "Mocking Bird" loud speaker unit made by the Morrison Laboratories has been changed from \$5 to \$7.50.

The Coto-Coil Company, Providence, R. I., has discontinued the sale of its radio and electrical products to the wholesale and retail trade and will hereafter devote its entire facilities to the production of similar material for manufacturers only.

The Stewart-Warner Speedometer Corporation, Chicago, Ill., has made arrangements to broadcast every day from its own studio through station WBDN on a wave length of 226 meters. The first program went on the air August 1. It has planned to broadcast every evening from one to four hours.

Ernest Ingold, Inc., northern California distributor for Atwater Kent, recently opened its new building at 930 Van Ness Avenue, San Francisco. The building is a three-story structure and is devoted exclusively to radio.

The Daven Radio Corporation, Newark, N. J., announces the following changes in its personnel: K. R. Moses, formerly sales promotion manager of the Crosley Radio Corporation and sales manager of the "Amberola" division of Thomas A. Edison, Inc., becomes sales manager of Daven; W. A. Balevre, formerly with the Adams-Morgan Company becomes advertising manager; C. B. L. Townley, formerly with the International General Electric Company, has been appointed purchasing agent; M. D. Runyon has been appointed special representative.

The Daven sales department has established an office at 332 South Michigan Avenue, Chicago, with G. D. Harris in charge. A sales office has also been opened in the Baltimore Building, 14th and Walnut Streets, Kansas City, Mo., with Fred Garner in charge. F. D. Rankins has been appointed New England sales representative, with offices in the New Chamber of Commerce Building, Boston, Mass., and R. A. Sayres will cover the New York City territory, making his headquarters at the Newark factory. Mr. Sayres was formerly with the A. H. Grebe Company.

The Gilbert-Keator Corporation, New York City, has been appointed distributors for the Kolster Radio Receivers, made by the Federal Telegraph Company, New York City.

The Freed-Eisemann Radio Corporation, Brooklyn, N. Y., held its annual stockholders' meeting recently, at which all officers, including the Board of Directors, were re-elected. The officers are: Joseph D. R. Freed, president; Emil Eisemann, vice-president; Alexander Eisemann, treasurer, and Arthur Freed, secretary. The fiscal statement showed a healthy financial condition.

"Straight Line" Is Fall Condenser Demand

(Continued from Page 484)

dealer should never lose sight of the fact that a good mechanical design makes up for a million deficits of resistance—nearly. If a condenser goes bad in a set, it literally means rebuilding and the dealer usually loses either prestige or money or both by selling poor mechanical condensers.

Keep Posted on Demand

In stocking condensers, remember that those with coils afford the two basic elements of radio frequency tuning. They are the major stock parts. Hence, it is logical to assume that a reasonably large stock can be carried in proportion to other parts. If you carry a minimum stock, keep posted on what is getting the most demand and keep your orders in ten days ahead of stock carried. On slow moving types, carry a minimum that will satisfy the occasional buyer.

Balance your vernier dials, compensating dials, and plain in proportion to stock. Remember, the compensating dials are apt to run ahead of straight-line frequency condensers for already sold set owners. New buyers therefore are usually new builders or professionals and rather critical of new types.

It may be confessed that the writer although in a position to be well posted on condenser conditions, and having given constant study to the prospective condenser market, is willing to admit that what is coming next is a pure guess. Until the season bites hard, it is only common sense to suggest "go slow and work with only essential stock, then as the lucky numbers turn up, order on basis your competitor will not get deliveries."

Entertainment Is the Keynote in Selling

(Continued from Page 498)

have to, or feel so inclined; but it will become a nuisance certainly if all the profit in the new transaction is eaten up in a too generous allowance. On the re-sale, schoolboys who are long on enthusiasm but short on cash are potential customers, the classified columns of newspapers will uncover others, and the guiding rule should be, get some sort of a profit.

Sets accepted as trade-ins come in useful, too, if you conduct a rental business. And if you don't, you should. Renting out sets helps the income, particularly in the off-season, and such a service is always in demand when special events are due on the air. Our New York store has had as many as thirty sets out at a time, and exactly half of the sets we send out regularly on rental stay out; the customer buys them, because whatever he has paid as rent applies on the purchase. Oftentimes a buyer is thus found who could not be sold under any other conceivable set of circumstances.

ANOTHER thing I can't see is why every retailer doesn't handle parts. The "roll your own" business should be twenty per cent of every store's total; parts and accessories should pay the rent, at least. And don't forget, the hobby fellow buys the year round.

As a final thought, precious little has been done to put over the appeal of radio as a gift. People are getting married each month in the year. Mothers' birthdays have no regard for the calendar, either.

Well, I guess that's about all of my story. I have mentioned most of the obvious things—some of them so obvious that nothing whatever has been done about them. Which

is no reason for neglecting them any longer. So, as I said at the outset, what has been set down here may not be new, but these are fundamental merchandising principles by which the buying season certainly can be extended if adopted by every retailer in the radio business, or even by a majority. After all, a principle is a principle and nothing more. It has to be applied to obtain a result. If nothing new, startling or "revolutionary" has been stated in this article the same might be said of the multiplication table, though who will deny it is unailing in its results if applied but accomplishes nothing until it is used.

New York Shows Boost Stock Prices

Radio stocks started their upward climb immediately preceding the New York radio exhibitions, held last month. Optimistic statements as to the possible Fall market for radio were reflected on both lists, some of the stocks registering gains averaging between 5 and 8 points. New highs for the season were established by Brunswick, Freed-Eiseman, Garod, Hazeltine, Manhattan, Radio Corporation and Stewart-Warner. Each of these stocks gained 5 points or more over last month.

Radio Stock Quotations

Stock	1924		1925		Current Market Sept. 22
	High	Low	High	Low	
American Bosch Mag.	38 $\frac{1}{2}$	22 $\frac{1}{4}$	54 $\frac{1}{2}$	26 $\frac{1}{2}$	36
Apco Manufacturing Co., A	26 $\frac{3}{8}$	22	22
Brunswick-Balke Col. Co.	50 $\frac{1}{4}$	48 $\frac{1}{8}$	49 $\frac{3}{8}$	24	33 $\frac{1}{2}$
De Forest Radio	28 $\frac{3}{4}$	21	34	18 $\frac{1}{2}$	25 $\frac{1}{2}$
Dubilier Condenser	33 $\frac{7}{8}$	32 $\frac{1}{2}$	35 $\frac{1}{4}$	11	18 $\frac{3}{4}$
Duplex Condenser	12	11	17	2 $\frac{1}{2}$	9 $\frac{1}{2}$
Freed-Eisemann	33 $\frac{1}{2}$	27	33 $\frac{1}{2}$	7	16 $\frac{1}{2}$
Freshman Co., Chas	23 $\frac{1}{8}$	21 $\frac{1}{2}$	28	9 $\frac{1}{2}$	16 $\frac{3}{8}$
Garod Radio	17 $\frac{3}{4}$	2	12 $\frac{1}{4}$
General Electric, Comm.	322	193 $\frac{1}{2}$	337 $\frac{1}{4}$	227 $\frac{1}{4}$	311
Grimes Co.	26 $\frac{3}{4}$	9	21 $\frac{1}{2}$
Hazeltine Corp.	48 $\frac{1}{4}$	13	51 $\frac{3}{4}$	14 $\frac{1}{2}$	23 $\frac{3}{4}$
Inter Ocean Radio	16 $\frac{3}{4}$	6 $\frac{3}{4}$	14	1 $\frac{1}{2}$	3 $\frac{3}{4}$
Jones, Jos. W. Co.	.95	.15	9	1	3 $\frac{7}{8}$
Liberty Radio	8	5 $\frac{3}{8}$	9	6 $\frac{3}{4}$	8
Manhattan Electric Supply	49 $\frac{3}{4}$	33 $\frac{1}{4}$	59	42 $\frac{1}{2}$	56
Mu-Rad Radio	5 $\frac{1}{2}$	4 $\frac{3}{4}$	5 $\frac{1}{2}$
Music Master	21 $\frac{1}{2}$	8 $\frac{3}{4}$	16 $\frac{1}{2}$
Pathe Co., A.	49 $\frac{3}{4}$	38 $\frac{3}{4}$	92	42 $\frac{1}{4}$	78 $\frac{7}{8}$
Radio Corp. Comm.	66 $\frac{7}{8}$	19	77 $\frac{7}{8}$	48 $\frac{3}{8}$	60 $\frac{1}{8}$
Rova Radio	18	9 $\frac{1}{8}$	14 $\frac{1}{4}$	2 $\frac{1}{2}$	2 $\frac{1}{2}$
Sleeper Radio	17	15	19 $\frac{3}{8}$	4 $\frac{1}{2}$	6 $\frac{1}{2}$
Stewart-Warner	100 $\frac{7}{8}$	48 $\frac{1}{2}$	70 $\frac{7}{8}$	55	78 $\frac{1}{2}$
Thermiodyne Co.	19 $\frac{1}{2}$	12	22 $\frac{1}{2}$	6 $\frac{1}{2}$	12 $\frac{1}{2}$
Thompson Radio	21	7	25	6	13 $\frac{1}{4}$
Tower Manufacturing Co.	28 $\frac{7}{8}$	18 $\frac{1}{2}$	24 $\frac{1}{2}$	5	9
Victor Talking Machine Co.	116 $\frac{3}{4}$	65	77 $\frac{3}{8}$
Ware Radio	39 $\frac{1}{2}$	13 $\frac{3}{4}$	40 $\frac{1}{2}$	8	16 $\frac{1}{2}$
Weston, A.	27 $\frac{1}{2}$	19 $\frac{5}{8}$	26 $\frac{1}{2}$

Service Is Foundation for Future Sales

(Continued from Page 499)

the customer are thus made fully conversant with the terms of the sale.

The agreement reads as follows: "Within 30 days of this date, we agree to replace without charge to purchaser, any parts that prove defective or to exchange the set for another of the same make if it is advisable to do so. We also agree to service this set for this thirty-day period, without charge or expense to the purchaser. Service after the thirty days will be charged to purchaser at our prevailing rate.

"We do not guarantee tubes or batteries, except as specifically stipulated by their manufacturers. We make no guarantee as to this set receiving a specified station or to the receiving of distant stations beyond the capacity of the set under local conditions."

Signed... (Store) (Purchaser)

"No free service" is the proud policy of J. L. Hudson and Company, Detroit, Mich. Obviously, as all calls are charged for, this service department is on a paying basis, \$1.50 an hour is the customary charge, although, if the set itself is found to be at fault, no charge is made. The service man is paid \$40 a week, and the service department accounts for one-fifth of the set sales. So, J. J. Stacey, manager of this radio department, is one of the few adherents of the "charge for every call" plan.

The service car of this company carries a full line of supplies so that if any are needed while out on a call, they may be sold to the customer without delay.

The most unique service department yet discovered, is the one operated by the Joyce Frint Company, Artesia, New Mex., under the management of R. G. Knoedler. Knoedler says he has never had to make a service call after the free limit expired, which, in this case, is thirty days.

At first thought, this may seem to be an ideal condition, but on second consideration, there seems to be something radically wrong. Knoedler reports a service expense per set sold of 10 per cent, which is high in the extreme. This means that, on a \$200 installation, the service expense is \$20, and that it is spent within one month after the set is sold. Since no calls have ever been made after the free period is over, there is absolutely no service call remuneration coming in. It is the cash collected for calls after the free limit that keeps many service departments from being a liability.

From an analysis of this department, it would appear that too many calls are being made—too much service given—during the first month. His customers are taking advantage of this dealer's good nature and he should call a halt.

The best way for a dealer in a small community to handle service is not to charge for the call, but only for supplies, according to D. B. Mosier, manager of the radio department of the Bristol Trading Company, Bristol, Col. Repair time is charged for, however,

and for mileage when a call is made in the country. To these service policies, Mosier ascribes 20 per cent of his sales.

Auto Supply and Miscellaneous Stores

Of all the main classes of stores handling radio, the auto supply establishment is found to have the least definite service policies. Sixty per cent of these stores report they give free service "as long as necessary." In almost every case, however, the service calls are used as a means of selling accessories and getting new leads, thus repaying the free service costs.

The Auto and Radio Supply Company, Casselton, N. D., is one of the auto supply stores with a definite service plan. One year's free service is given, then the charge being \$1 an hour. This one-year service costs approximately three per cent but this is made up through the sale of supplies. Despite the policy in force, this shop believes a more satisfactory method is to make a charge for every call.

The free service cost incurred by the Sport-Radio Center, Hartford, Conn., is not considered a debit from the profit made on the set sold, as the service man always manages to sell enough small accessories and get enough leads to more than pay for the service.

The president of the company, I. E. Wiesen, believes that three months should be the free service limit, although his company is committed to the policy of one year's free service. Wiesen points out that only three months service is given on new automobiles and that radio should receive an equal amount.

For service calls outside the free class, Wiesen gets \$1.50 an hour and pays his service man \$30 a week.

Joseph Micklewright, proprietor of the Auto Electric Service Station, Haverhill, Mass., is committed to the plan of giving free service "as long as the set lasts." "We do not call it an expense," Micklewright says, "as we get new leads, sell parts, supplies, new sets and recharge batteries. At least half of our sets are sold through the leads picked up on service calls, so we think the calls show us a big enough

profit without charging for the call itself. In one case, we have sold three sets through a customer who is a total loss as a service proposition."

The service men of the Manhattan Auto Supply Company, Brooklyn, N. Y., are also trained as salesmen, and are instructed to convince the customer that it is essential to have all batteries up to standard. It is their duty to push the sale of batteries, battery chargers, battery eliminators, new tubes, and similar equipment, thus lessening the need for service calls and also making them pay for themselves.

A year's free service is given and a charge of \$2 an hour made for all other calls. The service men get \$35 a week and about two-thirds of their calls are payable. A free service cost of \$5 a set is met by the sale of accessories and also through prospects thus obtained, ten per cent of the sales being attributed to the service policy.

Two automobile stores with exactly opposite service policies have found service a non-paying proposition. The Orland Exchange, Orland, Cal., gives practically no free service, charging \$1 an hour, including transportation, for every call. Yet this service department does not pay for itself and is responsible for no additional sales. Despite the loss this department obviously shows, the store believes a charge should be made for every call after the first.

The J. V. Romigh Company, North Platte, Neb., gave free service all last year, yet the service department does not show a profit and has not been built up into a sales feature.

In the case of these two organizations, arguments both for and against free service may be found. In the former, the "charge-for-every call" plan did not meet the service expense and in the latter, the free service policy was not made to account for new leads and accessory sales. This, however, was probably due not to any fault of the plan itself but to a lack of ability on the part of the service man to acquire the knack of selling. It proves the theory more convincingly than ever that the service man should also be a good salesman.

Radio Expositions Ahead

October 3-10: Philadelphia Radio Exposition, The Arena, Philadelphia, Pa.

October 5-10: Northwest Radio Exposition, St. Paul Auditorium, St. Paul, Minn.

October 10-16: National Radio Show City Auditorium, Denver, Col.

October 12-17: St. Louis Radio Exposition, Coliseum, St. Louis, Mo.

October 12-17: Boston Radio Show, Mechanics' Hall, Boston, Mass.

October 12-17: Second Annual Montreal Radio Show, Windsor Hotel, Montreal, Canada.

October 17-24: Brooklyn Radio Show, Twenty-third Regiment Armory, Brooklyn, N. Y.

October 19-24: Buffalo Radio Show, Buffalo, N. Y.

October 19-25: Second Annual Cincinnati Radio Exposition, Music Hall, Cincinnati, O.

October 27-November 7: Second Wireless Exhibition, City Exhibition Hall, Manchester, England.

November 2-7: Second Annual Toronto Radio Show, King Edward Hotel, Toronto, Canada.

November 3-8: Detroit Radio Show, Arena Gardens, Detroit, Mich.

November 7-15: Cleveland Radio Show, Public Auditorium, Cleveland, O.

November 11-15: Third Wisconsin Radio Exposition, Milwaukee Auditorium, Milwaukee, Wisc.

November 17-22: Fourth Annual Chicago Radio Show, Coliseum, Chicago, Ill.

Complete Specifications of Batteries—Season 1925-1926

Specifications of radio products, with the name and address of the manufacturer, together with complete information concerning each product is a monthly feature of *Radio Retailing*. This service is wholly for the benefit of readers and is without charge of any kind whatsoever to the manufacturers listed. It is *Radio Retailing's* desire to make these pages a representative directory of radio products, so that, by

keeping and filing them each month, the dealer will always have at hand the information he wants to know about any radio set, reproducer or accessory. Manufacturers are invited to send specifications of their products for representation in these tables, which will be revised, brought up-to-date and published in rotation. For battery chargers and battery eliminators, see the next (November) issue. For loud

speakers, earphones and phonograph units, see September issue, pages 291-294. For radio receivers, season 1925-26, see August issue, pages 160-165. For makers of knock-down sets in kit form, see June issue, pages 545-546. For portable receivers and loop antennas, see May issue, pages 448-451. Complete listings of all radio manufacturers and products appear in McGraw-Hills' Radio Trade Directory.

A Batteries—Storage

Name and Address of Manufacturer	Trade Name	Model Number	List Price	Overall Dimensions in Inches	Weight in Lb. Oz.	Type of Container	Terminal Voltage	Capacity in Amperes Hours	Normal Charging Rate in Amperes	Period of Guarantee Yrs. Mos.		
Advance Battery Manufacturing Co., Louisville, Ky.	Powerfield	6-5-GA	\$14.50	7 1/2 x 6 1/2 x 7 1/2	36	Rubber	6	60				
		6-7-GA	18.00	8 1/2 x 6 1/2 x 7 1/2	45	Rubber	6	90				
		6-9-GA	21.00	10 x 6 1/2 x 7 1/2	53	Rubber	6	120				
American Storage Battery Co., Chicago, Ill.	Invincible					Rubber		80 100 120				
Am-plus Storage Battery Co., Chicago, Ill.	Am-plus		12.00	6 1/2 x 6 1/2 x 7 1/2	30	One piece Hard Rubber	} 6.6	60		18		
			14.00	8 x 6 1/2 x 7 1/2	40			80	18			
			16.00	9 1/2 x 6 1/2 x 7 1/2	45			100	18			
			18.00	10 1/2 x 6 1/2 x 7 1/2	50			120	18			
			20.00	12 x 6 1/2 x 7 1/2	63			140	18			
Arco Battery & Plate Co., Fort Wayne, Ind.	Arco					Rubber	6	60-180	4-8	1		
Bartholomew Battery & Supply Co., St. Louis, Mo.	Sphinx	811	15.00	9 x 7 1/2 x 9 1/2	56	One piece Rubber	} 6	100	5	1		
		1013	18.00	10 1/2 x 7 1/2 x 9 1/2	66			120	6	1		
Bong Battery Co., Chicago, Ill.	Bong	300 B.R.A.-85	24.00	7 1/2 x 7 x 10	43	Rubber	6	102	8	2		
Buckeye Electric Mfg. Co., Gladwin, Mich.	Blue Blaze		25.00	9 x 7 1/2 x 8 1/2	45	Hard Rubber Hard Rubber Hard Rubber	} 6	120	10	1		
			30.00	10 1/2 x 7 1/2 x 8 1/2	65			160	10	1		
			35.00	11 x 7 1/2 x 8 1/2	75			175	10	1		
Campbell Elec. Co., Kansas City, Mo.	Camel					Rubber and Wood		60-150				
Carlisle & Doughty Philadelphia, Pa.	C & D	L-35-A	9.00	5 1/2 x 7 1/2 x 8 1/2	21 8	Wood	6	40	S 4 F2	12		
		L-37-A	11.00	6 1/2 x 6 1/2 x 8 1/2	30	Rubber	6	60	S 6 F3	12		
		L-39-A	13.00	7 1/2 x 6 1/2 x 8 1/2	36 8	Rubber	6	80	S 8 F4	12		
		L-311-A	15.00	9 1/2 x 6 1/2 x 8 1/2	44	Rubber	6	100	S10 F5	12		
		L-313-A	17.00	10 1/2 x 6 1/2 x 8 1/2	50 4	Rubber	6	120	S12 F6	12		
		L-315-A	23.00	11 1/2 x 6 1/2 x 8 1/2	58 8	Rubber	6	150	S14 F7	12		
Cincinnati Storage Battery Co., Cincinnati, Ohio	Cincinnati Cincinnati Cincinnati		18.00	7 1/2 x 6 1/2 x 7 1/2	45	Rubber	6	70-80	5	18		
			22.50	10 1/2 x 6 1/2 x 7 1/2	55	Rubber	6	90-110	7	18		
			18.50	13 1/2 x 6 1/2 x 7 1/2	65	Rubber	6	120-140	9	18		
Cleveland Engineering Laboratory Co., Cleveland, Ohio	Storad	R-3	12.75	7 1/2 x 7 1/2 x 6 1/2	45	Rubber	2	60	4			
		R-4	14.25	9 x 6 1/2 x 10	50	Rubber	4	80	5			
		R-5	16.00	9 x 6 1/2 x 10	55	Rubber	6	100	6			
Continental Battery Co., St. Louis, Mo.	Continental	100-AH	17.00	9 x 9 1/2 x 7	45	Hard Rubber	6	60		3		
D-G Storage Battery Co., Chicago, Ill.	D.-G.		9.95 to 42.00			Wood and Rubber	6	60-80	4-8	2		
Dixie Storage Battery Co., Baltimore, Md.	Dixie							60 90 120		1 1 1		
Edison Storage Battery Co., Orange, N. J.	Edison	1-B-1	11.80	7 1/2 x 4 1/2 x 12 1/2			1.4	18.75	3.75			
		*1-B-1-R. C.	34.65	17 1/2 x 8 x 11 1/2			1.4	18.75	3.75			
		1-B-2	14.10	7 1/2 x 4 1/2 x 12 1/2			1.4	37.50	7.50			
		3-B-1	27.50	8 x 8 x 12 1/2			4.2	18.75	3.75			
		*3-B-1-R. C.	47.10	17 1/2 x 8 x 11 1/2			4.2	18.75	3.75			
		3-B-2	33.25	8 x 8 x 12 1/2			4.2	18.75	7.50			
		5-B-2	52.20	12 1/2 x 8 x 12 1/2			7.0	37.50	7.50			
		*5-B-2-R. C.	78.50	25 1/2 x 8 x 11 1/2			7.0	37.50	7.50			
		5-B-4	74.80	18 x 8 x 12 1/2			7.0	75.00	15.00			
		5-B-1	40.00	12 1/2 x 8 x 11 1/2			7.0	18.75	3.75			
		*5-B-1-R. C.	60.00	23 1/2 x 8 x 12 1/2			7.0	18.75	3.75			
		Electric Storage Battery Co., Philadelphia, Pa.	Exide	1-KZR-5	4.85	2 1/8 x 4 1/2 x 6 1/2	5	Rubber	2	24	2	
				2-KZR-3	6.60	2 1/2 x 4 1/2 x 6 1/2	6	Rubber	4	12	1	
				1-LXL-9-1	7.50	3 1/8 x 7 1/8 x 9 1/8	13	Wood	2	100	6	
2-KZR-3	9.35			4 1/8 x 7 1/8 x 9 1/8	14	Wood	4	50	3			
3-LXL-5-1	12.65			6 1/2 x 6 1/2 x 9	24 8	Composition	6	50	3			
3-LXL-7-1	13.60			8 x 7 1/8 x 6 1/2 x 9	33 8	Composition	6	75	4.5			
3-LXL-9-1	17.25			9 1/2 x 6 1/2 x 9	42 8	Composition	6	100	6			
3-LXL-11-1	19.85			11 1/8 x 6 1/2 x 9	51	Composition	6	125	8			
3-LXL-13-1	22.50	13 1/4 x 6 1/2 x 9	59 8	Composition	6	150	9					
Fontana Bros. Battery Co., Springfield, Mass.	Invincible	0-P-5	18.00	9 1/2 x 9 x 7	40	Rubber	6	100-120	5.5	18		
Franklin Storage Battery Co., Chicago, Ill.	Franklin					Wood and Rubber				18		
General Sales & Service Co., Moline, Ill.	General		12.00	9 x 6 1/2 x 9 1/2	47	Rubber	6	100	6	18		

A Batteries—Storage (Continued)

Name and Address of Manufacturer	Trade Name	Model Number	List Price	Overall Dimensions in Inches	Weight in Lb. Oz.	Type of Container	Terminal Voltage	Capacity in Ampere Hours	Normal Charging Rate in Amperes	Period of Guarantee Yrs. Mos.
General Lead Batteries Co., Newark, N. J.	Titan	TWL	11.60	3 1/2 x 7 3/8 x 9 1/8			4	40		
	Titan	TWL-N	14.80	4 1/2 x 7 1/2 x 9 1/8			4	60		
	Titan	TWL-N	19.40	6 1/2 x 7 1/2 x 9 1/8			4	90		
	Titan	TWL-N	24.20	8 x 7 1/2 x 9 1/8			4	120		
	Titan	TWL-N	29.70	8 1/2 x 7 1/2 x 9 1/8			4	150		
	Titan	TWL	16.30	5 1/2 x 7 1/2 x 9 1/8			6	40		
	Titan	TWL-N	21.20	6 1/2 x 7 1/2 x 9 1/8			6	60		
	Titan	TWL-N	26.80	8 1/2 x 7 1/2 x 9 1/8			6	90		
	Titan	TWL-N	33.20	11 1/2 x 7 1/2 x 9 1/8			6	120		
	Titan	TWL-N	39.60	12 1/2 x 7 1/2 x 9 1/8			6	150		
	Titan	TWL	23.20	6 1/2 x 7 1/2 x 9 1/8			8	40		
	Titan	TWL-N	30.20	8 1/2 x 7 1/2 x 9 1/8			8	60		
	Titan	TWL-N	38.50	11 1/2 x 7 1/2 x 9 1/8			8	90		
	Titan	TWL-N	46.55	14 1/2 x 7 1/2 x 9 1/8			8	120		
	Titan	TWL-N	58.00	16 1/2 x 7 1/2 x 9 1/8			8	150		
General Storage Battery Co. St. Louis, Mo.	General	172	13.50	6 1/2 x 7 3/8 x 8	35	Rubber	6	60		1
		173	15.00	8 1/2 x 7 3/8 x 8	41	Rubber	6	80		1
		175	18.50	9 1/2 x 7 3/8 x 8	50	Rubber	6	100		1
		176	24.50	10 1/2 x 7 3/8 x 8	55	Rubber	6	120		1
		177	40.00	14 1/2 x 7 3/8 x 8	75	Rubber	6	200		1
Gill Storage Battery Co., San Bernardino, Cal.	Gill	RR	16.50	9 x 7 1/2 x 8 3/8	55	Wood Rubber	6.3	80	S8 F4	1
			17.50	9 x 7 1/2 x 8 3/8	55		6.3	80	S8 F4	1
Gould Storage Battery Co., Inc., New York	Gould	R4-15	8.50	5 1/2 x 6 1/2 x 7 1/2	12 8	Glass jar Glass jar Hard Rubber Hard Rubber	2 or 4	15 or 30	1	6
		R6-30	14.00	4 1/2 x 3 1/2 x 7 1/2	23 8		6	30	1 1/2	6
		R6-80	17.00	6 1/2 x 9 1/2 x 9 1/2	41 12		6	80	5	6
		R6-120	21.00	7 x 11 1/2 x 9 1/2	55 4		6	120	7 1/2	6
Grant Storage Battery Co., Minneapolis, Minn.	Grant	611-R	16.75	9 x 7 1/2 x 9 1/2	50	Rubber Composition	6	100	5	18
Hartford Battery Mfg. Co., Milldale, Conn.	Hartford	RB-50	\$17.00	7 3/8 x 6 1/2 x 9 1/2				50		18
		RH-70	18.00	8 1/2 x 6 1/2 x 9 1/2			70			
		RH-100	19.50	9 1/2 x 6 1/2 x 9 1/2			100			
		RH-130	22.00	11 1/2 x 6 1/2 x 9 1/2			130			
Hazelett Storage Battery Co., Cleveland, Ohio	Hazelett	1-R	16.50	9 1/2 x 7 1/2	41	Composition	6	100	6	1
Henderson Battery Co., Spokane, Wash.	Aladdin	100	20.00		46	Rubber	6.3	100	5	2
Hobbs Storage Battery Co., Los Angeles, Cal.	Hobbs	6-HX-11-A	16.95	9 x 7 1/2 x 9 1/2	47	Hard Rubber	6	100	5	
Jelly Battery Co., Los Angeles, Cal.	Jelly	F-11	25.00	9 1/2 x 8 1/2 x 7 3/8	50	Wood and Rubber	6	100	5	2
Kalb Electric & Mfg. Co., St. Louis, Mo.	Keeco	209	9.00					40		
		6540	13.50				40			
		6767	15.55				67			
		6990	18.50				90			
		6110	19.50				110			
		6130	23.50				130			
		702	44.00				110			
Kelley Battery Corp., Norfolk, Va.	Kelly		12.00		50	Rubber Composition	6.5	85	7	1 and 2
			to 20.00		to 70			to 150		
Kelman Electric Co., Rochester, N. Y.	Kelman	RKA-BB	24.00	10 x 6 1/2 x 7 1/2	54	Rubber	6	120-150	6	1
Liberty Battery Co., Chicago, N. Y. *Unconditional	Liberty					Rubber	6		5	*
Lyons Storage Battery Co., Phila., Pa.	Lyons					Rubber	6	40-160		3
Mac Rae Hector Co., Baltimore, Md.	Champion	3-LT-7-A	15.00	7 1/8 x 9 1/8 x 8 3/8	45	Rubber	6	100	6	18
Marko Storage Battery Co., Brooklyn, N. Y.	Marko	6-W-7	17.15	9 1/2 x 6 1/2 x 9 1/2	45	Rubberlith Rubberlith	6	90	8	1
		6-W-9	20.80	10 1/2 x 6 1/2 x 9 1/2	53		6	120	10	1
Mid-West Storage Battery Co., Indianapolis, Ind.	Blue Mid-West	6-RA-100	18.00	10 x 9 1/2 x 6 1/2	50	Hard Rubber Hard Rubber	6	100	8	1
		6-RA-125	22.00	11 1/2 x 9 1/2 x 6 1/2	60		6	125	10	1
Music Master Corp., Philadelphia, Pa.	Music Master Music Master	6-90	19.50	7 1/2 x 8 1/2 x 7 3/8	35 8	Wood Wood	6	90	2-5	2
		6-110	23.50	7 1/2 x 8 1/2 x 8 1/8	43 8		6	110	2-5	2
National Utility Battery Co., Mount Prospect, Ill.	Utility	W-15-R		2 1/2 x 7 1/2 x 8 1/2			2	40		2
		W-17-R		2 1/2 x 7 1/2 x 8 1/2			2	60		2
		W-25-R		3 1/2 x 7 1/2 x 8 1/2			4	40		2
		W-27-R		4 1/2 x 7 1/2 x 8 1/2			4	60		2
		W-37-R		6 1/2 x 7 1/2 x 8 1/2			6	60		2
		W-39-R		7 1/2 x 7 1/2 x 8 1/2			6	80		2
		W-311-R		9 1/2 x 7 1/2 x 8 1/2			6	100		2
		W-313-R		10 1/2 x 7 1/2 x 8 1/2			6	120		2
		W-315-R		11 1/2 x 7 1/2 x 8 1/2			6	140		2
Perrine Quality Products Corp. Boston, Mass.	Perrine		16.50		50	Hard rubber	4 or 6	70	2	1 and 2
			to 32		to 150			to 5		
Philadelphia Storage Battery Co., Philadelphia, Pa.	Phileo Phileo	UD-86 76-RX	16.00	10 1/2 x 4 1/2 x 6 1/2	21 8	Glass Rubber	6	36	1	
			18.85	9 x 6 1/2 x 9 1/8	38		6	90	3	
Prest-O-Lite Co., Inc., Indianapolis, Ind.	Prest-O-Lite	43-MRR	4.75	2 3/8 x 4 3/8 x 6 1/2	5 8	Hard Rubber Hard Rubber Hard Rubber Hard Rubber Hard Rubber Hard Rubber Glass	4	15		
		23-MRR	4.75	2 3/8 x 4 3/8 x 6 1/2	5 8		2	30		
		67-RHRK	11.90	6 1/2 x 6 1/2 x 8 1/2	30 8		6	60		
		69-RHRK	13.75	8 1/2 x 6 1/2 x 8 1/2	37 8		6	80		
		611-RHRK	15.80	9 1/2 x 6 1/2 x 8 1/2	44 8		6	100		
		613-RHRK	20.50	10 1/2 x 6 1/2 x 8 1/2	51 8		6	120		
		69-RRLK	38.25	18 1/2 x 9 1/8 x 13 1/2	107		6	140		
Puckett Storage Battery Co., Elgin, Tex	Puckett	R-611	18.00	9 x 9 1/2 x 7 1/2	47	Rubber	6	100	6	18
Standard Battery Mfg. Co., Fort Worth, Tex.	Standard	400-404			35 to 60	Wood and Rubber	6	35-120		1
Star Storage Battery Co., Muncie, Ind.	Star	RH-3	21.00	9 1/2 x 6 1/2 x 7 1/2	47	Rubber	6	100	6	1
Stewart Battery Co., Chicago, Ill.	Stewart	RC-BH	18.60	8 1/2 x 6 1/2 x 7 3/8	59	Rubber	6.6	100	5	3

A Batteries—Storage (Concluded)

Name and Address of Manufacturer	Trade Name	Model Number	List Price	Overall Dimensions in Inches	Weight in Lb. Oz.	Type of Container	Terminal Voltage	Capacity in Ampere Hours	Normal Charging Rate in Amperes	Period of Guarantee Yrs. Mcs.
Sturges Multiple Battery Co., Jamaica, L. I., N. Y.	Sturges Multiple	603	17. 50	7 $\frac{1}{2}$ x7 $\frac{1}{2}$ x9 $\frac{1}{2}$	35	Wood	6	70-80	4	2
	Sturges Multiple	603-R	18. 50	7 $\frac{1}{2}$ x7 $\frac{1}{2}$ x9 $\frac{1}{2}$	35	Rubber	6	70-80	4	2
	Sturges Multiple	604	19. 50	9x7 $\frac{1}{2}$ x9 $\frac{1}{2}$	41	Wood	6	90-100	6	2
	Sturges Multiple	604-R	20. 50	9x7 $\frac{1}{2}$ x9 $\frac{1}{2}$	49	Rubber	6	120-130	8	2
	Sturges Multiple	605	23. 50	10 $\frac{1}{2}$ x7 $\frac{1}{2}$ x9 $\frac{1}{2}$	49	Wood	6	120-130	8	2
	Sturges Multiple	605-R	24. 50	10 $\frac{1}{2}$ x7 $\frac{1}{2}$ x9 $\frac{1}{2}$	49	Rubber	6	120-130	8	2
Sturges Multiple	606	27. 50	11 $\frac{1}{8}$ x7 $\frac{1}{2}$ x9 $\frac{1}{2}$	35	Rubber	6	70-80	4	2	
Superior Battery Mfg. Co., St. Louis, Mo.	Superior	313-R-1	15. 00	9x7	45	Rubber	6	100	6	1
Thomas Battery Corp., New York	Thomas	6-5-100R	15. 00	7 $\frac{1}{2}$ x10x9	45	Hard Rubber	6	100	4	2
Universal Battery Co., Chicago, Ill.	Universal	PAG-3	3. 60	2 $\frac{1}{2}$ x4x7 $\frac{1}{2}$	5	Glass	2	15	5	
	Universal	PAR-2	4. 00	1 $\frac{1}{2}$ x3 $\frac{1}{2}$ x6 $\frac{1}{2}$	3	Rubber	2	30	3	
	Universal	PAG-5	4. 50	2 $\frac{1}{2}$ x4x7 $\frac{1}{2}$	6	Glass	6	30	6	
	Universal	PAR-4	7. 75	2 $\frac{1}{2}$ x3 $\frac{1}{2}$ x6 $\frac{1}{2}$	5	Rubber	4	30	5	
	Universal	Jr.-5	13. 50	6 $\frac{1}{2}$ x7 $\frac{1}{2}$ x9 $\frac{1}{2}$	32	Rubber	6	50	5	
	Universal	Jr.-11	18. 00	9 $\frac{1}{2}$ x7 $\frac{1}{2}$ x9 $\frac{1}{2}$	43	Rubber	6	80	10	
	Universal	Jr.-13	20. 00	10 $\frac{1}{2}$ x7 $\frac{1}{2}$ x9 $\frac{1}{2}$	50	Rubber	6	100	12	
	Universal	WR-9	22. 50	10 $\frac{1}{2}$ x7 $\frac{1}{2}$ x9 $\frac{1}{2}$	49	Rubber	6	100	10	
	Universal	RR-9	22. 50	10 $\frac{1}{2}$ x6 $\frac{1}{2}$ x9	50	Rubber	6	100	10	
	Universal	RCR-9	24. 00	10 $\frac{1}{2}$ x6 $\frac{1}{2}$ x9 $\frac{1}{2}$	52	Rubber	6	100	10	
Universal	GR-5	24. 40	12 $\frac{1}{2}$ x7 $\frac{1}{2}$ x12	53	Rubber	6	50	8		
Vesta Battery Co., Chicago, Ill.	Eau	R6-Eau-7				Rubber		75		
	Eau	DR6-Eau-9				Rubber		105		
	Eau	R6-Eau-9				Rubber		100		
	Eau	R6-Eau-11				Rubber		125		
	Standard	R6-7				Rubber		60		
	Standard	R6-9				Rubber		80		
Standard	R6-11				Rubber		100			
Standard	R6-13				Rubber		120			
Victor Storage Battery Co., Rock Island	S.O.S.	RM-9	\$16. 00	9x6 $\frac{1}{2}$ x8	48	Rubber	6	60-80	7	18
	S.O.S.	RM-11	20. 00	9x6 $\frac{1}{2}$ x9	52	Rubber	6	95-110	10	18
	S.O.S.	RM-13	23. 00	9x6 $\frac{1}{2}$ x10 $\frac{1}{2}$	63	Rubber	6	110-130	12	18
Weber Battery Co., Chicago, Ill.	Weber			9x6 $\frac{1}{2}$ x9	45	Hard Rubber	6	100	5	1
Westinghouse Union Battery Co., Swissvale, Pa.	Westinghouse	6-BRO-7	12. 00				6	60	5	
	Westinghouse	6-BRO-9	14. 00				6	80	6. 5	
	Westinghouse	6-BRO-11	16. 10				6	100	8. 5	
Willard Storage Battery Co., Cleveland, O.	Willard	MCCR-10	14. 00	7 $\frac{1}{2}$ x2 $\frac{1}{2}$ x8 $\frac{1}{2}$	19	Hard Rubber	4	35		
	Willard	FWR-3	15. 00	8 $\frac{1}{2}$ x6 $\frac{1}{2}$ x7 $\frac{1}{2}$	36	Hard Rubber	6	90		
	Willard	FWR-5	19. 50	10 $\frac{1}{2}$ x6 $\frac{1}{2}$ x7 $\frac{1}{2}$	50	Hard Rubber	6	120		
	Willard	MCCR-4	20. 00	10x3x7	19	Hard Rubber	6	45		
	Willard	FRR-3	21. 00	8 $\frac{1}{2}$ x6 $\frac{1}{2}$ x7 $\frac{1}{2}$	36	Hard Rubber	6	90		
	Willard	FRR-5	27. 00	10 $\frac{1}{2}$ x6 $\frac{1}{2}$ x7 $\frac{1}{2}$	50	Hard Rubber	6	120		
Witherbee Storage Battery Co., N. Y. C.	Witherbee	R6-80	21. 00	9 $\frac{1}{2}$ x6 $\frac{1}{2}$ x9 $\frac{1}{2}$	40	Rubber	6	80	4	2
Wolke Electric Co., Louisville, Ky.	Wolkee	502	13. 50	9 $\frac{1}{2}$ x9x7	50	Rubber	6	100	3	2
Wright Battery Co., Flint, Mich.	Keystone	Wright grid	11. 91	9x6 $\frac{1}{2}$ x9 $\frac{1}{2}$	45	Rubber	6	82	8	1
Yale Electric Corp., Brooklyn, N. Y.	Yale	6-A-60-R	13. 50	7 $\frac{1}{2}$ x7 $\frac{1}{2}$ x9	32	Rubber	6	60	6	3
	and	6-A-90-R	16. 00	10x7 $\frac{1}{2}$ x9	42	Rubber	6	90	8	3
	Franco	6-A-120-R	19. 50	12 $\frac{1}{2}$ x7 $\frac{1}{2}$ x9	52	Rubber	6	100	10	3

Key: S=start, F=finish.

A Batteries—Dry Cell

Manufacturers Name and Address	Model Number	List Price	Dimensions in Inches	Weight in Lb. Oz.	Type of Container	Terminal Voltage
Bright Star Battery Co., Hoboken N. J.	Bright Star 6-A	\$0. 50	2 $\frac{1}{2}$ diameter	2	Chip-board	1. 5
Burgess Battery Co., Chicago, Ill.	6	. 50			Cardboard	1. 5
	232	. 50			Cardboard	4. 5
Burn-Boston Battery & Mfg. Wks., Boston, Mass.	Addwater No. 1	1. 25	2 $\frac{1}{2}$ x2 $\frac{1}{2}$ x7 $\frac{1}{2}$	2 8	Water proof	1. 5
Carbon Products Co., Lancaster, O.	Ace 61	. 45			Moisture proof	1. 5
	Ace 63-S	4. 50			Moisture proof	4. 5
Comet Co., Cleveland, O.	565	. 60				3 and 4. 5
French Battery Co., Madison, Wis.	1211	. 45	2 $\frac{1}{2}$ x6 $\frac{1}{2}$	2 3	Cardboard	1. 5
	1212	1. 10	5 $\frac{1}{2}$ x2 $\frac{1}{2}$ x7		Cardboard	1. 5
	1213	1. 80	7 $\frac{1}{2}$ x2 $\frac{1}{2}$ x7		Cardboard	4. 5
Manhattan Electric Supply Co., New York	2445	. 40	2 $\frac{1}{2}$ x6 $\frac{1}{2}$	2	Round	1. 5
	2448	. 40	2 $\frac{1}{2}$ x6 $\frac{1}{2}$	2	Square	1. 5
Marathon Battery Co., Wausaw, Wis.		. 50	2 $\frac{1}{2}$ x6	2		1. 5
Music Master Corp., Philadelphia, Pa.	151	. 60	6x2 $\frac{1}{2}$	2 4	Cardboard	1. 5
National Carbon Co., New York	Columbia Ignitor	. 40	2 $\frac{1}{2}$ x6	13	Cardboard	1. 5
	Eveready 71-11	. 45	2 $\frac{1}{2}$ x6	13	Cardboard	1. 5
Niagara Searchlight Co., Niagara Falls, N. Y.	Niagara	. 40	2 $\frac{1}{2}$ x6	2 4	Round	1. 5
Revivo Battery Co., New York	Re-vi-vo		2 $\frac{1}{2}$ x6	1		1. 6
Stuart Products Co., Chicago, Ill.	5690	. 60	2 $\frac{1}{2}$ x6	2	Cardboard	1. 5
Wireless Dry Cells, Ltd., Niagara Falls, N. Y.	Reliance	. 40	2 $\frac{1}{2}$ x6	2	Wire bound } wood box }	1. 5
	Maximite	. 60	2 $\frac{1}{2}$ x6	2		
Yale Electric Corp., Brooklyn, N. Y.	101-R	. 45	2 $\frac{1}{2}$ x2 $\frac{1}{2}$ x6 $\frac{1}{2}$			1. 5

B Batteries—Storage

Name and Address of Manufacturer	Trade Name	Model Number	List Price	Dimensions in Inches	Weight in Lb. Oz.	Type of Container	Terminal Voltage	Capacity in Milliamps	Normal Charging Rate in Amperes	Period Guarantee Yrs. Mos
Aidifen Battery Co., Cincinnati, O.	Aidifen		\$35.00 45.00				100 100	1700 3000		
Bong Battery Corp., Chicago, Ill. . . .	Bong	402 BRB	20.00	9x13x9½	37	Wood	48	7500	½ to 1	2
Brant Battery Co., Los Angeles, Cal.	Brant		26.00	12x5x9½	21	Wood	100	2750	¼	2
Brinker-Van Cliff Corp., New York City	Beehive Beehive		25.00 35.00	14x7½x8 14x7½x8	20 20	Wood Wood	100 140	2500 2500	½ ½	2 2
Campbell Electric Co., Kansas City, Mo.	Camel Camel					Rubber Rubber	24 48			
Cincinnati Storage Battery Co., Cincinnati, O.	Cincinnati		15.00			Glass	48	3000		18
Cleartone B Battery Co., New York City	Cleartone Cleartone	B 100 B 140	21.00 30.00	14½x7½x6 19x7½x6	17 22	Wood Wood		1500 1500	1 1	2 2
Cleveland Engineering Labs., Cleveland, O.	Storad Storad	4524 4548	7.50 14.00	11½x4x6 11½x8½x6	12 23	Wood Wood	24 48	4500 4500	½ ½	
D. A. Radio Co., Buffalo, N. Y.	Dareo	304	28.00	14½x6½x9	27	Wood	110	1600	2/5	2
D. G. Storage Battery Co., Chicago, Ill.	D. G.					Wood and rubber	24 48	2500 2500	½ ½	
Economic Appliance Co., Irwin, Pa.	Eaco	Alkaline B	6.00		5	Glass	30	325	½	1
Edison Storage Battery Co., Orange, N. J.	Edison Edison	18X 36X	13.60 24.75	7½x4½x6½ 10x7½x5½			25.2 50.4	2500 2500	1/10 1/10	
Electric Storage Battery Co., Philadelphia, Pa.	Exide Exide	12-LR-2 24-LR-2	9.60 17.90	9½x7½ 13½x7½	13 25	Wood and Glass	24 48	6000 6000	½ ½	
General Lead Batteries Co., Newark, N. J.	Titan	B-6000-48	19.00	12½x8x7½	25	Glass	48	6000	½	2
Gilbert Battery Co., Bridgeport, Conn.	Gilbert	D-1	25.00	14x7½x7½	21	Glass	100	3000	1/10	1
Gould Storage Battery Co., New York	Gould Gould	B B	8.50 42.00	6½x3½x5½ 18x8x6½	7 8 38 11	Hard Rubber Hard Rubber	24 96	2000 2000	1/10 1/10	6 6
Grant Storage Battery Co.	Grant	48	9.90	9½x13½	32	Wood	48	3500	1/10 to ½	
Gray Electro Chemical Labs. Bayonne, N. J.	Gray Gray Gray	E AC DC	25.00 32.50 32.50		20 25 25	Wood Wood Wood	100 100 100	2500 to 3000	½ ½ ½	2 2 2
Hartford Battery Mfg. Co., Milldale, Conn.		12W 48WB	10.00 20.00				24 48			
Hazelett Storage Battery, Cleveland, O.	Hazelett	41-B	19.50	13½x10x6½	27	Glass	96	3000	1/10	1
Henderson Battery Co., Spokane, Wash.	Aladdin	48 96	12.50 25.00		23	Wood	50	3500	½	2
Ideal Battery Mfg. Co., Huntington, Ind.	Tip Top	96 J	12.50	5x6½x7	12	Wood	96	1200	½	1
Jelly Battery Co., Los Angeles, Cal.	Jelly-B	C	30.00	9½x6½x8½	28	Wood	100	2650	½	2
Kelman Electric Co., Rochester, N. Y.	Kelman		7.50	13x4½x6	14 8	Rubber	24	3500	½	1
Lane Mfg. Co., Chicago, Ill.	Lane		25.00	16x9½x7½	20	Glass	100	1000	1/5	
Liberty Battery Co., Chicago, Ill.	Liberty					Rubber	24	2500	½	
Lyons Storage Battery Co., Philadelphia, Pa.	Lyons					Wood and glass	48	5000	½	3
Marko Storage Battery Co., Brooklyn, N. Y.	Marko Marko		9.95 19.25	6½x8½x8 12½x8½x8	17 35	Wood Wood	24 48	4500 4500	½ ½	1 1
McKinney Co., E. A., Santa Ana, Cal.	Super-Macs		20.00	7x9½x13½	44	Wood	100	3250	½	1 6
National Utility Battery Co., Mount Prospect, Ill.	Utility	Q-122 Q-242		13½x4½x5½ 13½x9½x6			24 48	3000 3000		
Perrine Quality Products Co., Boston, Mass.	Perrine		25.00		28	Glass	100	3000	½ to 2	1
Philadelphia Storage Battery Co., Philadelphia, Pa.	Phileo Phileo Phileo	248-DX 83 X 86 H	17.50 19.88 25.00	11½x7½x6½ 13½x8½x5½ 13½x8½x7½	22 46 63	Wood Wood Wood	48 80 80	3000 3000 6000	½ ½ 3/10	
Prest-O-Lite Co., Inc., Indianapolis, Ind.	Prest-O-Lite Prest-O-Lite Prest-O-Lite Prest-O-Lite	24 XRR 24 LRR 48 XRR 48 LRR	10.50 11.85 18.90 23.45	10½x8x6½ 10½x8x6½ 19½x8x6½ 19½x8x6½	15 8 22 22 8 42 8	Glass Glass Glass Glass	24 24 48 48	3500 6000 3500 6000	½ ½ 3/10 ½	
Revivo Battery Corp., Garfield, N. J.	Rechargeable Dry-cell	B B	3.00 6.00	3½x4½x6½	4 7	Metal Metal	22½ 45		½ ½	
Smith, B. W., Danbury, Conn.	Hawley	(21 sizes)	3.00 21.00			Wood and Glass	22½ to 157½	1250	1/5	2
Star Storage Battery Co., Muncie, Ind.	Star		8.00 15.50	13½x5½x6½ 13½x9½x6½	12 24	Wood or Rubber	24 48	6000 6000	½ ½	1 1
Stewart Battery Co., Chicago, Ill.	Stewart		11.00	9x13½x5½	32	Rubber	48	3000	½	3
Todd Electric Co., New York City	Todd Todd	URR 3 VG 5	21.00 21.00	14x8x6½ 10x6x6½	18 10	Wood Wood	100 100	1250 1250	1/5 1/5	1 1
Universal Battery Co., Chicago, Ill.	Universal Universal Universal	RB-2 RB-24 RB-48	.60 8.00 15.00	1½ dia. 8½x6½x6½ 11½x7½x6½	1 12 25	Glass Glass Glass	2 24 48			

B Batteries—Storage (Concluded)

Name and Address of Manufacturer	Trade Name	Model Number	List Price	Dimensions in Inches	Weight in Lb. Oz.	Type of Container	Terminal Voltage	Capacity in Milliamps	Normal Charging Rate in Amperes	Period of Guarantee Yrs. Mos.
Vesta Battery Corp., Chicago, Ill.		24 RD 2		16½ x 2½ x 6½			24	4000		
		24 RD 2T		16½ x 2½ x 6½			24	4000		
		24 RC 2		13 x 4½ x 6½			24	2500		
		48 RC 2		13½ x 8 x 6½			48	2500		
		24 RB 2		17 x 4½ x 8			24	5000		
		48 RB 2		17 x 9½ x 8			48	5000		
Westinghouse Union Battery Co., Swissvale, Pa.	Westinghouse	24 RG 2	9.85	7½ x 5½ x 4½		Glass	24	3500		
Willard Storage Battery Co., Cleveland, O.		HR 127	16.00	10½ x 7½ x 6	18	Glass	48	6000		
		HR 127	18.50	10½ x 7½ x 6	19	Glass	48	6000		
		WTAM 127	19.00	12½ x 8½ x 7½	35	Glass	48	6000		
		WTAM 127	21.50	12½ x 8½ x 7½	36	Glass	48	6000		
		CBR 127		12½ x 8½ x 7½	35	Glass	48	6000		
Wetherbee Storage Batt. Co., New York City	Wetherbee	B 48	17.00	12½ x 8½ x 7½		Glass	48	5000	1	2

B Batteries—Dry Cell

Name and Address of Manufacturer	Model Number	List Price	Dimensions in Inches	Weight in Lbs. Oz.	Type of Container	Terminal Voltage	Tapped *
Advance Battery Corp., New York	154	\$1.50	3½ x 2 x 2½	1		22½	No
	152 V	1.75	3½ x 2½ x 5½	2		22½	No
	152	1.75	4 x 2½ x 2½	2 8		22½	Yes
	153	1.90	4 x 2½ x 2½	1 8		22½	No
	302	3.00	5 x 6 x 2½	4 4		45	Yes
	301	3.75	8 x 6½ x 3½	8 8		45	Yes
	301 V	3.75	8 x 3 x 7	9 4		45	At 22½
	Burgess Battery Co., Chicago, Ill.	4156	1.50	3½ x 2 x 2½	1		22½
5156		1.75	4½ x 2½ x 2½	1 9		22½	No
5158		1.75	2½ x 2½ x 6	2		22½	No
2158		2.00	4½ x 3½ x 7	5		22½	No
2156		2.00	6½ x 4 x 3	3 4		45	Yes
5308		3.25	2½ x 4½ x 5½	9 9		45	At 22½
2306		4.00	6½ x 3 x 7½	9 8		45	Yes
2308		4.00	3½ x 6½ x 7	9 8		45	At 22½
Bright Star Battery Co., Hoboken, N. J.	1550	1.50	3½ x 2½ x 2½	1	Chip-board	22½	No
	1591	1.75	3½ x 2½ x 5½	2 4	Chip-board	22½	No
	1503	1.90	4½ x 2½ x 2½	1 8	Chip-board	22½	No
	1590	2.00	6½ x 4 x 3	5	Chip-board	22½	Yes
	1595	2.00	4 x 2½ x 7½	4 4	Chip-board	22½	No
	3005	3.75	6½ x 8 x 3	9 8	Chip-board	45	Yes
	3095	3.75	8 x 3 x 7½	9 4	Chip-board	45	At 22½
	3060	4.75	8½ x 4½ x 7½	13	Chip-board	45	At 22½
Brite-Lite Battery Co., Cleveland, O.	1520	2.00	6½ x 4 x 3	4 8	Corrugated	22½	Yes
	1540	3.75	8 x 6½ x 3	9	Corrugated	22½	Yes
	1560	4.75	8 x 6½ x 4½		Corrugated	45	Yes
Burn-Boston Battery & Mfg. Wks., Boston, Mass.	Double Life 125	4.00			Waterproof	22½	Yes
Carbon Products Co., Lancaster, O.	315	1.50	2 x 2½ x 3½	1		22½	No
	2151	1.75	3½ x 2½ x 5½	1 14		22½	No
	515	1.90	4 x 2½ x 2½	1 10		22½	No
	1152	2.00	4½ x 2½ x 7½	4		22½	No
	115	2.00	6½ x 4 x 3	3 14		22½	Yes
	715	3.25	7½ x 4½ x 4	4 12		22½	No
	1302	3.75	8½ x 2½ x 7½	7 8		45	At 22½
	730	4.75	9 x 6½ x 4	9 12		45	At 22½
Comet Co., Cleveland, O.	560	1.75	4½ x 3 x 3			22½	No
	570	1.90	4½ x 2½ x 3			22½	No
	562	2.00	6½ x 4½ x 3½			22½	Yes
	563	3.75	6½ x 8 x 3½			45	Yes
	564	3.75	8 x 2½ x 7½			45	At 22½
	566	4.75	8 x 3½ x 7½			45	At 22½
Curtis-Leger Fixture Co., Chicago, Ill.	B-EX-L	15.00	6 x 3 x 2	3	Hard rubber	22½, 45, 67½, 90	
Diamond Electric Specialty Corp., Newark, N. J.	B-4	1.50	3½ x 2½ x 3	1	Corrugated	22½	Yes
	B-8	1.90	3½ x 2½ x 6	2 8	Corrugated	22½	No
	B-5	1.90	4 x 2½ x 2½	1 9	Corrugated	22½	No
	B-1	2.00	6½ x 4 x 3	4 8	Corrugated	22½	Yes
	B-10	2.50	6½ x 4 x 4½	6 4	Corrugated	22½	Yes
	B-6	3.75	8 x 3 x 7½	9	Corrugated	45	At 22½
	B-20	4.75	7½ x 6½ x 4½	12 8	Corrugated	45	Yes
French Battery Co., Madison, Wis.	4151	1.50	3½ x 2½ x 2½	1 2		22½	No
	5151 BP	1.75	4½ x 2½ x 2½	1 9		22½	No
	1153	1.75	5½ x 3½ x 2½	2 4		22½	No
	2151	2.00	7½ x 4½ x 3½	4 15		22½	No
	2153	2.00	7½ x 4½ x 3½	4 15		22½	Yes
	9151	2.50	6½ x 4 x 3½	4 9		22½	Yes
	2301	3.75	8½ x 6½ x 3½	9 5		45	At 22½
	2303	3.75	8 x 7½ x 3½	9 5		45	At 22½
	9303	4.75	8½ x 4 x 7½	13 11		45	
	Giant Radio Battery Co., Inc., New York	101	1.75	3½ x 2½ x 2			22½
106		2.15	4½ x 2½ x 2½			22½	Yes
102		2.50	5 x 2½ x 3			22½	Yes
104		3.00	6½ x 4 x 3			22½	Yes
103		4.25	6 x 5 x 2½			45	Yes
105		5.50	8 x 3 x 6½			45	Yes
Marathon Battery Co., Wausau, Wis.	1540	1.50	3½ x 2 x 2½	1		22½	No
	1550	1.90	4½ x 2½ x 2½	1 8		22½	No
	1551	1.75	2½ x 2½ x 6	2		22½	No
	1570	2.00	6½ x 4 x 3	5		22½	Yes
	1521	2.00				22½	Yes
	1590	2.50	6½ x 4 x 4½	6		45	Yes
	3020	3.75	7½ x 6½ x 3	9 8		45	At 22½
	3021	3.75	8½ x 3 x 7½	10		45	At 22½
	3091	4.75	8½ x 4 x 7½	14		45	At 22½
Music Master Corp., Philadelphia, Pa.	224	1.75	4½ x 2½ x 2½	1 8	Pasteboard	22½	No
	225	2.00	6½ x 4 x 3½	4 7	Pasteboard	22½	Yes
	450	3.75	7½ x 6½ x 3½	8 4	Pasteboard	45	Yes
	451	3.75	8 x 3 x 7½	8 8	Pasteboard	45	At 22½

B Batteries—Dry Cell (Concluded)

Name and Address of Manufacturer	Model Number	Price List	Dimensions in Inches	Weight in Ounces	Type of Container	Terminal Voltage	Tapped Voltages
National Carbon Co., New York	763	1.50	3 1/8 x 2 1/8 x 2 1/8	1 3		22 1/2	No
	768	1.75	4 1/8 x 2 1/8 x 2 1/8	1 9		22 1/2	No
	764	1.75	3 1/2 x 2 1/8 x 5 1/8	2 8		22 1/2	No
	766	2.00	6 1/2 x 4 1/8 x 3 1/8	5		22 1/2	Yes
	767	3.75	8 x 6 1/8 x 3 1/8	8 11		45	Yes
	772	3.75	8 1/8 x 3 1/8 x 7 1/8	9		45	At 22 1/2
	770	4.75	8 1/8 x 4 1/8 x 7 1/8	13 12		45	At 22 1/2
Niagara Searchlight Co., Inc., Niagara Falls, N. Y.	190	1.75	3 1/2 x 2 1/8 x 6 1/8	2		22 1/2	No
	300	2.00	6 1/8 x 4 x 3	4 8		22 1/2	Yes
	250	2.00	4 1/8 x 3 1/8 x 7 1/8	4 8		22 1/2	No
	500	3.75	8 x 3 1/8 x 7 1/8	9		45	At 22 1/2
	550	3.75	8 x 5 1/8 x 3	9		45	Yes
	600	4.75	8 x 4 1/8 x 7 1/8	15		45	At 22 1/2
Stuart Products Corp., Chicago, Ill.	5671	1.50	3 1/8 x 2 1/8 x 2 1/8	1		22 1/2	No
	5687	1.75	3 1/8 x 2 1/8 x 5 1/8	2 12		22 1/2	No
	5672	1.90	4 1/8 x 2 1/8 x 2 1/8	1 8		22 1/2	No
	5683	2.00	6 1/8 x 4 1/8 x 3	1 10		22 1/2	Yes
	5680	4.00	8 1/8 x 6 1/8 x 3	9 4		45	Yes
	5684	4.00	8 1/8 x 3 1/8 x 7 1/8	9 4		45	At 22 1/2
Sunlight Battery Co., New York	168 U	1.20	2 1/2 x 3 1/8 x 5 1/8	1 8	Cardboard	22 1/2	No
	168	1.20	2 1/2 x 2 1/8 x 4 1/8	1 8	Cardboard	22 1/2	Yes
	164 U	1.60	2 1/2 x 4 1/8 x 7 1/8	2 8	Cardboard	22 1/2	No
	166	1.60	2 1/2 x 6 1/8 x 4	5	Cardboard	22 1/2	Yes
	169	2.50	2 1/2 x 5 x 6	7	Cardboard	45	Yes
	172 U	3.00	2 1/2 x 7 1/8 x 8	8 8	Cardboard	45	At 22 1/2
	167	3.00	2 1/2 x 2 1/8 x 7 1/8	8 8	Cardboard	45	Yes
Usona Mfg. Co., Inc., New York	220	1.75	3 1/8 x 2 1/8 x 5 1/8	2 4		22 1/2	No
	210	1.90	4 x 2 1/8 x 2 1/8	1 9		22 1/2	No
	225	2.00	6 1/8 x 4 1/8 x 3	4 4		22 1/2	Yes
	145	3.75	8 1/8 x 2 1/8 x 7 1/8	7 10		45	At 22 1/2
	245	3.75	8 1/8 x 6 1/8 x 3	8 8		45	Yes
	345	4.75	8 1/8 x 4 x 7 1/8	12		45	At 22 1/2
Volton Battery Co., Brooklyn, N. Y.	Volton 940	3.75	6 1/8 x 8 x 3	8	Cardboard	45	Yes
	Volton 942	3.75	8 x 2 1/8 x 6 1/8	8	Cardboard	45	At 22 1/2
	Queen B 110	3.75	6 1/8 x 8 x 3	8	Paper	45	Yes
Winchester Repeating Arms Co., New Haven, Conn.	5146	1.50	2 1/2 x 2 x 3 1/8		Waterproof	22 1/2	
	5247	1.90	2 1/2 x 2 1/8 x 6		Waterproof	22 1/2	
	5249	1.90	2 1/8 x 2 1/8 x 4 1/8		Waterproof	22 1/2	
	5547	2.00	3 1/8 x 4 1/8 x 7		Waterproof	22 1/2	
	5546	2.00	3 x 4 x 6 1/8		Waterproof	22 1/2	Yes
	6546	3.75	3 x 6 1/8 x 7 1/8		Waterproof	45	Yes
	6548	3.75	3 x 8 1/8 x 7 1/8		Waterproof	45	At 22 1/2
Wireless Dry Cells, Ltd., Niagara Falls, N. Y.	415	1.50	2 1/8 x 3 1/8 x 3	1	Corrugated	22 1/2	No
	215-V	1.75	3 1/8 x 2 1/8 x 6 1/8	2 8	Corrugated	22 1/2	At 18
	115-T	2.00	7 x 4 1/8 x 3 1/8	4 4	Corrugated	22 1/2	Yes
	1415-T	2.75	7 x 4 1/8 x 5 1/8	6	Corrugated	22 1/2	Yes
	330-T	2.40	5 1/8 x 4 1/8 x 3 1/8	3 8	Corrugated	45	Yes
	130-V	3.75	8 1/8 x 3 1/8 x 7 1/8	9	Corrugated	45	At 18 and 22 1/2
	130-T	3.75	8 1/8 x 7 x 3 1/8	8 4	Corrugated	45	Yes
	1430-V	4.75	8 1/8 x 4 1/8 x 7 1/8	12	Corrugated	45	At 22 1/2
Yale Electric Corp., Brooklyn, N. Y.	1515	1.50	3 1/8 x 2 1/8 x 2 1/8	1		22 1/2	No
	1517	1.75	4 1/8 x 2 1/8 x 2 1/8	1 8		22 1/2	No
	1528	1.75	3 1/8 x 2 1/8 x 2 1/8	2 3		22 1/2	No
	1512 V	2.00	6 1/8 x 4 1/8 x 3 1/8	4 9		22 1/2	Yes
	3045 U	3.75	7 1/8 x 6 1/8 x 3 1/8	7 14		45	Yes
	3044	3.75	8 x 3 1/8 x 7 1/8	8 9		45	At 22 1/2
	3061	4.75	8 x 4 1/8 x 7 1/8	1 14		45	At 22 1/2

* Standard taps are 1 1/2, 1 3/4, 1 7/8, 2, 2 1/4 and 2 1/2 volts

C Batteries—Dry Cell

Name and Address of Manufacturer	Model Number	List Price	Dimensions in Inches	Weight in Ounces	Type of Container	Terminal Voltage	Tapped Voltages
Advance Battery Co., New York	31-C	\$0.60	4 x 1 1/2 x 3	13		4 1/2	3
Bright Star Battery Co., Hoboken, N. J.	7,117	.60	4 x 1 1/2 x 3	16	Chip-board	4 1/2	3
Burgess Battery Co., Chicago, Ill.	5,360	.40	2 1/8 x 1 1/8 x 2 1/8	4	Waterproof	4 1/2	No
	2,370	.60	4 x 1 1/2 x 3	16	Waterproof	4 1/2	1 1/2 and 3
	5,540	.85	4 x 1 1/2 x 2 1/8	9	Waterproof	7 1/2	1 1/2, 3, 4 1/2 and 6
Burn-Boston Battery Mfg. Co., Boston, Mass.	Double life	.50			Waterproof	4 1/2	1 1/2
Carbon Products Co., Lancaster, O.	Ace 023	.60	1 1/2 x 3 x 4	14		4 1/2	1 1/2 and 3
Comet Company, Cleveland, O.	565	.60				4 1/2	3
Diamond Electric Specialties Corp., Newark, N. J.	330	.40	2 1/8 x 1 1/8 x 3	6		4 1/2	1 1/2 and 3
	3	.60	4 x 1 1/2 x 3 1/8	14		4 1/2	1 1/2 and 3
	530	.85	4 x 1 1/2 x 3	10		7 1/2	1 1/2, 3, 4 1/2 and 6
French Battery Co., Madison, Wis.	231-R	.60				4 1/2	1 1/2 and 3
Giant Radio Battery Co., New York	100	.70	4 x 3 x 1 1/2			4 1/2	
Marathon Battery Co., Wausau, Wis.	3,201	.60	3 1/8 x 1 1/8 x 3	12		7 1/2	3
	5,501	.85	4 x 1 1/2 x 2 1/8	9		4 1/2	1 1/2, 3, 4 1/2 and 6
Music Master Corp., Philadelphia, Pa.	4	.60	3 1/8 x 1 1/8 x 3	14	Pasteboard	4 1/2	1 1/2 and 3
	7	.80	4 1/8 x 1 1/8 x 2 1/8	9 1/2	Pasteboard	7 1/2	1 1/2, 3, 4 1/2 and 6
National Carbon Co., New York	771	.60	1 1/2 x 3 x 4	14		4 1/2	1 1/2 and 3
Niagara Searchlight Co., Niagara Falls, N. Y.	3-C	.60	4 x 1 1/2 x 3	14		4 1/2	3
Stuart Products Co., Chicago, Ill.	5,685	.60	4 x 1 1/2 x 3	14		4 1/2	1 1/2 and 3
Sunlight Battery Co., New York	171	.50	1 1/2 x 3 1/4 x 3 1/8	13		4 1/2	1 1/2 and 3
Usona Mfg. Co., New York	120	.60	4 x 3 x 1 1/2	14		4 1/2	1 1/2 and 3
Volton Battery Co., Brooklyn, N. Y.	965	.60	4 x 1 1/2 x 3	9	Cardboard	4 1/2	3
Winchester Repeating Arms Co., New Haven, Conn.	3,247	.40	2 1/8 x 2 1/8 x 1 1/8		Waterproof	4 1/2	3
	3,546	.60	3 1/8 x 2 1/8 x 1 1/8		Waterproof	4 1/2	
Wireless Dry Cells, Ltd., Niagara Falls, N. Y.	33-C	.45	2 1/8 x 1 x 3 1/4	5		4 1/2	1 1/2 and 3
	13-C	.60	4 x 1 1/2 x 3 1/8	12		4 1/2	1 1/2 and 3
Yale Electric Corp., Brooklyn, N. Y.	312	.60	3 1/2 x 1 1/8 x 3 1/4	16		4 1/2	

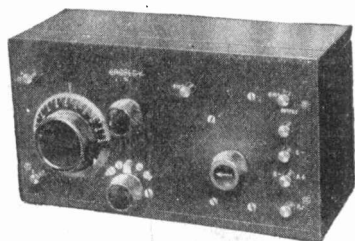

Crosley 51 Regular
A 2-tube long range set, now at the new low price, \$14.75.

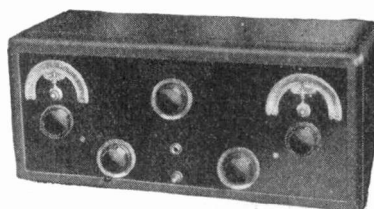

Crosley Super-Trirdyn Regular
In the Super-Trirdyn 3 tubes do the work of 5. Matchless performance. \$45.00.

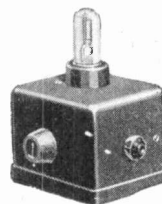

The Crosley Pup
A real long range one tube receiving set, \$9.75.

Not One Sided

Sound engineering, progressive design and accurate manufacture are not wholly responsible for Crosley's present position in the Radio World.

True, these have bred the Crosley reputation for performance. Yet the performance of any product, superior as it may be, can never single-handed carry its maker to the undisputed leadership of an industry.

Crosley today is the world's largest builder of radio sets, because Crosley sets have always given "owner-satisfaction," because Crosley prices have al-

ways reflected the economies of large volume production and because Crosley's merchandising policies have always enabled Crosley dealers to operate soundly, securely—and at a profit.

Of this, a typical example is the Crosley field organization. With headquarters in strategically located cities, twenty-five experienced radio merchandising men are working with Crosley distributors and dealers on their individual local sales problems so as to make the Crosley franchise more valuable, more desirable—and more profitable to those who now hold it.

THE CROSLEY RADIO CORPORATION

Cincinnati, Ohio

Owning and operating WLW, first remote control, super-power broadcasting station.

CROSLEY RADIO

B E T T E R · C O S T S L E S S

A Complete Line

Crosley manufactures a complete line of radio receiving sets which are licensed under Armstrong U. S. patent No. 1,113,149 and range in price from \$9.75 to \$60.00 without accessories—ten per cent higher west of the Rockies. For further information about the Crosley line, write Department 130.



Crosley De Luxe Combination

Musicone De Luxe	\$27.50
Super-Trirdyn Special ..	60.00
Console Table	25.00
Complete	112.50

GOLD SEAL TUBES

A Tube Tie-up You'll Like!

IF you are in business to stay and prosper, you will like the Gold Seal Tube Proposition. It is clean-cut, above-board and backed by men who, like yourself, are in the Radio business to stay.

From the moment Gold Seals were introduced they were a success. One man told another—how good the tube was—what a sound organization there was behind it. The Tube made good—and so did we. That was without advertising and without fan-fare.

Now . . . Gold Seal Tube Advertising

We are telling over 600,000 radio fans who read Radio News, Radio Digest and Popular Radio all about Gold Seals in full page space. We are making your first sales easier, starting Gold Seals from your shelves. After that all of us can leave it to the tubes to make good all we say and think about them. *There will be no disappointments in Gold Seal Tubes.*

There are responsible Gold Seal Tube distributors nearly everywhere—firms you like to deal with. Ask your own distributor or write us for information.



Everywhere
\$2.50
and
Guaranteed

Manufactured
in All
Types

These Things Interest You

- 1—LONGER DISCOUNTS: Gold Seals enable you to make a real profit.
- 2—GUARANTEE: Gold Seals carry a broad, sensible guarantee, backed up by
- 3—A PLANT well equipped, well financed, and run by radio engineers who know tube making from your angle.
- 4—GUARANTEE AGAINST PRICE REDUCTION. We cover distributor and dealer alike—and we mean what we say.
- 5—POLICY: A definite policy with a fair price that all distributors and dealers co-operate to maintain.

Based on these Gold Seal Tube facts, we can appoint a few additional, exclusive distributors of standing. Your territory may be open. Please write us.

GOLD SEAL PRODUCTS COMPANY, Inc.
250 PARK AVENUE, NEW YORK

Announcing the *New* radio battery that is always charged

HERE is something that will be welcomed by all radio fans—a compact “A” storage battery and charger, known as the Exide Radio Power Unit.

This unit is assembled in an attractive metal case, and is kept at all times connected to the ordinary house current as well as to the radio set.

Upon raising a small switch on the end of the unit, the receiving set is ready for use; by throwing it down, the battery is automatically placed on charge. Thus battery-charging, in its most convenient form, practically becomes a part of set operation.

The battery, of course, is an Exide, specially designed for the unit, and has ample capacity for any receiving set—whether that set uses one tube or ten. As there are no moving parts to wear or get out of order, maintenance cost is low.

Finished in a rich mahogany color, the Exide Radio Power Unit is furnished in two sizes—one, for sets using 4-volt tubes; the other, for sets using 6-volt tubes; retailing at \$28 and \$38 respectively—slightly higher west of the Rockies.

This new battery unit is a distinct step forward in radio equipment. It will be widely advertised to the public and you should anticipate a quick and large demand. Do not delay in placing your order.

And don't overlook the Exide “A” and “B” storage batteries and the rectifier for recharging “B” storage batteries.

The Electric Storage Battery Company
Philadelphia

Exide Batteries of Canada, Limited, 153 Dufferin Street, Toronto

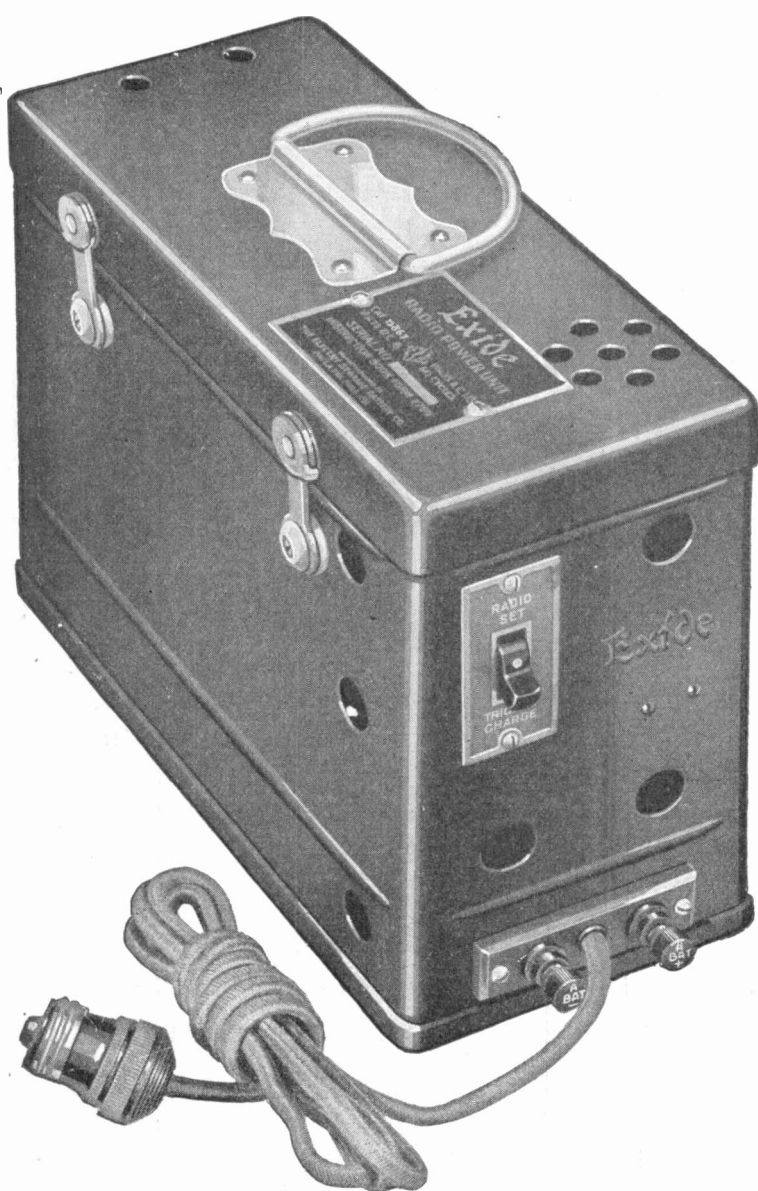

Exide

RADIO POWER UNIT

FOR BETTER RADIO RECEPTION, USE STORAGE BATTERIES

FADA

Radio

Hitch your wagon
to a star!



COMET — across the sky — brilliant — but a flash — and forgotten —

Star — shining forth night after night — clear — steady — permanent.

No great industry — no vast business enterprise, but that has in its firmament — comets and stars. You who look upon radio as a great thriving industry — hardly past its first steps — but sure to grow into immense proportions — which? — the star or the comet for you?

FADA RADIO has won leadership by pioneer work — fair dealing — sheer merit — engineering skill — and a Standard of Reception — by which more and more all radio reception is being judged.

Stability has marked the fundamental principles and practices of every branch of the organization responsible for FADA RADIO. Sane vision has characterized every advance in manufacturing and sales policies.

Approval and recognition by leading distributors and alert dealers is demonstrated in the remarkable increase of August sales over previous years.

The FADA RADIO exclusive franchise for your territory may still be open.

Hitch your wagon to the FADA RADIO star — for certain profits — on a permanent basis.

Write or wire now to

F. A. D. ANDREA, INC.

CHICAGO

NEW YORK

SAN FRANCISCO

Fada Radio, Ltd.—Toronto

Fada Radio, Ltd.—London

Manufacturers of TUNED RADIO FREQUENCY receivers
using the highly efficient NEUTRODYNE principle





NEUTROLETTE
192-A \$85
5-Tube, 3-Dial Control

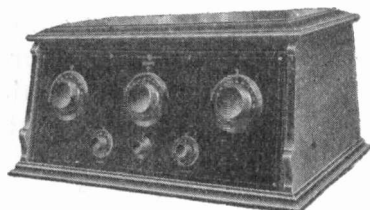

NEUTROCEIVER
175-A \$125
5-Tube, 3-Dial Control

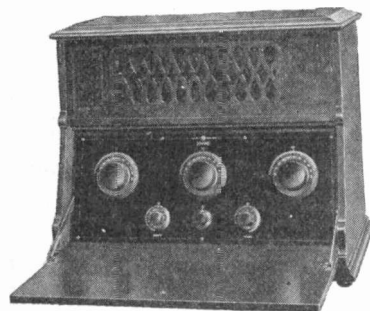

NEUTROLA
185-A \$175
5-Tube, 3 Dial Control
Self-contained loud speaker

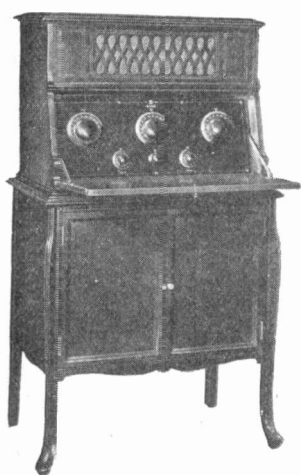

NEUTROLA-GRAND
Model 185/90-A \$225
Model 185-A mounted on the
190-A Base Unit.

FADA Radio

Here are the FADA Business Builders

The FADA RADIO line is among the most beautiful and comprehensive ever offered.

It permits a wide selection for every type of purchaser. Efficient five-tube Neutrodyne sets ranging from \$85 to attractive Art Cabinet Models up to \$300. All models may be used with dry cell or storage battery tubes.

The beauty of FADA encasements and the perfection of FADA reception make quick sales and real profits wherever the FADA line is seen.

FADA advertising has put the FADA Authorized Dealer into a class by himself in the public mind.

If you want quick turnover, steady growth and good profits—join this class of progressive merchants. Hitch your wagon to a Star!

F. A. D. ANDREA, INC.
NEW YORK
CHICAGO SAN FRANCISCO

Fada Radio, Ltd.
Toronto

Fada Radio, Ltd.
London

Manufacturers of
TUNED RADIO FREQUENCY receivers
using the highly efficient NEUTRODYNE principle



QUEEN ANNE DESK
SF-30/70 \$300
Same receiver unit as
Neutroceiver
5-Tube, 3 Dial Control
Self-contained loud speaker



CONSOLE
SF-10/70 \$275
Same receiver unit as
Neutroceiver
5-Tube, 3-Dial Control
Self-contained loud speaker

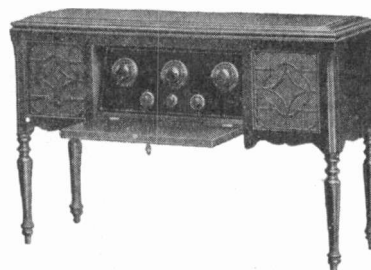

DAVENPORT TABLE
SF-10/70 \$225
Same receiver unit as
Neutroceiver
5-Tube, 3-Dial Control
Self-contained loud speaker



BEETHOVEN GRANDE
SF-20/70 \$250
Same receiver unit as
Neutroceiver
5-Tube, 3-Dial Control
Self-contained loud speaker

Ten Manufacturers To Endorse This

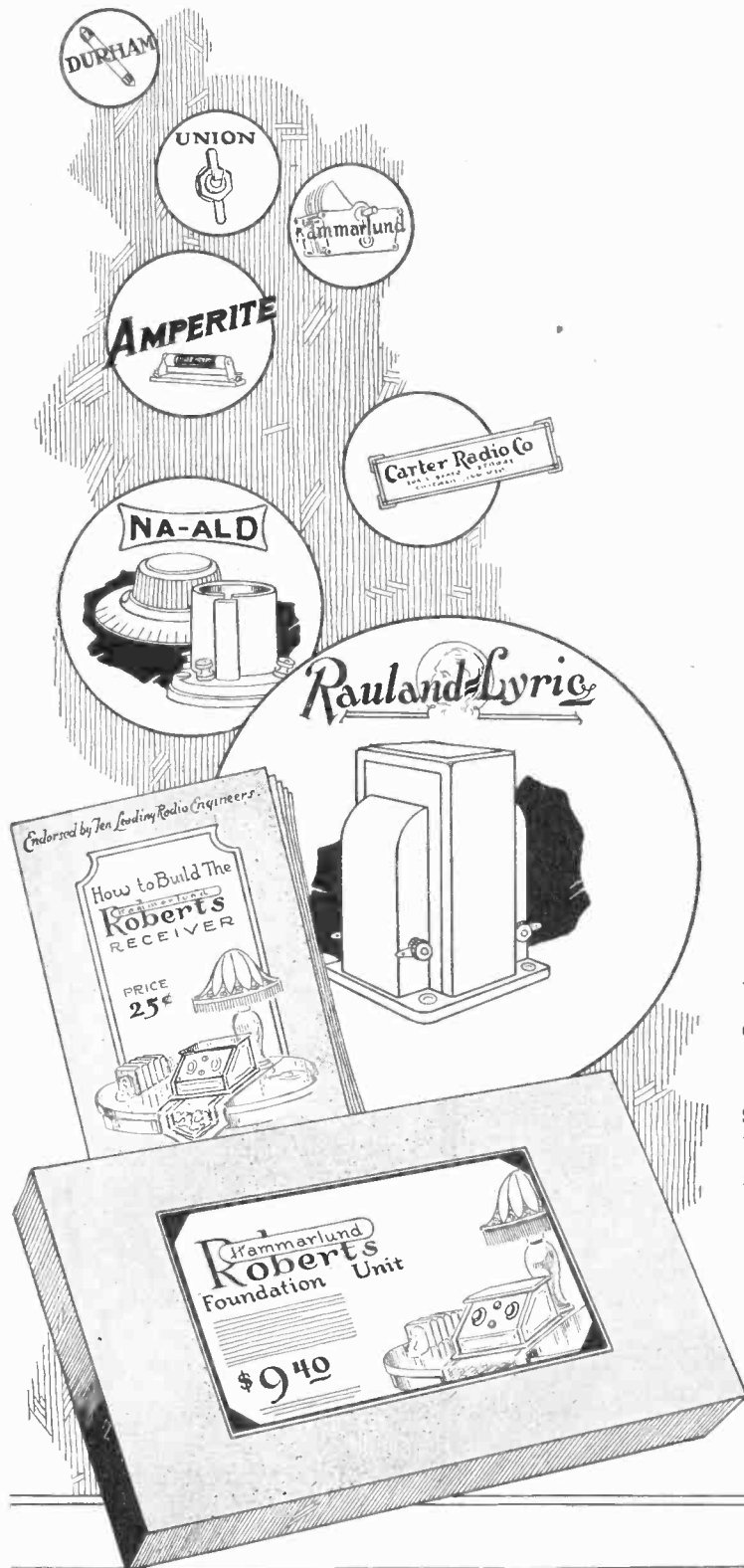

A GREAT co-operative effort of first importance to you. Ten nationally known parts manufacturers combine to promote your parts business. A united sales effort backing an entirely new receiver, the Hammarlund-Roberts. A five-tube radio receiver founded on the popular Roberts circuit, designed and perfected by ten leading radio engineers. A receiver as sensitive as a Super-Heterodyne, selective in crowded areas; easy, non-critical tuning; non-radiating; perfect tone on extreme volume without distortion.

A Unique Sales Plan— No Extra Overhead

Unique from your point of view. You can cash in on this plan without heavy investment in complete kits. The Hammarlund-Roberts Foundation Unit contains bakelite panel, drilled bakelite sub-panel, hardware and wire; listing at \$9.40, it is the only special item you need.

All other parts are standard and found as regular stock on nearly all dealers' shelves. Stock this Foundation Unit and you have the key to a \$60.85 sale of complete parts. You can profit from the force and prestige of this combined effort.

Strictly a plan devised to help you sell standard, specified, nationally known parts. The greatest combined effort, to boost the sale of parts, ever launched and backed by

Write for further details

Hammarlund Roberts

Hammarlund-Roberts,

of Radio Parts Combine New Receiver

the strongest parts manufacturers in the industry.

Twenty Sales in ONE

Every Foundation Unit you sell means twenty sales of standard parts from your regular stock. You get the profit of set sales without the overhead or speculation of stocking costly, bulky receivers that have to be demonstrated, installed and maintained. This plan prevents substitution and assures the sales of all the parts required to build the Hammarlund-Roberts Receiver. You should carry all the specified units as regular stock.

This receiver has been laboratory designed by ten leading engineers. No one man's or one group's conception of five-tube possibilities, but the composite of the leaders' convictions. In designing this new standard of efficiency, the consulting engineers had at their disposal the finest parts the market affords—regardless of cost—they were not handicapped in building to a price.

Here's a receiver so simple in design that anyone can easily build it from instructions in the Hammarlund-Roberts "How to Build It" book. The efficient operation of this receiver is assured only when these specified parts are used. If you do not already stock all these items—get in touch with your jobber.

Write for a supply of this most complete book, giving complete details on assembling, wiring and operating the Hammarlund-Roberts Receiver. Subject to the regular jobber and dealer discounts.

Associate Manufacturers

All-American Radio Corp.	Carter Radio Company
Hammarlund Mfg. Co., Inc.	Dubilier Condensers
Alden Manufacturing Co.	Union Radio Corp.
Radiall Company	International Resistance Co.

Write for further details

Hammarlund
Roberts

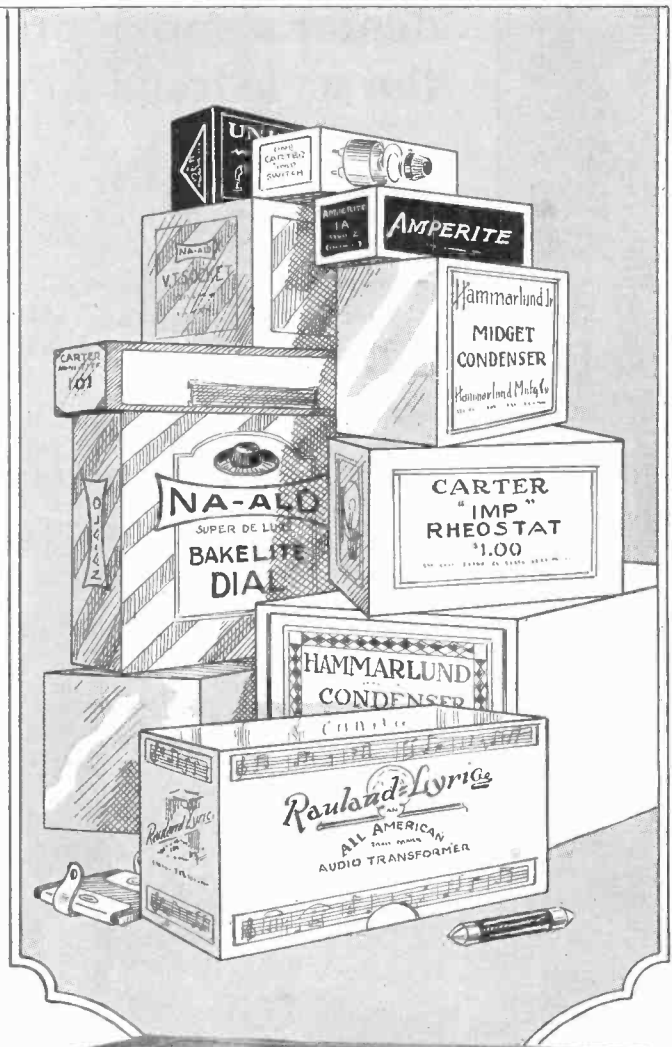

1182-J Broadway, New York City

RADIO-MASTER

A Ward Industry

FROM FOREST

TO DISPLAY ROOM

Radio Master fine cabinets are the dealer's most profitable answer to the style trend in radio merchandising

For those customers of yours who will accept only the best and whose good judgment enables them to pick it when they see it, and for those others who can be readily converted to the best by a little well directed salesmanship, the Sussex, a Radio Master model of surpassing quality, was designed.

In every detail of design, workmanship and finish it merits the approval of the most discriminating judge of cabinet work and furniture design. It may well become the most treasured piece of furniture in the home. It is built to that ideal.

Behind the entire Radio Master line—consoles, highboys, table models, and phonograph cabinets—stand the great Ward Industries with their extensive financial resources and their own forests, mills and workshops.

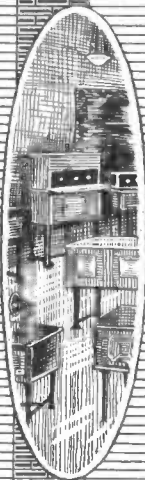
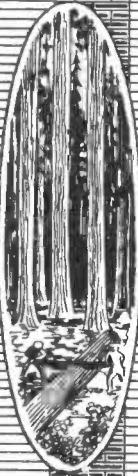

Complete details and terms will be sent to radio manufacturers, jobbers, or dealers upon request.

The List Price of the Sussex is \$80.00

The **Radio Master**
CORPORATION OF AMERICA
BAY CITY, MICHIGAN

MASTERS OF THEIR CRAFT

Simpler, More Selective, More Sensitive, the New

MAGNAVOX

is making Radio History

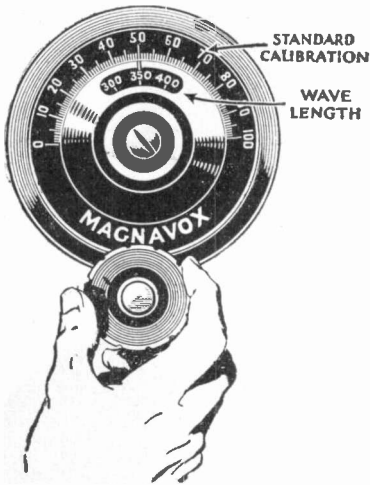

"At the turn of a single dial!"

Magnavox has perfected the single dial control. In the new Magnavox a flick of the fingers makes you master of the air. The new Magnavox is ultra-sensitive. It is factory tuned with the Magnavox tuning meter, 1000 times more sensitive than the human ear. The new Magnavox is ultra-selective—the new Magnavox circuit and Torodial R.F. Transformers tune out the big, powerful stations at will—turn the single dial of Magnavox to the wave length of the station desired and no other station can butt in.

No Magnavox Set can ever become obsolete

because Magnavox Receiver Units are interchangeable except in the case of Magnavox Junior. Should our constant research show that the Magnavox circuit can be improved, it will only mean a change in units to bring most Magnavox sets right up to date.

The new Magnavox is making radio history—the new Magnavox sells on demonstration—and demonstrations are easy with Magnavox.

For your profits sake, write or better still, wire our nearest office today for the name of your territorial distributor.

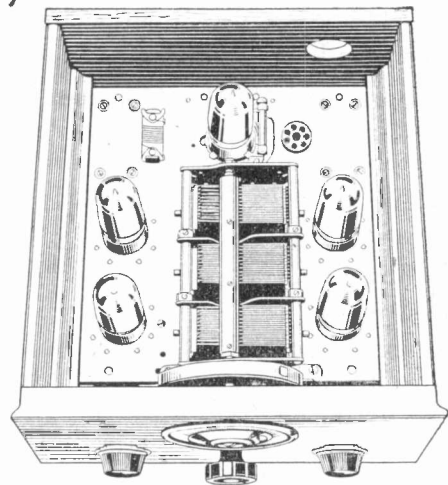

Magnavox Interchangeable Receiver Unit—fits all new Magnavox models except Magnavox Junior.

THE MAGNAVOX COMPANY

1315 So. Michigan Avenue, Chicago, Ill.

Oakland, Calif.

130 West 42nd Street, New York

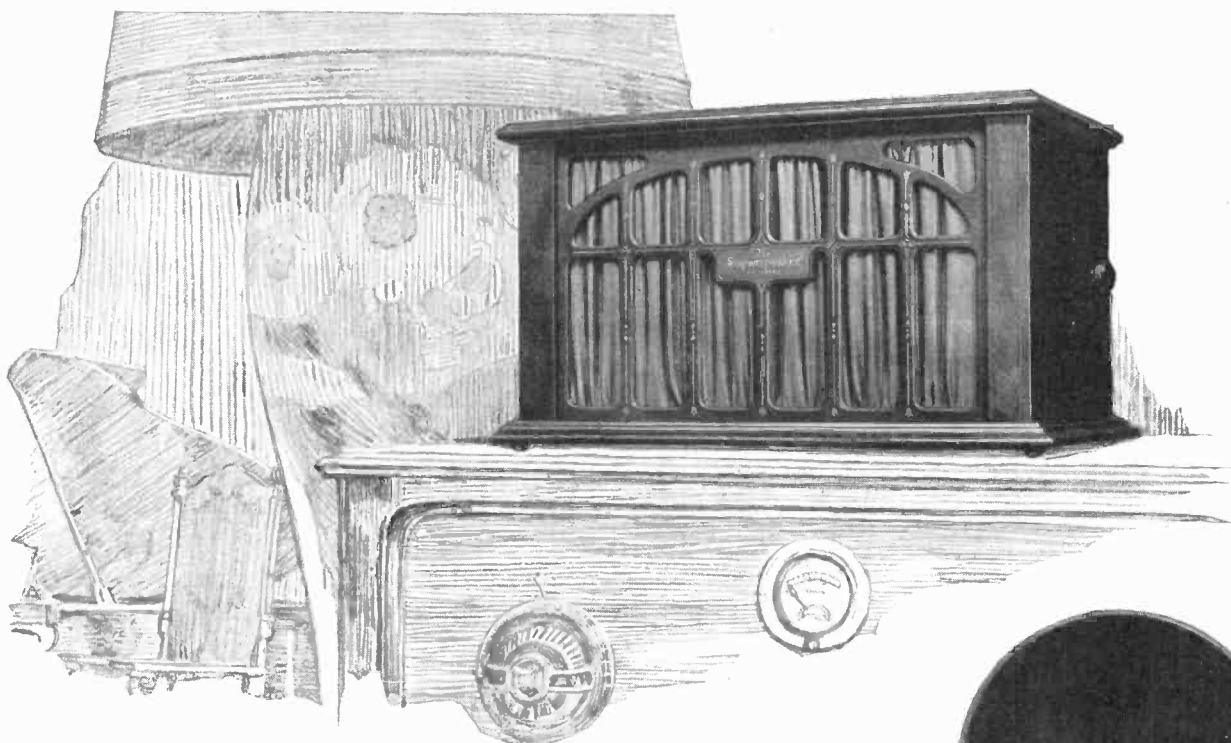

Two Superspeakers Now— Both by JEWETT

With the new Jewett Superspeaker Console, a Radio reproducing instrument enters the realm of fine furniture.

Yet there is no sacrifice of brilliancy, volume or tone.

For the Console is, in every essential, a Superspeaker. Its design is by the same staff of young Radio Wizards. Its concealed horn has the same proved Superspeaker air column. Its reproducing unit is the same exclusive, adjustable Jewett Vemco.

See how harmoniously this Console blends into any setting your customer chooses—how notably it graces the most perfectly appointed living room. And rely on it always to give Radio duplicated by but one other instrument we know—The Superspeaker itself.

Console cabinets are Jewett Built, of walnut or mahogany. Top is inlaid with Arlington Ivory. Grille is pressed leather. Drape is silk in a neutral brown.

A highly perfected product by a builder world famous in the field of Quality Radio reproducers, and a tremendous asset to every holder of a Jewett Dealer Franchise.

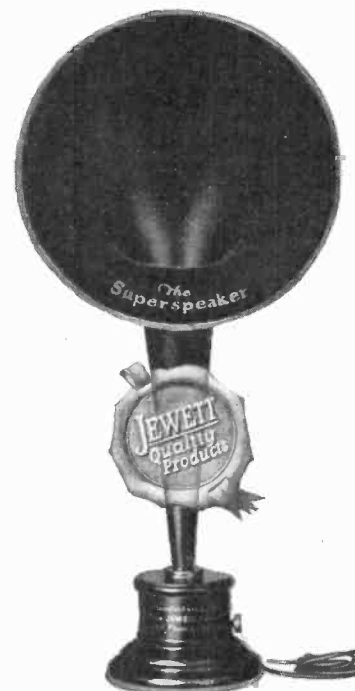

DEALERS:—Place your orders now, for there will surely be another famine in Superspeakers.

JEWETT RADIO & PHONOGRAPH COMPANY

5696 Telegraph Road

Pontiac, Michigan

Quality Broadcasting to Match
Quality Products—Station WJR

JEWETT

"There Is No Substitute For The Best"

© 1925 Jewett Radio & Phonograph Co.

The slow 2-ampere battery charger is as obsolete today as the old "one-lunger" of 1903

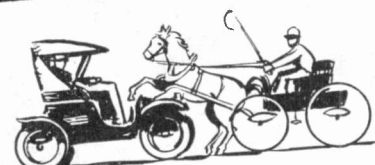

Buy nothing but an up-to-date 5-ampere charger!

The New Improved
5 AMP. A & B
GOLD SEAL
HOMCHARGER
\$19.50



Over 500,000 already in use

Charges 150% Faster!

Better Because:—

New micrometer adjustment, hinged lid, and carrying handle.

No bulbs to buy or break.

Can be used anywhere—contains no acids or other harmful liquids to spill.

Approved by underwriters—trouble-proof, shock-proof and fireproof.

Beautiful cabinet in maroon and gold.

It takes only one-third as long to charge a battery with the New Improved GOLD SEAL HOMCHARGER. The big, healthy 5-ampere charging rate does away with the long bothersome waits that were necessary when the obsolete slow 2-ampere charger was the best that radio offered.

The New Improved GOLD SEAL HOMCHARGER charges 150% faster—will charge your battery overnight! And it charges both A and B batteries without additional equipment.

Don't let anybody sell you a slow 2-ampere charger—they are obsolete—out-of-date. You need a modern charger with a full 5-ampere rate. Insist on the GOLD SEAL HOMCHARGER.

Free Write for new edition of our instructive booklet on radio operation "The Secret of Distance and Volume in Radio."

The Kodel Radio Corporation
 503 East Pearl Street Cincinnati, Ohio

WKRC
 Owners of Kodel Broadcasting Station WKRC on the Alms Hotel. Send for program.

The New Pfanstiehl

"OVERTONE" RECEIVER

"Single Dial Six"

Having six tubes and but one dial

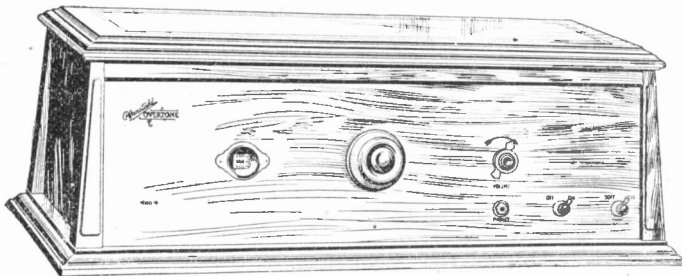

MODEL 10—Overtone Single-dial 6-Tube Receiving Set. Price \$155.00 (less accessories)

AFTER all the complicated radio receivers people have had to contend with, it is a pleasure to operate the new Pfanstiehl. There is nothing like it. You do not have to adjust or fix anything. A child can get as good results as a technician.

The Pfanstiehl Overtone receiver has the simplest radio frequency circuit we have ever seen. It dispenses with the adjusting and neutralizing devices found in other sets. They are not needed. No stray radio energy can "spill over" between circuits. Hence no devices are required to correct it.

You Tune with a Single Dial

It is so simple you can tune in the dark. You do not have to grope around adjusting dials. You turn at once to the wave length desired. The illuminated station finder is a great convenience. It facilitates the logging of stations. It also acts as a signal to show whether the power is on or off.

A Perfect "Overtone" Receiver

The matchless tone of the Pfanstiehl Overtone receiver is of course due to the overtones. They are perfectly reproduced because the pattern of vibrations which make them is kept intact—an exclusive Pfanstiehl accomplishment.

The radio panel is of wood, swept clean of all non-essentials. It is rich looking. The tuning dial is of wood. All exposed metal parts are gold plated. The soft amber glow of the station finder adds a brilliant touch to the panel assembly.

An Exclusive Dealer Franchise

The Pfanstiehl line is sold through exclusive dealers who are thus protected against unfair competition and price cutting. Whatever good-will the dealer builds up for Pfanstiehl is his own. He enjoys a liberal profit and is expected in return to push the line aggressively with the cooperation of the maker.

For further details, address

PFANSTIEHL RADIO COMPANY

11 South La Salle Street, Chicago, Illinois

Prices West of the Rockies Slightly Higher

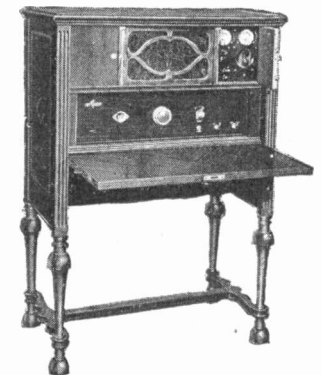

MODEL 10C—A complete 6-Tube Single-dial Console Overtone Receiver with Overtone Speaker, Control Board, Battery Charger and Compartments for Battery built in. Price \$450.00 (less tubes and batteries).



MODEL 10S—Overtone Single-dial 6-Tube Receiving Set with demountable Console Stand. Overtone Speaker built in. Price \$200.00 (less tubes and batteries).



MODEL 8—A low priced 2-Dial 5-Tube Receiving Set, Pfanstiehl quality throughout. Price \$85.00 (less accessories).

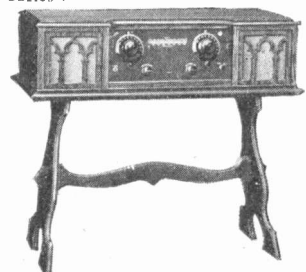

MODEL 8C—Two-dial 5 Tube Receiving Set, demountable from console stand, permitting use on floor or table. Overtone Speaker built in. Price \$135.00 (less tubes and batteries).

“Quality and Appearance”

The two big factors in future Radio Sales

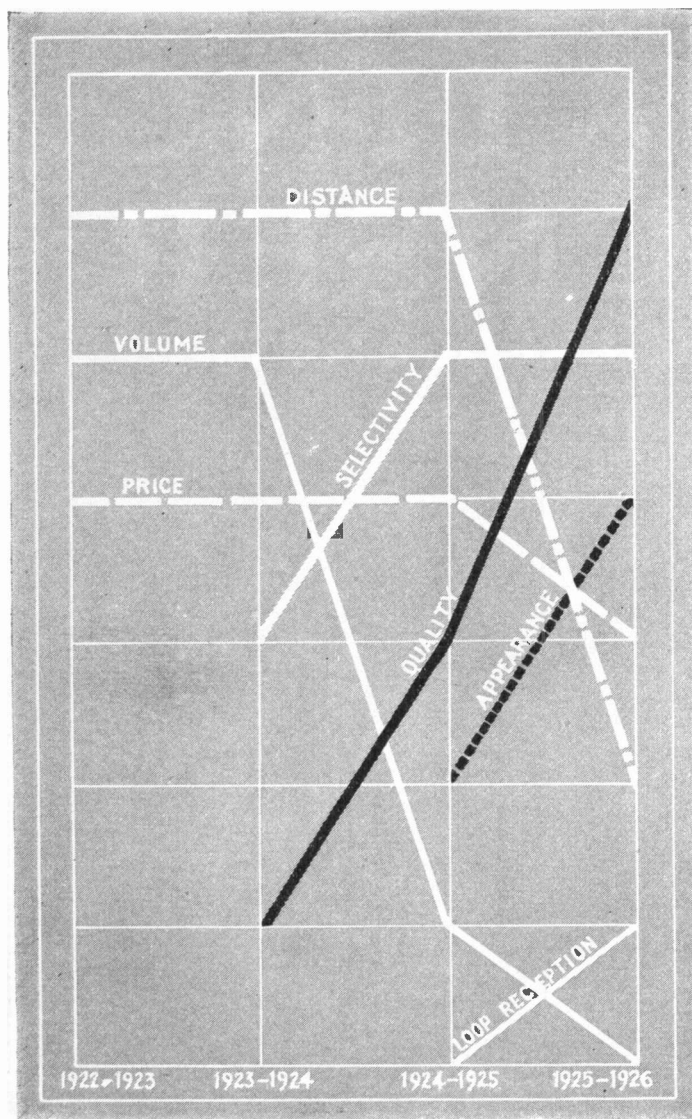

Courtesy of Radio Retailing

Investigation shows that “quality and appearance” are taking the lead as factors in the purchase of Radio Sets.

In consequence, it is more important than ever before that dealers make sure that the radio sets they sell are Bakelite insulated.

The use of Bakelite is a definite aid to quality performance, and its permanently handsome color and finish add to the appearance of any set.

Bakelite insulated sets and accessories mean customer satisfaction.

Radio applications of Bakelite

- | | |
|--------------------|-------------------|
| Adaptor | Loud Speaker Horn |
| Amplifier | Mounting Panel |
| Condenser | Panel Switch |
| Dial | Plug |
| Front Panel | Potentiometer |
| Grid Leak | Rheostat Base |
| Headset | Transformer |
| Knob | Tube for Coil |
| Lightning Arrester | Windings |
| Loop | Tube Socket |
| | Tube Base |

Write for Booklet 39

BAKELITE CORPORATION

247 Park Avenue, New York, N. Y.
Chicago Office: 636 West 22nd Street

Bakelite is an exclusive trade mark and can be used only on products made from materials manufactured by the Bakelite Corporation. It is the only material which may bear this famous mark of excellence.

BAKELITE

REG. U.S. PAT. OFF.

3616-B



BAKELITE
is the registered trade mark for the phenol resin product manufactured under patents owned by the Bakelite Corporation.

THE MATERIAL OF A THOUSAND USES

The AMSCO

ALLOCATING CONDENSER

(STRAIGHT LINE FREQUENCY)

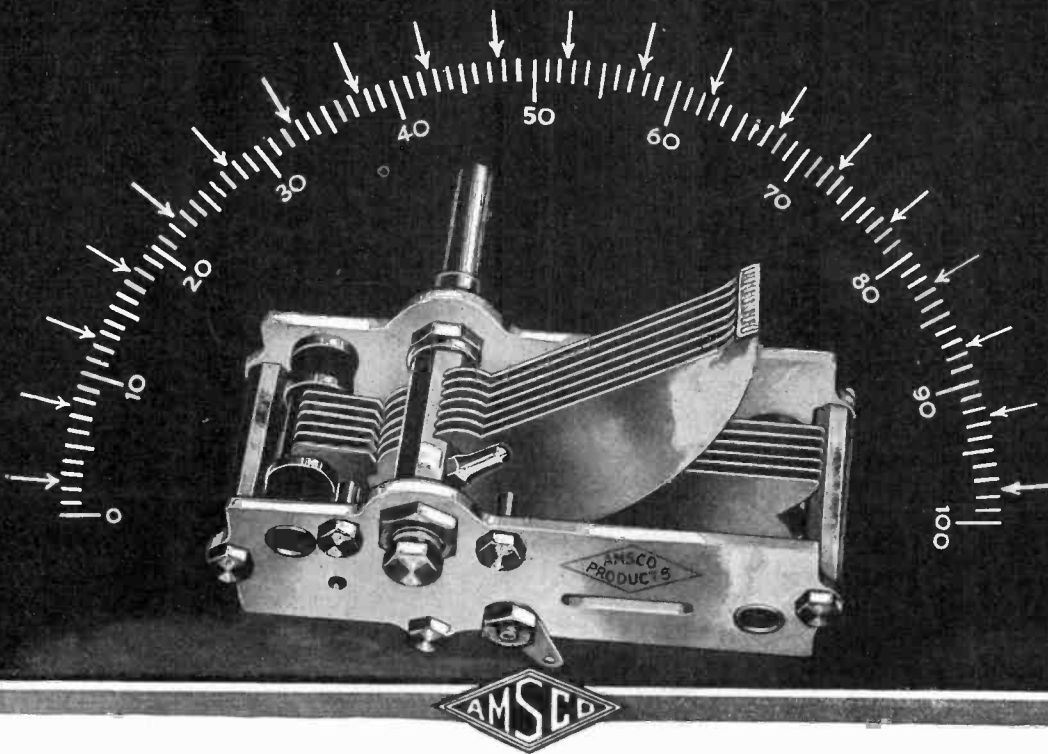

Spreads the Stations Over the Dial

The new AMSCO Allocating Condenser is the triumphant combination of electrical engineering and mechanical ingenuity. *Electrically efficient in unscrambling the stations on your dials. Each dial degree from 1 to 100 will be found to represent 10 broadcasting kilocycles accurately over the entire scale—"a station for every degree."* *Mechanically ingenious in correcting the fault of other S.L.F. Condensers—it conserves space! Scientific low-loss construction. Rigidity with light weight.*

Made in three capacities—Single or Siamese. Ask your dealer, or write for details of the entire AMSCO Line of engineered radio parts.

AMSCO PRODUCTS, INC. Dept. N.
Broome and Lafayette Streets, New York City

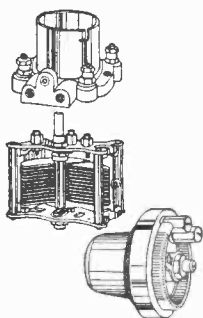

New!—a handsome instrument at a low price, the AMSCO Vernier Dial gives finesse to your fingers. Steps down 13 to 1, backwards or forwards, without momentum or back-lash.



No One Has Ever Lost Money On MUSIC MASTER

**This Broadcasts the Biggest Fact
in the whole Field of Radio!**

IF OUR merchandise wasn't better than other "bests"; if our models became unsalable through changes or price cuts; if our prices were not attractive; if our merchandising policy wasn't sound—somebody—somewhere—would have lost money on MUSIC MASTER.

But no one has ever lost money on MUSIC MASTER! No more absolute proof can be offered to convince you that our quality satisfies; that our merchandise is *always* an asset; that our prices are attractive; and that our merchandising policy is sound.

Ninety-three million Americans are reading the MUSIC MASTER Story, and volume sales prove that MUSIC MASTER'S great campaign of National Advertising is effective.

Our story is the greatest true story ever told in radio. Make it *your* story. Get the MUSIC MASTER Sales Franchise for your store—if you are in open territory.

These franchises are granted only to dealers of standing who have the energy to get the most out of their territories.

Write or wire us, or get in touch with our nearest authorized distributor.

Music Master Corporation

Makers and Distributors of High-Grade Radio Apparatus
128-130 N. Tenth Street

CHICAGO NEW YORK PHILADELPHIA PITTSBURGH MONTREAL
Canadian Factory: Kitchener, Ontario

**The Most Complete
Radio Line Under
a Single Trade Mark**

Ten Styles of Receiving Sets
—Only Successful Circuits—
\$50—\$460

Nine Models of Reproducers—
Horn, Cabinet, Pedestal; Lamp
and Hangers—\$18—\$100

All Types and Shapes of Bat-
teries—Multi-Cell Dry "A"—
"B" and "C" as well as Storage
"A" Batteries—\$.60—\$23.50

—and a Complete Line of Ac-
cessories—each and every item in
the line the very best
obtainable



TYPE 300
Exquisitely designed mahogany console cabinet. Five tubes. Sliding controls on illuminated panel. Large battery compartments. "B" battery eliminator when used makes outside antenna and ground unnecessary. With-out equipment—\$300. Model XII. Reproducer \$35 additional.



TYPE 100
Five tubes. Resonant reproduction, exceptional range. Massive mahogany console cabinet. "B" battery compartments in cabinet. With-out equipment—\$100.

Another
WESTON
Contribution

-the NEW Two Inch

**RADIO
 PANEL
 VOLTMETERS**

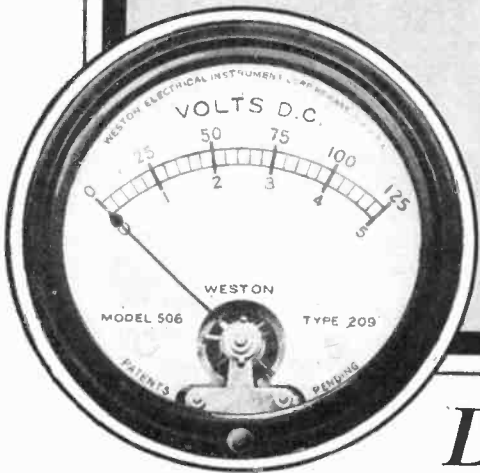
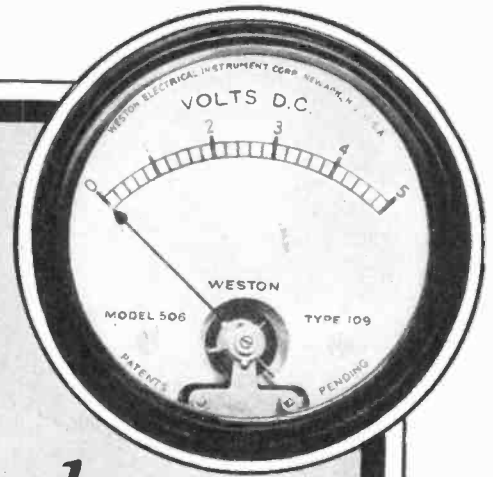

Distribution is Fast!

ORDER AT ONCE TO MEET YOUR SURE DEMAND!

MODEL 506 Voltmeters are instruments of distinction. They have been especially developed for service in connection with radio receiving sets. This means that every part has been designed and constructed in such manner that the completed instruments shall, in fact, be high grade, dependable products notwithstanding that the dimension of the containing case has been reduced to a two-inch diameter. It also means that electrical adjustments and selection of ranges have been made to properly conform to the essential requirements whether they be merely to measure filament voltage of a single tube, or to measure voltages at various points of the receiving circuit, or the voltages of A and B batteries.

We, therefore, wish to emphasize that Model 506 is not merely an instrument of small size. On the contrary, notwithstanding its small size, it is an excellent voltmeter of standard Weston quality and workmanship and purchasers may feel assured that it will render an unequalled character of permanently satisfactory service.

The outstanding advantages of the Model 506 on a radio receiving set are:

1. Its compact size and handsome appearance.
2. Its permanent accuracy of a satisfactory character.
3. Its well illuminated, legible scale.
4. Its high internal resistance (125 ohms per volt).
5. Its dependability in denoting circuit conditions assuring economical operation of tubes and efficient performance of the set.

For further information write for Model 506 Circular.

WESTON ELECTRICAL INSTRUMENT CORPORATION
 25 Weston Avenue, Newark, N. J.

STANDARD THE WORLD OVER

WESTON

Pioneers since 1888

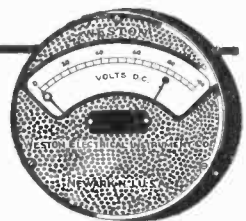
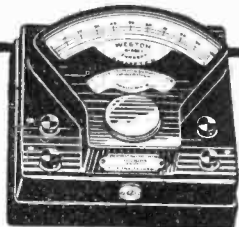

SHERMAN RADIO ACCESSORIES

Profit the Dealer and help the user

SHERMAN BATTERY CLIPS

One Piece—Spring steel—Lead Coated

JUST WHAT'S BEEN WANTED

A Battery Clip

One piece of tempered spring steel all sealed over with hot lead. No loose parts to wear out or corrode.

All Spring—Grips like a Tiger.



U. S. Pat. No. 1,543,524

DEALERS PRICES

No. 50 Carton of 10, ea.—.16, jaws open 1½-in. for big battery posts.

No. 25 Carton of 10, ea.—.105, jaws open 1-in. for Radio A Battery.

No. 10 Carton of 10, ea.—.06. Radio B Storage Battery.

Cheaper, Because They Work Better—Handle Easier—Last Longer

RIGID BATTERY CONNECTORS

Provide a strong, neat and simple mechanical means of securing a perfect contact and eliminate the danger and nuisance of a confusing tangle of loose wires resulting from the use of flexible wire connectors.

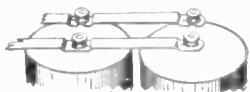

Parallel Connections
(+ sizes—2 to 5 cells)

They snap on in a jiffy without removing nuts



Series Connection

Space cells slightly apart and hold them rigid

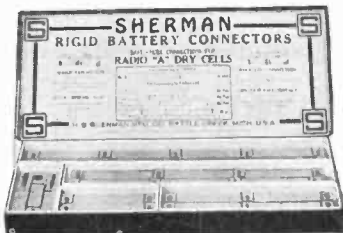

SELF-SELLING ASSORTMENT

A handsome display box containing properly balanced quantities of all sizes. Enables dealers to secure initial stock at small outlay. Contains 102 pieces listing at \$9.00. **\$5.00** Dealer's Price

For replacement the five numbers are packed separately in cartons of fifty. Prices on request.

LIGHT GROUND CLAMPS

Can be easily and quickly applied with perfect efficiency and without soldering.

ALL COPPER

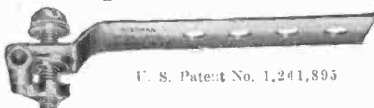

U. S. Patent No. 1,241,895

ONE PIECE

Design and construction same as the popular SHERMAN Ground Clamp—the only difference is in the thickness of copper which is lighter.

DEALER PRICES

- No. 1. ¾ to 1 in. Pipe. \$2.80 per 100 carton
- No. 2. ¾ to 2 in. Pipe. \$3.80 per 100 carton
- No. 3. ¾ to 3 in. Pipe. \$4.75 per 100 carton

*Right size for Radio fits Radiator Piping

TWO TROUBLE SAVERS

Make strong, quickly detachable connections of cords, extensions and lead wire by simple means without resorting to complicated, "fussy" radio contrivances which are both expensive and hard to manipulate.

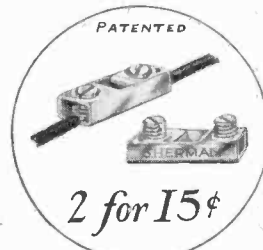

2 for 15¢

Patented Approved
Display Carton of 50—
Dealer price, \$2.05

SHERMAN FIXTURE CONNECTOR

Solderless, all brass with non-removable screws. A long popular fitting, finding added uses in Radio.

For connecting—

Aerial lead-in wires, ground wire extensions, battery extension wire, multiple headsets, two loudspeakers, etc.

EXTENSION CONNECTOR

A pair of fixture connectors within a handsome insulating case. For—

Loud Speaker extension.

Replaces portable jack and plug at less than a third of their cost.

Takes any kind of wire; expensive cord with metal tips not essential.

Multiple headsets — the simplest, quickest, cheapest method. All double cord extensions.

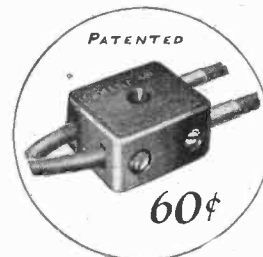

60¢

Carton of 12
List, 60 cents each
Dealer discount, 35%

HANDSOME DISPLAY CARTONS
Insure Attention and Make Easy Sales

ASSORTMENT NUMBER THREE

Small Terminals for building radio sets. Labor saving wire fittings for installing.

Contains over 2000 pieces. Well assorted quantities of Sherman Terminals (9 styles) cord tips—flexible Battery Connectors—and Sherman Fixture Connectors.

SELLS QUICKLY AT OVER 300% PROFIT

Dealer Price \$6.00. Sells at \$26.50



Sold By Jobbers

H. B. SHERMAN MANUFACTURING CO.
BATTLE CREEK, MICHIGAN, U. S. A.

"Quality Is Season's Watchword"

"Fidelity of Tone Production Will Be Greatest Public Demand this Fall"—*Radio Retailing*, issue of August, 1925.

Radio Retailing asked one hundred dealers in ten states what was the most important thing in Radio today.

They all said "Tonal quality is the first requisite."

For years Daven has pioneered quality. It is gratifying to see our vision come true and our judgment substantiated.

Daven engineers have long recognized that the present day receiving set needed to be greatly improved from a quality standpoint. They worked

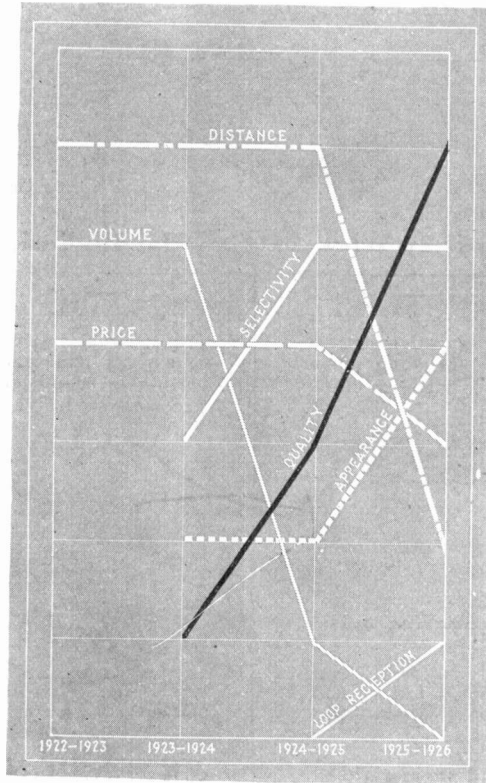

A graph from August issue of *Radio Retailing*, showing the most important selling point of Radio from 1922 to date.

and perfected Resistance Coupled Amplification, the only existing method known whereby you can procure amplification without distortion and no distortion means simply quality.

The Daven Resistance Coupled Amplifier shown below can be conveniently added to any existing set owned by the public. Manufacturers and amateur set builders should also investigate Daven Resistance Coupled Amplification. Your set will not be 1926 Model unless it is Daven Resistance Coupled.

DAVEN RESISTANCE COUPLED AMPLIFICATION

To the public—Daven Resistance Coupled Super Amplifier in a genuine Bakelite base complete with all resistors, grid leaks and condensers inserted—\$15. In kit form, for those who like to build their own, including special Type A Daven Condensers, \$9.00.

To radio dealers—Send for our complete catalog and the name of our nearest established distributor.

To set manufacturers—The facilities of our Engineering Department are yours to command. Call upon

us at any time. We can offer you constructive advice on how to improve the audio end of your set.

THE RESISTOR MANUAL is the handbook of Resistance Coupled Amplification. At your dealer's 25c. By mail postpaid 30c. Dealers, write for a free copy.

"The Sine of Merit"

DAVEN RADIO CORPORATION

Resistor Specialists

Newark

Reg. U. S. Pat. Off.

New Jersey

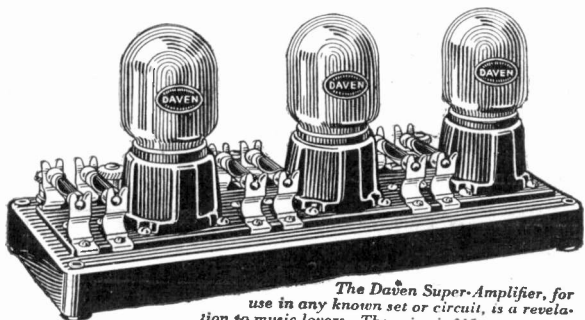

The Daven Super Amplifier, for use in any known set or circuit, is a revelation to music lovers. The price is \$15.

DAVEN PRODUCTS ARE SOLD ONLY BY GOOD DEALERS

CLIP THIS COUPON

C-10-25

DAVEN RADIO CORPORATION
158-160 Summit Street, Newark, New Jersey

Please send me the following on Resistance Coupled Amplification:—

- Check One Resistor Manual. 30c. is enclosed.
- Complete Catalogue (free).
- Dealer Proposition

Name.....

Address.....

For Dealers: Send your letterhead or card, or this coupon and we will have our nearest distributor communicate with you.

THE BIG LITTLE THINGS OF RADIO

Quality
Products
Popularly
Priced

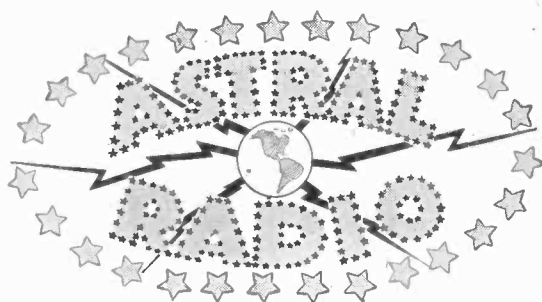

Backed
By a Fair
Dealer
Policy



Type A \$67.50
Solid Mahogany Cabinet

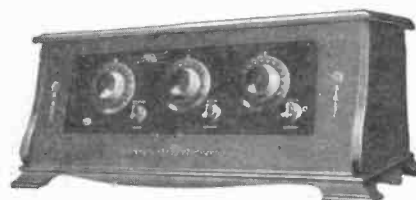

Type B—\$90
Solid Mahogany Cabinet

A Complete Line of Ready Sellers

Five Tube Tuned Radio Frequency Receivers of Quality That Stand the Most Exacting Comparison for Distance, Selectivity, Volume, Clarity

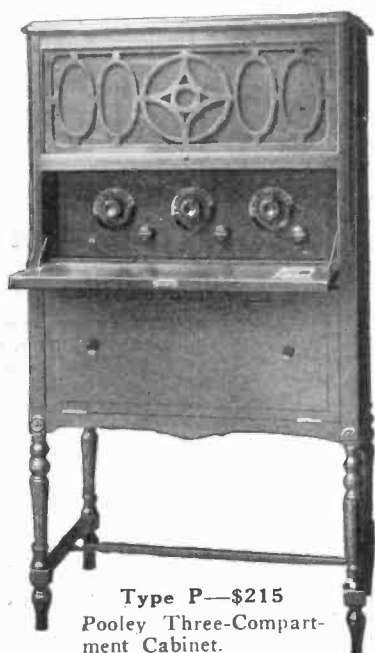

Type P—\$215
Pooley Three-Compartment Cabinet.
50-in. x 26-in. x 16-in.
Pooley Built-in Radio Speaker.



ASTRAL TONE THROAT

A speaker for any make of receiver, \$25.

Rich Mahogany finish. All-wood Construction.

The great interest displayed in the entire Astral line at the New York Radio Show proved Astral products will be big sellers this season.



Type C—\$175
Three - Compartment Mahogany Cabinet.
48-in. x 29½-in. x 15-in.
Built-in Radio Speaker.

AT THE RADIO SHOWS:
Chicago—Sept. 28-Oct. 3
Space 28 American Exposition Palace
Philadelphia Radio Exposition, Oct. 3-10
Space 66—The Arena
Boston Radio Exposition, Oct. 12-17
Space 132—Dept. B.

Some valuable territory still open to distributors and dealers for the Astral franchise.

Astral Radio Corporation

1237 North Broad Street
Philadelphia, Penna., U. S. A.

The Newest Thing in Radio

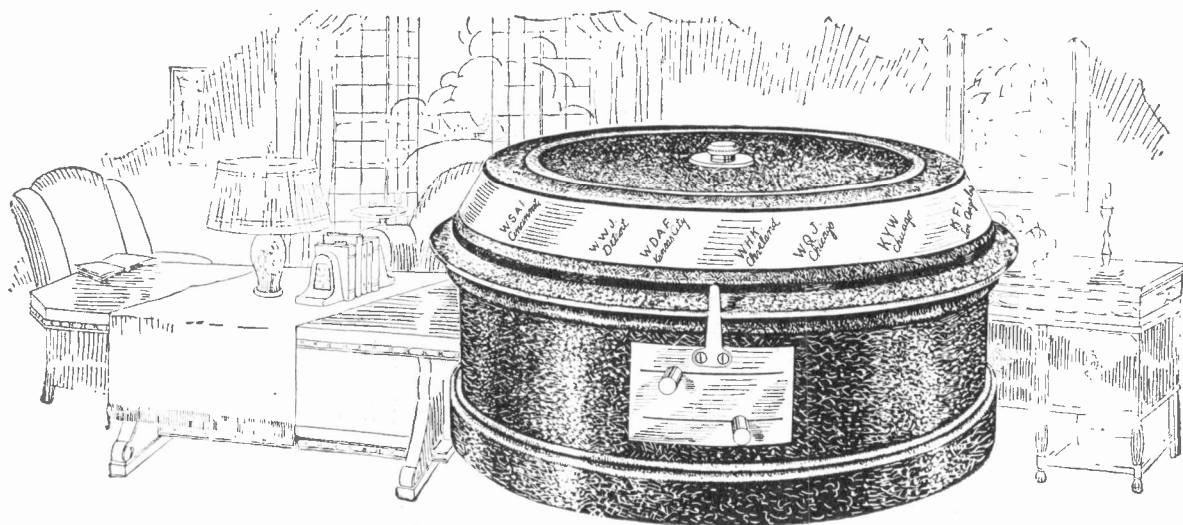

NO DIAL 5-TUBE RECEIVER

Whenever a plant, embracing over 20,000 square feet of floor space, becomes taxed to full capacity within thirty days after announcing a brand new product—

It Must Be Behind a Winner!

REASONS WHY NO-DIAL IS THE BEST SELLER

FROM THE CONSUMERS' POINT OF VIEW

The price is right—
ONLY \$98.00 (Less accessories).
10% additional west of Rocky Mountains.

EASY TO OPERATE

Any one can operate a NO-DIAL successfully. Just rotating the cover brings in station after station—far and near, loud and clear.

VISIBLE STATION RECORD

The station register upon the cover permits the owner to make a permanent station record without need of a log-book. Stations once found can always be brought in instantly again at the same recording point.

LOUD AND CLEAR AS A BELL

The tonal qualities of the NO-DIAL will please everyone. They are so sweet and so clear, so mellow. Tube for tube the NO-DIAL recognizes no superior and on test has outperformed many higher priced receivers.

REVOLUTIONIZING RADIO

In form, beauty, performance, simplicity and results, NO-DIAL is positively revolutionary and unique in radio manufacture. The compact circular case of spun aluminum absolutely shields it from body capacity. Finished in popular brown crystalline, it is a perfect match for most high grade loud speakers.

FROM THE DEALERS' AND JOBBERS' POINT OF VIEW

NO-DIAL is something really new—just what you have been looking for.

SIMPLICITY

The simplicity of the NO-DIAL 5-tube radio frequency resistance coupled receiver, together with its outstanding performance, make it a set people want—a set they will *ask for*. Word of mouth advertising will do the rest.

IT'S PROFITABLE

Because of a limited number of distributor and dealer franchises—prices will be upheld and each merchant will receive his full and legitimate *profit*. Our discounts are generous—our prices are popular.

LOW SERVICE COST

Our *Guarantee* is such that you are protected against losing a big part of your profit thru service. Don't overlook this point—you, alone, realize its supreme importance.

DOMINANT ADVERTISING PROGRAM

All the important radio papers, newspapers and many national and farm magazines are being used to carry millions of NO-DIAL messages to your prospects. The NO-DIAL simplicity appeal attracts attention—inspires prospects to action.

Mail Today!

THE OHIO STAMPING & ENGINEERING CO., Dayton, Ohio
Dept. C-10.

Gentlemen:

Send me all the details regarding a NO-DIAL FRANCHISE.

Name

Address

City

State

Centralize That "Action"
in *Your Store*

BUT HURRY! DON'T WAIT!

See your jobber or mail the coupon today.

THE OHIO STAMPING & ENGINEERING
COMPANY

Dayton, Ohio, U. S. A.



\$25

West of Rockies, \$26.50
In Canada, \$35

The SAAL Soft SPEAKER

brings the best out of any radio set

SAAL Jr.

The same in every respect as the Saal Soft Speaker except it measures 18½ instead of 21½ inches in height.

\$20 West of Rockies, \$21
In Canada, \$27.50

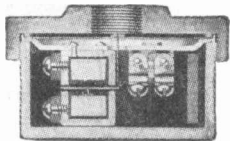

In the Saal Soft Speaker Unit the action of four pole pieces of a powerful magnet are connected on a carefully poised armature. This armature is connected to the diaphragm by a pin. This pin moves the diaphragm with a push and pull motion. There are no springs. The action is extremely precise, producing all consonants and overtones, yet the unit can't get out of order. This unit is used as standard by many leading manufacturers of fine radio receivers in built-in models.

HERE is a radio reproducer you can sell to your most particular customer with the knowledge that it will render permanent service and stand up under the most constant usage.

The Saal does not force your customer to choose between volume and tone quality. It combines volume with a velvet tone. It is not a fad. It is not a trumpet. It is a faithful reproducer of radio programs. It is properly constructed and shaped for the accurate reproduction of sound. It removes the objection to loud speakers. It has no blare, no blast, no metallic ring.

The Saal Soft Speaker is made to last a lifetime. The neck is of aluminum. The bell is of genuine Bakelite. There is no

wood, no tin, no composition. It has nothing to warp, crack or deteriorate. The reproducing unit is of all-metal construction and cannot be harmed or "blasted" by the loudest receiver. It maintains its tone with any volume. There is no adjustment knob to complicate tuning. It is guaranteed to give satisfaction to the user.

In appearance the Saal with its black bell, black crackle throat and graceful lines is the aristocrat of horns. Also furnished with a brown bell and gold or silver stippled throat at \$5 extra. It is manufactured by a company with years of experience in the music business. A large plant insures prompt delivery. It is thoroughly advertised. Order through your jobber. Jobbers write to us.

SAAL *Soft* SPEAKER

VOLUME WITH TONE QUALITY

Manufactured and guaranteed by H. G. SAAL COMPANY, 1800 Montrose Ave., Chicago, Ill.

Have You the Energy for Volume Business?

Practice has proved that nearly every demonstration in the home sells a Thermiodyne.

Home demonstration! That's the key to *volume* business.

But when you send men or women out to canvass the homes and arrange for demonstrations, back them up with

The Famous Master Control

Thermiodyne

Reg. U. S. Pat. Off. [Ther-mī-odyne]



**THERMIODYNE—Model TF6
Console De Luxe**

Model TF6, enclosed in Console Cabinet of genuine walnut, with built-in Loud-Speaker, and with space for Batteries and Charger. All equipment concealed. No wires required for local stations.

Price (without accessories) . \$275
Rocky Mountain and Coast
States \$290

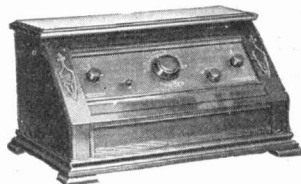

**THERMIODYNE—Model TF5
Five Tubes**

Master Control Radio built on same successful principles as TF6. Phenomenal selectivity, distance-getting ability and tone quality. Two Stages of Thermionic Frequency, Detector, and two stages of Audio Frequency. Master Control. Outdoor Antenna. Finished in duo-tone walnut.

Price (without accessories) . \$100
Rocky Mountain and Coast
States \$110

The moment women see Thermiodyne's wonderful Master Control and understand that all they need do is turn it just half-way around to bring in instantly, in rapid succession, each and every station on the air—they are *interested*.

The moment *any* prospective purchaser of radio hears Thermiodyne in his or her own home, Thermiodyne is *wanted*.

Our advertising in the great national magazines; our advertising in your local newspapers, in which we co-operate; our merchandising policy; our trade-in and time-payment plans—back you to the limit.

And now with so many stations on the air, Thermiodyne's super-selectivity brings Thermiodyne into its own and

This is Thermiodyne Year

People no longer tolerate squeals, howls, distortions. They want natural, resonant, mellow tones. They get them with Thermiodyne and they get them *instantly*.

Thermiodyne has everything to insure success to the energetic merchant. Beautiful models rightly priced; trade-in plans; time-payment plans that do not eat into your capital at all; vigorous, convincing advertising; and best of all—performance that challenges any set at any price—anywhere, at any time.

**If you want to do a *real* radio business,
tie up to Thermiodyne!**



**THERMIODYNE—Model TF6
on Speaker Table**

Handsome, well constructed Table, with built-in Loud Speaker, speaker unit and horn concealed by open grille. Ample room for Batteries and Charger. Genuine Walnut finished to match Model TF6.

Price of Speaker Table \$60

Rocky Mountain and Coast
States \$65

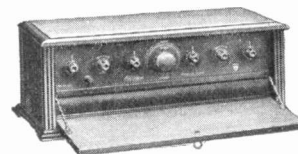

**THERMIODYNE—Model TF6
Six Tubes**

Powerful, smooth-working instrument, with Three Stages of Thermionic Frequency before detector, detector, and Two Stages of Audio Frequency. Master Control. Indoor or Outdoor Antenna. Genuine Walnut cabinet with interior compartment for "B" Battery.

Price (without accessories) . \$150

Rocky Mountain and Coast
States \$160

THERMIODYNE RADIO CORPORATION

1819 Broadway, New York

Canadian Sales Office: Dominion Thermiodyne Radio, Ltd., 425 Phillips Place, Montreal, Quebec

Tell'em *this* about the **Super-Ducon**

1. It takes the place of "B" batteries.
2. It has a specially designed RCA tube—Rectron UV 196—that accomplishes full wave rectification and has an average life of over 1000 hours.
3. It is absolutely noiseless when properly installed.
4. It is compact, economical, efficient.

The market for Super-Ducons is there—the perfected Super-Ducon is here. Ask your jobber to ship you one—and see how fast it sells.

Type 800 operates on a house current of 110 to 125 volts, 60 cycles A.C.
List price \$47.50.

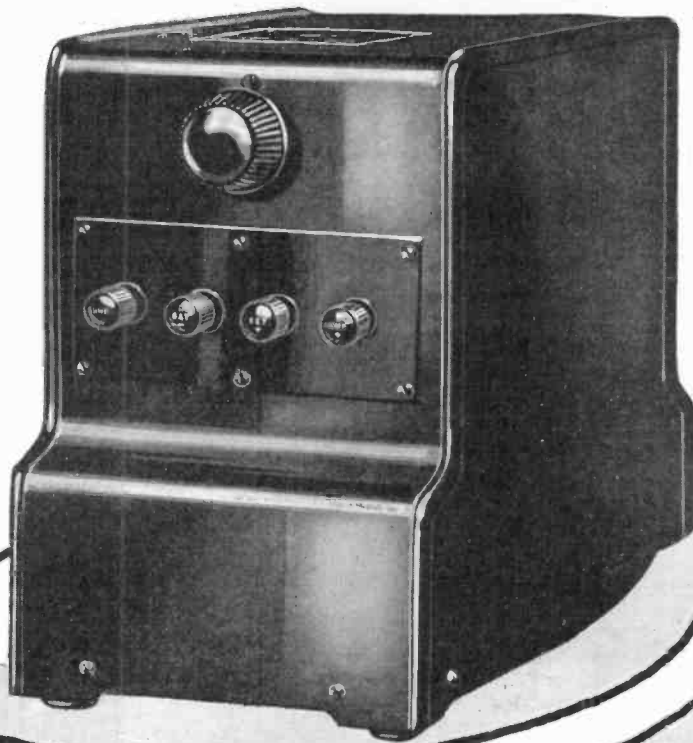

Dubilier

CONDENSER AND RADIO CORPORATION

OPERADIO

The Original Self-Contained Radio

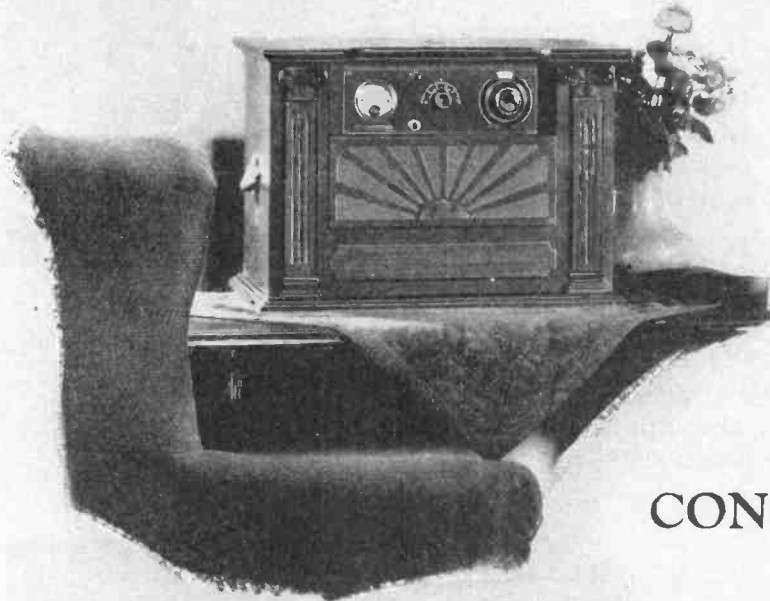

The
CONSOLETTA

A Beautiful New Cabinet Operadio Widely Demanded—Enthusiastically Welcomed

The tremendous popularity of the Operadio—which has increased radio enjoyment by making it available anywhere—has led to this beautiful six tube cabinet set for home and apartment use.

The set in its compact mahogany case may be easily carried to any room of the house. Like all Operadios, it is entirely self-contained; no outside wires or connections being used.

The special loop supplied with the set is used either concealed within the cabinet, or exposed,

plugged into the top when extremely directional effects are desired.

The dealer who sells the Operadio line this year can meet any demand for high-grade receiving set, yet carry a comparatively limited stock. Public goodwill for this well-known name, together with many revolutionary developments for 1926, mean a prosperous year for dealers obtaining the Operadio franchise.

Write or wire for full information and terms.

THE OPERADIO CORPORATION : 8 So. Dearborn St., Chicago, Ill.

Built by the Manufacturers of the Famous Operadio Portable



The Operadio Portable may be used anywhere indoors or out, upstairs or down.

It is a complete, self-contained set, and may be closed and carried anywhere.

For those who desire a furniture model, the Tudor Cabinet is available to house the set.

A Message to Dealers Who Think

(With apologies to Clarence Darrow)

Look at this radio. It has three dials . . . Where is the three-handed operator?

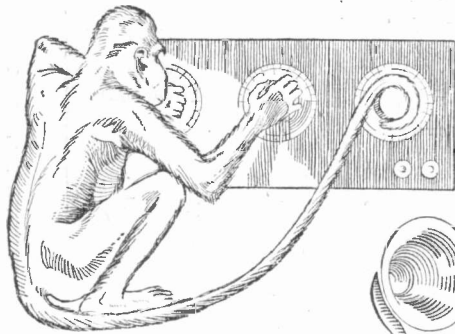

Now look again. The secret is out. Here is the operator of the three-dial radio. He has two hands and a useful tail. He is the operator.

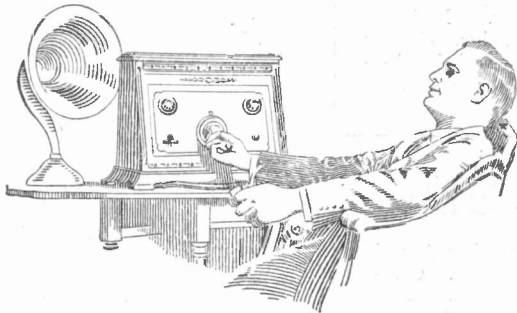

Most people, however, do not have three-handed operators in their homes. So they prefer a radio they can operate themselves. Here it is—the Mohawk. It has five tubes—but only *one* dial to tune.

What, you ask, will this one-dial radio do? Is it selective? Does it give distance? Volume? Free range of the air? Beauty of tone? Undistorted, life-like reproduction?

Our answer is this. The Mohawk gives *three-dial* results with the use of only *one* dial. It has a patented, three-in-line *balanced* condenser. That is the reason. Compare results. Judge for yourself.

Other things being equal, everyone prefers a one-dial radio—a radio made

for *women* as well as men. That explains the tremendous popularity of the Mohawk, the pioneer one-dial radio. That also explains the many announcements of one-dial sets now in the papers. Mohawk success has awakened the entire industry!

But only Mohawk has the patented *balanced* condenser. Only Mohawk can give three-dial results with just one dial. Sell the Mohawk and you will increase your radio sales this season. Write today for literature and list of Mohawk Jobbers.

Manufacturers
MOHAWK CORPORATION OF ILLINOIS
Independently organized in 1924
Chicago, Ill.

Sales Department
THE ZINKE COMPANY
1323 So. Michigan Ave.
Chicago, Ill.

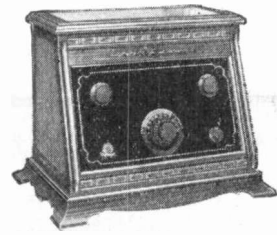

Mohawk Model 100, five tubes just one dial to tune. Retail price, without accessories, \$100.

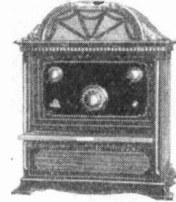

Mohawk Consolelette, Model 110, retail price without accessories, \$175.

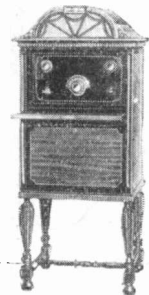

Mohawk Console, Model 115, retail price without accessories, \$225.



Mohawk No. KU51 Kit contains all parts, including cabinet, for assembling a Mohawk Radio. Retail price, \$75.

The Mohawk was selected from among 47 radios as standard equipment on the Pan American, crack train on the L & N Railroad. A test will tell you why.

Mohawk Radio

Manufactured by Mohawk Corporation of Illinois
Independently Organized in 1924

5 tubes — just ONE dial to tune





ACME WIRE RADIO PRODUCTS

Celatsite Wire



(Single Strand)

Tinned copper bus bar wire with a non-flammable "spaghetti" insulation, for wiring radio sets. It can be stripped of its insulation easily for making connections and can be bent and re-bent without cracking. Moisture proof. High insulation value. Colors: red, yellow, green, brown and black—one for each circuit. Supplied in 30 inch lengths. Write for Folder "E".

Celatsite Wire (Flexible Stranded)

Latest development of Celatsite. Flexible, stranded, tinned copper wire in a non-flammable, moisture-proof "spaghetti" insulation. For sub-panel and other "point to point" wiring of radio sets. Red, yellow, green, brown and black—a color for each circuit.

Write for Folder "E"

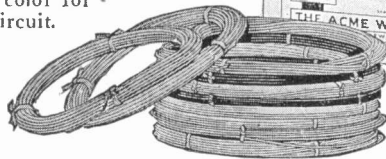
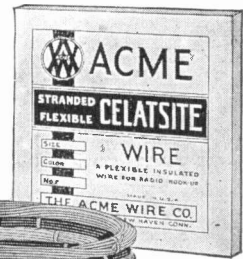

Celatsite Battery Cable

A neat, multiple cable, 5 feet long, for connecting A and B Batteries, or other current supply, to your set. Composed of five Flexible Celatsite Wires, red, yellow, green, brown and black—enclosed in a brown silk braid, a color for each terminal. No chance of short circuiting wires and "blowing" tubes. Adds greatly to the appearance of your set. Write for Folder "E"

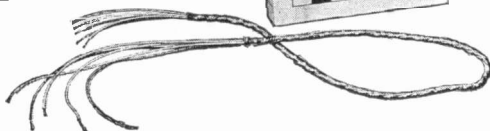

Stranded Enamel Antenna Wire

Seven twisted strands of enameled copper wire. This greatly increases signals by presenting greater surface to incoming waves. Enameling each strand prevents corrosion and resulting weak signals. 100, 150 or 200 foot coils, boxed. Write for Folder "E"

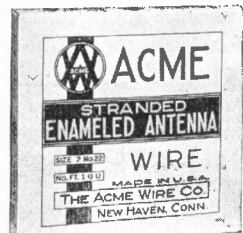

Wire for Loop Antenna

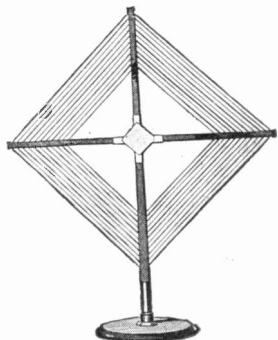

Make your own loops with Acme loop wire from instructions in the magazines. Made of 65 strands of fine copper wire insulated with green silk. Neat; non-stretching; flexible for folding. Write for Folder "E"

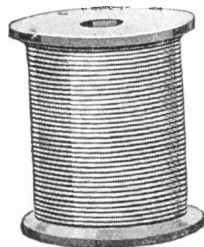

"Spaghetti"

Flexible Varnished Tubing

An insulated covering to be slipped over bus bar wire to protect it from contact with other wires. A perfect protection for all "danger" points. Costs a little more, but worth a LOT MORE than the ordinary grade offered. 30 inch lengths. Red, yellow, green, brown and black for wires No. 10 to 18. Write for Folder "E"

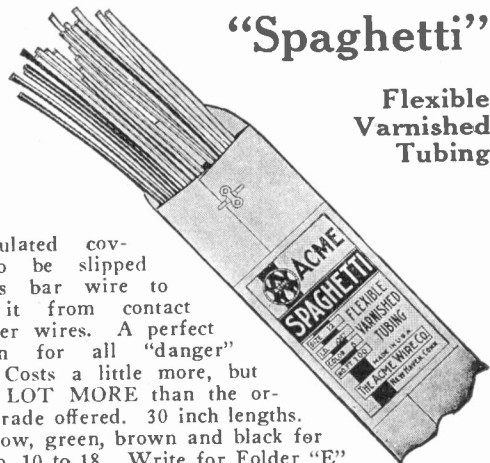

THE ACME WIRE CO., Main Office and Works, NEW HAVEN, CONN.

BRANCHES: New York, 52 Vanderbilt Ave.; Chicago, 427 West Erie St.; Cleveland, Guardian Bldg.; Boston, 80 Federal St.

\$98⁵⁰



Instantaneous Acceptance Everywhere

Air-Way is selling itself to the radio trade with an almost unbelievable celerity. Scores of dealers are placing stock orders *the very same day* they demonstrate the single receiver that was ordered for a test. Air-Way supremacy is emphatic, unmistakable, clean-cut. Air-Way's greater beauty is obvious when the set is unpacked. The Air-Way sales policy marks an epoch in radio merchandising.

Get the facts on the Air-Way "Certificate of Satisfaction," the most constructive sales force at the disposal of the radio dealer today and an inexhaustible source of immediate and future dealer profit.

Air-Way Electric Appliance Corporation
TOLEDO, OHIO
Export Department, 220 Broadway, New York, N. Y.



Air-Way embodies the resistance-coupled principle of amplification in a six-tube set so simple and easy to operate that owner satisfaction is enthusiastic and permanent. Three models — receiving set \$98.50; with built-in speaker \$137.50; console model \$197.50.

Air-Way Electric Appliance Corporation,
Toledo, Ohio
Please send me data and prices covering the new Air-Way
Radio Receivers.
Firm Name
Address
Your Name



This Sign Means RADIO PROFITS!

*Will it be displayed
in YOUR window?*

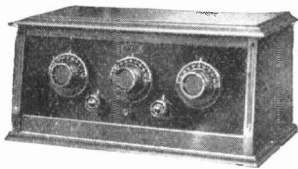

A-10 Five tubes—199's or 201-A's. Balanced tuned radio frequency. Cabinet has rich brown mahogany finish. Federal standard parts used throughout. Length 24 inches, height 11 inches, depth 12 inches. **\$75.00** Without accessories

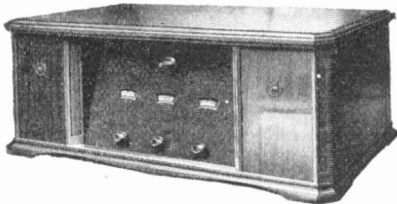

B-20 Five tubes—199's or 201-A's. Balanced tuned radio frequency. Genuine mahogany cabinet with rich finish. Micrometer tuning controls. Space for batteries. Length 30 inches, height 13 inches, depth 15 inches. Without accessories . . . **\$100.00**

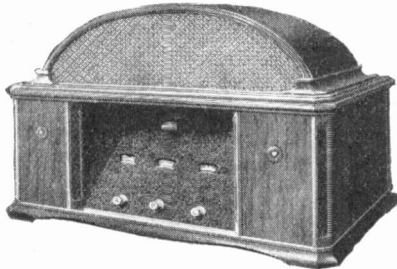

B-30 Five tubes—199's or 201-A's. Balanced tuned radio frequency. Extremely sensitive and selective. Mahogany cabinet finished in rich, lustrous brown. Micrometer tuning controls. Ample space for batteries. Federal enclosed adjustable speaker. Exceptional volume and tone. Length 30 inches, height 20 inches, depth 15 inches. Without accessories **\$130.00**

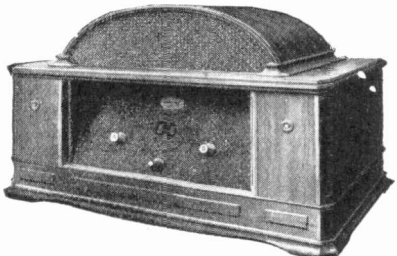

C-30 Seven tubes—199's or 201-A's. Balanced tuned radio frequency. Genuine mahogany cabinet, with rich brown finish. Two micrometer tuning controls. Space for batteries. Operates on self-contained loop. Federal enclosed adjustable speaker. Length 36 inches, height 23 inches, depth 18 inches. Without accessories **\$200.00**

The new, simplified Federal Ortho-sonic line is a line you can sell with absolute confidence and give your whole-hearted support. Designed by Federal engineers—built in Federal factories by Federal craftsmen to Federal's high standards of quality. *You know what that means.*

In addition we offer the new and exclusive Ortho-sonic principle—the latest and greatest development in realistic, lifelike reproduction—beautiful cabinet-work and *popular prices.*

Write at once. Get the Federal proposition. Get the sign in your window. Our big national advertising campaign in magazines and newspapers is reaching hundreds of thousands. Everywhere the thrilling Ortho-sonic tone test is being demanded. Be ready to make these sales.

Read the liberal provisions of the Federal proposition. Profit-making discounts! Exclusive territory! National advertising! Powerful sales helps! And, back of it all, the name *Federal*, which is a guaranty of clean-cut business methods. Get lined up for the big fall trade. Write at once for our proposition and the name of your wholesaler.

FEDERAL RADIO CORPORATION
Buffalo, N. Y.

(Division of Federal Telephone and Telegraph Company)
Operating Broadcast Station WGR, Buffalo

Federal

ortho-sonic



C-35 Same mechanism as C-30 but housed in handsome highboy cabinet. Superior quality built-in Federal Speaker. Length 27 inches, height 54 inches, depth 17 inches. Without accessories **\$300.00**



B-36 Five tubes—199's or 201-A's. Balanced tuned radio frequency. Floor cabinet of choice mahogany woods with rich, two-tone brown finish. Enclosed Federal Speaker. Space for batteries. Length 35 inches, height 43 inches, depth 21 inches. Without accessories **\$250.00**

In addition to the six sets illustrated the new Federal Ortho-sonic line includes:

B-35 Mechanism same as B-20 (illustrated). Beautiful cabinet of selected mahogany, finished in rich two-tone effect. Enclosed speaker. Ample space for batteries. Length 35 inches, height 43 inches, depth 21 inches. Without accessories **\$250.00**

C-20 Same mechanism as C-30 (illustrated) but without enclosed speaker. Genuine mahogany cabinet, finished in rich brown. Operates on self-contained loop. Length 36 inches, height 16 inches, depth 18 inches. Without accessories **\$165.00**

C-40 Same receiving mechanism as C-30 but housed in specially designed custom-built hand-carved cabinet. Every detail of feature is provided in this model to make it the last word, not only as a Radio Receiving Set, but also as a beautiful furniture piece for the select home. Without accessories . . . **\$350.00**

Note: We are continuing our models 141, 142, 143 and 144

No Hum— No Distortion!

AERO B eliminates the faults encountered in other "B" Battery eliminators.

There is no hum with an Aero B. It furnishes a steady, constant, dependable plate current without the A. C. hum. Aero B does not distort the music. It brings it in as clear and full-toned as the best "B" Battery when the latter is fully charged.

Not only does Aero B do away with hum and distortion, but it gives the maximum volume of which the set is capable. Aero B never decreases volume but frequently *increases* it.



is a *perfected* "B" Battery eliminator. Exhaustive tests on all types of tube sets have conclusively proved that here at last is a trouble-proof "B" Battery eliminator that will give even better results than a Battery.

Write for complete details on Aero B *now*. Try one on any set and prove its efficiency to your own satisfaction. They are sold only on "performance on your own set" basis.

THE GLENN L. MARTIN CO.
Radio Division Cleveland



RETAIL PRICE

\$42.00

*Sold only through the
best recognized
jobbers*

For the man who believes his own ears

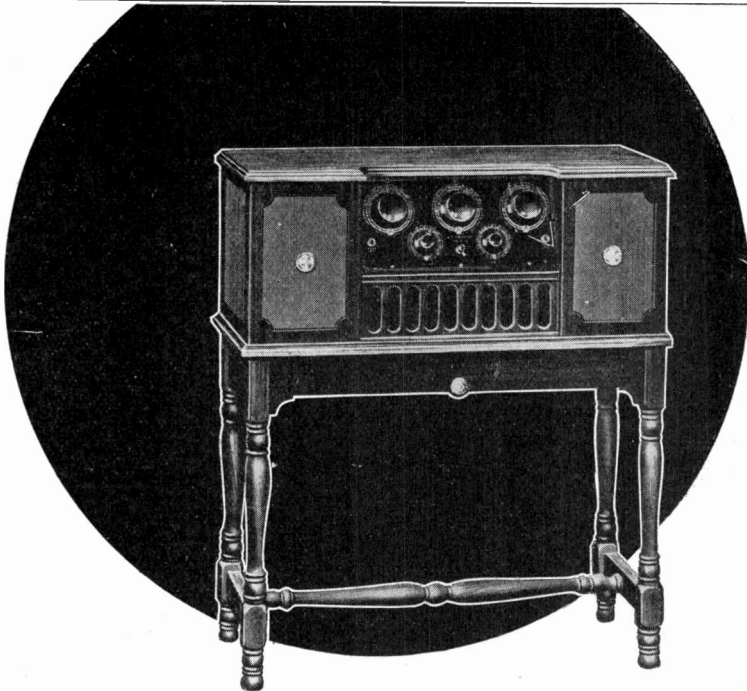

Let This Receiver Talk for You

Put your trust in *A-C Dayton* and you can count on bigger profits, growing good will and a soundly established business. The *A-C Dayton* speaks for itself—not only to the public but to the dealers as well!

Consider the Console, for example. A full range instrument capable of equalling or *bettering* the reception of any other receiver regardless of price, it offers in addition, compactness, beauty and extremely popular price. It stands but thirty-eight inches high—an ideal furniture model for any home, large or small. It is completely contained, in-

cluding loud-speaker, with "A" Battery cabinet lined with asphaltum. And it retails at \$185 (\$190 west of Denver), as compared with prices ranging from \$250 upward for similar models of other makes.

In terms of "dealer performance," these things mean easier sales, quicker profits and more ready turnover.

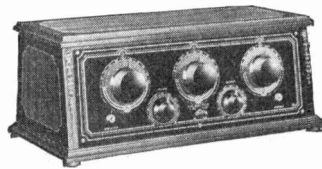

The A-C DAYTON Standard Cabinet, Type XI-10. List price, \$115; west of Denver, \$120.

They stand for increased good will and multiplied satisfaction for your trade. With those things goes our guarantee of constantly maintained prices.

Wild and unsupported claims, whether made by manufacturer, jobber or dealer, will take radio nowhere. Performance is all that counts with your trade; it should be all that counts with you. Seek the line that speaks for itself—as the *A-C Dayton* does! Send the coupon today for full description of the line with prices and discounts.

The A-C Electrical Manufacturing Co.
DAYTON, OHIO

Makers of Electrical Devices for More Than Twenty Years

A-C DAYTON

RADIO

MEMBER
RMA

A-C Electrical Mfg. Co., Dayton, Ohio.
Gentlemen: Please send me full information concerning the A-C DAYTON line with details of your Selling Service for 1925-26.

Signed
Street
City
State R R 10

Stock these parts they sell!

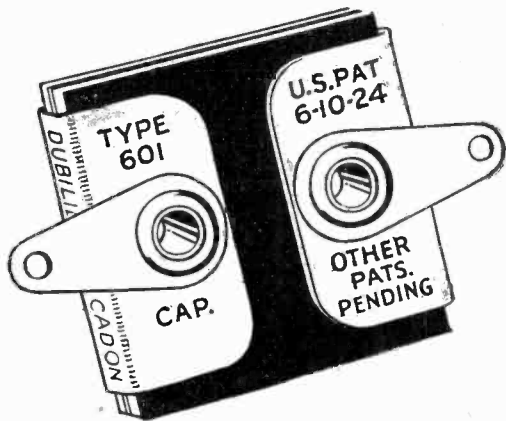

601 Micadon—The standard fixed condenser of radio, made in accurate and permanent capacities. Extension tabs for simple assembly.

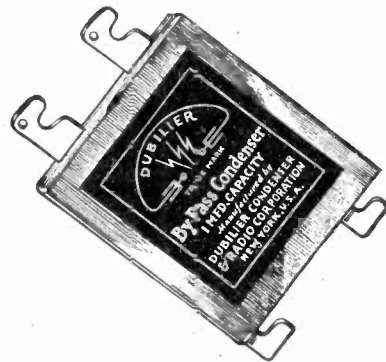

By-Pass Condenser—A device which smooths out the fluctuations of the "B" battery and provides an even flow of current. Intended for use with "B" batteries of not more than 150 volts.



Ducon—A Ducon, plugged in on any light socket, takes the place of an unsightly, cumbersome antenna.

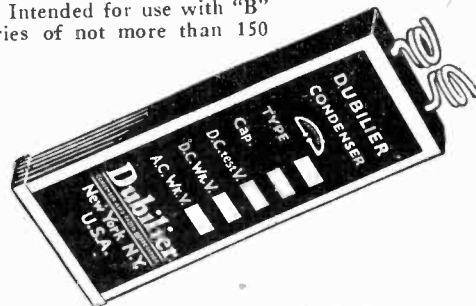

Type 577 Condenser—An extremely efficient condenser of the low-loss type—normal voltage rating 1,000 volts, 60 cycles A.C.—especially adapted for use in low power vacuum tube transmitters.



Metaleak—The new resistance unit with the metalized filament.

Dubilier

CONDENSER AND RADIO CORPORATION

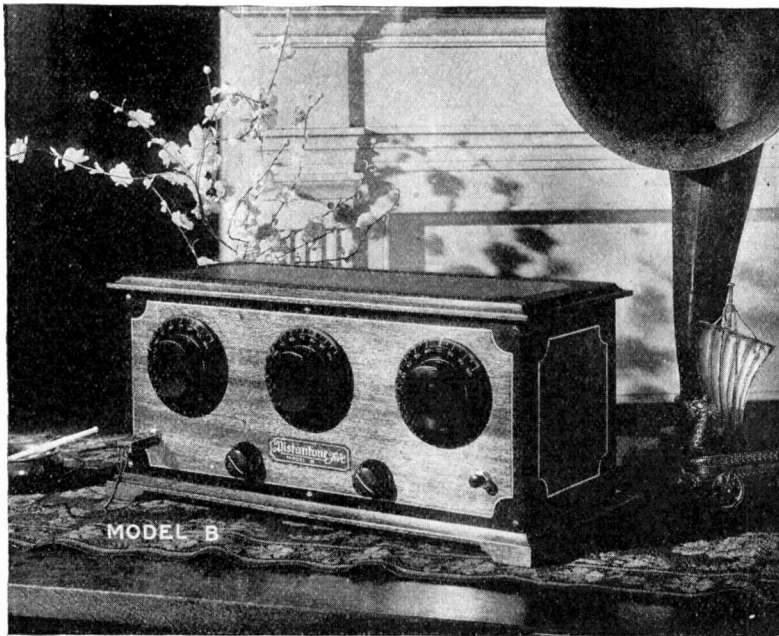

This is the
new Model "B"

A five-tube radio frequency
receiver

List price **\$47⁵⁰**
without
accessories

Description

Light colored mahogany cabinet, ebony edges, three-ply veneer walnut front panel 7½"x19".

The first essential to big sales is a price that enables the biggest number of people to buy, and performance which will give satisfaction to the eventual consumer.

The "Distantone Five," Model A and Model B, at the remarkably low price of \$37.50 and \$47.50, are without question the biggest radio value out of the entire field.

Yet, price is not the only dominant factor behind Distantone's vast sales.

The **Distantone** *Five*
A FIVE TUBE TUNED RADIO FREQUENCY RECEIVER

ON DISPLAY AT THE SECOND RADIO WORLD'S FAIR

—Booth 7, Section 4

Where can you find a sales proposition like this?

The Distributors' and Dealers' propositions behind these models are attractive. These receivers are built upon a foundation of Responsibility to our customers.

Model "A" **\$37⁵⁰**
List price without
accessories

The "Distantone Five" gives the radio public a receiver that is sensitive and selective. A receiver that meets the modern demands to bring through programs of distant stations, while local stations are in full operation. Clarity, tone and volume are also major considerations in the modern receiver. The "Distantone Five" reproduces with equal beauty, the bass rumble of the organ, the blare of the brass, and the harmonic of the violin.

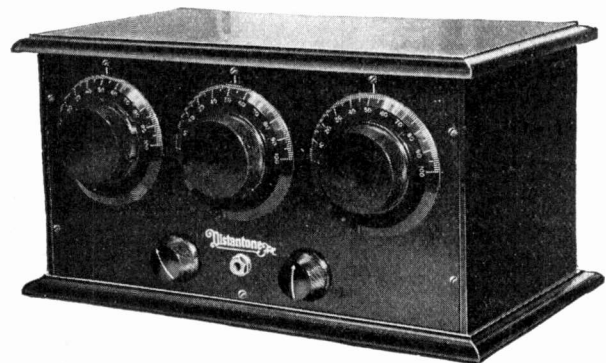

Richly finished Mahogany cabinet, polished control panel 7x14 in. with interior apparatus shelf, arranged so that only the vacuum tubes and tuning condensers are visible.

Distributors wanted in some territories

DISTANTONE RADIOS, INC.
LYNBROOK, LONG ISLAND, N. Y.



Just plug in - as you would any other electrical appliance

The EPOM "B" Battery Eliminator was one of the first radio accessories to be recognized by the wholesale and retail trade as distinctly an Electrical Product of Merit.

Central Station power offers an unfailing source of "B" Power direct from any lighting socket when rectified and filtered through the EPOM "B" Eliminator.

To realize the importance of the EPOM to your immediate sales, you have only to study its five features. Point by point, they show the EPOM to be alone in its class. Get the details now!

There is an urgent demand for a good "B" battery eliminator and EPOM IS GOOD.

EPOM ELECTRICAL PRODUCTS OF MERIT "B" Battery Eliminator

These distributors after exhaustive tests have approved the EPOM "B" Battery Eliminator and are prepared to fill your orders promptly.

- | | |
|---------------------------------------|---|
| NEW YORK, E. B. Latham & Company | KANSAS CITY, B-R Electric Company |
| NEW YORK, Shiley-Pittman Elec. Corp. | CLEVELAND, Erner Electric Company |
| NEWARK, Tri-City Elec. Company | CLEVELAND, Republic Electric Co. |
| NEWARK, E. M. Wilson & Son | COLUMBUS, Erner & Hopkins Co. |
| PHILADELPHIA, Jones-Beach & Co. | CINCINNATI, Post-Glover Elec. Company |
| PHILADELPHIA, F. H. Stewart Elec. Co. | PITTSBURGH, Union Electric Company |
| BOSTON, Pettinelli-Andrews Co. | INDIANAPOLIS, Indianapolis Elec. Sup. Co. |
| BOSTON, Wetmore-Savage Elec. Sup. Co. | DETROIT, Electrical Specialties Co. |
| HARTFORD, So. New England Elec. Co. | ST. LOUIS, Wesco Supply Company |
| HINGHAMTON, Elliott Engineering Co. | NEW ORLEANS, Wesco Supply Company |
| SYRACUSE, Burr-Fowler Company | ATLANTA, Carter Electric Co. |
| UTICA, Steifvater Elec. Co. | BIRMINGHAM, Matthews Electric Co. |
| BALTIMORE, Southern Elec. Co. | DALLAS, Southwest G. E. Company |
| RICHMOND, Southern Elec. Co. | HOUSTON, Southwest G. E. Company |
| CHICAGO, Commonwealth Edison Co. | |

EPOM CORPORATION (Dept. E.)
114 East 47th Street, New York City





There's a Real Organization Behind Arborphone

A Perfected Receiver

\$55.00
LIST

(Add \$5.00 west of the
Rocky Mountains)

*Built for years of
satisfactory service.
(Not a one-year set)*

*Featuring Radio's
most advanced
achievements*

*Easy to separate
all stations*

*"All you could ask
of a Radio"*

That is the answer to the first question most dealers ask—especially those who have been through several years of radio.

For 10 years this organization has designed and built the finest precision products. Before introducing the Arborphone Precision Receiver the financial resources and engineering brains of our entire organization were utilized to make possible a radio receiver at a popular price.

Performance in receiving sets is determined first by the "hook-up," second by the quality of the parts selected. Look under the lid of the Arborphone—quality is instantly apparent. Listen to reception through the Arborphone—you will concede all our boasts of exceptional reception.

Appearance too is most important. Arborphone is an aristocrat. Any fastidious woman will exclaim at its beauty of design and artistry and want it instantly for her nicest room.

\$55 buys this perfected receiver. Each sale will create many more. Only a few dealers in each territory can sell Arborphone. To those dealers we have an offer that makes the franchise worth their while.

Wire collect or write for
sales plan—an Arborphone
representative will see you.

MACHINE SPECIALTY COMPANY
ANN ARBOR, MICHIGAN

10 Years' Experience in Precision Products

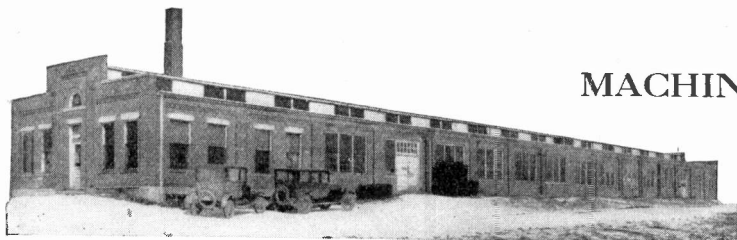

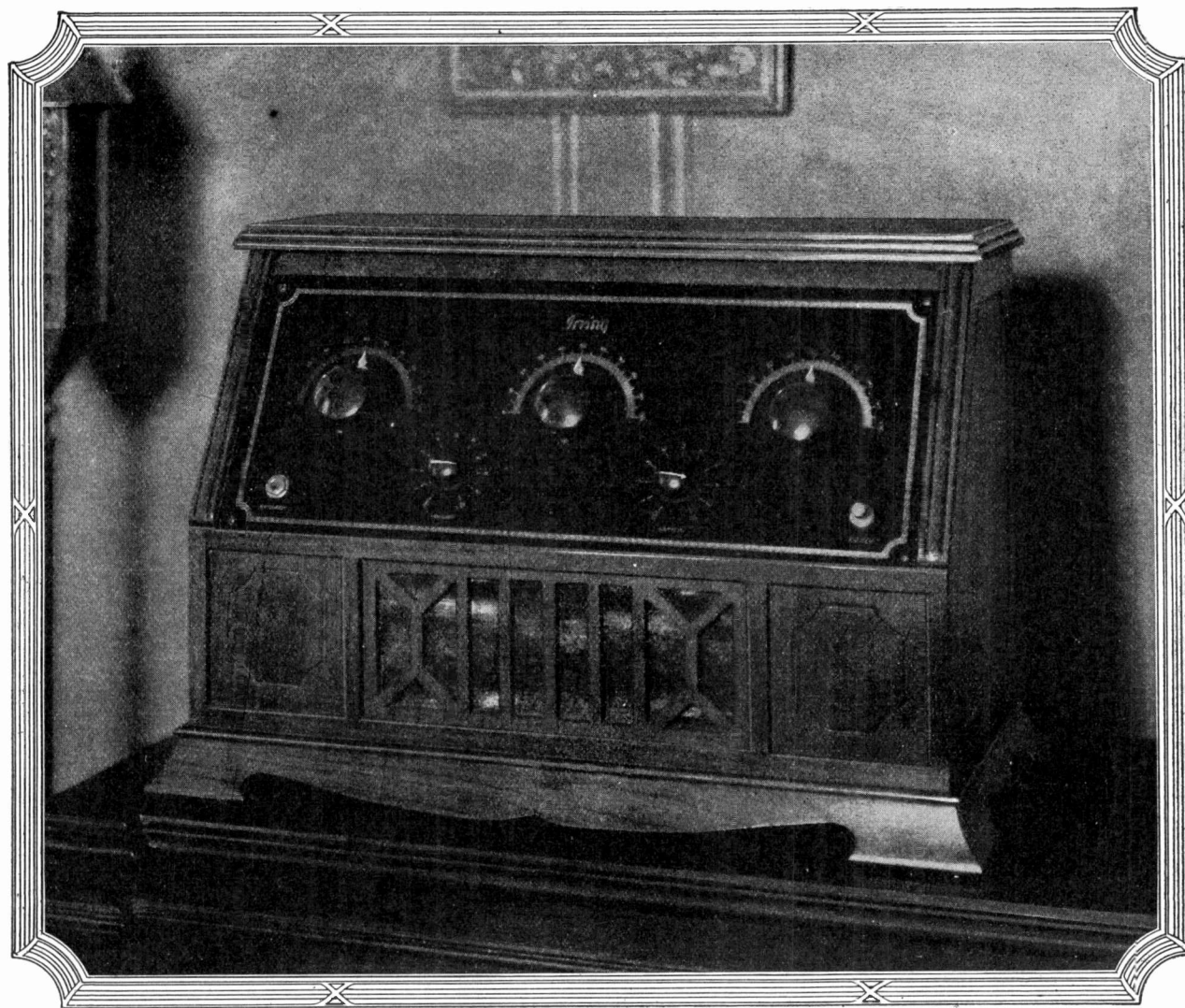

This is the Line for You to Handle

Jobbers, distributors and dealers, looking for a successful and dependable line of Radio Receiving Sets to represent, are invited to correspond with us. You will, after examination and tests of our sets and a perusal of our policies, choose us as one radio manufacturer you will be proud to represent during the years to come.

The Irving is a most strikingly beautiful and efficient radio receiving set. Tested under most severe conditions, it demonstrates, time after time, its superiority as to tone quality, volume, selectivity and range. Cabinets are genuine mahogany or walnut with a famous permanent satin finish.

The price range is from \$55.00 for the straight front type; \$65.00 for the sloping panel type; \$95.00 for the self-contained speaker type, illustrated; and \$125.00 for the console type; the most amazing and wonderful radio offering this year.

Our jobber and dealer protection policies are based on the fundamentals of good business, the same principles which have governed successful American business throughout the years. They mean sales and profits for you.

We are building a splendid nation-wide organization of distributors, jobbers and dealers and invite you to join with us. Write for details regarding a real sales franchise for you.

IRVING RADIO CORPORATION
143 East Broad Street, COLUMBUS, OHIO

I R V I N G



3 Routes to Sales



In the set market, biggest of all, Thorola dealers are fortified with the 5-tube Thorola Islodyne. It is the only receiver embodying the original *Isolated Power* principle of Thorola Low-Loss Doughnut Coils. Now interference is nil; selectivity is positive—you can demonstrate it. Sets are uniform; no embarrassing disappointments. The appearance is exquisitely distinctive. And tone is the tone which has made Thorola one of the permanently big names of radio.

Thorola tone also gives Thorola dealers the strongest loud speaker line. With new burnished Bakelite horn—the largest Bakelite form ever produced; with important technical refinements such as the self-harmonizing feature; with the identifying, beautiful gold throat-band, Thorola 4 at \$25 continues as the speaker aristocrat of the world!

Smaller, but bristling with Thorola quality, is the Thorola Junior at \$15, putting Thorola dealers powerfully into both ends of the speaker market.

Thorola stores also are the center of interest for set-builders. Only Thorola Low-Loss Doughnut Coils assure the results experimenters are seeking today. Not only the enclosed field of these coils, but the exclusive Thorola low-loss construction contributes to their epochal performance.

In complete receivers, in loud speakers, and in vital radio parts, Thorola dealers have a clear edge, backed by Thorola popular, class, and technical advertising. And with additional new Thorola parts: Low-Loss S. L. F. Condenser, Golden Audio Reproducing Transformer, Rheostat and Fixed Condenser, Thorola guarantees your 1925-26 season.

REICHMANN COMPANY, 1725-39 W. 74th St., CHICAGO



Thorola

I S L O D Y N E



The T. R. F. KIT

The complete Low Loss Inductance System, comprising two tuned circuit transformers and an antennae coupler with a uniquely constructed variable primary for governing the selectivity of the antennae circuit.

List \$12.00

Sell the Coils Which Proved Themselves BEST In the World's Hardest Coil Markets

Aero Coils have been the favorites in Chicago and New York — because in these cities there are so many high powered stations completely covering the broadcast band. No other coil cuts through this tangled mass of broadcasting as do Aero Coils — because none but Aero Coils can resonate so sharply.

95%
Air
Dielectric

No Dope Used
on Windings
All Turns
Uniformly
Air Spaced
Patents Prevent
Imitation

The patent-protected principle upon which Aero Coils are built permits them to resonate on a "knife's edge," at any frequency. This means abso-

lute *selectivity*, perfect *sensitivity* and ability to bring in distant stations, through any interference, with tremendous *volume!*

Every Aero Coil sold sells a dozen more. This is the experience of dealers everywhere — because the performance of Aero Coils is so noticeably superior to that of any other

type of conductance. Stock Aero Coils. Let your trade know you have them. Big advertisements in the national radio magazines are sending Aero Coil buyers to your store.

Write us at once for prices—or get in touch with your jobber.

AERO PRODUCTS, Inc.
217 No. Desplaines Street, CHICAGO

AERO COIL

Low Loss
Inductance Systems

Use AERO COILS

Wherever An Inductance Is Required

THE ONLY AIR DIELECTRIC COILS HAVING
VARIABLE PRIMARIES IN ANTENNAE
CIRCUITS

The Aero Coil 3-Circuit Tuner

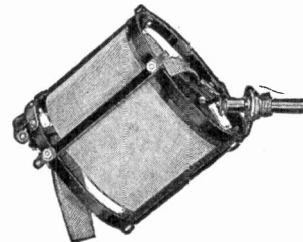

Another adaptation of the patented protected Aero-Coil construction and for that reason the most efficient three-circuit tuner ever offered. More than covers the broadcast wave band when shunted with a good .00035 condenser. This is the tuner which

in a 3-tube set brought in Havana, Cuba, in the daytime, in Chicago. Price.....\$8.00

The Aero Coil Radio Frequency Regenerative Kit

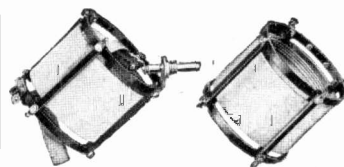

Consists of one AERO COIL 3-Circuit Tuner and one AERO COIL Antennae Coupling Transformer. Makes the most powerful, most selective 4-tube, non-radiating set possible to build. Price\$11.00

The Aero Coil Wave Trap Unit

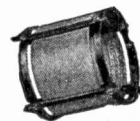

Also for Crystal Sets

By reason of the characteristics made possible by the Aero Coil construction, this unit makes a very efficient wave trap or crystal set. Price.....\$1.00

The Aero Coil Oscillator for Super Heterodynes

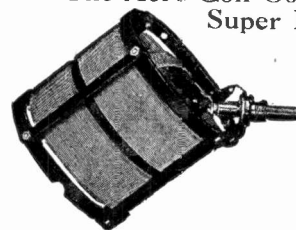

The characteristics achieved through the use of the Aero Coil principle make of this instrument the ready means to tremendously increase the efficiency of the oscillator circuit in any Super Heterodyne receiver. Pr. \$5.50

Special Offer

Money back guarantee
you be the judge

Order a Sample

\$19.95

Send your check for \$19.95
—we'll send the set. Try it
out for five days, then if you
wish, return it and your
money will be refunded.
Only one to a dealer at this
special price.

Money-Back
Guarantee

Try the set out under all conditions—your conditions—not ours. Make comparisons. Examine the materials, look into the workmanship and study the principle. Don't take our word for a single thing—you be the judge—then, if you aren't satisfied, carefully pack and return to us for full credit.

MELODY

Proof that they are
made right—

Specifications

1. Circuit—Tuned Radio Frequency.
2. Bi-focal Coils.
3. Cabinets all hand finished in mahogany finish and two-tone Genuine Mahogany.
4. Panel—"Veri-Chrome" Beauty Panel.
5. Transformers—Thordarson.
6. Condensers—High Grade Low-loss adjustable capacity.
7. Controls—Only two dials.
8. Sockets—Positive contact sockets.

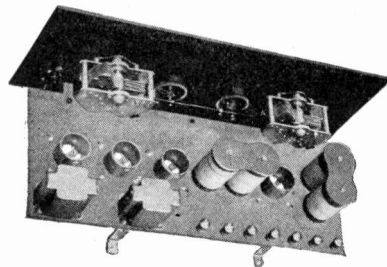
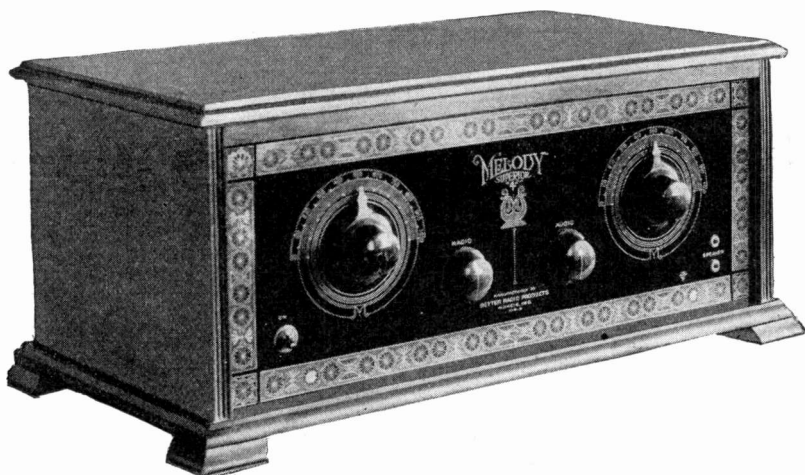

Seeing Is Believing

ORDER A SAMPLE.

See for yourself what it is, show it to prospects. See why it sells, learn why you should sell it. There's a big demand and real honest-to-goodness profits for you. You have nothing to lose and everything to gain.

The sample offer itself is a mighty big bargain.

ANYONE CAN SELL IT.

For it has the APPEARANCE, PRICE and PERFORMANCE—that makes sales. Dealers, distributors and salesmen who are dissatisfied with high prices, small margins, poor quality and over-crowded competition in old slow moving lines can now show a distinct, fast selling line.

ANYONE CAN BUY IT.

We have a complete line of "4" and "5" tube models retailing from \$39.00 to \$149.00. A price and model to suit every need and pocketbook can't help but satisfy and get you the business.

The absence of new fangled "IODINES," etc., puts your customer at ease and quickly rings the cash register.

ANYONE CAN USE IT.

Two dials—two rheostats. Logs easy on any length aerial. Simple to use. No new principles for argument. BEST materials make for good reception.

The workmanship speaks for itself, in good, clear and sharp tones in loud speaker.

SEE FOR YOURSELF.

Appearance, price and satisfaction are what we have to offer—nothing more. These three points sell sets—no matter what kind they are. That is exactly what we have built into Melody radio sets.

WHAT COULD BE FAIRER?

We have the courage of our convictions. If our sets won't meet the approval of you dealers they won't sell—that's all. If they are O. K. you'll know it and we'll get your repeat business. Let's go—we have a trade-winning, money-making proposition for you. Order Now.

Better Radio Products, Muncie, Ind., U.S.A.

If you want the best!

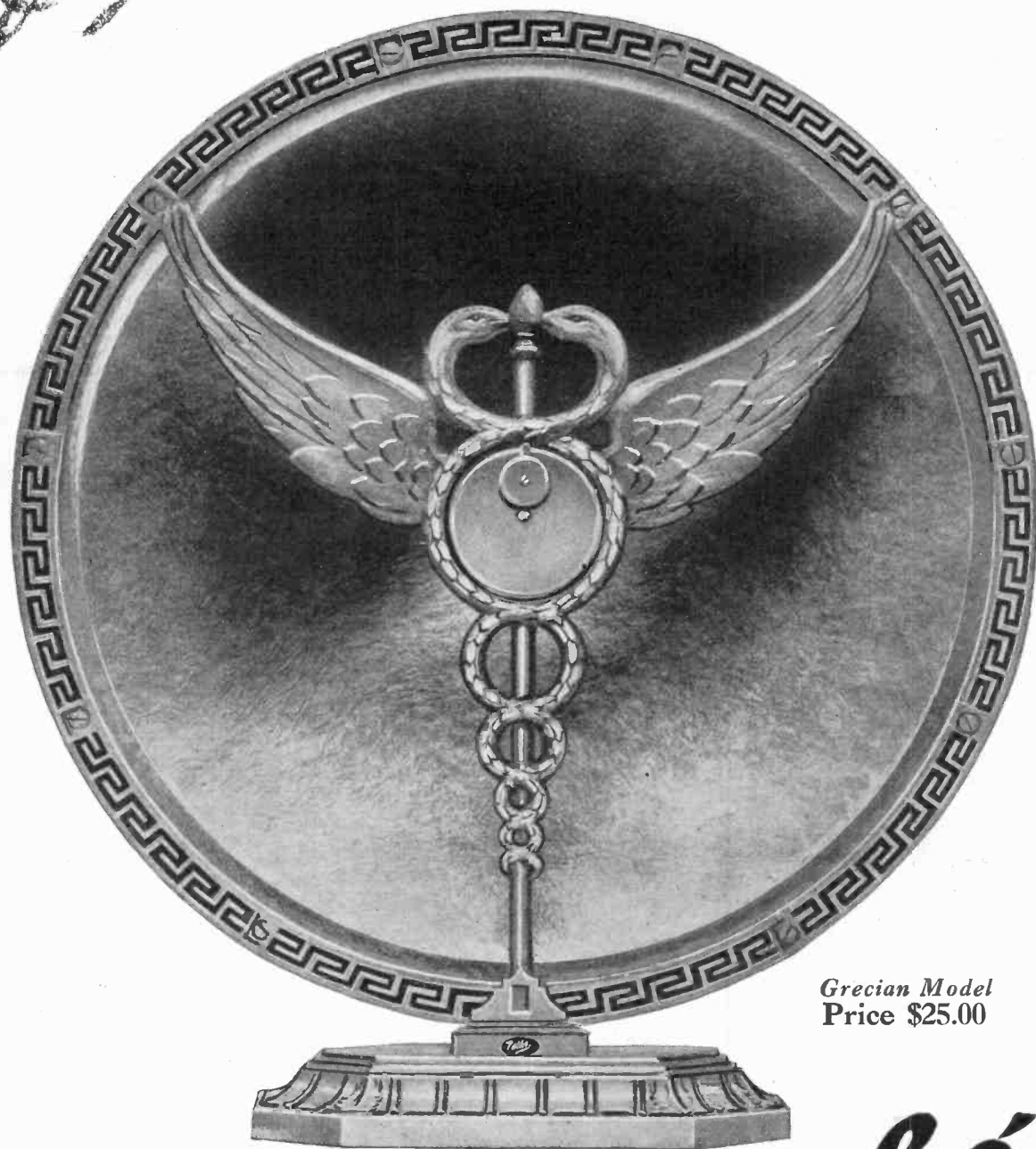

*Grecian Model
Price \$25.00*

*The new Pathé sets operate
on house current*

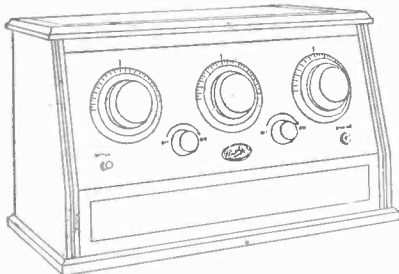

Some territories for both jobbers and retailers still open. Write.



CONE LOUD SPEAKER

Exquisite in tone
Exquisite in design
Exquisite in workmanship

PATHE PHONOGRAPH AND RADIO CORPORATION
DEPT. 30 20 GRAND AVENUE, BROOKLYN, N. Y.



Radio Receiver



The Year's Greatest Radio Value

Every Tube Set Owner Is a Prospect for These

The Valley B-Eliminator takes the place of B batteries and provides B current from the house lighting circuit at a constant voltage all the time. It is a new and better source of B current.

The Valley Battery Charger also works off the house lighting system and is the only charger needed for recharging both A and B storage batteries. The Valley Charger is known all over the country. We have always been able to sell all that we could make.

Your jobber can supply you. Or write us for further information.

<p>The B-Eliminator Retail Price \$30.00</p>	<p>The Battery Charger Retail Price \$19.50</p>
--	---

That's what we set out to build — radio value in a receiving set which has never before been equalled.

And that is what enthusiastic dealers and satisfied users everywhere say we have accomplished in the Valleytone 5-tube Tuned Radio Frequency Receiver.

The Valleytone provides the easy, distinct separation of stations, only four or five meters apart. . . . Reproduction that inspires amazed approval for its

natural faithful tone. . . . Greater volume without distortion.

And in appearance, a knock-out. A beautiful walnut cabinet finished in two tones — striped in gold. Bakelite panel engraved and lettered in gold.

Consult your jobber or write us for the full story of the Valleytone Receiver. We are telling that story to millions this year in magazine and newspaper advertising, and we are looking for good dealers to profit with us on the year's greatest radio value.

VALLEY ELECTRIC COMPANY, Radio Division, St. Louis, U.S.A.
Branches in principal cities



The Valleytone is mounted in a solid walnut cabinet finished in two tone with inlaid gold stripes. Bakelite panel, engraved in gold.

Retail Price **\$115.00**



The Special Valley Table like the above with built-in loud speaker and compartments for all batteries, etc.

Retail Price **\$60.00**

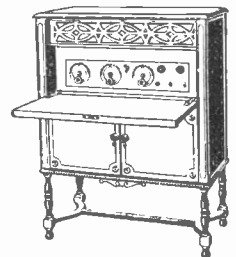

The Console Model Valleytone
Retail Price **\$250.00**

Valley Electric

Another
**BOSCH
 RADIO
 PRODUCT**

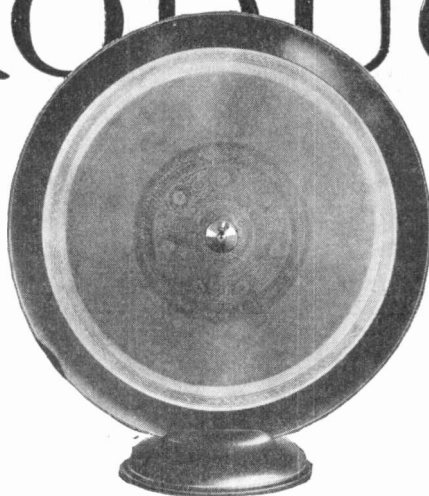

PRICE
\$14⁵⁰

The
Junior AMBOTONE

ANOTHER Bosch Radio triumph. The announcement and immediate nationwide acceptance of the Bosch Radio Receiver, the Amborola, and the Bosch Reproducer, the Ambotone, is now followed by another Bosch Radio product.

Bosch now announces the Junior Ambotone. The Junior Ambotone is a radio reproducer with an unusual tonal quality built to the famous Bosch standard of precision. Following the Ambotone principles of reproduction, the Junior Ambotone gets its mellowness from wood.

The Bosch ability to manufacture to precision standards, accounts for the tone quality. The Bosch ability to build with accuracy in quantities accounts for the remarkably low price. The greatest value in radio—the Junior Ambotone—at \$14.50.



TRADE MARK

American Bosch Magneto Corporation
 SPRINGFIELD, MASS.

The One Dial MU-RAD

Transcontinental Receiver



MODEL A—LIST PRICE \$175

Sockets Fit All New
Type Tubes

Give Your Customers What They Want

The Mu-Rad Single Dial Receiver created a tremendous sensation at the recent radio shows. This proves that the public wants a receiver with *ONE* dial control. Mu-Rad has eliminated the complexities of multiple dials—it is so simple and easy to operate that any child can tune it. Just *one* dial to turn to get country-wide reception. Just one dial to turn to get utmost selectivity—and *not one* desirable feature sacrificed for simplicity.

Your customers demand permanency. Experts say that this receiver will probably not be improved upon for some time to come—*this feature is selling Mu-Rad.*



MODEL B—LIST PRICE \$125
Sockets Fit All New Type Tubes

Mu-Rad Dealers Get FREE Advertising

Mu-Rad dealers receive 100 per cent factory co-operation. Each Mu-Rad dealer gets *FREE* local advertising in his local newspaper carrying his name and address. Think of it! When a Mu-Rad dealer makes a sale we spend our own money to create *more sales* for him. Dealers everywhere are taking advantage of this business building opportunity. In addition to your local advertising, national advertising in dominating space is broadcasting the Mu-Rad story to your customers. A strong consumer demand is resulting. Ride this advertising wave to more sales and profits. Mu-Rad means big business for you this season. Are you ready for it?

MU-RAD RADIO CORPORATION

Factory
Asbury Park
New Jersey

General Sales Offices
Dept. C. 2
972 Broad Street
Newark, New Jersey

DIS-TON

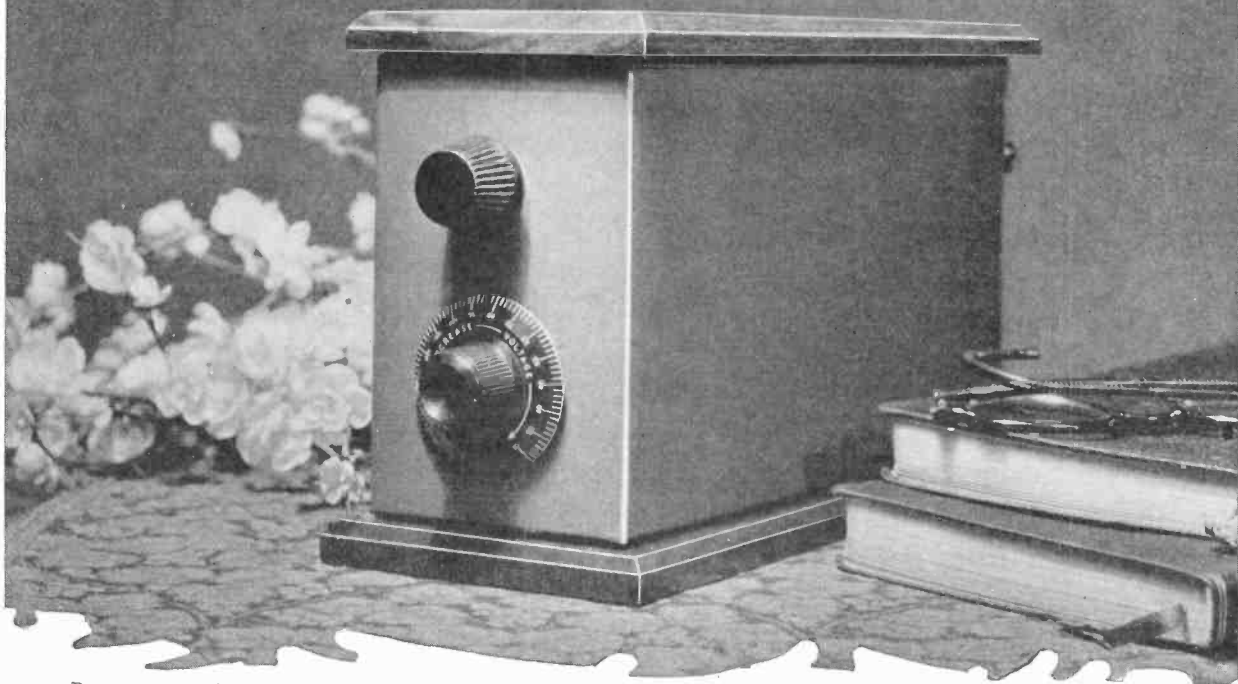

DIS-TON replaces "B" Batteries and gives with Alternating House Current Supply greater Clarity, Volume, Distance and Selectivity. Handsomely finished in Duco with solid walnut satin finish top and bottom. Beautiful in appearance and performance.

Provides Extra Profits on Every Set You Sell [and have sold]

The Radio Public is ready to pay you a legitimate profit for bringing the *right* eliminator of "B" Batteries to its attention. DIS-TON is guaranteed to give greater clarity, volume, selectivity, and distance. It is free from current noises and A C hum.

You are the Judge

DIS-TON is offered to the trade on only one basis. Confirm every DIS-TON advantage—hear for yourself the obvious gain in overall efficiency it gives the sets you sell—from single tube to super-heterodyne. Convinced by your own tests, you are prepared to offer DIS-TON to your trade on the same basis.

Backing you up is a strong advertising campaign not only nationally, but also consumer literature for distribution by you to your prospects.

Start Getting DIS-TON Profits Now

We have arranged a Free Trial Offer which will interest every dealer mindful not only of profits but the quality of merchandise he sells and the radio reputation of his store. DIS-TON profits are sizable and permanent. Write for the Free Trial Offer as the first step in getting your share.

RADIO PRODUCTS, INC.

Dept. RR

Richmond, Ind.

Jobbers and Sales Distributors—write or wire us for territory

Diston

List Prices—Complete Ready for Operation (including Rectifier Tube)	
110 volt, 60 cycle AC	\$40.00
110 volt, 50 cycle	48.00
110 volt, other than 50 or 60 cycle	60.00

Diston Kit

Essential Diston Parts for the Set Builder, Experimenter and the man who "wires his own." Covered by regular Diston Guarantee.	
110 volt, 60 cycle AC	\$28.50
110 volt, 50 cycle AC	35.75
110 volt, other than 50 or 60 cycle	42.75

What Dealers Are Finding Out

OUR Models "S" and "C" (The Cabinet), are equipped with the new extra large diaphragm of broad pitch range. It brings in the heretofore unreachable bass notes as well as the high.

Pure tonal quality, just what seasoned radio listeners want and BUY, is another achievement by Bristol engineers.

BRISTOL THE ONLY AUDIOPHONE Loud Speaker

Satisfies The First Time

Non-metallic horns, freely vibrating sound chambers and an electromagnetic tone mechanism are effective selling features of the Bristol. They all contribute to that pure harmony of reception which distinguishes the Bristol.



Model S
\$25

14½ in. rubber horn. Cast metal throat. Velvet mat finish with Silvered base decoration.

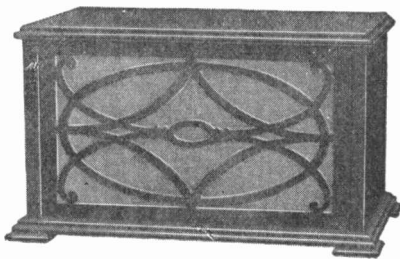

Model C \$30.00

*Represented by
Branches in
9 Principal Cities*

- Boston Old South Bldg.
- Philadelphia Widener Bldg.
- Birmingham Age-Herald Bldg.
- Chicago Monadnock Block
- New York 114 Liberty St.
- Pittsburgh Frick Bldg.
- Detroit Book Bldg.
- St. Louis Boatman's Bank Bldg.
- San Francisco Rialto Bldg.

Bristol Sales Helps Help

The Bristol Company backs up a dealer with regular national magazine advertising. The window display with its daily bulletin feature is a sparkling new idea. There are handsome booklets for distribution and Giant Advertisements for window stickers. Send for our big prospectus telling the whole story.

Four Bristol Models

Three horn types, Models S, J and Baby Grand at \$25, \$20 and \$15. The Cabinet Model at \$30.

*The Season Is On
Stock the Bristol Line New*

Send for Bristol literature which gives full description of the great Bristol Line of Loud Speakers.

The Bristol Company

Radio Division, AL
Waterbury, Conn.

For 36 years makers of the highly sensitive and accurate Bristol Recording Instruments designed to record the most minute variations of heat, cold, density, humidity, etc.

Model Twenty

A new one-dial Kennedy combining simplest operation with accurate control. All broadcast stations conveniently separated from one end of the dial to the other. Lists at \$90.00, without accessories. Slightly higher west of Rockies.

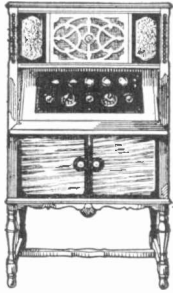
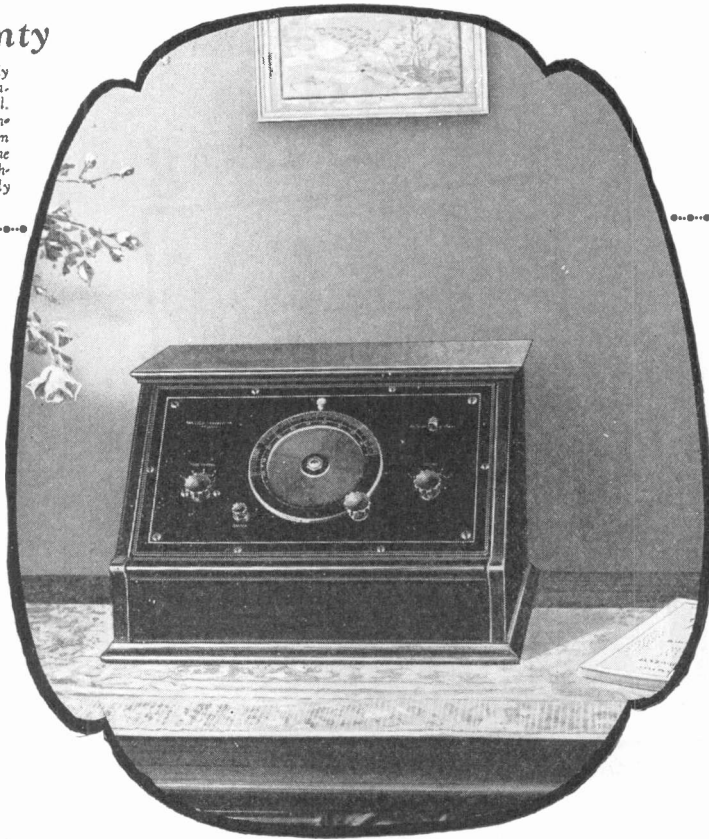

Royal Sixteen

A completely self-contained set, including superb reproducer with full-throated tone chamber, all built-in. Lists at \$235.00 (without accessories). Slightly higher west of the Rockies.

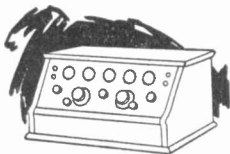

Model Fifteen

The outstanding performer in the radio field. Only two dials for tuning. Highly selective, with tone pure, natural and life like. Price \$120.00 (without accessories). Slightly higher west of the Rockies.



Royal Speaker

Model Six-Thirty

A console speaker de luxe enclosed in mahogany cabinet with beautifully grilled front. Lists at \$40.00. Slightly higher west of the Rockies.



Speakers

Embodies the same reproducing unit used in the Kennedy Royal Speaker. Two sizes. Model Six-Ten, 12 in. bell, \$20.00. Model Six-Twenty, 15 in. bell, \$25.00. Slightly higher west of the Rockies.

Radio Dealers are Flocking to this Highly Attractive Radio Line

Radio dealers! Model Twenty is the latest addition to the famous Kennedy line. It's a real seller—combines royal radio reproduction with one dial and accurate control. This new 5-tube receiver features a special Kennedy development. Its 5" dial is so arranged that all stations are conveniently separated over the entire scale, even those whose wave lengths are ordinarily "jammed" together. This feature, added to its high selectivity, makes Model Twenty the ideal instrument to operate and the ideal instrument to sell.

Model Twenty is every inch a Kennedy—designed, engineered and manufactured to those high standards that make all Kennedy receivers stay sold and free from "come-backs" or excessive service.

Real Protection for You in the Kennedy Franchise

The Kennedy Dealer Protective Franchise offers every radio dealer a real working goal. It grants him exclusive sales privileges in his own community—protects him against encroachment, unfair competition, overlapping, dumping, "gyp" practices and other evils that have menaced the radio trade. Get full details on the Kennedy Protective Dealer Franchise—take the road to permanent radio success.

Colin B. Kennedy Corp. 2019 Locust St. St. Louis, Mo.

KENNEDY



The Royalty of Radio

Colin B. Kennedy Corporation, 2019 Locust St., St. Louis, Mo.
You may send particulars of the Kennedy Protective Dealer Franchise and full information on the complete Kennedy line.

NAME.....ADDRESS.....CITY.....STATE.....



“Some Hustler”!

This came from a reader just four days ago. It came in a letter. The writer said, “I want a copy of every issue of *Radio Retailing*. In the first copy I saw I recognized the spirit and the interest back of it. It sure is ‘some hustler!’”

Not only is *Radio Retailing* hustling all the time for your benefit but the results are what you’re looking for! The hustling gets results!

Every copy gives you definite, tried and tested methods for increasing radio sales! Don’t put off returning the coupon below!

The biggest \$1 value ever offered the radio dealer!

The coupon below will save you money and make you money!

That’s a fact—the coupon below will save you money and make you money!

It will save you money because the regular rate to *Radio Retailing* is \$2 a year. And if you’ll fill out the coupon, attach a \$1 bill to it and return it to *Radio Retailing* headquarters you’ll save \$1.

That’s saving money—that’s saving \$1!

It will make you money because returning it will bring you *Radio Retailing* for a whole year. And receiving this service regularly means that you’ll know exactly what the foremost radio concerns all over the country are doing to increase sales.

So return the coupon right away! It’s the biggest value for \$1 ever presented for your consideration!



Return the coupon now!

FOR A WHOLE YEAR!

Radio Retailing		Attached is \$1. Enroll me as a charter subscriber to <i>Radio Retailing</i> which will give me the service for a year. Start the service with the next issue.	
Tenth Ave. at 36th St., New York, N. Y.			
NAME		NAME OF COMPANY	
STREET	CITY	BESIDES RADIO WE SELL	

The King Cole Radio will deliver—



*Satisfactory service
to your customers*

*Substantial profits
for yourself*

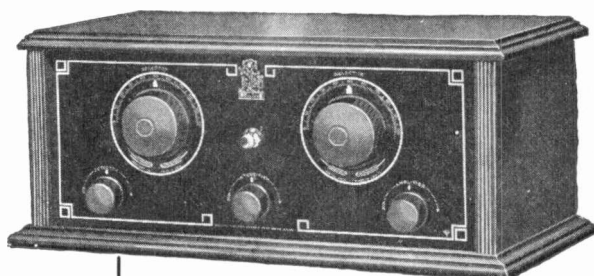

The King Cole is a distinctly new departure in receiving sets that will give your customers highly satisfactory and dependable reception, along with simplicity of operation.

Offered on a franchise selling plan to *the* progressive dealer in each community it gives you a good selling quality receiver at a good profit with absolute protection to you and your customer.

Look over features of the King Cole Receiver—get one now, test it in any way under your conditions and your requirements—then get the details of our sales franchise. Isn't that a fair offer? And let us remind you that the radio season is right upon us.

Features—

- Two dials—easy to operate.
- Quality of reception but NOT at a sacrifice in range.
- Excellence of appearance.
- Economy of operation—four tubes.
- Covers all broadcasting wavelengths including new low waves recently allotted.
- Designed to work with storage battery, dry battery, or the new A.C. tubes.
- Unqualifiedly guaranteed in every particular.
- List price \$80.00

Parts Dealers

Investigate the King Cole line of quality parts—A. F. transformers, reactance amplifiers, antenna wire, square and round bus bar, magnet wire in fractional pound packages.

Anylite Electric Company

FORT WAYNE

Since 1914

INDIANA

More satisfaction—
more profit too

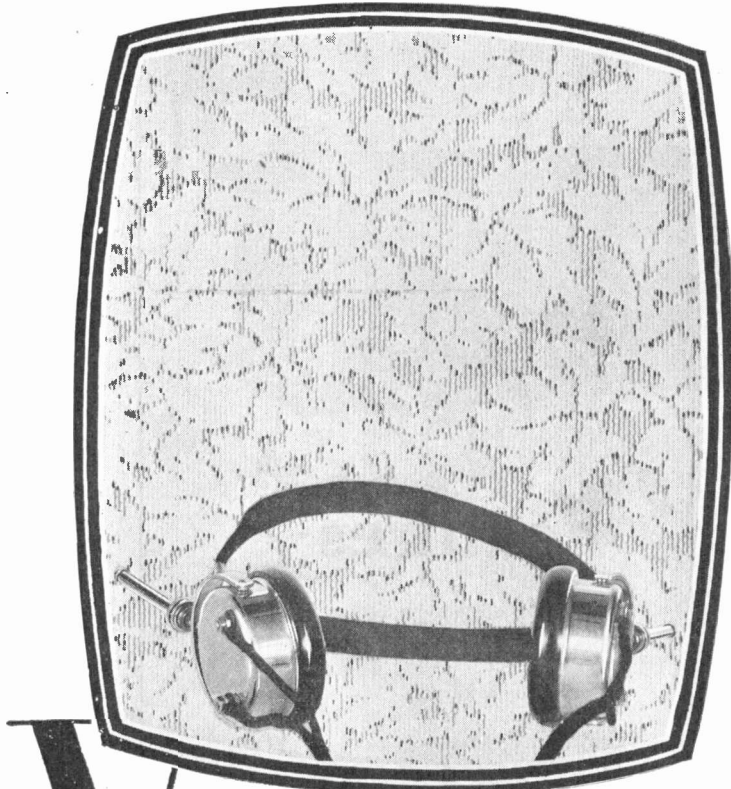

Viodyne

EVERY jobber and dealer takes a certain pride in being able to personally recommend a product—to pass along to his trade the good news of a “find.”

There is satisfaction in it—and there’s profit too, in the case of the Viodyne.

The Viodyne was developed by the man who was responsible for many of the outstanding features of the better known phones. The Viodyne is his greatest achievement of all.

An attractive proposition for jobbers and dealers. Write for particulars.

Why headphones are indispensable to the enjoyment of radio—reasons why you can make an extra profit by selling them!

They help get distant and low power stations more clearly.

They shut out outside disturbances.

They permit the use of the radio when the rest of the household wants to talk, read, etc. They prevent disturbing sleeping members of the family.

When the program is of interest to only one member of the family (such as baseball, prize fights, etc.), headphones solve the problem.

They reproduce more perfectly than the best of loud speakers.

MANUFACTURED BY

T-B-H RADIO COMPANY

Dansville, New York

Boston Representative: Martin, Hartley & DeWitt Sales Co.

For Better Radio
For Greater Profits



The Radio fan of today is seeking greater efficiency and improved appearance.

**FIBROC
(BAKELITE)
PANELS**

with their many superior features offer the best “buy” for the customer and the best “seller” for the dealer.

If increased business and increased profits interest you, write for our dealers proposition.

**Fibroc-Bakelite
Features**

High dielectric strength assuring lowest dielectric losses. Great tensile strength. Will not warp, crack, chip, feather or cold flow. Easily worked. Readily engraved. In black, high polish or mat finish; mahogany, circassian walnut or natural finish. Standard sizes each packed in individual envelope.

Fibroc Insulation Co.

258 Lincoln Ave.

Valparaiso, Ind.

For winding coils, sell them

FIBROC-BAKELITE TUBES

The Bosworth

All Wave

Air Set

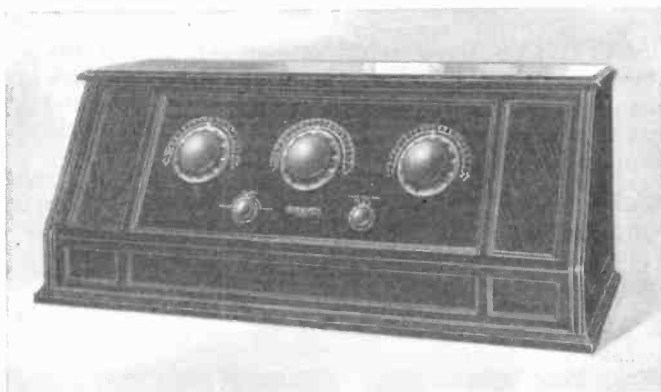

Adaptable to Low Wave Lengths Down to 50 Meters

Build for the future—with the set made to meet radio developments—the Bosworth All-Wave Air Set.

An easy adjustment, a twist of the dials—any station from 60 to 50 meters is at your command, ordinarily with 4 tubes.* Often excessively loud when 5 tubes are used.

On any wave length, Bosworth tones are true—a mirror-like reproduction. In addition, its excellent selectivity, easy tuning, economical operation make it the logical choice of your customers.

And attractive! Bosworth cabinet design and treatment are distinctive—solid antique brown mahogany, panel grained, etched bronze with molded bakelite knobs that match the cabinet.

Priced at \$155.00 equipped down to 150 meters—coverage to 50 meters at small additional cost. West of Rockies, add \$10.00.

Get the facts on the Bosworth Protective Plan—the coupon will bring them.

**We wish to come out in the open with those distributors and dealers who differed with us about our "4 tube statement" in the September issue. The Bosworth All-Wave Air Set will positively operate a loud speaker over the whole United States, under ordinary conditions with 4 tubes. This has been tested and proved in various localities. To all those who may still doubt the "4 tube" efficiency of the Bosworth, we invite communication and will gladly prove our statements to them personally.*



BOSWORTH
ELECTRIC MFG. COMPANY

The Bosworth Sales Plan Embraces:

- 1—Territorial Protection.
- 2—Price Protection.
- 3—Design Protection.
- 4—Cut Price Protection.
- 5—Guarantee of 100% Customer Satisfaction.

**WRITE
FOR
DETAILS**

BOSWORTH ELEC. MFG. CO.,
Main and Lexington Aves., Norwood, Ohio

Please send details concerning the Bosworth All-Wave Air Set and the Protective Sales Franchise.

We are: Distributors () Dealers ().

Name

Address

City State

MDeC: 9-10-25

Supremacy

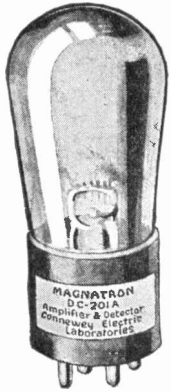

Magnatron DC-201A, DC-199, and DC-199 (large base) now list for only \$2.50

MAGNATRONS have achieved supremacy in the vacuum tube field, but the constant vigilance which has brought these tubes to the fore has not for one moment been lessened. Every part, from contacts to filament, is tested, constantly tested.

Small wonder, then, that Magnatrons have become equally popular with fan and dealer. When you sell Magnatrons you are selling something that will *not* come back to someone who *will*.

Connewey Electric Laboratories, Magnatron Bldg., Hoboken, N. J.

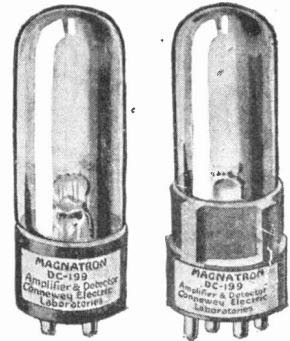

++&—B++
New! REX—the tube for "B" Battery Eliminators

MAGNATRONS

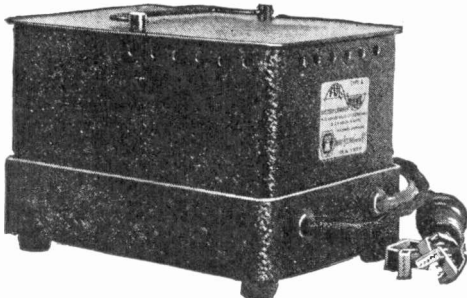

Model "A"

For radio "A" and 6 volt automobile batteries.
A. C. line, 40 to 60 cycle, 110-120 volts.
Battery—6 volts 6-8 amperes.
Comes complete with cords, plug and leaded clips.
\$18.00 List (East of the Rockies)

Model "A-B"

For charging radio "A" and "B" batteries *separately*, or to charge *both simultaneously*.
A. C. line 40 to 60 cycle, 110-120 volts. Battery—"A", 6 volts 3-4 amperes; "B", 48 to 96 volts in series, 1/10 ampere, up.
\$22.00 List (East of the Rockies)

FACTS ABOUT FUL-WAVE

- The only charger that charges A and 96 volts of B Batteries at the same time.
- Uses the Full electric wave to charge almost in half time.
- More economical to operate.
- Requires no water, chemicals or maintenance.
- Needs no adjustment.
- Quiet in operation.
- Cannot blow fuses.
- Not affected by jolts or jars.
- Cannot overheat.
- Foolproof. It is sealed at the factory.
- Absolute guarantee printed on each charger.

It made a great hit with
CONSUMERS at the **SHOWS**



Uses the FULL
A C Current—
not half of it!

Its simplicity of construction and operation, its economical use of current, the fact that it has no acids or chemicals, that it cannot get out of order, that it needs no expensive tubes—all these are things that *you* too can appreciate, because they make it *easier* to sell and it *stays* sold.

Test a Ful-Wave *yourself* and you will know how great an advance it is. Write for details.

LIBERTY ELECTRIC CORP. of NEW YORK - 342 Madison Ave. New York



Performance, Appearance and Price
SELL THE DYMAC SELECTO FIVE

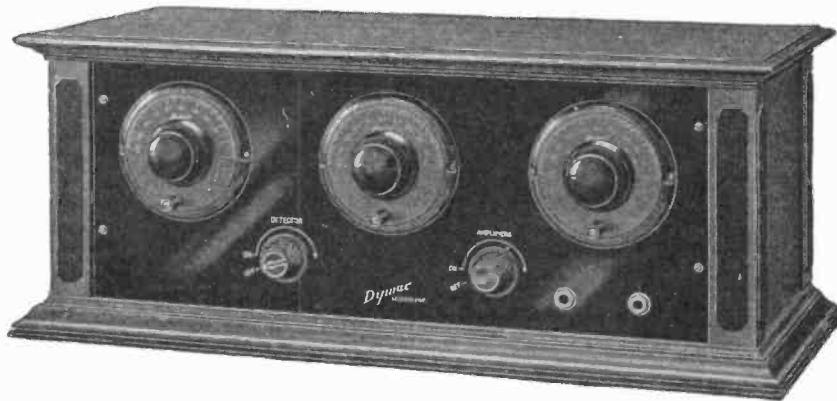

DYMAC Type "G" Standard Headset
 Tone tested and correctly balanced. It is light in weight with comfortable headband. Every radio owner needs one. List, \$5.00



DYMAC Type "E" Headset
 A popular priced Headset of exceptional quality. Improved headband. Each phone is carefully tested and matched before it leaves our factory. List, \$3.00

IF peculiar local conditions make reception difficult and handicap your sale of receiving sets, the DYMAC Selecto Five will solve this sales problem.

Built on an entirely new principle but made throughout of DYMAC Guaranteed Parts, this remarkable receiving set has outperformed neutrodynes, superheterodynes and regeneratives under the most rigid tests.

With its handsome walnut finished mahogany cabinet and ebonized panels and base, everyone takes the DYMAC at \$75 for a much higher priced instrument.

Backing your sales effort is effective DYMAC National advertising in the Saturday Evening Post, Country Gentleman and a selected list of sectional farm papers. Here is an outstanding sales opportunity in radio. Get in touch with the nearest DYMAC Factory Sales Agent and take advantage of it.

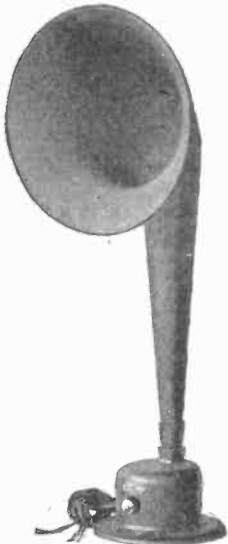

DYMAC Loud Speaker
 Handsome black deckled enameled finish with unusually wide range and accurate rendition of tonal values. A fitting sales companion to the DYMAC Selecto Five. List, \$8.50



DYMAC Vernier Dial
 A practical Dial which simplifies radio tuning. Central knob for coarse tuning with lower knob for finer tuning. Handsomely finished in black and silver satin. List, \$1.50

ELECTRICAL PRODUCTS MFG. CO.

Providence, Rhode Island

New York Office: Metropolitan Tower

Export Office: Ad Auriema, Inc., 116 Broad St., N. Y. City

DYMAC FACTORY SALES AGENTS

- | | |
|---------------------------------------|--------------------------------------|
| Chicago—E. V. Finson | Omaha—Leonard Kohn. |
| Cleveland—Factory Sales Co. | Fort Worth—Savage & Schmid |
| Boston—Hastings Elec. Sales Co. | Seattle—Fred. L. Tomlinson Co. |
| Washington—W. Lester Baker | San Francisco—Fred. L. Tomlinson Co. |
| Minneapolis—Twin City Radio Sales Co. | Los Angeles—Fred. L. Tomlinson Co. |
| St. Louis—Scott Gardner | Vancouver, B. C.—John E. T. Yewdall. |
| Kansas City—Wm. S. Reid Sales Co. | |
| Denver—Schmidt Sales Co. | |

Ask nearest Factory Sales Agent for catalog of complete line of DYMAC Guaranteed Radio Equipment

Other DYMAC Accessories and Parts

- Loud Speaker Unit, \$5.00
- Audio Frequency Transformers, \$2.50 to \$4.00
- Soldering Set, standard, \$2.50
- Crystal Set, complete, \$7.50
- Sub-panel Socket, 75c.
- Jacks, 50c. to 90c.

EVERY **Dymac** PRODUCT
 GUARANTEED FOR ONE YEAR

CROWE

ETCHED METAL

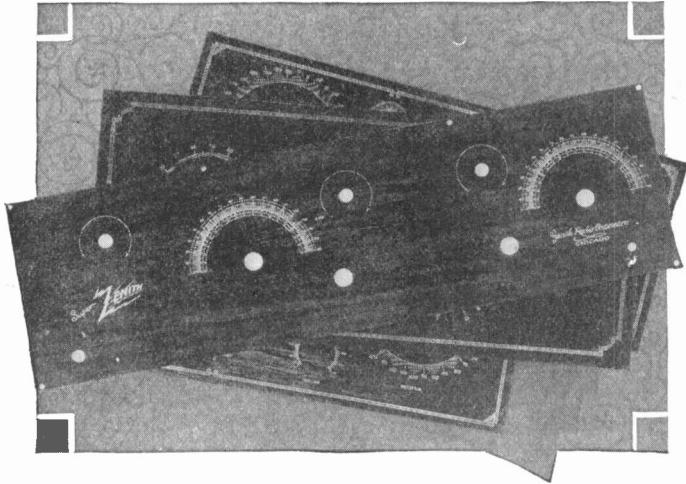

Important to Dealers and Their Salespeople!

Many of the leading makes of receiving sets you will sell this season are paneled with Crowe Etched Metal Panels. Their introduction marks a long step forward in better radio reception.

Dealers wishing to better acquaint themselves and their salespeople with the technical superiorities of this new paneling medium are invited to write us for a report of laboratory tests, together with copies of our instructive folder, "Why the Receiving Set I Buy Should Be Paneled with a Crowe Metal Panel."

Address

Crowe Name Plate & Manufacturing Co.
1749 Grace Street Chicago, Illinois

PANELS



Super-ZENITH
ERLA
OZARKA

Pearson

MARVELO

Beckley-Ralston

BLUE DIAMOND

Irving

HARMONSON

BOSWORTH

WORKRITE

These, among others, carry Crowe Panels.



Give Your Patrons
the Best Aerial
—and cut your installation
costs and service troubles

Effarsee

ANTENNAE
REG. U. S. TRADE MARK
PATENT PENDING

"Very selective and improvement in volume over outside aerial."

Connecticut dealer.

"Twice the range and more volume."

Ohio dealer.

"Two thirds less static."

Idaho amateur.

"It surely will get them from coast to coast."

Chicago amateur.

"Got seventy-eight stations from coast to coast in two nights."

Detroit experimenter.

(COPIES OF LETTERS ON REQUEST)

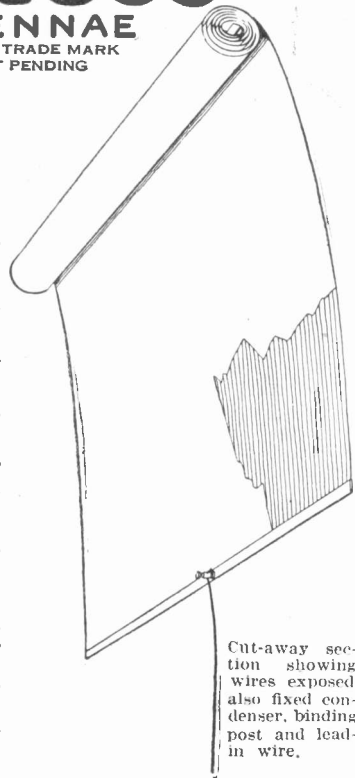

Cut-away section showing wires exposed, also fixed condenser, binding post and lead-in wire.

READ the testimonials—they bear out all of our claims for the Effarsee Antennae. It has the range and volume of a long antenna, the selectivity of a very short aerial—and cuts static to a minimum.

Lowers Your "Complete" Price \$10.

Now you can undersell your competitor at least \$10, because there is no installation cost. The Effarsee can be hung on a wall, in a closet, placed under a rug. It operates EVERYWHERE.

Outside aerials have been the "bug-bears" in the past with most dealers. 90% of service troubles could be traced to a poor connection, icicles and snow on the aerial in cold weather, etc. Now, these troubles are banished forever.

Type IXL (large) \$4.00
Type BXL (small) \$2.50

Most good jobbers have Effarsee Antennae in stock. If not, write direct TODAY for our proposition and liberal discounts but DO NOT DELAY.

FISHWICK RADIO CO.

Central Parkway and Elm Street
CINCINNATI, OHIO

Single Dial Tuning

Yet Greater Selectivity



The Wave Master Console

A beautiful genuine mahogany model with inbuilt horn.

\$235.00

Also made in a handsome Console Model. Price \$275.00

"NOW I Get What I Want When I Want It"



Standard Model 5-Tube Wave Master in beautifully finished cabinet of solid genuine mahogany. Price

\$125.00

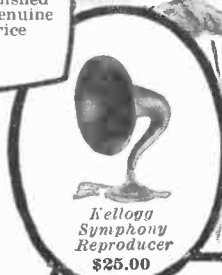

Kellogg Symphony Reproducer
\$25.00

A PROFIT that is yours to keep —all of it!

Only the inexperienced dealer will choose a radio set for his trade solely on the basis of the profit margin it offers him.

With wise merchants, profit comes third. First, they want to know that the manufacturer is in business to stay. Second, they demand that the set shall be as nearly trouble-proof as possible.

A profit that must be dribbled away in making repeated service calls on disappointed customers is not a profit at all.

Kellogg dealers collect a good profit and KEEP it. No other radio receiver of equal power and range is more nearly fool-proof, so simple in design and operation as the 5-tube WAVE MASTER. Its one-dial tuning, with greater selectivity, is an unbeatable combination.

As for the future of the Kellogg Switchboard & Supply Company, it is amply guaranteed by its past history. What Rolls-Royce means to buyers and sellers of motor cars. What Steinway stands for in the piano trade—that is what KELLOGG has represented in the great electrical industry for the past 28 years.

Let us prove to you that the WAVE MASTER is easier to sell than to compete against. Mail the coupon for our attractive proposition. Ask for Folder No. 12-J.

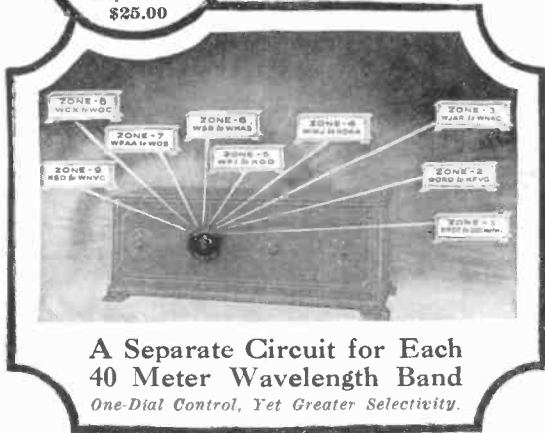

*Just
Out-*

**Here
It Is!**

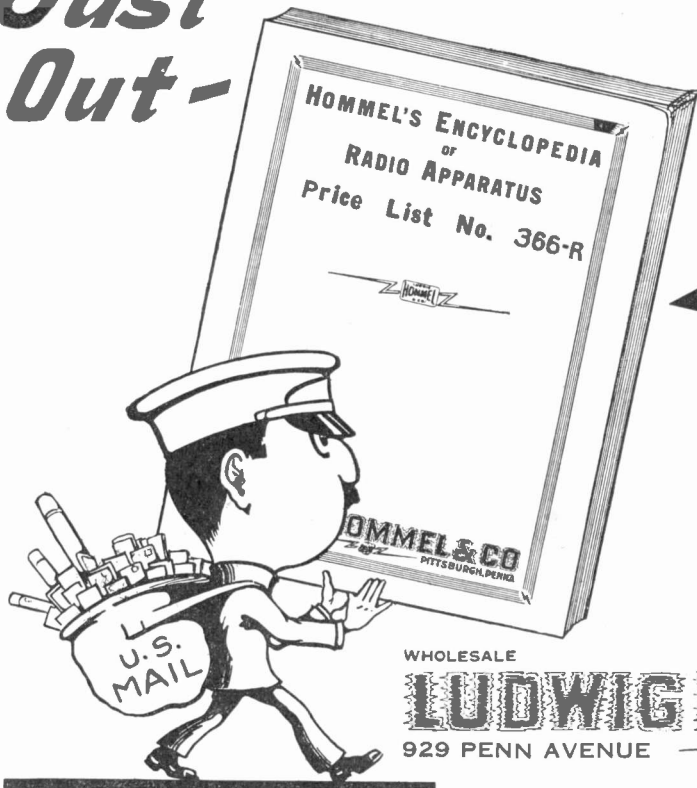

*Send for it
NOW*

WHOLESALE

EXCLUSIVELY

LUDWIG HOMMEL & CO
929 PENN AVENUE PITTSBURGH, PA.

ANNOUNCING

the

Type 334 Condensers

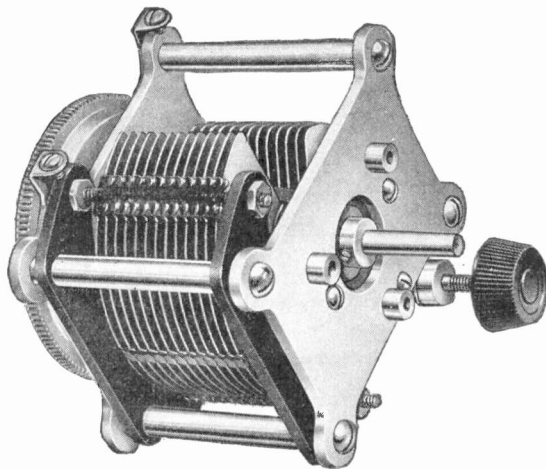

In certain instances of radio construction the shielding effect of a metal end plate condenser is particularly important.

In accordance with the policy of the General Radio Company to supply the demand for a complete line of quality parts, the type 334 condensers with metal end plates have been developed and are now ready for distribution.

This new condenser is similar, with respect to plate construction and bearings, to the already well known Type 247 condensers.

The type 334 condensers incorporate as many of the superior electrical features as is possible to use in metal end plate construction.

In addition to its high electrical efficiency, particular attention has been given to ruggedness, permanence of calibration, and uniformity between separate condensers. These are the factors essential to successful operation in modern radio sets.

The above features of the General Radio type 334 condensers combined with popular prices make General Radio condensers the outstanding values of the opening of a new radio season.

Order thru your jobber now or write for our new revised price sheet.

Type	Capacity		Price
334-H	500 MMF	With Vernier	\$5.25
334-F	500 MMF	With Counterweight	4.25
334-P	350 MMF	With Vernier	5.00
334-N	350 MMF	With Counterweight	4.00
334-M	250 MMF	With Vernier	4.75
334-K	250 MMF	With Counterweight	3.75

GENERAL RADIO COMPANY
30 State St., Cambridge, Mass.

GENERAL RADIO

“Behind the Panels of Better-Built Sets”

A Complete Unit

The BEAR CAT
Model 55
Price \$160.00
with built-in loud
speaker and battery
space.

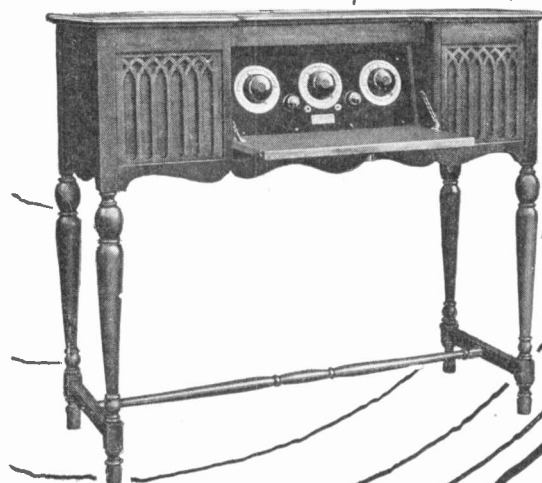

All-in-one package, Dry Tube Radio Receivers

Not only is the WELLS BEAR CAT made to do that which a radio set is expected to do, but also, it is designed and perfected to save dealers assembly and servicing costs.

The simple thing about the WELLS BEAR CAT is that it is a complete unit—sold as an all-in-one-package. You simply hand it to the customer—the customer carries it away complete—the assembling is done in your place of business—the customer has nothing to do but connect to antenna, ground and tune in.

To The Experienced Radio Dealer

You have sold sets requiring storage batteries. You know what it means then to both yourself and customer when we tell you that the WELLS BEAR CAT does away with the inconvenience and service costs of the storage battery. This means much, especially in rural communities.

No storage battery set operates better—none requires less service cost, because the WELLS BEAR CAT set being an all-in-one-package can be brought to the dealer for any service required.

We request that you make comparisons with the best makes of storage battery sets—we want you to see the difference—to see the real value of this “dry tube success”—to see the advisability of selling the WELLS BEAR CAT.

Our exclusive franchise to Jobber and Dealers is an attractive one and proves very advantageous to every one concerned.

The Wells Radio Mfg. Co.
2710-12 N. Ashland Ave., Chicago, Ill.

The BEAR CAT
Model 5
Price \$110.00
with built-in loud
speaker and battery
space.

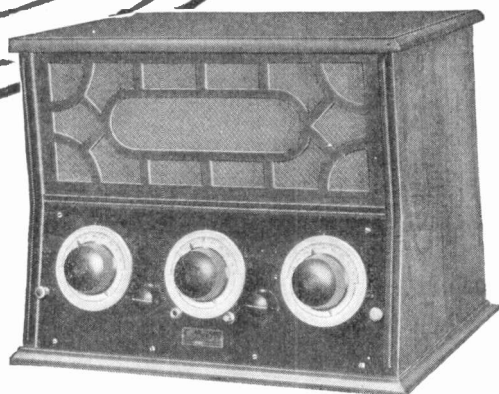

The BEAR CAT
Model 50
Price \$95.00
Same as Model 5,
except without built-in
loud speaker. Ample
space for batteries.

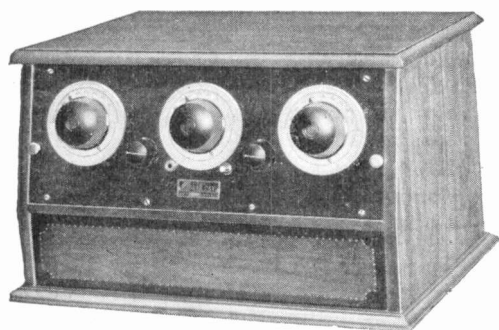

The Wells
BEAR CAT

THE DRY TUBE SUCCESS

"We are therefore glad to congratulate you on having achieved the manufacture of a hydrometer which is far superior to most others which we have tried."

Very truly yours,
 XXXXXX ELECTRIC CO.
 (Name on Request)
 Chief Engineer.

SUCH flattering words from one of the foremost battery and battery charging equipment engineers does not come unearned. He knows batteries and hydrometers from a practical and technical standpoint and when he says "and yours we are glad to state are perfect by every laboratory test" it means just that. The

AYANBEE
Radio Battery Tester
 For "A" and "B" Storage Batteries is perfect by every laboratory test. Why search for a dependable battery tester, when the searching has been done for you in the laboratory of a well-known electrical equipment manufacturer.

Dealers: See your jobber.
 Jobbers: Write for Discounts.



LIST
 75c

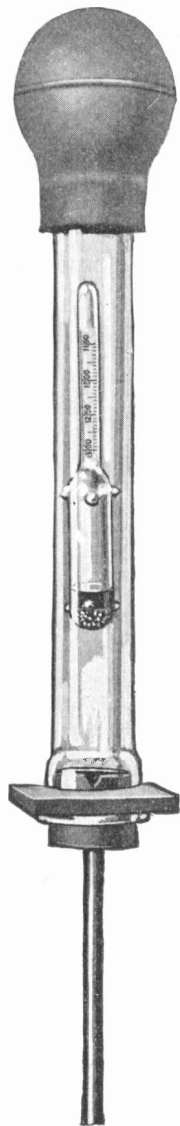

"Unless the Float
 is Right,
 the Reading
 is Wrong"

The Scranton Glass Instrument Co., Inc.
 Scranton, Penna.

The Loud Speaker that has the whole country talking!



The KODEL MICROPHONE LOUD SPEAKER

Not since the days when people stood in line to buy crystal sets has there been such a sensational radio seller as the new Kodol Microphone Loud Speaker.

An exact replica, in actual size and appearance of the transmitting microphone used in broadcasting. The efficient Kodol reproducing unit is mounted inside the microphone case with an ingenious new snail-shell horn—produces a volume and quality of tone equal to any of the larger speakers—its non-vibrating metal tone chamber absolutely eliminates all distortion.

\$15 model incorporates the Kodol, Jr. unit; \$20 model contains the larger standard Kodol unit.

Ask your jobber to show you the Kodol Microphone Loud Speaker, or write direct for descriptive literature. See the announcement of Kodol Radio Receivers and the New Improved A and B Gold Seal Homcharger in this magazine.

THE KODEL RADIO CORPORATION
 503 E. Pearl Street Cincinnati, Ohio



The New MURDOCK NEUTRODYNE RECEIVER

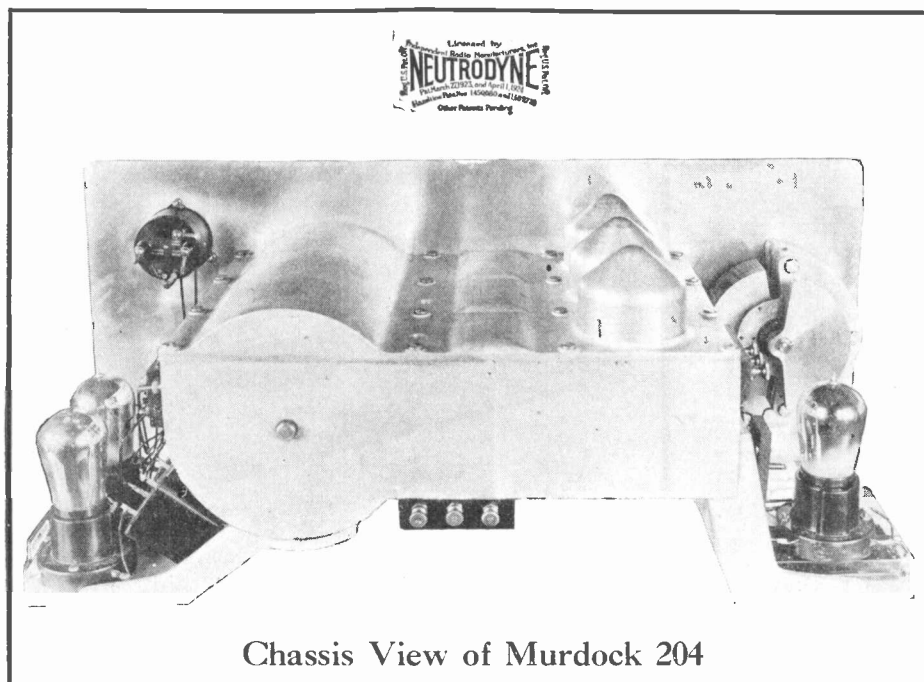

No Antenna or Ground!

THE latest achievement in radio by radio's pioneer manufacturers. Radically new. No other set like it. Two-dial control. Easier to tune than a one-dial set.

Murdock scores again!

Ask your distributor or jobber about the new Murdock 204 or wire us for details.
Wm. J. Murdock Co., Dept. 101, Chelsea, Mass.

MURDOCK RADIO

Standard since 1904

THE TUBE WITH A SENSIBLE GUARANTEE 

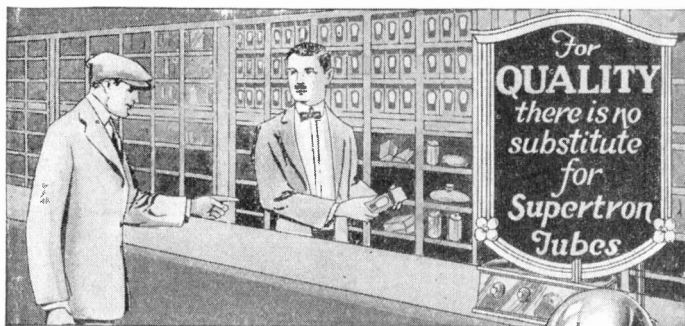

**They want!
What they want!
When they want it!**



You owe that service to your customer in consideration of patronage.

You owe that service to yourself in consideration of profit and good-will.

**Earn Both—give them Supertron.
As good as a tube can be.**

Not "Just Guaranteed" that's nonsense, but Guaranteed by a serial number with identification that's sensible.

ALL TYPES **\$2.00** EACH

Canada \$2.75

DISTRIBUTORS

- C. E. Niehoff & Co. Chicago
- Firestone Radio Set Co. Chicago
- Yahr & Lange Drug Co. Milwaukee
- The Roycraft Co. Minneapolis
- Hippee-States Auto Sup. Des Moines
- Sorenson Lamp Co. Des Moines
- Orr Bros. Cedar Rapids
- Radio Dealers Sup. Co. San Francisco
- Western Light & Fix. Co. Los Angeles
- Keystone Radio Dist. Co. Philadelphia
- Keystone Radio Dist. Co. Philadelphia
- Allentown Radio Dist. Co. Allentown
- Goodlin Auto Sup. Co. South Bend
- Fort Wayne Iron Store. Ft. Wayne
- Swanson Electric Co. Evansville
- M. H. Johnson Electric Co. Utica
- Hinsdill Electric Co. Troy
- American Phonograph Co. Albany
- Rosen Talking Machine Co. Boston
- Balt. Hub Wheel & Mfg. Co. Baltimore
- Cycle Auto Supply Co. Buffalo
- H. D. Taylor Co. Buffalo
- Iroquois Sales Co. Buffalo
- Hamburg Bros. Pittsburg
- Radio Stores Inc. Denver
- Reynolds Radio Co. Denver
- Burr-Powler Syracuse
- Ed. J. Goetz Co. Cincinnati
- Elgin Radio Corp. Elgin
- Alberta Radio Co. Alberta, Canada
- Imperial Radio Co. Sault Ste. Marie, Canada

BRANCH OFFICES

- ATLANTA Georgia Savings Bank Bldg.
- DALLAS 2006 1/2 Commerce St.
- PHILADELPHIA 353 No. 4th St.
- INDIANAPOLIS 19 Arcade
- CHICAGO 21 E. Van Buren St.
- PITTSBURGH 1406 Keenan Bldg.
- DETROIT 714 Lafayette Bldg.
- MINNEAPOLIS 229 So. 4th St.
- KANSAS CITY 410 E. 14th St.
- DENVER 1641 Stout St.
- SAN FRANCISCO Rialto Bldg.
- BUFFALO 293 South Elmwood
- BOSTON 99 Bedford St.
- OMAHA, NEB. 625 Securities Bldg.
- LOS ANGELES 443 So. San Pedro St.

SUPERTRON MFG. CO., Inc.
HOBOKEN, NEW JERSEY

Export Dept. 220 Broadway, N. Y. City

SUPERTRON
A SERIAL NUMBER GUARANTEE

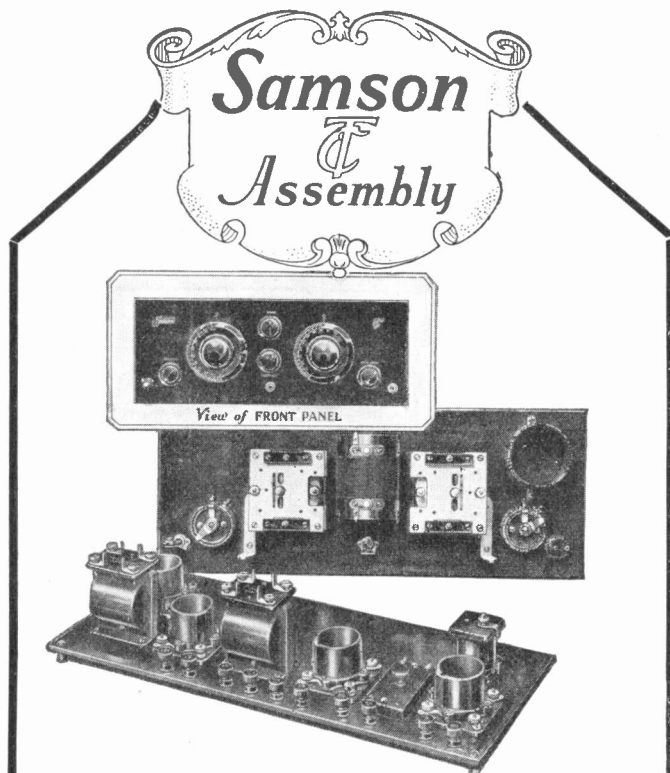

Your Confidence Is Deserved

In space of but 18 x 7 x 7 inches SAMSON Engineers, by combining new and vital parts of SAMSON manufacture with other fine standard parts, have created this improved assembly based on a fundamental and successful circuit. Easily wired in a few hours. An independent Radio Testing Laboratory reports: "A high power set designed to cut thru locals and to bring in distant stations with perfect quality and volume." A copy of the complete article will be mailed on request.

Samson TC Assembly of best standard parts mounted on genuine Formica engraved and drilled panels all ready for wiring—\$65.00.

Rebuild Your Present Set

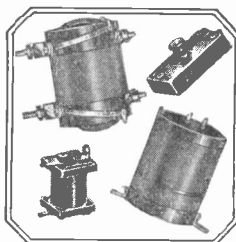

The new and vital parts of the Samson TC Assembly are included in the Samson Transcript Kit and may be combined with the parts you have.

Kit Price \$14.75

Samson Electric Company

Manufacturers Since 1882

Canton, Mass.

Sales Offices in 30 Principal American Cities



Samson
Radio Products

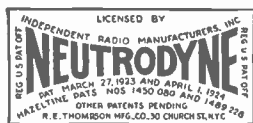

*Super-Thompson
Duo-tone Console*

List price, \$360. A 5-tube special Neutrodyne with single master control, large Queen Anne mahogany console cabinet, with space for all batteries or battery eliminator. Includes the newly developed Thompson Duo-Tone sound reproducing system. Creates a sound perspective and provides a range of tonal reproduction never heretofore attained. The greatest contribution to radio realism since broadcasting began.



Buyers are asking for

Thompson Sets

THE public has discovered Thompson tonal quality to be superior. It knows that back of it lies fifteen years of laboratory research work and the practical production of 116 different types of radio instruments. It knows that Thompson products are somewhat ahead of the times. It buys Thompson Radio with eagerness and with confidence. These things, combined with the Thompson trade policy that has stabilized and protected the dealer's profits, make the Thompson line preferred by dealers of the better class. From such we will be glad to receive inquiries. R. E. Thompson Manufacturing Company, 30 Church Street, New York City.

All prices slightly higher west of the Rocky Mountains and in Canada

*Thompson
Grandette*

List price, \$125. The standard 5-tube Thompson Neutrodyne in a vertical mahogany cabinet. Uses dry or storage battery tubes. Great distance, clarity and volume. The performance of this model immediately established the enviable position occupied by Thompson in the radio industry.



*The Thompson
Speaker*

List price, \$28. The standard by which all other speakers are still judged. Employs a special cone-shaped diaphragm with large composite horn. Six other special features.

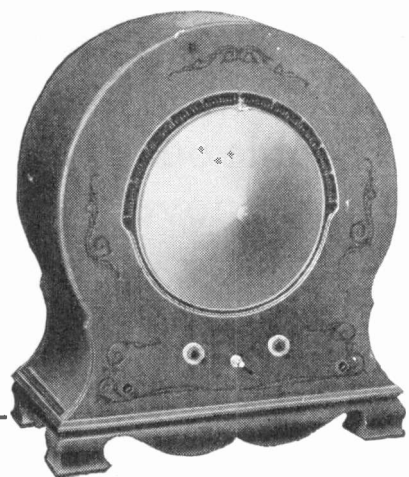
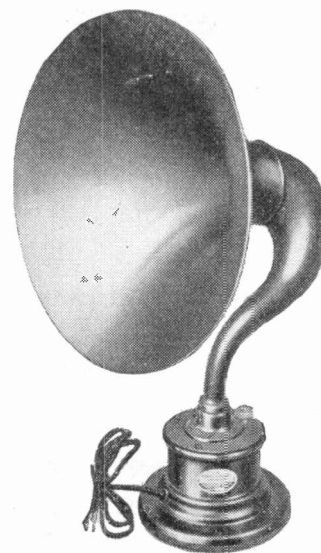

Thompson Minuet

List price, \$150. A 5-tube dry-cell Thompson Neutrodyne Receiver combined with improved cone-shaped speaker. Unique "apartment house special" for use where space is at a premium. All batteries are self-contained. Does not use a storage battery. Operates on dry-cell tubes. If necessary will operate on a wire around the picture moulding. Size—21½ inches high, 18½ inches wide, 10½ inches deep.

THOMPSON RADIO

FREE TO DEALERS — "Electrad" Lead-In mounted on display card. Write for yours today. No strings attached — nothing else to buy.

"ELECTRAD" Lead-In. A tremendous market for this efficient accessory. Made to satisfy "Electrad's" high standards of quality — there is a difference. Water proofing and insulation of superior quality. List 40c.

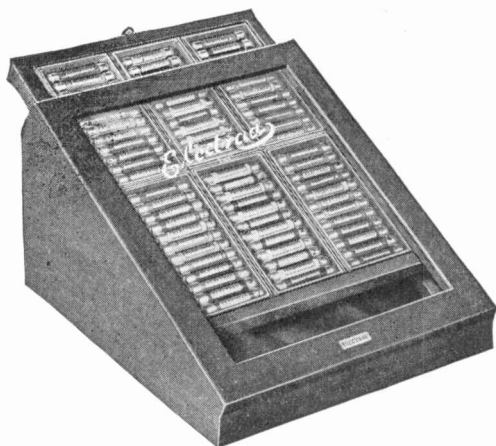

"ELECTRAD" CERTIFIED GRID LEAKS — Absolutely accurate, calibrated in fixed resistances from $\frac{1}{4}$ to 10 megohms. Mahogany finish display cabinet FREE with order of six dozen grid leaks. List 50c each.

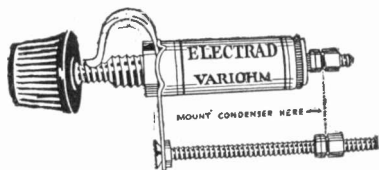
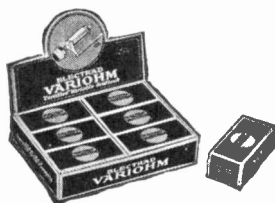
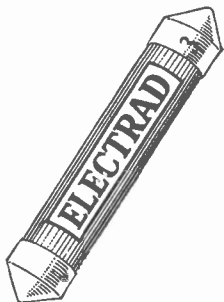

"ELECTRAD" VARIOHM — A variable grid leak for extra fine tuning. Resistance variable from $\frac{1}{4}$ to 30 megohms. List \$1.25 for panel mount, \$1.50 for base mount.

NOTE: The Variohm will also be supplied with Electrad Grid Condenser Attached. List Price \$1.50.



ELECTRAD Inc.

brings to Radio the precision of eminent radio engineers and designers — men whose creations are improving radio reception.

With the unusual design of our radio essentials we blend practical experience. Experimentation and study enable our experts to mate novelty and utility.

DEALERS AND JOBBERS

The "Electrad" line is compact, comprehensive and nationally advertised. Individually packaged and packed in our "Sales-Maker" counter cartons. *Wire or write* for the "Electrad" proposition. We'll answer promptly, definitely, convincingly!

ELECTRAD Inc.

428 BROADWAY, NEW YORK CITY



Going Strong

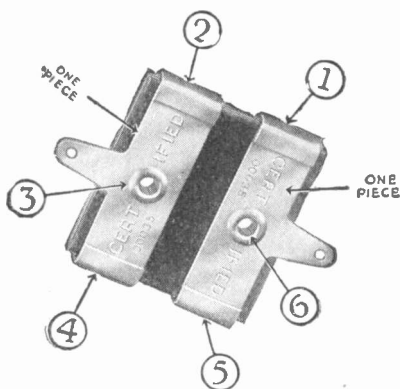

"The Six Point Pressure Condenser"

THE "ELECTRAD" Certified Fixed Mica Condenser is a revelation in accuracy and design. Ingenious, rigid binding and firm riveting fastens parts securely at Six different points, insuring positive electrical contact. Impervious to temperature and climatic variations. Exerts even pressure upon the largest possible surface—can't work loose. Binding strap and soldering lug in one piece. Accuracy and quietness assured always. Value guaranteed to remain within 10% of calibration. Standard capacities, 3 types. In sealed dust and moisture proof packages, price 30c to 75c.

These features broadcast nationally by aggressive advertising in leading radio magazines present profitable sales opportunities to alert retailers. Send for booklet and samples.

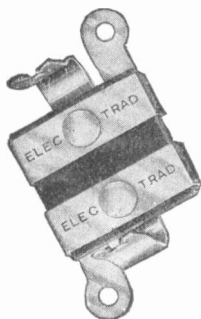

TYPE G-S— with brackets and special arms for socket mounting.

Licensed under Pat. No. 1,181,623, May 2, 1916 and applications pending.

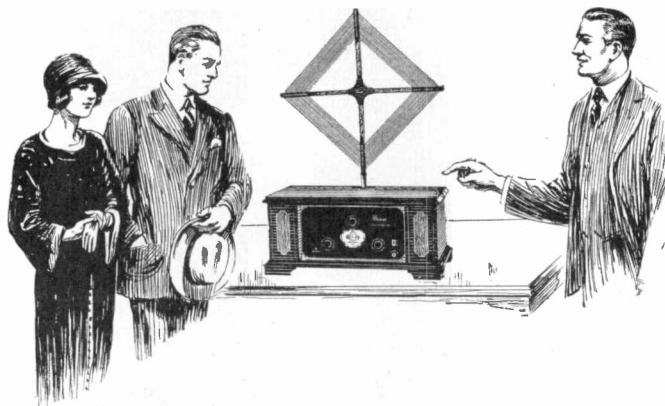

"It has no equal for extreme distance range"

A DEALER can make such a broad statement in offering the Priesse Straight Eight to a customer and a comparative demonstration will be the convincing proof.

No set on the market today has the great energy amplification of the "Straight Eight"—an 8-tube set having an amplification of 4,000,000 before the detector. This great energy amplification means d-i-s-t-a-n-c-e, with unexcelled clarity—what the public is looking for in radio sets today.

Its loop operation gives a Priesse dealer an overwhelming advantage over his competitors in making home demonstrations. Its *one* turning control, with visible wave length indicator graduated in one-meter divisions, is a feature that means sales.

Our liberal dealer discount, plus protective features, will interest progressive dealers. Write or wire us to arrange for the earliest possible demonstration by our distributor in your territory.



Console model with enclosed panel operated loop and built in loudspeaker and battery compartments \$285

Priesse
TRADE MARK
STRAIGHT EIGHT

PRIESSE RADIO CORPORATION
695 BROADWAY  NEW YORK, N.Y.

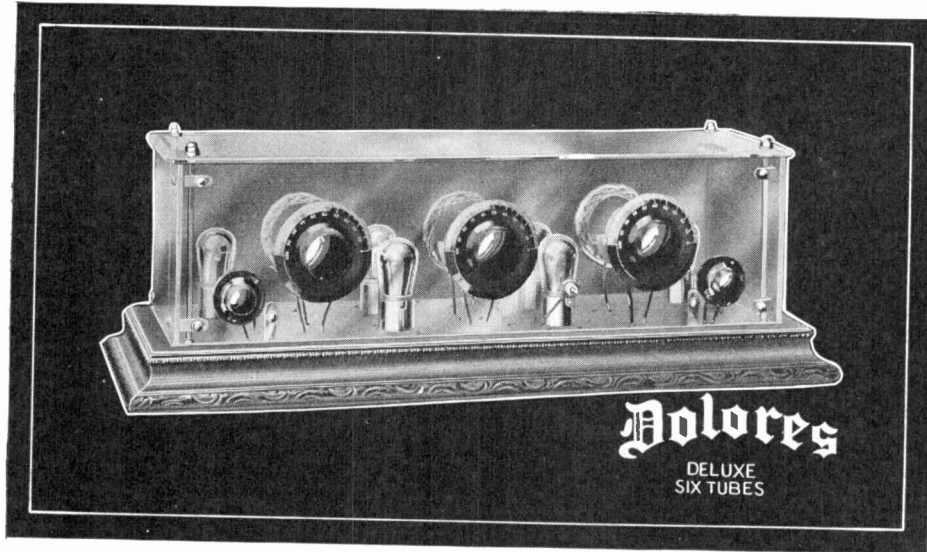

This is music—this is beauty

Dealers find that in its setting of crystal plate glass, the Dolores draws an unprecedented flood of requests for demonstrations

The Dolores is distinctive in its simplicity, its performance, its beauty.

"You see the goodness of its inmost parts."

Its true musical tonal quality has not been excelled in any other instrument,—and we realize the strength of this assertion.

Its volume is such that in many cases, dealers

have used fixed condensers or resistance on the "lead in" to reduce its volume on the loud speaker. Every set is tested on the air before shipping.

Its makers are not of mushroom growth, having manufactured for 24 years, all sorts of tools and metal goods, specialties. Every day we make tens of thousands of radio parts for other manufacturers.

Some Small and Large Territories Open!

A sound and aggressive merchandising policy for dealers and jobbers. Territory and price protection, and a discount that gives energetic dealers leeway to sell on time, to accept trade-ins and and still make a good profit.

Write for details.

FRED W. GOERDES COMPANY DEPT. R. 81-85 Mt. Prospect Avenue, Newark, N. J.

At last! Positive Simplicity

THE RECEIVER THAT HAS NO EQUAL

The DIALLESS RADIO

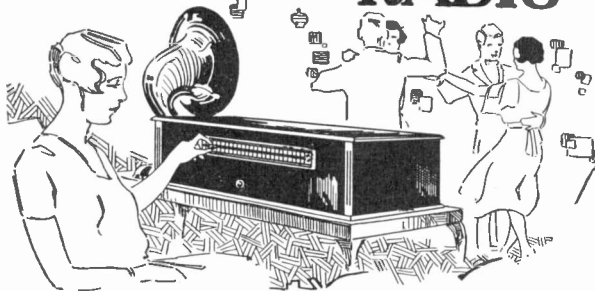

6 Tubes. Lists at \$150.
Gould and other patents pending

The DialLess is a precision instrument, thoroughly tested before leaving our factory. Produces unsurpassed results on either outside antenna, inside antenna or a loop.

The parts used in this machine are of the best material and workmanship. Each part is tested separately before assembling. The Cabinet is of solid mahogany, beautifully finished.

DialLess Radio Corporation
115 Federal Street - Boston, Mass.

Easy Operation: It tunes as positively and as accurately as the combination of a safe is worked. A small child can operate this set without the least difficulty.

Tone Quality and Power: It will bring in distant stations with the same volume as local, yet it can be tuned down for use in the sick room or hospital without impairing its clarity. Most stations are brought in on the Loud Speaker without using a headset for tuning.

High Selectivity: It exhibits the greatest selectivity that is possible without impairing the tonal quality or volume.

Great Distance: It places a whole continent within its range. Gives good reception on average evenings within a radius of 2,000 miles and is equally efficient on all wave lengths.

Stability: It holds a station indefinitely and cannot be "knocked off a station" by radiations from neighboring sets. Does not howl or squeal in any manner and is perfectly balanced under all operating conditions.

Special Introductory Offer to Dealers.

DialLess Radio Corp., Boston, Mass.
115 Federal St., Boston, Mass.
We are interested in your special introductory offer to dealers, your special price for sample sets to dealers, and we would like to have your authorized dealers proposition. We believe we can sell sets this year.

Name
Address
City



Sell 'em Radio on the Meyer-Kiser Plan

Increased Profits By Using the Time Payment Plan

THE MEYER-KISER monthly payment plan for radio sales is extremely simple. Under our plan the dealer receives the full retail price of the set, in cash, exactly as in the case of a straight cash sale. There is no hold back or retainer, and the dealer is thus able to give his customer the full benefit of credit terms, but without using one cent of his own money to do so.

Our plan is simple, and is readily explained to the purchaser. The financing charge is added to the unpaid balance and any transaction can be computed in a half minute's time. There is nothing complicated and no involved figuring to irritate the purchaser.

*Meyer-Kiser will help
you—write us today—*

Any radio dealer in good standing can use the Meyer-Kiser Plan. Payments of monthly installments are made to the dealer at his own place of business. This practice keeps the customer coming to the store, giving the dealer every opportunity to keep in touch with his trade and to continue selling accessories and equipment. Because we deal only with responsible dealers, our rates are low.

MEYER-KISER CORPORATION
Meyer-Kiser Bank Building
INDIANAPOLIS, INDIANA

Sangamo Mica Condensers

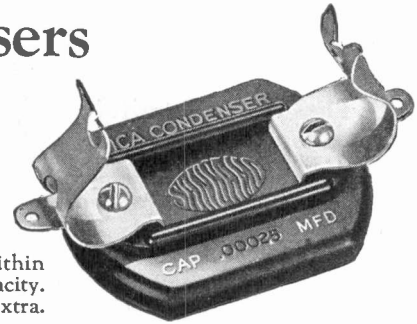

Accuracy guaranteed within
10 per cent. marked capacity.
Resistor clips 10 cents extra.

In reflexing - -
where accuracy brings results

BECAUSE of their high accuracy, Sangamo Mica Condensers give splendid results in reflex circuits, where exact capacity is necessary to success. Any receiver, whatever the circuit, is improved by the use of Sangamo Condensers, because they *are* accurate, and they *stay* accurate.

The accuracy of these condensers is not affected by heat or cold, moisture or acid fumes, soldering or electrical surges.

Being solidly molded in smooth brown bakelite, they will not chip or crack even if dropped several feet to a hard cement floor. The edges are rounded, and high ribs increase their mechanical strength. Show a Sangamo Condenser to any set builder who is particular about fine workmanship, and watch his face light up with appreciation.

You can keep one in a glass of water on your show case or in the window to show how waterproof it is. The condenser will not be hurt in the least.

The guarantee of accuracy is the pledged word of an established manufacturer known all over the world as a leader in making precision electric recording devices.

Sangamo Condensers are made in all standard capacities, with or without resistor clips. They are not expensive. Quite otherwise, in fact.



Waterproof

Heatproof

Fumeproof



THIS display card is now ready. Ask your jobber.

Sangamo Electric Company
Springfield, Illinois

RADIO DIVISION, 50 Church Street, New York

OFFICES IN
PRINCIPAL CITIES
For Canada—Sangamo Electric Co. of Canada, Ltd., Toronto
For Europe—British Sangamo Co., Ponders End, Middlesex, Eng.
For Far East—Ashida Engineering Co., Osaka, Japan

"The Voice from the Sky"

A Loud Speaker of Striking Beauty

Its beauty excelled only by its pleasing reception.

The Most Beautiful Speaker on the Market

With its artistic design and tonal qualities it has a double sales value and is an attractive piece of furniture.

A Utah Unit is used in the base. The overall Height is 24-in., with a bell diameter of 12-in.

Will appeal to the most discriminating buyer.

List Price \$30.00

Write for Further Information and Discounts



Design Patented By L. ROMANELLI

Manufactured by

Florentine Art Productions, Inc.

838 W. Austin Ave., Chicago, Ill.

General Sales Agent

KABERNA & CO.

54 W. Lake St., Chicago, Ill.

KEYSTONE LIGHTNING ARRESTERS

Now is the time to stock Keystone Arresters

\$1.50 each

In Canada \$2.00

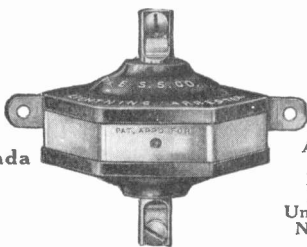

Approved by The National Board of Underwriters No. E-1835

Big sales for the Nationally advertised Keystone Radio Arrester are just ahead. Place your order now for your stock of this famous Arrester—made of genuine Bakelite and brass parts. You can sell nearly every customer a KEYSTONE RADIO LIGHTNING ARRESTER. Simply include a Keystone Arrester with every set you sell. Try it today.

Order from your Jobber or write for complete information.

ELECTRIC SERVICE SUPPLIES Co.

Manufacturer of Nearly Two Million Lightning Arresters

Philadelphia, 17th and Cambria Sts.; New York, 50 Church St.; Chicago, Monadnock Bldg. Branches: Boston, Scranton, Pittsburgh.

The Mark



of Tone Quality

Exactly Exponential Ceramic Material Scientific Diaphragm Loading



A distortionless reproducer of the audio frequencies — no "clipping" at either end of the scale.

Manufactured by Chicago Signal Company

Exclusively for

PARCELLS & COMPANY

68 W. Washington St., Chicago

The Wilson "B"
Radiopower-Unit

Pats. Pend.

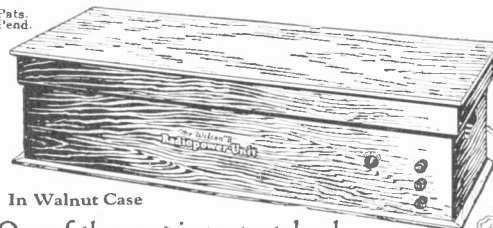

List \$35

In Walnut Case

One of the most important developments of the season. A dry storage "B" battery, together with *Automatic* trickle charger, built into a handsomely finished combination walnut case. As convenient as an eliminator, *but will not set up the slightest hum in the receiver.*

Dependable and economical. Delivers constant voltage. Requires no attention except to switch it on and off. No acid to spill. No moving parts to get out of order. Every set owner is a prospect regardless of the type of unit he is now using. This will be a Radiopower-Unit year.

Place an order for your requirements now.

Pats. Pend.

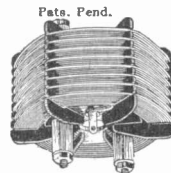

The Andrews
Paddlewheel-Coil

Made in three types adapting it to nearly all standard hook-ups. *Has exceptionally high ratio of inductance to resistance with minimum distributed capacity. Moisture proof. No dope on windings.*

Increases range, volume and selectivity. Improved tone quality is noticeable throughout the entire wave length band. Losses are negligible. Used in highest grade receivers such as Andrew's *Deresnadynce*, and *Buckingham*. We can furnish constructional blueprints of many receivers and circuits using this superior coil. **List Price \$3.00.**

Our Technical Department will answer Inquiries.

Duo-Spiral Folding Loop

List \$8.50

A compact and beautifully proportioned loop. Handsomely finished in silver and mahogany. Has insulated handle and graduated dial. Reduces static and helps to cut out interfering stations. A special model for super-heterodyne and all other standard circuits. Made in 18 and 24 inch sizes.

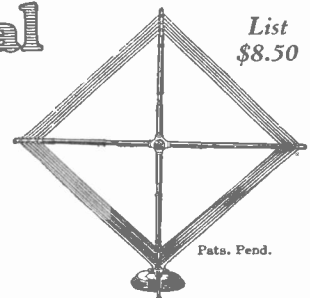

Pats. Pend.

Stock these thoroughly dependable and extensively advertised products. Discounts on request.

Radio Units Inc.

1317 First Avenue

Maywood, Illinois

Perkins Electric, Limited, Toronto, Montreal, Winnipeg

FREE ideas for your business

Here's a chance for you to get some valuable ideas for your business FREE—ideas similar to those that doubled Anderson Bros.' business in four months; increased another firm's sales \$144 a day; saved another user \$1,000 in printing costs; netted another \$300 profit from one day's use.

ROTSPEED STENCIL DUPLICATOR

We will tell you how you can reproduce these ideas with a Rotospeed—without type or cuts—without fuss, muss or delay. Rotospeed prints anything that can be hand-written, type-written, drawn or ruled—quickly and at a very low cost.

"Rotospeed is certainly speedy. We can turn out 500 letters in jig time. We have only praise for the machine."

H. J. Harmer and Son

Ten Days FREE Trial

Send us your name. In return we will send some money-making, money-saving ideas that apply specifically to your business, also full details of the Rotospeed and our FREE trial offer. No cost or obligation.

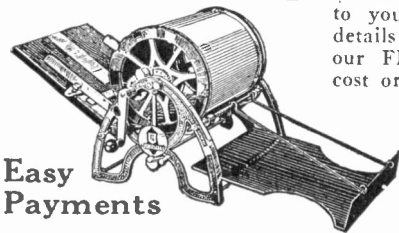

Easy Payments

The Rotospeed Company
335 Fifth St.,
Dayton, Ohio

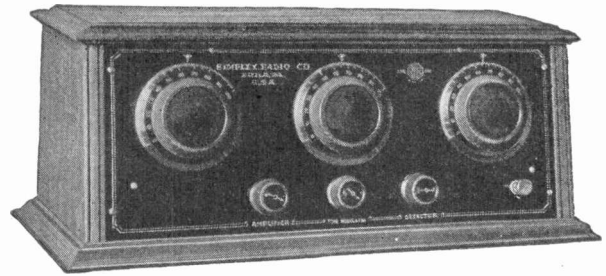

The New Simplex SR 8

\$65 list

Embodies the latest refinements of radio engineering—and at a popular price. Five tube tuned radio frequency circuit. Tone modulator gives gradual, noiseless adjustment, from a whisper to maximum volume. Straight line wave length condenser spreads stations conveniently over the dial. Extremely selective. Genuine mahogany cabinet, beautiful Adam Brown finish. Sloping panel makes tuning convenient. Thirty years of manufacturing experience guarantees the highest standards of quality and workmanship throughout.

Jobbers and Dealers, We Have an Attractive Proposition. Write for it.

SIMPLEX RADIO CO.

Plant and General Offices
Main and Rec'or Streets, Philadelphia

THE BIG BUY IN RADIO

The Radio of Proven Merit

Many Exclusive Features

CONSOLE

Model No. 700
A Quality 6-Tube Console with built-in Loud Speaker and a Beautiful Brown Walnut Cabinet. Price Complete \$175.00

Model No. 502

Exactly the same as Model 500, except that it has 6 Tubes. This superior set using only 3 Vernier Dials lists at \$80.00 and works on inside Aerial

THE INDIANA HYPERDYNE

Is the Big Buy in Radio. We receive letters daily telling us of the startling results dealers are having with our sets—and why? Because the owners, with amazing precision are getting dependable performance with selectivity—distance—volume, and tone-quality unheard of in a Radio anyways near its price.

This ultra quality Radio Receiver will give you a substantial profit and will give your customers the best they can buy at a nominal cost. Investigate now! Learn the Facts!

Write your jobber or us direct for full descriptive literature, attractive window displays and dealer's help.

Description—A De Luxe five tube long distance receiver with a Beautiful Hand-Rubbed, Solid Mahogany Cabinet 24x8x12, with a 15° Sloping Panel. All parts fabricated from The Best Quality Raw Materials. Set made complete and thoroughly tested in our large modern plant.

\$65.00 LIST



MODEL 500

INDIANA MFG. & ELEC. CO.
Factory and General Offices - Marion, Indiana

Offices
Eastern Sales Office
Geo. L. Holmes,
1819 Broadway, N. Y. City
Southeastern Sales Office
Darling & Nevins, 411 Ga.
Sav. Bk. Bldg. Atlanta, Ga.
Western Sales Office
T. A. Mitchell Co., Balboa
Bldg., San Francisco, Cal.
Southwestern Sales Office
F. J. Keller Co., 220 E. Rio
Grand St., Ft. Worth, Tex.

TREGO

The World's Lowest Priced 5-Tube Tuned Radio Frequency Set

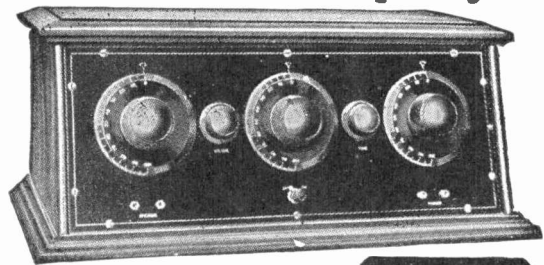

Long Range

HERE'S the set that sells and satisfies! It's the TREGO 5-Tube Tuned Radio Frequency Set—highest quality at a price within the reach of all. Retail at only \$45.00. Gives you Big Profits. Sells 10 to 1 over higher priced sets. Millions want it!

Storage or dry-cell operation. Backed by our Iron-Clad Guarantee. Sold only through dealers.

Send for Monthly Catalog and exclusive dealer plan. This TREGO TRF5 is only one of the hundreds of profitable, quick-selling items listed—just off the press. Get your copy now—cash in on fall and winter radio demand.

List Price
\$45.00

TREGO RADIO MANUFACTURING CO.
Manufacturers and Wholesale Distributors
1444 Chestnut Street KANSAS CITY, MO.

SUPER-BALL ANTENNA

Patent Pending

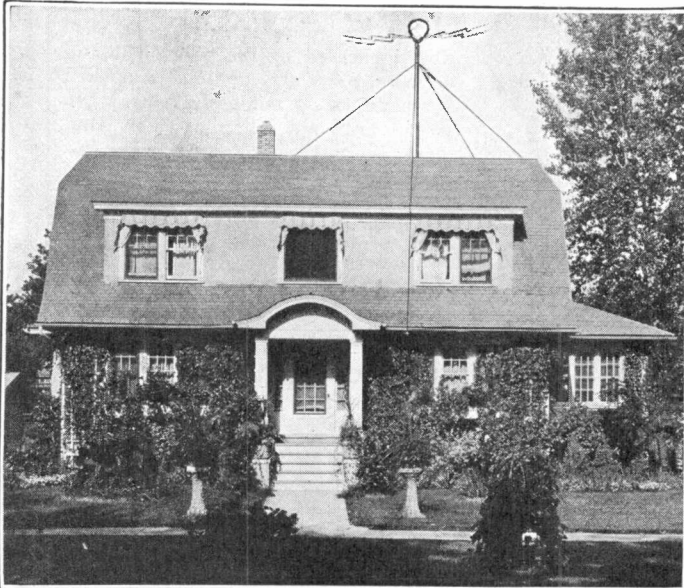

It's New—It's Ornamental—It's Practical. It's the best Antenna since the erection of the first Wire Aerial.

Mr. Radio Dealer:—A radio set on your demonstrations is only as good as the aerial you have it connected to. The days of the unsightly wire aerials are gone forever. Hook up to the Super-Ball-Antenna and make every demonstration a clean sale.

ORDER A SAMPLE from your jobber or direct. See for yourself what it is, and what it will do, and after testing the Super-Ball Antenna you will never erect another wire aerial.

The Super-Ball-Antenna has shattered all antenna sales, BECAUSE

- It's Extremely Selective.
- It's Non-Directional.
- It's Completely Weatherproof.
- It's Simple To Erect.
- It's Ornamental.
- It's Practical and Efficient.
- It's the Best Time Saver and Money Maker the Dealer Ever Had in Stock.

Be Ready to Supply the Demand.

Dealers! See Your Jobber To-Day.

List Price, \$10.00

MANUFACTURED BY
SUPER-BALL ANTENNA CO.
GREEN BAY, WISCONSIN

DIATRONS PRESENT—

a Profitable Selling Arrangement for Responsible Distributors, Jobbers and Dealers.

DIATRON TUBES are the finest radio tubes on the market—hundreds of tests prove it daily. They are the expected result of thorough tube knowledge, standardization in manufacture, rigid inspection and careful testing—all of which insures every DIATRON user the height of perfection for radio reception.

Last year's DIATRON output was entirely absorbed by selling agents then established. NOW, with increased output, we are establishing additional sales outlets, and for reliable distributors and jobbers we have a Progressive Merchandising Policy and high Quality Product that virtually guarantee sales satisfaction to all concerned.

WRITE—It is to your interest to know all about this.

FREE—to all radio salesmen—a Valuable Booklet, "WORTH WHILE FACTS ABOUT RADIO TUBES." Free, when requested on your letterhead. To all others, 25 cents.

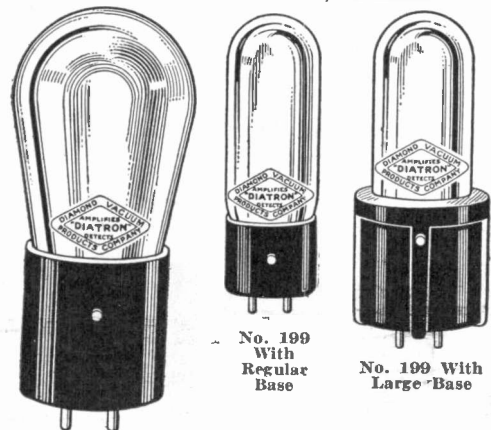

Nos. 201A and 240*		DIATRON No. 199.	
Both are detectors or amplifiers.		With regular or large base.	
Filament Volts 5.		Filament Volts 3.	
Filament Amperes25		Filament Amperes06	
Plate Voltage, 22 1/2 to 135.		Plate Voltage, 22 1/2 to 90.	

*DIATRON No. 240 is the only tube manufactured for the Radio Frequency side of Neutrodyne and Tuned Radio Frequency Sets Made before January 1, 1925.

List price for all types, \$2.50

GUARANTEE

"Any DIATRON that will not bring in signals will be replaced, no charge, whether the fault is due to a broken or burned out filament or other causes if returned to us at any time within 75 days of purchase by a jobber or 45 days of purchase by a dealer."

Diatron Special Feature

This illustrates the grid and filament with the plate removed. The filament is so supported that filament and grid must move together and cannot short circuit if the tube is jarred to an extent that would change the position of either element. Every turn of the grid is electrically welded. Patents applied for.

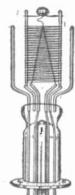

NOW, send for "Worth While Facts About Radio Tubes"

DIAMOND VACUUM PRODUCTS CO.

4053 Diversey Avenue
Chicago, Illinois

A new line of
COIL UNITS
USING
HEXCELL  **COILS**

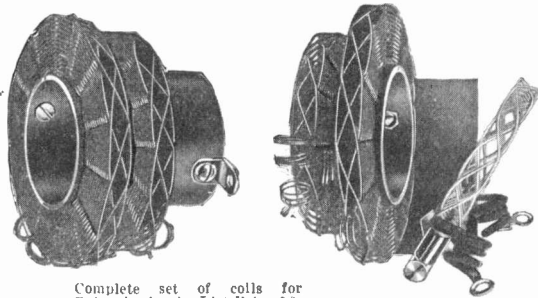

Complete set of coils for Robert's circuit, List Price \$6.

	List Price
3 circuit HEXCELL tuner 200-575 meters.....	\$3.00
Complete set of HEXCELL coils for Robert's circuit	6.00
Complete set of HEXCELL coils for Browning-Drake circuit with new improvements.....	6.00
Short wave HEXCELL extra low loss 3 circuit tuner 40-115 meters	3.50

We have put real electrical and mechanical engineering into our inductances. Particular attention is given to efficient operation at the lower end of the Broadcast Wave Band. Our coils are finished in beautiful silk shades, each coil having a different color. Highly polished bakelite and nickel mounting parts used. Merchandise packed in attractive boxes.

A live line for live dealers
Liberal jobber and dealer discounts.
Write for information.

Eastern Electric & Manufacturing Company
Providence, Rhode Island
Licensed manufacturers of Zig-Zag Coils

The Best Plug at a Better Price!

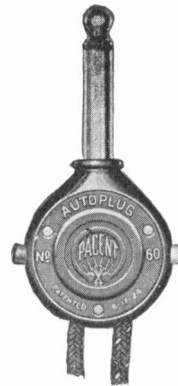

THE PACENT AUTOPLUG
Now --- 60c.

THIS plug is entirely shock-proof, for the entire length of the cord tips is encased by the plug shell and no metal parts are exposed. The shell is made of genuine Bakelite. No screws are used in its assembly, and there is nothing to work loose or cause trouble.

Cat. No. 60. Price 60c.

Pacent parts are used, by 40 leading manufacturers in the construction of their sets. It will profit you to get in touch with us.

Manufacturers—Dealers—Jobbers write for full details of the Pacent Line.



Trade Mark

PACENT ELECTRIC COMPANY, INC.
91 Seventh Avenue, New York City

Washington
Minneapolis
Boston
San Francisco
(Chicago)
Birmingham

Pacent
RADIO ESSENTIALS

Philadelphia
St. Louis
Buffalo
Jacksonville
Detroit
Pittsburgh

Canadian Licensees: White Radio, Limited, Hamilton, Ont.

DONT IMPROVISE - PACENTIZE

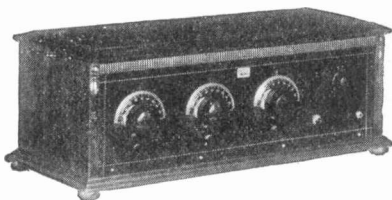

Model D-15

The Diamond T
is a 5-tube tuned Radio
frequency receiver

THREE MODELS

Special S-10.....	\$49.50
De Luxe D-15.....	80.00
Console C-20.....	160.00

We have a local advertising campaign for each dealer.

Exclusive franchise for one dealer in a town.

Our Guarantee is to replace any defective machine with a new one within a year.

This Guarantee relieves the dealer of repairs and service, as he can give the customer a new receiver instead of repairing old one.

Write for our dealer proposition.

DIAMOND T RADIO MFRS.

South Bend, Ind.
Salesmen wanted in all states.

Economy Fly Cutter

A new adjustable cutting tool for cutting holes in panels. Can be used as a hand tool or applied to brace or drill press. Will cut steel as well as insulating material.

A handy radio tool. Designed right, made strong. You can sell many of them.

List price \$1.00.

Economy Soldering Terminals

Made of tinned brass, uniform and in two sizes. Twenty cartons like the one below are packed in a large carton. Each little carton contains 50 soldering terminals. Easy to display and handle. Our great output makes the price lowest. A really profitable seller.

Economy Screw Assortment

A complete, compactly packed carton for convenience in display and selling. Contains 20 individual packages of radio screws, nuts and soldering terminals. Every article chemically tinned, giving a lustrous nickel-like finish and making for better and easier soldering.

Jobbers, dealers, write and get our attractive selling proposition.

Economy Screw Corporation

Manufacturers of Machine Screws, Nuts, Washers and Soldering Terminals
5215-17-19 Ravenswood Ave., Chicago, Ill.

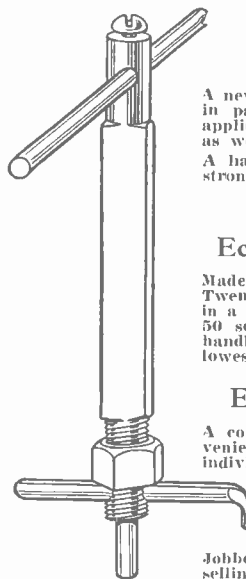

Small Size



Large Size



Super-Selector

5 Tube Set \$80

EXCLUSIVE TERRITORY

We are assigning exclusive territory only. We guarantee to maintain prices during the winter of 1925-6. We refuse to deal with "gyp" or cut price houses. And, on top of all this, we offer you, in a handsome cabinet, a set that holds its own in selectivity, volume, distance and tone with any set at any price. If interested, write on your letterhead.

POINTS IN ITS FAVOR

- Operates on either dry cells or storage batteries.
- Uses either UV 201-A type or UV 199 type tubes without change of construction details of wiring. Any kind or arrangement of tubes. Changed from one type of tube to any other in less than 30 seconds.
- It has a selectivity control.
- Its patented CLARIFIER not alone filters out extraneous noises, but clears up muffled signals to full brilliancy. A remarkable new development.
- It uses less B Battery current.
- Its volume is full, equal to any set; controllable at will.
- A good distance getter.
- Tonal fidelity is its strongest characteristic.
- There is absolute control over oscillation. Low wave lengths can be brought in just as easily as the high.
- The logging of the stations is fixed and exact.

THE LANGBEIN-KAUFMAN RADIO CO. 511 Chapel St. (Dept. M) New Haven, Conn.



*Compares Favorably With Any Set at Any Price—
Price Maintenance and a SQUARE DEAL GUARANTEED*

Resistance Coupling

! ! !
One stage RF, one stage of transformer coupling and two stages of resistance coupling.

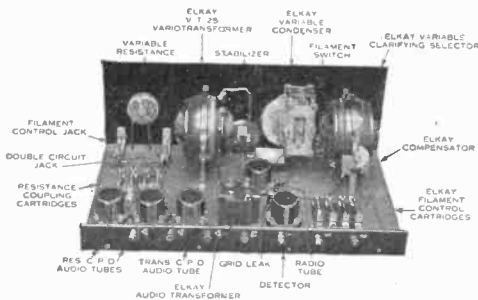

SET AND KIT PRICES

Type 4-S Four tube set.....	\$70.00
Type 5-S Five tube set.....	80.00
Type 4-K Four tube kit.....	60.00
Type 5-K Five tube kit.....	65.00



40-10-2% DEALER DISCOUNT

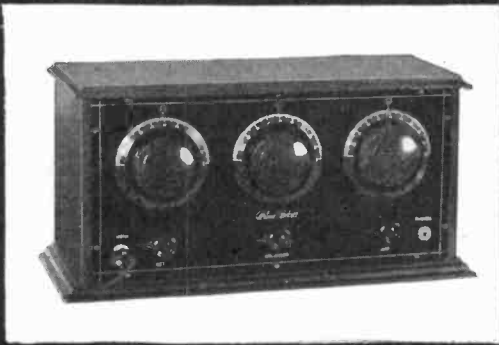

\$13.50 LIST PRICE

LESS 40-10-2%

\$7.14 NET PRICE TO DEALERS

NEW FIVE-TUBE BLUE BIRD
This Five-Tube Tuned Radio Frequency Receiver combines beauty, mastercraftsmanship and superb quality. Housed in elegant massive walnut finish cabinet. Quality clear through. Will please most discriminating.

\$42.50 LIST

LESS 40-10-2%

\$22.49 NET PRICE TO DEALERS

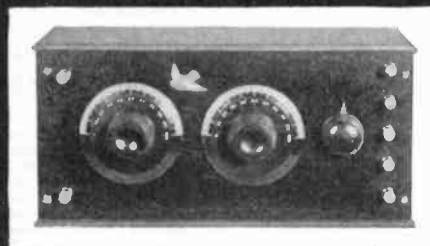

BLUE BIRD ONE-TUBE WONDER

Combines low-cost, great selectivity and simplicity of control. Wonderful for volume and distance. Highly finished genuine cedar and mahogany finish cabinets. Best one-tube receiver on market.

DEALERS—You'll make big money with the Blue Bird Receivers. You make both the wholesaler's and retailer's profits. Your inquiries and orders are solicited.

On Exhibition
Boston Radio
Exposition
October 12-17

AUTOMATIC RADIO MANUFACTURING Co., Inc.

28-30 CROSS STREET, BOSTON, MASS.

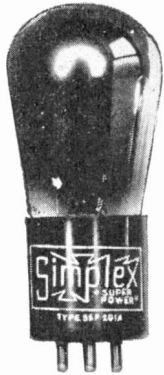
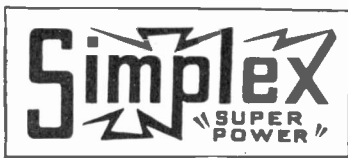

Type 201A Bakelite Base, Silvered and Blue.

The Elixir of Set Life

Just as the heart is the most vital organ of the human body the tube is the most vital part of the radio set. The Simplex Super Power Tube performs its function in the radio set with the same sensitivity, accuracy and regularity as the healthy heart in the human body.

Dealers

We know that you are interested in PROFIT. Let us convince you that you can make 100% profit on the Simplex Super Power Tubes and still supply your customers with the perfect tube at a very attractive price.

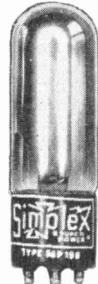

Type 199 Bakelite Base, Silvered and Blue. Also with Adaptor Base.

Jobbers and Distributors

Jobbers
Territories open. Ask for information and discounts.

Increase your tube profit by handling the Simplex Super Power Radio Tubes.

GUARANTEE—Tubes may be returned within 10 days—for credit—if unsatisfactory.

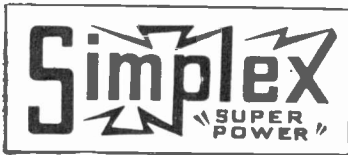

TITANIA MANUFACTURING COMPANY
105 West 40th Street, NEW YORK CITY, U. S. A.

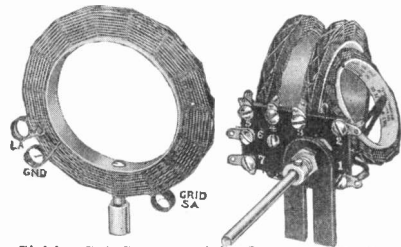

Sickles Coil Set No. 24 for Browning-Drake Circuit. Price \$7.50.

SICKLES DIAMOND-WEAVE COILS

(Trade Mark Registered Aug. 4, 1925)

For Browning-Drake, Roberts, Craig, and Hoyt Circuits

(Coils Patented Aug. 21, 1923)

Superiority of design and workmanship, combined with fair prices and a sound merchandising policy, have made Sickles Diamond Weave Coils leaders in their field.

Manufacturers and builders of quality sets have been coming to Sickles Coils in ever increasing numbers as performance facts became known. The trend toward Sickles equipment is stronger than ever this fall.

"DIAMOND-WEAVE," our registered trade-mark, has acquired profit value which it is paying manufacturers of sets, jobbers and dealers to tie up with. The public is being informed and reminded constantly of Sickles Coils through extensive national advertising. *Send for Descriptive Catalog.*

The F. W. Sickles Co.
140 Union Street, Springfield, Mass.

Tells at a glance whether battery is low, half charged, or full! Just press the button.

Registers current flowing to the set. When charger is in use, it shows the charging rate.

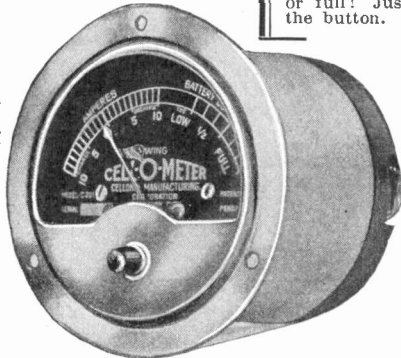

Dealers Wanted To Supply This Waiting Market

Its name tells the story. "Cell-O-Meter" is more efficient than voltmeter, ammeter and hydrometer combined! It shows the amount of current flowing to the set, and whether battery is low, half charged or full. When charger is working it gives the charging rate. It keeps the battery at its most efficient point, warns when the battery needs attention! Eliminates the messy hydrometer. No more spoiling of rugs and furniture. It is easy to wire up. Two models — one which fits into the panel of the set and one mounted attractively on wood. The latter makes an excellent counter display, too! Dealers—Write for literature, dealer discounts, and introductory offer giving your distributor's name.

\$7.50 List

CELL-O-METER
CELOKAY MFG. CORP.
Sales Office—1705 Flatiron Bldg., New York, N. Y.

Mr. Dealer!

you cannot afford to omit from your stock of Parts the

New G-K Spring Binding Post

Nationally Advertised. Approved by leading Radio Engineers. Several exclusive features. Fully protected by Patents.

We started out to build a better Post and the Trade tells us that we have succeeded.

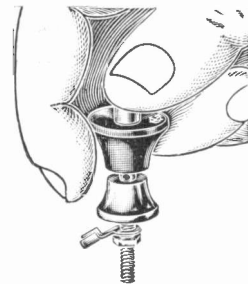

Highly polished Nickel plated Post
Genuine Bakelite Knob
Spring Contact and Release

Shaft slotted in line with hole—no fishing with wire.
Knurled base—will not slip on panel.

The Bakelite Knob is built into the Post and marked with the usual engravings. *The slotted shaft is an exclusive feature.*

CARRY THEM AND YOU WILL SELL THEM AS THE DEMAND IS ASSURED

Jobber and Dealer Information on Request.
Price 15c. each.

GANIO-KRAMER COMPANY, Inc.
238-240 West 53rd Street, New York City, N. Y.

AMPLION

*The World's Standard
Loud Speaker*

ALFRED GRAHAM & CO., LONDON, ENG.—Patentees.

Six Models

\$12 to \$42.50

Long tone travel with gradual amplification is provided in compact space by the acoustically correct dragon shape of The Amplion.

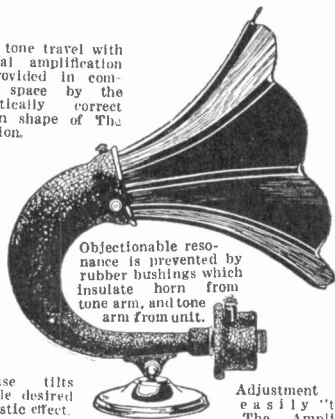

Objectionable resonance is prevented by rubber bushings which insulate horn from tone arm, and tone arm from unit.

Hinged base tilts horn to angle desired for best acoustic effect.

Adjustment for easily "tuning" The Amplion to each individual set.

The World's Largest Selling Loud Speaker!

Get One to Test From Your Jobber*

ABROAD—to give you some conception of the actual supremacy of Amplion performance—The Amplion outsells all other loud speakers the world over. This condition has prevailed for years—in fact, practically since 1920. In that year the originators and world's oldest makers of loud speakers—Alfred Graham & Co., London, England—created The Amplion for radio. Their thirty years previous experience in producing loud speakers for use on land and sea made it possible to perfect a radio reproducer which has never been equalled for sensitivity, clarity or volume.

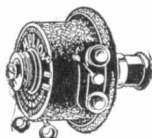

Phonograph Units in Two Sizes

DEALERS! JOBBERS!

* Test The Amplion—in comparison with any or all other makes—and learn why it is the largest selling loud speaker throughout the world. Though more recently introduced to America, it is rapidly paralleling its success abroad. Nation-wide advertising on a greatly extended scale is creating new interest and increasing the demand. Write immediately for the attractive 1926 Amplion proposition.

THE AMPLION CORPORATION of AMERICA
Executive Offices Suite E, 280 Madison Ave., New York City
Canadian Distributors: Burndep of Canada, Ltd., Toronto.

TRADE
NEW **KARDONSTRIP** YORK
MARK

You—who know set values—
would appraise
this instrument at \$70

**A new idea
in construction
makes it possible!**

A new idea in radio construction—

The total elimination of soldered connections and the adoption of riveted construction throughout!

The advantages are too obvious to require elaboration.

—but the big point is that the cutting down in production costs makes it possible to produce a set to list at \$35—yet featuring the best parts and excellent workmanship. Due to the complete elimination of all soldered joints we have done away with all servicing troubles arising from loose and broken connections.

Riveted construction is, of course, more sturdy and absolutely permanent.

In this popular price class the Kardon is bound to set a new sales pace. The profit and the sound proposition back of it makes the selling worth while.

Exclusive jobbers distribution territories open!

Write for details.

KARDON RADIO CORP.
294 East 137th Street, New York, N. Y.

\$35
List

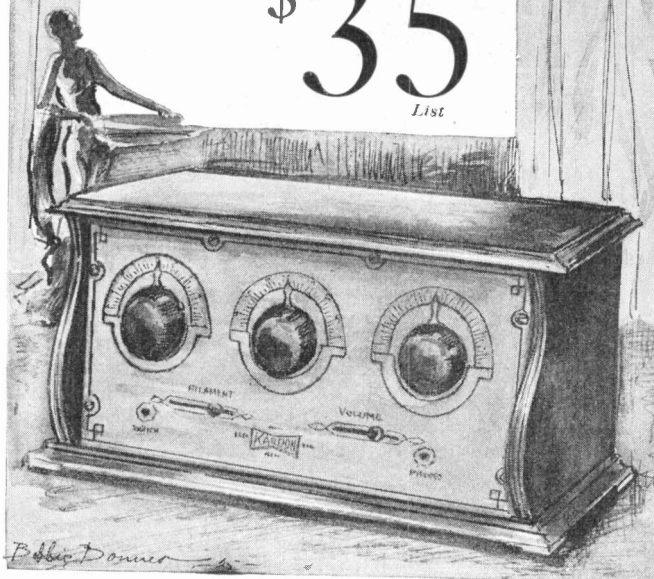

Bob Donner

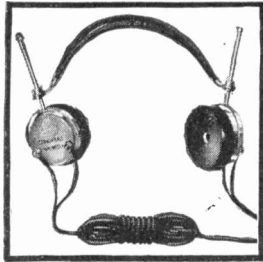

**Cannon-Ball
Headsets
are Real
Sales Makers**

A Headset is a natural accessory of Radio. It increases the popularity of Radio and gives greater satisfaction. A program is received as transmitted. And by reducing the volume, the beautiful musical notes or spoken words are brought out clearly.

It makes for privacy. Folks may listen-in without disturbing others. And for long distance reception, it is reliable and most satisfactory. Every receiving set should be equipped with several Headsets.

Sell a good Headset such as the Cannon-Ball. It is extremely sensitive, light in weight—comfortable. And it is guaranteed by a well established, reliable manufacturer.

LIST PRICES: Cannon-Ball \$3.50; Cannon-Ball Junior \$2.75; Grand \$4.75; Cannon-Ball Loud Speaker \$12.50. See your jobber.

CANNON & MILLER CO., Inc.
Springwater, N. Y.



**HOWE
RADIO
RECEIVER
\$1.75**

*The Crystal Set That
Creates NEW "Radio
Fans"*

Summer Sales of 25,000 in New Orleans,
15,000 in Houston, and so on.

THE HOWE Radio Receiver is the dealers best aid in reaching that skeptical 80% of the public which has not yet been "bitten by the Radio Bug."

The 250,000 HOWE Receivers already sold have been "Stepping Stones" to the purchase of tube sets.

The HOWE Receiver is most decidedly Not a Toy—it brings in loud and clear all stations within a 25 mile radius, and has good selectivity. Its Low Price induces the non-user of Radio to "get into the game."

We shall be glad to hear from Jobbers and Dealers who are not selling the HOWE in large quantities

HOWE AUTO PRODUCTS CO.
120 N. Green Street, CHICAGO, ILL.

**Get a "Line" on the
Condenser Market**



Learn about the DUPLEX S.L.F. Condensers, designed to meet the requirements of the straight line frequency demand. Backed by a clean merchandising policy that helps eliminate unfair competition. Nationally advertised; known everywhere as precision instruments. Reputation, appearance and performance make them easy to sell.

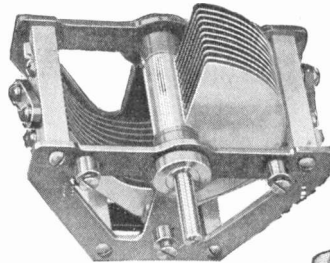

**DUPLEX
STANDARD**

DUPLEX STANDARD Straight Line Frequency condensers, "none better made," conform to Bureau of Standards specifications for lowest losses and best electrical characteristics.

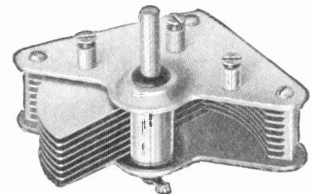

DUPLEX JUNIOR

DUPLEX JUNIOR Straight Line Frequency condensers, "best at the price," are for set builders who seek performance—with economy.

The specially cut-out stator keeps DUPLEX S.L.F. Condensers to the same small panel space occupied by the previous models. There is no odd-shaped rotor to cause short circuits.

Duplex Condenser & Radio Corp.
34 Flatbush Avenue Extension, Brooklyn, N. Y.

**PARAMOUNT
RADIO
WHOLESALE DISTRIBUTORS**

WHOLEHEARTED co-operation with the dealer has always been the prime policy of our house. The largest stock of nationally advertised and standard merchandise, backed by an efficient organization, has made possible the effective development of this policy.

RADIO

- | | | | |
|----------|---------|--------------|-----------|
| Balkite | Frost | Apex | Bradley |
| Howard | Temler | Bremer-Tully | Karas |
| Eveready | Thorola | All-American | Jefferson |
| Carter | Premier | Cunningham | Utah |

**PARAMOUNT ELECTRICAL SUPPLY
COMPANY**
160-C W. Lake St., Chicago, Ill.



**Surplus Stocks Are
Easily Disposed of** *Through the*

"SEARCHLIGHT SECTION"

"FOR SALE" announcements are carefully read by the trade.

"SEARCHLIGHT" Ads bring prompt and profitable returns.

Displayed—\$5.00 or less an inch per insertion.

SUPERADIO DYNOMETER



Superadio Dynometer is equipped with head phones and plug. Price \$120. Liberal Discount

Measures Amplification Factor, Plate Impedance and Mutual Conductance on any Tube

Tests 3 Tubes Per Minute

No Curves or Calculations

Direct Reading

We invite inquiries from reliable manufacturers' representatives and dealers on this revolutionary device.

The Dynometer means a new era in radio because, now, only TESTED tubes will be wanted.

Write for our proposition.

The New Superadio Receiver

2—Dial Control—S.L.F. Condensers

This truly remarkable 5-Tube Set is on entirely new principle. A beautiful job inside and out with many advanced features. Lists at only \$56.00. and painstaking development. Works Write today for our liberal proposition.

DE WITT-LA FRANCE CO., INC.

54 Washburn Avenue, Cambridge, Mass.

BOSTON REPRESENTATIVE:
Martin, Hartley & DeWitt Sales Co., 99 Bedford St.

CHICAGO REPRESENTATIVE:
William A. Welty & Co., 36 So. State St.

PYCO RADIO TABLE



Top 32-in. x 16-in.
Height 30 in.

Made of selected hardwood, with special plywood panel top. Shipped knocked down and crated. Weight 48 lbs.

\$5.50 (Dealers Price)

No. 1501 Walnut Finish.
No. 1502 Mahogany Finish.
All shipments F.O.B. Orleans, Vt.

THE PARKER-YOUNG COMPANY
131 State Street
BOSTON, MASS.

PYCO Radio Furniture is sturdily and honestly built, and is well finished with genuine Du Pont "DUCO."

Eighty years of manufacturing experience guarantee the quality of PYCO Products.

**Make This Table
A Sales Leader**

COUPON

THE PARKER-YOUNG CO., 131 State St., Boston, Mass.

Gentlemen:—Please send us _____
 No. 1501 PYCO Radio Tables.
 No. 1502 _____
 _____ express.
 Inclosed find check for \$_____
 of PYCO Radio Furniture.

Name _____ Also send us your catalogue
 Street _____ Very truly yours,
 City _____
 State _____

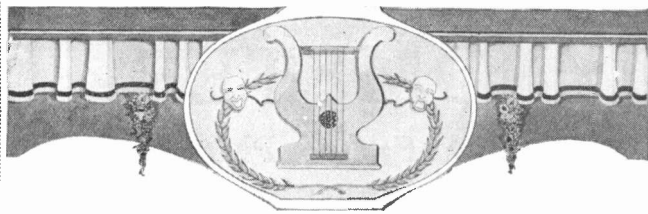

Without Exaggeration!

You can buy radio on the strength of exaggerated statements or you can be guided in your purchase by the reputation of the manufacturer and the actual performance of the article itself.

The Holtzer-Cabot Electric Co. has just celebrated its fiftieth anniversary. A half century spent in building a reputation for quality electrical products, equalled by few, and surpassed by none. The experience gained through this period has enabled us to produce a remarkable loud speaker about which we could say much without exaggeration. We prefer, however, to let the instrument speak for itself. Knowing that its performance will convince you of its merits. Before you buy your stock of loud speakers be sure to make a test of the Holtzer-Cabot National.

National Loud Speaker
\$12.00
Adjustable Control
(Regular Trade Discounts
Granted)

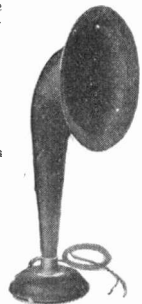

1875-1925
For Fifty Years
Manufacturers
of Quality
Electrical
Apparatus

The Holtzer-Cabot
Electric Co.
125 Amory St.
BOSTON, MASS.



“Big 6”
A Great Value at \$90.

Demonstrate the new Audiola “Big 6” set (6 tube) to your customers and it is sold! The way it brings in distant stations with maximum volume over the loud speaker, in clear, natural tones, is ample proof of performance. And the price—only \$90.00 is an inducement to buy, not an obstacle for salesmen to overcome.

Also a new five tube model at \$60.



Radio Company

430 South Green St.
Chicago

“Audiola Protects Jobbers”

Sold!

The dealers, the public and over 150 manufacturers are “sold” on

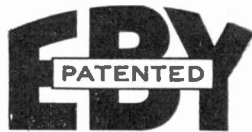

BINDING POSTS

for the very good reason that the manufacturers *specialized* on this one product until perfection was reached. Furthermore, EBY Posts are intelligently merchandised, properly packed, nationally advertised and priced to retail at a worth-while profit.

*The Tops Don't Come Off
25 Different Markings*

The H. H. EBY MFG. CO.
Philadelphia, Pa.



15c
Plain or
Engraved



*Simply Lay the Talking Machine
Needle in the Dulce-Tone Reed!*

RADIO owners and prospects know the clear, distortionless reproduction of which a talking machine is capable. That's why Dulce-Tones are easy to sell. The demand for an instrument which will actually link to radio the fine tone qualities of the talking machines which most families already own, is almost universal. Dulce-Tone's ever increasing sales prove it!

THE TEAGLE COMPANY

1125 Oregon Avenue

Cleveland, Ohio

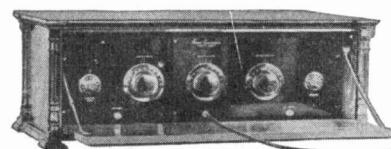

New “double-volume” universal model. Price remains at \$10. (In Canada, \$14.)

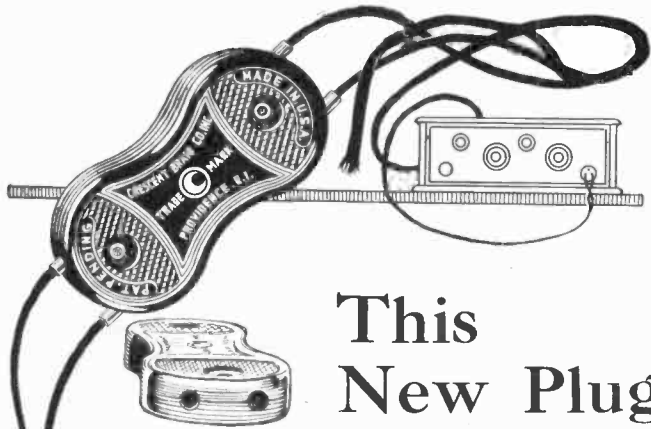

This New Plug

Helps You Sell



THE plug holds cord terminals *securely*, yet a very slight side-pressure on the pins instantly releases them. It's entirely automatic with no tiny screws to fuss with—or lose.

It gives you an added "talking point" for the PREMIER Cord. Every owner of a loud speaker needs this combination—a tightly-braided Extension Cord that will not kink or fade, plus the handiest connecting plug ever made. That's PREMIER!

List \$1.75

Don't forget "Premier, Jr."

He's of lighter construction but comes in attractive carton, complete—with universal plug. In a variety of lengths for folks who want still greater leeway.

25 ft. length List \$1.50
 35 ft. length List 1.75
 50 ft. length List 2.00

Crescent Braid Co., Inc.
 Providence, Rhode Island

Makers of Extension
 Cords, Battery Cables and
 Phone Cords for headsets
 and loud speakers.

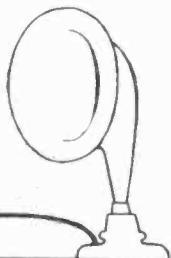

\$22.00
 Complete with
 2 bulbs. \$14.00
 without bulbs.
east of Rockies.

QUIET
 FAST
 SAFE

The New TWIN BULB

HANDY CHARGER

Features
 that mean

Sales For You

YOU as a dealer are interested in whether or not an item will sell after you stock it. Before perfecting the New Twin Bulb HANDY we made a very careful study of just what radio owners wanted in a charger. Into this charger we have built those features that your customers want. We mention them here and will let you judge for yourself the salability of the New Twin Bulb HANDY CHARGER.

1. Charges at a very fast rate.
2. Absolutely quiet.
3. Cannot overcharge or discharge battery.
4. Equipped with special ammeter.
5. Beautiful in Appearance.
6. Charges them all.

"A" Batteries 4-5 amperes to 6 volt batteries.
 "B" Batteries up to 120 volts in series.

The "push-pull" method using *both* halves of the AC wave, accounts for the fast, economical rate of charge. Place your order for the New Twin Bulb HANDY CHARGERS with your favorite jobber.

INTERSTATE ELECTRIC CO.

4349 DUNCAN AVE.
 ST. LOUIS MO.

The Korach Tuned Loop

Tuning Feature
Directional

Collapsible
Can be Logged

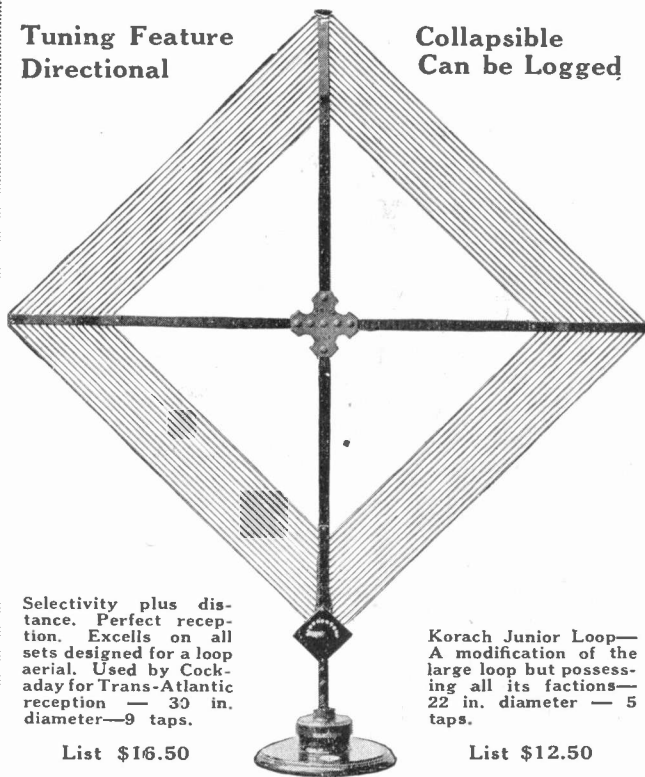

Selectivity plus distance. Perfect reception. Excels on all sets designed for a loop aerial. Used by Cockaday for Trans-Atlantic reception — 30 in. diameter—9 taps.

Korach Junior Loop—A modification of the large loop but possessing all its factions—22 in. diameter — 5 taps.

List \$16.50

List \$12.50

KORACH RADIO CO.
20 E. Jackson Boulevard, Chicago

Molded Bakelite for Radio

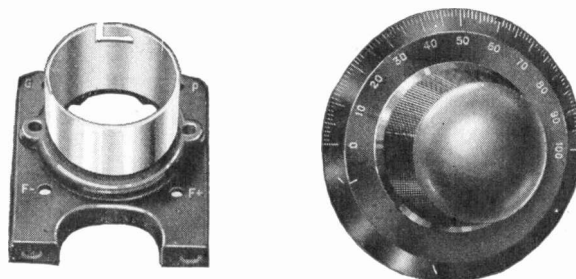

Bakelite and Condensite knobs, dials, socket bases, rheostat bases, condenser end plates, and other parts, produced by our large and experienced Molding Organization.

American Insulator Corp.
52 Vanderbilt Avenue, New York City

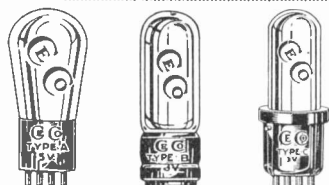

	"A"	"B"	"C"
Filament Volts..	5.0	3.0	3.0
Filament Current.	0.25	.06	.06
Plate Voltage..	20 to 120	20 to 80	20 to 80

Made with Brass and Bakelite Bases

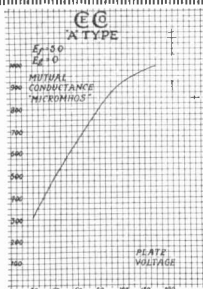

Above chart shows why the CeCo Tube is most successful in audio and radio frequency circuits. Write for complete set of graphs.

CeCo Tubes

Make a Good Receiver Better!

All tubes look pretty much alike; appearance doesn't tell you a darn thing about performance. There's only one way to be SURE. Buy tubes only when you see the name CeCo on the package and on the tube itself. Then you may be certain of maximum results—clarity of tone, rich volume, long life.

Every CeCo Tube fully guaranteed. Tests of nationally known laboratories confirm the results of our own tests and prove our claim to superiority.

Write for New, Illustrated Catalog with Test Charts.

C. E. MANUFACTURING COMPANY, Inc.
702 Eddy Street, Providence, R. I.

Trade Supplied thru Jobbers Only!

Jobbers—write for details and prices. Set Manufacturers, ask us about our SPECIAL MATCHED tubes.



The 1925-26 Line of

New and Improved FRESHMAN MASTERPIECE

**Five Tube Tuned Radio
Frequency Receiving Sets**

Sold direct to selected dealers—one dealer only in towns of less than 25,000 people—specified localities in larger cities.

**No More Cut-Throat Competition
No More Losses on Installment Sales**

Eight distinctive models from \$39.50 to \$115.

Write to either office for complete information.

Chas. Freshman Co. Inc.
Radio Receivers and Parts
FRESHMAN BUILDING
240-243 WEST 40TH ST.—NEW YORK, N.Y.
CHICAGO OFFICE — 327 S. LA SALLE ST.

Just Hear It!

MODEL 24
Five tubes, Tuned Radio Frequency. Rich mahogany cabinet, 7-in. x 22-in., with a beautiful etched metal panel.

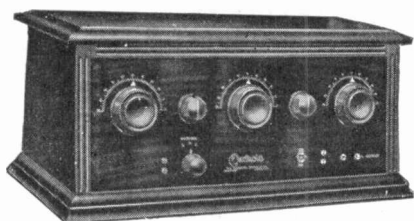

\$59.50

Electrola

COMPARE the Electrola for clarity and tone. Try it for volume. Test it for distance and selectivity. We challenge you to find any receiver, regardless of price, that will give your customers any better service, more pleasure and satisfaction, and that is a bigger value than the Electrola.

We urge such a comparison because the Electrola is NOT an assembled set. Every part entering into its construction, except the cabinet, is made by us in our own factory.

We know what Electrola will do and has done for others, and are equally confident it will give your customers the same all-around radio satisfaction.

Valuable Electrola Territory Still Open

Write today for particulars regarding exclusive dealer franchise and the name of your nearest distributor who will be glad to give you an "Electrola" demonstration.

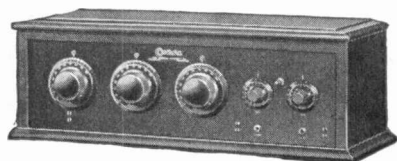

MODEL 18—\$80.

Five tubes, Tuned Radio Frequency. Rich mahogany cabinet, 7-in. x 24-in. Great distance getter, and a beautiful piece of furniture.

AMERICAN SPECIALTY CO.
BRIDGEPORT, CONN.

America's Oldest Manufacturers of Radio Parts

WHY FORE BECAUSE

Rapid turnover, a liberal margin of profit and satisfied customers are necessary to larger dividends.

If you want to know why and how send Radiogram Coupon at once—that's all.

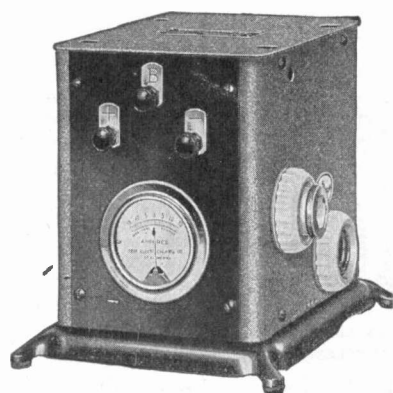

Master Fore Charger
\$18.50 List

Charges all Radio "A" and Automobile Storage Batteries and all Radio rechargeable "B" batteries. Only one moving part.

Fore Dual Tube Charger
\$28.00 List

Charges all Radio "A" Batteries and all Automobile Storage Batteries at 2 or 5 ampere rate as desired. Also Radio "B" at any rate desired.

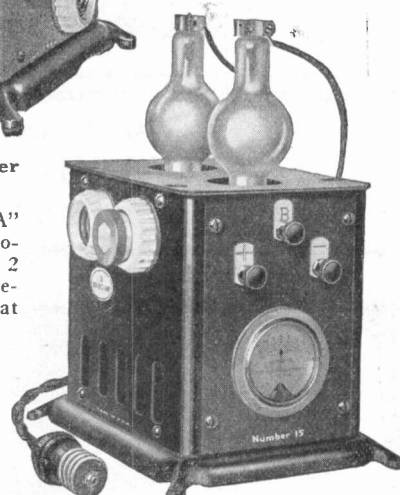

Fore "B" Eliminator
\$36.00 List

delivers 95 volts on amplifying circuit at maximum. Detector tap delivers from 0 to 60 volts. Both circuits variable.

Manufactured by
FORE ELECTRICAL MFG. CO. THE ZINKE COMPANY
5255 N. Market St. 1323 S. Michigan Ave.
ST. LOUIS, MO. CHICAGO, ILL.

RADIOGRAM

Fore Electrical Mfg. Co., St. Louis, Mo., Manufacturers
The Zinke Company, Chicago, Ill., Sales Department

Name

Address

City..... State.....

An Absolutely New Development—

The Washburn Interchangeable Tuned Radio Frequency Kit

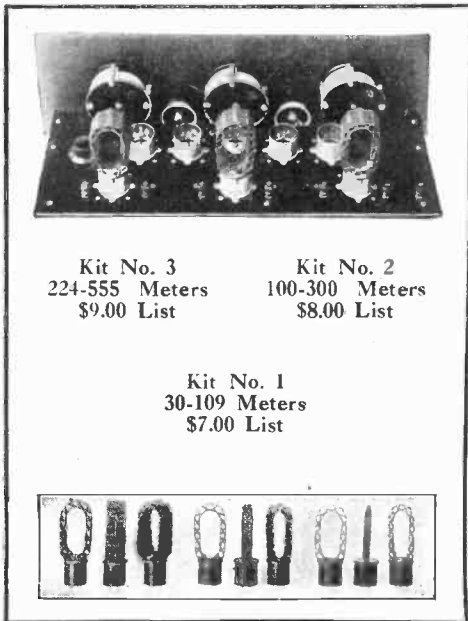

Kit No. 3
224-555 Meters
\$9.00 List

Kit No. 2
100-300 Meters
\$8.00 List

Kit No. 1
30-109 Meters
\$7.00 List

Short Waves are here. WGY on 38 meters, McMillan on 40 meters, KDKA on 64 meters—rebroadcasting and many large transatlantic stations—all on short waves. The all-wave features of Washburn Interchangeable Coils are right in line with this new development.

on bakelite bases for socket mounting as shown here.

Low in Cost

The cost of building an all-wave receiver is but little more than the cost of building a set with fixed tuning range.

You will have demands for short wave parts this season. Get ready now with a supply of Washburn Interchangeable Coils. Attractive repeat business—radio fans are not satisfied until they have all three sets.

Tunes 30 to 555 Meters

Each kit contains three matched, low-loss, sharp tuning Interchangeable coils and complete wiring diagram for building five tube, tuned radio frequency, all-wave receiver, for clear powerful reception. Coils are all built

Endorsed by leading authorities—See Oct. issue Radio News, pages 448-449



Sold Through Jobbers. Order Today
THE WASHBURN BURNER CORP.
KOKOMO, INDIANA



"HOME" TUBE TESTER
Tests plate current of large tubes, in the set, showing whether they are good, fair or poor amplifiers.

List Price, \$8.50.

"PROFESSIONAL" TUBE TESTER.
Specially designed for radio stores and service men. Equipped with plate and filament voltmeter—also plate milliammeter. For large and small tubes.

List Price, \$30.00



Every New and Dyed-in-the-Wool Set Owner Needs a Sterling Tube Servicing Instrument

When you sell a set, a battery charger, or tubes, simply suggest a Sterling Tube Tester or Tube Reactivator or both to your customers. You'll be surprised at the interest shown in these *essential*, new products.

You'll find that your customers already know a good deal about Sterling equipment through the pages of national and newspaper advertising. They appreciate dependable Sterling accuracy—Sterling confirmation of results through meter readings on each instrument—Sterling quality, and the good appearance of all equipment bearing the name "Sterling."

Why shouldn't they? Since 1906 Sterling's reputation for fine quality products has been increasingly enhanced.

THE STERLING MFG. CO.
Dept. R CLEVELAND, OHIO

Sterling Tube Servicing Equipment



"UNIVERSAL" TUBE TESTER

More than a tube tester. Really a complete set servicing instrument for service and house use in testing tubes, batteries, transformers, sockets and wiring circuit. For large and small tubes. Equipped with plate and filament emission meter and plate milliammeter.

List Price, \$18.00.

TUBE REACTIVATOR.
Renews worn out filaments of all thoriated tubes. Also valuable for matching tubes in set. The meter tells when reactivation is necessary and shows improvement of tubes after treatment.

List Price, \$12.50.

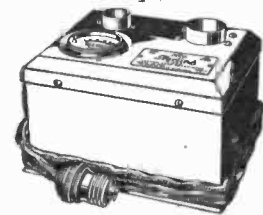



**The
REMO
TRUMPET**
(Concert Type)
It acknowledges no superior!

We have found the secret for beautiful tonal quality with volume in all the registers high or low.

It has been tested against every loud speaker of importance and acknowledges no superior.

List Price \$25.00

Send for a sample and be convinced. Beautifully finished in crystal black and grained mahogany with antique gold detail.

REMOLA CONCERT CABINET

Has the same tone quality as the Remo Trumpet above. A beautiful loud speaker in mahogany finished cabinet.

List Price \$25.00

Both these loud speakers will be sent on 10 days' free trial thru your regular seller.



The REMO CORP.
Meriden, Conn.



PATENTS PENDING

It's Arrived!
The New-Idea Condenser!

For a long time the radio public has been waiting for some revolutionary improvement in variable condensers. Now it's here!

FURNELL
360° TAPER COIL
CONDENSERS

have been found by professionals to be as superior to the old style condenser as the tube set is to the crystal.

The Furnell Taper Coil principle is such a tremendous advance forward, as to distinguish it as the new standard of condenser efficiency.

No projecting plates—no gears—no racks. No solder. No washers. Nothing to get out of alignment. Nothing to become loosened. Nothing to get out of order.

This remarkable device has been tested and highly approved by Cockaday of Popular Radio Laboratory and by other well-known authorities.

Write for interesting plans and prices.

**JOBBERS, RETAILERS
MANUFACTURERS**

may expect the Furnell Taper Coil Condenser to excel all previous condenser records, in brilliancy of performance and in sales activity. Wire or write.

The Furnell Manufacturing Corp.
889A Broad St., Newark, N. J.

Give 'em what they want—

**DURHAM Variable
High Resistance**

New panel mounting



Now being featured in national advertising

with noted patent plunger
\$1.00

Early orders indicate full-capacity production shortly. Better order now.

Standard style



Fits all clips 75c.

Both types in these sizes	No. 100—1,000 to 100,000 ohms
	No. 101—0.1 to 5 megohms
	No. 201—2 to 10 megohms

Order by style and size
Write for New Fall Sales Plan

DURHAM & CO., Inc.
1930 Market St., Philadelphia.

The Unit of Unfailing Dependability

MACFADDEN B-POWER GENERATORS

\$ 35⁰⁰

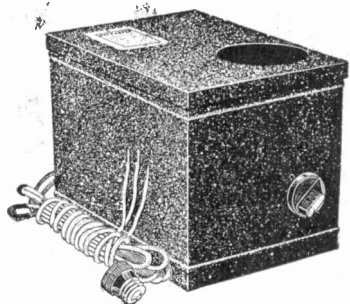

Liberal
Discount

Are now selling in their third season. Experience and improvements have developed what we consider to be an absolutely dependable unit.

Dealers can sell this B-POWER GENERATOR with full confidence in its continued satisfactory performance. Sold under a guarantee that really guarantees.

NO ACIDS NO ODORS NO NOISE

Operates on 110 V. 60 cycle A.C. current. Turn on the juice and forget B-battery troubles for life.

It's a Real Job

MACFADDEN & CO., INC.

2204 Arch St., Philadelphia, Pa.

NAXON

Toroidal Transformer

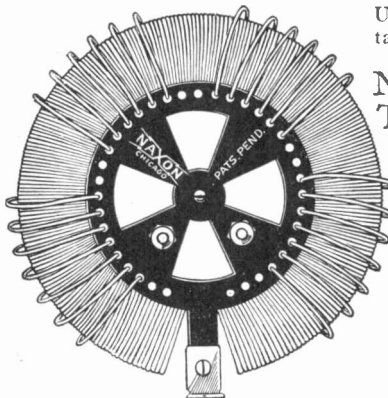

Unusual results are obtained with

NAXON TOROIDAL TRANSFORMERS

Because of the following scientific principles:

1. Correctly distributed external primary.
2. Maximum magnetic coupling with minimum capacity coupling.
3. Absence of usual secondary eddy-current losses.
4. Sturdy construction without coil housings to absorb energy.
5. Each turn a perfect toroid. No trick style windings with losses at every angular bend.
6. Low resistance spaced windings.
7. Silver-plated primary reduces skin loss.

These advantages coupled with the attention-compelling counter display package are making ready sales for dealers.

Correspondence Invited

Naxon Electrical Laboratories

4526 Cottage Grove Ave.,

Chicago, Ill.

Convenience
combined with
Beauty

The Beauty of appearance and convenience of Standard Radio Cabinets appeals to radio buyers.

No. 400

Height 49 in.

Depth 16 in.

Width 36½ in.

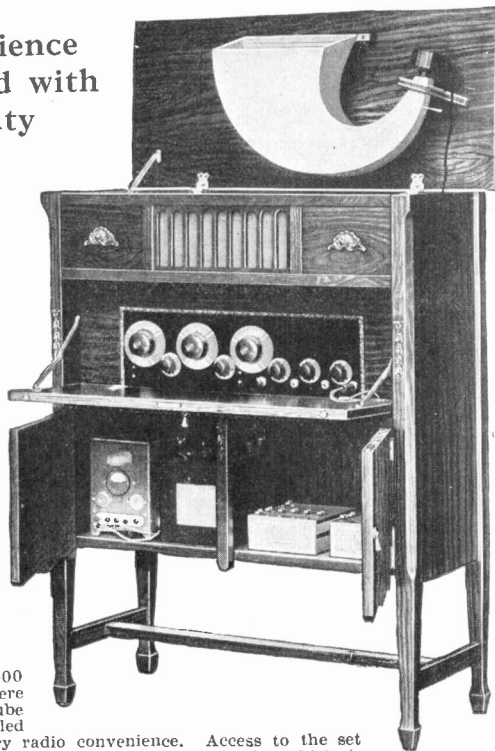

Cabinet No. 400 illustrated here with five tube set assembled combines every radio convenience. Access to the set is simple—just raising top of cabinet to which is attached loud speaker horn. This horn is made entirely of spruce wood which is conceded to be best. Cabinets are made in Antique Brown, Mahogany or Antique Burl Walnut. Write for dealer Transportation allowance and Discount list.

STANDARD PIANO BENCH MFG. CO.
1221-1227 W. LAKE ST., CHICAGO, ILL.

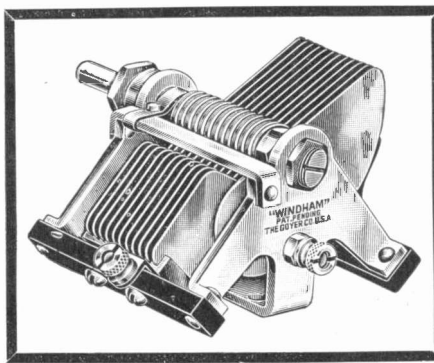

Small
Rigid
Durable

The New "Windham"

Station Separating Condenser

A NEW { STANDARD OF EXCELLENCE
MEASURE OF WORKMANSHIP
DEGREE OF SATISFACTION

For Those Who Are Seeking Better Things in Radio

Let us tell you more about this superior condenser that sells at a price within the reach of all.

Desirable territory may be had, if you write today.

THE GOYER COMPANY

Willimantic, Conn., U. S. A.

THE HOUSE of SUPER-SERVICE

Distributors of

- | | |
|--------------|---------------|
| Radion | Pacent |
| Cunningham | Premier |
| Balkite | Howard |
| Brandes | Utah |
| Remler | Allen-Bradley |
| All-American | Weston |
| Frost | Dulce-Tone |
| Dubilier | Burgess |
| Benjamin | Jefferson |
| Rasla | Erla |
| Carter | Signal |
| Gould | Bremer-Tully |

and Many Other Nationally Known Products

Dealers:—Write for a FREE copy of "HARRY ALTER'S POCKETBOOK," the convenient-to-carry Buying Guide listing over 2,500 items.

The Harry Alter Co.
ELECTRICAL and RADIO SUPPLIES
Ogden at Carroll Ave.
CHICAGO ILL.

COILS
for
RADIO

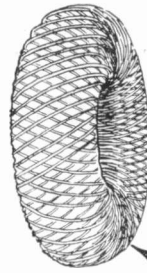

Balloon Honeycombs

Wave Wound Spirals



Transformer Windings

Honeycomb Inductances

We Wind For The
Manufacturer Only

COTO-COIL CO.
PROVIDENCE
R. I.

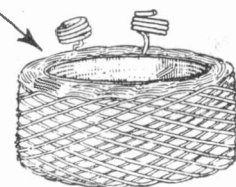
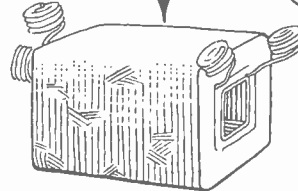

Jones
MULTI-PLUG
THE STANDARD SET CONNECTOR

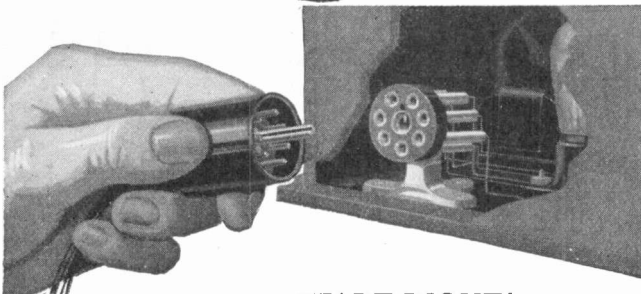

START RIGHT!

Handle Radio Sets Multi-Plug Equipped or Equip Those You Have with Our Type BP Adaptable To Any Set

You can then demonstrate one or a number of sets from one set of batteries as all Multi-Plugs are interchangeable. A plug and socket connection between the batteries and the radio is as essential as a cord and socket on an electric iron, and your customers will want one with the set he buys or for the set he now has. It will pay to stock Jones Multi-Plugs which are nationally advertised and non-competitive. Write today for descriptive folder and prices.

HOWARD B. JONES, CHICAGO, ILL.
618 S. Canal St.



A Sign of Good Service

Today the radio dealer wants to impress his customer with the *quality* of his stock—for the wise radio buyer now knows what quality means in radio.

The Bodine Loop looks its quality—in beauty of design, in its special features, in its obviously different construction. You not only increase loop sales, but give your customers an impression of quality when your counter or show window displays the

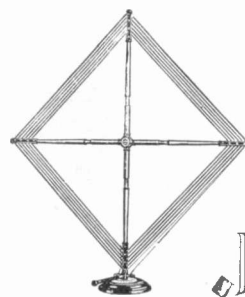

BODINE
BASKET WEAVE
FOLDING LOOP

The Bodine is a really artistic bit of furniture—graceful and beautiful, with green silk wire and slender frame of brown mahogany finish. Two feet square when set up. Folds into a box 3 1/2 x 6 x 18 inches in size.

The basket weave method of wiring used exclusively by the Bodine Loop insures superior results. A calibrated dial allows directional logging of stations, and an insulated handle for turning loop prevents the effects of body capacity.

There is a Bodine Loop designed to give perfect service with every set suited to loop reception. Excellent for Remler Super Het; special models for Grebe Synchronphase and Radiola Super Het. Prices \$8.50—\$10.

BODINE ELECTRIC CO.
2242 W. Ohio Street, Chicago, Ill.

Attractively Packed

Both Ground Clamp and Lead-In are conveniently packed. 50 in each attractive display carton. Standard package: 10 cartons. Dealers and jobbers should learn about our attractive proposition for new and bigger radio sales.

More Money on small accessories!

Carry accessories which have distinctive points that will draw the interest of the public, and you can depend upon them to sell themselves!



The Nifty Ground Clamp

Completely weatherproof—pliable—thoroughly insulated—with high grade rubber. Simple and easy to use.

The Nifty Lead-In

No tools required—no soldering necessary. This ground clamp is made of tinned copper and brass. Easily adjusted to pipes most commonly used with diameters from 1/4 inch to 1 15/16 inches.



AMOROSO MANUFACTURING CO.
14 Sears Street, Boston, Mass.



Lincoln

Collapsible Loop Aerials

Standard of the Radio Industry

Popular prices, national advertising, and the recommendation of one user to another, have made Lincoln Loops leaders in their field. Lincoln Four-Point Tapped Loop lists at \$8.00; Lincoln Center Tapped Loop at \$6.50.

Write for catalog fully describing Lincoln Loops, Low-Loss Condensers and other Lincoln Guaranteed Products.

LINCOLN RADIO CORPORATION
224 North Wells St., Chicago, Ill.



KEY TO THE AIR

SCORES AGAIN!

A Complete Radio Receiver \$2, List

Pyradiolin Panel, Key to the Air Low Loss Coil, Clever and Sharp Tuner, Westinghouse Type Binding Posts, Key to the Air Permanent Detector. (No cat-whiskers.)

The lowest priced Receiver in the world equipped with this standard Detector. A real little wonder.

Usual Key to the Air Guarantee.

STAFFORD RADIO CO., 3R, Medford Hillside, Mass.
Jobbers and Dealers. Send for sample Receiver



Burns

LOUD SPEAKER

With Concert Unit

Large size and scientific construction in the Concert Unit gives remarkable tone values which with the special amplifying properties of the Burns horn produce wonderful results.

Burns horn is of a distinctive design with pyralin flare in several handsome finishes.—It pleases the eye as well as the ear.

MANUFACTURERS
American Electric Company
State and 64th Sts., CHICAGO, U. S. A.



Subscribe now

to

Radio Retailing

Special Introductory Offer

\$ 1.00

Regular Price \$2.00

Postage to Countries Outside U.S. and Canada \$1.00 Extra

Radio Retailing
Tenth Avenue and 36th St., New York, N. Y.

Here is \$1.00. Please enter my subscription to begin with the next issue.

Name

Address

City State

10-35



Steinite

Guaranteed Products
Boost Your Profits

\$ 6 ONE TUBE SET
1,500 Mile Range
Easy to Sell—Stay Sold

5-Tube Set	\$60.00
2-Tube Set	\$12.50
Long Distance Crystal Set	\$6.00
Interference Eliminator	\$1.00

STEINITE DISTANCE CRYSTALS
Jobbers and Dealers Write for Wholesale Prices and Discounts

Steinite Laboratories
General Sales Office
504 South State Street, Chicago, Ill.
Factory, Atchison, Kansas

Regenerative Licensed Under Armstrong Patent No. 1113149
Size 4x7x2 Attractive—Simple



HIGHEST QUALITY HARD RUBBER

RADIO PANELS

This new Hood Florentine Panel means—

*Rich and distinctive appearance
No fingerprints, smudges or scratches
Highest quality radio material
A novel and serviceable panel*

The last word in Panels for Quality Sets—

*Easy to drill and engrave
Furnished in all popular sizes
Packed in attractive Hood envelopes
One side Florentine finish, reverse plain*

A big sales help to set manufacturers
Fast selling and profitable for dealer

Write for name of nearest distributor,
samples, prices, etc.

Hood Rubber Co., Watertown, Mass.
Hard Rubber Dept.

Actual
Size

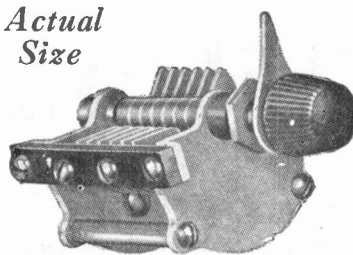

CONTINENTAL
LO LOSS

JUNIOR CONDENSER \$1.²⁵
is a profitable item at

This little marvel is a miniature low loss condenser of advanced design and precision workmanship which makes a perfect vernier.

At \$1.25 list price, you have a ready market for these quality instruments which have none of the faults of friction attachments or geared dials.

If your jobber cannot supply you, write direct to Condenser Headquarters and we will gladly fill your demands.

Condenser Headquarters

GARDINER & HEPBURN, Inc.
611 Widener Building, Philadelphia, Pa.

EVERY KIND of ANTENNA WIRE

SOLID—in copper
in tinned
in enameled

STRANDED—plain copper
tinned
enameled
7 by 22 and 7 by 24

BRAIDED—in tinned
in enameled
in bronzed
16 strands and 20 strands

FLAT RIBBON—in copper
in tinned
in enameled
17 strands and 25 strands

We also make silk and cotton covered loop wire, as well as Litz wire. Ten to 65 strands. We make special wires for special purposes and as this is our entire business we are in a position to give you the *best at the lowest price*, and **QUICK DELIVERIES**. Just tell us what you need.

Dealers everywhere ask your jobber for Literature and Sales-pulling prices

ROSS WIRE COMPANY
69 Bath Street, PROVIDENCE, R. I.

Radio Antenna



Stock the Full Line of French RAY-O-VACS

A sale is profit and every sale you lose runs up your overhead. You need never lose a battery sale with a stock of French Ray-O-Vacs for they are built right, priced right and there's a size and shape to meet every customer's demands—ten models in all.

All French Ray-O-Vacs are built to the same high standard of quality, but the larger sizes last longer in proportion to cost and you make more profit. Push the larger sizes.

FRENCH BATTERY COMPANY, Madison, Wisconsin
ATLANTA DALLAS KANSAS CITY CHICAGO NEW YORK MINNEAPOLIS

FRENCH RAY-O-VAC
Radio's Best Batteries

What will close Scrutiny



*How one manufacturer, applying the McGraw-Hill
"Four Principles of Industrial Marketing,"
discovered new opportunities for
increased sales and profits*

THIS MANUFACTURER had been spreading his sales effort over more than thirty industries. His salesmen had endeavored to sell prospects in all these different fields, although many of the industries they covered could not possibly use their products in appreciable amounts. Consequently, much time and effort were wasted on unprofitable markets.

With so many fields to cover, the salesmen could not become experts in the application of their type of equipment to the needs of any specific industry. They were generalists, and the manufacturer was compelled to accept an

inconspicuous position in the general classification "machinery manufacturers." His "Jack of all trades" policy had gained him no recognition as "master" of any.

Applying the McGraw-Hill "Four Principles of Industrial Marketing" this manufacturer accomplished the following:

- 1 MARKET DETERMINATION.** He classified his worthwhile prospects into six distinct groups in which he found 80% of his potential market. These six groups were then set up for thorough study and intensive sales development.

of your Market Reveal?

- 2 **BUYING HABITS.** With but six markets to concentrate on, he became familiar with the buying habits of each, thus reducing his sales resistance. Moreover he was better able to discuss the applications of his machinery to these industries.
- 3 **CHANNELS OF APPROACH.** He concentrated his sales promotion work on six markets in a direct and specific manner. The waste of "casting bread upon the waters" gave place to direct and resultful methods.
- 4 **APPEALS THAT INFLUENCE.** He is advertising and selling in specific terms instead of generalizing. His story carries a message of vital interest to the buyers of each market.

THE net result is that this manufacturer by studying the specific application of his equipment to the industries where his largest potential volume lay, and concentrating his efforts in the industries, found greatly enlarged opportunity for sales. And he also found greater opportunity for profit by standardizing production on fewer types of application.

What Will Close Scrutiny of Your Market Reveal?

WILL you also find a few industries so outstanding in their importance to you that they over-shadow all others? Will you find that you can simplify your selling by classifying your worth-while prospects into groups with similar buying habits?

Whatever you find, a true inventory of your sales possibilities in each industry is as necessary as an inventory of finished products and materials on hand.

If you haven't available the necessary data upon which to base a study of your markets, the McGraw-Hill Company may be able to help you.

The McGraw-Hill Company is the focal point for information on the activities of many industries. The moves of industry are mirrored there and reflected to the world through fifteen McGraw-Hill publications.

The knowledge of industry gained by 50 years of intimate contact is at the service of manufacturers who seek to sell industry most efficiently.

It will be a pleasure to assist manufacturers and their advertising agents in analyzing their markets and applying the McGraw-Hill "Four Principles of Industrial Marketing" to their own selling and advertising.

The first step will be to read "Industrial Marketing" which graphically covers the results of a broad study of the buying habits of industry. This book will be sent upon request to any manufacturer whose market embraces any of the industries covered by the McGraw-Hill publications.

McGraw-Hill Company, Inc., New York, Chicago, Philadelphia, Cleveland, St. Louis, San Francisco, London, Publishers of

McGraw-Hill Publications

REACHING A SUBSTANTIAL MAJORITY OF THE POTENTIAL BUYERS IN THE INDUSTRIES THEY SERVE

Mining
ENGINEERING & MINING JOURNAL PRESS
COAL AGE
Radio
RADIO RETAILING
RADIO TRADE DIRECTORY

Electrical
ELECTRICAL WORLD
JOURNAL OF ELECTRICITY
ELECTRICAL MERCHANDISING

Industrial
POWER . AMERICAN MACHINIST
CHEMICAL & METALLURGICAL
ENGINEERING
INDUSTRIAL ENGINEER

Overseas
AMERICAN MACHINIST
(EUROPEAN EDITION)
INGENIERIA INTERNACIONAL

Construction & Civil Engineering
ENGINEERING NEWS-RECORD
Transportation
ELECTRIC RAILWAY JOURNAL,
BUS TRANSPORTATION

This advertisement is the fifth of the series which is appearing in the *New York Times*, *Philadelphia Public Ledger*, *Pittsburgh Gazette-Times*, *Cleveland Plain Dealer*, *Detroit Free Press*, *Chicago Tribune* and *New York Herald-Tribune*; in *Printers' Ink*, *Advertising and Selling Fortnightly*, *Class*, and in the McGraw-Hill Publications. The purpose of these advertisements is to arouse a national appreciation of the need for improving industrial sales efficiency, and to awaken a keener interest in the correct principles of industrial selling.

RADIO CRYSTAL ORE

Pure Steel Galena direct from our mines, for use of Radio and Crystal Manufacturers.

KELSO NATIONAL MINING CO.
Georgetown, Colo.

Radio Parts

Everything from Aerial Insulator to Ground Clamp

Built on 35 Years' Electrical Manufacturing and Development.

Write for Catalogue 4-W

RADIO DIVISION OF THE

HART & HEGEMAN MFG. CO.
HARTFORD, CONN.

MUTER Dependable Radio Products

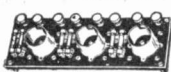

Resistance Amplifiers—
Completely assembled - - - List **\$8.00**



Audio Frequency Transformer
— Quality at a popular price. - - - List **\$2.25**

Sold by Leading Jobbers — Ask for Catalog

LESLIE F. MUTER COMPANY
76th and Greenwood Ave. Chicago, Illinois

BIG DISCOUNTS TO DEALERS

RADIO SETS-PARTS-KITS

There is a lifetime opportunity for making money in radio. Get our new big catalog, see the bargains in standard radio parts, sets, kits at rockbottom wholesale prices. Huge stocks ready for quick shipment.

This price list means big profits for you. Wonderful special offers on sets, tubes, batteries. Write for FREE copy before you buy.

Complete Wholesale Price List

W. C. BRAUN COMPANY 34-68 S. Clinton St., Chicago, U. S. A.

Telephone Cords

High-grade Cords for all makes of Headsets and Loud Speakers

We solicit your 1925 Business.

Write for Prices.

Gavitt Manufacturing Co., Inc., West Brookfield, Mass.

SEARCHLIGHT SECTION

SURPLUS STOCKS—BUSINESS OPPORTUNITIES

UNDISPLAYED—RATE PER WORD:
Positions Wanted, 6 cents a word, minimum \$1.25 an insertion, payable in advance.
Positions Vacant and all other classifications, 10 cents a word, minimum charge \$2.00.
Proposals, 40 cents a line an insertion.

INFORMATION:
Box Numbers in care of any of our offices count 10 words additional in undisplayed ads.
Discount of 10% if one payment is made in advance for four consecutive insertions of undisplayed ads (not including proposals).

DISPLAYED—RATE PER INCH:
1 to 3 inches.....\$6.65 an inch
4 to 7 inches..... 6.40 an inch
8 to 14 inches..... 6.20 an inch
Rates for larger spaces, or yearly rates, on request.
An advertising inch is measured vertically on one column, 3 columns—30 inches—to a page.

Radio Retailing

LOUD SPEAKERS

We have on hand a complete set of Machinery, Tools and Dies for the manufacture of Pyralin Loud Speakers.

Anyone interested in the manufacture of same can have this machinery reasonable. This machinery can also manufacture any part of a loud speaker that is to be made of Pyralin.

SOCIETY SPEAKER MFG. CORP.
89 Bridge St., Brooklyn, N. Y.

\$ CASH PAID \$

We buy for cash, all electrical and radio goods, surplus stock, radio sets, parts, loud speakers, electric fans and motors, etc. We buy any quantity—No stock too large for us. Manufacturers and jobbers send us your close out lists.

STUART RADIO SURPLUS **BOSTON**
MASS. CORPORATION

LOUD SPEAKERS

We offer 1000 Loud Speakers made of Pyralin, at a very attractive figure.

SOCIETY SPEAKER MFG. CORP.
89 Bridge St., Brooklyn, N. Y.

“Opportunity” Advertising:

Think “Searchlight” First!

What Do Customers Want?

Benjamin Tuned Radio Frequency Transformers

Even in what has been considered an excellent set, it is astonishing what an improvement in tone, quality, volume and selectivity the introduction of these coils produces. Low Resistance. Low Distributed Capacity. Uniform, both in inductance and distributed capacity. Space wound, air core; double green silk insulation—the nearest approach to an all air dielectric construction and the highest type of inductance possible. Coils are coupled so as to reduce capacity coupling to a minimum.

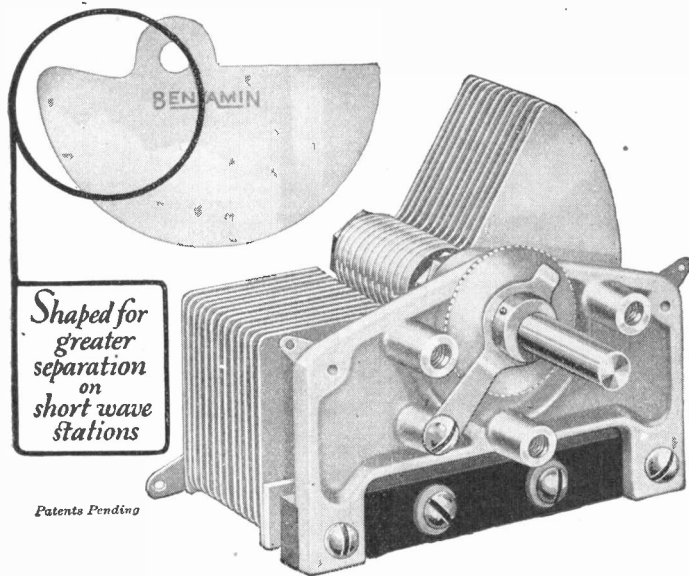
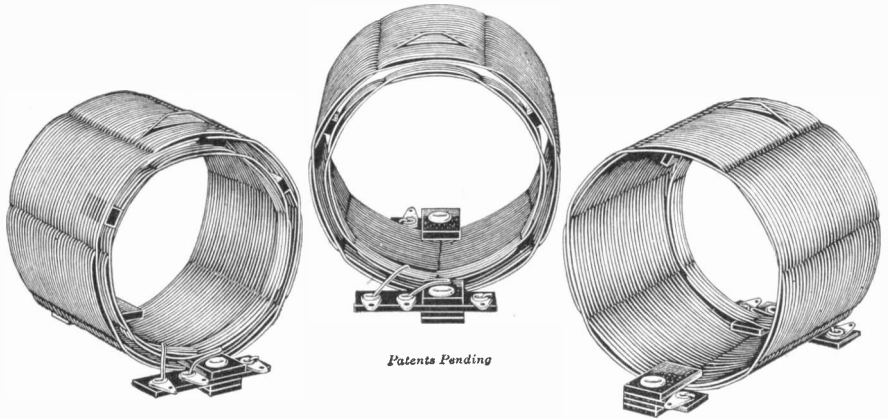

Benjamin Low Loss, Long Range Condensers

First of all a wonderful low loss condenser. The shape of the rotor blades spreads the broadcast range on the lower wave lengths, eliminating bunching of stations on the lower side of the dial and makes tuning very easy. A beautiful instrument, in unpolished silver plate finish. Friction disc on rotor shaft adjusts turning tension without loosening or throwing plates out of alignment. Made in three sizes: 13 plate for .00025 Mfd., 17 plate for .00035 Mfd., and 25 plate for .0005 Mfd. Drilling template furnished with each condenser.

Benjamin Cle-Ra-Tone Sockets

Benjamin Cle-Ra-Tone Sockets prevent the transmission of outside vibrations into microphonic disturbances. Four delicately adjusted double springs support the socket—"float" it above the base—and absorb all jars and shocks. Handy lugs make soldering easy. Furnished also in gangs on Bakelite sub-panels for compact set building. NOW READY—the new "Push" type Cle-Ra-Tone Sockets for standard UX "Push" type tubes.



Benjamin Radio Products are nationally distributed through recognized radio wholesalers

Benjamin Electric Mfg. Co.

120-128 South Sangamon Street
Chicago

247 W. 17th Street
New York

448 Bryant Street
San Francisco

Manufactured in Canada by the Benjamin Electric Mfg. Co. of Canada, Ltd.,
Toronto, Ontario



The APCO "B" Kit

Honors are Undivided

TO the APCO "B" Kit belongs the honor of being one of the few successful devices for furnishing "B" current direct from lamp socket to set.

The APCO "B" Kit enables your customers to build their own "B" Battery Eliminators in about an hour. Its parts come mounted and ready to wire. Ten feet of lamp cord with plug, four feet of wire, and two 201-A or 301-A tubes are the only extras needed to complete the work.

The APCO "B" Kit operates at a very small cost with ample current for the largest set. It represents the sales opportunity of a lifetime for you.

List Price \$30.00

Some people prefer a "B" Battery Eliminator in a closed mounting, and they will want the APCO Rectodyne. It consists of the parts which make up the APCO "B" Kit, enclosed in a handsome case, a complete unit, ready to install.

List Price \$44.00

APCO MANUFACTURING COMPANY

Providence

154 Nassau St.
New York

RADIO DIVISION

1438 S. Michigan Ave.,
Chicago

Rhode Island

2005 E. 15th St.,
Kansas City, Mo.



"A" Battery
Charger
No. 77
List. \$18.50

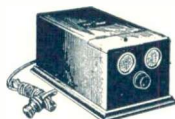

Rectodyne.
No. 66
List. \$44.00

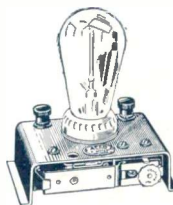

"B" Battery
Charger
No. 89
List. \$4.00



"A" Battery
Charger
No. 79
List. \$12.50

NEW

Six and Eight tube

"SUPER-HETS"

are stirring a buying market

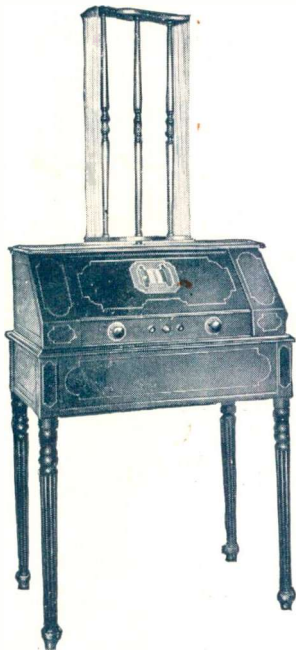

Radiola 28, "Jefferson desk" type new RCA uni-control, eight-tube Super-Heterodyne with attached loop. As dry battery operated receiver, gives volume in excess of that obtainable from storage battery operated receivers. Space inside cabinet for all dry batteries.

If used with Radiola Loudspeaker Model 104, Radiola 28 operates completely from 60 cycle, 110 volt A. C. lighting circuit, eliminating all batteries. Tuning mechanism consists of new RCA uni-control system employing "straight line" frequency condensers giving equal spacing of all stations on tuning scale. List price, including 7 Radiotrons UX-199, 1 Radiotron UV-877 and 1 Radiotron UX-120. \$260.

VOLUME! Tone! Fine appearance. And all the performance of a Radiola Super-Heterodyne. Add to these the new uni-control operations and other refinements—and you have a vigorously re-awakened radio market.

Surveys of the past year have shown that the one set most asked for by prospective buyers was the Super-Heterodyne. Now everyone is asking to see and hear the *new* Super-Heterodyne. If you have it there to show, you have a self-made sale.



Ask the nearest RCA distributor for catalog describing all the new Radiolas and Radiola Loudspeakers and Radiotrons. Get in line for radio's biggest autumn season!

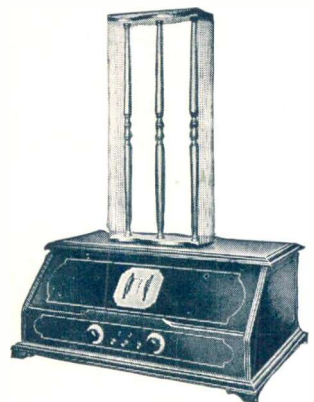

Radiola 25, new RCA six-tube uni-control Super-Heterodyne, table type with attached loop. Dry battery operated with space in cabinet for all necessary batteries. If used in conjunction with Radiola Loudspeaker Model 104, Radiola 25 operates from 60 cycle, 110 volt A. C. lighting circuit, requiring no batteries.

Tuning mechanism consists of new RCA uni-control system employing "straight line" frequency condensers giving equal spacing of all stations on tuning scale. List price, including 5 Radiotrons UX-199, 1 Radiotron UV-877 and 1 Radiotron UX-120 . \$165.

RCA-Radiola

MADE BY THE MAKERS OF RADIOTRONS

Creating new loudspeaker standards

Plug in the new RCA Cone type Loudspeaker Model 100 on any good set. One hearing will sell you—one hearing will sell any customer. It is clear-toned—true in every range of tone, high or low. List price \$35.

