

NEW ENGLAND

5 C. Per Copy  
\$1.00 a Year

# RADIO PROGRESS

REG. U. S. PAT. OFF.

Acknowledged Authority  
and Guide for Radio Fans  
in New England

Established March, 1924

JANUARY 1, 1926

## In This Issue

The New Electric Eye

Special Article by H. V. S. Taylor

A Modified Roberts Hook-up

Southern Gateway of New England

Hints on Sharp Tuning

Experimenting on Very Fast Waves

A Soprano-Bass Loud Speaker

(New England)

UNLIKE ANY OTHER RADIO MAGAZINE  
"YOU CAN READILY UNDERSTAND IT"

TIFA-

# RIVOLI

**"ALWAYS GOOD COMPANY"**

RIVOLI is always good company—good company because it is a thing of beauty and because if there is anything on the air, Rivoli will get it to entertain you. No skill is needed to bring in the broadcast stations.

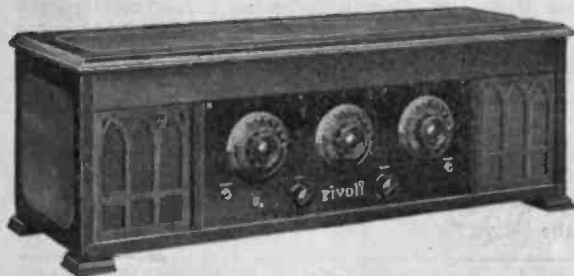

The Rivoli De Luxe combines all the convenience of a built-in speaker and a built-in battery compartment with the grace and beauty of a finely designed table model radio set. The cabinet is fashioned in two-tone mahogany with panel to match and sunburst dials that lend a pleasingly original touch. Symmetry is retained by the two silk-backed grills. . . . . **\$75.00**



The Rivoli Junior has been designed for those who must economize in space. In point of quality, the Junior is fully up to Rivoli standards. The cabinet is considerably better and more carefully finished than sets selling at a low price. Finished in mahogany with a generous flare to set off the panel... **\$60.00**

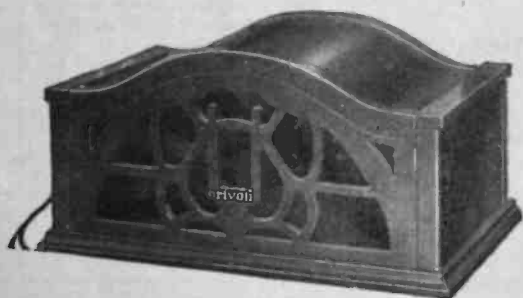

The Rivoli Speaker has successfully combined extreme beauty with acoustical perfection. Its tone chamber is constructed entirely of two-tone wood, seasoned by a special process. The front of the Rivoli Speaker is a grill, fashioned in a pleasingly decorative motif. The well known balanced type of unit is used. The Rivoli Speaker always harmonizes perfectly with its surroundings... **\$30.00**

The Rivoli Radio Line is manufactured by the Radio Industries Corp., 131 Duane St., N. Y. City

Always Mention New England Radio Progress When Writing to Advertisers.

# rivoli

**"ALWAYS GOOD COMPANY"**



\$125.00

The Rivoli Console is a beautiful creation. It is designed in the period of William and Mary, and is constructed of two-tone mahogany. The finely carved legs, the cleanly cut grill which hides the speaker and battery compartments, the metal fittings, all lend an expensive air which seem out of all proportion to the remarkably low price. The built-in speaker is a revelation and recreates the broadcasting artist so clearly that he seems to be standing in the same room.



\$50.00

The Rivoli Table is a radical departure in the construction of radio tables. It has ample space for any table type of radio set, either large or small, generous battery compartments for housing A and B batteries and chargers or eliminators, and features a grilled speaker outlet behind which any form of horn or cone can be mounted. Aside from its utility, the Rivoli Table is a beautiful piece of furniture, designed in two-tone mahogany or walnut. It solves the problem of where to put your radio set.

*(Space allowed for radio set is 36 in. long x 11 in. deep x 10½ in. high)*

Write for interesting literature describing the entire Rivoli Radio line.

Radio Industries Corporation, 131 Duane St., New York City

Always Mention New England Radio Progress When Writing to Advertisers.



# ANNOUNCEMENT

To Radio Advertisers Everywhere and  
Radio Dealers in New England

A New Policy—Another Progressive Step

A Radical Change to Meet the Demand of These Galloping Radio Times, Giving Advertisers a Concentrated, Controlled, Specialized Circulation of

**40,000 Paid Subscribers in  
NEW ENGLAND**

WITH A TIE-UP

With New England Radio Dealers who are the Subscription Agents for  
NEW ENGLAND RADIO PROGRESS

The Price has been Reduced from 15c. to 5c. a  
copy and from \$3.00 to \$1.00 a year

EFFECTIVE WITH THIS ISSUE

The addition of "New England" to the title and the concentration of the circulation to the New England States—the most fertile, easiest sold, most economical distribution territory in the world—will give advertisers wonderful results.

Our Page Rate Per Thousand Circulation is Very Low Compared with Other  
Leading Radio Magazines

And We GUARANTEE the Circulation

---

Don't Scatter Your Sales Efforts. Get Distribution and Sales Volume  
in New England FIRST. People and Places  
Are Close Together Here.

---

The One They All Like!

*New England Radio Progress*

COR. TEMPLE AND PUBLIC STS., PROVIDENCE, R. I.

Established March, 1924, as Radio Progress

# Cold Questions

**Which a Radio Manufacturer or his Advertising Agency should ask the publisher of a Radio Magazine.**

**If 80 per cent. of the answers are satisfactory and true, it will pay that manufacturer to advertise in that magazine**

Here are the ANSWERS which NEW ENGLAND RADIO PROGRESS gives:

**AND 100 PER CENT. OF OUR ANSWERS ARE TRUE!**

How old is it? Two years next March.  
 What is there about its circulation distinctive or superior to other magazines? It is concentrated in the six New England States, and being "New England's Own Radio Magazine," the readers feel almost an affection for it. Thus, the reader-interest is unusually high.  
 What is the experience and education of the Editor? His literary and writing experience was acquired at Yale. His technical training came from Massachusetts Institute of Technology, of which he is also a graduate. The Research Laboratory of the Westinghouse Company gave him the practical experience in testing and engineering work which a radio editor needs. While there he was one of the two men who in 1913 first started all radio work of the Westinghouse Company.  
 What is the subscription price? 5c each; \$1.00 a year.  
 Do you give a premium to subscribers? No.  
 How often issued? Twice a month.  
 What advantage is that as compared with a monthly publication? Changes and advances are being made in radio too rapidly to be covered in a monthly. Readers demand such news and descriptions while they are fresh and new.  
 How do you get circulation? Through radio dealers in New England, who sell yearly subscriptions,—and from news-stand sales.  
 How much circulation is outside New England? About 10%.  
 Who is the publisher? The Oxford Press, John F. O'Hara, Proprietor.  
 Is it connected with any society or association, or the organ of any? No.  
 Who reads it? Broadcast listeners or "fans."

What distinguishes its reading matter from other magazines? It is written so that anyone may understand it. It is so easy to read, so plainly written, that even the technical terms are clear, and the reader knows exactly what is meant.  
 How does the advertising rate compare with others? Compared with nine other leading radio magazines, NEW ENGLAND RADIO PROGRESS has a lower rate per page for each one thousand of circulation than six have. It is higher than one, and the same as the other two.  
 How do you prove circulation? By open books or sworn statement.  
 Do you guarantee the claimed circulation? Yes, and give a pro rata refund of the advertising rate should there be less than the rate is based on.  
 How much circulation? 40,000 net paid on all issues after January 1st, 1926.  
 Why don't you publish more pages of reading matter? Questionnaires to our readers prove that we give them all they want and all they have time to read. "Too much to read" is the kick now-a-days. There is a great waste in this on the part of publishers in this age, and it has to be paid for by the high advertising rates many have to charge.  
 Do you give write-ups of the products of your advertisers? When there is a news value.  
 Has NEW ENGLAND RADIO PROGRESS any dealer influence? Yes, a great deal.  
 Why? Because they sell yearly subscriptions for us and are every day handling our magazine, showing it to prospective subscribers, etc.

## Double Barreled Advertising

is what you get in NEW ENGLAND RADIO PROGRESS. The only consumer magazine with a TIE-UP to the dealers in New England, who are our Subscription Agents.

This dealer influence and circulation which you surely get is of great value, yet costs you nothing extra.

### NEW ENGLAND RADIO PROGRESS ADVERTISING RATES

Effective January 1, 1926,  
and for Six Months Only

| Per Issue                    | 1 Time   | 4 Times  | 12 Times |
|------------------------------|----------|----------|----------|
| Full Page                    | \$120.00 | \$110.00 | \$100.00 |
| Half Page                    | 60.00    | 55.00    | 50.00    |
| Quarter Page                 | 35.00    | 30.00    | 27.50    |
| Small space, agate line      | .40      | .35      | .32      |
| Back Cover, 2 colors         | 200.00   | 200.00   | 175.00   |
| Inside Front Cover, 2 colors | 150.00   | 135.00   | 125.00   |
| Inside Back Cover, 2 colors  | 150.00   | 135.00   | 125.00   |

Issued on the 1st and 15th of every month.  
Forms close 10 days earlier.  
See Standard Rate and Data Book for further data.

# NEW ENGLAND RADIO PROGRESS

HORACE V. S. TAYLOR, EDITOR

Volume 2, Number 20

5c Per Copy, \$1.00 Per Year

## Contents for JANUARY 1, 1926

|                                       | Page |  | Page |
|---------------------------------------|------|--|------|
| The New Electric Eye.....             | 9    | Editor's Loud Speaker:                   |      |
| A Modified Roberts Hook-up.....       | 13   | The New Name.....                        | 27   |
| A Soprano-Bass Loud Speaker.....      | 17   | Packing the Sardines.....                | 27   |
| Hints on Sharp Tuning.....            | 19   | Saving Civilization.....                 | 28   |
| The Izzy A. Nutt Family.....          | 22   | The Southern Gateway of New England..... | 29   |
| Experimenting on Very Fast Waves..... | 23   | American Radio Relay League.....         | 34   |
| Five "Genes" in One Station.....      | 25   | Dr. Radio Prescribes.....                | 35   |
| Fone Fun for Fans.....                | 26   | United States Broadcasting Stations..... | 38   |

FRANK W. MAAS, ADVERTISING MANAGER,  
220 Devonshire St., Boston, Mass.

*New York Representative*  
Sheldon C. Kniffin.....503 Fifth Ave., New York  
Phone—Murray Hill 3149

*Western Representative*  
W. T. Diehl.....30 North Dearborn St., Chicago  
Phone Central 5410

NEW ENGLAND RADIO PROGRESS is issued on the 1st and 15th of each month by the Oxford Press at 8 Temple Street, Providence, Rhode Island. John F. O'Hara, Publisher. Yearly subscription in U. S. A., \$1.00. Outside U. S. A., \$1.25. Single copies 5 cents. Entered as second-class matter, April 4, 1924, at the Post Office at Providence, R. I., under the Act of March 3, 1879. Address all communications to NEW ENGLAND RADIO PROGRESS, 8 Temple Street (P. O. Box 728), Providence, R. I. Title registered at United States Patent Office.

The publishers of this magazine disclaim all responsibility for opinions or statements of contributors which may at any time become subject of controversy.

# SUPERADIO RECEIVER

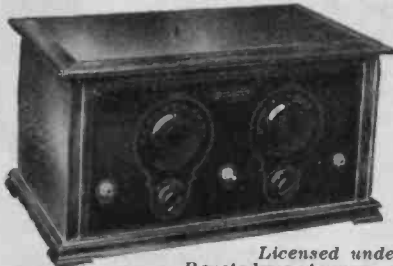

*Licensed under  
Reactodyne Agreement*

Remember—now you can buy TESTED tubes—where the Superadio Dynameter is on the job. Measures plate impedance, amplification factor and mutual conductance of any tube without calculations or curves.

## 5-TUBES 2-DIALS

At last—true beauty is combined with scientific design so that results never before expected are now easily achieved. Wonderful tonal quality, marvelous power and only \$56.00.

The Superadio operates on a radically new principle—inductive reaction—yet you get the best on the air with the least effort. Write for literature.

## DE WITT LA FRANCE CO., INC.

54 Washburn Avenue

Cambridge, Mass.

*Boston Representative*

Martin, Hartley & De Witt Sales Co., 99 Bedford St.

*Chicago Representative*

William A. Welty & Co., 36 So. State St.

## What a Nickel Will Buy For You

---

The chief trouble with "B" battery eliminators has been that the tubes used were very short lived. Here is a new device which does not need to have parts replaced. See **"This 'B' Eliminator Won't Burn Out."**

With this kind of weather many roads are in poor shape. There has recently been started a radio service which keeps track of bad conditions and detours. It is described by Vance in **"A 3,000-Mile Road Map."**

If you have been reading this magazine during the past year, you will know what most of the improvements in the art have been. Even at that you will be interested in **"What 1925 Did for Radio,"** by Liston.

The most exciting thing which will happen this month will probably be the tests to try to pick up Europe. **"All About International Radio Week"** is a description by Arnold of how to do your part in these experiments.

Did you know that radio was no longer the enemy of the talking machine industry, but was actually lending it a hand? Taylor explains this in **"How Radio Makes Phonograph Records."**

**"Make Your Radio Beat Your Friends"** is the interesting title under which Rados gives a very good description of how to improve the operation of the ordinary receiver.

Parker, the well known patent attorney, has written a very readable article, **"Making Money on a Radio Patent."** You will want to know about it even if you are not an inventor.

One of the silver tongued announcers has gone off the air. If you want to know about it read **"A Pioneer Broadcaster Shuts Up,"** in the issue of January 15, price five cents.

**With this issue, January 1, 1926,  
the price of Radio Progress  
has been reduced to**

**5c**

**Subscription Price Will Be \$1.00 a Year**

As a member of the big family of fans who read RADIO PROGRESS, you will be glad to learn that we are still keeping "Abreast of the times," and in this case are way ahead of the field.

THIS REDUCTION IN PRICE will not be accompanied by a decrease in the value and interest of the magazine to you. Instead we are going ahead with plans to give you even a better and bigger periodical than it has ever been before.

The aim will be continued to write especially for those radio fans and broadcast listeners who are intelligent and interested in the art, but who have not had a special education in radio. In other words, we want this to be YOUR MAGAZINE and would like your comments and criticisms.

**Watch for the next issue**



# New England Radio Progress

"ALWAYS ABREAST OF THE TIMES"

Vol. 2, No. 20

JANUARY 1, 1926

5c Per Copy, \$1.00 a Year

## The New Electric Eye

*It Can Sing As Well As  
See By Radio Waves*

By OLIVER D. ARNOLD

YOU are not surprised when you see a flash of electricity, nor when you hear music brought by radio. However, we are now reversing the process as it is possible to have an electric device see you.

The idea of having an electric eye is not new. The element selenium can be used for this purpose. It is a kind of cross between a metal and a piece of

light as for instance comparing lamp bulbs or for use in radio movies or a thousand other places where you want light to affect an electric circuit. If it were as simple as it sounds, there would be no need for further experimenting. Unfortunately it is difficult to make a cell of this stuff which is reliable. When you let a 50-watt lamp shine on it some days it will change the resistance a lot more than others depending on the temperature, humidity and even apparently on the way the selenium happens to feel.

### It Takes Its Own Time

Another objection to this material is that by doubling the light, the change is not doubled. Naturally it would be much better if the resistance kept in step with the illumination. Still more trouble is found in the fact that when the light is turned off the resistance does not immediately come back to its former value. It is slow and conservative and takes its time about arriving at the point where it is going.

In order to have any chance of inventing radio movies, it is necessary that we have some sort of electric eye which will get rid of these three troubles. In other words, it must be always the same; the change must be proportional to the amount of light which strikes it; and last it must snap to its final value instantly. By combining many of the ideas already found in radio it has been possible to get a cell which will do these very things.

### Light for a Grid

This device is called a "Photo Electric Cell." It works in the same general way as the selenium but without its difficulties. It has been found that when

the metals, sodium, or potassium have a beam of light directed upon them, they give off a stream of electrons in a way similar to the glowing filament in your vacuum tubes. But instead of using a grid to control the amount of current all that is necessary is to vary the light.

Perhaps you will say that you are not very familiar with sodium. If so, you should take the statement with a grain of salt, since ordinary table salt is composed of one part of sodium combined with one part of chlorine. Although chlorine is one of the poison gases used in the war, when its attention is taken up with sodium, it is entirely harmless and in fact will spoil your entire dinner if there isn't enough of it (salt) on your meat.

### It Jerks Water in Two

Sodium and potassium are two metals which are very much alike and when deposited on the glass of a tube they look

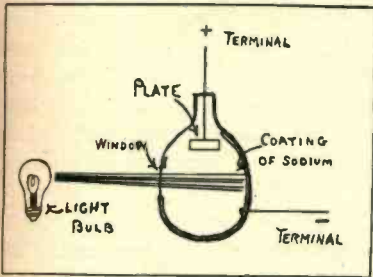

Fig. 1. Here is the General Idea of a Photo Cell.

glass although as just mentioned, it is an element and cannot be analyzed into anything else. It is called selenium as it was thought that this material made up a good part of the moon and the moon god's name was Selene.

### When Light Strikes Cell

The peculiar thing about this substance is that its resistance changes very sharply with light. In the darkness a small piece of it may have hundreds of thousands of ohms resistance but when a powerful light shines on it its value drops to a fraction. By making a cell of this material and connecting it in circuit with battery and a meter you will find that the pointer of the latter sweeps over the scale whenever light strikes the cell.

This would seem to be the ideal arrangement to enable you to measure

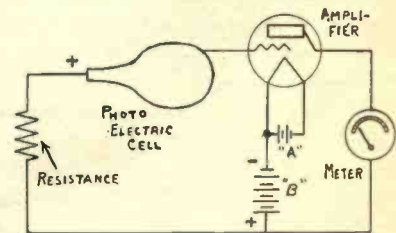

Fig. 2. This Circuit Turns Light Vibrations Into Electricity.

exactly like silver. However, do not try to make a mirror with either of them unless you expect to use it in a vacuum. They are both so very fond of oxygen that they will not last at all in the air, but immediately become rusted or oxydized. Their affinity for oxygen is

so tremendous that if you drop a small piece of potassium into a pan of water it will jerk the molecules of water in two and seize the oxygen part while it lets the hydrogen escape into the air.

Water you recall is one part of oxygen combined with two parts of hydrogen. The potassium seizes the oxygen with such great violence that it gets red hot

the filament. The latter you will recall gives off swarms of electrons which are attracted across to the plate under the influence of the "B" battery voltage. It is this crowd of negative charges passing through the plate circuit which gives the output current of the vacuum tube and operates the telephones or loud speaker.

as the latter is connected so that the— runs to the grid where in this case the plus is substituted. As the grid is now positive, a small current will flow through the "B" battery and cell whenever light shines through the window.

Of course the amplifier works in the ordinary manner and as its output is supplied by the same "B" battery to the plate. The variable current from the photo electric cell thus amplified is read on the meter, as shown. Of course additional steps of amplification may be used if desired.

No Time is Lost

This cell has the advantage over the selenium as already described in the following particulars: (1) As the action takes place inside the vacuum tube, there is no chance of weather or moisture having any effect. It is also independent of ordinary changes of temperature. (2) When you give it twice the light, it will show this immediately by giving a deflection on the meter twice as great. In other words, the needle moves in proportion to the amount of illumination received by the cell. (3) The action takes place so rapidly that there is apparently no time lag between a change in light and a corresponding difference in the current.

A new tube which promises to simplify this process and which may be the basis for the successful sending of motion pictures by radio, has been developed by V. K. Zworykin, a physicist of the research department, Westinghouse Electric & Manufacturing Company.

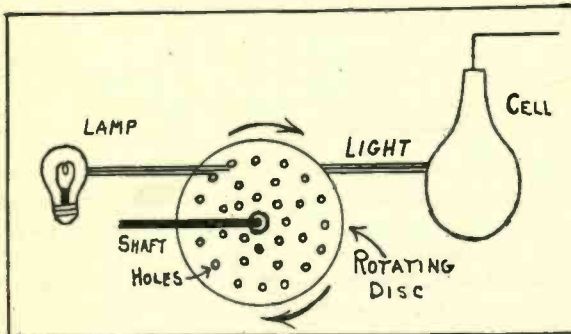

Fig. 3. This Arrangement Causes Light to Play a Tune.

and sets fire to the hydrogen which is being released. The latter suddenly bursts into flames without applying any match and we have the queer spectacle of water setting fire to a lump of material thrown on it. It would never do to call the firemen to put out such a conflagration, as it would only burn all the fiercer as they played their streams upon it.

Homesick for Its Pal

Of course the vacuum inside the photo electric cell means that all air, and with it the oxygen, has been exhausted from the tube. Since there is no oxygen there the potassium cannot combine with it however homesick it may feel for its pal. A thin film of this metal deposited on the inside of the glass will thus last in a vacuum for years.

In coating the inside of the bulb, there is a small opening left which forms a window (Fig. 1) which allows light to shine through and strike the metallic layer. This layer is also in contact with a terminal or wire brought out through the glass which is labeled in our cut. Another terminal carries a plate of tungsten as shown.

Now it has been found that potassium and sodium have the extraordinary quality of sending out quantities of negative electrons or particles of electricity when light shines upon them. That is the same sort of action you get in a 201A tube or a WD11 when you light

Like a Reversed "C" Battery

This photo electric cell has exactly the same motion as just described. Unfortunately, however, the amount of current given off by the metal coating is quite small even under a powerful light. It is not nearly as big as that obtained from an audio frequency amplifier. So to get much effect from the cell it is desirable to connect a step of amplification to its output as appears in Fig. 2. Notice here we have the cell with a resistance in series, with the "B" battery forcing current to the grid of the vacuum tube. However, the polarity is not like that of an ordinary grid battery

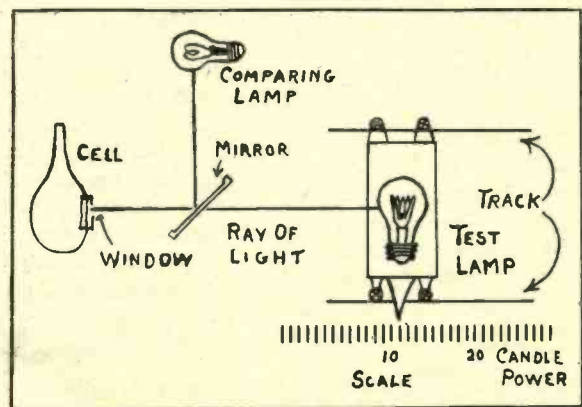

Fig. 4. Here the Photo Cell Does Away with a High-Priced Laboratory Tester for Electric Bulbs.



**Smoke Rings a Bell**

This new tube is really the combination of the photo electric cell, which turns light into electric impulses with a common amplifying tube such as used in a radio receiving set, which amplifies the current produced by the photo-electric cell and for the first time makes it available for practical uses. In other words, it combines the two tubes (cell and amplifier) which are seen in Fig. 2 into a single unit. How successful the Zworykin tube is, was shown at the New York Electrical Show, when an automobile searchlight was played on the tube, and a puff of cigarette smoke blown between it and the searchlight caused a change in the electric current of the tube strong enough to throw a relay switch and ring a bell.

Ordinary photography, in reproducing an image of a person or scene on a photographic print, depends upon the fact that things of different colors and textures throw off varying amounts of light. This change in the light has an effect on the action of the chemicals on separate sections of the photographic plate. The result is that the different shades of light produced in the various sections of the plate create an easily recognizable image of the original subject.

**Does it Mean Radio Movies?**

Scientists familiar with the Zworykin tube believe that through its use the variations of light in the different parts of a scene may be used to produce variations in electric current in such a way that the scene can be reproduced at great distances by means of radio.

The Zworykin tube is an elongated vacuum vesse with the electron-emitting metal coated on the inside of the glass. When the unit is connected with "A," "B," and "C" batteries of suitable characteristics, no current will flow through the tube's plate circuit when the film is in darkness. When light strikes the film, the current begins to flow, its strength being in proportion to the intensity of the light. The current is amplified in much the same manner as the signals induced in a receiving set are amplified by the tubes in the set. By reversing connections, the operation of the tube can be reversed, so that it will produce in *darkness* a current which will be cut off when light is admitted to the electron-emitting film.

Not only is the tube very sensitive in respect to the faithfulness with which its electric current follows the variations of light, but its reaction to the light is exceedingly rapid, being on the order of one one-hundred thousandth (1/100,000) of a second.

The possibility of creating a new musical instrument by utilizing this photo-electric effect has been brought out by Dr. Peter I. Wold, Professor of Physics at Union College. A photo-electric cell is connected to the broadcast circuit of a sending station and a disc with many rows of perforations placed between the cell and a light source, Fig. 3. A battery of 135 volts has its negative terminal connected to the potassium coating and its positive terminal to the tungsten plate of the cell. When light falls on

the potassium coating, electrons are given off and travel to the tungsten plate, thus constituting a current. By means of a motor the disc with circular rows of holes is rotated between the light and the cell. When the disc is revolved slowly, a low pitched note is given off, rising gradually as the speed of the disc increases.

**How Light Plays a Tune**

In Prof. Wold's apparatus, the disc contains four rows of holes, the outer row with 48 holes, the next row with 36, the third with 30, and the inside row with 24 holes. By covering one row or another he secures different notes. Using the first three rows, he produces the major chord, do-mi-sol. By uncovering all four rows he secures notes of good organ quality.



Fig. 5: The Inventor, Zworykin, is Seen Inspecting a Sample of the Electric Eye Which Can Sing.

For the construction of an organ, the ingenious experimenter would need only to have rotating discs with rows of holes of the right numbers and arranged so that the light could pass through the holes to the photo-electric cell. Any row or combination of rows could be played by small slides operated from a keyboard and the loudness of the notes might be

the mirror is in place the "comparing lamp" reflects light into it, but when moved the "test lamp" shines in its window. The test lamp is mounted on a small carriage which may be wheeled back and forth nearer and farther away from the cell. This carriage carries a pointer which travels over a scale which reads directly in candle power.

scale. Now with the mirror removed, the photo electric cell will be turned on and a reading taken on the meter. Next the mirror is replaced and the comparing lamp adjusted either by varying its voltage or its position so that it gives the same meter reading. The standard lamp is now removed and a lamp to be tested substituted. It is shifted back and forth on the carriage to a position where the meter will still read the same value. The carriage pointer will then indicate the answer directly in candle power.

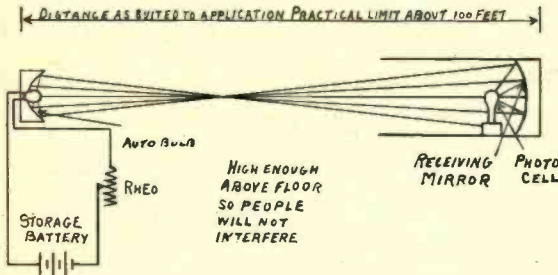

Fig. 6. If Anything (Including Smoke) Gets in the Beam of Light, the Electric Eye Will See it and Sound the Alarm.

controlled conveniently by regulating the brightness of a lamp. A loud speaker could be used to convert the electrical vibrations into sound waves (notes). One of the important features of the photo-electric cell is that it is practically instantaneous in its action. It does not require time to build up as in the case of some other electric musical instruments.

**The Light You Pay For**

Another way of using this radio tube in a practical application is in checking up electric bulbs. Probably you know that in manufacturing these bulbs it is necessary to test a certain proportion of them as a routine matter. Every so often a bulb is picked out of the line being manufactured and is sent to the testing laboratory to make sure that it has as much candle power as you are paying for. It requires a skilled operator with good eyes to test out the brightness of all these lamps and so increase production and also reduce the cost considerably of the laboratory. Such a method has been found possible by using the photo-electric cell.

If instead of a trained observer some method could be devised which would give a reading on the lamps without the need of special eyesight, it would increase production and also reduce the cost considerably of the laboratory. Such a method has been found possible by using the photo-electric cell.

Fig. 4 makes this plainer. Notice that at the left is a cell with a mirror in front of it which may be removed. When

It is not possible to make the reading of the meter (Fig. 2) give an answer in candle power, since from day to day the "B" battery will fall in voltage and the photo electric cell may vary over a period of time. The way the apparatus is operated is to use a standard lamp whose candle power is known and compare the lamps for test with it to see how they rate.

Keeping Up the Tests  
In order to make sure that the photo electric cell is not changing in value, it is only necessary to replace the mirror every hour or so and see if the comparing lamp gives the same meter reading as before. If it does, then the testing of lamps is resumed, while if a change is noted, the standard lamp is again used to calibrate the apparatus just as at first.

Another interesting application of this device can be worked out from the following experiment. Suppose we have an electric lamp focused by a mirror across the room shining on one of these bulbs. Make the connections so that with the light at normal brightness no current will pass through the outside circuit of

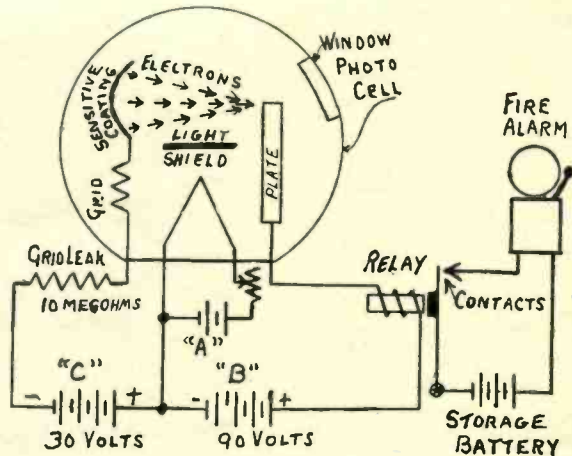

Fig. 7. Here is the Hook-up of the Smoke Detector. It Uses "A," "B" and "C" Batteries Just Like a Radio.

The standard lamp whose candle power is known is put on the carriage which is slid back and forth until the needle points at the known amount of light. For instance, suppose it happens to be a 50 candle-power lamp. The carriage will be slid until the pointer reads 50 on the

the tube. Then when there is any falling off in the illumination the voltage will be unbalanced and the output wires will become alive.

After the Rat Arrives  
Now let us put this apparatus down  
Continued on Page 33



# A Modified Roberts Hook-Up

## Latest Details of This Popular Circuit Are Explained

By HARRY J. MARX

**WOULD** you like to wear a suit of clothes that had been patched up here and there? Or even one that had been made over from some other style? Yet it really happens that many a regular hook-up is improved from time to time by the patches and alterations which are built in by fans who keep experimenting with the original set. And the circuit which is built and rebuilt by the greatest number of fans is the most likely to profit by such development.

### Popularity Must be Deserved

Of course it is the judgment of radio fans that is final in deciding the effi-

ciency of a circuit. What better proof of the value of a hook-up than the continued popularity which is extended to the Roberts receiver? Still, every circuit is in a state of continuous evolution. The greater the popularity the more there will be experimenting with it. This has been the case with the latter which has now been crystalized as the Hammarlund-Roberts circuit.

the result of the experimental work and final judgment of ten radio engineers. It has been so designed and so simplified that the layman of radio fans needs only to follow the details of instruction in order to build a set that will duplicate the original just like a manufactured article.

**Two Tubes in Parallel**

Here is a circuit employing one stage of tuned, neutralized radio frequency amplification of high efficiency, a regenerative detector, then a stage of normal audio frequency amplification, followed by a form of power amplifier that employs a single audio transformer but re-

curacy of design that is known. But all this careful attention of design is based on the importance of using apparatus as good as that specified and around which the entire receiver is designed.

### Reflex Feature Omitted

The reflex feature of the old circuit has been eliminated because of the difficulties that many fans have encountered in the construction of reflex sets. This change has also been instrumental in an improvement of selectivity of the set.

Although a home-built receiver, it resembles the manufactured sets in appearance and surpasses many of them in performance. A sloping panel regularly

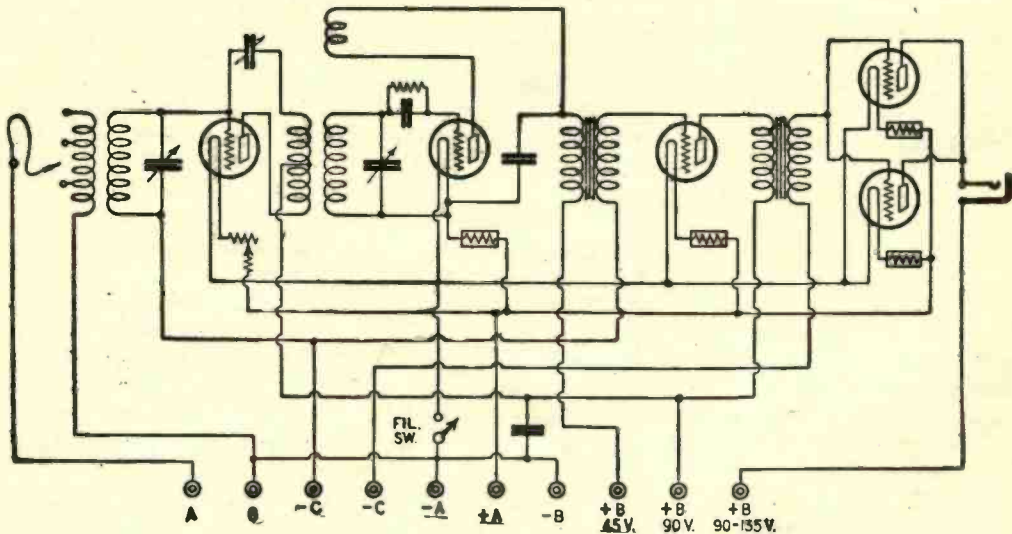

Fig. 1. This Modified Roberts Hook-up is Thought by Many to be an Improvement on the Original. It Uses No Reflex.

quires two tubes in parallel connection. This last arrangement is one of the best methods in which the volume that is delivered from the second stage can be utilized with great clarity of reception and that high degree of tone quality which is so desired by the more critical fan.

It is apparent that the circuit embodies practically every important and worthwhile refinement of control and ac-

engraved and with gold finish marking may be used, which will make even the modest fan prone to boast of his set.

The coils are of low-loss type, designed especially for this circuit. This provides for tuning over the entire broadcast wave frequency range and with the degree of selectivity necessary to eliminate powerful interference from local stations in order to bring in long distance ones.



### Building Up the Volume

Straight line frequency condensers are recommended, as they provide for proper separation of stations on a basis of uniform spacing of dial graduations. Because of omitting the reflex features, the first tuning circuit is more effective in separating the stations than before. The efficiency of the detector circuit tuning is obvious when we stop to consider the regenerative feature. Turning the little tickler knob helps to build up the volume on long distance stations.

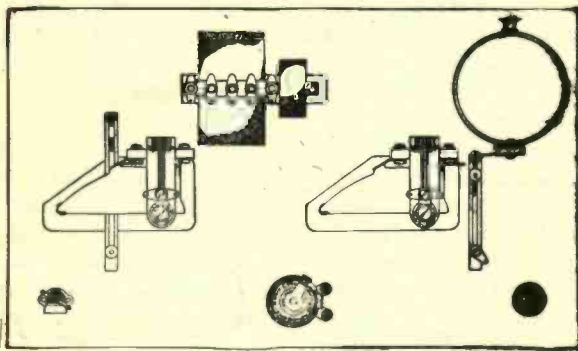

Fig. 2. The Placing of the Tuning Coils is Important

Volume is controlled by means of a rheostat for the first or radio frequency tube. This may be used to reduce excessive volume right at the input tube, and therefore avoids the distortion on loud locals due to overloaded detector and audio tubes.

### All the Family Knows

There are two major controls—the condenser tuning dials and two minor—the tickler for selectivity and the rheostat for volume. This is simple enough for the home where every member of the family wants to know how the set works so as to use it himself.

In the usual set-construction article, the fan must lay out his panel, drill and countersink the holes; rarely has he the opportunity of owning an engraved panel. In this case the drilled and engraved bakelite, with a sub-panel and even brackets for mounting may be purchased as a unit. The complete parts for building the set without a cabinet will cost about \$61.00.

### Can't Use Old Junk

The big item in a receiver is of course the circuit, but the selection of apparatus used is almost as important. Contrary

to what many think, you cannot substitute anything on hand or that can be bought cheap. Many a circuit has been condemned simply because substitutes failed to produce.

The panel and sub-panel are drilled for the parts listed. Others may not fit, unless you do some drilling yourself.

### LIST OF PARTS REQUIRED

- 1 Hammarlund-Roberts Foundation unit.
- 1 Set, Hammarlund-Roberts coils.

- 1 Fixed condenser .006 mfd.
- 10 Phone Tip Jacks (Union used).

The "foundation unit" contains the drilled and engraved front panel, a drilled sub-panel and brackets. In addition it includes a coil mounting plate, grid condenser mounting posts, wire, fixed four ohms resistance and all the necessary lugs, screws and nuts for assembly.

### Three Coils on One Unit

The Hammarlund-Roberts Coils consist of two units—with a special primary winding, a standard secondary and a variable tickler coil. These units must be efficient low loss apparatus in order to perform their function properly.

The variable condensers must be of similar quality so as to eliminate losses and keep the selectivity which is characteristic of the set. The audio transformers were selected because of their ability to work without distortion. They are important factors when clear and beautiful reception is desired. The ballasts control the filaments of four tubes and eliminate rheostats with the exception of the one which is used as a volume control.

### Don't Use Paper Strips

No value is given for the grid leak as it differs for various tubes—but it is important that the resistance remain fixed and not susceptible to atmospheric changes. Cheap paper strip types should not be used.

The assembly of apparatus on the front panel is shown in Fig. 2. The brackets appear, but cut off so as to avoid confusion. The shield plates of the condensers are against the panel. The one on the left in the illustration goes be-

- 2 Audio transformers (Lyric used).
- 2 Condensers .0005 mfd.
- 1 "Midget" condenser, about .00016 mfd.
- 5 Sockets.
- 1 1 3/4 inch dial.
- 2 4 inch dials.
- 1 Rheostat, (20 to 30 ohms).
- 1 Single Circuit Jack.
- 1 Battery switch.
- 1 Grid leak.
- 4 Filament ballasts.
- 1 Grid condenser .00025 mfd.
- 1 Fixed condenser .002 mfd.

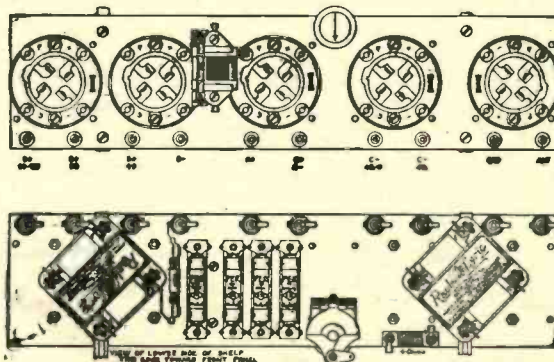

Fig. 3. The Upper View is Top of Sub-base, While the Lower is the Bottom, Looking Up.

hind the bracket. It is best to mount the condensers and shield plates before fastening the brackets to the panel.

mounted in the position illustrated. It is important that units be fastened with terminals located about as shown. The antenna coil mounts on a brass plate,

which is fastened with two screws fitting into tapped holes in the right hand bracket.

The coil with tickler should be

antenna coil mounts on a brass plate,

In the sub-panel assembly, there are

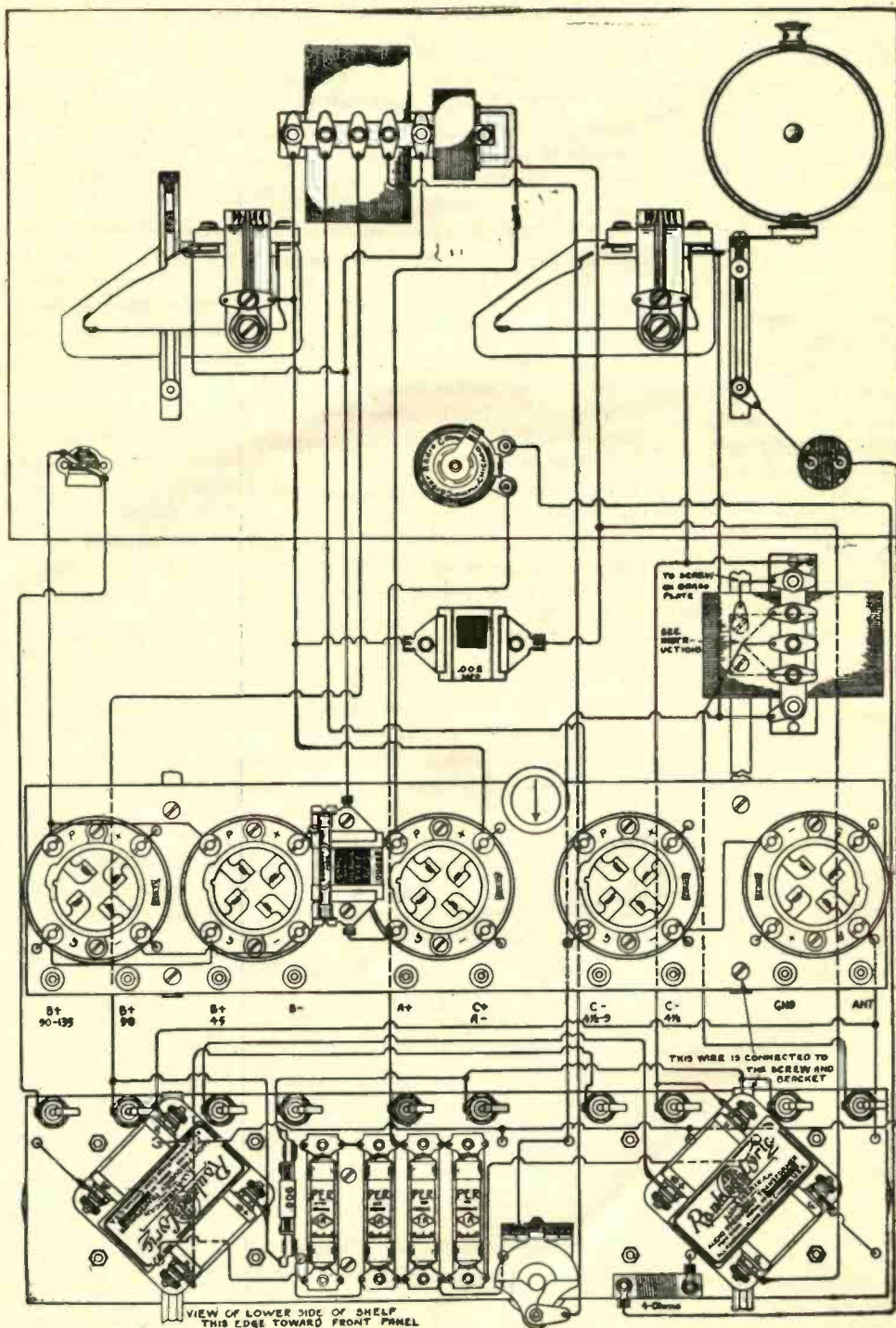

Fig. 4. Here is the Complete Wiring. The Upper Part Shows Rear View of the Panel; the Center is Top of Sub-base, While Bottom is the Assembly Underneath.



two sides to be considered. Fig. 3 shows the top in the upper half of illustration; this should be assembled first. The four sockets on the left have their terminals facing the same but the one on the right is reversed from these. The center socket is fastened with two screws that go into tapped holes in the sub-panel but the others require screws and nuts as clearance holes are drilled for these. The grid leak is mounted on two brass supports, furnished with the foundation unit.

#### Supported by the Wiring

The lower half of Fig. 3 shows the underside of the sub-panel, mounted on the brackets with the transformers in place. The tenphone tip jacks should be fastened as shown. The filament ballasts are fastened by means of screws which go into tapped holes in the sub-panel. The four ohm fixed resistance and the .006 by-pass condenser are shown in place but are not fastened, the wiring holding them in place.

It must be kept in mind that the tubes in this receiver are not laid out as in the conventional set—that is, the radio frequency tube first, the detector next and then the audio frequency tubes. Instead, for simplicity and short leads in wiring, the first audio tube was placed on the extreme right, Fig. 4. The second from the right is the radio frequency amplifier, the one in the center the detector and the two on the left are the parallel connected tubes of the second audio stage.

#### The Iron Must Be Hot

In wiring this set these points are important—all leads are to be kept short as possible and all joints should be well soldered. This doesn't mean slap solder all over everything. Make it hold—use a hot iron. The filament connections go in first.

Alongside some of the socket terminals are shown holes through which the wires are intended to pass in order to connect to the units on the lower side. These holes are also shown in the view of the bottom side. The wires disappear into these holes in the upper view and should be followed up from the respective holes in the lower picture. Where wiring disappears under some unit such as a transformer it is shown in dotted

lines in order to complete the connection.

Most of the filament wiring can be entirely finished before the sub-panel is mounted on the brackets and the transformers put in place.

#### Bracket in the Negative

In the lower right corner there is a note "This wire is connected to the screw and bracket." Before the transformer is mounted, a terminal lug is passed over the screw on the rear edge fastening the sub-panel to the right bracket. The lead from the B—, A— and C+, and the ground phone tip jacks, is connected to this terminal. This puts the bracket in the negative filament circuit. Where this bracket is fastened to the front panel a terminal lug is shown under the nut on the lower screw of the bracket. This lug is wired to the battery switch which closes this negative circuit of the switch.

This negative filament and ground lead must be connected to the first lug near the front panel on the upper terminal strip of the antenna coil. This is done by fastening a lug under one of the screws that hold the mounting plate on the aluminum bracket.

#### Try Three Antenna Posts

The antenna coil unit has six terminals, two lower ones for the secondary circuit, and four on the upper strip—one of which is grounded as explained. The other three are antenna terminals and are placed there so the fan can try all of them with the set in operation, to find which gives the best results. The antenna lead can be flexible with a clip on the end so the connection can be altered as desired. This is the reason for the note, "see instructions."

Turn the volume control on full and advance the sensitivity dial to its maximum position. Now, by simultaneously rotating the two tuning dials at approximately the same settings, a squeal should be heard in the loud speaker, provided any stations are "on the air." Adjust the dials for maximum squeal and then reduce the setting of the sensitivity dial. This will eliminate the squeal and result in reception of music or whatever is being broadcast at the time.

#### How to Cut Down Volume

Perhaps on local stations the advancement of the volume control to its limit

will produce distorted reception because of tubes overloading. If this is the case it is only necessary to reduce on the setting of the volume control, or else reduce the amount of "B" battery voltage applied to the last audio amplifier tubes.

Regeneration should be obtained smoothly by advancing the sensitivity control, that is the tube should go in and out of oscillation quite evenly and slowly. If this is not the case reduce the voltage on the detector applied to the "B" positive 45 jack.

Tune in some moderately strong station, and, listening in with head phones or loud speaker, turn out the radio frequency tube by means of the volume rheostat. Adjust the midget condenser setting until signals either disappear entirely or at a decided minimum. It will be necessary to retune slightly after this and then the tube should again be turned out and the condenser readjusted slightly to a more exact position. There is a distinct minimum of sound when the neutralizing condenser has been correctly set.

#### HARD WORK DOESN'T KILL

Persons often ask whether tubes used in a regenerative set (where the regenerative tube performs double duty) or in a reflex set, (where the reflexed tube is used twice) will last as long as tubes used in other sets. The double duty performed by tubes used in reflex and regenerative circuits has no effect on their burning out, as the tube life depends only on the filament, which is operated at the same temperature in every type circuit.

#### MANN TELLS BOY OF BEARS

A novel method of presenting information of the life and manners of the animals at the National Zoological Park at Washington has been instituted at Station WRC by Dr. William M. Mann, Superintendent of the Zoo Park. Through the medium of dialogue between himself and Master Hugh Clark, questions of particular interest to other boys are asked by the boy and answered by Dr. Mann. These talks about lions, tigers and other beasts will be repeated at intervals throughout the winter.

# A Soprano-Bass Loud Speaker

## A New Kind of Diaphragm Is the Secret

By RICHARD E. CONNET, Providence

HOW fast will it run?" That used to be the question asked of automobile salesmen, but now it is assumed that most any car will carry you faster than the law allows and the inquiry now is directed more towards comfort. In the same way time was when *distance* was all that radio purchasers asked for.

from a piano. A tuning fork if a good one gives nothing but a single note—the fundamental. If you can recall hearing one, you will realize that it is dull and lifeless. By adding the various harmonics in different strengths, we may build up tones which are identical with those given by the different musical in-

times and so forth up the scale, gives a character to the tone which shows our ear that it is the vibration of a violin.

Now let us say that the player of the instrument is just learning and he gives a squeak on the violin, Fig. 2. Right away the fundamental drops in volume and the higher harmonics become a lot louder. Our ears are able to note the difference right away and what we hear we call a squeak.

### Note is Badly Mangled

Now, in their investigations of the trouble with loud speakers, the experimenters found that microphone and amplifiers reproduce the various frequencies fairly well, and that in a good set the note reaches the last jack without much distortion. But the ordinary loud speaker mangles a good note beyond recognition. And here is the reason. The diaphragm in a phone or a loud speaker is made of a single disk of thin metal tied tightly down all the way around the outside. It vibrates much more strongly at one frequency (about 500 vibrations a second, usually) than at any other. Some of the very low frequencies do not get any response at all.

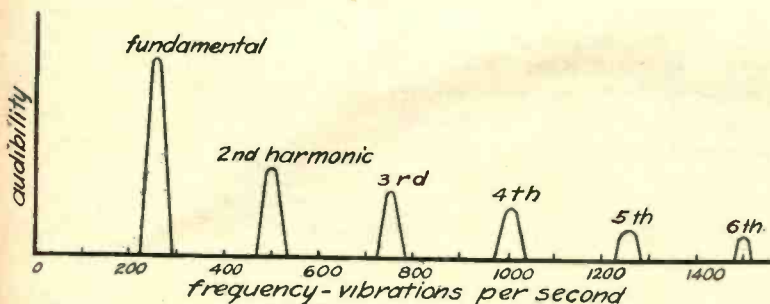

Fig. 1. Here is the Thumb Print of a Rich Violin Tone, Middle "C."

But nowadays everybody wants a set with "tone" in it. People talk about this quality as though it had just been invented, and had not existed in old radios at all. It is there, but the trouble was that the tone was the wrong one. For a long time experimenters and manufacturers sought to find out why radio loudspeakers sounded so flat and soulless; why they lacked the proper timber. I shall see if I can explain just what they found and what one manufacturer did to fix the trouble.

### How a Rich Note is Made

Music, as most of us know, consists of vibrations of the air ranging from 16 to about 6,000 oscillations a second. Usually, as in the case of a rich violin note, there are a dozen or so different speeds of vibration going at once in a single note. The high overtone (two or three thousand vibrations) may be very faint, but they are nevertheless very necessary for the quality of the note.

It is this matter of overtones or harmonics that enables us to tell a violin

instrument. Thus the particular blare of the brass wind instruments is caused by prominent ninth and eleventh harmonics

### Building Up Its Characters

In general the fundamental will be by far the loudest or most prominent. This is revealed in Fig. 1, which shows a vi-

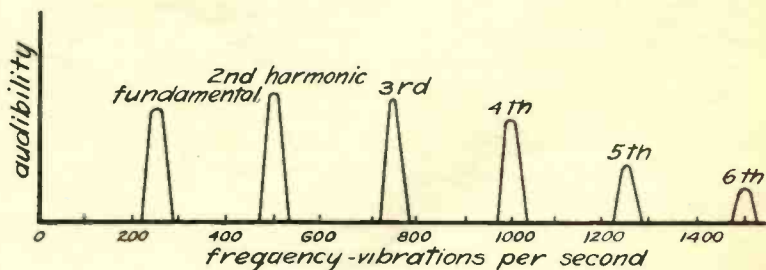

Fig. 2. Notice How a Poor Speaker Has Abused the Note of Fig. 1.

bration of 256 oscillations per second. This is the tone given out by middle C on a piano. In addition, however, there is a fairly strong vibration at just double this speed (second harmonic) which is an octave higher. The third harmonic at three times 256 or 768, a fourth, four

If the edges of the disk are loosened to make it respond to the low notes, the vibrations change their character, and the sound becomes tinny. This type of sound is called a "noise" rather than a "note." Fig. 3 shows how a noise looks, and also shows a pure note. You see that the



vibration starts and stops as the diaphragm as a whole flutters back and forth, and of course the tone given off is not smooth and pleasant.

**Clamping Cuts Low Notes**

The disc which is clamped around the edges of course cannot oscillate as a whole since the edges at least do not move at all. But this clamping reduces the amplitude or loudness of the low notes while letting through the high tones just as before. As a result the loud speaker modifies the vibrations of Fig. 1 to look like those of Fig. 2. Even this is decidedly better than the noise of Fig. 3, but still is not very good.

The problem of the experimenters then, was to produce a diaphragm that would reproduce all tones faithfully. Their first attempt was to connect the disc to levers which were actuated by the magnets, but

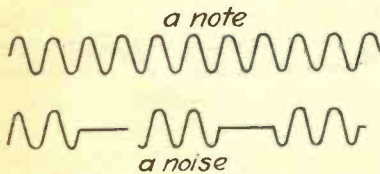

Fig. 3. What a Phonograph Record Would Show of a Note and a Noise.

levers are likely to rattle and are too heavy to give the high notes well. Then they tried paper cones and levers. Some speakers are very successful, but they are likely to reproduce certain notes better than others, usually lower notes than the old type of speaker gives. This point of resonance often comes about at the tone of a man's voice, and that makes him sound toothless. So that was not so good.

**Stops When Pushing Ceases**

Then a Russian acoustic expert, Dr. Fisher by name, who lives in Boston, tackled the proposition. He reasoned first that the most foolproof method of reproduction is to have the magnets of the phone act directly on the diaphragm without any levers. Second. He said the low notes, Fig. 4, are best reproduced with a piece of parchment tightly stretched like a drum head, but not quite as big. Parchment or paper, being rather limp, does not vibrate like a tuning fork, but will move back and forth rather

slowly when it is pushed, and stop almost immediately when the pushing ceases. But parchment cannot be

in one direction than in the other, thus eliminating any little bit of natural vibration period that it might have.

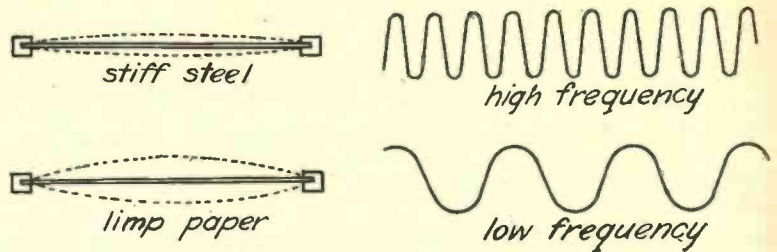

Fig. 4. The Steel Diaphragm is Especially Suited to High Frequency Notes, and the Slow Paper to Low Ones.

moved by a magnet; only iron or steel will do that.

Third, for high notes a piece of stiff iron will be the best. A small piece will vibrate at the highest frequencies (Fig. 4) quite readily, and moreover, it can be operated directly from a magnet. If the three features could be combined, a good speaker should result. So he proceeded to combine them. He took a disc of soft iron about the size of a quarter dollar, and joined it to a ring about two and a half inches in diameter by four strips about three-sixteenths of an inch wide, Fig. 5. This was of course made by stamping or sawing a single large sheet. This diaphragm is only three or four thousandths of an inch thick and is very light. The central disk, being free around the edges, vibrates easily and is not confined to any one frequency. But it is held sufficiently tight by the four strips to prevent making a "noise." Then he took a piece of extremely tough parchment paper of the variety used in some of the better lamp shades, and stuck it to the front of the diaphragm. It is stretched until it is perfectly taut and then cemented firmly to the disc. He wouldn't tell how he did it, but I think that he steamed the paper until it expanded and then cemented it to the disc and let it dry and contract.

**Is Warped on Purpose**

The parchment has very little weight and is perfectly flexible, so it responds to almost any frequency of vibration. The completed disc looks like Fig. 5. It is made slightly warped and becomes straight when the cover is screwed down on it, so that the paper is stretched more

The disc, when placed in a standard magnetic loud speaker unit, is now ready to reproduce exactly any changes in the amount of magnetism caused by changes in the current from the amplifi-

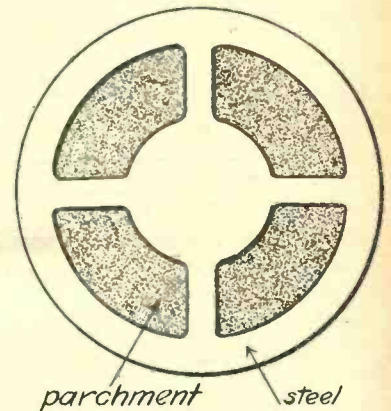

Fig. 5. This Diaphragm Combines the Good Qualities of Both Steel and Parchment.

er. With a horn shaped according to the proper physical law, which is well known to acoustic experts and made of non-vibrating material, the speaker gives a reproduction that is startling in its perfection.

**HEAD PHONES AND SAXOPHONES**

Six out of every 10 music stores in the United States handle radio sets along with the musical instruments.

**Mailing Lists**  
 Will help you increase sales  
 Send for FREE catalog giving counts  
 and prices on thousands of classified  
 names of your best prospective customers—  
 National, State and Local—Individuals,  
 Professionals, Business Organizations  
 99% Guaranteed 5¢ each  
**ROSS-Gould Co.** 6121. St. Louis  
 10th St.



# Hints On Sharp Tuning

## How to Improve in Radio's Greatest Indoor Sport

By ERIC H. PALMER, Freed-Eisemann Co.

THERE was once a baby who played with his father's Swiss watch. After that for some reason it didn't keep time very well.

In other words even if you have a good instrument it will not necessarily do the best work. Besides the need for high grade construction you must also have the proper adjustment. This applies just as much to a radio set as it does to a Swiss watch. Of what use is a \$300.00 receiver if you don't tune it properly?

### Various Kinds of Logs

Radio's "hunting season"—or is it "fishing time?"—is here. Wintry nights mean impressive logs—the kind blazing away in the fireplaces and also those which are records of radio reception.

In a few years, perhaps, radio may be so far advanced as to make it possible for you to get good reception at great

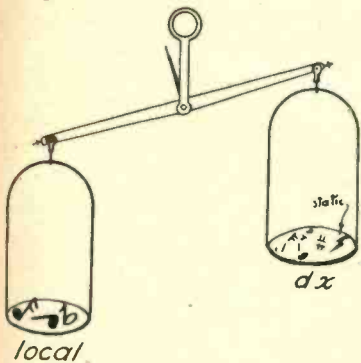

Fig. 1. With Some Fans, the Clearness of Locals Outweighs the Lure of DX.

distances throughout the year, and in the day time, but at present the best results come only with darkness in the fall and winter months.

Tuning in long distance stations gives the same thrill as comes from stealing home in baseball, making a putt of thirty feet in golf, or bringing in a tar-

pon, unassisted; but with the prospects for your success many times greater. The blue ribbons of personal gratification are awarded for cross country reception, and also for hearing overseas; but of course there is less likelihood of the latter, owing to differences in time between Europe and America.

### Your Chance to Hear Europe

To offset this obstacle, during the annual international tests, to be held the week of January 24, European broadcasters will send programs destined for American and Canadian ears in the early morning hours, so that fans on this side of the Atlantic may tune in for them between 11 P. M. and 12 P. M., Eastern time.

Stations on this continent will remain off the air for this period. Such tests in the past have enabled a large number of people to hear one or more European stations, this being particularly true in November, 1924. It is hoped that in January atmospheric conditions will be even more favorable, and that a million fans will rejoice at hearing music from 2LO, London, SRB, Brussels, and stations on 1,000 to 600 kilocycles (300 to 500 meters wave length) in France, Germany, Spain, Italy and maybe other countries.

### How Honolulu Hails

Sometimes, but very rarely, tuning in to stations so far off may be just mere chance. Some fortunate individual, knowing practically nothing about the how-it-works of radio, (he has not been reading NEW ENGLAND RADIO PROGRESS, you see), with a dilapidated looking assortment of coils and a single bulb, may get the surprise of his life by twisting some rotor at random and immediately hearing a whisper in the head phones to the effect that Honolulu hails the hearer. That happens once in a lifetime.

There is always present, as in fishing, the element of uncertainty. The thrill of the unexpected makes the game worth while for young and old, and there is no telling how great the degree of success may be on a cool and clear night. Then it is that radio waves seem to maintain their strength as well as speed

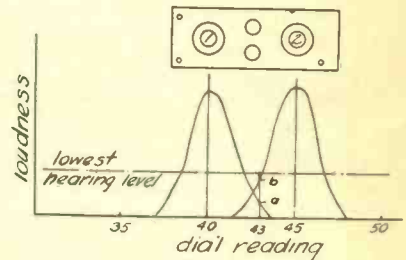

Fig. 2. The Curves of Loudness of Each Dial Show Why They Cannot be Tuned Alike.

over marvelous distances and even at 2,000 miles may be picked up and amplified into pleasurable song and story. There, in brief, we have the lure of radio. Thus are created new DX-ers.

### Catching the Faint Strains

For those few in our population who do not know yet what a DX-er is, may we explain that "DX" is wireless code for "long distance," and the expression in broadcasting means pulling in California or London if you live in Boston, and getting Newark or Australia if you reside on the Pacific Coast. A DX-er is an individual who persistently applies himself to the task of manipulating the dials with the most delicate touch to catch faint strains of music that emanate from far removed points and are thus made more entrancing.

Hearing a very distant station or two enables a man to boast in the office next morning that when it comes to radio he is the "original cat's whisker"—and who can resist the temptation?

### Perhaps Invite Divorce

Hour after hour, deaf to all protests by little Johnnie, who wants to hear the jazz band (when did you ever hear a real boy insist on listening to the bedtime story?) disdaining to answer an irate better half, the male DX-er, a personification of concentration, invites insomnia and divorce in the relentless pursuit of mystic waves from the other side of the world. Women folk brag, too, about sitting up until 4 A. M. trying to get something by which to dominate the conversation at the next tea party. We

live at considerable distance away from any station, and so have no locals.

### Don't Make Promises Now

In the early stages of radio—even yet, in many cases—some wonderful promises of coast to coast reception were conveyed in the advertisements of manufacturers and dealers. The largest and most reputable manufacturers now make no extravagant claims, because DX reception is governed by so many factors other than the mere perfection of the apparatus which leaves their factories.

Steady long distance reception de-

It has been prepared by competent engineers. It gives the do's and don'ts in detail, with regard to proper installation and operation, with modifications to fit various cases, such as the erection of an indoor aerial instead of the more desirable outdoor antenna, where, as in apartment buildings, it may be impossible to string wires on the roof. The book will tell you when and how loops will work. All these directions are conveyed to you after intensive research. Follow them closely.

### Sit Back in Pride

Do not try to tune in long distance stations by using the loud speaker. Tune in with the head phones, if you want real success and get surprises that are worth talking about. Then, after you have heard distant signals, if they are strong enough, you can plug in the loud speaker—and sit back in justifiable pride.

But experience is the only safe guide to DX reception. The next basic consideration is to ascertain the true settings of your dials, which hardly ever register the same—if you have three, as many sets do. When one reads 52, the others may be 54 and 51. The rule will govern all settings for stations of different wave speeds.

The need for the accurate setting of each of the dials appears from Fig. 2. Here we have a receiver with two dials and the loudness of the signal on different dial readings is shown by the two peaks. Of course under ideal conditions these two should coincide. There are two reasons why they as a usual thing do not. In the first place it is impossible to make coils and condensers in lots of several thousand which are so exactly identical that they will tune to a wave at the very same number on the dial. The slightest variation in the spacing of the condenser plates or the tightness of the winding on the coils will cause a slight shift in the dial setting.

### Picks Out Pipes in Walls

Besides this there is the condition unknown to the manufacturers of how close the set is to be installed to various pipes and wires in the walls of your house. These outside conductors are bound to have a serious effect on the exact position of tuning in your set. If it is installed near the window the first dial will pick up a station on perhaps 40, but when

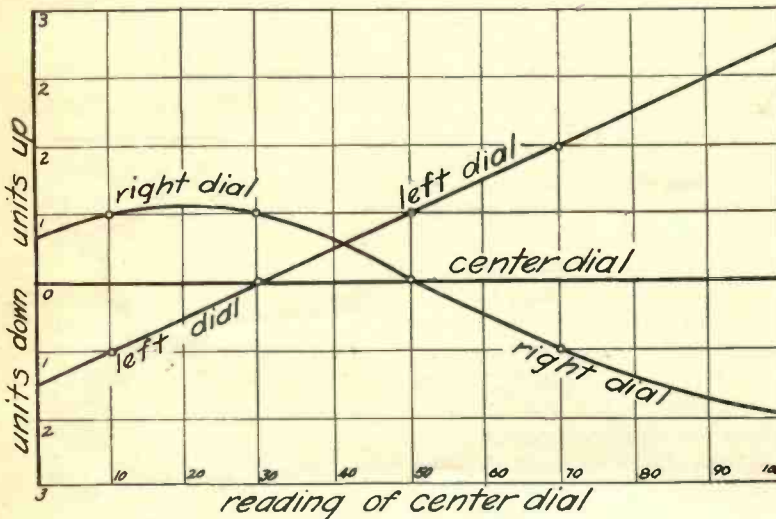

Fig. 3. This Way of Recording Differences in Dial Readings Helps You to Pick Up New Stations Which You Have Not Heard.

are familiar with the jokes that have been written along this line. The big change in this situation is that the women have become more sympathetic, even if they have not all become rabid fans.

There are people who have no desire to listen to a distant station. They are content with a good quality and volume of reception of local programs, particularly if they reside in metropolitan centers where the best music and oratory are furnished. They never try for distance. Good clear notes from the local (Fig. 1) outweigh the DX tones which are thin and interrupted by static even though the hearer can boast that they started 2,000 miles away. But such people seem to be in the minority. Most folks, some time or another, especially those who have just purchased receivers, are keenly anxious to score a record or perhaps record a score of the faraway stations they bring in. Thousands also

pend first on a good receiver, then fine tubes, "A" and "B" batteries in proper condition, a correct antenna and ground, and a minimum of static or other interference. But even with all these aids, you cannot attain best results consistently without the knack of sharp tuning, which requires a lot of skill, favorable surrounding circumstances, and a fair measure of good luck, whether you are fussing with a one-tube receiver or proudly displaying the deluxe equipment

### Watch the Professor

The average fan needs advice on these points, particularly in regard to sharp tuning, and we shall strive to give him the results of long experience. A novice can't learn to run his radio by watching an expert any more than a piano pupil can become proficient by pondering Paderewski's playing.

Let us assume that you have read very carefully the instruction book which comes with the set you have purchased



moved over close to the steam radiator this reading will drop to 38. Maybe the second dial is reduced only one number, while the third one may even be raised in its reading.

Getting back to Fig. 2, we notice that to get the broadcaster in question we must tune one dial to about 40, while the other one is set at 45. Unfortunately we cannot split the difference by setting them both at 43. In that case the loudness of the signals coming through the first tuner would be shown at point A, while through the second the amplitude would be as indicated at B. Both these volumes are below the line labeled "Lowest hearing level," and so could not be picked up at all by our ears. Of course if there were a third tuning dial as is used for instance in a neutrodyne set, the same reason would apply to it, making the conditions even harder to meet.

**Getting the Hang of Dials**

Probably the best way to get at the readings is as follows: Pick up a local station and ascertain at just which figures on the controls the signals come in loudest and clearest. Try the same thing on stations 100 to 300 miles off. Then when you are certain that this combination has been mastered, you are ready for those minute adjustments that with selective receivers (that is, those which do not tune broadly) should enable you to hear stations that before you only hoped to get. A variation of a notch on one dial makes considerable difference.

In making a log or record of stations already heard the best way is undoubtedly to write down the call letters followed by the readings of the three dials. This is the way which it is universally done. However, such a record does not help so much in picking up new stations which you have never heard before. For such a case the method shown in Fig. 3 is probably the most satisfactory. Here we have plotted on the horizontal scale the readings of the middle dial. The vertical heights show the difference in readings for the two end adjustments.

**How to Make a Chart**

To make such a curve find some station which comes in at about 10 on the middle knob. The dial on the left will be set say at one division lower—9, while the right hand one may be one higher—11. This information is to be recorded

on the diagram, Fig. 3, by putting a dot at one space below the line for the left dial and one above the line for the right one. Now pick up a station at 30 on the center dial. Let us assume that the left also reads 30, while the right is 31. This information is similarly recorded on the curve.

Similar readings are taken at 50, 60, and points above. When the curve is completed it allows us to make the corrections of the two end dials at a glance. For instance looking at the curve, how should we tune when the middle dial reads 20? Glancing at Fig. 3, you can see that the left hand dial should be set half a division low (19½), while the upper one must be turned one division higher (21). In this manner it is much easier to do fine tuning.

as a detector. Quite frequently there is a difference in the tubes and a little experimenting in placing them in position is worthwhile. As you doubtless know, the modern tubes although intended to be absolutely alike in their characteristics, nevertheless show differences in various circuits. One tube may be a particularly good audio amplifier, while another will shine as a detector.

**Time to Swap Tubes**

So in Fig. 4 we have the five tubes in a tuned radio frequency set as labeled. What we want is two tubes which are particularly good as radio frequency amplifiers for the first pair, then a fine detector, and last two good audio amplifiers. Suppose the fourth tube as shown happens to be an unusually fine detector

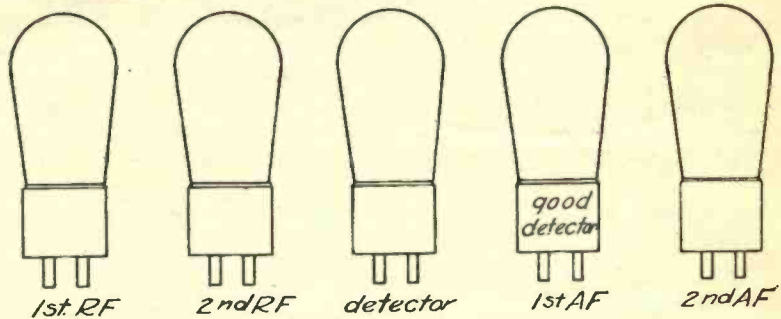

Fig. 4. This is an Arrangement of Tubes in a Neutrodyne

**When to Detune**

Distance reception, even on the most extraordinarily good nights, is naturally not as clear as local reception. The incoming wave is interfered with by static, spark transmission, transmitter whistles from the apparatus of the broadcasting stations, disturbances caused by power lines and sparking motors, and radiation from oscillating receivers encountered on the way. The ratio of interference compared with the amount of signal is greater than the ratio of interference compared with the signal picked up from local stations. And yet a distant program may be strong enough to permit of slight detuning, that is, moving a dial half a notch to one side, thus weakening the signal, but rendering it clearer. Amplification of this weaker signal will give good loud speaker reception for the ordinary sized room.

Do not forget to shift the tubes about until you ascertain which one serves best

and an indifferent amplifier. It is wasting its sweetness in the fourth socket. By swapping it back to the third position, we shall get considerably better reception.

Of course you would not know until you had tried that such a tube was really an ace as a detector. The only way to do is to shift them around until best results are obtained. This is rather a tedious task unless you have one extra tube. The latter may be compared with each of the regular tubes in turn, until it is found where it makes the most difference. Leaving it there, the one which has been withdrawn to make room is then tried out in the other sockets and so forth until the best all round results are obtained.

Sensitive ears and sensitive fingers are certainly called into play in the search for DX. And your throat gets some good exercise when you may yell with gratification, "I've got Japan."

# THE IZZY A. NUTT FAMILY

by EARLE  
HARVEY

© RADIO PROGRESS

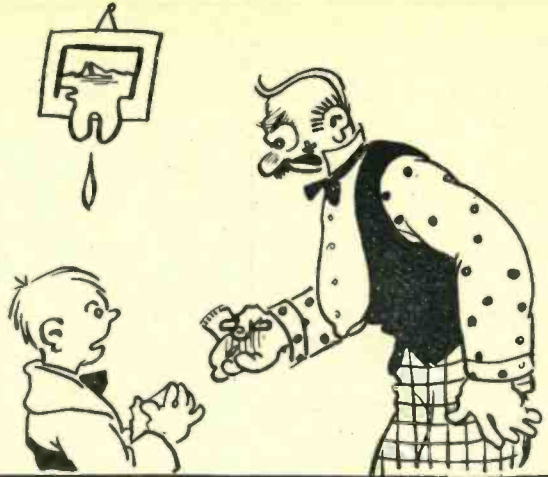

Scene 1.—The bathroom of the Nutt family.

Squeal, Squeak, Squeeee—eak!

"Villie! Vill you please stop monkey-ing mit dot radio? Do you vant to blow out der condenser?"

No let up—Squeel, Squeak, Squeeee.

"VILLIE, I said vill you please stop? Already I cut my face mit der safety razor—you, you make me nervous—all the time I imagine, Poof goes the radiation tubes!"

"I'm not hurting anything, papa!" Squeak.

"It makes me mad, vot do you know about tuning a radio? Didn't I vork in a piano factory vonce? I am an experienced piano tuner, der same mit a radio; Now please go away from dot radio or it gives a spanking!"

Squeak, squeel, squeee—

"STOP IT! Here I come for you, now I finish cutting a shave off my face, and it gifs you a licking vot you von't soon forget!" (Rushes out of bathroom, steamed up like a factory whistle five minutes before quitting time.)

"Aha, now vere iss he, not by der radio, oh dere you are out in the kitchen. Trying to hide you little Shenanigan! Answer me like an educated man!—Vy did you squeak the radio?"

"Papa, I was only grinding coffee for Ma!"

"Vy didn't you say dot in der first place? Now vill you please put dot coffee grinder away!—go out und swing on der back fence gate, you vill get der same results! Now please be quiet while I tune in something."

Scene 2.—Like Scene 1, only more so.

He sits down, rolls up sleeves, glances at the evening paper for the best programs on the air and starts his evening's

performance.

Squeel—squ—burr—Weather for tomorrow will be—squeak, burr—Chili news item—Chili workmen strike for more wages, burr——"For goodness sake, I got two stations all at vonce, a vonderful set I haf here." "Ah here comes some beautiful moosic,——— When you and I were sev-ven-teen and and Dot, dash dash dot, . . . . dot—dash, eggs selling for thirty cents. that closes the market quotations from Station KAT, signing off. Squeak, squeeeall — — Tra la la la Oh hi lo my ole lady hi lo — — "Opera—Ba, vy don't some of them singers learn to talk English?"

"Now vot? (twists dials frantically,) I can't get a signal. Mabee the "B" battery needs some more bees in it."

"Papa" (voice from under the window outside.)

"Vot is it, Villie?"

"May I have that lead pipe out here?"

"No."

"I thought you would say yes."

"Vell, I say no, and you can hear me, ain't it?"

"Sorry papa, I just sold it to Mr. Grabowski, the junk man for five cents."

"Oh yay!" (Flops over the back of a chair, like the way they do in comic strips) "That was my ground!"





# Experimenting On Very Fast Waves

## Lots of Room for Broadcasters On These Special Frequencies

By WILLIAM C. RADOS, Arlington Heights, Mass.

AMERICA has never been noted for being slow. And no one can possibly call the present generation very dilatory. So it is not remarkable that the radio fans in this country, particularly the younger ones, are turning in increasing numbers to the high speed or short length waves.

Great activity is being displayed by the operators in experimenting along these lines. The 3,000 and 3,750 kc. (100 and 80 meters) work is well known of course, as much of it has been transatlantic transmission. The 7,500, 15,000, and 60,000 kc. (40, 20, and 5 meters) operating is not so well known, as it has not been used to talk to Europe.

### Takes Little Time of Money

These fast wave experiments do not require very much apparatus. The set shown in Fig. 1 was built by the author in about an hour and worked very suc-

cessfully. A word on the fast waves here is just the thing the tired broadcast listener needs. It takes very little

room there is in the ether for waves at this high speed. You know there is lots of interference between the broadcasters

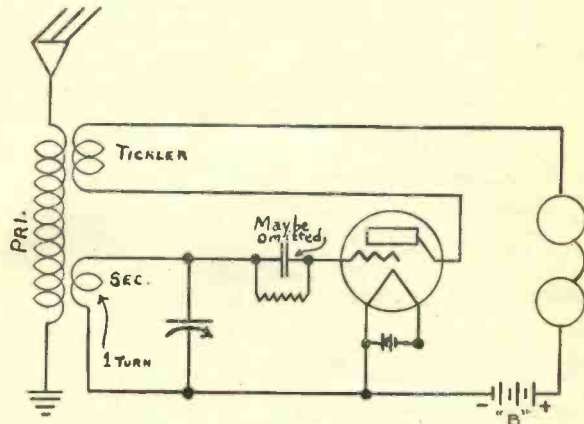

Fig. 2. Here is the Hook-up of Set in Fig. 1, Except Only One Bulb is Used. time, apparatus, or money.

Perhaps you do not realize how much

at the ordinary kilocycles. Indeed it is said that many would-be sending stations are willing to pay large sums of money for the privilege of getting an assignment in the class B band. Two and sometimes three or four big sending stations must share time on the same wave because there are not enough frequencies to go around among all those who want to talk to the world.

### Room for 96 Stations

You know that the entire range of broadcasting at present lies between 200 and 545 meters. These values correspond to 1,500 and 550 kilocycles (kc). Here is a range of 950 kc. which would allow 96 stations at the standard separation of 10 kc. But let us assume that the wave band were to be extended up to 20,000 meters, or 15 kc. From 200 to 20,000 meters is then the range between 1,500 and 15 kc. or 1,485 total. Here would be 149 different waves or channels of communication.

Now take the band between four and five meters. To get the corresponding frequency in each case you will recall that you divide the meters into the number 300,000. This gives us 75,000 and 60,000, respectively. Here is a difference of 15,000 kc., or more than ten

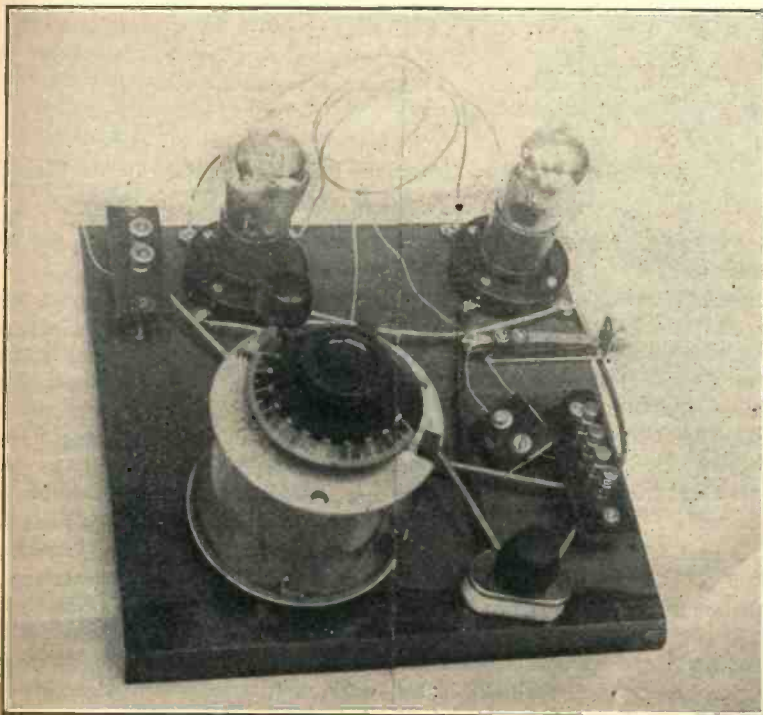

Fig. 1. It Does Not Take Much Apparatus to Make Up This Fast Wave Set.



times the entire band between 200 and 20,000 meters. Let us repeat that, as it is quite startling when first heard—there is space in the ether for 10 times as many stations between 4 and 5 meters without interference as there is in the entire band from 200 to 20,000 meters. When we come to build a set, we do not use one coil and condenser only to tune

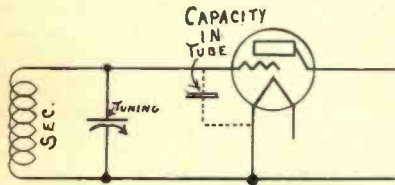

Fig. 3. This Shows How Capacity In Tube Tends to Slow Down Tuning.

from 200 to 20,000 meters, and neither should we expect one single condenser and coil to bring in from 60,000 to 75,000 kc. However, much of this range may be covered by a properly designed set. Reception of these high frequencies can be obtained by the use of the ordinary tickler coil hook-up.

Tube Without a Base

Using the circuit of Fig. 2 with a .0005 variable condenser across a one-turn grid or secondary coil on a three-inch tube, and a three-turn tickler coil about half an inch away, it oscillates over the entire condenser range. This type of receiver has to be carefully con-

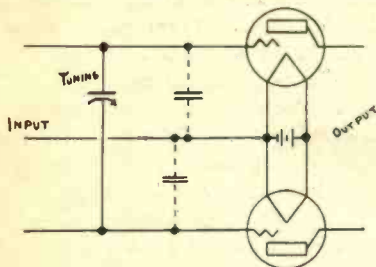

Fig. 4. The Principle of Cutting the Stray Capacity in Two.

structed in order to cut down tube capacity. I used a tube with no base, the plate and grid leads coming out on opposite sides. This cuts down the capacity across the grid coil.

In Fig. 3 we may see how this tube capacity cuts down the upper speed limit to which the set may be tuned. Notice that the capacity or condenser action in the tube itself is in parallel with the main tuning condenser. The total action is that of the sum of these two capacities. It is obvious that if the tube capacity amounts to very much, then the sum of the two will be sizable even though the tuning condenser may be turned to the zero. Such a large capacity prevents picking up the short or high speed waves. If we can cut down this intra-tube effect, we shall have a circuit which can successfully be used on frequencies from 60,000 to 75,000 kc.

Cutting Them in Two

You naturally will prefer to use the

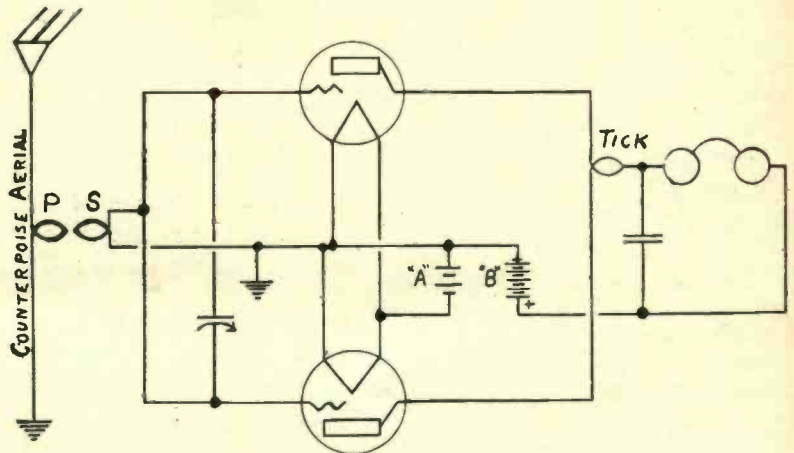

Fig. 5. By Thus Using Two Tubes on Principle of Fig. 4, We May Get the High Speed Waves.

ordinary tubes in running experiments, and some way must be found to reduce this internal capacity if they are to be successful. A rather ingenious scheme appears in Fig. 4, where two tubes are wired so that the capacity of the two is in series. Putting two condensers in series, as you will doubtless recall, cuts the capacity down to one-half. In this way, standard tubes with ordinary bases may be used.

The actual wiring of the set may be seen in Fig. 5. A single turn for primary and the same for a secondary is used. A tickler is tapped at the middle and the lead for the telephone is taken off. This gives a sort of push-pull effect with the two tubes, as they are both working together.

Must Cut Down Losses

A regular .0005 mfd. condenser was used instead of a special small one. If one is purchased primarily for this work it is better to buy a small one, however. A condenser with a low minimum capacity must be used. The losses must be low. The one illustrated in Fig. 1 has these qualifications and is excellently made.

The socket shells were removed to cut down the amount of metal present. Two tubes as nearly alike as possible should be used. No grid condenser or leak is necessary. The grid coil must be a one-turn coil of bus bar with the ends attached directly to the terminals of the sockets. The plate or tickler coil is exactly the same as the grid coil, the di-

ameter being five inches for five-meter work.

The complete circuit is given in Fig. 5, which is the same for transmitting and receiving except for the plate voltages. A copper tube, 5 meters (16 feet) long is used for the antenna about ten feet above ground. Another tubing 5 meters long is used for the counterpoise. Both are rigidly fastened. This circuit as a receiver will furnish much information and study to the broadcast listener who wants to try a little experimenting.

By using larger coils this circuit can be used up to 15,000 kc. (20 meters.) This wave is by far the best for daylight work and recently two American stations 2,500 miles apart communicated with each other in the middle of the day.

# Five "Genes" In One Station

## A Queer Coincidence at One of the Popular Broadcasters

By VANCE

DO you know my friend?" said an acquaintance whom I met in France. "He lives in New York and his name is Smith."

However you would not think that there would be so much confusion about anyone called "Eugene," as this is by no means a common name. But what would you think of a broadcasting station that had three men each with that name? Then suppose there were four of them. Even that wouldn't be a circumstance to Station WKRC, Cincinnati, as there are no less than five (count them, five) Eugenes in this broadcasting establishment.

### Like Yelling Out "Fire"

Indeed when anybody rushes into that station and calls "Gene," he gets as much attention as though he yelled "Fire," or "I've found a quarter." To get rid of this difficulty they have given each chap a number just as if he had been "sent up." So to be sure that you are getting the right man you must give the number like "Gene 3" or "Gene 5."

At the head of the list stands Gene 1, who is the studio director, Eugene Mittendorf. Next in line you will find Eugene Perazzo, whose musical ear is of great use to him, seeing that he is the musical director. Then we have Eugene Schmidt, the tenor soloist of the Cincinnati Conservatory of Music. Eugene Wesselman is number 4, and Eugene Huber completes the list. These last two are operators in the station, and spend their time making sure that the music which reaches your ear from this station is as sweet and clear as the voices of the singers who present the programs.

### A Prize for Each One

It is so remarkable to find five men of the same name that the five "Genes" have issued a challenge to any other radio station in the world to produce five men named just alike, even though it

may be Tom or John. They offer a prize of two slightly used theatre tickets to each of the five if they are ever found.

At the head of this quintet comes Gene Mittendorf, who appears in Fig. 1. From

radio artists who are scheduled to sing and play on the program have a bad case of "artistic temperament," which means that at any time they wish they can have a tantrum or arrive at the studio half



Fig. 1. This is Gene No. 1, Who Directs the Station When He Isn't Saxophoning.

this picture you could never guess what instrument he plays, but I will let you in to the secret—it is a saxophone. Does he ever play it to the microphone? Oh, yes. You must know that many of the

an hour late, or in any other delicate way mix up the order of the performers.

### Filling Up the Holes

When two virtuosos both appear at



once it taxes the tact of the director in deciding which shall come first. But when *neither* one shows up, there is an ominous pall of silence which settles over the gloomy studio, for the audience *must* be entertained, and it would never do to leave a hole in the program.

In such an event our friend Mitten-dorf grabs his trusty saxophone in his fists and proceeds to coax from it sweet strains for the delectation of the unseen throngs of admirers. And that boy certainly can play. That brings us right to the point of his secret sorrow.

Yes Eugene No. 1, for all the fact that we cannot see any lines of grief on his countenance in our portrait, still has a secret sorrow. This private pain comes from the fact that he lives in an apartment building in Cincinnati, and like most apartment houses, he has neighbors close above, below and on all sides. And here is a peculiar feature of human nature. Although the radio fans who hear his warblings, clap their hands in delight, the neighbors clench their fists in despair.

#### Why He is Forced to Wait

More than once a jealous janitor has thumped at his door and told him to "Bury the brass," or whatever other phrase is used by janitors on such an occasion. As a result, "Mitty" has to wait until Station WRC signs off in the evening before he can get busy with his beloved instrument and toot toot out the blue notes for which a saxophone is famous.

But it is not alone as a performer that our hero is noted. He has studied seriously the folk songs of the early American settlers. Keen students of the history of the United States point out that in the mountain fastnesses of Kentucky the real folk lore songs of this country have been preserved and are still played and sung in the cabins that are found in the clearings atop the mountains.

#### Musician Wanders in Counties

Anxious to present those oldest of American tunes to the public for the first time, Eugene No. 1 arranged with the Cincinnati Post and the Rudolph Wurlitzer Company to send a musician for a trip through several counties in Kentucky. Pulaski, Harlan, Knott,

Letcher, Estill, McGoffin and Jackson counties were visited. In many instances the tunes had to be copied by hand, as no printed scores could be found. After arranging the music, WKRC has been offering a series of programs featured as "Lonesome Tunes from the Mountains of Kentucky."

Among the songs, many of them two

hundred years old, which have been sung are: "Frog Went a Courting," "Barnyard Song," "Brother Green," "Lady and the Glove," "Little Mohoe," "Lord Batesman," "Loving Nancy," "Sweetheart in the Army," the "Hangman's Song," and "Billy Boy." These songs are still the popular ones in the country made famous by John Fox, Jr.

## Fone Fun For Fans

### Getting Acquainted

First Pedestrian (to man who has just bumped into him)—"Clumsy idiot!"

Second Ditto (with ready wit)—"Glad to know you. Mine's Brown."—Boston Transcript.

### Experiment Going on

Fresh—"Say, prof., how long could I live without brains?"

Prof.—"That remains to be seen."—The Guide.

### A Knight of the Bath

A countryman, unfamiliar with such luxuries, passed the night at a modern hotel.

"Well, did you have a good night's rest?" the clerk asked him next morning.

"No, I didn't," was the reply. "The room was all right, but I couldn't sleep very much, for I was afraid some one would want to take a bath, and the only door to it was through my room."

—Boston Transcript.



Mistakes will happen, as Johanna Grosse, WLW organist, now knows. A funeral wreath, instead of a bouquet of flowers, was sent to her by an admiring fan who telegraphed his order. She is far from being dead and is one of the liveliest organists playing for radio and theatre audiences.





# EDITOR'S LOUD SPEAKER

## THE NEW NAME

Well, we've gone and done it. Just as we told you in the last issue, the price of this magazine has been cut from fifteen to five cents a copy.

All the comments we have received on this proposed change have been favorable. Our thousands of readers must have thought that each issue was well worth fifteen cents or else they wouldn't have paid it. And just as the action of Congress in reducing taxes is not ruffling the feelings of many people, so the giving of fifteen cents worth of radio for five cents isn't causing a big display of temper.

## Changed Name, Too

But in addition to reducing our price, we have also changed the name to NEW ENGLAND RADIO PROGRESS. Maybe you wonder why this addition in our title has been made. There are two main reasons for the change.

In the first place we feel that the people of New England will be proud of a magazine which caters to them and tries to present their own particular viewpoint. Just as we all get out and cheer for our own baseball team even though we have not a cent invested in the company, so we all like to realize that a publication is conducted with the idea of giving as good local service as possible.

New England is a rather compact group, and although the population contains a large proportion of foreign born, still they all are glad to call themselves Americans, and there is a sort of family feeling all over the six states. The grip of radio has grown so rapidly here that we know of only two men who are

not interested in the art—one is stone deaf, and the other believes himself to be Napoleon. So New Englanders will undoubtedly feel that a magazine of their own is quite appropriate.

## "Where Are You From?"

The other reason for our change of name lies outside of New England. Whenever you go to New York or Chicago or San Francisco, you will meet plenty of people who are evidently strangers in the great city. After learning their names the next question you ask is "Where are you from?" If they hail from another section of the country, does that prejudice you against them?

Time was when most people thought their own state was really the center of the country and outsiders were "furriners." But education and travel and particularly radio broadcasting has shown us all that the South is as interesting as the North, and that the West is just as smart as the East. So if we meet a man from the opposite corner of the United States, we feel that his acquaintance with another section of the country lends a further charm to his personality.

## Progress is Universal

This magazine has a good many friends and readers all over the United States, and to those outside New England we wish to say that we shall do our best to continue to interest you, for Progress in radio is not local, but appeals to you wherever you are.

In this connection we should like to repeat that we are making a special effort to please you who are now reading this and we hope you will jot down your comments

and criticisms on a postal and address it to the editor.

## PACKING THE SARDINES

When you think of things being terribly crowded together, it is customary to say "Packed like sardines." But you could almost change this figure and say "Packed like radio waves," since they certainly are squeezed in pretty tight together.

One of the good results, however, of the recent radio conference under Secretary Hoover was that it was decided to quit crowding any further waves into the present broadcast band. But many people seem to be afraid that the broadcast range will be increased so as perhaps to take in as far up as 2,000 kilocycles (150 meters).

## Reducing the Babble

There are two good reasons why there is no cause for alarm at the present time. In the first place, the whole idea of the conference was that there are already too many people broadcasting and that if any change is made it should be in the direction of reducing rather than increasing the babble of voices now coming through the ether.

The only idea in making a larger channel for sending stations would be to enable a lot more new broadcasters to operate and as this is, as already said, just the opposite of what is wanted, it seems that there is no good reason for such a change.

## Hard to Speed Up

A further serious objection is found in the fact that modern radio sets would not be able to pick up the new wave frequen-



cies. Just as in a motor car, it is easy to change the engine so that the machine runs slower than before, but hard to increase the upper speed limit, so with a receiver it is easily possible to insert additional coils to slow down the rate of vibration (increases the wave length). But when it comes to increasing the speed or kilocycles, it can't be done with ordinary construction.

Since the whole idea of the broadcasters is to be heard by the general public, it would not pay any company to send out programs on a wave which only a small number of fans could pick up. The larger the number

reached the more valuable the broadcasting privilege is.

In view of these two good reasons for retaining the present range of waves you may feel safe that you will not have to buy a new radio in order to keep up with the possible changes in frequency or wave length.

#### SAVING CIVILIZATION

We all know that radio is a great entertainment to us and also an educational factor of considerable value. But now Chancellor Flint of Syracuse University points out that it also has a big place in saving our civilization.

Fifty years ago the average man had to work 12 or 14 hours a day to keep up with his standards of living and give his family the comforts to which they felt they were entitled. In the last few decades, however, labor-saving machinery has come in to such an extent that eight or nine hours work a day is enough to provide all that is necessary to keep up with the procession.

What shall be done with this large increase of leisure time? If it is largely spent in loafing or the gratification of the lower forms of desires, it will certainly reduce or even stop our further development.

Here is where radio comes into the picture. With the wonderful programs which are being broadcast these days and which appeal to the spiritual side of us, and with the series of lectures and talks on so many different subjects of interest, it is certain that we are all building up the better side of our natures which might otherwise remain undeveloped. More power to labor-saving machinery and to radio.

#### MEET THE FAMILY

Because of the intense interest of radio fans in the personnel of the "Capitol Family," who have broadcast special programs every Sunday evening, Major Edward Bowes, Managing Director of the Capitol Theatre, has arranged to have photographs of the individual members made into souvenirs for distribution among the radio audience.

The present "Capitol Family" consists of Caroline Andrews, Majorie Harcum, William Robyn, Gladys Rice, Yasha Bunchuk, Rudy Wiedoeft, Josef Fuchs, Julia Glass, Siguard Nilsson, Celia Tur-rill, Dr. Billy Axt, Max Herzberg, David Mendoza, Tommy Dowd, Joseph Green, Henry Heil, Gene Smith, Pietro Capodiferro, Martha Wilchinski, Chester Hale, Doris Niles and Ballet Corps.

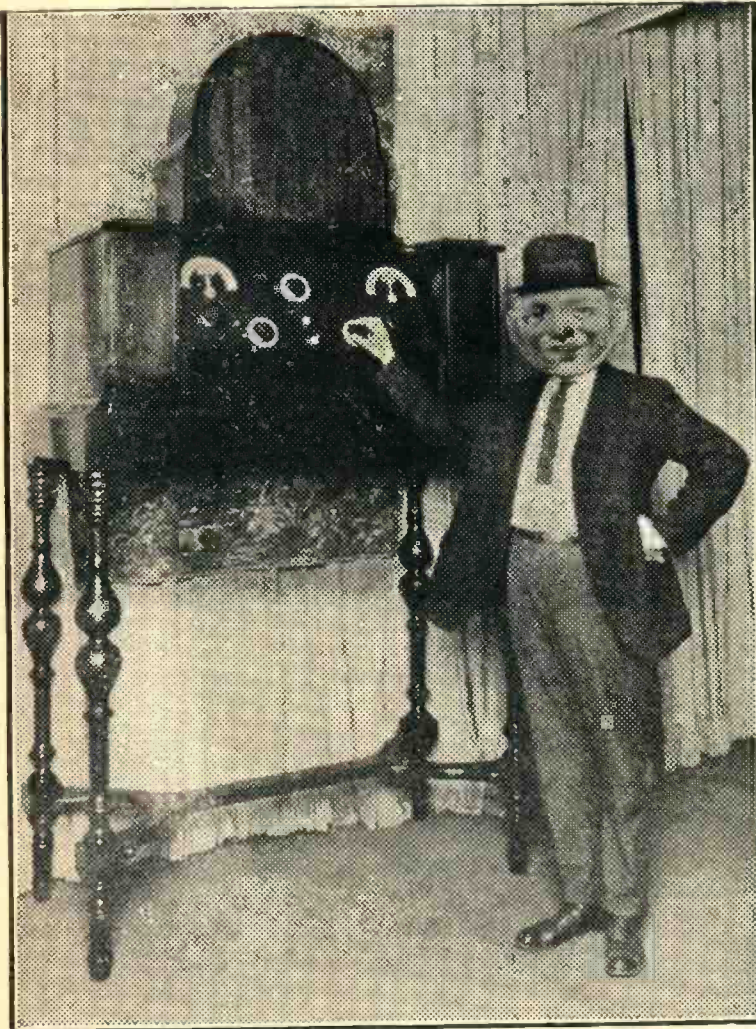

This unique mechanical figure, using a musicone reproducer for a head, answered questions asked by visitors at a radio show. The automaton stood beside a giant model of one of the new radios.

Subscribe now for New England Radio Progress. 5c per copy—\$1.00 per year.



# The Southern Gateway of New England

## *Interesting Facts and Figures About Station WJAR of Providence*

By JAMES A. REILLY and H. W. THORNLEY, STATION WJAR

**G**OOD evening, everybody; this is Station WJAR, The Outlet Company, Providence, The Southern Gateway of New England," and so, the Outlet Co., broadcasting on 980 kc. (305.9 meters) starts on their evening of entertainment for the radio fans of near and far.

drops off the A in giving his own initials.

### Always Watching Program

There are others who have to look after the transmission, and they include Howard W. Thornley, Chief Radio Engineer; Thomas C. J. Prior, operator,

small. On an evening when the performance is in the local studios and followed by a relay program, the second operator on watch will work with a representative of the American Telephone & Telegraph Co. This engineer from New York is assigned by Station WEAJ to WJAR



Fig. 1. Here's the Harmonious Honolulu Four. Artie McKenzie is at the Left, Then Bill Lonogan, Fran Wright and Don Ball in the Corner.

Possibly it is the voice of "JR," James Reilly, announcer and director of programs, or the tones of "JB," John J. Boyle, announcer. An interesting point is that the director has the same initials as the station, except the W. Fearing that there would be confusion in the minds of listeners if they heard "This is JAR of Station WJAR," Reilly always

and Harold V. Flood, operator, not forgetting the studio accompanist Miss Gladys E. A. Smith. Without the operating staff "on the job," the transmission of radio broadcasting programs would be of a very unsatisfactory nature, as the operator on watch must carefully follow the program to insure that the volume does not become too great or

to assist in checking up on the telephone lines.

You possibly do not realize the preliminary work necessary for programs relayed from New York City, Washington and other points. A level must be maintained on these wires from the broadcaster to WJAR at Providence This line leaves New York City, coming

along the shore to New Haven, Connecticut, and then changes its course to Hartford, where the level on the line must be brought up to that of the sending end.

#### Keeping Up Sound Level

When Hartford and New York are cleared, the line is patched through to Providence, where the same operations are necessary between these points. A direct line is then patched from the Providence Test Board of the A. T. & T. Co. to WJAR. The same operations are necessary to bring these lines in condition so that the level is constant from the broadcaster, WEAJ, to Station WJAR. There is also an emergency line run parallel to the regular broadcasting relay wires. A Morse Line (telegraph) is connected from WJAR to the studios at New York for all communication.

This makes a broadcasting line, a spare and a communicating system all going at once—a total of three circuits or six wires. This need for six wires is one of the items that makes long distance broadcasting expensive. The "level" spoken of is maintained by proper adjustments of the telephone amplifiers which work just like the audio frequency steps in your own set. By correct adjustments the loudness of the music is kept practically constant all along the line.

#### Monk Cloth for Draping

At WJAR on the fifth floor of a fine building are located the two main studios for broadcasting. Studio A is so constructed that the reverberation of sound is entirely overcome. The ceiling is the product of extensive engineering research, and the side walls are draped with monk cloth. This room is luxuriously furnished to give the artists a homelike atmosphere. A Chickering Grand Piano is located at one end of the hall, while at the other end is the signal panel, installed on the wall, allowing the announcer to keep in communication with the control room.

An adjustable stand is used to support the microphone, allowing it to be raised or lowered according to the music to be broadcast and the height of the artist broadcasting.

In the extreme end of the studio the signal box is mounted out from the wall, which enables the announcer to keep in communication with the operating room. When the green light is lit it indicates

to the announcer that the operator in the station has the apparatus running and that he has control of the air.

#### The "Ahs" of the Artist

However, it wouldn't do any good for you to tell your troubles to the microphone at this stage of the game. It is still soulless and dead in spite of the carrier wave which the green light shows is going out on the ether. It is necessary to be able to kill the microphone in this way, as many performers become rather nervous when they approach the sending instrument, and it would never do to let their "ums" and "ahs" go out

instead of a bell a white glow lamp is used, and its silent signal disturbs neither musician nor broadcast listener. In this way the director is able to use the local phone to communicate with the attendants in the operating room located on the floor above.

Studio B has been so designed as to have the proper acoustical properties necessary to give clear reproduction of all voices and instruments, and is now used for experimental purposes. The ceiling is covered with heavy monk cloth shaped up to the center in tent form. The walls are also draped with the same material, which is hung twelve



Fig. 2. Earl Shean at the Piano, and His Trusty Band of Musicians. Their Instruments Will All Stand Without Hitching.

to a world who thinks that the artists at least are enjoying it.

But when all is ready and the soprano has gripped her courage in both hands and patted her hair into shape (although none of her hearers can possibly see it), the director pushes a button and the red light blossoms into a glow. Shh—the microphone has come to life, and whatever you say will be used against you. As long as that red gleam is seen no secrets can be told in the studio.

#### You Never Have Heard This

Right in the middle of a song did you ever hear the shrill tinkle of a telephone bell coming from the broadcasting station? No, and you never will. For in-

ches from the blank walls, in this way allowing an air space between the curtain and the wall. The floor is padded with heavy wadding paper and then covered with a thick green carpet.

#### No Echo is Present

This room is entirely free from reverberation of any kind, thereby giving each voice or instrument its true tone without the presence of echo, which is detrimental to the broadcasting of voice or music. This studio is equipped with a Chickering Ampico Grand Piano and also an Orthophonic Victrola, which are used in the event of tests or experiments.

The operating room is a fire-proof building located on the roof (six stories



above the ground) housing all the generators, batteries and apparatus necessary to transmit the music to the radio listener.

The wires from the microphone in the studio run over to the signal panel as it is there you remember the switch with the red light is installed. Then they go to the speech amplifier which has three stages and increases the magnitude of the currents many thousand times. Of course it has been very carefully designed so that it can provide this tremendous boost of energy without any distortion of the original sound waves. The operator can manipulate it so that the proper amount of energy is produced no matter how loud or soft the sounds in the studio may be.

**How the Transmitter Works**

The transmitter is used to produce high frequency electrical waves and vary their loudness in accordance with the voice current received from the speech amplifier. The system used is generally known as the "Heising" modulation system and is similar in principle to that used so successfully in the transmission system of our common battery telephone exchange. The electrical energy from the speech amplifier is fed into the grid or input circuit of a 50-watt amplifier tube. The output of this circuit is connected through a transformer to the input of two 250-watt tubes in parallel, which together act as a modulator of the high voltage oscillations. Two other 250-watt tubes are used as the oscillator. The modulator and oscillator are connected through a choke coil across a 1600-volt, direct current supply system.

The operating is as follows: When the speech amplifier is sending no energy to the radio telephone transmitter, the direct current divides equally between the plate circuits of the oscillator and modulator, and oscillations of a constant amplitude are produced. When the speech amplifier picks up some music, it changes the grid potential of the modulator tubes in accordance with the variations of the sound waves.

The variations on the grid alter the direct current through the modulator. Since the choke coil in the direct current makes practical a constant current supply, the variations in the direct

current on the oscillator must be equal and opposite.

**A Choke in Your Cellar**

This action can easily be repeated in your water pipes at home. The main line coming through the water meter in the cellar is the supply of direct current. Suppose you turn the shut-off at the meter part way so that it reduces the amount of water which can flow when the faucets are open. This

stant it means that whatever liquid goes through the kitchen faucet must be subtracted from what had been going into the bath tub.

**Dashes in the Bath Room**

In this way if your brother in the kitchen wanted to send you a telegraph signal up to the bathroom he could turn his faucet on and off and you would see the same change in your faucet at the bathroom except that when he increased



**Fig. 3. This Handsome Looking Chap Has a Voice Just as Pleasing. He Sings Tenor.**

shut-off is then like the choke coil which also holds a constant current (of electricity).

Now go upstairs to the bathroom and open the cold water faucet in the bathtub. The water will flow out in a stream which will remain constant. Suppose now someone at the kitchen turns on the faucet at the sink. What will happen? Of course, a stream will now flow out of this new opening. But since the shut-off (choke coil) in the cellar is holding the total amount of water con-

his flow yours would diminish and the opposite. By turning his handle on and off in a series of dots and dashes you would be able to read the message. Instead of dots and dashes the radio station uses the vibrations of the microphone in the studio to turn off and on the current but the principle is the same.

Four ammeters mounted on the face of the transmitter panel indicate to the operator the value of the current in the various circuits. Two control knobs just below the meters enable him to regulate

the frequency of the oscillations and the amount of the power radiated. Under normal operating conditions the high frequency power in the antenna circuit is about 500 watts. The wave frequency (length) is measured by the wave meter

rent driving two generators. The large machine in the center is the high voltage unit supplying current to the plates of the large 250-watt tubes. This machine generates 1600 volts at a rating of 2 kilowatts. The third unit supplies cur-

age cells. There is also in the power room a large Tungar Rectifier used for charging both the storage plate and filament batteries.

This panel has mounted on it two meters, one a 25-volt DC meter for measuring the filament supply to the 250-watt tubes and the other a 2500-volt DC meter for indicating the pressure supplied to the plates of the large tubes. There are two field rheostats for controlling the supply to both the plates and filament of the tubes. The normal current supply for these tubes is  $15\frac{1}{2}$  volts DC to the filaments and 1600 volts DC to the plates. Below are two push switches which control the starting of the apparatus by closing relays located back of the panel.

#### Wrapped with Death

From this you will see that the operators do not have any chance to come into direct contact with any of the high voltage circuits. You know 1600 volts is not a pressure to be played with. If a man must keep his mind constantly on a lot of wires wrapped around with death it is sure that he cannot give his best attention to keeping the tones of the singer sweet and pure.

Of course, this constant attention to the music is one of the necessary duties of the operating engineer. He must listen all the time to a Western Electric horn which is used as the "monitor." By throwing a key on the amplifier panel the operator is able to listen to music as it goes into the radio transmitter and also as it sounds when taken out of the air. This system gives the operator a good chance to check up on the quality of the transmission he is getting from the apparatus.

#### Uses These Guys

On the roof of the building are located two one hundred feet steel tube masts from which the antenna is suspended. These masts are securely guyed four ways by large guy cables. These cables are broken up every 25 feet by porcelain strain insulators. This is done to stop these cables from absorbing energy from the antenna. The aerial which is suspended between these masts is 125 feet long and has four wires consisting of seven strands of No. 18 silicon bronze twisted together.

At the ends of each of these wires

Continued on Next Page



Fig. 4. Miss Alice McLaughlin, the Soprano Soloist, Always Delights Her Audience.

which is mounted on the right hand side of the desk.

#### 350 Volts of Battery

All energy used for transmission is received from the power room. The three-unit generator consists of a 5 H. P. operated on 220 volts alternation cur-

rent for the filaments of the large tubes and the rating is 15 volts at  $4\frac{1}{2}$  kilowatts. All currents for the speech amplifier are obtained from batteries. The filament current at 12 volts is supplied by two 120-ampere hour storage batteries and the plate current of 350 volts is supplied by seven units of Willard stor-



**THE NEW ELECTRIC EYE**

Continued from Page 12

deep into the hold of a vessel where the night watchman seldom penetrates. The beam of light plays constantly on the tube and so the bell connected to the ends of the output wires is silent. Now a rat arrives on the scene and eats through the box of some combustible chemical. Soon a fire is started and thin wisps of smoke curl up to the ceiling. But this same smoke for an instant blots out the light which was shining on the photo-electric cell. Immediately the voltage is unbalanced and the fire alarm bell sounds its warning.

You will notice this system is pretty fool proof for it depends on a steady light shining across the hold. If the electric wires should break or the lamp burn out the darkness resulting would immediately throw on the alarm and the condition would be remedied at once.

**The Coating is Excited**

The idea can be followed perhaps better by referring to Fig. 6. At the left we have the automobile headlight which is lit by means of the storage battery. The beam travels across the room which is to be protected until on the other side it strikes the receiving mirror and is reflected on the photo cell. The light rays shining through the window excite the sensitive coating as described and the fire alarm is prevented from operating. When even a small amount of smoke drifts across the path, and so cuts down the illumination on the cell, the relay is thrown and the fire bell sounds its warning.

A detailed view of the apparatus appears in Fig. 7. This shows the interior construction diagrammatically of the combined photo cell and amplifier tube. Notice that the grid of the amplifier is connected to the sensitive coating and the plate is common to both the amplifier part (lower part) and also the cell half (above.) A "B" battery of about 90 volts is connected to the plate in the ordinary way except that instead of having a headset or loud speaker to be operated by the current we have a relay which will ring the fire alarm bell.

**A High "C" Pressure**

In addition to the "B" battery there

is also a "C" of about 30 volts working through a grid leak of 10 megohms. The customary "A" battery rheostat is used for controlling the filament. In other words, the amplifier half of the tube is just about like standard, except for the high value of "C" voltage and grid leak.

The operation of the device is like this: When light shines through the windows it strikes the sensitive potassium coating and this action allows a lot of negative electrons to fly out from it and over to the plate. They are attracted to the plate because of the plus potential on it from the 90-volt "B" battery. Of course this stream of electrons makes up a negative current of electricity. Where is this coming from? It is supplied from the negative pole of the "C" battery through the grid leak. Owing to the fact that the negative charge on the sensitive coating is passing off continually in the form of the electrons, there is no negative charge left on the grid, which you will remember is connected to the coating.

**No Longer Shaken Loose**

Since the grid has no negative charge and the plate has the 90-volt "B" battery connected to it there will naturally be quite a current which, working the relay, will attract its armature and hold the contacts open. This prevents the fire alarm bell from ringing. But now suppose that the light stops shining on the sensitive coating. Right away the negative electrons stop passing over to the plate since the light can no longer shake them loose.

As a result of this stoppage of the flow, the negative charge from the "C" battery accumulates on the grid as it can easily pass through the ten megohms if given a short time. This accumulation on the grid makes it very strongly minus and right away it chokes the plate current in accordance with the regular amplifier action of any ordinary radio tube. Since the plate current can no longer flow, the relay is not energized, and so it drops its armature as shown in Fig. 7. The contact closes and the storage battery rings the fire alarm bell.

**Tiny Bulb Protects Liner**

A photograph of the inventor of this combined tube, Dr. Zworykin, appears in

Fig. 5. You will notice he is holding in his hand a small bulb, which is the photo electric cell in question. It looks so small that you would hardly believe it formed such a great protection to a big Atlantic Liner.

Other practical applications of this cell will undoubtedly be made from time to time as it grows in reliability and ease of operation. As already pointed out, movies by radio may perhaps be one of the possibilities.

**SOUTHERN GATEWAY OF N. E.**

Continued from Previous Page

there are four strain insulators which separate the wires from the spreaders, which consist of twenty-foot lengths of one and a half-inch pipe. Just ahead of the insulators there are inserted in each wire a safety hook which is tested to open at a strain of 350-lb. This safety hook prevents anything except the wire itself from falling in case of a severe storm. At one end of the antenna the four lead-in wires are taken off and are brought through a porcelain bushing into the operating room where the connection is made to the radio transmitter.

**Listening for Trouble**

On the desk in the operating room is located a Western Electric Type 12C Receiver which consists of a detector and two-step amplifier. The wave frequency range of this receiver is from 1000 to 500 kilocycles (300 to 600 meters). Just ahead of the receiver is a wave-trap which enables the operator to listen on a wave of 500 kc. (600 meters) during the program, in case distress signals should be sent out from some ship at set, when the would immediately shut down his transmitter until told to resume transmission by the Naval Station at Newport, R. I.

Our photographs show some of the popular players from Station WJAR. Perhaps one of the most frequently sought after group is the Honolulu Four, Fig. 1. It seems that Hawaiian music appeals to classical critics and jazz Johnnies alike. Fig. 2 shows the orchestra which you hear so much with the leader himself at the piano. Two soloists of note are pictured in Fig. 3 and 4—William Carrigan, tenor, and Miss Alice McLaughlin.

# American Radio Relay League

## 1200 FREE MESSAGES

Members of the Chicago Radio Traffic Association, which is affiliated with the American Radio Relay League, piled up an enviable record with 1,205 messages handled for visitors to the Chicago Radio Show, which has recently closed. These transmitting radio amateurs established a special sending station at the show for the purpose of aiding

and variety of radio receivers in operation on the show floor, so much interference was set up that the amateur receiver in the same hall was unable to work well.

In consequence, the men in charge of the booth distributed the messages to the more conveniently located member stations of the American Radio Relay

nation-wide story author, the Director of the WBZ Radio Nature League, writes: "Last week I went to New York. I didn't have a seat reserved but was fortunate in obtaining one on the train. When the Pullman conductor came to collect the fare, he said, "This is Mr. Burgess, isn't it?" I admitted the charge. The conductor asked to shake hands and I inquired how he knew me. 'I recognized your voice,' said he." Mr. Burgess ends his letter by adding, "Now what chance is there for a man to remain incognito when even his voice is recognized by total strangers, I ask you?"

## A RADIO ANTIQUE

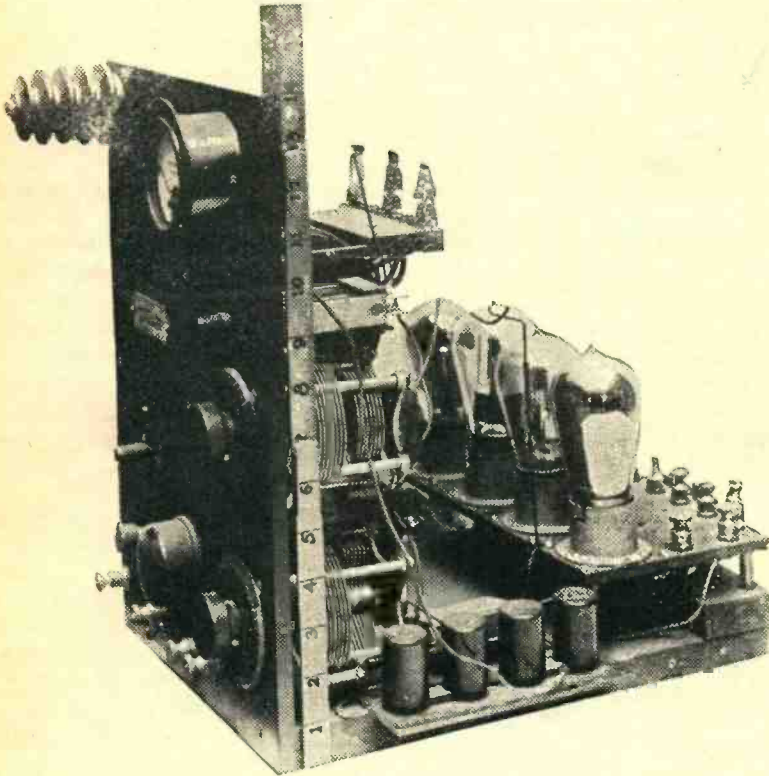

Here is a little transmitting station equipment which was first used in 1919 and is said to be one of the pioneers of broadcasting. It is only 14 inches high and may be held in the hands.

patrons in conveying greetings to their friends throughout the country. This follows the policy of the League and Association in handling message traffic via amateur radio without cost to sender or receiver.

In co-operation with a Chicago newspaper, a transmitter was assembled, a special license secured and message blanks provided at one of the booths of the show. The transmitter worked well, but due to the enormous number

League and the traffic was handled without further difficulty.

This co-operation between broadcast listeners and transmitting amateurs created a splendid bond of understanding between the two groups, according to men most intimately concerned with the message handling work.

## IT GAVE HIM AWAY

In a letter received by Westinghouse Station WBZ from Thornton W. Burgess,

## BEATS THE ICE PACK

Amateur radio, through the station of J. R. Evans of Great Bend, Kan., has finally linked up the center of the North American continent with the Antarctic. Working at 5:10 a. m., Central Standard Time, the Kansas station, an official relay of the ARRL, established communication with ship station AQE aboard the Norwegian Whaler "Sir James Clark Ross," at a time when the ship was held fast in an Antarctic ice pack at latitude 69 degrees south and longitude 178 degrees east.

The Kansas station first linked up with the ship in the southern ice-pack, November 13. It took almost an hour and a half for the two to clear their signals to a point where they were clearly understandable. Once this was accomplished further communication was easy. Since that time the Kansas station has been keeping a steady schedule with the ship taking letters and messages from the vessel and its crew to friends and agents in this country as well as other parts of the world.

At a later day, the ship informed Mr. Evans that it had broken its way clear of the ice pack and was slowly steaming southward toward the Ross Sea.

This latest accomplishment on the part of amateur radio is taken to indicate that it will henceforth serve as the regular means of communication between vessels in the Southern ice, in the same manner as it has served for the MacMillan expedition and the Canadian Government Steamer Arctic in the Northern ice pack.



# R DR RADIO PRESCRIBES.

**NOTE:** In this section the Technical Editor will answer questions of general interest on any radio matter. Any of our readers may ask not more than two questions, and if the subjects are of importance to most radio fans they will be answered free of charge in the magazine. If they are

of special interest to the questioner alone, or if a personal answer is desired, a charge of fifty cents will be made for each answer. This will entitle the questioner to a personal answer by letter. However, if the question requires considerable experimental work, higher rates will be charged.

**Question.** Is it a practical thing to combine the grid resistance and leak into a single unit?

**Answer.** Yes, if you get a good make. Fortunately every style of tube works with a .00025 mfd. grid condenser as well as at any other value. That means that the various combined units all have this one capacity but have different values of leak. By selecting the one which fits your tube best you have a neat solution of the problem of the two separate items.

**Question.** What is meant by "microphonic" noises?

**Answer.** Some tubes are built with filaments and grids which are not anchored very rigidly to the glass. As a result the inside elements can sometimes be set into mechanical vibration. When this occurs the change in spacing between grid and filament causes a difference in input and this cause is reproduced much louder in the output of the tube. If such a set is hooked up through amplifiers to a powerful loud speaker which is placed too near or on top of the set itself it sometimes happens that these sound vibrations will strike the panel and make it and the tubes inside vibrate. Since it is the oscillations which cause the sound and the sound which produces the oscillation the action goes round and round in endless chain and the set howls. The remedy is either to get better tubes or else to move the speaker farther away from the radio.

**Question.** Which is better to check the charge in a storage battery, a voltmeter or a hydrometer?

**Answer.** If the battery has not been tampered with, the hydrometer is much more satisfactory since it is considerably easier to read and understand. The voltmeter has only a slight change in its indication between full and empty while the hydrometer moves up and down about an inch and a half in the ordinary size of instrument. However, if you suspect that someone has tried to deceive you in regard to a battery charge, the voltmeter is the device to use since its readings cannot be changed by a dishonest battery man.

**Question.** Why can not the ordinary "B" battery tester be used to measure the voltage of a "B" eliminator?

**Answer.** This instrument takes a great deal of current—several times as much as a big radio set. A "B" battery is able to give this big output for a few seconds without changing its pressure and so the device may be used very nicely for testing "B" batteries. However, an eliminator has a much smaller output usually 50 or 60 milliamperes. This is a great plenty to operate any ordinary set but will not be adequate to work the "B" tester. For that reason when connected to an eliminator the heavy drain on the device will drop the voltage to a small fraction of what it was the instant before. Such a reading has no meaning at all.

**Question.** In connecting a "B" battery is it better to run the "B" minus lead to the "A" plus or minus?

**Answer.** Opinion is about equally divided on this matter although it seems better practice to use the "A" plus terminal. Those who prefer the minus point out that in measuring with a voltmeter it is unnecessary to shift the negative lead of the instrument with this latter connection. It can be hooked on to the common minus terminal and all pressure readings may be made from that one point. This is indeed a convenience although it is of no value to most fans since it is very rare that they make a lot of voltmeter readings.

On the other hand, by using the "A" plus for the "B" battery return you add several volts to the pressure of the latter unit. A "B" battery is about the most expensive form of electricity you can buy. The "A" battery gives you a lot more energy for less money. If you can make it serve as part of the "B" pressure it is considerably better from an engineering point of view. That is why the latter method of connection is becoming more popular.

**Question.** How does tuned radio frequency differ from the neutrodyne circuit?

**Answer.** They are exactly alike except that the latter uses a method of neutralizing the leakage capacity effect which is found in most radio frequency sets. This method of neutralizing is supposed to give better and clearer results. Those who are not licensed to use the neutrodyne patents claim that their sets do not need such extra adjustments while the neutrodyne people claim that they do.



**GETS FORTY COLLARS**

Now that the dust—or rather the mud—of the World Series has settled, and the correspondence department of WEA F is gradually getting back to normal conditions, a glance through the thousands of letters received by Graham McNamee, the popular WEA F announcer who described the games for the WEA F chain of stations, reveals many interesting angles, both humorous and pathetic, on

**EASY TO WORK**

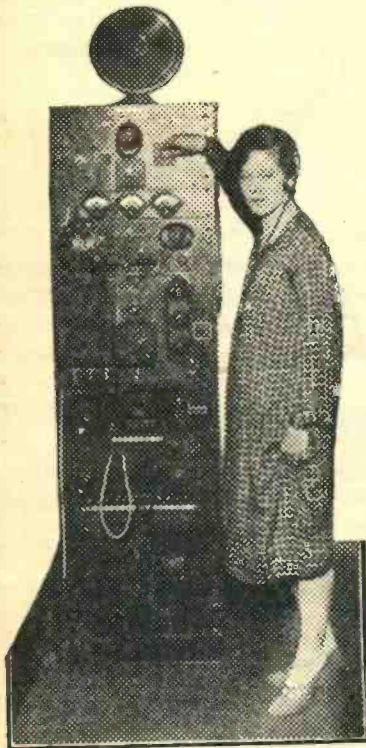

This control panel is what hooks the outside pick-up (a theatre, for instance), to the sending station.

the infinite variety of listeners, and on the most unusual conditions of reception.

The shut-ins seemed to have gotten greatest delight from the games, for the excitement of the contests made them forget for a while, at least, their afflictions. Hundreds of disabled war veterans, both of the World War and Civil War, tubercular patients, old men and women, doctors and nurses, crippled children, Old Peoples Homes, sent touching individual and group letters expressing appreciation. Shut-ins of a different type—prisoners who used up half of their letter writing privilege of two a month, members of the Alimony Club in

the Ludlow Street Jail, New York City, who broke their loud speaker in the enthusiasm, light-house and light-ship keepers, isolated farmers and farm wives were heard from.

Striking coal miners in Pennsylvania, old maids who didn't quite understand baseball, ex-ball players, priests, ministers and school children, seemed to have enjoyed the games with equal enthusiasm. In Massachusetts a whole school was excused to listen in, and in New York City a teacher reports that the boys begged to be allowed to remain in after school to hear the games on the school set! One teacher had his English pupils, both boys and girls, write letters to McNamee thanking him for his broadcasting. A dentist eased the pain of his victims by installing a loud speaker in his operating room, where he extracted teeth to the tune of "three out—all out."

So realistic was the description of the weather that a woman wrote in that after listening to the game for an hour she called her young child back to put on his rubbers, even though the sun was shining in that city. Another woman reports that at the end of the first four games she found her face chapped from the "radio wind."

Among the unusual personal gifts sent in were about forty collars of all sizes and descriptions sent to Graham, following his statement that he couldn't keep his collar clean at Pittsburgh, a hand forged horse shoe about as big as a dime, a basket of grapes, a perfect chocolate cake, eggs which before reaching him had "gone wrong," a dictograph cylinder (broken in transit) which evidently contained a record of his broadcasting, a sweater, a bead watch bob with his initials worked in, etc.

**GRAVITY BATTERIES.** Tested by Bureau of Standards. Runs 1/4 amp. tube for 2400-3200 hrs. No acid, sulphating or weekly attention. Price \$6.60 for 6, size 6x8, 3-lb. zincs, &c., 6.36 volts in series. Extra zincs, 6 for \$2.65. Blue vitriol, 25 lbs., \$2.65 (3-lb. per cell). Shpg. wght. crated 75 lbs.

**BALLOON AERIAL** for best DX. London-Paris with 1 tube. Write for literature. Hydrogen procured in tanks or made in jug. Price \$5 plus pstg. (5-lb). large reel, gas fixtures, extra antenna wire, instructions, 3 30-in. balloons, etc. Satisfaction assured.

**CHIMNEY AERIAL.** Protected by asbestos, large 6-in. cage construction. Inconspicuous, chimney high and super-sensitive as an inside aerial. Price \$2, plus pstg. (3 lb.), 75 ft. heavy gauge coil antenna. Just drop it down chimney.

**INSULATED RIBBON WIRE.** To be wound edgewise for maximum inductance in making radio coils. Equivalent to No. 24 round wire, \$4.50 per lb.

EVERETT SCANLON, RADIO SPECIALTIES, LAKEWOOD, RHODE ISLAND.

**In 15 Minutes I Will Give You the Secret of a Perfect Memory**

**I Guarantee to Increase Your Memory 100% In 10 Days**

Not by any abstract, tiresome, difficult-to-master method; not by the old system of association of ideas or thoughts. Not by hard study, rotation exercises or repetition of words or sounds. It is not a book. There is nothing to study—nothing to repeat. It is by far the newest, best, simplest method ever devised. I will give you a memory in one week's time that will surprise you. In one month things that occurred 30 days ago will be as fresh and clear in your mind as if they happened yesterday.



**GEO. J. SPINNER**  
Author and Educator  
to rise to my present position as an educator in professional and scientific circles; it gave me a good vocabulary, developed my powers of perception and analysis and fitted me to write on a hundred subjects.

**My Secret for 30 Years**

I have given my secret to thousands. I have used it myself for more than 30 years. It enabled me

**Command Success**

My VI-FLECT method of memory-building is for those who are ambitious to improve their business, professional, social or financial condition. VI-FLECT will develop your brain-power—your ability—lift you out of the rut; you will no longer stumble, mumble, nor grope for words with which to express yourself. You will be surprised how easily you can remember names, faces, dates, figures, appointments, duties, etc. It will enhance your importance as an employer, your value as a manager or employee, increase your worth, your ability, expertness, raise your salary, help you in business, professionally, socially, politically—in every way.

**Learn My Secret**

I prefer to place my secret within the easy reach of everyone. Therefore, the price I am going to ask for VI-FLECT—my wonderful method of memory-building, which I have developed and perfected during my 30 years of constant study and application is ONLY \$5.00.

Let nothing stand between you and a successful, happy, prosperous future. If it is not convenient to enclose the money, or if you prefer, I will mail your copy of VI-FLECT and you can hand the small amount to your postman when he delivers the package. The important thing is—SEND NOW.

**COUPON**

Geo. J. Spinner,  
416 S. Dearborn St., MB738  
Chicago, Ill.

Dear Sir: Please send me my copy of VI-FLECT for which I enclose \$5.00. I will try your VI-FLECT method of memory-building for 10 days, and if it does not increase my memory 100% I am to return it and you are to give me my money back without argument.

Name .....

Address .....

City ..... State .....



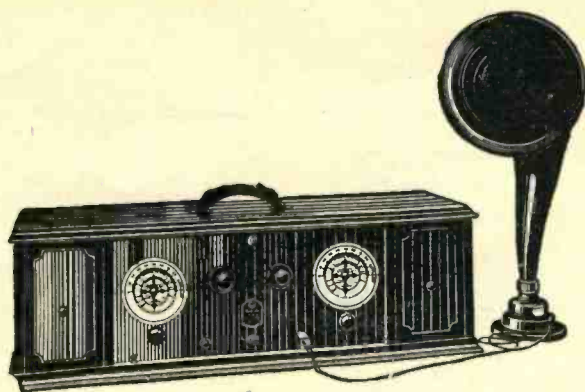

**Which is Better—**

**A Cheap Set for Cash---or  
A GOOD Set ON TERMS**

**?**

---

*The Good Set is Cheapest in the End*

---

Bay State specializes on the better grade sets, like Radiola, DeForest, Adler Royal, Magnavox, and sells on Convenient Terms.

Write for information. Address Dept. A.

**BAY STATE RADIO CO.**

---

*The House of Radio Service*

---

**116A Washington Street**

**Boston, Mass.**

Always Mention New England Radio Progress When Writing to Advertisers.



UNITED STATES BROADCASTING STATIONS  
ARRANGED ALPHABETICALLY BY  
CALL LETTERS

K.C. W.L. W.P.

Abbreviations: W.L., wave length in meters; K.C., frequencies in kilocycles; W.P., wattpower of station.

|       |  |               |
|-------|--|---------------|
| KDKA  | —Westinghouse Elec. & Mfg. Co., E. Pittsburgh, Pa.   | 970-309- var. |
| KDFM  | —Westinghouse Elec. & Mfg. Co., Cleveland, O.        | 1200-250- 500 |
| KDZB  | —Frank E. Siefert, Bakersfield, Cal.                 | 1430-210- 100 |
| KFAB  | —Nebraska Buick Auto Co., Lincoln, Neb.              | 880-341-1000  |
| KFAD  | —McArthur Bros. Mercantile Co., Phoenix, Ariz.       | 1100-273- 100 |
| KFAJ  | —University of Colorado, Boulder, Colo.              | 1150-261- 100 |
| KFAU  | —Independent School Dist. of Boise, Boise Idaho.     | 1060-283- 750 |
| KFBK  | —Kimball Upson Co., Sacramento, Cal.                 | 1210-248- 100 |
| KFBL  | —Leese Brothers, Everett, Wash.                      | 1340-224- 100 |
| KFBU  | —Bishop N. S. Thomas, Laramie, Wyo.                  | 1110-270- 500 |
| KFCB  | —Nielsen Radio Supply Co, Phoenix, Ariz.             | 1260-238- 100 |
| KFCF  | —Frank A. Moore, Walla Walla, Wash.                  | 1170-256- 100 |
| KFDJ  | —Oregon Agricultural College, Corvallis, Ore.        | 1060-283- 500 |
| KFDM  | —Magnolia Petroleum Co., Beaumont, Tex.              | 950-316- 500  |
| KFDX  | —First Baptist Church, Shreveport, La.               | 1200-250- 100 |
| KFDY  | —S. Dak. Ste. Col. Ag. & Mech. Arts, Br'kngs., S. D. | 1100-273- 100 |
| KFEQ  | —Scroggin, & Co. Bank, Oak, Nebr.                    | 1120-268- 500 |
| KFGC  | —Louisiana State Univ., Baton Rouge, La.             | 1120-268- 100 |
| KFGH  | —Leland Stanford Junior Univ., Stanford Univ., Cal.  | 1110-270- 500 |
| KFI   | —Earl C. Anthony, Los Angeles, Cal.                  | 640-469-3000  |
| *KFJF | —National Radio Mfg. Co., Oklahoma, Okla.            | 1150-261- 500 |
| KFKU  | —University of Kansas, Lawrence, Kans.               | 1090-275- 500 |
| *KFKX | —Westinghouse Elec. & Mfg. Co., Hastings, Neb.       | 1040-288-5000 |
| KFLR  | —University of New Mexico, Albuquerque, N. Mex.      | 1180-254- 100 |
| KFLV  | —Swedish Evangelical Mission Church, Rockford, Ill.  | 1310-229- 100 |
| KFLZ  | —Atlantic Automobile Co., Atlantic, Iowa.            | 1100-273- 100 |
| KFMQ  | —University of Arkansas, Fayetteville, Ark.          | 1000-380- 750 |
| KFMR  | —Morningside College, Sioux City, Iowa.              | 1150-261- 100 |
| KFMX  | —Carleton College, Northfield, Minn.                 | 890-337- 500  |
| *KFNF | —Henry Field Seed Co., Shenandoah, Iowa.             | 1140-263- 500 |
| KFOA  | —Rhodes Dept. Store, Seattle, Wash.                  | 660-454-1000  |
| *KFON | —Echophone Radio Shop, Long Beach, Cal.              | 1290-233- 500 |
| KFOO  | —Latter Day Saints Univ., Salt Lake City, Utah.      | 1270-236- 250 |
| KFOR  | —David City Tire & Electric Co., David City, Neb.    | 1350-226- 100 |
| KFOX  | —Technical High School, Omaha, Nebr.                 | 1210-248- 100 |
| KFPR  | —Los Angeles County Forestry, Los Angeles, Cal.      | 1300-231- 500 |
| KFPY  | —Symons Investment Co., Spokane, Wash.               | 1130-266- 100 |
| *KFOA | —The Principia, St. Louis, Mo.                       | 1150-261- 100 |
| KFOB  | —Searchlight Publishing Co., Fort Worth, Texas.      | 1140-263- 150 |
| *KFOU | —W. E. Riker, Alma (Holy City), Calif.               | 1380-217- 100 |
| KFRB  | —Hall Bros., Beville, Texas.                         | 1210-248- 250 |
| KFRU  | —Stephens College, Columbia, Mo.                     | 600-500- 500  |
| KFSG  | —Echo Park Evangelistic Assn., Los Angeles, Cal.     | 1090-275- 500 |
| KFUM  | —W. D. Corley, Colorado Springs, Colo.               | 1240-242- 100 |
| KFUO  | —Concordia Seminary, St. Louis, Mo.                  | 550-545- 500  |
| KFUT  | —University of Utah, Salt Lake City, Utah.           | 1150-261- 100 |
| KFVE  | —Film Corporation of America, St. Louis, Mo.         | 1250-240- 500 |
| KFVW  | —Airfan Radio Corporation, San Diego, Cal.           | 1220-246- 500 |
| *KFWA | —Browning Bros. Co., Ogden, Utah.                    | 1150-261- 500 |
| KFWB  | —Warner Bros. Pictures, Inc., Hollywood, Cal.        | 1190-252- 500 |
| KFWH  | —F. Wellington Morse, Jr., Chico, Cal.               | 1180-254- 100 |
| KFWI  | —Radio Entertainments, Inc., So. San Fran., Cal.     | 1330-226- 500 |
| KFWM  | —Oakland Educational Society, Oakland, Cal.          | 1430-207- 500 |
| KFWO  | —Lawrence Mott, Avalon, California.                  | 1420-211- 250 |
| KFWU  | —Louisiana College, Pineville, La.                   | 1260-238- 100 |
| KFXB  | —Bertram O. Heller, Big Bear Lake, Cal.              | 1480-202- 500 |
| KFXF  | —Pikes Peak Broad. Co., Colorado Springs, Col.       | 1200-250- 500 |
| KFYD  | —N. Baker, Muscatine, Iowa.                          | 1170-256- 250 |
| KGB   | —Tacoma Daily Ledger, Tacoma, Wash.                  | 1200-250- 100 |
| KGO   | —General Electric Co., Oakland, Cal.                 | 830-361-3000  |
| KGU   | —Marion A. Mulrony, Honolulu, Hawaii.                | 1110-270- 500 |
| KGW   | —Portland Morning Oregonian, Portland, Ore.          | 610-491- 500  |
| KHJ   | —Times-Mirror Co., Los Angeles, Cal.                 | 740-405- 500  |
| KHQ   | —Louis Wasmer, Spokane, Wash.                        | 1100-273- 500 |
| KJR   | —Northwest Radio Service Co., Seattle, Wash.         | 780-384-1000  |
| KLDS  | —R. Ch. Jesus Christ, L. D. Sts., Independence, Mo.  | 680-441-1000  |
| KLS   | —Warner Bros. Radio Supplies Co., Oakland, Cal.      | 1200-252- 250 |
| KLX   | —Tribune Publishing Co., Oakland, Cal.               | 590-508- 500  |
| KLZ   | —Reynolds Radio Co., Denver, Colo.                   | 1130-266- 250 |
| KMA   | —May Seed & Nursery Co., Shenandoah, Iowa.           | 1190-252- 500 |
| *KMTR | —K. M. Turner Radio Corp., Los Angeles, Cal.         | 1260-238- 500 |
| KNRC  | —Clarence B. Juneau, Los Angeles, Cal.               | 1440-208- 250 |
| KNX   | —Los Angeles Express, Los Angeles, Cal.              | 890-337- 500  |
| KOA   | —General Electric Co., Denver, Colo.                 | 930-322-5000  |
| KOB   | —New Mexico Col. of Agriculture, State Col., N. Mex. | 860-349-1000  |
| KOCH  | —Omaha Central H. School, Omaha, Neb.                | 1160-258- 250 |
| KOCW  | —Oklahoma College for Women, Chickasha, Okla.        | 1190-252- 200 |
| KOIL  | —Monarch Manufacturing Co., Council Bluffs, Ia.      | 1080-278- 500 |
| KPO   | —Hale Bros., San Francisco, Cal.                     | 700-428-1000  |
| KPRC  | —Houston Printing Co., Houston, Texas.               | 1010-297- 500 |
| KPSN  | —Pasadena Star-News, Pasadena, Cal.                  | 950-316-1000  |
| KOP   | —H. B. Read, Portland, Ore.                          | 1410-213- 500 |
| KQV   | —Double-Hill Electric Co., Pittsburg, Pa.            | 1090-275- 500 |
| KQW   | —First Baptist Church, San Jose, Cal.                | 1330-231- 500 |
| KRE   | —Berkeley Daily Gazette, Berkeley, Cal.              | 1170-256- 100 |
| KSAC  | —Kansas State Agric. College.                        | 880-341- 500  |
| *KSD  | —Post-Dispatch, St. Louis, Mo.                       | 550-545- 500  |

|       |   |               |
|-------|---|---------------|
| KSL   | —The Radio Service Corp., Salt Lake City, Utah.   | 1000-300-1000 |
| KSO   | —A. A. Berry Seed Co., Clarinda, Iowa.  | 1240-242- 500 |
| KTAB  | —Tenth Ave. Baptist Church, Oakland, Cal.   | 900-333-1000  |
| KTBI  | —Bible Institute of Los Angeles, Los Angeles, Cal.  | 1020-294- 750 |
| KTCL  | —American Radio Tel. Co., Inc., Seattle, Wash.  | 980-310-1000  |
| KTHS  | —New Arlington Hotel Co., Hot Springs, Ark.   | 800-375- 500  |
| KTNT  | —Norman Baker, Muscatine, Iowa.   | 1170-256- 500 |
| KTW   | —First Presbyterian Church, Seattle, Wash.  | 660-454-1000  |
| KUO   | —Examiner Printing Co., San Francisco, Cal.   | 1200-250- 150 |
| KUSD  | —University of South Dakota, Vermillion, S. D.  | 1080-278- 100 |
| KUOM  | —State Univ. of Montana, Missoula, Mont.  | 1230-244- 250 |
| KUT   | —University of Texas, Austin, Texas.  | 1308-231- 500 |
| KVOO  | —Voice of Oklahoma, Bristow, Okla.  | 800-375- 500  |
| *KWCR | —H. F. Paav, Cedar Rapids, Iowa.  | 1080-278- 500 |
| *KWKS | —Wilson Duncan Studios, Kansas City, Mo.  | 1270-236- 100 |
| KWKH  | —W. G. Paterson, Kenonwood, La.   | 1150-261- 500 |
| KWSC  | —State College of Washington, Pullman, Wash.  | 860-349- 500  |
| KWWG  | —City of Brownsville, Brownsville, Texas.   | 1080-278- 500 |
| KYW   | —Westinghouse Elec. & Mfg. Co., Chicago, Ill.   | 560-535- 500  |
| KZKZ  | —Electrical Supply Co., Manila, P. I.   | 1110-270- 100 |
| KZM   | —Preston D. Allen, Oakland, Cal.  | 1250-240- 100 |
| KZRO  | —Far Eastern Radio, Manila, P. I.   | 1350-222- 500 |
| KZUY  | —F. Johnson, Elser, Baguio, P. I.   | 833-360- 500  |
| NAA   | —United States Navy, Arlington, Va.   | 690-435-1000  |
| WAAP  | —Chicago Daily Drivers Journal, Chicago, Ill.   | 1080-278- 200 |
| WAAM  | —I. R. Nelson Co., Newark, N. J.  | 1140-263- 500 |
| WAAW  | —Omaha Grain Exchange, Omaha, Neb.  | 1080-278- 500 |
| WABI  | —First Universalist Church, Bangor, Me.   | 1250-240- 100 |
| WABO  | —Lake Avenue Baptist Church, Rochester, N. Y.   | 1080-278- 100 |
| WABQ  | —Haverford College Radio Club, Haverford, Pa.   | 1150-261- 100 |
| WABX  | —Henry B. Joy, Mount Clemens, Mich.   | 1220-246- 500 |
| WADC  | —Allen Theatre, Akron, O.   | 1160-258- 500 |
| WAFD  | —Albert B. Parfet Co., Port Huron, Mich.  | 1090-275- 500 |
| WAHG  | —A. H. Grebe Co., Richmond Hill, N. Y.  | 950-316- 500  |
| WAIU  | —American Insurance Union, Cloumbus, O.   | 1020-294- 500 |
| WAMD  | —Hubbard & Co., Minneapolis, Minn.  | 1230-244- 500 |
| WAPI  | —Alabama Polytechnic Institute, Auburn, Ala.  | 1210-248- 500 |
| WARC  | —Am. Rad. & Research Corp., Med'd H'lsde, Mass.   | 1150-261- 100 |
| WBAA  | —Purdue University, West Lafayette, Ind.  | 1100-273- 250 |
| WBAK  | —Pennsylvania State Police, Harrisburg, Pa.   | 1090-275- 500 |
| *WBAL | —Consolidated Gas, Elec. Lgt. & Pr. Co., Balt., Md.   | 800-375-1000  |
| WBAO  | —James Millikin University, Decatur, Ill.   | 1110-270- 100 |
| WBAP  | —Wortham-Carter Publishing Co., Fort Worth, Tex.  | 630-476-1500  |
| *WBBL | —Grace Covenant Church, Richmond, Va.   | 1310-229- 100 |
| WBRR  | —People's Pulpit Assoc., Rossville, N. Y.   | 1100-273- 500 |
| WBCN  | —Foster & McDonnell, Chicago, Ill.  | 1130-266- 500 |
| WBES  | —Bliss Electrical School, Takoma Park, Md.  | 1350-222- 100 |
| WBNY  | —Shirley Katz, New York, N. Y.  | 1430-210- 500 |
| WBOQ  | —A. H. Grebe Co., Richmond Hill, N. Y.  | 1270-236- 100 |
| WBRE  | —Baltimore Radio Exchange, Baltimore, Md.   | 1300-231- 100 |
| WBT   | —Charlotte Chamber of Commerce, Charlotte, N. C.  | 1090-275- 250 |
| WBZ   | —Westinghouse Elec. & Mfg. Co., Springfield, Mass.  | 900-331-2000  |
| WBZA  | —Westinghouse Elec. & Mfg. Co., Boston, Mass.   | 1240-242- 250 |
| WCAC  | —Connecticut Agric. College, Mansfield, Conn.   | 1090-275- 500 |
| WCAD  | —St. Lawrence University, Canton, N. Y.   | 1140-263- 250 |
| WCAE  | —Kaufmann & Baer Co., Pittsburg, Pa.  | 650-461- 500  |
| WCAH  | —Entekin Electric Co., Columbus, O.   | 1130-266- 500 |
| WCAJ  | —Nebraska Wesleyan Univ., Univ. Place, Nebr.  | 1180-254- 500 |
| WCAL  | —St. Olaf College, Northfield, Minn.  | 890-337- 500  |
| WCAO  | —A. A. & A. S. Brager, Baltimore, Md.   | 1090-275- 100 |
| WCAP  | —Chesapeake & Potomac Tel. Co., Wash., D. C.  | 640-469- 500  |
| WCAR  | —Southern Radio Corp. of Texas, San Antonio, Tex.   | 1140-263- 500 |
| WCAU  | —Durham & Co., Philadelphia, Pa.  | 1080-278- 500 |
| WCAX  | —University of Vermont, Burlington, Vt.   | 1200-250- 100 |
| WCBD  | —Wilbur G. Voliva, Zion, Ill.   | 870-345-5000  |
| WCBO  | —First Baptist Church, Nashville, Tenn.   | 1270-236- 100 |
| WCCO  | —Washburn Crosby Co., Minneapolis, Minn.  | 720-416-5000  |
| WCEE  | —Liberty Weekly, Elgin, Ill.  | 1090-275-1000 |
| WCLS  | —H. M. Couch, Joliet, Ill.  | 1400-214- 150 |
| *WCSS | —Congress Square Hotel Co., Portland, Me.   | 1170-256- 500 |
| WCWU  | —Clark University, Worcester, Mass.   | 1260-238- 250 |
| WCWS  | —Charles W. Selen, Providence, R. I. (Portable).  | 1430-216- 100 |
| WCX   | —WJR—The Detroit Free Press and Jewett Radio and Phonograph Co., Pontiac, Mich., (operating jointly). | 580-517-2500  |
| WDAD  | —Dad's Auto Accessories, Inc., Nashville, Tenn.   | 1330-226- 150 |
| WDAE  | —Tampa Daily News, Tampa, Fla.  | 1100-273- 250 |
| WDAP  | —Kansas City Star, Kansas City, Mo.   | 820-366- 500  |
| WDAG  | —J. Laurence Martin, Amarillo, Tex.   | 1140-263- 100 |
| WDBE  | —Gilham-Schoen Electric Co., Atlanta, Ga.   | 1110-270- 100 |
| WDBK  | —M. F. Bros Radio Store, Cleveland, O.  | 1320-227- 100 |
| *WDBO | —Rollins Garage, Winter Park, Fla.  | 1250-240- 500 |
| WDBR  | —Tremont Temple Baptist Church, Boston, Mass.   | 1150-261- 100 |
| WDCH  | —Dartmouth College, Hanover, N. H.  | 1170-256- 100 |
| *WDOD | —Chattanooga Radio Co., Inc., Chattanooga, Ill.   | 1170-256- 500 |
| WDWF  | —Dutew. W. Flint, Cranston, R. I.   | 680-441- 500  |
| WEAF  | —American Tel. & Tel. Co., New York, N. Y.  | 610-492-5000  |
| WEAI  | —Cornell University, Ithaca, N. Y.  | 1180-254- 500 |
| WEAM  | —Borough of North Plainfield, N. Plainfield, N. J.  | 1150-261- 250 |
| WEAN  | —Shepard Co., Providence, R. I.   | 1110-270- 500 |
| WEAO  | —Ohio State University, Columbus, Ohio.   | 1020-294- 500 |
| WEAR  | —Goodyear Tire & Rubber Co., Cleveland, Ohio.   | 770-389- 750  |
| WEAU  | —Davidson Bros. Co., Sioux City, Iowa.  | 1090-275- 100 |



# The Heart of Your Radio Set

A Grid Leak is essential on every set. There are few sets made which wouldn't be improved by the use of a Variable Grid Leak.

Even the set makers admit that.

But those makers say—"Show us a good Variable Grid Leak,"—because they know that most of the variables on the market have been a failure.

## Right now -- we're showing them

Buy It



Try It

Volt-X Ball-Bearing  
Variable Grid Leak

### If you are not satisfied, return it and get your money back

This GRID LEAK is made by an organization which has been handling delicate electrical instruments for years. We know what it means to build accurately and substantially. We KNOW that this GRID LEAK is as nearly perfect as human hands and precise machinery can make it —we're glad to have you try it with the knowledge that if it doesn't do what we claim for it, your money will be refunded.

Clip the coupon, and send it in with \$1.00—a grid leak will be mailed at once.

**BURTON & ROGERS MFG. CO.**

**755 Boylston St.**

**Boston, Mass.**

Please  
send me one  
of your VOLT-X  
VARIABLE GRID  
LEAKS.

I enclose \$1.00 with  
the understanding that  
this merchandise is guaran-  
teed to give satisfaction, or  
may be returned.

NAME.....

ADDRESS.....

Always Mention New England Radio Progress When Writing to Advertisers.

K.C. W.L. W.P.

K.C. W.L. W.P.

|   |               |
|---|---------------|
| WEBC—Walter C. Bridges, Superior, Wis.                      | 1240-242-100  |
| *WEBH—Edgewater Beach Hotel Co., Chicago, Ill.              | 810-370-1500  |
| WEBJ—Third Avenue Railway Co., New York, N. Y.              | 1100-273-500  |
| WEBK—Grand Rapids Radio Co., Grand Rapids, Mich.            | 1240-242-100  |
| WEBL—Radio Corp. of America, United States (portable)       | 1330-226-100  |
| WEBM—Radio Corp. of America, United States (portable)       | 1330-226-100  |
| WEBW—Beloit College, Beloit, Wis.                           | 1120-268-500  |
| WEEL—Edison Electric Illuminating Co., Boston, Mass.        | 630-476-500   |
| WEMC—Emmanuel Missionary Col., Berrien Springs, Mich.       | 1050-286-500  |
| WENR—All-American Radio Corp., Chicago, Ill.                | 1130-266-1000 |
| WEW—St. Louis University, St. Louis, Mo.                    | 1210-248-100  |
| WFAA—Dallas News & Dallas Journal, Dallas, Tex.             | 630-476-500   |
| WFAV—University of Nebraska, Lincoln, Neb.                  | 1090-275-500  |
| WFBG—William F. Gable Co., Altoona, Pa.                     | 1080-278-100  |
| WFBH—Concourse Radio Corp., New York, N. Y.                 | 1100-273-500  |
| WFB1—Galvin Radio Supply Co., Camden, N. J.                 | 1270-236-250  |
| *WFBJ—St. John's University, Collegeville, Minn.            | 1270-236-100  |
| WFB1—Onondoga Hotel, Syracuse, N. Y.                        | 1190-252-100  |
| WFBM—Merchant Heat & Light Co., Indianapolis, Ind.          | 1120-268-250  |
| WFBR—Fifth Infantry, Maryland N. G., Baltimore, Md.         | 1180-254-100  |
| WFDF—Frank D. Fallain, Flint, Mich.                         | 1280-234-100  |
| WFI—Strawbridge & Clothier, Philadelphia, Pa.               | 760-395-500   |
| WFKB—Francis K. Bridgman, Chicago, Ill.                     | 1380-217-500  |
| WFR1—Robert Morrison Lacey, Brooklyn, N. Y.                 | 1460-205-100  |
| WGBB—Harry H. Carman, Freeport, N. Y.                       | 1230-244-100  |
| WGBF—Finke Furniture Co., Evansville, Ill.                  | 1270-236-100  |
| WGBQ—Stout Institute, Menomonie, Wis.                       | 1280-234-100  |
| WGBS—Gimbel Bros., New York                                 | 950-316-500   |
| WGBU—Florida Cities Fin. Co., Fulford By-The-Sea, Fla.      | 1080-278-500  |
| WGBX—University of Maine, Orono, Me.                        | 1190-252-100  |
| WGCP—D. W. May, Newark, N. J.                               | 1190-252-500  |
| WGES—Coyno Electrical School, Oak Park, Ill.                | 1200-250-500  |
| WGHB—Geo. H. Bowles Developments, Clearwater Fla.           | 1130-266-500  |
| WGHF—Geo. H. Phelps, Inc., Detroit, Mich.                   | 1110-270-1500 |
| WGMU—A.H. Grebe & Co., Inc. (portable), Richmond Hill, N.Y. | 1270-236-100  |
| WGN—The Tribune, Chicago, Ill.                              | 810-370-1000  |
| WGR—Federal Telephone Mfg. Corp., Buffalo, N. Y.            | 940-319-750   |
| WGST—Georgia School of Technology, Atlanta, Ga.             | 1110-270-500  |
| WGY—General Electric Co., Schenectady, N. Y.                | 790-380-5000  |
| WHA—University of Wisconsin, Madison, Wis.                  | 560-535-750   |
| WHAD—Marquette Univ. and Mil. Jour., Mil. Wis.              | 1090-275-500  |
| WHAG—University of Cincinnati, Cincinnati, O.               | 1290-233-100  |
| WHAM—University of Rochester, Rochester, N. Y.              | 1080-278-100  |
| *WHAP—Wm. H. Taylor Finance Corp., New York, N. Y.          | 1250-250-500  |
| WHAR—Seaside Hotel, Atlantic City, N. J.                    | 1090-275-500  |
| WHAS—Courier Journal & Louisville Times.                    | 750-400-500   |
| WHAT—George W. Young, Minneapolis, Minn.                    | 1140-263-500  |
| WHAV—Wilmington Elec. Spectly Co., Wilmington, Del.         | 1130-266-100  |
| WHAZ—Rensselaer Polytechnic Institute, Troy, N. Y.          | 790-380-1000  |
| WHB—Sweeney School Co., Kansas City, Mo.                    | 820-366-500   |
| WHBF—Beadsley Specialty Co., Rock Island, Ill.              | 1350-222-100  |
| WHBH—Culver Military Academy, Culver, Ind.                  | 1350-222-100  |
| WHBP—Johnstown Automobile Co., Johnstown, Pa.               | 1170-256-100  |
| WHBW—D. R. Kienzle, Philadelphia, Pa.                       | 1390-216-100  |
| WHDI—Wm. Hood Dunwoody I. Inst., Minneapolis, Minn.         | 1080-278-500  |
| WHEC—Hickson Electric Co., Inc., Rochester, N. Y.           | 1160-238-100  |
| WHK—Radio Air Service Corp., Cleveland, O.                  | 1100-273-250  |
| WHN—George Schubel, New York, N. Y.                         | 830-361-500   |
| WHO—Bankers Life Co., Des Moines, Iowa                      | 570-526-5000  |
| *WHT—Radiophone Broadcasting Corporation, Deerfield, Ill.   | 1260-238-2500 |
| WIAD—Howard R. Miller, Philadelphia, Pa.                    | 1200-250-100  |
| WIAS—Home Electric Co., Burlington, Iowa.                   | 1180-254-100  |
| WIBA—The Capital Times Studio, Madison, Wis.                | 1270-236-100  |
| WIBC—L. M. Tate Post No. 39, V.F.W. St. Petersburg, Fla.    | 1350-222-100  |
| WIBO—Nelson Brothers, Chicago, Ill.                         | 1330-226-1000 |
| WIBW—L. L. Dill, Logansport, Ind.                           | 1360-220-100  |
| *WIBX—Grid-Leak, Inc., Utica, N. Y.                         | 1460-205-150  |
| WIL—St. Louis Star, Benson Radio Co., St. Louis, Mo.        | 1100-273-250  |
| WIP—Gimbel Bros., Philadelphia, Pa.                         | 950-508-500   |
| WJAD—Jackson's Radio Eng. Laboratories, Waco, Texas.        | 850-353-500   |
| WJAG—Norfolk Daily News, Norfolk, Nebr.                     | 1110-270-200  |
| WJAM—D. M. Perham, Cedar Rapids, Ia.                        | 1120-268-100  |
| WJAR—The Outlet Co., Providence, R. I.                      | 980-306-500   |
| WJAS—Pittsburgh Radio Supply House, Pittsburgh, Pa.         | 1090-275-500  |
| *WJAX—City of Jacksonville, Jacksonville, Fla.              | 890-337-1000  |
| WJAZ—Zenith Radio Corp., Mt. Prospect, Ill. (Limited).      | 930-322-1500  |
| WJBI—Robert S. Johnson, Red Bank, N. J.                     | 1370-219-250  |
| WJBL—Wm. Gushard Dry Goods Co., Decatur, Ill.               | 1110-270-500  |
| WJBO—Bucknell University, Lewisburg, Pa.                    | 1420-211-100  |
| WJJD—Supreme Lodge L. O. Moose, Mooseheart, Ill.            | 990-303-500   |
| WJR—Same as WCX.  |               |
| WJY—Radio Corporation of America, New York, N. Y.           | 740-405-1000  |
| WJZ—Radio Corporation of America, New York, N. Y.           | 660-454-1000  |
| *WKAF—WKAF Broadcasting Co., Milwaukee, Wis.                | 1150-261-500  |
| WKAQ—Radio Corporation of Porto Rico, San Juan, P. R.       | 880-341-500   |
| WKAR—Michigan Agric. Col., E. Lansing, Mich.                | 1050-286-1000 |
| WKBB—Sanders Bros., Joliet, Ill.                            | 1400-214-100  |
| WKBE—K. and B. Electric Co., Webster, Mass.                 | 1300-231-100  |
| WKBG—C. L. Carrell (portable), Chicago, Ill.                | 1390-216-100  |
| WKBK—Shirley Katz, New York, N. Y.                          | 1430-210-500  |
| WKRC—Kodel Radio Corp., Cincinnati, O.                      | 710-422-1000  |
| WKRC—Kodel Radio Corp., Cincinnati, O.                      | 920-353-1000  |
| WKY—E. C. Hull and H. S. Richards, Oklahoma, Okla.          | 1090-275-100  |

|  |               |
|--|---------------|
| *WLAL—First Christian Church, Tulsa, Okla.               | 1200-250-100  |
| WLB—University of Minnesota, Minneapolis, Minn.          | 1080-278-500  |
| WLBL—Wisconsin Dept. of Markets, Stevens Point, Wis.     | 1080-278-500  |
| WLBT—Liberty Weekly, Elgin, Ill.                         | 990-302-2500  |
| WLIT—Lit Bros., Philadelphia, Pa.                        | 760-395-500   |
| WLS—Sears, Roebuck Co., Chicago, Ill.                    | 870-345-1500  |
| WLSI—Lincoln Studios, Inc., Providence, R. I.            | 680-441-500   |
| WLTS—Lane Technical High School, Chicago, Ill.           | 1160-258-100  |
| WLW—Crosley Radio Corp., Harrison, O.                    | 710-422-5000  |
| *WLWL—Mis. Soc. of St. Paul the Apostle, New York        | 1040-288-1500 |
| WMAF—Round Hills Radio Corp., Dartmouth, Mass.           | 680-441-1000  |
| WMAK—Norton Laboratories, Lockport, N. Y.                | 1130-466-500  |
| WMAQ—Chicago Daily News, Chicago, Ill.                   | 670-448-500   |
| WMAZ—Mercer University, Macon, Ga.                       | 1150-261-500  |
| WMBB—American Bond & Mortgage Co., Chicago, Ill.         | 1200-250-500  |
| WMBG—Michigan Broadcasting Co., Detroit, Mich.           | 1170-256-100  |
| WMBF—Fleetwood Hotel, Miami Beach, Fla.                  | 780-384-500   |
| WMC—Commercial Appeal, Memphis, Tenn.                    | 600-500-500   |
| WMCB—Greeley Square Hotel Co., Hoboken, N. J.            | 880-341-500   |
| WNB—Shepard Stores, Boston, Mass.                        | 1200-250-100  |
| WNAC—Shepard Stores, Boston, Mass.                       | 1070-280-500  |
| WNAD—University of Oklahoma, Norman, Okla.               | 1180-254-250  |
| WNAP—Wittenberg College, Springfield, Ohio.              | 1090-275-100  |
| WNAT—Lennig Bros. Co., Philadelphia, Pa.                 | 1200-250-100  |
| WNBH—New Bedford Hotel, New Bedford, Mass.               | 1210-248-250  |
| *WNJ—Radio Shop of Newark, Newark, N. J.                 | 1290-233-150  |
| WNOX—People's Tel. & Tel. Co., Knoxville, Tenn.          | 1120-268-500  |
| WNYC—City of New York, New York, N. Y.                   | 1190-233-100  |
| WOAI—Southern Equipment Co., San Antonio, Texas.         | 760-395-2000  |
| WOAN—James D. Vaughn, Lawrenceburg, Tenn.                | 1060-283-500  |
| WOAW—Woodmen of the World, Omaha, Nebr.                  | 570-526-1000  |
| WOAX—Franklyn J. Wolff, Trenton, N. J.                   | 1250-240-500  |
| WOC—Palmer School of Chiropractic, Davenport, Iowa.      | 620-484-5000  |
| WODA—O'Dea Temple of Music, Paterson, N. J.              | 1340-224-250  |
| WOI—Iowa State College, Ames, Iowa.                      | 1110-270-750  |
| WOK—Neutrowound Radio Mfg. Co., Homewood, Ill.           | 1380-217-5000 |
| WOO—John Wanamaker, Philadelphia, Pa.                    | 590-508-500   |
| WOQ—Unity School of Christianity, Kansas City, Mo.       | 1080-278-1000 |
| WOR—L. Bamberger & Co., Newark, N. J.                    | 740-405-500   |
| WORD—People's Pulpit Association, Batavia, Ill.          | 1090-275-5000 |
| WOS—Missouri State Marketing Bureau, Jefferson City, Mo. | 680-441-500   |
| WOVO—Main Auto Supply Co., Fort Wayne, Ind.              | 1320-227-500  |
| WPCC—North Shore Congregational Church, Chicago, Ill.    | 1160-258-500  |
| WPG—Municipality of Atlantic City, Atlantic City, N. J.  | 1000-300-500  |
| WPRC—Wilson Printing & Radio Co., Harrisburg, Pa.        | 1390-216-100  |
| WPSA—Pennsylvania State College, State College, Pa.      | 1150-261-500  |
| WQAA—Horace A. Beale, Jr., Parkersburg, Pa.              | 1360-220-500  |
| WQAM—Electrical Equipment Co., Miami, Fla.               | 1140-263-100  |
| WQAN—Scranton Times, Scranton, Pa.                       | 1200-250-100  |
| WQAO—Calvary Baptist Church, New York, N. Y.             | 833-360-100   |
| WRAK—Economy Light Co., Escanaba, Mich.                  | 1170-256-100  |
| WRAM—Lombard College, Galesburg, Ill.                    | 1230-244-100  |
| WRAX—Flexon's Garage, Gloucester City, N. J.             | 1120-268-500  |
| WRC—Radio Corporation of America, Washington, D. C.      | 640-469-100   |
| WRCO—Wynne, Radio Co., Raleigh, N. C.                    | 1190-252-100  |
| WREO—Reo Motor Car Co., Lansing, Mich.                   | 1050-286-500  |
| WRM—University of Illinois, Urbana, Ill.                 | 1100-273-500  |
| WRMU—A. H. Grebe & Co., Richmond Hill, N. Y.             | 1270-236-100  |
| WRR—Experimenter Publishing Co., New York, N. Y.         | 1160-258-500  |
| *WRY—Dallas Police & Fire Dept., Dallas, Tex.            | 1220-246-500  |
| WRST—Radiotell Mfg. Co., Bay Shore, N. Y.                | 1390-216-250  |
| WRVA—Larus & Brother Co., Inc., Richmond, Va.            | 1170-256-1000 |
| WRW—Tarrytown Radio Research Labs., Tarrytown, N. Y.     | 1100-273-500  |
| WSAI—United States Playing Card Co., Mason, O.           | 920-326-5000  |
| WSAJ—Grove City College, Grove City, Pa.                 | 1310-229-250  |
| WSAN—Allentown Call Publishing Co., Allentown, Pa.       | 1310-229-100  |
| WSAR—Doughty & Welch Electric Co., Fall River, Mass.     | 1180-254-100  |
| WSAX—Zenith Radio Corp., Chicago, Ill.                   | 1120-268-100  |
| WSB—Atlanta Journal, Atlanta, Ga.                        | 700-428-1000  |
| WSBC—World Battery Co., Chicago, Ill.                    | 1430-210-500  |
| WSBF—Stix, Baer & Fuller, St. Louis, Mo.                 | 1100-273-250  |
| WSBT—South Bend Tribune, South Bend, Ind.                | 1090-275-250  |
| WSDA—The City Temple, New York, N. Y.                    | 1140-263-250  |
| WSKC—World's Star Knitting Co., Bay City, Mich.          | 1150-261-100  |
| WSMB—Saenger A'm'h Co., & Maison Blanche N. O. La.       | 940-319-500   |
| WSM—Nat'l Life & Accident Ins. Co., Nashville, Tenn.     | 1060-283-1000 |
| WSMK—S. M. K. Radio Corp., Dayton, Ohio.                 | 1090-275-500  |
| WSOE—School of Eng'ng of Milwaukee, Milwaukee, Wis.      | 1220-246-500  |
| WSRO—Radio Co., Hamilton, Ohio.                          | 1190-252-100  |
| WSUI—State University of Iowa, Iowa City, Iowa.          | 620-484-500   |
| WSY—Alabama Polytechnic Institute, Auburn, Ala.          | 1200-250-500  |
| WTAB—Fall River Daily Herald Pub. Co., Fall R'vr, Mass.  | 1130-266-100  |
| WTAC—Penn. Traffic Co., Johnstown, Pa.                   | 1120-268-100  |
| WTAG—Worcester Telegram Pub. Co., Worcester, Mass.       | 1120-268-500  |
| WTAM—Willard Storage Battery Co., Cleveland O.           | 770-389-3500  |
| WTAR—Reliance Electric Co., Norfolk, Va.                 | 1150-261-100  |
| WTAT—Edison Illum'ing Co., Boston, Mass. (portable).     | 1230-244-100  |
| WTAW—Agri. & Mech. Col. of Texas, Col. Station, Tex.     | 1110-270-500  |
| WTIC—Travelers Insurance Co., Hartford, Conn.            | 860-349-500   |
| WWAD—Wright & Wright, Philadelphia, Pa.                  | 1200-250-250  |
| WWGL—Radio Engineering Corp., Richmond Hill, N. Y.       | 1410-213-500  |
| WW1—Ford Motor Co., Dearborn, Mich.                      | 1130-266-500  |
| WWJ—Detroit News, Detroit, Mich.                         | 850-353-1000  |
| WWL—Loyala University, New Orleans, La.                  | 1090-275-100  |

\*Additions and corrections.

†Wave Length Temporarily Assigned.



# The Two Outstanding Parts In Radio !

## Give Low Losses and Amplification Without Distortion to Any Set

**Q**UALITY and distance are what a radio set must give. To insure Quality, amplification without distortion is essential. And to insure Distance, low losses are essential. That is radio in a nutshell.

People in whose sets Acme Transformers are used, are sure of hearing concerts "loud and clear" so a whole roomful of people can enjoy them.

The Acme A-2 Audio Amplifying Transformer is the part that gives quality. It is the result of 5 years of research and experimenting. It gives amplification without distortion to any set. Whether you have a neutrodyne, super-heterodyne, regenerative or reflex, the addition of the Acme A-2 will make it better.

To get the thrill of hearing distant stations loud and clear, your set must have low losses, for it is low losses that give sharp tuning to cut through the locals, and it is low losses that allow the little energy in your antenna to come to the amplifier undiminished. That's what the Acme condenser will do for any set. And it will do it for years, because the ends can't warp, the bearings can't stick and the dust can't get in and drive up the losses several hundred per cent.

The Acme Reflex (trade mark) owes its success and its continued popularity to these two outstanding parts in the radio industry, for low losses and amplification go hand in hand.

Use these two parts in the set you build. Insist on them in the set you buy.

Send 10 cents for 40-page book, "Amplification without Distortion"

WE HAVE prepared a 40-page book called "Amplification without Distortion." It contains 19 valuable wiring diagrams. In clear non-technical language it discusses such subjects as Radio Essentials and Set-building; How to make a loop; Audio frequency amplifying apparatus and circuits; Instructions for constructing and operating Reflex amplifiers; How to operate Reflex receivers; Antenna tuning circuits for Reflex sets; "D" Coil added to Acme four tube reflex; "D" coil tuned R. F. and Reflex diagrams; and several more besides. It will help you build a set or make your present set better. Send us 10 cents with coupon below and we will mail you a copy at once.

## ACME APPARATUS COMPANY

Transformer and Radio Engineers and Manufacturers

DEPT. (AS), CAMBRIDGE, MASS.

SEND THIS COUPON

ACME APPARATUS COMPANY,  
Dept. (AS), Cambridge, Mass.

Gentlemen:—

I am enclosing 10 cents (U. S. stamps or coin) for a copy of your book "Amplification without Distortion."

Name .....

Street .....

City..... State.....

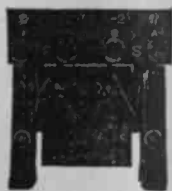

Acme A-2 Audio Frequency Amplifying Transformer

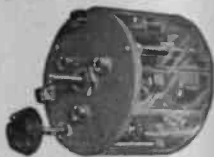

Acme Low-Loss Condenser

# ACME ~ for amplification

Always Mention New England Radio Progress When Writing to Advertisers.