

November 15, 1925
15 Cents a Copy

RADIO PROGRESS

Reg. U. S. Pat. Off.

*'Always Abreast
of the Times'*

I Am Glad I Saw the Show

SEE PAGE 23

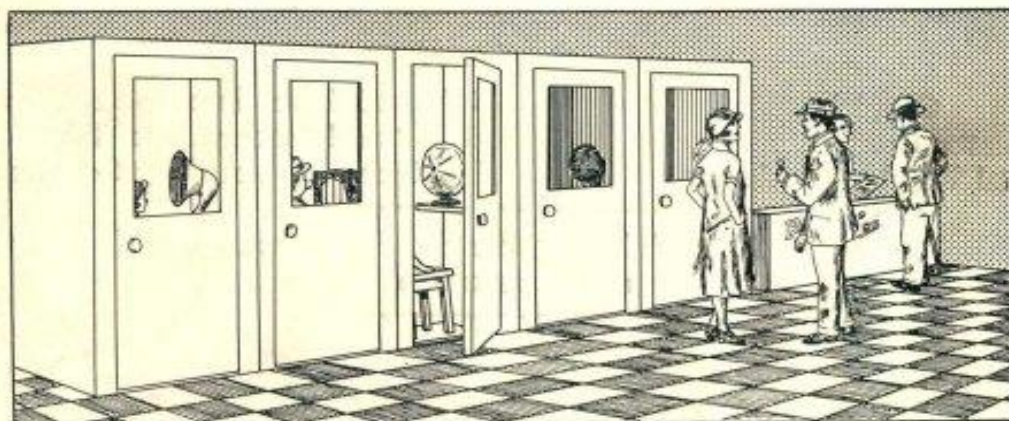

WHAT DO BOOTHS REVEAL?

A New England Publication

NATIONAL

**VELVET CONDENSERS
VERNIER AND DIALS**

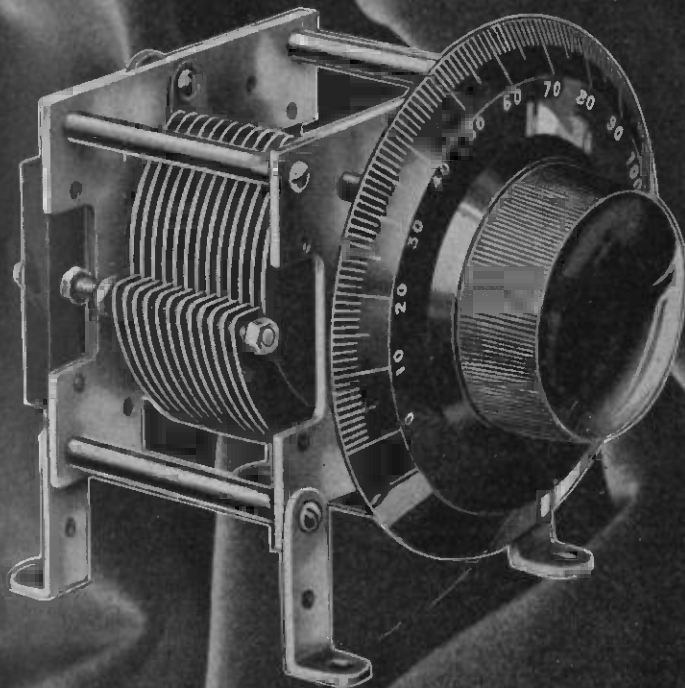

Made by the NATIONAL COMPANY, INC.
Exclusive Manufacturers of
The NATIONAL
Browning-Drake TRANSFORMER

Write for Bulletin 105 R. E.
NATIONAL COMPANY, INC., 110 Brookline St., Cambridge, Mass.



RICO-DYNE DE LUXE SET

(HAVING NEW STRAIGHT-LINE RADIO FREQUENCY CONDENSER)



Type B
De Luxe

\$75

Beautiful in appearance and still more beautiful in performance. Mahogany cabinet of classic design. Uses 5 UV201 A tubes with storage battery or UV199 tubes with dry cell batteries. There is room for the dry cell batteries in the cabinet. The De Luxe model contains a loud speaker with the famous MELOTONE Unit, which gives remarkably clear and loud reproduction. Sensitive, selective, non-oscillating. A tuned radio frequency set of the highest order at a remarkably low price.

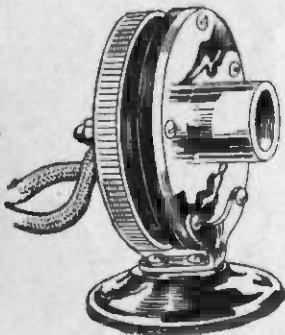

ADJUSTABLE

MAKE FULL USE OF YOUR PHONOGRAPH

MELOTONE — "None Better"

Adjustable phonograph unit
makes your phonograph
a perfect loud-speaker

\$7.50

The Melotone Has All the Qualities of the \$10 to \$12 Units



THE NATION'S FAVORITE HEADSET

RICOPHONES — The Headset of Real Value

There is more quality, real honest-to-goodness quality packed into RICOPHONES than you'll find in any headset at twice its price! Compare and see.

\$2.75

Manufacturers of the famous "RICO" straight line condensers, at \$1.75 each. The "Tropadyne" circuit is supplied free with every tuned "Tropaformer" that we manufacture for all long wave transmission. "Tropaformers" \$6.75 each. Dealers—write or wire for wonderful proposition.

RADIO INDUSTRIES CORPORATION,
131 DUANE ST., NEW YORK CITY.

Gentlemen: I am enclosing \$..... for the items checked below. Kindly ship at once.

..... RICO-DYNE DE LUXE SET, \$75.

..... MELOTONE UNIT, \$7.50.

..... RICOPHONES, \$2.75.

NAME

ADDRESS

My Dealer is CITY

RICO

for all
Long Wave
Circuits

RICO Products on this Page Will Improve Your Radio 100% TROPAFORMERS



The sensitivity, selectivity and volume obtained in all types of long-wave circuits depends entirely upon the intermediate frequency transformer. TROPAFORMERS have been specifically designed to meet the new scientific requirements of long-wave circuits. The TROPAFORMER combines transformer and condenser. The condenser is shunted across the secondary winding of the transformer, and by its use the transformer may be tuned to any definite wave length between 3,000 and 9,500 meters. Only in TROPAFORMERS will long-wave circuit users find these advantages, and these advantages are patented for TROPAFORMERS exclusively! **\$6.75**

Free Hook-up of the Famous Tropadyne Circuit with Each Tropafomer Ordered.

DID YOU EVER BUILD A SET THAT GOT "COAST TO COAST"?

You Can with the RICO-DYNE 5-Tube Auto-Balanced
Cellu-Weld Tuned Radio Frequency Kit

\$38.75

Complete Knockdown Set as illustrated with full instructions how to build this marvelous set within a few hours.

Greatest Radio Value in History—This is What You Get:

1—Pair Ricofones. 1—Genuine Bakelite Front Panel, completely drilled and engraved. 1—Genuine laminated Bakelite Sub-Panel—with sockets already mounted. All mounting holes properly drilled. 2—Auto Balanced Tuned Radio Frequency Units—perfectly matched and balanced. 3—Beautiful 4-inch Dials. 1—Variable Grid Leak and .00025 M.F. Condenser. 1—4 to 1 Audio Transformer. 1—2 to 1 Audio Transformer. 1—.002 Fixed Mica Condenser. 1—.006 Fixed Mica Condenser. 2—Single Circuit Jacks. 1—Filament Control Switch. 1—30-ohm Rheostat. 1—10-ohm Rheostat.

FOR THOSE WHO WANT TO BUY ONLY THE RICO-DYNE KIT

HERE IS JUST WHAT THEY WANT:

It seems unusual that with the tremendous volume, selectivity and distance-range of the Rico Auto Balanced set, it should be so simple to construct. Yet, nevertheless, this is true. We have letters from fans who tell us that they constructed their Rico set within a few hours. The plans which accompany the Rico Kit are so simple that we believe this is so. Any beginner need only to read English in order to construct the Rico set. This Kit contains 3 Auto Balanced Tuned Radio Frequency Condensers, Inductance Units, factory matched, book of instructions and drilling template. You can't go wrong!



\$16.50

RICO-DYNE HAS SET
NEW RECORDS IN RADIO!

for
bliss!

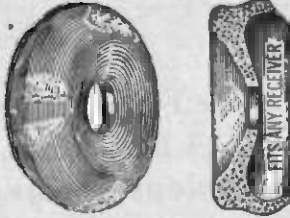

SPONGE RUBBER

RICO FONEKUSHIONS

You'll know what real ear-phone comfort is when you use RICO FONEKUSHIONS. They are made of soft, pure sponge rubber, and fit any make of headphone. They are like soft, downy pillows for your distance-seeking ears. **50c**

for
better
tuning

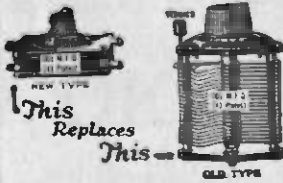

RICO STRAIGHT LINE CONDENSERS

In the old days, folks used horses. Now they can get as much power out of one auto as from 40 horses. It was all right, too, a few years ago, for folks to use the old-time condensers, but now, since Rico brought forth the RICO STRAIGHT LINE CONDENSER, which occupies two-thirds less space than the ordinary mesh plate type, everyone modernizes his set with the RICO STRAIGHT LINE CONDENSER.

No. 411—.00025 mfd.\$1.75
No. 423—.0005 mfd. 1.75
No. 450—.001 mfd. 1.75
Inclusive with Dials. Without Dials. \$1.50.

Each of these
Rico products
means added
pleasure and
value to your
Radio Set.

If Your Dealer Cannot Supply You—Use This Coupon. No Money Down!

RADIO INDUSTRIES CORPORATION
131 Duane Street, New York City

Please send me C. O. D. the following:Tropafomers, \$6.75Straight Line
Condensers, \$1.75Ricofones, \$2.95Oscillating Coll, \$3Fonekushions, 50c
.....Melotone Attachment, \$7.50.

Name Address

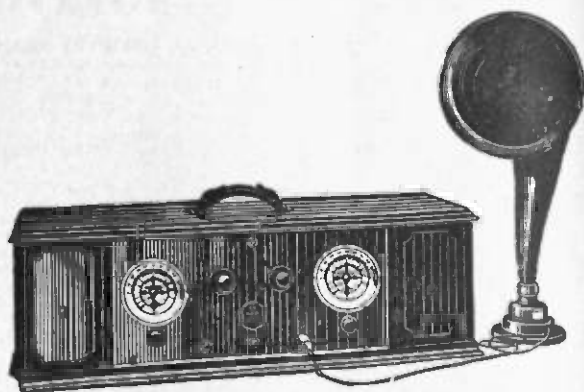

Which is Better—

**A Cheap Set for Cash---or
A GOOD Set ON TERMS** ?

The Good Set is Cheapest in the End

Bay State specializes on the better grade sets, like Radiola, DeForest, Adler Royal, Magnavox, and sells on Convenient Terms.

Write for information. Address Dept. A.

BAY STATE RADIO CO.

The House of Radio Service

116A Washington Street

Boston, Mass.

Extracts from a Few of the Many

LOVE LETTERS

FROM THE READERS OF "RADIO PROGRESS"

And Not One of Them Solicited

"The style of your magazine and its motto are so good."

F. J. POETEL,
U. S. Patent Office, Washington.

"Your Mr. Taylor is the only writer whose work has been so clearly worded that I could get the idea with little effort. 'More power to him.'"

B. W. PERCIVAL, Lynn, Mass.

"We like RADIO PROGRESS, but don't see enough of it!"

H. S. FRAINE,
of Doubleday, Page & Co., N. Y.

"Your magazine gives so much on the fundamentals of radio that I have decided to subscribe for it. Most people depend on this magazine to keep them instructed on the subject about which the publication deals. Very few buy books. I appreciate it very much and hope it will grow large."

DR. J. S. CANTRELL,
Proprietor Snowwhite Eggfarm, Carthage, Mo.

"I like RADIO PROGRESS because its articles are clear and concise, especially those of H. V. S. Taylor."

A. A. CONSTEIN,
Ph. G., D. D. S., Upper Sandusky, Ohio.

"RADIO PROGRESS is the most interesting radio magazine I have yet seen, and strikes a happy medium between being too technical and ignoring technical explanation altogether. May 'you live long and prosper.'"

(Dr.) M. S. DELAND,
State Hospital, Topeka, Kan.

"Your magazine has a very pleasing presentation of its subjects without too much technicality, and understandable."

A. J. WERTZEL,
Vice. Pres. United States National Bank, Superior, Wis.

"Enclosed find 50c. for copies Nos. 9, 10 and 11 of RADIO PROGRESS to COMPLETE MY FILE, as I missed them while on my vacation."

FRANK HANUS, Cleveland, Ohio.

"I like your magazine very much and hope you will keep up the good work in publishing such clean cut articles."

E. T. LEWIS,
Baltimore, Md.

"Interest in your progressive little magazine as well as the desire to obtain the special hook-up number of Jan. 15th has prompted me to enclose." etc.

CORLISS GALLOGLY,
Alden, Minn.

"I like your magazine very much."

JOHN GILLMAN, Long Island City, N. Y.

"While your magazine may not have the bulk of some of your contemporaries the subject matter is excellent, being clearly written and accurate."

E. J. WAGNER, Chicago.

You Radio Manufacturers

Who want to advertise where you can make the largest sales for the smallest expense will never do it until you advertise in RADIO PROGRESS

There are more than 20,000 other readers like those above who are awaiting your announcements.

RADIO PROGRESS

8 TEMPLE STREET

PROVIDENCE, R. I.

RADIO PROGRESS

HORACE V. S. TAYLOR, EDITOR

Volume 2

Number 17

Contents for

NOVEMBER 15, 1925

	PAGE
BUILDING A ONE-CHILD CONTROL.....	9
AMERICAN RADIO RELAY LEAGUE	12
LOOKING AHEAD	13
WHAT OTHERS LIKE IN RADIO.....	16
A ONE-CONTROL SUPERHET.....	19
I AM GLAD I SAW THE SHOW.....	23
WATER-COOLED RADIO	25
EDITOR'S LOUD SPEAKER:	
CONFERENCE NO. 4	29
EAVESDROPPING ON AN ELECTRON	31
OPEN WINDOWS—SLEEP—RADIO.....	35
UNITED STATES BROADCASTING STATIONS	38

New York Representative

SHELDON C. KNIFFIN.....503 Fifth Avenue, New York—Phone Murray Hill 3149

Western Representative

W. T. DIEHL.....30 North Dearborn Street, Chicago—Phone Central 5410

RADIO PROGRESS is issued on the 1st and 15th of each month by the Oxford Press at 8 Temple Street, Providence, Rhode Island. John F. O'Hara, Publisher. Yearly subscription in U. S. A., \$3.00. Outside U. S. A., \$3.50. Single copies, 15 cents. Entered as second-class matter, April 4, 1924, at the Post Office at Providence, R. I., under the Act of March 3, 1879. Address all communications to RADIO PROGRESS, 8 Temple Street (P. O. Box 728), Providence, R. I. Title registered at United States Patent Office.

The publishers of this magazine disclaim all responsibility for opinions or statements of contributors which may at any time become subject of controversy.

Look for These in Our Next Issue

"**How Electrons Are Your Friends**" is the title of the second half of Professor Wold's article, of which the first section appears in this issue. He explains how these tiny particles of electricity make up everything we know of and are vitally concerned in your life.

You hear a lot about harmonics these days. Sometimes they are good and sometimes bad. A case of where the fifth harmonic performs a very necessary part in the art of radio is described by Taylor in "**Throwing a Crystal Into Fifth Speed.**"

There are many "B" battery eliminators on the market which do away with these high voltage cells. However, most everybody still uses "A" batteries to light the filament. There is oftentimes a lot of bother to renew or recharge these elements. You will be interested in the description Vance gives of a device which one big company has designed in, "**Forget the "A" Battery With Unipower.**"

Did you read Laing's article in this number? The second half, "**What Will Tubes be Next Year?**" is even more interesting. Do not miss this.

It is not often we see an article dealing with radio hundreds of years ago. However, Farley has written a story which you will read right through when you start it. See, "**The Wonderful Dynosauro-dyne.**"

Every evening that the radio set is running the program is the most important thing. It may seem simple to hear the smooth flow of the announcer's words as he tells what the next piece will be. But it is no easy matter to get together a list of numbers which people will like. How a big station does this is explained in "**Producing Programs to Please You,**" by Holman.

These Atwater Kent radio hours on Sunday nights are giving a great deal of pleasure. Some of the artists, while very good in concert work, have disappointed a little over the air. Others have been particularly pleasing. In "**Golden Girl of Metro on the Air**" Arnold gives us an intimate story of one of the best stars to be heard in the series.

Neutrodyne and other radio frequency hook-ups sometimes suffer from lack of selectivity. Marx has gone into this matter and in his "**Cutting Locals Out of RF Sets**" he shows ways of bringing about a great improvement in many radios so that the selectivity is much better.

The Two Outstanding Parts In Radio !

Give Low Losses and Amplification Without Distortion to Any Set

QUALITY and distance are what a radio set must give. To insure Quality, amplification without distortion is essential. And to insure Distance, low losses are essential. That is radio in a nutshell.

People in whose sets Acme Transformers are used, are sure of hearing concerts "loud and clear" so a whole roomful of people can enjoy them.

The Acme A-2 Audio Amplifying Transformer is the part that gives quality. It is the result of 5 years of research and experimenting. It gives amplification without distortion to any set. Whether you have a neutrodyne, super-heterodyne, regenerative or reflex, the addition of the Acme A-2 will make it better.



Acme A-2 Audio Frequency Amplifying Transformer

To get the thrill of hearing distant stations loud and clear, your set must have low losses, for it is low losses that give sharp tuning to cut through the locals, and it is low losses that allow the little energy in your antenna to come to the amplifier undiminished. That's what the Acme condenser will do for any set. And it will do it for years, because the ends can't warp, the bearings can't stick and the dust can't get in and drive up the losses several hundred per cent.

The Acme Reflex (trade mark) owes its success and its continued popularity to these two outstanding parts in the radio industry, for low losses and amplification go hand in hand.

Use these two parts in the set you build. Insist on them in the set you buy.

Send 10 cents for 40-page book, "Amplification without Distortion"

WE HAVE prepared a 40-page book called "Amplification without Distortion." It contains 19 valuable wiring diagrams. In clear non-technical language it discusses such subjects as Radio Essentials and Set-building; How to make a loop; Audio frequency amplifying apparatus and circuits; Instructions for constructing and operating Reflex amplifiers; How to operate Reflex receivers; Antenna tuning circuits for Reflex sets; "D" Coil added to Acme four tube reflex; "D" coil tuned R. F. and Reflex diagrams; and several more besides. It will help you build a set or make your present set better. Send us 10 cents with coupon below and we will mail you a copy at once.

ACME APPARATUS COMPANY

Transformer and Radio Engineers and Manufacturers
DEPT. (AS), CAMBRIDGE, MASS.

SEND THIS COUPON

ACME APPARATUS COMPANY,
Dept. (AS), Cambridge, Mass.

Gentlemen:—

I am enclosing 10 cents (U. S. stamps or coin) for a copy of your book "Amplification without Distortion."

Name

Street

City..... State.....

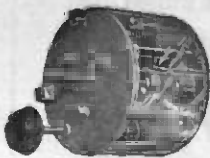

Acme Low-Loss Condenser

ACME ~ for amplification

RADIO PROGRESS

"ALWAYS ABREAST OF THE TIMES"

Vol. 2, No. 17

NOVEMBER 15, 1925

15c PER COPY, \$3.00 PER YEAR

Building a One-Child Control

Why Most Sets Have Two or Three Dials to Tune

By HORACE V. S. TAYLOR

Do you like to work? Most people don't very well, and so if you have a radio set which needs three dials to be adjusted correctly, the thought must occur to you, "How much easier it would be if turning only one knob would do the tuning!"

The set manufacturers realize this natural feeling on the part of the fans and so there is quite a tendency to reduce the number of handles on a radio. Not even at that only a few different makers are using one control sets. If the "one-man top" is so much sought after in automobile use, why not a "one-child control?" Then any one would be able to tune in without much bother on any station within range of the receiver.

Making Them Keep Together

Let us see why it is that the different set builders cannot agree as to the advantages of a single control dial. Take the neutrodyne, for instance, or other models using three dials to adjust the tuning of two steps of radio frequency amplifiers and a detector. It would seem simple to connect the three dials together mechanically, as shown in Fig.

The picture shows single idler gears, but a method of belts might be used just as well. This accomplishes the result of making all the condensers turn together as a unit from the center dial.

With such a scheme there might be a small amount of slip, or backlash between the different gears. However, this is not as serious as another kind of trouble which is experienced. The three dials of such a style of set are supposed to read alike when tuning in any station within the broadcast band. It is very rare to find such a set. How many of your friends have radios which they log by putting down a single reading? To tell the truth, we have never seen such an instrument.

Why Are They So Different?

There are two different kinds of variations. The first is that illustrated in Fig. 2. The dial readings are shown at the bottom and the capacity appears at the left. These curves run parallel to each other. Owing to different leakage capacities inside the set or for other reasons, which will be mentioned later, the capacities for three different dials are not identical when tuning in a distant station. Perhaps the first dial may read two divisions higher than the second, which latter is two higher than the third.

third. It may be that the coils themselves vary in such a way that a progressive difference in the dial readings is necessary.

If the readings happen to be just alike on the three dials when tuning in distant stations, then by far the easiest scheme to understand and very likely the neatest to build is the one which appears in Fig. 4. Here a single shaft with its one dial turns the rotors of the three condensers which are mounted in line, one behind the other. Since it is customary in most modern hook-ups to ground the rotor, it does no harm if the

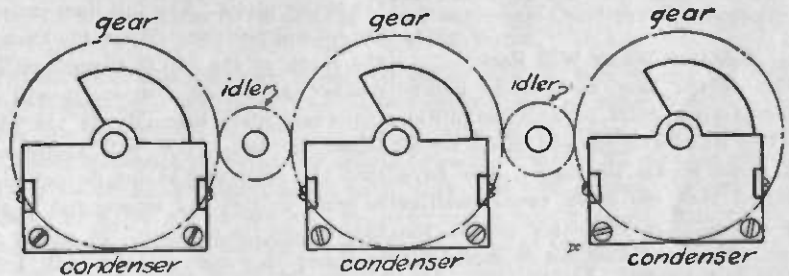

Fig. 1. A Simple Way of Omitting Two Controls. Unfortunately it Usually Will Not Work at All Well.

With such a set a high frequency wave (short wave length) will be brought in on dial readings of say 18-16-14. At the middle of the scale the reading will be 55, 53, 51. A slow vibration will call for 91, 89, 87. Of course the last dial may need to be higher rather than lower than the middle and the first will perhaps be between the other two, depending entirely on the required capacities.

One Gets Ahead of Others

A different kind of vibration is revealed in Fig. 3. Here, instead of running along in parallel lines the condensers all start together, but No. 1 increases its capacity for a given setting faster than either of the other two. Here again it may not be the first which has the highest setting, but the second or

three revolving elements on this shaft are all connected together and to the frame. The three stators of course are insulated from each other and are connected one to each of the three tuning coils.

When One is Too Big

This method of control is quite popular, being used in a number of sets. As before mentioned, if for any setting of the dial the three capacities are correct, then you will readily see that this system can hardly be improved on. However, if it happens that one of the condensers, say the end one, is too big compared to the other two, what are you going to do to remedy the situation?

If you turn the knob so that the last condenser is reduced to the proper value

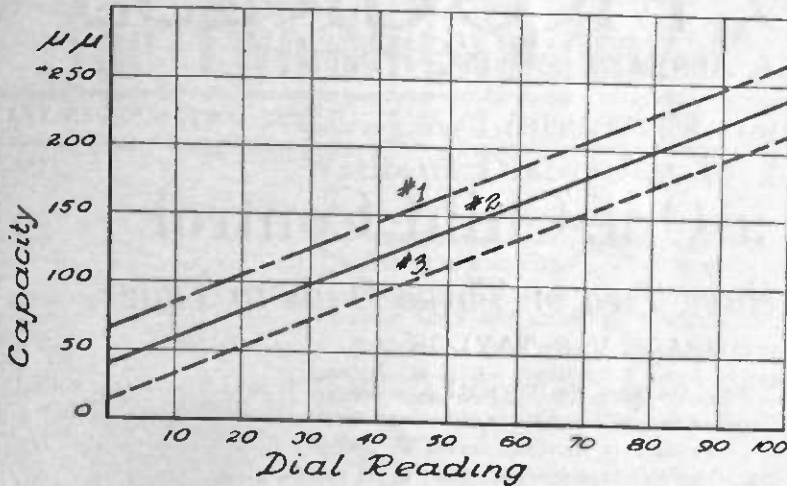

Fig. 2. This Type of Correction of the Dials is Easy to Apply, Since They Differ by the Same Amount at All Waves.

to bring in the wanted wave, then the other two capacities are also reduced, and since they were correct before, they must be wrong now. Of course the same objection, exactly, may be urged against the geared layout, which was pictured in Fig. 1. How is this to be overcome? To get around this difficulty there are various methods of what is known as "compensation."

A Stator Which Will Rock

One of the easy methods to understand, if not to build, is explained in Fig. 5. This illustrates the end condenser of the three shown in Fig. 1. We have assumed that the other two capacities are correct, but that this one is too large. The rotor must not be moved for the reason already mentioned. How then,

can we reduce the capacity? By mounting the stator so that it is not absolutely fixed but can be shifted slightly on the same axis as the rotor, we may rock the stationary plates slightly and so get them out of mesh to some extent with the movable plates.

The cut shows one method of rocking the stator plates. The full lines indicate the normal position. When the knob on the crank at the top is turned until it reaches the dotted position, it will tip the whole plate assembly to the place shown in dots. You will notice now that the rotor and stator do not mesh as much as they did before, and so this has reduced the capacity. By proper adjustment this compensation will bring the capacity to the correct value as

shown by the fact that the signal comes in much louder than before.

Getting Three of a Kind

Of course if the value of this condenser happened to be too small, rather than too large, a slight motion in the opposite direction would remedy this condition. By applying such a compensator to the other end condenser, it is possible to adjust the middle one exactly right for the preferred program by means of the one main tuning knob and then to make a slight correction on each of the other capacities by their own individual adjustments.

If the type of variation between the three capacities is that shown in Fig. 2, where the three lines run parallel, it is a great advantage. In such a case it is only necessary to reduce the high capacity, or increase the low one of the two ends until they exactly mate with the middle. You will notice that the difference between any two is always the same all the way from the low to the high

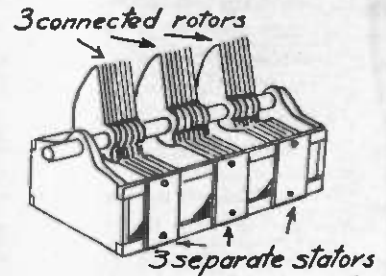

Fig. 4. An Ideal Arrangement When Coils and Condensers Are Identical.

end of the scale. That means a correction which is right for one spot is equally good for any dial setting. With such a radio it would be unnecessary to bring the two compensating knobs out to the panel as when they were once set they need never to be interfered with again.

Only a Few Such Cases

Unfortunately, such a case is rather unusual. The type shown in Fig. 3 is more ordinary as a correction. In such a case the compensating handles must be turned to give more or less meshing of the stator, depending on what the dial setting is. For instance, with the curves as shown, no compensation would be needed with the dial at the lower end of the scale. As the capacity was increased, however, more and more adjustment of these extra knobs would be required.

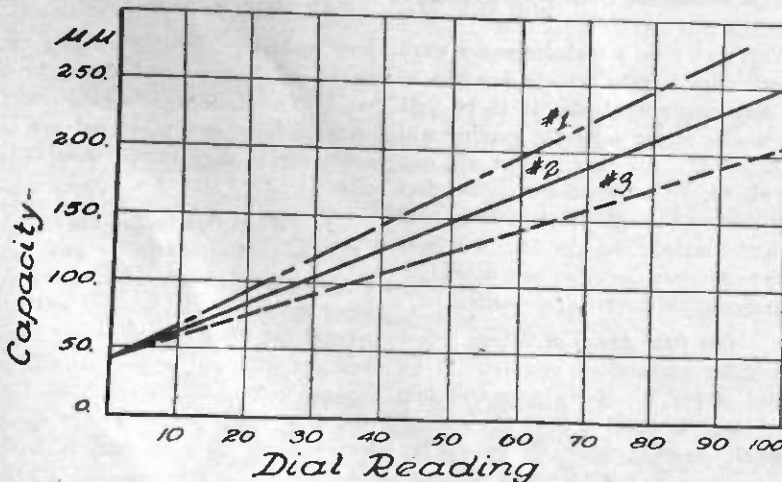

Fig. 3. This Kind of Variation is Much More Common Than Fig. 2. It is Much Harder to Correct, as it Varies at Different Waves.

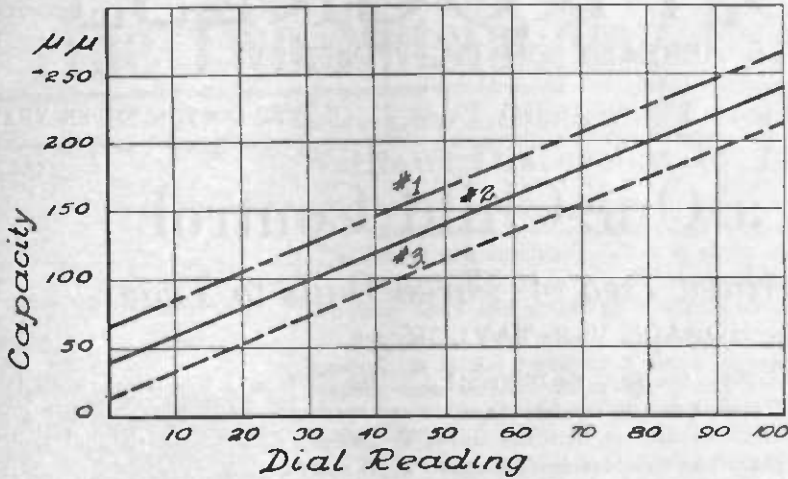

Fig. 2. This Type of Correction of the Dials is Easy to Apply, Since They Differ by the Same Amount at All Waves.

to bring in the wanted wave, then the other two capacities are also reduced, and since they were correct before, they must be wrong now. Of course the same objection, exactly, may be urged against the geared layout, which was pictured in Fig. 1. How is this to be overcome? To get around this difficulty there are various methods of what is known as "compensation."

A Stator Which Will Rock

One of the easy methods to understand, if not to build, is explained in Fig. 5. This illustrates the end condenser of the three shown in Fig. 1. We have assumed that the other two capacities are correct, but that this one is too large. The rotor must not be moved for the reason already mentioned. How then,

can we reduce the capacity? By mounting the stator so that it is not absolutely fixed but can be shifted slightly on the same axis as the rotor, we may rock the stationary plates slightly and so get them out of mesh to some extent with the movable plates.

The cut shows one method of rocking the stator plates. The full lines indicate the normal position. When the knob on the crank at the top is turned until it reaches the dotted position, it will tip the whole plate assembly to the place shown in dots. You will notice now that the rotor and stator do not mesh as much as they did before, and so this has reduced the capacity. By proper adjustment this compensation will bring the capacity to the correct value as

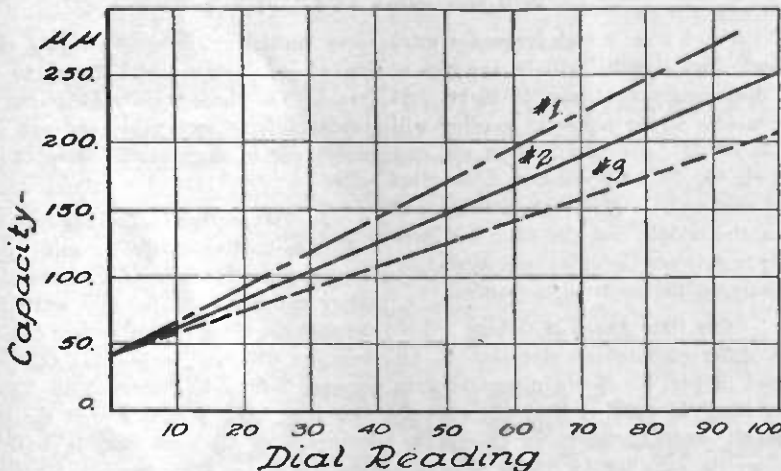

Fig. 3. This Kind of Variation is Much More Common Than Fig. 2. It is Much Harder to Correct, as it Varies at Different Waves.

shown by the fact that the signal comes in much louder than before.

Getting Three of a Kind

Of course if the value of this condenser happened to be too small, rather than too large, a slight motion in the opposite direction would remedy this condition. By applying such a compensator to the other end condenser, it is possible to adjust the middle one exactly right for the preferred program by means of the one main tuning knob and then to make a slight correction on each of the other capacities by their own individual adjustments.

If the type of variation between the three capacities is that shown in Fig. 2, where the three lines run parallel, it is a great advantage. In such a case it is only necessary to reduce the high capacity, or increase the low one of the two ends until they exactly mate with the middle. You will notice that the difference between any two is always the same all the way from the low to the high

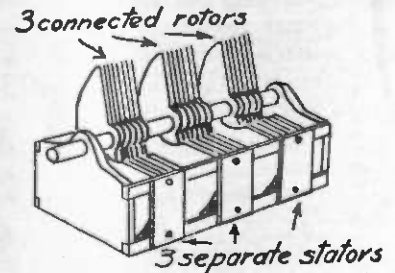

Fig. 4. An Ideal Arrangement When Coils and Condensers Are Identical.

end of the scale. That means a correction which is right for one spot is equally good for any dial setting. With such a radio it would be unnecessary to bring the two compensating knobs out to the panel as when they were once set they need never to be interfered with again.

Only a Few Such Cases

Unfortunately, such a case is rather unusual. The type shown in Fig. 3 is more ordinary as a correction. In such a case the compensating handles must be turned to give more or less meshing of the stator, depending on what the dial setting is. For instance, with the curves as shown, no compensation would be needed with the dial at the lower end of the scale. As the capacity was increased, however, more and more adjustment of these extra knobs would be required.

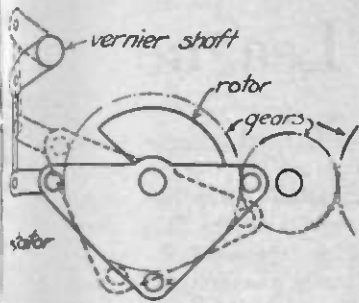

Fig. 5. The Compensator on a Condenser May Shift the Stator.

You may wonder what the advantage of such a correcting scheme. We started out with three dials and reduced them to one. Then we add a couple more for correction, which brings us back to the original three. How are we any better off than at the start?

We Are Now Better Off

This is a logical question. Although it may seem at first glance to be foolish to use a complicated scheme when we still have the three knobs, you will find that such an arrangement works out much better than the ordinary three dial device. You see that with three main dials we must shift all three at once and have them all about right in order to hear a distant station and in fact even a local program provided a sharp tuning set is used.

With the new scheme we still have three handles, to be sure, but only one of them is the tuner. The other two are merely slight corrections on the setting of the first. If you turn the two compensators to mid position and then forget them, you will be able to hear all the locals well and many of the loud, distant stations. Some, even of the fainter stations, will be brought in provided the set is well made to start with. Such faint stations, however, will hardly be understood as the words may be faint and blurred.

Tuning for Station Not Running

Now is the time to adjust by the compensators. Once having heard the distant station (which is more than you often do with the three-dial tuner) it is a simple matter to give a slight twist to the extra knobs and bring the program up to its loudest point. There is still the difference in the world between adjusting a minor control on a station you can hear and adding with a main

control to try to bring in some station which you don't know is there or which may not be running.

Getting back to the method of making a slight correction in capacity, a rather neat way of adding capacity is to use a small vernier condenser in parallel with the main unit. Notice that this is a scheme for adding to the large condenser. But suppose that the value is already too big for sharp tuning. How can you get around such a condition? Naturally by adding to the smaller capacity the two may be brought to the same point.

The Condenser Its Own Switch

However, if one curve crossed the other it would require some kind of switching to transfer the vernier capacity

it is hooked up to the right hand main unit. In this way it can correct for a center condenser, which may be either larger or smaller than the end one.

You may finally ask whether there is no way of working a single control without any compensation at all. Unfortunately, the answer is no—unless the particular set is individually calibrated at all different wave frequencies. When you recall that shifting the dials half a division will completely lose some distant stations, you can see why the manufacture of sets in large quantities cannot be accurate enough to make all the controls vary exactly alike, unless special attention is given to them.

A Cam for Control

The idea displayed in Fig. 7 is one

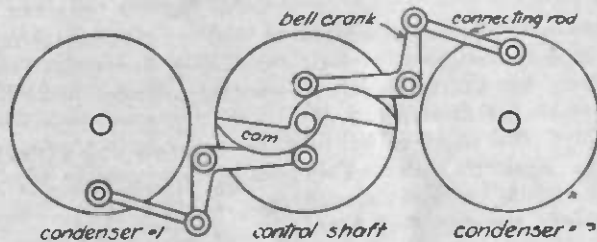

Fig. 7. With a Cam Arrangement it is Possible to Omit the Compensation Through Accurate Work.

ity from one to the other unit as needed. A very neat arrangement for obtaining these results appears in Fig. 6. The knob is connected to the rotor of a small, three-plate condenser, which serves as a vernier for either one of two large main condensers. When the pointer is turned to the left it closes a contact on the long curved strip as shown, and this connects the vernier capacity to the left hand condenser. Turning the pointer toward the top reduces this capacity. When turned to the off position, the condenser is disconnected from either main unit, and on further rotation to the right

which may be used to get rid of the compensation, provided tests are given on this set at enough wave frequencies to make sure that all controls are identical. In this scheme the center dial turns the middle condenser as usual. A cam attached to its shaft works the left hand condenser and another unit on the right. The precise mechanism here drawn out consists of a bell crank and connecting rod. This is not the best mechanical means of transferring the motion, but its details may be worked out in a number of ways. The essential part is that the device is operated by cams.

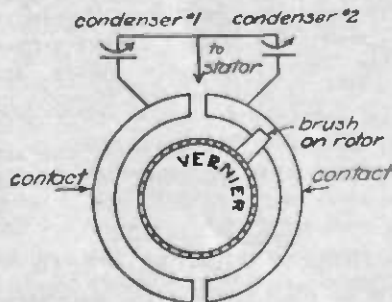

Fig. 6. An Ingenious Combination of Switch and Condenser.

The shape of the individual curve of this mechanism, of course, is subject to the builder. If, for instance, for any given wave the capacity of the left hand condenser is incorrect, it is a simple matter to bring the outline of the cam into a slightly different position so as to raise or lower the condenser reading to fit. By checking at enough points and filing or fitting the cam outline to correspond it is possible to design a set

Continued on Next Page

American Radio Relay League

CONVERSING ONE DAY APART

WHILE it has been the customary thing for several years for members of the American Radio Relay League on the east coast of the United States to carry on nightly conversations with their fellow-members in England, and even in continental Europe, the problem of two-way communication between the Pacific Coast of the American Continent and the British Isles remained an unsolved mystery. To Jack Nutt, owner and operator of radio station 6VC and 6BAN, of Los Angeles, fell the honor of first establishing reliable communication.

Other Pacific coast radio amateurs had successfully copied messages from their British brethren, but the perversity of nature seemed always to stop any attempt at reply. The plight of British amateurs was much the same. They could hear the Pacific Coast but seemed unable to answer the man they heard calling.

This long record of difficulty was very effectually broken when Nutt succeeded in establishing contact with British amateur radio station 2SZ, owned and operated by C. W. Goyder of Mill Hill, London, NW7, and carried on a conversation with the British amateur continuously for forty minutes.

Another interesting phase of the conversation was the fact, that it was carried on with each operator working a different calendar day. It was 6 o'clock Sunday morning in London and only 10 o'clock Saturday night in Los Angeles.

U. S. WINS TWO PLACES

Amateur radio has received definite recognition as an international undertaking of value to the entire world, with the official acceptance of the International Amateur Radio Union by the League of Nations headquarters in Geneva, Switzerland. This organized group of amateur radio telegraphers has branches in most of the civilized countries of the globe and sections are in process of forming in those countries not yet represented.

In the United States and Canada the

Union has thriving sections, with the 20,000 members of the American Radio Relay League as a nucleus.

Officers of the Union are: International—President, Hiram P. Maxim of Hartford, Conn.; Vice President, Gerald Marcuse of Caterham, Surrey, England; Secretary-Treasurer, K. B. Warner of Hartford, Conn.; Counsellors-at-Large, Jean G. Mezger, Neuilly-sur-Seine, France, and Frank D. Bell, Palmerston, South, New Zealand.

The organization's international aims are to promote co-operative regulation for amateur radio communication, to provide amateur tests and to develop a system of handling private messages based upon the message plan now in use with the American Radio Relay League.

WINS HIS STIRRUPS

James Morris, owner of radio station 110 of Atlanta, has just been awarded a pair of miniature Chilean stirrups for his success in carrying on two-way communication with Major R. Raven Hart of Los Andes, Chile, owner of amateur radio station 9TC. This makes the sixth radio district in the United States to be recorded in the log book of Major Hart's station. Only three more remain for him to complete the entire area of the United States.

When Major Hart first began the schedule of work with the United States he arranged with the American Radio Relay League, of which he is a distinguished member, to award a pair of Chilean wooden stirrups to the first radio amateur in each of the nine United States districts successfully to carry on a two-way communication with the Chilean station. The stirrups themselves are remarkable in their difference from other such implements. They are carved from a single piece of wood, in exact replica of the regular stirrups in use by the natives of Chile, and are decorated with symbolical carvings on the outer surface.

THE RAG CHEWERS SPREAD

As an illustration of the friendship that are developed through the amateur radio telegraph, officers at the American

Radio Relay League Headquarters in Hartford point to the rapid growth of a special group of league members, known as "The Rag Chewer's Club," which is devoted to the promotion of friendly conversations by amateur radio.

In the last few years, when amateur radio stretched out until it was able to carry on reliable communication across the continent and the oceans, the need was felt for some organized group to foster this spirit of radio friendship. A group of league members, in almost nightly communication with each other, formed the charter membership and established the rule that each other league member who carried on a successful half-hour or more conversation with some member of "The Rag Chewer's Club" might also become a member of the club.

So popular did the organization become, that in the few months of its existence it has attained a total membership of over 700, and recommendations for new members are arriving daily at the League Headquarters here.

There are members in every state of the United States and every province of Canada, but the membership that gives the greatest "kick" according to club members, is that which is gradually appearing in countries beyond the sea. Six countries in Europe and Asia are already represented. A well developed effort is on foot in many other nations where there are league members to enlarge the foreign membership of the club by carrying on transoceanic conversations.

BUILD A ONE CONTROL

Continued from Previous Page

which will be absolutely right in all elements for any waves to which they may be tuned.

It might be pointed out that such a correctly designed set would have to be worked either with a loop or standard aerial since the size and shape of the wave collecting antenna have some effect on the required capacity for the first tuner.

Looking Ahead

Do You Want to Know What Will Probably Happen in Radio Next Year?

By A. K. LAING, Pelham Manor, N. Y.

"It's going to be a pleasant day to-morrow," says your friend, and sure enough it turns out to be fair. When this has happened once do you hail him a weather prophet? Probably not, for such predictions are right at least half the time anyway, just by luck. The same thing applies to some radio predictions. With so many guesses as to what is coming, some of them are bound to hit it right. There is little to be gained by poking one's nose into the far future, especially in one's own

that is always a year or two ahead of production, it is possible to predict with some accuracy what changes are due to take place in the next five years.

There is a two-fold benefit in doing this. First, it is an aid to the fan who builds his own radio receiver, in helping him to choose the most progressive parts now being offered, and those which are apt to have the longest life before becoming obsolete. Second, the realization that the public knows about and wants certain possible developments is an influence upon the manufacturer that causes him to be as progressive as possible, in the hope of being first to offer the improved equipment.

Patents in the Safe

At the present time it is quite common knowledge among radio men connected with the trade that some really worth-while inventions and patents are kept locked up in safes in order to allow the manufacturers to sell off their present machinery before starting production on the better products to which they hold the patent rights. This is perfectly ethical from the merchandizing point of view, and an economic necessity.

For instance, take the case of the UV-201A tube. This has been superseded by the new UX-201A. The difference is that the former has a base like that shown in Fig. 1, in which the contact springs press up against the ends of the prongs. The new tube, however, has longer pins with springs bearing at the side. This is an advantage in the way of considerably better contact. See Fig. 2.

Throwing Out Old Tubes

There is no excuse for making any more of the UV-201A rather than the UX equivalent, since the latter tube can be used just as well in the old style sockets. However, would you expect the manufacturers, jobbers and dealers to throw away their stock of old style

tubes? Who would stand the expense of this tremendous loss? No one blames the trade for continuing to put out the former variety until they are exhausted and only then change over to the latter development.

A campaign of publicity will aid, therefore, in directing the public buying to the best products now offered, those least likely to become obsolete, as well as in stimulating the early appearance of developments which could and should be on the market at the present time.

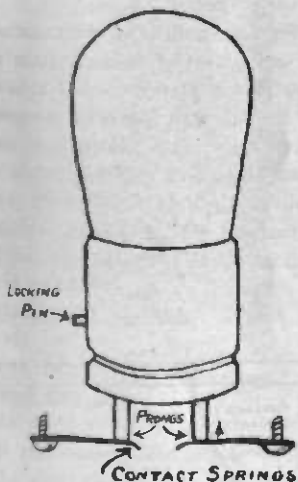

Fig. 1. Although This Base is Superseded, it is Still Sold.

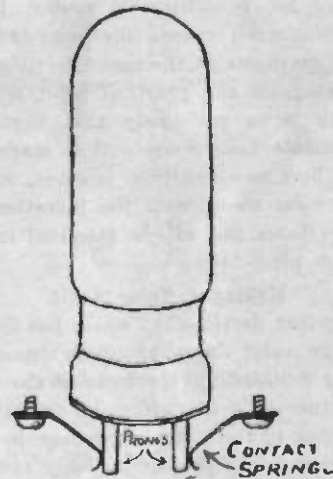

Fig. 2. In Time This Base Will be the General Favorite.

country. The law of averages works upon predictions just as it does upon automobile accidents, or attendance at baseball games. A few of the many become true, through sheer luck. Most are erroneous, and soon forgotten.

What About the Year 1930?

So I do not intend to prophesy about radio conditions in the year 2000 A. D. but by gathering up the threads of present tendencies in the design and construction of apparatus, and by looking over the mass of laboratory data

The law of supply and demand works in radio as well as everywhere else. When the public knows that a product can be had, and clamors for it, one need not doubt that it will shortly make its appearance.

Three Paths to Follow

There are at least three pronounced positive trends of development in present day manufacturing that we can be sure will find further development in the near future. In the order of their appearance in the field of broadcast reception, these

are (1) the Low-Loss movement, (2) the tendency for better tone quality and more faithful reproduction, and (3) the trend toward the higher frequencies (shorter wave lengths.)

If we include non-technical details, there is the very pronounced swing to-

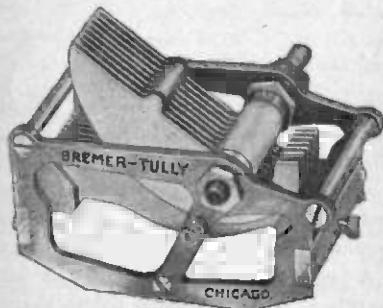

Fig. 3. The Drift to Condensers with Minimum Insulation is Very Marked.

ward more beautiful cabinets and panels to be considered. I have not included the desire for simplicity of tuning, i. e., single control, because this seems to have been developed at the time of writing to an adequate and practical point beyond which it is not likely that anything but minor refinements will be made. I note here one exception, however, which will come about with the invention of newer tubes and will be discussed in its proper place later.

Making a Tube to Fit

Another development which has found so far only the slightest evidence of being followed up (in some of the new UX tubes) is the proper co-ordination of tubes to their particular uses, in opposition to the present tendency toward standardization of the same type for all purposes. Laboratory workers have realized for years that tubes could be made of much greater efficiency than those now being manufactured, but only recently has the press of competition actually forced the beginnings of an interest in their development.

We come lastly to an almost unpredictable element, new circuits. The 1924 craze for new circuits tumbling one after another in rapid succession taught us one fact. A new circuit is seldom of any particular importance unless it presents a new principle, or a new and more efficient combination of old principles.

As a matter of fact, practically all the important circuits and combinations now known have been pretty well developed and only refinements are at present going forward.

This is Not Guess Work

The preceding brief summary is intended to show that the matter of prediction in this case is not one based on mere chance, as well as to bring together for emphasis the most important channels of development. I shall now take up the main divisions separately and in more detail.

Low-loss instruments are by no means a development of the last year or two. They have been in constant use in many laboratories for eight or ten years. At the Bureau of Standards efforts were made to minimize losses in all laboratory radio devices from the very inception of the radio division. But low priced low-

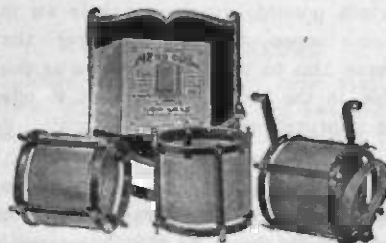

Fig. 4. This Type of Coil Has Very Low Losses. Tube is Cut Away.

loss instruments are a decided innovation. The trade as a whole did not seem to realize that it was delicate and exact construction, rather than the low-loss feature, that placed so prohibitive a price on laboratory equipment. Once that fact was established, the low-loss movement assumed big proportions.

So far it has gone by fits and starts, a sort of follow-the-leader game, and the leader has been lacking in several rather obvious details that are open for further development. For example, the condenser and coil have come in for most of the attention in the campaign for lower losses.

Never Noticed Some Losses

Thus Fig. 3 shows a low-loss condenser, which has been well worked out to minimize both dielectric and metal losses. Fig. 4 illustrates the form of coil in which the spool on which the wire is wound is cut away so that there

is almost nothing left. Some very important points, such as antenna insulation, loop construction, vacuum tube bases and sockets, and grid leaks, have received less attention than they deserve. Similarly, while every effort has been made to reduce installation losses of one kind or another in both condensers and coils, eddy current losses have been almost entirely ignored in both.

For example, many of the present low-loss condensers have been so designed, in order to minimize dielectric material and to remove it as far out of the field as possible, that they have much bulky metallic supporting material that adds little if at all to the capacity of the condenser. This excess metal, especially when it is in the field of nearby coils, and connected in the circuit itself, is free to absorb power and waste it as heat in the same manner that an improperly laminated transformer coil will do it. The perfected low-loss condenser of the future will have almost no extraneous metal. Some of the best examples now on the market have fairly thin end plates of metal that are themselves stator plates.

This Can Never be Done

The purely ideal condenser is one that has an absolutely uniform dielectric material at all points where there is an electrostatic field, has plates of zero resistance, equally spaced at all points, and contains no metal which is not a part of the condenser surface, and no

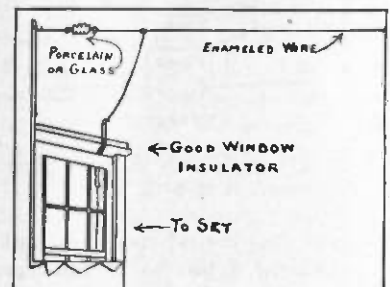

Fig. 5. Three Places Where Losses Are Usually Fairly High.

dielectric which is not in the field. This is obviously impossible of attainment, but it can be approached a great deal more closely than is being done at present.

From the above it will be seen that the stator and rotor should be cut from

plates of solid metal, or else all plates should be soldered together. Yet there are many brands now being offered that have this feature or try to compensate for it by cutting parts of the plates and joining them mechanically into one another.

Designing the Perfect Coil

With low-loss coils there is room for more to be done. Coil losses in receivers are higher than condenser losses. The theoretically perfect coil is a solenoid of bare wire immersed in a medium that has a dielectric constant zero (if there were any such). This would give pure inductance with absolutely no distributed capacity. The practical problem is therefore to support a solenoid in air, (which has prac-

As soon as a sturdy commercial equivalent can be discovered for this form of winding the losses in the average receiver will be reduced considerably.

The low-loss feature in tube construction will be taken up later in the general discussion of the future forms of vacuum tubes.

Have You a Good Insulator?

The chief advance in reducing antenna losses (Fig. 5) has centered about the substitution of glass and porcelain insulators for the leaky composition types. Insulation of the lead-in is a field for further development. The conventional lead-in strips that are designed for use under a window, are especially bad in wet weather. Better insulated substitutes can be made without any trouble whatsoever. As soon as the public acustoms itself to the idea that an investment of a dollar instead of ten cents in a lead-in insulator would be profitable in the long run, the article will appear.

There is also apparent a decided trend toward antennas of non-corrosive materials. Bare copper is giving way to insulated wire for aerials. The most practical material now available is solid or stranded enameled copper wire. The enamel preserves the clean surface of the copper long after a bare wire would be hopelessly corroded. The well known fact that radio currents exhibit the "skin effect," that is, a tendency to travel on the surface of a wire instead of evenly through its diameter, makes it imperative that the surface be kept clean and bright if best results are expected.

Gave 50% More Current

The importance of this fact does not come out very easily in receiving sets, when a gradual change as the antenna slowly corrodes goes unnoticed. But in transmitting outfits it can be followed by watching the fall in the amount of current radiated. The writer substituted, a short while ago, solid No. 12 enameled copper wire for the bare corroded wire of the same diameter that had been used for some time at a prominent New England relay station, and this change alone was responsible for a rise of fifty per cent. in the current radiated. This does not mean that as much as fifty per cent. more power was radiated, but indicates that the resistance

of the antenna had been lowered very considerably.

Loop antennas now on the market are often subject to the drawbacks of both the outside aerial and the coils within the set. The most efficient forms are cylindrical (Fig 6) rather than square. If a pure cylinder is impossible, they should be in the form of a polygon with as many sides as possible. The wires on the average loop should be spaced not more than three or four to the inch, and should be supported the same as with coils, with no metal and as little dielectric material as possible. For most amateur uses the solenoid type of loop is preferable to the flat spiral, Fig. 7, although the latter is easier to build.

In summing up the low-loss movement, we may say that it works for the elimi-



Fig. 6. This Cylinder Loop Has the Highest Selectivity, but Takes Up Room.

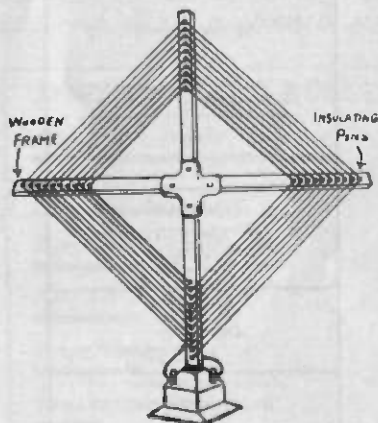

Fig. 7. Edge Wound Loop Saves Space and is Easy to Build.—Not as Efficient as Fig. 6.

ally the lowest dielectric constant (air) with an absolute minimum of insulating material. The individual wires should be spaced about one-half their own diameter apart for best results, and should be in the form of a perfect cylinder. The various lattice arrangements introduce losses, and while they are superior to single layer coils on a cylinder of insulating material, they are often not as good as a properly supported solenoid.

So we may look in the future for more efficient means of mounting applied to the conventional solenoid. Coils supported only by strands of cotton thread interwound between the turns have been used for some months by experimenters.

nation of three kinds of losses, in very simple and direct ways. First, it reduces all losses of leakage and resistance by using insulating material of the very highest quality at all essential points and by using pure copper for all conducting surfaces including condenser plates; whenever parts such as the latter cannot be cut from a single block of copper, it stipulates that the unit parts be soldered together. Second, it calls for the reduction of all power wasted in the insulation, commonly grouped as dielectric losses, by reducing solid dielectric material to an absolute minimum in the vicinity of an electrostatic field. Third, it provides for the reduction of eddy cur-

Continued on Next Page

What Others Like in Radio

4,000 Fans Answered the Six Questions About Their Preferences

WHEN a man walks down a street wearing the new hat he has just bought and sees a dozen other chaps with similar head gear he feels pleased with himself at picking out such a popular design.

But suppose it is a woman who sees her hat duplicated exactly on a dozen heads. When she gets home she will

To Find What People Like Along these lines it is interesting to see the results of a survey recently made by the "True Story Magazine." This has not been made public by that periodical, but is here released for the first

(6) What batteries do you prefer? The first question is particularly intriguing. How to get a man interested in buying radio is a deep problem not only for the radio stores, but also for young Tom and Bill, and Alice, who

Neighbor's Set 31.3%
Special Programs 13.2%
World Series 10.2%
Advertisement in Magazine 8.3%
Radio Article in Magazine - 7.5%
Presidential Convention - 7.4%
Dealer Display - 6.5%
Advertisement in Newspaper - 6.3%
Radio Article in Newspaper - 6.2%
Banquet Speeches - 3.1%

Fig. 1. What Made You Buy a Set? Here Are the Most Popular Reasons.

either give it to the maid or use it to start the kitchen fire. And in the same way when it comes to radio some fans like to be right in style and have just what all their neighbors are buying while others want something exclusive which will not be seen in the home of anyone else in town.



Friends' Advice

Manufacturer's Reputation



Magazine Ad



Dealer's Advice



Newspaper Ad



Window Display



Fig. 2. How Was the Brand Selected? Probably Your Friends Had a Big Influence, as Well as Advertising.

time through their courtesy. The idea was to find out how the radio enthusiasts had become interested and what kinds of instruments they preferred.

Six questions were sent out to a list of several thousand people scattered all over the United States. Over four thousand answers were received. While of course, this is a small part of the broadcast listeners in the United States still it gives a pretty good idea of what people think in this new art. Since the names were selected at random and do not represent any special classes in the communities the results are undoubtedly representative of the average states.

Here Are the Six Questions

Here is a list of the six questions which went out in this questionnaire:

- (1) What made you want a radio?
- (2) How did you select your set?
- (3) What qualities most appealed to you?
- (4) What receivers are most popular?
- (5) What loud speakers do you like best?

LOOKING AHEAD

Continued from Previous Page

rent waste by eliminating all ungrounded metal in the vicinity of an electromagnetic field, reducing all metal supports to minimum bulk, and by confining electromagnetic fields to a limited area as in the case of toroid coils and "binocular coils."

Pick Good Ones by Eye

When the three principles enumerated above, and the basic reasons for them, are fully understood, it is a simple matter to choose good apparatus by external appearance, and to predict the trend in future instruments, which will follow a policy of further elimination of losses by a more exacting application of these principles of elimination of extraneous material of all kinds.

One of the most interesting and important fields for brilliant development is that of tubes. However, this subject must be reserved for the concluding installment of this article in the next (Dec. 1) issue.

...been trying to induce their father to
...a fan for these many months. If
...children had the secret of getting
...parents to buy there would not be
...homes without a loud speaker.

Fun from the Brown Box
Here is the way the factors were
...by those who had already bought
... Fig. 1. Listening to the music
...their neighbor's radio was a very

right behind. It appears that the dealers
...are not as smart as some of them seem
...to think in getting people to buy sets.
In other words, a large majority of
...their customers are already sold before
...they enter the radio store.

Last of all come the banquet speeches.
This is not to be wondered at, as many
...talks that we have heard would appear
...to put on the brakes rather than step

than it does at present, since the class
...of dealers handling radio is becoming
...more reliable. Many of those who used
...to sell sets, did not know much of any-
...thing about them, and so their advice
...wasn't worth much.

At the end of the list, following news-
...paper advertisements, is window display.
Naturally the appearance of the set is
...about all that can be learned from a
...window, and as will be seen later, this
...factor, though important, is not nearly
...as good a reason for buying as some
...others.

Hot Wad in Their Mouth

Under the qualities which appeal most,
...each one who answered the questions indi-
...cated first, second and third choices,
... Fig. 3. For first choice, the greatest
...need was tone. Anyone who has heard
...the average set of a year or so ago,
...knows that the speakers talk as if they
...had a wad of hot spaghetti in their

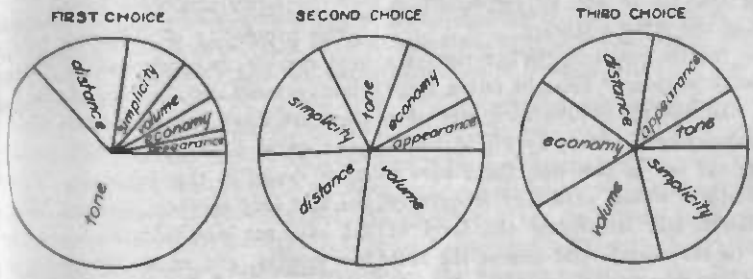

Fig. 3. When the Fans Were Choosing, These Qualities Impressed Them Most. Tone Stands at the Head of the List.

...pelling reason. This is not at all
...surprising as many people do not realize
...how much radio has advanced in the last
...few years and until they hear the
...entertainment as they sit at their leisure
...they cannot believe that so much en-
...tertainment can come from a little brown

Kept Us After Midnight
Next in order, but not even half as
...much of a reason, are special programs.
Included in this list would undoubtedly
...be the Victor presentations of last
...spring, and also the Atwater Kent and
...Cainert concerts which are now appear-
...ing each week. It is no wonder that
...these unusual programs should convert
...so many to own a radio. Follow-
...ing next comes the world series. All of
...those who fell before this temptation
...are probably men who are baseball
...fans. There is a great satisfaction in
...following the games right while they
...are being played, rather than reading
...about what did happen some hours ago.
Next came the magazines—the adver-
...tisements and editorial matter. Nearly
...as big were the presidential conventions,
...which kept a lot of us up with the
...pages glued on our heads until one
...hour and two o'clock in the morning. Shall
...you ever forget that "24 votes for Un-
...derwood?"

The dealer display figured down
...pretty well in the column with news-
...paper advertisements and write-ups

on the gas when it comes to selling
...radios. Beside the reasons already
...given, there were a large number of
...scattering ideas which did not have
...enough of the following to be recorded.

I Believe What He Says

"How did you select your set?" The
...effect our friends have on us is revealed
...by the answer to this question in Fig. 2.
Theater managers have found that the
...word of mouth is a lot more powerful
...than anything else in the advertisement
...of their plays. Suppose I start to see
...a show which has been advertised as the
...best one since the time of Adam. Just as
...I am leaving I run across friend John
...and ask him how he liked the play last
...night. "Rotten," he replies, so I don't
...go. And in the same way, Fig. 2 shows
...that the influence of what my friend
...says is way ahead of anything else in
...affecting my choice.

Next in line comes the reputation of
...the manufacturer. This is as it should
...be. If the makers of a line of goods
...could not depend on the goodness of
...their product as a big influence in sell-
...ing other sets, of what use will it be
...to them to spend the extra time and
...money needed for improvements?

Lots of Poor Advice

Magazine advertising, which really
...helps to make the reputation of the
...manufacturer follows next. Then comes
...the dealer's advice. Probably this item
...would stand higher a year from now



Fig. 4. In This Survey Here is the Way the Various Sets Ranked in Popularity.

mouths. The kind of tone which sounds
...natural and undistorted is certainly a
...good thing to aim for.

The second most popular quality was
...distance. This shows the vote of the DX
...hounds who would rather hear the coast
...in a faint and broken whisper than
...a good clear program which is being

LOUD SPEAKERS

- Magnavox
- Music Master
- Atwater - Kent
- Brandes
- Western Electric
- Manhattan
- Atlas
- Dictogrand
- Amplion
- Herald
- Thompson
- Bristol
- Rola
- Timmons
- Jewett

Fig. 5. Loud Speakers Had a Big Field, with Many Others Not Given Here.

played only a hundred miles away. Probably a year ago, the vote for distance would have been much greater than it is now.

Where the Burglars Shone

Simplicity of control came next. This desire is seen reflected in the reduced number of controls needed in operating a set. We remember a very expensive radio of two years back which had no less than 16 handles to be used in operating. It seems that only the experienced safe crackers and burglars were able to master such intricate controls. Volume, economy and appearance brought up the rear about equally.

For second choice, the vote was more evenly divided. Tone dropped to a low place because so many voters had already put it in first choice. Volume and distance were the favorites for this position, with simplicity following close on their heels.

Came in at the End

Third choice was even more scattering. Tone, which appeared at the end, added

enough votes so that it was seen in some position on practically every list. Simplicity and economy showed up big as being in everyone's mind, even though they did not figure first. One surprise was the fact that appearance did not make a bigger showing. This last year, the radio manufacturers have made a big drive on this quality. Other things being equal, there is no doubt that the nice looking set will have the choice, but it seems that it is not as important as some of the other qualities.

The fourth question, "What receivers are most popular?" brought out a large field. In the three-tube and over sets the popularity is shown by Fig. 4. Following the end of this list, there were a dozen others which were very frequently mentioned, but fell below the level of those in the sketch. Of course the fact that their names are not given here is no reflection on their quality or desirability.

Reasons for Popularity

Taking the five leaders, the reasons for their prominence is probably somewhat as follows, aside from their merit: Atwater Kent has received a great deal of good will from the Metropolitan Stars whom they are presenting each week. Crosley makes a line which is very low priced considering the quality. Radio Corporation is favorably known as one of the pioneer manufacturers in the field. Freed-Eisemann is the largest manufacturer of the well-known Neutrodyne. Freshman has specialized on the tuned radio frequency amplifier.

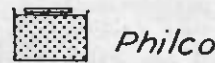
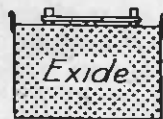
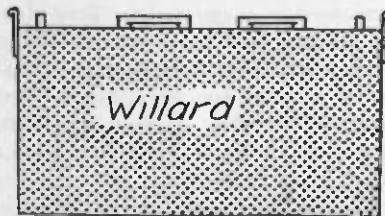

Fig. 6. There Were Only Four Very Popular Radio Storage Batteries.

Eveready

Burgess

Dry "B" Batteries

- Franco
- Willard

Fig. 7. "B" Batteries Showed Popularity of a Few Lines.

The popularity of different makes of loud speakers is illustrated in Fig. 5. As already mentioned in regard to Fig 4, there are many worthy names which receive quite a few votes but less than those shown in this schedule. Some of the best loud speakers now on the market have not been sold for more than a few months, and naturally their names will not appear in the same number as those of the older manufacturers.

The Big Four of Batteries

Most all these sets make use of batteries, both "A" and "B." In the storage battery field the four makers shown in Fig. 6 were way ahead of any of the others. Probably this is to be attributed more to the influence of sales and advertising than to great superiority of the product. Most storage batteries put out these days by reputable manufacturers are very satisfactory.

The "B" batteries, too, showed a pronounced drift to four different makes as appear in Fig. 6. They are all well constructed and will give a long life in your set. There are many newer makers, however, who have a fine product and will probably appear well up in the list if a similar ballot is taken two years from now.

ONE FACE IN 100,000,000

Among the thousands of letters received by Graham McNamee following the broadcasting of the World Series, one of the most interesting from the point of view of novelty was the one that a Western fan addressed to him by pasting his picture, clipped from a newspaper, on the outside of the envelope. Although there was neither name or address, the letter reached WEAf without delay. He could never commit a crime and then "melt into the crowd."

A One-Control Superhet

It is Nearly as Easy to Build as to Operate

By HARRY J. MARX

Did you ever see a woman come down the street dressed in a very elegant gown and only when she came close did you recognize her as an old maid? It was the change in her appearance that misled you. In the same way the set which we are about to describe will probably not be recognized by its outside appearance. There is one style of receiver which it is nearly easy to name, and that is the superheterodyne. When you see a two-condenser control with nothing else, you usually pick it out right away as one of this style.

Volt Meter Saves You \$ \$

However, the day when two dials were needed to operate it are past. Here is a well fledged superhet with only a single tuning dial. There is so little apparatus mounted on the panel, Fig. 1, that you are really glad to notice the volt meter at the left, which is used to adjust the potential on the filament. This unit is not really required, but in a six-tube set there is a lot of money to pay if you run the tubes at too high a voltage, and so cut their life in two. The volt meter prevents such a catastrophe.

The most popular two-tuning control has been the old superhet, not only because of the ease of operation, but also for its high degree of selectivity. This, then, would be a most natural circuit for use in a single-control receiver, and it could be arranged. And it has.

The S-C (single control) Capacity Element consists of two condensers mounted in such a manner that their capacities may be simultaneously varied with a single dial, reading from 0 to 180 degrees. In addition, one of the condensers may be varied through 20 degrees of dial movement as a compensator without disturbing the setting of the other. At the mid-point of the compensating adjustment, both condensers have equal capacity at any dial reading, and

this compensator gives a plus or minus variation sufficient to cover any inequalities of tuning.

One Double Condenser Used

Although this S-C capacity element may be used in connection with any receiver where a double condenser can be substituted for two single ones, we are now concerned only with its application to the superheterodyne circuit. This hook-up consists essentially of two tuning controls, one to adjust the loop and the other to vary the oscillator frequency in order to produce the proper beat for the intermediate amplifier. This unit lends itself in wonderful manner to this

vary the turns in the loop until it will also give 1,000 kc. with the same condenser setting. When this has been done, the compensating condenser will not be needed at that point since the two capacities are alike and tuned to the same wave speed.

Once Right—Always Correct

If they are both right at 1,000 kc., they will be nearly correct all over the broadcasting range. Small differences in required capacity may be found at various points on the dial, but this slight change is taken care of by adjusting the compensator and so bringing the waves together.

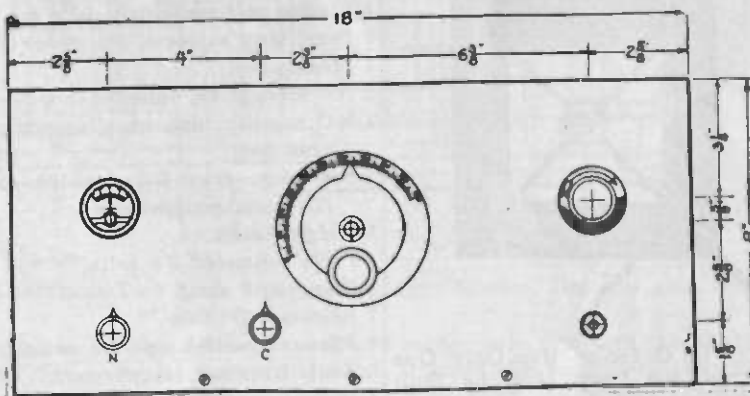

Fig. 1. How is This for a Simple Panel for a Superheterodyne? The Voltmeter at the Left May be Omitted, but Lengthens Life of Tubes.

type of circuit because the proper value of loop inductance may be obtained by correct design.

The idea is this. If the loop is quite small, then the capacity to tune it will have to be very large and vice versa. By selecting the right number of turns, the capacity to fit can be worked out at any figure within reason. Suppose now that it is found by experiment that to tune to say 1,000 kc. (300 meters) requires the right-hand condenser to be turned half way into mesh. Let the left-hand condenser be adjusted to the same position. All we have to do now is to

The superheterodyne is different from tuned radio frequency in the respect that it depends for its proper action on the constant difference of frequency between two tuned circuits. It is therefore only necessary to provide the same tuning range in each of the circuits, and the compensator can be set so that one condenser will always provide more capacity than the other, thereby giving the desired beat frequency.

You will recall that with this type of set it is the *difference* in frequency which counts. That means that the oscillator can be set at say 50,000 kc.,

either above or below the incoming wave. Either way will give exactly the same results. In designing the compensator and its setting, it is possible to adjust the oscillator permanently to run either slightly faster or slightly slower than the signal which is tuned by the first condenser.

The Steps Must be Matched

The problem was to devise a simplified circuit in which the most efficient kind of amplification possible would be obtained through sharply tuned intermediate frequency transformers. This has been accomplished. Greater efficiency can be obtained from sharply tuned, air core transformers than the untuned, iron core type. The difficulty of course has always been in properly matching such sharply tuned units, and in addition the problem of local oscillations.

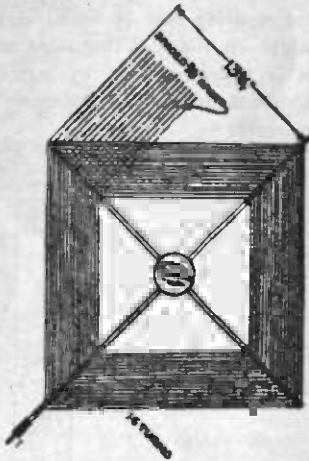

Fig. 2. In Order to Use Only One Control, the Loop Must be Built Just Right.

A common way of preventing the squeals and distortion, which arise from oscillations between the various tubes, has been to use a potentiometer. This method works well in that it does remove the oscillations, but it causes a loss in the circuit and so less selectivity and distance.

Saves Half Your "B" Battery

Instead of using a potentiometer with its losses, this set biases the grids of all tubes, except the detector, with a negative charge of $4\frac{1}{2}$ volts. In this way the plate current consumption is cut down to 10 milliamperes or less against a usual consumption of about

double. The ingenious method of transformer adjustment and neutralization makes it possible to eliminate all oscillation tendencies.

Very few home set builders have the means of making the necessary adjustments for checking the matching of the transformers, the balancing of capacities, and the proper neutralization of all oscillation tendencies. Because of this, the popular and efficient Hanscom Superunits were evolved. In these, all the intermediate transformers, filters, oscillator coupler and balancing condensers with tube sockets have been assembled in one compact design. All the delicate yet vital balancing, matching and checking has been already done in a well equipped laboratory. The unit goes into the hands of the constructor all ready for assembly in the set with only the minor wiring yet to be added.

What You Must Get

The parts required for this set are as follows:

- 1 Front panel, 8 x 18.
 - 1 Base panel, 10 x 12.
 - 1 Binding post panel strip, $\frac{7}{8}$ x 4.
 - 2 Panel strip supports, $1\frac{1}{2}$ inches long.
 - 4 Binding posts.
 - 1 "C" battery, $4\frac{1}{2}$ volts.
 - 1 S-C capacity element (Hanscom recommended).
 - 1 Superunit, type B-2 for 199 tubes (Hanscom recommended).
 - 1 Midget condenser.
 - 1 Panel voltmeter, 0-5 volts.
 - 1 Rheostat, 6 ohms.
 - 1 Rheostat, 30 ohms.
 - 1 Filament control jack (or switch).
 - 2 Audio frequency transformers.
 - 1 By-pass condenser, 1 mfd.
 - 1 Loop aerial (see Fig. 2).
 - 1 Cabinet to suit.
- Necessary wire, screws, terminal lugs, etc.

The superunit and S-C capacity element which were used in building this set, were the product of the Hanscom Radio Devices Company, of Woonsocket, R. I. Of course, other devices equally good might be substituted. However, the ones recommended are already adjusted so as to make easy wiring and assembly.

In the circuit diagram, Fig. 3, the superunit part of the circuit is enclosed in the heavy dotted line. Other parts are shown with a slightly heavier line.

The capacities of the different condensers are given, with the exception of the four marked "A," "B," "C" and "D." The two marked "A" and "B" are put in during an assembled test, their value is very critical and must be determined by test. Condensers "C" and "D" are not so critical but will vary, so no value is given.

What the Knobs Do

The panel layout is shown in Fig. 1. The small knob and pointer marked "C" is the compensator adjustment of the S-C capacity element, while "N" is the midget condenser for controlling oscillation of the first tube. The rheostat shown is the 30 ohm, the six ohm is in the rear.

The rear of the panel and sub-panel are clearly shown in Fig. 4. The heavy lines indicate the connections that are already made, while the lighter lines indicate the wiring that must be done to the balance of the apparatus. This corresponds to the connections as shown in Fig. 3, the hook-up diagram.

On the right side of the S-C capacity element will be seen a rectangular piece that projects below it. At the lower end of this piece there is a circle marked "C." This is the eccentric bearing actuated by the knob and pointer, and rocks the right condenser assembly, thus permitting proper compensation for any variations.

Sub Base Carries Parts

The arrangement of the different parts on the base panel is clearly shown; no dimensions are needed as there is ample room. The "C" battery is clamped down on the right side. The binding post panel strip is mounted above the base panel, making use of the $1\frac{1}{2}$ inch panel strip supports. This keeps the level of the strip the same as the rest of the apparatus. The superunit has two legs and the transformer mounted on the under side, permitting a level setting of the unit for fastening to the base panel. The two audio transformers and the by-pass condenser are also fastened to the sub-base panel in the positions shown.

The instrument on the upper right side of the front panel, Fig. 4, is the voltmeter. Below it is the midget condenser, "N," corresponding to the same marking on the circuit diagram, Fig. 3. On the left side, the filament control jack is shown in the lower corner. This

type of jack may not be so well known to some, but the type shown in the circuit diagram can be used.

Special Jack or Switch

As already mentioned in the list of material, you may use an ordinary jack if you prefer, and a filament switch. Many fans believe that the control jack is more apt to get out of order than the switch. Furthermore, the former unit requires that the plug and cord be withdrawn every time, and to some people this is a nuisance. However, the control jack is neater since it eliminates one piece of apparatus.

Above it are the two rheostats. The 30-ohm is the master rheostat for controlling all the tubes and can be

Coils and Wires Kept Apart

The actual wiring in the set has been reduced to such a minimum that it hardly appears necessary to devote much time to instructions on the subject. Keep all the wires as far away as possible from the coils. This is of the utmost importance in order to avoid trouble. Naturally, leads should not be made any longer than necessary and be sure of a good soldering job. If in doubt about terminals, a comparison of the circuit diagram and the picture, Fig. 4, should easily solve the difficulty. Be careful not to break any delicate wires of the tuning coils.

The loop areal is pivoted in a bushing in the top of the cabinet so the loop

cabinet. This will allow the use of short, flexible leads direct to the set. Two binding posts on the lower upright are required in order to make connections. The loop can be made in the collapsible style if so desired.

The ends of the four arms should be of bakelite or hard rubber so as to avoid any losses which would be detrimental to selectivity. The loop is directional in its effect, and in tuning this will be found of decided advantage in improving the selectivity where interference is bad.

Won't Work Without Plug

After the batteries have been connected, the tubes inserted, the loop leads attached, and the loud speaker plugged

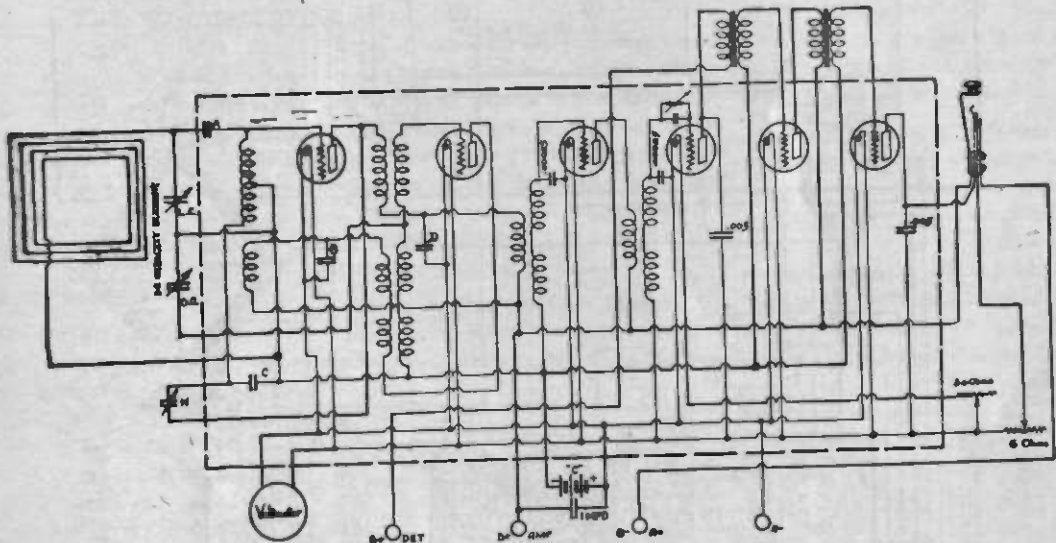

Fig. 3. The Hook-up of the Set Shows Oscillator, Two Steps Intermediate Amplification, Detector and Two Steps of Audio.

mounted directly on the front panel or as an extension of the face plate on the capacity element, which can be obtained with a special larger size plate for use in this receiver. The 30-ohm rheostat is mounted on the front panel in the position shown in the panel layout, Fig. 1. This rheostat controls the filament current of the second intermediate stage and acts as a throttle valve on the input of the detector, which allows a perfect control of the volume without sacrificing quality. As it is connected in series with the main rheostat controlling all the tubes, it may be turned on full without damaging the tubes. The base may be fastened to the front panel by means of metal angles or by passing machine screws into tapped holes in the base panel.

leads pass through a hole in the cabinet and fasten directly to the proper terminals. If desired, two more binding posts can be added.

How to Make the Loop

In order to have the proper inductance value in the loop, so that the tuning range of the condenser will check closely with that of the oscillator circuit, it becomes important that the loop be built to the specifications shown in Fig. 2. About one hundred feet of lamp cord or other insulated flexible wire is required. No specific instructions are required relative to the construction of the four arms, as any builder will possess sufficient ingenuity to make the frame. It will be found convenient to have the loop mount and pivot on the top of the

in the jack, then turn the 30-ohm rheostat on the front panel full on; now turn the 6-ohm rheostat on the inside until the voltmeter reads about three volts. The best setting can be found after the set is in operation. Once this is adjusted it need not be touched any further, with the exception when the battery may be in run-down condition. The 30-ohm rheostat in front can be used for regulation of volume. Of course, these adjustments cannot be made until the plug is inserted in the jack, as this closes the circuit and lights the tubes.

It should now be possible to tune in a signal by rotating the dial slowly throughout the entire wave length range. For this preliminary tuning the small midget condenser, "N," should be set at

maximum capacity. For local stations this will not be found critical, but for long distance work the adjustment will be very important. After the signal has been tuned in, the small compensator knob, "C," should be turned until the signal is at maximum intensity and the loop may be rotated for the best receiving position.

to adjust the inside rheostat from time to time in order to keep the voltmeter reading up to the mark.

In the center of the third tube socket from the left, Fig. 4, there is a hole through the base panel of the superunit and the slotted shaft of the variable gridleak can be seen. By shaping a small piece of wood like a screwdriver and

is available. Powell Crosley, Jr., the radio manufacturer, frequently obtained excellent results with his portable set while on hunting trips, by attaching its ground terminal to a wire fence.

Few campers and farmers know that this scheme often works better than a metal plate buried in the ground, cistern or even a well. The fence acts as a

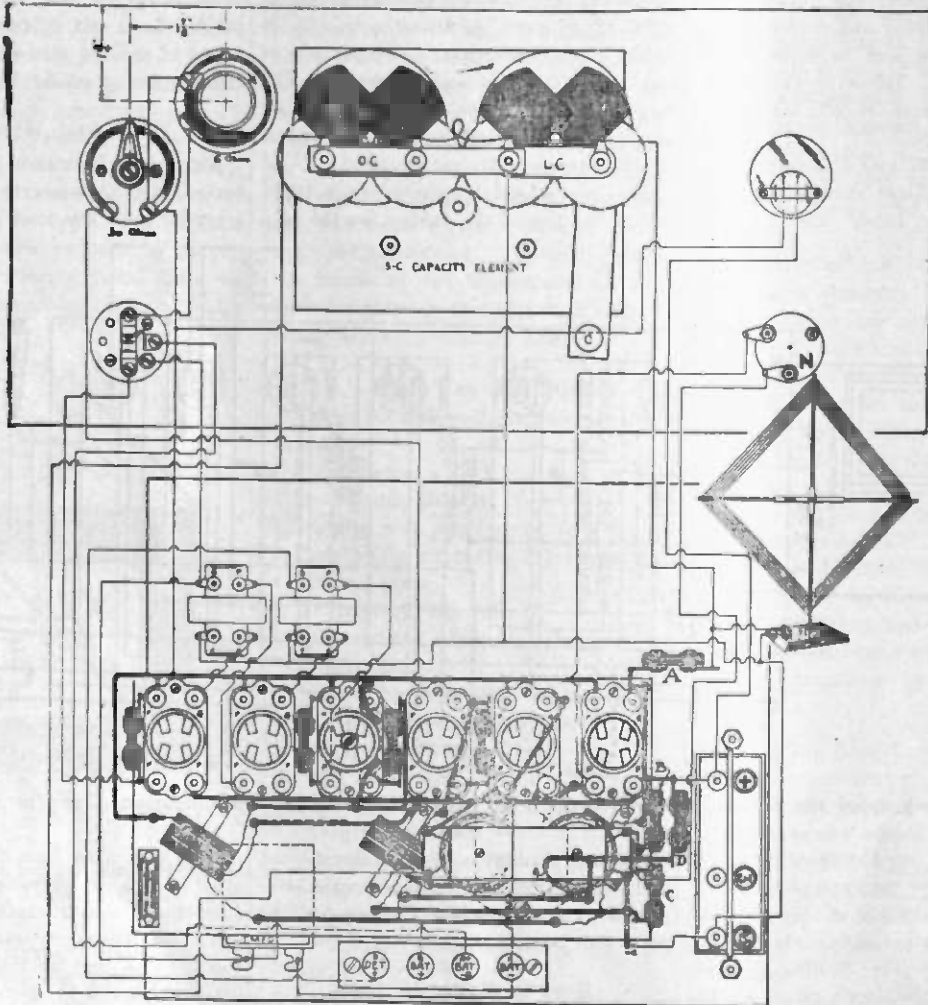

Fig. 4. This Picture Diagram Indicates How the Parts Are Mounted. The Six-Ohm Rheostat is on the Back of the Panel. with Knob at Rear.

Using Aerial and Loop

Very often the volume may be materially increased, particularly on long distance work, by connecting a ground wire or antenna to the filament end of the loop. This end is the one which is connected to the "C" battery and is the terminal which may be touched with the finger with but little effect if any on the signal strength.

As the voltage of dry cells, if used, decreases with age, it will be necessary

inserting it in the slot, the gridleak may be adjusted. Do not use a metal tool. A counter-clockwise movement increases the resistance. Each unit is adjusted, but it may require slight readjustment after testing.

A CAMPER'S GROUND

A wire fence acts as a very efficient substitute for a ground, especially in dry places where no good ground connection

counterpoise, forming a condenser of which the ground acts as one plate and the wire the other. Inasmuch as the radio-frequency currents travel easily through condensers, connecting a radio set in this way is almost equivalent to hooking it up directly to ground.

Farmers who have difficulty in locating good ground will also find streams useful. A bare wire strung along in the bed of a stream, or buried in a spring is often quite effective.

I Am Glad I Saw the Show

Some of the Newest Things on Display are Described!

By RICHARD E. CONNET, Providence

The biggest circus does not always have the funniest clowns. And in the same way if you want to get the most intimate idea of radio developments you will sometimes find them easiest to discover at an exposition of average size. To one interested in the progress of radio, the Boston Radio Show this year was notable. The first one here, three years ago, was mostly a great exhibition of parts. Assembled sets were scarce and were only for the rich man who couldn't put together one of his own. This year only about ten per cent. of the exhibits were of parts, and all the rest were complete sets and loud speakers.

Hiding Behind a Dial

Of the parts exhibit there were few notable things. The most striking was a Straight Line Frequency condenser small enough to hide behind a four-inch dial; which is not the usual thing with S. L. F. condensers. It was really a beautiful job, and should become very popular, especially as it has every indication of having extremely low losses.

There were any number of vernier dials, good, bad, and indifferent, mostly bad. The chief trouble with this style of condenser equipment is that there is apt to be wear and lost motion and also that the stations can not be logged so well as with the plain type.

There are many styles of indicator for the controls. Pointers sliding over a stationary scale are beginning to get popular. It is gratifying to note that they are gradually working away from the old dial idea into more graceful indicators behind windows, or even horizontal scales.

Jelly Does Not Spray

Two firms have produced storage batteries of the size and shape of a dry cell with the intention of placing them in sets using UV-199 tubes. With price

low and quality high, they are commendable, except that I think they might perhaps cause corrosion if placed inside the same cabinet with the set. However, the makers claim there is no spray from the acid. A jellied electrolyte is found in one of the batteries, which should be all right.

Loud speakers occupy a greater attention than they ever have before. Everybody seems to want a loud speaker, and many apparently prefer a cabinet rather than a horn type. The old horn speakers were there in full force, but those having a magnet fed by a storage battery have become obsolete. Nobody has big batteries any more.

Seven to One for Cone Speaker

The cone speaker is rapidly becoming one of the most popular, gaining from

one make two years ago, to at least seven now. In general they are very pleasing in appearance and in quality of sound. Some of them, however, have a peculiar rasping tone in reproducing the talking voice. Since they vary in motive power from a standard phone unit to a clever arrangement of magnets and hinges, there is a variety of results to be expected, and one must try them all before making a selection.

Among the horn speakers there is little improvement, although one manufacturer tells me that his company plans a speaker with a new kind of diaphragm soon. It is to be in effect an eccentric diaphragm which will reproduce low and high notes with equal faithfulness, and will have no resonance period. Details are to be published shortly.

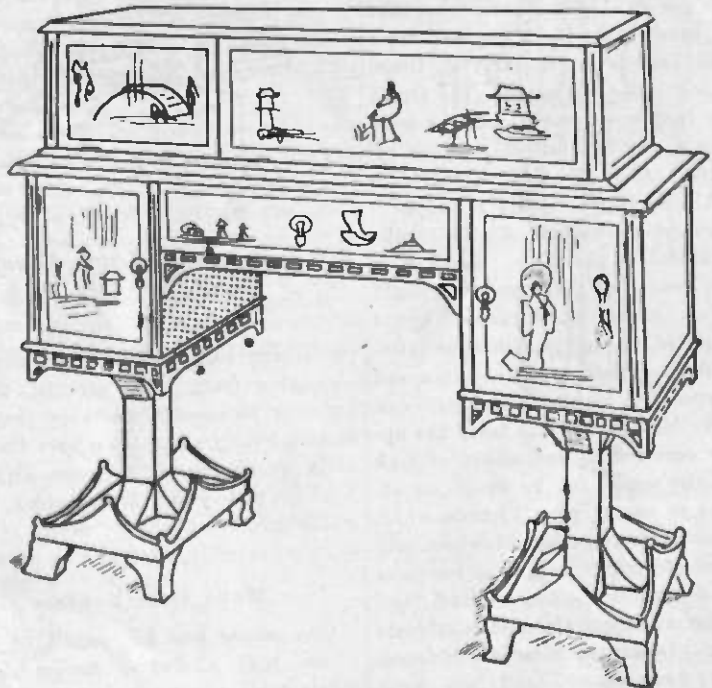

Fig. 2. This Quaintly Carved Cabinet Shows How Elaborate Some of the Woodwork is in These Pieces of Furniture.

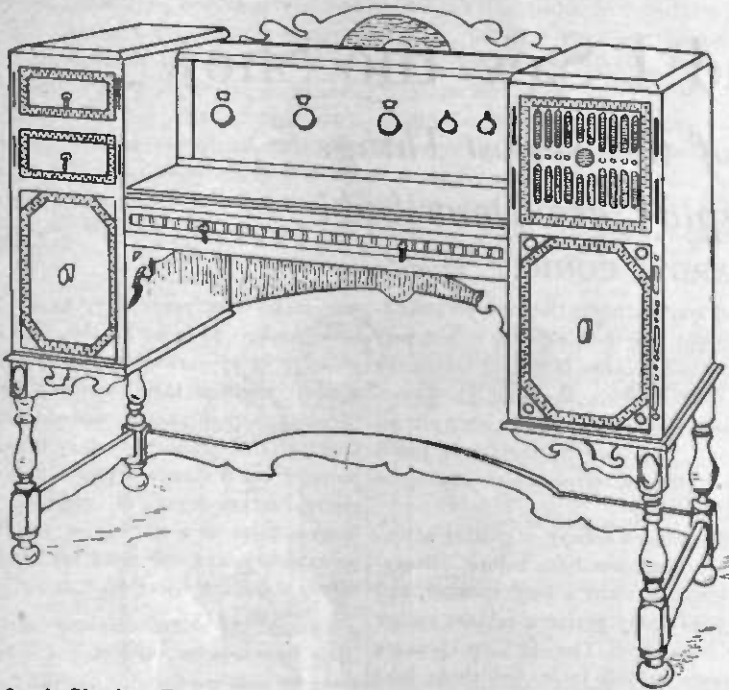

Fig. 3. A Sloping Panel and Compartments Which House Batteries and a Built-in Loud Speaker Are Standard.

What do Booths Reveal?

At this point I wish to relieve myself of a few brickbats. At the radio shows the custom is to prohibit exhibitors from operating their loud speakers. Consequently one can only choose the best looking speakers at the show, and later visit the various stores carrying them, to find out how they sound. The stores may use indifferent sets to run the tests and cannot possibly deliver uniform results with other stores. It is therefore impossible usually to obtain a comparative idea of the speakers. If booths were provided at the shows, (see Fig. 1, on front cover) so that the horns could speak for themselves, the sales would be stimulated, the buyers would be satisfied, and the salesmen could often sell more expensive models than they can now. The idea of uniform tests has apparently occurred to one maker of high grade instruments, for he shows an attachment to mount on a Victrola which would modulate a speaker anywhere, any time, and uniformly well. The company is to be congratulated on its stand.

Now for the big feature—the cabinets and sets. Of course some are hideous, but they are scarce, and the large majority are beautiful in appearance and behavior. The trend is toward dialless

sets with inclined panels. Everything over fifty dollars has one or more stages of tuned radio frequency amplification. There are new ways without number of

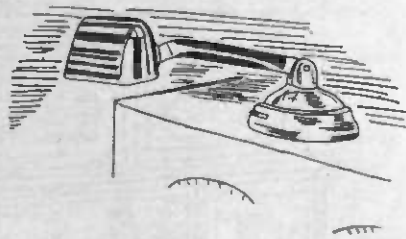

Fig. 4. This Radio Lamp Allows You to Tune as You Sit in a Dark Room.

preventing oscillations in the amplifier, —ranging from "split circuit" to "inherently balanced," whatever that may mean. Nearly all of them have the three dials interconnected by some sort of a fishline and pulley arrangement, or a worm wheel and shaft. Many of them are graduated in kilocycles or meters.

Music From Nowhere

One maker has his panels of brass, etched with a dreamy design showing music coming out of nowhere. It is a work of art, and I like the idea. Another has a set in black lacquer with a

Japanese motif, Fig. 2. The most beautiful of all is a line produced by a famous Chicago concern. The set, which is a perfect beauty in itself, is placed in a variety of cabinets ranging from Old English to modern Chinese. It is controlled by one unobtrusive knob, and has an illuminated scale in the middle.

The most popular style of cabinet is the console, with the panel sloping, and placed between two upright closets which hold the loud speaker and the batteries. This style is probably destined to become as representative of radio as the upright cabinet is of the talking machine to-day (Fig. 3).

There was an attractive little accessory shown, that is much in keeping with the growing desire on the part of the fan to sit in the darkness and listen to his music, and perhaps smoke his pipe. It is a miniature piano lamp (Fig. 4) battery operated and quite effective. It is finished in gilt, making it so pretty, that it will certainly be imitated far and wide.

BREAKING INTO THE PROGRAM

In the past, it has been the policy of studio managers to keep a broadcast program going continuously, and nothing short of an accident to the transmitter itself could interrupt an event once it had been started.

Station WJZ is one of the first to break away from the old ideal. While it will adhere to the former standard as closely as possible, nevertheless, the director feels that at times an emergency may arise so that a short interruption is the proper action.

WJZ has recently instituted a news service, by which the happenings of the entire world are brought to the studio in news form for broadcasting. In future, when an event of national importance occurs, whatever is being broadcast at that instant will be interrupted, so that the public can be informed of the fact and then broadcasting will be resumed.

Naturally, these interruptions will not be frequent, and when they do occur, the cause will be sufficient so that listeners will be glad that they got the news, even though there was a break in the music

Water Cooled Radio

Some Parts Have a Hot Time and Must be Cooled

An Interview from B. G. LITTLE, East Pittsburgh

Did you ever put your hand on a rheostat carrying the current for several tubes? If so, you probably jerked it away again as the wire gets quite hot. This is especially true of tubes using the UV-200 tube, which takes 20 amperes to light the filament. However, the rheostat is not the only part that warms up to its work. Of course, the filament itself runs at a high temperature. Indeed, that is what the "A" battery is used for—giving it a sufficient amount of heat. It must glow with a dull red color in the 11, 12, and 201A styles. In the 200, the wire is up to a white heat.

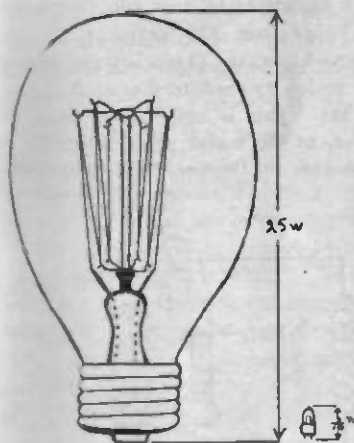

Fig. 1. This Compares an Ordinary Lamp with a WD Tube as Far as Power is Concerned.

Find Bed in Flames

Of course, you know that such a glowing filament warms up the tube itself. Take an electric light bulb for instance. In the 100-watt size the glass gets so hot that you cannot touch it with your bare hand. A 25-watt lamp is not nearly as bad, owing to the smaller amount of power. But people who have wrapped up even a small size of electric bulb in a towel and put it in their bed for a hot bottle, have sometimes returned to find

the bed in flames. The power liberated is small but the energy keeps piling up until finally the cloth takes fire.

In a receiving set the power taken by the filament is so small that it does not raise the temperature of the vacuum tube to a very high degree. Remember that the watts are found by multiplying the pressure in volts by the current in amperes. Thus a 25-watt lamp consumes about one-quarter of an ampere. Multiplying 110 volts by a shade less than one-quarter, gives 25 watts for the answer.

They Use Small Power

The WD 11 and 12 tubes take 1.1 volts at one-quarter ampere. This gives about 3/10 of a watt consumption. The 201A consumes a lot more power as it can afford to, since it is supplied from a storage battery. Five volts times one-quarter ampere is equal to 1 1/4 watts for this style. The UV-199 is the most economical of all. It consumes 1/16 ampere at three volts, which is equal to 3/16 watt.

To be exact, the power used by the tubes is not supplied entirely by the "A" battery. A little energy comes from the "B" battery through the plate circuit. The current in this circuit is only a few one-thousandths of an ampere, and so when multiplied by the pressure on the plate, the answer is very small. Even this power is not all

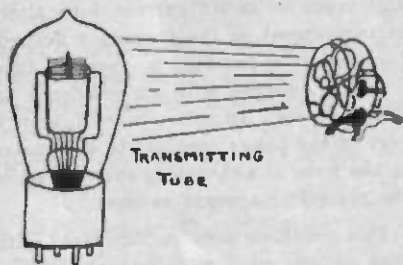

Fig. 2. Cooling the Sending Tubes by Air is Practical Up to Moderate Power.

expended in the tube, but appears largely in the phones, loudspeaker, or transformer.

Are Real Hot Plates

When you compare these amounts of power with the 25 or 50-watt of an ordinary electric light, you will see why the receiving tubes do not get very hot (Fig. 1.) However, at the sending stations, conditions are quite different. Not

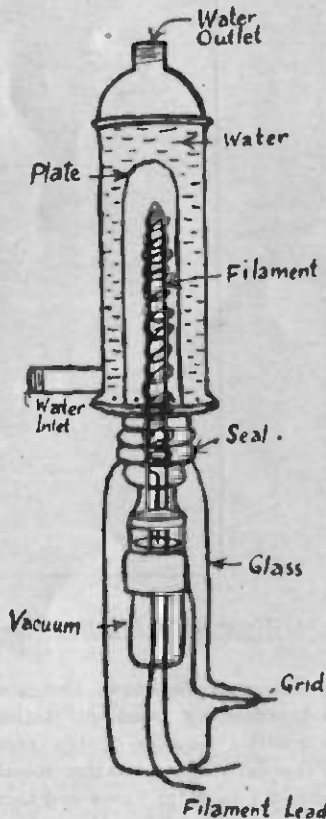

Fig. 3. Here is an Inside View of a High Capacity Water Cooled Tube.

only do the filaments take large amounts of power, but the plates, owing to the fact that there are thousands of volts used, and that the current may be measured in amperes, liberate large quantities of heat as well.

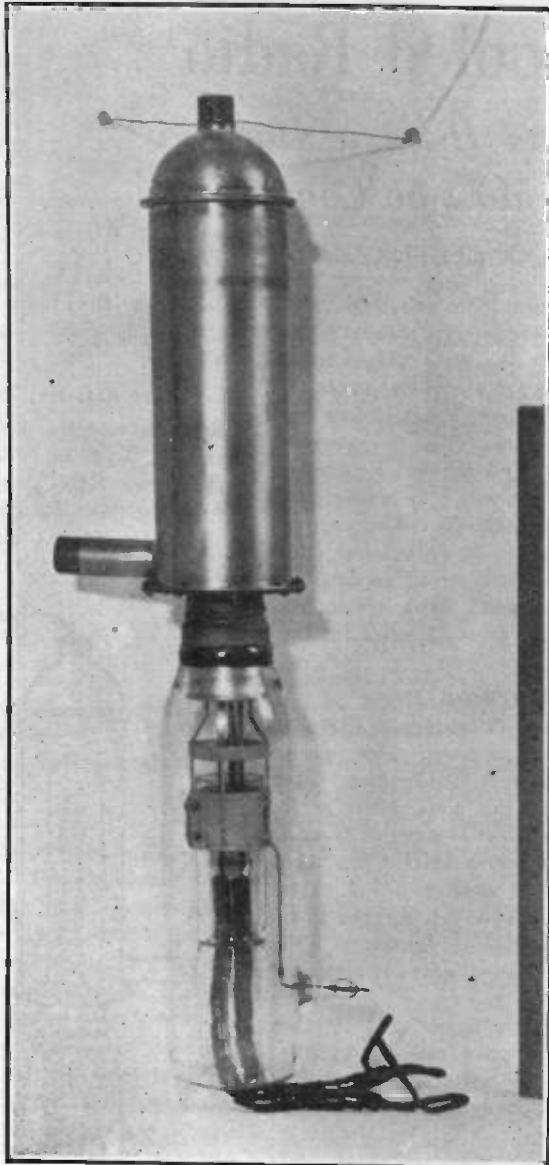

Fig. 4. Here is the Big Brute as Seen Close by. The Upper Metal Part is the Water Jacket.

As many people know, the modern radio broadcasting (sending) station is made possible because of the vacuum tube, the device that enables sound to be changed into radio waves and then at your receiver changed back again into sound. The vacuum tubes at a broadcasting station are much larger than receiving tubes, but are the same in principle.

The Heat Part is Wasted

A vacuum tube, when employed as oscillator for a radio broadcasting transmitter, converts one kind of electrical

power into another variety. It changes continuous or direct current into alternating current at the frequency desired. Like most apparatus, a vacuum tube does not operate with an efficiency of 100 per cent. In other words, only a part of the power supplied to it appears in the form of alternating current, while the remainder appears as heat.

This condition may be compared with that of an automobile motor. Only a part of the total power in the gasoline appears as mechanical power at the rear wheels, the balance being liberated as

heat in the cylinders and bearings. This heat is carried away by the cooling water to the radiator and there it is released to the stream of air sucked through by the fan. What happens if the water gets so low in your cooling system that it no longer will circulate? The cylinders get so hot that the water which does touch them starts to boil, and if the action goes far enough, the car will lose power and the pistons may even seize in the cylinders.

Boiling Because It's Frozen

The same kind of action often occurs in early winter, when a slight freeze prevents the water from travelling through the hose connections to the radiator. Again the cylinders get so hot that they boil the water which touches them. So we have the strange paradox of an automobile running along, steaming and boiling because it is frozen.

In like manner the smaller sending tubes up to 250 watts do not need any artificial cooling. They run quite hot as would a 250-watt electric light bulb, but this does no special damage, as they are supported in heat resisting sockets.

Tubes from 250 watts up to perhaps three kilowatts (3,000 watts) are usually cooled by air forced around them with a fan. This is not very effective, however, as the metal parts inside the tube are able to dissipate their heat through

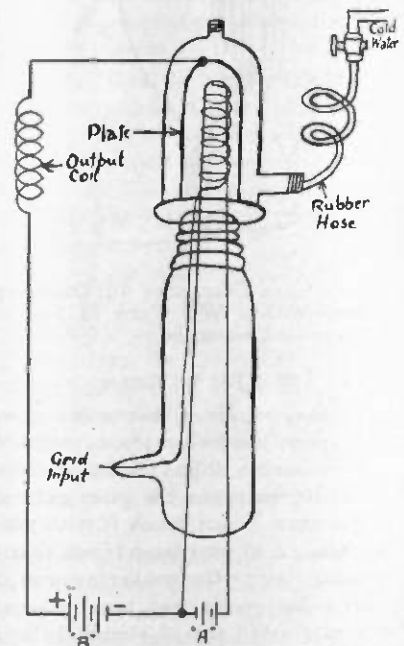

Fig. 5. The Water Supply Must be Insulated, and Here is the Reason.

radiation only, and the blast of air merely cools the outer glass surface of the tube, Fig. 2. Above 3 kw. it is more convenient to employ water as the cooling means.

Because It Must Run Red

In these large sizes of bulbs, the conditions are reversed compared with the small sizes. That is, the plate instead of developing only the smaller part of the wasted heat, is responsible for the largest share of it. The filament, while supplying some hundreds of watts, is still way in the minority. Furthermore, the filament *must* operate at high temperature, as it is only when red hot that it liberates the electrons which go to make up the sending current. The plate on the contrary, does not work a bit better when hot. For this reason, it is desirable to keep its temperature down to moderate figures.

In order that the water may efficiently carry away the heat appearing on the plate of the tube, it must come into contact with it. The metal plate is therefore made a section of the outside of the tube, which serves the double purpose of maintaining the vacuum inside the tube, and allowing water to be circulated in contact with the plate.

Plate Made Air Tight

The general arrangement of a large size sending tube appears in Fig. 3. The vacuum is held in the lower part by the glass vessel, and in the upper part by the metal cylinder, labelled "plate." These two are melted together at the seal. The arrangement of filament and grid is like what you are familiar with in a receiving tube. The big difference is that the plate is made air tight, and is part of the containing vessel.

Around the metal plate is a water jacket with two hose connections to let the water in and out. This liquid flows continuously, and is used to cool the plate, as has been described in regard to an automobile. The lower part, or glass, contains the supports for filament and grid.

Glass Beads Strung on Wire

Fig. 4 shows a photograph of the tube. The parts are all clearly seen except for the plate which, of course, is inside the water jacket. Notice the two heavy leads which come out from the bottom of the tube. They are made of this large size because the filament current

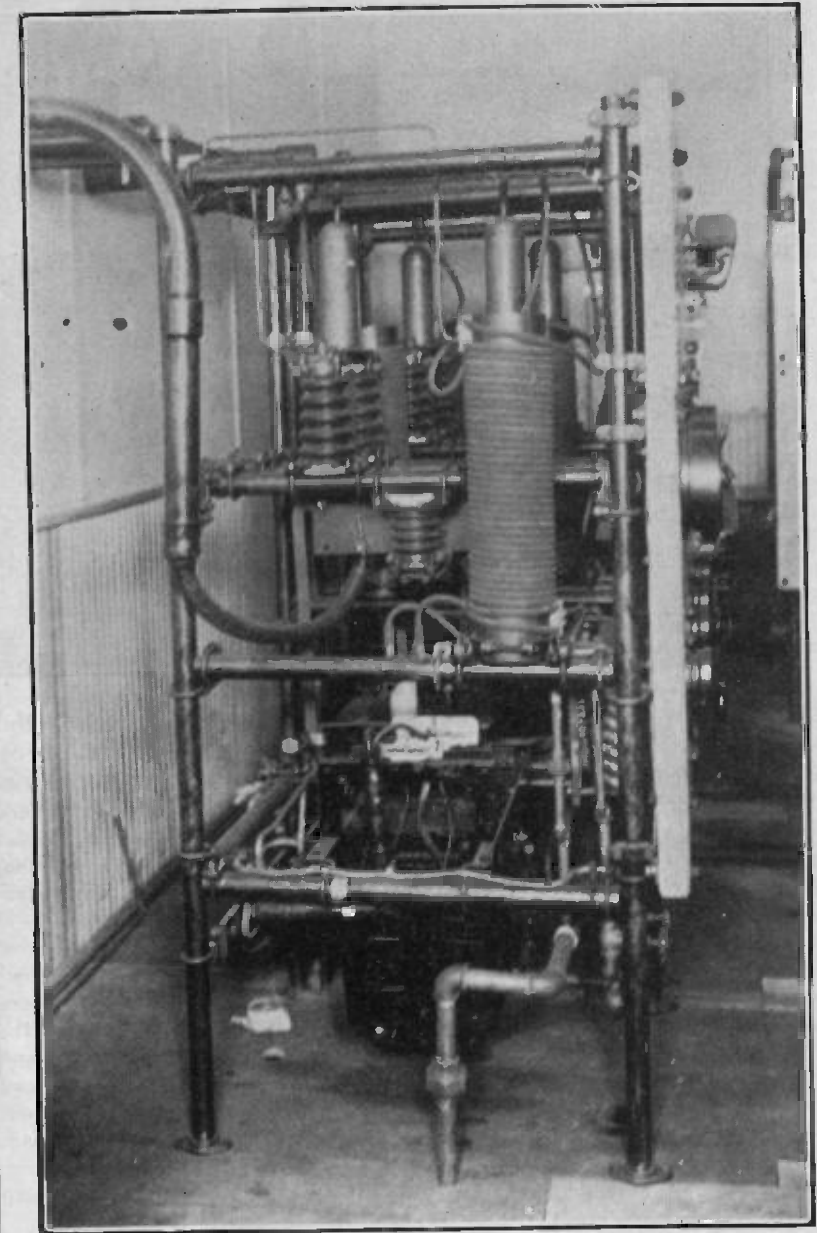

Fig. 6. This is a Transmitting Panel. Notice the Coils of Rubber Hose. These Are Used to Insulate the Water Supply for Cooling the Tubes.

is 100 amperes or more, depending on the output of the tube. The insulation on these two leads is made up of a lot of small glass beads. This makes a flexible connection, but one that is well insulated.

Jacket at 3,000 Volts

The water, after cooling the tube and itself becoming heated, may be run through a radiator, cooled and used again, exactly as is done in the case of

the automobile motor, or it may be thrown away and fresh, cool water continuously supplied to the tube. Since ordinary water is to some extent a conductor of electricity, it is necessary to have a long column of water of small cross section between the vacuum tube and the water supply pipes in order that the high voltage may not leak to ground.

The reason for this need of insulation will be grasped from Fig. 5. The filament is shown as heated by an "A"



Fig. 7. On the Left of This Picture of KDKA May be Seen the Sets of Water-Cooled Tubes Like Fig. 4; Also the Coils of Hose.

battery, although a large output generator is usually used instead. The source of plate voltage may come from a storage "B" battery as shown, or the latter may be replaced by a high voltage special plate generator. The exact source of this potential does not interest us at the present time. The pressure is fed through the output coil (which later transfers its energy to the aerial) to the metal plate as shown. You can readily see that the cooling water and its jacket will be at a pressure equal to that of the plate, which is several thousand volts above ground.

If the water were supplied through a metal pipe, connected to the city water mains, this pipe would evidently be a dead short circuit on the plate potential. Some way must be arranged to prevent such a loss of voltage. This is provided for by using a rubber tube or hose, instead of a metal one. Since rubber is a good insulator, it will not allow any of the plate supply to leak to ground through its own material.

A Twenty-Foot Hose

However, we have water itself to consider. Water, as you know, is a partial conductor. It is not a good one, however, if a long path is required for the electric current. For this reason,

about 20 feet of small rubber hose is used in both inlet and outlet water lines to the tube. This great length, coupled with the small area of cross section, cuts the leakage current down practically to zero.

To dispose of such a long piece of hose might be thought a problem. However, it is easily solved as may be seen by referring to Fig. 6. Notice that the two rubber hose are coiled round and round the vacuum tube and finally end at two ordinary water pipe connections which connect to the city water main and the sewer, respectively. Of course, as already explained, a circulating pump may be used instead if so desired.

Gives 20 Times the Output

Thus by means of water cooling, the capacity of the vacuum tube has been increased from perhaps 5 kw., the limit of glass tubes, to 100 kw. For greater power than this, several tubes may be used in parallel.

A battery of tubes with this kind of connection appears in Fig. 7, which shows an interior view of the transmitting room of Station KDKA. If you look carefully, you will see the coils of rubber hose at the left end of the cut. Some of these tubes are used in sending out the ordinary wave at 970 kc. from

this station, while others are employed to give the high frequency (short wave length) oscillations which are picked up quite readily even as far away as South Africa.

WHAT COULD BE SWEETER?

October 19, 1925.

The program directors at WEAf are always eager to receive comments on their programs, as it is only from this source that the numbers can be improved and arranged in accordance with the public taste. The following card received from a fan shows an example of this helpful correspondence.

"Dear Sirs:

"As I have nothing to do, I am writing to you, and as I have nothing to say, I will close.

"Yours truly,



Mailing Lists

Will help you increase sales
Send for FREE catalog giving complete
and prices on thousands of classified
names of your best prospective customers
99% - National, State and Local - Individual,
Professionals, Business Cooperatives.

99% Guaranteed 5¢ each

ROSS-GOULD CO. 612 S. 10th St. St. Louis

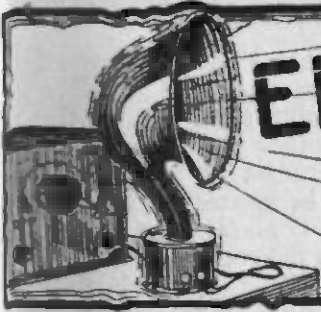

EDITOR'S LOUD SPEAKER

CONFERENCE NUMBER FOUR

The attention of the radio listeners of the country has just been centered in Secretary Hoover and his Fourth National Conference. This has been the biggest ever called, both in its elaborate program and also in its list of invited delegates.

As we go to press the action has not advanced far enough to give you complete details of the conclusions arrived at. However, we can explain what was discussed and brought to a vote. Indeed, the complete results of this meeting will probably not be known until the plans are put into execution and given some weeks or months trial.

Why We Lead World

It is only fair to give the Department of Commerce credit for a large part of the progress which the United States has made in this science. We lead the world in radio largely because of the beneficial results which have come from the first three conferences. If you think that the ether is pretty well messed up, with conflicting and interfering programs from so many stations, just try to imagine what it would have been if previous meetings had not divided up the various channels and got some semblance of order.

Another item for which we must thank our government is in regard to taxes. America is the only country of any size where the broadcast listeners don't have to pay a tax for the privilege of listening in. Every month as regular as the full moon, radio fans in other lands must pay up

for the pleasure they get from their sets.

Code Faded Out

Why is it that the general trouble from the dots and dashes of code messages does not bother us the way it used to a year or two ago? It shows that the radio inspectors are attending to business. They have closed up the sending stations of those amateurs who, because of carelessness or poor equipment, were letting their waves slop over into the broadcast band. Besides this, the government has kept after the operators on shipboard to improve their apparatus so that no harmonics would conflict with the broadcast band.

Besides this, there were two waves at 1,000 and 667 kc. (300 and 450 meters) which ship stations were allowed to use. These

two frequencies streak straight across the band which the sending stations used, and so people who lived near the coast were apt to be much troubled by code on these two waves. The conference a year ago stopped American ships from using these objectionable frequencies and furthermore, they convinced most of the foreign nations that they too must keep away from these disturbances of the broadcasting band.

Grown Up Now

During the last year the biggest change has been the great increase in power in the sending aerials of the broadcasting station. A year ago only two stations used more energy than that needed to run an ordinary electrical flat iron (500 watts). Now there are 27 stations each of which puts ten times this power

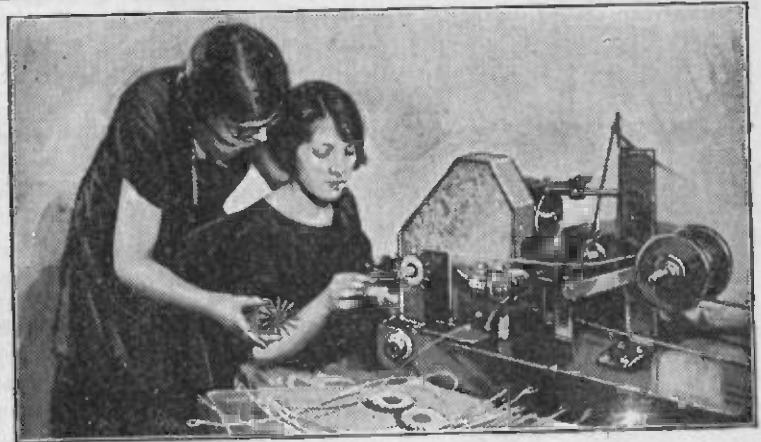

AN AUTOMATIC SPIDER

One of the popular forms of coil for tuners is the spider web. This is wound on a fibre or wooden form and by criss-crossing the wires around the spokes it looks as if the completed coil might have been made by a big spider.

While this operation may be done by hand, it is tedious and difficult to make a nice looking job. The cut shows an automatic machine which will wind 800 coils a day. The wire is automatically zig-zagged back and forth as the winding form is revolved and the result is a perfect coil which gives sharp tuning.

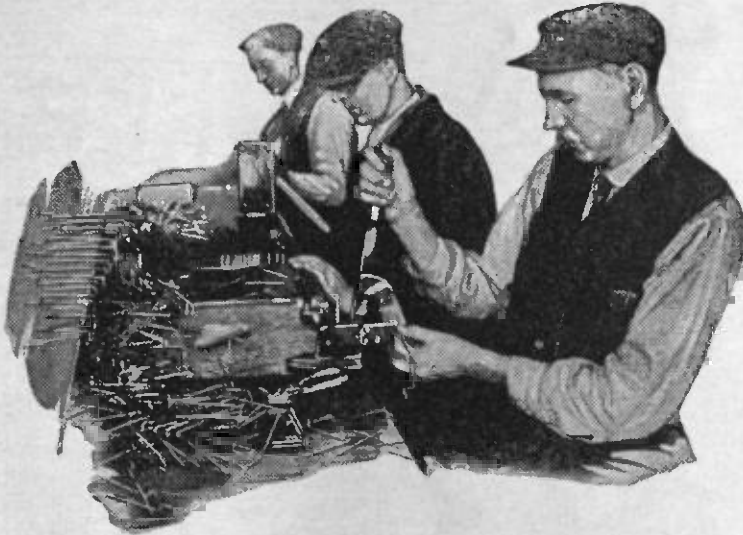

MAKING THE BENDS

Every radio set uses a good many short lengths of busbar wire. If you build your own you will find that it takes quite a good deal of time to get the right length and the bends located in the correct position.

In the commercial sets this matter is taken care of by having a special machine called a jig for each particular piece of wire. A gauge shows the right length and then the various bends are made by hand by operating the one or more levers on each machine. Our photograph shows clearly how this is being done in making the Trirdyne receiver.

into the ether. One transmitter (WGY) has an output of 100 times this value.

The fears of the timid in regard to these large increases have not been realized. It is like the troubles of the pioneer railroads. When the proposition was made to increase the speed of trains up to twenty-five miles an hour, some people were horrified and exclaimed that all those living within a mile of the track would certainly be killed as the train swept by at any such speed. So some radio men thought that super-power would blow up the vacuum tubes right in our sets.

Distance or Area?

This brings us the problem of the smaller local station. The area which is completely covered by good service day and night, summer and winter, is small for even the powerful stations. Tests by the Bureau of Standards indicate that the *area* covered is proportional to the watts. Many people used to think that the *distance*, rather than the area increased as the power. For instance, if the broadcasting station increases from 500 to 50,000 watts that gives a ratio

of 100 to 1. If they can be heard over an area one hundred times as big, it means that the distance of reliable reception will be only ten times as big. (A circle with ten times the radius has 100 times the area, you will recall.)

That being the case, it seems that the local station will always have a place in the scheme of things. It is something similar to a magazine and a newspaper. You read a national magazine (RADIO PROGRESS, for instance) however, you want to see a local newspaper from your home town.

What About the Ads?

One of the big questions of the present time is that of toll service or advertising. Fortunately, so far there are only a few stations who have ventured to send direct talks telling of the merits of the advertiser's products. However, it is hard to keep men who are spending thousands of dollars for an hour's entertainment from wanting to have their names mentioned again and again in connection with the advertised article. In this way a lot of pressure is brought to bear on the broadcasters. Discussion of this fea-

ture should have a good effect on broadcasting.

Getting them out of the cities is another question. Of course, the studios at sending stations must be located in the most convenient places, but the aerials which radiate the power may just as well be situated fifteen or twenty-five miles away. It is only by discussion of this problem and getting public opinion aroused that it will be possible finally to eliminate broadcasting aerials from the centers of population.

Time to Choose

Next on the docket comes the crowding of the air with too many programs. There are 197 out of a total of 578 stations which are using at least 500 watts, and perhaps these are 175 parties who are now trying to get permission from the Department to go on the air. While the present policy of letting everybody in has made possible the wonderful development it looks as if it were time to begin to pick and choose a little.

If we are not to take on a lot of new sending stations, what about the old ones. Undoubtedly many of them are not being tuned in on by any number of fans. Their service is poor and their programs unpopular. The chief trouble is to find out what following each broadcaster has, and to suppress those stations which are not able to please the fans.

Secretary Hoover recommends that the Federal Government assign wave frequencies to various localities and then let the inhabitants of those places decide for themselves who shall be allowed to use the waves assigned. For instance, a certain big city will be given five different frequencies to use. But perhaps there are a dozen different stores and companies in the town who want to broadcast. All right, let the city or the county, or perhaps the state in which the town is located do the picking and select five firms who may make use of the assigned waves.

Eavesdropping on An Electron

You Can Hear the Mites Which Work Your Vacuum Tube

An Interview from PROF. PETER I. WOLD, Union College

Did you ever get a telegram at midnight? Probably you were so interested in the message that you did not think much about the boy who delivered it to you, and yet it is likely that he was a human being and was as important to some people. In the same way when you listen to your radio set, you are so interested in the program that it is doubtful if you think very much about the little messengers which carry the electricity through the vacuum tubes to bring the music to your ears. But it is the study of these tiny electrons that has made possible the wonderful improvement in vacuum tubes in the last few years.

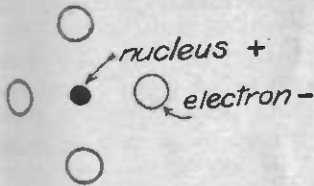

Fig. 1. An Atom Has Small Heavy Plus Charge Surrounded by Large Light Electrons.

With An Air of Mystery

What kind of a beast is it anyway—this electron? Everybody has heard of them and recently it has been possible even to hear them. They are so tiny that there is no chance of seeing them. Indeed, an electron is a small charge of negative electricity, the smallest charge of electricity which can exist, and is an essential part of the atoms which make up matter as we know it. Many people, having heard of "electrons" on several occasions, are of the impression that they are a rare, mysterious something which scientists have discovered, but which do not concern most folks. Electrons are mysterious in spite of all the information we have gathered, for there is a mystery to anything if there is still something to find out about it.

But they are not rare; in fact, they

are the most common thing in the universe. When you place your hand on the table, or take a mouthful of breakfast bacon, you are in contact with untold numbers of electrons and with nothing else; for every atom of matter is made up of a nucleus of positive electricity surrounded and well guarded by a number of electrons. Of course, you are not aware of them as electrons, for it is generally difficult to separate them from their atoms, and even if they were separated, it would need special apparatus to detect them.

Nucleus is Well Guarded

The general idea is crudely shown in Fig. 1. There is a "Nucleus" which consists of charges of positive electricity in the center, and a number of electrons which are particles of negative electricity around it. In any ordinary atom of every material the positive charge of the nucleus is exactly equal to the negative charge of the electron. It is very much smaller and heavier, however. We do not know yet exactly how the various parts of the atom are arranged, as Fig. 1 is intended only as a crude way of showing the atom.

Every different element has a different number of electrons starting with one for hydrogen, up to 92 for uranium. By suitable treatment, substances may be made to give up some of their electrons, and a few materials like radium will give up some electrons spontaneously—these being the so-called "radioactive" substances.

It seldom happens that a practical discovery like radio is sprung on a startled world until after a long series of careful experience had been made in regard to the theory of the invention. The discovery of the electron is no exception to this. In fact, it may be said to be the culmination of a century of work in the electrical field. Of the numerous contributors, I would make mention of

that prince of experimental scientists, Michael Faraday.

Changes Liquids, Not Metals

In addition to his many other important contributions to science, Faraday, about 90 years ago, discovered the laws of electrolysis. You can run electricity through a wire for years, and the metal is not changed in the least. But when the current is passed through a liquid, it always changes the material in some chemical way. That is what is meant by electrolysis. His discoveries are used in nickel plating, making aluminum, and many other arts.

If you dissolve a chemical compound in water and next dip two metal plates into the solution, and then pass an electric current through this combination, you will find that the compound is usually broken up and certain materials are deposited on the plates. The explanation is that in solution the chemical compound is dissociated or broken up into positively and negatively charged ions. If, for example, we make a solution of hydrochloric acid, (Muriatic Acid is its common name), consisting of hydrogen and chlorine, the acid will be broken up into hydrogen atoms or ions, each carrying a plus charge, and chlorine ions each carrying a minus charge, Fig.

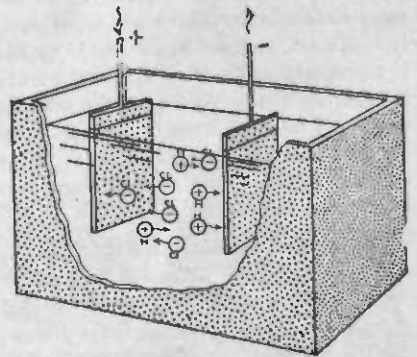

Fig. 2. In a Plating Cell the Salts in the Bath Are Broken Into Two Parts.

2. The positive ions will travel towards the minus metal plate, and the negative ions toward the plus plate. Now the smallest charge which any ion has been found to carry is that which goes with hydrogen, and all other ions are found to have the same charge or an exact multiple of it.

Weighing Unseen Balls

It is just as if we wanted to find the weight of a billiard ball, and that they were done up in packages so that we did not know how many each package contained. We might weigh several hundred packages and find the scales showed the following number of ounces: 8, 4, 10, 2,

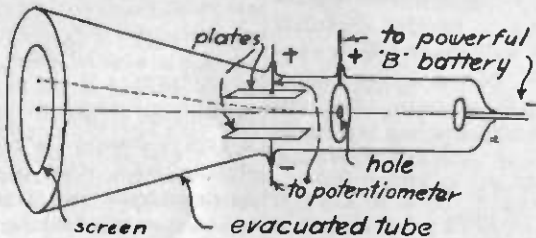

Fig. 3. The Path of the Electrons is Curved Up When a Charge is Put on the Two Plates.

30, 16, 2, 12, and so forth. Notice that the smallest number which we ever run across is 2, and that all the other weights are exactly a whole number of times this smallest value. We should naturally conclude that the weight of one billiard ball was 2 ounces. Of course if we found a single case where the weight was an odd number or a fraction it would show immediately that a single ball must weigh less than 2 ounces, and we must measure further.

The fact that every other charge is always an exact multiple of hydrogen suggests that the charge on this element is a natural unit of electricity. At the same time, the hydrogen ion or atom is the lightest one we know of, i. e., has the smallest mass (weight), and so the ratio of its charge to its atomic mass is of special interest since it must be larger than for any other element. Bear this in mind, for it is an important fact to which I shall refer again.

Defied the Master Minds

I must call your attention to another class of phenomena which was studied extensively during the century preceding the discovery of the electron. You know that air and other gasses are very poor conductors of electricity. At ordinary pressures in air, we get only a

violent discharge as in lightning, but if the pressure is reduced to one-third or less the discharge becomes continuous, and takes on a color and form which depends on the gas used and the pressure. The effects produced are frequently exceedingly beautiful but complex. Many scientists worked on these phenomena in attempts to find an explanation for them, but for many decades they defied the efforts of the ablest minds.

In the course of the investigation, it was found that the electric current was due to small electrified particles, some of which carried plus charges and some

negative charges. It was generally accepted that these particles were some form of matter, but it could not be said whether they were atoms or things larger than atoms. Very few had the boldness to suggest that they might be smaller than atoms. One of the characteristic effects produced by such a discharge was that of fluorescence, i. e., when these particles, especially the minus ones, struck certain substances, they caused them to give off a beautiful faint light.

You Have Seen Fluorescence

The best example of this kind of glow is to be found in the little balls which are often hung on an electric light chain to shine in the dark and show where to turn on the light at night. This fluorescence is caused by the rays from a tiny amount of radium salts striking the material inside the ball. Another example of the same idea is the luminous dial on a watch which enables you to tell the time at night.

About 1897, J. J. Thomson of Cambridge University, England, undertook some work on the problem of the electron. He made a glass tube (Fig. 3) with a metal electrode at each end and pumped out most of the air. He then connected one electrode to the plus end

of a powerful electric "B" battery generator and the other electrode to the minus end. An electric discharge now took place consisting of a stream of plus carriers travelling toward the negative electrode, and minus ones going to the positive. A small hole in the plus electrode permitted some of the minus carriers to pass through. They then travelled in a narrow stream to a fluorescent surface, making a bright spot of light.

Moving the Spot of Light

Above and below this stream were placed metal plates which could be charged. The negative particles (electrons) would be attracted upward towards the positive plate, and so the position of impact on the fluorescent surface would be changed. This made the spot of light move up. The amount of the deflection of the spot of light depended on the charge of the particle, on its mass (weight), and on its velocity, all of which were unknown.

By performing a similar experiment, using however, a magnetic field to deflect the negative particles, it was possible for Thomson to find the velocity of the particles and it came out to be in the neighborhood of 20 to 50 thousand miles per second, (not per hour) depending on the voltages used in the tube. This is much higher than had ever been found for any atoms, even hydrogen, which is the lightest. Professor Thomson was also able to find the ratio of the charge of the particles to their mass, but was not able at that time to find these two separately. The value obtained for this ratio was highly surprising, for it came out about 1800 times larger than the value I spoke of for hydrogen by electrolysis.

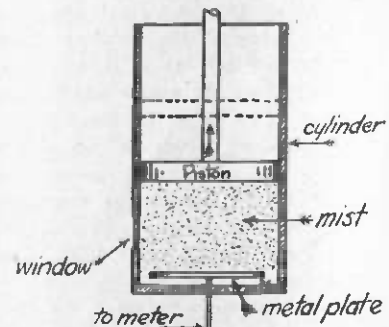

Fig. 4. This Shows How a Rainstorm Starts.

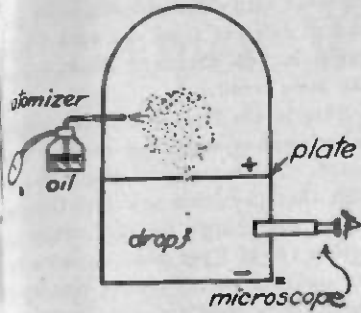

Fig. 5. The Oil Drops Pick Up Minus Charges and Then Dance.

Which Way Would You Guess?

What conclusions are to be drawn from this? Either the charge on the particles is 1800 times as large as on the hydrogen atom, the mass being about the same, or the mass (weight) of the corpuscles is 1800 times smaller than for the hydrogen atom (or some combination). The former conclusion did not seem probable in view of the experiments in electrolysis of solutions. On the other hand, it was difficult for many scientists to think there were particles of smaller mass than the hydrogen atom.

To get this difficulty in mind, suppose I tell you that in a certain school yard there are a lot of boys all the same age, who weigh altogether 1,000 pounds. The question is how many boys are there and how heavy is each one. Until we get further details we cannot tell whether there are ten boys of 100 pounds each, 20 boys weighing 50 pounds, or any other of the many possibilities. If we knew either the number of boys or the individual weight, we could immediately find what the missing value is. The same trouble bothered the scientists on this problem.

They All Gave Same Answer

Thomson tried the experiment on many different gases, and with different metal electrodes in the tube with the amazing result that this ratio came out

the same in all cases. While it was not possible at the time to find the charge alone on the atom, or to find the mass alone, and so definitely show which conclusion was right, the prevailing opinion was that the particles carried the same charge as the hydrogen atom, but were of a much smaller mass.

Since they could be obtained from any substance, it indicated very definitely that the atoms of different elements, which formerly had been considered indivisible, were actually complex systems and could be subdivided. This indication has been amply verified since then and has been the starting point of much of the wonderful scientific progress of the past two decades.

Could Not Tell Them Apart

Naturally the quantities which interest us most, to start with, are the charge, "e" on an electron, and the mass, "m," i. e., the quantity of matter. As just described, Thomson found the ratio "e/m" and it came out about 1800 times larger than for any other known case, but that he was unable at the time to find e and m separately. Later he did this, and the particular experimental work by which he accomplished it stands out as one of the finest pieces of research work in science, and is well worth describing.

Let us consider for a moment what his problem was. If he could find the mass, m, alone, he could then find the charge, e; or if he could find e alone, he could find m, but it seemed entirely out of the question to isolate one of these particles, and even if it were possible, the quantities to be measured would be far too small for the most sensitive instruments.

Count a Few Millions

It is possible to permit a stream of these minute particles to fall on an electrode or metal plate and collect the electricity which they carry. If then, we could find how many particles were col-

lected, we could immediately find the charge on each. But the charge is so small for each one that it takes hundreds of millions of them to give a charge large enough to measure directly. How then, can we count this large number? Certainly only by some indirect method.

In order to explain this, I must digress for a moment. You know that air such as is in your house, usually contains water in the form of vapor. When the amount of vapor becomes large, we say the humidity is high, and we find it exceedingly uncomfortable. We speak of the humidity as being, say, 80 per cent. or 90 per cent., and imply that when it is 100 per cent. that the space is holding as much moisture as it can. This is true. But as the temperature becomes lower, the maximum amount of moisture which can be held is less.

Why Cold Pitchers Sweat

If then, we are near saturation and we lower the temperature enough, there will be more moisture present than the air can hold, and the excess condenses. This is what occurs when moisture gathers on a cold pitcher in summer, and when clouds are formed. It has been found that in order for such condensation to take place, there must in general be something in which the action can start. Usually this occurs on the numerous dust particles present in the air, and a cloud or fog of small drops results. If the air has been very carefully purified so that there are no such dust particles, no condensation will take place unless the temperature has been lowered much below the saturation point.

Now it was soon found that if electrified particles or electrons are present instead of dust particles, that condensation will take place very readily, each one collecting on itself a small drop of water. The size of the drops depends

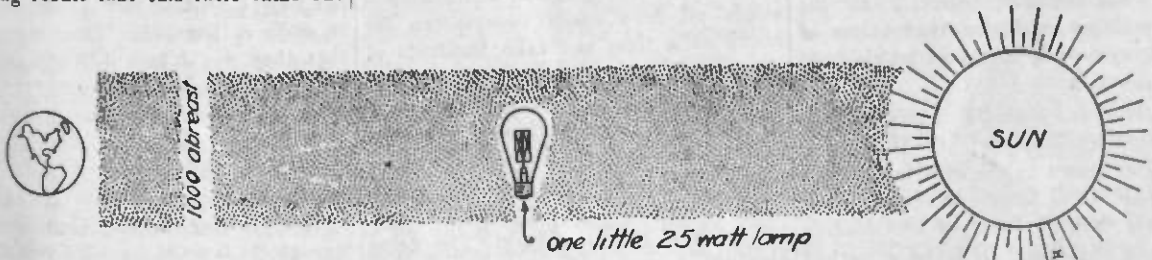

Fig. 6. A Procession of Electrons 1000 Abreast Reaching to the Sun Must Pass 25 Times to Light a Small Lamp for One Second.

on how many of the charged particles there are, and the amount of excess moisture. The small drops will start falling, but being very tiny, they encounter much resistance in the air and so they settle down very slowly at a rate depending on the size of the drops.

X-Rays Make the Mist

Thomson made use of all this in the following manner (Fig. 4): He had a cylinder, closed by a piston, filled with air saturated with moisture. He jerked out the piston and so increased the volume suddenly, thus causing a quick drop in temperature, and therefore a supersaturation. At the same time he produced (by X-rays) in the cylinder a larger number of those negative electrons he had been studying and immediately each one became a center of condensation, and so a fog appeared. The small drops now settled at a certain rate, and then, by observing this and knowing the laws of nature, he could calculate their size. When they had all settled on a plate on the bottom of the vessel, he weighed it. Knowing the amount of water thus collected and the size of each drop, he found the number of drops—i. e., the number of electrons he started with, and thus his counting was done.

At the same time that the drops were collected on the plate they brought with them their electric charges, giving a single large charge. Taking this charge and dividing by the number of drops, he found the charge on each drop—i. e., the charge on each of the original electrons.

Almost Smaller Than Nothing

The result of this exceedingly brilliant piece of work was that it showed conclusively that the charge, e , on the electron is the same as on the hydrogen atom, and so that the mass of the electron is about 2000 times smaller than that for the hydrogen atom. Thus scientists were brought definitely to the epoch-making conclusion that atoms of matter were complex things which could be subdivided.

Beautiful and splendid as this work is, it must be pointed out that the possibilities of errors in the experiment as a whole, are quite large. It remained for Professor Millikan, one of our leading American physicists, to devise a method of much higher accuracy, and I should like to describe this briefly.

Spraying and Watching the Oil

In spite of its smallness, Professor Millikan did actually isolate and find the effect of a single electron. In a rather small glass vessel (Fig. 5) containing a metal bottom, he inserted a metal plate about 2 inches above the floor, thus dividing the vessel into two chambers. The upper plate had a small hole at the



Fig. 7. Multiply a Baseball to Earth Size. The Same with an Electron, and it Can't be Seen.

middle. Leading into the upper chamber he had an atomizer of the same kind as you may use for spraying your throat, and with this he forced into the upper chamber a spray of oil. The small oil drops started to settle, and occasionally one would pass through the small hole into the lower chamber. Near this hole he placed a microscope in order to see the drop. From the rate at which it fell he could determine its size and weight.

He now charged the two metal plates, the upper one positive and the lower one negative. If the drop of oil itself happened *not* to be charged, it would not be affected by this. He now ionized some of the air in the lower chamber by means of X-rays, producing negative electrons. Occasionally one of these would attach itself to the drop, charging it, and then the drop would be attracted to the upper (+) plate. From the change in its velocity of falling which occurred, he could calculate the charge which had been picked up by the drop.

They Got the Same Answer

By varying the voltage on the metal plates, Professor Millikan could keep a single oil drop under observation for hours at a time and take hundreds of readings on it as it picked up one charge after another. The important fact stood out that this charge always came out the same, indicating that there is a minimum small unit of electricity which cannot be subdivided—i. e., that electricity is atomic in nature. The value obtained agreed well with that which J. J. Thomson found, but was much more accurate. This experiment has been

repeated with different kinds of oil drops and of different sizes, and with different gases in the chambers, *always giving the same result.*

This is the famous Millikan oil drop experiment of which you no doubt have heard. The accuracy of the work is so high that physicists now feel that they know the charge on the electron to within 1/5 of 1 per cent. A corresponding accuracy was, of course, obtained for the mass or weight of the electron.

Use Up 20 Zeros

After having talked so much about the measurements of the charge of the electron and of its mass, you are no doubt interested in knowing what the values are. The charge of the electron comes out about 1.6 divided by ten to the twentieth power (100,000,0. . . for 20 zeros) of the unit of charge which we commonly use in measuring quantities of electricity. That is, put down a decimal point, nineteen ciphers, and then the number sixteen. This probably does not mean much to you except that it shows the charge to be very small. Perhaps an illustration will help.

Take such an incandescent lamp as you have nearby as you sit at your radio set. Probably it is a 25-watt lamp. The current which flows through the lamp consists, as I shall explain to you in the concluding part of this article, of a stream of electrons. How many of these mites with the small charge they carry, must pass through the filament of the lamp in one second in order that the necessary amount of electricity shall be carried through?

Twenty-five Trips to the Sun

In order that we may visualize this better, let us imagine that the minute electrons are magnified so that they are as large as the average drop of water—say 1/10 of an inch in diameter, and that they are lined up, one after the other in a string. How long would the line be? I hesitate to tell you. But let us make a thousand of these strings so that they would pass us 1,000 abreast, Fig. 6. The line would reach from here to the sun *twenty-five times*. You can imagine then how many electrons pass each second through your lamp, and it may be interesting to mention that the electric power company sends these through the lamp at a cost to you of less than one ten thousandth of a cent.

What about the mass or weight of

Continued on Next Page

Open Windows—Sleep—Radios

How to Get Best Results From Radio Daily Dozen

By ELIZABETH COLE, New York

AFTER shutting off your radio, have you ever gone to bed with the chilly feeling that foretells a cold is coming on? With no thought of taking any bed-time exercises to the tunes from your loud speaker, you crawl into bed tired and achey and bury your head in the covers. You struggle to get your feet warm by twisting them into a bow-knot, and wake up in the morning with a headache, backache and a well-started head cold. "Yes," you say, "but if I'd opened my windows wide I'd be even warmer!"

You wouldn't be worse because of outdoor air, however—it would be because you probably tried your open window sleeping without making a business of dressing warmly. Not only yourself but your bed must be equipped especially for cold weather sleeping. Be a blanket under you as well as over you. Have an outing flannel night robe, preferably of the pajama type, and wear a loose flannel dressing gown over this if necessary. Some persons prefer a sleeping bag, but this is not essential. Warm knitted bed socks will keep the feet cosy (even at the foot

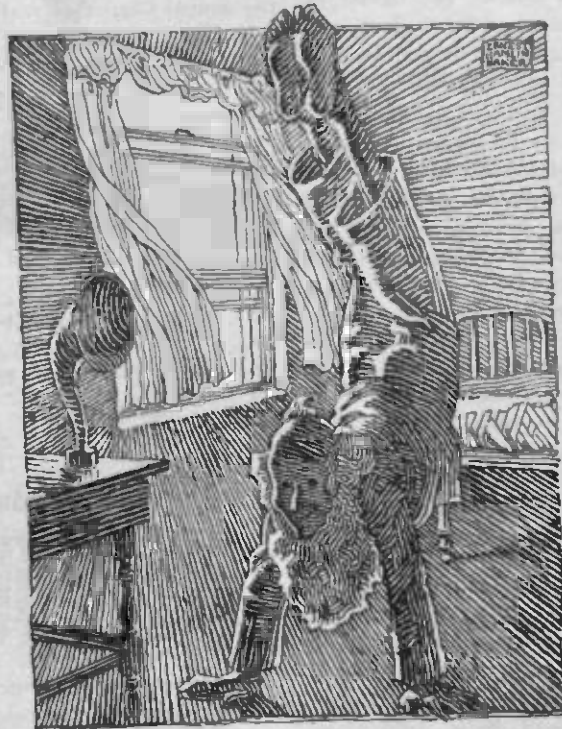

Fig. 1. What Keeps Grandpa So Full of Pep (of the bed!). In extreme weather, a knitted hood with or without shoulder cape may be necessary. (For further details about outdoor sleeping equipment write to the Journal of the Outdoor Life, 370 Seventh Avenue, New York City.)

Continued on Next Page

EAVESDROPPING ON AN ELECTRON

Continued from Previous Page

The electron? Expressed in pounds it is about two divided by ten to the thirtieth power; that is, put down a decimal point, twenty-nine ciphers and the number two. Here again the quantity is so small that it has very little meaning for us, in fact, one is at an almost total loss for a suitable comparison. We may consider the electron and the drop of water again. If both of these were magnified in the same proportion until the electron has the same mass as the drop of water, the drop would have a larger

mass than all the stars in our whole universe.

Microscope of No Use

Now, what about the size of the electron? We do not have accurate information on this, but it is generally taken as a sphere with a diameter of about one dividend by ten to the thirteenth power, i. e., the number which might be placed end for end in one inch would be 10 million million. Or, expressed in another way, if we compare a baseball and an electron, and magnify each in the same proportion till the ball is as large as the earth, (Fig. 7) the electron still would not be large enough for us to see it with the most powerful microscope.

These illustrations do not help us

much except to impress on us the smallness of the quantities with which we are dealing. The marvel is a double one; first, that there are such small quantities, and second, that science has made it possible to measure them.

Not only can they be measured, but the study of them has changed most profoundly our outlook on the universe from stars to radio tubes, and has modified our theories and explanations in regard to many of the common things happening around us.

In the second half of this article (in the Dec. 1 issue) I shall discuss some of the ordinary things of life which have been affected by our knowledge of electrons.

OPEN WINDOWS—SLEEP, RADIOS

Continued from Previous Page

Quality Not Quantity

Real woolen blankets, while expensive for the initial cost, will wear longer in the end and are light as well as warm. A light down quilt on top of everything will be a good guarantee against both cold and tired limbs. The lighter the clothing the more rested will one feel in the morning, for it is not quantity but quality of bedding that counts.

"Well, what will all this wonderful equipment do for me?" you ask. Just this. Everybody needs fresh air as a tonic. It is a medicine, free and really easy to procure. Fresh air cleanses and purifies the whole system and will prevent sickness, especially colds. It builds up resistance and is a necessity to every bodily function. Men and women who have become used to living day and night in outdoor air at any temperature (from 40 degrees below to 72 degrees above) have found that their bodies become hardened to the cold air. They gradually feel the same exhilaration as most people's faces experience in winter.

In the summer it is easy enough to be convinced that sleeping with windows open is a most desirable practice. It is in the fall and winter when people must realize the importance of cultivating this habit. Then is the time to throw open your bedroom windows wide, place your bed where the most air will strike it. (avoiding draughts, however), make a business of equipping it and yourself with the proper clothing, and gradually become accustomed to the refreshing tonic of outdoor air every night.

When You Turn on Radio

Then when you jump out of bed in the cold morning hours and turn on your radio for the "Daily Dozen" (Fig. 1) before leaping into your shower or tub you will know you are alive. The world will seem a happier place because you feel full of pep and health. Even blue Mondays may disappear! It is only in this way that you can obtain the full benefit from the radio exercises in the morning.

The National Tuberculosis Association and its affiliated state and local associations preach open windows—fresh air, day and night. They also preach

the need for plenty of exercise, sleep, nourishing food and a yearly physical examination to keep track of the general health. Their work is financed by the annual sale of Christmas seals. RADIO PROGRESS readers can help stamp out tuberculosis by throwing open their windows at night and by exercising indoors with windows open to the strains of their radios. At this season when the annual Christmas seal sale is being held they can also help by buying seals.

Here are some of the health maxims which have been emphasized in the radio health talks:

Open windows promote good health.

Health blows in through the open window.

To get rid of that tired feeling, open the window at night.

An open window in the office, the shop, or the home during the day will even up the temperature and will make you feel better.

AMUSEMENT ADS FOR BROADCASTING

Broadcasting super-station WHT, located in the Wrigley Building, Chicago, is believed to be the first radio station to use the advertising columns of the daily papers to announce their programs.

One Friday morning recently, the Chicago Herald and Examiner and the Chicago Tribune carried a fifty line "ad" at the head of their amusement columns announcing WHT's Sunday Radio Program. The advertisement was also carried in all Chicago evening papers on the same date.

Chicago's first radio program advertisement announced Paul Rader's two Sunday sermons, the first at three o'clock on "New Vacation Roads," and the second at 7:00 p. m. on "What is Authority?" The WHT announcement also gave the times of the National Radio Chapel's musical program for Sunday.

Chicago theatre managers registered a protest with the WHT broadcasting station for using the amusement columns for radio advertising, claiming that radio was harming the theatrical business enough without radio advertisements being run in the theatrical amusement columns.

In 15 Minutes I Will Give You the Secret of a Perfect Memory

I Guarantee to Increase Your Memory 100% In 10 Days

Not by any abstract, tiresome, difficult-to-master method; not by the old system of association of ideas or thoughts. Not by hard study,



rotation exercises or repetition of words or sounds. It is not a book. There is nothing to study—nothing to repeat. It is by far the newest, best, simplest method ever devised. I will give you a memory in one week's time that will surprise you. In one month things that occurred 30 days ago will be as fresh and clear in your mind as if they happened yesterday.

My Secret for 30 Years

I have given my secret to thousands. I have used it myself for more than 30 years. It enabled me

to rise to my present position as an educator in professional and scientific circles; it gave me a good vocabulary, developed my powers of perception and analysis and fitted me to write on a hundred subjects.

Command Success

My VI-FLECT method of memory-building is for those who are ambitious to improve their business, professional, social or financial condition. VI-FLECT will develop your brain-power—your ability—lift you out of the rut; you will no longer stumble, mumble, nor grope for words with which to express yourself. You will be surprised how easily you can remember names, faces, dates, figures, appointments, duties, etc. It will enhance your importance as an employer, your value as a manager or employee, increase your worth, your ability, expertness, raise your salary, help you in business, professionally, socially, politically—in every way.

Learn My Secret

I prefer to place my secret within the easy reach of everyone. Therefore, the price I am going to ask for VI-FLECT—my wonderful method of memory-building, which I have developed and perfected during my 30 years of constant study and application is ONLY \$5.00.

Let nothing stand between you and a successful, happy, prosperous future. If it is not convenient to enclose the money, or if you prefer, I will mail your copy of VI-FLECT and you can hand the small amount to your postman when he delivers the package. The important thing is—SEND NOW.

COUPON

Geo. J. Spinner,
416 S. Dearborn St., MB738
Chicago, Ill.

Dear Sir: Please send me my copy of VI-FLECT for which I enclose \$5.00. I will try your VI-FLECT method of memory-building for 10 days, and if it does not increase my memory 100% I am to return it and you are to give me my money back without argument.

Name

Address

City

State

Growing in popularity

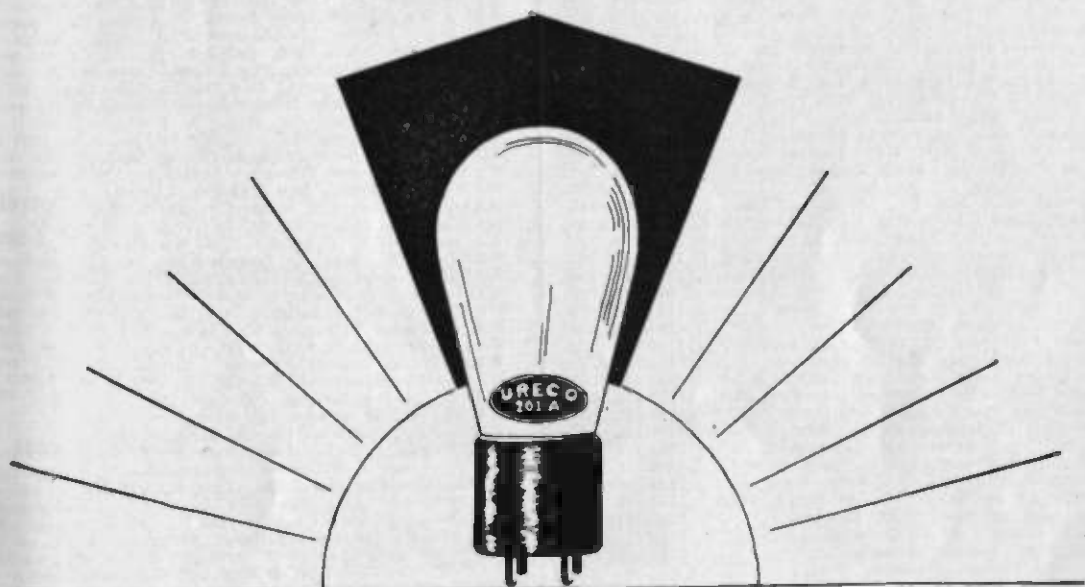

URECO RADIO TUBES

ACTUALLY give you the wonderful reception that is claimed by other tube manufacturers. URECO, specially matched, will do justice to your set by sending forth from your loud speaker that clear, distortionless reproduction you have been striving to attain.

Install a set of URECO TUBES in your set, and see the difference.

Ask your dealer for URECO. He carries the following sizes: U201A, U200, U199 (peanut and adapter base), U120 (3 volt power tube), U112 (6 volt power tube).

New England Distributors

American Consolidated Electric Co. of N. E.

Phone: Kenmore 0752

169 MASSACHUSETTS AVENUE

BOSTON, MASS.

**UNITED STATES BROADCASTING STATIONS
ARRANGED ALPHABETICALLY BY
CALL LETTERS**

K. C. W. L. W. P.

Abbreviations: W.L., wave length in meters; K.C., frequencies in kilocycles; W.P., wattpower of station.

K. C. W. L. W. P.

KDKA—Westinghouse Elec. & Mfg. Co., E. Pittsburgh, Pa.	970-309- var.
KDPM—Westinghouse Elec. & Mfg. Co., Cleveland, O.	1200-250- 500
KDZB—Frank E. Siefert, Bakersfield, Cal.	1430-210- 100
*KFAB—Nebraska Buick Auto Co., Lincoln, Neb.	850-341-1000
KFAD—McArthur Bros. Mercantile Co., Phoenix, Ariz.	1100-273- 100
KFAJ—University of Colorado, Boulder, Colo.	1150-261- 100
KFAU—Boise High School, Boise, Idaho.	1080-278- 500
KFBK—Kimball Upson Co., Sacramento, Cal.	1210-248- 100
KFBL—Leese Brothers, Everett, Wash.	1340-224- 100
KFBY—Bishop N. S. Thomas, Laramie, Wyo.	1110-270- 500
KFDJ—Oregon Agricultural College, Corvallis, Ore.	1180-254- 500
KFDX—Magnolia Petroleum Co., Beaumont, Tex.	950-316- 500
KFDY—First Baptist Church, Shreveport, La.	1200-250- 100
KFDZ—S. Dak. Ste. Col. Ag. & Mech. Arts, Br'kngs., S. D.	1100-273- 100
KFEO—Scroggin & Co. Bank, Oak, Neb.	1120-268- 500
KFFV—Graceland College, Lamoni, Iowa.	1200-250- 100
KFGC—Louisiana State Univ., Baton Rouge, La.	1120-268- 100
KFGH—Leland Stanford Junior Univ., Stanford Univ., Cal.	1110-270- 500
KFGX—First Presbyterian Church, Orange, Texas.	1200-250- 500
KFI—Earl C. Anthony, Los Angeles, Cal.	640-469-3000
KFFJ—National Radio Mfg. Co., Oklahoma, Okla.	1150-261- 225
KFKX—Westinghouse Elec. & Mfg. Co., Hastings, Neb.	1040-288-2000
KFLR—University of New Mexico, Albuquerque, N. Mex.	1180-254- 100
KFLV—Swedish Evangelical Mission Church, Rockford, Ill.	1310-229- 100
KFLZ—Atlantic Automobile Co., Atlantic, Iowa.	1100-273- 100
KFMQ—University of Arkansas, Fayetteville, Ark.	1000-390- 750
KFMR—Morningside College, Sioux City, Iowa.	1150-261- 100
KFMX—Carleton College, Northfield, Minn.	890-337- 500
KFNF—Henry Field Seed Co., Shenandoah, Iowa.	1130-266- 500
KFOA—Rhodes Dept. Store, Seattle, Wash.	660-454-1000
KFON—Echophones Radio Shop, Long Beach, Cal.	1290-233- 100
KFOO—Latter Day Saints Univ., Salt Lake City, Utah.	1270-236- 250
KFOR—David City Tire & Electric Co., David City, Neb.	1330-226- 100
KFOX—Technical High School, Omaha, Neb.	1210-248- 100
KFOY—K. M. Turner Radio Corp., Los Angeles, Cal.	1260-238- 250
KFPR—Los Angeles County Forestry, Los Angeles, Cal.	1300-231- 500
KFPY—Symons Investment Co., Spokane, Wash.	1130-266- 100
KFQB—Searchlight Publishing Co., Fort Worth, Texas.	1140-263- 150
KFQC—Kidd Brothers Radio Shop, Taft, Cal.	1300-231- 100
KFOU—W. E. Riker, Holy City, Calif.	1350-222- 100
KFRB—Hall Bros., Beville, Texas.	1210-248- 250
*KFRU—Stephens College, Columbia, Mo.	600-500- 500
KFSG—Echo Park Evangelistic Assn., Los Angeles, Cal.	1090-275- 500
KFUM—W. D. Pyle, Colorado Springs, Colo.	1240-242- 100
KFUD—Concordia Seminary, St. Louis, Mo.	550-545- 500
KFVE—Film Corporation of America, St. Louis, Mo.	1250-240- 500
KFVA—Airfan Radio Corporation, San Diego, Cal.	1220-246- 500
KFWA—Browning Bros. Co., Ogden, Utah.	1150-261- 100
KFWB—Warner Bros. Pictures, Inc., Hollywood, Cal.	1190-252- 500
KFWD—Arkansas Light & Power Co., Arkadelphia, Ark.	1130-266- 500
KFWH—F. Wellington Morse, Jr., Chiclo, Cal.	1180-254- 100
KFWI—Radio Entertainments, Inc., So. San Fran., Cal.	1360-220- 500
KFWM—Oakland Educational Society, Oakland, Cal.	1430-207- 500
KFWO—Lawrence Mott, Avalon, California.	1420-211- 250
KFWU—Louisiana College, Pineville, La.	1260-238- 100
KFXC—Santa Maria Val. R. Co., Santa Maria, Cal.	1430-210- 100
KFXF—Pikes Peak Broad. Co., Colorado Springs, Colo.	1200-250- 500
KGB—Tacoma Daily Ledger, Tacoma, Wash.	1200-250- 100
*KFYD—N. Baker, Muscatine, Iowa.	1170-256- 250
KGO—General Electric Co., Oakland, Cal.	830-361-3000
KGU—Marion A. Mulrony, Honolulu, Hawaii.	1110-270- 500
KGW—Portland Morning Oregonian, Portland, Ore.	610-491- 500
KHJ—Times-Mirror Co., Los Angeles, Cal.	740-405- 500
KHO—Louis Wasmser, Seattle, Wash.	1100-273- 100
KJR—Northwest Radio Service Co., Seattle, Wash.	780-384-1000
RLDS—R. Ch. Jesus Christ, L. D. Sis., Independence, Mo.	680-441-1000
KLS—Warner Bros. Radio Supplies Co., Oakland, Cal.	1240-242- 250
KLX—Tribune Publishing Co., Oakland, Cal.	590-508- 500
KLZ—Reynolds Radio Co., Denver, Colo.	1130-266- 250
KMA—May Seed & Nursery Co., Shenandoah, Iowa.	1190-252- 500
KMO—Love Electric Co., Tacoma, Wash.	1200-250- 100
KNRC—Clarence B. Juneau, Hollywood, Cal.	1440-208- 250
KNA—Los Angeles Express, Los Angeles, Cal.	890-337- 500
KOX—General Electric Co., Denver, Colo.	930-322-5000
KOB—New Mexico Col. of Agriculture, State Col., N. Mex.	860-349-1000
KOCH—Omaha Central H. School, Omaha, Neb.	1160-258- 100
KOIL—Monarch Manufacturing Co., Council Bluffs, Ia.	1080-278- 500
KOP—Detroit Police Dept., Detroit, Mich.	1080-278- 500
KPO—Hale Bros., San Francisco, Cal.	700-428- 500
KPRC—Houston Printing Co., Houston, Texas.	1010-297- 500
KPSN—Pasadena Star-News, Pasadena, Cal.	950-316-1000
*KOP—H. B. Read, Portland, Ore.	1410-213- 500
KOV—Double-Hill Electric Co., Pittsburg, Pa.	1090-275- 500
KRE—Berkeley Daily Gazette, Berkeley, Cal.	1160-258- 100

KSAC—Kansas State Agric. College	880-341- 500
KSD—Post-Dispatch, St. Louis, Mo.	550-545- 150
KSL—The Radio Service Corp., Salt Lake City, Utah	1000-300-1000
*KSO—A. A. Berry Seed Co., Clarinda, Iowa.	1240-242- 500
KTAB—Tenth Ave. Baptist Church, Oakland, Cal.	1250-240- 500
KTBI—Bible Institute of Los Angeles, Los Angeles, Cal.	1020-294- 750
KTCL—American Radio Tel. Co., Inc., Seattle, Wash.	980-310-1000
KTHS—New Arlington Hotel Co., Hot Springs, Ark.	800-375- 500
*KTW—First Presbyterian Church, Seattle, Wash.	660-454-1000
KUO—Examiner Printing Co., San Francisco, Cal.	1220-246- 150
KUOM—State Univ. of Montana, Missoula, Mont.	1230-244- 250
*KUT—University of Texas, Austin, Texas.	1308-231- 500
KWEC—Wilson Duncan Studios, Kansas City, Mo.	1270-236- 100
*KWKH—W. G. Paterson, Kennonwood, La.	1150-261- 500
KWSC—State College of Washington, Pullman, Wash.	860-349- 500
KWWG—City of Brownsville, Brownsville, Texas.	1080-278- 500
KYW—Westinghouse Elec. & Mfg. Co., Chicago, Ill.	560-535-2000
KZKZ—Electrical Supply Co., Manilla, P. I.	1110-270- 100
KZM—Preston D. Allen, Oakland, Cal.	1240-242- 100
KZRQ—Far Eastern Radio, Manila, P. I.	1350-222- 500
KZUY—F. Johnson, Elser, Baguio, P. I.	833-360- 500
NAA—United States Navy, Arlington, Va.	690-435-1000
WAAB—Valdemar Jensen, New Orleans, La.	1120-268- 100
WAAC—Tulane University, New Orleans, La.	1090-275- 100
WAAF—Chicago Daily Drovers Journal, Chicago, Ill.	1080-278- 200
*WAAM—J. R. Nelson Co., Newark, N. J.	1140-263- 500
*WABI—First Universalist Church, Bangor, Me.	1250-240- 100
WAAW—Omaha Grain Exchange, Omaha, Neb.	1080-278- 100
WABA—Lake Forest University, Lake Forest, Ill.	1320-227- 200
WABO—Lake Avenue Baptist Church, Rochester, N. Y.	1080-278- 100
WABX—Henry B. Joy, Mount Clemens, Mich.	1220-246- 150
WADC—Allen Theatre, Akron, O.	1160-258- 500
WAFD—Albert B. Parfet Co., Port Huron, Mich.	1090-272- 500
WAHG—A. H. Grebe Co., Richmond Hill, N. Y.	950-316- 500
WAMD—Hubbard & Co., Minneapolis, Minn.	1230-244- 500
WAPI—Alabama Polytechnic Institute, Auburn, Ala.	1210-248- 500
WARC—Am. Rad. & Research Corp., Med'f'd H'side, Mass.	1150-261- 100
WBA—Purdue University, West Lafayette, Ind.	1100-273- 500
WBAK—Pennsylvania State, Police, Harrisburg, Pa.	1090-275- 500
WBAO—James Millikin University, Decatur, Ill.	1110-270- 100
WBAP—Wortham-Carter Publishing Co., Fort Worth, Tex.	630-476-500
WBAV—Erner & Hopkins, Columbus, Ohio.	1020-294- 500
WBAX—John H. Stenger, Jr., Wilkes-Barre, Pa.	1170-256- 100
WBBL—Grace Covenant Church, Richmond, Va.	1310-229- 150
WBBS—Foster's Pulpit Assoc., Rossville, N. Y.	1100-273- 500
WBCE—Foster & McDonnell, Chicago, Ill.	1130-266- 500
WBES—Bliss Electrical School, Takoma Park, Md.	1300-222- 100
WBNY—Shirley Katz, New York, N. Y.	1430-210- 500
WBOQ—A. H. Grebe Co., Richmond Hill, N. Y.	1270-236- 100
WBRE—Baltimore Radio Exchange, Baltimore, Md.	1300-231- 100
*WBT—Charlotte Chamber of Commerce, Charlotte, N. C.	1090-272- 100
WBZ—Westinghouse Elec. & Mfg. Co., Springfield, Mass.	900-331-2000
WBZA—Westinghouse Elec. & Mfg. Co., Boston, Mass.	1240-242- 250
WCAC—Connecticut Agric. College, Mansfield, Conn.	1090-275- 500
WCAD—St. Lawrence University, Canton, N. Y.	1140-263- 250
WCAE—Kaufmann & Baer Co., Pittsburg, Pa.	650-461- 500
WCAH—Entrekin Electric Co., Columbus, O.	1130-266- 500
WCAJ—Nebraska Wesleyan Univ., Univ. Place, Neb.	1180-254- 500
WCAL—St. Olaf College, Northfield, Minn.	890-337- 500
WCAO—A. A. & A. S. Brager, Baltimore, Md.	1090-275- 100
WCAP—Chesapeake & Potomac Tel. Co., Wash., D. C.	640-469- 500
WCAR—Southern Radio Corp. of Texas, San Antonio, Tex.	1140-263- 100
WCAU—Durham Co., Philadelphia, Pa.	1080-278- 500
WCAX—University of Vermont, Burlington, Vt.	1200-250- 100
WCBC—University of Michigan, Ann Arbor, Mich.	1310-229- 200
WCBD—Wilbur G. Voliva, Zion, Ill.	870-345-5000
WCBO—First Baptist Church, Nashville, Tenn.	1270-236- 100
WCCO—Washington Crosby Co., Minneapolis, Minn.	720-416-5000
WCCE—Charles E. Erbstein, Elgin, Ill.	1090-275-1000
WCLS—H. M. Couch, Joliet, Ill.	1400-214- 150
*WCSS—Congress Square Hotel Co., Portland, Me.	1170-256- 500
WCWU—Clark University, Worcester, Mass.	1260-238- 250
*WCWS—Charles W. Selen, Providence, R. I. (Portable)	1430-210- 100
WCX and WJR—The Detroit Free Press and Jewett Radio and Phonograph Co., Pontiac, Mich., (operating jointly).	580-517-2500
WDAD—Dad's Auto Accessories, Inc., Nashville, Tenn.	1330-226- 150
WDAE—Tampa Daily News, Tampa, Fla.	1100-273- 250
WDAG—Kansas City Star, Kansas City, Mo.	820-366- 500
WDAP—J. Laurence Marlin, Amarillo, Tex.	1140-263- 100
WDBE—Giham-Schoen Electric Co., Atlanta, Ga.	1080-278- 100
WDBK—M. F. Broz Radio Store, Cleveland, O.	1320-227- 100
WDBO—Rollins College, Winter Park, Fla.	1250-240- 100
WDBR—Tremont Temple Baptist Church, Boston, Mass.	1150-261- 100
WDCH—Dartmouth College, Hanover, N. H.	1170-256- 100
WDWF—Dutee W. Flint, Cranston, R. I.	680-441- 500
WDZ—James L. Bush, Tuscola, Ill.	1080-278- 100
WEAF—American Tel. & Tel. Co., New York, N. Y.	610-492-5000
WEAI—Cornell University, Ithaca, N. Y.	1180-254- 500
WEAM—Borough of North Plainfield, N. Plainfield, N. J.	1150-261- 250
WEAN—Shepard Co., Providence, R. I.	1110-270- 500
WEAO—Ohio State University, Columbus, Ohio.	1020-204- 500
WEAR—Goodyear Tire & Rubber Co., Cleveland, Ohio.	770-389- 750
WEAU—Davidson Bros. Co., Sioux City, Iowa.	1090-275- 100

The Heart of Your Radio Set

A Grid Leak is essential on every set. There are few sets made which wouldn't be improved by the use of a Variable Grid Leak.

Even the set makers admit that.

But those makers say—"Show us a good Variable Grid Leak,"—because they know that most of the variables on the market have been a failure.

Right now -- we're showing them

Buy It

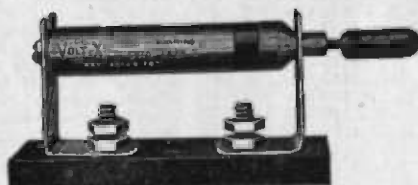

Try It

Volt-X Ball-Bearing
Variable Grid Leak

If you are not satisfied, return it and get your money back

This GRID LEAK is made by an organization which has been handling delicate electrical instruments for years. We know what it means to build accurately and substantially. We KNOW that this GRID LEAK is as nearly perfect as human hands and precise machinery can make it —we're glad to have you try it with the knowledge that if it doesn't do what we claim for it, your money will be refunded.

Clip the coupon, and send it in with \$1.00—a grid leak will be mailed at once.

BURTON & ROGERS MFG. CO.

755 Boylston St.

Boston, Mass.

Please
send me one
of your VOLT-X
VARIABLE GRID
LEAKS.

I enclose \$1.00 with
the understanding that
this merchandise is guaran-
teed to give satisfaction, or
may be returned.

NAME.

ADDRESS.

K.C.W.L.W.P.

WEBC—Walter C. Bridges, Superior, Wis.	1240-242-100
WEBH—Edgewater Beach Hotel Co., Chicago, Ill.	810-373-1000
WEBJ—Third Avenue Railway Co., New York, N. Y.	1100-275-500
WEBK—Grand Rapids Radio Co., Grand Rapids, Mich.	1240-242-100
WEBL—Radio Corp. of America, United States (portable)	1330-226-100
WELM—Radio Corp. of America, United States (portable)	1330-226-100
WEW—Beloit College, Beloit, Wis.	1120-268-500
WEET—Edison Electric Illuminating Co., Boston, Mass.	630-476-500
WEMC—Emmanuel Missionary Col., Berrien Springs, Mich.	1050-286-500
WENR—All-American Radio Corp., Chicago, Ill.	1130-266-1000
WEW—St. Louis University, St. Louis, Mo.	1210-248-100
WFAA—Dallas News & Dallas Journal, Dallas, Tex.	630-476-500
WFAV—University of Nebraska, Lincoln, Neb.	1090-275-500
WFBG—William F. Gable Co., Altoona, Pa.	1080-278-100
WFBH—Concourse Radio Corp., New York, N. Y.	1100-273-500
WFBJ—Galvina Radio Supply Co., Camden, N. J.	1270-236-250
WFBK—Onondaga Hotel, Syracuse, N. Y.	1190-252-100
WFBM—Merchant Heat & Light Co., Indianapolis, Ind.	1120-268-250
WFBP—Fifth Infantry, Maryland N. G., Baltimore, Md.	1180-254-100
WFD—Frank D. Fallain, Flint, Mich.	1280-234-100
WFI—Strawbridge & Clothier, Philadelphia, Pa.	760-395-500
WFKB—Francis K. Bridgman, Chicago, Ill.	1380-217-500
WFLR—Robert Morrison Lacey, Brooklyn, N. Y.	1460-205-100
WGBB—Harry H. Carman, Freeport, N. Y.	1230-244-100
WGBF—Finke Furniture Co., Evansville, Ill.	1270-236-100
WGBQ—Stout Institute, Menomonee, Wis.	1280-234-100
WGBS—Gimbel Bros., New York	950-316-500
WGBU—Florida Cities Fin. Co., Fulford By-The-Sea, Fla.	1080-278-500
WGBX—University of Maine, Orono, Me.	1190-252-100
WGCP—D. W. May, Newark, N. J.	1190-252-500
WGES—Coyno Electrical School, Oak Park, Ill.	1200-250-500
WGHB—Geo. H. Bowles Developments, Clearwater Fla.	1130-266-500
WGHP—Geo. H. Phelps, Inc., Detroit, Mich.	1110-270-500
WGMU—A. H. Grebe & Co., Inc. (portable), Richmond Hill, N. Y.	1270-236-100
WGN—The Tribune, Chicago, Ill.	810-373-1000
WGR—Federal Telephone Mfg. Corp., Buffalo, N. Y.	940-319-750
WGST—Georgia School of Technology, Atlanta, Ga.	1110-270-500
WGY—General Electric Co., Schenectady, N. Y.	790-380-4000
WHA—University of Wisconsin, Madison, Wis.	560-535-750
WHAD—Marquette Univ. and Mil. Jour., Mil., Wis.	1090-275-500
WHAG—University of Cincinnati, Cincinnati, O.	1290-233-100
WHAM—University of Rochester, Rochester, N. Y.	1080-278-100
WHAP—William H. Taylor Finance Corp., Brooklyn, N. Y.	1250-250-100
WHAR—Seaside Hotel, Atlantic City, N. J.	1090-275-500
WHAS—Courier Journal & Louisville Times	750-400-500
WHAT—George W. Young, Minneapolis, Minn.	1140-263-500
WHAV—Wilmington Elec. Specty Co., Wilmington, Del.	1130-266-100
WHAZ—Rensselaer Polytechnic Institute, Troy, N. Y.	790-380-500
WHB—Sweeney School Co., Kansas City, Mo.	820-366-500
WHBF—Beardsley Specialty Co., Rock Island, Ill.	1350-227-100
WHBH—Culver Military Academy, Culver, Ind.	1350-227-100
WHBP—Johnstown Automobile Co., Johnstown, Pa.	1170-256-100
WHBW—D. R. Kienzie, Philadelphia, Pa.	1390-216-100
WHDI—Wm. Hood Dunwoody I. Inst., Minneapolis, Minn.	1080-278-500
WHEC—Hickson Electric Co., Inc., Rochester, N. Y.	1160-258-100
WHK—Radio Air Service Corp., Cleveland, O.	1100-273-250
WHN—George Schubel, New York, N. Y.	830-361-500
WHO—Bankers Life Co., Des Moines, Iowa	570-526-5000
WHT—Radiophone Broadcasting Corporation, Deerfield, Ill.	1260-238-1500
WIAD—Howard R. Miller, Philadelphia, Pa.	1200-250-100
WIAS—Home Electric Co., Burlington, Iowa	1180-254-100
WIBA—The Capital Times Studio, Madison, Wis.	1270-236-100
WIBC—L. M. Tate Post No. 39, V.F.W. St. Petersburg, Fla.	1350-222-100
WIBO—Nelson Brothers, Chicago, Ill.	1330-226-1000
WIBW—L. L. Dill, Logansport, Ind.	1360-220-100
WIL—St. Louis Star, Benson Radio Co., St. Louis, Mo.	1100-273-250
WIP—Gimbel Bros., Philadelphia, Pa.	590-508-500
WJAD—Jackson's Radio Eng. Laboratories, Waco, Texas	850-353-500
WJAG—Norfolk Daily News, Norfolk, Nebr.	1110-270-200
WJAK—Clifford L. White, Greentown, Ind.	1180-254-100
WJAM—D. M. Perham, Cedar Rapids, Ia.	1120-268-100
WJAR—The Outlet Co., Providence, R. I.	980-306-500
WJAS—Pittsburgh Radio Supply House, Pittsburgh, Pa.	1090-275-500
WJAZ—Zenith Radio Corp., Mt. Prospect, Ill. (limited)	930-322-1500
WJBC—Hummer Furniture Co., La Salle, Ill.	1280-234-100
WJBI—Robert S. Johnson, Red Bank, N. J.	1370-219-250
WJBL—Wm. Gushard Dry Goods Co., Decatur, Ill.	1110-270-500
WJJD—Supreme Lodge L. O. Moose, Mooseheart, Ill.	990-303-500
WJR—Same as WCX.	
WJY—Radio Corporation of America, New York, N. Y.	740-405-1000
WJZ—Radio Corporation of America, New York, N. Y.	660-454-1000
WKAA—H. F. Paar, Cedar Rapids, Iowa	1080-278-500
WKAF—WKAF Broadcasting Co., Milwaukee, Wis.	1150-261-250
WKAQ—Radio Corporation of Porto Rico, San Juan, P. R.	880-341-500
WKAR—Michigan Agric. Col., E. Lansing, Mich.	1050-286-1000
WKBB—Sanders Bros., Joliet, Ill.	1400-214-100
WKBE—K. and B. Electric Co., Webster, Mass.	1300-231-100
WKBG—C. L. Carrell (portable), Chicago, Ill.	1390-216-100
WKBK—Shirley Katz, New York, N. Y.	1430-210-500
WKRC—Kodel Radio Corp., Cincinnati, O.	710-422-1000
WKRC—Kodel Radio Corp., Cincinnati, O.	920-353-1000
WKY—E. C. Hull and H. S. Richards, Oklahoma, Okla.	1090-275-100
WLAL—First Christian Church, Tulsa, Okla.	1200-250-150

K.C.W.L.W.P.

WLB—University of Minnesota, Minneapolis, Minn.	1080-278-500
WLBL—Wisconsin Dept. of Markets, Stevens Point, Wis.	1080-278-500
WLIT—Lit Bros., Philadelphia, Pa.	760-195-500
WLS—Sears, Roebuck Co., Chicago, Ill.	870-345-500
WLTS—Lane Technical High School, Chicago, Ill.	1160-258-1000
WLW—Crosley Radio Corp., Harrison, O.	710-422-5000
WLWL—Mis. Soc. of St. Paul the Apostle, New York	1040-288-1000
WMAC—Clive B. Meredith, Cazenovia, N. Y.	1090-275-100
WMAF—Round Hills Radio Corp., Dartmouth, Mass.	680-441-1000
WMAK—Norton Laboratories, Lockport, N. Y.	1130-466-500
WMAQ—Chicago Daily News, Chicago, Ill.	670-448-500
WMAZ—Mercer University, Macon, Ga.	1150-264-500
WMBB—American Bond & Mortgage Co., Chicago, Ill.	1200-250-500
WMBC—Michigan Broadcasting Co., Detroit, Mich.	1170-256-100
WMBF—Fleetwood Hotel, Miami Beach, Fla.	780-384-500
WMC—Commercial Appeal, Memphis, Tenn.	600-500-500
WMCA—Greeley Square Hotel Co., Hoboken, N. J.	880-341-500
WNAF—Shepard Stores, Boston, Mass.	1200-250-100
WNAC—Shepard Stores, Boston, Mass.	1070-230-500
WNAD—University of Oklahoma, Norman, Okla.	1180-254-250
WNAP—Wittenberg College, Springfield, Ohio	1090-275-100
WNAT—Lennig Bros. Co., Philadelphia, Pa.	1200-250-100
WNAX—Dakota Radio Apparatus Co., Yankton, S. Dak.	1230-244-100
WNJ—Radio Shop of Newark, Newark, N. J.	1290-233-100
WNOX—People's Tel. & Tel. Co., Knoxville, Tenn.	1120-268-500
WNYC—City of New York, New York, N. Y.	1190-233-100
WOAI—Southern Equipment Co., San Antonio, Texas	760-395-1500
WOAN—James D. Vaughn, Lawrenceburg, Tenn.	1060-283-500
WOAW—Woodmen of the World, Omaha, Nebr.	570-526-1000
WOAX—Franklyn J. Wolff, Trenton, N. J.	1250-240-500
WOC—Palmer School of Chiropractic, Davenport, Iowa	620-484-1000
WODA—O'Dea Temple of Music, Paterson, N. J.	1340-224-500
WOI—Iowa State College, Ames, Iowa	1110-270-750
WOK—Neutrowound Radio Mfg. Co., Homewood, Ill.	1380-217-5000
WOO—John Wanamaker, Philadelphia, Pa.	590-508-500
WOX—Unity School of Christianity, Kansas City, Mo.	1080-278-1000
WOR—L. Bamberger & Co., Newark, N. J.	740-405-500
WORD—People's Pulpit Association, Batavia, Ill.	1090-275-5000
WOS—Missouri State Marketing Bureau, Jefferson City, Mo.	680-441-500
WOVO—Main Auto Supply Co., Fort Wayne, Ind.	1320-227-500
WPG—Municipality of Atlantic City, Atlantic City, N. J.	1000-300-500
WPRC—Wilson Printing & Radio Co., Harrisburg, Pa.	1390-216-100
WPSC—Pennsylvania State College, State College, Pa.	1150-261-500
WQAC—Horace A. Beale, Jr., Parkersburg, Pa.	1360-220-500
WQAA—Gish Radio Service, Amarillo, Tex.	1280-234-100
WQAM—Electrical Equipment Co., Miami, Fla.	1140-263-100
WQAN—Scranton Times, Scranton, Pa.	1200-250-100
WQAO—Calvary Baptist Church, New York, N. Y.	833-360-100
WQAE—Economy Light Co., Escanaba, Mich.	1170-256-100
WRAM—Lombard College, Galesburg, Ill.	1230-244-100
WRAV—Antioch College, Yellow Springs, Ohio	1140-263-100
WRAX—Flexon's Garage, Gloucester City, N. J.	1120-268-500
WRC—Radio Corporation of America, Washington, D. C.	640-466-1000
WRCO—Wynne, Radio Co., Raleigh, N. C.	1190-252-100
WREO—Reo Motor Car Co., Lansing, Mich.	1050-286-500
WRK—Doron Bros. Electrical Co., Hamilton, O.	1110-270-100
WRM—University of Illinois, Urbana, Ill.	1100-273-500
WRMU—A. H. Grebe & Co., Richmond Hill, N. Y.	1270-236-100
WRNY—Experimenter Publishing Co., New York, N. Y.	1160-258-500
WRR—Dallas Police & Fire Dept., Dallas, Tex.	1150-261-350
WRST—Radiotel Mfg. Co., Bay Shore, N. Y.	1390-216-250
WRW—Tarrytown Radio Research Labs, Tarrytown, N. Y.	1100-273-500
WSAI—United States Playing Card Co., Cincinnati, O.	920-326-5000
WSAJ—Grove City College, Grove City, Pa.	1310-229-250
WSAN—Allentown Call Publishing Co., Allentown, Pa.	1310-229-100
WSAR—Doughty & Welch Electric Co., Fall River, Mass.	1180-254-100
WSAX—Zenith Radio Corp., Chicago, Ill.	1120-268-100
WSB—Atlanta Journal, Atlanta, Ga.	700-428-1000
WSBC—World Battery Co., Chicago, Ill.	1430-210-200
WSBF—Stix, Baer & Fuller, St. Louis, Mo.	1100-273-250
WSBT—South Bend Tribune, South Bend, Ind.	1090-275-250
WSDA—The City Temple, New York, N. Y.	1140-263-500
WSKC—World's Star Knitting Co., Bay City Mich.	1150-261-100
WSMB—Saenger A'm'n Co., & Maison Blanche N. O. La.	940-319-500
WSM—Nat'l Life & Accident Ins. Co., Nashville, Tenn.	1060-283-1000
WSMK—S. M. K. Radio Corp., Dayton, Ohio	1090-275-500
WSOE—School of Eng'ng of Milwaukee, Milwaukee, Wis.	1220-246-500
WSRO—Radio Co., Hamilton, Ohio	1190-252-100
WSUI—State University of Iowa, Iowa City, Iowa	620-484-500
WSY—Alabama Polytechnic Institute, Auburn, Ala.	1200-250-500
WTAB—Fall River Daily Herald Pub. Co., Fall R'vr, Mass.	1130-266-100
WTAC—Penn. Traffic Co., Johnstown, Pa.	1120-268-100
WTAG—Worcester Telegram Pub. Co., Worcester, Mass.	1120-268-500
WTAM—Willard Storage Battery Co., Cleveland O.	770-389-3500
WTAR—Reliance Electric Co., Norfolk, Va.	1150-261-100
WTAT—Edison Illum'ing Co., Boston, Mass. (portable)	1230-244-100
WTAW—Agri. & Mech. Col. of Texas, Col. Station, Tex.	1110-270-500
WTIC—Travelers Insurance Co., Hartford, Conn.	860-349-500
WTD—Wright & Wright, Philadelphia, Pa.	1200-250-250
WWGL—Radio Engineering Corp., Richmond Hill, N. Y.	1410-213-500
WWI—Ford Motor Co., Dearborn, Mich.	1130-266-500
WWJ—Detroit News, Detroit, Mich.	850-353-1000
WWL—Loyala University, New Orleans, La.	1090-275-100

*Additions and corrections.

Growing
in popularity

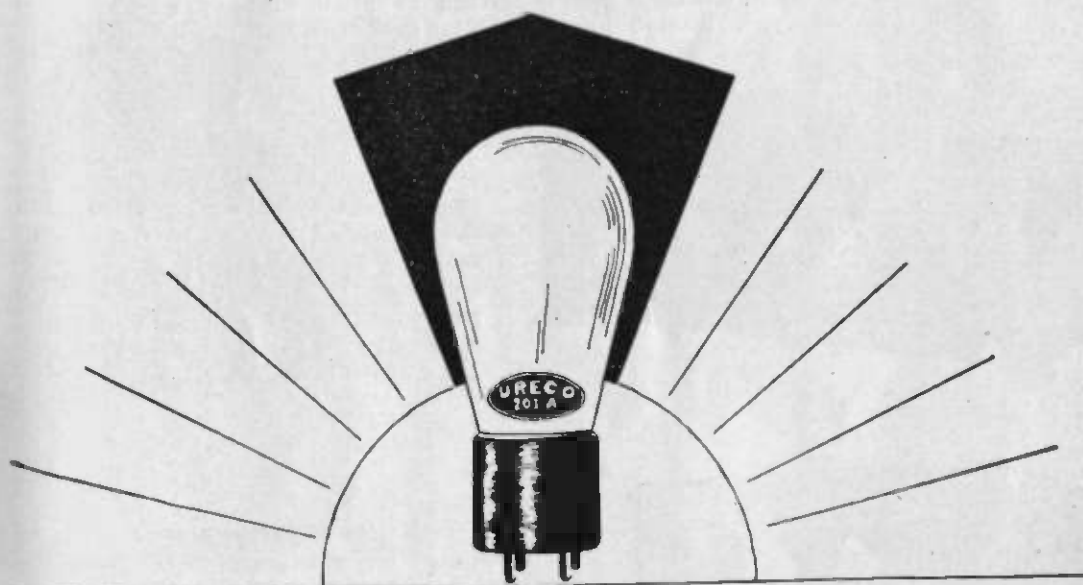

URECO RADIO TUBES

Have proved to be a revelation to those who have not as yet obtained the satisfaction claimed by the other tube manufacturers.

The tube is the heart of your set. If you are striving for distortionless reception—try URECO.

Your Dealer carries all types to suit your requirements.

New England Distributors

American Consolidated Electric Co. of N. E.

Phone: Kenmore 0752

169 MASSACHUSETTS AVENUE

BOSTON, MASS.

RIVOLI

"ALWAYS GOOD COMPANY"

RIVOLI is always good company—good company because it is a thing of beauty and because if there is anything on the air, Rivoli will get it to entertain you. No skill is needed to bring in the broadcast stations.



The Rivoli De Luxe combines all the convenience of a built-in speaker and a built-in battery compartment with the grace and beauty of a finely designed table model radio set. The cabinet is fashioned in two-tone mahogany with panel to match and sunburst dials that lend a pleasingly original touch. Symmetry is retained by the two silk-backed grills. **\$75.00**



The Rivoli Junior has been designed for those who must economize in space. In point of quality, the Junior is fully up to Rivoli standards. The cabinet is considerably better and more carefully finished than sets selling at a low price. Finished in mahogany with a generous flare to set off the panel. **\$60.00**

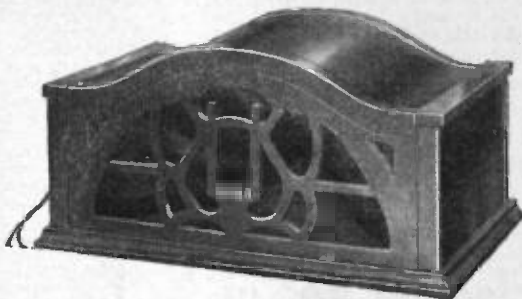

The Rivoli Speaker has successfully combined extreme beauty with acoustical perfection. Its tone chamber is constructed entirely of two-tone wood, seasoned by a special process. The front of the Rivoli Speaker is a grill, fashioned in a pleasingly decorative motif. The well known balanced type of unit is used. The Rivoli Speaker always harmonizes perfectly with its surroundings. **\$30.00**

The Rivoli Radio Line is manufactured by the Radio Industries Corp., 131 Duane St., N. Y. City

Rivoli

"ALWAYS GOOD COMPANY"



\$125.00

The Rivoli Console is a beautiful creation. It is designed in the period of William and Mary, and is constructed of two-tone mahogany. The finely carved legs, the cleanly cut grill which hides the speaker and battery compartments, the metal fittings, all lend an expensive air which seem out of all proportion to the remarkably low price. The built-in speaker is a revelation and recreates the broadcasting artist so clearly that he seems to be standing in the same room.



\$50.00

The Rivoli Table is a radical departure in the construction of radio tables. It has ample space for any table type of radio set, either large or small, generous battery compartments for housing A and B batteries and chargers or eliminators, and features a grilled speaker outlet behind which any form of horn or cone can be mounted. Aside from its utility, the Rivoli Table is a beautiful piece of furniture, designed in two-tone mahogany or walnut. It solves the problem of where to put your radio set.

(Space allowed for radio set is 36 in. long x 11 in. deep x 10½ in. high)

Write for interesting literature
describing the entire Rivoli
Radio line.

Radio Industries Corporation, 131 Duane St., New York City

At Last! At An Unheard of Price!

A SURE FIRE

SUPER-HETERODYNE KIT

A
Superadio
Product

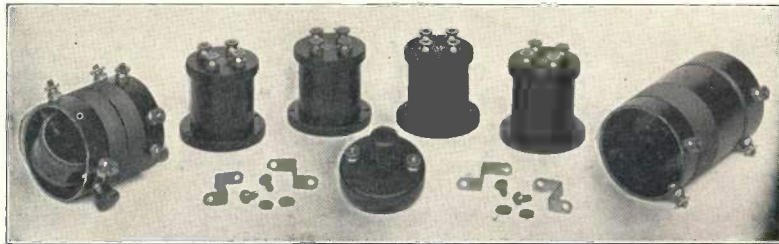

A
Superadio
Product

SUPERADIO KIT, \$17.⁵⁰ SUPERHETERODYNE K

MATCHED TRANSFORMERS—TUNED INPUT

EASY TO BUILD

EASY TO OPERATE

UNSURPASSED DISTANCE VOLUME AND SELECTIVITY

WONDERFUL TONE

Kit Consists of:

- | | |
|------------------------------|-------------------------------------|
| 1 Antenna Coupler | 1 Tuned Input Transformer |
| 1 Oscillator Coupler | 3 Matched Intermediate Transformers |
| 1 Special Variable Condenser | Hardware for Mounting Couplers |

Booklet, With Diagrams and Full Layouts
and Information

Manufactured by

DE WITT-LAFRANCE CO., Inc.

54 Washburn Avenue

Cambridge, Mas

Sales Representatives:

Martin, Hartley and Foss Co.

99 Bedford Street, Boston, Mass.