

August 15, 1925  
15 Cents a Copy

# RADIO PROGRESS

Reg. U. S. Pat. Off.

*'Always Abreast  
of the Times'*

## IN THIS ISSUE

Understand the Wire Table

By HORACE V. S. TAYLOR

A Radio Newspaper on Shipboard

Build Your Own Radio Meter

Shaving Static from Your Signals

Peak and Canyon Trip with Radio

A New Type of All Wave Set

---

YOU WILL UNDERSTAND THIS  
MAGAZINE --- AND WILL LIKE IT

A New England Publication

**At Last! At An Unheard of Price!**

A SURE FIRE

## **SUPER-HETERODYNE KIT**

A  
Superadio  
Product



A  
Superadio  
Product

**SUPERADIO KIT, \$17.50**  
**SUPERHETERODYNE**

MATCHED TRANSFORMERS—TUNED INPUT

EASY TO BUILD

EASY TO OPERATE

UNSURPASSED DISTANCE VOLUME AND SELECTIVITY

WONDERFUL TONE

Kit Consists of:

- |                              |                                     |
|------------------------------|-------------------------------------|
| 1 Antenna Coupler            | 1 Tuned Input Transformer           |
| 1 Oscillator Coupler         | 3 Matched Intermediate Transformers |
| 1 Special Variable Condenser | Hardware for Mounting Couplers      |

Booklet, With Diagrams and Full Layouts  
and Information

Manufactured by

# **DE WITT-LAFRANCE CO., Inc.**

54 Washburn Avenue

Cambridge, Mass.

Sales Representatives:

Martin, Hartley and Foss Co.

99 Bedford Street, Boston, Mass.

# NATIONAL

**VELVET CONDENSERS  
VERNIER AND DIALS**

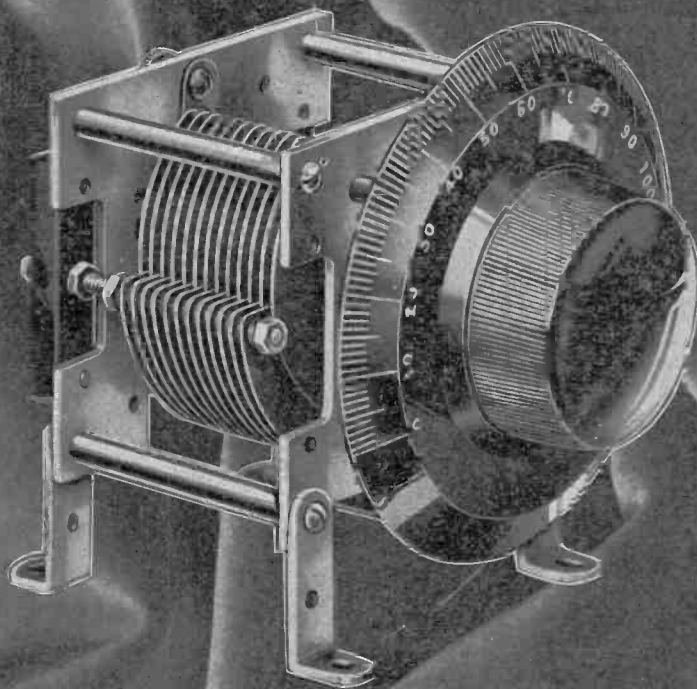

Made by the NATIONAL COMPANY, INC.  
Exclusive Manufacturers of  
**The NATIONAL  
Browning-Drake TRANSFORMER**

Write for Bulletin 135 R. E.  
NATIONAL COMPANY, INC., 110 Brookline St. Cambridge, Mass.



# The Marvelous 5-Tube Radio Frequency Set



## RICO-DYNE

An assurance of perfect performance, faithful tone production and \$100 radio receiver value, all for

**\$60.**

Mahogany Cabinet  
The Set with a Punch

**AUTO BALANCED 5-TUBE RADIO FREQUENCY**  
The combination of "RICO" CELLUWELD Low Loss Coils and Variable Condensers is made mechanically perfect. The Coils are welded firmly to the support of the rotor plates, our own patented principle. Selective and non-oscillating, the "RICO" "AUTO-BALANCED" TUNED RADIO FREQUENCY SET accomplished by carefully setting the neutralizing angle of the Coils at the factory; remains permanent due to the CELLUWELD process.  
The Complete Ricodyne Kit contains everything. The set you can build in 3 hours. Price Complete.....\$38.75

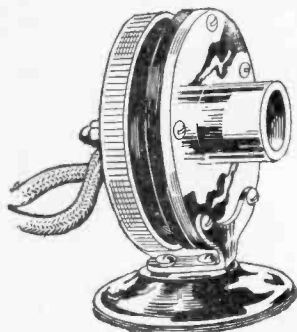

ADJUSTABLE

## MAKE FULL USE OF YOUR PHONOGRAPH

### MELOTONE — "None Better"

Adjustable phonograph unit  
makes your phonograph  
a perfect loud-speaker

**\$7.50**

The Melotone Has All the Qualities of the \$10 to \$12 Units



## THE NATION'S FAVORITE HEADSET

### RICOPHONES — The Headset of Real Value

There is more quality, real honest-to-goodness quality packed into RICOPHONES than you'll find in any headset at twice its price! Compare and see.

**\$2.95**

Manufacturers of the famous "RICO" straight line condensers, at \$1.75 each. The "Tropadyne" circuit is supplied free with every tuned "Tropaformer" that we manufacture for all long wave transmission. "Tropaformers" \$6.75 each. Dealers—write or wire for wonderful proposition.

RADIO INDUSTRIES CORPORATION,  
131 DUANE ST., NEW YORK CITY.

Gentlemen: I am enclosing \$..... for the items checked below. Kindly ship at once.

..... RICO-DYNE SET, \$60.

..... MELOTONE UNIT, \$7.50.

..... RICOPHONES, \$2.95.

My Dealer is .....

NAME .....

ADDRESS .....

CITY .....

# RICO

for all  
Long Wave  
Circuits

## RICO Products on this Page Will Improve Your Radio 100% TROPAFORMERS



The sensitivity, selectivity and volume obtained in all types of long-wave circuits depends entirely upon the intermediate frequency transformer. TROPAFORMERS have been specifically designed to meet the new scientific requirements of long-wave circuits. The TROPAFORMER combines transformer and condenser. The condenser is shunted across the secondary winding of the transformer, and by its use the transformer may be tuned to any definite wave length between 3,000 and 9,500 meters. Only in TROPAFORMERS will long-wave circuit users find these advantages, and these advantages are patented for TROPAFORMERS exclusively!

**\$6.75**

Free Hook-up of the Famous Tropadyne Circuit with Each Tropafomer Ordered.

## DID YOU EVER BUILD A SET THAT GOT "COAST TO COAST"?

You Can with the RICO-DYNE 5-Tube Auto-Balanced  
Cellu-Weld Tuned Radio Frequency Kit

**\$38.75**

Complete Knockdown Set as illustrated with full instructions how to build this marvelous set within a few hours.

### Greatest Radio Value in History—This is What You Get:

1—Pair Ricofones. 1—Genuine Bakelite Front Panel, completely drilled and engraved. 1—Genuine laminated Bakelite Sub-Panel—with sockets already mounted. All mounting holes properly drilled. 3—Auto Balanced Tuned Radio Frequency Units—perfectly matched and balanced. 3—Beautiful 4-inch Dials. 1—Variable Grid Leak and .00025 M.F. Condenser. 1—4 to 1 Audio Transformer. 1—2 to 1 Audio Transformer. 1—.002 Fixed Mica Condenser. 1—.006 Fixed Mica Condenser. 2—Single Circuit Jacks. 1—Filament Control Switch. 1—30-ohm Rheostat. 1—10-ohm Rheostat.

## FOR THOSE WHO WANT TO BUY ONLY THE RICO-DYNE KIT

HERE IS JUST WHAT THEY WANT:

It seems unusual that with the tremendous volume, selectivity and distance-range of the Rico Auto Balanced set, it should be so simple to construct. Yet, nevertheless, this is true. We have letters from fans who tell us that they constructed their Rico set within a few hours. The plans which accompany the Rico Kit are so simple that we believe this is so. Any beginner need only to read English in order to construct the Rico set. This Kit contains 3 Auto Balanced Tuned Radio Frequency Condensers, Inductance Units, factory matched, book of instructions and drilling template. You can't go wrong!



**\$16.50**

RICO-DYNE HAS SET  
NEW RECORDS IN RADIO!

for  
bliss!

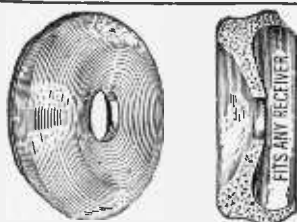

SPONGE RUBBER

## RICO FONEKUSHIONS

You'll know what real ear-phone comfort is when you use RICO FONEKUSHIONS. They are made of soft, pure sponge rubber, and fit any make of headphone. They are like soft, downy pillows for your distance-seeking ears.....

**50c**

for  
better  
tuning

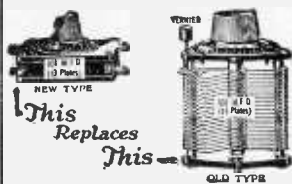

## RICO STRAIGHT LINE CONDENSERS

In the old days, folks used horses. Now they can get as much power out of one auto as from 40 horses. It was all right, too, a few years ago, for folks to use the old-time condensers, but now, since Rico brought forth the RICO STRAIGHT LINE CONDENSER, which occupies two-thirds less space than the ordinary mesh plate type, everyone modernizes his set with the RICO STRAIGHT LINE CONDENSER.

No. 411—.00025 mfd. ....\$1.75  
No. 423—.0005 mfd. .... 1.75  
No. 450—.001 mfd. .... 1.75

Inclusive with Dials. Without Dials, \$1.50.

Each of these  
Rico products  
means added  
pleasure and  
value to your  
Radio Set.

If Your Dealer Cannot Supply You—Use This Coupon. No Money Down!

RADIO INDUSTRIES CORPORATION  
131 Duane Street, New York City

Please send me C. O. D. the following: .....Tropafomers, \$6.75 .....Straight Line  
Condensers, \$1.75 .....Ricofones, \$2.95 .....Oscillating Coil, \$3 .....Fonekushions, 50c  
.....Melotone Attachment, \$7.50.

Name .....Address.....

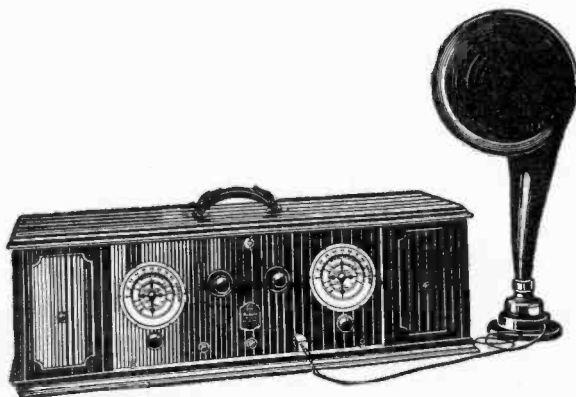

**Which is Better—**

**A Cheap Set for Cash---or  
A GOOD Set ON TERMS**

**?**

---

*The Good Set is Cheapest in the End*

---

Bay State specializes on the better grade sets, like Radiola, DeForest, Adler Royal, Magnavox, and sells on **Convenient Terms.**

Write for information. Address Dept. A,

**BAY STATE RADIO CO.**

---

**The House of Radio Service**

---

**116A Washington Street**

**Boston, Mass.**

## ANNOUNCEMENT

# The Massachusetts Standardizing Laboratory

Announces an entirely new standardizing service to the manufacturers, jobbers and dealers in Radio Vacuum Tubes.

Under this service every vacuum tube is tested and sealed with the standardizing seal of this laboratory, which carries the following constants as obtained in the test of the tube:

**AMPLIFICATION FACTOR**

**PLATE RESISTANCE**

**MUTUAL CONDUCTANCE**

Every subscriber to this service is furnished with standard figures of merit and tables of values showing the proper use and specification of all tubes according to their rating on the standardizing test.

Our facilities for research are at the disposal of subscribers.

If you make or sell good tubes, have them standardized. It is the only way to show the user that he has a good article.

**Send for Folder describing the Vacuum Tube Standardizing Service**

## **Massachusetts Standardizing Laboratory**

**CHELSEA, MASS.**

# RADIO PROGRESS

HORACE V. S. TAYLOR, EDITOR

Volume 2

Number 11

*Contents for*

*AUGUST 15, 1925*

	PAGE
UNDERSTAND THE WIRE TABLE . . . . .	9
AMERICAN RADIO RELAY LEAGUE. . . . .	11
RADIO IS MAKING POLITICS. . . . .	13
BUILD YOUR OWN RADIO METER. . . . .	15
A NEW TYPE OF ALL WAVE SET. . . . .	19
A RADIO NEWSPAPER ON SHIPBOARD. . . . .	22
EDITOR'S LOUD SPEAKER:	
A RADIO CIRCUS . . . . .	25
SEND US A THORN . . . . .	26
ANNOUNCING THE NEW VACUUM TUBES. . . . .	27
PEAK AND CANYON ON TRIP WITH RADIO. . . . .	30
DR. RADIO PRESCRIBES . . . . .	34
FUN FOR FANS . . . . .	36
U. S. BROADCASTING STATIONS. . . . .	38

RADIO PROGRESS is issued on the 1st and 15th of each month by the Oxford Press at 8 Temple Street, Providence, Rhode Island. John F. O'Hara, Publisher. Yearly subscription in U. S. A., \$3.00. Outside U. S. A., \$3.50. Single copies, 15 cents. Entered as second-class matter, April 4, 1924, at the Post Office at Providence, R. I., under the Act of March 3, 1879. Address all communications to RADIO PROGRESS, 8 Temple Street (P. O. Box 728), Providence, R. I. Title registered at United States Patent Office.

The publishers of this magazine disclaim all responsibility for opinions or statements of contributors which may at any time become subjects of controversy.



# The Two Outstanding Parts In Radio !

**Give Low Losses and Amplification  
Without Distortion to Any Set**

**Q**UALITY and distance are what a radio set must give. To insure Quality, amplification without distortion is essential. And to insure Distance, low losses are essential. That is radio in a nutshell.

People in whose sets Acme Transformers are used, are sure of hearing concerts "loud and clear" so a whole roomful of people can enjoy them.

The Acme A-2 Audio Amplifying Transformer is the part that gives quality. It is the result of 5 years of research and experimenting. It gives amplification without distortion to any set. Whether you have a neutrodyne, super-heterodyne, regenerative or reflex, the addition of the Acme A-2 will make it better.



Acme A-2 Audio Frequency Amplifying Transformer

To get the thrill of hearing distant stations loud and clear, your set must have low losses, for it is low losses that give sharp tuning to cut through the locals, and it is low losses that allow the little energy in your antenna to come to the amplifier undiminished. That's what the Acme condenser will do for any set. And it will do it for years, because the ends can't warp, the bearings can't stick and the dust can't get in and drive up the losses several hundred per cent.

The Acme Reflex (trade mark) owes its success and its continued popularity to these two outstanding parts in the radio industry, for low losses and amplification go hand in hand.

Use these two parts in the set you build. Insist on them in the set you buy.

Send 10 cents for 40-page book, "Amplification without Distortion"

WE HAVE prepared a 40-page book called "Amplification without Distortion." It contains 19 valuable wiring diagrams. In clear non-technical language it discusses such subjects as Radio Essentials and Set-building; How to make a loop; Audio frequency amplifying apparatus and circuits; Instructions for constructing and operating Reflex amplifiers; How to operate Reflex receivers; Antenna tuning circuits for Reflex sets; "D" Coil added to Acme four tube reflex; "D" coil tuned R. F. and Reflex diagrams; and several more besides. It will help you build a set or make your present set better. Send us 10 cents with coupon below and we will mail you a copy at once.

## ACME APPARATUS COMPANY

Transformer and Radio Engineers and Manufacturers

DEPT. (AS), CAMBRIDGE, MASS.

SEND THIS COUPON



Acme Low-Loss Condenser

ACME APPARATUS COMPANY,  
Dept. (AS), Cambridge, Mass.

Gentlemen:—

I am enclosing 10 cents (U. S. stamps or coin) for a copy of your book "Amplification without Distortion."

Name .....

Street .....

City..... State.....

# ACME ~ for amplification

## Looking Ahead to Our Next Issue

---

The biggest sending station in the world is the new one which the General Electric Company recently used for a three-day experimental test. How does such a transmitter work? What does it look like? What kind of results were obtained by the many listening fans? All these questions will be answered in the illustrated article, "**Real Super Power Sending**," by Stein.

One poor tube in your set is a lot worse than one bad tire on your machine. A method of finding out where the trouble lies, which makes it as easy to find as is a blowout, is described by Nickerson in "**Testing Tubes for Poor Performance**."

The inventor of the AUDION tube, Lee De Forest, has just returned from abroad, where he has been looking into radio conditions. He ran across some rather unusual kinks across the water and he has explained some of them in "**Some Radio Novelties in Europe**."

You probably know that it is against the law to burn down your own house. Are you also aware that the patent laws forbid doing many of the things which most radio fans have tried at one time or another? As the patent owners are beginning to get after those who infringe, it will be well for you to read the article by the patent attorney, Parker, "**Don't Try to Beat the Patent Laws**."

One of the big cities in the East is now quite a bit in the limelight—Atlantic City. They have two broadcasting stations, one of which is run by the municipality. Some interesting experiences which have occurred at the famous boardwalk are skillfully told by Goldman in "**What Are the Wild Waves Saying?**"

McClatchie, from Stuttgart, Germany, has a very interesting description of the peculiar system which is used in Germany, under which the broadcasting stations are run. The government pays the artists, but where does it get the money? Don't miss "**Germany Broadcasting Not Like Ours**."

Taylor's article, "**Watch Your Lightning Arresters**," will appear next time. By following the instruction given, you may be able to increase the efficiency of your set to a much higher value. You must also be sure to avoid trouble with the fire insurance people.

# RADIO PROGRESS

"ALWAYS ABREAST OF THE TIMES"

Vol. 2, No. 11

AUGUST 15, 1925

15c PER COPY, \$3.00 PER YEAR

## Understand the Wire Table

### *Easy Way of Remembering This Useful Information*

By HORACE V. S. TAYLOR

THE wire table showing the size and weight of perhaps the most necessary part of a radio set can be found in all reference books. However, there is call for it to be clipped from a magazine and perhaps pasted in your scrap book.

Although most radio fans are more or less familiar with this useful table, there are perhaps a good many who do not understand the relation between the various sizes and also how it is possible to memorize the table well enough so that you can tell offhand about almost any wire which is mentioned. While this material is not claimed to be new in print, it may perhaps have escaped the attention of our readers.

#### How the Ratios Run

The big thing about this table is its regularity in that every three sizes doubles the area and weight of the wire. When you double the area, of course, it halves the resistance and so every three numbers will cut the resistance in two. Of course, when the diameter is doubled, the area is four times as big. From this it follows that three numbers doubles the area and three numbers more doubles it again to four times. Four times the area is twice the diameter and so the rule that every six numbers doubles the diameter.

To check this rule start with No. 10. Notice the diameter and also the resistance of the wire. Three sizes smaller will be No. 13. The resistance then will be just double. Three sizes smaller than this will be No. 16. Here the resistance is again doubled or four times that of

No. 10, and as explained above the six sizes have just halved the diameter.

#### Follow This Sample

We might just as well have started with any other number. For instance, if you take No. 20 wire, then 23 will have twice the resistance and No. 26, four times. The diameter of 26 will be half that of 20. Going up just one size increases the resistance by 25 per cent and two sizes increases it by 60 per cent.

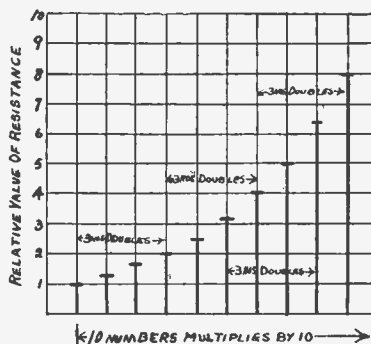

Fig. 1. The Height of Each Line Shows How Resistance of Wire Sizes Compare

Suppose you want to compare the sizes ten numbers apart. The first three will double the resistance, the second three will double it again to four times, and the third three (nine in all) will double that again to eight times. We have now one more size to go from nine to ten. As just explained, this increases the resistance 25 per cent, or one-quarter. A quarter of eight (which we found is the increase for nine numbers) is two, which added to the eight makes

ten. In other words, every ten numbers multiplies the resistance by ten.

This is quite startling and yet is the fact that makes the wire table so easy to remember. Compare No. 12 with No. 2. That is ten numbers, so it will have ten times the resistance. The table will show you that this is correct. No. 22 should have ten times again, and No. 32 ten times on top of all that. If you look in the columns of resistance, you will find that this is the case.

#### Knowing Where to Start

Now that you know the relation between sizes, you want to remember some starting point to work from. No. 10 wire is the easiest to remember, since it has a resistance of just one ohm per 1,000 feet and a diameter of 1/10 of an inch. With this as a foundation, you can build the whole wire table in your head. For instance, what is the diameter of No. 16 wire? Six sizes has doubled the diameter of .2, (2/10) of an inch.

What is the resistance of No. 17 wire? Going up three sizes to 13 has doubled and three more to 16 has quadrupled the resistance. Four times 1 ohm is 4 ohms per 1,000 feet. Going one more size from 16 to 17 increases the resistance 25 per cent. Twenty-five per cent more than 4 is 5. This you will see is the correct answer from the table.

What is the resistance of No. 25 wire? Jumping from 10 to 20 gives ten times the ohms, or 10. Raising to 23 doubles this value to 20. Two more numbers to 25, adds 60 per cent or 12 ohms, which makes a total of 32 for the answer.

Comparing the table we notice that the exact resistance is 33 ohms, but this is as close as you can figure taking into account slight irregularities and also the fact that the decimal places are not carried out beyond the third figure. The temperature of the wire also may make a difference of considerable more than this.

**How It Got Its Name**

In the table, Column A gives the wire size, in the American gauge. This is oftentimes called B&S, after Brown & Sharpe who originated it. We are omitting the odd numbered wire below No. 12 and above No. 30, as such sizes are not used in radio work. This column is repeated at the right hand end so as to make it easy to read across.

Column B gives the diameter of the bare wire in thousandths of an inch. Rather than make every one of these read as a decimal, it is more convenient to put the answer down directly in thousandths, which are called mils. Thus size 0 is 325 mils (325/1000) or .325 inches. In the same way size 40 is 9.9 mils or .0099 inches.

Column C shows the area in circular mils. These figures are equal to those of Column B multiplied by themselves.

Thus for wire size 0, 325 times 325 equals 106,000. As already explained, only the first three significant figures are kept and the rest are made zeros. The advantage of circular mils is that the numbers make it easy to compare the resistance of two wires. If one has say twice the area in circular mils, it will have twice the cross section and half the resistance. Also the circular mils are used in a good many formulas for computing size of wire.

**Changes Mils to Inches**

Column D reduces the area from circular mils to square inches. It takes 1,273,000 circular mils to make one square inch. Column D is found by dividing C by this number.

Columns E and F show the resistance and also the weight of bare copper wire. These values are given per thousand feet for if the amount were stated per foot, the numbers would be so small that the column would be full of decimal points. Naturally, if you want the value for one foot, you divide the figures given by 1,000. Of course, the resistance of copper changes quite a bit with temperature. The values here are correct for ordinary room temperature in the summer time. In winter the resistance is slightly less, owing to the cold.

**GOING TO THE SHOW?**

**These Dates Have Already Been Announced for Big Radio Expositions**

August 22-28—Third Annual Pacific Radio Exposition, Civic Auditorium, San Francisco.

September 5-12—Third Annual National Radio Exposition, Ambassador Auditorium Los Angeles.

September 12-19—Fourth Annual National Radio Exposition, Grand Central Palace, New York City.

September 14-19—Second Annual Radio World's Fair, 258th Field Artillery Armory, New York City.

September 14-19—Pittsburgh Radio Show, Motor Square Garden.

September 14-19—Winnipeg, Canada, Radio Show, Royal Alexandra Hotel, auspices Associated Radio of Canada.

September 21-26—Omaha Radio Trade Exposition, City Auditorium, auspices Omaha Radio Trade Association.

September 28-October 3—National Radio Exposition, American Exposition Palace, Chicago, 440 South Dearborn street, Chicago.

September 28-October 3—Calgary, Alta. Canada Radio Show, Memorial Hall.

October 3-10—Philadelphia Radio Exposition, Arena, auspices Philadelphia Radio Jobbers and "Public Ledger."

October 5-10—Second Annual Northwest Radio Exposition, Auditorium, St. Paul.

October 5-11—Washington Radio Show and Convention.

October 12-17—Boston Radio Show, Mechanics' Hall.

October 12-17—The Southwest National Radio Exposition, Coliseum, Radio Trades Association.

October 12-17—Second Annual Montreal Show, Windsor Hotel.

October 17-24—Brooklyn, N. Y. Radio Show, Twenty-third Regiment Armory.

October 19-25—Second Annual Cincinnati Radio Exposition, Music Hall.

November 2-7—Second Annual Toronto Radio Show, King Edward Hotel.

November 3-8—Detroit Radio Show, Arena Gardens, auspices Radio Trade Association of Michigan.

November 9-15—Milwaukee Radio Exposition, Civic Auditorium.

November 7-15—Cleveland Radio Show, Public Hall.

November 17-22—Fourth Annual Chicago Radio Exposition, Coliseum.

A	B	C	D	E	F	A
Gage No.	Diameter Copper Mils	Area Circular Mils	Area Square Inches	Resistance Per 1000 ft. Ohms.	Weight Per 1000 ft. Lbs.	Gage No.
0	325.	106,000.	.0829	0.100	319.	0
2	258.	66,400.	.0521	0.159	253.	2
4	204.	41,700.	.0328	0.253	201.	4
6	162.	26,300.	.0206	0.403	79.5	6
8	128.	16,500.	.0130	0.641	50.0	8
10	102.	10,400.	.00815	1.02	31.4	10
12	81.	6,530.	.00513	1.62	19.8	12
13	72.	5,180.	.00407	2.04	15.7	13
15	57.	3,260.	.00256	3.25	9.86	15
17	45.	2,050.	.00161	5.16	6.20	17
19	36.	1,290.	.00101	8.21	3.90	19
21	28.5	810.	.000636	13.1	2.45	21
23	22.6	509.	.000400	20.8	1.54	23
25	17.9	320.	.000252	33.0	0.970	25
27	14.2	202.	.000158	52.5	0.610	27
29	11.3	127.	.0000995	83.4	0.384	29
30	10.0	101.	.0000789	105.	0.304	30
32	8.0	63.2	.0000496	167.	0.191	32
34	6.3	39.8	.0000312	266.	0.120	34
36	5.0	25.0	.0000196	423.	0.0757	36
38	4.0	15.7	.0000123	673.	0.0476	38
40	3.1	9.9	.0000078	1,070.	0.0299	40

Fig. 2. This Table Gives the Necessary Information About All Radio Sizes of Wire

# American Radio Relay League

## MACMILLAN JAMS THE SEATTLE

News from the Navy-MacMillan expedition is causing a flood of radio messages to member stations of the American Radio Relay League throughout the United States and Canada. Some of the more active stations handle several hundred words each from WNP and WAP, the fast wave stations on the "Bowdoin" and "Peary." Messages to friends and relatives of the members of the expedition, news dispatches to the National Geographic Society from Donald B. MacMillan, reports to the Navy Department at Washington, all swell the total traffic that these amateur stations handle.

Several unique events have marked the reception of the two stations since their entrance into the Northern seas. The Antipodes have reported with Station 2AC in New Zealand, owned and operated by I. H. O'Meara of Gisborne, acknowledging receipt of some of the messages from WAP. This station has picked up signals practically every night since the expedition first reached Newfoundland waters.

### When the Waves Entwined

From California comes the report of L. Eldon Smith, District Superintendent of the American Radio Relay League with Station 6BUR at Whitties, that his reception of a message from the MacMillan expedition on a 7500 kc. (forty meters) wave got tangled with one from NRRL, the experimental station operated by Lieutenant F. H. Schnell, traffic manager of the league, on board the U. S. S. Seattle, flagship of the Pacific Fleet.

At that particular time the Navy-MacMillan expedition was skirting the Labrador coast and the "Seattle" was steaming about 2,000 miles south of Honolulu.

From still another part of the world, London, England, comes the word that J. A. Partridge of Station 2KF had carried on communication with WNP on July 12. R. Bartholomew of Garra-chales, Porto Rico, owner of Station 4SA, also carried on regular traffic with this record-breaking fast wave station.

## WESTINGHOUSE LENDS MAN

A few weeks ago there was officially sent out from the ancient port of Quebec the Canadian Government steamship Arctic, under command of the veteran explorer, Captain J. E. Bernier, carrying as one of the important members of the personnel, Robert M. Foster, an enthusiastic transmitting member of the American Radio Relay League.

Apart from the duties which have taken Captain Bernier and his ship to the Far North this summer, the Arctic

will complete the series of fast wave experimental tests which were started last summer between the C. G. S., Arctic and Canadian members of the American Radio League, who in the past few years have supplied the links that connected many explorations parties with civilized lands.

Robert M. A. Foster, the official operator for the coming tests, although in his early twenties, has had a notable career in the radio field. He has been connected with the commercial and ex-



Frank Dole, who has been an exhibitor, breeder and judge of dogs for over 40 years, and who is a recognized authority on all breeds, is giving a series of talks on dogs from Station WJZ at 7 o'clock every Tuesday evening.

perimental divisions of both the Marconi Company and the Canadian Westinghouse Company. He was for a time editor of the Canadian Wireless Magazine, the first radio publication in Canada.

To perform his forthcoming duties for the Canadian Government he has been granted a leave of absence from his work with the Westinghouse Company.

The ship, which weighed anchor in July, will operate its fast wave station with special call letters of VDM.

#### AMATEURS AID ARMY

The work of member stations in the American Radio Relay League in assisting the military authorities with reports during the recent Defense Day tests has brought a letter of commendation to President Hiram P. Maxim of the League from Colonel George McD. Weeks, acting Chief of Staff of the Third Corps Area, as follows:

"There were approximately one hundred and fifty (150) amateurs who volunteered their services for handling messages relative to defense test activities. The result obtained impressed this headquarters with the effectiveness of this organization as a means of rapid and efficient transmission of messages and a realization of the valuable assistance that could be rendered in case of national emergency."

#### RUNS LIKE A CLOCK

WNP and WAP, radio stations on the Bowdoin and Peary, ships of the Navy-MacMillan expedition to the far north are sending home their daily news of the work through American and Canadian stations of the American Radio Relay League with clock-like regularity. A great number of amateurs in both countries, as well as some in Europe, have already heard these two stations and several have carried on conversation with John L. Reinartz, operator of WNP.

E. H. Koeper of Elmhurst Manor, L. I., was the first operator to report the receipt of messages from the expedition to the National Geographic Society, the chief sponsor of the organization. He reported that WAP, for which he handled traffic to the Navy Department and to the National Geographic Society, was coming in clear, but that its tone swung considerably, indicating that the Peary was rolling in the heavy seas, north of

Nova Scotia. His conversations were on at 7,500 kc. (40 meters.)

#### The Link to His Home

Donald C. S. Comstock of East Hartford, Conn., operating station 1MY, has been in communication with Reinartz at WNP in addition to picking up reports from Denmark that WNP had been heard in Copenhagen. Comstock's station served as the relay point between Reinartz and Mrs. Reinartz at her home in South Manchester, a few miles from East Hartford. Comstock received news dispatches for the National Geographic Society at the same time.

In carrying on the family conversa-

#### THE LATEST FAN

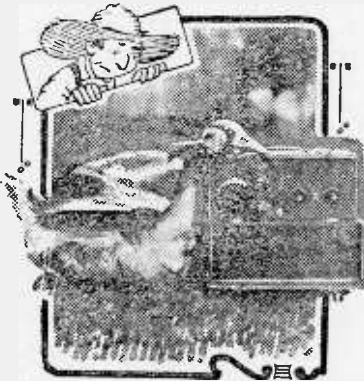

This goose likes to listen to the radio. Her favorite poetry is the "Lays of Ancient Rome." She is now listening to the lecture by the Housewives' League, "Should Eggs be Fried on the Top or the Bottom?"

tions for Mr. and Mrs. Reinartz, Comstock relayed the messages from the Far North by telephone and immediately returned Mrs. Reinartz's reply to her husband.

The Copenhagen messages picked up at the Comstock station reported both stations of the expedition coming in strong and asked that they try for two-way work with the Danish station.

#### THIRD NATIONAL CONVENTION

Amateur radio enthusiasts in great numbers from the United States and Canada and to some extent from Europe

and other countries will gather at the Edgewater Beach Hotel in Chicago, August 18 to 21, to attend the Third National Convention of the American Radio Relay League. Included in the attendance will be internationally noted experts in all branches of radio and amateurs who are experimenting with this fascinating science in their own homes.

The convention, the first in two years, is being staged under the auspices of the Chicago Radio Traffic Association of which W. E. Schweitzer is president. It is planned to have papers and demonstrations on many of the startling radio discoveries of the past two years, such as photographs and motion pictures by radio, quick-wave, low-power transmission in daylight and kindred developments.

#### Hoover Will Be There

Among the men prominent in the radio world expected to attend the convention are Secretary of Commerce Herbert Hoover and C. Francis Jenkins, inventor of radio photography and radio motion pictures.

Another part of the convention work that will be of great interest is the gathering of radio telegraphers in the traffic field. These operators, whose work makes possible nightly talks between men on opposite sides of the country, are to discuss betterments in their message handling work.

Where radio communication in the past with the lower powered stations has been largely during hours of darkness, the introduction of quick (short) wave work within recent months promises many new developments.

#### CODE KEEPS COP IN COMMUNICATION

Chief of Police James P. Cole of Flint, Mich., has the distinction of being perhaps the first police head in this country to care for the daily routine of his position by means of radio during a long period of absence from the city. While Chief Cole attended the recent Indianapolis gathering of the International organization of police chiefs he maintained steady touch with his department at home, directing all of its activities and passing on all of its problems.

# Radio is Making Politics

## *What Governor Smith of New York Has Found Out About Broadcasting*

**T**WENTY-FOUR votes for Underwood." Do you remember how that cry rang night after night for a thousand times? Or was it a hundred? Perhaps you thought that radio was a joke as regards politics at that time—but it is a joke no longer.

Of course, when you bring in broadcasting for a serious issue, it is necessary to use a little tact. Mayor Hylan of New York stirred up considerable unfavorable comment in many publications by what they thought was his one-sided presentation of his own case. It is so much easier to turn a knob on your receiver and get rid of a tiresome speaker than it is to get up from your seat and go out of a lecture hall that many an old style public speaker, who could hold his audience together when they were there in person, cannot now keep his listeners with him much beyond the fifth paragraph.

### Did You Vote for Bonds?

When a referendum of voters is held, it often times happens that nine-tenths of them do not know what it is all about. Have you not yourself sometimes gone to the polls at election time and seen a question something like this. "Shall the treasury put out a bond issue for such and such a project?" On thinking it over, were you entirely clear as to what the project was, and whether it was worth the money it would cost?

It has been found that the voters are only half way (or less) informed on so many questions which are voted on that it seems desirable to have a "radio referendum." In such a case one (or indeed several) big broadcasting station which is located so that most of the voters of a district are within sound of its "voice," is used by speakers to explain to the fans what the question to be voted on is all about.

### The Speaker is All Wrong

Avoiding the mistake of WNYC, New York, as mentioned above, *both* sides of

the argument are given an equal chance at the microphone. If you happen to be a determined Democrat, you will hate to hear a regular Republican broadcast how much better his party is than yours provided you know that your side will not have a chance to get back at him. But if it is only a question of waiting until the orator gets through before

your party has a chance to come back strong and show where he is all wrong, you are quite willing to listen for an hour if necessary to his talk.

The radio referendum may, in a few years, be provided for by law. Until the result of such a popular vote becomes binding on your elected representatives, the radio appeal for the sentiment of



Fig. 1. Gov. Smith of New York Has Found That "Mike" is His Best Listener in Political Campaigns

the voters may be expected to have an important part in voicing the wishes of the electorate and in influencing the action of the Congressman.

#### Governor Appeals to Voters

Governor Alfred E. Smith of New York State has several times appealed to the voters on matters of importance to them, and he is convinced that radio broadcasting has entered on a new and almost limitless field of public service.

Governor Smith says: "The American Democracy covers so vast a territory that we must heartily welcome an art that brings its executives and legislators into the closest contact with the public they have been elected to serve. The advantage is double. It expedites the sending of an intimate message to the whole body of citizens, and it secures to the speaker a more prompt and frank expression of personal opinion than he could obtain in any other way. Thus there is preserved a mutual relationship that is of especially high value as new problems arise which can best be solved by a renewed meeting of many minds.

#### Citizens Are Very Close

"Recent experiences in broadcasting matters of public moment through the medium of WGY have given me a new sense of close fellowship with my fellow citizens; their many replies have been a help and an inspiration in seeking a solution to the questions which an executive can conscientiously answer only in the full light of the common thought."

WGY, one of three powerful stations of the General Electric Company, (the others being KGO and KOA) is located at Schenectady, within sixteen miles of the Capitol at Albany, which is connected to the radio equipment by wire and lines. From time to time the Governor, legislators and department heads have called on WGY for the privilege of using its facilities to reach the citizens. Whenever this could be done consistently and with fairness to those already scheduled on the program, the Schenectady station has given of its time.

#### Tells How to Dodge Detours

The health department offers weekly talks; the highway department, during the summer months, furnishes the automobile owner with a report on road con-

ditions; the agricultural department, as well as the department of farms and markets, issues frequent bulletins of interest to the farmer, including in this bulletin service, special harvest weather reports. Last fall when fires in the Adirondack Mountains forced a suspension of hunting, WGY was used by the Governor and by the conservation commission in warning those already in the woods that an emergency existed and that hunting was banned. One of the first and most interesting of Albany programs was the broadcasting of the inauguration address by Governor Nathan L. Miller.

Governor Smith, as well as the Republican leaders whom he has opposed, has recognized the growing importance of radio in legislative matters and has used the facilities of WGY to take a radio referendum on pending legislation.

#### How to Spend Money

In March of this year when Governor Smith found his plans on a financial program opposed he appealed to the people by radio discussing the subject, "Spending the People's Money." The response from the audience, conveyed directly to the elected representatives, resulted in harmonizing the views of the Governor and the legislature.

A second radio referendum on matters legislative was taken in June after Governor Smith had called a special session of the legislature to reconsider the park program.

Before the legislature convened in special session, Governor Smith broadcast his views from WGY. His voice, amplified by the radio power station, was carried to every part of the state. Wire lines also relayed it to WJZ in New York, and this station broadcast the speech. Two nights later Senator John Knight, Leader of the Majority, replied to the Governor and presented his side of the controversy. Still later, Judge Alphonse T. Clearwater, a member of the Niagara State Reservation Commission, gave a radio discussion on the issue.

The voters were thus able to hear both sides of the question and many of them wrote to their representatives in Albany requesting action on one side or the other.

#### Getting After the Voters

The radio broadcasting station power-

ful enough to reach every part of the state, offers a free and effective medium to sound out the sentiment of the electorate. The idea of appealing to voters to write to their state and national representatives is almost as old as legislatures, but the old method of appeal takes a great deal of time. It requires the enlistment of a large working force, and very often many public meetings to arouse public action.

In one meeting, advertised by press and radio, the speaker can reach by radio a great audience, and if his arguments are presented in an orderly and effective way, he is assured of a response. If sufficient letters are received, the elected officials are almost certain to be swayed in their action by the sentiment expressed.

#### The "Drop-a-Line" Habit

For three years the radio audience has been educated in the habit of writing letters of comment on programs and artists. The radio stations have encouraged the habit because these letters are the only possible substitutes for the applause which a performer was accustomed to receive. It is quite natural, therefore, for a listener after hearing an address and a request that he express his views, to write to assemblyman or senator.

Perhaps you may think that the number of possible listeners to political addresses is so limited by the lack of radio sets that it could not have much effect on the big body of voters. Of course, this is true to some extent. However, we may divide the population into two classes—one of these is the kind that boasts "I've voted the straight Republican ticket for the last fifty years and I'm going to continue until I die." Such a man of course would not be influenced by a radio set or by anything else for that matter.

#### Picking the Proper Party

The other type of person is the one who may have party leanings, but who will use his head when it comes to voting and will try to pick out the candidate or the issue which he really believes is best for the country. In his case, radio may play a very powerful part.

Which of these two men is more apt

Continued on Next Page



# Build Your Own Radio Meter

## *How to Construct and Operate a Very Useful Unit*

By C. WILLIAM RADOS

SOME workmen in a tall smoke stack the other day, heard music by radio coming down the stack without any receiving set. At least that is what the newspapers said.

Of course, it really must have been the men's imagination working overtime or else a joke, since no radio of any kind will work without a detector. A loud speaker or pair of phones is just as necessary and to these must be added the coils, wiring, etc., which make up a set. But next to these essentials what is the most useful device which you can have?

### All That It Will Do.

The radio meter which we shall describe probably wins the first prize. After you have used one you will say that it is almost a necessity. With it you can tune your set to a distant station's wave and know that if he can be heard at all, you will hear him. You can measure the wave speed of interfering radio telegraph stations and thus recognize them as ship, amateur, etc. You can use it as a rejector or interference eliminator and assure yourself of undisturbed reception.

If you are experimentally inclined, you can make all kinds of technical measurements such as comparing inductances and capacities, measuring resistances, checking frequencies, and determining best windings for coils.

The radio meter, also known as a frequency meter, a decimeter, or wave meter, is simply a coil and condenser

adjusted so that the pointer reads wave frequencies (or vibrations per second) instead of mere numbers or degrees. Thus when your dial on the *radio* set reads 50, it means to you perhaps KGO or WBAP. The number 50 might just as well be "abc" or "\$%†." It would be just as good an indicator for KGO or WBAP. On the radio meter, however,

a scale which will mean something after it has been calibrated. This will be mounted in a box so that it may be carried.

The two essential parts of this instrument are the variable condenser and the coil. A condenser which is mechanically very rugged *must* be used. Pick a first class unit like the General Radio, Acme,

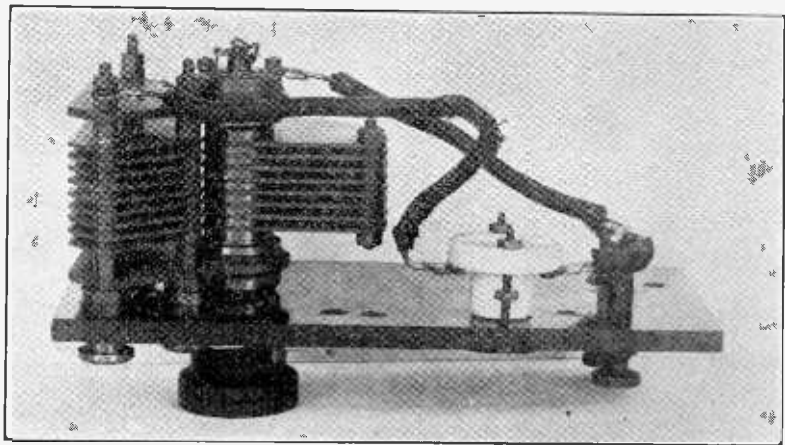

Fig. 1. A Rugged Condenser Like This One Must be Used or Else the Readings will Shift

when the dial reads 50 it will mean to you 700 k. c. If you have a clean white scale on your dial, you will probably want to pencil in this wave speed and thus do away with meaningless numbers.

### A Reading Means Something

So we see that the radio meter consists of a coil, a variable condenser, and

Cardwell, or Premier. If you know some army, navy, or commercial operator, ask him if he can procure for you a commercial condenser such as they use on ships and in the army. The one used in the illustration Fig. 1, has plates 1/16 inch thick. If it is rugged it will not lose its calibration when jarred or dropped. It is not necessary to bother

### RADIO MAKING POLITICS

Continued from Previous Page

to be the owner of a radio set? The first is more likely to think that a receiver is a "new-fangled contraption" and very probably has not bought one. The independent thinkers, on the other hand, are pretty sure to be the proud possessors of all up-to-date equipment and un-

less their finances forbid they certainly will be numbered among the ranks of broadcast listeners. So it looks as if political speeches sent out on the air, would reach the class of people who will be most affected.

A democracy with radio should prove more representative than one without it. Concerted approval or disapproval of

a plan of legislative action may now speedily reach the attention of the elected official. Interest in state and national policies should no longer be limited to the casting of a ballot on election day. Common action, produced by a radio address, will make the average citizen feel that this is in fact a government of, for and by the people.

about "low loss." If your condenser is strong and husky, it will suffice.

The reason for the heavy plates is not to reduce the resistance as much as it is to prevent the thin pieces of metal from becoming bent. When condenser plates are evenly spaced, they have a certain

#### It Covers the Range

The coil is wound on a form about  $3\frac{1}{2}$  inches in diameter. Use 25 turns of No. 20 dec., and wind on as tightly as possible. Give the coil a light coat of "dope" and hang up to dry. When thoroughly dry, put on a couple of

or to 300 kc. (1,000 meters), all that is necessary is to wind a new coil and slip it on. The coil for which the details were just given will cover a range of from 1,360 to 600 kc. (220 meters to 500 meters), making it just right for broadcast reception.

With a good condenser and coil, you have the makings of a good radio meter. But you will need a box or panel of some sort to mount the instrument on. The set photographed (Fig. 2) shows about the handiest way there is to mount such a meter. The box used is a voltmeter case such as electricians, telephone men, and laboratories have. It measures  $7\frac{1}{2}$  inches square inside which is plenty large enough to contain the panel.

#### Are You Near a Transmitter?

Mount the condenser on a small rubber or radion panel with a pair of large binding posts as shown in the photo. If you think that you may ever work

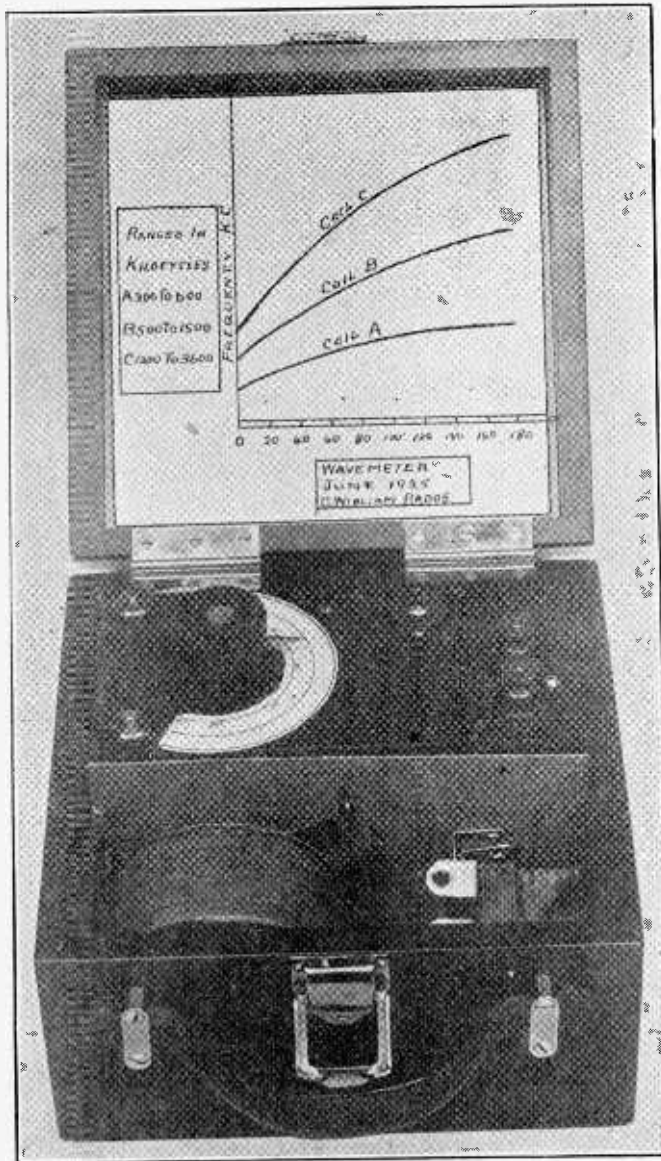

Fig. 2. Here is a View of Complete Meter; Extra Coils Are in Front. The Curves on Cover Read Direct

capacity, depending on the dimensions, but as soon as anyone of the plates (except end ones) gets bent the capacity always increases. You will want to be able to rely on this meter and so you must make sure that the condenser does not change its value.

husky terminals as in the photographs: If you are going to use only one coil, you may fasten it permanently to the panel, but it is a much more flexible arrangement to mount the coils as in the photograph, Fig. 2. Then if you want to get up to 3,000 kc. (100 meters)

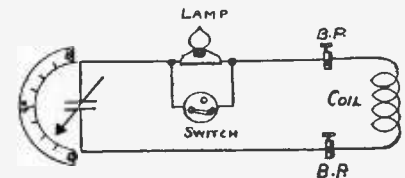

Fig. 3. Here is the Simple Hook-up of This Meter

around any kind of a radio transmitter, then mount on the panel a small 1-volt flash lamp and socket. The binding posts are used for connecting the coils and the lamp is an indicator which will light up when you bring it near a transmitter.

As this lamp naturally takes some energy even though it is very small in watts, it will not work with an ordinary receiver. The amount of power picked up by a receiving aerial is so very minute that even if all of it were concentrated in this lamp, it would not even glow. However, when used near a transmitting set, the power is sufficiently great to make it shine.

As it introduces resistance into the line, it is a disadvantage to leave it in circuit unless it is being used. That is why in Fig. 3 a switch is shown which short circuits the lamp when not in use.

#### How Much For a Case?

The case is a real convenience, because many uses will develop, not the least of which will be loaning it to your neigh-

bors. The case with its carrying handle comes in very handy. I got mine at an electrician's for the low price of one dollar. This is very cheap for a new solid oak case. The cover of these cases will slip off so that the meter may be placed on top of a receiving set and used as a wave trap.

When making the scale for this instrument, you must decide whether you are going to use meters or kilocycles or perhaps both. Of course, meters wave length has been the standard in the past, but it looks now as if frequency were going to be used as it is much easier to understand and to work with. Both scales will be illustrated in this article so that you can take your choice.

**Why Two Scales Are Used**

Two separate scales are to be made. One of these, Fig. 4, is pasted to the instrument underneath the pointer; this shows clearly as the semi-circular white

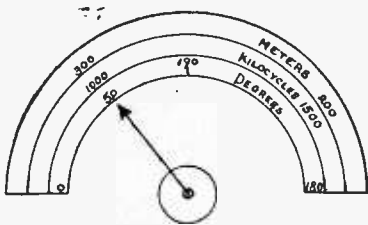

Fig. 4. The Semi-circular Scale Reads Both Speed and Length of Waves

paper in Fig. 2. The other, Fig. 5, is pasted in the cover of the box. The lower one is marked off in degrees, kilocycles and meters. Of course the latter two are to tell what wave is being used while the degrees are needed only to compare the reading with the chart in the cover. The latter is more accurate than the semi-circular scale but not nearly as convenient.

The chart in the cover is also arranged to carry the curves of three or four different coils—as many as you use. The scale under the pointer had better be limited to the range which you use most, that of the broadcasting stations. To use the upper chart, notice what number of degrees the pointer rests on and then run up the line as shown in Fig. 5, from the number 50 until it meets the curve. From there go straight across to the left until the answer is found—1,000 kc. in this illustration.

**It Does Not Start At Zero**

Notice that the chart does not start

with a zero wave opposite zero degrees. This is because there is a certain amount of leakage capacity in the set even when the condenser dial is turned to zero degrees. The line of the wave is not straight since an ordinary condenser plate is used. If instead you employed a condenser which had its plates shaped so as to give straight line frequency, then Fig. 5 would be straight. The same thing is true with straight line wave length if used with a corresponding condenser.

In laying out the dial scale, Fig. 4, notice that as the kilocycles of frequency increase, the wave length in meters decreases. Thus 1,000 kc. is opposite 300 meters while 1,500 kc. is equivalent to 200 meters. To convert from one to the other, divide 300,000 by the figure for either meters or kilocycles and it will give you the answer in the other unit. A more exact figure for this constant is 299,800.

In order to make the scale read up from left to right in kilocycles, attach the knob to the condenser shaft so that when the movable and stationary plates are in mesh the pointer reads zero. In that case the meters will decrease from left to right. To make the meters read up, the pointer should read 180 degrees with the plates in mesh.

**Capacity Goes As Square**

With a good condenser, which has a low ratio of minimum to maximum capacity, as the rotor is turned from way out to way in mesh, the range of frequency will be at least three to one. That is, if we start at 500 kc. it will run to 1500, while if a larger coil is used so that it starts at 200, then the upper range will be 600 kc. Remember that the frequency does not vary uniformly as the capacity is changed. It is the square of the capacity which counts, and so to get a three to one ratio of frequency or wave length for that matter, we must have a 9 to 1 ratio of total capacity. Since there is some leakage capacity in the wiring, it will require a condenser whose ratio between high and low is probably ten or twelve to one or more to accomplish these results.

The only hard part about this instrument will be the calibration. Your meter up to this point is as valuable as any other coil and condenser connected together, in that you do not know what

the wave speed of the meter is when your pointer reads say 50.

Calibrating consists in marking the scale so that it will read in wave speeds or lengths. With your receiving set ready, tune in some station a few hundred miles away. Use head phones and tune the wave in as sharply as possible. The station is to be preferably one of the accompanying list (Fig. 6), as all these broadcasters have been certified by the federal government.

**Use a Certified Station**

This list is taken from the Department of Commerce "Radio Service Bulletin." They represent measurements made by the Bureau of Standards over a period of nearly two years. You will notice that the last two columns which give the average and the greatest per cent error in the waves sent out by the stations, is remarkably low. Of course, this table shows only what has been

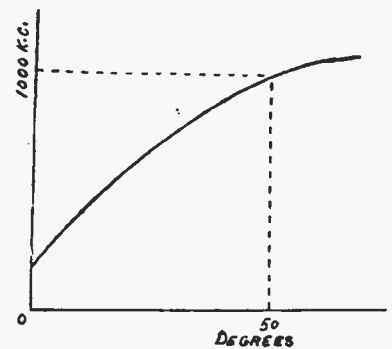

Fig. 5. How to Use the Curves in Cover of Fig. 2

done in the past and the Government naturally gives no guarantee that they will keep up the good work in the future.

When the station is in well, put your radio meter on top of the receiver cabinet close to the secondary. Turn the radio meter knob until you hear a click in the phones. Mark the point on the scale. Then turn the handle to some other point until you hear another click. Mark this spot, too. The point half-way between these two marks will be the wave length which is the same as that of the distant station. To insure accuracy when you have located two points thus, increase the distance between the radio meter and the receiver. By doing this you will be able to bring the two points together, and so get a better check on the wave length. By marking several points thus on the

Station.	Owner.	Location.	As- signed fre- quency (kilo- cycles).	Period covered by meas- urements (months).	Num- ber of times meas- ured.	Deviations from assigned fre- quencies noted in measurements.	
						Aver- age.  Per cent.	Greatest since Apr. 20, 1925.  Per cent.
WVA.	United States Army.....	Annapolis, Md.....	100	2	34	.02	0.4
WEAF.	American Telegraph & Tele- phone Co. ....	New York, N. Y.....	610	5	52	0.0	0.0
WCAP.	Chesapeak & Potomac Tele- phone Co. ....	Washington, D. C.....	640	20	94	.1	.2
WRC.	Radio Corporation of America.	Washington, D. C.....	640	17	74	.1	.2
WSB.	Atlanta Journal .....	Atlanta, Ga.....	700	20	84	.1	.3
WGY.	General Electric Co.....	Schenectady, N. Y.....	790	23	126	.1	.1
WBZ.	Westinghouse Electric & Manu- facturing Co. ....	Springfield, Mass.....	900	13	39	.1	.2
KDKA.	Westinghouse Electric & Manu- facturing Co. ....	East Pittsburgh, Pa.....	970	20	163	.1	.1

Fig. 6. These Stations Are So Steady That the U. S. Government Recommends Them as Frequency Standards

scales, you will get an idea of the range your meter covers.

After you have calibrated one coil you draw the curve as shown in Fig. 5. Another coil may now be substituted as Fig. 6 illustrates. Its calibration will lie above or below the line already drawn, depending on the size and number of turns in the winding. Three or four such coils will include the entire range of frequencies usually used. Even a single coil, if it has the right number of turns (which may be found by experiment) will cover the broadcast range.

Of course, there are other ways of calibrating your radio meter. Instead of listening to a distant broadcast station you can set another wave meter into oscillation (use a buzzer) and then turn your own until it clicks.

**Getting It From Washington**

If you can read code, you will be able to calibrate it by listening to WWV, Washington, which sends out the most accurately tuned waves in the country. Such waves especially intended for tests are sent out twice a month.

The simplest use of your radio meter is for tuning your set. Suppose you are listening for Scotland which you know is transmitting on 660 kc. (452 meters.) Set your receiver oscillating and then turn your radio meter until it is on 660 kc. Leaving it there on top of your radio, turn your receiver dials until you hear the familiar clicks again. You will know that your set is at tune or adjusted for 660 kc.

Now suppose you have your set tuned to this wave speed. Of course, Scotland may be a little off, say 658 or 662 kc.

Then all you have to do is move your dials just a trifle one way or another, and if you do not hear your station, you can be sure that no one else in your vicinity can pick them up at that particular time unless his set is a lot more sensitive than yours. Contrast that with the usual method of turning dials, wiggling rheostats, lighting tubes, etc.

**Helps You Get Call Letters**

Another great use is that of identifying distant stations. You often hear

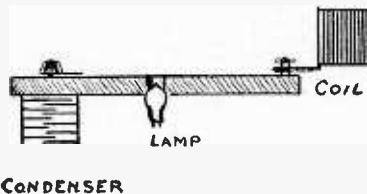

Fig. 7. The Range of Waves is Governed by the Coil. Its Size May be Conveniently Changed.

some announcer's indistinct far-off numble of words which you try in vain to pick up. If you have your radio meter handy you can check up on the wave speed used and so identify the unknown station.

Another use is the designing of the circuits for a new hook-up. Suppose you have built a new set and want to find out its wave range. Run it with the above mentioned click method, first with the dials turned to 0 and then with them turned to 100. If you want to hear KDKA or WGY on the high speed wave (short length) and your radio meter is calibrated it will be very easy for you to find them.

As you have read in previous issues of this magazine, MacMillan is using the high speed waves for both radio telephone and telegraph. By using a radio meter, you will have a much better chance of being the first in your neighborhood to pick up WNP, MacMillan.

**Will be Glad to Help You**

Of course, there are many other ways the radio meter can be used as it is the fundamental measuring instrument in radio work. By bringing it near an amateur transmitter and turning the pointer, the lamp will light up when the two are in tune. As the many other measurements are too numerous to put down here, I will state that I will be glad to give anyone writing in further information. Write me care of RADIO PROGRESS and enclose a self stamped and addressed envelope.

**NOT A CORD OF WOOD**

By this time, almost everyone in the audience of WEAF and the chain of stations has heard the new "trademark" of the Silvertown Cord Orchestra playing every Thursday at 10:00 p. m. The distinguishing sound which opens and closes the hour are the chimes struck first individually and then together, forming the so-called "Silvertown Chord." This latter innovation was made as the result of a letter sent in by a listener-in in Valhalla, N. Y., who had noticed that other stations were also using the chime idea and suggested the "chord" as a play on words and distinctive signal for Joseph Knecht's popular musicians.

# A New Type of All Wave Set

## Here are the Construction Details of a Small Set, With a Large Range

By EDWARD W. SMITH, Boston, Mass.

CAN you read the code? If so, you are able to get a good deal of enjoyment out of your radio set that the mere broadcast listener must miss.

However, you naturally don't want a set which will pick-up only dots and dashes, but refuses to bring in the musical program. Code signals, you recall, run on 15,000 cycles and up (200 meters and below) and also in the band around 500 kc. (600 meters). A radio set which will pick up such a wide band of frequencies is usually quite bulky.

### How to Get in Small Space

With the idea of combining in the small space that happened to be available, a set that could be used for the reception of broadcast programs and an all-wave set for bringing in the slower waves, the writer hit upon the following design for a receiver which would have these qualities. The instrument gives excellent service in the field for which it was designed and it is with the idea in mind of bringing to your attention whatever may be new or unusual in its construction, that this article was

written. For the convenience of those who may contemplate its construction, a list of the parts used is given at the end of the article.

The wiring diagram of the set is given in Fig 1.

Coils L1, L2, L3 are the windings associated with the tuning of the broadcast range of the receiver and were constructed as follows: The primary coil, L1, of the broadcast receiver, consists of nine turns of about No. 23 double cotton covered Litzendraht, wound directly over the secondary, in the middle with the turns spaced about one-eighth of an inch apart. L2, L3 are respectively the secondary and tickler coils and are arranged so that the tickler rotates within the secondary. In constructing this unit, the writer took an old Shamrock vario-coupler and removed the stand and rotor from it. The winding, which had previously been on the rotor was removed, and a new winding consisting of about 20 turns of the same double silk covered Litzendraht wire as was mentioned above was wound on.

The Litzendraht wire consists of 49

strands of No. 40 enamelled wire, which are distributed into seven bundles of seven strands each.

### How This Wire Differs

This is the equivalent in area of copper of No. 23 wire. The Litzendraht, of course, differs from ordinary lamp cord, which contains a number of wires in this respect. The wires, which make up the strands of lamp cord, are individually not insulated, and as they all touch each other the current flows freely between them. The Litzendraht, on the other hand, is made up of strands, each of which is enameled, and thus insulated from its neighbors.

The bundles of seven wires are so arranged that each one of them occupies all positions possible in the complete cable. Such wire has very small high frequencies resistance provided that care is taken in soldering it to see that all the component wires are securely soldered at both ends, and that no strands are broken.

A new secondary coil form was then made of three and five-eighths inch, out-

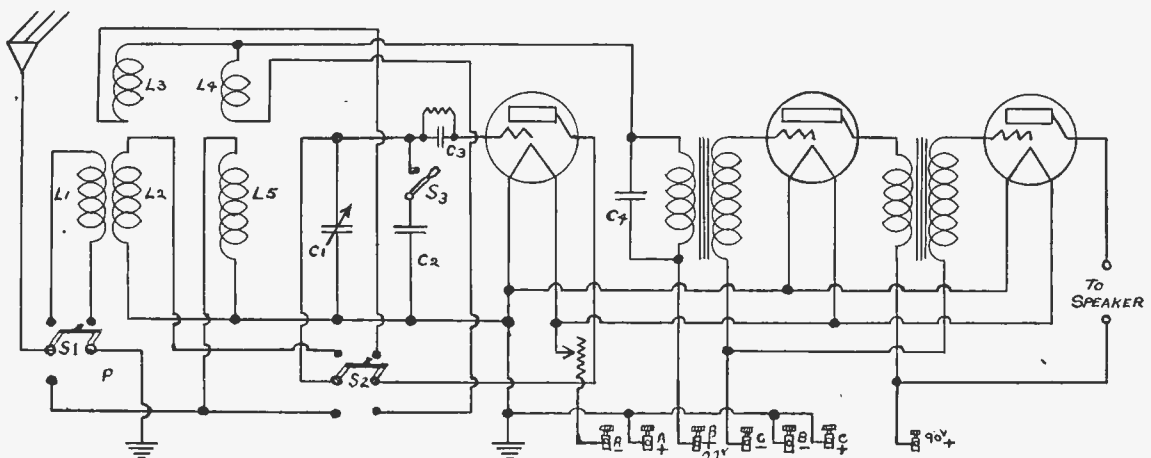

Fig. 1. This Hook-up Uses a Four-pole Double Throw Switch, Shown Here Divided Into S1, S2. The Entire Range of Radio and Wireless May be Heard

side diameter bakelite tubing two and one-half inches long. On this form the secondary coil was then wound, consisting of 45 turns of the Litzendraht wire and the whole assembled as it was originally, with the tickler coil rotating within the secondary. This done, the primary coil was constructed as mentioned above, and the ends secured by threading them through two small holes at either end of the secondary coil form.

**Does It Seem Foolish?**

It may appear foolish at first thought that Litzendraht should be recommended

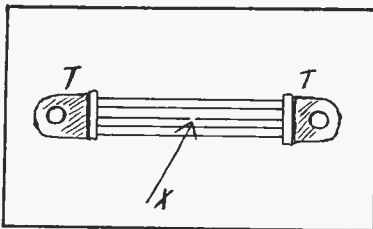

Fig. 2. This Illustrates Why Litzendraht Must be Well Soldered

for the secondary winding of a regenerative set, since the tickler coil will introduce energy into the secondary which will tend to make up for any losses that may occur, the degree depending on the tightness of coupling of the tickler. Such might be the case if it were not for the phenomenon of "threshold" voltage. The detector tube requires a certain minimum (threshold) voltage on the grid to make it work at all. Therefore, decreasing the resistance of the secondary circuit by the use of Litzendraht, and low power factor (low loss) condensers, will tend to bring in stations which would otherwise not be heard, if the signal received from them was not sufficient to bring the grid voltage to the threshold value.

With this in mind it is very important that in soldering to the various coils, especially the secondary, great care should be taken to see that each individual wire of the Litzendraht is clean and securely soldered. It is very easy to run up the resistance of such a coil by insecure soldering.

**Can't Take a Detour**

This idea is made plain in Fig. 2. Here are two terminals, P and P, which are connected by a lot of wires in parallel. These latter represent Litzendraht. Of course, they are really woven

or twisted together, so that they keep changing their position in the cable, but to make it plainer they are here shown side by side. There is a break in one of the wires at X. If this were ordinary cable the current would flow around this break by leaving the end of the broken strand and flowing sidewise into the surrounding copper wires and then back again into the other broken end.

With Litzendraht this can not be done. As already explained, such wire has each individual strand insulated from its neighbors so the cross flow around the break is prevented. Of course it follows that the entire strand is dead and worthless. The break, instead of being in the middle, may be at the end where it is not well soldered. The result in any case is a reduction of the conductivity and a proportional increase in the losses.

**Must Have Good Range**

For the condenser, C1, any good low loss condenser may be used, such as the Hammerlund, Cardwell or Premier, provided that it has the right capacity. Condensers of this type usually have a low minimum capacity, eight per cent.

our drawing this switch is shown in two different sections, each of two poles. This is in order to make the diagram easier to follow. Actually a single four pole unit would be preferable, although two double pole switches would work as well. The particular one used in this case was an old telephone switch. In the middle or off position all circuits are open, while throwing the switch arm down or up connects in either the honeycomb or the broadcast circuit, respectively.

**When to Omit One Wire**

It will be noticed in the diagram that throwing the switch, S1, into the up position connects in the variocoupler set while the down position throws in the honeycomb set. The point, P, on switch, S1, which would normally be used for the ground end of the honeycomb coil connection is left open and the filament battery positive grounded (lower center of diagram). This was done to cut out one wire and at the same time it tends to stabilize the secondary circuit of the broadcast receiver, preventing it from oscillating.

Turning next to the slow (long) wave end of the hook-up, it can be seen that

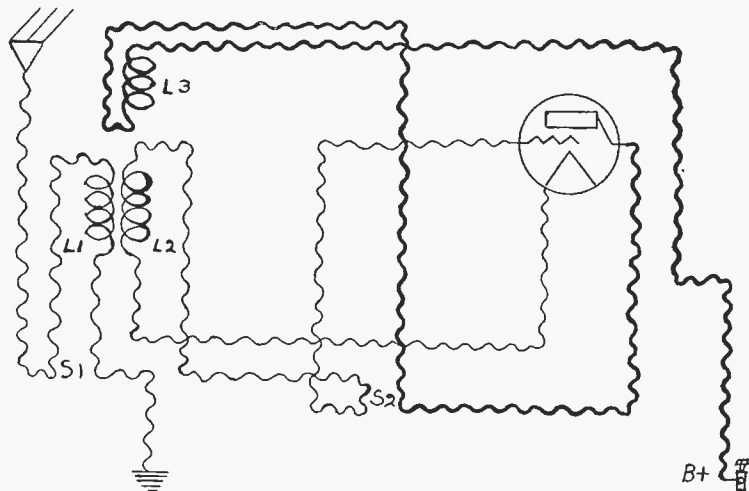

Fig. 3. This Diagram Shows Course of Waves Through Fig. 1 When Used on Broadcasting Range

or less of the maximum value. This wide range is distinctly worth while, as it increases the possible wave-speed range with a given coil.

The anti-capacity switch, S1, S2, shown in Fig. 1 is used for changing over from the broadcast receiver to the honeycomb receiver and consists essentially of two double-pole double throw switches. In

this consists of a single circuit arrangement with a tickler coil to produce regeneration. The reason that a circuit which is normally rather unselective, especially on the slower waves, was chosen will be explained in detail a little further on. Suffice to say that it has given very satisfactory results. The same condenser is used to tune this circuit as is

used for the short wave set but provision is made to shunt it by a .0005 microfarad Dubilier mica condenser to give greater wave frequency range.

#### Use Whatever Tube You Want

As this set was designed with the idea in mind of having maximum flexibility and efficiency with a minimum of controls, the filaments are all operated from the same rheostat, and UV-201A sockets are used throughout. This makes it possible to use any type of tube, with the trifling change of using adapters if other than 201A tubes are used.

This condenser is controlled by switch, S3. When this is closed, it adds its capacity, C2, to that of the main control, C1. Since the latter has a maximum figure of .0005, you see it will double the total number of microfarads, bring it up to a figure of .001. By thus doubling the capacity, the effect on wave frequency is increased 40 per cent. You might naturally conclude that this change in capacity would halve the frequency (double the wave length) but the effect on wave speed varies as the square root of the capacity, not as the capacity itself.

#### A Special Leak Needed

The next point of interest and importance in the set is the variable grid leak for the detector tube. In the set described it was of the familiar type to all radio fans, the Bradleyleak. For the proper operation, or perhaps more accurately, the best operation of any detector tube, it is essential that the grid leak be of the proper value for the tube with which it is to be used. Since as we shall see later, the operation of the set I am describing depends to a very large extent upon having a variable grid leak which can be depended on, the writer recommends that a Bradleyleak or one equally good be used.

Turning to the rest of the circuit, you will see that it is of the conventional design, using a "C" battery to bias the grids of the audio amplifying tubes. Any good brand of audio transformer may be used but those having a high primary inductance are to be preferred since they tend to increase the amplification of the lower frequencies which are often woefully lacking when cheap transformers are employed.

#### Uses Two Control System

Operation of the set is carried on as follows: With the switch, S1, S2 in the

up position, according to the diagram, the broadcast end of the circuit is connected in. Tuning is carried on easily and conveniently by varying the condenser, C1, in the diagram while the volume is controlled by varying the coupling of the tickler coil, L3. The two control system makes the operation of the set extremely simple over the broadcast range.

The course of the radio waves in that case is shown in Fig. 3. The oscillations run down from the aerial through switch, S1, primary L1, to ground. The secondary vibrations run from the coil through switch S2 to the grid, and also to the filament. The output from the plate is conducted by switch S2 to the tickler, L3, and from there to the "B" battery. The output from the detector is ampli-

circuit. By varying the resistance of the grid leak this audio oscillation may be varied over a range of from roughly two cycles per second to a frequency which is above the audible range.

#### Adjust Grunt with Leak

In using a grid leak which is smoothly variable, the whole range can be covered without any abrupt changes in frequency. In tuning the slow wave end then, the adjustments are first carried out in the ordinary way. As soon as the desired station is tuned in, the tickler coil is brought up until the grunt is heard. The grid leak resistance is then increased until the note changes to a very high pitched whistle which is almost inaudible. A slight readjustment of the tuning will then bring the signal desired up to a point where at a con-

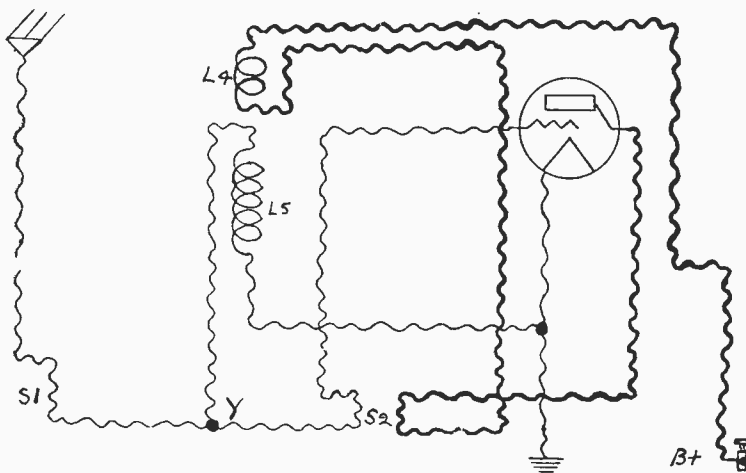

Fig. 4. By Switching to Wireless Range, the Vibrations Divide at Y, and Are Tuned Through L5

fied through two steps of audio in the ordinary manner.

Before explaining the best method of operating the set when switched to the slow wave circuit, it might be well to go into a little detail concerning the theory of its operation in order that the operator may have a clearer idea of what he is doing. Probably all operators of broadcast sets or at least all of them who have used a single circuit radio have noticed that with the tuning condenser set at any particular value, bringing the tickler coupling up will make the set oscillate at its own natural period and that if the coupling be still further increased, a kind of audio frequency oscillation is produced in the phones which varies from a sort of grunt up to a high squeal depending on the constants of the

servative estimate it is ten times as loud as it was before. At the same time a very noticeable increase in selectivity is brought about.

In working at these slow (long) waves, switch, S1, S2, is thrown down with the results shown in Fig. 4. Here the waves start at the aerial and are carried by switch, S1, to the point Y, where they divide. The main part of the oscillation goes through coil, L5, where it is tuned by the condenser, and the voltage tap from Y passes through switch, S2, to the grid. The output from the plate is lead through S2 to tickler coil, L4, and from there back to the "B" plus.

Brings in Europe Well  
As the reader has probably deduced  
Continued on Next Page

# A Radio Newspaper on Shipboard

## *How a Daily Sheet is Published for the Passengers*

An Interview from J. H. Walker, Chief Operator, Belgenland

**H**AVE you ever been listening to a radio program and in the middle heard the announcer state that the station would shut down immediately? Perhaps he continued an explanation that an SOS call had just been picked up from some ship at sea.

Such an incident, although not common, shows a comparison of the real importance of broadcasting and ship messages. Of course, the programs every evening as picked up on millions of radios throughout the country are enjoyed to a much greater extent than any code messages. But if you should happen to be trapped on a burning boat way out on the ocean, you would be mighty glad to know that wireless would bring aid in time to save you.

### Besides the SOS Call

But there is another service which is given by wireless with much greater

regularity although it is not nearly so dramatic. This is the furnishing of news to various vessels on their way across the seas. All the big boats have a daily

Seated at a sending key in one of the trim brick buildings of the great radio station in Marion, Massachusetts, which the motorist passes on the road from

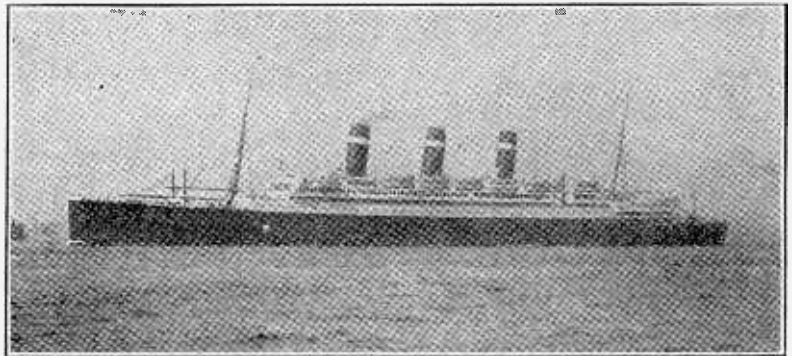

Fig. 1. This Steamer "Belgenland" Gets a Newspaper by Radio Every Day

newspaper, and, of course, except for ship's items, everything comes in through the aerial.

New Bedford to Cape Cod, a young man broadcasts every night across the wide  
Continued on Next Page

### A NEW TYPE

Continued from Previous Page

by this time, a form of super-regeneration is used to increase the sensitivity and selectivity of a circuit which is normally rather insensitive. That it accomplishes the desired result there is no doubt, for the writer has been able to bring in almost all the slow wave stations in Europe, some of which operate on waves around 30 kc. (10,000 meters) where the interference is very bad. These stations came in loud and clear on one stage of audio with practically no interference whatever, lowering the pitch of the variation frequency by means of the volume of the signal, but too much of this is not to be recommended as a point is finally reached where the strength of the squeal is greater than the signal.

This method of increasing the volume can be used at broadcast wave lengths

as well as the longer waves, although the writer does not recommend it when receiving music, as the variation frequency tends to tear up the program unless a very high variation frequency is used in which case the amplification is cut down considerably. Another serious disadvantage of this method is that it radiates waves from your aerial and so destroys the enjoyment of all your neighbors.

### Try It Out Yourself

Just what variation frequency is best suited to each particular case the experimenter can easily determine for himself, as it is easily changed by varying the grid leak, no special coils and condensers being necessary.

The honeycomb coil mounting is one of the ordinary two coil types with one fixed and one adjustable coil holder, and is mounted on the front of the panel. The coils to use depend on what wave

you are after.

With the belief that the average experimenter prefers to design his own panel, cabinet and so forth, the writer has purposely omitted these details, but it might possibly be of assistance to the experimenter to know that the set which has just been described is mounted on a 7-inch by 18-inch panel and sub-base 6 inches deep.

The list of parts is given below:

- 1 Shamrock variocoupler or equivalent. See text.
- 1 Two coil honeycomb coil mounting.
- 1 Rheostat, 2 ohm.
- 1 Variable grid leak (Bradleyleak.)
- 1 .0005 microfarad variable condenser.
- 2 .00025 microfarad mica condensers.
- 1 .00025 microfarad grid condenser.
- 1 Anti-capacity switch. See text.
- 2 Audio transformers.
- 3 UV-201A tube sockets.
- 6 lengths of bus bar wire, approximately
- 8 Binding posts.



### A RADIO NEWSPAPER ON SHIPBOARD

Continued from Previous Page

Atlantic and down into the Carribean, a well written summary of the day's happenings in the United States. At a more powerful station, at New Brunswick, N. J., another operator is engaged in broadcasting similar news summaries on a different wave speed to more distant parts of the globe.

#### "Sparks" Picks Up the "Press"

On almost every passenger ship at sea, in the ocean lanes between United States ports and Europe, among the Islands of the West Indies, and even down toward the equator near the South American coast, "Sparks," the radio operator, with receiving cups clamped to his ears,

is intent on picking up the tick of the distant keys at Marion or New Brunswick, that spell out through the ether the news of the day, which he sets down on long sheets headed "Press."

In this process lies the foundation of this novel and far reaching effect of the radio—the publication of newspapers at sea. The big liner now must issue a daily sheet for her passengers or be out of style. When crossing any of the wide oceans, the traveler in these days is never so far from land that the material for his daily paper does not reach the ship. Distance counts scarcely at all in the situation. Static interference from local thunderstorms may delay the receipt of the day's news on certain ships, but generally the invisible waves vibrating from the station in New

Jersey or that in Massachusetts find their mark in every ship at sea for which they are destined. Agencies which deal in news for ships are the senders of these messages.

#### Belgenland is Biggest User

The station at New Brunswick has such range that its messages have been picked up even in the Red Sea by the Red Star Liner Belgenland, (Fig 1) which makes an annual pleasure voyage around the world, and throughout the voyage publishes a daily paper filled with radio information, known as "The Cruise News." The experience of this ship with the receipt and publication of "press" is quite interesting, since she handles more of it, on one of her world-girdling voyages, than any of the great transatlantic liners in the same period.

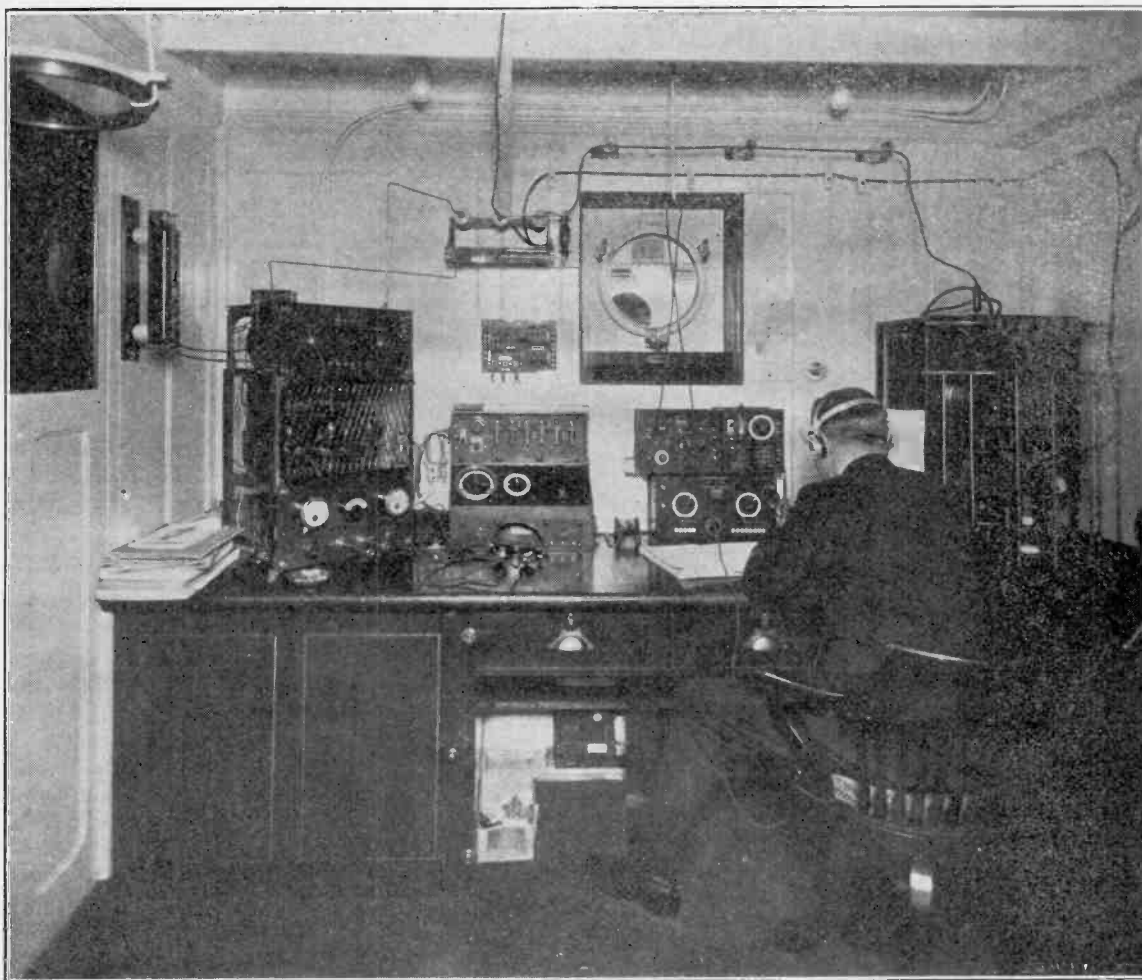

Fig. 2. Here is Where the Newspaper Copy Arrives Each Day. The High Voltage Transmitter is Seen at the Left. The Operator is Called "Sparks"

On the Belgenland's voyage from New York around the world westward last winter, on which she was absent 4½ months, she was in daily receipt of press reports, either from America or Europe, and for many days in succession, from both.

All the way from New York to the Panama Canal, a distance of 2,196 miles, she received daily news bulletins from Chatham, Massachusetts, a pioneer station in sending press, whose functions in broadcasting news have since been taken over by the station at Marion.

#### Frisco to Hong Kong

In the Carribean, the Belgenland also picked up a press service sent out from the naval radio station at San Diego, California, and another from San Francisco. After passing through the canal she was in daily receipt of those services until after she had passed Hawaii, and of the San Francisco service until she reached Hong Kong.

Incidentally it may be mentioned that all the leading governments maintain stations, generally connected with their naval intelligence departments, that are used for telling the news of the day. In other words, all the big governments are engaged in peddling propaganda by radio. In most instances, any ship at sea is welcome to receive it, and make such use of it as may be desired. On small ships not publishing newspapers, the officers read their daily news in this form.

Germany is the most active and skilled in broadcasting this kind of propaganda, and its great station at Nauen is the most far-reaching from which ships at sea receive daily "press."

#### How Did They Get There?

The Belgenland's operator came into touch with Nauen at 179 degrees west longitude, half way round the globe from Central Europe, and midway between Hawaii and Japan. The messages after covering about 12,000 miles of space, came through clearly, but the operator could not tell which way they had come around the globe. As a matter of fact, they had come both ways. East or West, their direction took them across a great continent—Europe and Asia in one case, and North America in another—before they winged over the trackless waste of ocean to the little room on the upper deck of the cruising liner.

In the eastern seas the editor of the ship's newspaper had an abundance of "press" from different sources. A high-powered station at San Francisco transmitted news all the way across the Pacific and the China Sea. The Japanese have an effective station sending out news bulletins in English. The United States navy base for the Philippines also sends out a news letter from Cavite. The English have a station at Colombo, Ceylon, with a range of some thousands of miles, covering the Bay of Bengal, the Indian Ocean, the Arabian Sea and the Red Sea, through which press messages sent the Belgenland from New York were received.

#### Propaganda from Oxford

West of Colombo, direct news contact with Europe was resumed through the German station at Nauen, and a powerful English propaganda station at Oxford. The news from the latter naturally was given preference, as it was extremely well prepared, and dealt with daily events in England, with many references to affairs in the United States. Debates in Parliament on international affairs were well reported.

At Suez Canal the Belgenland came in touch with the new station at New Brunswick, N. J., from which it took "press" across the Mediterranean. In the Atlantic it was again in touch with Chatham.

Through the means here outlined, the passenger coming down to luncheon on the cruise ship found daily at his plate a copy of his "Cruise News," containing fresh advices from his home country and the rest of the world beside. Perhaps it should have been considered a marvel that a man or woman steaming through the Straits of Malacca or the Arabian Sea could read an accurate account of a debate in Congress or in the British Parliament but a few hours after the speeches were delivered. But in this age nothing is long a novelty, and the appearance of the daily paper on shipboard was accepted as a matter of course, whether the vessel was 10,000 or 500 miles from New York.

#### Globe Girdling is New

While publishing newspapers at sea is not a recent development, as the transatlantic liners have had daily papers for several years, it is only recently that the perfection of long-range

stations has made possible the receipt of daily press reports by a ship cruising around the globe.

Methods of handling copy on board ship also have been improved in recent years. The mechanical equipment of the radio operator is no more like the original equipment than a six-cylinder auto is like the "one lugger" of 1895. Editorial preparation of the news received by radio on shipboard has been largely done on shore, where the messages are prepared by trained newspaper men, and in some cases the headlines to be used over each item are transmitted with the text.

#### Why Metal Screen is Used

Fig. 2 shows a view of the radio room on board the ship. Notice the small amount of apparatus that is visible. The high tension equipment is shown at the left behind the wire screen. Of course, the idea is that it must be protected so that no one may get a shock from touching it. The receiving equipment is in the middle of the table. Naturally very sensitive apparatus must be used to pick up the waves coming in from such a long distance. At the right is the tuner for obtaining the right wave speed (wave length).

On its receipt, the message is duplicated. On most ships one copy goes to the commander, one to the purser, and one is retained by the radio operator. As the world cruiser carries an editor to get out its daily paper, a copy also goes to him. This copy is edited at once, and sent to the ship's printing office, where three printers soon set the matter in type. The paper is run off on an electrically operated press, and is ready for distribution at noon.

#### No-Newspaper Days

On days when the ship is arriving at a port, or has just left port, no paper is issued, but the "press" is posted on the bulletin board near the main companionway. Special market reports, prepared at New York, and sent by the steamship company, sometimes supplement the press reports and these, when not published, also are posted.

Most "press" is received on shipboard at night, as atmospheric conditions are then most favorable to transmission, and the air is free from traffic. Static interference is a more frequent cause of trouble in receiving press messages than any other.



# EDITOR'S LOUD SPEAKER

## A RADIO CIRCUS

This is the time of year when vacations are in full bloom. It is also the time when radio expositions are commencing to get into bud.

No doubt you have seen the announcements of various shows to be held in the fall. But this brings up a rather interesting point. Who ought to run the radio shows? There are two general plans for the management.

### Promoters Pocket Profits

In the first place, many of the expositions in the last two or three years have been controlled by professional promoters. These men go around from town to town and put through radio shows which are made just as big as possible. They are frankly money-making schemes, and the exhibitors, and also the public are charged just as much as the traffic will bear. When the fair is all over the promoters divide up the profits among themselves.

The other scheme is to have the exhibits held under the auspices of the local radio association, which may be a Listeners' League, or Code Club, or perhaps a Dealers' Association. In any event, the fees are set at a low enough value so that the expenses only will be covered and if there is a small amount of money left in the treasury at the close of the event, then this sum is either divided among the members or contributed to charity.

Many of our big radio expositions in the past have been conducted under the first plan and there is no doubt but that the management has been fairly good. The idea of the high tariffs and

the large profits lining the purses of private promoters has not appealed either to the radio makers and dealers or to the broadcast listeners.

### Indianapolis Does It

The Broadcast Listeners' Association of Indianapolis has recent-

ly brought this matter to a head. They are opposed to a "Radio Circus," as they term the outside managed event. They are going to run an exposition, to be held late in September. They have announced that only those interested in the manufacture and sale of radio and the listeners them-



Rudolph Ganz, the conductor of the St. Louis Symphony Orchestra, who has been acting as guest conductor of the New York Philharmonic Orchestra in their concerts broadcast from the Lewisohn Stadium by Stations WJZ, WGY and WRC.

selves will have any voice in the management.

This appeals to us like a move in the right direction. It certainly seems as if the best interest of radio would be met better by such a scheme than by a profit-producing plan for the benefit of the circus managers.

#### SEND US A THORN

Most prefer roses, but at present we need a few thorns. Many of our readers write in to us

about this magazine. However, they all say the same thing—that they like it very much and think it is fine.

Of course, we are naturally pleased, and even flattered to know that our efforts are meeting with approval. But such comments do not help us to improve at all. A few readers say that they like such and such an article, mentioning it by name. That is something of a help, since it gives us an indication of what kind of material is wanted.



Fritz Reiner, Conductor of the Cincinnati Symphony Orchestra, has been very popular as guest conductor on his recent visit to New York. He has been heard on the air a number of times.

#### Tell Us It's Bad

What we want most of all, however, is for you to tell us what you *don't* like about our sheets. If you would say, for instance, that such and such a write-up by John Smith is rather stupid and uninteresting, and that So and So writes such a difficult style that you can't understand—that is the sort of letter which helps us to make a better magazine.

Perhaps you do not like the output of some of our editorial staff. It might even be (horrible thought) that you think this loud speaker is tuned in on a lot of static. If you do, by all means drop us a line and let us know how interesting such articles aren't. Otherwise, how should we know when to fire the editor?

#### No Mind Readers Here

There are probably a good many holes in the magazine which you would like to see filled. Maybe you want more hook-ups or perhaps you would like tables of engineering data. All right, tell us so. Or again, perhaps you would like to know why radios are built a certain way, or what laws of electricity are involved in say a detector tube or an amplifier. Not being gifted as mind readers, we cannot tell that you want such things unless you drop us a line.

As a last thought, get right down to brass tacks. Be sure to mention the name of the author and the titles of the articles which bore you and don't try to spare anybody's feelings. We have very tough skins here, and the harder you complain the more we shall thank you.

#### Nearly Half are Dead

Of the 1,180 broadcasting stations which have been "on the air" since September, 1921, only 550 are active to-day.

#### Tongues Taught by Radio

Anyone in central Europe can learn foreign languages by radio. Different hours each day are devoted to the various languages.

# Announcing the New Vacuum Tubes

## *Bases are Changed and a New Line of Rectifiers has been Added*

An Interview from J. L. Bernard

**W**HAT is wrong with the vacuum tube? If you have not abused the filament or shaken it up too hard, about the only thing that goes wrong in usual operation is the contacts.

There are two styles of contact which have been used. In one of these the springs push up against the ends of the four prongs (as shown in Fig. 1) as in the UV-201A, UV-199, and WD-12. The other style uses the *side* of the prongs for contact (Fig. 2) as obtained in the WD11.

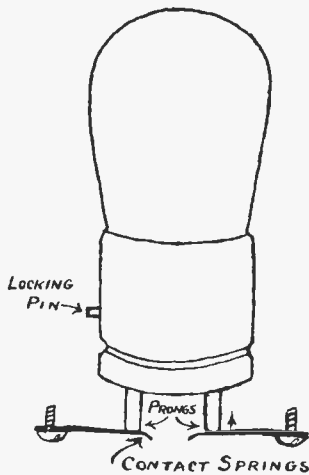

Fig. 1. This is the Style of Contact Now Used on Tubes

### Solder Makes Poor Contact

There have been two objections which occasionally have been urged against the style of Fig. 1. In the first place, the ends of the prongs are always covered with solder, since that is the method of fastening the wire leads. The solder is not nearly as good a contact material as brass, as it is apt to oxidize. Besides this the only way of holding the tubes against the spring contact pressure is by means of a single locking pin. If the base of the tube happens to fit loosely in the socket, the springs on the

other side from the locking pin may not have enough pressure against the contacts to make good connections.

The style of spring used in the WD11 (Fig. 2) gets rid of both objections. The contact is made on the *side* of the prongs instead of on the end and of course these are brass and so give a good connection. Then there is no lock needed to hold the bulbs in the socket, as the springs do not try to force it out. The contacts may be made as stiff as you like and even though the socket is not a very close fit all four prongs will make a good connection to the contact springs.

### It is the Push That Wins

Because this "push" type of base is better than the bayonet type (Fig. 1) the Radio Corporation has decided in the future to standardize on this new style. They will be known as the "UX" line instead of the "UV."

The RCA denied reports which have been in circulation that Radiotrons equipped with the new "UX" standardized base would provide a performance superior to the tubes which are at present equipped with the "UV" base. As a matter of fact, there is no difference whatever in the structure, technical characteristics or performance of Radiotrons equipped with either a "UV" or a "UX" base. The only difference between these two types of tubes lies in the design of the base itself.

Of course, the new tubes will be built with all the latest improvements made during the last year, but as far as that is concerned so will the old style. Slight detail changes are being made all the time, as the research laboratory makes improvements. These small differences however, are not big enough to justify a change in the name or the number of the tube.

### Three Styles of Bases

Three different types of Radiotron

bases are in use at this time, as follows:

(a) *Navy Standard tube base* of the so-called "bayonet" type, which fits the Navy type of socket, and which in the majority of cases is employed for vacuum tubes of the storage battery type, such as UV-201A and UV-200.

(b) *UV-199 base* which also is of the bayonet type, is smaller than the Navy base, has shorter contact pins and requires a type of socket which makes contact on the bottom of the pins. This base is used only with Radiotron UV-199.

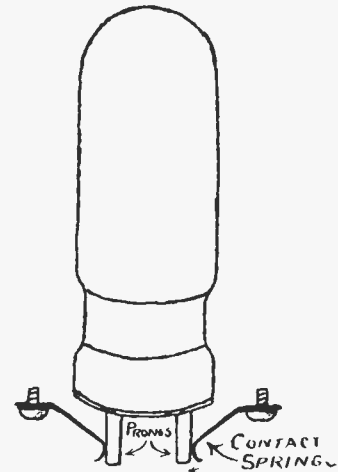

Fig. 2. The New UX Line Has Springs Which Bear on side of Prongs

(c) *WD-11 base* which is of the "push" type having long contact pins which make contact on the sides. One of the four pins is of larger diameter than the others and is connected to the plate of the tube.

In view of the large number of Navy type of sockets already in use in broadcast receivers, it became necessary in devising a New Standard Base to make provision for filling these sockets, otherwise it would have been necessary to continue the production of tubes with the Navy base.

The new RCA Standard Radiotron Bases will be made in two sizes (with respect to the moulded portion of the base), but they will have identical contact pins, and identical spacing of the pins.

**How the New Bases Differ**

The large size standardized base (for storage battery types of tubes) will have the same diameter and the same bayonet pin as the present Navy base, but with the following exceptions:

(a) The contact pins will be longer than in the Navy Base.

**Locking Pin Not Needed**

The large "UX" base appears in Fig. 4. You will notice that the spacing and size of the pins is exactly the same as in Fig. 3. This simplifies the making of the bases as only one jig or form for lining up the prongs answers for all the new tubes. Observe that there is a locking pin shown on this base. It will not be needed with the new sockets, but will be used when one of the new tubes is inserted in an old socket.

Fig. 5 gives a view of the new style as it appears from an angle. The long slender prongs are shown here very

**Present Sockets Need Not Change**

All broadcast receivers having Navy types of sockets, i. e., originally designed for storage battery type tubes, will as explained above, accommodate the 201A type either with the new standardized base ("UX" type) or with the Navy base ("UV" type).

As time goes on, radio manufacturers will no doubt adopt the UX-199 tube (Fig. 6) and the WX-12 for dry battery sets. The RCA will maintain stocks of these two types to meet this demand. Stocks of the UV-199 and WD-11 will also be kept on hand to take care of the replacement requirements for dry battery sets having the "UV" or "WD" bases.

The RCA states that the five standard tubes for receiving purposes, which it has had on the market for the past few years, will continue to be its standards for radio reception. However, three new types of Radiotrons, designed solely for audio-frequency amplification and for use in the last stage of the radio broadcast receiver, will be announced later when they have been fully developed.

**UX-120 is a Loud One**

Radiotron UX-120 is among the proposed group, and is a special dry battery power amplifier requiring 135 volts on the plate and 22½ volts grid bias. When it is connected to the last audio stage of radio broadcast receiver, it will provide loud speaker volume approximately double that obtainable from the storage battery type of receiver using 201A tubes. Fig. 7 shows this tube in the last audio step of a superhet. A special adapter makes it fit.

The RCA has another special audio amplifier in the course of development for sets of the storage battery type. This will be known as UX-112, which also requires 135 volts on the plate for maximum performance, and which when con-

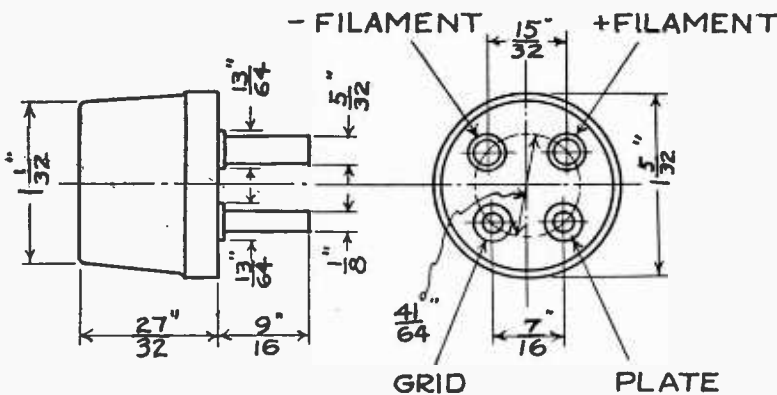

Fig. 3. The Small Bases Have These Dimensions. Note the Two Large Prongs (Top) and Two Small Ones

(b) The two contact pins connected to the filament will be larger than the grid and plate pins (thus insuring that the tube is inserted in the socket in the proper way.)

The distance from the bayonet pin to the end of the contact pins will be the same as in the Navy base. In other words, when such tubes as WD-12, UV-201A and UV-200 are equipped with the new standard base, they may be used interchangeably in the Navy socket or in the new RCA "push" socket.

The small new standard base for UV-199 tubes will have exactly the same prong dimensions and prong spacing as the larger standardized base. The moulded part will be approximately the same size and shape as that of the present WD-11 and UV-199 bases.

The small "UX" socket is shown in Fig. 3. Notice that the four prongs are quite long and are not all the same size. As already explained, this is to allow plenty of room for the spring contacts to bear against the side of these pins and to prevent the chance of inserting the tube in the wrong position in the socket.

clearly. And remember that you cannot tell from their size and spacing whether you have the large or the small style of tubes. The only reason for having two different sizes is to distinguish immediately between units for storage battery and dry cell use.

To accommodate tube replacements on dry battery operated sets, UV-199 and WD-11 with their original bases will be continued in production and carried in stock as long as there is any demand for these tubes.

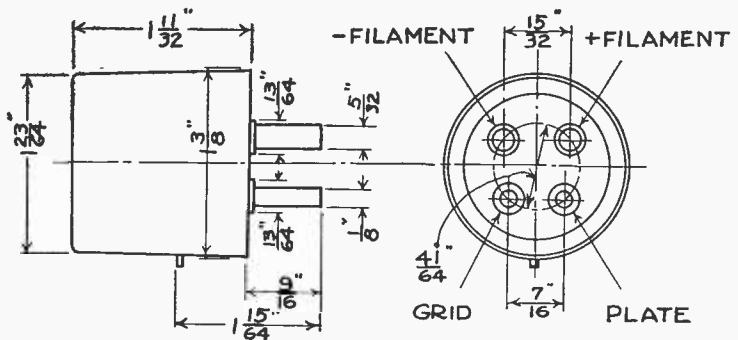

Fig. 4. Here is the Large Base. Observe That the Pin Spacing and Size is Just Like the Small One, Fig. 3.

nected to the last audio stage of a broadcast receiver, gives loud speaker volume considerably louder than obtained from a 201A tube in the last audio stage.

A third super-power amplifier tube under study is to be known as UX-210, which provides loud speaker volume far in excess of any type of audio amplifier

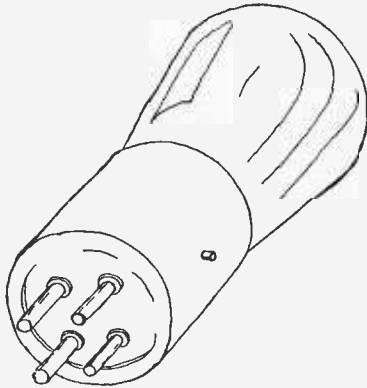

Fig. 5. This Shows a Side View of Tubes. The Two Heavy Posts Are Clearly Seen

tube now in use. The filament of the UX-210 Radiotron may be operated directly from a 6-volt storage battery, with upward of 150 volts required for the plate. It may also be used as a 7.5 watt transmitting tube or as an audio frequency amplifier, the plate and filament current for which can be supplied by a rectifier-amplifier unit.

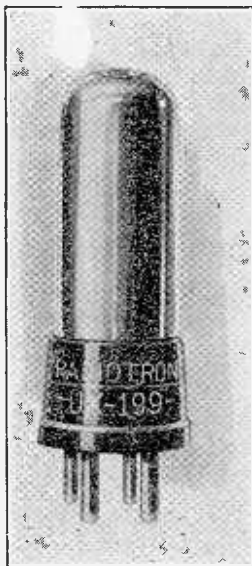

Fig. 6. The UX199 Differs from the UV199 Only in the Four Prongs

**For Omitting the "B" Battery**

It is also reported that the Radio Corporation will introduce two types of rectifier tubes for use in "B" battery eliminators and current supply device. One tube, known as UX-216B, has an output of 65 milliamperes. This is a single way or half-wave rectifier. By this it is meant that all the positive halves or loops of the alternating current wave are sent into the battery to charge it while the negative halves which would normally discharge the battery are suppressed. If you want to use both halves of the wave, then it is necessary to reverse the negative loops

All of the new Radiotron tubes are equipped with the new RCA standard "UX" base. In due time, no doubt, adapters will appear on the market which will permit the use of these special tubes in the last audio stage of present type broadcast receivers. All of the three amplifiers, UX-120, UX-122, and UX-210, are tubes which provide improved quality of loud speaker reproduction.

**The Old Styles Still Continued**

None of these new Radiotrons supersede existing types. They were designed for the special purpose of giving greater audio outputs from existing sets.

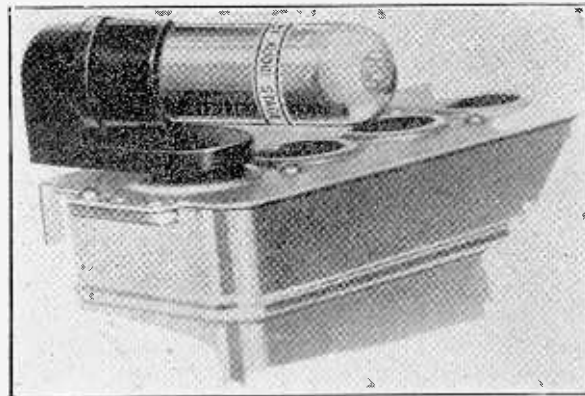

Fig. 7. Here is a No. 120 Tube with Special Adapter in Last Stage of Superhet

so that they also run into the battery for charge rather than out on discharge. Another rectifier tube known as the UX-213, gives this double way or full-wave amplifier and provides an output of 65 milliamperes for "B" battery eliminators and other similar current supply devices.

A table showing the various characteristics of the line is given below. The first five tubes are the ones which are to be superseded. The UX-200 will replace the UV-200, and so on down the list. It is stated that some of the tubes will be delivered to the trade about September first.

**TABLE OF OLD AND NEW TUBES**

No.	Base Needed	Size	Filament Volts	Battery	Use
UV 200	Old	Large	5.0	Storage	Detector
UV 201-A	Old	Large	5.0	Storage	Detector and amplifier
UV 199	Old	Small	3.0	Dry	Detector and amplifier*
WD 11	Old	Small	1.1	Dry	Detector and amplifier*
WD 12	Old	Large	1.1	Dry	Detector and amplifier
UX 200	Old or new	Large	5.0	Storage	Detector
UX 201-A	Old or new	Large	5.0	Storage	Detector and amplifier
UX 199	New	Small	3.0	Dry	Detector and amplifier
WX 11	New	Small	1.1	Dry	Detector and amplifier
WX 12	Old or new	Large	1.1	Dry	Detector and amplifier
UX 120	New	Small	3.0†	Dry	Power amplifier
UX 112	New	Large	5.0†	Storage	Power amplifier
UX 210	New	Large	6.0†	Storage	Amplifier and transmitter
UX 216-B	New	Large	7.5†	Storage	Half-wave rectifier
UX 213	New	Large	5.0†	Storage	Full wave rectifier

\*The two tubes marked thus will be continued in production only as there is a demand for them.

†The five tubes marked thus are still in the development stage.

# Peak and Canyon on Trip with Radio

## *How Mountains and Valleys Affect a Receiving Set*

By ERIC H. PALMER, Freed Eisemann Radio Corporation

**H**AVE you ever been a mile under ground? Or several miles up in the air? How do you suppose a radio set would feel in the Grand Canyon, which is about a mile deep, or up on the summit of Pike's Peak?

These interesting questions bothered the Chamber of Commerce of Brooklyn, and they sent out an expedition which would find out among other things how a radio set behaved under these extreme conditions. As the summer is the worst time it was decided to make the tests during the warm weather. The plan was to do the big jumps across the country by train, but use an auto for local traveling.

### Go! You Every Time

Any red-blooded sportsman would delight in the very newest of sports, running a radio on a transcontinental train. It is one of the most interesting and at the same time uncertain of pursuits. Almost every mile there are new sensations—results quite unexpected; and the very stations which seem most likely to be "caught" are never even heard, while those we never count on come rolling in merrily regardless of location, seemingly.

Starting out one Sunday with the Brooklyn Chamber of Commerce on its good will journey from coast to coast, I began a test that to a radio enthusiast was alive with possibilities, but was ready to accept disappointments, knowing that there could be no guarantee of marvelous DX reception, regardless of what might have been done previously from fast moving trains.

### A Moving Antenna

An antenna about sixty feet long on the roof of the Pullman was used for the experiment with a Freed-Eisemann receiver and a Western Electric 14-A amplifier—which sometimes was very useful in overcoming the noise of the train.

The ground was a connection to the rear axle of the car. Lehigh Valley and Santa Fe Railroad officials were very much interested in this test and predicted that soon every limited train in America would carry a receiving set.

As dusk came, with a slight drizzle, the official investigation began, and with it the first thrill for the members of the party, for it was a message from home

Tabernacle in Chicago, via WHT, were listened to; and merry music arrived from WEAN, Providence, and WHN, New York. Crossing several steel structures near Niagara Falls, reception abruptly ceased, but as soon as the train moved away from the vicinity reception improved as if by magic. With complete darkness signals gained in strength.

On the following night, passing out of

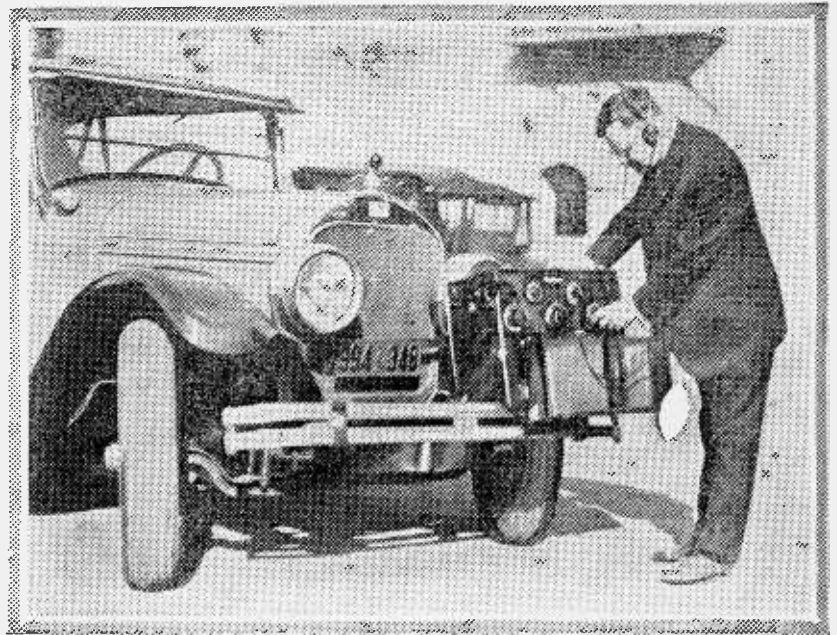

Fig. 1. The Author is Shown with His Special Portable Neutrodyne, Which Showed Unusual Results

that floated through the ether. WBBR, the International Bible Students' Association in Brooklyn, was sending out its regular Sunday evening concert, and as we rolled along past Lake Seneca the vocal and instrumental numbers were clearly heard on the loud speaker.

### Couldn't Hear at Niagara Falls

Within the next few hours religious services from the Central Presbyterian Church, Buffalo, through WGR, and the

Chicago, WCEE, WHT, WWAE, WJJD, and a dozen other stations were tuned in. The route was generally level and no surprising developments occurred, other than the absence of static interference. A member of the Chicago police force was singing in one of the smaller stations of the Windy City, WGEF, and the retiring president of the Brooklyn Chamber, Arthur S. Somers, well known as a basso as well as a business man,



sang many favorite airs in company with the singer whose notes we were hearing via radio.

The next night, on the way to Kansas City, came a real feature, community singing on the train, lead by voices from far away New Orleans. Thirty of us participated for an hour or more. WSMB was responsible for this treat and for lively dance music that followed. The announcer read off a string of telegrams from people in many states, announcing reception all over the country, and we would have contributed to the applause but for the fact that we did not stop near a telegraph station in time to reach WSMB before they signed off.



Fig. 2. The Trip West Was Never Dull

Took Prize for Static

A perfect din followed. No static within remembrance could beat that racket. The railroad conductor laughed. "Why, you're passing a 6,000-volt electric line," he declared. That explained it. The train veered to the right and the remaining portion of the program was received.

There was nothing further of special interest in the radio line until we went up thousands of feet over the mountains. In the Rockies, which were naturally a shield against extraordinary results, there was continual fading as the train

rounded curves, with majestic peaks wherever the eye could reach. KOA, Denver; KFKX, Hastings, Neb., and several others, but with lesser strength, were heard as the train sped past Pueblo with programs that were of much interest to those on board. But every time the train passed a steel frame building or took a sharp turn, fading was perceptible.

High Power Has the Pep

The thermometer had risen pretty high when we started out and continued to rise, so that every radio listener can understand that reception was particularly difficult, as against midwinter results. But one thing was plain, the stations using higher power came through regularly, like WHT, Deerfield, Ill.

California stations came in, as far as this trip was concerned, for the first time just before reaching Gallup, Arizona, and trainmen told us that they are rarely heard before 11 p. m., mountain time, if at all. KOA continued with great volume for a hundred miles or more in this section.

The sister stations, KOA Denver, and KGO, Oakland, were rivals for preference as the train was speeding towards William, Arizona, and they continued to be heard on our loud speaker until the close of the programs. The thermometer was up past the 70 mark and the air very dry. Stations of less power could only be heard on the phones. Several of these stations had sketches and skits which lasted half an hour without any mention of call letters.

Talking to Beat the Train

Announcers in many places seemingly tried to beat the train in point of speed as far as their introductions were concerned. They should all be cautioned to speak far more slowly in order that people a great many miles away might know to whom they are listening. Surely artists would appreciate being heard on speeding trains, but they cannot get full credit if the announcers do not do their part. Train noises must be overcome and rapid speech is lost in the rattle.

From all the far ends of the earth, summer tourists come to see the masterpiece of nature, the Grand Canyon of the Colorado River in Arizona. Probably, also, the ether waves of a hundred broadcasting stations start for this popular region, but as like as not they never

penetrate radio receivers handled by hopeful enthusiasts.

Down in the Canyon, where the temperature hits the high spots, static rules in the vacation season, and even super-power stations have hard work breaking through, except in the late hours. Of course, eastern stations under daylight saving schedules are not received until winter comes.

Tuning Deep in Abyss

Pacific Coast transmitters are most successful, and with patient and careful tuning, results are well worth the experiment, deep down in the abyss. Up on the top, about 9 o'clock at night, the

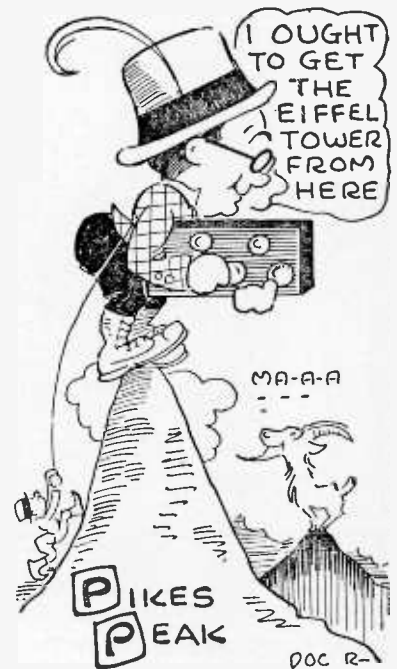

Fig. 3. Have You Ever Listened in on Top of a Mountain?

log may show a dozen or more stations on an extraordinarily good night and three or four on the average.

To the experimenter, the Grand Canyon is therefore an ideal place for devising ways and means of reducing atmospheric interference. Here is a chance to try every method—burying the antenna (in the few places where this is possible), shortening the aerial, using various lengths of wire for counter-poise effect, and so on, and while the canyon is not the paradise of broadcast reception, good luck might be had during the day, too, as a pleasant surprise.

The expert on Grand Canyon reception is C. H. Ingels of the Hotel El Tovar, on which there are several aeri-als and in which there a number of sets. "For half of the year, at least, we have wonderful reception in and about the Grand Canyon," he explained.

#### Where Boston Beats New York

"Several scientific organizations, such as geological surveys, have been here, and even down at the bottom have brought in most of the country at one period or another, but strange to say, New York has not been received as often as Boston or Montreal. California stations come in well as a rule, no matter

is lots of fun when darkness comes and after 11 o'clock I have been getting fine results for the last few weeks."

#### What the Hopi Indians Thought

Hopi Indians who live near the Canyon were not keen on listening in. They looked upon the radio set as a device of evil spirits, but when their palms were crossed with silver, some of them consented to try on the head phones. When asked for impressions as to the miracle of radio, they just shrugged their shoulders and went about their knitting. They still stick to the ways of their ancestors and are opposed to modern inventions.

After seeing how our set worked in

peaks rising abruptly from the plains beneath. It was amid this sublime spectacle at the summit of Pike's Peak in Colorado that my greatest thrill in radio was recorded (May 21, 1925.)

On the ground I had thrown an insulated 50-foot wire for an aerial, and buried, as far as I could among the rocks a copper spike with the ground connection, and at its base I had piled some of the eternal snows of the mountain, in order that the moistening process might prove helpful for ground effect.

#### Heard My Own Name

Music sounded, the clear tones of a piano, and then came the dramatic moment. A cheery voice resounded and this is what I heard:

"Eric Palmer, we welcome you to Pike's Peak as a radio explorer from the East. Greetings." •••

Who would not have been stunned by such a circumstance? I was awed. Without a word, I handed the phones over to friends and they almost danced in excitement. "Why, they are talking to you!" they exclaimed. "And now listen to the music."

I ran into the little hotel on the summit and wired a telegram of appreciation to the man who had made possible that eventful moment—Dr. William Reynolds of Denver, a radio enthusiast, speaking from the little station in his home which is operated by him with the sole assistance of Mrs. Reynolds. It is KLZ, on 1320 kc. (226 m.), and is on the 250 watts power, with a record of being heard in Samoa, England, France and other phenomenal distances. And in the sunshine on Pike's Peak, 75 miles away from the transmitter, KLZ came in like the proverbial bell.

#### No Grounds Can be Found

In the heart of the mountains, radio fans stated, reception is uncertain, due to the shielding of the antenna by the peaks, but nearer the tops, coast to coast reception in the winter months is not unusual with powerful receivers. The great difficulty is securing an adequate ground and the usual process is the erection of a counterpoise.

An unusual incident of that kind was narrated at the Cave of the Winds near Manitou by George W. Miller, who used the first audion bulb ever seen in Colorado.



Fig. 4. This is at the Bottom of the Grand Canyon, One Mile Down. C. H. Ingels is Shown Making Tests

where the party is located. On the rim results are universally good.

"Now with the heat of summer, we cannot tell what will be received, but here you, at the very first try, get music almost at noon from KGO, 700 miles away, even though there is much static. That is the way it goes. Down at the bottom, along the bed of the Colorado River, it is next to impossible to get anything.

"There is no question but that summer broadcast reception has improved, but down in this section we cannot say there has been a solution of the static problems, during the hours of light. But there

the depths of the canyon, the next point was to try it out on the high crests of the mountain. Pike's Peak is one of the most famous of this region, so that seemed an appropriate location for further experiments. I shall never forget the results of that day.

#### On the Top of the World

I was standing almost at the top of the American continent, with my ears buzzing from the extraordinary change from the sea level to which I am accustomed, and my eyes were entranced by the dazzling view of 60,000 square miles on all sides far below, with majestic

"Here we have a 100-foot antenna," he said, "but we cannot have a ground in this limestone, so I use a counterpoise attached to the electric socket and it works well indeed. The Cave of the Winds overlooks Williams Canyon, where reception is poor. You can see it looking down and no need to tell you that these walls choke off the radio waves. But right *in the cave*, in any of its recesses, we can hear almost or quite as well as outside."

Three Points of California

The last part of our trip was laid in California. This state is full of three things—climate, automobiles, and radio apparatus. It has an amazing skyline, not always a vision of mountains, orange trees and tall palms. Most of it seems to be made up of wires—heavy cables carrying high tension currents, in many instances, but principally all kinds of aerials for the reception of broadcasting.

Antenna-land begins at the very edge of the Golden State, just across the line from Tia Juana, and extends to the northermost border. Sunshine and realtors may be the two chief attributes of California, according to popular conception, but when a humble radio explorer sets foot on the Pacific Coast other circumstances and people strike his eye.

Won't Hear Themselves Praised

Every evening the air is filled with enthusiastic speech and inspiring music about the wonders of the state. Naturally, a visitor immediately comes to the conclusion that it is no marvel that any ordinary Californian can talk an Easterner deaf and dumb on the virtues of his chosen home, in view of all the information and inspiration that passes through the ether. But that idea is all wrong. "We don't listen to it," they declared, as they twisted their dials in pursuit of music from afar. But those who come for the first time and tune in are bewildered by the ceaseless propaganda by aggressive communities through the air—and it is addressed to neighboring towns as well as to folks hundreds and perhaps a thousand or more miles away.

California has adopted the radio as the instrumentality of the most vigorous boosting campaign that could be imagined. Each Chamber of Commerce, Civic Board, Rotary Club, Lions, Exchange,

Kiwanis, and Optimist Club, with finesse and the utmost sincerity and conviction, are telling the world what advantages their respective sections offer. Almost all radio programs contain selections, musical and vocal, that are preceded by a paragraph or two with regard to this or that feature of the particular town represented. And they, purveyors of such entertainment and instruction, are positively delighted to receive telegrams, cards and letters, testifying that these messages have been heard. Cartloads of oranges, to cite one example, go out to people of the Atlantic Coast or in Alaska



Fig. 5. The End of the Long Journey Wasn't So Bad

and Canada who hear such programs and ask for more. But the native Californian, as stated, either does not need such inspiration to boom his state, or is "fed up" on the boosting—and he wanders far afield from the standpoint of radio, to see if KDKA, Pittsburg, is coming in again.

Poor Taste in Aerials

Touring through Southern California by automobile, one finds house after house with all manner of aerials, but to the experienced operator it does seem that the wires in most cases are too long. The antennas are of fine appearance

carefully put up, but in hundreds of instances there are two long wires, when a single short would be more efficient. The explanation given is that they hope to bring in the New York stations and feel that with longer wires this will be more likely, with the result that for local reception tuning is broader. It was not difficult in the main centers to hear a dozen or more stations without any antenna or with only a short indoor wire.

Riverside seems to be the radio paradise. With 6,000 homes, there are more than 3,500 radio sets, and it is expected the town will roll up a 102 per cent (this is California) showing very shortly. And in Santa Barbara, another great residential community, the situation is about the same, although here there is a "dead spot" and reception is not equal to that achieved further south. In Los Angeles and San Francisco radio enthusiasm is on the increase, but there are so many broadcasters that except with the highly selective sets, DX work is out of the question part of each night.

Radio certainly has given the Californian boosting brigade, several million strong, an extraordinarily interesting and successful method of conveying their propaganda, and it will be kept up with accentuated fervor, now that Californians whisper to you that they heard Florida was doing some great work, too, towards enticing the free-spending American tourist. It is a sort of rivalry of the air, in addition to everything else, and radio listeners in all quarters this winter will hear from both states glowing descriptions of these fair lands. And who can deny, as we sit around our northern firesides and hear the storm raging without, that we are rather thrilled by the thought that some fair soprano is singing for us amid the flowers of these southern climes, and we cannot blame the "Gogetem" Club secretary for chiming in with a few eloquent words about his territory.

All these things are what help to make America great, so let us all send off via the ether waves, that California too may hear some of the wonders of our own places. The result will be that we shall get better acquainted, like each other more, and work enthusiastically for the common object of making the United States more prosperous and more deserving of that prosperity.

# R DR RADIO PRESCRIBES.

**NOTE:** In this section the Technical Editor will answer questions of general interest on any radio matter. Any of our readers may ask not more than two questions, and if the subjects are of importance to most radio fans they will be answered free of charge in the magazine. If they are

of special interest to the questioner alone, or if a personal answer is desired, a charge of fifty cents will be made for each answer. This will entitle the questioner to a personal answer by letter. However, if the question requires considerable experimental work, higher rates will be charged.

**Question.** In an article by Rados, in the February issue, there is a description of a transformer for working a tungar bulb in the five ampere size. Please give instructions for a similar unit to use with the two ampere bulb.

**Answer.** The two ampere tungar is similar to the five ampere size, but in a few details there is a difference, as it uses a smaller bulb. The same size core can be used but the windings are different. The primary consists of 500 turns of No. 20 dcc. The secondary winding is of 70 turns of No. 14 dcc. wire. These two coils will be in series, so they are wound side by side on the wooden form at the same time. After they are wound, tape them and place on one long core leg. On the other long leg goes the filament winding which is composed of a conductor of double No. 14 dcc. 11 turns. A tap is taken out at the middle, and this tap is also two No. 14 dcc. wires laid side by side. This transformer is built exactly as the other one was, and the mounting is the same.

**Question.** Why can not alternating current be used for lighting vacuum tube filaments, after it has been run through a transformer?

**Answer.** The alternating current, which you get from your house mains, is unsuitable for your tubes for two reasons. In the first place the pressure is so high that it will burn out the tube in an instant. The second trouble is that the current reverses its flow back and forth sixty times every second.

By running the electricity through a transformer the pressure is reduced from 110 down to whatever is needed

for your tube, say six volts. The trouble of the periodic reversing direction has not been removed with this drop in pressure. In the case of the filament, however, it is not the reversal of direction which does the damage. Every time the current changes its flow, it necessarily drops to zero for an instant, and that is why it is unsuitable in a vacuum tube. The electricity has only one idea in life, as it runs through the filament, and that is to make the wire hot. During the instant when no current flows, the wire naturally cools off to some extent and that changes the amount of "B" battery current flowing through the phones. The result is that a pronounced hum is heard from the receiver. By using a thick, heavy filament, this action is reduced, but cannot be entirely eliminated.

**Question.** How is the best method to test a set to make sure that there are no broken wires?

**Answer.** There is just one way for making such a test, and that is to use voltage from a battery or transformer with something to indicate when the current is flowing. A dry cell is quite suitable to supply the electricity, although a "B" battery will serve just as well except for its much higher cost. If much of this work is to be done, it is often advisable to use a small toy transformer to give six or eight volts for making this test.

For the indicator to tell whether the current is flowing or not, a pair of phones is often used. This, however, has the disadvantage that it is too sensitive. When listening for the click, which is heard when the circuit is continuous, it sometimes happens that leakage over

insulation will give enough sound in the head set to make you think that the wiring is all right. Another trouble with the phones for test is that you cannot get an indication of when the wire is actually carrying current, but only when the action starts and stops. Even at that the phones are so handy that they are often used for this purpose.

The best indication of the current flow is a small lamp. If you run this test very often, it will pay to get a three-volt automobile dash lamp, which sells for 20 cents. This is connected in series with the battery and lights up whenever the wire which is being tested is continuous without a break. In case of a poor contact or bad joint the light goes out.

**Question.** In winding one of the new doughnut coils, are 200 turns too many to use, and if not, why is the number so much larger than on a variocoupler?

**Answer.** The number of turns on such a coil usually runs from 200 to 250. Use No. 23 wire, which will make the inside of the hole of the doughnut about three inches in diameter. The forms on which the coils are wound up should be  $1\frac{1}{4}$  to  $1\frac{1}{2}$  inches in diameter. The reason for using so many turns as compared with a coupler, is that the latter uses tubing three or more inches across, which gives an area four or five times as great. This is compensated for by the smaller number of turns of wire.

**Question.** What is the principle on which the rheostat is omitted from the filament circuit of a tube and a resistance like an Ampererite used in its place?

**Answer.** There are several such products on the market, which work in the

same way. The scheme uses a resistance, which is non-adjustable, but is made of an alloy with very high temperature coefficient. That is, it increases its resistance very greatly when it gets hot. When such a unit is connected in the filament circuit, if it is properly designed and the voltage from the battery is normal, then the right amount of current will pass through the filament. If the pressure on the filament is raised, then more current immediately flows through the circuit, which heats up the ballast resistance and so sharply increases its number of ohms. This higher value prevents the current through it and the filament from increasing very sharply.

Of course, the style of unit which will work with a storage type tube is quite different from that which is suitable for a dry cell. In the same way different values of resistance must be used, depending on how much current the tube filament is designed to take.

*Question.* Why is it stated that three stages of resistance coupled amplifier is usually equivalent to about two of transformer coupling?

*Answer.* The reason is found in the fact that amplification between stages of audio frequency is obtained from two sources. In the first place the tubes raise the voltage up to about six or eight times. Besides this, the transformers themselves have a ratio which is sometimes 3½ to 1 or more rarely as high as 6 to 1. In the resistance coupled hook-up only the first of these sources of increase can be obtained. As the transformers are not used, naturally their ratio has nothing to do with it.

*Question.* In a neutrodyne set why cannot the three dials be fastened together by a belt or chain or else some kind of link motion?

*Answer.* This idea of yours has been tried out a good many times, but there is one rather serious objection. The readings of three dials are seldom exactly alike. Thus you may pick up your favorite station with the three dials reading 48, 52, 51. If this relationship held over all the range it would be simple to use a belt to make them all turn alike, but at the lower values of such a set as likely as not the readings may be 10, 8 and 7. From this you can

**TOO JAZZY FOR JOHN BULL**

Another evidence that Americans live faster than any other nation on earth, both in their work and play, is contained in a statement by Vincent Lopez, who is back on the air at WEAf every Tuesday, Thursday and Saturday from 11 to 12 p. m. He relates that while in England playing at the Kit-Kat Club, an exclusive London rendezvous, he had to slow down his dance music to a marked degree for the benefit of the staid Britishers, who could not keep up with the American rate.

**WHO ARE THE REAL RUBES?**

The sophisticated New Yorkers have been patting themselves on the back as being the only ones who appreciate classical music, but the returns from the broadcasting of the Philharmonic Society Concerts from the Lewisohn Stadium has proved them to be all wrong. In fact, the results have proved just the opposite.

Stations WJZ, WRC, and WGY have been broadcasting these events for some time; in fact, Station WJZ transmitted them all during the summer of 1924, and at that time the letters of appreciation from points outside the Metropolitan area outnumbered those of the city dwellers in a ratio of 2 to 1. And in the mail received by that station this spring, prior to the announcement of the resumption of the broadcasting of the Stadium Concerts, the number of inquiries as to whether the concerts would be broadcast showed a ratio of almost three from "the country folks" to one from New Yorkers. This year the Stadium Concerts are being broadcast by WJZ, WGY, and WRC on Monday, Friday and Saturday nights starting at 8:25.

see how impossible it would be to fasten the three dials together so that the same relations between numbers held all over the range.

**RAIN RELEASED BY RADIO?**

Responsibility for the unusual amount of rain which the Transvaal, South Africa, has been having during the last four months is laid, by some of the weather prophets, at the door of Station KDKA, Pittsburgh, Pa.

These prophets have heard the theory advanced that the rain which is said usually to follow a battle is caused by some great disturbance of the air during the cannonading at the time of the engagement. They reason that the unusually rainy weather of the present year also is caused by some great disturbance in the air, and in casting about for the thing which caused the upheaval, they naturally hit upon the radio station. You see the international fast wave relay signals from this station are coming in so strong in that part of the world for the last several months that they are heard nightly without difficulty by the radio amateurs.

Some of those who do not believe in this theory point out that in the United States, where the signals should be much stronger on account of the shorter distance traveled, there has been no account this year of a condition similar to that in the Transvaal, where there has been more rain in the last four months than for years. (Of course, though, it may be the Volstead law that makes the U. S. so dry.)

**GRAVITY BATTERIES**

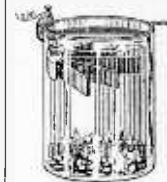

High duty "A" batteries with a 600-800 ampere-hour capacity at one-half ampere rate of discharge, as tested by U. S. Bureau of Standards. Use series-multiple connections for greater loads. Just right for a one or two-tube set. Complete instructions with each purchase.

Price of six gravity batteries, size 6 x 8, \$6.60. Extra zincs for above batteries, six for \$2.65. Blue vitriol for making electrolyte, 25 lbs., \$2.65 (3 lbs. per cell). Shipped all crated, F. O. B.

**BALLOON AERIALS**

Penetrate the "etherial deep" for long distance. Works equally well on amateur and broadcast wave lengths. Price \$5.00 plus postage and includes all necessary equipment and gas fixtures and three 30-inch pure gum pilot balloons. "Lots of fun and a good high aerial."

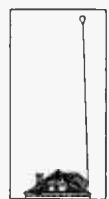

EVERETT SCANLON  
Radio Specialists  
Lakewood, Rhode Island

**Free Mailing Lists**  
Will help you increase sales  
Send for FREE catalog giving counts and prices on thousands of classified names of your best prospective customers—National, State and Local. Individuals, Professions, Business Congresses.  
**99% Guaranteed** & **5¢ each**  
ROSS-Gould Co. 612N. 10th St. St. Louis

# Fone Fun For Fans

### With Apologies to Longfellow

The shades of night were falling fast,  
 The guy stepped on it and rushed past,  
 A crash—he died without a sound,  
 They opened up his head and found—  
 Excelsior!—Baltimore Sun.

### A Look Ahead

"And how soon are you retired in the air service?"

"Generally after about two years."

"Really? And what are you retired as—a colonel?"

"No—an angel."—Twice Told Tales.

### Helping the Thrills

"But," said the cautious screen star who was about to perform an apparently dangerous feat, "suppose the rope should break?"

"By George!" cried the director. "That's a good idea!"—American Legion Weekly.

### Some Feat, Too

"Mother," said a little boy after coming from a walk. "I've seen a man who makes horses."

"Are you sure?" asked his mother.

"Yes," he replied. "He had a horse nearly finished when I saw him; he was just nailing on his back feet."—Our Dumb Animals.

### Good News from Doorn

One—"I just passed by the ex-Kaiser's home and heard him singing."

Two—"What was he singing?"

One—"Ain't gonna reign no mo'!"—Texas Ranger.

### Enough is Enough

Lawyer (helping pedestrian up)—Come with me, my man. You can get damages."

Pedestrian (groggy)—"Heavens, man I've got all the damages I want. Get me some repairs."—New Smyrna Breeze.

## HOW TO GET YOUR NAME INTO THE MAGAZINE—By Mortimer

CONSTRUCT A SET SO SMALL THAT YOU CAN HARDLY SEE IT, OR—

—MAKE ONE OF SUCH A SIZE THAT YOU ARE UNABLE TO TURN THE DIALS WITHOUT HELP

BE THE FIRST SUCCESSFULLY TO OPERATE A RECEIVER BY MEANS OF THE FEET

MORTIMER

# In 15 Minutes I Will Give You the Secret of a Perfect Memory

## I Guarantee to Increase Your Memory 100% In 10 Days

Not by any abstract, tiresome, difficult-to-master method; not by the old system of association of ideas or thoughts. Not by hard study, rotation exercises or repetition of words or sounds. It is not a book. There is nothing to study—nothing to repeat. It is by far the newest, best simplest method ever devised. I will give you a memory in one week's time that will surprise you. In one month things that occurred 30 days ago will be as fresh and clear in your mind as if they happened yesterday.



### My Secret for 30 Years

I have given my secret to thousands. I have used it myself for more than 30 years. It enabled me to rise to my present position as an educator in professional and scientific circles; it gave me a good vocabulary, developed my powers of perception and analysis and fitted me to write on a hundred subjects.

### Command Success

My VI-FLECT method of memory-building is for those who are ambitious to improve their business, professional, social or financial condition. VI-FLECT will develop your brain-power—your ability—lift you out of the rut; you will no longer stumble, mumble, nor grope for words with which to express yourself. You will be surprised how easily you can remember names, faces, dates, figures, appointments, duties, etc. It will enhance your importance as an employer, your value as a manager or employee, increase your worth, your ability, expertness, raise your salary, help you in business, professionally, socially, politically—in every way.

### Learn My Secret

I prefer to place my secret within the easy reach of everyone. Therefore, the price I am going to ask for VI-FLECT—my wonderful method of memory-building, which I have developed and perfected during my 30 years of constant study and application is ONLY \$5.00. Let nothing stand between you and a successful, happy, prosperous future. If it is not convenient to enclose the money, or if you prefer, I will mail your copy of VI-FLECT and you can hand the small amount to your postman when he delivers the package. The important thing is—SEND NOW.

### COUPON

Geo. J. Spinner,  
 416 S. Dearborn St., MB738  
 Chicago, Ill.

Dear Sir: Please send me my copy of VI-FLECT for which I enclose \$5.00. I will try your VI-FLECT method of memory-building for 10 days, and if it does not increase my memory 100% I am to return it and you are to give me my money back without argument.

Name .....

Address .....

City .....State.....

# Biltmore Master Reflex



We wish to announce our

## Model V1 Master Reflex Receiver

which we are about to place on the market.

It has taken more than a year of constant improvement on one of the most popular reflex circuits which has ever been designed to develop this receiver.

And we have been well repaid for our efforts. We have completed this six tube machine, a set extreme in sensitiveness and excellent in selectivity.

But most important of all, the receiver is perfect in tone! We will compare it with any standard receiver, and guarantee that it wins the opinion of all who hear, that it has the finest tone of any receiver manufactured.

If your dealer is not yet supplied, we shall gladly fill your order direct, and if you are within a reasonable distance of Boston, we shall be pleased to have the receiver installed and demonstrated in your own home, and to your own satisfaction.

**MODEL V1 \$115**



**DEALERS ARE REQUESTED TO WRITE**

**Please mention RADIO PROGRESS**

**THE BILTMORE RADIO COMPANY**

**BOSTON 30**

**MASS.**





# The Heart of Your Radio Set

A Grid Leak is essential on every set. There are few sets made which wouldn't be improved by the use of a Variable Grid Leak.

Even the set makers admit that.

But those makers say—"Show us a **good** Variable Grid Leak,"—because they know that most of the variables on the market have been a failure.

## Right now -- we're showing them

Buy It

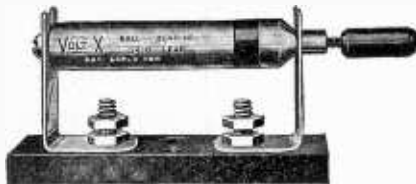

Try It

Volt-X Ball-Bearing  
Variable Grid Leak

### If you are not satisfied, return it and get your money back

This GRID LEAK is made by an organization which has been handling delicate electrical instruments for years. We know what it means to build accurately and substantially. We KNOW that this GRID LEAK is as nearly perfect as human hands and precise machinery can make it—we're glad to have you try it with the knowledge that if it doesn't do what we claim for it, your money will be refunded.

Clip the coupon, and send it in with \$1.00—a grid leak will be mailed at once.

**BURTON & ROGERS MFG. CO.**

755 Boylston St.

Boston, Mass.

Please  
send me one  
of your VOLT-X  
VARIABLE GRID  
LEAKS.

I enclose \$1.00 with  
the understanding that  
this merchandise is guar-  
anteed to give satisfaction, or  
may be returned.

NAME . . . . .

ADDRESS . . . . .





## STATIC ELIMINATION

WITH the approach of summer, every radio fan looks with a certain amount of dread to the Enigma of Radio—Static. For more than a quarter of a century, scientists in many parts of the world have applied their knowledge and skill to the problem of eliminating Static. Most of their attempts have resulted in failure.

Science recognizes but one device capable of curbing the annoying electrical disturbances, and that is the loop antenna. Electrical storms, like other weather disturbances, find their origin in various points of the compass. It is obvious, then, that by the use of a directional loop turned to a direction away from the disturbance, the disagreeable static noises may be tuned out.

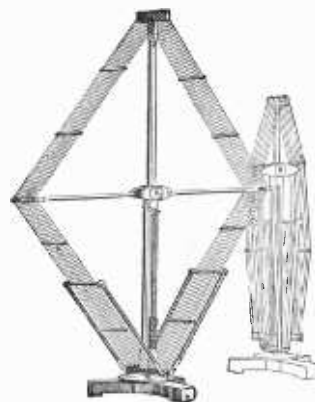

The superior construction of the DTW IMPORTED COLLAPSIBLE LOOP enables it to perform this function to much better advantage than other loop antenna devices. Forty-two inches high by forty inches wide, its inductance consists of fourteen turns of genuine Litzendraht cable, made up of sixty individual strands, insulated, twisted and covered with double green silk.

The woodwork is mahogany and all metal parts are highly nickeled. A graduated metal table at the base accurately gives the station direction. The turns are sectionized and by unique design all "dead end" effect is absolutely eliminated. The center tap permits its use without modification for all types of Super Heterodynes. The loop is collapsible and by means of the adjustable slide it may be actually used as the tuning unit of the set. No other loop incorporates such perfection of design, and no other loop can give such marvelous results.

**Price, \$25.00**

CUT OUT

I am interested in the DTW loop advertised in RADIO PROGRESS.

Please send me literature descriptive of the loop.

(Name) .....

(Street) .....

(City) ..... (State) .....



# Happiness for \$6.00 a Step!

Of course we mean one step of amplification. If you have a one or two-tube set you no doubt enjoy it, but it is nothing now compared with what it will be after you add one step of our RADICLEAR amplification. Instead of straining your ears to catch the murmur of that distant station, you will find that it comes in loud and clear.

Of course, any transformer will give increased loudness. Most of them also cause a lot of noise or distortion. The RADICLEAR transformer is noted for the fact that it never plays a tune of its own but reproduces only the program which the detector feeds to it.

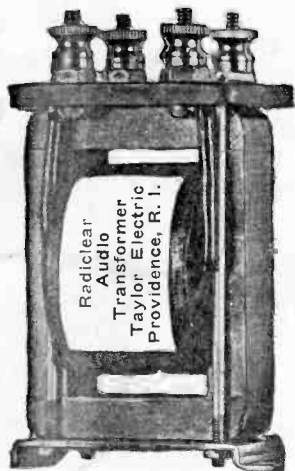

One reason for the clear tone of the RADICLEAR is the measured air gap in the iron. Other units by interlacing the sheets or laminations get variable magnetic resistance. In our product the leaves are not interlaced, but are butted against each other with a measured air gap. The result is that the usual falling off in the tone of high and low notes is not found in this instrument.

The transformer itself sells for \$3.95 postpaid.

If you want the entire kit, containing everything needed to add one step of audio to your set, the price is only \$6.00. The kit contains the famous RADICLEAR transformer, socket, rheostats, four-spring jack "B" battery binding post, and wire for the whole job. Use the blank for happiness.

The Taylor Electric Company,  
1206 Broad Street,  
Providence, R. I.

Please send me the following by parcel post. (Mark which one you want.)  
Radiclear Audio Transformer @ \$3.95  
Amplifier set complete @ \$6.00  
(Socket to fit.....tube)  
Audion Crystal @ 25c.  
Gold Plated Cat Whisker @ 15c.

I enclose \$.... to pay for these.  
(These above prices include the postage.)

Send them to me C. O. D. I will pay the above price plus postage.

(Indicate which way you wish to pay.)

Name.....

Address.....

## TAYLOR ELECTRIC CO.

1206 Broad Street  
Providence, R. I.