

200

June 1, 1925

15 Cents a Copy

RADIO PROGRESS

Reg. U. S. Pat. Off.

'Always Abreast of the Times'

IN THIS ISSUE

Loops Disturbed by Metal Masses

By HORACE V. S. TAYLOR

Run Your Tubes from Lamp Socket

Build a 20-Meter Wave Receiver

Majorie Harcom of Roxy's Gang

Double "D" Coil for Transformers

Radio Fog the Latest Disease

Using Both Ears for Receiving

YOU WILL UNDERSTAND THIS
MAGAZINE --- AND WILL LIKE IT

A New England Publication

At Last! - At An Unheard of Price!

A SURE FIRE

SUPER-HETERODYNE KIT

A
Superadio
Product

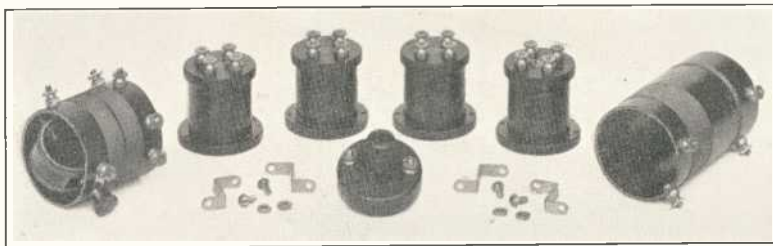

A
Superadio
Product

SUPERADIO KIT, \$ **15**.⁰⁰
SUPERHETERODYNE

MATCHED TRANSFORMERS—TUNED INPUT

EASY TO BUILD

EASY TO OPERATE

UNSURPASSED DISTANCE VOLUME AND SELECTIVITY

WONDERFUL TONE

Kit Consists of:

- | | |
|------------------------------|-------------------------------------|
| 1 Antenna Coupler | 1 Tuned Input Transformer |
| 1 Oscillator Coupler | 3 Matched Intermediate Transformers |
| 1 Special Variable Condenser | Hardware for Mounting Couplers |

Booklet, With Diagrams and Full Layouts
and Information

Manufactured by

DE WITT-LAFRANCE CO., Inc.

54 Washburn Avenue

Cambridge, Mass.

Sales Representatives:

Martin, Hartley and Foss Co.

99 Bedford Street, Boston, Mass.

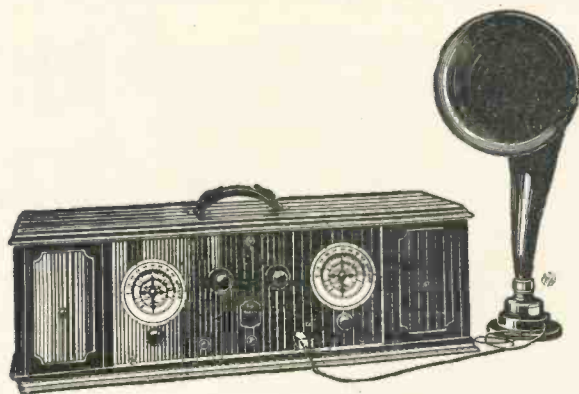

Which is Better—

**A Cheap Set for Cash---or
A GOOD Set ON TERMS**

?

The Good Set is Cheapest in the End

Bay State specializes on the better grade sets, like Radiola, DeForest, Adler Royal, Magnavox, and sells on **Convenient Terms.**

Write for information. Address Dept. A,

BAY STATE RADIO CO.

The House of Radio Service

116A Washington Street

Boston, Mass.

The Marvelous 5-Tube Radio Frequency Set

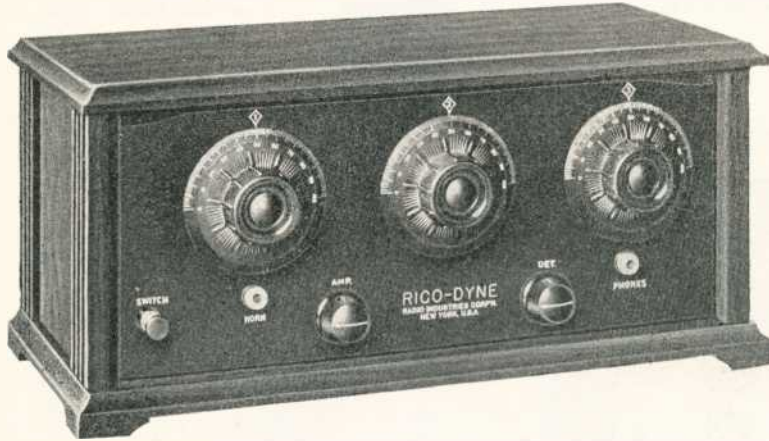

RICO-DYNE

An assurance of perfect performance, faithful tone production and \$100 radio receiver value, all for

\$60.

Mahogany Cabinet

The Set with a Punch

AUTO BALANCED 5-TUBE RADIO FREQUENCY

The combination of "RICO" CELLUWELD Low Loss Coils and Variable Condensers is made mechanically perfect. The Coils are welded firmly to the support of the rotor plates, our own patented principle.

Selective and non-oscillating, the "RICO" "AUTO-BALANCED" TUNED RADIO FREQUENCY SET accomplished by carefully setting the neutralizing angle of the Coils at the factory; remains permanent due to the CELLUWELD process.

The Complete Ricodyne Kit contains everything. The set you can build in 3 hours. Price Complete.....\$38.75



ADJUSTABLE

MAKE FULL USE OF YOUR PHONOGRAPH

MELOTONE — "None Better"

Adjustable phonograph unit makes your phonograph a perfect loud-speaker

\$7.50

The Melotone Has All the Qualities of the \$10 to \$12 Units



THE NATION'S FAVORITE HEADSET

RICOPHONES — The Headset of Real Value

There is more quality, real honest-to-goodness quality packed into RICOPHONES than you'll find in any headset at twice its price! Compare and see.

\$2.95

Manufacturers of the famous "RICO" straight line condensers, at \$1.75 each. The "Tropadyne" circuit is supplied free with every tuned "Tropaformer" that we manufacture for all long wave transmission. "Tropaformers" \$6.75 each. Dealers—write or wire for wonderful proposition.

RADIO INDUSTRIES CORPORATION,
131 DUANE ST., NEW YORK CITY.

Gentlemen: I am enclosing \$..... for the items checked below. Kindly ship at once.

.....RICO-DYNE SET, \$60.

.....MELOTONE UNIT, \$7.50.

.....RICOPHONES, \$2.95.

My Dealer is

NAME

ADDRESS

CITY

RICO

for all
Long Wave
Circuits

RICO Products on this Page Will Improve Your Radio 100% TROPAFORMERS



The sensitivity, selectivity and volume obtained in all types of long-wave circuits depends entirely upon the intermediate frequency transformer. TROPAFORMERS have been specifically designed to meet the new scientific requirements of long-wave circuits. The TROPAFORMER combines transformer and condenser. The condenser is shunted across the secondary winding of the transformer, and by its use the transformer may be tuned to any definite wave length between 3,000 and 9,500 meters. Only in TROPAFORMERS will long-wave circuit users find these advantages, and these advantages are patented for TROPAFORMERS exclusively!

\$6.75

Free Hook-up of the Famous Tropadyne Circuit with Each Tropafomer Ordered.

DID YOU EVER BUILD A SET THAT GOT "COAST TO COAST"?

You Can with the RICO-DYNE 5-Tube Auto-Balanced
Cellu-Weld Tuned Radio Frequency Kit

\$38.75

Complete Knockdown Set as illustrated with full instructions how to build this marvelous set within a few hours.

Greatest Radio Value in History—This is What You Get:

1—Pair Ricofones. 1—Genuine Bakelite Front Panel, completely drilled and engraved. 1—Genuine laminated Bakelite Sub-Panel—with sockets already mounted. All mounting holes properly drilled. 3—Auto Balanced Tuned Radio Frequency Units—perfectly matched and balanced. 3—Beautiful 4-inch Dials. 1—Variable Grid Leak and .00025 M.F. Condenser. 1—4 to 1 Audio Transformer. 1—2 to 1 Audio Transformer. 1—.002 Fixed Mica Condenser. 1—.006 Fixed Mica Condenser. 2—Single Circuit Jacks. 1—Filament Control Switch. 1—30-ohm Rheostat. 1—10-ohm Rheostat.

FOR THOSE WHO WANT TO BUY ONLY THE RICO-DYNE KIT

HERE IS JUST WHAT THEY WANT:

It seems unusual that with the tremendous volume, selectivity and distance-range of the Rico Auto Balanced set, it should be so simple to construct. Yet, nevertheless, this is true. We have letters from fans who tell us that they constructed their Rico set within a few hours. The plans which accompany the Rico Kit are so simple that we believe this is so. Any beginner need only to read English in order to construct the Rico set. This Kit contains 3 Auto Balanced Tuned Radio Frequency Condensers, Inductance Units, factory matched, book of instructions and drilling template. You can't go wrong!



\$16.50

RICO-DYNE HAS SET
NEW RECORDS IN RADIO!

for
bliss!

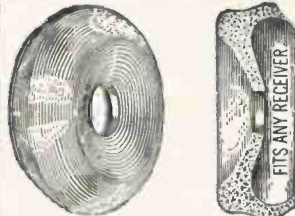

SPONGE RUBBER

RICO FONEKUSHIONS

You'll know what real ear-phone comfort is when you use RICO FONEKUSHIONS. They are made of soft, pure sponge rubber, and fit any make of headphone. They are like soft, downy pillows for your distance-seeking ears.....

50c

for
better
tuning

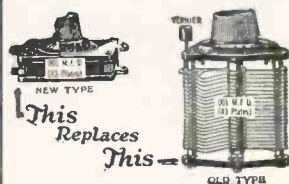

RICO STRAIGHT LINE CONDENSERS

In the old days, folks used horses. Now they can get as much power out of one auto as from 40 horses. It was all right, too, a few years ago, for folks to use the old-time condensers, but now, since Rico brought forth the RICO STRAIGHT LINE CONDENSER, which occupies two-thirds less space than the ordinary mesh plate type, everyone modernizes his set with the RICO STRAIGHT LINE CONDENSER.

No. 411—.00025 mfd.\$1.75
No. 423—.0005 mfd.1.75
No. 450—.001 mfd.1.75

Inclusive with Dials. Without Dials, \$1.50.

Each of these
Rico products
means added
pleasure and
value to your
Radio Set.

If Your Dealer Cannot Supply You—Use This Coupon. No Money Down!

RADIO INDUSTRIES CORPORATION
131 Duane Street, New York City

Please send me C. O. D. the following:Tropafomers, \$6.75Straight Line
Condensers, \$1.75Ricofones, \$2.95Oscillating Coil, \$3Fonekushions, 50c
.....Melotone Attachment, \$7.50.

Name Address

NATIONAL

**VELVET CONDENSERS
VERNIER AND DIALS**

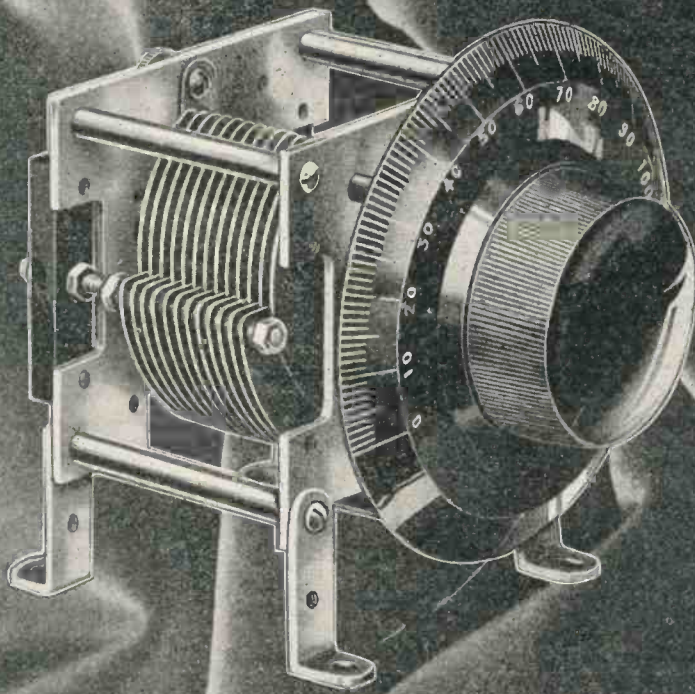

Made by the NATIONAL COMPANY, INC.
Exclusive Manufacturers of
**The NATIONAL
Browning-Drake TRANSFORMER**

Write for Bulletin 105 R. E.
NATIONAL COMPANY, INC., 110 Brookline St., Cambridge, Mass.



ANNOUNCEMENT

The Massachusetts Standardizing Laboratory

Announces an entirely new standardizing service to the manufacturers, jobbers and dealers in Radio Vacuum Tubes.

Under this service every vacuum tube is tested and sealed with the standardizing seal of this laboratory, which carries the following constants as obtained in the test of the tube:

AMPLIFICATION FACTOR

PLATE RESISTANCE

MUTUAL CONDUCTANCE

Every subscriber to this service is furnished with standard figures of merit and tables of values showing the proper use and specification of all tubes according to their rating on the standardizing test.

Our facilities for research are at the disposal of subscribers.

If you make or sell good tubes, have them standardized. It is the only way to show the user that he has a good article.

Send for Folder describing the Vacuum Tube Standardizing Service

Massachusetts Standardizing Laboratory

CHELSEA, MASS.

RADIO PROGRESS

HORACE V. S. TAYLOR, EDITOR

Volume 2

Number 6

Contents for

JUNE 1, 1925

	PAGE
LOOPS DISTURBED BY METAL MASSES.	9
AMERICAN RADIO RELAY LEAGUE.	12
RADIO FOG THE LATEST DISEASE.	13
RUN YOUR TUBES FROM LAMP SOCKET.	15
MAJORIE HARCOM OF ROXY'S GANG.	19
BUILD A 20-METER WAVE RECEIVER.	20
DOUBLE "D" COIL FOR TRANSFORMERS.	23
FONE FUN FOR FANS	28
EDITOR'S LOUD SPEAKER:	
SALE OF POSTAGE STAMPS	29
HELPING A SICK BATTERY	29
WHAT IT COSTS TO BROADCAST	31
NEW PRODUCTS OF SPECIAL INTEREST.	34
DR. RADIO PRESCRIBES	36
LIST OF U. S. BROADCASTING STATIONS.	38

RADIO PROGRESS is issued on the 1st and 15th of each month by the Oxford Press at 8 Temple Street, Providence, Rhode Island. John F. O'Hara, Publisher. Yearly subscription in U. S. A., \$3.00. Outside U. S. A., \$3.50. Single copies, 15 cents. Entered as second-class matter, April 4, 1924, at the Post Office at Providence, R. I., under the Act of March 3, 1879. Address all communications to RADIO PROGRESS, 8 Temple Street (P. O. Box 728), Providence, R. I. Title registered at United States Patent Office.

The publishers of this magazine disclaim all responsibility for opinions or statements of contributors which may at any time become subjects of controversy.

The Two Outstanding Parts In Radio !

**Give Low Losses and Amplification
Without Distortion to Any Set**

QUANTITY and distance are what a radio set must give. To insure Quality, amplification without distortion is essential. And to insure Distance, low losses are essential. That is radio in a nutshell.

People in whose sets Acme Transformers are used, are sure of hearing concerts "loud and clear" so a whole roomful of people can enjoy them.

The Acme A-2 Audio Amplifying Transformer is the part that gives quality. It is the result of 5 years of research and experimenting. It gives amplification without distortion to any set. Whether you have a neutrodyne, super-heterodyne, regenerative or reflex, the addition of the Acme A-2 will make it better.



Acme A-2 Audio Frequency Amplifying Transformer

To get the thrill of hearing distant stations loud and clear, your set must have low losses, for it is low losses that give sharp tuning to cut through the locals, and it is low losses that allow the little energy in your antenna to come to the amplifier undiminished. That's what the Acme condenser will do for any set. And it will do it for years, because the ends can't warp, the bearings can't stick and the dust can't get in and drive up the losses several hundred per cent.

The Acme Reflex (trade mark) owes its success and its continued popularity to these two outstanding parts in the radio industry, for low losses and amplification go hand in hand.

Use these two parts in the set you build. Insist on them in the set you buy.

Send 10 cents for 40-page book, "Amplification without Distortion"

WE HAVE prepared a 40-page book called "Amplification without Distortion." It contains 19 valuable wiring diagrams. In clear non-technical language it discusses such subjects as Radio Essentials and Set-building; How to make a loop; Audio frequency amplifying apparatus and circuits; Instructions for constructing and operating Reflex amplifiers; How to operate Reflex receivers; Antenna tuning circuits for Reflex sets; "D" Coil added to Acme four tube reflex; "D" coil tuned R. F. and Reflex diagrams; and several more besides. It will help you build a set or make your present set better. Send us 10 cents with coupon below and we will mail you a copy at once.

ACME APPARATUS COMPANY

Transformer and Radio Engineers and Manufacturers

DEPT. (AS), CAMBRIDGE, MASS.

SEND THIS COUPON

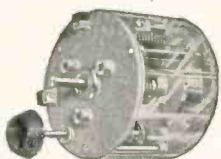

Acme Low-Loss Condenser

ACME APPARATUS COMPANY,
Dept. (AS), Cambridge, Mass.

Gentlemen:—

I am enclosing 10 cents (U. S. stamps or coin) for a copy of your book "Amplification without Distortion."

Name

Street

City..... State.....

ACME ~ for amplification

June 15 Will Be a Good Number

We all know how radio has taken hold of our homes. The army is finding that it is one of the most powerful means of making war that has ever been discovered. It is hard to get authoritative information from the War Department on such matters. Rados has succeeded in obtaining a series of official photographs to illustrate "**Radio in the U. S. Army.**"

The magazines are full of stories about transmitting photographs by radio. This is being done quite regularly now. Indeed, the method has advanced so far that in "**Sending Newspapers by Radio,**" samples of this work are given, including a newspaper transmitted through the air.

In the June 1 issue, you find a description of a receiving set which will pick up the highest speed vibrations which MacMillan will send out on his North Pole Expedition. This subject will be continued from the sending end in "**Talking to MacMillan on Twenty Meters,**" by Vance.

Do you think of chemistry as a dry study? Then read "**The Romance of Chemistry in Radio,**" by Hurd.

One of the biggest advances in the art towards making broadcasting real, is the scheme by which your left and right ear do not hear the same music together. This strange phenomenon is explained by Arnold in "**Using Both Ears for Receiving.**"

The studio man sometimes has to do some weird stunts to pick up the music in a life-like manner. Some of these incidents are explained in "**Broadcasting from a Belfry.**"

You talk about music going "On the Air." Do you really mean on the ether? Some think there is no such animal. The latest discoveries along this line is explained by Taylor in "**What About the Ether?**"

RADIO PROGRESS

"ALWAYS ABREAST OF THE TIMES"

Vol. 2, No. 6

JUNE 1, 1925

15c PER COPY, \$3.00 PER YEAR

Loops Disturbed By Metal Masses

Why Radio Waves Sometimes Seem to Turn Corners

By HORACE V. S. TAYLOR

WERE you ever lost in a fog? Sometimes a small boat gets caught in the drifting clouds of vapor when out a few miles from land. If there is a fog horn nearby it is supposed to give the direction of the shore to the man at the wheel. However, sometimes the

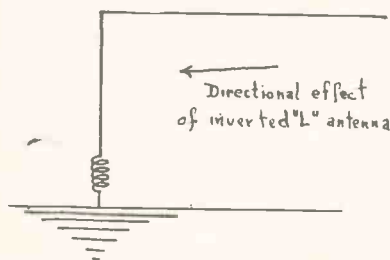

Fig. 1. Here Loudest Signals Come from the West

blasts from the horn seem to be coming from all ways at once.

Radio waves ordinarily do not suffer from such change of direction. On board an ocean liner there is equipment for finding out from what direction such impulses are arriving. That is the principle of the radio compass. But radio waves do not always travel in straight lines.

When the Lights Go Out

As a matter of fact there is the curvature of the earth. If they went absolutely straight the way rays of light do they would shortly leave the earth's surface and go ploughing out into space. That is what happens to rays of light. At night when a ship steams out from the harbor, you are able to see the lights on the deck and also the one at the top of the mast. However, as the

boat proceeds the lowest lights fade away. When the ship has reached a distance of five or six miles from land the deck lights can no longer be seen, although the mast head's gleam is still visible. Why have the lower lights disappeared?

It is a case of the curvature of the earth, cutting off the straight line which would otherwise run from the lamp to your eye. The world is a globe and has a diameter of 8000 miles. This is pretty big to be sure, but even at that a few miles are enough to allow the whole of the ship to drop below the horizon. A few miles further even the light from the top of the mast will have dropped from sight. The radio is still

A Mirror in the Clouds

Just what causes this curvature of the radio has not been fully proved. Most of the scientists think that it is on account of the fact that high up in the clouds the layer of rarefied air happens to be at just the right vacuum to become a good conductor. The earth also is a good conductor and these two surfaces are thought to act like mirrors in reflecting the electrical vibrations. You can readily imagine that if you spread out a sheet of looking glass a hundred miles long over the surface of the ground and had another one to match it up in the clouds that the light from a vessel would be reflected back and forth between these two mirrors,

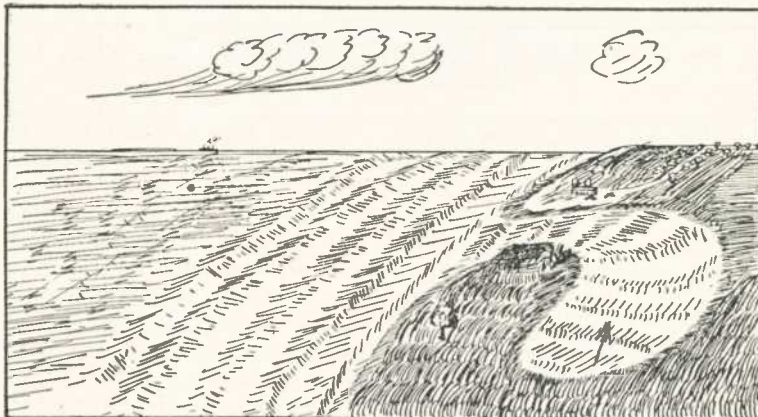

Fig. 2. Notice How in the Cove the Waves Appear to be Coming in from the North Instead of the West

working, however, without any trouble at all. This proves that wireless waves do not obey exactly the same law as light.

so that you would be able to see the illumination, even when the ship itself was way below the horizon.

What we refer to particularly at the

present time is not the slight bending of ether waves around the earth. In addition to this effect there is a much sharper deflection caused by large masses of metal which may exist near your receiving set. Such effects are found for instance in buildings which contain a heavy steel framework to support the various stories. That is why radio reception in a steel sky scraper is apt to be poor.

Lead-in Is Not Directional

The best way to locate trouble from masses of metal is with a loop set. The reason for this, of course, is the fact that an ordinary aerial responds to waves coming from all directions almost equally well. To be sure, a flat top inverted L has a directional effect, as

ing. Although this principle is absolutely correct, still difficulties are sometimes met in making use of it. You see the loop is very near sighted and can recognize the radio waves only right at the spot. If they have turned a corner a short distance before reaching the loop, no notice of such a change will be given by the receiving set.

Just Like Ocean Waves

This is illustrated better in Fig. 2. Suppose we have a cove along the shore of the ocean. The waves come in from the West and break in regular rows along the sloping shore. If a very near sighted man were to notice where the breakers came from he would conclude that the ocean lay to the West, and of course, he would be correct.

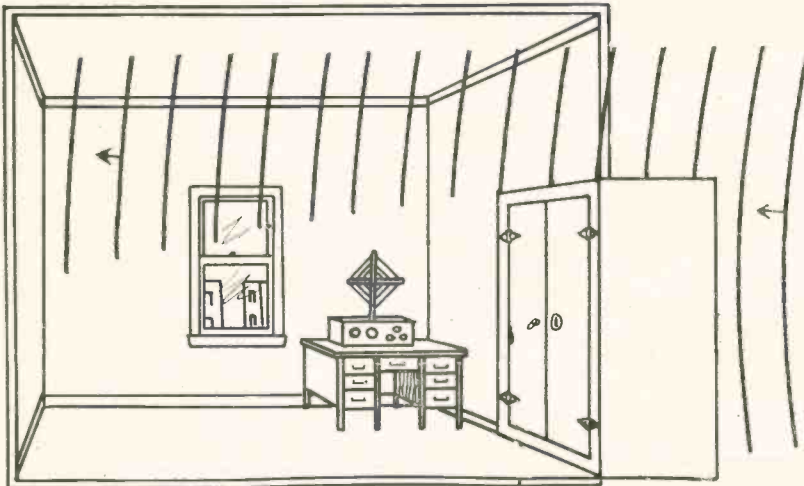

Fig. 3. The Waves from the Right Are Cut Off by the Safe, Which Throws Radio Set Into Shadow

shown in Fig. 1. Waves from a sending station which lies as the arrow points (from the West) will come in louder than similar stations in the East. However, the difference in the two directions is not very well marked with the ordinary aerial. You see that the vertical part, or lead in, which naturally has no directional effect, supplies so much of the total energy to the set, that the extra amount picked up by the flat top does not add enough more to cause a serious difference between the best and worst directions.

A loop, however, as is well known, will not pick up any waves, from a direction along the axis of the winding. This is the general principle of finding which way such oscillations are travel-

Suppose, however, instead of watching the waves along the main beach he should go to the lower end of the cove. As the billows strike the neck they are deflected around the corner and at the lower end they have swung around completely. Our nearsighted friend in this position would notice that they approach from the North, as shown by the arrow, and he would undoubtedly say that the ocean lay due North. There is nothing in the motion of the waves themselves as they reach this point that would indicate that they had turned a corner a few yards before.

This is the same principal which the loop follows in picking up radiation. If heavy masses of metal have deflected such vibrations out of their original

line, then the loop will indicate only the direction in which they travel right at that spot. Of course, at sea, this is not a very serious objection to the radio compass as the loop may be located at a point on board the ship far enough removed from steel masses and turrets, so that such a deflection will be very small. In steel apartment houses, on the other hand, such a bending of the rays may be quite marked. The shielding effect reduces the force of the waves to a large extent in addition to bending them.

Not Safe for Radio Waves

Of course, you know that an aerial will collect the energy of radio vibration out of the air. That is what an aerial is for. But do you realize that the radio waves do not know an aerial from any other large piece of metal, which they may meet on their travels. Take the safe, which is built into the wall, as shown in Fig. 3. Here is a big metallic object and immediately the radio oscillations quite naturally think it is a fine sample of aerial. The result is that the safe will absorb a large proportion of the energy coming in from the broadcasting station. This is represented by the curved lines of our diagram. These lines show the position of the crests or peaks of the radio waves at a certain instant. Of course, they are moving with the speed of light—186,000 miles per second.

As the sending station from which they started lies at the right, they are naturally moving to the left. Those which strike the safe are perfectly satisfied and will go no further. The radio set which is located in the shadow of this safe-aerial, is naturally shielded to a very large extent. Since the safe is not 100 per cent. efficient in pulling the energy out of the air, the loop will succeed in picking up a slight disturbance, and if the radio set is powerful enough you will hear some music. It will not, however, be nearly as loud and distinct as it would have been if no shielding had disturbed it.

Tuning Out Same Wave

Another effect which is noted in steel buildings is the lack of sharpness of tuning for direction. If two sending stations are broadcasting at about the same frequency (wave length) it is

usually possible to separate them completely with a loop set, by turning the loop in such a direction that the axis points straight at the unwanted sending station. In this way the waves from the latter are reduced to zero in the aerial, while the other stations will have its waves diminished only a little, or indeed, not at all if it should happen to lie at right angles to the first station. In this way a powerful local may be suppressed and distance brought in even at about the same frequency.

When set up in a steel frame building such a receiver oftentimes is unable to separate the two stations any more. The trouble is this. The steel girders which support the building act like so many aerials and suppress a good deal of the energy which would otherwise operate the receiver. Besides this they have a very pronounced effect in changing the direction of the waves after they have entered the building. For instance, if your set is installed near a window the metal frame and lath will act very much like the neck of the cove shown in Fig. 2, and as a result waves which started in various directions will all swing in through the window and from that go to the set.

Set Loses its Selectivity

Understand that it is not because the window is open or because it lets in the light that this directional effect results. It is for the reason that all around through the walls are big pieces of metal while the window itself has none. For this reason most of the broadcasting stations will apparently lie in the direction of the window. Right away you can see that the two outside stations which are transmitting at the same time will now both seem to lie in the same direction. So turning the loop will now no longer suppress one without at the same time destroying the other. And as we have already assumed that both are going at the same vibration speed, (wave length), you will see that they can not be separated, but will interfere with one another. That is the main reason why many users of loop sets in the city report that they are not very selective. The same outfit taken to a wooden house will be found

to give the sharp selectivity which is advertised by its manufacturers.

While we are on the subject of loops, another point should be mentioned. Such a set is so very sensitive that it will pick up and amplify the disturbances which will not bother the ordinary equipment. Suppose that you have in your cellar a washing machine. Fig. 4. It is sending out waves when operating from the electric motor. Naturally these vibrations are very weak, but with the powerful receiver, which you have upstairs, they are easily picked up. If the washing machine happens to be running at a time when you are listening in, you

Electric vibrators, violet ray machines, and heating devices, which may contain a temperature regulator, or thermostat, may also cause disturbances in a sensitive loop aerial. Naturally all outside interference, like that from squealing regenerative sets, and trouble in high voltage insulators, will be picked up by a loop as well as by an ordinary aerial. However, much of such trouble can be avoided with a loop, by turning it in the direction to give the least response.

Make This Test Yourself

While there is no doubt that a loop set using a receiver like a superhetero-

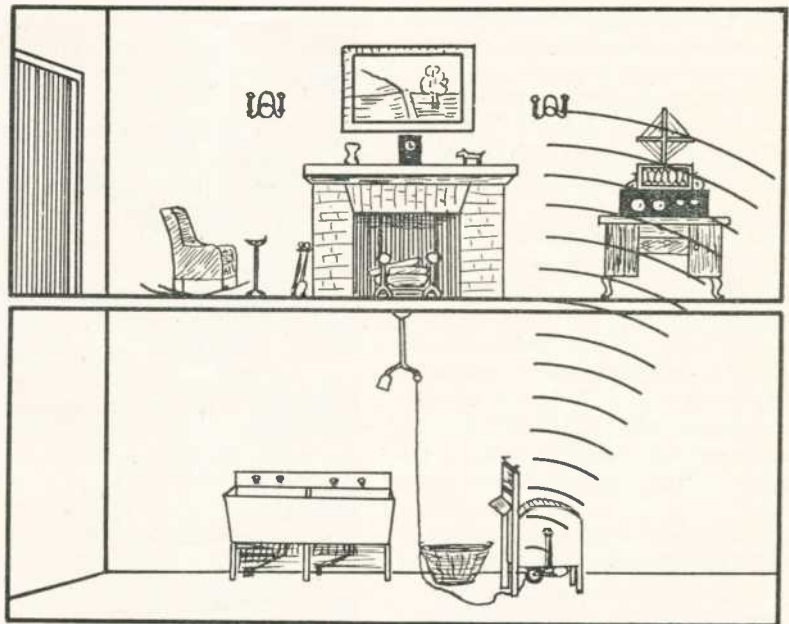

Fig. 4. Disturbance in the Cellar Interferes with the Loop of the Set Upstairs

naturally are much disgusted by the large amount of static you pick up.

Why Your Neighbor Boasts

Your neighbor next door is not having this trouble at all. He has an outside aerial and a much more insensitive radio. His aerial is so high in the air that the greatly increased distance away from your washing motor reduces the effect very largely. Added to that is the fact that his set does not have the sensitiveness which yours does. Naturally he boasts to you that his radio is very superior because it is not troubled by static.

dyne is one of the best outfits which can be bought, still it is well when thinking of investing in one to try out this experiment. Get your radio dealer to install the instrument in the room where you want to use it and then run it for a few days. If you find serious trouble from any of the causes which have been mentioned, then you may have to resort to an outside aerial and a relatively insensitive set.

In case you are not able to put up an outside aerial then you are simply out of luck and you will have to do the best you can with the loop.

American Radio Relay League

REDUCING INTERFERENCE

The usefulness of Vigilance Committees, as sponsored by the American Radio Relay League, is being amply demonstrated in the territory around Buffalo. These Vigilance Committees are organized for the express purpose of tracing interference with the reception of broadcast radio programs.

In spite of the fact that there are many different varieties of radio interference, amateur wireless enthusiasts were, up until now, forced to bear most of the blame when broadcast programs were not received with the clearness that the set owner expected.

To check up on local conditions, the Radio Association of Western New York which is affiliated with the American Radio Relay League, formed the Vigilance Committee.

Take Away His License

Already local listeners have been very much pleased with the results attained by this committee. All the complaints that are filed with the Radio Association are investigated, and recommendations for remedies made by the committee. In cases where it is found that an amateur operator has been violating the regulations, the committee recommends changes to secure compliance. Where the interference appears to be intentional, it is recommended that the license of the offender be forfeited.

Many times it is the listening fan who is at fault, as has been shown by the tests of the committee. In some instances it was found that the fans who complained were using single-circuit tuners. This type of set cannot tune out nearby stations, so governmental officials refuse to give consideration to complaints from owners of such instruments.

It has been pointed out by the committee and by the officials, that amateurs operating their stations under the eighty-five meter wave length (3,530 kc.) are so far away from the broadcasting bands, that they furnish no interference in any efficient tuning device.

How Test is Started

The first step in investigating a com-

plaint in this area is a test of the receiving set over which the interference made its appearance. If the trouble is not here, then the committee takes up the outside question.

The local committee is composed of six men who represent all fields of radio.



Gen. Robert Lee Bullard, who will address the radio audience in the Memorial Day exercises to be broadcast by Station WJZ on May 30.

Robert Trago of Station 8BSF, is chairman, while a prominent member of the committee is Ernest Roy, an expert on the staff of the Radio Corporation of America. The other members are

Charles S. Taylor, Benedict V. K. French, John C. G. Miller, and John Lichman, Jr.

Similar Vigilance Committees in communities throughout the country, have, according to reports to League Headquarters in Hartford, justified their existence in every community where they are working. Other cities that have shown important results after the appointment of committees are Oakland and San Francisco, Cal.; Elizabeth, Bloomfield and Bayonne, N. J. In a number of radio clubs throughout the country, Interference Committees perform the same duties.

KIDDER CALLS KANSAS

Amateur radio achieved new laurels recently when Vertice Wilson, 21 year old licensed amateur operator of Ottawa, Kansas, successfully transmitted a message to Chief Radioman, Harry Kidder, U. S. N., who is stationed in the U. S. Naval radio station at Los Banos, Laguna, Philippine Islands. Wilson and several other operators from other parts of the country were heard, but Wilson's conversation was reported completely by Kidder in a letter received by Wilson. The message was sent on 3,750 kilocycles (80 meters.) Recently Wilson also received a "proof of reception" card from station 6BGG at Honolulu.

RIP VAN WINKLE CALLS BULL DOG

Household pets are not immune from the attraction of radio. G. W. Bannister of R. D. No. 2, Orion, Michigan, writes that during the performance of "Rip Van Winkle" by the WGY (Schenectady) Players, he had difficulty in restraining his bull dog from climbing into the loud speaker when Rip, awakening from his long sleep, whistled for Schneider.

Free

Mailing Lists

Will help you increase sales
Send for FREE catalog giving counts
and prices on thousands of classified
names of your best prospective customers—
National, State and Local—Individuals,
Professions, Business Concerns.

99% Guaranteed
by refund of 5¢ each

ROSS-Gould Co. 612½
10th St. St. Louis

Radio Fog the Latest Disease

Perhaps This is the Trouble When Your Station Fades

By A. F. VAN DYCK, Radio Engineer, Radio Corporation of America.

WHAT is worrying fans most just now? The best way to tell is to read the mail which comes into a large broadcasting station. The questions which are received give a pretty good idea of what listeners want to know.

In the mass of letters which WGY receives from listeners, certain questions are asked again and again by many different inquirers. Some of these questions cannot be answered, as they involve radio phenomena which are not

of electric forces. We cannot see or hear or otherwise observe with our senses just how this disturbance behaves, as we can with either light or sound waves. We consider it quite natural that a stone wall stops the light beam from a searchlight, or that a bugle call can be heard much farther over water than through a forest, or that under certain air conditions on a desert the mirage phenomenon is observed. To know what to expect in radio, we need only to remember that some things in space will stop, or reflect, or perhaps absorb the travelling radio waves, just as some other things in space stop or absorb or reflect light waves or sound waves. We must not expect radio waves to travel out from a transmitting station, over some enormous distance to a receiving station, without encountering some obstacles somewhere in its path.

As an illustration of how various waves are affected, look at Fig 1. This shows three different kinds of radiation. At the top an antenna is sending out radio waves in all directions. Underneath that an electric light gives oscillations at a much higher speed, and the light rays striking any object, make it visible. At the bottom an electrical bell causes sound vibrations in the air which, striking a listener's ear, give the sensation of tone. Although all three kinds of waves are stopped by a steel wall, still there are various materials which allow some to pass and not others.

Blocking Light or Radio

Fig. 2 makes this clearer. At A, we have a curtain which shuts out light. However, sound passes through it quite easily and so do radio waves. B is a double pane of glass such as is used as a storm window in winter. This will pass light without any trouble. Radio will also thread it without knowing it

is there. But sound is pretty well blocked, and that is why such a construction is used in telephone booths. At C, is a wire screen. Such a mesh lets through the sunlight and sound without any trouble. Radio waves, on the other hand, find it impossible to pass such a barrier, although a brick wall at D allows free access to radio while blocking out both light and sound.

There is some substance in the space around the earth which has a blocking effect upon radio waves. This substance

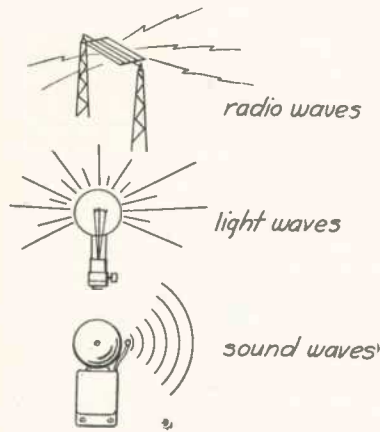

Fig. 1. Three Different Kinds of Radiation

completely understood by scientists even to-day. The answers and explanations which we shall give in this article should be understood as the ones which are believed to be nearest the truth, although they have not had a rigid proof.

Obstacles the Radio Waves Meet

First, let us consider what radio transmission is. We know that a radio transmitting station sends out from its antenna in all directions, a disturbance

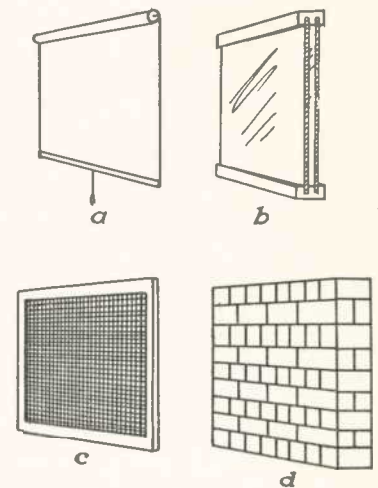

Fig. 2. Different Obstacles—Transparent to Some Waves, but Not to Others

is not uniformly distributed through space, but is present here and there, and is continually changing its location and strength, and consequently has very erratic effects on the passage of radio waves. The condition is quite similar to the use of a searchlight in a fog which is being blown around by the wind. Fig. 3 shows how this works out. A powerful searchlight is mounted

on a ship so that the rays strike the shore in the distance. A bank of fog drifts across the beam. This causes considerable fading of the light at the shore receiving station. Now the beam is bright and again it almost entirely disappears. If a fog of charged air particles drifts in the path of a stream of radio waves, the same fading effect will be noticed in the receiving set.

This explains too, why one transmitting station, of two or more which are being heard at the same time, may get weaker, while the others do not.

For example, suppose a receiving station in Chicago is picking up New York and also San Francisco. A patch of fog might drift in between Chicago and New York and weaken the New York signals, while those from San Francisco

frequent in the summer than in the winter season, presumably because of the greater influence of the sun on the earth and its atmosphere during that season. Unfortunately, no way of avoiding this difficulty is known to-day. The transoceanic radio stations have to be equipped with high power apparatus in order to work through the bad period of the day and year, although at certain

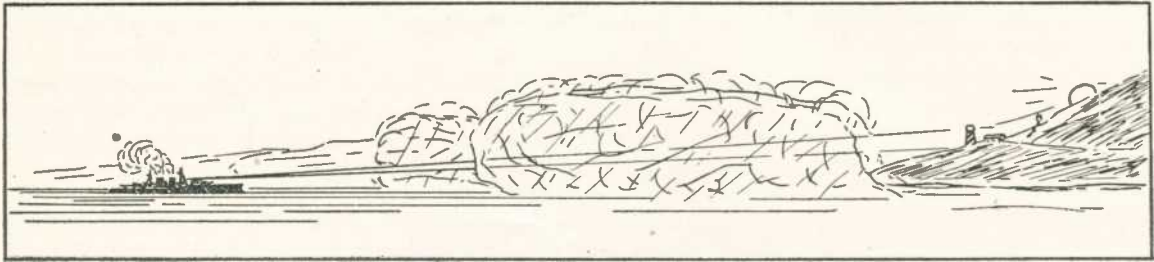

Fig. 3. Just as Cloud Bank Cuts Off Rays of Searchlight, So Cloud of Charged Air Intercepts Radio Waves

Waves Have Exciting Trip

This radio fog is commonly supposed to be made of ionized air, that is, air which by some influence has become a partial conductor of electricity. Of course, such a radio fog never stands still, and is changing from moment to moment under the influence of the complicated conditions of our atmosphere, and so the radio wave passing through space surely has an exciting journey. It is apt to meet electrically charged clouds, patches of ionized air, and perhaps other obstacles of which we know nothing.

It is a fact which you have no doubt observed, that it is possible to work radio communication over much greater distances at night than in the daytime. This may be explained by the effect of the sun upon the air, which causes ionization of it, and is most active in the daytime, and practically absent at night. The sun is responsible without question, in view of the fact that very erratic results in long distance reception are always noticed at sunrise and sunset.

One Fades, Another Not

With the preceding statements in mind, it should be clear that when one is receiving over long distances—several hundred of miles—it is natural for the waves to come strong at one moment, and to fade away considerably the next, as some obstacle to radio waves comes between the transmitter and receiver.

remained unchanged. Whenever in reception over a considerable distance, one observes a variation in the intensity of the signals, it is most likely due to fading caused by some obstruction to the travelling waves somewhere between the two stations, and not to any fault of the transmitting station itself.

times and seasons less power may be used. This is proved by the successful transmission across the ocean by low power amateur stations.

For the sake of clearness, we have so far described the cause of fading signals as due to obstructions in the path of the radio waves. Sometimes the

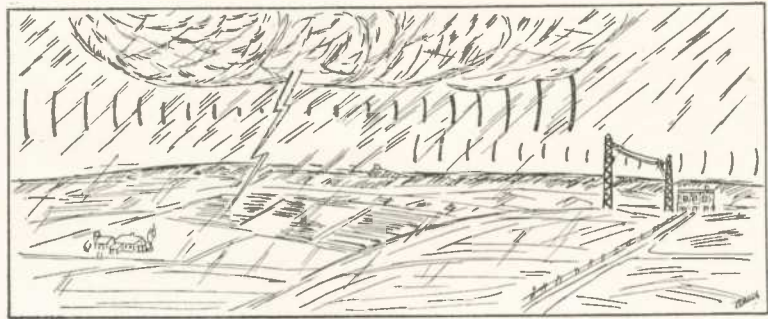

Fig. 4. Stroke of Lightning Sends off Waves Just Like Broadcasting Stations, Only Louder

Two Different Routes

Another cause which probably is active in the case of fading is that of waves from the sending station which arrive at the receiver by two different routes. Part probably come by way of the ground, while the rest traverse the rarified air 45 or 50 miles above the ground. Many radio engineers think that the difference in the time taken for the waves to travel by these two paths accounts for the decrease in loudness of the music. These effects are much more

radio clouds actually reflect the waves much as a mirror does a light ray, and so very peculiar reception effects are then noticed. Sometimes the signals are made stronger instead of weaker, and again they may be lost altogether, as the several effects of reflection and absorption combine.

Marconi First Heard Static

And now, let us consider that arch enemy of radio—Old Man Static. When Marconi first began to receive messages

Continued on Page 18

Run Your Tubes from Lamp Socket

Getting Rid of Batteries is Certainly a Great Convenience

By C. WILLIAM RADOS, Arlington Heights, Mass.

DID you buy your wife a new rug when the battery sopped over on the old one and ate a hole through it? Or perhaps you use dry cells so there is no danger of the acid spilling. In that case you have continual bother with buying a new set of cells and furthermore the rheostat must be adjusted every night to compensate for the drop in voltage.

Your radio set is probably satisfactory, but like all things human, is not perfect. The average man has to keep a storage battery or two charged, or else he has to keep buying fresh bat-

teries. A further instrument can be purchased to get rid of his "A" batteries as well. However, such an installation costs so much that the number of fans who invest is rather small.

Such devices all consist of a transformer, a rectifier and a filter. The transformer takes a 110-volt wave of alternating current and reduces this pressure to 1.1, 3 or 6 volts (depending on what kind of tube you use) for the "A" battery. Another kind of instrument gives 22 volts for the detector and either 45 or 90 for the amplifier. This is shown in Fig. 1.

The amplifier changes the alternating current which runs in both directions, first one way and then the other, into a pulsating current which does not change its direction of flow. If both halves of the wave are used as occurs when a double tube unit is employed, then the rectified pressure will look as in Fig. 2. Notice that the pulsating current has each loop above the line showing that the current does not reverse, whereas in Fig. 1, the negative loops were below the line.

When You Don't Mind the Buzz

If this pulsating current is fed to the detector and amplifier tubes, then the set will work very nicely provided it is code which you are picking up. The dots and dashes will consist of a series of impulses making a buzzing sound in your ear. These impulses happen sixty times every second, since it is 60-cycle current which is supplied by the electric central station. However, if it is music which you wish to hear, it will not do at all for the buzz of these pulsations will be so loud as to overpower the music.

That is why a filter is used, which strains out this buzzing noise by cutting down the peaks of the hills in Fig. 2, and filling up the valleys. In the

lower half of this sketch, the pulsating wave is shown in dots and the voltage which has been smoothed out, is shown in its steady state by the dashes. The smooth pressure is now ready to be fed to the receiving set in place of both "A" and "B" batteries.

Which Kind Have You?

You must know that there are two different kinds of electricity, either of which may be the service you get from your light sockets. If you live in a large city nearby the sub-station, it is quite likely that it will be direct current which is now on your lines. In the smaller towns and at some distance from the central station, it is

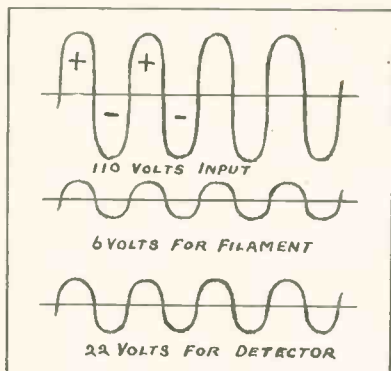

Fig. 1. Operation of Transformer (Not to Scale)

teries for the filaments. With every receiver there is also the expense of buying a fresh "B" battery two or three times a year. Aside from the expense, there is the bother of connection and disconnection and of carrying batteries and charger around. Wouldn't you like a device that you could connect to your radio set and then forget batteries?

Factory Built for \$50

If the reader has plenty of money or is a poor constructor, he can purchase for about \$50.00 an attachment which will connect to his lamp socket and through this device to his set, thus

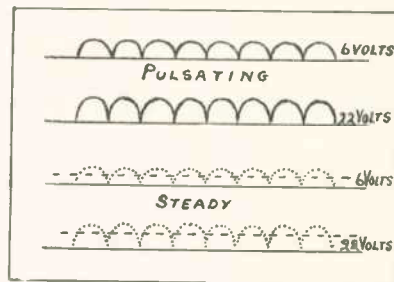

Fig. 2. This is What the Rectifier Does

customary to have an alternating current supply.

But even the direct current obtained from the local electric light company is too ragged or uneven to use in your radio unless it is smoothed out by a filter. A filter is nothing more than some coils of wire and one or two condensers which cut down the ripples and smooth the current. (See October 1, 1924, copy of RADIO PROGRESS for a complete discussion of filter.) To use this kind of current, you will not need a transformer or rectifier, but will require some resistances and a filter.

Up to High Pressure Peak

The other kind of service, as just men-

tioned, is called alternating current (AC). Practically all the homes outside of the cities are using it, but in case you are not sure of your own house, call up the electric light company to be certain, as the device will not work at all if connected to the wrong kind of current. Alternating current is continually changing its pressure. The 110-volt 60-cycle house current varies all the way from zero to 157 volts, 120 times per second.

emitted by the same bulb when working on 110 volts DC. The same thing is true of all kinds of heating apparatus. An electric flatiron gets just as hot on direct current and on alternating current, provided they both have the same voltage. But to obtain this result the peak pressure of the alternating wave is considerably above its normal rating. Even when the pressure is reduced to six volts, it will still change from zero to about 9 volts 120 times per second.

have consisting of several hundred turns, wound on a closed iron core, would do in this case. As the secondary winding is not needed, it is left open circuited.

The condensers are best obtained from the telephone trouble men who can get you a couple for about fifty cents apiece. They are Western Electric 1 microfarad condensers. They are connected up as in Fig. 3, and constitute the filter. (See previous copies of RADIO PROGRESS for clear discussion of filters.) Briefly, the filter is used to smooth out the electric current so that it will be as good as current from a storage battery. For that reason the condensers should be as big as possible. If you can get 5 or 10, or even 30 microfarad condensers cheaply, by all means do so because your filter will be even better. The same holds true with the transformer coil. The bigger the coil used, the smoother and better the current will be.

The Only Hard Part

The only hard part to procure will be the potentiometer. You will need a potentiometer with about 10,000 ohms resistance. Go to your local electrician first, as he probably can get something for you that will suffice. It must have one or two, preferably two, sliders on it, and it looks not unlike a long tuning coil. Your electrician will have something that will answer, and if you press him hard enough, he will go down to the cellar and hunt. Although it may look different from Fig. 4, if it has from 6,000 up to 11,000 ohms resistance, and has one or two sliders or switch arms, it will do.

If the potentiometer has just 11,000 ohms, then the current through it will be 110 divided by 11,000 or 1/100 of an ampere. This is, of course, equal to ten milliamperes. For this reason, it is impractical to take more than four or five milliamperes for your tube, which limits the operation to a set with not over three tubes. If you have more than this number, then it will be advisable to use a lower resistance potentiometer which will pass more current.

Why it Will Not Work Filament

For the same reason you can not supply the filament from this potentiometer, as not enough current flows. The filament of a UV-199 requires 1/16 of an ampere to operate, while the WD-11, WD-12, and UV-201A each consume 1/4 ampere. Of course, these figures must

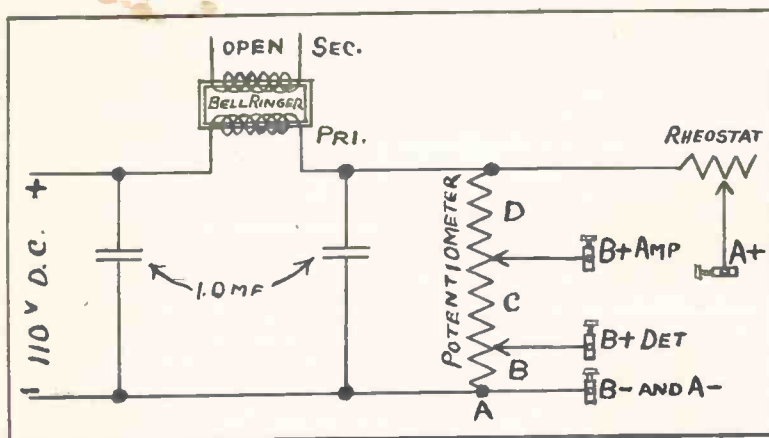

Fig. 3. Hook-up for Direct Current. The Filter Strains Out the Hum

The reason why the peak of the pressure runs up so high is this. If you have an electric light, rated at 110 volts and 50 watts, you would expect it to work on a 110 DC or AC. It is quite evident that the amount of energy it took on this pressure of direct current would be considerably greater than would occur on alternating current, if the latter had a peak of only 110. You see that in such a case most of the time would be below that figure, and so the average amount of heating would certainly be very much less.

When AC Equals DC

In order to get at a wave of current which would give the same results on an electric light, it is found by experiment that the voltage at the peak must run up considerably higher than the equivalent DC pressure. It is found by experiment just what value of peak is necessary in order to give the same amount of light on either type of service. Then (by definition), the potential of an AC line is defined as 110 volts if it gives exactly the same amount of light in an incandescent lamp as is

It is somewhat similar to a hand-driven water pump. If you have watched a pump raising water out of a cellar into the gutter, you will notice that the water stream is jerky. It is strong at times and then again it is weak. This happens at regular intervals, and so could be timed with a watch. Now the same thing occurs with alternating current (AC.) It is strong at one instant, and then dies away and reverses its direction.

Direct Current Parts

To begin with, a description will be given of the apparatus to use with a direct current source. The following units will be needed:

- 1 Bell ringing transformer
- 2 1 mfd paper condensers
- 1 Rheostat, special
- 1 Potentiometer, special.

The transformer may be the kind used to run toy trains, or perhaps part of a power transformer. Only one coil of this will be used,—the primary coil in the case of the toy transformers. The idea is to make a powerful inductance coil. Indeed, any coil which you may

be multiplied by the number of tubes which are lighted in parallel. To operate the filaments, you must work a high resistance in series so as to reduce the 110 volts down to a point where the tubes can use it. A drop wire or potentiometer might also be used here, but it is very wasteful of current, since for efficient operation, it is necessary that at least as much current be thrown away through the drop wire as is used in the bulbs, and in most potentiometers, the

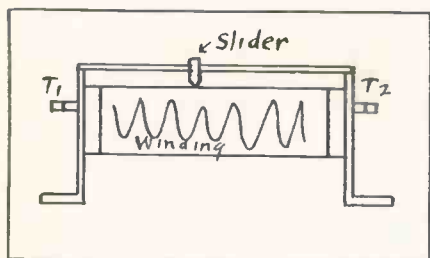

Fig. 4. This is a Special High-Resistance Potentiometer

ratio of current consumed to the amount used is at least three or four to one.

A resistance, on the other hand, passes only as much current as is useful in the device which is being operated, (the tubes.) Of course, considerable voltage is wasted in such a resistance as is necessary to cut down from 110 to the tube pressure. However, the same is true in regard to a potentiometer and this loss is in addition to that of the extra current waste.

How to Find Right Resistance

The amount of resistance necessary to cut the voltage down to the right value can not be told until the kind of tube and the number used is known. Here is the way to calculate it. First multiply the current per tube (as given above) by the number of tubes used. This gives the total current consumption. If this is to be three UV-201A tubes, we shall have 1/4 ampere times three equals 3/4 ampere. Next divide 110 volts by this figure to get the amount of resistance. In our illustration, it is 110 divided by 3/4 equals about 150 ohms. Somewhat more than this value would usually be supplied in order to be able to cut the current down to a point below this rating. About 200 to 300 ohms would be right in this example.

Here it might be pointed out that a 200-ohm potentiometer used as a resist-

ance by omitting one terminal would seem to be ideal for such a case. It will not do at all, however. The trouble is that such a potentiometer is designed for passing a few hundredths of an ampere, and when we try to run three-quarters through it, it will be burned up in short order. The rheostat must be big enough so that such a large current as 3/4 ampere may flow without doing it any harm.

Don't Blow All of Your Tubes

Take a good look at Fig 3, and check up on your wiring, as a mistake may blow all your tubes at once. This device is foolproof if connected correctly, but like many other things, is troublesome when handled incorrectly. The potentiometer is between the points A and D in Fig. 3. B is one slider about one-quarter of the distance from D. This gives 18 to 27 volts for the detector tube plate.

The other slider, C, if used may tap off any pressure from 22 up to 110 volts to operate the amplifier. Ordinarily, about one-half to three-quarters of the way up is satisfactory. If slid up too far to get too high a pressure on the amplifier tubes, distortion is likely to occur unless a suitable "C" battery is used to get the proper bias on the amplifier grids. A slider to adjust this voltage is not necessary, however. How often do you vary the pressure of the amplifier plates by shifting "B" battery terminals at the present time? If you find that one setting will do for all conditions, then there is no more need of varying a slider with this apparatus. Just solder the wire half or three-quarters of the way up and leave it there.

How to Tell the Plus Wire

As you probably know, your house electric service is probably connected to ground, the same as your radio set is. Therefore, you must connect your radio in only one way to the house current reducer. Put the two wires from a lamp socket in a tumbler of salt water. Be sure to keep the wires well separated, as if they touch together they will blow a fuse. The wires when immersed in the salt water will give off bubbles. If you watch closely, you will see that only one wire is bubbling. This is the negative.

Mark the other wire, which is the

plus, carefully in some way. The usual method is to tie a knot in this wire. An ordinary knot looked at from the side, suggests the plus mark and the unknotted wire (which gave off the bubbles) is of course the minus.

The house current reducer just described will light the filaments of your tubes, will supply the plate current for them at the same time, and also charge the storage "B" battery for a friend. To charge a "B" battery, connect it to the points A and C. The way to get rid of your batteries, if this source of current is alternating will now be explained.

List of Parts for AC

This method is adaptable to the greatest number of people as most houses use AC. The list of parts is as follows:

- 2 1-microfarad paper condensers
- 1 Bell ringing transformer
- Resistance wire
- 1 Special transformer
- 1 201A tube.

The tube may be a UV-201A of a small tungar bulb.

If your radio receiver uses only a single UV-199 tube, then you may be able to operate the rectifier with a UV-201A tube. However, the output from the plate of a 201A is barely enough to work the filament of even a single UV-199. Of course, if the plates only of your set are to be supplied by this battery eliminator, then several tubes can be operated at the same time from a 201A rectifier. To work the filaments of an amplifier set, you must have a rectifier bulb with an output big enough to supply their filament current. This means that a small tungar bulb will be needed. The price of such a bulb is four dollars.

Winding the Transformer

Obtain enough transformer iron 1 1/4 by 3 1/4 inches to make a stack about 5 inches high. The iron should be sheet of about No. 28 gauge. The primary winding will consist of 500 turns of No. 20 wire double covered cotton (DCC). The charging winding is 70 turns of No. 14 DCC. The filament coil consists of eleven turns of No. 14 DCC wire, doubled so as to carry the current without heating.

The two wires of the filament winding should lie side by side in two even layers, and a tap should be brought out at 5 1/2 turns. The primary and charging windings are wound at the same time

over one wooden form 1½ inches square. The filament coil will be wound on the iron core direct, when the core is assembled.

The transformer core is 1¼ inches square in cross section, and has a window 2 inches square. The primary and charging windings are slipped off the wooden form and slipped on the core, both going on one leg.

Filter is Also Needed

The filament winding will go on the other leg. Fig 5 will give a clear understanding of the method of connection. The filter is the same as used with the DC instrument. This will supply filament current for up to eight 201A tubes when using a small tungar bulb. This will not furnish plate current, however. In that case, "B" batteries, but no "A's" will be needed.

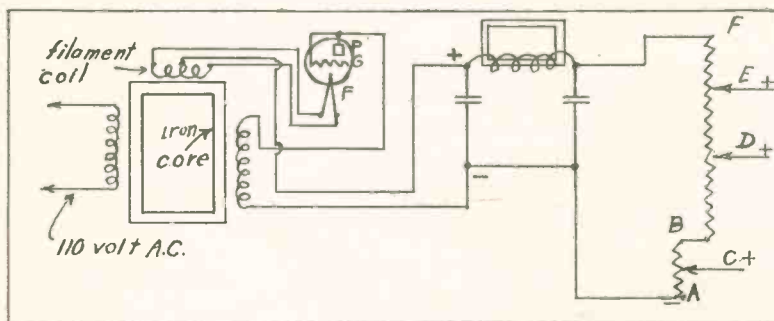

Fig. 5. Hook-up for Alternating Current. The Vacuum Tube is the Rectifier

In using Fig. 5 for operating the filaments of your set, the potentiometer shown at the right is not needed. Instead a resistance, in amount depending on the number and style of tubes used, is connected in series with the "A" plus terminal. The potentiometer is shown here as illustrating how to connect up this unit when used for giving out plate current as will be explained in a later paragraph.

Different Winding for "B" Use

To furnish plate current so that "B" batteries will not be required, the same scheme as in Fig. 4 may be used provided the transformer windings are changed to correspond. In this case, the transformer core consists of iron as mentioned above, but the dimensions are ¾ inch cross section; outside diameter, 3¼ by 3¾.

Insulation 1/16 inch paper between primary and core; 1/16 inch paper between primary and secondary; paper be-

tween layers, 1/32 inch both primary and secondary. Secondary, layer wound, 1150 turns No. 28 or No. 30 SCC, over primary on each leg.

The filament winding will consist of 41 turns No. 14 DCC on one of the unused core legs. Notice that a UV-201A tube is used as a rectifier, and the plate and grid are connected together. The range on the potentiometer from A to B is right to tap off the pressure for working the detector tubes. This in general will run from 18 to 22 volts. This tap is represented by arrow, C. Arrow D, gives 45 to 90 volts for the plate of the amplifier tubes. Arrow E, is a high voltage tap which may be used in special cases to give up to 135 volts where special hook-ups call for such high pressure. However, it usually is not needed. This scheme may also be used to charge

storage "B" batteries in the same way as was described under the direct current scheme.

A 4,000 Turn Choke Coil

Fig. 5 gives the wiring diagram. The filter is the same as in the DC case, and the potentiometer is the same. For the choke, a coil of 4,000 turns No. 36 SCC or any audio frequency transformer core will do.

It will be found advisable to keep the house current changing equipment at least six feet away from the radio set as the latter will pick up noises from the equipment if brought any closer. February 1st issue of "Radio Progress" contains some excellent information on the building of transformers and coils.

As there are many other ways by which you can get the house current to be of use in your radio, if you have any questions, I would be glad to answer them if you will address me care of

RADIO PROGRESS, if accompanied by a self-addressed stamped envelope.

RADIO FOG

Continued from Page 14

over distances of a few miles, he noted, besides the signals he was listening for, noises which had nothing to do with the signals, and every receiving operator since that time has heard this same interference.

These noises have been called "strays," or "atmospherics," or "static." The elimination of them is probably the most important problem in radio communication to-day. The intensity of this disturbance is different at different parts of the earth's surface, being progressively worse from the temperate to the tropical zones. The intensity of static varies greatly with the seasons of the year. For example, in the northern part of the United States, it is practically absent during the winter months, increases during the spring, and is most severe during the summer. There are at least two or three kinds of static, but the most troublesome kind is the one which is due to travelling electric waves, in nature just like radio waves, and which is caused by electrical disturbances somewhere in space as shown in Fig. 4. Notice that the stroke of lightning from the cloud sends out oscillations of the same frequencies or wave lengths which the broadcasting area is transmitting. What chance has the listener who pulls in every vibration of the frequency at which his set is tuned? The stroke of lightning, since it is much more powerful than any radio station going, naturally has right of way through his detector and amplifier tubes so it is not surprising that he is bothered by the snaps and crashes.

Why Static is Continuous

A lightning flash produces a travelling electric wave, much like the radio wave. If we assume that lightning flashes, large and small, are occurring continuously somewhere, we have a reasonable explanation of static.

Of course, these discharges are not all lightning to the earth, the majority being small discharges inside of or between clouds. Also it is probable that the continuous atmospheric changes above the surface of the earth, such as

Continued on Page 22

Majorie Harcom of Roxy's Gang

*She Said "Good-bye" and
Then Won a Big Prize*

By RUTH JUDITH GORDON

GOOD old Gilbert and Sullivan! Where is there to be found more rollicking fun, more gaiety of tune, more brightness of costume, than in "Pinafore" or the "Mikado!"

Roxy, that excellent show-man, re-

vives scenes from them frequently on the stage of the Capitol Theatre in New York, and his "gang" frisk about and enjoy themselves to the utmost. You have heard of course, through the stage microphone on Sunday nights, and you undoubtedly recall with pleasure Majorie Harcom's vivacious interpretation of "Buttercup," and many others of the leading roles. To see dark-haired Majorie saucily tossing her head as she capers about in her colorful milkmaid outfit, is a delight only second to hearing her excellent contralto voice.

Still Sounds Like Dixie

Majorie was not born near the White Lights of Broadway. She comes, instead, from the "Sunny South" from which she has drawn her vivacity and charm. When she goes home to Richmond, Virginia, her friends crowd about her to hear her talk with what they call a "New York" accent. But in reality, there is just enough of the southern drawl left to be fascinating. If you have ever heard her sing "Dixie" with Betsy Ayres, both of them with "Roxy's Gang" at the Capitol, you'll know that Dixie-Land and Dixie-Speech have not lost her altogether.

It was about seven years ago that Majorie took the train for New York. No, she wasn't coming to seek her fortune in the big city, but just the same she found her fortune waiting for her. She went up to say good-bye to her brother who was going to the war. At a tea which she attended, a man heard her sing and told her about the scholarship offered by the Pleiades Club of New York, where in an open competition, she won the prize,—her voice training for a year,—and so in the big city she stayed.

How She Met the "Gang"

At home Majorie had been soloist in the First Baptist Church, and in a synagogue, and now her ambition is to be

Continued on Page 22



And Majorie Can Cook as Well as She Can Sing

Build a 20-Meter Wave Receiver

How to Follow MacMillan in His Dash to the North

An Interview with E. F. McDONALD, Jr., Zenith Radio Corporation

THOSE who complain that peace times have no heroes are all wrong. Just think of Commander Donald B. MacMillan. After spending most of last year up near the North Pole among unbelievable hardships, he finally returned to America. But a few months here have satisfied him, and now he is off on another dash to the frozen North.

His expedition leaves in June for the Arctic regions. He is travelling under the auspices of the National Geographic Society. This fact alone shows the high regard the Commander holds as an explorer. His adventures on the last trip were at times very thrilling. Of course, when he leaves in June, he may never be seen again, as the expedition is menaced by many dangers. It will be most interesting to keep in touch with him on his travels.

To do this, you will need a radio receiver which can get up to 15,000 kc, which is the equivalent of 20 meters length. Such a high speed of vibration can not be received on any ordinary set, which is too sluggish. Instead, a special form of receiver must be built. With such an instrument you will be able to listen to MacDonal'd for a good share of this summertime. It is hoped that he will be able to keep in touch with the United States all the time, but it is probable that while his party is in twenty-four hour daylight near the North Pole, he may experience trouble in getting his radio waves across.

A receiver capable of picking up such high frequency short wave vibrations has been developed at the Zenith Laboratories under the direction of Lieutenant John L. Reinartz. Fig. 1 shows the portraits of Commander Donald B. MacMillan at the left, Lieutenant John L. Reinartz, and next to him, Commander E. S. MacDonal'd. This receiver is described as follows:

Do Not Use Top Switch

The hook-up is shown in Fig. 2. The radio waves come from the aerial through antenna coupling coil, D, to ground. This coupling coil varies in length according to the frequency which you wish to pick up. Of course, a tapped coil could be used in such a location, and a tap switch in such a case would pick out the proper number of turns.

on a two inch or two and one-half inch diameter tube. When picking up the 3,750 kc. (80 meter band) ten turns of No. 16 dcc will be right. This coil is spaced about half an inch to an inch away from the secondary.

Three Coil Secondary

Coil ABC is really a single coil tapped in two places, as shown in the diagram.



Fig. 1. The Explorer, the Inventor and the Manufacturer Decide on the Trip

However, this is not a good idea when working with such high speed waves, as the end losses in the coil when used on a small number of turns, is very large. Instead it is much better to have an arrangement like a honey comb coil mounting, which will take various coils depending on the frequency.

When receiving 7,500 up to 15,000 kc, (40 to 20 meters) coil D is five turns of No. 16 double cotton covered wire wound

Each part, A, B, and C, has three turns each for the 20-meter band, six turns each for the 40-meter band, and 12 turns each for the 80-meter band. Three coils are required to cover the entire range from below 20 meters to over 80 meters.

Coil G is a radio frequency choke coil which may consist of a form one inch in diameter and three inches long wound full of any wire in the neighborhood of number 30 DCC.

Condensers E and F should have about five plates each, and may, if desired, be cut down to five plates from a larger condenser by removing the extra number.

May Use Amplifiers

The usual grid condenser and leak are connected between the tube and the secondary coil as shown. A head set follows the choke coil G. Of course, an ordinary amplifier, either one or two steps, may be added at this point, if desired. There is no great advantage in using two steps on the phones and a loud speaker is seldom employed to receive code. However, there is considerable music and entertainment going at slightly under 100 meters and if you wish to pick up such signals, loud speaker operation on two steps of audio is a good proposition.

Notice that there is no by-pass condenser. In most sets it would be required, but with this scheme of hook-up it is a detriment. The reason will be explained shortly.

The wave paths of the set are relatively simple. The primary is excited from the aerial through coil D to ground.

coil AB and induces vibrations in it which are impressed across the grid and filament. This secondary is tuned by condenser E. In order to hold the wave length down to small limits, which

vented the choking action of phones from being added to that of G and the result would have been that a larger choke coil would have been needed. So be careful not to use a by-pass con-

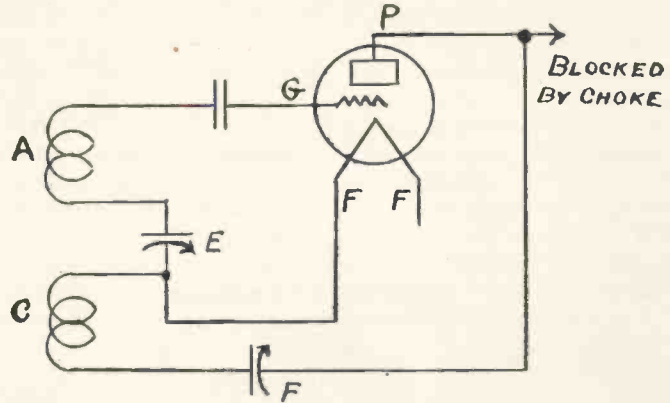

Fig. 3. The Feed Back Circuit of Fig. 2 is Shown in Detail

means a high speed of vibration, condenser E does not bridge the whole coil but only about half of it.

Why By-Pass Is Omitted

The output from the plate divides. The high frequency can not pass choke coil G and so is forced down to condenser F.

As just mentioned, the high frequency from the plate passes through condenser F and coil C to the filament, as shown better in Fig. 3. This furnishes the tickler of feedback action, which makes the set oscillate if condenser F is turned in too far. By adjusting the latter a very delicate control of the regeneration is obtained. The low or audio frequency can not follow the path just described, as such slow speed vibrations will not run through such a small condenser as F. Instead it passes through the choke coil without any hindrance since the latter having no iron does not impede the slow vibrations. From there the audio threads the telephone and "B" battery to the filament. This completes the action of the set.

Gaining Selectivity

A convenient way for laying out the panel is illustrated in Fig. 4. At the top the primary coil is shown at the left. The secondary, with its four terminals, is next to it. The closer these coils are spaced together, the louder in general will be the reception. However, very close spacing cuts down the selectivity. Usually half of an inch makes a good separation, although this must be tried out in your individual set to get the satisfactory results.

The two dials read the position of condenser, E, which does the tuning, and F, which controls the feedback. In the set as made by Zenith, instead of using

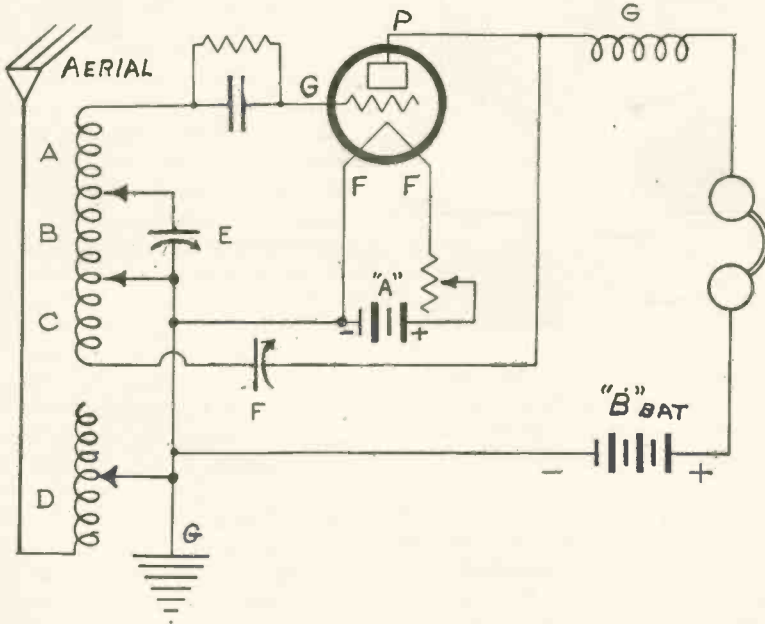

Fig. 2. This is the Hook-up Which Will Reach the Pole

As already explained, although a tap switch is shown in Fig. 2, it is much better to vary the number of turns by changing the coil itself. The magnetism from the primary acts on the secondary

The inductance of the phones is added to that of choke G to prevent the passage of radio frequency. If a by-pass condenser had been connected in parallel with the phones, it would have pre-

ordinary combined dials and knobs, a pointer is substituted, which sweeps over a stationary, graduated scale. The pointer is turned by a gear arrangement from the knob in the lower corner. This makes a neat way of adjusting, since a continuous vernier action is obtained. It is also easier to read the position of a pointer sweeping over a stationary scale, than it is the more customary arrangement of a fixed pointer with a movable scale. However, in building this set if you prefer to use the ordinary dials, which are more easily obtained, then they will be mounted on the two condenser shafts, and the knobs in the lower corners will be omitted. The rheostat knob which is also used to turn off the

has so far never felt the tread of white man's foot. It is not even known whether there is land there or if it is nothing but solid floating ice.

The equipment to be taken on the Bowdoin has already been tested at Chicago. With it it was possible to communicate with New Zealand. Lieutenant F. H. Snell, traffic manager of the American Radio Relay League, picked up Chicago's signals on shipboard 1600 miles off San Francisco. This is a total distance of about 3000 miles.

When the Airplanes Talk

The expedition is carrying with them two airplanes, each of which will carry radio equipment. Of course for use way up in the air it is very necessary to

much constructive work in wave lengths below one meter, in frequencies so high that they were not possible of measurement with the present day instruments. Lieutenant Reinartz believes that he will eventually be able to reach the natural period of certain metals.

MAJORIE HARCOM

Continued from Page 19

a concert singer. She was discovered early in her stay in New York by Samuel L. Rothafel. This accounts for the fact that the last two years have found her singing her Southern songs on the stage of the Capitol, as well as from its broadcasting station. Possibly, too, you've bought some of her Edison records.

Perhaps some lucky man will prevent Majorie from carrying out her concert plans for her tastes are all domestic. She loves cooking and sewing and best of all she loves children. She will stop anywhere to talk to a little one and her own little niece looks like a doll in the adorable creations which Aunt Majorie makes for her. However, while the listeners-in continue to voice their appreciation Majorie won't be able to desert us entirely.

RADIO FOG

Continued from Page 18

the formation of water vapor clouds, are accompanied by electrical disturbances which travel to the earth.

Blame Sun Spots, Too

We know that static is worse in the summer when variations in the atmosphere are greater and more frequent. Also it is often observed in the winter time, that the formation of snow causes static. Without knowing definitely the origin of this disturbance, it seems safe to assume that the actions which take place in our atmosphere, due to the air, the sun, sun spots, water vapor, etc., are responsible for the creation of these irregular, irresponsible and very troublesome waves which we call static.

Since they are so much like the radio waves in nature, no way has yet been found of eliminating them completely. Progress has been made in the last few years, however, and the transoceanic stations are much more free of this interference than formerly. The problem of complete elimination of static is the most difficult one in radio, and if solved, we shall have a new epoch in radio.

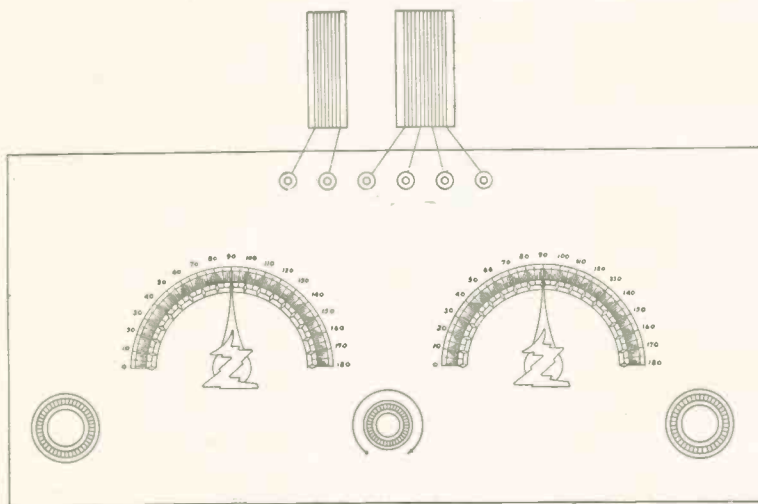

Fig. 4. The Panel of This 15,000 k.c. Set is Quite Simple. Primary and Secondary Coils at Top

set is in the lower center.

How Will 24-Hour Daylight Be?

In using this set this coming summer it is difficult to say which of the two high frequencies or low wave lengths, will be found best. This will have to be worked out by MacMillan himself, after he has reached the frozen North. Especially, after he reaches continuous daylight, conditions will be hard to predict.

He will use two vessels in making the exploration, the Neptune, with regular radio equipment, and the Bowdoin, with the high speed "shortwave" transmitter and receiver, designed along the lines just explained. He will explore as much as possible of the unknown area near the Pole. There lies an immense track of about one-million square miles, which

have as light a weight as possible, and so the transmitting apparatus on board will not be suitable for sending long distances. Instead, signals will transmit only a few miles to the Bowdoin which will pick up the signals and repeat them to observers in the United States. If the voices come through loud enough, one or more of the big broadcasting stations may find it possible to retransmit them a second time at the usual broadcast frequencies. This will hardly be possible, however, except under exceptionally good weather conditions.

While 15,000 kilocycles (20 meters) has made wonderful strides in the past six months, it is by no means to be believed that this is the minimum that will be reached. Lieutenant Reinartz has done

Double "D" Coil for Transformers

Build a Seven Tube Set Leaving Out the Whistles

By HARRY J. MARX

EASY or hard conditions—which are the best for testing out new apparatus? I think you will agree that a new device which is able to pass a hard test is usually better than one which fails, even though it may be later used under conditions not quite so severe. If you believe this, the super-heterodyne is the best test for transformers, coils, condensers, and the like, since such a radio is probably the most powerful hook-up known.

The term "Super-heterodyne" is familiar to every radio fan. Unfortunately, it is usually coupled up with a vision of a set with eight or ten tubes, a cabinet that is measured in yards, requiring an experienced radiotrician to build it and months of experience for satisfactory operation.

Seven Tubes, 7x18 Panel

Strange to relate, every one of these impressions has been refuted in the building and operating this "D" coil super-het. First, only seven tubes are used. Second, the panel is only seven by eighteen inches. This may seem remarkable, but even though it is so very compact, there is no interference be-

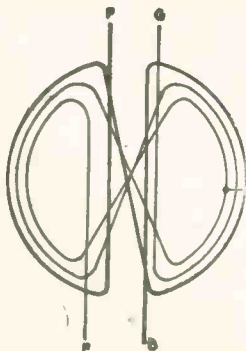

Fig. 1. Principle of the "D" Coil

tween one tube and another. The reason will be explained shortly.

The construction is simple; in fact anyone who has ever built a radio need not worry about any difficulties in

building this receiver. As to its operation,—that is simple enough for anyone to handle. Watch the folks at home bring in most of the long distance stations without paying attention to locals. Silent night is unnecessary—almost any night will do for bringing in the far ones!

Faults of the Old Portables

For the past three years, numerous designs have been offered in the line of portable sets for summer use. Few people are satisfied to stay in-doors during hot weather to listen to radio programs. Then again, receivers needing aerial and ground connections were not practical propositions for taking along on summer recreation trips. Antennas of sufficient length required a lot of trouble for erection. If loop aërials were used, then the results were often doubtful—especially in volume and selectivity. In an effort to make sets compact, the various pieces of apparatus were jammed together until every unit nearly touched or rubbed against another.

As might be expected, there was considerable trouble from this closeness of the parts. You must remember that wherever a current flows through a wire or coil, it always creates magnetism in the surrounding parts. And working this idea backwards, whenever we have magnetism changing its strength of direction, then a voltage or pressure is induced in any nearby metal. Indeed, this is the fundamental principle of a transformer. The primary current sets up magnetism in the surrounding iron core and this varying magnetic field induces an electrical pressure in the secondary winding. In such a case the action is quite necessary. Indeed, that is why we use a transformer. But unfortunately in a compact radio set as ordinarily built, two adjacent coils think they are parts of a transformer, and

give this very action, even when it is unwanted.

Where Most of Trouble Lies

In order to attain compactness without these difficulties, all induced mag-

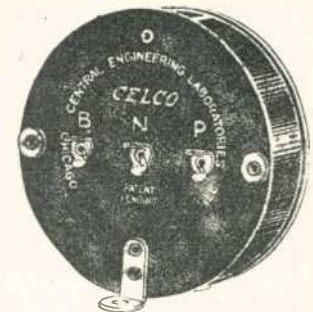

Fig. 2. This is How the Completed Transformer Looks

netic fields and capacity coupling between units must be reduced to a minimum. This is easier said than done. Super-heterodyne circuits are usually acknowledged as superior in efficiency of selectivity and volume to all other types of circuits. But rarely do they lend themselves to compact construction—hence the yard long cabinets. It is only by spacing the units far apart that the action just described is weakened enough so as not to cause howling. The chief trouble is usually found between the intermediate transformers which connect the first detector to the second. These are called the "interstage" units.

The first detector is the one which changes the frequency from the high or radio vibration speed of 500 to 1500 kc. (600 to 200 meters) down to a much lower oscillation speed. This is because such lower frequencies are amplified much more efficiently. The second detector takes the intermediate frequency and again reduces it this time to audio. It is the intermediate kc transformers which are constructed with the double "D" winding. The coils look like two capital D's, the first one being turned

around. Another way of describing it would be like a figure 8, turned over on its side.

Construction of D Coil

This winding is shown in Fig. 1. Notice that the primary starts with the plate connection, P, and first turns round clockwise through the left hand coil, then counter clockwise, through the right, ending up at the "B" battery connection, B. The secondary winding starts at F, (filament) turns around counterclockwise, then clockwise, coming out at G (grid). Tap, N, is taken off for connecting to the neutralizing condenser. The completed transformer as put out by the Central Engineering

other at any points outside the winding. By the same token if magnetic leakage should occur from say the audio transformer or any other source inside the set, the magnetic field, which passed through this intermediate transformer, would generate a plus voltage in one-half the "D" coil and a minus in the other half.

In this way, we see that not only does the double "D" work well without sending out a disturbance to its neighbors, but besides that, in case some other piece of apparatus is not so considerate and *does* create an interfering flux, the transformer will not pick it up and so cause an oscillation.

is placed inside the case of the transformers. In the hook-up diagram, Fig. 3, they are indicated in dotted lines and marked TC. The filter coupler, CU-2, is also peaked by means of a condenser, also marked TC, across the primary instead of the secondary. This method sufficiently flattens the amplification curve to give undistorted reception with maximum volume.

Not Tipped Like Neutrodyne

The secondary winding has been tapped to a terminal marked N, as already explained. This permits the use of neutralizing condensers. They are indicated in dotted lines (NC) in the diagram but have not been used in the

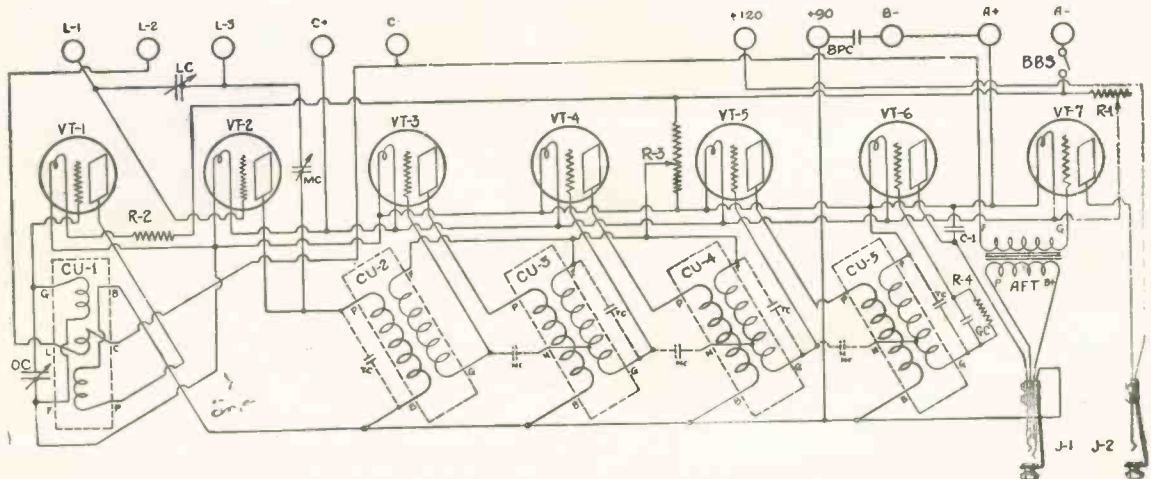

Fig. 3. Hook-up of Set. Notice That Intermediate Transformers Are Tuned by a Fixed Condenser

Laboratories of Chicago, is shown in Fig. 2.

The great advantage of this type of winding lies in the fact that it creates a closed field, running around and passing through the openings of the two D's. Because of this closed field, no interference is noticeable from one stage to another, so making it possible to mount all units very close together without creating trouble.

Balances Out Interference

You see the idea is this. Suppose we have a current running from the "B" battery at B. One half the coil will feel this current running round to the right, but the other half will get the effect of a left hand location. The two together will practically neutralize each

Transformers Tuned to 32 kc.

The turn ratio between the secondary and primary windings is four to one. Each transformer is adjusted at the factory so that voltage ratio has this value of four to one at a single peak which occurs at thirty-two kilocycles. However, the amplification factor is practically the same all the way from 27 up to 37 kc. This allows the so-called "side bands" (which are caused by the audio frequency) to pass without distortion. Vibration speeds very far away from these values, either up or down, are pretty well suppressed. That is one of the reasons why such a hook-up is so sharp in its tuning.

This shape of the output curve is brought to a peak at 32 kc. by means of a condenser across the secondary, which

finished set. They can be added where it is desired for better control of plate-grid capacity feed-back. Such a neutralizing of capacity is like that used in a neutrodyne set to prevent oscillation. The latter hook-up you will recall, tips the transformer coils at a special angle to prevent coupling between stages. This exact tipping of the coils is not needed, however, with the double "D" transformers.

The complete hook-up diagram is shown in Fig. 3. The oscillator coupler, CU-1, is of the standard type, encased to match the intermediate frequency transformers and the filter coupler.

Both the variables, LC (loop condenser) and OC (oscillation condenser) should be of a high quality type, with a capacity of .0005 microfarad. A

resistance unit, R-2, is used to control automatically the filament of the oscillator tube, VT-1. A power rheostat, R-1, controls the filaments of the other tubes.

A Midget Condenser

A small midget condenser, MC, of about 45 micro-microfarads (.000045 mfd) is used for controlling the regeneration in the tube, VT-2. The potentiometer should have a resistance of 200 ohms.

A by-pass condenser, BPC, (1.0 mfd) is connected across the "B" battery from B minus to plus 90. Another fixed condenser, C-1, (.001 mfd) is connected from the plate of the detector tube, VT-6, to the A plus lead.

Only one stage of audio amplification is necessary, but a very good transform-

Omits Drilling 28 Holes

This arrangement of using a gang socket for the base, saves all the trouble of drilling for and mounting seven sockets. In addition, it simplifies all wiring which can then be kept entirely out of sight under the shelf. A small Benjamin grid leak panel may be fastened to a lug on the shelf supporting bracket, thus providing a convenient place for mounting the grid leak and condenser.

For best results and least trouble, the sooner the old wooden baseboard is forgotten in radio construction, the better. Particularly when covered with dust and dirt, it becomes a grid lead which short circuits the units to one another and

Parts You Need

- 1 Panel, 3/16 x 7 x 18
- OC, LC, 2 Low loss variable condensers, .0005 mfd.
- MC 1 Midget variable condenser, 45 micro-mfd.
- CU-1 1 Celeo oscillator coupler
- CU-2 1 Celeo filter coupler, 32 kc.
- CU-3, 4, 5 3 Celeo "D" Transformers, 32 kc.
- R-1 1 Power rheostat, 6 ohms
- R-2 1 Self-adjusting resistance
- R-3 1 Potentiometer, 200 ohms
- 1 Benjamin Cle-ra-tone seven gang socket
- 1 Set Benjamin shelf supporting brackets
- 1 Benjamin grid leak panel

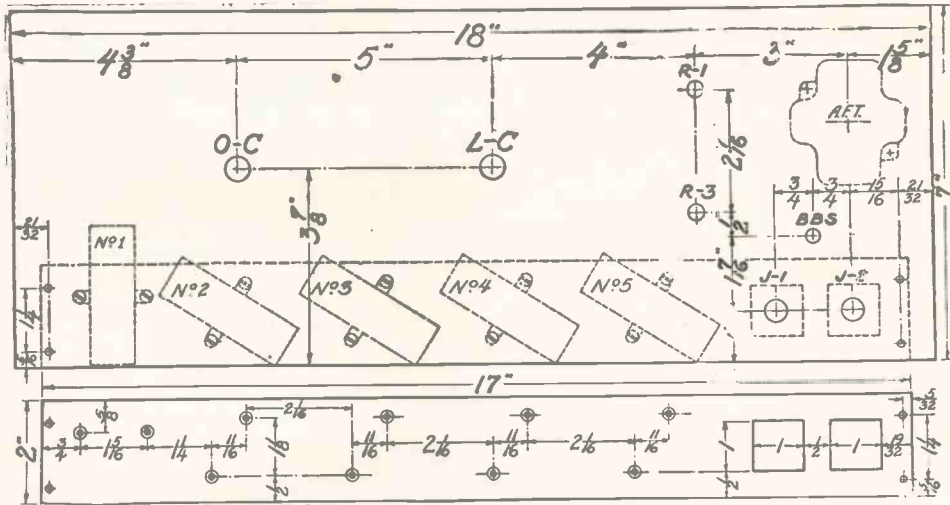

Fig. 4. Drilling Plan for Base. Bakelite Strip Plan is Shown Below

er should be used in order to get the best out of the set. A battery switch is added so the set can be turned off without touching the rheostat adjustment.

In order to use a 7x18 panel, and for compactness behind the front panels, a seven gang socket, shelf type, is necessary. The Cle-Ra-Tone is a good one. This has each socket unit mounted on shock absorbing springs, necessary for all modern tubes, and is made by the Benjamin Electric Manufacturing Co. of Chicago. A set of Benjamin shelf supporting brackets may be used for mounting the gang socket to the panel. These gang sockets are made up with standard or 199 tube sockets as either can be used with this circuit.

creates plenty of trouble without being suspected.

The greater the number of tubes used in a set, the more important becomes the necessity of using good judgment in the selection of apparatus. The factors of compactness and portability are entirely dependent on the type of units used in the set. Every type of transformer cannot be mounted as close together as indicated in the layout, Fig. 4. In order to use a 7x18 panel, this is essential. Deviation from the directions and illustrations is apt to detract from the efficiency of the set. While some may believe an extra stage of audio would be nice, it is unnecessary and would only require a larger panel and another socket.

- GC 1 Grid condenser with clips, .00025 mfd.
 - R-4 1 Tubular grid leak, 5 meg-ohm
 - C-1 1 Fixed condenser, .001 mfd.
 - BPC 1 By-pass condenser, 1 mfd.
 - BBS 1 Benjamin battery switch
 - AFT 1 Audio frequency transformer
 - J-1 1 Double circuit jack
 - J-2 1 Single open circuit jack
 - 1 Transformer panel strip
 - 2 Dials, vernier, 4-inch
 - 1 Cabinet or case to fit
 - 100 feet bus bar wire
 - Miscellaneous screws, nuts, lugs, etc.
- No binding posts are specified as they are included in the Benjamin seven gang socket. In fact the center binding post

is removed in order to mount the resistance, R-2.

Kept Out of the Way

The front panel layout is shown in Fig. 4. All markings of identification of the various units correspond to those given in the hook-up diagram, Fig. 3. The oscillator condenser is kept to the left side, while the loop condenser is placed in the center. The rheostat, R-1, is mounted toward the top on the right side. This control requires least adjustment and is therefore kept out of the way. The potentiometer, R-3, was placed below it for accessibility as it is decidedly more important in operation of controls. The audio transformer is mounted on the rear of the panel in the upper right hand corner. Its loca-

mounting the Celco units are not drilled in the front panel. The two bracket holes on each side are drilled in both panels with a No. 25 drill. The Benjamin battery switch mounts just above the two jacks in the hole, BBS. The jacks, battery switch, and potentiometer should be mounted in place before the shelf, brackets and units.

A clear illustration of the seven gang socket and the supporting brackets is shown in Fig. 5. The brackets are fastened to the shelf by means of the four screws. The center binding post is removed and the hole used for mounting the clip base of the resistance, R-2, on the under side of the shelf. On the right side the grid leak panel is indicated in dotted line with the condenser and leak mounted in position. The .001

through the panel, the bracket and the strip, respectively, and fastened with a brass nut in the rear.

No wiring is run on the top of the gang socket shelf. The leads are run along underneath and up through the holes of the terminal rivets and soldered in place. No flexible leads are necessary to these terminals as the sockets float on these terminal springs, thus providing an extremely efficient cushioning of the sockets. This eliminates all microphonic tendencies of the tubes and also does away with all danger of breaking the tube filaments in carrying around the set in an automobile or other means of transit. Accidental knocks against the set while it is in operation will not be heard in the loud speaker.

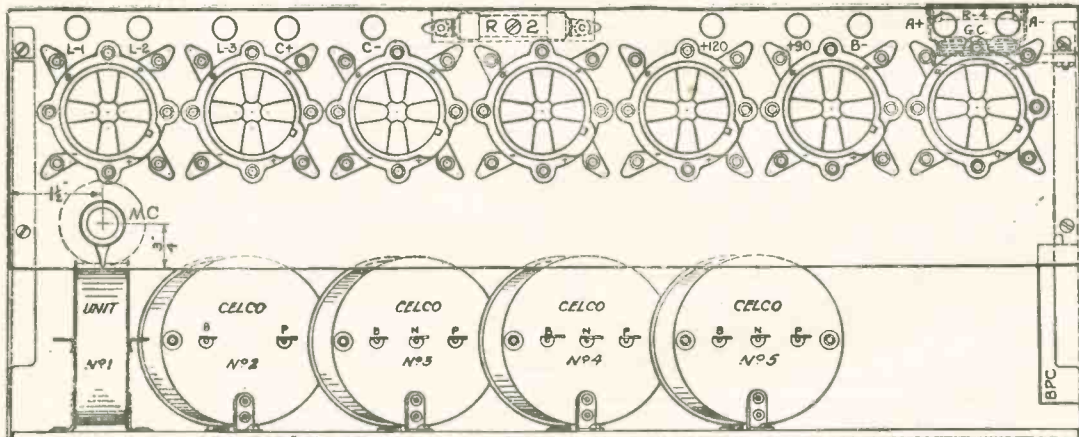

Fig. 5. Layout of Sockets and Transformers. The Sockets Come Seven in a Unit

tion is indicated, but mounting holes should be added as taken from the transformer used. This also holds true of the condensers, rheostat and potentiometer.

In the panel layout, there is indicated in dotted lines the panel strip used for mounting the five Celco units. This strip is detailed below the panel layout, Fig. 4. The relative position of the five Celco units is shown in dotted lines in the upper drawing. This panel strip with the units mounted on it is fastened in place with the same screws that hold the Benjamin shelf supporting brackets to the front panel. This is shown in Fig. 5.

Mounting in Right Order

The two one-inch squares on the right side of this panel strip are clearance holes for the jacks indicated as J-1 and 2 in the panel layout. The holes for

mfd. by-pass condenser, BPC, is fastened to the right hand bracket as shown. The .001 mfd. fixed condenser is held in position under the shelf with the wires used for connections. This is not shown in the illustration.

The midget condenser, MC, is shown in position on the left side of the shelf. Dimensions are given for locating the two center lines. Binding post markings agree with those indicated in the hook-up diagram.

Mounting the Transformer Strip

This illustration shows the way the terminals on the Celco units should face when mounting them on the panel strip. The F, L, and G terminals of the oscillator coupler, Unit No. 1, should face toward the left. In mounting the shelf and transformer strip on the panel, the screws should be inserted from the front

Beware the Paste

Keep all leads as short as possible and make sure that all joints are really soldered and not stuck together with soldering paste. Scratchy, noisy, broken reception usually indicates a poor joint in soldering.

Don't try to make any changes in the hook-up until you have made it up and tried it out as specified. Super-heterodyne circuits do not as a rule lend themselves to the multitude of alterations that pop into the mind of a radio fan.

For those who are unacquainted with the usual wiring diagram shown in Fig. 3, the picture diagram, Fig. 5, will be found decidedly to simplify their troubles in following the connections. In wiring up a set it will be found much easier to use a colored pencil, and as each connection is made the correspond-

ing line in the diagram should be gone over. This makes it easy to follow the untouched black lines and avoids all possibility of omitted connections.

Spaghetti covered wire, with various colors, will help distinguish the different leads and simplify tracing out the circuits.

All connections to the five Celco units should be made first, as they will be the only ones a little difficult to get at. Connect the five B terminals and the lower lug of jack, J-1, with one wire. Then connect the F terminals of units

leak and condenser in series with the grid of the detector tube and the grid terminal on Unit No. 5.

Keep all leads to the oscillator coupler unit No. 1 separated from others as much as possible. These wires are apt to create interference with leads in the long wave amplifier stages. They are all relatively short and should present no difficulties.

Don't Confuse Rotor and Stator

Make sure that the connections to the variable condensers are as indicated for

switch, the tube, VT-1, should light. Now turn the rheostat, R-1; all tubes should light.

Use a Loop Tapped in Center

A tapped loop should be used with this receiver. Best results have been attained with one wound like a single layer coil, on a square frame, 28 inches to a side. Eleven turns spaced 3/8 to 1/2 inch apart are required to cover the wavelength range in conjunction with the .0005 mfd. variable condenser, LC. About 105 feet of wire will be necessary

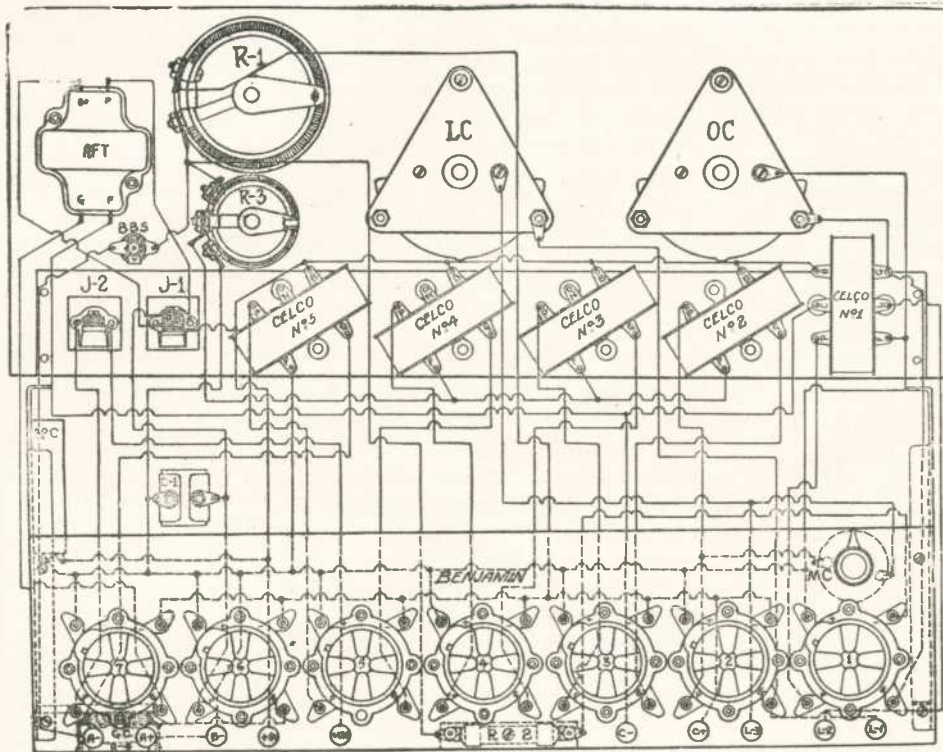

Fig. 6. Rear View of Panel and Base. Notice How Direct Most of the Leads Are

2, 3, and 4, to the slider arm terminal of the potentiometer, R-3.

Long and Branch Leads First

Then make all the remaining connections to these units and start on the filament leads. Always take those leads first which are longest and have the most branches to various pieces of apparatus. The short leads can always be added afterwards. Of course where a lead makes it difficult to get at another connection, then a little good judgment should be used.

The condenser, C-1, can be held in position by the leads to which it is soldered. Don't forget to hook the grid

stator and rotor. This is important in order to eliminate capacity effects. Some condensers have the connections on the front or panel end but for convenience they are shown on the rear in Fig. 6.

After all connections have been made, insert seven tubes (UV-199 or UV-201-A) in the sockets. First connect the "A" battery to the "B" minus and the plus 90 binding posts and see if any tubes light with the battery switch in or out. If they do, check all wiring because something is wrong. Try the same thing on plus 120 instead of plus 90.

If this is all right connect the "A" battery to the "A" plus and "A" minus binding posts. Pull out the battery

for this loop. The one end is connected to L-1, the other end at L-3, while a tap at the exact center of the loop is used for post, L-2.

If the loop is changed at any time, then the adjustment for condenser, MC, will have to be altered.

In making this feedback adjustment, tune in a low wavelength station. Make sure the two major condenser dials are adjusted for maximum results. Now turn the condenser knob, MC, until the tone is purest and the volume is maximum. If a squeal or howl is heard as the MC knob is touched, just turn back the potentiometer knob, R-3, until this

Continued on Page 28

Fone Fun For Fans

Why They Parted

Ermyntrude—"They tell me you love music."

Reginald—"Yes, but never mind; keep right on playing."—The Sydney Bulletin

Or Perhaps Forty Years Hence

It is a solemn thought that you, gentle reader, may be reading this paragraph twenty years hence in a dentist's waiting-room.—Passing Show (London).

Borrowing as a Fine Art

"Hullo, Brown. Are you using your lawn-mower this afternoon?"

"Yes, I'm afraid I am."

"Splendid! Then you won't be wanting your tennis racket—I've broken mine!"—Humorist (London).

Try Your Luck!

"Take out a policy. One customer got her arm broken the other day and we

paid her \$500. You may be the lucky one to-morrow."—From an ad.

First Catch Your Microbes

Doctor—"Deep breathing, you understand, destroys microbes."

Patient—"But, doctor, how can I force them to breathe deeply?"—Boston Transcript.

All Set For it

Fair Motorist—"Really, I didn't hit you intentionally."

Irate Victim—"What have you got that bumper on your car for if you aren't aiming to hit someone?"—Williams Purple Cow.

Health Hint

"Take care of your teeth," says an advertisement. We have nothing but scorn for the careless person who leaves them smiling inanely in the bathroom.—The Humorist (London.)

DOUBLE "D" COIL

Continued from Page 27

disappears and the adjustment can be satisfactorily made. After having made this adjustment for a low wavelength it will be found satisfactory for the high wavelengths, but the reverse does not hold true.

How to Avoid Squeals

Never turn the potentiometer knob so

far around that the set squeals, howls and growls, but work on the negative side for sharp tuning. In receiving, a station will come in only once on the loop condenser dial, but there will be two settings for each station on the oscillator dial. The adjustment of dial, OC, will be found much more critical than that of the loop condenser. The directional effect of the loop should not be ignored in order to get the maximum

selectivity possible from this receiver.

Vernier dials will be found essential for the critical adjustments of real long distance reception. A really good set of tubes should be used in order to get the best possible results.

As each station is tuned in, a log should be made of the dial setting. Always try to get the two settings of the oscillator dial. One of the two will always be found best where interference from another station is experienced. When a record has been made of four or five stations, curves can be drawn and the exact dial settings for any wavelength within the range very accurately determined.

When to Use 199 Tubes

The circuit will be found equally satisfactory with either 201-A or 199 tubes. The "A" tubes naturally furnish more volume. If the set is to be carried around in an automobile, the storage battery of the car can be used for an "A" battery and "A" tubes will give the best results. Where batteries must be carried along, the 199 type of tube will do very satisfactorily.

The voltage of the "C" battery will be found to vary, about seven volts are normally required. As the plate battery voltage is raised, the bias must likewise be increased.

Don't try to burn the filaments any brighter than necessary. Keep the setting of the rheostat, R-1, back to the point where reception is found to be clearest.

A cabinet can be constructed to fit, or if desired, a convenient portable case can be built. If the latter is done, the loud speaker horn with a unit can be incorporated in the case. Space should be provided for all the batteries required for operation of the set.

Size of Portable Set

The loop aerial can easily be made of the collapsible type and carried around in a compartment in the case. A portable unit of this type need not measure more than about 16 x 20 x 24 inches. This makes a very convenient size for carrying around on any trip for the summer.

Many have had real pleasure out of their radio receivers this winter—why not enjoy them in the summertime, too?

RADIO PROGRESS
8 Temple St. (P. O. Box 728)
Providence, R. I.

Date.....

You may enter my subscription to **RADIO PROGRESS**

for.....year { 1 year \$3.00
2 years \$5.50

Signature.....

Send it to this address

Paid by (PRINT)

Check

Cash

Money order



SALE OF POSTAGE STAMPS

These are the days when the big department stores are apt to carry headlines announcing sales of radio sets, at which the price is cut to a half or a quarter of the regular amount. However, many of them bring to mind the story of the sale of postage stamps.

It seems that a man was on his way to the post office to buy some stamps, when he was met by a friend. The latter advised him not to buy his postage that day, as he had heard from the postmaster that a sub-station was going to have a sale of 13 two cent stamps for a cent and a quarter. Although the story sounded fishy, it was decided to postpone the purchase until the next day so as to take advantage of this wonderful opportunity.

A Bargain at P. O.

Sure enough, when he finally asked the postal clerk about it, he was informed that this price was correct—13 stamps *were* selling for a cent and a quarter, but since a quarter is 25c, it was hardly much of a bargain. The same idea holds for a good many of the sales which are now being advertised.

Conditions in radio are still quite different from those of practically all other lines. The sets of the different manufacturers look so unlike and work so differently, that no ordinary inspection will tell whether they are late or early models. This is not true with automobiles for instance. The shape and appearance of cars have been standardized so much that they will conform to the same general lines. Even a car like a Franklin, which works on an entirely different principle—air cooling—has final-

ly put out a model with an imitation radiator whose sole purpose is to make it look about like the rest.

You Can't Tell Old One

If a car three or four models back, were to pull up in front of your door right away you would be struck with the fact that it was not the latest. But when a radio is looked over, if it seems a little out of the ordinary, it may be because it is an old style or, on the other hand, perhaps it is two jumps ahead of all the rest. It is only by taking such an instrument home and by trying it out as compared with some other set, that you can get a line on its performance.

Even a demonstration for half an hour at your home is not worth a very great deal in showing the value of the set. Conditions change so from night to night, that it is quite possible for a poor set on one evening to do much better work than a good set the next night. It is only by trying out a radio for a week or so or by comparing two sets one right after the other, that a worthwhile decision can be made.

Radio dealers are in the market to make money. This is perhaps a startling fact and one which never occurs to many fans. Dealers can not stay in business very long if they continue to sell their stock for less than they paid for it. When you see a \$150.00 outfit offered for \$39.90, what do you conclude? Of course, the dealer may be selling out and making such a tremendous sacrifice in order to wind up the business, but that does not happen often.

Like Auto Without Starter

The most likely reason for such

a sale is this. While radio principles have not advanced much in the last year, still there have been a great many older sets on the market, which had not been brought up to date in their operation. It is just as if a big automobile company still had a great many cars in its warehouse, which had no way of starting except by cranking by hand. Of course, they would have to move such white elephants at a very low price. These sets are in the same category. The manufacturers have been trying to unload them on an unsuspecting public for at least six months, and as they see the quiet time of the year approaching, they feel that they need the money. The reason that they sell for such a low figure is because that is all such a set is worth. Indeed, many radios of obsolete type are hardly worth anything at all.

When you see such a sale advertised, if you happen to be located way out in the country, where selectivity is of no great value, owing to the absence of any local stations, then you *may* get your money's worth when you buy a superseded set. However, you should do so with your eyes open, and realize that for city use such a hook-up is worthless.

HELPING A SICK BATTERY

It is reported that some of the tribes in Africa have the pleasant little custom of taking a ten-pound pebble, and with it, tapping on the head of those old folks who do not seem to be worth much to the tribe any longer.

While such a custom would be frowned on in civilization, it is a rather happy habit when applied

to batteries—both "B" and dry cells. A good rule to follow is to discard a battery when the voltage has dropped to two-thirds of normal. This would be one volt for a single cell or fifteen and thirty volts for the $22\frac{1}{2}$ and 45-volt sizes of "B" batteries, respectively.

When in town, most fans follow such a custom. Perhaps they do not take the bother to measure the battery pressure with a meter but when the battery gets old enough to cause poor reception, out on the dump go the old batteries. However, if you are on a

they improve the music may be explained in this way.

When a battery runs down from being used, there are two important changes that may go on in it. The one which is most easily observed is the fall in voltage or pressure. A new dry cell will give out one and one-half volts, but as more and more electricity is taken from it, this value falls continuously, until after its current has been used a long enough time, the voltage drops to zero. This effect can easily be followed by connecting up a volt meter. The reading on this in-

but a battery has a certain amount of resistance, just as a wire in a rheostat has. If this were not the case, then on a dead short circuit there would be nothing at all to limit the current flow and as a result, it would increase indefinitely to a million or a billion amperes. As a matter of fact, a new dry cell, when short circuited through an ammeter, will give about thirty amperes, which shows a resistance of $1\frac{1}{2}$ divided by 30 or $1/20$ ohm. Three dry cells in series would then have $3/20$ ohms. A "B" battery has higher values than this.

When a cell has been in use for some time, this resistance will have increased considerably. Such a resistance is in series with that of the wires and units connected to it. Thus in the filament circuit the resistance of the "A" battery is added to that of the rheostat wiring and filaments. By turning the rheostat knob, the total value of this sum is adjusted until the right amount of current flows. Because of this chance of adjusting the rheostat, the internal resistance does not play much part in the "A" battery circuit, since as it goes up, the rheostat resistance may be cut down.

When Battery Chokes

In the "B" battery circuit, we have a different condition. Here there is no adjustment. To be sure, the audio waves go through the phones, loud speaker, or transformer of the primary, which may have a resistance of one or two thousand ohms. But the radio frequency waves from the detector tube are by-passed with a condenser which blocks the audio waves owing to its small size (.001 mfd.) The wiring of the plate circuit has a low resistance, and so a high value of "B" battery resistance may have an undue effect. To be sure it is in series with the plate resistance of the tube, but even at that the "B" battery may have some choking action on the signals.

Continued on Page 32



Mrs. Julian Heath, the president of the National Housewives' League, Inc., who is a daily feature of WJZ's Women's Hour, giving the "Daily Menu."

vacation and have pitched your tent fifty miles out along the back road, it may not be so easy to obtain new units.

A Battery Tonic

In such a case, there is a small device which you may take with you which will act like a tonic on the signals coming in. This is in the form of a large capacity mica or paper condenser. It should have a value of one-half of one microfarad. The style used in ordinary Bell telephone sets are very satisfactory. The reason

instrument will equal the number of cells in series multiplied by the pressure per cell. For instance, with a new "B" battery of 15 cells, the meter will read $15 \times 1\frac{1}{2}$, which equals $22\frac{1}{2}$ volts. This value, as stated, will fall off continuously with use until the battery is thrown out.

Its Own Resistance

There is another change which is also going on at the same time. This is an increase in the internal resistance of the cell. Perhaps you had not thought about it,

What it Costs to Broadcast

Get the Figures Before You Decide to Go On the Air

By VANCE

THE old-fashioned sewing bee produced as much talk as it did sewing. A person with good ears could get snatches of a dozen conversations all going on at once. It is nearly as bad in the radio field at the present time, particularly in the bigger cities.

Just now everybody seems to want to talk at once over the air. A great deal of good advertising follows those who broadcast. But it costs something to equip and run a station. It is not so easy to get the exact figures from many operators, as they naturally do not want to give away trade secrets. However, here are some of the figures which are as reliable as can be obtained.

When building a station, the aerial is the one thing which catches the eye, but there is a lot more to be paid for than this unit. That does not mean that it is cheap to put up a good antenna. Of course, if you have a tall building on which to support the poles, a great deal of expense is saved. If you have to build tall masts from the ground up, it is easy to sink \$1,000 or \$2,000 in this structure alone.

There is a great deal more apparatus required in sending than in receiving. Every unit costs a good deal more, too, as the voltage necessary runs up very much higher than in your home radio set. The pressures of "B" battery, for instance, will run over 2,000 volts on a powerful sender, rather than 45 or 90, which you ordinarily employ. The aerial must be insulated for thousands of volts, instead of for a fraction of a volt.

An ordinary small station using a few hundred watts in the Class A division, will cost between \$20,000 and \$30,000 to build. Such a price does not include any fancy frills like storage "B" batteries and remote controlled apparatus. At such a price the studio would be adjacent to the sending station. In that

way, considerable expense could be saved for long lines and relay switches. It is the fashion nowadays for the big stations to have their main studio in town while the sending aerial and equipment is located 20 or 30 miles out in the country. Of course, such a separation means that several electrical lines must be built connecting the two or

pronounced that in some cases, this 500 watt limitation may be waived. That means still further expense for those Class B stations which decide to take advantage of the situation.

The Boston Edison Company has spent about \$80,000 recently for their station, WEEI. This included the changes required in their buildings and also the

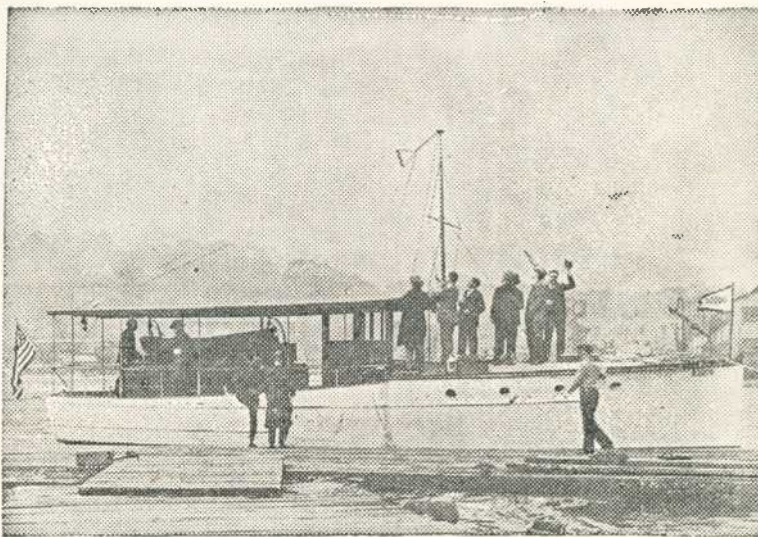

Engineers rigging antenna on Cruiser "Elco," which carried a short wave transmitter in the first broadcasting of an intercollegiate eight-oar crew race. This event, The Childs Cup Race, between Columbia, University of Pennsylvania and Princeton, was broadcast direct from the Harlem River, New York, by Station WJZ on Saturday morning, May 23.

else must be leased from one of the wire companies.

Counting in such expenses, a big station like those in New York, will run anywhere from \$100,000 to \$300,000. As the tendency is to use more power in the aerial, of course, these prices will continue to rise. Remember that the Department of Commerce at Washington has been permitting stations to increase their output in steps of 500 watts at a time, and indeed has recently an-

large steel towers. Such an electric company is naturally in a position to obtain many of their supplies at a discount, so it is reasonable to suppose that an ordinary concern would have to pay about \$300,000 for such equipment.

When it comes to operating the station, it is no poor man's job either. As yet, the expense of talent is not very great. Up until comparatively recently, broadcasting talent was not paid at all. The advertising value to the perform-

ers and the novelty of radio were both great enough so that plenty of performers could be easily found to supply all needs. However the novelty has worn off by now, and many artists want something tangible to show for their pains.

In spite of the fact that much of the talent is now paid, still this item does not bother the sending stations as much as it might. You see a great many manufacturers are using radio as a means of advertising. Sometimes, such companies pay the broadcasting station for the use of their facilities and sometimes, in the case of Roxy and his gang at Station WEAJ, New York, the value of the performance is regarded so highly by the broadcaster that no money passes either way for the use of the stations.

In such cases where a manufacturer takes a half hour or hour of a station's time, he always furnishes his own talent. This is true whether he is charged for the use of the microphone or not. That means that he has to settle the bills for the musicians whom he employs. If he is fortunate enough to have enough talent inside his own organization, he may be able to get them to sing as part of their radio work, and so include their payment in their salaries. At any rate, the sending station does not have to worry about that.

The salaries of the station operators are another matter. Even a comparatively small station which runs a regular schedule of as much as five days a week will require a personnel of at least a dozen men. The biggest stations have sixty or seventy on their payroll.

Besides the labor charge, there is a fairly large expense in the way of supplies. Tubes have a way of giving out—perhaps you have noticed that yourself. But instead of paying \$2.00 or \$3.00 for a new one, how would you like to pay over \$100.00 apiece. And the cost of electricity is fairly high. Remember that the 1,000 or 1,500 watts at which the station is rated, means power actually radiated out from the aerial. The amount of energy used in operating all the rest of the equipment is tremendously greater than this.

All these expenses added together will cost \$40,000 or \$50,000 for a small station, and from that figure up to \$300,000 a year for the big ones. When you multiply these sums by the total number of sending stations in the United

States, it is expected that \$5,000,000 in operating expenses will be paid out the coming season in order to provide entertainment for you and your family.

Taking the Boston station once more as representative of the following figures announced by President C. L. Edgar. The cost for operating for the first quarter of 1925 was \$13,200.00. For next year, the budget includes payroll, \$33,000.00; office supplies, \$2,500.00; studio supplies \$3,000.00; goodwill broadcasting (for boosting the Boston Edison Company) \$10,000.00; travelling expenses and miscellaneous, \$2,500.00; total \$50,000.00.



Joska deBabary

During the several years of radio activity, Joska deBabary, the famous violinist, heard over Westinghouse Station KYW, has been one of the staunch stand-bys of that station.

The many radio fans who have learned to tune in KYW when broadcasting from the Congress Hotel, because of the excellent programs given from that studio, have heard Joska deBabary and his orchestra and enjoyed their wonderful performance. His quartet is heard daily during the dinner hour, when the home people can tune in and enjoy the same dinner music as given to patrons of the Congress Hotel.

Perhaps you may wonder where all this money comes from. Of course, every bit of the expense is paid by someone who thinks that the advertising value is at least as great as the cost. Stations like KDKA, Westinghouse, and WGY, General Electric, to name the biggest manufacturers, natur-

ally are interested in selling their sets. When you realize that about 3,000,000 radios have been sold either complete or in parts, at an average cost of perhaps \$60.00, it is easy to see that broadcasting is not a very large tax on the industry.

Besides this, the sending stations are beginning to collect tidy bits of money from their advertisers who rent their stations. A while ago the price at New York was \$10.00 a minute for a talk. This has been advanced to \$250.00 for ten minutes if a talk featuring the company's line is presented. If in the form of music or other similar entertainment, with the only advertising a listing of the company's name and principle product, a half hour is given for \$250.00.

Of course, a national advertiser who wants to use half a dozen or more stations simultaneously, the cost is even higher. The chain of seven stations out of New York, brings a cash price of \$1,200.00 an hour. And if you say "charge it," that costs you \$400.00 more. You see the talk is not like a piano, which the house can take back again if you don't pay up as you promised.

In spite of these high figures, it seems that all three parties, broadcaster, advertisers and listeners in, are well pleased with the arrangement. In fact, they are too well pleased, as the general complaint is that there are too many broadcasters, too many advertisers, and too many (squealing) receiving sets.

EDITOR'S LOUD SPEAKER

Continued from Page 30.

If a large condenser, as described, is connected across the "B" battery with one terminal on the plus and the other on the minus, it will allow the alternating current waves to flow through it rather than through the battery. If the resistance of the latter is as low as it should be, such a condenser will not affect the operation of the set at all. But if you are stranded in the wilds with a poor "B" battery, it may assist you considerably in clearing up a feeble station.

In any event, it does no harm to any set, and so it is often advised that such a condenser be carried with a portable set.

Selectrol Super-Five

ENGLAND, SCOTLAND, SPAIN HEARD ON LOUD SPEAKER

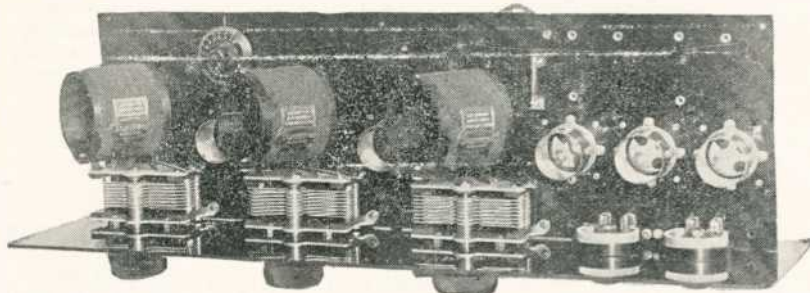

HERALDING
THE
Wonder Set
THE
WHOLE
WORLD
HAS BEEN
LONG
AND
ANXIOUSLY
AWAITING

It is impossible to even begin to describe the many unusual and novel features embodied in this wonderful new receiver

SPECIAL INTRODUCTORY OFFER

Selectrol SUPER-FIVE

INCLUDING

Five Radiotron 201A Tubes—Tower's Scientific Phones
Highest Grade Storage Battery—B Batteries, 90 Volts
Leader Loud Speaker Equipped with Novel Tone Control
Beautiful Mahogany Radio Table with Leatherette Top and Battery Shelf

Complete Outfit—Ready to Operate \$128

INSTALLED IN YOUR HOME

Ask Your Local Dealer to Demonstrate This Set for You, or Write Direct to Us and We Will Make Arrangements for a Demonstration.

STANDARD RADIO CO.

3 TREMONT ROW, DEPT. S.

BOSTON, MASS.

DEALERS—Write for our Attractive Proposition

New Products of Special Interest

FOR BATTERY LEADS

The "Valley" clip was designed so that battery acid-corrosion would have no damaging effects. All parts of the clip are electroplated with an acid-resisting metal—both a protector and an excellent conductor of electricity. This process penetrates the clip itself, and for this reason, these clips resist acid-corrosion better than those which are lead or nickel-plated.

Valley Clips are made of sheet steel of extreme toughness, blanked and shaped in automatic dies, with ribs and



Fig. 1. An Acid-Resisting Clip

channel shaped to give added strength. The channels of the two halves are opposed to each other so as to form a neatly-rounded shape.

The spring action between the parts is obtained by means of a coiled spring of steel that surrounds the rivets holding the halves of the clip together. This spring is oiled-tempered after forming and is proportioned so that it gives an easy but positive action that forces the sharp teeth of the jaws through any

scale or corrosion on the battery terminals; teeth hold tight and make a perfect electrical contact. This is shown in Fig. 1.

INGENIOUS HAND-VISE PLIERS

A thumb-screw lock makes it possible to retain an object firmly in po-

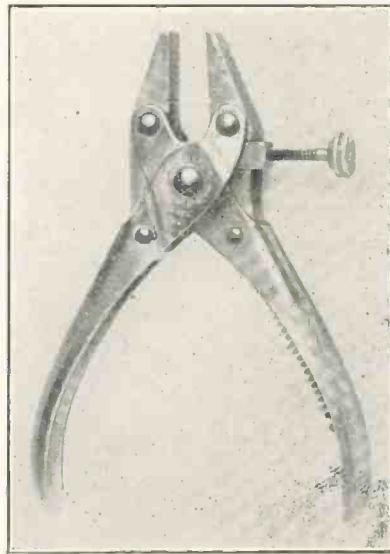

Fig. 2. Pliers That Stay Put

sition, even after the hand pressure is released. This makes it very handy for

filing parts, holding two pieces of metal in fixed position for soldering, and for gripping rod stock that must be rotated while being filed. It is an extremely efficient tool where several operations are to be done without releasing the work. See Fig. 2.

When the thumb-screw is unscrewed the full length, there remains a pair of powerful, compound leverage pliers with parallel jaws, for ordinary use around bench or automobile. This is the invention of W. A. Bernard, who has made a life study of pliers.

Cut Costs on Radio Batteries

Crawford, closed circuit, gravity batteries as formerly used for telegraph work. These batteries are high duty and can operate your radio set on six volts for nearly two years without any attention whatever. The zines in these batteries weigh almost two and four pounds respectively and have a considerable longer life than a regular dry cell. Gravity Batteries, 5x7 inches, 300 ampere hour capacity, crated, six for \$6.60. Extra zines, six for \$2.10. Gravity Batteries, 6x8 inches, 600 ampere hour capacity, crated, six for \$9.60. Extra zines, six for \$2.65. Blue vitriol for above batteries, 10 lbs. \$1.25. 25 lbs. \$2.65. Shipped via freight, F. O. B. Terms cash with order. EVERETT SCANLON, Radio Specialties, Lakewood, Rhode Island.

ively and have a considerable longer life than a regular dry cell. Gravity Batteries, 5x7 inches, 300 ampere hour capacity, crated, six for \$6.60. Extra zines, six for \$2.10. Gravity Batteries, 6x8 inches, 600 ampere hour capacity, crated, six for \$9.60. Extra zines, six for \$2.65. Blue vitriol for above batteries, 10 lbs. \$1.25. 25 lbs. \$2.65. Shipped via freight, F. O. B. Terms cash with order. EVERETT SCANLON, Radio Specialties, Lakewood, Rhode Island.

IZZY A. NUTT—HE SHOWS A BURST OF HEAD WORK—BY HARRY





It's **INSULINE**, the Best there is



**Ready Drilled and Engraved Panels for 11 Standard Circuits
Now in Stock**

These drilled and engraved panels for standard circuits are made of genuine Insuline and manufactured to the same high standard as required

by prominent set manufacturers. The factory made "Look" adds to the appearance of any home made set.

	Fada 5 Tube Neutro- dyne,	Fada 5 Tube Neutro- dyne,	Ambas- sador 3 Tube,	Ambas- sador 4 Tube R. F.	Cocka- Day Super- Het. Reflex	Fresh- man Master- piece, 5 Tube Reflex	Rasla Reflex 3 Tube	Brown- ing Drake	B. T. Name- less	Roberts Knock- out 4 Tube
	7"x26" x3/16"	7"x24" x3/16"	7"x18" x3/16"	7"x21" x3/16"	7"x24" x3/16"	7"x18" x3/16"	7"x18" x3/16"	7"x28" x3/16"	7"x24" x3/16"	7"x21" x3/16"
Black.....	\$5.00	\$4.80	\$3.50	\$4.00	\$5.00	\$3.50	\$3.50	\$5.50	\$4.50	\$4.50
Mahogany.....	6.00	5.70	4.00	4.50	6.00	4.00	4.00	6.50	5.50	5.50
Frieze Finish.....	6.00	5.70	4.00	4.50	6.00	4.00	4.00	6.50	5.50	5.50

**Our Plant is Equipped to Handle Special Work on Cutting,
Drilling and Engraving to Specification**

INSULINE DIALS 4" Diameter Beautiful Design Special 75c Each	INSULINE LOW LOSS SOCKETS Side Wipe Contacts Special 75c Each	INSULINE SUB PANEL Specially made for the 5- tube T. R. F. and can be used with any hook-up re- quiring a five-tube base lay- out. 7x17x3/16 hard rubber mounted with genuine nickel plated sockets and strong phosphored bronze contact springs securely eyeleted to base. Will improve the in- side appearance of any set. Special \$4.00 Each
---	--	---

HOW TO ORDER. Tear out this sheet and check the items wanted, together with how many of each, fill in the coupon and mail the page together with your check or money order to cover the cost of same. We pay the postage.

Radio Panel & Parts Corp.
Insulating Co. of America
59 WARREN STREET NEW YORK CITY

Enclosed is my money order for \$.....
Please ship items checked to:
NAME ADDRESS
CITY STATE

STANDARD SIZE PLAIN RADIO PANELS INSULINE

FRIEZE FINISH

Size	Thickness	List Price
7"x10"	3/16"	each \$1.10
7"x12"	3/16"	each 1.30
7"x14"	3/16"	each 1.50
7"x18"	3/16"	each 1.90
7"x21"	3/16"	each 2.20
7"x24"	3/16"	each 2.50
7"x26"	3/16"	each 2.80
7"x28"	3/16"	each 3.30
7"x30"	3/16"	each 3.50
7"x36"	3/16"	each 4.30

INSULINE MAHOGANY

Size	Thickness	List Price
7"x10"	3/16"	each \$1.20
7"x12"	3/16"	each 1.60
7"x14"	3/16"	each 1.80
7"x18"	3/16"	each 2.40
7"x21"	3/16"	each 2.80
7"x24"	3/16"	each 3.20
7"x26"	3/16"	each 3.50
7"x28"	3/16"	each 4.00
7"x30"	3/16"	each 4.50
7"x36"	3/16"	each 5.00

INSULINE

BLACK PANELS

Size	Thickness	List Price
7"x10"	3/16"	each \$0.95
7"x12"	3/16"	each 1.20
7"x14"	3/16"	each 1.40
7"x18"	3/16"	each 1.70
7"x21"	3/16"	each 2.00
7"x24"	3/16"	each 2.30
7"x26"	3/16"	each 2.50
7"x28"	3/16"	each 2.90
7"x30"	3/16"	each 3.30
7"x36"	3/16"	each 4.00

R DR RADIO PRESCRIBES.

NOTE: In this section the Technical Editor will answer questions of general interest on any radio matter. Any of our readers may ask not more than two questions, and if the subjects are of importance to most radio fans they will be answered free of charge in the magazine. If they are

of special interest to the questioner alone, or if a personal answer is desired, a charge of fifty cents will be made for each answer. This will entitle the questioner to a personal answer by letter. However, if the question requires considerable experimental work, higher rates will be charged.

Question. Does not a step of radio frequency amplification ahead of a regenerative detector prevent the tube from squealing and disturbing the neighbors?

Answer. Such a hook-up using a "buffer tube," as it is called, reduces the radiation from your set to a low value. However, it does not entirely kill such radiation for the following reasons: The grid and plate of the RF tube act like the plates of a small condenser with the space separating them as insulation. Since the plate is connected to the detector, it will receive any squeals which the tickler may cause. If an amplifier tube were a strictly one-way device, then this vibration could not go backwards and appear in the aerial. But owing to the tube capacity, as just mentioned, a certain small proportion is conducted from plate to grid, and of course such oscillations will appear in the aerial and be radiated to all neighboring sets. Fortunately, the proportion is small enough so that no one beyond a few hundred feet will be disturbed unless your tickler is turned up to a ridiculous extent.

Question. How is a condenser made so that it separates the low wave length stations easier than most condensers do?

Answer. The change in wave lengths at high frequencies is rather abrupt with any condenser which has plates shaped like a semi-circle. This is because in tuning the high frequency stations, most of the stator is not meshed with the rotor. A small shift in the rotor means a big proportional increase in the capacity.

If instead of semi-circles the plates

are shaped like a crescent moon, then when first meshed together the points will meet instead of the broadsides and the change in capacity for each degree on the dial will be small. Since the increase of capacity with each degree is so tiny the decrease in frequency, or increase in wave length, is also small. That results in separating the stations which have a high speed of vibration. When the condenser is turned so that it is one-third or more in mesh the higher rate of increase per degree does not cut much figure since at the slower speeds the wave lengths are separated by many more meters.

Question. What is meant by non-inductive resistance?

Answer. To explain this term it is necessary to understand the difference in effect between direct and alternative current. With the former it makes no difference how a resistance is wound up. When the current alternates or even when it changes its value very rapidly, the winding of the wire in the coil plays a part. The coil effect, or electrical weight, is called the inductance. It is the quality which is wanted when building a tuner.

In controlling a current by resistance, however, no tuning effect is desired. To make the coil non-inductive, it is necessary that the winding turn first to the right and then to the left an equal amount. To accomplish this, take the length of wire which you are going to use and double it in the middle, so that it forms a cable of two strands, then wind this cable on the spool either right

or left handed—it makes no difference. As you trace the wire from one terminal to the other, you will find that it spins around so many turns in one direction until it gets to the middle point, and the same number of turns in the opposite direction again. This gives it an electrical weight or inductance of zero.

Question. In which direction should the primary and secondary coils of a tuner be wound?

Answer. The direction in which the wire is wound makes no difference at all in a tuner. Some people have claimed that the amount of coupling is affected by this direction, but this is absolutely wrong. It is customary to wind the two coils in the same direction merely because they are both wound in a lathe, and it is easier to keep the rotation the same than it is to stop after one coil is done and reverse the lathe's motion. However, if you are winding coils by hand, such an argument is foolish.

Of course, it makes a difference how the connections of the tuner are made. If both coils are wound in single or banked layer on the same tube, then it is best to connect the aerial at one end of the tube and the grid at the other. This brings the two low potential connections, i. e., ground and filament, close together. Such a scheme of connection separates widely the grid and aerial, and so reduces the unwanted leakage capacity between them. It also makes a difference which way the tickler coil is connected relative to the secondary, but since this polarity is easily changed after winding, it is not important.

Biltmore Master Reflex



We wish to announce our

Model V1 Master Reflex Receiver

which we are about to place on the market.

It has taken more than a year of constant improvement on one of the most popular reflex circuits which has ever been designed to develop this receiver.

And we have been well repaid for our efforts. We have completed this six tube machine, a set extreme in sensitiveness and excellent in selectivity.

But most important of all, the receiver is perfect in tone! We will compare it with any standard receiver, and guarantee that it wins the opinion of all who hear, that it has the finest tone of any receiver manufactured.

If your dealer is not yet supplied, we shall gladly fill your order direct, and if you are within a reasonable distance of Boston, we shall be pleased to have the receiver installed and demonstrated in your own home, and to your own satisfaction.

MODEL V1 \$115



DEALERS ARE REQUESTED TO WRITE

Please mention RADIO PROGRESS

THE BILTMORE RADIO COMPANY

BOSTON 30

MASS.

UNITED STATES BROADCASTING STATIONS
ARRANGED ALPHABETICALLY BY
CALL LETTERS

Abbreviations: W.L., wave length in meters; K.C., frequencies in kilocycles; W.P., wattpower of station.

K.C. W.L. W.P.

- KDKA—Westinghouse Elec. & Mfg. Co., E. Pittsburg, Pa. 970-309-1000
- KDPM—Westinghouse Elec. & Mfg. Co., Cleveland, O. 1200-250-500
- KDYL—Newhouse Hotel, Salt Lake City, Utah. 900-333-500
- *KDZB—Frank E. Siefert, Bakersfield, Cal. 1430-210-500
- KFAB—Nebraska Buick Auto Co., Lincoln, Neb. 1250-240-700
- *KFAD—McArthur Bros. Mercantile Co., Phoenix, Ariz. 1100-273-100
- KFAE—State College of Washington. 860-349-500
- KFAF—Western Radio Corp., Denver, Colo. 1080-278-500
- KFAJ—University of Colorado, Boulder, Colo. 1150-261-100
- KFAU—Boise High School, Boise, Idaho. 1090-275-500
- KFBK—Kimball Upon Co., Sacramento, Cal. 1210-248-100
- KFCF—Frank A. Moore, Walla Walla, Wash. 1170-256-100
- KFDM—Magnolia Petroleum Co., Beaumont, Tex. 950-316-500
- KFDX—First Baptist Church, Shreveport, La. 1200-250-100
- KFDY—S. Dak. Ste. Col. Ag. & Mech. Arts, Br'kngs., S. Dak. 1100-273-100
- KFEQ—Scroggin & Co. Bank, Oak, Nebr. 1120-268-100
- KFFV—Graceland College, Lamon, Iowa. 1200-250-100
- KFGC—Louisiana State Univ., Baton Rouge, La. 1120-268-100
- *KFGA—Oklahoma College for Women, Chickasha, Okla. 1190-252-200
- *KFGH—Leland Stanford Junior Univ., Stanford Univ., Cal. 1110-270-500
- *KFI—Earl C. Anthony, Los Angeles, Cal. 640-469-2000
- KFIF—Benson Polytechnic Institute, Portland, Ore. 1210-248-100
- KFIQ—First Methodist Church, Yakima, Wash. 1170-256-100
- KFIZ—Daily Com'lth & Seifert Rad. Corp., Fondulac, Wis. 1100-273-100
- KFJF—National Radio Mfg. Co., Oklahoma, Okla. 1150-261-225
- KFJM—University of No. Dak., Grand Forks, No. Dak. 1080-278-100
- KFKB—Brinkley-Jones Hosp. Assoc., Milford, Kans. 1100-273-500
- KFKQ—Conway Radio Laboratories, Conway, Ark. 1200-250-100
- KFKU—University of Kansas, Lawrence, Kas. 1090-275-100
- *KFKX—Westinghouse Elec. & Mfg. Co., Hastings, Neb. 1040-288-2000
- KFLR—University of New Mexico, Albuquerque, N. Mex. 1180-254-100
- KFLV—Swedish Evangelical Mission Church, Rockford, Ill. 1310-229-100
- KFLZ—Atlantic Automobile Co., Atlantic, Iowa. 1100-273-100
- KFMQ—University of Arkansas, Fayetteville, Ark. 1000-300-500
- *KFMR—Morningside College, Sioux City, Iowa. 1150-261-100
- KFMT—George W. Young, Minneapolis, Minn. 1140-263-100
- KFMC—Carleton College, Northfield, Minn. 890-337-750
- KFNF—Henry Field Seed Co., Shenandoah, Iowa. 1130-266-500
- KFOA—Rhodes Dept. Store, Seattle, Wash. 660-454-500
- KFOC—First Christian Church, Whittier, Cal. 1270-236-100
- *KFON—Echophone Radio Shop, Long Beach, Cal. 1290-233-100
- *KFOO—Latter Day Saints Univ., Salt Lake City, Utah. 1150-261-250
- KFOX—Technical High School, Omaha, Nebr. 1210-248-100
- KFPG—Oliver S. Garrettson, Los Angeles, Cal. 1260-238-100
- KFPR—Los Angeles County Forestry, Los Angeles, Cal. 1300-231-500
- KFPY—Symons Investment Co., Spokane, Wash. 1130-266-100
- *KFQA—The Principa, St. Louis, Mo. 1150-261-100
- *KFQB—Searchlight Publishing Co., Fort Worth, Tex. 1180-254-150
- KFQC—Kidd Brothers Radio Shop, Taft, Cal. 1300-231-100
- *KFQZ—W. E. Riker, Holy City, Calif. 1350-222-100
- KFQZ—Taft Radio Co., Hollywood, Calif. 1330-226-250
- KFRB—Hall Bros., Beville, Texas. 1210-248-250
- KFRU—Ethical Radio Co., Bristow, Okla. 760-395-500
- KFRW—United Churches of Olympia, Olympia, Wash. 1360-220-100
- *KFSG—Echo Park Evangelistic Assn., Los Angeles, Calif. 1090-275-500
- KFUM—W. D. Corley, Colorado Springs, Colo. 1240-242-100
- KFUO—Concordia Seminary, St. Louis, Mo. 550-545-500
- KFUT—University of Utah, Salt Lake City, Utah. 1150-261-100
- *KFVE—Film Corporation of America, St. Louis Mo. 1250-240-500
- *KFVJ—First Baptist Church, San Jose, Cal. 1330-226-500
- *KFVK—Sacramento Chamber of Com., Sacramento, Cal. 1210-248-500
- *KFWA—Browning Bros. Co., Ogden, Utah. 1150-261-500
- KFWB—Warner Bros. Pictures, Inc., Hollywood, Cal. 1190-252-500
- *KFWD—Arkansas Light & Power Co., Arkadelphia, Ark. 1130-266-500
- *KFWF—St. Louis Truth Center, St. Louis, Mo. 1400-214-250
- KGO—General Electric Co., Oakland, Cal. 830-361-2000
- *KGU—Marion A. Mulrony, Honolulu, Hawaii. 1110-270-500

K.C. W.L. W.P.

- KGW—Portland Morning Oregonian, Portland, Ore. 610-491-500
- KHJ—Times-Mirror Co., Los Angeles, Cal. 740-405-500
- KHQ—Excelsior Motorcycle & Bicycle Co., Seattle, Wash. 1100-273-100
- KJR—Northwest Radio Service Co., Seattle, Wash. 780-384-1000
- KJS—Bible Institute of Los Angeles, Los Angeles, Cal. 1020-294-750
- KLDS—Reorg. Church of Jesus Christ of Latter Day Sts., Ind., Mo. 1120-268-250
- KLS—Warner Bros. Radio Supplies Co., Oakland, Calif. 1240-242-250
- KLX—Tribune Publishing Co., Oakland, Calif. 590-509-500
- KLZ—Reynolds Radio Co., Denver, Colo. 1130-266-250
- *KMO—Love Electric Co., Tacoma, Wash. 1200-250-100
- KNX—Los Angeles Express, Los Angeles, Cal. 890-337-500
- *KOA—General Electric Co., Denver, Colo. 930-322-2000
- KOB—New Mexico Col. of Agriculture, State Col., N. Mex. 860-349-750
- KOP—Detroit Police Dept., Detroit, Mich. 1080-278-500
- KPO—Hale Bros., San Francisco, Cal. 700-428-500
- *KPRC—Houston Printing Co., Houston, Texas. 1010-297-500
- KQV—Doubleday-Hill Electric Co., Pittsburg, Pa. 1090-275-500
- KSAC—Kansas State Agric. College. 880-341-500
- KSD—Post-Dispatch, St. Louis, Mo. 550-545-750
- KSL—The Radio Service Corp., Salt Lake City, Utah. 1000-300-1000
- KTHS—New Arlington Hotel Co., Hot Springs, Ark. 800-375-500
- KTW—First Presbyterian Church, Seattle, Wash. 660-454-750
- KUO—Examiner Printing Co., San Francisco, Cal. 1220-246-150
- KUOM—State Univ. of Montana, Missoula, Mont. 1230-244-500
- KYW—Westinghouse Elec. & Mfg. Co., Chicago, Ill. 560-535-1500
- KZKZ—Electrical Supply Co., Manila, P. I. 1110-270-100
- KZM—Preston D. Allen, Oakland, Cal. 1240-242-100
- KZRO—Far Eastern Radio, Manila, P. I. 1350-222-500
- *WAAB—Valdemar Jensen, New Orleans, La. 1120-268-100
- WAAQ—Tulane University, New Orleans, La. 1090-275-100
- WAAF—Chicago Daily Drivers Journal, Chicago, Ill. 1080-278-200
- WAAM—I. R. Nelson Co., Newark, N. J. 1140-263-250
- WAAW—Omaha Grain Exchange, Omaha, Neb. 1080-278-500
- *WABA—Lake Forest University, Lake Forest, Ill. 1320-227-200
- WABI—Bangor Hydro-Electric Co., Bangor, Me. 1250-240-100
- WABL—Connecticut Agric. College, Storrs, Conn. 1090-275-100
- WABN—Ott Radio (Inc.) La Crosse, Wis. 1230-244-500
- WABO—Lake Avenue Baptist Church, Rochester, N. Y. 1080-278-100
- WABX—Henry B. Joy, Mount Clemens, Mich. 1220-246-500
- WADC—Allen Theatre, Akron, O. 1160-258-100
- WAFD—Albert B. Parfet Co., Port Huron, Mich. 1170-256-250
- WAHG—A. H. Grebe Co., Richmond Hill, N. Y. 950-316-500
- WAMD—Hubbard & Co., Minneapolis, Minn. 1230-244-100
- WARC—Am. Rad. & Research Corp., Medif'd H'side, Mass. 1150-261-100
- WBAI—Purdue University, West Lafayette, Ind. 1100-273-250
- *WBAK—Pennsylvania State Police, Harrisburg, Pa. 1199-202-500
- WBAO—James Millikin University, Decatur, Ill. 1090-275-100
- WBAP—Wortham-Carter Publishing Co., Fort Worth, Tex. 630-476-1000
- *WBAY—Erner & Hopkins Co., Columbus, Ohio. 1020-293-500
- *WBBG—Irving Vermilya, Mattapoisett, Mass. 1210-248-250
- WBBJ—Grace Covenant Church, Richmond, Va. 1310-229-100
- WBBM—Atlas Investment Co., Chicago, Ill. 1330-226-200
- WBBP—Petoskey High School, Petoskey, Mich. 1260-238-100
- WBBR—People's Pulpit Assoc., Rossville, N. Y. 1100-273-500
- WBSB—Bliss Electrical School, Takoma Park, Md. 1350-222-100
- *WCBN—Foster & McDonnell, Chicago, Ill. 1130-266-500
- *WBOQ—A. H. Grebe Co., Richmond Hill, N. Y. 1270-236-100
- WBS—D. W. May, Newark, N. J. 1190-252-200
- WBT—Southern Radio Corp., Charlotte, N. C. 1090-275-250
- *WBZ—Westinghouse Elec. & Mfg. Co., Springfield, Mass. 900-331-2000
- WCAD—St. Lawrence University, Canton, N. Y. 1140-263-250
- WCAE—Kaufmann & Baer Co., Pittsburg, Pa. 650-461-500
- WCAH—Clyde R. Randall, New Orleans, La. 1130-266-200
- WCAI—Entekin Electric Co., Columbus, O. 1130-266-200
- *WCAJ—Nebraska Wesleyan University, Univ. Place, Nebr. 1180-275-100
- WCAL—St. Olaf College, Northfield, Minn. 890-337-500
- *WCAO—Kranz-Smith, Baltimore, Md. 1090-275-100
- WCAP—Chesapeake & Potomac Tel. Co., Wash., D. C. 640-469-500
- WCAR—Southern Radio Corp. of Texas, San Antonio, Tex. 1140-263-100
- WCAU—Durham & Co., Philadelphia, Pa. 1080-278-500
- WCAX—University of Vermont, Burlington, Vt. 1200-250-100
- WCAY—Milwaukee Civic Br'dstng Assoc., Milwaukee, Wis. 1130-266-250
- WCBC—University of Michigan, Ann Arbor, Mich. 1310-229-200
- WCBD—Wilbur G. Voliva, Zion, Ill. 870-345-1500
- WCBI—Nicoll, Duncan & Rush, Bemis, Tenn. 1250-240-150
- WCCO—Washburn Crosby Co., Minneapolis, Minn. 720-416-1500
- WCEE—Charles E. Erbstein, Elgin, Ill. 1090-275-300
- WCK—Stix, Baer & Fuller Dry Goods Co., St. Louis, Mo. 1100-273-100
- WCM—Texas Markets & Warehouse Dept., Austin, Tex. 1120-268-250
- WCN—Foster & McDonnell, Chicago, Ill. 1130-266-500
- WCTS—C. T. Sherer Co., Worcester, Mass. 1120-268-100
- WCWU—Clark University, Worcester, Mass. 1260-238-250
- WCX—Detroit Free Press, Detroit, Mich. 580-917-500

The Heart of Your Radio Set

A Grid Leak is essential on every set. There are few sets made which wouldn't be improved by the use of a Variable Grid Leak.

Even the set makers admit that.

But those makers say—"Show us a **good** Variable Grid Leak,"—because they know that most of the variables on the market have been a failure.

Right now -- we're showing them

Buy It

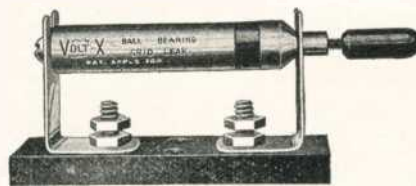

Try It

Volt-X Ball-Bearing
Variable Grid Leak

If you are not satisfied, return it and get your money back

This GRID LEAK is made by an organization which has been handling delicate electrical instruments for years. We know what it means to build accurately and substantially. We KNOW that this GRID LEAK is as nearly perfect as human hands and precise machinery can make it—we're glad to have you try it with the knowledge that if it doesn't do what we claim for it, your money will be refunded.

Clip the coupon, and send it in with \$1.00—a grid leak will be mailed at once.

BURTON & ROGERS MFG. CO.

755 Boylston St.

Boston, Mass.

Please
send me one
of your VOLT-X
VARIABLE GRID
LEAKS.

I enclose \$1.00 with
the understanding that
this merchandise is guaran-
teed to give satisfaction, or
may be returned.

NAME

ADDRESS

K.C.W.L.W.P.

WDAE—Tampa Daily News, Tampa, Fla.	1100-273-250
WDAG—J. Laurence Martin, Amarillo, Tex.	1140-263-100
WDBE—Gilham-Schoen Electric Co., Atlanta, Ga.	1080-278-100
WDBK—M. F. Broz Radio Store, Cleveland, O.	1320-272-100
WDBR—Tremont Temple Baptist Church, Boston, Mass.	1150-261-100
WDBY—North Shore Congregational Church, Chicago, Ill.	1160-258-500
WDWF—Dutee W. Flint, Cranston, R. I.	680-441-500
WDZ—James L. Bush, Tuscola, Ill.	1080-278-100
*WEAA—Frank D. Fallain, Flint, Mich.	1280-234-100
*WEAF—American Tel. & Tel. Co., New York, N. Y.	610-492-2500
*WEAH—Wichita Board of Trade, Wichita, Kas.	1120-268-100
WEAI—Cornell University, Ithaca, N. Y.	1180-254-500
WEAT—University of So. Dakota, Vermilion, So. Dak.	1080-278-100
WEAM—Borough of North Plainfield, No. Plainfield, N. J.	1150-261-250
*WEAN—Shepard Co., Providence, R. I.	1110-270-250
WEAO—Ohio State University, Columbus, Ohio.	1020-294-500
WEAR—Goodyear Tire & Rubber Co., Cleveland, Ohio.	770-389-1000
WEAU—Davidson Bros. Co., Sioux City, Iowa.	1090-275-100
*WEAY—Irjs Theater, Houston, Tex.	1110-270-500
WEBB—Edgewater Beach Hotel Co., Chicago, Ill.	810-370-1000
WEBJ—Third Avenue Railway Co., New York, N. Y.	1100-273-500
WEBL—Radio Corp. of America, United States (portable).	1330-226-100
WEBM—Radio Corp. of America, United States (portable).	1330-226-100
WEBW—Beloit College, Beloit, Wis.	1120-268-500
WEEL—Edison Electric Illuminating Co., Boston, Mass.	630-476-500
WEMC—Emmanuel Missionary Col., Berrien Springs, Mich.	1050-284-500
WEW—St. Louis University, St. Louis, Mo.	1120-246-100
WFAA—Dallas News & Dallas Journal, Dallas, Tex.	630-476-500
WFVA—University of Nebraska, Lincoln, Neb.	1090-275-500
WFBG—Eureka College, Eureka, Ill.	1250-240-100
WFBG—William F. Gable Co., Altoona, Pa.	1080-278-100
WFBH—Concourse Radio Corp., New York, N. Y.	1100-273-500
WFBY—Galvin Radio Supply Co.	1270-236-100
WFBK—Dartmouth College, Hanover, N. H.	1170-256-100
WFBM—Onondoga Hotel, Syracuse, N. Y.	1190-252-100
WFBM—Merchant Heat & Light Co., Indianapolis, Ind.	1120-268-250
WFBP—Fifth Infantry Maryland N. G., Baltimore, Md.	1180-254-100
WFBY—U. S. Army 5th Corps Area, Ft. Benj. Har'is, Ind.	1160-258-100
WFI—Strawbridge & Clothier, Philadelphia, Pa.	760-395-500
*WFKB—Francis K. Bridgman, Chicago, Ill.	1380-217-100
*WGAQ—W. G. Patterson, Shreveport, La.	1110-273-250
WGAZ—South Bend Tribune, South Bend, Ind.	1090-275-250
WGBA—Jones Electric & Radio Mfg. Co., Baltimore, Md.	1180-254-100
WGBB—Harry H. Carman, Freeport, N. Y.	1240-244-100
*WGBS—Gimbel Bros., New York.	950-316-500
*WGES—Coyne Electrical School, Oak Park, Ill.	1200-250-500
WGN—The Tribune, Chicago, Ill.	810-370-1000
WGR—Federal Telephone Mfg. Corp., Buffalo, N. Y.	940-319-750
*WGS—Georgia School of Technology, Atlanta, Ga.	1110-270-500
*WGY—General Electric Co., Schenectady, N. Y.	790-380-2000
*WHA—University of Wisconsin, Madison, Wis.	560-535-750
WHAD—Marquette University, Milwaukee, Wis.	1000-275-500
WHAG—University of Cincinnati, Cincinnati, O.	1290-233-100
WHAM—University of Rochester, Rochester, N. Y.	1080-278-100
*WHAP—William H. Taylor Finance Corp., Brooklyn, N. Y.	1250-240-100
WHAR—Seaside Hotel, Atlantic City, N. J.	1090-275-100
WHAS—Courier Journal & Louisville Times.	750-400-500
WHAV—Wilmington Electric Supply Co., Wilmington, Del.	1130-266-100
WHAZ—Rensselaer Polytechnic Institute, Troy, N. Y.	790-380-500
WHB—Sweeney School Co., Kansas City, Mo.	820-366-500
WHBF—Beardsley Specialty Co., Rock Island, Ill.	1350-222-100
WHBH—Culver Military Academy, Culver, Ind.	1350-222-100
WHBW—D. R. Kienzie, Philadelphia, Pa.	1390-216-100
WHDI—Wm. Hood Dunwoody I. Inst., Minneapolis, Minn.	1080-278-500
WHEC—Hickson Electric Co., Inc., Rochester, N. Y.	1160-258-100
*WHK—Radiovox Co., Cleveland, O.	1100-273-250
*WHN—George Schubel, New York, N. Y.	830-361-500
WHO—Bankers Life Co., Des Moines, Iowa.	570-526-500
*WHT—Radiophone Broadcasting Corporation, Deerfield, Ill.	1260-238-1500
WIAD—Howard R. Miller, Philadelphia, Pa.	1200-250-100
WIAC—Journal-Stockman Co., Omaha, Neb.	1080-278-250
WIAS—Home Electric Co., Burlington, Iowa.	1180-254-100
WIBA—The Capital Times Studio, Madison, Wisc.	1270-236-100
WIBC—L. M. Tate Post No 39, V. F. W. St. Petersburg, Fla.	1350-222-100
*WIBF—S. P. Miller Activities, Wheatland, Wisc.	1300-231-500
*WIBK—University of the City of Toledo, Toledo, O.	1460-205-100
WIL—St. Louis Star, Benson Radio Co., St. Louis, Mo.	1100-273-250
WIP—Gimbel Bros., Philadelphia, Pa.	590-308-500
WJAD—Jackson's Radio Eng. Laboratories, Waco, Texas.	850-353-500
WJAG—Norfolk Daily News, Norfolk, Neb.	1110-270-250
WJAR—The Outlet Co., Providence, R. I.	980-306-500
WJAS—Pittsburgh Radio Supply House, Pittsburgh, Pa.	1090-275-500
WJAZ—Zenith Radio Corp., Chicago, Ill. (portable).	1120-268-100
*WJBC—Hummer Furniture Co., La Salle, Ill.	1280-234-100
*WJBD—Ashland Broadcasting Committee, Ashland, Wisc.	1290-233-100
*WJJ—Supreme Lodge, L. O. Moose, Mooseheart, Ill.	990-303-500
WJY—Radio Corporation of America, New York, N. Y.	740-405-1000
WJZ—Radio Corporation of America, New York, N. Y.	660-454-1000
WKAQ—Radio Corporation of Porto Rico, San Juan, P. R.	880-341-500
*WKAR—Michigan Agric. Col., E. Lansing, Mich.	1050-286-750
WKRC—Kodel Radio Corp., Cincinnati, O.	710-422-1000
WKY—WKY Radio Shop, Oklahoma, Okla.	1090-275-100

K.C.W.L.W.P.

WLAL—First Christian Church, Tulsa, Okla.	1200-250-150
WLBL—Wisconsin Dept. of Markets, Stevens Point, Wis.	1080-278-500
WLIT—Lit Bros., Philadelphia, Pa.	760-395-500
WLS—Sears, Roebuck Co., Chicago, Ill.	870-345-500
*WLW—Crosley Radio Corporation, Harrison, O.	710-422-500
WMAA—Clive B. Meredith, Cazenovia, N. Y.	1090-275-100
WMAF—Round Hills Radio Corp., Dartmouth, Mass.	833-360-500
WMAF—Round Hills Radio Corp., Dartmouth, Mass.	833-360-100
WMAK—Norton Laboratories, Lockport, N. Y.	1130-466-500
WMAQ—Chicago Daily News, Chicago, Ill.	670-448-500
WMAV—Kingshighway Presbyterian Church, St. Louis, Mo.	1210-248-100
WMAZ—Mercer University, Macon, Ga.	1150-261-100
WMBB—Trion Ball Room, Chicago, Ill.	1200-250-500
WMBF—Fleetwood Hotel, Miami Beach, Fla.	780-384-500
WMC—Commercial Appeal, Memphis, Tenn.	600-500-500
WMCA—Greeley Square Hotel Co., New York N. Y.	880-341-500
*WNAB—Shepard Stores, Boston, Mass.	1200-250-100
WNAC—Shepard Stores, Boston, Mass.	1070-280-500
WNAD—University of Oklahoma, Norman, Okla.	1150-254-250
WNAP—Wittenberg College, Springfield, Ohio.	1210-248-100
WNAT—Lennig Bros. Co., Philadelphia, Pa.	1200-250-100
*WNAY—People's Tel. & Tel. Co., Knoxville, Tenn.	1290-233-500
WNAX—Dakota Radio Apparatus Co., Yankton, S. Dak.	1230-244-100
WNJ—Radio Shop of Newark, Newark, N. J.	1290-233-100
WNYC—City of New York, New York, N. Y.	570-526-1000
*WOAI—Southern Equipment Co., San Antonio, Texas.	760-395-1000
WOAN—James D. Vaughn, Lawrenceburg, Tenn.	1060-283-500
WOAW—Woodmen of the World, Omaha, Neb.	570-526-1000
*WOC—Palmer School of Chiropractic, Davenport, Iowa.	620-484-2000
WOI—Iowa State College, Ames, Iowa.	1110-270-500
WOO—John Wanamaker, Philadelphia, Pa.	590-508-500
WOO—Unity School of Christianity, Kansas City, Mo.	1080-278-500
WOR—L. Bamberger & Co., Newark, N. J.	740-405-500
*WORD—People's Pulpit Association, Batavia, Ill.	1090-275-2000
WOS—Missouri State Marketing Bureau, Jefferson City, Mo.	680-441-500
WOWL—Owl Battery Co., New Orleans, La.	1110-270-100
WPAJ—Doolittle Radio Corporation, New Haven, Conn.	1120-268-100
WPG—Municipality of Atlantic City, Atlantic City, N. J.	1000-300-500
WPSC—Pennsylvania State College, State College, Pa.	1150-261-500
WQAA—Horace A. Beale, Jr., Parkersburg, Pa.	1360-220-500
WQAC—Gish Radio Service, Amarillo, Tex.	1280-234-100
WQAM—Electrical Equipment Co., Miami, Fla.	1120-268-100
WQAN—Scranton Times, Scranton, Pa.	1200-250-100
WQAO—Calvary Baptist Church, New York, N. Y.	833-360-100
WQAS—Prince-Walter Co., Lowell, Mass.	1190-252-100
WOJ—Calumet Rainbow Broadcasting Co., Chicago, Ill.	670-448-500
WRAA—Rice Institute, Houston, Tex.	1170-256-100
WRAF—The Radio Club, Laporte, Ind.	1340-224-100
WRAK—Economy Light Co., Escanaba, Mich.	1170-256-100
WRAL—Northern States Power Co., St. Croix Falls, Wis.	1210-248-100
WRAM—Lombard College, Galesburg, Ill.	1230-244-100
WRAV—Antioch College, Yellow Springs, Ohio.	1140-263-100
WRAX—Flexon's Garage, Gloucester City, N. J.	1120-268-100
WRBC—Immanuel Lutheran Church, Valparaiso, Ind.	1080-278-500
*WRC—Radio Corporation of America, Washington, D. C.	640-469-1000
WREO—Reo Motor Car Co., Lansing, Mich.	1050-286-500
WRK—Doron Bros. Electrical Co., Hamilton, O.	1110-270-200
WRM—University of Illinois, Urbana, Ill.	1100-273-500
WRR—Dallas Police & Fire Dept., Dallas, Tex.	1150-261-350
WRW—Tarrytown Radio Research Laboratories	1100-273-500
WSAB—S. E. Missouri State Tech's Col., Cape Gir'du, Mo.	1090-275-100
WSAC—Clemson Agric. Col., Clemson College, S. C.	890-337-500
WSAD—J. A. Foster Co., Providence, R. I.	1170-256-100
WSAG—Gospel Tabernacle, St. Petersburg, Fla.	1130-266-500
*WSAI—United States Playing Card Co., Mason, O.	920-326-500
WSAJ—Grove City College, Grove City, Pa.	1310-229-250
WSAP—The City Temple, New York, N. Y.	1140-263-250
WSAR—Doughty & Welch Electric Co., Fall River, Mass.	1180-254-100
WSAV—Clifford W. Vick Radio Const. Co., Houston, Tex.	833-360-100
*WSB—Atlantic Journal, Atlantic, Ga.	700-428-500
WSL—J. & M. Electric Co., Utica, N. Y.	1240-242-100
WSMB—Saenger A'm't Co., & Maison Blanche N. O. La.	940-319-500
*WSMK—S. M. K. Radio Corp., Dayton, Ohio.	1090-275-500
WSOE—School of Eng'ing of Milwaukee, Milwaukee, Wis.	1220-246-100
WSRO—Radio Co., Hamilton, Ohio.	620-483-100
WSUI—State University of Iowa, Iowa City, Iowa.	620-484-500
WSY—Alabama Polytechnic Institute, Auburn, Ala.	1200-250-500
WTAB—Fall River Daily Herald Pub. Co., Fall R'vr, Mass.	1130-266-100
WTAC—Penn. Traffic Co., Johnstown, Pa.	1430-210-100
WTAM—Willard Storage Battery Co., Cleveland, O.	770-389-1500
WTAQ—S. H. Van Gorden & Son, Osseo, Wis.	1180-254-200
WTAR—Reliance Electric Co., Norfolk, Va.	1150-261-100
WTAS—Charles E. Erbstein, Elgin, Ill.	990-302-1000
WTAT—Edison Illum'ing Co., Boston, Mass., (portable)	1230-302-100
WTAW—Agric. & Mech. Col. of Texas, Col. Station, Tex.	1110-270-250
WTHS—Flint Senior High School, Flint, Mich.	1370-219-250
WTIC—Travelers Insurance Co., Hartford, Conn.	860-349-500
WWAD—Wright & Wright, Philadelphia, Pa.	1200-250-100
WWAE—Lawrence J. Crowley, Joliet, Ill.	1240-242-500
*WWAO—Michigan College of Mines, Houghton, Mich.	1140-263-250
WWI—Ford Motor Co., Dearborn, Mich.	1130-266-500
WWJ—Detroit News, Detroit, Mich.	830-353-500
WWL—Loyala University, New Orleans, La.	1090-275-100

*Additions and corrections.

**TOBE C.
DEUTSCHMANN**
Fine Radio Apparatus

STATIC ELIMINATION

WITH the approach of summer, every radio fan looks with a certain amount of dread to the Enigma of Radio—Static. For more than a quarter of a century, scientists in many parts of the world have applied their knowledge and skill to the problem of eliminating Static. Most of their attempts have resulted in failure.

Science recognizes but one device capable of curbing the annoying electrical disturbances, and that is the loop antenna. Electrical storms, like other weather disturbances, find their origin in various points of the compass. It is obvious, then, that by the use of a directional loop turned to a direction away from the disturbance, the disagreeable static noises may be tuned out.

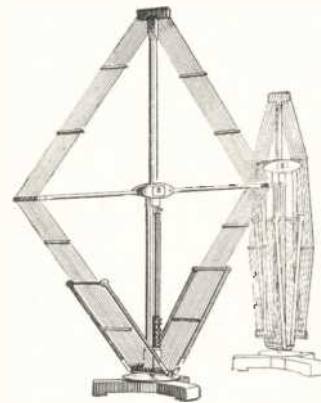

The superior construction of the DTW IMPORTED COLLAPSIBLE LOOP enables it to perform this function to much better advantage than other loop antenna devices. Forty-two inches high by forty inches wide, its inductance consists of fourteen turns of genuine Litzendraht cable, made up of sixty individual strands, insulated, twisted and covered with double green silk.

The woodwork is mahogany and all metal parts are highly nickeled. A graduated metal table at the base accurately gives the station direction. The turns are sectionized and by unique design all "dead end" effect is absolutely eliminated. The center tap permits its use without modification for all types of Super Heterodynes. The loop is collapsible and by means of the adjustable slide it may be actually used as the tuning unit of the set. No other loop incorporates such perfection of design, and no other loop can give such marvelous results.

Price, \$25.00

— CUT OUT —

I am interested in the DTW loop advertised in RADIO PROGRESS.

Please send me literature descriptive of the loop.

(Name)

(Street)

(City) (State)

TOBE C. DEUTSCHMANN
Sole American Distributor
46 CORNHILL, BOSTON, MASS.



She Sent Away 3000 Miles

It is more convenient to buy from the corner store. But you often get better results if you will send away for what you need.

One of our customers, realizing this, sent all the way from the State of Washington, about 3,000 miles away. She understood that she got a better instrument and paid less for it than she could obtain in her own town.

It pays to buy your Audio Transformers from us. There are a few units put out by other manufacturers which are as good as ours, but they all sell at a very much higher price. If you are looking for a reasonable cost, and especially for a high quality article, the RADICLEAR Transformer is the one you need.

As a protection to you, we guarantee to refund your money inside of two weeks if you are not satisfied with the RADICLEAR. As a matter of fact, less than one per cent. of our customers have asked for this privilege.

One reason why this unit is so popular is the fact that it was built to such close standards. Each RADICLEAR is tested out and matched against a standard, and any which do not meet this rigid test are thrown out. If you buy a second unit a year from now it will be a perfect match for the one you send for to-day.

As a convenience, use the coupon in the corner.

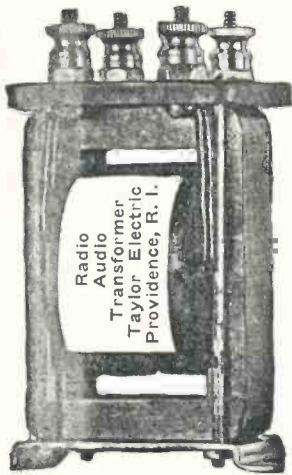

The Taylor Electric Company,
1206 Broad Street,
Providence, R. I.

Please send me the following by parcel post. (Mark which one you want.)

Radiclear Audio Transformer @ \$3.95

Amplifier set complete @ \$6.00

(Socket to fit.....tube)

Audion Crystal @ 25c.

Gold Plated Cat Whisker @ 15c.

I enclose \$.... to pay for these.
(These above prices include the postage.)

Send them to me C. O. D. I
will pay the above price plus postage.
(Indicate which way you wish to pay.)

Name.....

Address.....

TAYLOR ELECTRIC CO.

1206 Broad Street

Providence, R. I.