

September 1, 1924

15 Cents a Copy

RADIO PROGRESS

*'Always Abreast
of the Times'*

IN THIS ISSUE:

Judging Jacks for Real Results

Special Article by H. V. S. Taylor

Static and Fading in Warm Weather

More About Transmitter Amplifier

How to Reflex the Neutrodyne

Forget-Proof Filament Switch

YOU WILL UNDERSTAND THIS
MAGAZINE--AND WILL LIKE IT

PUBLISHED TWICE A MONTH

RADIO PROGRESS

HORACE V. S. TAYLOR, EDITOR

Volume 1

Number 12

Contents for SEPTEMBER 1, 1924

	PAGE
JUDGING JACKS FOR REAL RESULTS.....	5
STATIC AND FADING IN WARM WEATHER.....	9
WHEN RADIO CONTROLS ITSELF.....	11
MORE ABOUT THE TRANSMITTER AMPLIFIER.....	13
TALKING TO THE MIKE.....	14
TOURING WITH OUR EARS ALONE.....	15
AMERICAN RADIO RELAY LEAGUE.....	17
HOW TO REFLEX THE NEUTRODYNE.....	19
PORTRAITS OF POPULAR PERFORMERS.....	22
EDITOR'S LOUD SPEAKER:	
DRIVE IT BY BELT.....	23
THE VOGUE OF THE VERNIER.....	24
HIGH SPEED WAVES WILL REACH POLE.....	25
FORGET-PROOF FILAMENT SWITCH.....	26
HUMOROUS HAPPENINGS AT A STUDIO.....	27
FONE FUN FOR FANS.....	28
DR. RADIO PRESCRIBES.....	29
LIST OF BROADCASTING STATIONS.....	31

Do you know how it is that a good many different broadcasting stations can all send the same programme without interfering? It is quite a technical problem. See "REBROADCASTING THE TIME SIGNALS" in our next issue.

You hear a great deal about filters these days. Do you know what they are and how they work? This is explained in an article in the September 15 issue of RADIO PROGRESS.

Almost everyone uses a loud speaker these days, but many do not understand how they work. In the next number, the article, "THE INSIDE OF A MAGNAVOX," will describe the workings of this popular speaker.

RADIO PROGRESS is issued on the 1st and 15th of each month by the Oxford Press at 8 Temple Street, Providence, Rhode Island. John F. O'Hara, Publisher. Yearly subscription in U. S. A., \$3.00. Outside U. S. A., \$3.50. Single copies, 15 cents. Entered as second-class matter, April 4, 1924, at the Post Office at Providence, R. I., under the Act of March 3, 1879. Address all communications to RADIO PROGRESS, 8 Temple Street (P. O. Box 728), Providence, R. I. Title registered at United States Patent Office.

The publishers of this magazine disclaim all responsibility for opinions or statements of contributors which may at any time become subjects of controversy.

About that Cat Whisker



Some wires work much better than others



Perhaps you think that a cat whisker is any piece of fine wire resting on your crystal. To be sure, most anything will give you some music, but the best results are obtained by brass or copper wire. When new and bright, nothing else is needed, but copper and brass tarnish and corrode. To prevent this, it is best to have a thin plating of gold on the outside of the wire.

Our gold plated cat whiskers are made up as described, and will fit any crystal detector.

Price, postpaid, 15c

We also furnish the well-known AUDION crystals for 25c, postpaid.

TAYLOR ELECTRIC CO.

1206 BROAD STREET
PROVIDENCE, R. I.

Hub Cycle & Auto Supply Co., Inc.

19-37 Portland St., Boston, Mass.

Automotive, Bicycle and Radio Jobbers

Exclusive New England Distributors for

Harvard Auto and Radio Batteries

Uncle Sam's Master Tuning Coils

Tower's Phones

Dealers, write for Catalogues and Discount Sheets

Radio Dealers!

Practically every Radio Fan who comes into your store will subscribe to RADIO PROGRESS, if you will keep a few copies on your counter. Those who won't subscribe will at least buy a single copy.

Why not ring up some of this business on your Cash Register? We will help you and will put you in touch with our distributor in your territory.

You'll be surprised when you discover how big an item this business will amount to in the course of a year. And you take absolutely no risk, nor do you have to invest a single cent of capital.

GET ABOARD! Send us your name and address to-day.

RADIO PROGRESS, 8 Temple St., P. O. Box 728, Providence, R. I.

RADIO PROGRESS

"ALWAYS ABREAST OF THE TIMES"

Vol. 1, No. 12

SEPTEMBER 1, 1924

15c. PER COPY, \$3 PER YEAR

Judging Jacks for Real Results

A Change of Connection Sometimes Brings Improvements

By HORACE V. S. TAYLOR

CRYSTAL sets rarely use a telephone jack. The particular advantage of the crystal is that it is very inexpensive and gives good results. Since it is rare to work a crystal with an amplifier (unless it is reflex) there is no chance of using a jack to control the amplifier tube. That is the reason why this unit is seldom seen on a crystal set.

The next step up the ladder is the single tube radio. With such an equipment a jack is often included; as it is quite a convenience to be able to plug the phones in and out. Even here this apparatus is not required and many sets



Fig. 1. The Most Popular Jack

use binding posts to hitch the phones to. They are quite satisfactory, but, of course, connecting and disconnecting requires several seconds of time, while plugging in the phones is a matter of half a second. When tests are made with different sets of phones or various loud speakers it is important to use as short a time as possible in shifting from one to the other. An orchestra plays its music with expression and one measure will often be several times as loud as the one before. The same applies to a singer, and even a good speaker will raise and lower his voice to avoid a monotone.

Quick Work for Tests

So if a change from one phone to another is made, when a few seconds are

consumed in tightening up the connections by binding posts, then the test is not of very much value, since the loudness of the music has very probably changed in that time. Of course, if one instrument is greatly superior to the other, such a trial is sufficient to pick out the better instrument. But in these days most all phones on the market work well, and in trying to find out which is the better we must look for small differences in tone. To do this it is absolutely necessary that the change from one to the other be made just as quickly as possible, and any time longer than that required to pull out one plug and push in another is likely to reduce the value of the experiment considerably.

There are other advantages to be gained from using a jack, even on only a single tube set. For instance, in families having small children it is better to pull out the plug and hang the phones up where they are out of the reach of little hands. Otherwise, it will be found that the ear pieces are fine dishes to make mud pies in. Of course, with binding posts the tips can be disconnected, but it is usually so much bother to do this that it is apt to be neglected. A jerk on the plug is all that is needed to remove the head phones when this scheme of connection is used.

Accident Insurance for Set

Still another reason for using this device is found in the fact that

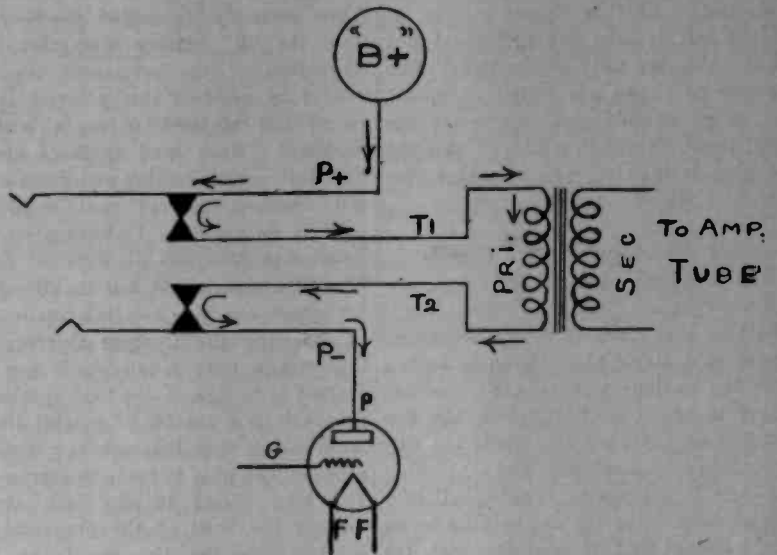

Fig. 2. Hook Up of Jack Shown in Fig. 1

sometimes the telephone cord will get caught in something or will perhaps get twisted around a person's arm or foot. If he makes a quick move the user of the phones will sometimes give quite a jerk to the cord. With the old style of binding post terminals it means that the radio set is very likely to be jerked off the table. But if a jack is used, the plug will slip right out of it long before the pull is heavy enough to shift the set itself. This is almost as good as accident insurance for the set, as it is probable that more radios are pulled off the shelf in this way than in any other.

When it comes to radios with two or more bulbs, it is customary to use jacks for connections for electrical reasons.

contacts with the upper spring. When a plug is inserted these two springs are bent away from the two center contacts and so no longer touch them.

The diagram of connections is shown in Fig. 2. Here the path of the current is traced when the jack is removed. This might represent the detector, or first step, in a two-amplifier set. The polarity is shown so that the shell or tube of the plug is positive and the tip is negative. This is the ordinary method of connection, but it need not be strictly followed. Many people connect up their sets without any regard for the polarity of this unit. In general it makes no difference. However, some of the phones and many of the loud speakers are designed so that the current should run

positive and the plus of the phone should be connected to the shell. In case the connections are reversed at the jack, it is only necessary to reverse the phone connections at the plug to accomplish the same result.

However, there is one advantage in making the long spring plus. Since this is a rather standard convention, it means that if you have several loud speakers to test, or if you wish to use your loud speaker with several sets, then all phones or plugs can be made interchangeable by using this same polarity. When you wish to test out a new speaker, just connect the positive to the shell and you can plug it in detector, first or second step of any set where this convention is observed, and there will be no danger of reversing the polarity of the horn. For this reason we shall maintain this convention through the rest of this article.

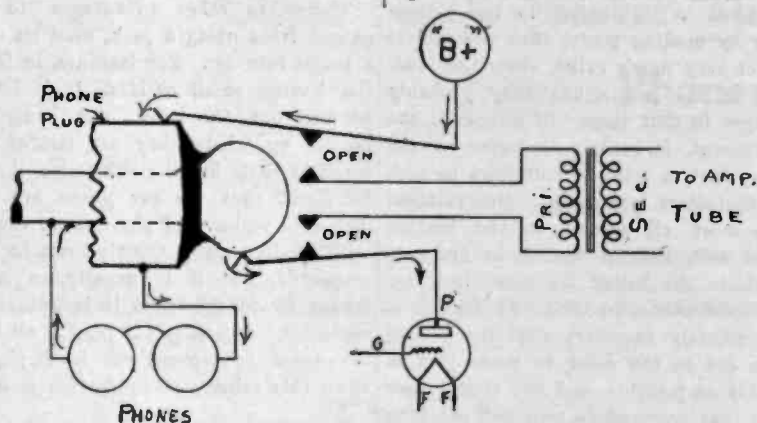

Fig. 3. How Plug Acts as Double Pole Switch

The four terminal unit is the one most often used. This is shown in Fig. 1. At the left is seen the hexagonal nut which holds the unit to the panel. Two washers as shown are usually supplied, one to go outside and one inside the panel itself. Through a hole in this nut the plug is inserted, and it makes contact with the two springs.

Plug Has Only Two Contacts

The telephone plug has only two contacts. This may surprise some people who have seen three or four phones connected to a single plug. Even in such a case the various phones are connected either in series or parallel to the two contacts on the plug. One leads the current into the head set and the other conducts it out again. That is all that is necessary. The tip of the plug forms one terminal and it contacts with the lower spring in the drawing. The shell or tube forms the other terminal, which

through them only in one direction. When correctly connected the current from the "B" battery strengthens the magnetism of the permanent magnets and if by accident this polarity is reversed the magnets' strength will be weakened. Such loud speakers always have instructions coming with them which tell whether the red cord should be positive or negative. Unfortunately different manufacturers use different polarities with their cords, but the directions with each one give full information.

Getting the Current Correct

Once you have found which way the current is to flow in the loud speaker or phones it is a matter of no real importance which way the jack is connected, provided the plug is made to correspond. The long spring in the jack always touches the shell of the plug and the short spring the tip, so if the long spring is made the positive, as shown in Fig. 2, then the shell will always be

How the Transformer Works

Getting back to Fig. 2, we notice that the long spring of the jack is connected to the "B" plus terminal, which will be 22 volts, if this is the detector, or maybe 45 to 90 volts, if an amplifier. The shorter spring runs to the plate of the vacuum tube. If this is the detector of a regenerative set the tickler coil is inserted between the jack and the plate. But in any event, the current finally reaches the plate. The two center springs run to the two primary connections of the audio transformer. Usually it makes no difference which is which. However, if the transformer terminals are labelled "B" and "P" then care may be taken to see that they run to the proper springs so that the battery and plate will correspond with "B" and "P." If these connections should happen to be reversed, our tests have shown that it is difficult to notice any difference.

When the phone plug is out, the course of the current is from the "B" battery plus to the long spring, center spring, then through the primary of the transformer, back to the jack, the short spring, and from there to the plate of the vacuum tube. When the phone plug is inserted as shown in Fig. 3, it raises the two springs and so opens the connections. You will notice that the primary of the transformer, and so the amplifier step just beyond, is entirely disconnected. The current now runs from the "B" plus and long spring to

the shell of the plug, then through the phone cord to the head set, back again to the tip of the plug, and so through the short spring to the plate.

Like Double Pole Switch

By comparing Figs. 2 and 3 it will be seen that the plug and jack act just like a double pole, double throw (d. p. d. t.) switch. When the plug is out it connects "B" plus and plate to the transformer; when plug is inserted it throws the same connections to the phones. In some of the older sets a d. p. d. t. switch was mounted on the panel to do this very thing and the phones and transformer were connected permanently to blading post. Of course, this construction gave just the same electrical results, but was not nearly as neat and required extra apparatus mounted in the cabinet. For that reason this switch idea has been abandoned.

Four-Prong Jacks Obsolete

Although a great many sets are using the four-spring jacks as just described, as a matter of fact they are going out

the "B" battery to point X, where it flows to the right through the primary, then to the center spring and short spring (since the contacts are closed) direct to the plate. When the phone plug is inserted, it opens the contacts just as before, and the short spring rests on the phone tip, as it did in Fig. 3. Since the long spring is omitted, contact is made between the frame of the jack and the plug where the latter is inserted through the hexagonal nut. The course of the electricity is as follows: Starting from the "B" plus, it goes to the left at point X, out through the shell of the plug (not shown), back through the tip, into short spring, and the tube plate. The audio transformer is disconnected, since the short spring is raised, so breaking the contact.

The advantages of this two-spring jack over the four-spring shown in Figs. 2 and 3 are twofold. In the first place, when the plug is withdrawn, thus connecting in the primary of the transformer, there is only one pair of springs and contacts in circuit instead of two. This cuts the contact resistance down to

of Figs. 3 and 4 were mentioned as being for the detector or first step. The last step of an amplifier, of course, can not run to a transformer beyond, because if it did it would not be the last step. If we assume that a three-tube radio is being considered, then two of the jacks will be connected as shown, but the third will have only two wires running to it, one from "B" plus and the other from "P." A jack like either Fig. 3 or Fig. 4 is suitable for use in



Fig. 5. Automatic Filament Control

the last step merely by leaving out the connections which are shown running to the transformer. As a matter of fact, we prefer to use the same kind of jack for both steps, since it saves getting two different styles of unit, and in case it were later decided to change the hook-up of the set, then such jacks could be used for either purpose. However, some builders prefer to use a special style of end jack. This looks like Fig. 4, except that the middle spring is omitted.

Control Jacks

In some sets the rheostat is used to turn off the filament current when the last station signs off. Others use a snap switch. But some people don't want to be bothered by these means, and so install an automatic control jack. Of course, one advantage of such control is that there is no danger of forgetting to snap off the switch, and so leaving the battery running all night. Once the phones are pulled out of the set you can be positive that everything is dead. Such a control device is shown in Fig. 5. Here only one spring is used, which means that this jack would be the last step in an amplifier circuit. Of course, if it were to be an intermediate jack, then another spring would be used, as was illustrated in Fig. 4. It is omitted here to simplify the appearance of the unit.

It will be observed that above the short spring "P" are two other springs carrying contacts which mate. This pair is separated from the lower part of the jack by a strip of insulation, "S," which is flexible. When the plug is withdrawn the contacts are separated, as shown, but when it is inserted it raises the

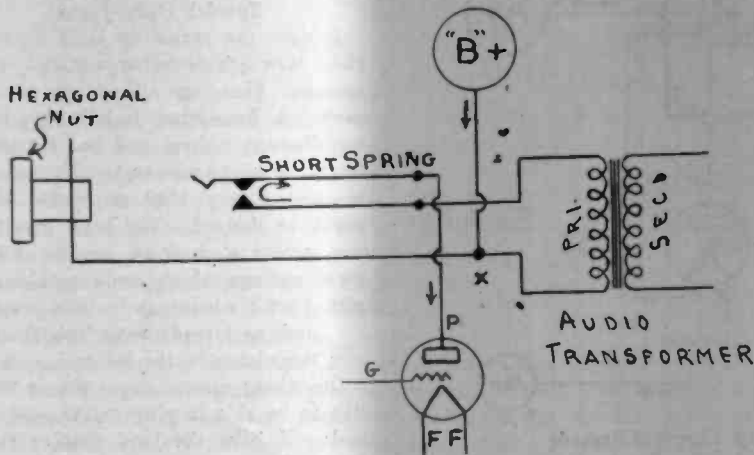

Fig. 4. A Two Spring Jack Does Work of Four Springs

of style as fast as radio fans realize that two-spring jacks are really a lot better. The connections for such a unit are shown in Fig. 4. This differs from the unit in Fig. 2 in that it omits the long contact spring, and the one that mates with it. The short spring is connected to the plate of the vacuum tube just as before. The frame or body of the jack runs to the "B" plus battery, and also to one of the primary terminals of the transformer. When the plug is withdrawn current runs from

half of what it was before, and also greatly reduces the chance of trouble at the jack. The other advantage is that when the jack plug is inserted, thus making use of the phones, only one spring contact is made. The shell does not have to depend on a spring for carrying the current. Instead, it uses the large brass hexagonal nut, which has a large area of contact.

Last Step Connections

It will be noticed that the hook-ups

spring and with it strip "S," which makes contact F2 touch F1.

Hook-up of Control

The hook-up of such a control jack is shown in Fig. 6. The frame of the jack runs to "B" plus, just as it did in Fig. 4, and the short spring is connected to the plate. Thus the action of the "B" battery is no different from what it had been before. F1 and F2 are inserted in the filament circuit. The current from the "A" battery runs to F1 through the contacts when closed to F2, then to the filament of the vacuum tube and through the rheostat to A minus. Thus when the plug is inserted the filament is lighted and when it is withdrawn the set is turned off. Only one tube is shown in this drawing, but the same jack can control any number of filaments in parallel. If the set is a mod-

ern one, which uses only one rheostat, as was described in the August 15 issue of RADIO PROGRESS, then the latter can be set to the proper point to give the right current to all the tubes, and when through using the radio the plug is pulled without touching the rheostat. When ready to listen again, inserting the phones turns on everything and the rheostat is not touched until the battery has dropped enough in voltage to require further adjustment.

Some sets are built so that by plugging into successive jacks the tubes are

lighted, but only up as far as will be needed for use. That is, when the detector only is connected, then the other tubes will be extinguished. Such operation can not be obtained with the kind of jack illustrated in Fig. 6. This latter uses only two springs for filament control, whereas three are needed. A unit to take care of these conditions looks like that of Fig. 6, except that a third filament control spring is added on top. When the plug is out the middle and lower springs touch, but when it is in, the middle and top springs contact. The diagram of connections for this scheme is not shown here, as it is always included with the particular style of jack which is purchased.

We Do Not Recommend It

Personally, we are not particularly inclined to its use. In the first place, it is somewhat more complicated and the

for any ordinary stations there is no need of using anything but the last step. If, however, a loud local station is wanted, then the final step may give too much volume. This is a good place to change to a lower amplification, but about the same results may be obtained by cutting down on the feedback or reducing the coupling of the set or making some other adjustment which will reduce the volume of the sound.

In case it is felt that it is necessary to use the next to the last step, a filament control like that of Fig. 6 can still be used, provided there is no objection to leaving the last tube burning when not in use. This is not a serious objection, as the current taken by the modern tubes is small. However, it is admittedly a waste of electricity to have it lighted when the earlier step is being listened to. To get around this difficulty and still use simple connections it is possible to put a separate rheostat in the filament circuit of the last tube and turn it out by the rheostat when not in use. Of course, when the plug is withdrawn the last tube is disconnected like any of the others.

Special Duty Jacks

Besides the styles of jacks described there are others using six and seven springs. These are all entirely unnecessary. A five-spring jack having three for filament control and two for transferring from phones to transformer will accomplish any kind of results which could be desired. We have never yet run across a hook-up needing six to eight springs which could not be simplified with advantage to take not over five, and, as already remarked, the simpler the wiring is, the better.

One thing more. Some people would like to be able to plug in the telephone and still have the loud speaker going. It will be a surprise to many that this can be done very simply. All that is required is to use a double spring jack (any number more than this will do) and insert it in series with the primary of the audio frequency. When the phones are out the current will run through the jack contacts direct to the transformer and so operate the loud speaker. When the plug is inserted it will cut the phones into series connection with the transformer, but the latter will still be operating and so both phones and speaker will be heard at the same time.

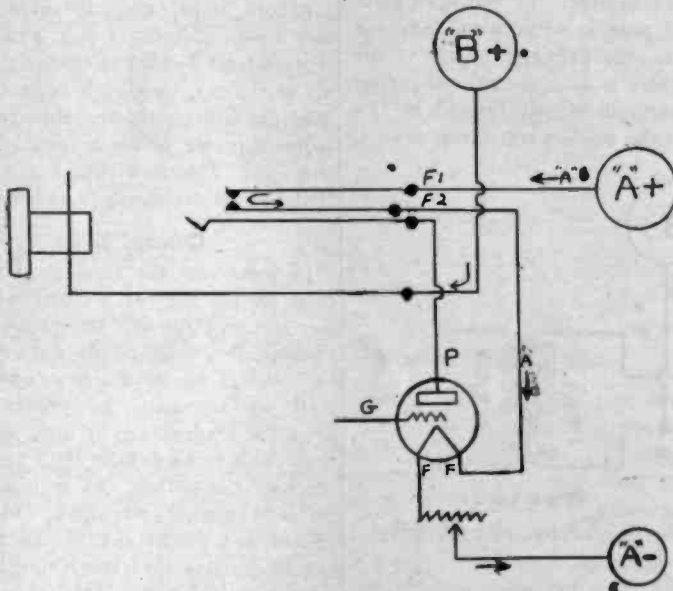

Fig. 6. Why Inserting Plug Lights Filament

general tendency is to simplify sets as much as possible. Furthermore, the majority of radios operate practically all the time on full strength. We have seen many a set with three or four jacks and only the last one shows any evidence of being used. It is rare that a receiver with a good loud speaker ever is used with phones except for getting the most distant stations which can not be heard well on the horn. In such a case, of course, the last step is always used, since the trouble is that the reception is not loud enough already, so

Static and Fading in Warm Weather

Why Distant Stations Fade Less Than Nearer Ones

By R. H. LANGLEY, Radio Engineer, General Electric Co.

PERHAPS among the relatives of the keenest radio enthusiasts there may be found some who will welcome the vacation trip as a chance to get away from radio. These people are, however, a very small minority and most of us will welcome the vacation trip as a new chance to see what radio can do.

Vacation time is, fortunately, very well supplied with broadcasting stations, at least, for those who live and take their holidays in the eastern section of the United States. There are several powerful stations so located as to give service almost continuously through the summer. These stations have sufficient power to overcome many of the difficulties previously encountered in the summer time.

Summer Time is Better

The vacation trip offers many advantages from the radio standpoint, whether we are interested in experimenting or merely in being entertained. The rural districts with their usual lack of steel buildings and intricate lighting networks are ordinarily far more favorable to radio reception than the crowded metropolitan districts. The signal strength from distant stations is often immeasurably greater in the open spaces of the country. This in itself offers an interesting possibility of comparison between the results obtained in the city and those obtained in the country.

Another advantage of vacation land is the fact that it is ordinarily so far from all the broadcasters that there is no severe local interference to overcome. Here we can choose any one of a fairly large number of stations with a freedom which is not possible in the immediate neighborhood of one of them.

Vacation land is the place where silence dwells. This gives us another advantage because in the cities there is an undercurrent of noise which, whether we realize it or not, is automatically subtracted from the radio signals we hear.

In the country there is no such noise and the radio signals which we receive are just so much louder and clearer, and better to listen to.

What Causes Static?

Of course there are certain enemies of radio reception, which will follow us to the mountains or the seashore, and which in the very nature of things are worse in the summer time. Static and fading, calling these by their popular names, are worse in the summer time largely because of the great number of hours of daylight, and the fact that the effect of this daylight lasts well into the night. The sun acts on the atmosphere

has been reflected back to the earth. The sun creates these reflecting surfaces, and they last long after darkness has fallen.

Like Soldiers Keeping Step

This action is shown better in Fig. 1. Suppose we have a line of soldiers marching single file, straight to the right along "line." Each man steps in the footprints of the man in front of him. The leader, whom we will call Soldier 1, continues straight on, left, right, left, right, and leaves the footprints in the snow, as numbered "1." Soldier 2, directly behind, of course leaves the same prints. But when he reaches point A he turns to the left until he strikes the reflecting surface, which in this case is a

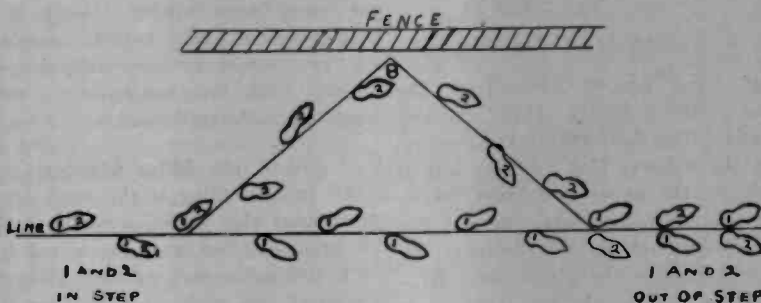

Fig. 1. Footsteps In and Out of Phase

for many hours and leaves it in a disturbed condition from which it does not recover during the few hours of darkness. Static is probably the result of this action over the large number of daylight hours in warming the earth's atmosphere and thus creating excessive electrical disturbances in it, which last through the night.

Recent investigations have indicated that fading is also due to the action of sunlight although probably because of an entirely different effect. Fading is the result of two waves arriving at the receiving station in such a relation as periodically to cancel each other. One of these waves has travelled over the ground, and the other one has gone into the upper layers of the atmosphere and

fence. This turns him back again at point B and he keeps on marching, left, right, until he strikes the main line again at point C. Here he falls in behind Soldier 1 again. But notice that in going this extra distance out to the left he has lost one step, so that he no longer treads in the footprints of the man ahead. Instead his tracks, Number 2, lie right out of step with Number 1.

The same thing holds true with the radio waves, but instead of reflecting to the left or right, some of them will be curved upwards into the air by the various hills which they meet. When they strike the reflecting layer several miles up in the clouds, these wandering waves are deflected down again. If the

distance between the cloud and the earth happens to be just right they will get exactly out of step with the main body of vibrations, which continued straight on like Soldier Number 1.

Power Increases Fading

Some of the broadcasting stations have, during the past winter, increased their power to such an extent as practically to overcome the static difficulties, at least in so far as reasonably short distances are concerned. This increase in power, however, is probably of no benefit in overcoming the fading. In some cases it may even make it more severe. This is because when the two waves cancel, the minimum signal will be just as low as ever, but the maximum signal when the two waves add will be very much greater when the power of the transmitter is increased, and so the ratio between the maximum and the minimum will, therefore, be worse. This is shown by Fig 2. The direct wave is represented by a light line and the re-

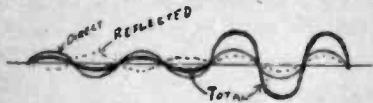

Fig. 2. Fading from Big Distance

flected wave, coming down from the clouds, is shown dotted. When the two are added together, the total is represented by a heavy line. At the left of the figure the upper and lower waves, which are only moderately strong, are out of phase, and so the reflected vibration almost kills the direct one. As a result, the sum of the two (heavy) is only a small oscillation, that is, it is not very loud. In the right hand half of the figure the reflecting cloud has shifted its position so that the two waves are now in phase. This is evident, since they are both above and both below the line together. The total is found by adding up the two and is fairly loud. Comparing the right and left hand curves will show that the variation in volume is about three to one.

More Power, More Fading

In Fig. 3 are shown similar conditions except that both direct and reflected waves are much more powerful than they were in Fig. 2. It will be seen that when they subtract one from the other, the total, or wave which affects the radio, is small, just the same as in Fig. 2. But

when they add in the right hand half, since they are now in phase, the resultant is very loud. Comparing the two halves as before, we find the ratio in loudness is about six or seven to one, instead of three to one as before. The latter ratio would be considered moderately bad fading, but when it gets as bad a proportion as five to one or more, then the fading would be considered very bad. This explains why the louder stations often fade more than softer ones.

If the distance between this layer and the earth happens to be just right then the upper wave No. 2 will be just out of step, or out of phase, as it is called, and in this way they will to a large extent cancel or neutralize each other. If the distance is still greater, the upper wave may fall back a couple of steps. This will bring it right into phase again, the same as our Soldier No. 2, would have been in step with Number 1's footprints if he had dropped back two steps instead of one. In such a case the two radio waves would add together and be quite powerful. For an intermediate spacing, such that the upper waves were neither exactly in or exactly out of phase, then the result of the two would be something between adding and subtracting—the music would be moderately loud.

First 100 Miles Hardest

All in all, fading is the worst enemy of summer time vacation radio. It has its greatest effect at distances of from 80 to 100 miles, and we shall often find ourselves just about this distance from a station which we would like to receive. Fortunately, however, there are always other stations nearer or further away on which the fading will probably be negligible.

We shall find the countryside pretty well supplied with radio sets to-day. Hardly any village or hamlet is so small but what it will have two or three radio enthusiasts and these people who live away from the big centers of entertainment appreciate the advantages which radio offers them to a very thorough extent. In the larger resorts we shall very frequently find radio sets installed for the entertainment of summer guests. These sets, however, will not take the place of a radio receiver of our own which we are free to use as we please.

Radio Sets on Automobiles

Because so many of us make our vacation trips by automobile, I am going to give just a few brief suggestions for using a radio on a car.

Almost any set will do very nicely for this purpose. It must, of course, be built with sufficient strength to withstand the trip. It need not have any great degree of selectivity unless we are going to be near a powerful station. The ordinary single circuit regenerative receiver is plenty selective enough for us out in the country. The hook-up of such a set and the description of the way it works, was given on Page 16 of RADIO PROGRESS July 1, 1924. The radio may be installed permanently in the car and the vacuum tubes lighted from the storage battery.

The set can be wired directly to this battery as the switch or the rheostats on the set are used to disconnect the receiver from the battery. Almost any car will have some pocket or space under the seats where the "B" batteries can be installed. If the vacuum tube filaments are lighted from the starting battery, it will probably not be possible to use the radio set while the engine is going, due to the noise which will come back through the battery. It is usually undesirable to use the set while on the road, however, because there is enough noise in the car to make it difficult to get good reception; also there are very few radio sets, except the superheterodyne receivers which are sufficiently sensitive to work without an antenna.

If you *must* receive while on the road, use a superheterodyne receiver with a small loop, be sure that the tubes are mounted on springs or cushions to avoid noise caused by the vibration of the car, let the set have its own independent filament batteries, and use head phones to shut out the noise of the car.

A Portable Aerial

For the sets that must have an antenna, a very nice method is as follows: Use a single strand of ordinary lamp cord. This wire is selected because it is easy to get, it will stand considerable abuse without seriously kinking and breaking, and because it has insulation which will protect it if it touches parts of the automobile or other conductors. Let this piece of wire be, say, 60 feet long. Get 75 feet of good stout braided

Continued on Page 16

When Radio Controls Itself

Showing How Georgetown Observatory Speaks to the Whole Nation

By ALFRED N. GOLDSMITH, B. S., Ph. D., Fellow, I. R. E.,
 Director of Research, Radio Corporation of America

IN a busy age like the present, everyone appreciates the value of time. The rough idea of the time of day given by ancient and picturesque devices like the sundial will not meet the requirements of a hurried civilization. Modern watches and clocks must be accurate to within a few seconds a day, and chronometers and standard clocks must be still more precise in their reading. The furnishing of correct time to the people of a great country like the United States calls for considerable planning and organization, and the use of the most recent scientific methods. Radio has stepped into the breach, and is meeting the demands for standard time signals in a thoroughly satisfactory way. The manner in which radio broadcasting is used to give time signals is of general interest, and is in addition so peculiar a use of broadcasting in several ways that it is worth considering in detail.

U. S. Depends on Georgetown

The official time for the United States is obtained primarily from the Naval Observatory at Georgetown. Here an extremely accurate astronomical clock is used as the standard, and is properly regulated and controlled by observations on the stars. So far as man can now calculate, the time given by such clock is accurate to within a very small and known error. Indirectly this clock is used to control an electrically operated switch or relay which is capable of closing a circuit once every second. From Georgetown, a wire line runs to the great Naval radio station at Arlington, Virginia. The electric currents passing over this wire line from the master clock at Georgetown control the sending key of a high power radio telegraph transmitter at Arlington. This sending apparatus is a so-called continuous wave transmitter operating at a frequency of 113 kilocycles (for a wave length of

2,650 meters). The accompanying drawing shows the general arrangement schematically.

It would, of course, be possible for a suitable radio receiver to pick up the Arlington time signals directly, but there are several objections to such direct reception. In the first place, the wave length of the Arlington time signals is far above the tuning range of the vast majority of radio broadcast receivers, so that it would be necessary for most listeners to purchase a new radio in order to hear the time signals direct from Arlington. In the second place, these signals, being continuous in modulated waves, can be heard only on a regenerative receiver which is in the oscillating condition—through bringing the tickler or intensity control up to the point where the set would produce musical notes ("birdies") on ordinary broadcasting stations. This is, however, an undesirable condition for existing receivers because it also converts them into small, very low power transmitters and may cause local interference with reception by other listeners. And, in the third place, the weather reports and other interesting information at the end of the time signal transmission from Arlington are appropriately in Continental telegraph code, and therefore would not be directly understood by the great majority of broadcast listeners, who cannot read such telegraphic code.

Your Radio Must Hear It

It is therefore desirable that the Arlington time signals should be sent out on a frequency or wave length which the average broadcast receiver is capable of picking up, that the signals should be so sent out that they can be heard by the ordinary regenerative receiver in the same unobjectionable and non-oscillating condition as is used for normal radio telephone reception, and that the addi-

tional information, such as weather forecasts, should be in the form of spoken words which will be universally understood.

All of this can be done by using the local broadcast transmitting station as shown in the accompanying drawing, Fig 1. A high-grade receiving set which is capable of reliably picking up the Arlington time signals is installed, for example at station WJZ of the Radio Corporation of America at Aeolian Hall, New York. The loud time signals coming from this receiving set are then sent directly into the power amplifier of the broadcast transmitter at WJZ and thus

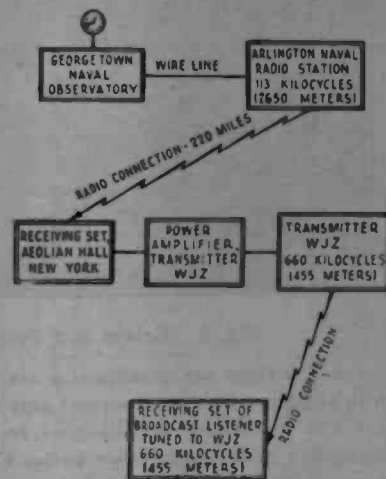

Fig. 1. Road Map of Time Signals

control the transmitter itself, being relayed at the frequency of 660 kilocycles (wave length of 445 meters), which can be readily received by the usual radio. Considerable care has to be taken to prevent the powerful signals which are being sent out from the station WJZ from affecting the local receiver of the Arlington signals, which is picking up the incomparably feebler oscillations coming hundreds of miles from Arlington. A

highly selective receiver, carefully installed and shielded, is necessary for the purpose.

One Signal Starts Another

Examination of the drawing will show clearly that the master clock at Georgetown is controlling the radio transmitter at WJZ by means of a radio connection between Arlington and New York. In other words, we have the interesting situation of a radio signal in turn controlling another radio signal on a different frequency or wave length. The method is known as radio relaying of signals, and has been successfully used as well for the transmission of broad-

or alternatively to permit speech to be sent out directly, is shown in the accompanying photograph, Fig. 2. The switching arrangements provided have proven very satisfactory in practice.

How the Dots Are Arranged

Arlington time signals are sent out at noon and ten in the evening (eastern standard time). They consist of the following:

Announcement that the time signals are about to be transmitted.

Twenty-nine dots from 11 hours, 56 minutes, 00 seconds to 11 hours, 55 minutes, 28 seconds.

After a pause, the spoken announcement of the weather forecast for the next day.

It will be noted that the first four minutes of the time signals are alike, and that the fifth minute differs only in the length of the pause immediately preceding the long dash which gives the exact noon signal. The government rightly requires that any broadcast station which sends out time signals shall do so by some process which will be free from any possibility of human weakness or personal error. That is, the radio relaying process for the time signals must be entirely automatic, and the process used at WJZ, as may be gathered from the description, fully meets this requirement. We have therefore in this method a means for bringing to the great group of broadcast listeners astronomically accurate time through the use of their regular receiving set, and thus adding one more benefit to the many which radio broadcasting has conferred on the community.



Fig. 2. Relays and Switches for Re-Broadcasting

cast concerts from one broadcasting station to another, and the subsequent automatic and practically simultaneous re-transmission of the same concert from a second station on a new frequency or wave length. This method promises to have some useful applications in the future.

The requirement that the weather forecasts and the like shall be comprehensible by every listener is readily met by having these first copied by a skilled receiving operative at WJZ and then read to the radio audience by one of the announcers. The equipment for receiving the time signals from Arlington and for sending them into the broadcast transmitter at WJZ for re-transmission,

A pause of two seconds (one dot omitted).

Twenty-five dots from 11:55:30 to 11:55:54.

A pause of six seconds (five dots omitted).

Twenty-nine dots from 11:56:00 to 11:56:28.

This is repeated every minute until 11:59:30.

Twenty dots from 11:59:30 to 11:59:40.

A pause of eleven seconds during which it is announced that

"The next long dash will be twelve o'clock eastern standard time."

A long dash beginning accurately at 12:00:00 noon.

POWERFUL FRENCH STATION

France has just built a new broadcasting station, which is the most powerful in the country. It is located in the suburbs of Paris. Power is brought into the station at 25 cycles, 5500 volts, and this drives three big motor generator sets, which convert the alternating to direct current. Each of these three machines feeds six vacuum tubes at 15,000 volts on the plate. To light the filaments current is taken from a twenty volt storage battery. The magnetic modulator, which is the instrument connecting the voice current and the antenna current, is able to pass from 2 up to 32 amperes into the aerial.

The latter is supported by two steel towers, 330 feet high, which is about one-third the height of the Eiffel Tower, in Paris. The insulators on this line are very large, and will withstand an operating pressure of 60,000 volts. Two different wave lengths are used by this station; 6,000 meters carries the program to New York and 8,000 to South America.

More About the Transmitter Amplifier

Enclosing the Unit in Sound-Proof Box is an Improvement

By C. H. WEST

THERE was recently published in **RADIO PROGRESS** (Issue of July 15, 1924) an article on "Transmitter Amplification," and probably many radio experimenters have built this piece of apparatus, some meeting with success and others "up a tree" on some point or other. There are also a multitude of others who are waiting for this circuit or another one to become an accepted fact before digging down into their pockets, and breaking Dime Savings Banks on any sort of would-be junk leading to a "wild goose chase."

The writer has continued his experiments on this "freak" circuit, and does not propose to give it up until he has attained a system of amplification which will reproduce the artist's efforts in exact and undistorted tones, be it a lecture or some country "rube" with a violin playing "Fisher's Hornpipe" with variations. This circuit does about all that could be asked, yet it cannot be truthfully stated under the cherry tree that it is the Acme of Perfection. However, distortion, even though it be a minimum has subsequently been reduced still further towards the zero point.

Distortion and the Mike

A microphone is classed as a sensitive piece of apparatus. It reproduces everything one cares to hear and in some cases a good deal more than is wished for. A "mike" picks up foreign and exterior noises, which are transmitted and become part of that effect called "distortion."

If a broadcasting microphone were enclosed in a sound proof chamber, it would naturally be useless as far as becoming a reproducer of music, etc. For that reason it is placed in the air suspended on springs or resting on a rubber cushion to prevent metallic jars and shocks from becoming part of the transmission. On the other hand, trans-

mitter amplification can be helped to a wonderful degree by enclosing the "mike" and telephone receiver in a sound proof box or chamber. This is what the writer did, and with a few other modifications, not only greatly improved this type of amplification, but also reduced distortion to that point where it need hardly be mentioned. Likewise, the strength of signals were increased to a much greater intensity and penetrative power.

In Sound Proof Box

As will be noticed in Fig. 1, the microphone and telephone receiver are enclosed in a sound-proof box constructed of wood 1 inch thick. The box should be 6 or 8 inches long and about 5 inches high. The "mike" is fastened to one end of the box while the receiver is at the opposite side and in line.

A silvered violin string is soldered to the exact center of the receiver diaphragm, the opposite end of wire being soldered to the diaphragm of the microphone or telephone transmitter. The wire is stretched firmly, but not tight, as this would cause the receiver diaphragm to be pulled too far away from the pole pieces, and thus decrease signals. An adjustment will be found by experiment where signals are received in a truly marvelous and natural tone.

Uses One Tube Receiver

It will be remembered from a previous article published, that this system consisted of picking up the station on your present one bulb receiver, retransmitting it on a low wave without interference to others, again detecting the signal thus transmitted, and amplifying it by the usual method of two stages of audio frequency.

The addition of a radio frequency unit has no distinct advantage, owing to the short distance between the transmitter

and two stage amplifier. However, the addition of a third step audio frequency amplification, either the straight or "push-pull" method will bring in stations to terrific strength; likewise our old friend "Distortion" might be present.

Reflex Would Be O K

The main point of further experiments are along the development of a one bulb receiver that is a distance getter, sensitive and selective. It can be of the Reflex type employing a crystal detector as a rectifier, or might be one of radio frequency employing one or more tubes. This would greatly increase the cost of maintenance and operation, but nevertheless, would make a wonderful piece

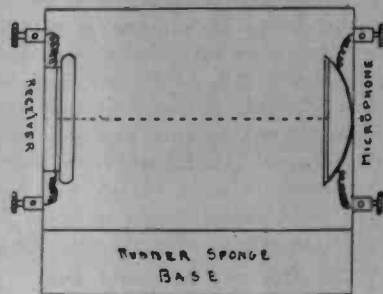

Fig. 1. Arrangement of Parts

of apparatus. We leave that part to the "boys" with the pocketbooks.

The trend towards better radio reception seems to be in reducing expense of construction and operation, and simplicity with a minimum number of controls. The writer has experimented along these lines for a number of years on various types of one bulb receivers, and has fallen back on the old reliable "Ultra Audion Circuit," that in his estimation, is the best if properly constructed.

Talking to the Mike

Do You Know What Makes a Good Radio Speaker?

By RICHARD K. MORTON

IN these days all radio station directors are looking for new material to present to their large audiences. For this reason every good singer or musician is pressed into the service and gets a chance sooner or later to show his friends what he can do. But besides this, there is an insistent demand for speakers to lecture on various interesting topics. Some have to do with the news of the day and others with the fundamentals of science, music, or art, which remain unchanged with the centuries.

In view of the large number of requests for information on so many different topics it is not strange that a good many people who have not thought about it seriously before, are being asked to express their views before the microphone. Judging from the character of speeches which one often hears, it is safe to say that many of the speakers are new to radio broadcasting, if not to speaking before an audience in person. There are so many who stutter and stammer and talk as if they had in-growing tongues. It may be that you will be the next person who will send your voice out into the air to be heard by countless listeners. If so, here are a few points which should be borne in mind when talking over the air.

Cut Out the Ahs and Ums

Radio phonetics (the science of sounds) cannot now be disregarded by a good radio station. It is the basis for all interest in transmission of the voice. A good radio speaker knows exactly what he is going to say—with no "ahs" and "ums." He does not continually joke; his word is clear, business-like, and comprehensive. His voice is carefully modulated, and his words precisely enunciated.

What can a station do in this matter? Station WGI, Medford Hillside, Mass., with 100 watts power, permits the speaker to be seated while talking, and the announcer places a large microphone

about two feet in front of him. Before he begins, he is cautioned to speak naturally and with good enunciation. WGI broadcasts many talks, and takes pride in their quality. Station WBZ, Springfield, Mass., with 1,000 watts, has a beautiful and sensitive microphone specially used for speeches. Station WTAB, Fall River, Mass., with 100 watts, is a stickler for good enunciation. It permits only a few to be in the inner studio during a talk. It prevents its well-appointed studio from becoming stuffy. The operator, situated on the roof of Hotel Mohican, signals instantly if the voice is not going out clearly. WTAB's announcer keeps his announcements business-like and correct.

Don't Shock the Mike

A radio station may further help the radio speaker by testing his voice first, by pointing out to him ambiguous and difficult combinations of words, which he proposes to use. It may caution him against alliteration (words beginning with the same letter), poor emphasis, poor breathing, shocking the microphone by sudden outbursts, or letting his voice trail into a mumble. It should frown against memory work.

What can the speaker himself do to improve radio phonetics? I have found, after giving many radio speeches, that any word of more than three syllables must be articulated with special care. Awkward phrases and indefinite allusions must be sacrificed. One's talk should be written (or typed) on unfolded paper (to eliminate crackling), preferably about 9 by 6 in. If any errors occur in the final copy, they are sure to disconcert the speaker when he gets before the microphone. The final "g," indefinite pronouns, banalities such as "perfectly," "fine," "thing," and the like, must receive special attention. The short, well-turned compound sentence, employing a striking contrast of ideas, is an especially effective medium for radio composition.

Mind Your P's and Q's

Labial sounds, such as v, b, z, and p, should be carefully articulated. Neither sickly thin voices, nor stentorian monotones, go well over the radio.

Remember during the convention how many of the speakers had voices so hard to understand. They spoke almost without inflection, and many seemed to think they must yell as loud as possible in order to be heard. As a matter of fact, the loudness of the waves going to the aerial depends on the volume control of the sending station. There is an adjustment which is being made continuously by one of the sending operators which keeps the loudness correct. If a speaker shrieks at the top of his voice it only means that the control operator reduces the amplification proportionately and the same volume reaches the air. But there is this difference between the shout and the ordinary voice—in the latter all the natural tones are heard easily and clearly. But in a shout the character of the voice changes and a strained sound is substituted for the smoothness ordinarily heard. That is why some of the inexperienced speakers at the Conventions were so hard to understand.

Puns are Taboo

Excited, rapid, or slovenly enunciating voices are unfortunate over the radio. A great many puns and expressions can be easily understood in print, but are absolutely flat on the air. Series of big words, split infinitives, like "to almost fall," misplaced modifiers, and repetition are not advisable. While careful enunciation may sound affected to the radio speaker himself, it is a relief to the listener-in wearing uncomfortable ear-phones.

After interviewing announcers of several stations, I am convinced that the radio directors will soon take steps to safeguard the quality of delivery illustrated by the speeches they broadcast.

Touring With Our Ears Alone

We Send Them Away But Leave Our Bodies Behind

THE ordinary house fly, as we all know, has thousands of eyes. Each of them probably gives him a different picture of his surroundings. All his eyes, however, are bunched together, and every eye sees almost the same scene. The only way Mr. Fly can see something new is to go to a new place, and take his generous supply of vision along with him.

Man is pretty much in the same fix. His two eyes see just about as much as the fly's many eyes, and he has to move his whole body around the world, if he wants to feast his eyes on some new picture. Of course, photography and the printing press have done a lot for man. They bring him more or less faithful reproductions of distant scenes and things, and the motion picture puts a measure of animation into these images.

How is a Man Like a Fly?

But the fly can see the pictures too, so man is not much better off, so far as seeing is concerned. The pictures may not mean much to the fly; he may misinterpret them; but man frequently makes the same mistake, and no one would choose to look at even a motion picture, rather than see the scene itself.

Man's ears were even more limited than his eyes. He could see great distances,—he could look into the very depths of space, and with the telescope and the microscope, see the greatest and the smallest (or almost the smallest) things in the universe. But he could only hear over very limited distances, a few thousand feet, and there were no instruments to increase this power of hearing.

Then came the telephone and later radio broadcasting. The telephone, in its present state of development, makes it possible for anyone to talk to anybody almost anywhere. It extends our ears and our voices, and annihilates the miles that may be between two people

who must talk to each other. It is a tremendous help to us.

Makes the Many Like the Few

But just as the world provides many wonderful things for us to see, so it also provides many fine things for us to hear. Some of us, a very limited few, can find the time and the means to travel and see some small part of a beautiful world. The rest must stay at home and be content with what we can

amusement, almost any time we wish to. We can send them to great cities to hear the symphony orchestras; we can take them into the churches to hear the famous preachers; we move them into the studios where carefully chosen artists have come to sing or play for us. We transport them into the hotel dining rooms where dance orchestras are playing, and we can send them to banquets and conventions.

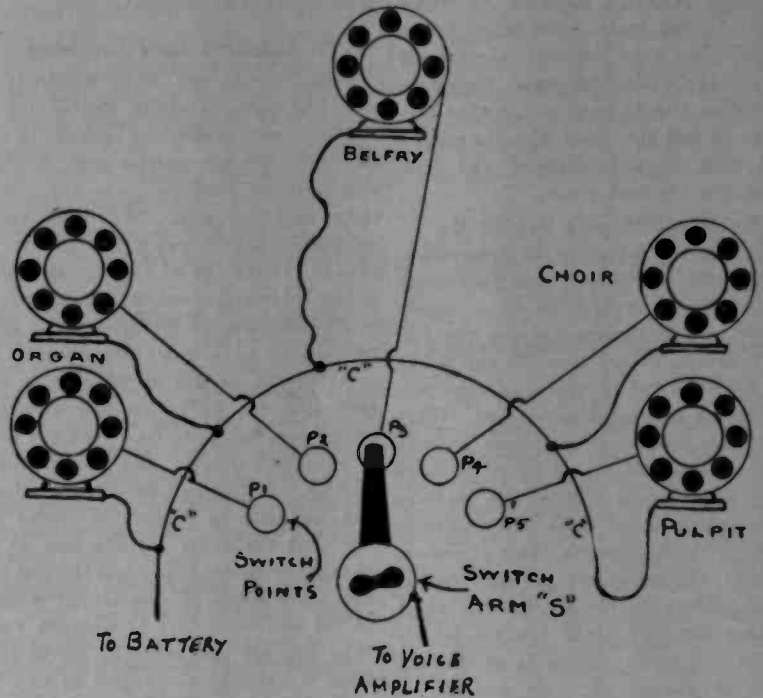

Fig. 1. How to Switch from One Mike to Another

learn from pictures and books. Also, some few of us live in the great centers where the feasts for the ear are to be found, and some can go and hear them. But here again, most of us cannot hear such things, or could not until radio came.

Radio broadcasting extends our ears. Even today, with this new art starting only its fourth year, we can send our ears into a dozen different places of

Beating the Ticket Taker

Today our ears can go to many places where we cannot go. They can go out across the miles and listen in places where, even if we had the time and the means we could not gain admission. They can enter the great national conventions, for example, and without inflicting any discomfort on the rest of our body that stays at home, they can hear the deliberations of the political

parties, and the speeches of the national leaders. They can even go into the White House, and sit beside our President when he reads his message.

The great convention halls that have recently attracted our attention are very large, as such places go, but it would have been quite impossible for even a thousandth part of those who sent their ears to these places by radio, to have been there themselves. Radio not only takes your ears and mine to these places, but everybody's, and there is no crowding.

When we send our ears away by radio (let us say to hear a famous orchestra), it is not at all like going ourselves. If we should go personally, we must be content with the best seat we could obtain, and should not know, until the performance started whether it was a good seat or not. Many of us would not have good seats. But when we go by radio, we have the best location for hearing the entire program, regardless of whether this is in a seat, on the ceiling, or in mid air. Men who are experts have been there beforehand and have found this the best place.

Fooling Whispers Behind Us

When we go in person to hear an entertainment, we take our two ears along, and use them as best we can. Unless we are very fortunate, we miss parts of the program, do not hear all the words, and are disturbed by others near us, who are not as interested as we are. When we go by radio, we may have a dozen ears, all carefully placed for us to catch every syllable and note of the performance, and protected from any disturbing noise. If it is a church, there is one ear to hear the organ, or perhaps two or three. There is another for the choir, another for the pulpit, another for the belfry, and so on. There is an operator there to change us from one ear to another as the service proceeds.

Figure 1 shows how this switching is done. Say five microphones are to be used. They are all connected together by wire "C" and to the storage battery to furnish current. The other terminal from each "mike" runs to an individual switch point, P1, P2, etc. Switch arm "S" makes contact with these points in turn, like those you see on receiving sets.

When the Preacher Starts

The sending operator, who must be on the job during the entire broadcasting,

adjusts this switch to pick out the particular mike he wants to use. If you will listen carefully next Sunday, you will notice this. When the choir stops singing and the minister starts to preach, for an instant his voice will sound very faint and far off. Then there is a click, and immediately his tones are loud and natural. This is caused by the mike in the choir stall picking up his voice faintly from a distance; then the switch is turned, and the mike in front of him gets his full utterance.

Of course the actual switch used as just described is somewhat more elaborate than the sketch shows, but the principal is the same. As a matter of fact, each mike has three terminals instead of two, as it is double; for that reason, the switch is also made double. The operator does not have to bother with this, however, as it is automatic.

A Hundred Ears Listening

Each evening we have hundreds of electrical ears, carefully located for us in the most interesting places in the country. We sit quietly and comfortably at home, and we make any one of those ears our own. We listen where we please, and if we do not like it, we change. If the car at the Chicago Hotel is not entertaining us, we change to one in Philadelphia, or Montreal. The miles between us have lost their meaning.

Naturally, we are learning to be very critical about what this new extension of our ears brings to us. We have much to say about quality, and faithful reproduction, but we shall have to be patient, and we must be reasonable. Who will say that the radio reproduction of the distant orchestra is any less faithful than the photograph of the Grand Canyon or the motion picture of Niagara Falls? Who will say that what we get by radio from a national convention is any less accurate or informing than what we can learn about it from newspapers? Who will say that radio, with its few brief years of development, has made less progress than any other art, in extending our senses to a distance?

STATIC AND FADING

Continued from Page 10

cotton fish line. This should be of the variety used for salt water fishing. Tie the line to the end of the wire, and at the other end of the line fasten a stone a little smaller than your fist. Have

this ready in the car carefully coiled so that it can easily be unwound.

When you are ready to put up the antenna select the best tree that is available. Lay the coiled aerial carefully on the ground so that it will unwind freely and throw the stone over a branch of the tree. The cord will carry the wire up into the tree. Now pull the wire back so that the joint between the cord and wire is just clear of the branch of the tree. The cord will act as an insulator and will be all that is necessary except in very rainy weather. Now coil up what is left of the wire, tie it to the top of the car and connect the other end to the radio set. It will be found that an antenna of this kind is very satisfactory for short periods, and it is inexpensive and easy to put up and take down.

Connecting the Ground

For a ground connection use the body of the car. Connect the ground terminal to some point on the car which you are quite sure connects to the body, the

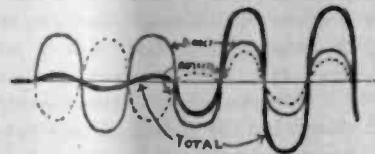

Fig. 3. Fading from About 80 Miles

frame and the engine. Ordinarily this will be an ample ground due to the capacity between the car and the earth, the car being insulated from the earth by the rubber tires. If you are anxious to secure a better ground, throw a coil of bare wire into a neighboring well, brook, or lake, allowing it to unwind as much as possible; connect the end of this wire to the ground terminal. If there is no water near, lay an insulated wire along the ground, directly under the antenna.

The hills and the forests have their effects on radio reception. They tend to absorb the signal. If you can choose, therefore, pick out a point on open level ground as far away from hills and thickly wooded patches as possible. This does not mean that no signals can be received in the forest or in the deep valleys, but that they will be better in the open level stretches.

If this is the first summer you have had the opportunity to take the radio set along, I strongly urge you to try it. It will be the source of considerable pleasure and a much better knowledge of the possibilities of radio broadcasting.

American Radio Relay League

15 MONTHS TO BUILD AERIAL

The building of an amateur radio telegraph station in the little mountain town of Troy, Montana, is no easy task, as Frank W. Prince, a youthful radio experimenter, discovered when he cut two fifty foot poles for an antenna mast and brought them five miles by river, part of which is a roaring rapids. The normal speed of the river is about twelve miles per hour, four times as fast as a man walks, so he had to run his motor boat at a rapid rate to keep the heavy poles from ramming him.

More than fifteen months elapsed from the time that he cut the poles until he could hoist the aerial. The roads in this part of the country are so full of turns that it was impossible to haul the poles and there was nothing left to do but take the more dangerous course and transport them all the way by water. The huge antenna mast now stands about 90 feet above the ground.

His Own Ideas Mostly

The complete station required many months of work and is regarded as one of the best in the northwest, despite the fact that Prince has had practically no opportunity to associate with other radio men, and has never seen another continuous wave amateur transmitter. He acquired all of his knowledge of radio from books and current radio magazines.

Now he can converse in code with scores of amateurs some of whom are as far away as 800 miles. "Many freak conditions are encountered here," he says "all stations within 200 miles are very inconsistent, while it is comparatively easy to raise Pacific coast stations or those in Idaho and Washington." He is a member of the American Radio Relay League and handles a great deal of the A. R. R. L. amateur message traffic in this section. His station call is 7AGF.

POLISH AERIAL FOR SHORT WAVES

Do you remember the old "sea-going" joke about the green radio operator who

was ordered aloft to grease the antenna and mast so that the signals would slide off the easier? This is proving no idle jest to many transmitting amateurs who want to reduce their wavelength in order to take advantage of the new short waves allowed by the government.

This comes about following the interesting discovery that the black oxide coating which appears on copper wire soon after an antenna has been erected has an alarmingly bad effect on short waves and reduces the antenna power to a great extent. This is due to the pronounced skin effect. Howard F. Mason, department editor of "QST," points out very frankly that there are only two solutions to the problem; either the amateur must use enameled wire or build his antenna and mast so that the former can be taken down frequently and the wires polished.

All that remains now is, for someone to discover a practical use for a left-handed monkey wrench and the jokers of both sea and land will be put to shame for all time.

Among other features of the antenna installation that have turned up in connection with short wave work is the bad effect of imperfect dielectrics in the field of the antenna and also poor insulators. Mr. Mason declares that all ground leads, counterpoise leads and antenna leads should be "rigidly supported at least one or two feet from all solid materials."

The majority of amateurs are much pleased with the new assignment of wavelengths and literally thousands are engaged in adjusting their sets in order to "get down" on these bands.

SECOND TRAFFIC MEETING

A second traffic meeting of radio amateurs from all over the state is scheduled to be held at Madison, Wis., Labor Day, September 1, according to announcement made here by Clarence N. Crapo, assistant division manager in charge of the state for the American Radio Relay League. The Madison Amateur Radio Club, responsible for a similar gathering last July, are sponsoring this state meeting.

Mr. Crapo said that a special effort is being made to have present at this meeting the five district superintendents who supervise the traffic affairs of the League in the state as well as other traffic department personnel. In addition to considering plans for perfecting the amateurs traffic organization, the Madison Club through its secretary, Otto C. Austin, will bring to the attention of state members the question of organizing a state association of radio operators.

Milwaukee delegate proposes to suggest that the Wisconsin Amateur Radio Association, partly organized in 1921 by the Milwaukee Radio Amateurs' Club, Inc., be revived. The purpose of this new association would be to foster city radio clubs and to serve as a headquarters for amateurs who live in communities too small to support adequately a radio organization of any kind.

PRIZE FOR TALKING WITH BOWDOIN

Percy C. Noble, operator of the amateur radio transmitting station 1BVR in Westville, Mass., has just been awarded the prize of one hundred dollars in gold offered by U. J. Herrman, managing director of the Radio Manufacturers' Show Association, to the first amateur to re-establish radio communication with the Arctic ship, "Bowdoin," in charge of Captain Donald B. MacMillan, the polar explorer.

In his report to the American Radio Relay League, Mr. Noble stated that MacMillan was preparing to leave for home as soon as the ice cleared from Refuge Harbor.

LABRADOR LONGS TO LISTEN

After depending for many months on dog sleds and small vessels to keep him in touch with the outside world, Wilfred T. Grenfell, the "Labrador doctor," whose work helping natives and fishermen has received world-wide recognition, can now try out the value of radio in the many hospitals scattered through Labrador and Newfoundland.

Dr. Grenfell always thinks first of the patients and volunteer workers among whom he has been spending a life of sacrifice. He is hopeful that all of the missions under the International Grenfell Association will be equipped with radio sets, that will bring to these dreary outposts of civilization, the finest music and educational programs.

All Made in America

Seven complete receiving sets of the finest grade, built in U. S. A., are to be installed in the Grenfell missions this fall by C. A. Service, assistant secretary of the American Radio Relay League, who was assigned the work by the Grenfell Association. He expects to set out soon from Boston after having shipped all of the radio equipment.

Much of the inspiration in the project has been furnished by Eldon Macleod, of Dorchester Center, and associated for some time in the work of the New England Grenfell Association. Mr. Macleod has taken a great interest in the matter and it is through his financial help and the co-operation of manufacturers that the expense was met.

The assistance of the American Radio Relay League was asked for the purpose of selecting the equipment and allowing its assistant secretary the necessary leave of absence in which to undertake the installing of the sets. He will also investigate the power facilities of the missions in order to determine whether it will be possible to install amateur telegraph transmitters for inter-communication.

Cut Off From the World

The need for a special radio service of this kind was made evident when, in the middle of winter, fire destroyed one of the hospitals and the facilities were such that it was found impossible to get any word to the outside world for two months. The survivors were compelled to depend on dog teams to reach their ultimate destination and the task forms one of the interesting annals of the Grenfell association.

In winter all but the largest of the hospitals are closed and the personnel remaining are faced with eight months of extreme cold during which communication with other missions, or base of supply, is practically impossible by the primitive means to which the doctors and the other workers in the field are

forced to resort. Only radio can bring to these people the vital contact with civilization.

What the marvels of broadcast reception will mean to the natives who have never been outside of Labrador, it is difficult for any one to conjecture, but Dr. Grenfell was quick to see the educational possibilities for them and a means of relieving the monotony of the winter months for those unaccustomed to the life and environment.

THEY PLAYED LIKE THUNDER

WGY, the Schenectady broadcasting station of the General Electric Company recently broadcast the music of a thunderstorm and it probably had a pleasing sound to those living on sun-

More," it was a real storm with as a accompaniment of hail. To the listener it might have appeared that the orchestra was taking liberties with the music but the apparent improvisations were introduced by the elements. The sound of thunder, wind and rain was picked up by the microphone and broadcast with the tranquil music of the overture. What is more, the thunder didn't quit when the conductor, Leo Kliven, lowered his baton at the end of the number.

"DIANA" MAY BE AERIAL

New York.—At last the famed "Diana" atop the Madison Square Garden tower may become modernized. There's talk of converting her into the "world's most exquisite antenna."

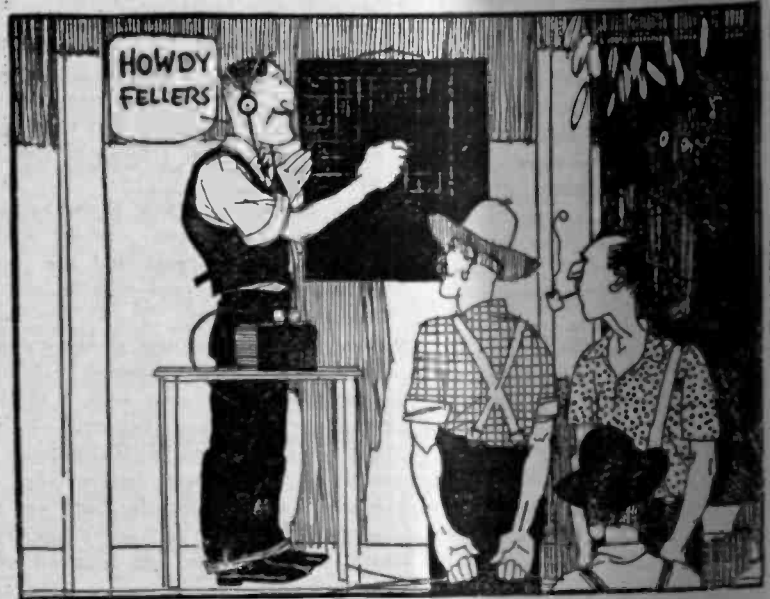

BROADCAST BILL "SCORES" FOR RADIO

Broadcast Billy a baseball fan—
He hates to miss a game;
But when he has to stay at home
He gets there just the same.

His radio reports the game
And follows every play,
His neighbors also get the scores
For that's the modern way:

By Del.

parched farms. The storm occurred during the broadcasting of a concert by the Schenectady Little Symphony orchestra from Central Park, Schenectady. The musicians had just started "The Calm," a section of Rossini's overture from William Tell, when unexpected and unwelcome reinforcements joined the orchestra. Contrary to the prediction offered by "It Aint Goin' to Rain no

James F. Kerr, manager of the first radio world's fair to be shown next autumn, is originator of the idea. He believes Diana can make herself useful in broadcasting and receiving.

Now three wireless engineers are conducting experiments with the view of converting the Saint-Gaudens masterpiece into a radio aerial.—Crosley Radio Weekly

How to Reflex the Neutrodyne

A Five Tube Hook-Up with Only Three Tubes

By CHARLES R. WEXLER and ARTHUR SLEPIAN

(EDITOR'S NOTE—This is the third and concluding article of a series on the construction and operation of the Rice Neutrodyne. The first and second parts, which have already appeared in previous issues of RADIO PROGRESS, took up in detail the construction and method of neutralization of the circuit by the Rice Method. This final article will discuss among other things various modifications such as reflexing, loop reception, regeneration, the use of dry-cell tubes, and trouble shooting.)

Antenna and Ground

The most suitable antenna for use with the neutrodyne is a comparatively short span, say 75 feet long, and 40 feet high, if possible, keeping in mind that reception improves greatly with height. Preferably, the antenna should be located away from all projections such as buildings, trees, etc., and as far from all electric wires as may be. The aerial should be erected at right angles to nearby telephone, power, and lighting circuits. The antenna should not touch or even come close to metallic bodies of any kind, and rope may be used instead of wire for "tie" and "guy" wires. The same precautions apply to the antenna lead-in wire which should be short and may well be a continuation of the antenna, to eliminate losses due to a poor connection or contact. The lead-in should run as directly as possible to the set, and always run directly away from the set rather than crossing it, otherwise stray electro-static coupling may result.

An indoor aerial may be used and will usually give very satisfactory results, having considerably more selectivity, altho the range may be decreased slightly. It is surprising what a difference in reception results from using an ordinary ground and a good ground. Very often, great care is exercised in the construction of an antenna only to offset

this by the use of a poor ground since such a connection is necessarily a part of the antenna circuit. The ground wire should consist of a rather heavy copper wire (No. 14 is about right) connected as directly and as short as possible by means of a good ground clamp to a cold water pipe. This being at ground potential, no precaution need be taken to insulate it. Remember,—make the ground short, keep it away from the lead-in, and make certain of good contact between the wire and the pipe, and the pipe and the ground!

The best way to get a good ground is to use the cold water pipe. The clamp should be fastened on between the water meter and the place where it enters the cellar. This allows the waves to reach ground without the need of going through any joints in the pipe.

Tubes are Important

The first article recommended the use of 201-A tubes (or C301-A which are identical) throughout, for these reasons: this type of tube is one of the best all around radio and audio frequency amplifiers, and also it does not draw heavily upon the battery. Undoubtedly, the UV200 (or C300) is a better detector than the 201-A, but this is a "soft" tube, that is, has some gas in it, instead of a practically perfect vacuum like the other, so it is rather critical as to filament current, plate voltage, etc. And since its filament consumption is one ampere, whereas the 201-A type draws only $\frac{1}{4}$ ampere, the use of the latter tube as a detector is to be preferred in general. Also a higher plate voltage (up to 45 volts as a detector) may be used with it since this is a hard tube, resulting in a stronger signal.

The employment of various dry-cell tubes in many neutrodynes has been attempted without any marked success in neutralizing and operation. However, the Rice Neutrodyne circuit may be readily neutralized using dry-cell tubes;—

with the understanding that since many dry-cell tubes are essentially not as efficient as the 201-A type, we cannot expect equal operation in both cases. Still, the results obtained are truly remarkable. For radio amplification, however, the UV199 is more efficient even than the 201-A. It is as an audio amplifier that the former is not as good as the latter.

Trouble Shooting Made Easy

This discussion on trouble shooting may be divided into two sections, the first for those who hear nothing on their sets, and the second for those who get fair reception but not really good.

The most common cause of silence is defective wiring; therefore, the logical

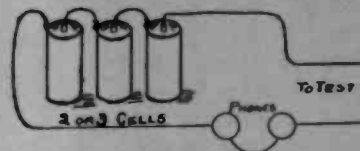

Fig. 11. Use This Test Circuit

thing to do is to check all connections in detail with the wiring diagram in Fig. 9 (as shown in last issue). Having made doubly certain that this has been followed to the slightest detail, if silence still results, the next thing to do is test for open circuits in the wiring and in the apparatus. This is done by connecting a pair of phones and a battery as shown in Fig. 11, and testing each coil and piece of apparatus for a complete circuit. Very often, this method will disclose an open circuit in a joint apparently well soldered, especially when rosin-core solder is used.

Having made certain that there are no open circuits in the apparatus, it is advisable to look at the contacts in the sockets. Many times the contacts have been bent permanently out of place. If the contacts are O. K., the trouble may lie in the tubes, the most common fault

being (often visible on close inspection) that the grid or plate is short-circuited by the filament, or that the grid and the plate are touching. This may be ascertained by employing the test circuit above. A frequent source of trouble and one that is readily shown up by the test circuit is due to the fact that the fixed condensers are shorted. This is indicated by a good strong click in the test circuit. There are numerous other possible sources of trouble among which are faulty audio frequency transformers, which may be due to either open or short circuited windings; bad contact in the phone jack; reversed polarity of the B battery; defective phones or loud speaker, etc.

When Music is Only Fair

In addition to any of the above possi-

have already anticipated a few of these possible changes, and have done some experimenting with this circuit on their own hook. For the benefit of the more conservative, various modifications of common interest will be discussed.

First, it has perhaps occurred to you that we might insert a variometer in the plate circuit of the detector tube to make the set oscillate when desired and to secure added volume by means of regeneration. The method of doing this is shown in Fig. 12. This gives a detail of the hook-up of Fig. 9, but modified by inserting the variometer directly in the plate circuit of the detector tube. When this variometer is adjusted so that it tunes to the same wave length which is being received, then the well known effect of regeneration will occur

by a switching arrangement in tuning in a station, and may be cut in if desired thereafter to secure regeneration. This modification is not very costly and well worth trying.

No doubt, the possibility of loop reception and reflexing has entered your minds, since the trend today seems to be toward omitting the aerial and the conservation of tubes. It is conceded that reflexing in the case of the ordinary neutrodyne is not very desirable, and has not met with any degree of success commercially. This is due mostly to various technical complications. When it is realized how difficult it is to neutralize completely the ordinary set, which does not make use of reflexing, then it will be easy to understand that it is nearly impossible to adjust an ordinary neutrodyne for reflexing. It is only where the neutralization is independent of everything except its own adjustable condenser that any kind of satisfactory results can be hoped for.

Reflexing the Neutrodyne

In the Rice Circuit, reflexing works out with beautiful simplicity and economy. A detail of reflexing is shown in Fig. 13. A loop of the usual design is tapped at the center, and is used in place of the secondary of the tuner. Reflexing is accomplished in the ordinary manner. From the above, it may be seen that the process of neutralization is entirely independent of reflexing. This is one of the beauties of the Rice Circuit.

The operation of this reflex circuit is similar to that described before. The loop (See Fig. 13) picks up the signal and tunes it by the 23-plate adjustable condenser. The oscillations occur between the center part of the loop connected to the grid and the outside, which is connected to the filament, through the "A" minus battery. The output from the plate runs through the primary of the radio transformer to the "B" plus battery. The secondary of this transformer is tuned by its adjustable condenser and runs to the grid of tube 2. The output from its plate is passed to tube 3 in the same manner, except that the radio frequency uses the .001 by-pass condenser, so that it will not have to pass through the phones. The output from tube 3, after passing the radio transformer, is rectified by the crystal detector.

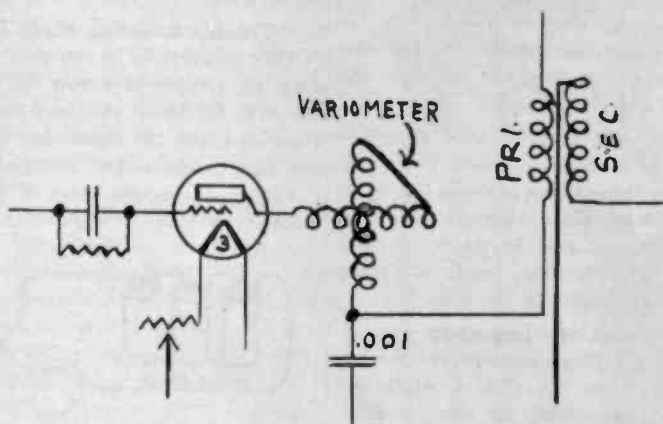

Fig. 12. Making Neutrodyne Regenerative

bilities, imperfect reception may be caused by one or more of the following; defective wiring; bad audio transformers; incorrect polarity of the transformers (both radio and audio); poor socket contacts; defective or improper grid leak and condenser; run-down "A" or "B" batteries; and imperfect neutralization. Very often a set refuses to oscillate even when the circuit is not neutralized. This is almost always due to defective tubes, if not traceable to open or short circuits. One more word in regard to tubes; it is well worth while, and may repay the effort many fold to juggle the tubes around, that is, try the tubes in as many combinations as possible until they work best. Altho the tubes run fairly similar, one tube may be an excellent detector and a poor amplifier and vice versa. This is especially true of the dry cell tubes.

Possible Modifications

In all probability, some of our readers

and the signals will become very much stronger.

In view of the fact that the set is neutralized, you may regenerate your head off with no fear of radiating or disturbing your neighbors since the two stages of neutralized radio frequency act as a clarifier or muffler and will not allow the oscillations to reach the antenna circuit. It is claimed by many that regeneration is as good as an additional stage of audio frequency without the additional cost. The disadvantage of regeneration is that the non-distorted quality and property of the Neutrodyne is lost. This does not amount to very much though, provided regeneration is not used to too great an extent. If the feed back is brought up only to the point where the music is loud but no evidence of squealing is heard, then no fear need be had of disturbing the reception. In practice, the plate variometer may be readily cut out

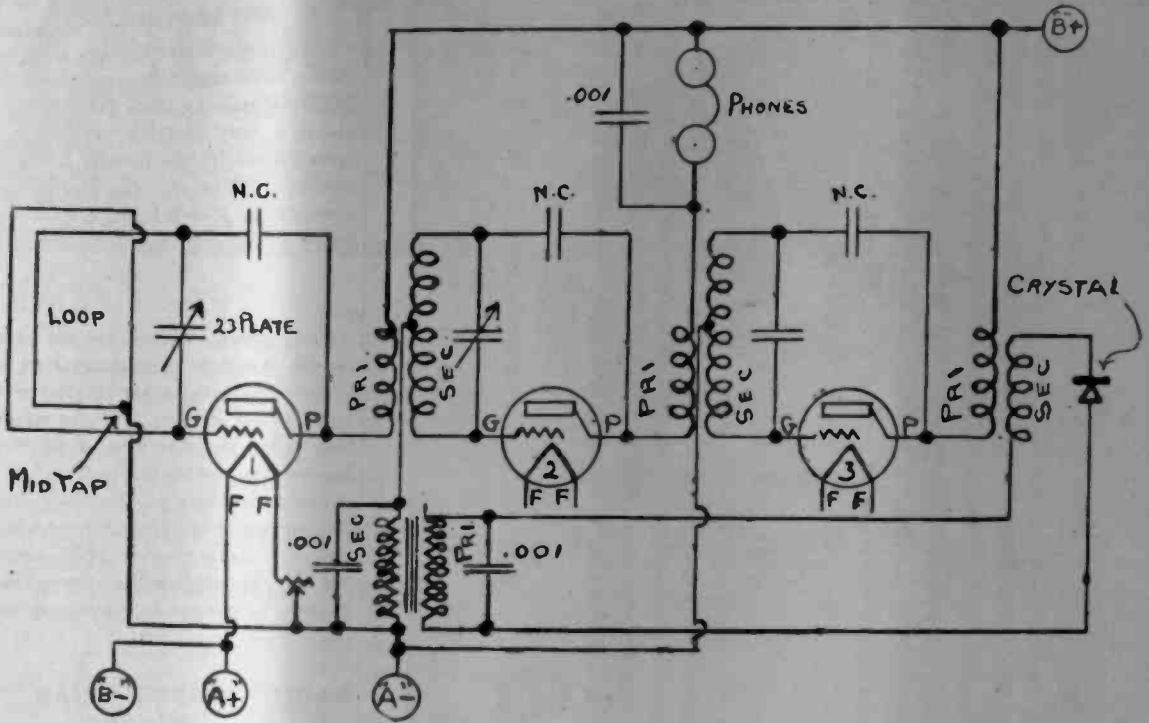

Fig. 13. Three Radio Steps, Crystal Detector and One Reflexed Audio Amplification

Course of the Audio

The audio frequency from the detector goes through the primary of the audio transformer, while the radio frequency uses the .001 condenser across it. The secondary is connected in series with the grid lead running to the second tube, and so impresses the audio frequency on this tube. The audio output from the plate traverses the primary of the radio transformer without effecting it, and then actuates the phones or loud speaker.

This gives the circuit through radio amplifiers 1, 2, and 3, then crystal detector, audio amplified 2 to the phones. The reason for using three .001 condensers is to allow the high frequency to avoid the coils in the phones and audio transformers, whereas the reflex low frequency will not pass through such small capacities. The three neutralizing condensers NC are adjusted in the same way as described in the previous article. If desired, a second step of audio frequency can be reflexed into tube 3 in the usual way by adding one more audio frequency transformer.

This completes the series of three articles on the latest modification of the neutrodyne.

WILL STATIC STAY SICK?

Radio fans country-wide will be delighted to know that for an uncertain period static will no longer interfere with their reception of broadcasting stations. This is the startling announcement made by one of the listeners of Westinghouse Station WBZ, residing in West Dover, Vermont. The explanation

of this timely announcement lies in the comment made by this fan which ran as follows: "O. M. Static (O. M. standing for Old Man) has gone to bed to-night with a cold so we got your concert very well. We hope he stays there." Here's hoping there is some truth in this inside information and that the cold is quite serious.

RADIO PROGRESS

8 Temple St. (P. O. Box 728)
Providence, R. I.

Date.....

You may enter my subscription to RADIO PROGRESS

foryear $\left\{ \begin{array}{l} 1 \text{ year } \$3.00 \\ 2 \text{ years } \$5.50 \end{array} \right.$

Signature.....

Send it to this address

Paid by (PRINT).....

Check

Cash

Money order

PORTRAITS OF POPULAR PERFORMERS

Our photograph shows Miss Ethel Miller, the mezzo-soprano. She is being presented by Ned Jakobs, and furnishes a very pleasing part of the concerts played by the famous Kudlach Ensemble. When she dresses in Spanish costume, as shown here, it makes us all look up time tables for Spain.



Miss Ethel Miller

The group which we see here is Joseph Knecht's orchestra. Just as the Waldorf-Astoria is one of the most famous hotels in New York, so its orchestra, under the direction of Mr. Knecht, has become one of the best known musical organizations in the city. Tune to 455 meters any Thursday evening and you will hear Station WJZ broadcasting its tuneful music from the roof garden, as played by these musicians.

RADIO WORSE THAN WAR WHOOPS

"Music hath charms to"—fill the savage breast with alarm and suspicion.

WTAM, broadcasting station of the Willard Storage Battery Company, recently received a relayed message from a party of Cleveland people telling how Indian guides at Doy Lake, Canada, reacted to their first radio concert.

The party was encamped on Dog Lake, about 900 miles north of Cleveland. Included in the outfit was a portable radio set. This was turned on during a dance program from WTAM. The Indians, none of whom had ever seen or heard of radio, watched in silence for a few moments and then took to their canoes.

Fear Radio, Not Telephone

They paddled some distance off shore and refused to return while music or words came from the little box full of wires and tubes. Moreover, they refused to comment on the radio set or to tell just what superstition caused their withdrawal. These same guides are accustomed to the use of telephone and talking machine but radio proved to be too much for their nerve.

They even refused to touch the set when camp was moved and the owners had to carry it themselves.



Joseph Knecht's Waldorf-Astoria Orchestra

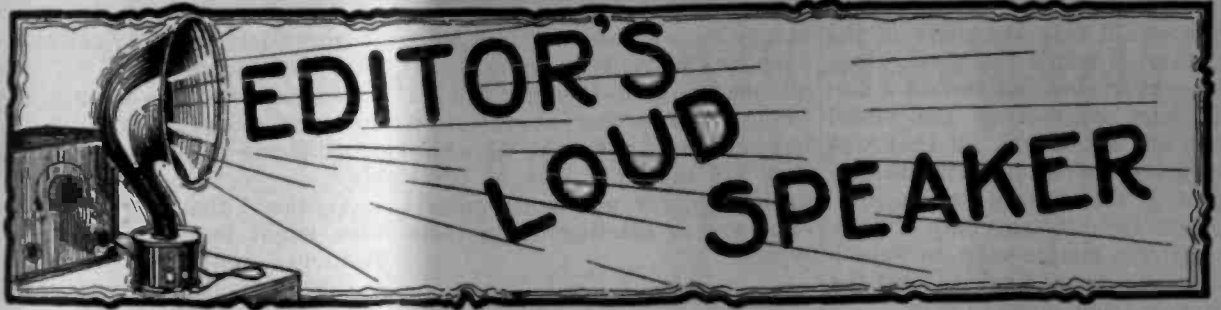

DRIVE IT BY BELT

WE are hearing a lot nowadays of doing this and that by radio. Of course, we have got the time signals that way for a good many years. Then they talk about driving torpedos, directing airplanes, blowing up fortifications, and finally sending pictures by radio. Of course, all this seems very wonderful, but are we not over working the idea of radio itself?

When you get right down to it radio is nothing but a method of transmitting a small amount of power. In order to do anything by this means a method must first be worked out to do the thing directly. For instance, if we can't lift a certain weight with a rope and pulley we certainly can't lift it by radio. If we find it impossible to steer a vessel in a certain way using electric wires, then it is sure that we can't steer it by radio. The latter may be compared to a message we write to a friend. It is positive that if our friend will not do a certain thing for us when we plead with him face to face then he will not do it if we write him a note asking the same thing.

By Wire or by Ether

Take the case of sending a picture by radio. There has been a great deal of excitement in the daily press because this feat has been accomplished, but as a matter of fact the surprising thing is not that a photograph has been transmitted through the air. The difficulty was to invent a method of reproducing the picture at a distance by electricity. Whether this electricity was carried from

one city to the other by a wire or by the ether did not make a great deal of difference.

In accomplishing this result the process consists of making a negative of the picture to be reproduced at a distance. This negative is wrapped around a cylinder or drum which rotates slowly. A light from a powerful lamp shines through a lens which focuses it on the negative. After it passes through it is caught on a sensitive cell which varies an electric current in accordance with the amount of light which the negative allows to pass. The current, then, varies up and down corresponding to the light or shadow of the picture.

Current Carries Picture

This varying current is transferred to another station 10 or 1,000 miles away. Here is where radio may enter. It makes no difference to the process whether this varying current is transferred over a telephone line, a telegraph wire, or through the air from a broadcasting station, as long as it arrives at the distant city without being distorted by leakage, static, or other interference.

Once this varying current has been received it is passed into a light valve which works on something of the principle of a volt meter. A heavy current gives a large deflection, which lets a lot of light through a lens. A small current reduces the deflection and light proportionately. The beams are directed on a sensitive film wrapped around a drum, just like the first one, and turning at the same speed. The result is a series of light and dark spots which give

a very good reproduction of the photograph.

Three Hard Problems

Notice that there are three separate parts to this problem aside from radio. One is to design a sending cell which converts the light variations into electrical waves. The second is to invent a valve which will reverse this action just described. And the third is to arrange a scheme to keep the two drums turning at exactly the same speed, because if one got a little bit out of step with the other it would mess up the picture frightfully.

The fact that these three problems have been solved so well is a feather in the caps of the inventors who have been working on this subject for a good many years. But remember that all three angles of the solution have had nothing to do with radio at all. Once we have reached the place where we can send photographs over a telegraph wire as described, then a slight modification only is needed to send the same pictures by the same equipment, but using a sending station instead of the telegraph line to get the current at the other end.

Steering a Torpedo

Another place where radio has been credited for development which it really could not claim is in the steering of boats and torpedoes from the shore. The experimental work needed to attain this result was not used in developing radio apparatus particularly. The big difficulty was to arrange the engines, reverse gear, rudder, etc., in such a way that electrical impulses coming over a

wire would take the place of the captain on board the boat. Once this was worked out so that a single wire connecting the vessel with the shore was all that was needed to make the boat behave itself as the captain on shore directed, then it was only a comparatively simple step to substitute radio for the cable to get the message from shore to ship.

The same mistaken idea is often held about the ability of electricity to do certain things. This brings to mind a story told by a famous electrical engineer a while ago. He said that a young man once asked him why an airplane could not be run by electricity. He replied by another question, why not run it by a belt? At first sight this seemed like a foolish question but as a matter of fact one is just as sensible as the other. Electricity is a way of transmitting power, not of making it. The same is true of a belt. No one would think of attempting to drive any machine by a belt unless he has some kind of an engine to run the belt.

Electricity is Like Belt

Now electricity in itself is not a form of original power. First of all we must have a waterfall or a steam engine or maybe a gasoline motor to furnish power. After we have got the power we can change it into the form of electricity and shoot it several hundred miles away to a distant city. But it is the water or coal or gasoline behind the electric generators which makes the wheels go around.

A somewhat similar case was heard when some young folks stopped in at a radio store one morning and asked to hear some music from KDKA, East Pittsburgh. It was explained that this station was not running that morning. This rather surprised the visitors and they exclaimed that they thought that radio stored up the music in the air and that it was sucked out at any time later by a good receiving set.

So the next time that you hear

of any remarkable new feat being done by electricity or by radio, by all means give these wonderful forces their proper appreciation, but realize at the same time that they are merely a way of transmitting power and not a source of power or intelligence in themselves.

THE VOGUE OF THE VERNIER

"If you want to improve your set," says your friend, "by all means add a vernier condenser. You can get a good one for around \$6.00." How often the radio builder hears advice something like this. After receiving the same remark enough times he will perhaps believe it and invest in a vernier with the idea that he will be able to hear a good many stations that he never got before.

If this is the thought in his mind he is doomed to disappointment. When a vernier is used on any radio apparatus, whether condenser, variometer, or rheostat, it positively will not enable him to get any more stations than he heard before. Nor will it tune out unwanted local broadcasting or sharpen his tuning in any way at all. These improvements might all be expected from reading some of the advertisements appearing in popular magazines.

An Auto on a Ferry Boat

A vernier is often a very desirable unit to have, but it does just one thing,—that is, it makes the set easier to control. What it amounts to is a kind of lever which enables the operator to get just the position of the shaft which he wants without having to move his dial a few thousandths of an inch at a time. It is something like running an automobile upon a ferry boat that is almost too small to hold it. In such a case the driver would not attempt to run the machine on board under its own power because if he went even a foot too far he would go overboard. Instead he would push the machine by hand the last few feet and so be able to stop

it accurately at the right place. No one doubts that the auto *might* be driven to exactly that spot and stopped there, but it is too difficult to control it in that way.

Another illustration of this idea might be found in the old fashioned elevator. Do you remember how the boy used to pull down on a rope to start his cage and when he reached the fourth floor where you wanted to get out he would guess at the point to give the rope another pull? If he had a good eye you would have to step up or down only on inch or so, but if he had been out late the night before he couldn't hit the floor much closer than six inches. That corresponds to the plain condenser when trying to pick up a faint sharply tuned station.

Vernier Like Controller

Then an electric controller was added, which enabled the operator to run the car so smoothly and easily that he could stop it exactly opposite the floor. That corresponds to the vernier. But how foolish you would think it, if someone told you that because of this smooth control the elevator could pick out several more floors than before. As long as the old installation was able to stop at every one with a little fishing for the exact level, then there is no chance of getting any more. The same thing applies in the radio case. If a condenser has the right number of plates so that the set can pick up every station within a certain radius then by adding a vernier no others will be heard.

Don't think from this that we do not advocate using a vernier. As a matter of fact this attachment is a great convenience and the better the radio set the more useful it is in getting the exact setting needed to clear up that distant station which you can just hear.

High Speed Waves Will Reach Pole

KDKA Will Talk to McMillan on Board the Ship Bowdoin

Owing to their short wave length, the signals transmitted from KDKA, have a world-wide range and offer the only solution to dependable voice communication at immense distances. For this reason, the steamship "Arctic" sailed recently from Quebec on a voyage to Etah, Greenland, carrying a full complement of special radio equipment suitable to pick up high speed broadcasts from KDKA.

The "Arctic" is carrying with it two Canadian Westinghouse special receivers, one of which is for delivery to Donald Mix, radio operator of the McMillan Expedition, somewhere along the Greenland coast, the other set is for use aboard the "Arctic." Both these sets

Three Kinds of Sending Sets

In addition to its receiving equipment the "Arctic" is equipped with three transmitting sets, one standard 1/2 kw., 600 meter spark set; one 1 kw., 2100 meter ICW (interrupted continuous wave) set; one 2 kw., 120 meter ICW set.

signals can be relayed from the "Arctic" to the "Bowdoin." It is thought that the two boats will be able to carry on in this manner until the special set can be delivered to the "Bowdoin," after which "KDKA" will transmit direct both on CW and on voice to the McMillan ship.



Fig. 1. Captain J. W. Bernier

are designed to receive special signals which will be transmitted from the new experimental station of the Westinghouse Company, at East Pittsburgh, Pa., every Monday night from 10:30 to 11:00, Eastern Standard Time.

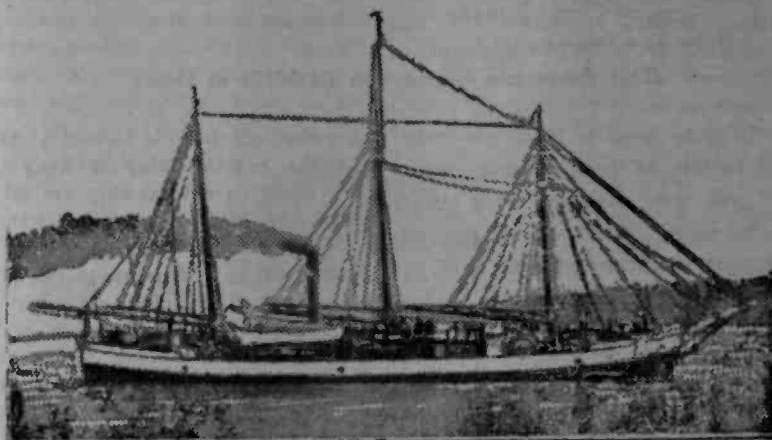

Fig. 2. The Vessel with Three Foot Walls

The call letters of the "Arctic" are "VDM" and it will operate on a wave length of 120 meters.

No more complete plans for carrying on a constant communication with the outside world were ever made by an Arctic expedition, particularly with respect to communication with the "Bowdoin," McMillan's ship, from which little has been heard in months.

To Talk Once a Week

KDKA will transmit every Monday night on short wave lengths. Thus when the "Arctic" arrives at the coast of Greenland she will have been in constant communication with the East Pittsburgh station. It is expected that when the ship reaches Greenland she will be able to get in touch with Donald Mix, radio operator with the McMillan expedition, either on his 2100 ICW set or on his 600 meter spark set. Then KDKA's

To insure that communication from the "Arctic" may be received in civilization, it has been arranged to equip two of the Hudson Bay Company boats, the "Bayeskime" and the "Nascopie" with Canadian Westinghouse special receivers, designed not only to pick up "KDKA's" special wave but also the signals from the "Arctic." It is hoped by this means to relay messages from the "Arctic" through the Hudson Bay Company's boats to the Labrador Coast stations and then on to Montreal. It is anticipated that the "Arctic," through its transmitting equipment will be able to keep in communication with Pittsburgh although it is quite possible that the ship's signals will be lost. However, KDKA will continue to send whether or not any acknowledgment gets through from the "Arctic."

Continued on Page 26

Forget-Proof Filament Switch

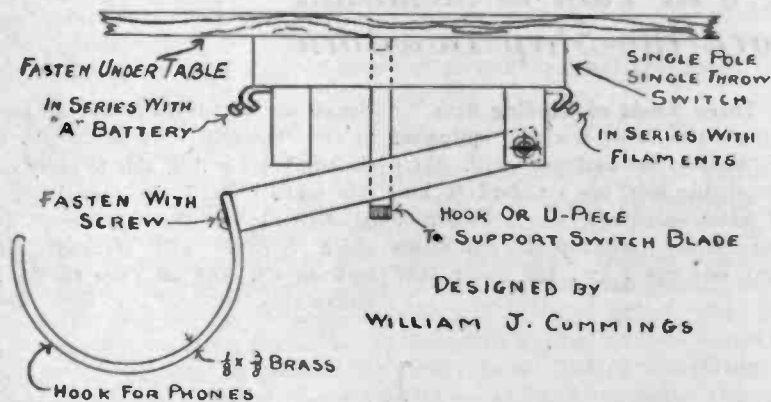

This Automatic Switch Can Be Made at Home

It is quite possible that you may forget to turn off your filament switch when you get through using your set some night. This results in running the battery out, if dry cells are used, or in requiring a recharge if you employ a storage battery. This occurs so often that William J. Cummings, of Eden Park, R. I., designed a special switch for this service which would be "forget-proof." It is installed on the underside of the table or shelf which supports the radio set.

A convenient hook is located so that it is the natural thing to hang the phones on it as soon as they are taken from the head. This act in itself turns off the "A" battery. The diagram shows the construction of this apparatus quite clearly. A further refinement might be added in the form of a spring, which would automatically close the contact when the weight of the phones was taken off the hook. However, we doubt whether this is necessary, since there is no danger of forgetting to close the switch when you wish to hear the music.

HIGH SPEED WAVES

Continued from Page 25

While the working schedule of the traffic has been arranged for every Monday night in the event that the necessities for additional communication arise, this schedule will probably be increased.

Up 92 Feet in the Air

The "Arctic" is in charge of Captain J. W. Bernier, Canada's veteran Arctic explorer. His portrait is shown in Figure 1. Captain Bernier, though 72 years old, is one of the most active men aboard ship and when going through the ice peaks he directs the operation of the ship from the crow's nest, which is 92 feet above the deck level. Last year he met McMillan at Etah and dined aboard the boat with him. Because he is going by way of Cumberland Gulf this year, instead of sailing direct up the Greenland Coast, it is anticipated

that he will not be in touch with McMillan until sometime in September.

Captain Bernier has a record of more than 20 years as an explorer. He has known personally all the notable explorers of the world including Perry, Amundson, Steffansen, Nansen and others.

The radio operators on board with Captain Bernier are chief operator William Choat and assistant operator J. Finnie. Mr. Choat is one of the best known radio amateurs in the Dominion of Canada and was entrusted with the mission of carrying on the "Arctic's" communication because of his long service with the amateurs.

18-HOLE GOLF BROADCASTING

For the first time in radio history, a golf match was broadcast August 2nd, direct from the links, by the station op-

erated by WDAR, Lit Brothers, in Philadelphia.

The match was between four of golf-dom's brightest lights, Max Maretan, amateur golf champion, 1924, and Jesse Sweetser, amateur golf champion, 1923, paired against Walter Hagen, British open champion, and Joseph Kirkwood, professional and trick shot champion.

To accomplish this new feat in broadcasting, the entire course of the Overbrook Golf Club, where the match was played, had been wired from one hole to the next. At each hole the microphone, on the end of an extension cord, was plugged into the circuit which lead into the Green Hill Farms Hotel at the end of the course.

BROADCASTING BEATS COLLEGE

The educational value of radio broadcasting is recognized by Frank E. Seavey of the department of English, Tufts College. In a recent letter to a broadcasting station he wrote: "When I think of the thousands of homes into which you are sending excellent music daily, homes in which, three years ago, no music above street songs was known, I feel that your work in education is vastly more important than ours."

ROXIE RELEASES RACER

A radio listener tells this one. Early one Sunday evening he was motoring homeward in somewhat of a hurry when behind him he heard the steady putt-putt of a motorcycle. Too late to slow down, he found himself at the roadside face to face with an officious gentleman in a brown suit. The usual pleading did not bring about the desired result, but in a last effort the motorist explained to the motorcycle cop that the reason he was hurrying home was to hear Roxie's "Hello, everybody," at 7:20, through WEA. "If you had a radio you'd understand."

The cop had one and WEA's ardent listener heard the "Hello, everybody," without a summons in his pocket.

Humorous Happenings at a Studio

Announcer Arlin Tells Some Funny Incidents at KDKA

H. W. Arlin; who is one of the voices at KDKA, is the world's pioneer announcer and also holds the record for continuous service as an announcer.

Mr. Arlin has been serving steadily in this position since February, 1921, and was the first person ever to be engaged for regular services before a microphone. In his long career before the radio public he has probably had more humorous experiences than fall to the lot of the average person in a lifetime.

Microphone Hears the Laughs

In recalling some of the incidents which occasioned mirth, either at the time they occurred or some time after the event, Mr. Arlin stated that the humor of the incidents depended, sometimes more upon the time, place and condition, rather than the actual event. He also stated that, to appreciate the humor in some of the incidents one must remember that the atmosphere within a studio is one of unusual quiet and that a tense feeling prevails because of the fact that the slightest noise will be transmitted by the microphone. A suppressed laugh, for instance, usually tends to magnify the funny side of an incident and results in some sort of spasmodic action.

The following, however, are given as some good examples of what a radio announcer has to contend with:

On one occasion, a mouth organ player was performing before the microphone. When he had finished one number Mr. Arlin asked him the name of his next, so that it could be announced. Arlin was told "The Holy City," and so announced the number. Imagine his consternation when the mouth organ artist started playing "The Palms." The humorous part of it all was that the player did not know his mistake until it was called to his attention. Because he played entirely by ear the name meant little to him. The same artist gets special attention when he plays now.

The microphone switch is always off when this player starts a piece, and is not switched on until the announcer is satisfied he is playing the piece that was announced.

Playing the Potato

One of Arlin's fellow-announcers did this. Having an ocarina player performing—an ocarina is sometimes termed a sweet potato, you know—he announced, "Mr. So and So, Sweet Potatoist, will now play," much to the

baritone solos, if announced under an assumed name.

Broadcasting a Cookie

Victor Saudek, leader of the KDKA Little Symphony Orchestra, once stood in front of the microphone chewing a cookie, forgetting that the switch was open. Arlin was called to the phone by the East Pittsburgh station operator and requested to find out what was causing the grating sound in the microphone. The secret was out as soon as



Announcer Arlin Tells Some Funny Stories of the Studio

consternation of the artist and to the mirth of those in the studio.

Upon another occasion, one of the singers, who has won considerable fame as a tenor, came to the studio with baritone solo music by mistake. Not being a baritone he didn't care to sing baritone music but, in order to help out on a short program, agreed to sing the

Mr. Saudek was spotted in front of the microphone, and there were smiles all around.

When announcing baseball scores one day, a pet bulldog, belonging to one of the Westinghouse men, rushed through the open studio door, upset the microphone stand with a fearful clatter, then

Continued on Page 28

Fone Fun For Fans

A teacher, examining a class of boys in history, looked at one lad and said, "You've heard of John Paul Jones, my boy?"

"Yes, sir."

"Well, what do you think Jones would be doing if he were alive to-day?"

The boy thought a moment. "Living on the old age pension," he replied.—*Holmes Store News.*

Everything Safe

The grocer's new cashier and book-keeper told her employer she had lost his check book.

"But it doesn't matter," she added, "I took the precaution of signing all the checks as soon as I got it—so, of course, it won't be of any use to any one else.—The Progressive Grocer.

The Shining Exception

"Did any of your family ever make a brilliant marriage?"

"Only my wife."—*Boston Evening Transcript.*

He was one of those fresh young fellows given to the use of slang. At the breakfast table, desiring the milk, he exclaimed, "Chase the cow this way, please."

"Here, Jane," said the landlady, "take the cow down to where the calf is bawling."—*The Beacon Light.*

"To what do you attribute your great age?" asked the city visitor to Grandpa Eben Huskins.

"I can't say yit," answered Grandpa, cautiously. "They's several patent medicine fellers dickerin' with me."

"Where's the car?" demanded Mrs. Diggs.

"Dear me," ejaculated Professor Diggs. "Did I take the car out?"

HUMOROUS HAPPENINGS

Continued from Page 27

barked two or three times. The dog raised a regular rumpus before he could be removed. Rather embarrassed, Mr. Arlin made an apology and continued reading the scores.

Useless Taxi Trip

Once when called upon to furnish a program in a hurry, Mr. Saudek called

"You certainly did. You drove it to town."

"How odd! I remember now that after I got out I turned around to thank the gentleman who gave me the lift and wondered where he had gone."—*Automotive Merchandising.*

Words of Wisdom

"Private Blank," said the Colonel severely, reprimanding a doughboy for a minor breach of military regulations, "what would you do if I should tell you that you were to be shot at sunrise?"

"Colonel," replied the Yank, watching the shadow of a grin steal over the officer's face, "I'd sure pray for a cloudy day."—*Indianapolis Star.*

Zoologically Speaking

A class in natural history was reciting.

The teacher asked, "Where is the home of the swallow?"

A long silence, and then a hand waved.

"You may answer, Robert."

"The home of the swallow," declared Robert, "is in the stummick."—*Grand Rapids Herald.*

Preparedness

Willie was under orders never to go in swimming. And mother meant to see that he obeyed. So one day she became suspicious.

"Willie, your clothes are wet," she said. "You have been in the water again."

"Yes, mother, I went in to save Charlie Jones."

"My noble darling! Did you jump in after him?"

"No, mother. I jumped in first, so as to be there when he fell in."—*Youth's Companion.*

upon one of his cornetists to take a taxi and hurry to studio with all speed, ready to go on in 15 minutes. The cornetist just made the studio in the last 10 seconds, dashed madly to the microphone, then remembered that he had left his music at home. The result was more consternation than ever.

Recently one of the station operators leaned against a switch, thus opening

the circuit. The music being transmitted was cut off in the middle. Many frantic telephone calls ensued while some one pushed the operator off the switch.

Perhaps one of the most humorous things, which ever happened to Mr. Arlin, one over which some people may moralize, occurred quite recently. The minister who presented the Bible stories from KDKA came without his Bible and asked Arlin to get him one. Arlin states that it took the better part of an hour and a search through East Pittsburgh until a Bible was procured. The program was hopelessly delayed.

Page the Murderer

At another time, not so recently, one of the speakers, while on his way to Pittsburgh Post studio, slipped in the street and was hurt. He was in so much pain that when he arrived at the studio, a make-shift bed was arranged from chairs, in order that the speaker could lie down. While lying thus on the chairs he gave his lecture. Just at the end, his pain became acute, and he let out a frightful yell, which of course, was transmitted. About 15 telephone calls were made that evening, inquiring the details of the horrible accident. The listeners-in thought the man must have been killed.

WORKING TO BEAT THE BAND

To secure faithful reproduction of large bands has always been a difficult problem for broadcasting experts. The volume produced by individual wind instruments varies greatly. The tone of each is necessary to a harmonious whole; consequently, if the microphone is not well placed, a very unfaithful reproduction is secured.

The United States Marine Band, which is broadcast through stations WEAJ and WCAP, is one of the best examples of such radiocasting, and the fan can best appreciate this by imagining himself as one of the listeners at the Concert Hall where the program is being played rather than as one of the radio audience in his home. Discriminating musicians have frequently remarked regarding the faithful reproduction of the Marine Band which is a feature of WEAJ's program on Monday evenings.

R DR RADIO PRESCRIBES.

NOTE: In this section the Technical Editor will answer questions of general interest on any radio matter. Any of our readers may ask not more than two questions, and if the subjects are of importance to most radio fans they will be answered free of charge in the magazine. If they are

of special interest to the questioner alone, or if a personal answer is desired, a charge of fifty cents will be made for each answer. This will entitle the questioner to a personal answer by letter. However, if the question requires considerable experimental work, higher rates will be charged.

Question. Is the book type of condenser made by the Crosley Company a low loss condenser?

Answer. Yes, this type of unit is very satisfactory from this standpoint. Owing to the small amount of insulating material and its high grade the losses are kept down to a low value.

Question. Where can I get a thermoformer such as is described in your issue of July 15?

Answer. This device for eliminating the need of using a "B" battery is still in the development stage and while the experimental models are working well, still the instrument has not yet been put on the market. It is probable that it will be for sale during the fall.

Question. What is meant by a "knock-out" receiver?

Answer. This is the trade name for a certain style of radio set first described in Radio Broadcast.

Question. Where can I get a transformer for stepping up the "B" battery pressure from 45 to 90 volts?

Answer. Unfortunately, there is no such instrument possible. A "B" battery works on direct current and transformers all require alternating current to operate them. The output from a battery can have its voltage reduced by a resistance, but cannot have it increased in any way except by using its power to drive a motor which in turn operates a generator wound for a higher voltage. Of course, all this is quite expensive and is absolutely impractical when it comes to radio receiving sets. A fuller discussion of this subject appeared in the August 15 issue of RADIO PROGRESS.

Question. How does the plate current of an amplifier tube vary as more "B" battery is used?

Answer. In answering this question we shall assume that the filament receives voltage enough so that it burns at its normal brightness. If it is not turned on far enough, then the current through the plate will be limited to the number of electrons which the filament gives off. In such a case the plate current is said to be "saturated" and any further increase in plate pressure by increasing the number of blocks of "B" battery will not increase the plate current appreciably.

If the tube is burning at the proper voltage, however, the emission of electrons from the filament does not affect the plate current. The latter is then governed entirely by the voltage on the grid and on the plate. In such a case as the pressure on the plate is increased the "B" battery current goes up even at a greater proportion. By this is meant that if you double the plate voltage the plate current will be multiplied by $2\frac{1}{4}$ or $2\frac{1}{2}$. That is one reason why using high plate voltages is so rough on the "B" battery. If you use 45 volts and then increase it later to 90 the current consumed will be more than double.

Question. Are radio or audio frequency transformers used in a superheterodyne?

Answer. Either or both of these styles may be used, but neither one is necessary for the operation of a real superhet. A third breed of transformer, called the intermediate, is one of the essential parts of this kind of sets. Instead of being tuned to about one mil-

lion cycle seconds, as is the radio transformer, or being suitable (but untuned) for one hundred to five thousand cycles, like the audio transformer, it is designed for use on around thirty thousand cycles. If an attempt is made to use intermediate transformers which are not properly tuned, then poor results will be had from the set.

Question. How does a filter remove the ripple from pulsating direct current?

Answer. A filter consists of a combination of coils and condensers which absorb any one or more frequencies for which they are adjusted. This is rather a difficult thing to explain in a short space and the subject will be discussed in detail in an article in the next issue of RADIO PROGRESS.

Question. Is it possible to make a superheterodyne out of some of the six-tube sets which have recently been put on the market at a very low price?

Answer. Doubtless the sets referred to are those which have been superseded by later models, and as a result have been cut in price down to less than one-quarter of their former figure. Such models usually can not be rebuilt to make really good supers. The reason is this: One of the essential parts of the super is the intermediate transformer. This is designed to take in only a very narrow band of waves. This is one reason why such a set is very selective. Only part of its ability to cut out loud nearby stations is due to the tuning system. The rest depends, as just mentioned, on the sharpness of tuning of the transformer. If an old style set is rebuilt, it will not have such sharp

tuned transformers. For this reason, a large part of the special features of the super will be thrown away. It will be better to rebuild such a radio into some other hook-up.

Question. In using a chemical rectifier should it be inserted in the positive or negative side of the battery line?

Answer. It makes no difference which side contains the rectifier. The only thing to look out for is to get the proper polarity. The aluminum plate must be connected to the plus of the battery or the lead to the negative. Either way will cause the battery to charge. If these connections are reversed, then it will discharge instead. It is customary to connect the resistance (lamps or wire) in the other side of the line. The advantage is that if either lamps or rectifier should become accidentally short-circuited, the other unit will prevent a dead short circuit on the line. Since they are connected in opposite wires there is less chance that both units would be shorted at the same time. However, this point is not very important and in case resistance and rectifier are connected together, it hardly pays to change the wiring.

Question. What is meant by neutralizing condensers?

Answer. These are adjustable condensers with very low capacity, usually less than .0001. They are used to prevent radio amplifiers from oscillating and after they are once properly adjusted, they need no further attention.

Question. How much variation is required in an adjustable leak?

Answer. Once a grid leak has been properly set for any given tube no further adjustment is needed at all. That is, the value of the leak does not depend on either the wave length or the loudness of the program being received. Some experimenters claim that on very weak signals they get slightly better results by changing the value of the leak, but most people do not find such an effect.

If your tube burns out and you substitute another of the same style and make, it will not be necessary to readjust the leak provided that both tubes were reasonably alike in their characteristics. Occasionally we find a vacuum tube which is a little different from its fellows in some respects and in that case a readjustment of the leak may

improve the reception. Of course, when changing from one style of tube to another it is best to experiment to see which leak gives the most satisfactory reception. In general it may be said that the UV-200 takes about one megohm, the WD-11 and WD-12 two, and the UV-199 and UV-201-A four megohms.

COMPRESSION RHEOSTAT WITH SWITCH

A compression type rheostat that can be switched off without being unscrewed is now obtainable. It overcomes the only inconvenience that the compression rheostat has, that of the number of revolutions required to turn it on or off—and the better the filament control device and the finer the adjustment it al-



Compression Rheostat

lows, the greater the number of turns that are necessary. The Fil-Ko-Stat, allowing very fine control of current flow, formerly had to be turned off like other compression rheostats; but it can now be left at approximately the correct adjustment, and the "A" battery be disconnected by means of the little nickel-plated switch that is attached to the regular Fil-Ko-Stat mounting screws on the front of the panel. No extra holes need be drilled. The price has not been advanced, despite the addition of the switch.

SOME NEW THEORIES OF HEAT

Are radio broadcasting stations responsible for late summers and early winters? A Pattersonville, N. Y. farmer believes so and promises frost in August because of the activity of radio stations. In a letter to WGY, the Schenectady, N. Y., station he explained his surprising and novel theory as follows:

"This broadcasting of music is good entertainment for the people in different parts of the country. But why is the weather so cold?

"I think that transmission of power

through the air freezes all the heat out of it. Think, twenty broadcasting stations in the New England States alone! Why we have had cold summers for three years, ever since they started broadcasting music and entertainments. Four or five years ago when there weren't any stations transmitting power we had warm summers. You know yourself when it is hot in the summer there are thunderstorms. Now there aren't any, and why?

"When it is a hot day and a thunder storm goes over, the lightning burns most of the heat and after the storm it is nice and cool. Now, when about ten or fifteen stations are going for about five hours each day, the electricity from these stations burns more heat than fifty storms. Here it is July already and it is so cold the grass doesn't show any life, the trees are bare and in August we may have frost. The weather is altogether different from what it was years ago. What are the farmers going to do!

"I may be wrong, but that is the cause of this cold weather, I think. Please try and get all the stations in the New England States and more besides to stop the broadcasting during the summer months and see if we don't get the good old warm days back again."

Heating the Church

This reminds us of a story told about the Puritans in the early days. The churches were unheated in winter, because it was thought wrong to strive for such bodily comfort on Sunday. But in a certain parish a lot of the younger people got together and insisted on putting in a stove.

The next Sunday it was quite cold. After the service the Elders got together and decided to install a much larger stove, because "the little one isn't powerful enough to heat the whole building, so it drives all the cold into the corners and makes them a lot colder than before."

Needless to say, the U. S. Weather Bureau does not agree with either of these theories of heat.



Mailing Lists

Will help you increase sales
Send for FREE catalog giving names
and prices on thousands of classified
names of your best prospective customers—
Retail, Wholesale, State and Local—Individ-
uals, Professions, Business Concerns.

99% Guaranteed 5¢ each
by refund of

ROSS-Gould Co. 612N. St. Louis
111th St.

If your dealer buys
his Radio merchandise
from us

What he sells you is O. K.

We are Rhode Island distributors for
All leading manufacturers of
sets and parts

UNION ELECTRIC SUPPLY CO.

60 PINE ST., PROVIDENCE, R. I.

Wholesale only. Positively no merchandise sold at retail.

RADIO FREQUENCY AMPLIFICATION with the BALLANTINE VARIOTRANSFORMER

*Get distance that everyone
can enjoy*

Let the whole family hear the announcer's
"This is Station ZYX, The Voice from 'Way
off Yonder!" They can—by adding BAL-
LANTINE Radio Frequency to your present
outfit. Providing, of course, you have a
loud speaker.

The voice or music will be clear and strong.
And you'll find it easier to separate the
various stations. BALLANTINE Units
may be hooked in between any standard
receiver and its audio amplifier.



Transformer only
for panel \$9.60
or base.....

At dealers or
postpaid

Keep your set "on
its toes" all sum-
mer with BAL-
LANTINE Variotransformers.

All wavelengths sharply tuned

Pure tones at maximum volume for the number of tubes
employed are assured by the continuously variable fea-
ture of the BALLANTINE transformer. For, this instru-
ment tunes sharply throughout the range of 200 to 600
meters. Pigtail connections and full shieldings prevent
stray noises. Notable results have been obtained in the
One-, Two-, and Three-Tube Reflexes as described in
Radio Broadcast.

BOONTON RUBBER MFG. CO.
Pioneers in Bakelite Moulding

324 Fanny Road, Boonton, N. J.



Complete radio fre-
quency amplifier unit
with socket
and rheostat... \$15.00



RADIO FREQUENCY AMPLIFICATION with the BALLANTINE VARIOTRANSFORMER