

RADIO & TV NEWS'

hi-fi

\$1.00

MAC

ANNUAL

& AUDIO HANDBOOK

1959



■ "All about Audio and Hi-Fi" - over 22 pages by G.A. Briggs

■ Latest techniques in stereophonic sound



Learn Radio-Television

Servicing or Communications by Practicing at Home in Spare Time

N.R.I. SENDS kits with which you practice building circuits common to Radio and TV sets. You LEARN-BY-DOING to locate Radio-TV troubles. As part of N.R.I. Servicing Course, you build Vacuum Tube Voltmeter and AC-DC receiver. Use VTVM to conduct experiments, earn extra money fixing sets in spare time.

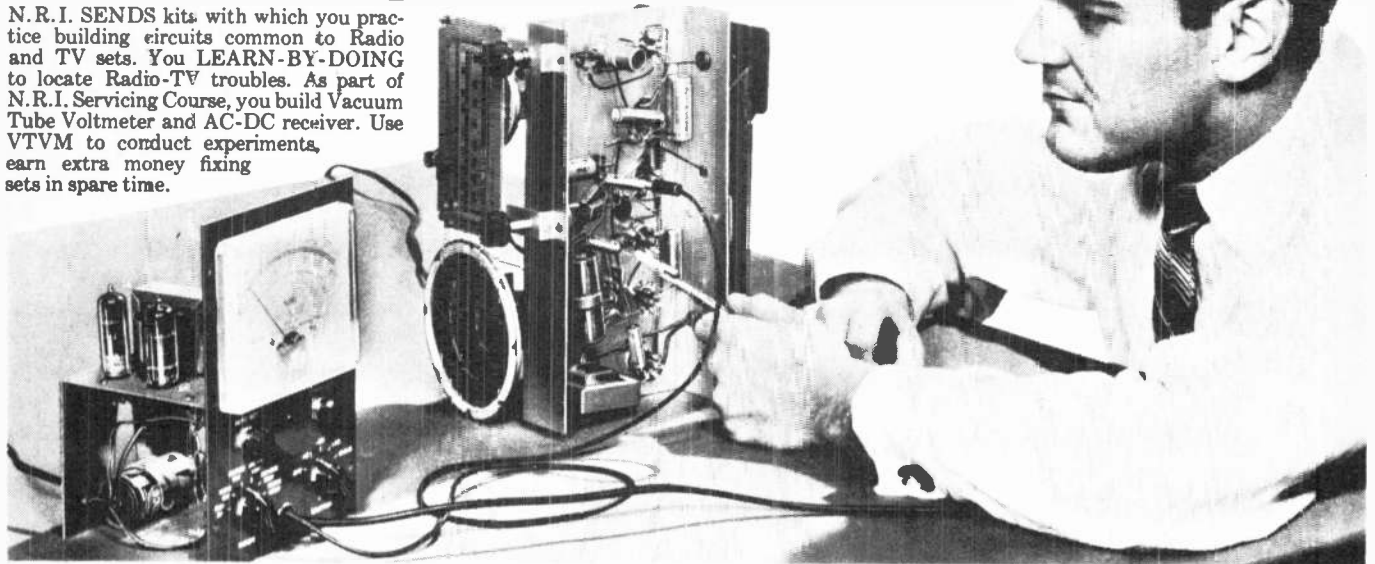

RADIO-TV BROADCASTING (see above) offers important positions as Operators and Technicians. RADIO-TV SERVICING Technicians (see below) needed in every community. Their services are respected, their skill appreciated.



Fast Growing Field Offers You Good Pay, Success, Bright Future



J. E. SMITH
Founder

Bigger than ever and still growing fast. That's why Radio-TV has special appeal to ambitious men not satisfied with their job and earnings. More than 4,000 Radio and TV stations. More than 150 million home and auto Radios, 40 million TV sets. Color TV promises added opportunities. For the trained man, there are good jobs, bright futures in Radio-TV Servicing or Broadcasting.

Training PLUS opportunity is the ideal combination for success. So plan now to get into Radio-TV. The technical man is looked up to. He does important work, gets good pay for it. Radio-Television offers that kind of work. NRI can supply training quickly, without expense of going away to school. Keep your job while training. You learn at home in your spare time. NRI is the OLDEST and LARGEST home study Radio-TV school. Its methods have proved successful for more than 40 years.

Added Income Soon - \$10, \$15 a Week in Spare Time

Soon after enrolling, many NRI students start to earn \$10, \$15 a week in spare time fixing sets. Some pay for their training and enjoy extra luxuries this way. Some make enough to start their own Radio-TV shops. NRI training is *practical*—gets quick results. Easy to understand, well illustrated lessons teach you basic principles. And you LEARN-BY-DOING by practicing with kits of equipment which "bring to life" things you study.

Find Out What NRI Offers

NRI has trained thousands for successful careers in Radio-TV. Study fast or slow—as you like. Diploma when you graduate. Mail coupon now. Paste it on a postcard or mail in envelope. ACTUAL LESSON FREE. Also 64 page catalog that shows opportunities, shows equipment you get. Cost of NRI courses low. Easy terms. NATIONAL RADIO INSTITUTE, Dept. 8MD6, Washington, D. C.

N.R.I. TRAINED THESE MEN FOR SUCCESS



"I was repairing Radios by 10th lesson. Now have good TV job." M. R. LINDEMUTH, Fort Wayne, Ind.



"Doing spare time repairs on Radio and TV. Soon servicing full time." CLYDE HIGGINS, Waltham, Mass.

"I had a successful Radio repair shop. Now I'm Engineer for WHPE." V.W. WORKMAN, High Point, N.C.



"There are a number of NRI graduates here. I can thank NRI for this job." JACK WAGNER, Lexington, N. C.



VETERANS Approved Under G.I. Bills

SEND FOR BOTH FREE

National Radio Institute

Dept. 8MD6 Washington 16, D. C.

Mail me Sample Lesson and 64-Page Catalog FREE. (No salesman will call. Please write plainly.)

Name _____ Age _____

Address _____

City _____ Zone _____ State _____

Accredited Member National Home Study Council

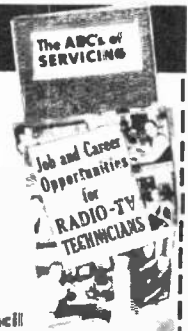

hi-fi

ANNUAL
& AUDIO HANDBOOK

1959

Contents

All About Audio and Hi-Fi	7
Amplifiers and Preamplifiers	33
Tape Recorders and Microphones	61
Loudspeakers and Enclosures	81
Stereo & FM	103



Oliver Read, publisher
David A. Findlay, editor

Art Fitzthum, art editor

Furman Hebb, assistant editor

Barbara Hearst, editorial assistant

John A. Ronan, Jr., advertising director

James F. Maxwell, Jr., advertising manager

a selection of articles from **RADIO & TV NEWS**

Cover Photo by: **Midori**

Amplifier: **British Industries**

Audio analyzer: **Heath Company**



ZIFF-DAVIS PUBLISHING CO., One Park Ave.,
New York 16, N. Y. William Ziff, President;
W. Bradford Briggs, Vice President; Michael H.
Froelich, Vice President; Michael Michaelson,
Vice President and Circulation Director; Victor C.
Stabile, Treasurer; Albert Gruen, Art Director.

AN FILE

of these superb **Classical High-Fidelity**

COLUMBIA and EPIC RECORDS FOR ONLY

\$3.98

if you join the Columbia  Record Club now — and agree to purchase 5 selections during the coming 12 months

BEETHOVEN: EMPEROR CONCERTO CASADESUS, Piano MITROPOLIS NEW YORK PHILHARMONIC	STRAUSS WALTZES and OVERTURES BRUNO WALTER	RACHMANINOFF: Rhapsody on a Theme of Paganini FRANCE: Symphonic Variations LEON FLEISHER, piano CLEVELAND ORCHESTRA / SZELL	Vivaldi: The Seasons 1 Music!	ROSSINI: WILLIAM TELL AND BARBER OF SEVILLE OVERTURES DONIZETTI: DAUGHTER OF THE REGIMENT OVERTURE SCHUBERT: MARCHÉ MILITAIRE TCHAIKOVSKY: MARCHÉ SLAVE STRAUSS: RADITZKY MARCH VAN KEMPEN, CONCERTGEBOUW AND LAMCUREUX ORCHESTRAS	NEW WORLD SYMPHONY DVOŘAK ORMANDY - PHILADELPHIA ORCH.
BACH: THE GOLDBERG VARIATIONS GLENN GOULD PIANO	MOZART REQUIEM BRUNO WALTER NEW YORK PHILHARMONIC WESTMINSTER CHOIR	Tchaikovsky "PATIETIQUE" SYMPHONY Mitropoulos, New York Philharmonic	FINLANDIA SIBELIUS FINLANDIA GRIEG SWAN OF TUONELA ALFVEN PEER GYNT SUITE No. 1 SWEDISH ANSPADY Philadelphia Orchestra - Ormandy	PAGANINI: Violin Concerto No. 1 SAINT-SAËNS: Violin Concerto No. 3 Lino FRANCESCATTI	LEVANT PLAYS GERSHWIN RHAPSODY IN BLUE CONCERT IN F AN AMERICAN IN PARIS

Members regularly enjoy performances by great artists like these:

- ★ Amsterdam Concertgebouw
- Sir Thomas Beecham, Bart.
- Eduard van Beinum
- Leonard Bernstein
- E. Power Biggs
- Budapest String Quartet
- Robert Casadesus
- Pablo Casals
- Cleveland Orch.
- Leon Fleisher
- Zino Francescatti
- Glenn Gould
- Arthur Grumiaux
- Clara Haskil
- I Music!
- Paul van Kempen
- Metropolitan Opera Assn.
- Dimitri Mitropoulos
- N.Y. Philharmonic
- David Oistrakh
- Eugene Ormandy
- Philadelphia Orch.
- Royal Philharmonic
- Albert Schweitzer
- Rudolf Serkin
- Isaac Stern
- George Szell
- Vienna Symphony
- Bruno Walter

The finest selection of American and European classical records ever offered by the world's largest record club

DAVID OISTRAKH ISAAC STERN violins VIVALDI: Concerto for Two Violins BACH: Violin Concertos 1 and 2 Philadelphia Orchestra - Ormandy	PORTS OF CALL RAVEL: BOLERO LA VALSE, PAVANE CHABRIER: ESPANA IBERT: ESCALES DEBUSSY: CLAIR DE LUNE Fugue in A Minor Fantasia and Fugue in G Minor	Albert Schweitzer BACH Toccata, Adagio and Fugue in C Minor Fantasia and Fugue in G Minor	STRAVINSKY: FIREBIRD SUITE TCHAIKOVSKY: ROMEO AND JULIET LEONARD BERNSTEIN NEW YORK PHILHARMONIC	RUDOLF SERKIN BEETHOVEN "MOONLIGHT" Sonata "PATIETIQUE" Sonata "APPASSIONATA" Sonata	Brandenburg Concertos Nos. 1, 2, 3 BACH PABLO CASALS
BEETHOVEN: QUARTETS 9 & 11 BUDAPEST STRINGS QUARTET	HAYDN "Surprise" AND "Drum-roll" Symphonies BEECHAM, Royal Philharmonic	BRAMHS: SYMPHONY NO. 4 WALTER NEW YORK PHILHARMONIC	DEBUSSY: La Mer RAVEL: La Valse Valsees Nobles et Sentimentales ST. LOUIS SYMPHONY / GOLDSCHMANN	TCHAIKOVSKY: serenade in a major BORODIN: nocturne BARBER: aragosto VAUGHAN WILLIAMS: greenleaves Strings of the Philadelphia Orchestra - Ormandy	SCHUBERT: "UNFINISHED" SYMPHONY MENDELSSOHN: MIDSUMMER NIGHT'S DREAM Schubert: "Unfinished" Symphony

... a convenient method of acquiring, systematically and with expert guidance, an outstanding record library of the world's finest music — at far less than the usual cost

- ★ You receive, at once, ANY 5 of the Columbia and Epic records shown above for only \$3.98
- ★ Your only obligation as a member is to purchase five selections from the more than 100 high-fidelity Columbia and Epic records to be offered in the coming 12 months. Thus, you receive ten records for the price of six — a saving of more than one-third on your record purchases
- ★ After purchasing only five records, you receive a Columbia or Epic Bonus record of your choice free for every two additional selections you buy
- ★ Each month the Club's staff of musical experts selects a classical recording that will be a distinguished addition to your record library. In addition, at least seven other exceptionally fine recordings, both classical and popular, will be available to you as alternate selections. All are fully described in the Club Magazine, which you receive free each month
- ★ You may accept or reject the regular Classical Selection, take any of the other records offered, or take NO record in any particular month
- ★ You may discontinue membership at any time after purchasing five records
- ★ The records you want are mailed and billed to you at the regular list price, now only \$3.98, plus a small mailing charge
- ★ You must be delighted with membership or you may cancel by returning the five records within 10 days

COLUMBIA  RECORD CLUB
Terre Haute, Indiana

SEND NO MONEY — MAIL COUPON TO RECEIVE 5 RECORDS FOR \$3.98

COLUMBIA  RECORD CLUB, Dept. 273-1
Terre Haute, Indiana
Please send me the 5 records whose numbers I have circled at the right, for which I am to be billed only \$3.98 plus small mailing charge — and enroll me in the Classical Division of the Club.

My only obligation is to purchase five selections from the more than 100 to be offered during the coming 12 months . . . at regular list price, plus small mailing charge. For every two *additional* selections I accept, I am to receive a 12" Columbia or Epic Bonus record of my choice FREE.

Name.....
(Please Print)

Address.....

City.....ZONE.....State.....

CANADA: Prices slightly higher, address 11-13 Soho St., Tor., 2B
If you wish to have this membership credited to an established Columbia or Epic record dealer, authorized to accept subscriptions, please fill in the following:

Dealer's Name.....

Dealer's Address.....124
© Columbia Records Sales Corp., 1958 © "Columbia," "Epic," "Mercury" Reg.

- CIRCLE 5 NUMBERS BELOW:**
1. Levant Plays Gershwin
 2. Beethoven: Emperor Concerto
 3. Beethoven: Quartets 9 and 11
 4. Mozart: Requiem
 5. Sibelius: Finlandia, etc.
 6. Beethoven: 3 piano sonatas
 7. Rachmaninoff: Rhapsody, etc.
 8. Vivaldi: The Seasons
 9. Tchaikovsky: "Patietique" Symphony
 10. Dvorak: "New World" Symphony
 11. Bach: Goldberg Variations
 12. Schweitzer Plays Bach, Vol. 1
 13. Rossini: William Tell Overture, etc.
 14. Strauss Waltzes and Overtures
 15. Mendelssohn: Midsummer Night's Dream; Schubert: "Unfinished" Symphony
 16. Firebird: Romeo and Juliet
 17. Vivaldi and Bach: Violin Concerto
 18. Haydn: "Surprise", "Drum-Roll" Sym.
 19. Brahms: Symphony No. 4
 20. Ports of Call
 21. Debussy: La Mer; Ravel: La Valse, etc.
 22. Bach: Brandenburg Conc. 1, 2, 3
 23. Paganini and Saint-Saens Concertos
 24. Strings of Philadelphia Orchestra M-31



Your High Fidelity Equipment— Stereophonic or Monaural— These B.I.C. Products Will Make It Outstanding—

Your friends who own or sell fine high fidelity equipment will advise you to assemble your entire high fidelity system with B.I.C. quality endorsed components...each the finest, fully guaranteed, uniformly better, yet competitively priced with ordinary components. Your continuing satisfaction is assured by really complete parts and service facilities throughout the U. S.

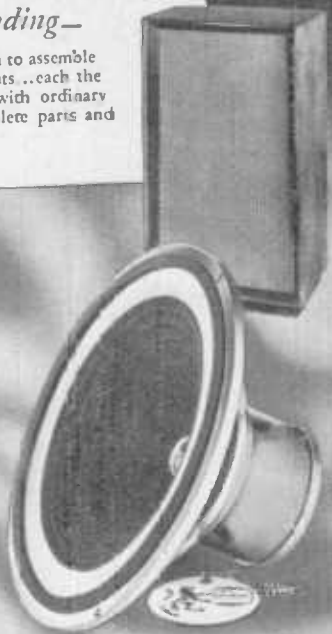

Garrard RECORD PLAYERS

Fully Wired for Both Stereophonic and Monaural Records.

35 years of experience producing record playing equipment, have resulted in a family of instruments known for time-proven features and enduring, superlative performance. They have earned their reputation as the world's finest record playing equipment.

Garrard Auto-Manual Record Changers



- Model RC98** — 4-speed auto change with variable control on all speeds. \$67.50
- Model RC91** — 4-speed auto change with variable control on all speeds. \$64.50
- Model RC121/II** — 4-speed auto change with variable control on all speeds. \$42.50

Garrard Turntables & Tone Arm



- Model 301** — The ultimate in transcription turntable with each speed variable. \$89.00
- Model 4H** — 4-speed 12" transcription turntable with built-in transcription tone arm. Complete \$59.50
- Model Y/II** — 4-speed manual player. A budget instrument with every basic Garrard feature. \$32.50

NEW! Model YPA/12 — Stereo Transcription Tone Arm with plug-in shell. Professional performance. Plays all records to 16". \$19.50

LEAK AMPLIFIERS

Stereophonic and Monaural

The world renowned Leak standards of craftsmanship are now available in stereo amplifiers and preamplifiers as well as monaural models. Leak amplifiers give the consumer the benefit of broadcast and professional quality components and workmanship, yet they are offered in a popular range of prices.

NEW! Leak Stereophonic Amplifiers and Preamplifiers

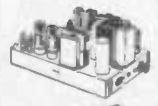

Leak Stereo Amplifiers are dual channel amplifiers of the highest quality. They are available in two models: "Stereo" 20, 115 watts Maximum Power Output (MPO) and "Stereo" 50, 220 watts Maximum Power Output (MPO). Each channel has a 100,000 ohm input impedance.



Leak "Point One Stereo" Preamplifier features Leak's famous "Point One" amplifier for all stereo and monaural sources, tape, records, radio and more. Switches search for signals and dual channel auto. channel search and stereo reversing. \$109.50

Leak Single Channel Power Amplifiers and Preamplifiers

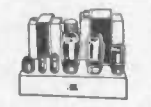

Leak Amplifiers are made to have long battery life. They are available in two models: "Leak" 100, 100 watts Maximum Power Output (MPO) and "Leak" 200, 200 watts Maximum Power Output (MPO). Each channel has a 100,000 ohm input impedance.



Leak Preamplifiers are designed and built specifically for Leak Amplifiers. Full complement of controls and inputs for every conceivable requirement. "Point One Plus" \$55.00, "Point One" \$39.00

Wharfedale SPEAKERS

For Natural Reproduction—Singly or in Pairs.

Designed and built under the direction of England's G. A. Briggs, Wharfedale Speakers, matching enclosures and speaker systems provide a unique quality of full-bodied, non-strident tone which has become associated only with this name.

Wharfedale Foam Suspension Speakers



- Tru-Tone** — 4" speaker with built-in tweeter. \$22.50
- Full Range** — 6" speaker with built-in tweeter. \$22.50 to \$78.50
- Low Frequency** — 8" speaker with built-in tweeter. \$44 to \$78.50

Wharfedale Speaker Systems and Enclosures



- SFB/3** — 3-way system in sand filled baffle. Custom \$198, Deluxe \$248
- W/AF/8** — 8" speaker with built-in tweeter. \$144.50 and \$199

R-J SPEAKER ENCLOSURES

Ideal for Stereo



The original small space loudspeaker enclosures with patented R-J design principles that assure full, smooth bass and unobstructed highs. Now available in these 5 newly styled models...

- RJ/8** For 8" speakers. Will fit into a single shelf enclosure 11" high x 21" long x 10" deep. In unfinished Birch hardware at \$28.50. In Mahogany, Walnut or Blum finish \$37.50.
- RJ/12S** For 12" speakers. Will fit in double shelf enclosure 21" high x 21" long x 16" deep. In unfinished Birch hardware at \$33.50. In Mahogany, Walnut or Blum finish \$42.50.
- RJ/12F** For 12" speakers. Floor model enclosure with legs. 21" high x 21" long x 16" deep. In unfinished Birch hardware at \$45.00. In Mahogany, Walnut or Blum finish \$54.00.
- RJ/15** For 15" speakers. Floor model complete with legs. 21" high x 21" long x 16" deep. In unfinished Birch hardware at \$45.00. In Mahogany, Walnut or Blum finish \$54.00.
- RJ/Super 8** A complete speaker system ready to play! 15" x 15" x 15" enclosure with built-in tweeter. The famous "Point One" Wharfedale Woofer 8"/8"/AL. In unfinished Birch hardware at \$50.00. In Mahogany, Walnut or Blum finish \$59.00.

River Edge Customized Cabinets and "Do-It-Yourself" Kits

50 models; 10 finishes; equipment and speaker components to fit components of all manufacturers. Kits and finished cabinets.



Genalex... Finest Audio Tubes
New K100—high power, low distortion, simplicity circuit. \$4.95 net. The original K100 power amplifier tube. This same design as U.S. #6X4 \$3.50 net. The original 2729 low hum input tube. \$2.95 net.

For literature write dept. AY-98& and please specify products. BRITISH INDUSTRIES CORPORATION, Port Washington, New York

TOM DONCASTER.

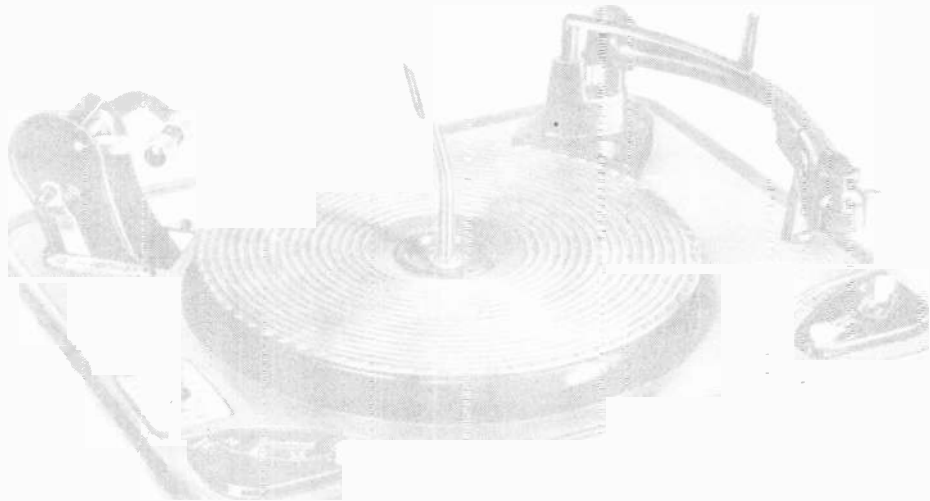

Section I

All About Audio and Hi-Fi

The Listening Ear	8
Room Effects	12
Room Resonance and Stereo	14
Testing Loudspeakers	16
Checking Speaker Performance	19
Electrostatic Speakers and Transient Response	22
Transient and Directional Effects	26
Speaker Power and Efficiency	28
Speaker Mounting	30

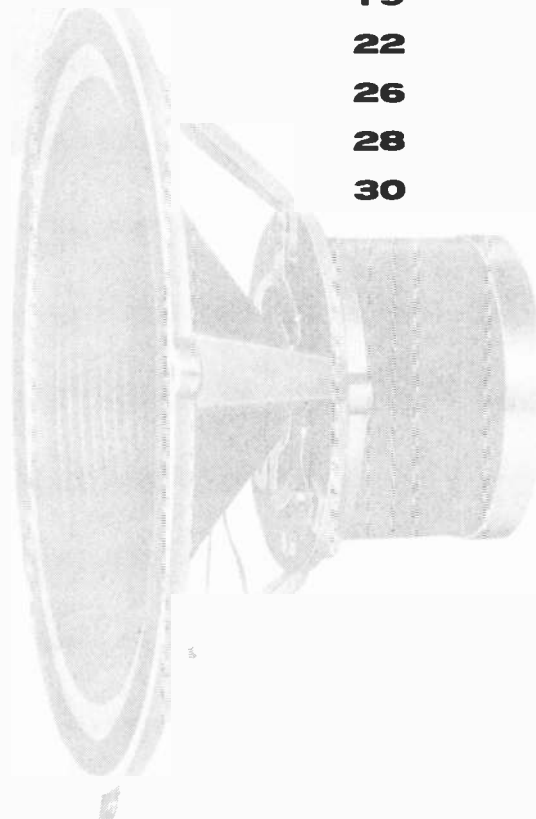

All About Audio and Hi-Fi



EDITOR'S NOTE: We take great pleasure in welcoming to these pages one whose wide experience and knowledge truly entitle him to be called a "noted authority" in the hi-fi field. Mr. G. A. Briggs' pre-eminence stems not from a theoretical, ivory-tower approach to the subject, but rather it is the result of endless experimentation, a well-developed sense of inquiry, and a serious (although good-humored) interest in good audio reproduction. Besides all this, Mr. Briggs has the peculiar ability to tell of his experiences in a crystal-clear, personal, down-to-earth manner that is a pleasure to read.

G. A. Briggs is managing director of the Wharfedale Wireless Works Ltd., England, which is engaged in making loudspeakers. Mr. Briggs started constructing acoustic phonographs, radios, and loudspeakers as a hobby around 1930. He started making speakers commercially in 1933. He has also dabbled in pianos and during the course of the last 25 years he has had forty different instruments in his home. Mr. Briggs is the author of the best-seller, "Loudspeakers," which is now in its fourth edition, as well as the popular "Sound Reproduction," "Pianos, Pianists, and Sonics," and "High Fidelity—the Why and How for Amateurs." Also, during the last three years, he has conducted nine lecture-demonstrations on sound reproduction in Canada, England, and in Carnegie Hall, New York.



Fig. 1. Photograph of the main items of test equipment used in tests forming the basis of this series of articles. Mr. R. E. Cooke is recording some information.

-The Listening Ear

By G. A. BRIGGS

Managing Director

Wharfedale Wireless Works Ltd.

Part 1. An informative and interesting series that will discuss high fidelity reproduction from the listener's point of view. Opening article describes the main qualities of the human ear as they are related to sound reproduction.

AS THE year 1956 was drawing to its quasi-peaceful close, I was very pleased to receive from the editors of this magazine an invitation to contribute a series of articles on audio topics, now generally designated as hi-fi. Because I am constantly making tests and experiments, it is very useful to have an incentive to place the results on record whilst they are fresh in the mind. In these experiments I have the valuable co-operation of our technical director, Mr. R. E. Cooke, B.Sc. (Eng.), who joined my firm some two years ago after spending a few years in the Designs Department of the BBC where he was engaged on problems connected with sound recording and reproduction.

Another reason for satisfaction is that I believe that any interchange of experience and opinion between our two countries is a good thing in the present state of the world, apart from the obvious fact that we can learn a lot from each other. (For instance, although we are fond of saying that you cannot make tea, I have developed the habit of using tea bags at home as a result of visits to America, and I should hate to go back to the messy business of loose tea leaves.)

American radio and audio magazines are read with avidity over here, and it would be a good thing if British journals could include more contributions from American writers, although the

usual rates of pay are rather thin; translated into dollars they would just about keep a moderate smoker in cigarettes.

On the more technical side we have nothing in this country to compare with some of your fine technical magazines, and, when it comes to test reports on instruments and equipment, your consumer testing organization reports are unique for candor and thoroughness. (Your greyhounds are half-way round the track before ours have realized that the traps are open and the hares are off!)

To conclude this preamble, I would like to stress the point that music and its reproduction are intended for man's delight, and my main reason for writing on the subject is that I enjoy doing so. Let us therefore approach all problems in a gay rather than a somber mood.

Scope of Articles

The title, "All About Audio and Hi-Fi," may be rather ambiguous. It does *not* mean that I am going to tell you all there is to know about it. (I do not know it all, nor do I think I know!) It simply means that I have a roving commission to deal with all or any aspects of the subject. I sometimes think that the term "high fidelity" has just about reached the limit set by the large notice which appears on the front door of a dance hall on

Broadway, which reads: "Most Exclusive Place in Town—Everybody Welcome." It is now quite usual to see portable radio sets and record players advertised in England as "hi-fi"; but despite this the term means something when properly applied, and it is very difficult to replace by a better one.

Equipment

As the main basis of this and subsequent articles will be actual tests and experiments, a brief outline of the instruments available will not be out of place, although I always believe that the skill and judgment of the investigators mean more than the cost of the equipment employed.

Photographs of the *Wharfedale* laboratory are reproduced in Figs. 1 and 2.

In Fig. 1 the main item is, of course, our Mr. Cooke, but other items worthy of note are, from left to right, automatic response curve recorder, a.f. oscillator, microscope, stroboscope, vacuum-tube voltmeters, sound level meter, phase-angle and impedance meter, oscilloscope with camera, etc.

In Fig. 2 the corner enclosure on the left is built of bricks, and to the left of that is an artificial reverberation device of Danish design. Moving to the right (no doubt wisely) we see a small *EJ* cabinet followed by a larger enclosure with special acoustic filter, to which we shall probably refer again in a later article. Sitting atop this cabinet is a 3" tweeter with volume control, and on the windowsill is a *Janszen* electrostatic speaker. Then we have a sand-filled baffle accommodating three speakers, with an exploded view of a *Klipschorn* on the extreme right. (The fact that three out of the six speakers shown are of American design does at least indicate that we are broad-minded!)

Lab Acoustics

When listening to loudspeakers in unusual rooms, allowance must be made for differences compared to furnished rooms in which domestic speakers are normally used. For instance, the laboratory in question has a longer reverberation time and sounds much brighter than an ordinary room. Some beneficial acoustic treatment has been applied; perforated *Celotex* tiles absorb excessive high frequencies over part of the walls, and half a dozen acoustic absorbers, designed by R. E. Cooke, each 5 ft. x 2 ft., operate in the range 100 to 8000 cps. (One of these can be seen in each photograph.) These units combine the functions of a Helmholtz resonator, stagger-tuned over the frequency range 700-1300 cps, and a membrane absorber. Nevertheless, I still prefer to make a *final* loudspeaker test at home, when domestic types are involved.

Room effects obviously play havoc with any loudspeaker response, although they do not invalidate the merits of level response as a starting point.

The Ear

In view of the importance of listen-

ing tests, we cannot do better than devote the remainder of this article to an elementary study of the function of the *human ear* as related to the problems of *sound reproduction*.

Its main qualities could, I think, be classified very simply as follows: (1) Sensitivity, or general acuity of hearing; (2) Response, or variation of acuity with frequency; (3) Tonal discrimination and power to assess volume levels accurately; (4) Sense of pitch; (5) Musical reaction and talent; and (6) Uniformity of qualities 1 and 2 between left and right ear.

For our purpose, the most important is No. 3, tonal discrimination, but we will deal with the others first.

Qualities 4 and 5: It is obvious that any of the six qualities could be possessed to an exceptional degree by one person, with only fair or even poor ability in the others, although it is reasonable to assume that Nos. 4 and 5 usually go together. (It is difficult to imagine that even an ultra-modern composer cannot hit the right note—or at least the one he wants.)

But experience shows that professional musicians are often poor judges of quality No. 3, and may be defective in qualities 1 and 2. (Beethoven was deaf for many years.) The reason for No. 3 failure is that the musician usually spends so much time near to the source of sound. I remember at rehearsals in the Royal Festival Hall, the organist Ralph Downes always maintained that we were reproducing the organ too loudly when he came into the body of the hall to listen. Similarly, a member of an orchestra hears something quite different from the conglomeration of direct and reflected sound heard by members of the audience. Volume level has a lot to do with it; I always maintain that the art of attaining realistic reproduction starts with setting the volume control correctly. The slightest touch up or down can make all the difference. The organist, when playing on a console placed near the pipes, hears less than

his audience, but a member of an orchestra hears more, so the training for No. 3 is poor in both cases.

It is also difficult for very musical people to ignore the music and performance, and concentrate on quality of reproduction. Many hi-fi fans err in the opposite direction!

Qualities 1 and 2: At the outset, we must be careful not to attach too much importance to acuity of hearing. We have already agreed that it has little to do with musical ability, and it is fairly easy to prove that sensitive ears are not necessarily discriminating ears, any more than a man with good eyesight is *ipso facto* an artist or a good judge of line and color.

But a reasonably good range of hearing is obviously required before any reliable assessment of tonal quality can be made. This was brought home to me recently during a rehearsal for a record concert, the items for which had been chosen by a talented musician and composer, who was apparently stone deaf above 5000 cycles and so remained quite oblivious to surface hiss, plops, and screaming highs which came from some records.

It is well known that hearing at high frequencies falls off with advancing years, but constant use of the ears in listening tests delays the decay.

The September, 1956 issue of *Wireless World* contained an interesting article on age, hearing, and hi-fi, entitled "Too Old at —?" by M. G. Scroggie, who said that those of us who are not so young as we were may be wondering why we should spend a lot of money on equipment for reproducing frequencies we cannot hear. Some measurements made on a few individuals by Mr. Scroggie are reproduced in Fig. 3, the numbers against the curves indicating the ages of the people tested. Frequencies below 1000 cps are omitted because no significant differences occur.

After studying these curves, we decided to make a few tests ourselves on members of our staff, but whereas Mr.

Fig. 2. Another part of the lab showing some speakers used for comparative tests.

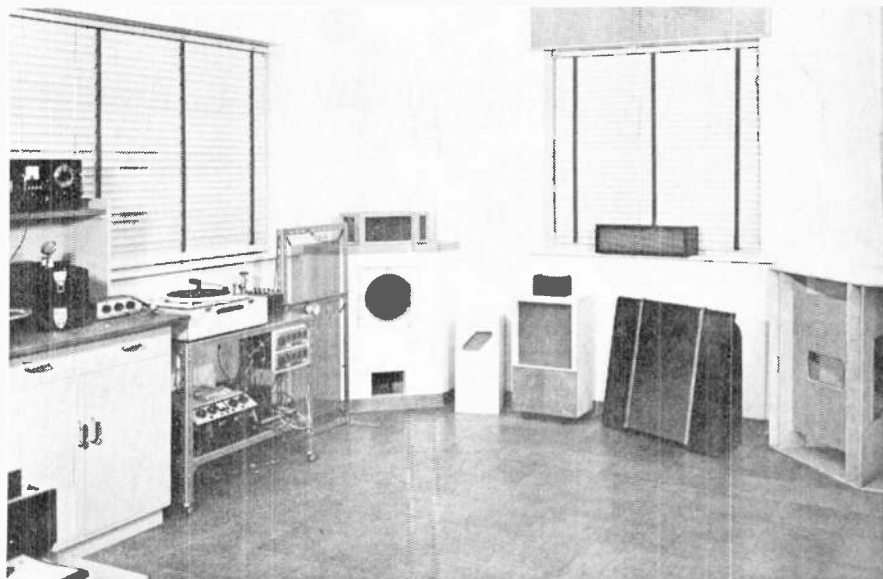

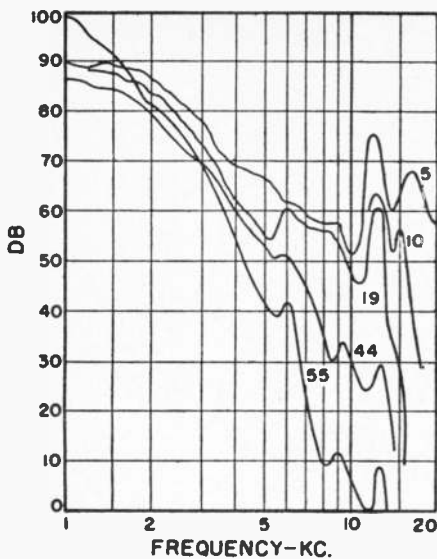

Fig. 3. Results of hearing tests made by M. G. Scroggie on persons of normal hearing between the ages of 5 and 55. Curves have been compensated for Fletcher-Munson threshold levels. (Curves redrawn from "Wireless World")

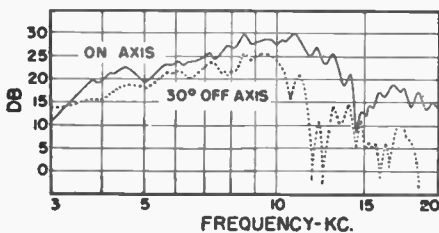

Fig. 4. Response curves of the 3-inch speaker used in the listening tests.

Scroggie used moving-coil headphones, we used moving-coil speakers, and this may account for the fact that our results showed much better standards of hearing at the high frequencies than did those of Mr. Scroggie and previous investigators. (After all, it is more natural to listen with two ears open to the air than with clamped-on headphones.)

A 3-inch unit with aluminum voice coil and light Bakelized cone was used as the sound generator. Although not flat, the response goes up to 20,000 cps (see Fig. 4) and the unit should be at least as good as a headphone. I was astonished that all those tested—ages between 20 and 46—could actually hear 18,000 cycles (usually with a boost of 50 db or more) as I am stone deaf in that region.

Now there are three people whose hearing and tonal judgment I have always rated very highly when assessing speaker performance. They are (1) my daughter, age 22; (2) our works manager, Mr. E. R. Broadley, age 46; and (3) myself. Please do not take the inclusion of myself as a sign of arrogance or conceit. We all think that what we hear is right because we never hear anything else.

As a matter of interest, response curves of these three subjects, prepared by Mr. Cooke, are shown in Fig.

5. As already mentioned, Mr. Scroggie made his measurements using headphones, no doubt in a very quiet room, and in such circumstances the threshold-level Fletcher-Munson curve gives appropriate compensation. Our experiments were made without headphones in a laboratory where slight background noise may be expected to produce some degree of masking at low intensities. The results have therefore been compensated by the Jensen threshold curve for a critical listener in low noise level. (*Jensen Technical Monograph No. 3, page 5, Fig. 5.*)

These tests show that it is possible for a young person of 22 to hear perfectly up to 14,000 cycles and quite well up to 18,000 cycles. Our sales director, Mr. Escott, age 31, and Mr. Cooke, age 32, kept within 15 db of this standard up to the 18,000 cycles limit imposed. Although I can actually hear 14,000 cycles, I was shocked to learn that I am some 90 db down at this frequency. The most interesting ears belong to Mr. Broadley, whose acuity is below mine up to about 10,000 cycles, but then remains very even up to 18,000 cycles, in spite of his 46 years. He has been making and testing loudspeakers along with me some 25 years, and I rate his judgment of performance very highly.

The general conclusion, as a result of these tests, is that loss of hearing with advancing years is frequently not as bad as has so often been assumed, and the faculty of hearing—in common with many other human accomplishments—is preserved by regular exercise or practice (like playing the piano or knitting).

It is a pity that deficiencies in hearing cannot be adjusted by "spectacles" which are so easy to prescribe for the eyes. Deaf aids are little better than

Fig. 5. Hearing curves taken with speaker held a few inches away from the right ear. Curves are corrected for loudness contour and are smoothed below 3000 cycles. Curve (A) is for Miss Briggs, age 22; curve (B) is for G. A. Briggs, age 66; and curve (C) is for E. R. Broadley, age 46. See text.

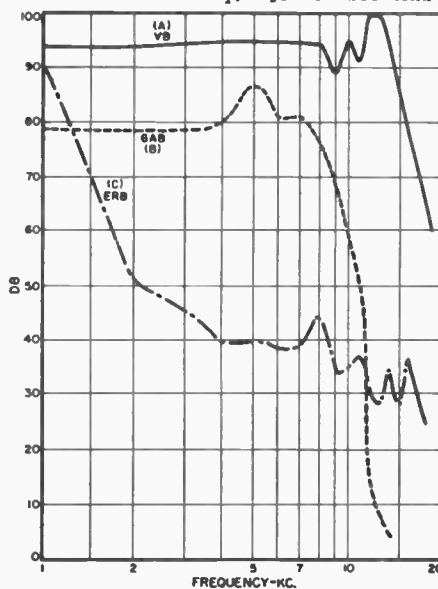

resorting to any port in a storm.

Quality No. 6: Few people hear equally with both ears, but I believe the natural tendency is to adjust the balance by turning the weaker ear towards the source of sound, so that quite wide variations could exist in one pair of ears without disqualifying the owner from a shrewd exercise of tonal judgment.

Quality No. 3: As with the gift of perfect pitch, the main basis of tonal discrimination is memory, coupled with the ability to hear and recognize resonances, harmonics, transients, and all the other qualities which go to make up a musical picture, plus a sensitive reaction to any form of distortion. An appreciation of music and regular concert-going to keep the ears fresh are obvious advantages. Anybody who unwittingly plays records too loudly or too softly is disqualified from the start, and it does not matter whether his amplifier is 10 watts or 100 watts. The "larger than life" platoon cannot be admitted into this select company.

Again in common with the gift of pitch, you either have tonal judgment or you have it not, and it is easily recognized in listeners when demonstrating sound equipment to various people, in spite of enormous variations in preference and taste. A spark of the talent—and talent it undoubtedly is—can develop into a flame by regular use.

I suppose the most skilled in the art are recording engineers who almost daily compare live with recorded speech and music and can recognize on a monitor speaker which piano out of a half a dozen studio models is being played. My complaint is that recording engineers hardly ever write about their activities (probably due to hush-hush policy) so views on the subject are left to be aired by semi-skilled but interested parties like your humble servant.

The most difficult application of tonal judgment—after recognizing that something is wrong—is the ability to recognize where the trouble originates. Poor recording, bad studio acoustics, line distortion, antenna or reception faults on FM, pickup distortion, amplifier faults, speaker trouble, listening room coloration, wrong setting of playback characteristics, wrong volume levels; these and many other sources of error need watching before final performance can be fairly judged.

For instance, the quality from FM at its best is so good that any shortcomings in the quality of program material are ruthlessly exposed on wide-range reproducers. A poor record via FM may sound as though the loudspeaker is out of center, and may actually sound better on a small speaker in a resonant cabinet than on a hi-fi system.

So we will conclude this article by stating that tonal discrimination is the most vital quality of the ear in audio activities, and that it involves placing a source of distortion quite as much as noticing it. In short, do not always blame the loudspeaker.

New G-E "Golden Classic" stereo-magnetic cartridge

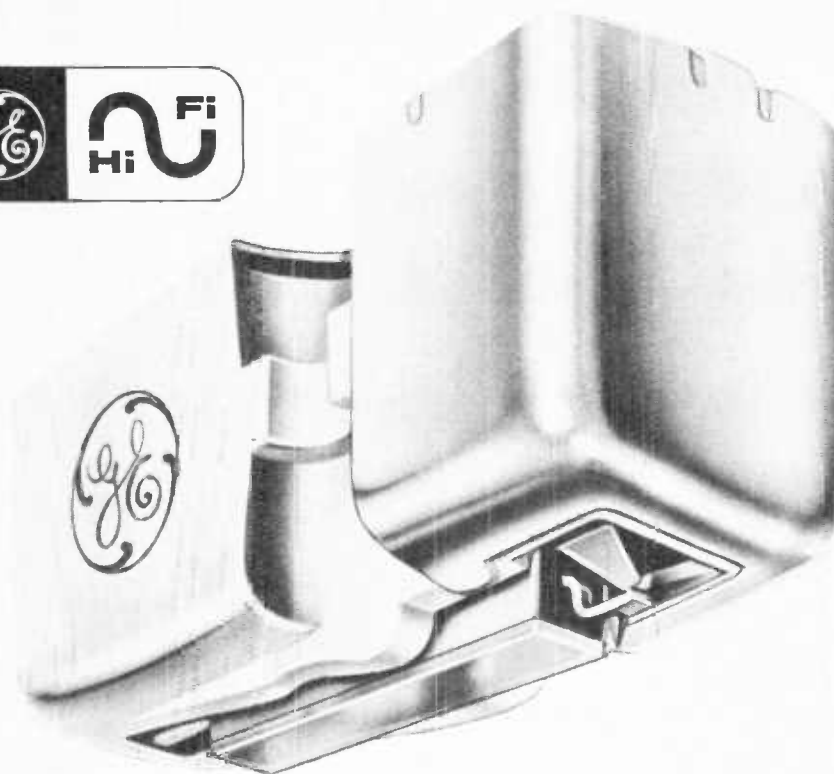

"GOLDEN CLASSIC" Model GC-7 (shown) with .7 mil diamond stylus \$23.95*
 "GOLDEN CLASSIC" Model GC-5 (for professional-type tone arms) with .5 mil diamond stylus \$26.95*
 "STEREO CLASSIC" Model CL-7 with .7 mil synthetic sapphire stylus \$16.95*
 *Manufacturer's suggested resale prices

makes stereo a practical reality—at a realistic price!

- Fully compatible with both stereophonic and monaural records
- Frequency response 20 through 20,000 cycles
- "Floating armature" design for increased compliance and reduced record wear. Effective mass of stylus approximately 2 milligrams
- High compliance in all directions—
 Lateral compliance 4×10^{-6} cm/dyne
 Vertical compliance 2.5×10^{-8} cm/dyne
- Recommended tracking force with professional-type tone arm 2 to 4 grams
- Consistently high separation between channel signals

(Specifications for Model GC-5 with .5 mil diamond stylus)

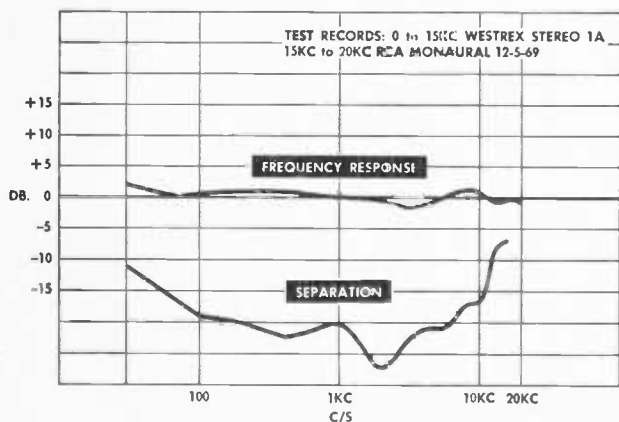

Smooth response on both stereo and monaural records.
 Consistently high separation between stereo channels.

Stereo is here! General Electric makes it official—with the new "Golden Classic" stereo-magnetic cartridge, a fitting climax to the famous line of G-E cartridges. For matchless reproduction, hear it with G.E.'s new "Stereo Classic" tone arm. Ask your dealer for a demonstration soon. Write for complete specifications. *General Electric Company, Specialty Electronic Components Dept., Section HFD, W. Genesee St., Auburn, N. Y.*

GENERAL  ELECTRIC

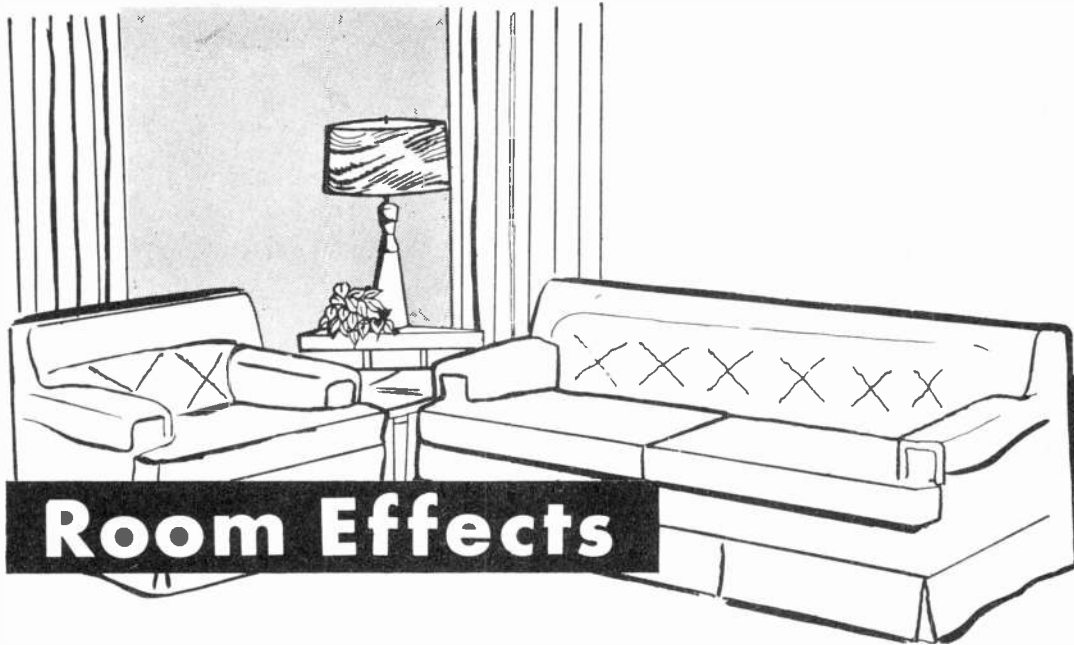

Part 2. Experiments with speaker placement show that listening room has considerable effect on reproduction.

HAVING dealt in a non-medical and non-technical way with the human ear, we naturally arrive at the room in which the ear is normally used for listening to reproduced music. Tonal discrimination must clearly involve an appreciation of what the room is doing to the sound.

Much has been written on room acoustics, but I still believe that the effects are greater than most people realize.

Size of Room

Some textbooks state that to reproduce a low-frequency sound the room must be at least as long as the wavelength you wish to reproduce, which means that a 50-cycle note requires a room nearly 24 feet long. The minimum usually advocated is half a wavelength, which means a 12-foot room for good bass down to 50 cycles, and I agree with this, but I do not agree that even smaller rooms are adequate.

As a matter of fact, a room about 11 feet long will have a main resonance at 50 cycles (with harmonics at 100 and 150 cps) and would tend to emphasize power-line hum from a noisy amplifier working into a good woofer. This, of course, refers to British power lines. At the 60-cycle power line frequency prevalent in the U. S. the equivalent room dimension would be 9 feet. It is clear that large rooms are better than small ones because the room resonances are lower in frequency and help to build up the bass in a region where it is often de-

ficient: Nobody says that a sound is inaudible if the room length is less than half the wavelength. It is simply not so well reproduced.

Concert Halls

The obvious way to avoid small room effects is to move into a good concert hall, where it is possible to hear what a loudspeaker is doing *before* it is affected by reflections from walls, and where the room (hall) resonances occur at much lower frequencies where they are less harmful. I know of no quicker or better way of assessing speaker performance, and I am unable to understand why nobody else advocates this technique; my voice is still like one crying in the wilderness.

It is not suggested that the final choice of one speaker for domestic use—out of say half a dozen samples—should be made in a concert hall, where conditions are different (and superior), but it is claimed that the reliable information so obtained can be applied to good purpose. I remember testing a speaker system with a new foam suspension to the cones, compared with a similar system with different cone surrounds, in St. George's Hall, Bradford, and in Carnegie Hall, New York, when everybody present immediately heard and appreciated the difference.

In short, a decision to adopt a new type of construction—cone, suspension, centering device, or a different cabinet, baffle, or horn, or even a change to electrostatic units—can often be made

in a few minutes instead of hours or days. This is achieved simply by improving the listening conditions.

Many of the effects to be observed cannot be produced by response curves taken in anechoic chambers or the open air.

Readers who do not own concert halls may wonder how all this affects them, and I agree it appears to be of rather doubtful value to amateurs. But there are thousands of halls which are used only a few hours a week, and serious investigators of sound reproduction could arrange tests without abnormal difficulty or expense. They would at least learn by comparison something of what a normal living room actually does to sound waves.

Ordinary Rooms

To get back to earth (before the Editor starts using his blue pencil), a general outline of my own listening room at home is given in Fig. 7. Apart from the fact that it is usually cluttered up with equipment and numerous loudspeakers (my wife is case-hardened), the furnishings, carpets, and curtains are normal.

The room measures 20 x 14 x 11 feet, so the main resonances occur at about 28, 40, and 50 cycles, but the odd shape at one end helps to break up the horizontal modes.

At A there is a permanent 3-speaker corner installation, which gives better results than any speaker ever tested in any other position in the room—in spite of the rude things often said

about corners and room resonance. At *B*, *C*, *D*, and *E* we do not find four more speakers, but simply one speaker tested in four positions. This is a 3-speaker sand filled baffle, measuring 34" x 31" with 12" sides, with 12" and 10" units facing forward, and a 3" tweeter mounted on a separate small baffle facing upward. The speakers radiate from both sides of the cones, and the main baffle therefore performs as a doublet at low frequencies (Fig. 6). (As the tweeter also radiates from two sides in a vertical direction, I suppose the whole system could be described as a "Quadlet," but I doubt if the Acoustical Society of America or if the A. E. S. will ever accept this new term!)

A speaker which radiates in one direction only, say from a reflex cabinet, is known as a simple radiator (not a "Singlet") and appears to be less susceptible to room effects than a doublet. I have therefore selected the open baffle, stand-anywhere model as the basis of this test, because results were easier to observe. Although a simple radiator does not behave in the same way as a doublet, many of the room deductions would still apply.

The first and most important lesson to be learned is that strong directional effects in middle and upper registers must be avoided like the plague. With a simple radiator this can often be done by facing the speaker into a corner or at an angle of 45° towards a hard wall, so that the sound is splashed into the room and thus loses some of its "loudspeaker" quality. In a good concert hall, undue directional effects give an even more unnatural result.

To revert to Fig. 7, the general conclusions are as follows, but it will be understood that other rooms, other speakers, other ears would give different results. It is equally important to remember that results vary according to the type of record or radio transmission being used. Large choral and orchestral works often contain a good deal of studio coloration or ambience which might clash with the room resonance. A rather dry, crisp recording is essential. Solo voice is an excellent test, but a good, clean piano record is hard to beat, as the frequency range covers seven octaves and any "boxiness" in reproduction is easily noticed. It is worthy of note here that the type of recording which sounds "right" in a good concert hall, and is therefore free from excessive recorded ambience, is ideal for these tests as it will not lead the ear astray.

Here are the findings for the various positions:

Position A: This has already been awarded pride of place. The 3-speaker system in use here is not movable, in common with many reflex cabinets and back loading horns designed to give optimum results from a corner. In short, the speaker objects to being pushed around, so it cannot conveniently take part in the tests under consideration. Room resonance may or may not be prominent, but can easily be

countered by the use of an extra speaker, which may be comparatively small, suitably placed in the room. Experiments on these lines will be described in Part 3 of this series.

Position B: runs very close to *A*, without exciting the full room resonance. Any speaker with a pronounced enclosure resonance around 50 cycles might sound better here than at *A*. Suits dance bands.

Position C: A nice combination of medium bass and good reflection of rear sound waves. Suits most types of music.

Position D: Ideal for those who prefer completely nondirectional effects. (There is no reason why the loudspeaker should always look the listener straight in the eye, or ear.) Very good on guitar and similar instruments. Room resonance well masked.

Position E: This position gives the impression that the music is being played in the room rather than through a hole in the wall, and is liked by some listeners.

A-B Testing

Some readers may suspect that the effects of speaker placing are being exaggerated, but an *A-B* test of two similar speakers often proves its importance. For instance if speaker *A* happens to be standing in a better position, acoustically, than *B*, a preference for *A* might be transferred to *B* simply by transposing the speakers. This is another reason why large hall tests are safer: a difference of two or three feet in position is of no consequence, but in a small room this may be serious.

Load Matching: Connecting an extra speaker in parallel with one already in use obviously halves the impedance, assuming that both speakers are the same. With modern negative-feedback amplifiers the output resistance is low and the damping factor is high, so a mismatch to the speaker load does not cause distortion—it merely reduces the available distortion-free power. Assuming your amplifier will give 20 watts

clean output, connecting a (perfect) 16-ohm speaker to a 16-ohm output circuit would make available the full 20 watts. If you then add another 16-ohm speaker in parallel, and halve the impedance of the load, the available power is also approximately halved. If you are not using more than 10 watts at any time, there is nothing to worry about; but if you are likely to exceed 10 watts, it is desirable to change to an 8-ohm output tap or thereabouts for better results.

"Perfect" matching never comes our way, because speaker impedance varies with frequency, so it is only necessary to come reasonably near. For instance, an output circuit rated at 8 ohms is quite satisfactory with nominal speaker loads between 6 and 10 ohms impedance.

If two or more speakers are to be added in parallel it would be advisable to work on a low output impedance, say 3-5 ohms, so that more power becomes available as the extra power-handling capacity is increased by connecting the extra speakers.

I hope these comments will encourage readers to try various experiments where room and furniture will permit. Even results from an ordinary radio set can often be improved enormously by removing the back and placing the cabinet across a corner at a suitable distance from the wall.

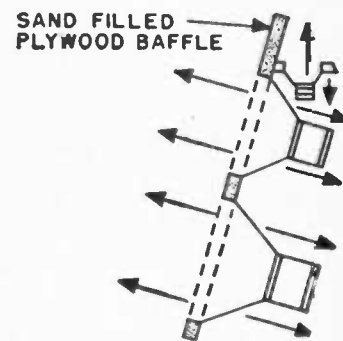

Fig. 6. Doublet speaker system used.

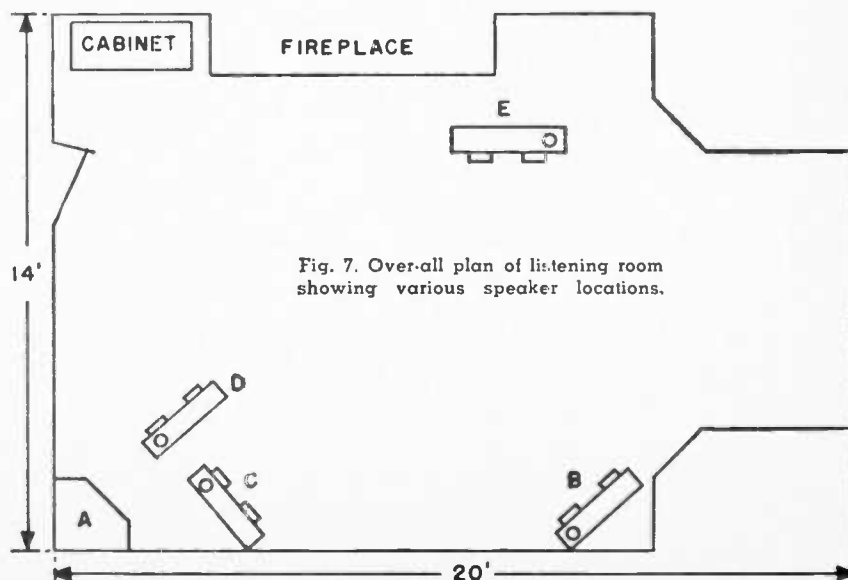
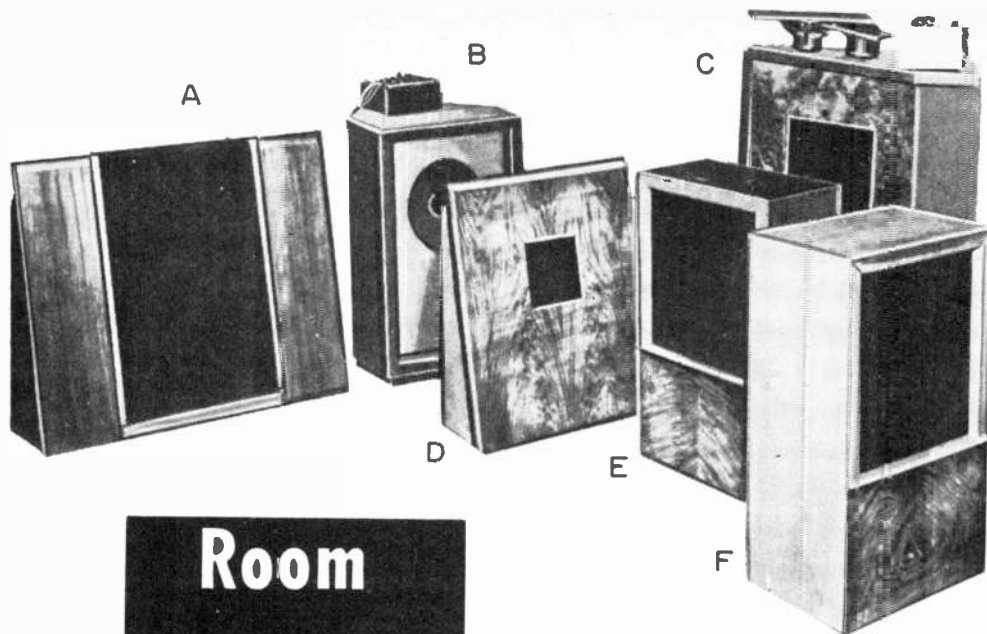

Fig. 7. Over-all plan of listening room showing various speaker locations.



Room Resonance & Stereo

Fig. 8. Photograph of speakers outlined in Fig. 9 (A) Three-speaker system used in tests described in Part 2. (B) "Super 12" in Electre-Voice "Aristocrat" cabinet. (C) Three-way corner system. (D) Ten-inch speaker on sand-filled 28" x 24" baffle. (E), (F) Ten-inch speaker in 2 cu. ft. bass-reflex enclosure with acoustic filter.

Part 3. Observations on reducing room resonances and providing 2-channel sound with multiple speakers.

IT SEEMS to me that the excellent results obtained from two-channel operation are, to some extent, due to the use of two loudspeakers which break up room resonance; therefore, similar room control can be achieved with single-channel output. I would not say that this is half way to stereo, but I think we could label it "demi-semi stereo."

The main difficulty (at least to my ear) is with solo items, as it is rather disconcerting to hear two Victoria de Los Angeles's instead of one; but judicious orientation of the extra speaker, *e.g.*, towards a corner, overcomes objectionable directional effects. A back-to-back set-up also gives excellent results with simple radiators. A few weeks ago I heard a demonstration of the Philips "Novosonic" system at Century House, London, and I was greatly impressed by the way in which room resonance was overcome by the judicious placing and spacing of one bass enclosure and two treble speakers working with a crossover at 300 cycles.

Added to this, our technical director, Mr. R. E. Cooke, recently returned from Denmark with his head all full of new and interesting ideas and developments. Now the main purpose of Mr. Cooke's visit was to spend some time with my friend David Hall, formerly Music Director, Classics Division, Mercury Record Corporation, U. S. A., and now lecturing at the University of Copenhagen.

I was most interested to learn that David Hall listens, at home, to several

speakers at a time in order to overcome room resonance, two of them being reflex cabinets with an acoustic filter similar to the units shown in Figs. 8 and 10. One is placed under the grand piano and the other under a desk. I quote Mr. Hall as follows:

"The reflex cabinet in the desk knee-hole is the thing for good bass, especially since the desk is *very* heavy and does not resonate."

I attach great importance to what he does, for the following reason. Prior to our first Carnegie Hall demonstration in 1955, I was anxious to have some guidance as to which American records would suit the hall (Carnegie, not David!). Mr. Hall gave us a list of some 30 records of various makes, and when I later compared the program with this list I was amazed to find that every commercial record used had been recommended thereon. This shows almost uncanny knowledge of acoustics and the effects of recording and reproducing characteristics.

As a result of these and similar experiences, I have carried out a number of listening tests at home, which I will now proceed to describe. My yardstick for judging reproduction is a very simple one: the arrangement which sounds least like listening to loudspeakers is the best.

It is necessary to include another plan of my own listening room to show the disposition of the half dozen speakers used in the tests. (See Fig. 9.) The corner speaker referred to as A in Fig. 7 of Part 2 now becomes C.

A photograph showing all the speakers assembled in a corner of the room is reproduced in Fig. 8. I have already explained that Mrs. Briggs is case-hardened, but before readers start sending her letters of sympathy I must add that the present conglomeration of speakers is unusual, even for me.

The speakers used in the test were *Wharfedales*, but the findings would hold true with any reasonably good specimens of any make. In fact, a potent argument in favor of the use of two speakers of different size and shape is that inequalities tend to be smoothed out. It is obvious that if you have a cabinet speaker which honks a bit in the bass, and you add an open baffle speaker in parallel, you reduce the honking by about half. As we have already agreed that room honking is reduced, we seem to be approaching the millenium of double loudspeaker demand. Even the rather boxy tone of the average radio set can be improved by simply adding an external speaker with no cabinet or baffle, thus removing half the sound from the box or resonator. The speaker units are shown externally in the diagram to indicate the direction in which they were facing. Any speaker could be switched on or off at will. My general opinions are as follows, but other rooms would produce different results.

1. Two speakers are much better than one, but three are only slightly better than two on large works. More than three not worth the space used.

2. Speakers A and C gave best results on chorus, orchestra, and organ. Then A and B, then B and C, then C and D.

3. Speakers C and D were best on solo items, and very satisfactory on

everything. Probably the best all-round acoustic set-up.

4. Speakers *B*, *D*, and *F* facing towards the left could be added to *A*, *C*, or *E* without producing disembodied effects on solos, and yet with beneficial results on all types of music.

5. Speaker *B* being very sensitive and directional was always preferred *not* facing straight into the room. Improved transient response from the high-flux magnet system could be heard when this "Super 12" came on.

6. The piano always sounded best with open mounting associated with *A*, *C*, or *D*. Cabinets like *B*, *E*, and *F* give a slightly "boxed-in" effect on this instrument. Speaker *A* alone was better than *B* and *E* or *E* and *F* together, but a cabinet/baffle combination was very good.

7. Baffle *D* with reflex cabinet *E* was better than the two cabinets *E* and *F* on practically all types of music.

8. Cabinets *E* and *F* were preferred standing back-to-back.

9. Most cabinet speakers used singly, other than corner models, give best results when pointing towards a corner or at an angle of 45 degrees to a hard wall, so that the sound is splashed into the room.

10. With two speakers, phasing often makes a big difference in the results. Always try reversing the leads to one speaker. In some positions, out-of-phase connection will be best.

11. For optimum bass, side-by-side (in-phase) placing is obviously best, but this arrangement is the least effective in killing room resonance.

No doubt many readers already possess a spare loudspeaker which could be mounted on a baffle and pressed into service for experiments on the lines indicated. Unlike stereo, equal sensitivity is not necessary, but the extra unit must at least be loud enough to make its presence felt to some extent.

Baffle *D* used in these tests was made from two sheets of ¼ inch plywood 28 x 24 inches with a ½ inch layer of sand between them. Two side pieces in ½ inch plywood 9 inches wide at the base and narrowing to 4 inches at the top support the baffle and provide a reasonable backward slope. The associated speaker unit should have a cone resonance below 40 cps for satisfactory performance.

Although a simple baffle is recommended for the second speaker in these tests, and the size described gives very good results with a suitable 10" unit, of the two I still prefer the reflex cabinet with acoustic filter for single speaker use on most types of program material. For one thing, there is more "beef" in the bass.

Stereo

As the domestic use of two-channel recording and reproduction appears to have made more progress in America than in Great Britain, I will confine my remarks to the expression of a few opinions which I have formed on the experience I have had so far.

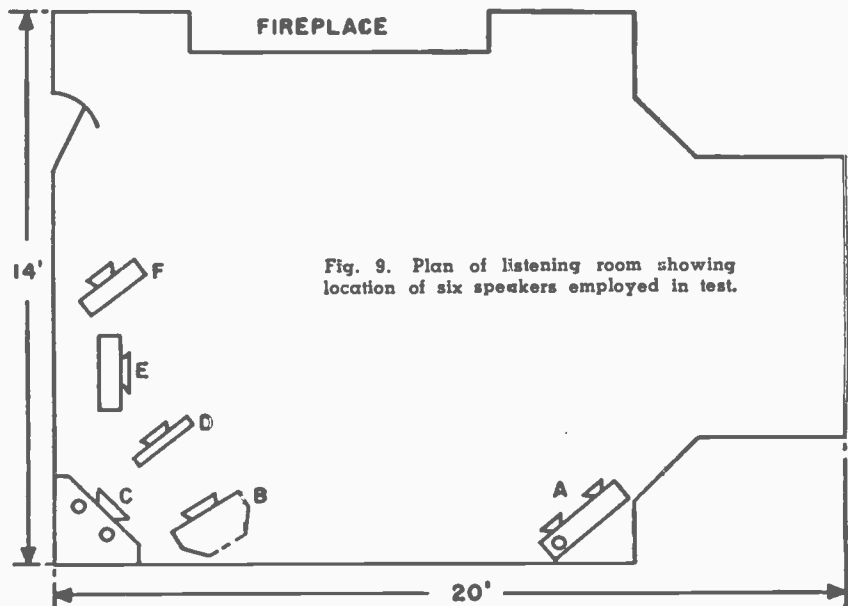

Fig. 9. Plan of listening room showing location of six speakers employed in test.

I am firmly of the opinion that the undoubted step forward in natural reproduction, which is possible with two channels, is due to sweeter top and fuller and rounder bass rather than to true stereophonic effects. When I hear the woodwind in an orchestra I am concerned (a) with what they play; (b) with how they play it; and, (c) with how it sounds. I am not the least bit interested in where they sit.

I agree that some stereo recordings used with directional loudspeakers, correctly placed, give very lifelike results to listeners also correctly placed. We played a couple of HMV "Stereosonic" tapes (7½ ips) in the Royal Festival Hall, London, in May, 1956, and my estimate is that about 1000 people out of 2500 heard something far superior to the best we did with single channel tape at 30 ips, but the remaining 1500 heard something unbalanced and unsatisfactory. Admittedly, the difficulties are far easier to overcome in small rooms (three channels are really necessary for large halls), but placing two loudspeakers and, say, half a dozen listeners ideally in a fully furnished room is not easy.

But if we forget stereo and use omni-directional loudspeakers we can have some glorious sound and sit where we like! Mr. A. R. Sugden of Brig-

house, Yorkshire, has given convincing demonstrations on these lines, and we demonstrated "Stereosonic" tapes at the 1956 Audio Fair in London using the speaker systems shown in Fig. 10. (The tweeters face upward.)

These views received strong confirmation recently when Allen E. Stagg, manager of *International Broadcasting Company*, London, played for me some two-channel orchestral recordings just made with a newly acquired *AmpeX* 300 machine (speed 15 ips). No special attempts at stereophonic depth had been made—in fact, the microphones were placed above the orchestra—with the result that excellent sound could be heard irrespective of the location of the listener.

One of the main virtues of two-channel operation is that studio and listening room coloration is reduced to a minimum. Also, in view of the ever prevailing difficulty of achieving perfection, "two channel" is a safer and sounder cognomen for the whole system than "stereo." Even movie houses, which went over to three-channel stereo with such a bang a few years ago, seem to be slipping and merely piping doctored sound levels into the various channels. I suppose they have decided that good stereo will not replace a good story.

Fig. 10. Photograph of two speaker systems used to demonstrate two-channel sound.



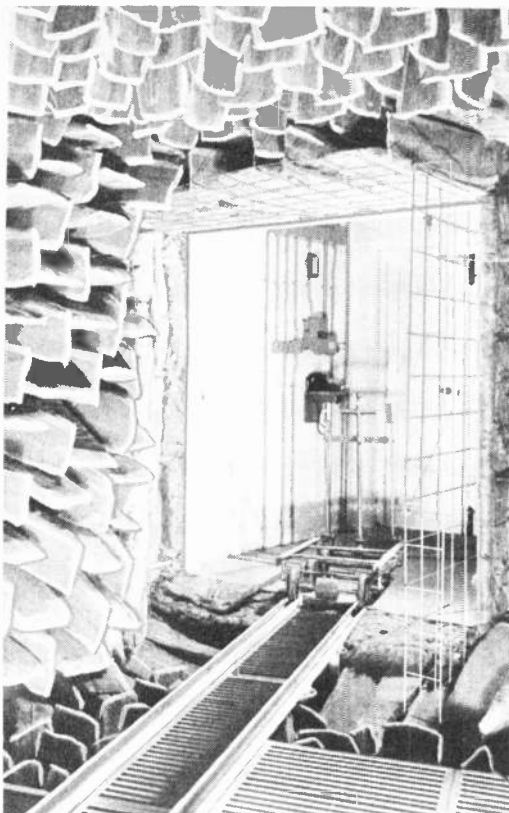

← Fig. 11. British Broadcasting Corp. anechoic room showing removable floor.

Testing

Loudspeakers

Part 4. Listening tests and acoustic response curves, with method of using live room for useful measurements.

IN THE previous articles of this series we have examined the problems of reproduction of sound as affected by the human ear and listening rooms. In other words, we have been dealing with sound waves after they have left the loudspeaker. We now come to the subject of this article which is the transducers themselves.

There are many ways of testing loudspeakers, but unfortunately there is no single test which will give us all the answers. By comparison, testing an amplifier is child's play; pickups are about half way between the two in elusiveness.

Useful speaker tests should include the following: objective listening, response curves, impedance curves, transient response and resonances, directional effects, power handling capacity, and efficiency. All of these qualities are seriously affected by the method of mounting the speaker, a problem which will merit at least a complete article in itself. But let us deal with the questions in order.

Objective Listening

It is most important to remember that our raw material is far from perfect: with both radio and records we have to take what we can get. The idea that records are turned out to a specified characteristic and can be played back perfectly by using an inverse of the characteristic always strikes me as fantastic—rather like believing in astrology, fortune-telling,

or fairies. At the recent Audio Fair in London I heard more than one demonstrator say: "This record is AES. I am therefore playing it with AES correction and no further use of tone controls." This he would proceed to do with a virtuous air, no matter how awful the results. I can see no sense in altruism of this sort. The only way to play records is to adjust the controls to suit the speaker, the room and number of people in it, and the condition of the record.

Now that the same original recording is often available to the general public in different forms, variations in "characteristics" can easily be found by comparing the finished articles. The available forms include the 33 $\frac{1}{3}$ and 45 rpm discs and 7 $\frac{1}{2}$ ips monaural and stereo tapes.

It is not at all strange that variations should crop up (it would be a miracle if they did not), but they are, in some cases, so great that it is difficult to believe that the same original material was involved. If the bass on a record has been attenuated by narrow groove spacing in order to get a complete movement on one side of the disc, the remedy is to apply some bass boost to the replay and forget all about the supposed recording characteristics.

Although we have used disc recordings to illustrate the point, our experience is that tapes display even wider variations, and top cut to avoid hiss is often necessary. In fact, there is ample evidence to show that the loud-

speaker is still not the only imperfect link in a modern reproducing chain.

I think it was Robert Browning who wrote, "What's come to perfection perishes." (Actually, I know it was Browning because I have been thumbing through my Anthology again.) If the words are true, it is to be hoped that we are still a long way from perfection in the art of sound reproduction.

Similar reservations apply to program material from FM radio, which at its best provides the finest quality of reproduced music available in England today; but if you use a tuner preset to the three available transmissions ("Home," "Light," and "Third" programs) and switch from one to the other, the variations in frequency range and tonal quality are enormous, and the use of wide-range hi-fi equipment becomes impossible without adequate means of tone control. My experience is that when the quality on one program is excellent, the other two are usually pretty grim.

Response Curves

The longer I test and listen to loudspeakers, the less importance do I attach to the response curve as the final arbiter of performance. I suppose the reason is that we do not listen to music with a slide rule. For instance, you cannot put a speaker in a box or on the end of a horn without making it sound as though it is in a box or on a horn. You can "tune" the box (reflex enclosure or Helmholtz resonator to the expert): you can line it and fill it with soft absorbers until theoretical perfection is attained, but you still end up with a speaker in a box and no response curve will show the effect. Of

course, the bigger the box, the less "boxy" the results. Fortunately, after a short period of listening the ear becomes punch drunk and no longer notices coloration: hence the ubiquitous radio receiver and radio-phonograph combination.

Incidentally, Mr. P. J. Walker had a similar experience when working on the design of full-range electrostatic speakers. He told me that he could easily increase the output at low frequencies by adopting some form of resonant enclosure of moderate size, but once this was done his new speaker sounded exactly like much cheaper moving coils and there was no point in proceeding.

I submitted the foregoing comments to Mr. Walker for his approval, and he added the following very interesting note:

"I did explore horns, vented enclosures, and completely sealed enclosures. They all introduced coloration except one, and that was a long and rigid tube built of brick with progressive Fiberglas damping. This was very good but not very practical."

As I have advocated bricks for many years as the cheapest and most effective way of avoiding panel resonance, I was interested to have this confirmation of their sterling qualities.

However, Mr. Walker wisely decided to increase the size of his speaker and retain its character, which would not show on a response curve.

There are many different ways of mounting and loading a loudspeaker—often with murderous results—and arguments about their merits and shortcomings have gone on for so long that the newcomer to hi-fi must find the outlook rather bewildering. In fact, discussion has been just about as endless and indeterminate in this country as on the subject of capital punishment. I think the following comment by the Archbishop of Canterbury would apply in both cases:

"This long and distressing controversy . . . (over capital punishment) is very unfair to anyone meditating murder."

No doubt the situation will eventually be resolved by a general decision to look on the speaker and its mounting as one item instead of two, as is presently the case.

In spite of limitations, response measurement still remains an important aspect of speaker tests and requires conditions approaching those of a free (acoustic) field. These conditions are usually obtained either by operating out of doors, with the loudspeaker hoisted clear of the ground, well away from buildings and other reflecting surfaces, or by the use of anechoic chambers.

The first method approaches the theoretical ideal but is fraught with practical difficulties due to the vagaries of the weather, wind, and ambient noises. In Great Britain the weather is capricious, and suitable dry spells with little or no wind rarely coincide with

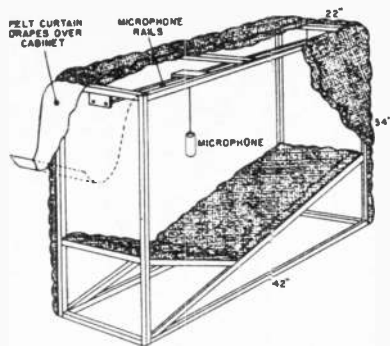

Fig. 12. Details on construction of absorbent enclosure used for the measurement of loudspeaker response in live rooms.

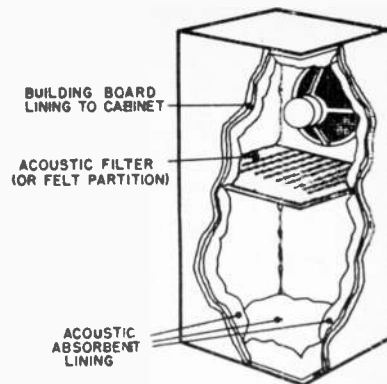

Fig. 13. Five cubic foot enclosed cabinet used for speaker mounting for response measurements with Fig. 12 enclosure.

periods of technical activity. On the other hand, anechoic chambers are very costly to construct. With Fiberglas wedges at £1 each, a room of reasonable size may cost upwards of £5000. The outlay of capital and use of valuable floor space can hardly be justified for occasional use. Furthermore, the average, medium sized anechoic chamber does not provide free-field conditions at frequencies below 100/150 cps, and measurements at very low frequency therefore require experienced interpretation.

Such limitations would hardly apply to the free-field room, described in Olson's "Elements of Acoustical Engineering," which is 32 feet x 20 feet x 20 feet after treatment (some room!) and I noticed during a visit to *Bell Telephone Laboratories* in 1955 that they have two anechoic chambers—one large and one small.

I do not know how many of these rooms have been built here in England, but I have visited half a dozen as follows: *BBC, G.E.C., G.P.O., Goodmans, Hawley Products, and Plessey*; and Mr. Cooke has had a look (forgive the rhyme!) at the National Physical Laboratory and the *Philips* installations.

The *BBC* room at its research department in Kingswood Warren, Surrey, is interesting on account of the loose grid floor which can be removed for very precise work. A view taken from the inside, looking towards the entrance, is shown in Fig. 11. (I have no precise information on what happens if you enter the dead room after the ironwork has been removed, except that shouts for help are inaudible.)

The walls, floor, and ceiling are lined with Fiberglas wedges 40 inches long and the useful room space measures 15 feet x 10 feet, 8 inches x 7 feet, 4 inches. This gives near-perfect free-field conditions down to 150 cps, but useful measurements can be made at much lower frequencies. A rubber-tired trolley for moving heavy enclosures can be seen in the doorway. When work is in progress the entrance is closed by a heavy door also fitted with the Fiberglas absorbent wedges.

To avoid the difficulties of open-air working and the high cost of building anechoic rooms, attempts have been made to carry out measurements in live rooms, the effects of standing waves being minimized by placing the microphone only a foot or so from the loudspeaker and by screening off the space around them with sheets of sound absorbent having an appropriate flow resistance. Mr. D. E. L. Shorter of the *BBC* showed us some response curves taken in this way. The speaker, which had an unvented cabinet, was mounted as far as possible from all obstacles. Using a velocity microphone to minimize room effects, the curve obtained was within 2 db of the corresponding curve taken in the dead room. The close microphone position introduces a spurious bass rise (which can be allowed for), together with some other errors at frequencies where the cone breaks up. However, these errors are nearly constant for a given type of speaker so that the method can be useful for production checking.

We find that we can get a lot of reliable information from curves taken in the absorbent enclosure illustrated in Fig. 12, which consists of a light wooden framework covered with sound absorbent material, with extra oblique layers of the same material above the floor. The frame is built of solid wood (2" x 2") covered by double layers of resin-bonded Fiberglas each 1" thick. It is large enough to permit measurements with loudspeaker/microphone spacings up to one meter (39.37 inches) and 30 degrees off axis in a vertical direction at that distance.

In a live room, sound from the loudspeaker reaches the microphone both directly and after reflection from the room boundaries. The purpose of the screen is to increase the ratio of direct to reflected sound. Obviously, sound waves reach the microphone directly without attenuation, but reflected sound is attenuated during its passage through the absorbent screens. Because of the close proximity of the floor it is advisable to use several layers of absorbent material on the bottom of the screen.

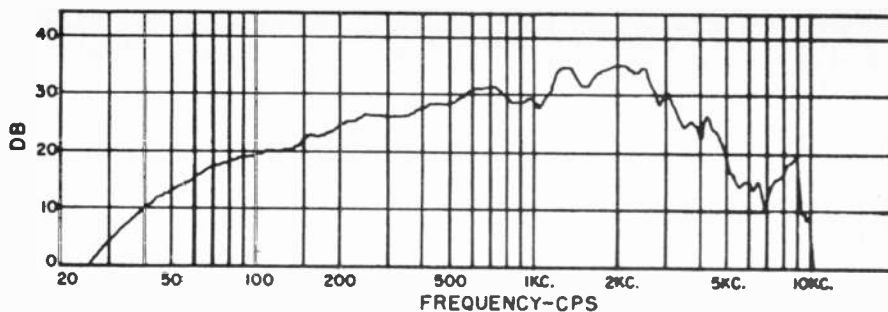

Fig. 14. Outdoor test employing a 15-inch loudspeaker in 5 cu. ft. closed cabinet standing on ground. Microphone 1 foot on axis. Input 1 watt at 400 cps.

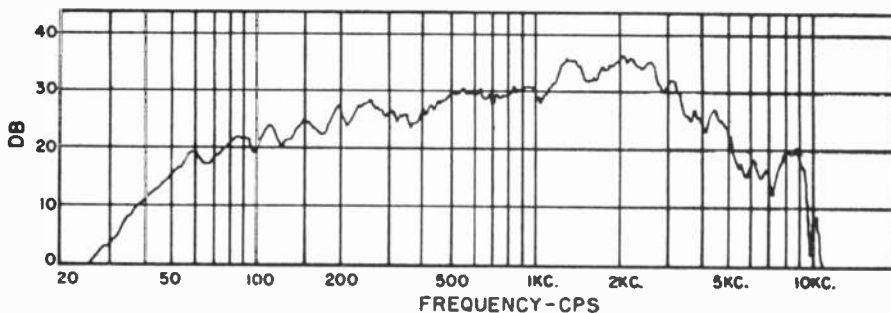
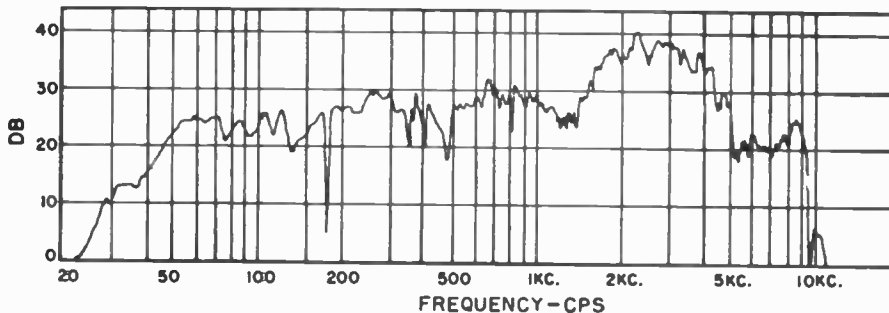

Fig. 15. Same setup described for Fig. 14 except indoors with absorbent enclosure.

Fig. 16. Indoor curve of 15-inch speaker mounted in 9 cu. ft. brick corner reflex enclosure. Microphone is 1 foot on axis in absorbent enclosure. Input as above.



A further improvement in the ratio of direct to reflected sound can be achieved by using a directional microphone with its axis adjusted to discriminate in favor of direct radiation.

There is no advantage in using a cardioid microphone as compared with a figure-eight type, because both have approximately the same ratio of direct/reflected pickup. The velocity type microphone has two thin lobes (front and back) whereas the cardioid has one fat frontal lobe, which in some cases can be a disadvantage because it picks up more floor reflections.

A suitable microphone is the *Standard Telephones and Cables* ribbon type 4038A, which has a uniform response from 40 to 12,000 cps to sound at normal incidence to the ribbon. Satisfactory direct/reflected sound pickup can be achieved by keeping the loudspeaker/microphone distance as low as one foot, for measurements up to about 2000 cps. Above this frequency such a small distance gives erroneous results because of the reflection effects taking place at the surface of the cone, and it is advisable to increase the microphone spacing to some 3 feet. Fortunately,

we are able to do this without introducing serious irregularities in the response reading, because the absorption coefficient of the Fiberglas screen increases rapidly with frequency. Where measurements are required at frequencies higher than 12,000 cps, we use a miniature Rochelle Salt sound cell microphone, or a miniature Rochelle Salt "X"-cut expander block. Both these instruments are small enough to have negligible diffraction effects up to about 20,000 cps, and both respond to much higher frequencies.

The loudspeaker under test may be mounted in the wall of the room—a perfect and simple infinite baffle—or it can be placed in a totally enclosed cabinet similar to the one illustrated in Fig. 13. This has a volume of 5 cubic feet, is rigidly braced and lined with building board to prevent panel resonance, and acoustically treated to avoid standing waves. The absorbent enclosure of Fig. 12 can, of course, be placed in front of a loudspeaker already mounted in a corner cabinet or horn.

The response curves of Figs. 14 and 15 show the results obtained. A 15"

foam-surround speaker was mounted in the 5-cubic foot enclosure and curves were taken in the open air (free-field) and in the lab (with absorbent enclosure). Incidentally, this 15" unit is normally recommended for use up to 1000 cps only, because of the rise in output in the 1000 to 5000 cps region.

It will be observed that the irregularities introduced by the room are about ± 2 db up to 1000 cps and less than ± 1 db above that frequency.

The severe low-frequency roll-off below 100 cps is due to the closed box which is small for a 15" speaker. Fig. 16 shows the output from the same unit mounted in a 9-cubic foot corner reflex enclosure built of bricks and mortar; at 50 cps the output is some 8 db higher.

It will be appreciated that this indoor method of taking curves with the microphone fairly close to the speaker makes it impossible to include the low-frequency output from the vent of a reflex enclosure in the main response curve. The vent of this 9-cubic foot enclosure resonates at around 35 cps and greatly enhances the output in the region below 50 cps.

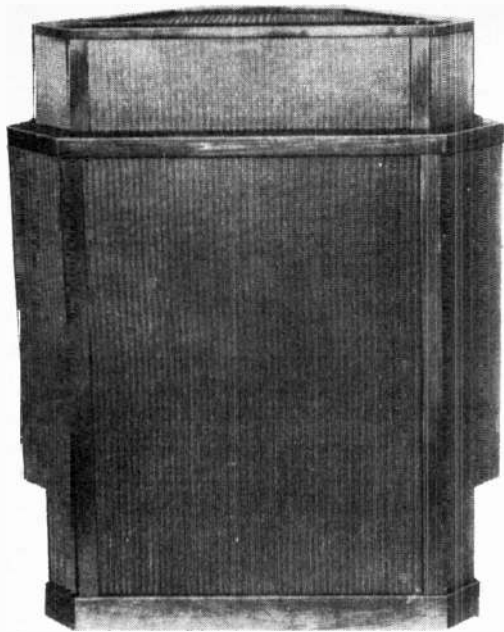

Impedance curves of speaker systems, such as this Briggs sand-filled 3-speaker corner enclosure, may be readily taken with a simple audio generator and high-Z meter.

Checking Speaker Performance

Part 5. More information on speaker listening tests and impedance measurements in evaluating performance.

AT THE end of Part 4 reference was made to the vent output from a 9 cubic foot corner reflex enclosure and the difficulty of including this in the main response curve. In order to see what comes out, one of these cabinets was turned upside down and the curve of Fig. 17A was the result. (Fortunately, sound waves do not know when they are upside down.) As it was impossible to prevent some of the sound waves from the front of the cone reaching the microphone, the vent was then sealed off and the curve of Fig. 17B was taken. The output from the port is therefore that of Fig. 17A minus Fig. 17B.

It is interesting to note that the dip in response around 200 cps which is shown in Fig. 18A is replaced by a peak in the vent output of Fig. 17A. This may account for the fact that the dip looks worse on paper than it sounds to the ear.

Ear vs Microphone

Having stated that a listening test is more important than a response curve as the *final* arbiter of speaker performance, there must be instances where the two are in conflict, and where the pure technician would choose one system or modification but a keen listener would choose another. There can be little doubt that loudspeaker design is not purely a technical problem; it is an art as well as a science.

The theoretical benefits of absorbent linings are clearly shown in the curves of Figs. 18A, 18B, and 18C, which were taken in the open air with a microphone distance of 4 feet. The speaker is a 15" foam surround unit.

The dip at 200 cps is due to top-to-bottom standing wave effect inside the cabinet (distance $35\frac{1}{2}" \approx$ half a wavelength at 200 cps). In the reproduction

of music the human ear does not notice a sharp dip on music as readily as it registers a peak. This dip is partially eliminated by the treatment of Fig. 18B, and more so by the extra padding of Fig. 18C which also removes minor irregularities between 500 and 2000 cps. The microphone is superior to the ear in noticing small variations in response.

As the 15" unit is normally used in the enclosure with a crossover at 1000 cps or lower, the dip at 1200 cps can be taken as a blessing in disguise.

Now to the question of choice. I would wager the proverbial little apple that nine technicians out of ten would plump unhesitatingly for the treated cabinet of Fig. 18C, but I still prefer the livelier performance of the untreated cabinet of Fig. 18A, and so do the majority of listeners. A treated enclosure is always available for test and comparison purposes and we raise no objection if users like to apply the treatment at home.

It is worth noting that folded corner horns constitute a form of enclosure free from absorbent linings and many listeners like the reproduction in spite of irregularities from reflecting surfaces, which show up on a response curve but do not necessarily distress the ear.

Home Tests—A Warning

Before leaving the subject of tests and response I should like to issue a word of warning about the use of variable frequency records for home tests of loudspeakers. Many test records with frequency bands going down to about 30 cps are being sold, but they can be rather dangerous and very misleading in use.

They are dangerous because they are used with power amplifiers. A speaker which will handle, say, 15 watts input on music might suffer very badly with 15 watts at a spot frequency in the 30-

100 cycle region. Only theater-type speakers could be expected to stand up to such punishment. A reasonable domestic limit would be 3.5 watts, according to size of speaker and type of enclosure.

Most frequency records are misleading for many reasons: in fact, no self-respecting engineer would waste time trying to test speakers with such doubtful material; he would use a first-class b.f.o. Pickup and tone arm resonances are still prevalent and rule out any accurate assessment of speaker performance.

But, in any event, it should be stressed that frequency tests of loudspeakers always require experienced interpretation, because misleading buzzes and rattles often arise. A cotton bag over the speaker may vibrate and cause a rattle at one frequency, but not on music; a piece of mesh may do the same. A panel of wood or an object in the room near the speaker may vibrate and sound exactly like a speaker fault. The cone in a loudspeaker with the very desirable attribute of free suspension can move such a big distance with large input at its resonant frequency that it might actually hit the fabric or mesh placed over the speaker opening; many amateurs would mistake this for a fault.

In writing the foregoing, I do not seek to deter users from making tests; I only wish to advise extreme caution, with a warning that 3 watts at 1000 cps may sound very loud, but below 100 cycles it begins to sound softer and softer due to the ear, and it is foolish to try to make 40 cycles sound as loud as 1000 by stepping up to 20 watts or more.

It is also most important to remember that it may be misleading to judge the performance of a speaker by its power handling capacity; it must be judged by what comes out—not by what

Fig. 17. (A) Open air response curve with microphone close to vent of 9 cu. ft. corner reflex cabinet. Input 1 watt at 400 cps. (B) Same setup as described for part A of figure except port closed to show the stray radiation from front of cone. →

goes in. After all, nobody praises a meal in a restaurant simply because it was expensive. It is clear that acoustic enclosures—especially small ones—usually restrict cone movement and make it possible to pump 10 or 15 watts into a speaker which might knock badly at some low frequency at 5 watts on open baffle, where the cone is free to move as it listeth. Any assumption that the enclosure is therefore two or three times as good as the open baffle would be a fallacy, because it is obvious that restricting cone movement reduces output and results in much waste of energy in small infinite baffles. Helmholtz resonators and exponential horns do, of course, help to push the low-frequency sound waves into the room where they are wanted, but even these devices are not always as efficient as is generally believed. There is room for further investigation here and we are hoping to deal with the question in some future article in this series. Directional effects are mainly responsible for the so-called efficiency of horn loading, and an open baffle is probably no less efficient in an average listening room (down to cut-off frequency due to size of baffle) because all the sound generated by the cone on both sides is used. The only way to increase such sound is by resonance and nobody wants to hear induced speaker resonances above 60 cycles.

To sum up on the question of home tests, my advice would be: (a) Always start frequency tests with the volume control in the minimum position and turn up cautiously, (b) judge low frequency performance by purity of sound rather than amount of noise, (c) do not expect too much below 40 cycles (Happy is he that expecteth nothing.), (d) move about when listening, as position in room makes a big difference in what is heard at various frequencies, and (e) remember that pickup and tone-arm resonances still exist, and if one of these coincides with a speaker resonance quite hefty effects may be produced.

This brings us to the end of the section dealing with response tests.

For furnishing a quick and reliable picture of the status of different speaker systems, an impedance curve is almost *sine qua non*. Proud owners of multi-speaker systems with six woofers, six squawkers, and a battery of

Fig. 18. (A) Open air response of 9 cu. ft. corner enclosure made with sand-filled panels. No absorbent lining was used here. The input was 2 watts at a frequency of 400 cps. (B) Same conditions as for part (A) but with glass fiber scattered on the bottom of cabinet. (C) Same as for two previous tests but with sides, top, and bottom lined with 1 inch cellulose wadding and fitted with Wharfedale acoustic filter.

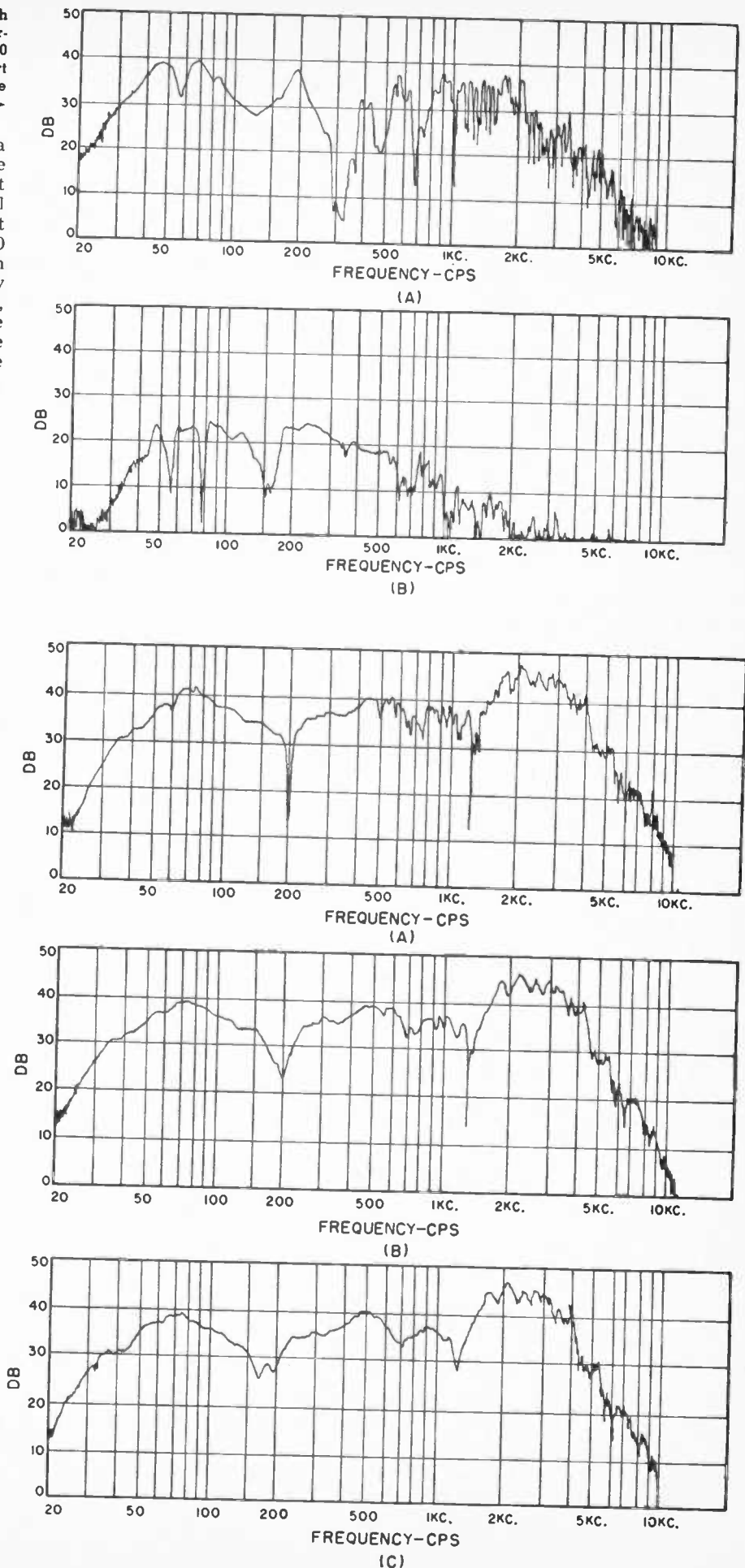

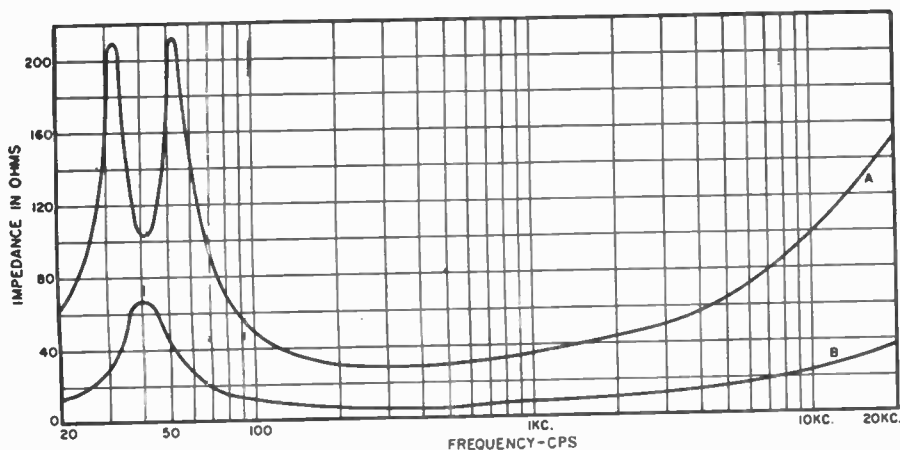

Fig. 19. The above impedance curves show the difference between series (A) and parallel (B) connections of the same two speakers having different cone resonances.

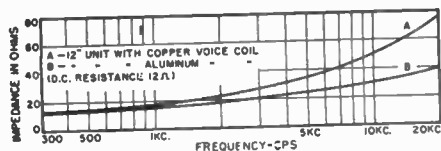

Fig. 20. Impedance curve of a 12-inch speaker unit fitted with a copper voice coil (A) compared to a unit fitted with an aluminum voice coil (B).

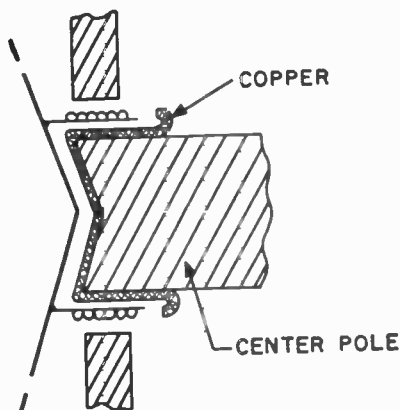

Fig. 21. Copper damping cap adopted by Philips to reduce voice coil inductance and improve the performance obtainable at the higher frequencies.

tweeters might well produce a level impedance curve as evidence of good performance.

The impedance curves of Fig. 19 show the difference between series and parallel connection of two speakers with different resonances. Parallel working always helps to smooth out irregularities

and is preferable to series connection for the practical reason that one speaker continues to work if the other breaks down, and because series connection destroys much of the benefit of the high damping factor of the modern amplifier (there is virtually a resistance in series with each speaker).

Two basic faults of the moving coil speaker have always been the rise in impedance at fundamental cone resonance and at frequencies above 1000 to 2000 cps. The effects of the bass resonance have been largely counteracted by the high damping factor of the modern amplifier, and the steep rise in impedance with frequency has been reduced by the use of aluminum voice coils and other devices. The effect produced by an aluminum coil is clearly shown in Fig. 20.

One advantage in using two or more speakers with or without a dividing network is that a more uniform impedance/frequency characteristic is possible. This is clearly shown in Fig. 22, where the impedance of a three-speaker baffle system (referred to in the article on listening rooms) is shown to be virtually flat apart from the bass resonance in the 20-50 cycle region where it is taken care of by the damping factor of the modern amplifier.

By using three speakers with voice coils of different resistance it is possible to vary the current flowing through each speaker and so obtain a balanced over-all performance. In the set-up in question, the voice coils vary between 7 ohms and 17 ohms d.c. resistance and are so arranged that the big unit does most of the work at low

frequencies, but the tweeter takes precedence at the other end of the scale through a 4 μ fd. capacitor. The middle speaker is not allowed to make a nuisance of itself in any region—it merely helps to smooth the results. All this is done without the cost—in decibels and dollars—of a dividing network, which is usually essential with reflex and horn loading.

Apart from mass, it is the inductance of a voice coil which causes the rise in impedance as the frequency goes up. For a given resistance, the inductance of an aluminum coil is about 30% less than copper. It was shown by Dr. Olson that the inductance in the voice coil can be reduced by covering the center pole of the magnet with copper. Philips has recently produced an interesting 8" speaker with a center pole design as shown in Fig. 21.

With this arrangement there is some loss of flux density as it is obviously necessary to reduce the diameter of the center pole to make room for the layer of copper. If this is .010" thick the magnet gap must be increased accordingly. On a 1" center pole with a given magnet this would reduce a 13,000 gauss magnet to about 12,000 gauss.

Another method of avoiding undue rise in impedance is to use a powerful magnet and saturate the pole tip; this is costly but it retains the benefits of high flux density, and has been adopted in one model by Goodmans.

Table 1 shows the rise in impedance between 400 and 15,000 cps with the various systems which have been discussed; broadly speaking, the improvement is in each case related to cost, but the aluminum coil is by far the cheapest device.

It is nearly ten years since I wrote the following in a little book:

"Whereas response curves vary enormously according to the method of taking them, and may even require a pinch of salt to aid digestion, an impedance curve at a given volume level can be accepted as a statement of fact."

These words are just as true today as they were then. A perfect loudspeaker would be one which looks like a pure resistance at all audio frequencies. The basic weakness of the electrostatic device is that, from the point of view of matching the amplifier, it looks like nothing on earth. Before Messrs. Janszen, Pickering, Leak, and Walker draw their revolvers and start shooting, I hasten to add that I am not insinuating that good and proper transfer of power is impossible; I only say it is a pity it is not easier and simpler to do.

Fig. 22. The impedance curve of the three-speaker baffle system described in text.

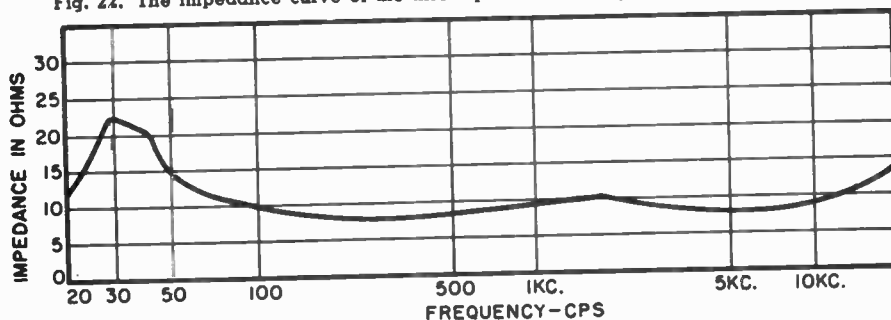

Table 1. Impedance of speakers discussed.

TYPE	IMPEDANCE (at 400 cps)	IMPEDANCE (at 15,000 cps)
8" (copper coil)	13 ohms	63 ohms
8" (aluminum coil)	8 "	18 "
12" (copper coil)	14 "	61 "
12" (aluminum coil)	14 "	33 "
8" (copper ring)	6.3 "	10 "
8" (less copper ring)	6.3 "	28 "
8" (saturated pole)	16.5 "	24.5 "

Electrostatic Speakers

& Transient Response

Part 6. Matching electrostatic tweeters to amplifiers, and factors that affect transient response of speakers.

THE question of load matching between amplifiers and electrostatic speakers is rather involved and the problems are not yet generally understood. Mr. R. E. Cooke, our technical director, has been making an investigation into what happens, and I do not mind admitting that I read his findings *in statu pupillari* (as a student); he admits with becoming modesty that he learned quite a bit himself. Here is the report in Mr. Cooke's own words. (As this is the sixth article in the series, it is time he showed his hand.)

For the sake of simplicity we usually refer to impedance by its numerical value alone, but, as the term implies, we are really dealing with a complex mixture of resistance and reactance. Reactance is the technical term for the blocking action due to an inductor or capacitor and the amount of reactance associated with a given impedance is often expressed as a phase angle. The sign of the phase angle, i.e., plus or minus, indicates whether the reactance is inductive or capacitive in nature, as the case may be.

For the purpose of simple discussion we can say that a phase angle of $+90^\circ$ corresponds to pure inductance and -90° corresponds to pure capacitance, while zero angle indicates pure resistance. Intermediate values relate to mixtures of resistance and reactance which may be inductive (positive) or capacitive (negative) in character.

Fig. 23 shows the phase angle and impedance characteristics of a 10" moving-coil loudspeaker with foam suspension when mounted on a plane baffle $2\frac{1}{2}$ feet square. The measurements were carried out using a *Muir-*

head impedance and phase angle meter Type D-728A in conjunction with a b.f.o. and standard resistance box. The impedance curve is quite ordinary and shows the usual peak at the fundamental resonance frequency, with a gradual rise above 400 cps due to voice-coil inductance. The phase angle curve is relatively unfamiliar, however, and shows that this typical unit behaves like a pure

resistive load at two frequencies only. The lower one corresponds to the fundamental resonance at 31 cps, and the upper frequency is 300 cps which occurs in the region of the lowest impedance value normally used for matching purposes. Between these two frequencies the loudspeaker is capacitive in its behaviour, while outside that region it behaves inductively. We know from experience that most

Fig. 23. Phase angle and impedance of 10" moving-coil speaker on a flat baffle.

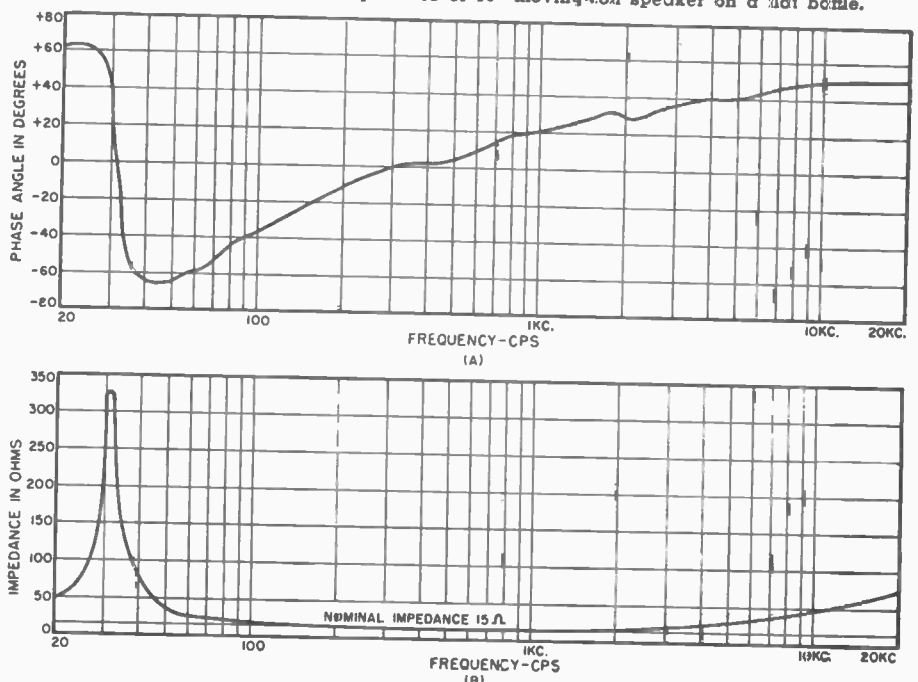

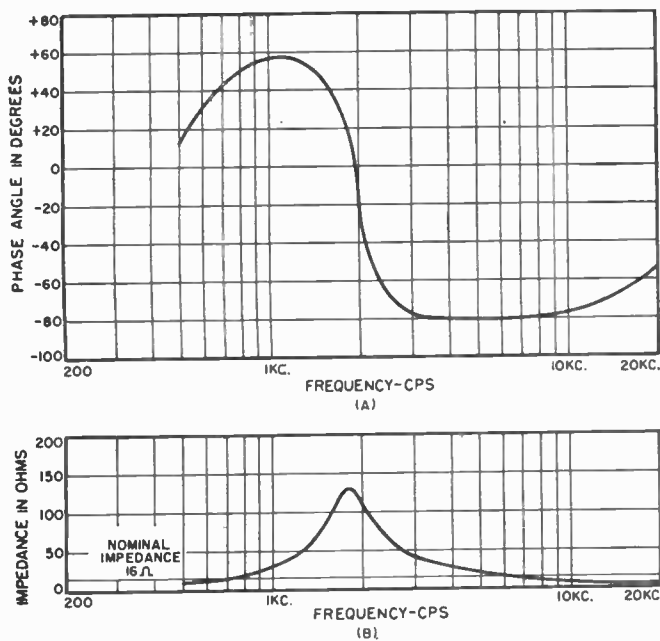

Fig. 24. Here are shown the phase angle (upper curve) and the impedance (lower curve) of a push-pull electrostatic tweeter. Note that, as is to be expected, phase angle is on the order of -80 degrees, which approximates a purely capacitive circuit.

impedance falls very much below the nominal matched value, and the same power output is expected.

In order to obtain some factual information, tests were carried out on a good quality power amplifier of reputable vintage. Its power output was rated at 12 watts and its nominal matching impedance was 16 ohms. Fig. 25 shows the effect of varying load resistance on the maximum output voltage at 15,000 cps. Similar results were obtained at other frequencies in the working range; 15,000 cps was adopted here because we happen to be interested in high-frequency performance for purposes of this discussion. The curve shows that the maximum voltage available, just short of clipping, falls away drastically as load resistance is reduced. For example, with a resistance of 5 ohms only 4.5 volts were available as compared with 15 volts across 16 ohms, corresponding to a drop of 10.5 db in maximum output voltage. In other words, when faced with a load resistance of 5 ohms the output of this amplifier is only equivalent to $1\frac{1}{4}$ watts related to its matching impedance of 16 ohms.

Fortunately, most practical amplifiers seem to have a slightly better performance as regards distortion and overload when working into reactive loads, and it appears that the resistance load is the worst case. When the electrostatic unit was connected to the amplifier used for the previous test, a maximum voltage of 5.7 was obtainable at 15,000 cps which, although better than the 4.5 volts obtained with a resistive load of the same value (5 ohms), is still 9 db below 15 volts.

This drop of 9 db does not mean that the output will be 9 db down at 15,000 cps during normal operating conditions. What it does mean is that this particular amplifier/loudspeaker combination will handle 9 db less input at 15,000 cps without distortion, relative to the mid-range input.

Thus if the amplifier is fed with a 15,000 cps signal and the level gradually increased, it is obvious that distortion will occur earlier than would have been the case with a load impedance of 16 ohms or more. The position could of course be eased by treating the loudspeaker as a 5-ohm unit and rematching with a suitable transformer, but this would result in a loss of sensitivity amounting to 5 db which would be unacceptable, especially in view of the fact that the electrostatic unit is already less sensitive than high-flux, moving-coil types.

Full-range electrostatic loudspeakers behave in a similar fashion at high frequencies, but the impedance can be prevented from rising too severely at middle frequencies by crossing over to an electrostatic bass section at a carefully chosen point. Clever circuit design also helps matters here, an artifice not open to the tweeter manufacturer because he has no control over the type of bass speaker with which

power amplifiers are quite happy when feeding loads of this type but it is generally accepted that electrostatic speakers present some new load matching problems; so we cannot do better than start by inspecting the phase-angle and impedance curves of a typical push-pull electrostatic tweeter of the latest type.

These are shown in Fig. 24, and we can see at once that electrostatics behave quite differently from moving coils. This particular electrostatic unit contains a built-in high-pass filter incorporating an inductor, which accounts for the peak in the impedance curve as well as for the positive phase angle below 2000 cps. Although the operating range is from 500 cps upwards, the interesting part of the curves is in the region above 3000 cps, where the impedance falls rapidly to 5 ohms at 15,000 cps although the unit is nominally rated at 16 ohms. Over a large part of the working range the phase angle is around -80° which approximates to a pure capacitance. This contrasts sharply with the moving-coil unit, which is inductive in the upper frequency range. Many power amplifiers employ over-all negative feedback taken from the secondary of

the output transformer. The loudspeaker load is therefore included as part of the feedback loop and its phase characteristics must be taken into account. In order to maintain stability, the phase of the feedback voltage must remain within certain limits and some amplifiers which have been designed to work with moving-coil loudspeakers may become unstable when faced with electrostatics.

However, there is no fundamental difficulty in building an amplifier which will remain stable while feeding this type of load and in course of time all high-quality power amplifiers will be designed with such operating conditions in view.

The real snag in matching an electrostatic loudspeaker to its driving amplifier is the problem of developing an adequate voltage across the loudspeaker terminals over the whole operating frequency range. The trouble arises because vacuum tubes are voltage amplifying devices which do not like working into low impedances. Consequently, although the average amplifier is not unduly worried by loads greater than the nominal matched impedance, the onset of distortion is usually serious if the load

Fig. 25. Effect of varying load resistance on maximum output voltage at 15,000 cps.

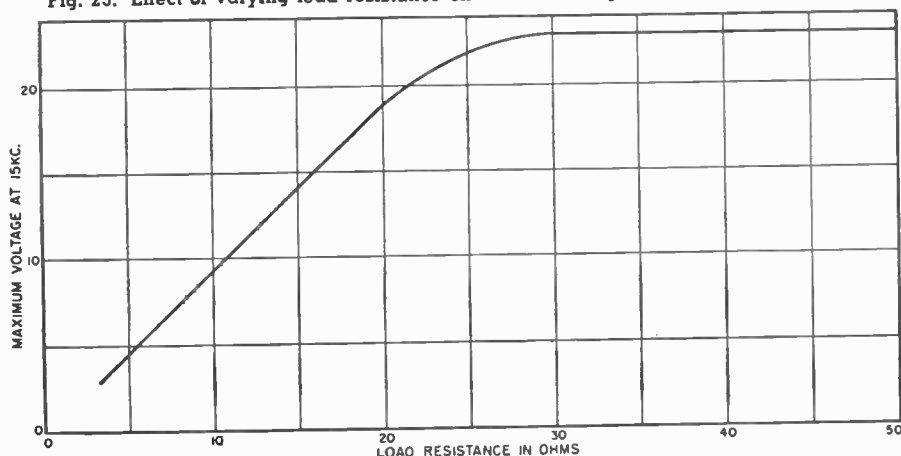

his unit may ultimately have to work.

As the frequency goes down, the impedance continues to rise, as one would expect with a capacitive device. In a typical case the impedance of a nominal 15-ohm electrostatic unit reaches 30 ohms at 40 cps. This is actually a benefit because the electrostatic is a voltage-operated device and the rising impedance insures that the amplifier can maintain its drive down to the lowest frequencies. On the other hand, the operation of a moving-coil speaker depends upon current, so that an impedance rise at low frequencies results in more difficult conditions for bass reproduction.

The question which now arises is whether this falling high-frequency impedance will cause the amplifier to run into distortion on speech and music, and here the usual crop of *if's* and *but's* begins to sprout. Certainly there is a tremendous amount of energy in sounds such as a cymbal crash, which make heavy demands upon the power amplifier, especially if recorded out of balance and reproduced at high level. It is therefore likely that electrostatic speakers will require the use of amplifiers in excess of 15 watts' rating if full-blooded reproduction is required. This increase in power is necessitated partly by the lower sensitivity of current electrostatic designs as compared with moving-coil types and partly by the mismatch referred to previously. It seems likely that 30-50 watt amplifiers will become more common as the electrostatic era dawns and develops.

Now that we have reached the subject of loudspeaker watts, this seems a good place to point out a few common fallacies. With the moving-coil loudspeaker most of our calculations are based on the nominal impedance at around 300-400 cps where we see from Fig. 23, the load is almost a pure resistance. In these circumstances it is permissible to calculate the power absorbed by the speaker from the formula:

$$\text{Power} = \frac{V^2}{Z} \text{ watts}$$

where: V = voltage across voice coil
 Z = loudspeaker impedance in ohms.

Thus in the case of the unit of Fig. 23, for 4 volts across the voice coil the power input would be:

$$\frac{4^2}{15} = 1.07 \text{ watts}$$

At all other frequencies, variations in impedance and phase angle must be taken into account by inserting phase angle into the formula, thus:

$$\text{Power} = \frac{V^2 \cos \phi}{Z} \text{ watts}$$

where: ϕ is the phase angle.
Hence for the same 4 volts at 31 cps, the power input has fallen to 0.05 watt. Although the power input to the unit has fallen so drastically, it must be remembered that the efficiency has increased enormously, due

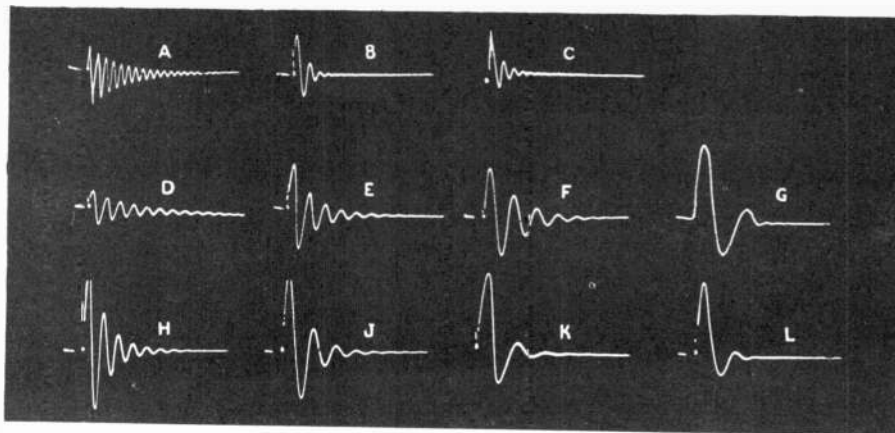

Fig. 26. Actual photographs of oscilloscope records of the shock effect on various speaker/cone/coil/magnet assemblies. (A) A 6-inch unit with low flux density, corrugated cone suspension. Note "ringing" with exponential decay rate and 22 vibrations before cone comes to rest. (B) A 5-inch unit with high flux density, cloth suspension, and a finer spider. Note big improvement over part A. Input at 0.5 volt. (C) Same as part B, but magnet reduced from 13,000 gauss to 5000. Note the 7 or 8 oscillations instead of the previous 4 or 5. Input increased to 1.5 volts to make up for the loss of sensitivity. (D) An 8-inch speaker with corrugated cone suspension is used. (E) Same as for part D but speaker uses a 13,000-gauss magnet. Note the greater sensitivity and better damping shown by the rapid rate of decay, with fewer oscillations. (F) Same as for part E but with cloth suspension, which lowers the frequency of the cone resonance and, in addition, reduces the number of vibrations. (G) Goodmans 8-inch unit with free-edge cone and saturated pole. Low resonance frequency and rapid decay rate is shown. (Note: The unit was referred to in previous article.) (H) A typical 12-inch unit with corrugated cone and a 13,000-gauss magnet. (J) Same as for part H but with cloth surround. Note the obvious improvement. (K) Same as for part J but magnet improved to 17,000 gauss. Again there is an obvious improvement. (L) A 15-inch unit with a large magnet. There is little or no ringing here.

to the fundamental resonance which occurs at 31 cps. The actual sound power output is therefore maintained to a great extent. Similarly, at 15,000 cps the input power is 0.16 watt, but here there is no resonance to boost efficiency so that the output falls accordingly. (Hence the importance of avoiding the impedance rise as much as possible, as already pointed out in Part 5.)

It is interesting to look at the electrostatic tweeter from the point of view of power absorbed for the same input of 4 volts. At 1950 cps where the phase angle is zero, the power absorbed is $\frac{1}{8}$ watt, while at 15,000 cps the power is $1\frac{1}{4}$ watts.

These few figures should suffice to show how meaningless it is to talk of loudspeaker watts by merely considering voltage and rated impedance.

Generally speaking, however, we are not concerned with the actual power absorbed by the loudspeaker, but by the voice-coil current in the moving-coil type and the voltage across the plates in the electrostatic type. Thus we strive to keep the impedance from rising in the case of the moving-coil and from falling in the case of the

electrostatic. With typical contrariety, nature opposes our efforts.

Transient Response & Resonances

These qualities are taken together because one is dependent on the other. Absence of resonance (or ringing) *ipso facto* results in good transient response provided a sufficiently wide frequency range is covered.

The basic difference between a loudspeaker and a musical instrument is that in the one all resonance should, in theory, be avoided like the plague, whereas in the other maximum resonance is the objective. Piano makers strain at the leash to increase the effectiveness of the soundboard or resonator, but the worst loudspeaker I ever heard was the result of fixing a moving-coil driver to a point on the

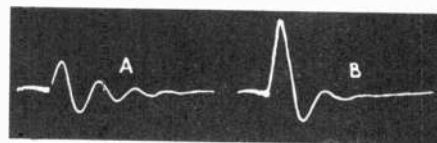
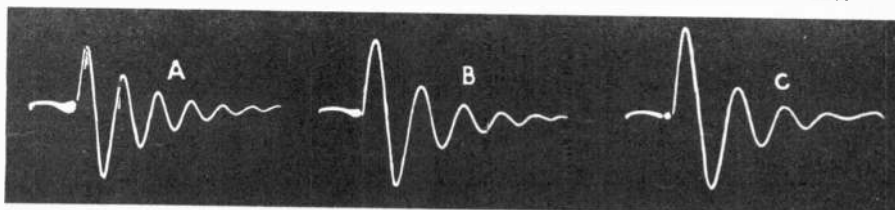

Fig. 27. Shock tests showing effect of magnet. (A) A 10-inch loudspeaker unit with a 10,000-gauss magnet. (B) Same as for part A but with a 14,000-gauss magnet.

Fig. 28. Shock tests showing the effect of various cone suspensions. (A) A 10-inch unit with corrugated cone surround. (B) Same unit with cloth and (C) foam surround.



soundboard of a piano. (It is impossible to make speakers for 25 years without trying a few silly ideas.)

The main resonances in a moving-coil unit are due to (a) fundamental cone resonance; (b) cone break up; (c) surround resonance; and (d) resonance of spider or centering device. In so far as the electrostatic speaker avoids these pitfalls it can be said to have a better transient response, but it must not be assumed that moving-coil design remains stagnant. The main cone resonance is virtually damped out by the modern amplifier and by high flux density in the magnet. The effects of cone break up can be side-stepped by the use of dividing networks, by soft cone texture in large speakers, and stiffer diaphragms in small units. Surround resonance is avoided by using soft cloth or foam plastic surrounds or by completely free suspension. The centering device is still a necessary evil with moving-coils, but its resonance is the least objectionable of those cited. In small units limited to frequencies above 1000 cycles, the conventional spider or corrugated disc can be dispensed with and the coil can be held in center with a simple cloth disc which is entirely resonance-free. (We adopted this arrangement on a 3" unit several years ago with complete success.)

The diaphragm in a moving-coil speaker is receiving shock after shock and it is this state of affairs which colors the reproduction. Pictures of the effect of shock treatment are therefore not without interest, and a few are reproduced in Fig. 26. The voice coil is held off its central position by applying a suitable value of direct current. When the circuit is interrupted the voice coil moves and the e.m.f. generated in it as the vibrating coil cuts the magnetic field operates the oscilloscope by the triggered time base, the result being photographed.

In all cases shown in Fig. 26, wider spacing between vibration peaks indicates a lower resonance frequency of the cone. The benefits of high flux density, non-resonant surrounds, and free suspension with low cone resonance are clearly shown. The cone assembly in examples A and D is obviously behaving like a drum and is typical of the cheap, mass-produced speaker.

It will be seen from Fig. 27 that with the same input voltage and identical cone and coil assembly the deflection of the voice coil is almost three times as great with the higher magnetic flux, but the coil comes to rest with half the number of oscillations. Translated into speaker performance, this means much higher sensitivity (or fewer watts from the amplifier!) plus cleaner reproduction and superior transient response. In fact, the virtues of high flux density—or in other words expensive magnets—are beyond dispute and are confirmed by the most primitive listening test.



HERE IS HOW YOU CAN CONVERT TO STEREO...

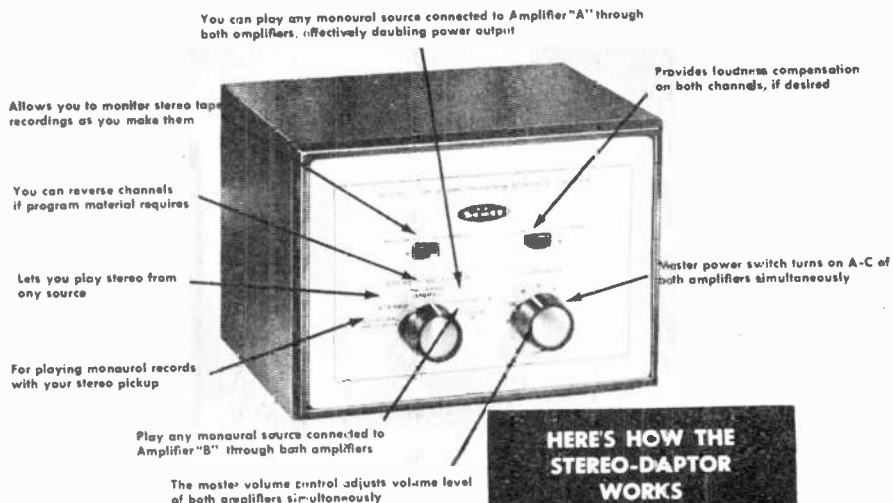

NEW H. H. SCOTT STEREO-DAPTOR

- Updates your *present* H. H. Scott System for Stereo records and tape.
- Lets you buy a monaural H. H. Scott System *now*; convert later.

Just add the Stereo-Daptor and a new H. H. Scott amplifier to your present H. H. Scott system and you can play the new stereo records, stereo tape, stereo AM-FM or stereo from any source.

The Stereo-Daptor permits control of two separate amplifiers from a central point. A Master Volume Control adjusts the volume levels of both channels simultaneously. Special switching lets you play Stereo, Reverse Stereo, use your Stereo Pickup on Monaural Records, or play monaural program material through both amplifiers at the same time. This gives you the full power of both amplifiers. No internal changes are required when used with H. H. Scott amplifiers.

IMPORTANT! Stereo-Daptor works with *All current H. H. Scott amplifiers and most older models . . . with any system having separate pre-amplifier and power amplifier . . . and with complete amplifiers having tape monitor input and output provisions.*

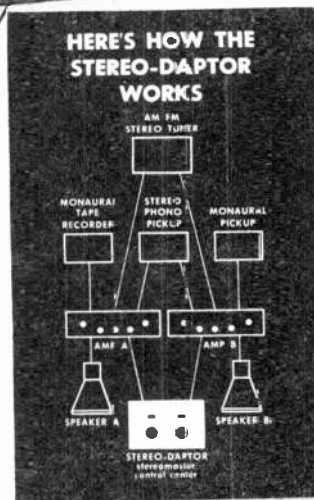

SPECIFICATIONS

H. H. Scott Stereo-Daptor
Stereo-master Control Center

Compatibility: Any amplifier in any of the groups shown below may be used with a second amplifier IN THE SAME GROUP for best results with the Stereo-Daptor.
Group I: 39-A, B, C, D; 210-F; 120-A; 120-B; 210-C.
Group II: 121-A, B, C; 210-D, E.
Group III: Any systems with separate preamplifiers and power amplifiers.
Group IV: Two identical complete amplifiers having tape monitoring input and output connections.

Controls: Master Volume; Loudness-Volume; Function Selector (with these positions — Stereo; Reverse Stereo; Monaural Records; Monaural Channel A; Monaural Channel B)
Tape Monitor: Power off (on volume control).

Connecting Cables: Four two-foot shielded cables are supplied for all necessary connections. Maximum recommended cable length 3 feet.

Custom Installation: The Stereo-Daptor is easily custom mounted, and no special mounting escutcheons are required.

Price: \$24.95* completely enclosed. Accessory cases extra.

*slightly higher West of the Rockies

Send for Complete Information Now



H. H. Scott Inc. 111 Powdermill Road, Maynard, Mass.
Export: Telesco International Corp., 56 West 40th Street, New York City

Rush me complete information on the New H. H. Scott Stereo-Daptor and your new catalog HFA

NAME

ADDRESS

CITY STATE

—Transients and Directional Effects

Part 7. How speaker mounting affects transient response ; how to avoid high-frequency beaming.

AT THE end of the previous article the effect of shock treatment on various speaker units was illustrated, but as a high-impedance source of about 56 ohms was used, the results showed more "ringing" than would occur under normal conditions of use where the high damping factor of the amplifier plays a not insignificant part.

The following tests show the effect of different methods of mounting a 10" speaker, 10-15 ohm type, with the source impedance reduced to 15 ohms to give a damping factor of about one-to-one. With open baffle mounting and a good magnet it will be seen from Fig. 31A that ringing has been virtually eliminated, in spite of the large initial displacement of the voice coil. A comparison of this curve with the others (B, C, D, and E) confirm the contention that you cannot put a speaker unit in a cabinet or on a horn without making it sound like it, because it affects the natural movement of the cone.

The cleanest results are obviously obtained from the open baffle, but nature is again perverse and limits our bass output by the size of the baffle. If we counteract this by increasing the bass input by 6 db per octave we tend to overload the unit, hence the de-

velopment of so many resonant enclosures and folded horns. But a couple of speakers in parallel on a baffle give a 3 db gain at low frequencies, and double the power handling capacity, and various methods of damping to avoid excessive cone movement and distortion, without boxing in, are possible.

It would be difficult to give a complete technical explanation of the results as shown in Fig. 31, but the following points strike me as significant. The reflex enclosure (B) reduces cone movement but increases power handling capacity. The corner model (C) weighs 44 pounds and shows signs of panel resonance, which can be heard in the program material. The huge and heavy exponential horn (D) is probably better than any folded horn but, surprisingly, still shows signs of metal ringing which is faintly audible on program.

The brick enclosure (E) shows a clean line and lowest resonance of the lot but is followed by slight traces of enclosure resonance, again faintly audible on program.

The circuit used for the tests is given in Fig. 32. A scope with a driven sweep is used. R_1 gives control of the input voltage (E_1) and R_2 enables the d.c. voltage across the oscil-

loscope terminals to be balanced out and so avoid the false transient due to the a.c. coupling of the scope input circuit.

Cone Breakup: Poor transient response is not entirely due to insufficient voice-coil damping. We are still left with the serious problem of low damped resonances in the cone itself and in the enclosure (if one is used) which are so loosely coupled to the driving system that electromagnetic damping is impossible. The effect of these resonances is to produce ringing and hangover at the various frequencies concerned and this, in turn, is manifest as coloration on speech and music.

Cone breakup usually results in a rise in output in a region above 1 kc., but before this is condemned out of hand a word of warning should be given. Many reflex enclosures boost the bass by resonance, but mask the upper register, and therefore require a speaker unit with strong output in the treble for a reasonably balanced performance. A "perfect" speaker unit with flat response would sound awful used alone in such a cabinet.

Various techniques have been devised for studying transient decay behavior using chopped tone and pulse excitation, but none of these methods

Fig. 31. Shock tests showing effect of speaker mounting. A 10" foam-surround, 14,000-gauss unit was used. Source impedance was 15 ohms and input was 4 volts. (A) Speaker mounted in plane baffle 2½ feet square. Note clean movement with abrupt finish. (B) Speaker in 2 cu. ft. reflex cabinet. Cone movement reduced, ringing drops off at exponential rate. (C) Corner horn-loaded reflex cabinet made of ¾" plywood. Uneven kink with continuous ringing. (D) Large exponential horn. 5½ feet long, 4 foot mouth, weighing 175 lbs. Note ringing from metal horn in spite of heavy construction. (E) Brick 9 cubic foot corner enclosure employed for the speaker. There was a large movement of cone with low resonance frequency.

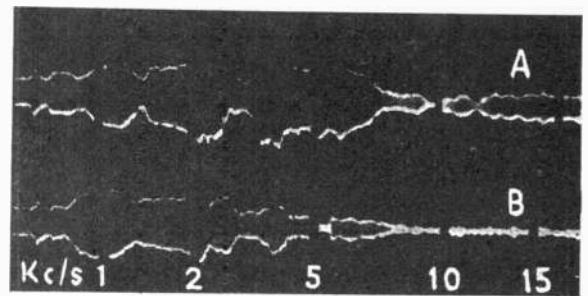

Fig. 29. Effect of 7" x 1" slot diffuser on 8" wall-mounted speaker. Mike is 18" on axis in open air. (A) shows the response without and (B) with diffuser.

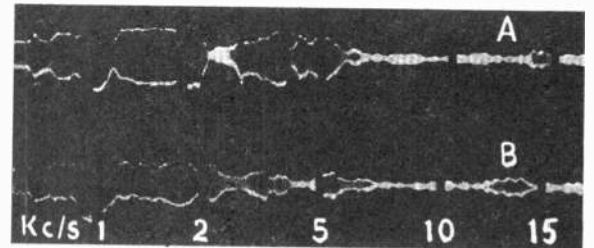
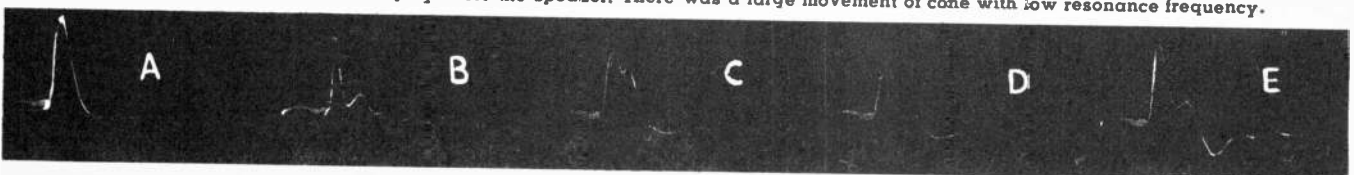

Fig. 30. Same as for Fig. 29 except that mike is 30 degrees off axis. (A) is response without and (B) is with diffuser.



has proved completely successful. The best tests to date are probably subjective ones employing white noise and male speech, as the coloration imparted to these sounds is quite distinctive on the A-B test. With experience, it is possible to locate roughly the trouble region by listening carefully to white noise. Panel resonance can be exposed by banging a cabinet with a hammer or even the fist; the general pitch of the sound so produced with flimsy enclosures is easily heard as coloration on white noise. Unfortunately white noise cannot be used as a complete guide until somebody produces the perfect speaker as a 100% reference point, so that we know exactly how white noise *ought* to sound.

General Definition: A transient is an energy pulse where the intensity changes over a wide range in a very short time. A hand-clap is an example of a sound with steep starting transients at high frequencies, but the termination is of equal transient significance. Wide frequency range and absence of hangover or ringing are clearly necessary for good transients of both varieties.

Centering Devices: Even the centering device has an effect on high-frequency performance and transient response. Corrugated discs are now used on the majority of loudspeakers because of speed of assembly, concentric reliability, and dustproofing of gap. But the open spider made of fine Bakelized fabric may give slightly better high-frequency performance and improved transient response. There are two main reasons. The disc is made with a neck about $\frac{1}{16}$ " in depth which is necessary for gluing the device to the cone and coil assembly. This has a damping effect on the transmission of the highest frequencies from coil to cone. The edge of the Bakelite spider is much finer and harder and this device also has a very quick restoring action on cone movement which cleans up the transient nature of the reproduction to an audible degree on A-B testing.

Directional Effects

It would be difficult to over-emphasize the importance of directional effects in middle and upper registers when natural reproduction is the objective. High-frequency beaming is often objectionable. Even in the Royal Festival Hall the effect of tilting middle and treble units upwards or to an angle of 45° can be observed by a listener at the back of the stalls at a distance of more than 100 feet. In fact I would go so far as to say that satisfactory reproduction in a concert hall is impossible if these directional effects are not carefully studied and controlled.

One of the simplest ways of spreading an objectionable beam and reducing peaks at 1-5 kc. resonance is to fit the well-known "KB" slot in front of the cone as illustrated at the left in Fig. 33.

The length of the slot should be the same as the piston diameter of the

cone, the width being determined according to the frequency range involved; it is most effective when it is less than the wavelength. Thus 1" wide will answer for frequencies up to 13,500 cps. With a 5" speaker, a slot 3" long and $\frac{3}{4}$ " wide is about right.

The oscillograms of Figs. 29 and 30 show the effect—on and off axis—of placing the slot diffuser in front of an 8" unit which gives excellent results in a small Helmholtz resonator but needs some control in the 1 to 5 kc. region when mounted on an open baffle. For this test, the speaker was mounted in a wall facing outside—probably the best arrangement ever devised for speaker measurements. The microphone distance was 18"—rather close—but the object was to study the effect of the diffuser rather than to produce an accurate response curve.

It will be noted that the output on-axis with the diffuser is about the same as 30° off-axis without the diffuser. The use of the diffuser greatly reduces the difference between axis and off-axis results. In short, there is much to be said for the device at frequencies above 1000 cycles, but with a single speaker covering the entire range there is severe obstruction at low frequencies. This can be largely overcome by altering the shape of the slot and adding extra holes, as shown at the right in Fig. 33.

Suitable dimensions for general use are:

Speaker	8"	10"	12"
Width of slot	1"	1"	1"
Diameter of four circles	2"	2½"	3"
Length of straight portion of slot	3"	3½"	4"
Over-all length of main slot	7"	8½"	10"

A sample diffuser can easily be cut out of a piece of cardboard for test and placed in front of the loudspeaker. If the effect meets with approval, a permanent sub-baffle of plywood can be made at moderate cost.

In order to test the effect of the modified diffuser, discs of aluminum foil (*genus*—milk bottle tops) were glued to the surface of the cone of an 8" speaker, fitted with aluminum voice coil to give some output even at 15 kc. The discs produced a mighty peak in output in the region of 2000 to 6000 cycles, with a rise of about 10 db.

Fig. 34. Oscillograms of response of 8" speaker with metal discs on cone. Curves taken in open air at an input of 1 watt. Mike is at 18" on axis. Speaker mounted in wall. (A) shows the response with a normal 7" diameter hole in the baffle. (B) is response with modified diffuser of Fig. 33 place in front of normal baffle.

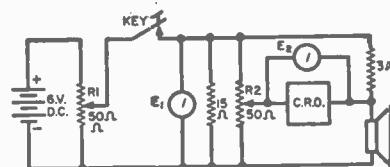
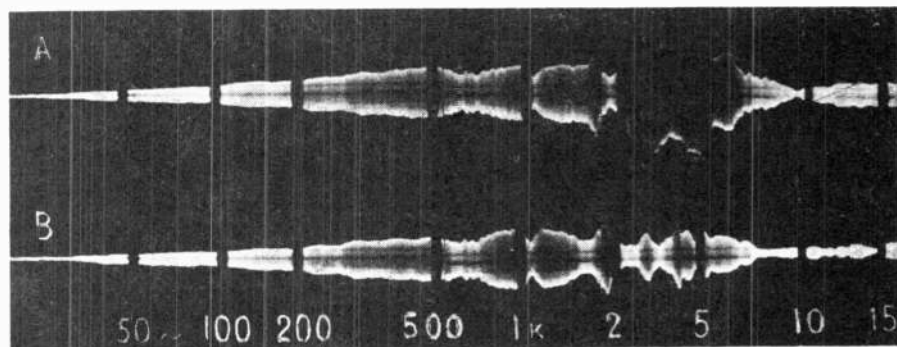

Fig. 32. Here is the circuit (after E. M. Price) used for transient tests.

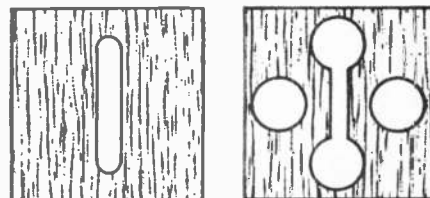

Fig. 33. Appearance of the Kolster-Brandes Ltd. slot diffuser is shown at the left. At the right is shown a modified diffuser designed for use with a single speaker. This diffuser avoids resonance and restriction of output at the lower audio frequencies. Quarter-inch or $\frac{3}{8}$ " plywood may be employed.

which was virtually removed by the slot diffuser, as shown in Fig. 34.

It will be observed that the effect of the diffuser is not very severe at frequencies above 6000 cps and it is negligible at frequencies below 2000. Incidentally the audio-frequency signal came from an amplifier with almost zero output resistance so the cone resonance in the bass is completely damped out.

Tests for drop in output at 30° off-axis showed an average fall of 6 db above 2000 cycles with no diffuser against an average loss of 3 db with diffuser. In plain language, this means that the diffuser reduces beam effect on-axis and improves the relationship between axis and off-axis response.

On the other hand, if you do not want to be bothered with diffusers, you can always turn the offending speaker with its face to the wall or pointing upwards; this gets rid of beam effects and camouflages peaks in response to a remarkable extent because the room gets to work on the sound waves before they reach the ear of the listener. If you are completely averse to beams and peaks you can fit a diffuser and turn the speaker away or tilt it at a suitable angle.

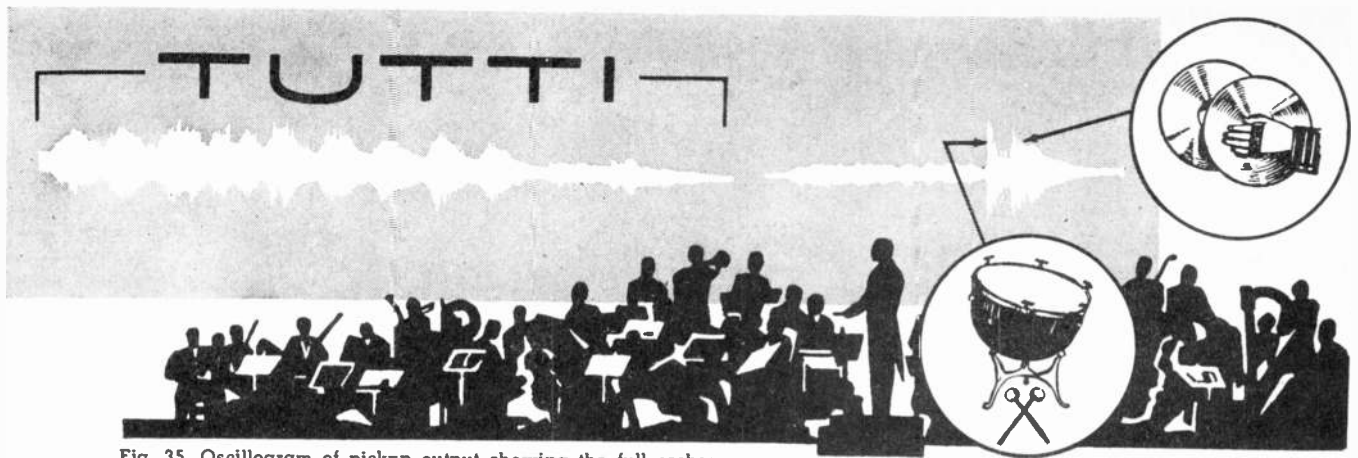

Fig. 35. Oscillogram of pickup output showing the full orchestra at the left, which is then followed by drums and cymbals.

SPEAKER POWER and EFFICIENCY

Part 8. Factors that determine the power handling ability and the efficiency of high-fidelity speakers.

WE HAVE seen that a diffuser can be used to subdue peaks in the upper register and reduce beaming effects. The problem can also be tackled electronically in the speaker circuit by using a filter.

A dividing network in multi-speaker systems is designed to limit the activities of each unit to its most satisfactory audio range and has become almost standard practice in wide-response installations. It is obvious that similar controls can be used on a single speaker or on two or more units working in parallel, although the full effect of a dividing network will not be obtained. There is, however, the benefit of smoothness from units working in parallel due to cancellation of resonances which rarely occur at identical frequencies in different speakers. The filter now described was made up by Mr. R. E. Cooke, and could easily be assembled at home by the average experimenter. It gives continuously variable attenuation up to 15 db centered around a choice of five frequencies, 2, 3, 4, 5, or 6 kc., selected by a switch. The "off" position of the switch enables rapid A-B comparisons with unmodified response of the speaker (s) to be made without altering the resistor setting.

The filter consists of a parallel-tuned LC resonant circuit shunted by a variable resistor R. The tapped air-cored inductor L is wound by hand; the 1 μ fd. capacitor C may be any good

paper type obtainable from jobbers. R is a wire-wound, linear taper variable, and S is an ordinary 6-position switch. The full circuit is given in Fig. 36.

The filter is placed in series with the loudspeaker, and the switch gives maximum rejection at various frequencies as follows:—

POSITION	INDUCTANCE	CENTER OF TROUGH
1	6.2 mhy.	2 kc.
2	2.8 mhy.	3 kc.
3	1.6 mhy.	4 kc.
4	1.0 mhy.	5 kc.
5	0.7 mhy.	6 kc.
6	Filter off	

With R set at its full value of 50 ohms, the maximum dip in response of about 15 db for each switch position is produced. A general picture of results is given in Figs. 39 and 40.

The air-cored inductor L consists of 303 turns of No. 18 SWG (No. 16 AWG) double cotton-covered copper wire. Tappings are brought out as shown in Fig. 36. The total resistance is only 1.2 ohms so the insertion loss is negligible outside the region of resonance.

Power Handling and Efficiency

These qualities in a loudspeaker are so interdependent that we might as well deal with them together.

I always think that for domestic use the power handling capacity of a speaker is a very much over-rated virtue; we are concerned with how much comes out of a speaker, not with how much we can put into it.

The main difficulty is the absence of any recognized system of rating, plus the fact that the method of mounting affects results. Probably the best assessment is to listen to the speaker on full orchestra—including cymbals—and also on organ and rate it at peaks which are free from roughness, harshness, and undue boominess. Full orchestra is mentioned here deliberately because, with modern recording techniques, there is far more power in the upper register than there used to be. In fact, the hi-fi craze has often produced too much top, but there are welcome signs of a return to sanity. Distortion at high frequencies is always much more distressing to the ear than at low frequencies.

The oscillogram of Fig. 35 shows that the peak produced by cymbals is almost equal to the drums. The output from a pickup was photographed on the scope. At the left we have full orchestra for comparison with drums and cymbals that follow. It is interesting to note the steep wavefront produced by these percussion instruments; any overloading of amplifier or speaker at these peaks would obviously mar results.

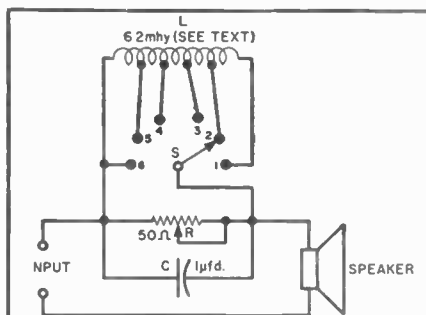
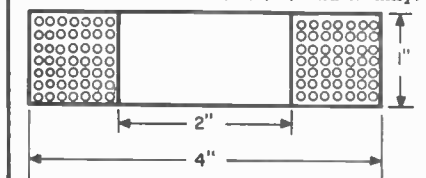

Fig. 36. Filter circuit that can be employed as tone control with speakers of 8-15 ohms impedance. (after E. M. Price)

Fig. 37. Dimensions of the 6.2 mhy. tapped coil used in the filter circuit. 303 turns of No. 18 British SWG (No. 16 AWG) d.c.c. wire is used with taps at 215, 163, 133, and 112 turns for 2.8, 1.6, 1, and .7 mhy.



Rating a loudspeaker at a single frequency is quite useless, because too much depends on the choice of frequency, and the speaker does not have to work at a single frequency—it always receives powerful harmonics. But this is not to say that *testing* a loudspeaker at a single frequency is useless. This is, of course, vital to any assessment of performance. We have already stated that method of mounting affects results. If reflex or horn loading improves the waveform at low frequencies for a given *output* of sound, then frequency doubling and trebling are reduced and so is intermodulation; but the important point is the output. No system can be judged merely by the amount of input it will take.

This is one reason why the open baffle is still better at the bass end than most people imagine, in spite of cut-off due to limitation of size. The cone is free to move as it likes and the sound waves from back and front enter the room without restriction. The speaker will handle fewer watts than reflex and enclosed cabinet types, but it needs fewer watts for equivalent acoustic output over most of the audio range. It is a pity that it is almost impossible to measure total speaker output, but it is very easy to measure and calculate input. (Mr. Cooke uses a sliderule, but I can still do it on my fingers.) This is why the habit of rating speakers on input and ignoring output has been so generally adopted.

It cannot be too strongly emphasized that true efficiency in a moving-coil speaker depends on flux density and this is the quality in a magnet that costs the money. And in this connection we refer to total flux, which is the product of gauss and gap dimensions (diameter, width, and depth.) It is impossible to assess the value of a magnet by a statement of gauss alone, as 13,000 lines per square centimeter with a typical 1" center pole would give 54,000 total flux, where 13,000 lines with a 1½" center pole would produce 145,000 lines, at an extra cost of about 100%.

Magnet weight gives a rough idea of value, but as the prices of magnetic alloys vary, the weight is not a complete guide. Actually, it makes no difference to the user which type of magnet is employed; whether it is alni, alnico, alcomax, ticonal, ceramic, or hygienic does not matter. The only thing that counts in value is the total flux. All modern magnets merit the description *permanent*.

Efficiency and Watts

It is always difficult to grasp the relationship between the power we put into a speaker and the amount of sound which comes out, because a twofold increase in power produces only 3 db increase in sound pressure, which is just easily perceptible. (To the ear, the increase sounds more like 33% than 100%.) Fig. 38 shows the relationship, taking 1 watt as a reference.

Acoustically, the increase in level caused by an increase in power from 30 to 60 watts is the same as from 1 to

Fig. 38. Relationship between the power input to a loudspeaker and the amount of sound that it produces, taking 1 watt as reference.

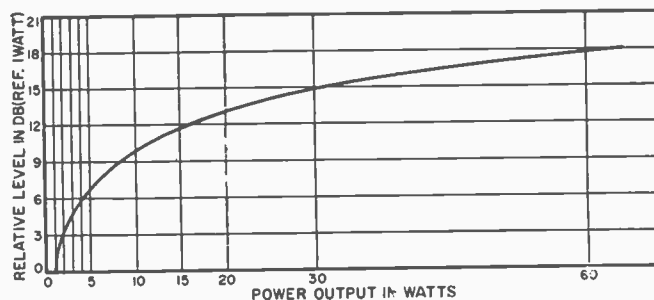

2 watts, but electrically it is quite a different story. As Fig. 38 shows, it pays to use a high-efficiency (i.e., high flux density) loudspeaker and work on the steep portion of the curve below 15 watts, because the next 3 db are at a high premium in terms of amplifier watts, which cost money and involve bulky equipment.

Measurement of Efficiency

This is even more difficult than rating power handling capacity. When I see it stated that the efficiency of horn-loaded speakers is 40% compared with 8% for reflex enclosures, and even as low as 2% for small infinite baffles, I can only conclude that the conditions of test do not even approximate the conditions of use, so the findings are of doubtful value to the average listener.

The question of where a test is made is of vital importance. For instance, if

you work under free-field conditions and measure the output at the mouth of a horn you will obtain a maximum reading, but if an open baffle is used the reading in front of the cone represents only half the output which would be available in a live room. The reverberation time of the listening room also affects results—the longer it is, the greater the build up of sound, but this would not necessarily affect all speakers to the same extent.

The strongly directional properties of horn loading are too well known to need further emphasis, but if efficiency tests are made on-axis they do not apply if you listen 30° off-axis. In other words, directional properties have a lot to do with the question, and an omnidirectional speaker system rated officially as 8% efficient might give an average sound level in a normal listening room almost equal to horn-loaded types rated much higher.

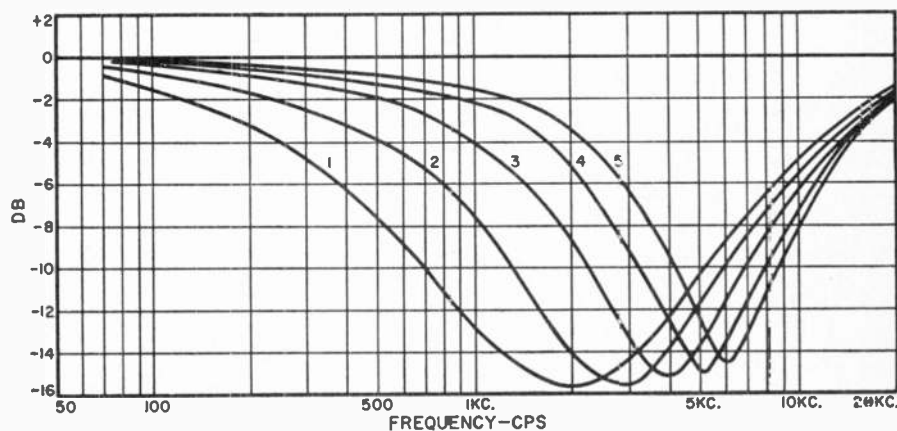
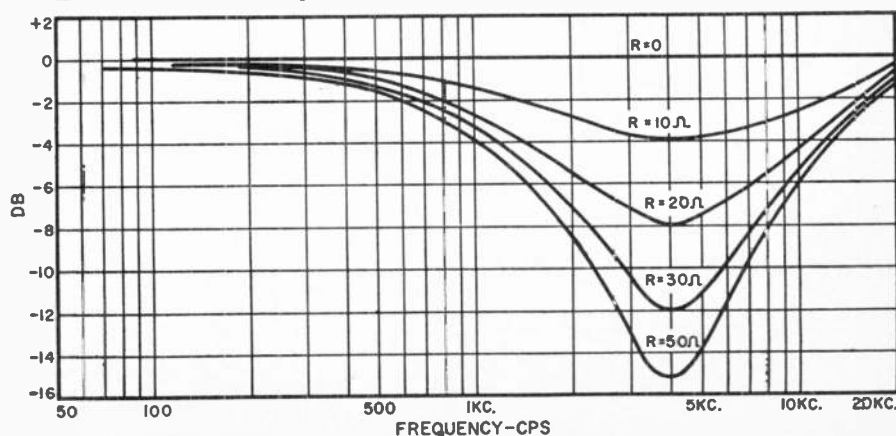

Fig. 39. Audio output response curves of the filter circuit described previously. Note that as more inductance is switched in the dip moves downward from 6 to 2 kc.

Fig. 40. These response curves show what happens to the attenuation as the resistor is varied and the coil tap remains on 3rd position. Maximum dip here is 15 db.



Speaker Mounting

Part 9. Concluding comments on cabinet construction along with characteristics of various cabinet types.

WE NOW come to the last—and most difficult to write—installment in this series of articles. In fact, if we had not already committed ourselves to deal with cabinets, baffles, etc., I think we should have put up the shutters at the end of Part 8. The subject is so vast, and so much has already been written about it, that it is difficult to know where to start; it is always much easier to write at length about a small problem than to deal briefly with a big one. At any cost, we must avoid a re-hash of what has gone before, but I think we might usefully begin by outlining our latest thoughts on the old, old questions that are so very important.

(1) The first thing to remember is that cabinets and horns are a necessary evil, used to avoid cancellation of sound waves from back and front of a cone. They don't improve the quality of sound and we should be much better off if we could do without them.

(2) Although it is possible to improve the performance of small enclosures by acoustic devices, it is almost impossible to make a small cabinet sound like a big one.

(3) With reflex enclosures, dodges like fitting pipes and diaphragms to vents make a difference to resonances, which are pushed around but not usually eliminated.

(4) Padding enclosures and hanging drapes in them gets rid of standing wave effects and often smooths the response, but the speaker unit is still working in a cabinet which colors results.

(5) Folded horns are a useful device for obtaining large-scale results in a limited space, but a folded horn is not truly exponential and never equals a straight one.

(6) Flat baffles are better than is generally believed. They are free from cabinet resonance. Two speakers in parallel on one baffle give a 3 db gain at low frequencies and double the power handling capacity so that bass lift can be used in the amplifier, resulting in four times the low-frequency output of a single unit. The floor also improves bass by reflection, and walls can be harnessed in the same good cause. Baffles are efficient because the sound from both sides of cone is used, and I am now inclined to the belief that equal air loading front and back is a good thing.

(7) Directional effects are serious. It is only necessary to look at an orchestra to realize how omni-directional most instruments are; hence the virtue

of omni-directional reproducers, especially in upper registers.

(8) Convenience in use is becoming more and more a necessity as the interest in hi-fi reaches the music lover as distinct from the sound enthusiast. Some compromise is always necessary and perfection is as far off as ever, so the foregoing drastic observations should not be taken too seriously.

Details are now given for the construction of reflex cabinets of two sizes. The fact that we deal with vented enclosures and not with corner horns does not mean that we have any prejudice against the latter; it simply means that we have done more work on reflex designs and therefore have more first-hand information available. Many people prefer horn loading; I could be happy with either if soundly conceived and constructed.

The cabinets described are fitted with an acoustic filter designed by my colleague, Mr. R. E. Cooke, and calculated to give bass without boom. The device is the subject of patent applications in this country and America and should therefore only be used privately in cabinets constructed at home. Although designed around Wharfedale 10" and 12" foam surround units, the cabinets can be used with other speakers provided the open baffle resonance does not exceed 45 cps.

The vent is tuned to resonate at about 40 cycles—low enough to avoid coloration and high enough to give body to the reproduction. The vent output will blow out a lighted match at the resonant frequency with 2 to 3 watts input to the speaker.

The acoustic filter is made of plywood and should form an airtight fit to the front, sides, and back so that the only air path from the upper compartment to the lower one is through the slits which permit the required trans-

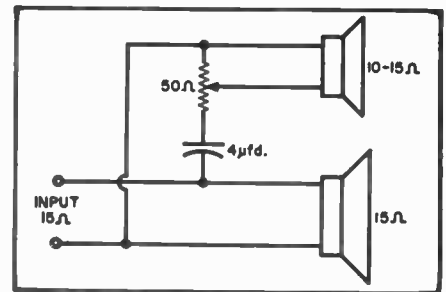

Fig. 42. Adding a 10-15 ohm tweeter to augment response above 3-5 kc. If the impedance of the main loudspeaker is 2-3 ohms, the tweeter should also be 2-3 ohms. The filter capacitor and volume control should then be 12 μ d. and 20 ohms respectively. For 8-ohm units, the capacitor that is employed should be about 6 μ d.

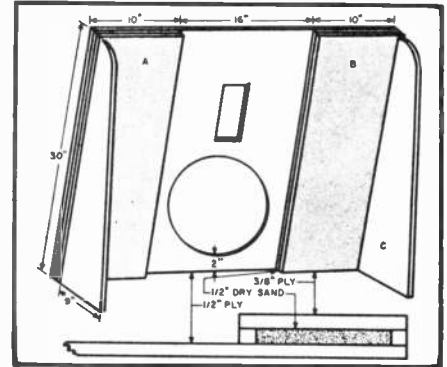

Fig. 43. Shown in this illustration is a back view of the simple flat baffle arrangement that is discussed in the accompanying text. The front sheet of plywood should be at least one-half inch thick. The two portions marked A and B are backed with three-eighths plywood which is spaced one-half inch for sand filling. This is shown in the detailed view. The side supports, marked C, may be constructed of one-half inch plywood. The dimensions shown are not critical.

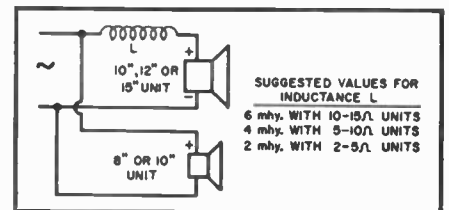

Fig. 44. Shown here is a useful circuit that may be employed to obtain good results with two loudspeakers mounted on an open baffle. The two speakers are connected together in-phase to avoid "hole" in the response.

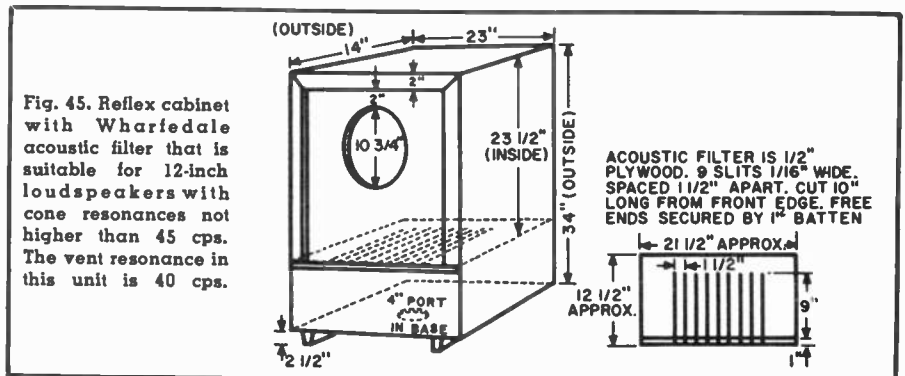

Fig. 45. Reflex cabinet with Wharfedale acoustic filter that is suitable for 12-inch loudspeakers with cone resonances not higher than 45 cps. The vent resonance in this unit is 40 cps.

mission of low frequencies only. This also explains why the lower compartment is not lined with absorbent material.

The design and dimensions for the 12" model are given in Fig. 45 and are self-explanatory.

The data for the 10" model is as follows:—

Cabinet in 3/4" plywood
Volume—2 cubic feet
Height—28" outside
Width—14" outside
Depth—12" outside
Vent—2" diameter circle

Acoustic filter in 3/4" plywood with four slits 1/16" wide and 8 1/4" long over-all. Position 17" from top, outside. Vent resonance 45 cps.

Taking into account size, cost, and ease of construction, the reflex enclosure still pays better dividends in the bass than any other system.

The smaller unit can with advantage be used in the larger cabinet, but the process should not be reversed.

Adding a Tweeter

If it is desired to improve the high-frequency response, the simplest method is to mount a tweeter on a small baffle—preferably facing upwards—and stand it on top of the main cabinet, using the circuit of Fig. 42.

Baffles

Having paid baffles a few compliments, the least we can do is to give the reader a few hints on how to get the best out of such a system.

Two speakers in parallel are the obvious choice for 3 db gain at low frequencies. Sheet aluminum 1/4" thick, backed with fiber board or coated with a damping medium, makes a splendid baffle and gives a nice crisp tone to the reproduction. If plywood is used it should be sandfilled as shown in Fig. 43. The dimensions combine reasonable performance with convenient size.

For the bass end, a 10", 12", or 15" speaker could be used, but the resonance should be not higher than 40 cycles. It must be made clear that it is the availability of low resonance units which makes possible this new approach to the long-discarded open baffle.

In order to reduce middle and treble but maintain maximum bass, an inductance can be placed in series with this unit, as shown in Fig. 44. The tapped coil (used alone) described in Part 8 would make an ideal variable control here.

The second speaker could be an 8" or 10" unit, with resonance preferably below 50 cycles, but even above 50 cps is acceptable because parallel working makes the higher resonance virtually harmless. Here we have shown a slot in place of the usual circular opening, to reduce beaming and improve high-frequency dispersal. Useful dimensions are: 8" unit, slot 3" x 7"; and 10" unit, slot 3" x 8". The two speakers must be correctly phased. If they are out-of-phase, you will have a 20 db loss at low frequency instead of a 3 db gain. Adding a tweeter with the circuit of Fig. 42 is simple and phasing at high frequencies is of no consequence in this case.

Even a single speaker can be used on a baffle with good results, but low cone resonance is essential. So much for baffles. At least they are free from boom.

Reflex vs Horn Loading

It is not our intention to hold a Beauty Contest and pick the winner here, nor do we propose to outline vital statistics; it is better to leave the choice to personal preference. But I do think that the response curves of Figs. 46 and 47 throw some light on the question of relative efficiency which was raised in the previous article.

Both curves were taken out of doors with the same 15" foam-surround unit, and with the cabinets placed in a corner formed by the walls of a building. The microphone distance was 4 feet on-axis in both tests.

The conclusions to be drawn from these tests are as follows:—

(1) The output below 100 cps is about the same in both cases.

(2) The main output from the horn is located between 100 and 400 cycles but, when comparing it with the reflex model, it should be remembered that this has considerable vent output with a peak around 200 cps as shown in Part 5.

(3) As usual, the working range of the horn is limited to 3 to 4 octaves, but the reflex design will easily extend to 7 octaves. Above 500 cycles, reflections play havoc with the output of the folded horn, but such effects are normally sidetracked by crossover networks.

So we are left with the 64,000 dollar question of how best to assess the efficiency of either system. If you take the horn performance between 100 and

300 cps, I will take the reflex output between 300 and 1000 cps and compare you, or I will take the next two octaves and knock you clean out of the ring. On the other hand, we can all take the region of 40 to 100 cycles and practically call it a draw.

The fact is that it is quite as logical to say that reflex loading is twice as efficient as horn loading because it covers twice as many octaves as to say that horn loading is much more efficient than other forms because it squirts out more concentrated sound. It is rather like taking a shower bath; the available jet of water must be nicely spread out for comfort.

It should be explained that these tests were made with a front-loading horn, the output from the back of the cone being purposely absorbed. Results would have been quite different with a back-loading horn, where the output from the front of the cone plays straight into the room. The axial response curve above 1000 cycles, for what it is worth, would then be similar to Fig. 46 but it would not be horn loading.

For ordinary listening, I would say that, by and large, horn loading gives more output than reflex cabinets, offset to some extent by directional effects when tests are extended to higher frequencies and shorter horns, where open baffles would be used in preference to reflex enclosures. The over-all difference is nothing like the off-quoted 40% efficiency for horns with less than 10% for other systems.

Using the models of Figs. 46 and 47 as the bass end of a 3-speaker system, I liked the reproduction from either and found it difficult to express a definite preference.

—50—

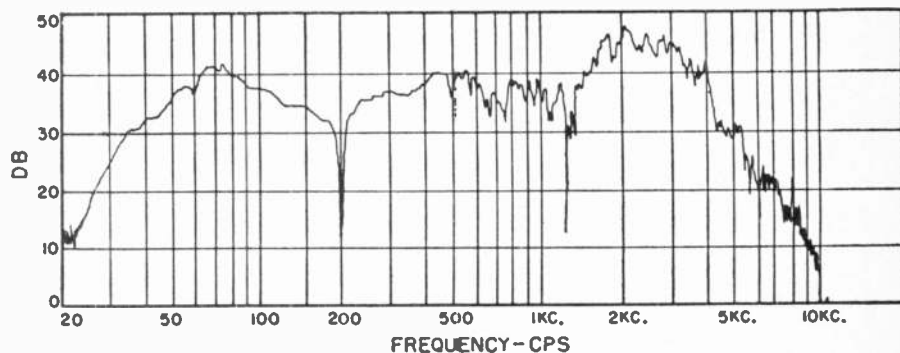

Fig. 46. Response curve of 15-inch loudspeaker unit in 9 cu. ft. corner reflex enclosure which has been constructed with sand-filled panels. The input level was 2 watts and the microphone distance was 4 ft. on axis, and 3 ft. above ground.

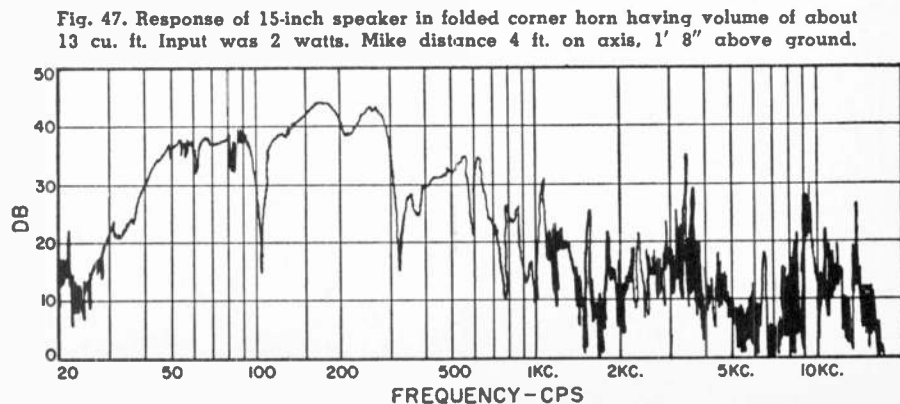

Fig. 47. Response of 15-inch speaker in folded corner horn having volume of about 13 cu. ft. Input was 2 watts. Mike distance 4 ft. on axis, 1' 8" above ground.

Tomorrow's Sound In Music...TODAY



THE FISHER

Stereophonic



101-R

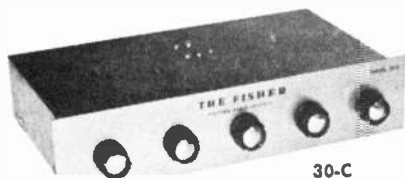

30-C

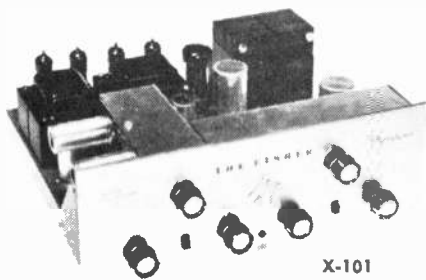

X-101

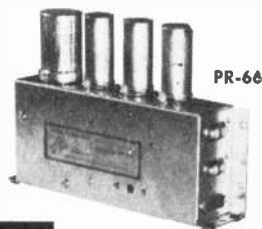

PR-66

LOOK TO FISHER FOR LEADERSHIP! For more than two decades, FISHER engineering skill has regularly produced basic developments that have set the pace in high fidelity.

Now, FISHER again takes the lead in the development of STEREOPHONIC sound. The most advanced features—*features you had not expected for years to come*, are yours to enjoy TODAY in every instrument bearing the name—FISHER.

THE FISHER "400"—Stereophonic Master Audio Control with virtually unlimited stereo and monaural uses. Equalization for records and tapes; Push-Button Function Selector; Cross-Over Network; Rumble Filter; Record-Monitor facilities. 16 inputs, 4 outputs.

THE FISHER 101-R—Stereophonic Gold Cascade FM-AM tuner. Separate FM and AM tuners on one chassis with separate MicroRay Tuning Indicators. For FM-AM stereo, FM multiplex, FM and AM monaural. Automatic interstation muting. AM Bandwidth Selector.

THE FISHER 30-C—Master Audio Control for a second, stereo channel—or for a monaural system. 6 inputs. Record and Monitor facilities. Phono and tape equalization. Microphone Preamplifier. Rumble Filter, Loudness Contour, Bass and Treble tone controls.

THE FISHER X-101—Stereophonic Master Control and Amplifiers. 32 watts of power, 75-watt peaks. 8-Position Function Selector: Equalization, Channel Balance, and Record Monitor facilities. Loudness Contour, Rumble Filter. Full-range, Bass and Treble controls.

THE FISHER PR-66—Stereophonic, dual-channel phono preamplifier for stereo and monaural applications. Equalized for the new stereo records. Use as a tape or microphone preamplifier, stereo or monaural. Hum, noise and crosstalk are inaudible.

WRITE TODAY FOR COMPLETE SPECIFICATIONS



FISHER RADIO CORPORATION · 21-41 44th DRIVE · LONG ISLAND CITY 1, N. Y.

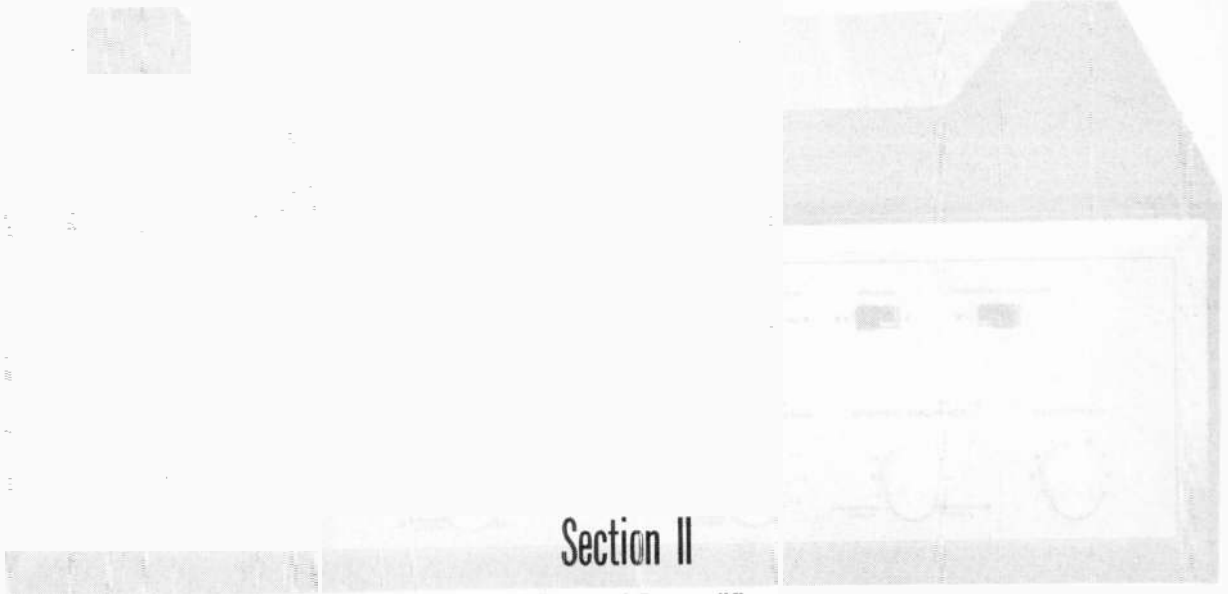

Section II

Amplifiers and Preamplifiers

High Power vs Low Power Amplifier	34
Measuring Amplifier Damping Factor	37
Why Do Amplifiers Sound Different?	40
Upgrading The Hi-Fi Amplifier	44
A Low Cost Hi-Fi Amplifier	48
A New Look At Positive Current Feedback	51
RC Filter Tone Control	54
Reducing Hum and Noise in Preamplifiers	57
Feedback	57
In Defense Of The Split-Load Phase Inverter	58

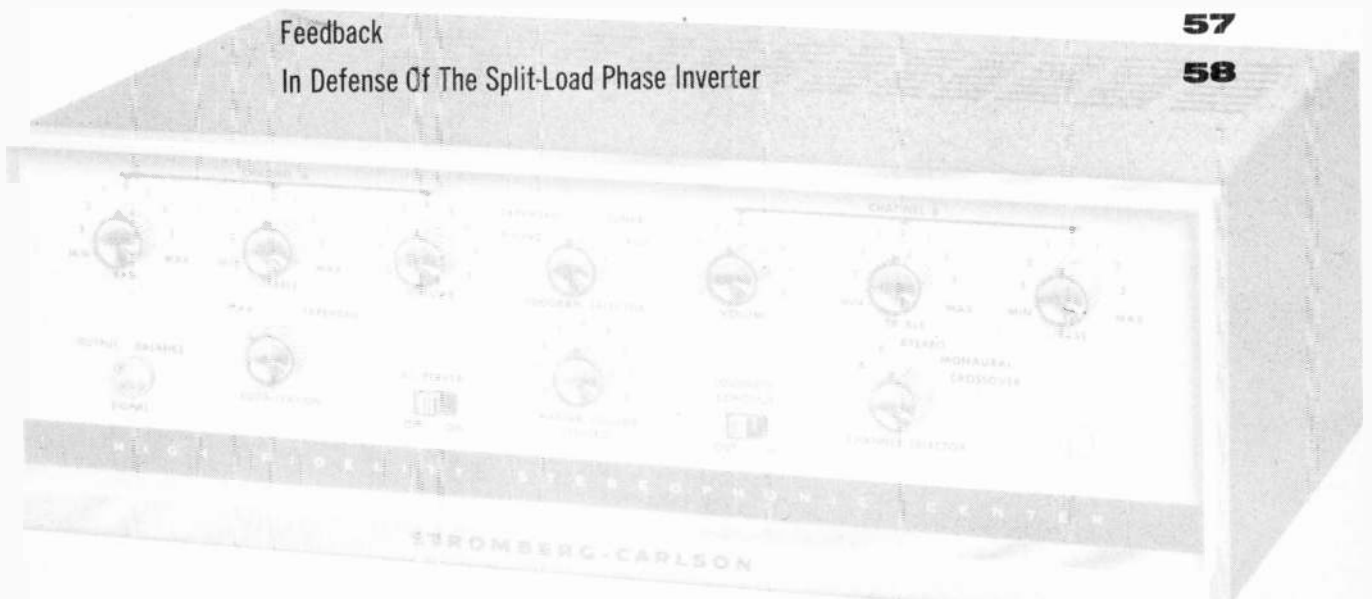

High Power vs Low Power Amplifiers

By
N. H. CROWHURST

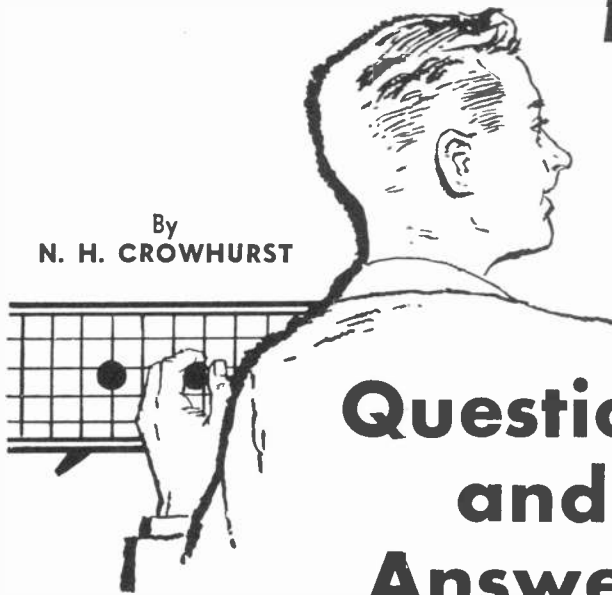

Questions and Answers

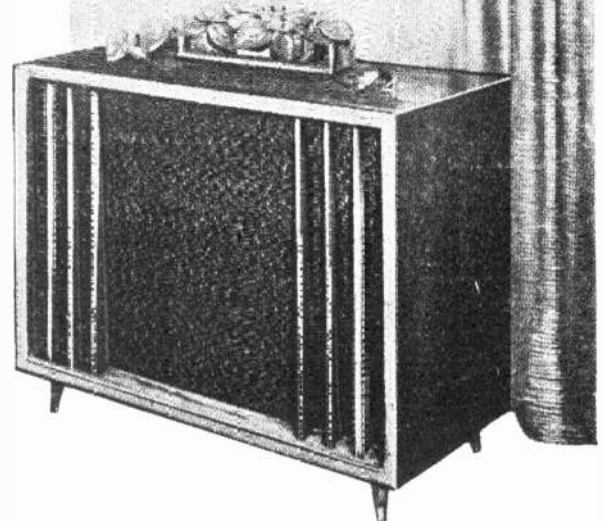

An excellent article that should go a long way in settling the power argument for some time to come.

AMONG high-fidelity people, whether by that term you imply the manufacturer or the user of the equipment, there are two very definite schools of thought, as soon as the question of power output from an amplifier is raised. One says the trend toward big, powerful amplifiers (30, 50, or 100 watts) is quite unnecessary, all you need for the average living room is, at the most, 2 watts, with maybe some "headroom," so perhaps you should get an amplifier with a 10 to 15 watt rating.

The other school says you don't have sufficient headroom to handle transients and special effects in the musical program unless you do go to high power amplifiers, rated at 30, 50, or 100 watts (the higher the better). There are very definitely two points of view here, but each protagonist presents his own viewpoint as if it were the only one.

One writer will tell the reader he really doesn't need an amplifier with 30 watts output, let alone more than that, while another writer comes along and tells the reader that any amplifier with less than a 30-watt output is totally inadequate. This leaves the unfortunate layman (Mr. Average American) in a state of confusion.

A simple way to tackle this problem seems to be to deal with the most basic questions from which it derives, so each reader can judge for himself.

Question 1: Why do some recommend high power, say 50 to 100 watts, when an amplifier with 10 to 15 watts sounds quite good?

Let's simplify the issue a little by just taking the two extreme wattages.

The contrast for ratings in between this will be that much less. Take an amplifier of 10 watts as compared with an amplifier of 100 watts. To the newcomer, this gives the impression that the 100-watt amplifier should sound 10 times as loud as the 10-watt amplifier. Unfortunately this is not true, due to a law, considered elementary by physiologists, called Fechner's Law.

This says that the sensation of loudness, like any other human sensation, is dependent upon the logarithm of the intensity of stimulus. Simply stated, the change in *sensation of loudness* is proportional to intensity *ratio*, not intensity *difference*, or the ratio between one power and another. As the human loudness sensation, at 1000 cycles at any rate, extends over a power ratio of 1,000,000,000 to 1, this means a ratio of 10 to 1 is just 1/12th the loudness "difference" between being just audible and the maximum intensity audible as sound. (Fig. 1.)

Expressed this way, even a 10 to 1 ratio, from 10 watts up to 100 watts, represents not a very big change in loudness. A change from 25 to 50 watts becomes only just perceptible—it is 3 db, and a change from 10 watts to 100 watts is only very little more than 3 times as much "difference" in loudness sensation—10 db, although one is a step-up of 2 to 1 in power, while the other is 10 to 1. This should help to set the stage for what follows and explains why the loudness sensa-

tions created by amplifiers at different power ratings are not as different as might be expected just by considering the power rating. A 50-watt amplifier gives 5 times as much power as a 10-watt amplifier, but this is only 7 db.

Larger power *can* be a disadvantage, unless the amplifier has a lower hum level. If the hum level is the same in each case, the hum from a 100-watt amplifier will be 10 db higher than that from a 10-watt amplifier. And loudness sensation at 60 or 120 cycles, the hum frequencies, is about three times as sensitive, so 10 db here is equivalent to 30 db at 1000 cycles. It can be the difference between an inaudible hum and one that is quite annoying during quiet passages.

Question 2: How is it that some 15-watt amplifiers sound louder and cleaner than some 50-watt amplifiers?

The hum question, just mentioned, can be a factor. There are others, but without getting involved in amplifier design and performance characteristics in detail, this depends on what is termed the "overload characteristic" of the amplifier.

Many amplifiers, rated to give 50-watt output, certainly do give 50 watts output. But try to make them give 51 watts and you might as well strive for the moon! It is not just that they refuse to give more than the 50 watts, but when the input is increased beyond that required to give 50 watts, the waveform becomes completely dis-

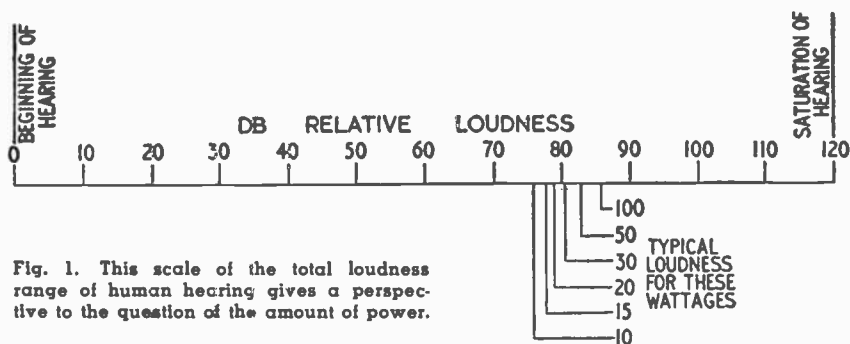

Fig. 1. This scale of the total loudness range of human hearing gives a perspective to the question of the amount of power.

torted. It is suddenly extremely evident to the listener that the amplifier has reached "the top."

On the other hand, many 15-watt amplifiers use quite a different kind of circuit. They may not give too much more than 15 watts before running into distortion troubles. They may become considerably distorted if you try to push 20 watts out of them. But the difference is that you can push in perhaps twice as much input and get a reasonably distorted output of 20 watts. (Fig. 2.)

If you push twice the voltage into a 15-watt amplifier, this would give 60 watts if the amplifier continued amplifying more without distortion.

Instead, you get 20 watts of tolerably distorted output. But, because you turned the voltage up this much, all of the lower level parts of the program sound like a 60-watt amplifier, and the peaks which should have 60 watts available to amplify them without distortion come out at about 20 watts without too serious distortion.

On the other hand, putting the same input into the 50-watt amplifier goes over the 50-watt level and produces extreme distortion, so you have to turn the input down to make quite sure the peaks never go beyond the 50-watt point. Program material that uses an average power of 5-15 watts with peaks running to 60 watts, will have occasional peaks running to 120 watts or more. The so-called 50-watt amplifier may need to be turned down to an average of only 2-6 watts to compare favorably with the 15 watt.

Question 3: Does the kind of loudspeaker you use have anything to do with the power needed from the amplifier?

It certainly does, and this is a point often overlooked in discussing the subject. A high-efficiency loudspeaker, of a type used in home high-fidelity systems, will have an efficiency of not more than 20%. This efficiency would

mean an output of 50 watts will give not more than 10 watts actual acoustic power. More often the efficiency will be not more than 10%.

But even with this much efficiency, about 2 watts of electrical output will give you all you need in the living room for the sound to become almost deafening at loud passages. It is quite true as claimed by the "low-power" people, that the actual sound energy you need in the living room is only a matter of hundreds of milliwatts at the peak.

But some loudspeakers, instead of running in the region of 10% efficiency, which is still relatively high for a loudspeaker, only achieve 1 or 2% efficiency. Take a 2% efficient speaker in comparison with a 10% efficient speaker. Obviously, a 10-watt amplifier with a 10% efficient speaker will produce the same acoustic output into the room as will a 50-watt amplifier with a 2% efficient speaker. Both will give a maximum of just 1 watt into the room.

Question 4: Is the use of electronic dividing networks of any advantage in making do with less power?

The whole problem in power rating on amplifiers is one of providing for peaks. The average power is quite a small fraction, probably not more than 1/10th, of the peak power necessary to handle the composite audio waveform adequately.

Consider an idealized case, in which the audio composite consists of a single sine-wave frequency in each of the frequency ranges handled by a three-way loudspeaker system. (Fig. 3.) The highest frequency can be considered as riding on the medium frequency, and then this composite can be considered as riding on the lowest frequency. Assume, for simplicity, that each of these waveforms has a peak amplitude of 10 volts across an impedance of 10 ohms, representing a peak power of 10 watts or an average power of 5 watts.

Then the total peak voltage will be 3 times 10, or 30 volts, representing a peak power of 90 watts, or an average power of 45 watts. This is what the amplifier rating would have to be to handle the composite signal. And yet the actual total power is only the sum of the three average powers, $5 + 5 + 5 = 15$ watts. So, for this idealized example, we need an amplifier with a rating of 45 watts, which means it will handle 90 watts peak, to satisfactorily accommodate the three 5-watt sine waves one on top of the other.

If we separate these three sine waves with an electronic dividing network, before we get to the power stage, so they are handled by separate power amplifiers, each amplifier will only need to handle its own 5 watts individually. This is the kind of argument put forward to show the advantage of an electronic dividing network. Of course, it will also reduce the possibility of intermodulation in the amplifiers and provides other advantageous features, but here we are discussing its possible advantage in making do with less total power.

What the argument just presented does not say is, how you would like a program consisting of just one sine wave in each of the frequency bands handled by your three-way system? It certainly would not sound much like music.

Typical musical programs will normally consist of: a single frequency, maybe with some harmonics, in the woofer range; a composite of several tones in the mid-frequency range, representing chords or the harmony of the music; while the tweeter or high-frequency range will only be carrying a comparatively small amount of power—just a few milliwatts—to give "definition" to the low- and mid-range material.

The biggest amount of power is probably required in the low and middle ranges. So from the standpoint of power division we can consider the problem as being essentially a two-way system. Sometimes there may be no low-frequency component but then the bulk of the power will be presented in the mid-range. This often occurs in musical programs. On the other hand, when there is a predominant low-frequency component, such as when a pleasant string bass "foundation" predominates, the other instruments are usually considerably quieter or at least do not require maximum power.

If you use your system exclusively for reproducing a string quartet, you probably could save on the total power required by using an electronic dividing network system. But if you play a more varied kind of composite material, then this advantage for using it seems to disappear, because on some occasions you will need to present the total power of the system through the mid-range channel. You will probably finish up needing an amplifier, for both the low- and mid-range channels, as big as a single amplifier would be to handle the full range.

The high-frequency channel, it is

Table 1. Maximum watts needed. Powers are those normally used as "average" ratings.

ROOM CLASSIFICATION	A		B		C	
	1	2	1	2	1	2
High-Efficiency Speaker (15%)	.25	1	1.25	5	6	25
Medium-Efficiency Speaker (5%)	.75	3	4	15	18	75
Low-Efficiency Speaker (1.5%)	2.5	10	12	50	60	250

true, can use considerably less power, but there is little possibility of achieving any worthwhile power economy by using electronic dividing networks here.

This does not argue, of course, against their use for reducing possible intermodulation distortion and providing other features that do not come within the scope of this article.

Question 5: Must the amplifier and loudspeaker power ratings be matched? For example, must I use a 30-watt amplifier with a 30-watt loudspeaker?

This question, with variations, often crops up. It is surprising how often someone wants to know why the 30-watt loudspeaker doesn't sound louder than the 10-watt loudspeaker, when both are operated from a 5-watt amplifier, although the latter piece of information is not usually volunteered, because it "seemed irrelevant." *The wattage rating of a loudspeaker is not an indication of how loud it will sound, but of how much power can be put into it.*

It does not mean the loudspeaker with the bigger rating will sound any louder if only 2 or 5 watts are actually delivered to it by the amplifier. This is dependent, not upon the *power rating* of the loudspeaker, but on its *efficiency*. If one loudspeaker has an efficiency of 2% and another of 10%, then the 10% loudspeaker will sound louder than the 2% one, *with the same power delivered to it.*

To answer the question directly, the only possible reason why amplifier and loudspeaker power ratings should be matched is to insure the loudspeaker is not damaged by being overworked. For example, a 50-watt amplifier fed into a 10-watt loudspeaker could burn out the voice coil or cause other damage to the loudspeaker. On the other hand, a 10-watt amplifier, worked into a 30-watt loudspeaker, will never cause any damage, because the loudspeaker can never get enough power to fully drive it.

Question 6: Is there any connection between the efficiency and power rating of a loudspeaker?

Only that you need to take both these properties into account to determine how loud the loudspeaker can go. For example, a 30-watt loudspeaker with 5% efficiency will accept 30 electrical watts from the amplifier before causing any serious damage to itself. The fact that it is 5% efficient means that 1/20th of the 30 watts or whatever power it actually gets from the amplifier is delivered to the room as acoustic energy (a maximum of about 1.5 watts). This should be more than loud enough for any living room, but to get the 1.5 watts you will need a 30-watt amplifier.

On the other hand, a 20-watt loudspeaker may have an efficiency of 15%. This means the loudspeaker will accept 20 electrical watts and, being 15% efficient, will convert these into 3 acoustic watts. Although the power rating of the loudspeaker is lower than the other one it will give a bigger acoustic output into the room from a smaller

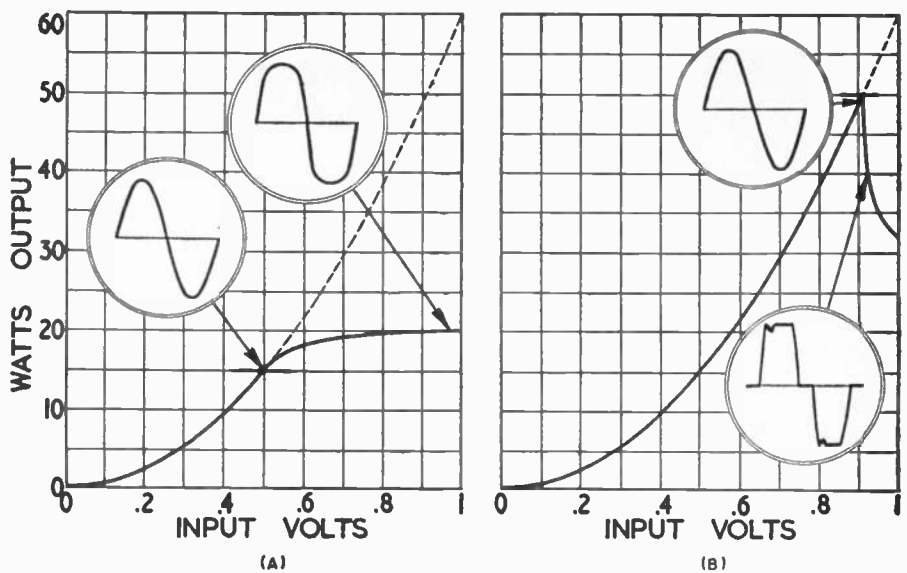

Fig. 2. The power output characteristics of a 15-watt amplifier (A) and a 50-watt amplifier (B) to show reason for difference sometimes noticed. The waveforms inset show output quality up to maximum output and beyond it, in each case.

amplifier (needing only a 20-watt amplifier in place of the previous 30-watt unit).

This says that, in considering the power needed for a system, you need to take into account not only the power rating, but also the efficiency of a loudspeaker. Beyond this there is no connection between the two. If a loudspeaker has a higher power rating it is not an indication, automatically, that it is either less or more efficient.

Question 7: Can you give me some idea how much power I shall need for my system?

As the foregoing questions have shown, this depends on a number of factors. To try and be specific, we will give a comparative table that shows a range of maximum power required for various typical conditions. Note that Table 1 gives figures ranging from a quarter of a watt to 250 watts, which covers the entire range recommended by both the high-power and the low-power advocates.

Three typical room classifications are listed: A is a typical room with tiled floor, smooth walls, and furnishings without much, if any, upholstery—a modern American recreation room—with quiet background, not too near a railroad track; B is an average room, with carpet on the floor (not necessarily wall-to-wall), well-draped or open windows, possibly some drapes at entrance to another room, and some upholstered furniture; C is a well damped room of considerable size, with wall-to-wall carpeting, plenty of heavy drapes, on walls as well as at windows, and a quantity of well upholstered furniture—a real "plush" suite. Ambient noise from the neighborhood will make some difference here, as well as the size of the room and the number of listeners.

Program classification takes into account two extremes, which might be described as "highbrow" and "low-

brow"! Under these columns the figures are based on the relative peak power rating needed to give a similar impression of peak loudness with the two types. Column 1 is for jazz music, or any variety where the general level remains fairly constant, or compression is used in recording. Column 2 is for a recording possessing wide dynamic range, high quality orchestral material.

Three rows of figures are given for different average efficiencies of loudspeaker. The percentages given are average, as no loudspeaker has constant efficiency at all frequencies. As few loudspeakers come with an efficiency rating, this does not help too much, except to give some idea of range, and we hope, some idea where to expect yours to come.

Fig. 3. The waveforms shown here illustrate the argument that the use of an electronic dividing network saves on the total power rating required. Validity of this argument is discussed in accompanying text.

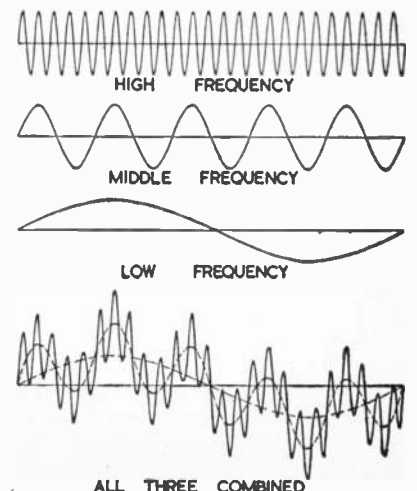

Measuring Amplifier Damping Factor

Described here are two methods that may be used to measure the damping factor of an audio amplifier.

THE KNOWLEDGE of what your amplifier's damping factor is has become more important recently. With high-efficiency speakers it was usually felt that the higher an amplifier's damper factor the better this would be for the speaker in damping out undesired resonances. However, with the advent of high-quality, low-efficiency speakers, and especially with such speakers mounted in infinite baffles or other such enclosures that do not add to the bass response, the use of an amplifier with too high a damping factor is undesirable. This would result in overdamping the speaker and reducing its output, especially at the bass end. Perhaps the day is not too far away when speaker manufacturers will specify optimum damping factors for their speakers when used in specific enclosures. Several values might be given for different types of listening tastes. The amplifier manufacturers have already started the ball rolling by providing, in some cases, a variable damping control that allows the user to set the damping factor at whatever value he requires.

At present most speaker manufacturers are quite reluctant to quote any optimum damping factors for amplifiers to be used with their loudspeakers. This is partly due to the fact that not enough experiments have been done along these lines and also that the results obtained at various damping factors is so subjective. Some listeners might like the way their speakers sound with one certain damping factor, others might prefer another value.

Typical values of amplifier damping factor depend, in the main, on the output circuit used. For example, with push-pull triodes without feedback the damping factors are in the range of 2 to 4. With push-pull beam power tubes the damping factor is apt to be less than this unless negative feedback

is used. With large amounts of negative feedback, tetrode damping factors may run as high as 10. Recent designs using triodes with feedback or "Ultra-Linear" stages with feedback may have damping factors from 10 to 30.

The measurement of an amplifier's damping factor is quite simple. This article will describe two methods of measurement.

Variable Resistance Method

To use this method a signal voltage is introduced into the input of the amplifier to be checked. This signal may come from the a.c. heater supply of the amplifier itself. Next the load is removed from the output terminals and the output voltage is measured with a suitable audio voltmeter. The input signal should be kept well below the overload point of the amplifier and below that point that might cause arc-over in the unloaded output transformer. Then a low value variable resistor (the author uses a 15-ohm wire-wound unit) is connected across the output terminals and this is adjusted until the voltmeter reading falls to one-half the unloaded value. Under these conditions the voltage across the variable resistor is equal to the voltage across the actual output impedance of the amplifier. See (A) of diagram. Now the variable resistor is removed and its resistance is carefully measured. This value of resistance is equal to the output impedance (technically, the effective source impedance) of the amplifier. If this resistance value is simply divided into the *nominal* output impedance of the amplifier (the value frequently marked on the amplifier itself), the result is the damping factor. For example, in the diagram shown assume that the value of the variable resistor is 1 ohm and that the measurement is being made on the 8-ohm tap of the amplifier, the damping factor is 8/1, or 8.

If it is found that the output voltage of the amplifier should rise when the load is applied, then this indicates that the amplifier has a negative damping factor. The resistance value that causes the loaded output voltage to be doubled is equal to the negative impedance of the amplifier.

Several problems may be encountered in using this method. One is that with amplifiers having very high damping factors, it might be difficult to adjust and to measure the very small values of resistance required to make the voltage drop to one-half. Another problem occurs when very low resistances are shunted across the output terminals of an amplifier; the primary impedance of the output transformer falls and the plate current through the output tubes may be excessive. In one case where this method was used, the plates of the output tubes became dangerously red. Another method that will yield the same answer but with none of the drawbacks is described below.

Voltage Regulation Method

To use this method a signal is applied to the amplifier and an output voltage measurement is taken with no load connected. Let us call this no-load voltage E_{NL} . Next, a resistor with a value equal to the nominal output impedance is connected to the output terminals of the amplifier. The amplifier is now properly matched. Then, a second voltage reading is taken under these fully loaded conditions. Call this full-load voltage E_{FL} . The damping factor of the amplifier is simply equal to the full-load voltage divided by the difference between the no-load and the full-load voltage, or $E_{FL}/(E_{NL} - E_{FL})$. This may be recognized as the inverse of the regulation formula. As a matter of fact the damping factor of an amplifier is a measure of its regulation. If, for example, the output voltage falls only a very small amount when the circuit is loaded, its regulation is good (low) and its damping factor is high.

To show that this method gives the same results as the variable resistance method, consider (B) of the diagram. Assume that the same amplifier with its 8-ohm output tap and its 1-ohm output impedance mentioned before is used. Assume further that the no-load voltage measures 4.5 volts. There is no drop across the 1-ohm output impedance with no current flow. With the 8-ohm load connected, the full-load voltage will fall to 8/9 the no-load voltage, or 4 volts, in the simple series circuit. The damping factor then is $4/(4.5 - 4)$, or 8. This is the same value that was obtained with the first method described above.

Obtaining the damping factor, using either of the methods described, may help you to evaluate the performance of your loudspeaker system and it will certainly give you one more important characteristic of your amplifier. —30—

Equivalent circuits for two methods described above for measuring damping factor.

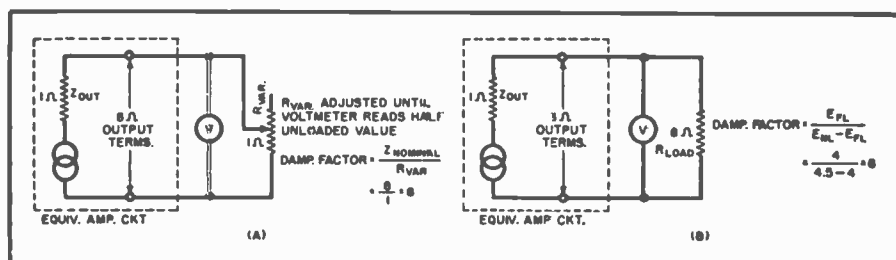



THE NEW STROMBERG-CARLSON COMPONENTS

Integrity in Music, as applied to high fidelity components, means reproduction which adds nothing to, or takes nothing from, the original performance.

Stromberg-Carlson's choice of this slogan is no accident. Just as your purchase of a component system is not a casual investment, our attitude toward the manufacture of components is very serious indeed. Each piece of gear must reflect the highest possible achievement of engineering, production, and musical skill. The guiding minds, hands and ears of the Stromberg-Carlson component group are those of professional electronic and acoustic engineers with extensive musical training.

The musical sound of our new components was the final critical test before they were made available to you.

We proudly submit our specifications to your critical judgment. These specifications are accurate and conservative. We have declared ourselves out of the "battle of exaggerated specifications." Please study our specifications to see how the phrase "Integrity in Music" takes on true life and meaning.

"There is nothing finer than a Stromberg-Carlson"



SELECTED FOR DISPLAY AT THE VIENNA INTERNATIONAL FALL FAIR

ASR-433 STEREO AMPLIFIER

The most important aspect of stereo is stage effect. The instruments of the orchestra should come back to you from their exact positions on the stage. How? The answer is balance. The ASR-433 is the stereo amplifier with "Tone-signal Balance," the surest method of achieving this realistic stage effect.

The ASR-433 is a superb monaural amplifier as well, giving you a full 24-watt output. The electronic crossover at 3,000 cycles provides output for 12 watts low and 12 watts high frequency operation. Every function has its own control for each channel and a master volume control is provided.

**All prices are Zone 1.*

SPECIFICATIONS:

POWER OUTPUT: 24 watts (2-12 watt channels).
 FREQUENCY RESPONSE: 20-20,000 cycles \pm 1 db.
 HARMONIC DISTORTION: Less than 1%. NOISE LEVEL: 63 db down. INPUTS: Magnetic Phono, Ceramic Phono, Tape Head, Tuner and Aux. Tape. OUTPUTS: 4, 8, 16 ohms and dual Tape Out. LOUDNESS CONTROL: In-out, continuously variable. TONE CONTROLS: Bass 15 db droop, 15 db boost; Treble 14 db droop, 12 db boost. EQUALIZATION: RIAA Mag. Phono. NARTB Tape Head. TUBES: 2-12AX7/7025, 2-6AV6, 2-6AU6, 4-EL84. CHANNEL SELECTOR: Channel "A," Channel "B," Stereo, Monaural, Crossover (at 3000 cycles). DIMENSIONS: 13 $\frac{1}{2}$ " W, 13 $\frac{3}{8}$ " D, 4 $\frac{1}{8}$ " H. PRICE: \$129.95* (Audiophile Net).

STROMBERG-CARLSON

A DIVISION OF GENERAL DYNAMICS CORPORATION

1476C N. GOODMAN STREET • ROCHESTER 3, N. Y.



Electronic and communication products for home, industry and defense... including High Fidelity Consoles; School, Sound, Intercom and Public Address Systems



RW-489
12" Soft Skiver Woofer.
\$49.95* (Audiophile Net).



RW-490
15" Soft Skiver Woofer.
\$99.95* (Audiophile Net).



RT-476
2 3/4" Tweeter.
\$9.95* (Audiophile Net).



RT-477
Induction Tweeter.
\$49.95* (Audiophile Net).



MSS-492
SPEAKER SYSTEM:

12" Soft Skiver Woofer, 8" mid-range, two 2 1/2" Tweeters. Available in cherry or walnut. 32 1/2" high, 33 3/4" wide, 16 3/4" deep. PRICE: \$249.95* (Audiophile Net).

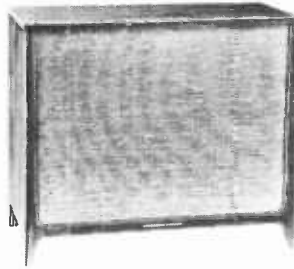

MSS-491
SPEAKER SYSTEM:

15" Soft Skiver Woofer, 8" mid-range, Induction Tweeter. Available in mahogany, walnut or limed oak. 32 1/2" high, 38 3/8" wide, 21" deep. PRICE: Mahogany—\$379.95*; Walnut—\$389.95*; Limed oak—\$389.95* (Audiophile Net).



MSS-481
SPEAKER SYSTEM:

8" mid-range, 2 1/2" tweeter. Available in mahogany, oak or walnut. 24 1/2" high, 19" wide, 10" deep. PRICE: Mahogany—\$69.95*; Walnut, oak—\$74.95* (Audiophile Net).



NEW SPEAKER SYSTEMS

Some speakers and speaker systems provide clean, sharp transients at low and low-low frequencies. Others are very linear in response at low and low-low frequencies. *Only the new Stromberg-Carlson multiple speaker systems give you both.*

Low end frequency response extends for at least an octave below that heretofore possible. The range of our MSS-491 system is 16-22,000 cps; the range of our MSS-492 system is 22-18,000 cps.

Speaker system resonance is lower than the un baffled free air cone resonance of the woofers themselves. The exceptional transient response, linear quality and extraordinary low frequency response are directly related to a carefully integrated design between our woofers and our quarter wavelength Acoustical Labyrinth® baffling system. Three-way crossover networks are included in the systems.

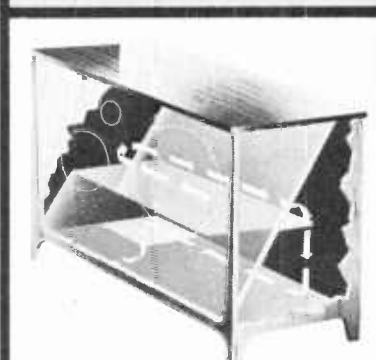

STROMBERG-CARLSON ACOUSTICAL LABYRINTH® BAFFLING SYSTEM

FOR FULL DATA ON ANY AND ALL ITEMS, SEE YOUR DEALER OR WRITE US DIRECT.

*All prices are Zone I.

NEW SLIMLINE® SPEAKERS



RF-484
15" COAXIAL TRANSDUCER.
PARTIAL SPECIFICATIONS:
Cone Resonance: 20 cps ± 5 cps. Power Handling Capacity: Woofer—more than 100 watts; Tweeter—more than 50 watts. Frequency Response: flat to 20,000 cps. 1M Distortion: 0.3%. \$149.95 (AUDIOPHILE NET)



RF-481
Slimline
12" Wide Range
Transducer. \$39.95 (AUDIOPHILE NET)



RF-482
Slimline
12" Coaxial
Transducer. \$59.95 (AUDIOPHILE NET)

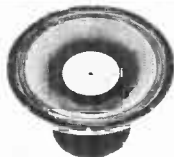

RF-475
15" Coaxial
Transducer. \$229.95 (AUDIOPHILE NET)



RF-483
15" Coaxial
Transducer. \$99.95 (AUDIOPHILE NET)



RF-480
Slimline 8" Transducer.
\$24.95* (AUDIOPHILE NET)



Why Do Amplifiers

Sound Different?

By NORMAN H. CROWHURST

Reasons for performance differences in audio power amplifiers having similar published specifications.

RECENTLY the opinion that the loudspeaker is the weakest link in the reproducing system and that amplifiers have progressed about as far toward perfection as it is possible to go has been widely expressed. As a basis for this conclusion, it is stated that the residual degree of various kinds of distortion present in modern amplifiers is so small as to be impossible to hear. However, many are not yet satisfied that this philosophy is true.

To illustrate this view, the following experience is by no means impossible or uncommon: two different amplifiers are compared, using the same pickup or tuner as a program source and the same loudspeaker. Both amplifiers, although of different design, use the same input and output impedances, provide the same damping factor for the loudspeaker, and give frequency responses and degrees of distortion which deviate by an acknowledged imperceptible amount—yet any discriminating listener can discern quite an appreciable difference between the sound of program played through the two amplifiers.

Why should these amplifiers sound different? A recent article on "Methods of Measuring and Specifying Audio Distortion" (August 1956 RADIO & TELEVISION NEWS) showed reasons why the same specified amount of distortion can sound different, according to the exact nature of the distortion, and pointed up the need for more precise methods of specifying such. This mostly related to the specification of distortion when clipping is involved.

But differences are noticed in the performance of amplifiers, even at

levels well below the clipping point. For example, a trumpet recording is played through the two amplifiers and on one sounds quite clean while on the other there is a definite harshness about the reproduction. When the gain control is turned back the harshness becomes less noticeable, but only because the level is that much lower—it does not disappear completely, as one would expect if it were due to clipping, or an overload effect.

It became quite evident that something happens inside some amplifiers that is not adequately covered by the specifications. Incidentally, the amplifiers were checked on the same measuring equipment and both found to conform to their published specifications, which ruled out the possibility that one was not as good as it claimed.

Experimental Confirmation

Some work the author has been doing recently has verified two possible contributing causes for this kind of difference. From the results of these experiments it seems quite possible for an amplifier to perform to extremely close limits under standard test measurements and yet, with program material, the same amplifier can produce temporary or transient distortion conditions that are loud enough to be perceptible. Both these transient conditions are related to the nature of the roll-off characteristic produced by the feedback.

It is well known that, when you apply more and more feedback to an amplifier, a condition is eventually reached where the amplifier becomes unstable. This is due to the fact that, at some frequency, usually below or

above the audio spectrum, the feedback becomes positive and causes oscillation. The frequency of this oscillation may be down in the region of 1 or 2 cycles or up in the region of 100 or 200 kilocycles, depending principally on which happens first.

Normally, of course, amplifiers are operated with considerably less than this amount of feedback, so they do not oscillate. Naturally, one would think that a margin of 2 to 1, or a little more, in this direction would be satisfactory to insure that the amplifier could not get unstable under any conditions. Many amplifiers have been designed with about this much margin.

This, however, overlooks certain fundamental facts that evolve from a mathematical consideration of feedback design. As this article is not written primarily for engineers, we shall refrain from going into the mathematics of such design. It is fairly easy to understand that, as we increase feedback, before the amplifier starts to oscillate, it will show a peak in the response, in the region of the frequency where it will eventually oscillate. The question is: how much must the feedback be reduced, below the amount which causes oscillation, before the peak is completely removed?

This is where the mathematics help some: in average amplifier design, we learn that the margin between oscillation and peaking, at the low-frequency end, is in the region of 18 db; while at the high-frequency end, it will be in the region of 12 to 14 db. These figures represent ratios of 8 to 1 and 4 or 5 to 1 respectively, both of which are considerably larger than the previously suggested margin of a little more than 2 to 1. These facts are illustrated in Fig. 1.

What Do Square-Wave Tests Show?

In comparatively recent times, the importance of an adequate margin at

the high-frequency end has been realized. This was shown up at first by the use of square-wave testing. If there is any peaking in the amplifier response, or if the roll-off is too sharp, this will show up on a square-wave test as ringing at the corners of the square wave, as shown in Fig. 3. Many amplifier designers have, accordingly, paid attention to this feature and made adjustments to the amplifier so as to prevent this ringing. This means that high-frequency peaking must be absent from the amplifier.

However, there may not be the full 12 to 14 db stability margin, because the designers have used a trick to produce a satisfactory square wave: phase-shift capacitors associated with the feedback circuit. It's true that this method produces perfect amplification of the high-frequency end, for transients as well as steady tone, *when the amplifier is connected to a resistance load.*

Sometimes the designer has been careful to make sure that the amplifier performs reasonably well into a reactive load, but to make this test he uses for his reactance a *capacitance* across the output.

What seems to have been overlooked is the fact that most people use dynamic loudspeakers (woofers, squawkers, and tweeters) whose impedance becomes that of an *inductance* at the high-frequency end—and an inductance that gives a reactance somewhat larger than the nominal voice-coil resistance. This means that the amplifier loading is quite different from the conditions under which it is tested, as shown in Fig. 2.

The nature of the "finagle" used can be seen by a glance at the schematic: it has at least a "phase correction" capacitor across the feedback resistor, and probably has several other small-value capacitors (values given in $\mu\text{mfd.}$, not $\mu\text{fd.}$) at various points in the circuit. This produces a satisfactory response with less than the basic 12-14 db margin, but because of this the arrangement is inevitably more critical of the correct loading on the amplifier output. This means that the use of the inductive loading provided by the loudspeaker voice coil results in a transient response which is probably worse than it would have been if the "finagle" had not been employed.

This fact accounts for the roughness in the high frequencies, observed with a number of amplifiers whose *measured* performance shows no trace of over-accentuation of the high frequencies, ringing on square waves, or distortion in this region.

Why the Struggle?

Perhaps a word is not out of place here, as to why this technique is employed. It arises principally from the current fashion for amplifiers to have a frequency response as near as possible from zero to infinity. Since zero to 20 cycles does not sound like a very big "piece," but 20 kilocycles to infinity sounds like an enormous range, the concentrated effort has been on

ESL Dust Bug the automatic record cleaner



The problems of dust, lint, and static buildup on phono records and pickup styli have been solved by this ingenious new invention which cleans the record as it is being played. The Dust Bug pad is slightly moistened with special, harmless fluid supplied in a replaceable applicator. This helps to loosen groove dust and dirt so it can be collected by the pad. It also eliminates the static charge present in all records. Every point on an LP record is cleared by the wide Dust Bug pad approximately one hundred times during a single play. A special model is available for record changers.

Standard model, (above) complete with fluid in applicator, only \$5.75.

Record changer model, (right) only \$4.75 complete.

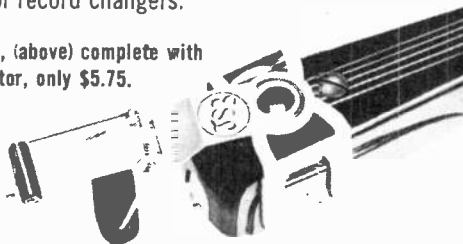

Acclaimed in two hemispheres!

"Has probably done more to preserve the life of records and stylus points than anything we have yet come across, even including super lightweight pickups!"

—HI-FI YEAR BOOK (London)

"After half a dozen plays, the surface of the disc looks exactly like a new, unplayed record. Noise, pops, and clicks are gone... Highly recommended... should be on every turntable"

—AUDIO (New York)



FOR LISTENING AT ITS BEST

Electro-Sonic Laboratories, Inc.

Dept. F • 35-54 Thirty-sixth Street • Long Island City 6, N.Y.

the latter end. As a result, amplifiers have been produced with specified frequency response extending to 30, 50, 100, and even 200 kc.

While some of our high-fidelity cartoonists have suggested that such amplifiers are for the birds, this trend has generally been taken rather more seriously. Because of this, amplifier designers have been faced with the necessity of meeting specifications of this kind, dictated by the promotion or publicity departments of their companies. To get the amplifier to perform to these specifications, they have virtually had to resort to the kind of tricks we have mentioned, because the only alternative requires an output transformer whose price would be prohibitive.

What About the "Low" End?

So much for the high-frequency end. The low-frequency end seems to have escaped attention although, as we found, its effects can be disastrous with some kinds of program material.

Most amplifiers probably have a stability margin at the low-frequency end of at least 2 to 1, or 6 db, and probably as much as 12 db. But, to avoid any peaking effect at a subsonic frequency, they need a margin in the region of 18 db. Unfortunately this peak

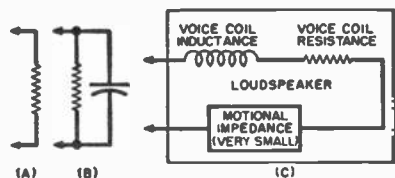

Fig. 2. (A) Common load used for testing although (B) is occasionally used. (C) Actual load offered by speaker to amplifier.

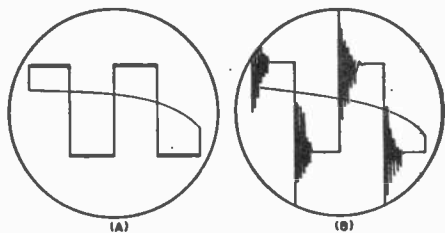

Fig. 3. (A) Good square wave applied to input and seen at output of very good amplifier. (B) A more common output waveform.

of maximum resistance; that is, so that its full 10,000 ohms is in series with the capacitor and the milliammeter. Now the switch is closed and low efficiency of the output transformer at this frequency.

That is a rather technical distinction—just what does it mean to amplifier performance? A peak in the response anywhere means that any transient condition can cause the system to ring at this frequency. If the amplifier has any kind of peak in the region of 1 or 2 cycles, a transient condition can cause the amplifier to produce a kind of low-frequency flutter of this frequency, which may take a few seconds to die away. But what kind of transient would do this?

What Is a Low-Frequency Transient?

The frequency of ringing is down at one or two cycles, so the normal transient, with a sharp wavefront, will not necessarily cause this kind of ringing. The waveform that will produce it is one that possesses a momentary d.c. component. Many of these occur in practical program material.

For example, the trumpet waveform we mentioned earlier is quite asymmetrical—this means it is equivalent to an a.c. waveform, with a number of component frequencies, plus a d.c. component which offsets the waveform on one side of zero. This probably occurs due to the fact that the instrument is blown and the air coming out constitutes a d.c. component. When a stringed instrument, especially a string bass, is plucked, or a percussion instrument is played, these, too, produce a momentary deflection of the waveform one way or the other from the zero line at the start of the tone.

Thus it can be seen that any of these kinds of program material can initiate the low-frequency ringing we have described.

So What Happens?

In the old-fashioned kind of amplifier, without feedback, this kind of program material will produce a momentary change of bias on each stage through the amplifier. The time taken for each bias to change will depend on the time constant, as it is called, pro-

duced by the coupling capacitor and the associated circuit resistors. In other words, a continued trumpet tone will cause the bias on each stage to re-adjust itself by some fraction and each stage will take a moment or two to settle down to its new bias value. This is illustrated in Fig. 4. The time taken for each stage to settle down will be dependent upon the time required for the coupling capacitor to change its charge: larger capacitors will take longer and smaller ones will allow the change to take place more quickly.

In a non-feedback amplifier all these changes will take effect at so slow a rate that they will not contribute any audible difference to the sound of the output. But when feedback is applied to the amplifier, all these time constants interact so as to make the amplifier almost into a low-frequency oscillator. It does not quite oscillate, otherwise the amplifier would be audibly unstable, but any of these transients coming along will set it into a momentary state of oscillation, which takes a few seconds to die away.

The oscillation itself is not audible, because it is only at 1 or 2 cycles and the output transformer prevents any appreciable voltage at this frequency appearing across the loudspeaker voice coil, also the loudspeaker does not produce appreciable response at this very low frequency. However, the low-frequency fluctuation occurs at measurable amplitude at some point inside the amplifier circuit itself.

The asymmetrical kick given by the program waveform can set up an oscillation twice as big as the effective d.c. component. This means that quite a large fluctuation can occur inside the amplifier which will not be audible outside of it.

Effect on Program

So why does it cause trouble? Because the gain of every stage in the amplifier varies with operating bias. This low-frequency fluctuation is like a periodic changing of the bias of several stages through the amplifier. Consequently the program material gets modulated at this low frequency. What we hear, then, is due to an in-

Fig. 1. (A) Ideal response when the feedback is correct; part curves show instability points as feedback is increased. (B) Effects of various stability margins on the over-all response; 12 db is proper for high end and 18 db for low end.

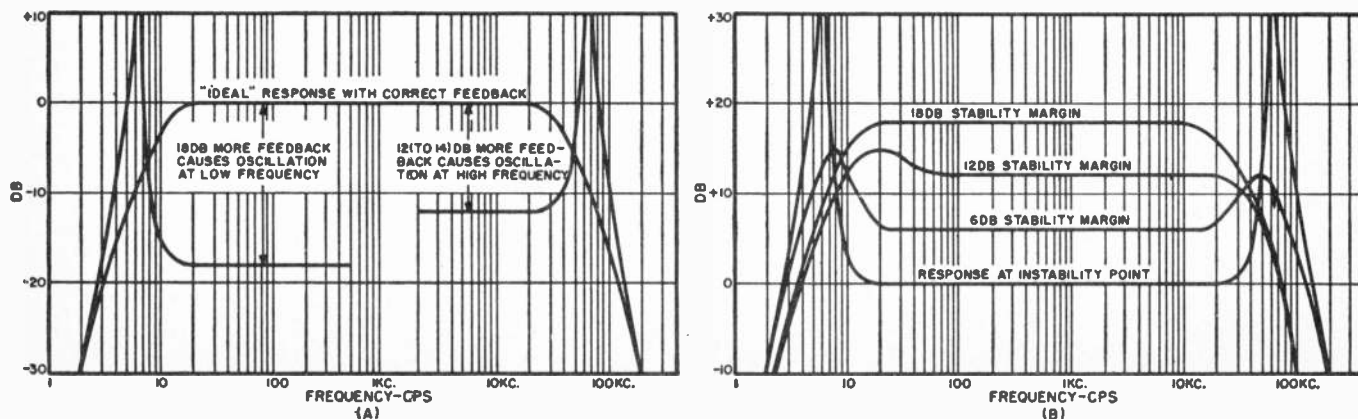

termodulation of the program material by this low-frequency oscillation.

If the feedback were not present (which, of course, is an impossible state to imagine, because the feedback is what is causing the oscillation), the effect most noticeable would be that the whole program would sound as if an electronic tremolo had been added. However, the presence of a large amount of feedback stabilizes the gain of the amplifier so the tremolo effect is not noticeable.

Instead, the same intermodulation that would cause a tremolo effect, but for the feedback, produces a much larger amount of IM distortion in the amplifier than occurs under static measurement conditions. This results in the harshness often observed in modern feedback amplifiers.

How All This Was Proved

These observations are not just the result of theorizing. To substantiate this, two amplifiers of conventional design were taken and modifications made to bring their designs into line with the established mathematical theory, giving the required stability margins at both ends of the frequency response to avoid peaking under any circumstances.

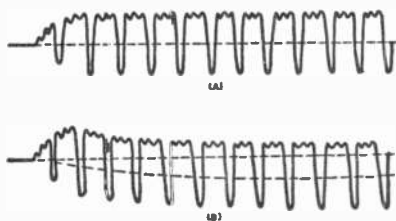
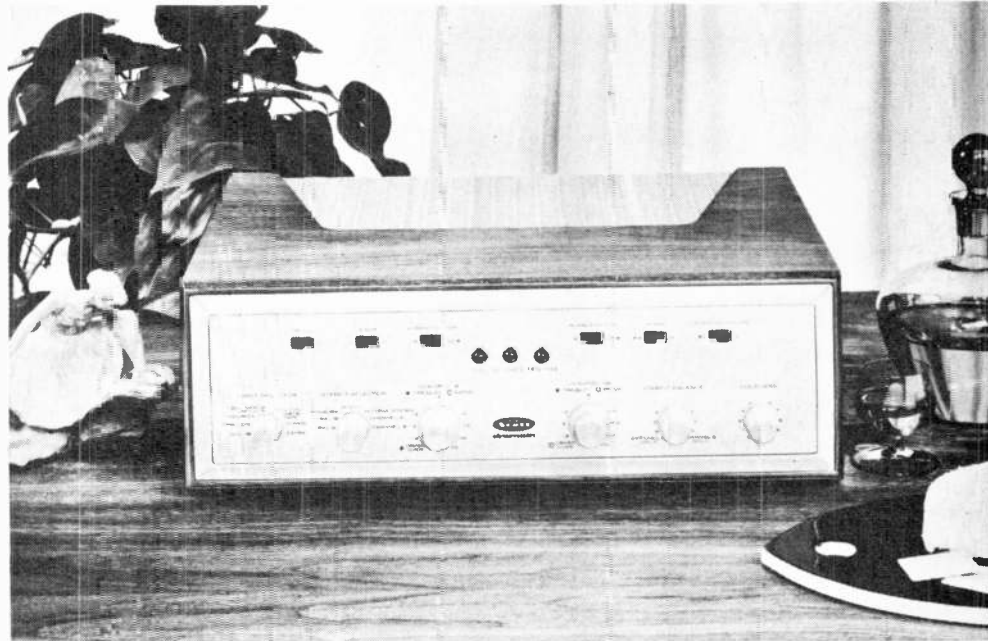

Fig. 4. (A) Asymmetric wave without isolating d.c. (B) Offsetting bias adjustment.

These changes resulted in a slight deterioration of the frequency response, but in neither instance did the response drop below 1 db at 30 cycles or 15 kc., which is still considered to be high fidelity. It is doubtful—extremely doubtful—whether a difference of 1 db at either 30 cycles or 15 kc. could possibly be heard “for itself alone.” A-B checks were then conducted between the amplifiers, using their original circuits and the revised feedback circuits.

A difference was quite noticeable in the reproduction of program material, particularly with the kinds of program material in which, as has been discussed, there is asymmetrical waveform—when wind instruments are playing, or string instruments are played by plucking. These experiments certainly seem to have uncovered at least some of the major differences that can exist between amplifiers with equally good specifications—differences that do not show up, at any rate, in the standard method of specification. These are, in fact, defects that are not in the book!

Now! The Most Important Product Announcement in the History of H. H. Scott!



Here are the exciting details on

The Stereo Amplifier that sets the Standards for the Next Decade!

The H. H. Scott engineering laboratories proudly introduce the new Model 299 40 watt stereophonic amplifier and control center. It contains many advance features that not only meet the needs of today's stereophonic program sources, but anticipate the requirements of the future. Check the details of this new amplifier, and see for yourself why the new 299 is superior to any other amplifier available.

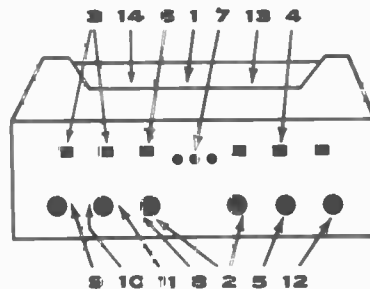

1 40 watt power stage consisting of dual 20 watt power amplifiers. You need this much power to meet the requirements of today's speaker systems. 2 Completely separate Bass and Treble controls on each channel so that different speakers may be matched. 3 Provision for connecting both a stereo phono cartridge and stereo

tape heads. 4 Phase reverse switch to compensate for improperly phased tape recordings or loudspeakers. 5 Special balancing circuit for quick and accurate volume balancing of both channels. 6 Separate record scratch and rumble filters. 7 Unique visual signal light control panel. Instantly indicates mode of operation. 8 Can be used as an electronic crossover (bi-amplifier). 9 Special compensation for direct connection of tape playback heads without external preamp. 10 Special switching lets you use your stereo pickup on monaural records. 11 You can play a monaural source such as an FM tuner through both channels simultaneously effectively doubling power. 12 Loudness compensation. 13 Stereo tape recorder output. 14 D.C. filament supply for preamp to virtually eliminate hum (80 db below full power output). 15 Distortion (first order difference tone) less than 0.3%.



Size in accessory walnut case: 15 1/4" w x 5" h x 12 1/4" d. Price \$199.95. (West of Rockies \$204.95)

Write for complete technical specifications and new catalog HFA



H. H. SCOTT, INC.
111 POWDERMILL RD., MAYNARD, MASS.
EXPORT: TELESCO INTERNATIONAL CORP.
36 W. 40TH ST., N. Y. C.

Upgrading the Hi-Fi Amplifier

By HERMAN BURSTEIN

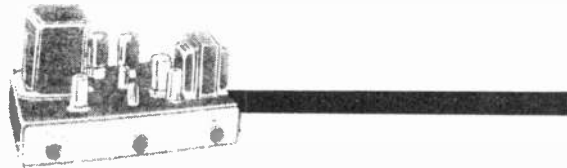
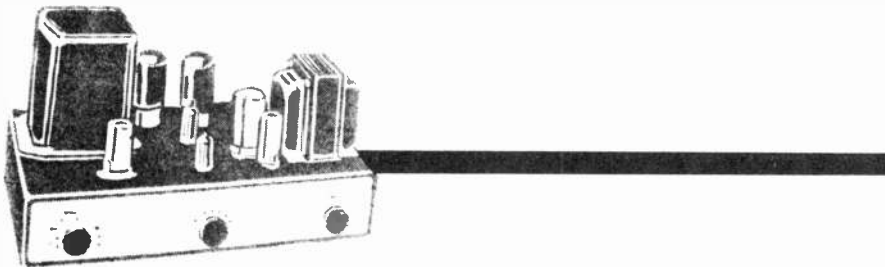
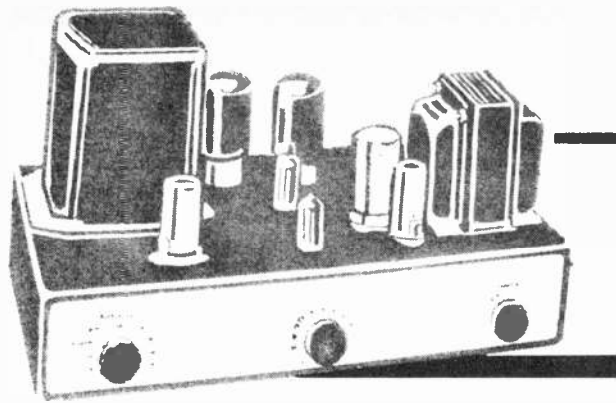

A step-by-step search for a really clean 15 watts output by slight changes in basic Williamson circuit.

STATEMENTS frequently appear in the audio literature that IM distortion below 1 or 2% cannot be detected by the ear. Yet in listening to several power amplifiers operating at moderate level, where no more than 1-watt equivalent sine-wave power is produced on peaks, a good ear will readily note that some amplifiers sound cleaner than others, even though in all cases the measured IM is below 1% at moderate level. This has been the cause of some concern to many listeners.

It would seem, therefore, that maximum permissible IM distortion is still open to question. In discussing this matter with various individuals in the audio field, some have indicated that the 1 or 2% limit should be radically revised downward. One, an engineer, stated that in a series of tests made with a number of power amplifiers, the findings of his ears inevitably correlated with the IM distortion found by instrument, even though the distortion was but a fraction of 1% at the test levels. On the other hand, it is possible that the differences among amplifiers are not actually due to distortion products, but rather to some other characteristic, and that the amount of IM is an index to this characteristic.

Desiring to do a little research on this question, the author recently borrowed a highly regarded 50-watt am-

plifier to compare with his 10-watt Williamson, vintage 1950. At quite modest reproduction levels, the 50-watter had a slight but definite advantage in terms of clarity, purity, and seeming ease. The initial temptation was to heave out the Williamson in exchange for a good 50-watter. On second thought, it was decided to have a go at the Williamson to see if it could be brought up to the quality of the comparison amplifier. The author's speaker system is relatively efficient; hence it was reasonably certain that the difference in performance of the two amplifiers was not due to power capacity, particularly since comparisons had been made at moderate listening levels.

The eventual result was that the Williamson was not tossed out—at least not yet. The events that took place serve as an illustration that, with the aid of a few readily available instruments, one can significantly improve the quality of an existing amplifier. There are still many 10- or 12-watt Williamsons around, as well as other amplifiers of similar wattage and not too different circuitry, which may be susceptible of such improvement. The audiophile or technician with access to the few necessary instruments can undoubtedly obtain results similar to those achieved by the author. The equipment used included an audio

oscillator and a *Heath* Audio Analyzer, which combines in one package an IM distortion meter, a highly sensitive a.c. v.t.v.m., and a wattmeter. Such units, which but a few years ago were seldom found outside the laboratory, today are available in kit form at truly low cost. Since they are very popular items, one has a good chance of being able to borrow them from an engineer or technician friend or perhaps rent them from a service shop. Or, of course, the unit may be built from a kit.

Before departing for parts unknown, the author decided to check where he had been and obtained the readings given in Table 1A on IM distortion in the Williamson.

Then began the search for improvements. The first two steps were virtually barren. These were to precisely balance the d.c. current through the output tubes and to replace each tube in the amplifier (again balancing d.c. current when the output tubes were exchanged). Each of the remaining steps, however, was fruitful.

1. The original Williamson circuit employed triode operation of the output tubes. The author decided to try a switch to "Ultra-Linear" operation, or rather an approach to it. The output transformer in the amplifier is a *UTC* LS-63, which has intermediate taps between the "B-plus" and plate taps, although not at a point representing

IM DISTORTION BEFORE CHANGES		IM DISTORTION IN QUASI "ULTRA-LINEAR" MODE		IM DISTORTION AFTER ALL CHANGES	
Equiv. Sine-Wave Power (watts)	IM%	Equiv. Sine-Wave Power (watts)	IM%	Equiv. Sine-Wave Power (watts)	IM%
15	11	15	3.57	15	1.75
10	3.20	10	.72	10	.21
5	.33	5	.40	5	.13
2	.22	2	.21	2	.08
1	.16	1	.14	1	.07
.5	.12	.5	.12	.5	.066
.1	.09	.1	.08	.1	.063
(A)		(B)		(C)	

Table 1. Improvements in IM distortion resulting from simple circuit changes.

about 18.5% of the impedance as called for in true "Ultra-Linear" operation. Nevertheless, by connecting these intermediate taps to the screen grids of the output tubes, definite improvement was achieved. Figure 1 shows the change in connections. Table 1B shows the results.

The improvement was an obvious one. The "Ultra-Linear" form of connection produced as little or slightly less distortion at low levels and decidedly less at high levels. An amplifier which barely qualified as a 10-watt was converted into a very satisfactory 15-watt.

(It should be mentioned that in checking IM distortion at various output levels, the wattmeter reading was always multiplied by 1.47, which is the customary thing to do, in order to convert the average power reading of the wattmeter into equivalent sine-wave power. The IM test employs a low-frequency voltage and a high-frequency voltage in the ratio of 4:1. These are fed into the power amplifier under test. Accordingly, the amplifier actually produces a total power proportional to $4^2 + 1^2$, which is 17, and this is what the wattmeter reads. However, the output of the amplifier is not a true sine wave, for it consists of one frequency superimposed on another. A sine wave with the same peak as the actual output would contain more power—designated as equivalent sine-wave power. Since the test voltages are proportional to 4 and 1, they add up to a peak voltage proportional to 5. A sine wave with a peak voltage proportional to 5 would produce a sine-wave

power output proportional to 25, because power is proportional to voltage squared. Thus the ratio of equivalent sine-wave power to actual power output is 25/17, or 1.47.)

2. As shown in Fig. 1, the author's version of the Williamson included a cathode bypass capacitor across the common cathode resistance of the output tubes. According to the literature at the time, this capacitor served to improve low-frequency response. Upon removal of this component IM distortion went down slightly but significantly, no doubt because of the current feedback produced by the unbypassed cathode resistance. A check of 20-cycle response (minimum frequency of the available oscillator) showed no deterioration in the response at low or high levels.

3. Next the author tried changing grid bias, by altering the value of cathode resistors in the various stages preceding the output tubes. Only in one case, at the input tube, did this measure help. Increasing the cathode resistor here from 470 to 870 ohms led to an appreciable drop in distortion.

4. The last measure was to adjust the amount of feedback from the secondary of the output transformer to the cathode of the input tube. Even after increasing the cathode resistor of this tube, it was found that feedback was only 14 db, whereas the design permits 20 db with stability. Using a pot as a temporary feedback resistor, it was adjusted for 20 db feedback. To determine amount of feedback, a very low signal input at 1000 cycles was used and amplifier output with and

without the feedback resistor connected was measured. When the setting of the pot was such as to produce a power ratio of 1:100, this signified 20 db feedback. Again there was improvement, owing to 6 db more feedback.

Table 1C shows the final results, incorporating the benefits of all four steps.

Below 10 watts, this performance compares with or excels that of some very highly regarded modern amplifiers, although the power capacity of the latter may extend to 30 or more watts. It should be noted that below 5 watts the IM distortion is probably less than indicated in the table inasmuch as the residual reading of the IM tester used, without an amplifier under test, was about 06%.

To make sure that the changes had not adversely affected frequency response or unduly altered sensitivity and other characteristics, these were checked. Response was found to be perfectly flat from at least 20 cycles (low end of the oscillator) to 25,000 cycles, dropping gradually thereafter in

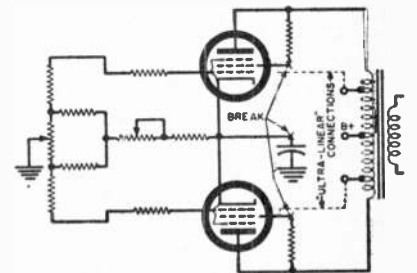

Fig. 1. Amplifier output stage changes.

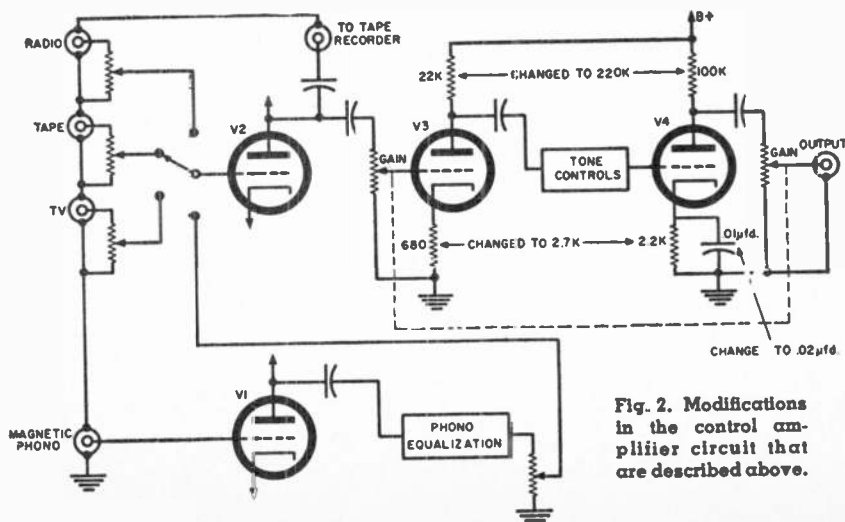

Fig. 2. Modifications in the control amplifier circuit that are described above.

MORE THAN 600,000 ELECTRONIC HOBBYISTS,

EXPERIMENTERS, STUDENTS AND HI-FI FANS

WATCH FOR ADS LIKE THESE EACH MONTH!

BEST Offer over \$125 buys my \$250 Zenith All-Transistor Trans-Oceanic Portable. Never used. Nathan, Suite 2018, 37 Wall Street New York 5.

"TRANSISTORS For Beginners." At last a treatment of transistors you can easily understand. Clearly describes in simple language transistor action, amplification, biasing, NPN and PNP transistors, etc. Completely diagrammed. A must for beginners. \$1.00. P. Polton, 3702 E. Oakwood, South Milwaukee, Wisconsin.

FOR Sale Custom-built 70 watt Heathkit amplifier (W6-M) guaranteed to exceed published specifications, \$135. Heathkit preamp (WA-P2) Custom-built, \$25. Purcell, Box 363, Michigan City, Indiana.

These classified ads are typical of the hundreds that appear each month in the pages of RADIO & TV NEWS, POPULAR ELECTRONICS and HiFi REVIEW. They bring top-notch results! As the above advertisers can attest, there's no better spot for a classified ad in the field of electronics!

If you have used equipment or information or services to sell, you too will find the classified columns of Ziff-Davis electronics magazines to be perfect market places. Your ad will get results quickly and profitably.

for complete details, drop a postcard to:

MARTIN LINCOLN
BOX HFA
Ziff-Davis Publishing Company
One Park Avenue
New York 16, New York

relatively smooth fashion; it was 3 db down at 40,000 cps and 6 db down at 100,000 kc. Sensitivity proved to be suitable: 1.7 volts input required for 10 watts output. Here it is appropriate to mention that two watts equivalent sine-wave power is the very most the author's relatively efficient speaker system can use. A calibrated oscilloscope has been placed across the power amplifier from time to time when feeding in various kinds of program material via FM, tape, and phono, and only at painfully loud levels did the scope show as much as the equivalent of a two-watt reading. Accordingly, it can be estimated that the most voltage required to drive this power amplifier is slightly under .6 volt.

No instrument check was made of signal-to-noise ratio, because with the amplifier connected to the speaker system absolutely no noise or hum was audible right at the speaker. In the matter of low hum content, it is of interest to note that the author's Williamson was built in the old-fashioned way, with *two* chokes in the power supply.

Before returning the power amplifier to use, it was decided to also check out the control unit, which was one of the very best in its day about seven years ago, although since outdone. IM distortion measured about 1.5% at 1.5 volts output (equivalent sine-wave voltage obtained by multiplying actual volts by 1.212), about 1% at 1 volt, about .5% at .5 volt, and proportionately less at reduced output. A couple of slight changes reduced IM to about .3% at 1.5 volts output and to less than .1% at normal levels. The modifications, shown in Fig. 2, consisted in part of changing the plate resistors in two triode stages to a substantially higher value inasmuch as triodes operate in more linear fashion as the plate load resistor is increased. At the same time, the cathode resistors had to be increased to maintain proper grid bias. As a means of keeping noise down, Allen-Bradley 1-watt resistors were employed, although on the basis of heat dissipation ½-watt ones would have been more than enough.

Upon checking frequency response of the control unit, it was found that the high end had been adversely affected somewhat, being about 4 db down at 15,000 cps at mid-setting of the volume control, which is the position where the greatest treble losses, due to circuit capacitance, take place. The deterioration resulted from increasing the plate load resistor in the output stage, with a consequent increase in output impedance and greater loss of high frequencies due to cable and other capacitance. (The control unit was built before the days when it became *de rigueur* to employ cathode followers in the output stage.) However, the situation was quickly corrected by using a .02 μfd. instead of a .01 μfd. cathode bypass capacitor at V_1 in Fig. 2. This maintained response flat within 1 db to 15,000 cps.

The final step was to coordinate the

input signal level to the control unit and the input signal to the power amplifier. Both units have input level-set controls and the problem of coordinating them is as follows. If the level control of the power amplifier is set high, this has the advantage of requiring less signal from the control unit, which means less distortion produced in the latter. The disadvantage, however, is greater amplification by the power amplifier of noise and hum generated within the control unit. To the extent that the input level set of the power amplifier is turned down to reduce noise and hum from the control unit, the input level of the control unit must be turned up in order to provide adequate drive to the former. The higher the input level setting of the control unit, the more the distortion generated therein.

First the gain control of the control amplifier was rotated to about three-quarters position to represent the maximum volume likely to be used; thus a reasonable volume reserve was maintained for special occasions. The input level-set of the power amplifier was backed down slightly so that the noise and hum heard through the speaker was imperceptible except within a couple feet or so. (Any listening done within a few feet would hardly be with the gain control at an advanced position.) Then the input level-sets of the control amplifier for each source (phono, FM, TV, tape) were adjusted so that, when typical program material was fed in, the maximum level ordinarily desired was, obtained at three-quarter setting of the gain control.

This procedure made it impossible to hear any noise or hum at moderate gain control positions and of course at advanced positions the signal would drown out the increase in noise and hum (chiefly noise). It may be added that the control amplifier is mounted so as to make the level-sets readily accessible for adjustment in the event a very weak signal source is used. In fact, the control amplifier is sufficiently sensitive so that, with input level set full on, a dynamic microphone can be accommodated by any one of the high-level input channels.

The final results can only be determined by ear and it is not too easy to be sure, especially when the equipment was not really poor to begin with. However, particularly when good program material is available, such as a first-rate tape recording or, better yet, live FM, it seems that the reproduction has gained ease and clarity and that listening fatigue has been set back another notch. Whereas the 50-watt comparison amplifier had a definite edge before the changes, afterward the Williamson seemed at least as clean. It was not feasible, with the efficient speaker system used, to introduce levels into the listening room where the superior power capacity of the 50-watter made a difference, as it would of course under outdoor, auditorium, or other large-area conditions at realistic levels of reproduction.

NOW 2 ASSEMBLE-IT-YOURSELF Schober ELECTRONIC ORGANS

SAVE HALF
NO SPECIAL SKILLS
PAY KIT-BY-KIT

Now you can afford an electronic organ. Whether you choose the full Concert model or the smaller Console, you have an organ equal to any made by the foremost manufacturers. In addition, you save over 1/2 the cost because you assemble it yourself... and you enjoy the thrill of achievement. Too, you purchase each kit only when you are ready for it.



2 different MODELS
2 different SIZES
2 different PRICES



CONCERT MODEL	CONSOLE MODEL
<ul style="list-style-type: none"> ☆ TWO FULL SIZE PIPE-ORGAN MANUALS, 122 KEYS ☆ OCCUPIES 3'5" x 4'7" FLOOR SPACE ☆ 26 STOPS AND COUPLERS ☆ 32 BASS PEDALS ☆ ASSEMBLED CONSOLE ☆ CONFORMS TO AMERICAN GUILD OF ORGANISTS SPECIFICATIONS FOR PIPE ORGANS ☆ COMPLETE STEP-BY-STEP INSTRUCTIONS 	<ul style="list-style-type: none"> ☆ OCCUPIES ONLY 2' x 3'2" FLOOR SPACE ☆ TWO FULL SIZE PIPE-ORGAN MANUALS, 122 KEYS ☆ 22 STOPS — ABOVE-KEYBOARD TABS ☆ 13 HEEL-AND-TOE BASS PEDALS ☆ 7 FULL OCTAVES OF TONE (DOWN TO 32 CPS) ☆ BUILT-IN SPEAKERS OPTIONAL ☆ ASSEMBLED CONSOLE ☆ COMPLETE STEP-BY-STEP INSTRUCTIONS

10" LP RECORD DEMONSTRATING BOTH MODELS
AVAILABLE FOR \$2, REFUNDABLE UPON PURCHASE

FREE NEW 1959 EDITION OF 16 PAGE ILLUSTRATED BOOKLET ON REQUEST

Write Now — See What Fine Instruments You Get At Such Great Savings

The **SCHOBERS ORGAN Corporation** • 2248-Q BROADWAY • NEW YORK 27, N. Y.

SCHOBERS KITS ALL OVER THE WORLD

☆ Designed by Richard H. Durr.

HI-FI ACCESSORIES

CROSSOVER NETWORK
WITH TREBLE CONTROL
ON GOLD EMBOSSED SOLID BRASS
MOUNTING PLATE — Model CN-6

1500 cycle Crossover Frequency. 6db/octave attenuation outside of pass bands. 9db variation in treble response. Constant impedance full network (LCR) type. Negligible insertion loss in pass bands. Operates with both 8 and 16 ohm speakers. Mounts on speaker enclosure with gold embossed brass plate. All brass hardware and instructions supplied. Packaged in attractive box with see-thru cover.

NET \$8.97

L-PAD WITH PHONE AND SPEAKER JACKS
Simplifies addition of phones and speaker to Hi-Fi system



Constant impedance devices for addition of phones and/or speaker to existing Hi-Fi system. Quality engineered L pad for smooth control of audio level. Ideal for monitoring Hi-Fi, P. A. and Inter-com equipment. Completely wired — amplifier output leads are attached to two screw terminals. May be installed in multiple units for classroom or auditorium listening. Brass gold embossed plate mounts in standard wall box or on panel of Hi-Fi set. Brass hardware supplied. Packaged in attractive box with see-thru cover.

Model JL-8 8 ohms NET \$7.77
Model JL-16 16 ohms

Vidaire

ELECTRONICS MANUFACTURING CORP.
BALDWIN • NEW YORK

PURCHASING A HI-FI SYSTEM?

Send Us Your List of Components For A Package Quotation

WE WON'T BE UNDERSOLD!

All merchandise is brand new, factory fresh & guaranteed.

AIREX RADIO

CORPORATION

64-A Cortlandt St., N. Y. 7, CO 7-2137

PARTIAL LIST OF BRANDS IN STOCK

Altec Lansing
Electrovoice
Jensen
Mortley
University
Acoustic
Research
Janszen
Wharfedale
Karlson
Viking
Concertone
Bell • G.E.
Weathers
Harman—Kardon
Elco • Pilot
Sherwood
Acrosound
Fisher
Bogen • Leak
Dynakit
H. H. Scott
Pentron
Ampro • VM
Revere
Challenger
Wollensak
Garrard
Miracord
Glaser-Steers
Rek-O-Kut
Components
Norelco
Fairchild
Pickering • Gray
Audio Tape
Full Line of
Cables

RCA 6973

A Low-Cost Hi-Fi Amplifier

Over-all views of the low-cost hi-fi amplifier along with its separate power supply. The new miniature beam power tube used is shown directly below.

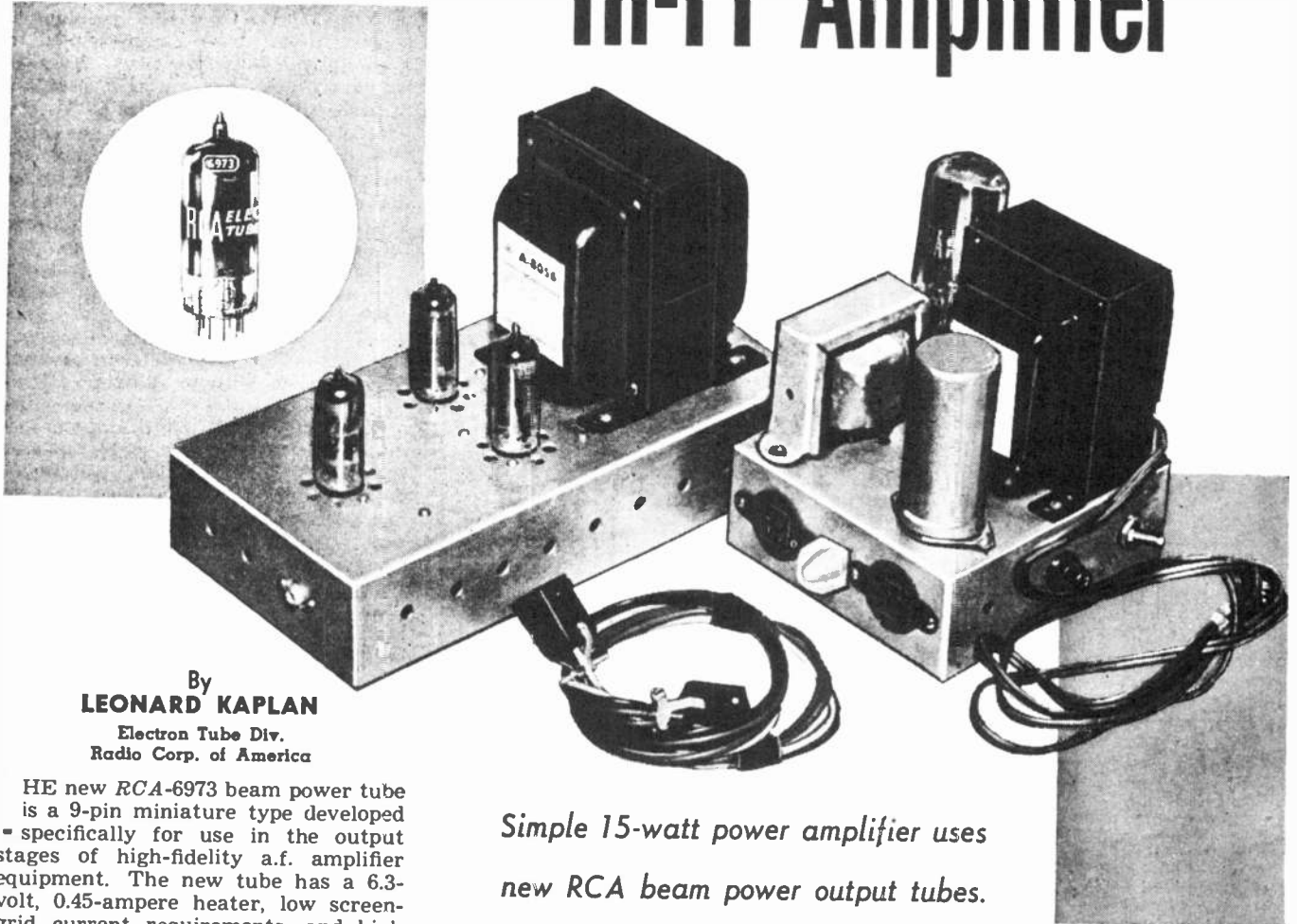

By
LEONARD KAPLAN
Electron Tube Div.
Radio Corp. of America

THE new RCA-6973 beam power tube is a 9-pin miniature type developed specifically for use in the output stages of high-fidelity a.f. amplifier equipment. The new tube has a 6.3-volt, 0.45-ampere heater, low screen-grid current requirements, and high plate and screen-grid voltage ratings which allow it to operate very efficiently in a variety of output circuits. It is provided with specially designed grid structures and a basing arrangement which assure cool grid operation and freedom from grid emission. This feature permits the use of much higher values of grid-No. 1 circuit resistance than are generally permissible for beam power tubes and gives the 6973 exceptionally high power sensitivity. Two 6973's, pentode connected, in a conventional push-pull class AB₁ output circuit can deliver as much as 24 watts of output power with very low harmonic distortion.

The characteristics of the 6973 have made it possible to design a simple, low-cost high-fidelity amplifier using only three tubes and having performance characteristics indistinguishable from those of amplifiers having much more complex circuits, using more tubes, and costing many times as much. The new amplifier employs only standard, non-critical components, and does not contain any circuits, bal-

*Simple 15-watt power amplifier uses
new RCA beam power output tubes.*

Power Output:	15 watts continuous; 19 watts for short bursts
Sensitivity:	.98 volt for 15 watts output
Frequency Response:	17 to 60,000 cps \pm 1 db
Output Impedance:	.65 ohm at 60 cps on 8-ohm tap
Total Harmonic Distortion at 1000 cps:	.17% @ 1 watt output; .19% @ 4 watts; .2% @ 8 watts; .4% @ 15 watts
Hum and Noise:	90 db below 15 watts (input shorted) 75 db below 15 watts (input open)

Table 1. The performance characteristics of the amplifier described below.

ancing adjustments, or other controls which might require the use of test equipment. Anyone with a soldering iron and a modicum of construction experience should be able to assemble the unit and duplicate the results obtained in the laboratory.

Design Consideration

The initial specifications for the amplifier were: (1) It should be capable of reproducing everything the human ear can detect and, therefore, should have a frequency response flat within \pm 1 db from 20 to 20,000 cps. (2) Total harmonic distortion at full output

should be less than 0.5% so as to be virtually undetectable to even the most discriminating listener.¹ (3) Because most authorities agree that a dynamic range of approximately 70 db is necessary for high-fidelity reproduction it should have a power output of at least 15 watts so as to be capable of reproducing a range of 75 db when used with speakers of average efficiency.^{1, 2} (4) To assure good loudspeaker damping and permit operation with any type of loudspeaker system, including the new electrostatic types, it should have the lowest possible terminal impedance and the highest

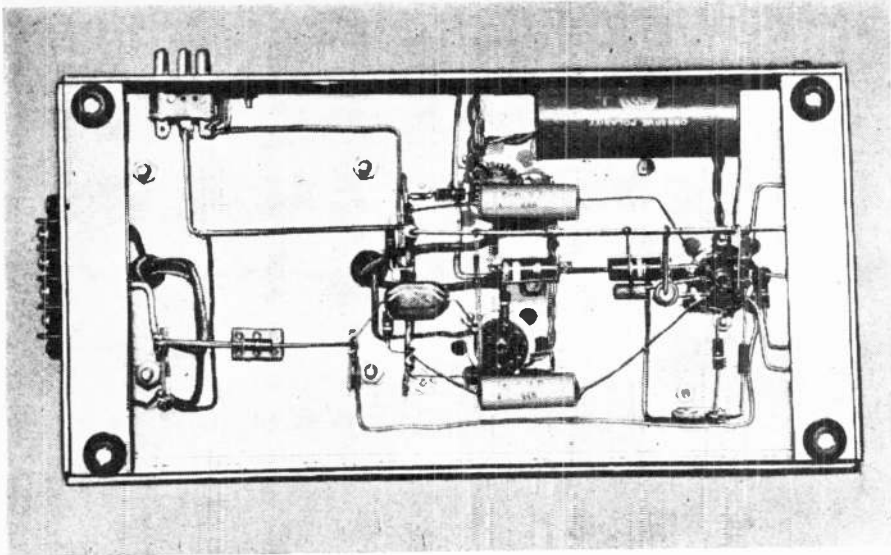

Bottom view of the amplifier itself is shown here. Note the simplicity of the wiring and the absence of any crowding. Note also the use of the ground bus.

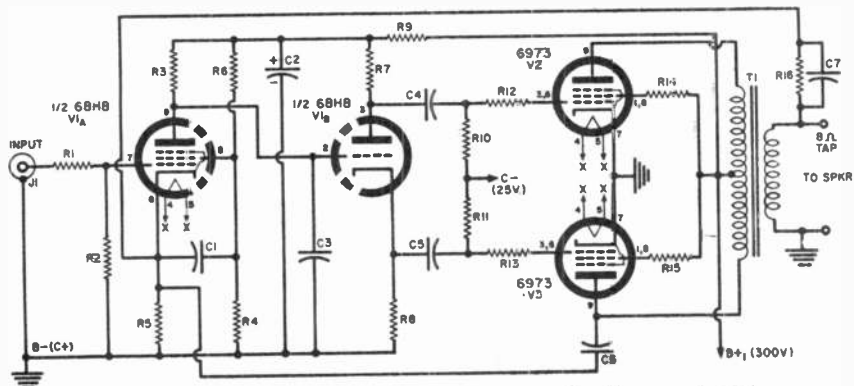

- | | |
|--|--|
| <p>R_1—10,000 ohm, $\frac{1}{2}$ w. res. $\pm 10\%$
 R_2—470,000 ohm, $\frac{1}{2}$ w. res. $\pm 10\%$
 R_3—220,000 ohm, $\frac{1}{2}$ w. res. $\pm 10\%$
 R_4—2.7 megohm, $\frac{1}{2}$ w. res. $\pm 10\%$
 R_5—680 ohm, $\frac{1}{2}$ w. res. $\pm 10\%$
 R_6—1.5 megohm, $\frac{1}{2}$ w. res. $\pm 10\%$
 R_7, R_8—15,000 ohm, 2 w. res. $\pm 5\%$
 R_9—3900 ohm, 2 w. res. $\pm 10\%$
 R_{10}, R_{11}—220,000 ohm, $\frac{1}{2}$ w. res. $\pm 10\%$
 R_{12}, R_{13}—1000 ohm, $\frac{1}{2}$ w. res. $\pm 10\%$
 R_{14}, R_{15}—100 ohm, $\frac{1}{2}$ w. res. $\pm 10\%$</p> | <p>R_{16}—6800 ohm, $\frac{1}{2}$ w. res. $\pm 10\%$
 C_1—.25 μfd., 400 v. capacitor
 C_2—40 μfd., 450 v. elec. capacitor
 C_3—15 μfd., 400 v. capacitor
 C_4, C_5—.1 μfd., 400 v. capacitor
 C_6—6.8 μfd., 600 v. capacitor
 C_7—180 μfd., 400 v. capacitor
 J_1—Input jack
 T_1—Output trans., 6600 ohms plate-to-plate to v.c. (Stancor A8056)
 V_1, V_2, V_3—6973 tube</p> |
|--|--|

Fig. 1. Complete schematic of the low-cost amplifier. This unit is not available in kit form but must be built by the home constructor from this circuit and parts.

Fig. 2. (A) Frequency response of the power amplifier taken at a reference level of 1.25 watts output. (B) Total harmonic distortion at various output powers.

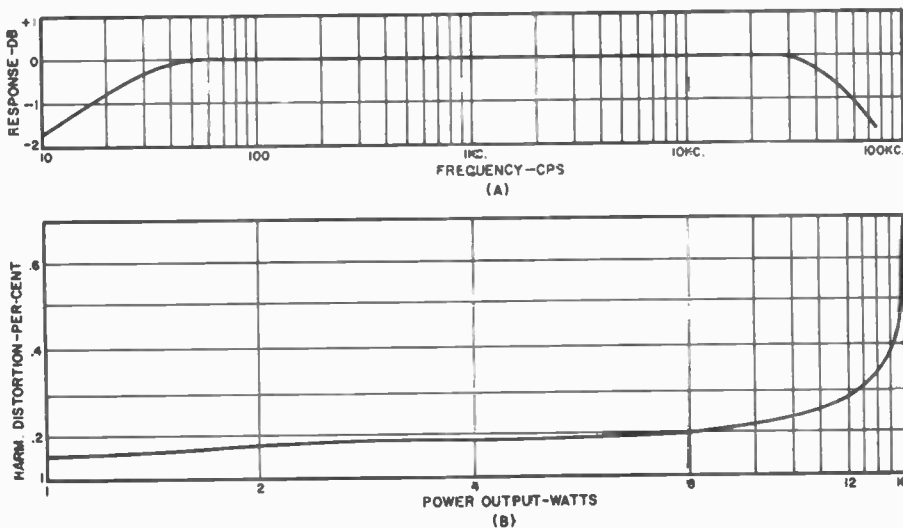

possible margin of stability. (Margin of stability is a term used to describe the ability of an amplifier to refrain from bursting into oscillation when used with a reactive load or when excited by signals having steep wavefronts.)

Circuit Design

The circuit of the amplifier is shown in Fig. 1. The amplifier employs a pentode input stage, direct-coupled to a triode split-load-type phase inverter which, in turn, drives a pair of 6973's in push-pull class AB. The 6973's are pentode connected and are operated with fixed bias. The input and phase-inverter stages use the recently introduced RCA 6BH8, which contains a high-gain pentode and a medium-mu triode in one envelope.

The use of direct coupling between the input and phase-splitter stages minimizes phase shift at low frequencies and consequently increases the amount of inverse feedback that may be used without danger of low-frequency instability. Because the plate voltage of the input stage determines the bias on the phase splitter the use of direct coupling can introduce certain difficulties, particularly in a high-gain, high-impedance circuit such as this one; that is, normal variations in the characteristics of the input pentode can produce wide variations in the operating point of the following triode. This difficulty has been substantially overcome by obtaining the screen-grid voltage for the pentode from a high-impedance voltage divider. This voltage divider serves two purposes: (1) it prevents excessive screen-grid voltage from being applied to the tube during the warm-up period; (2) the large IR drop in the 1.5 megohm resistor tends to stabilize the screen-grid voltage against the effects of changes in tube characteristics. Since the plate current and plate voltage of the pentode are highly dependent on the screen-grid voltage, the plate voltage also tends to stabilize from tube to tube so that any 6BH8 will perform well in the circuit.

One of the difficulties sometimes experienced with the split-load-type phase inverter is unequal high-frequency response in the two sections of the circuit due to the fact that the plate section has higher impedance to ground than the cathode section. This difficulty has been minimized to a large degree in the new amplifier by use of a low-value load resistance (15,000 ohms) for each of the sections. The resulting high-frequency unbalance is negligible within the audio-frequency range and is less than 2 db at 100,000 cps.

A class AB amplifier delivers highest efficiency and lowest distortion when operated with fixed bias. This method of operation has several advantages: (1) The quiescent currents are low and heavy currents are drawn only when power is being delivered to the load. Tube dissipation at normal signal

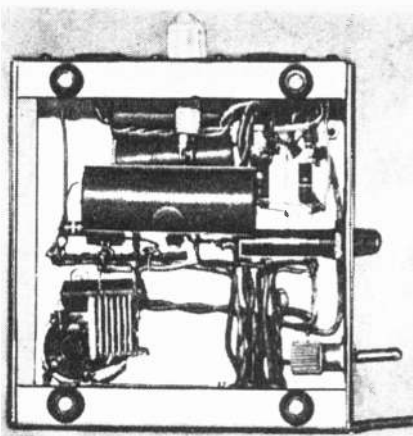

↑ Underside view of the separate power supply used with the amplifier. Selenium rectifier supplies fixed bias used.

Fig. 3. Diagram and parts list for separate power supply unit. A 6.3-volt pilot lamp may be wired to points "XX."

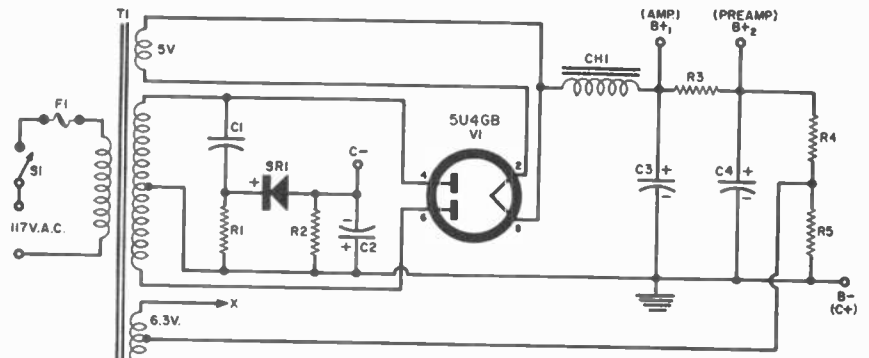

- R₁—15,000 ohm, 1/2 w. res. ± 10%
- R₂—68,000 ohm, 1/2 w. res. ± 10%
- R₃—4700 ohm, 2 w. res. ± 10%
- R₄—270,000 ohm, 1 w. res. ± 10%
- R₅—47,000 ohm, 1/2 w. res. ± 10%
- C₁—.02 μfd., 600 v. capacitor
- C₂—100 μfd., 50 v. elec. capacitor
- C₃—80 μfd., 450 v. elec. capacitor
- C₄—40 μfd., 450 v. elec. capacitor

- CH₁—3 hy., 75 ohm filter choke (Triad C13X or equiv.)
- S₁—S.p.s.t. switch
- F₁—2 amp fuse
- T₁—Power trans. 360-0-360 v. @ 120 ma.; 5 v. @ 3 amps; 6.3 v. @ 3.5 amps. (Stancor PC-8410 or equiv.)
- SR₁—20 ma., 130 v. selenium rectifier
- V₁—5U4GB tube

levels is very small and, therefore, is favorable for long tube life. (2) The reactance of the cathode bypass capacitor normally used in a self-biased stage is eliminated. Practical sizes of cathode-bypass capacitors seldom provide adequate bypassing at very low audio frequencies. Their reactance increases rapidly as the frequency is lowered and causes a corresponding increase in output impedance which is detrimental to the stability of the amplifier when large amounts of feedback are employed. (3) The elimination of the self-bias resistor allows the bias to be independent of signal level and allows optimization of bias for lowest distortion.

Negative voltage feedback of 19.5 db is applied around the entire amplifier to assure very low output impedance and minimize distortion. The small capacitors connected from the grid of the 6BH8 triode to ground and from the plate of one output tube (the lower one on the schematic) to the cathode of the input pentode increase the margin of stability substantially, as a glance at the photographs of the square-wave response in Fig. 4 will show.

Power Supply

Fixed-bias operation of the output stage requires that the plate supply have very good voltage regulation because the plate current varies considerably with the signal level. The circuit of the power supply is shown in Fig. 3. It is a conventional choke-input system, and provides excellent regulation at low cost. The fixed bias voltage for the output stage is obtained from one-half of the high-voltage winding of the power transformer through a capacitance-resistance voltage divider and a 20-ma. selenium rectifier. The voltage divider allows the use of a selenium rectifier having a rating of only 130 volts r.m.s. The center tap of the heater-supply winding is connected to a resistive voltage divider across the output of the power-supply. The resulting 50-

volt positive heater bias minimizes heater-cathode leakage and eliminates the need for hum-balancing adjustments⁵.

Conclusion

The extent to which the original objectives have been achieved may be seen from the performance data shown in Figs. 2 and 4 and in Table 1. It can be seen that in every respect the amplifier exceeds the original specifications.

REFERENCES

1. Langford-Smith, F., ed.: "RCA Radiotron Designer's Handbook," Chapters 13, 14, 21
2. Olson, H. F.: "Elements of Acoustical Engineering," D. Van Nostrand Co., First Edition, 1947, pgs. 483-487
3. Schade, O. H.: "Beam Power Tubes," Proceedings of the IRE, February 1938
4. Williamson, D. T. N.: "Design of a High-Quality Amplifier," Wireless World, April-May 1947 and August 1949
5. Heacock, D. P. & Wissolik, R. A.: "Low-Noise Miniature Pentode for Audio-Amplifier Service," Tele-Tech, February, 1951

—30—

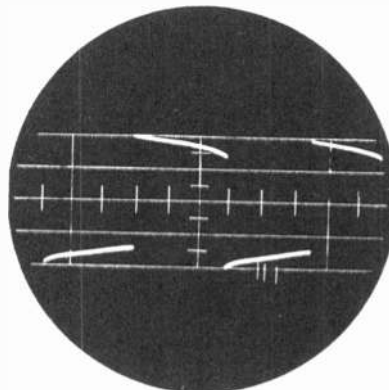

Fig. 4. (A) Square-wave response at 20 cps. Some waveform tilt is shown.

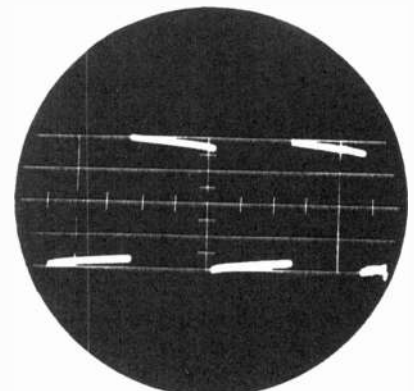

Fig. 4. (B) Square-wave response at 50 cps. A very slight tilt still remains.

Fig. 4. (C) A 5000 cps square wave is shown here. Note the very slight ringing.

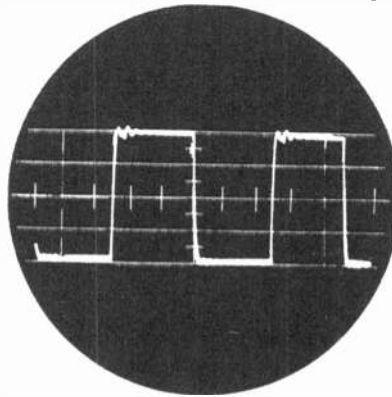
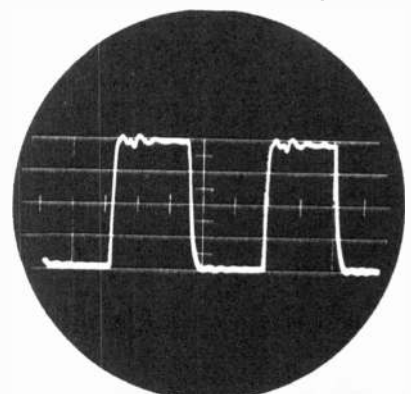
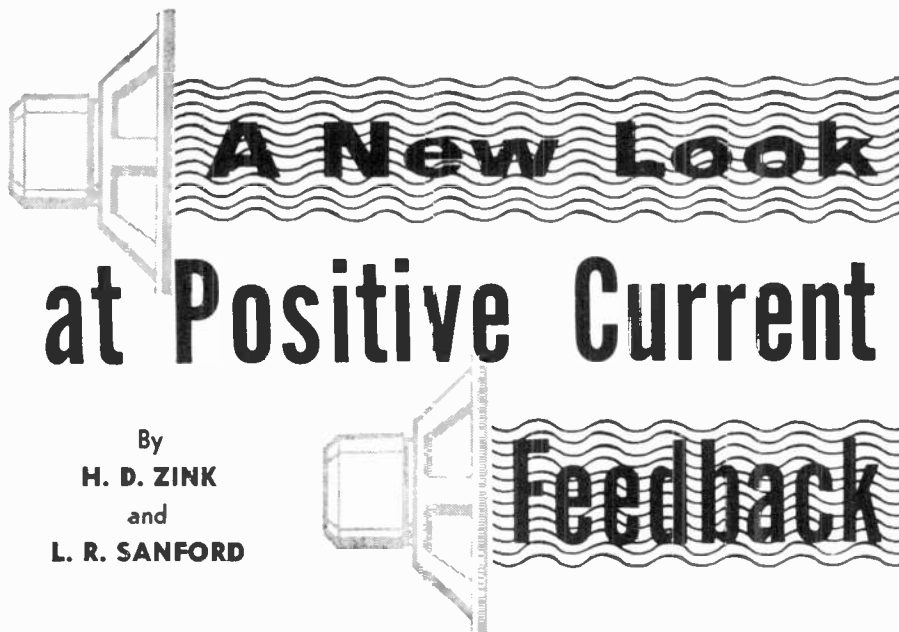

Fig. 4. (D) This is a 10,000 cps square wave. The slight ringing has been spread out.





A New Look at Positive Current Feedback

By
H. D. ZINK
and
L. R. SANFORD

Tests show that positive current feedback improves hi-fi systems which already have good loudspeakers providing the correct feedback circuit is employed.

THE use of current feedback to provide improved bass response in a high-fidelity speaker system has caused a lot of discussion pro and con. It has been argued that it cannot greatly improve speaker damping because the mechanical parts of the speaker are not coupled closely enough to the electrical parts.¹ It has also been argued that it might help on an inadequate speaker system but that it was worse than useless on a truly high-fidelity speaker.² On the other side, curves have been presented which give dramatic proof of the improved damping obtained with a particular kind of current feedback,³ but few details are given about the speaker system used and, therefore, no adequate conclusions can be drawn. This difference of opinion is understandable since the most desirable mode of loudspeaker operation for the best listening is not agreed upon even by experts in the field. The only way an individual can determine for himself the merits of such feedback is by the use of his ears.

What is actually accomplished with current feedback can be best understood by forgetting the ideas of damping, negative impedance, etc. for the moment and concentrating only on the frequency response. Anyone who has heard an audio oscillator through any speaker system has probably observed that while the response may be poor below a certain frequency, frequencies much lower than this can usually be reproduced if the power to the speaker at these frequencies is increased relative to the higher frequencies. Often, when this is done, appreciable harmonic distortion is present and the speaker cone rattles.

Usually for music system use, if the bass output from the speaker is increased by conventional bass-boosting techniques, then such distortions are objectionable. In the optimum use of positive current feedback these objections to low-frequency boosting are overcome by using a rising bass characteristic as part of the feedback network. This compensates for the loss of low-frequency acoustic output without the harmful effect noted, since the positive current feedback keeps the speaker cone under control and, thereby, significantly reduces the distortion which would otherwise result. In some cases, the frequency below which no acoustic output at all is obtained is actually lowered.

The term, positive current feedback, is disturbing to some because, as is well known, positive feedback increases the distortion of an amplifier to which it is applied. This is true in this application also, but it must be noted that the net feedback applied to the amplifier is never positive but simply less negative in the region where the positive current feedback is effective. See Fig. 1. The slight increase in distortion, which results from the decrease in the amount of negative feedback applied in the bass region, is more than offset by the decrease in speaker distortion in the same region. In the high-frequency region, where amplifier distortion is more disturbing, no positive feedback is applied and the amplifier characteristics remain unchanged. The important point to note is that positive current feedback applied to the amplifier is effectively negative feedback as far as the speaker cone is concerned. This point is not obvious, so

the following experiment will be described to suggest why this is actually the case.

Arrange a speaker, battery, multi-range ammeter, and a switch as shown in Fig. 2. With the switch on the "A" contacts so that the battery is out of the circuit, push the speaker cone in the minus direction and note the direction of the current generated by the movement of the voice coil through the speaker field. Assume this current flows in the direction of the arrow *I*. Now connect the battery through the "B" contacts so that the current which it causes to flow is also in the direction of the arrow, and note the direction in which the speaker cone moves. It is found that the speaker cone moves in the plus direction, that is, in the opposite direction from which it was moved in the first case. The current which acts on the speaker results in a plus motion of the cone whereas a minus motion of the cone produces the same direction of current when the cone reacts on the circuit. This means that when the cone oscillates after a driving signal has ceased, the current generated by the erroneous motion can be fed back through the amplifier to produce a driving current which will be in the same direction as the error current and that this current will drive the cone in the opposite direction. The net effect will be that the cone moves very little after the original driving force ceases. It can thus be seen that in order for the forces on the cone to cancel out (negative feedback) the error signal must be fed back without a change of phase (positive feedback).

When these facts are realized, the correct application of positive current feedback to any speaker system then becomes merely a matter of cut and try until the right boost characteristic is found. Since no electrical measurements can indicate the total effect, the final results must be reached by listening tests. The correct results are achieved when the speaker has a deeper bass than it has ever reproduced before without any trace of boominess.

The block diagram of the current feedback network used by the authors is shown in Fig. 3A. The essential difference between this circuit and similar ones used on commercial amplifiers is that no provision is made for negative current feedback, and an *LC* circuit is used in the frequency discriminating section of the feedback network instead of a single capacitor.

Fig. 1. Effect of positive current feedback on the frequency response of amplifier.

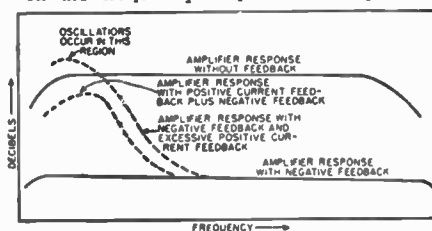

It is necessary to use an LC circuit because the single capacitor gives too much bass boost in a region where no boost is needed when used with some speaker systems (especially the Klipschorn and "Rebel" series). This results in an unpleasant over-accentuated bass sound and is probably the reason some have rejected the use of current feedback with high-quality speakers.

The 25-ohm potentiometer shunted across the 1-ohm resistor provides a means of varying the feedback from zero to full positive. Its use, except for comparison purposes, is questionable since usually full positive feedback is the most desirable condition. It could be omitted with no harmful effects in which case the 240-ohm resistor is tied to the ungrounded end of the 1-ohm resistor.

The amount of feedback and therefore the degree of bass boost may be varied in several ways aside from the use of the potentiometer. The principal way is by changing the value of the 1-ohm resistor. It will be noted that a dividing network is formed between the speaker impedance and the current feedback resistor, such that if the speaker is high impedance (16 ohms) less feedback voltage will be developed across the resistor than if the speaker impedance is low (4 ohms). That is, for a given resistor more bass boost would be obtained when feeding a 4-ohm speaker than when feeding a 16-ohm speaker. The 1-ohm resistor has been found satisfactory when used with a speaker system having a net impedance of 4 ohms and, therefore, in some instances a 4-ohm resistor might be desirable for a 16-ohm speaker system.

The amount of feedback and, therefore, the amount of boost can also be changed by changing the "Q" of the circuit elements used in the feedback network. The values called for usually require electrolytic capacitors and if these units are leaky or are used singly instead of in series pairs back-to-back, then less feedback will be obtained than would be expected. If the inductor used is variable, its "Q" will vary as it is tuned and this will also change the feedback. It should be noted that since the resistance in series with the speaker absorbs power it represents a loss in peak output, therefore, it is desirable to keep it as small as possible while still obtaining the required feedback voltage. Since high "Q" elements in the feedback network represent more voltage feedback than do low "Q" ones, they are to be preferred unless they give a boost characteristic that rises too sharply. This is an unlikely occurrence. It should be noted that the characteristics of the network, when not connected in the feedback loop, are not a good indication of the over-all amplifier response when the network is in the loop since a "Q" multiplication effect is obtained and the amplifier response is sharper than the network response.

To determine the constants of the

LC network shown in Fig. 3A, procure an audio oscillator or frequency test record whose range is slightly lower than the lowest range of interest and listen to the performance of the speaker system using a conventional negative feedback amplifier. Note: (1) the frequency at which the bass response just begins to roll off and (2) the frequency at which no more acoustic output is obtained irrespective of how much power is used to drive the speaker. An LC network having a low-pass or bandpass filter configuration is then designed so that the upper turnover frequency occurs slightly above the frequency at which the response starts to roll off and the peak response occurs slightly below the frequency at which no output is normally heard. (The hypothetical termination resistance necessary for calculating the filter sections can be assumed to be about 600 ohms since it has been found experimentally that this value gives networks that are satisfactory.) This network will serve as a starting point and by varying the parameters while listening to the system using an audio oscillator or tone record the best sounding arrangement can be determined. For those not technically able to perform such calculations, the networks to be discussed will give moderately good results on any speaker system and will serve as a starting point for more experimentation. It is not advisable to use music for the first tests since low-frequency tones occur rather infrequently and are of rather short duration so it is difficult to notice the effect of circuit changes.

The specific LC circuit configuration used with a Klipschorn is shown in Fig. 3B. This type of enclosure normally falls off below 27 cps so the feedback network is designed to become effective in this region and to provide 10 db of boost at 20 cps as measured across a resistive load. The response curve of the amplifier, when this circuit is used, is shown in Fig. 4A. It must be remembered that this curve was taken with a 16-ohm resistive load substituted for the speaker and does not necessarily represent the actual boost curve obtained with the speaker connected. In this case, sufficient feedback is obtained from a 1-ohm resistor even though the speaker is 16 ohms. Listening tests with an audio oscillator indicate that this amplifier-speaker system appears to be acoustically flat to below 20 cps.

Fig. 3C shows the network found best for use with the Klipsch "Rebel 4" enclosure. In the specific case considered here a G-E A1-400 speaker is used in the "Rebel 4," but the same circuit is also used on a "Rebel 4" with a much cheaper speaker and gives excellent results. The configuration is different from that used with the Klipschorn because more boost is required and it was found that a network that gave a steadily rising bass characteristic, such as used with the Klipschorn, caused the amplifier to motorboat when the feed-

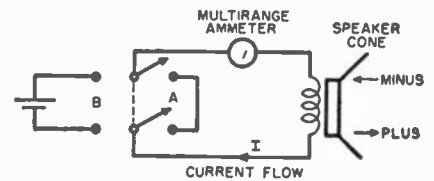

Fig. 2. Experimental setup that is used to determine how positive feedback works.

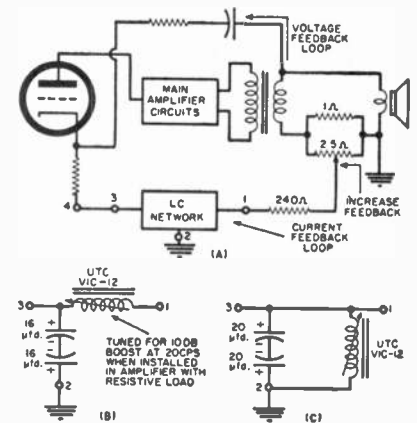

Fig. 3. (A) Location of positive current feedback network. (B) shows Klipschorn network. (C) shows Rebel 4 LC network.

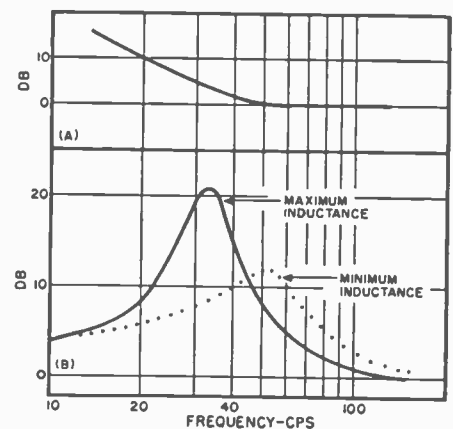
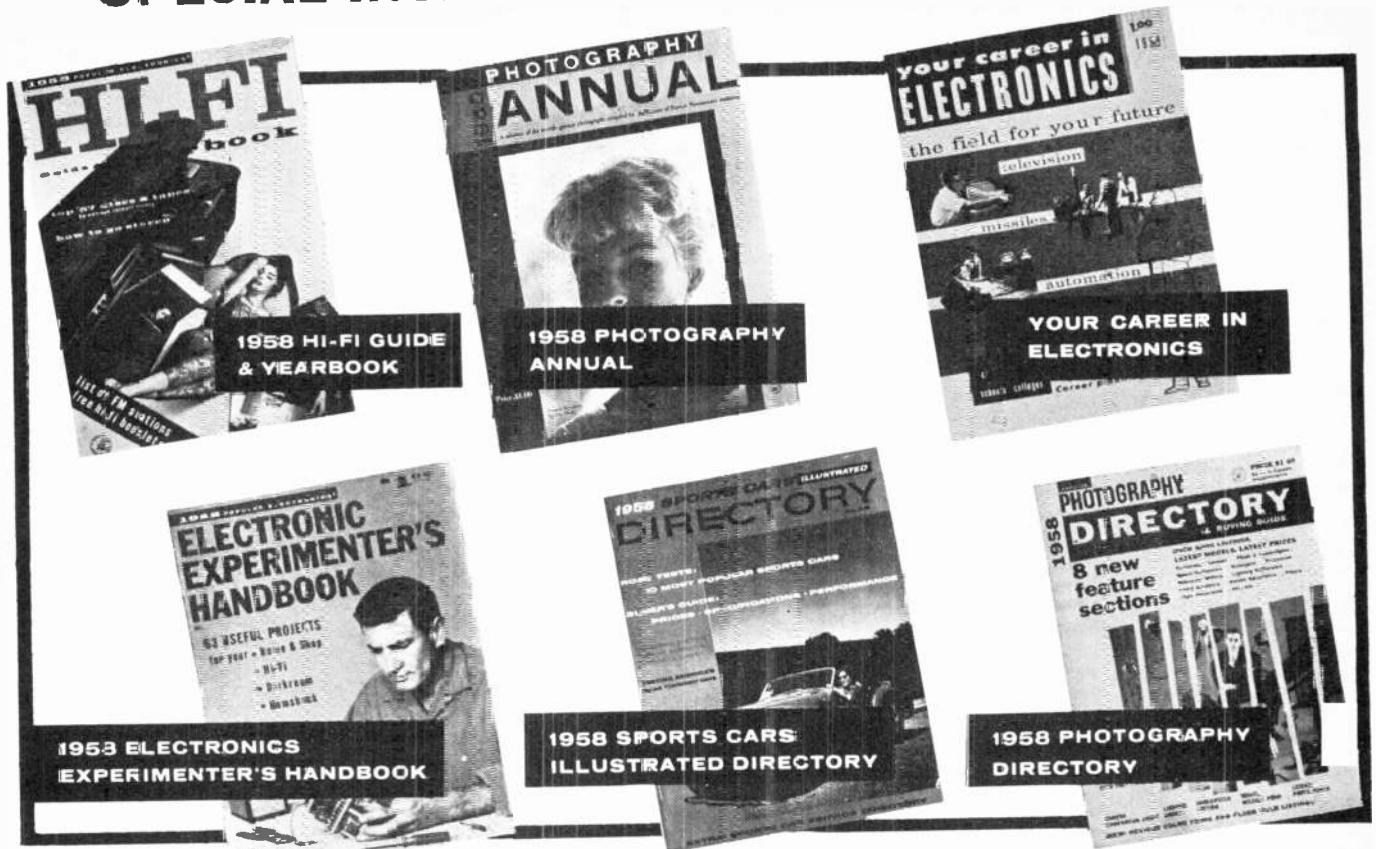

Fig. 4. (A) Amplifier response with networks shown in Fig. 3B and (B) Fig. 3C.

back was increased to the correct point. This was because, when enough positive feedback was provided in the required region, all of the negative feedback was cancelled out at some lower frequency and the net amplifier feedback became positive in this region and caused the oscillation (see Fig. 1). This condition is avoided with the configuration shown since it is arranged to peak at the lowest usable frequency and then fall off below this point so that the amplifier has almost full negative feedback in the critical motorboating frequency range. This configuration also largely eliminates thumps that occur when tuning through FM stations. Curves obtainable with this configuration are shown in Fig. 4B and it must be noted that these curves also were taken with a resistive load in place of the speaker.

SPECIAL-INTEREST BOOKS OF THE YEAR!



Don't miss these big dollar buys the most authoritative annuals for your hobby!

1958 HI-FI GUIDE AND YEARBOOK

See how to save hundreds of dollars, get more fun out of high fidelity. This is actually three books in one—**Improving Your Hi-Fi, Tape Techniques, and Getting into Stereo.** Latest ideas for buying, improving, using systems and components. Free easy to mount strobe disc, hundreds of pictures. Latest hi-fi developments in speakers, preamps, tuners, crossovers, tape, stereo, controls, turntables, heads, amplifiers, enclosures. Detailed listing of the best records, FM stations, a treasury of the year in high fidelity! 162 pages. \$1

1958 ELECTRONIC EXPERIMENTER'S HANDBOOK

60 exciting new projects for electronics "do-it-yourselfers." Nearly 200 pages of detailed, easy-to-follow plans, diagrams, and assembly instructions for devices that will improve your home, photo darkroom, ham shack, workshop, radio and hi-fi systems. Build intriguing games for children, special projects such as transistor slave flash unit. Each project fully illustrated. 194 pages. \$1

1958 PHOTOGRAPHY ANNUAL

Theme: "What is a Camera?" Here are the year's greatest photographs as selected by the editors of Popular Photography. Hundreds of photos, color and black-and-white, from the cameras of the world's masters—action, glamour, still-life, humor, realism, drama, candid—all with full descriptive notes. You'll profit from a special section on the most important camera of all—your camera. A helpful guide to learning from the photo masterpieces of others! 194 pages. \$1

1958 SPORTS CARS ILLUSTRATED DIRECTORY

The world's most complete illustrated listing of sports cars of the world. Detailed road tests of the most popular sports cars plus a buyer's guide for sports cars and economy cars. This perfect guide for sports car fans also features a complete national service directory—dealers and garages for sports car service and parts. If you're a sports car owner or wish to be, here's your book! 143 pages. \$1

YOUR CAREER IN ELECTRONICS

A 128-page handbook devoted to electronics—its growth, present and future—and the role you can play in this exciting field. Covers the career opportunities open, where to get technical training, gives helpful personal experiences of men already in electronics. Career planning chart, aptitude test to help you decide your future. Plus tips on how to earn money in your spare time, how on-the-job training works. **Your Career in Electronics** could be the most important publication you've ever read! 260 illustrations. \$1

1958 PHOTOGRAPHY DIRECTORY & BUYING GUIDE

A handsome catalog of all photographic equipment on the market, compiled by the editors of Popular Photography. Specifications, price, manufacturers of more than 5,000 products. Plus big extra features: simplified camera comparison charts...16-page section of Foto Facts...photo shortcuts to saving money...portrait lighting setups...sample model release forms...a roundup of the latest books on photography. 100 illustrations. 194 pages. \$1

THESE GREAT ANNUALS NOW AVAILABLE BY MAIL...
USE THE HANDY COUPON BELOW

SPECIAL-INTEREST BOOKS OF THE YEAR

AT POPULAR PRICES

Place check mark next to books desired.

- | | |
|---|--|
| <input type="checkbox"/> 1958 HI-FI GUIDE AND YEARBOOK | <input type="checkbox"/> 1958 PHOTOGRAPHY ANNUAL |
| <input type="checkbox"/> YOUR CAREER IN ELECTRONICS | <input type="checkbox"/> 1958 ELECTRONIC EXPERIMENTER'S HANDBOOK |
| <input type="checkbox"/> 1958 SPORTS CARS ILLUSTRATED DIRECTORY | <input type="checkbox"/> 1958 PHOTOGRAPHY DIRECTORY & BUYING GUIDE |

ZIFF-DAVIS PUBLISHING COMPANY
434 S. WABASH AVENUE, CHICAGO 5, ILLINOIS

HFA

Please send me the books I have checked at \$1 each. I enclose \$_____ in check or money order. (Add 10¢ for each book to cover postage and handling.)

Name _____

Address _____

City _____ Zone _____ State _____

RC Filter

Tone Controls

By H. ALAN SCHWAN

THE audiophile who builds his own equipment is inevitably faced with the problems of manual frequency response adjustment. Since the basement audio engineer rarely likes or feels at home with other people's tone control designs, outlining a simple control design procedure may be of interest.

It is generally agreed that a successful tone control must affect only the areas and quantities for which it is intended; i.e., a treble control must have no noticeable effect on the low frequencies or on the apparent volume level. Further, the use of inductances in tone control circuits is pretty well precluded by their expense and susceptibility to hum. Hence, RC filters will be considered exclusively. Finally, it is desirable to be able to design one extreme of a given control independent of the other extreme, that is, the characteristic of the tone control at one extreme setting should be determined by the circuit at that particular end and should not be affected by the circuit at the other end.

With these considerations in mind the author has developed a simple design procedure for a generalized RC tone control based on the fundamental circuit of Fig. 2. This circuit was chosen because it allows accurate, independent design of the two end positions while offering smooth continuous control.

For frequency response correction in audio amplifiers, four basic types of tone control settings will satisfy virtually all of the practical requirements. These settings are: treble boost, treble cut, bass boost, and bass cut. Two independent controls and four filters are required to allow practical combinations of these settings.

RC filters, whether boost or cut types, must necessarily be attenuators. A filter which gives an apparent boost characteristic in its active area does so by reducing the amount of attenuation in that area. The maximum amount of boost available is equal to

Practical design information and examples of tone control circuits for the audiophile who builds his own equipment.

the nominal insertion loss of the filter. Thus, a treble boost filter must be designed so as to reduce the insertion loss of the filter at the higher frequencies. However, if the filter is to have no effect on the low frequencies, it must not begin its reduction of attenuation until some minimum frequency is reached. Similar criteria apply to the bass boost filter.

Treble Boost Filter: The basic treble boost filter is shown in Fig. 1A. As the source frequency is increased from zero, no significant change in output level is noticed until the reactance of the capacitor starts to decrease toward the value of R_1 . At such a frequency the capacitor begins the effective bypassing of R_1 , and the impedance in series with the source and

the load (R_2) starts to decrease. As the input frequency increases further, the output voltage rises toward the input voltage until a frequency is reached where the capacitor's reactance is small compared with the resistance of R_2 . At this point, the capacitor is a virtual short circuit and the output is effectively connected directly to the input. Here, the attenuation has dropped to a negligible value and a treble boost has taken place.

The designer of such a filter is interested in the rate of boost, the maximum amount of boost available, and the point where significant boosting starts. The rate of boost in an RC filter is fixed by the fundamental nature of RC circuits at some value

Fig. 1. Basic RC tone control filter networks with their appropriate equations.

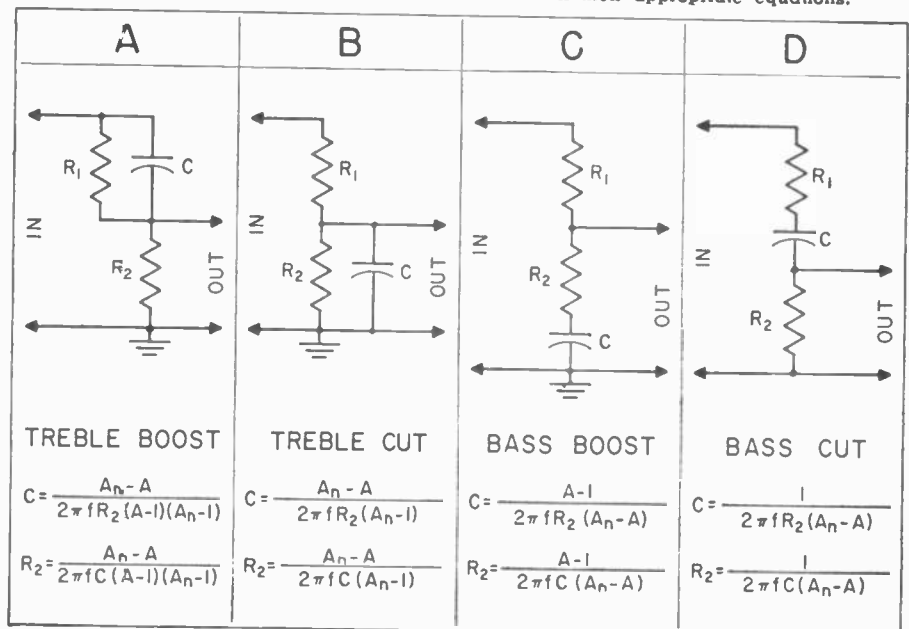

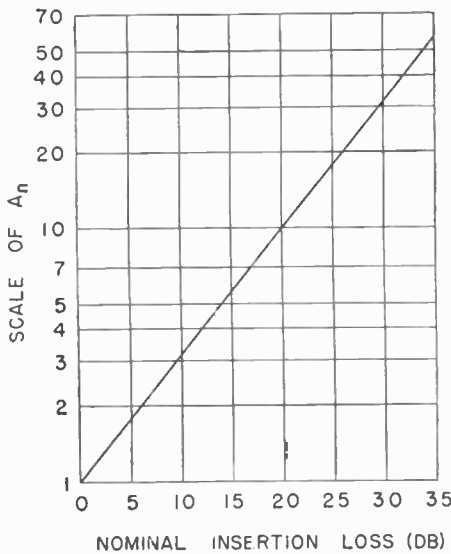

Table 1. Relation between nominal insertion ratio, A_n , and nominal insertion loss. Maximum boost desired is projected vertically to line, then horizontally to the vertical scale. This value of A_n is used in the equations.

less than six decibels per octave. However, the complete tone control circuit allows manual adjustment of the boost rate. The maximum amount of boost is equal to the nominal insertion loss of the filter where the nominal insertion loss is:

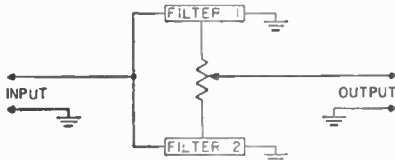
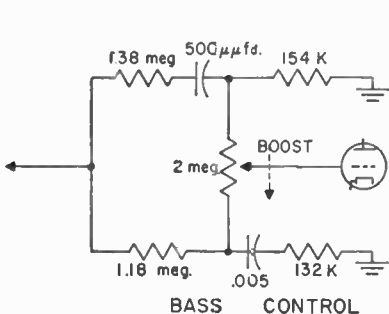
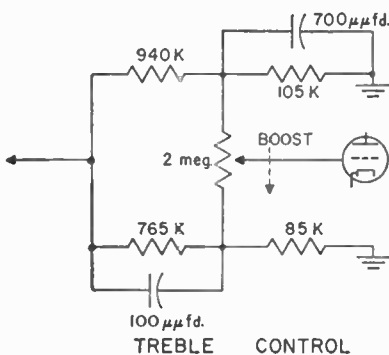

Fig. 2. Movement of pot wiper toward filter 2 causes the input-output relation to be modified more by filter 2 and less by filter 1. This is the basic tone control scheme.

Fig. 3. Treble and bass controls. Bass turnover is 500 cps, treble turnover is 1000 cps, and nominal insertion loss is 20 db.



$$\text{decibel loss} = 20 \log \frac{R_1 + R_2}{R_2} =$$

$$20 \log \frac{V_{in}}{V_{out}}$$

In practice, the amount of boost is chosen to suit the requirements of the tone control. Twenty decibels is usually assumed for this value and is generally adequate. If twenty decibels is assumed, then:

$$\frac{R_1 + R_2}{R_2} = 10, \text{ and } R_1 = 9R_2.$$

At this point it is necessary to investigate the source impedance. If the tone control is to be driven from the plate of a voltage amplifier, the control circuit should have a mid-frequency input impedance of around 500,000 ohms. This requires that $R_1 + R_2$ be near one megohm since the tube must drive two such filters in parallel. If the control is to be driven by a cathode follower, $R_1 + R_2$ should probably be in excess of 50,000 ohms. Assuming a plate loaded amplifier as a source, 0.1 megohm might be a good value to assume for R_2 as a start. (Thus R_1 plus R_2 equals one megohm.)

If we let A_n be the nominal insertion ratio of the filter and A be the ratio of input to output voltage at some frequency f , then the decibel boost at that frequency is the nominal insertion loss minus the attenuation at the frequency f :

$$\begin{aligned} \text{decibel boost} &= 20 \log A_n - 20 \log A \\ &= 20 \log \frac{A_n}{A} \end{aligned}$$

where:

$$A_n = \frac{R_1 + R_2}{R_2}$$

A consideration of the treble boost filter circuit shows that:

$$C = \frac{A_n - A}{2\pi f R_2 (A - 1) (A_n - 1)}$$

A determination of C can be made from this equation if a value of boost is assumed at some frequency. A convenient point to choose is the desired turnover point, the frequency at which significant boosting starts. The turnover point has a boost of three decibels and, for the treble boost circuit, should occur at around 1000 cps. Continuing with the previous assumptions in illustration, then:

$$\begin{aligned} C &= \frac{10 - 7.07}{2\pi \times 1000 \times 100,000 (7.07 - 1) (10 - 1)} \\ &= 85.4 \mu\text{fd.} \end{aligned}$$

It is preferable to use standard component values where possible, hence, the value of C is to be regarded as an approximation, and a more convenient value would probably be 100 μfd . However, if the value chosen for R_2 is kept and the rather arbitrary value of C is used, the turnover frequency cannot be expected to come out to the assumed value. Since the input impedance is rarely critical, it is expedient to alter the value of R_2 to bring the turnover frequency back to the

assumed value. The final value of R_2 , then, is found for the treble boost filter by substituting the desired turnover frequency, the new value of C , and the value of A at the turnover frequency into the equation:

$$R_2 = \frac{A_n - A}{2\pi f C (A - 1) (A_n - 1)}$$

In the present example, R_2 equals 85,000 ohms. R_1 is now found from the initial consideration of maximum boost where $R_1 = (A_n - 1) R_2$. In the example, $R_1 = 9R_2 = 765,000$ ohms.

The purist will insist on using these values for R_1 and R_2 . However, a slight deviation in the interest of allowing the use of standard values will usually be satisfactory. (Changing R_2 from the ideal 85,000 ohms to the standard 82,000 ohms and R_1 from the ideal 765,000 ohms to the standard 750,000 ohms will change the turnover frequency from the assumed 1000 cycles to 1040 cycles. Such an alteration is almost always admissible.) However, care should be taken to change both resistors by roughly the same percentage in the same direction.

Treble Cut Filter: The circuit for the basic treble cut filter is shown in Fig. 1B. As the source frequency is increased from zero, no change in output is noticed until the reactance of C approaches the value of R_2 . At such a frequency, effective bypassing of R_2 begins and the output voltage starts to drop.

The determination of the values to be used in this filter follows essentially the same procedure as was just outlined for the treble boost circuit. Assuming that this filter is to be used at the end of the tone control opposite from the treble boost filter, it should have a nominal insertion loss equal to that of the boost circuit in order to insure a constant volume level over the entire range of the control. Values of f and A are determined as before, and an approximate value of R_2 decided upon. In the case of the treble cut filter, an approximate value of C is determined from the equation:

$$C = \frac{A_n - A}{2\pi f R_2 (A_n - 1)}$$

and a standard value of C is chosen as close as possible to that determined by the equation. Then the final value of R_2 is calculated from the equation:

$$R_2 = \frac{A_n - A}{2\pi f C (A_n - 1)}$$

and a close standard value chosen. R_1 is then found as before.

The Bass Filters: If a very high frequency is applied to the input of the circuit of Fig. 1C, capacitor C will act as a short circuit and the output will be attenuated by the nominal insertion loss of the filter. As the input frequency is reduced, the reactance of C will increase until it approaches the value of R_2 , at which time the output will begin to rise significantly. As the signal frequency is reduced toward zero, the capacitor

reactance will approach infinity so that with d.c. applied across the input no attenuation occurs. Thus a boost has been effected across the output in the region between d.c. and where X_c approaches R_2 . The operation of the bass cut filter is similar.

The same procedure is followed in designing the two bass filters except that the equations used are:

$$C = \frac{A-1}{2\pi f R_2 (A_n - A)}$$

$$R_2 = \frac{A-1}{2\pi f C (A_n - A)}$$

and:

$$C = \frac{1}{2\pi f R_2 (A_n - A)}$$

$$R_2 = \frac{1}{2\pi f C (A_n - A)}$$

for the boost and cut filters respectively.

The Tone Control

The potentiometer used as a tone control to link any pair of filters should be large compared to the value of R_2 for either filter, otherwise adequate isolation of the two filters will not be effected and interaction will occur between them. If the pot is ten times larger than either R_2 , adequate isolation should be accomplished. If it is twenty times as large, the isolation can be considered complete.

Care must be taken not to load the output of the control or significant changes in volume level will be experienced as the tone control setting is changed. An ideal situation in this respect is to drive an amplifier grid directly from the pot wiper, as indicated in Fig. 3, using only the control circuit for the d.c. grid return.

If two tone controls are to be included in an amplifier, probably the most reasonable choice would be a treble and a bass control, although this is not the only possibility. This choice requires a treble cut filter at one end of the treble control and a treble boost filter at the other. It further requires a bass cut filter at one end of the bass control and a bass boost filter at the other. In this kind of an arrangement both filters connected to a given control should be designed to have the same turnover frequency.

Very nice single control units can be built by employing a bass boost filter at one end of the control and a treble boost filter at the other. The two-control design is usually to be preferred, however. In any event, the filters associated with any given control should have the same value of nominal insertion loss.

Resumé of Design Procedure

In brief, the procedure for the design of the filters is as follows:

1. Decide which pair of filters is to be coupled to a given control.
2. Determine the maximum desired boost and calculate A_n from the equa-

tion: $\text{decibel boost} = 20 \log A_n$, or determine A_n from Table 1.

3. Determine an approximate value of mid-frequency impedance, Z_1 , by considering the load requirements of the driver. (The tone control constitutes the load.)

4. Compute an approximate value of R_2 from the relation: $R_2 = Z_1/A_n$.

5. Choose some point on the desired frequency response characteristic of the filter; i.e., determine a value of boost or cut at some specific frequency. (Usually the turnover point will be chosen, but this is not necessary.) From the value of boost or cut thus known and from A_n found in step 2, find A , either from the equation:

$$\begin{aligned} \text{decibel boost} &= 20 \log A_n/A \\ \text{decibel cut} &= 20 \log A/A_n \end{aligned}$$

or from Table 2.

6. Calculate a first value for C by substituting the values for A_n , A , f , and R_2 found in steps 2 through 5 into the appropriate filter equation as listed in Fig. 1.

7. Choose a standard capacitor value near that calculated in step 6.

8. Insert the values of A_n , A , and f found in steps 2 through 5 and the value of C found in step 7 into the appropriate equation for R_2 as listed in Fig. 1.

9. Calculate R_1 from the equation: $R_1 = (A_n - 1) R_2$.

10. It is usually acceptable to use standard values for R_1 and R_2 if they are close to those calculated in steps 8 and 9.

It is to be noted that if R_1 and R_2 are expressed in ohms, then C will be in farads. If R_1 and R_2 are given in megohms, then C will be in microfarads.

Practical Filters

A practical example of each of the four types of filters in a tone control application is illustrated in Fig. 3. The values shown result in the response characteristics plotted in Fig. 4. These response curves represent the extreme limits of the tone controls.

The criteria used in designing the

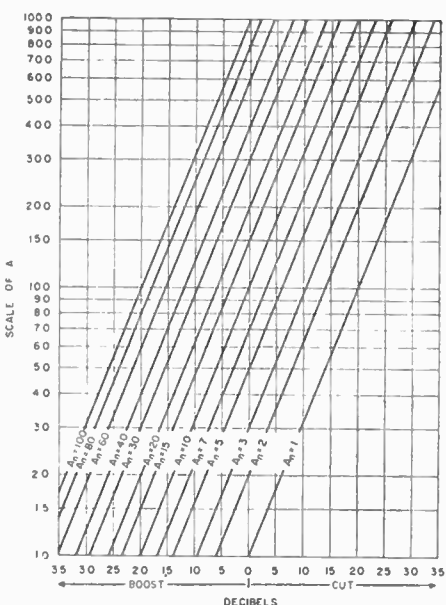

Table 2. Relation of input-output voltage ratio, A , of any RC filter with insertion ratio A_n and the decibel boost or cut. Project upward from the desired db value of boost or cut to the line representing value of A_n from Table 1. Then project horizontally to scale of A , and read the value of A .

filters illustrated were as follows:

1. Input impedance, roughly 500,000 ohms (individual filter input impedance, Z_1 , roughly one megohm).
2. Bass crossover point at 500 cycles.
3. Treble crossover point at 1000 cycles.
4. 20 decibels maximum boost.

It is to be noted that the exact values of R_1 and R_2 , as calculated from procedure described previously were employed; i.e., standard values were not substituted. It is suggested that the values of the components shown be computed by the designer to serve as a check on the over-all design procedure.

The technique described herein has given good results and should be very useful to anyone interested in the problems of tone control or fixed frequency response correction. -30-

Fig. 4. Response characteristics of four filters shown in Fig. 3. This represents the response of the controls when set at their respective extreme positions.

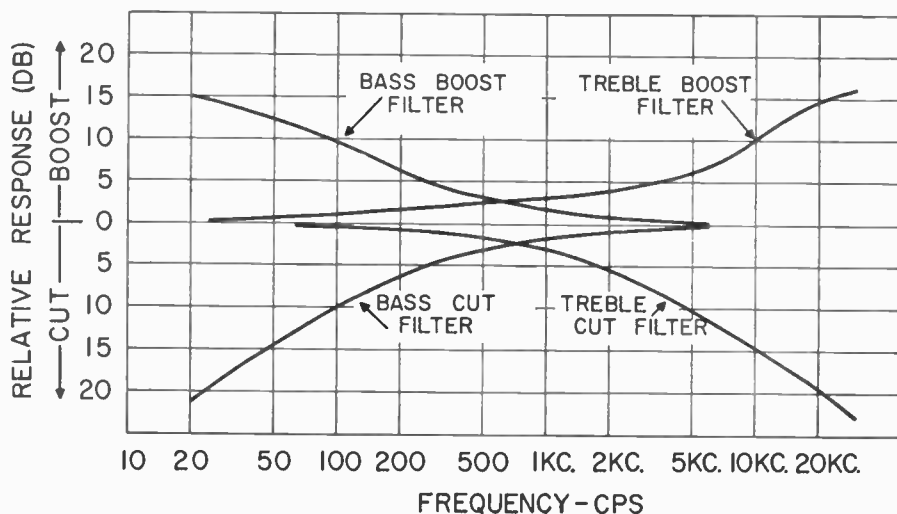

Reducing Hum and Noise in Preamplifiers

By SIDNEY TOBY

Here is a simple procedure that the audiophile can follow which will increase his enjoyment of fine-music listening.

IF THERE is no audible hum or noise from your loudspeaker at normal listening levels, when you are sitting in your favorite armchair, then you are in luck. If not, it is worthwhile spending a little time to reduce such hum and noise.

Providing the "B+" supply is adequately filtered and the layout of components is well designed, any residual hum can usually be traced to the use of a.c. on the preamplifier tube heaters. The use of d.c. on the heaters would remedy this but the rectifiers and capacitors needed to make the changeover are relatively expensive. In any case, the voltage drop across the rectifier precludes the use of the ordinary filament winding of the power transformer and there may not be another winding available.

There are various hum reducing devices that can be used, such as placing a potentiometer tapped to ground across the heater circuit, the use of positive bias on the heaters, and so on. These methods do not usually lower the hum level by more than a few decibels and are not completely satisfactory.

A much better arrangement is obtained by heating the first stage or two with the d.c. available from the cathodes of the power output tubes. This may be done by simply putting the heaters in series with the cathode resistor as shown in the diagram, and the only prerequisite is that the current through the cathode resistor be sufficient for the heaters.

If the cathode current is unknown, and there is no jack installed from which it can be measured directly, the cathode current may be easily calculated by measuring the voltage across the cathode resistor and dividing its value while it is still hot.

To cite an example, in the writer's amplifier the cathode current from the output tubes was 135 ma. The input tube in the preamplifier was a 12AX7, the heater of which is rated at 150 ma. (series) or 300 ma. (parallel). The heater circuit was therefore hooked up as shown in the diagram. Since the heater resistance of the 12AX7 is about 85 ohms when the tube is hot, the value of R_1 was that of the original cathode resistor minus 85 ohms. In general, the value of the cathode re-

sistor will be greater than the resistance of the input tube heater so that several heaters may be placed in series if desired. If the cathode current is too large, it is a simple matter to shunt (R_2) the heaters to get rid of the excess. The current used should be about 10 per-cent less than the rated value for the tube heater.

The use of d.c. on the heaters of the low-level preamplifier stages will result in a hum decrease of 10 decibels or better. In everyday terms, this can make the difference between a hum discernible from the other side of the room and one detectable only within a foot of the speaker, at normal listening levels.

The use of a heater current slightly less than the rated value will help considerably to reduce noise (tube hiss) at the sacrifice of a negligible amount of gain. Any remaining noise may be further reduced by replacing the cathode and plate resistors of the low-level stages by low noise resistors of the deposited carbon type.

Despite the seeming simplicity of this suggestion, this method works extremely well. Audiophiles with a slight technical flare and the courage to open the backs of their equipment will find that the time and trouble involved are well worth it. While it may seem to be a case of overdoing things a bit, the critical listener whose record library includes a generous sampling of chamber music, solo instrument performances, leader, and other traditionally "quiet" music will find that the removal of excessive noise and hum from their equipment will double their enjoyment of their selections. In any event, the suggestion has been made. Rest assured that the author has tried this circuit out and can vouch for its effectiveness.

Hum reducing circuit changes. See text.

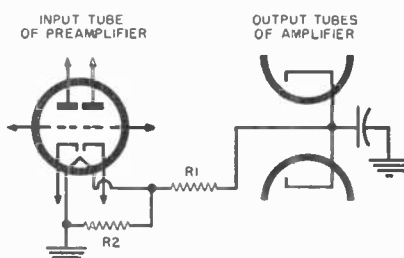

FEEDBACK

By PAUL W. KLIPSCH
Klipsch & Associates

MUCH has been written on the application of feedback to compensate for speaker impedance variation. The height appears to have been reached in claiming to have extended the range of a speaker. (Refer to the article "A New Look at Positive Current Feedback" by Zink and Sanford in the November, 1957 issue of RADIO & TV NEWS.)

Feedback in an amplifier, to obtain lower amplifier distortion, or to maintain a low internal amplifier impedance (nearly constant voltage with varying load impedance) or some condition between that and constant current; all these are good or useful, depending on the application. But to make a speaker go an octave lower by means of the altered internal impedance of an amplifier can be shown to be a fallacy.

In testing a speaker, a certain voltage is applied to its terminals. Since at the given frequency the speaker exhibits a certain impedance, a certain current flows. There results a certain sound output. Now at that frequency it makes no difference whether the internal impedance of the amplifier is high, low, or negative. It is the current in the voice coil that produces the force and its resultant motion. Assuming the amplifier to be free from distortion, it makes absolutely no difference whether the amplifier has zero impedance, has positive feedback, or even if its power rating is high or low as long as the power rating is adequate to produce the stipulated volts and amperes. Hence if a speaker is tested at its optimum input volt-ampere conditions, we can not improve the speaker response with an amplifier of some peculiar internal impedance characteristic.

Now, of course, the feedback may cause an altered frequency response; since the speaker impedance is a complicated function of frequency one could apply feedback of a type to raise the amplifier impedance, say, making it approach constant current instead of constant voltage, with resultant peaking of speaker output by compounding high efficiency with high power absorption at high impedance peaks. But as for making a speaker deliver undistorted acoustic power outside its operating range, this is an operation bootstrap. It's nice to wish for it, but wishful thinking doesn't make it so. Some have claimed to have obtained 20-cycle output from a Klipschorn; sure it can be done but at minute amounts of power; try to equalize that output up to "useful" levels and all one gets is distortion. This can be said of any speaker.

What the feedback proponents are accomplishing is simply an equalization which becomes a function of speaker impedance, for better or worse. Equalization has long been thought of as a means of extending speaker range, but invariably it increases distortion.

Furthermore it would be useless if a speaker did produce a fundamental tone at 20 cycles. Experiments with a stethoscope and pistonphone capable of 140 db pure sine wave pressures down to 2 cycles per second were studied aurally. Below about 35 cycles most listeners heard pulses rather than sine waves and no one tested so far heard fundamentals below about 28 cycles. This type of test is not extensive enough to state these results as being general, but they appear to be usual.

From
any Point of View,
more Experts choose
ACROSOUND
ULTRA-LINEAR II
60 watt amplifier

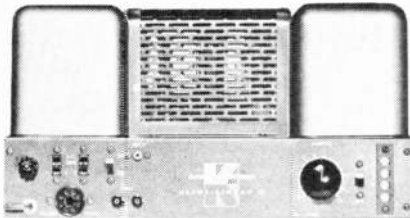

DESIGN The combination of patented ULTRA-LINEAR circuitry—plus new HYBRID FEEDBACK principle—VARIABLE DAMPING control, and ULTRA STABILITY, represents a new high in the art of amplifier design... an example of ACROSOUND'S latest achievement in AMERICAN Know-How. This superiority of design now enables anyone with or without any previous knowledge of electronics to assemble for himself or herself... (yes! it's that easy!)... the finest of amplifiers and at a most reasonable cost, in only two hours!

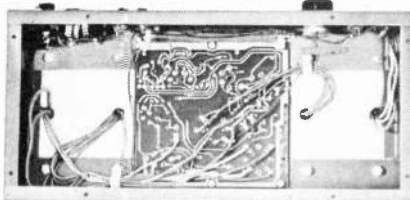

PERFORMANCE By listening test, or by instruments... second to none in clarity and frequency response. Normal level distortion is virtually unmeasurable—1M 1% or less at 60 watts, 120 watts peak. Completely stable... unaffected by loads, perfect square waves.

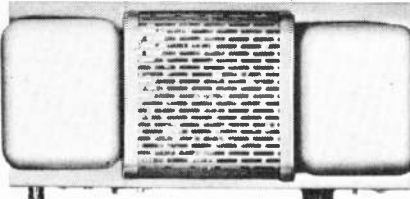

QUALITY Every part going into the assembly of critical and even non-critical circuitry is tested and checked to allow no more than $\pm 1\%$ variation from ACROSOUND'S standards. Specialized test equipment unavailable commercially was designed in ACROSOUND'S laboratories to achieve this result. Every printed circuit board is placed in trial operation on a laboratory amplifier. Output tubes are matched by trial and double checked.



COMPONENTS ACRO'S newest TO-600 output transformer with special hybrid winding—separates functions of output circuit and feedback circuit. Heavy duty, completely assembled, and thoroughly tested, printed circuit board assures uniformity of performance. Low distortion EL34 output tubes are operated well within their ratings ensuring long tube life and optimum performance.

PRICE In preassembled kit form so that you may save money, learn while doing, and have the proud satisfaction you built the best for only \$79.50 net... or if you feel you would prefer it laboratory assembled it still represents a bargain at \$109.50 net.

HEAR IT AT YOUR DEALER NOW!

BE READY FOR ACROSOUND DISTORTIONLESS PRE AMP DESIGNED FOR THE STEREO PHILE

Experts know why ACRO is best!
Others... Learn why! Write to

ACRO PRODUCTS
369 SHURS LANE
PHILA. 28. PA.

In Defense of the Split-Load Phase Inverter

By DANIEL P. PETERS

A very simple modification of the split-load phase inverter greatly improves the high-frequency balance.

THE SPLIT-LOAD phase inverter has been rather widely used in high-fidelity power amplifiers as the driver stage for push-pull amplifiers. Its popularity is certainly well deserved because of its simplicity and good balance over most of the audio range. The operation of the circuit may be readily seen from Fig. 1A below. An input signal is applied to the grid in series with a bias source (often obtained from the cathode resistor). When the incoming signal swings in a positive direction, the current flowing through the tube increases. Since this current flows through both cathode and plate resistors, the voltage drops across both resistors increase, hence, the output voltage at the cathode goes more positive and this output is in-phase with the input signal. Because of the cathode-follower action here, the amplitude of the output at this point is somewhat less than the input. At the plate output terminal however, the output voltage is 180 degrees out-of-phase with the input. This is because the increased voltage drop across the plate resistor reduces the available plate supply voltage, causing the actual voltage at the plate to go less positive (or in a negative direction). By reducing the value of the plate resistor to that of the cathode resistor, the signal voltage output at the plate is reduced to that value obtainable at the cathode. As a result two equal-amplitude but opposite-polarity voltages are available to drive a push-pull stage.

Unfortunately, designers often avoid using the split-load phase inverter due to a rather widely held impression of an inherently poor high-frequency balance. Referring to Fig. 1A, it may be

seen that this prejudice grows from the apparent differences in source impedance seen by the plate and cathode output loads. The cathode source impedance, being that of an amplifier with degenerative voltage feedback, is low. At the plate terminal, an amplifier with degenerative current feedback is seen, and the source impedance here is high.

The shunting effects of inverter tube capacitances, wiring capacitances, and input capacitance of the following stage are then supposed to reduce the high-frequency gain more rapidly at the plate, than at the cathode terminal.

However, an analysis of the circuit shows that as long as these shunt capacitances are equal, and shunt both terminals simultaneously, as is usually the case, the actual situation is rather favorable.

If there is no grid current, the plate and cathode currents must be identical. By nothing more complicated than Ohm's Law it therefore follows that if the impedances in series with the plate and cathode are equal, the voltage drops across them will also be equal.

To verify this, the circuit shown in Fig. 1B was bread-boarded to investigate the performance with various values of C_s in the two-decade frequency range from 2000 cycles to 200 kc.

The two outputs were monitored simultaneously on two identical meters to remove the possibility of the meters unbalancing the circuit. Each meter represented a resistance of 10 megohms in parallel with 50 μ fd. Resistors R_p and R_k matched within 1.0% as did the capacitors used for C_s . The meters were pre-calibrated to

Fig. 1. (A) Basic split-load phase inverter. (B) Inverter with shunt capacitance shown. (C) Inverter with variable balancing capacitor shown in the cathode circuit.

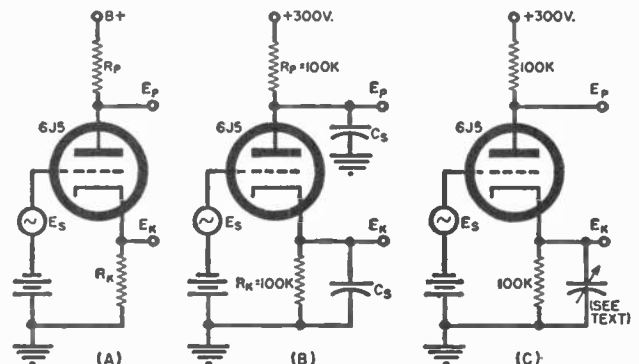

Improving The Cross-Coupled Inverter

By NICHOLAS PRYOR

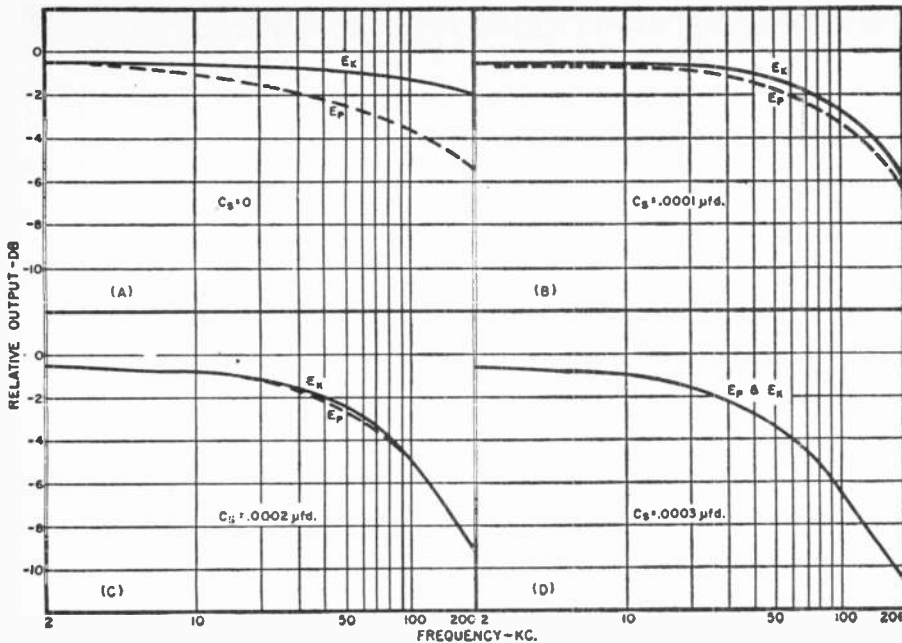

Fig. 2. Response of circuit in Fig. 1B with various amounts of shunt capacitance.

read the same, at a deflection of 0 db, on the range used.

Having taken these precautions the tests were performed and the results summarized in the graphs of Fig. 2. As shown, the balance between the shunt outputs improved as the shunt capacitance increased. This agrees with the theory but disagrees with the popular conception of the operation of this circuit.

In view of these facts, it is obvious that any unbalance at the high frequencies is due to a difference between the plate and cathode effective capacitances.

Having proved the foregoing, the author next set out to improve the balance, for the unshunted case. Since the unbalance was attributed to a difference between shunt capacitances, it seemed logical to connect a small capacitor in shunt with the output having the higher output voltage.

This was accomplished by connecting a 100 μ fd. trimmer capacitor between cathode and ground as shown in Fig. 1C. With the oscillator set at 200 kilocycles the capacitor was adjusted until the outputs from plate and cathode were equal. In this particular circuit, balance occurred at a capacitor setting of 50 μ fd. Fig. 3 shows the results of a frequency run on this circuit. There was no difference between the

outputs, at any frequency in the range tested.

A comparison of the results in Fig. 3 with the comparable unshunted case of Fig. 2 shows that the additional cathode shunting capacitor has actually improved the frequency response of the plate circuit by a factor of 2.7 db at 200 kilocycles. This is achieved with a drop of only 0.5 db in the cathode output at 200 kilocycles. For a change, we get something for almost nothing. The increase in plate circuit output is to be expected, since the capacitor is acting as a partial cathode bypass, thereby increasing the plate circuit gain.

The split-load phase inverter has always been an excellent circuit since the mid-frequency balance depends upon only two resistors and is not affected by tube parameters as are other inverters. It only requires one triode and has an over-all gain of slightly less than two. Unfortunately it has often been shunned because of a reputed high-frequency unbalance and many complicated circuits have been devised to replace it. Now, simply by the addition of a capacitor we achieve a circuit whose balance is as good, if not better, than the most complicated of its replacements. The addition of such a component is certainly worth at least a trial.

-30-

Fig. 3. Frequency response of the circuit shown in Fig. 1C with variable trimmer capacitor C' connected across the cathode resistor.

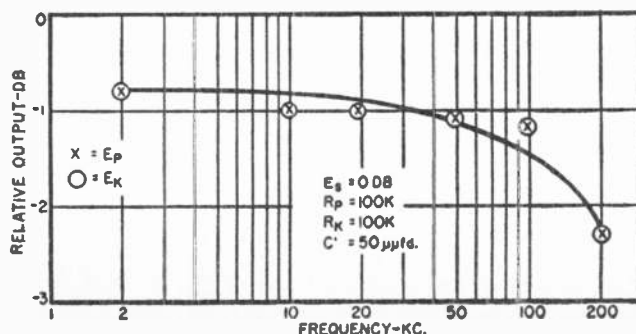

IN THESE days of extreme amplifier bandwidth, a phase inverter with good balance and low reactive phase shift over a wide frequency range becomes a necessary part of any amplifier design. The circuit that most nearly meets these requirements is the cross-coupled inverter developed in 1948.

There are, however, some incorrect notions about the balancing in the cross-coupled inverter. First, with a single-ended input, the balancing control between the cathodes of the first stage does not balance the dynamic characteristics of the amplifier. It merely balances the tube bias and equalizes the sensitivity of the two inputs. Since neither of these is very critical in the improved model of the inverter, this control can be omitted as it was in the original Van Scoyoc circuit. Provision for dynamic balance is included elsewhere in the new circuit. Also, the term "inherent balance" is somewhat misleading. Referring again to Fig. 1, it will be noted that both halves of the signal are equal only at the input of the second stage. This leaves variations in tubes and load resistors of the second stage to upset the balance. Another problem in the design is the high (30,000-ohm) output impedance which limits the high-frequency response and causes clipping as grid bias reaches zero in the power output stage.

Both of these problems can be solved simply by the addition of another cathode follower to the circuit. Because of the low d.c. voltage at the output of the cathode follower, it can be direct-coupled to the power stage without many of the problems of bias and static balance that usually accompany direct coupling. Direct coupling here eliminates a low-frequency phase shift point thus maintaining the stability of the amplifier. The low output impedance reduces high-frequency shift and allows some power to be delivered to the power stage. It can also be shown by the design equations for cathode followers that the gain of the stage can be varied by variations in the cathode resistance.

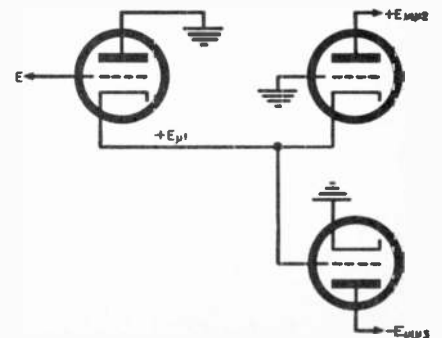
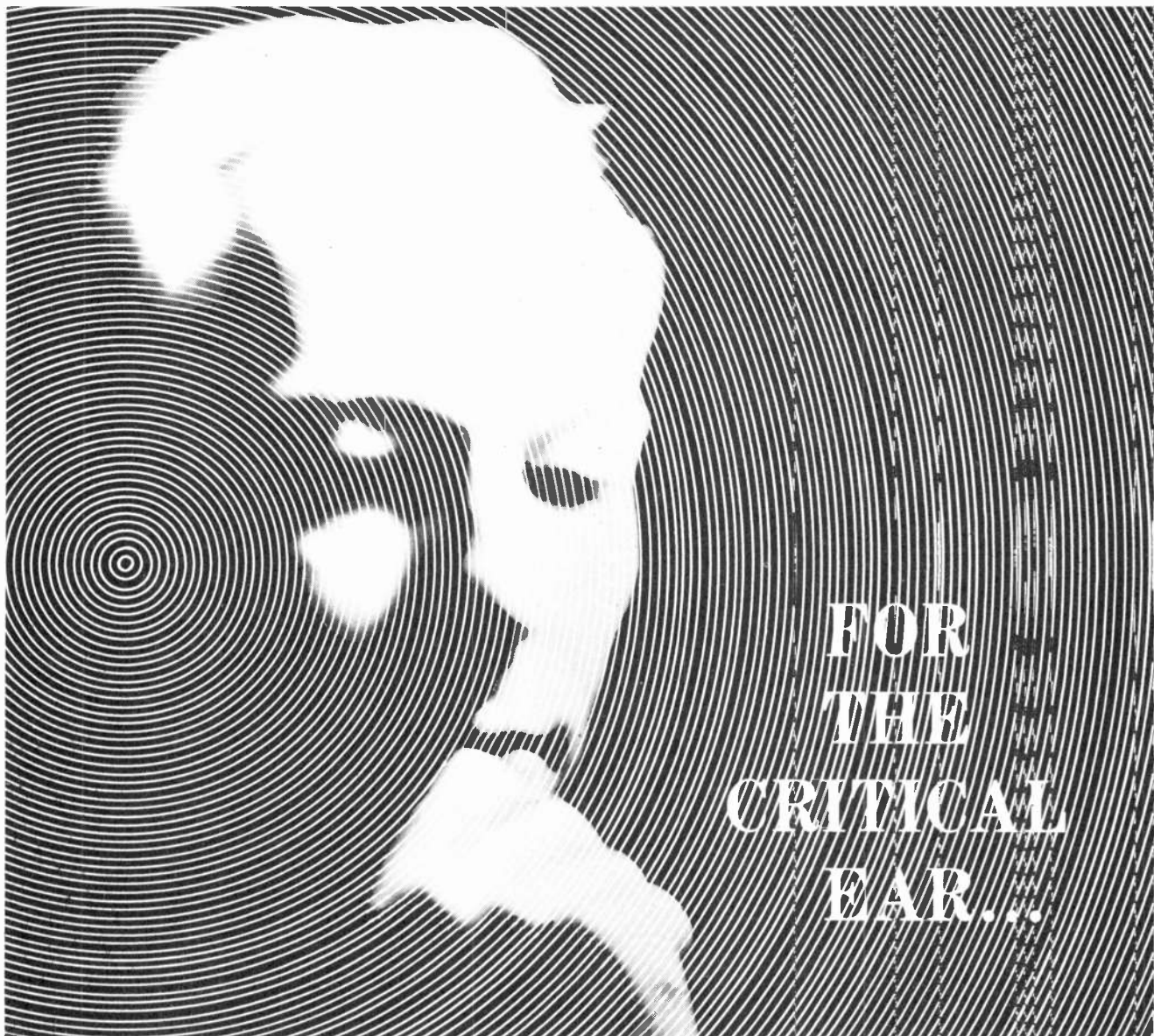

Fig. 1. Simplified inverter circuit showing just a.c. paths, in interest of clarity.



FOR
THE
CRITICAL
EAR...

the incomparable



Stereo Dynetic

C A R T R I D G E

The Shure Stereo Dynetic Cartridge is designed and built specifically for the listener who appreciates accuracy and honesty of sound. It separates disc stereo sound channels with incisive clarity. It is singularly smooth throughout the normally audible spectrum . . . and is without equal in the re-creation of clean lows, brilliant highs, and true-to-performance mid-range. Completely compatible . . . plays monaural* or stereo records. It is manufactured in limited quantities for the music lover—is available through responsible high fidelity consultants and dealers at \$45.00, audiophile net, complete with 0.7 mil diamond stereo stylus.

*For those who prefer a monaural cartridge with monaural records: Shure Professional Dynetic Cartridge or Studio Dynetic Tone Arm. Studio Dynetic tracks at one gram. (If conversion to stereo is desirable later, Shure "Plan-of-Protection" guarantees 75% trade-in allowance until Dec. 31, 1959.)

Literature available: Dept. M-3

SHURE BROTHERS, INC.
222 Hartrey Street • Evanston, Illinois



a note to the technically inclined:

Shure Stereo Dynetic Cartridges are individually tested and must meet or exceed the following specifications before being placed on the market:

Frequency response: 20 to 15,000 cps
Compliance: 4.0×10^{-6} centimeters per dyne
Channel separation: More than 20 db throughout the critical stereo frequency range.

Recommended Tracking Force: 3 to 6 grams.
The M3D fits all 4-lead and 3-lead stereo changers and arms. 10 second stylus replacement.

SHURE ALSO MANUFACTURES HIGH-QUALITY PICKUP ARMS, MICROPHONES, AND MAGNETIC RECORDING HEADS

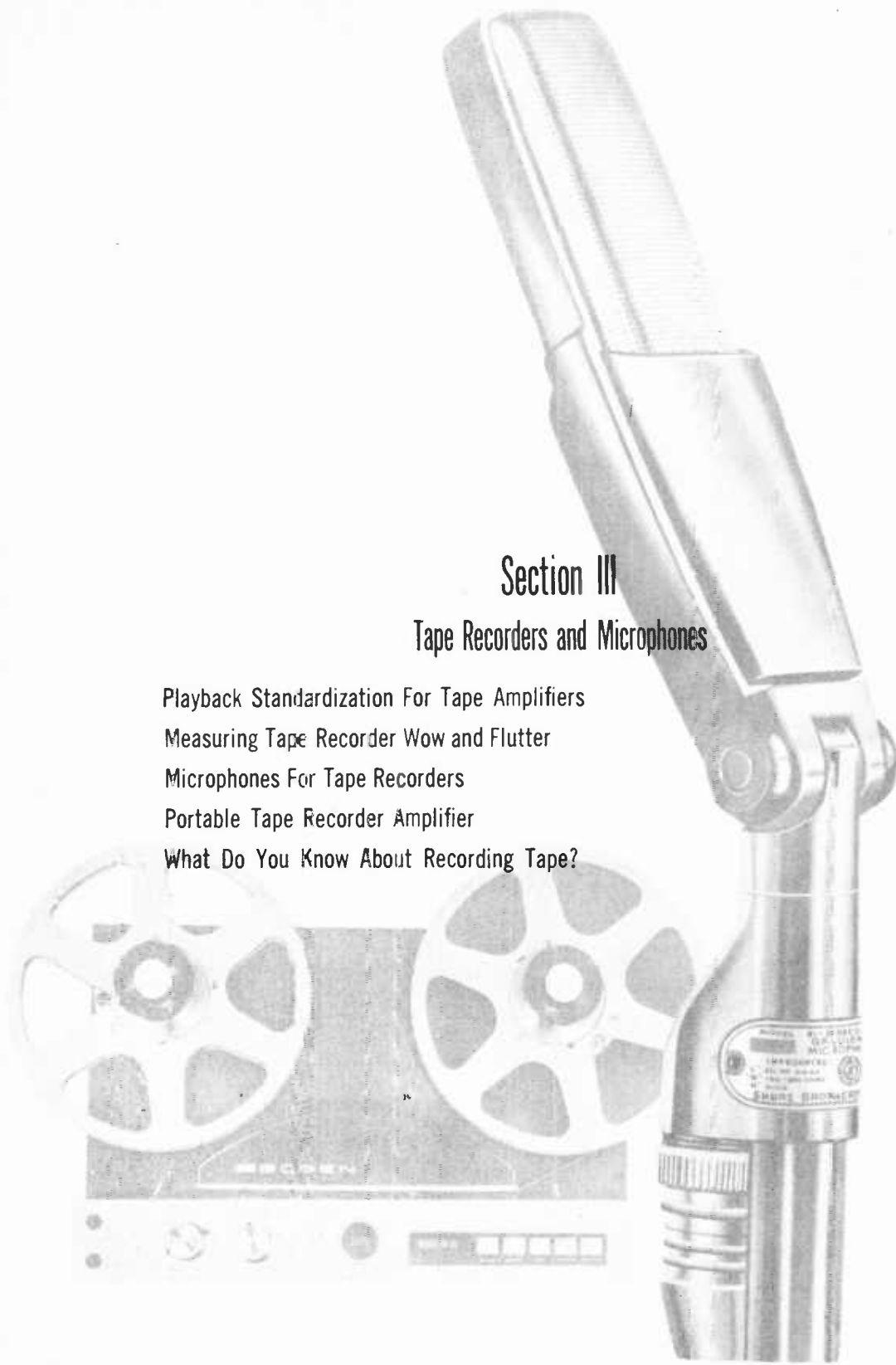

Section III

Tape Recorders and Microphones

Playback Standardization For Tape Amplifiers	62
Measuring Tape Recorder Wow and Flutter	67
Microphones For Tape Recorders	69
Portable Tape Recorder Amplifier	75
What Do You Know About Recording Tape?	79

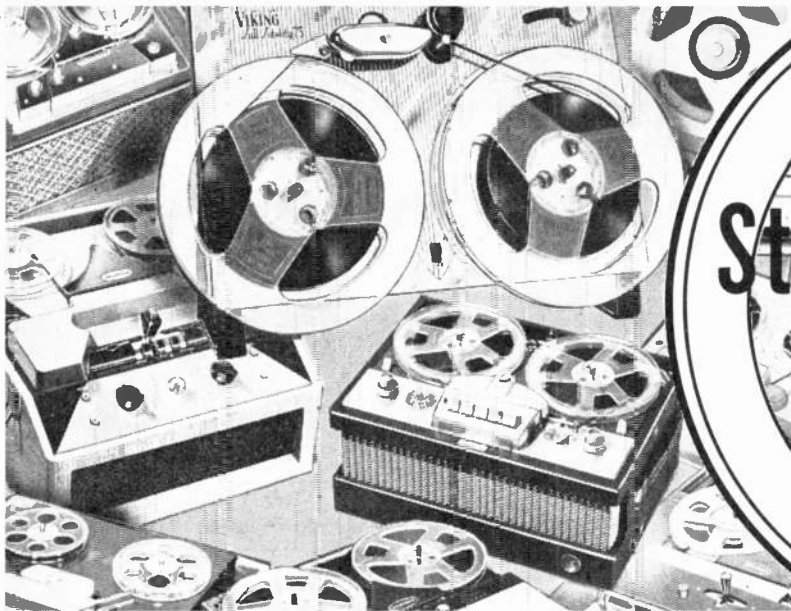

Playback Standardization for Tape Amplifiers

By HERMAN BURSTEIN

Equalization standards are discussed and specific recommendations are made for shaping playback curve.

ACCURATE equalization, within 2 db or less, of phono recording characteristics has long been a requisite of high-fidelity systems. The typical proud owner of a home music system would be outraged if he found that his preamplifier departs four or five db from the RIAA playback curve when he switches to this position. Yet many an audiophile encounters errors this serious in the playback of commercially recorded tapes, which are daily increasing in quantity and quality.

The reference here and in the rest of the discussion is to tapes operating at 7.5 ips, the speed in most common use because it is the slowest one (longest playing time) that permits a frequency response consistent with high-fidelity standards. The majority of the 7.5 ips recorded tapes call for NARTB playback equalization or *Ampex's* slightly modified curve, which differs at the very low end. *Ampex's* playback curve has about 1.5 db less bass boost at 50 cycles and about 2.0 db less boost at 30 cycles, a difference which is minor enough to be ignored here.

While most professional tape recorders of recent manufacture employ playback equalization reasonably close to the NARTB characteristic, at present the majority of moderate price ones do not. In some cases this cannot be helped because, for reasons of economy, the same equalizer network is used in both the record and playback modes, so that conformity with NARTB playback is out of the question. Other moderate price recorders, however, in keeping with the desirable practice of supplying treble boost principally in record and bass boost during playback, utilize different equalizer networks in each mode of operation. Nevertheless, although the opportunity is ready at hand, many in the latter

group of recorders still fail to utilize NARTB playback equalization.

Where a tape amplifier does not employ the NARTB playback characteristic, the deviation is always in the direction of supplying less boost than called for by NARTB. The reason, in part, is that a smaller quantity of bass boost reduces the problem of hum pickup, a dominating factor in the signal-to-noise ratio of a tape recorder. Moreover, the nature of tape recorder equalization is such that the less the bass boost, the less is the required treble boost in record. Reduced amounts of equalization necessitate less gain, making for a more economical tape amplifier. The relationship between bass boost and record treble boost derives from the fact that the playback head—apart from certain high-frequency losses that will be discussed—has an output which rises 6

db per octave with increasing frequency. When a small amount of bass boost is employed, that is, when bass boost starts at a relatively low turnover frequency, then in playback the rising output of the head, in effect, supplies treble boost above this turnover frequency. Therefore less treble boost is needed during "record."

The following discussion will first describe NARTB playback equalization. It will then examine a typical case where a tape amplifier of good quality, using a separate equalizer for playback, departs from the NARTB curve, so that it may be seen how serious are the resulting errors when a commercially recorded tape is played. The third part will discuss a popular bass boost circuit which lends itself to exact shaping of the playback characteristic. Lastly, means of compensating playback head losses will be

Fig. 1. Standard NARTB and Ampex tape playback equalizations.

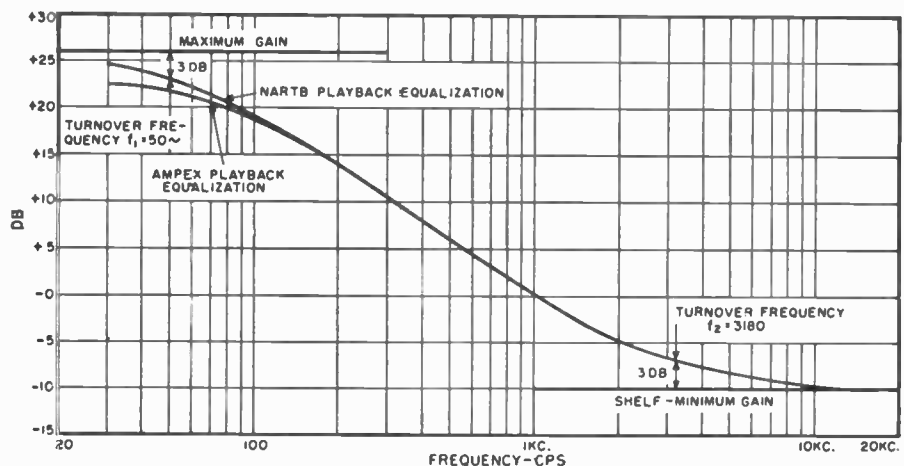

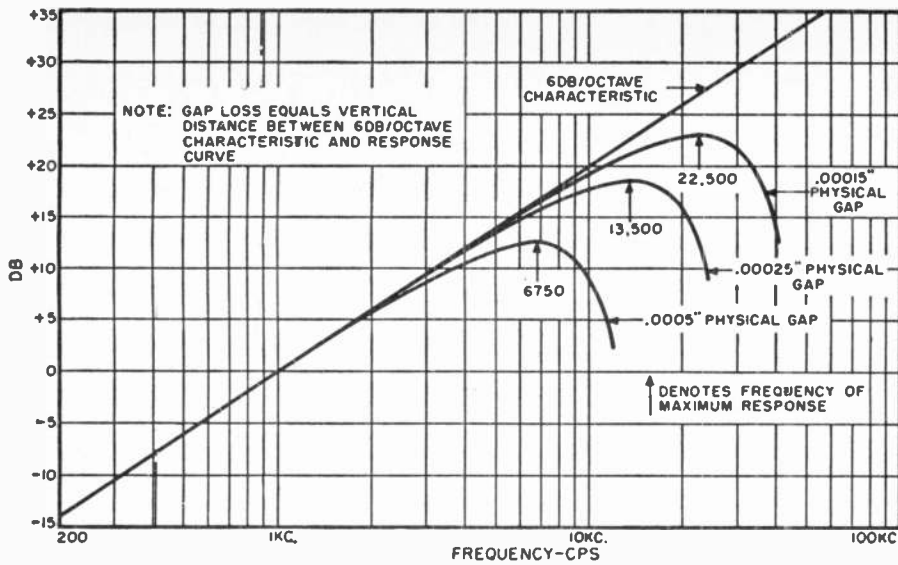

Fig. 2. Response of playback head at 7.5 ips to flat signals.

described inasmuch as these losses are a part of the total playback characteristic.

Promulgated in 1953 as the official standard for 15 ips tape recording, the NARTB playback curve has become an unofficial standard for 7.5 ips as well. This development may be ascribed to *AmpeX's* adoption of the NARTB curve (in essence) for 7.5 ips and to the widespread use of *AmpeX* equipment in the tape recording industry.

Fig. 1 shows the NARTB playback characteristic as well as *AmpeX's* slightly modified version of it. Record equalization must be such as to result in more or less flat response, with one important exception: To the extent that there are playback treble losses serious enough to require compensation, these losses must be equalized in playback. Fig. 1 does not include treble boost for compensating playback losses inasmuch as these vary from recorder to recorder. Playback treble losses are chiefly due to gap width of the playback head. The wider the gap, the greater the losses.

Losses at 7.5 ips due to gap width are indicated in Fig. 2 for three commercially available heads. Inasmuch

as tape heads have a 6 db per octave rising characteristic with frequency, gap loss equals the vertical distance between the 6 db per octave line and the head response to a flat recorded signal, as represented in Fig. 2. In the case of a very narrow gap, the loss may be small enough within the audio range so that no treble boost is considered necessary.

Returning to Fig. 1, it can be seen that the NARTB curve entails a relatively tremendous amount of bass boost, 36 db all told. There are two turnover frequencies. The principal one occurs at 3180 cycles, where gain is 3 db below minimum. The lower turnover frequency is at 50 cycles, where response is 3 db below maximum.

Non-NARTB Characteristic

Curve 1 in Fig. 3 shows the playback curve of a high-quality tape amplifier, one that was described in the December, 1956 issue of this magazine.¹ The curve is based on the values given in the schematic of the article, and has a lower turnover frequency of about 50 cycles and an upper one of about 700 cycles. As described in the article, the amplifier is used with

Fig. 3. NARTB curve and curve used in high quality amplifier.

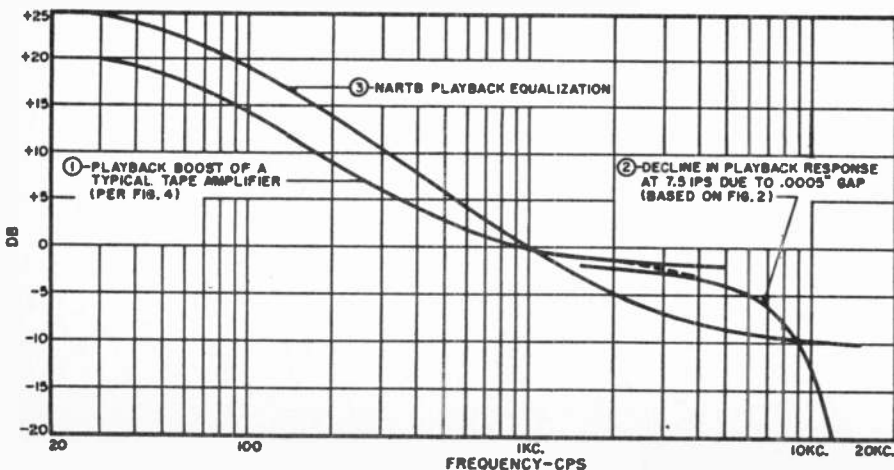

a .0005" head, resulting in a fall-off in playback response approximately as shown by Curve 2. Total playback response is therefore the sum of Curves 1 and 2. Comparing total response with the NARTB characteristic, it may readily be seen that equalization is deficient in bass and excessive in treble by 4 db or more over substantial portions of the audio spectrum.

Fig. 1 is not intended to be critical of a particular amplifier. Rather, it shows a typical situation. To remedy this situation, it is necessary to alter the values employed in the bass boost circuit and to provide for treble boost that will compensate the treble losses due to the head.

Shaping the Bass Boost

Fig. 4 shows, with a slight modification introduced for the sake of simplicity,² the playback boost circuit employed in the amplifier previously referred to. It is one of several variations of a popular and relatively simple circuit, which permits bass boost to be easily shaped with the desired degree of precision.

To understand how the circuit of Fig. 4 achieves bass boost and how this boost may be shaped, it is first necessary to reduce it to an equivalent circuit, as shown in Fig. 5. Fig. 5A shows that the input tube's plate resistance (r_p), load resistor (R_L), and following grid resistor (R_g) are effectively in parallel with each other and in series with equalization capacitor C and equalization resistor R to ground. C_1 of Fig. 4 has small enough reactance to be ignored. Fig. 5B simplifies the equivalent circuit, with R_1 being equal to r_p , R_L , and R_g in parallel.

At very high frequencies, where C has relatively little reactance, R_1 and R form a voltage divider. The gain remaining after voltage division constitutes what may be referred to as a shelf (see Fig. 1). As frequency declines, the reactance of C increases and the output leg of the voltage divider increases in relation to R_1 , so that output increases. At the frequency where the reactance of C equals R , response is 3 db above the shelf. This is the upper turnover frequency, f_s . In the case of the NARTB curve, f_s occurs at 3180 cycles (see Fig. 1). With further decline in frequency, the reactance of C and output continue to grow. However, when the reactance of C approaches R_1 in magnitude, the increase in output nears an end. At that frequency, f_1 , where the reactances of R_1 and C are equal, output is 3 db below maximum. For the NARTB curve, f_1 is 50 cycles.

Given the input tube's plate resistance, load resistor, and following grid

1. Johnson, Maurice: "A Professional Tape Recording Amplifier for Home Hi-Fi Systems."
2. In the original circuit, capacitor C was connected after coupling capacitor C_1 rather than directly to the plate of the input tube. Inasmuch as the two capacitors were in series as far as equalizer action was concerned, the value of C_1 had to be taken into account in calculating the appropriate value for C . With C connected directly to the plate, the value of C_1 may be ignored, simplifying matters.

resistor, the value of R_1 can easily be calculated, being the parallel value of these quantities. For the circuit of Fig. 4, R_1 is about 150,000 ohms. C is approximately determined by formula $C = 1/2\pi f_1 R_1$. If f_1 is to be 50 cycles according to the NARTB standard, then C is approximately .02 μ fd. R is determined by the formula $R = 1/2\pi f_2 C$. If f_2 is to be 3180 cycles per NARTB, R is about 2500 ohms. A variable resistor is often used for R so that the upper turnover frequency, which is of principal importance, may be obtained with the desired precision.

In some instances a triode input tube is used in place of a pentode. Triodes have much smaller plate resistance than pentodes, so that the resulting value of R_1 per the equivalent circuit of Fig. 5B is a good deal less. This will result in a larger value for C and a smaller one for R .

As previously stated, Fig. 4 is but one of several variations of a basic circuit. It has been shown that the plate resistance of the input tube plays a part in determining the lower turnover frequency. But plate resistance may vary from tube to tube of the same type, or it may change as the tube ages, thus altering the lower turnover frequency. This problem is more severe with a triode than a pentode because the triode, having a low value of plate resistance, is the principal factor in determining R_1 . To minimize the effect of the triode's plate resistance upon R_1 , the circuit of Fig. 6 is sometimes used, R_a (typically 100,000 ohms) being added. As shown in the equivalent circuit, R_a is effectively in series with the parallel combination of r_p and R_L ; R_g is in parallel with all the rest. Thus changes in r_p have relatively little effect.

The circuit of Fig. 6 has both a corollary advantage and disadvantage. The advantage is that playback treble boost may be obtained easily by bypassing R_a with a suitable capacitor, thus helping to compensate for head and other playback treble losses. The disadvantage is that the addition of R_a may result in high-frequency losses. One of the difficulties in using triodes for high-fidelity purposes is their relatively high input capacitance due to Miller effect. Input capacitance is a function of tube gain. In the circuit of Fig. 4, there is very little gain at high frequencies because of the loading effect of R and C ; that is, C is a virtual short circuit and R is only a few thousand ohms. In the circuit of Fig. 6, however, interposition of resistor R_a prevents the equalizer components from loading down the tube at high frequencies. Therefore gain remains high and so does input capacitance.

Also frequently used for bass boost is the feedback network shown in Fig. 7. This has the virtue of minimizing distortion at frequencies where feedback is appreciable (treble range). On the other hand, it is more difficult to obtain precise equalization with a feedback circuit because gain does not

vary inversely with feedback but varies inversely with the quantity $1 + AB$, where A is gain without feedback and B is percentage of output voltage feedback. To have a linear relationship between gain and feedback, it is necessary to start with a great deal of gain so that the factor AB is considerably greater (at least four times) than 1 throughout the range where equalization takes place. On the other hand, if there is too much feedback (too high a value of B) in order that AB should be at least 4, there is danger of overloading the output tube, with consequent distortion.

The circuit of Fig. 7 operates as follows: At very low frequencies (below 50 cycles), the shunt reactance of C is so great that feedback is limited to a very small value by R_1 , which is 620,000 ohms. As frequency increases, the reactance of C decreases, bypassing R_1 , increasing feedback, and decreasing gain. At 50 cycles, C 's reactance equals R_1 ; at this point feedback has increased 3 db and gain has dropped 3 db. With further increase in frequency, the reactance of C continues to drop, so that feedback rises and gain declines. When the reactance of C starts to become as small as R_a plus R_g , then feedback is essentially limited by these resistors; hence feedback approaches a halt and gain no longer drops as fast. C 's reactance equals R_a plus R_g at 3180 cycles, where gain is 3 db above minimum. In order to precisely control the upper turnover frequency, R_a should be variable.

Compensating Treble Losses

While gap width is the principal reason for playback head losses, hysteresis and eddy current losses in the head also produce a drop in treble response, although in a well-designed head the latter losses are minor, perhaps only one or two db at 15,000 cycles. Furthermore, there may be some treble losses due to capacitance of the cable between the playback head and the input tube and due to input capacitance of this tube. All these losses, to the extent that they exist, should be compensated in the playback amplifier so that response is reasonably flat to at least 10,000 cycles and possibly to 15,000 cycles. On the other hand, it is not necessary to maintain flat response to 15,000 cycles to completely satisfy the NARTB standard inasmuch as this standard permits response to be 4 db down at 15,000 cycles (and about 2 db down at 10,000 cycles).

Generally speaking, where the tape amplifier is well-designed and good heads are used, one can assume that playback treble losses due to cable capacitance, input tube capacitance, hysteresis, and eddy currents are minor. Therefore the principal task is to compensate gap width losses. The amount of compensation required for gaps of .0005", .00025", and .00015" is indicated in Fig. 2. In the case of a .0005" gap, the loss is 11 db at 10,000 cycles and 19 db at 12,000 cycles. The severity of the decline in response beyond 10,000

cycles makes it impractical to strive for flat playback response beyond this frequency when using a .0005" gap. It must be recognized that to the extent treble boost is used to elevate the audio signal, various forms of high-frequency noise are also accentuated.

Playback response flat or nearly flat to 15,000 cycles is quite feasible with a .00025" gap. At 15,000 cycles, response is down only 5 db, easy enough to compensate. In fact, *AmpeX* recorders, which use heads with a .00025"

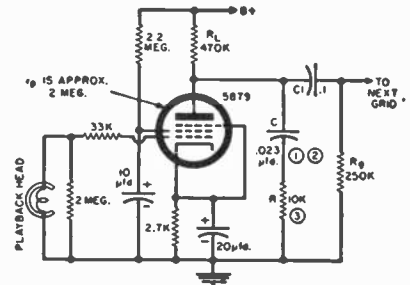

Fig. 4. Playback equalizer of amplifier.

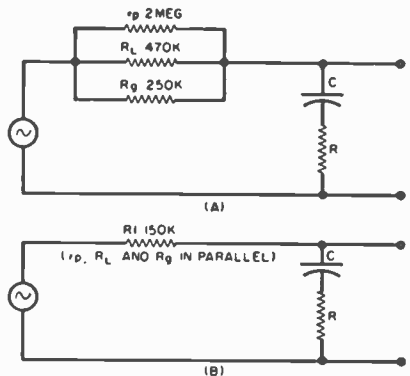
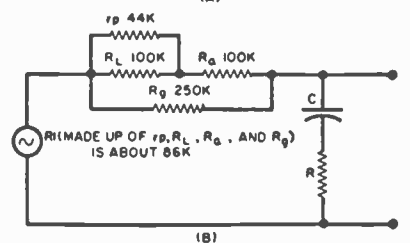
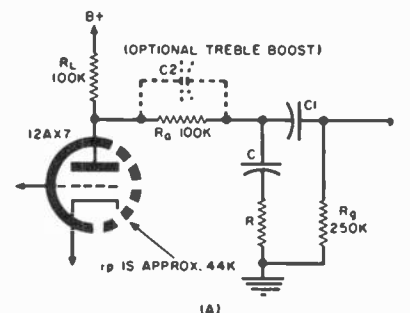

Fig. 5. Configurations for the equivalent circuits to that shown above in Fig. 4.

Fig. 6. Modified bass boost circuit to minimize effects of plate resistance change.



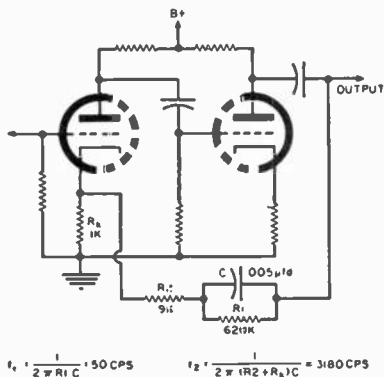

Fig. 7. Feedback bass boost circuit.

gap, do not even bother to use playback treble compensation in view of the trifling amount of boost needed to bring the recorders up to NARTB frequency specification. Instead, at 7.5 ips these machines depart slightly from NARTB principles by supplying something like one or two db extra treble boost *in record* so that over-all record-playback response is no more than 4 db down at 15,000 cycles, as stipulated by NARTB. In the case of the head with a .00015" gap, there is only a 2 db loss at 15,000 cycles, which eliminates the need for gap loss compensation.

The owner of a tape recorder who judges it necessary or desirable to provide playback treble boost in order to obtain adequate response on recorded tapes may assume that playback treble boost should approximately equal the losses indicated in Fig. 2, depending upon gap width of his particular playback head. If the gap is .00025" or narrower, he can omit playback treble boost, provided he is satisfied with response 4 db down at 15,000 cycles on his recorded tapes. A safer procedure, one that would show up not only gap losses but all other forms of playback treble loss, would be to check response when playing back a frequency tape recorded essentially according to the NARTB characteristic. An *Ampex* test tape would serve well in view of the extent to which the *Ampex* characteristic is used in commercially recorded tapes. In order for this procedure to yield a clear and accurate indication of treble losses, the playback amplifier should incorporate NARTB (or *Ampex*) bass boost. Furthermore, azimuth alignment must be precise in order to avoid confusion between treble losses due to azimuth misalignment and those due to other sources. Azimuth alignment tapes are available.

It is readily apparent from Fig. 2 that, if playback head gap losses are to be compensated, the required treble boost must have a very sharply rising characteristic. A steep slope can be obtained by several stages of RC boost, each stage yielding a maximum slope of 6 db per octave. A common procedure is to omit the usual large cathode bypass capacitor and use instead a suitable small value. Thus at low- and

mid-range frequencies there is current feedback and reduction in gain due to an essentially unbypassed cathode resistor, while at high frequencies the capacitor reactance becomes small enough to bypass the resistor, decreasing feedback and increasing gain. By repeating this procedure in two or more amplifier stages, a fairly sharp treble boost may be obtained. Of course, this procedure involves a loss of gain at low- and mid-frequencies, so that the playback amplifier must have sufficient reserve gain to permit this modification.

As previously discussed in connection with Fig. 6, treble boost can be obtained without any additional sacrifice in gain by placing a capacitor of suitable value across R_k . Value of the capacitor is determined by the formula $C_2 = 1/2\pi fR_k$, where f is the frequency at which it is desired that treble boost shall be 3 db up. Additional stages of treble boost are still needed to produce the required slope.

A sharply rising treble boost characteristic can be obtained in one stage by using LC components. An example is Fig. 8. The large cathode current feedback and reduces gain. This resistor is paralleled by LC in series. As LC approaches resonance, its impedance decreases rapidly in the manner of a tuned circuit, so that R_k is bypassed. As a result, gain rises sharply. The values shown in Fig. 8 produce a peak in response at 16,000 cycles, although a lower resonant frequency would be suitable for a .0005" head inasmuch as response much beyond 10,000 cycles is impractical for so wide a gap. Given the desired resonant frequency and given the value of L , the value of C is obtained by the formula $C = 1/(2\pi f)^2 L$. A TV width coil in the range of 20 to 50 mhy. is suitable for L . The amount of boost produced by the circuit of Fig. 8 depends upon the value of R_k . The larger its value, the greater the boost. The size of R_k should be experimentally determined and will ordinarily range between 5000 and 50,000 ohms.

Another basic method of producing a sharply rising characteristic is to resonate the playback head with a capacitor. The value of the capacitor will probably lie between .0001 and .001 μ fd., depending upon head inductance and the desired resonant frequency. Playback heads generally have an inductance ranging between .25 and 1 henry. Assume, for example, that the head has an inductance of .5 henry and it is desired to resonate the head at 15,000 cycles. Then a capacitor of .00022 μ fd. is indicated by the formula $C = 1/(2\pi f)^2 L$. Of course there is no guarantee that the rise in response due to resonating the head will exactly match the gap loss. Often, however, there is enough of a correspondence to make this a worthwhile procedure, especially since it is a simple and inexpensive method and costs nothing in terms of gain. The resonating capacitor can be switched in during

playback only, or it can be left in permanently, so that it also produces treble boost in the record mode. Correspondingly, the record treble boost circuit would have to supply that much less pre-emphasis.

Given a tape amplifier that meets NARTB qualifications for playback—NARTB (or *Ampex*) bass boost as shown in Fig. 1 and compensation, if needed, for gap and other treble losses—it remains for the amplifier to supply record equalization that produces over-all flat response. It is not the purpose of this article to discuss the modifications required to produce such response. It may be said here, however, that treble boost circuits along the lines of those indicated in Figs. 6 and 8 are commonly employed; also, the use of small cathode bypass capacitors is frequent. The behavior of these circuits has been explained, and the reader wishing to do so can experiment with various component values to achieve the desired record equalization.

It should be pointed out that use of the NARTB characteristic in playback involves putting a relatively large amount of signal on the tape at high frequencies in record. This necessitates substantial amounts of treble boost if bias current is to be great enough to hold distortion to an acceptably low value; the more bias, the larger are the treble losses in record. A considerable amount of record treble boost, in turn, requires that the tape amplifier have sufficient reserve gain from which this boost can be drawn. If the amplifier is quite marginal in the sense that it has very little record gain to spare, it is fruitless to attempt to modify the amplifier so that it conforms to NARTB requirements. Most tape amplifiers, however, have an appreciable amount of reserve gain, so that it is practical to modify them in accordance with NARTB principles.

If the owner does not wish to tamper with the record equalization of his machine, yet desires accurate playback of commercially recorded tapes, another course is open to him. By means of a switch, the proper capacitor and resistor values for NARTB playback equalization can be inserted into the playback equalizer whenever desired.

Fig. 8. RLC treble boost circuit.

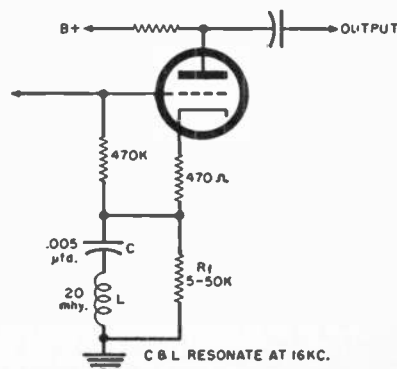

*take it from a
hi-fi dealer—*

KNOW YOUR EQUIPMENT BEFORE YOU BUY!

Any dealer will confirm it. The hi-fi fan who makes the smartest buy usually knows his equipment, prices and specifications before he even steps into a store.

Where can you get such helpful information? It's available in the HI-FI DIRECTORY & BUYERS' GUIDE—the world's only complete reference for the high fidelity fan. Virtually every piece of hi-fi equipment manufactured is listed in the 1959 HI-FI DIRECTORY & BUYERS' GUIDE—complete with prices, specifications and illustrations.

This year's edition is bigger than ever—180 pages of useful information, arranged conveniently into sections on tuners, amplifiers and preamps, record players, changers, turntables, tone arms, cartridges, tape recorders, loudspeakers and systems, enclosures and equipment cabinets.

In addition to listings, the HI-FI DIRECTORY & BUYERS' GUIDE contains helpful articles and features on what to look for, how to buy, advantages and disadvantages of different models, how to judge quality and recognize a bargain. Whether you're a hi-fi beginner or a veteran audiophile, this publication is worth its weight in diamond styli to you. Yet it costs only \$1.00. Be sure to pick up a copy at your favorite newsstand, hi-fi salon or electronics parts dealer.

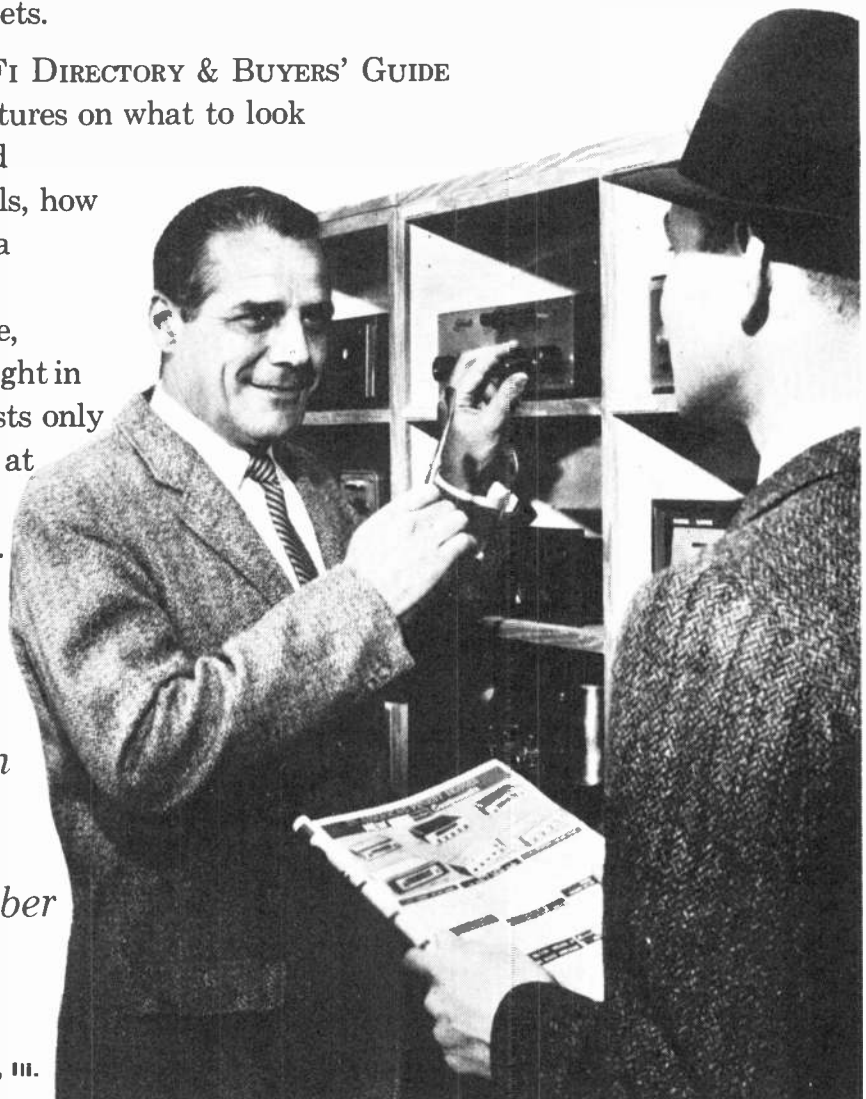

BUYERS' GUIDE
HI-FI
DIRECTORY
1959

Conductor goes to maestro and STEREO is
due to class and left wheel



Latest models and prices—enclosures—record changers and
turntables—tonearms—speaker systems—bits

*on
sale
in
October*



Ziff-Davis Publishing Co.,

434 S. Wabash Ave., Chicago 5, Ill.

Measuring Tape Recorder Wow and Flutter

A typical equipment setup for the wow and flutter measurements described here.

By
RICHARD GRAHAM

*Simple method checks changes in recorded pitch
by means of an oscilloscope and audio generator.*

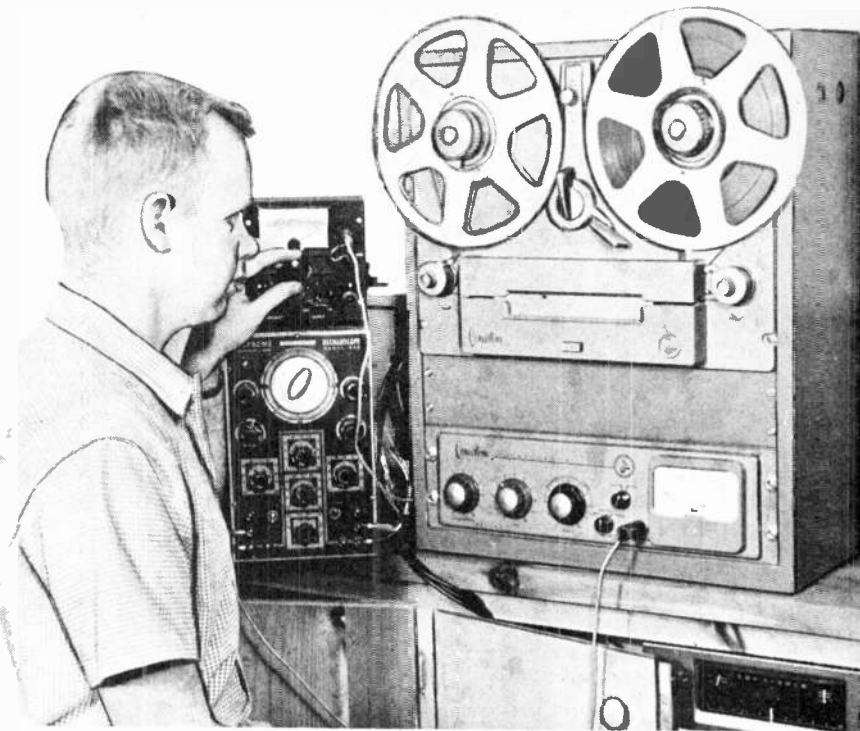

JUST how bad is the wow and flutter in your tape recorder? Probably ninety-nine out of a hundred of us couldn't answer this question, except to refer to the manufacturer's original claim for the machine. At the moment, this figure can probably serve only as the low limit for the wow and flutter figure for your machine. The fact of the matter is that it probably is worse now than when the machine was factory fresh. This is only natural. Everything, including ourselves, wears out or needs an occasional adjustment. But the important thing here is that if you have or can borrow an oscilloscope and an audio signal generator, then you can determine the wow and flutter figure of your tape recorder.

Naturally, the method to be described isn't quite as convenient as using a commercially built wow meter but, on the other hand, wow and flutter measurements aren't taken every day, so a little inconvenience can be tolerated. The only other alternative is to take your machine to a repair shop having a wow meter, for which a fee can be justly charged.

The wow and flutter figure represents a good "figure of merit" of the mechanical condition of your machine. It will readily indicate any dirt or flats on the driving capstan, any looseness in driving belts or capstan tension. Similarly, any varying drag in the take-up or spooling motors will be reflected in a poor reading.

This speed variation can usually be corrected by cleaning the vital parts or an adjustment. However these speed variations, which result in wow and flutter, can increase in magnitude so slowly, that the increasing wow is not obvious. When it does become obvious it will really be bad.

Wow and flutter are two words used to describe the same effect. Basically it is a frequency deviation (as compared to the original recorded frequency) expressed as a percentage of the original recorded frequency. In other words wow is:

$$\text{Per-cent wow \& flutter} = \frac{100 \times \text{freq. deviation of a recorded tone}}{\text{Average recorded frequency}}$$

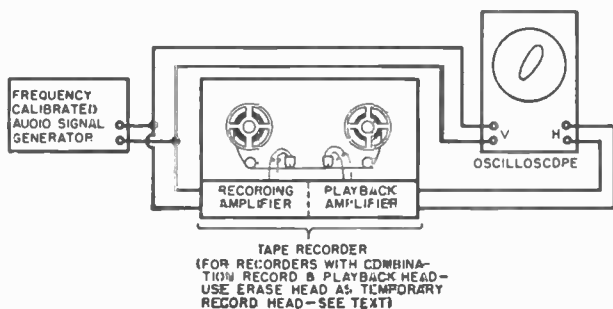

Fig. 1. Here is a block diagram of the equipment setup that is employed for the wow and flutter measurements described.

These frequency variations are quite obvious, too—even in the best recorders—including those with a price tag of around \$1000. For doubters, it's only necessary to record a 1000 or 2000 cps note from an audio signal generator and immediately compare the signal from the signal generator with that from the recorded signal on tape. It will be pretty obvious during a listening A-B test that the frequency being played back has some wiggles that the original didn't have.

While wow and flutter have the same effect in a recorder, they are defined somewhat differently. In general, wow is a frequency deviation which occurs at a rate of .1 to 20 cps, while flutter is at a rate of 20 to 200 cps. In tape recorder performance characteristic data, they are classified together with no differentiation between them.

The method of wow and flutter measurement to be described is based on the fact that in a machine with wow (practically all of them) there is a frequency difference between the signal being recorded and the signal being simultaneously played back. See block diagram of Fig. 1. This method infers, then, that the machine must have separate playback and recording heads. This is only partially true. Separate playback and record heads are required, but since waveform is not important in this test, the erase head can be made to serve as the recording head for the purposes of this test. This will be the case in the majority of recorders since only some home-type and professional machines feature separate recording and playback heads.

To make the check, simply disconnect at least one lead from the erase head in the recorder and connect the audio signal generator across the two

erase-head terminals. For the remainder of the discussion, the erase head will be considered the recording head. The oscilloscope waveforms to be observed later will be somewhat distorted when using the erase head as the recording head because of the lack of high-frequency bias, but the distorted waveshapes do not have any effect on the test or its accuracy.

Now suppose we proceed to record a 750 cps tone from the audio signal generator shown in Fig. 1. If the tape speed is 7.5 inches per second, then each inch of recorded tape will have 100 cycles recorded on it. For the purposes of our discussion, let us suppose the record head and the playback head are two inches apart. Then if we were recording the 750 cycle tone, as before, at 7.5 ips, then the tape between the two heads will have exactly 200 cycles recorded on it.

Now let's turn our attention to the scope pattern which can be observed as the audio signal is being recorded. Fig. 1 shows that the signal being recorded is also applied to the vertical amplifier of the oscilloscope while the output of the recorder from the playback head is applied to the horizontal amplifiers of the oscilloscope. This pattern will be a familiar Lissajous pattern illustrating a phase shift of anywhere between 0 and 180 degrees. Fig. 2 illustrates the typical patterns which might be observed. The pattern you will get in this hypothetical tape recorder will depend on the frequency being recorded and the distance between heads. At low frequencies this pattern will be essentially stationary. Now as the frequency is increased, a characteristic of the waveform will be noted which is the basis of the wow test. The pattern will "rock" back and forth, in other words, the phase of the signal being recorded is not remaining the same as the signal being played back. This phase change actually indicates an instantaneous frequency change between the input and output. For example, a shifting phase shift pattern of 90 degrees means that there is, at times, one-quarter cycle more actually recorded on the tape between the heads as compared to the average number of cycles.

Now let's get back to the performance of our hypothetical tape recorder. Suppose at the recorded frequency of 750 cps, the pattern observed on the oscilloscope rocked from a sloped line in one direction, to a circle, then to a closed line in the other direction, and then back again. This would mean that a total phase change of 180 degrees has occurred between the input and output signals. Since there are 360 degrees in one cycle, this would mean that there is 180/360 or 1/2 cycle difference between the average number of cycles recorded on the tape between the heads and the maximum and minimum number of cycles recorded in the same distance, due to tape speed variations. This statement should be studied a bit if you wish

Fig. 2. Typical patterns to be expected with the setup of Fig. 1. Patterns will be stationary at low frequency, but will shift as generator frequency is raised.

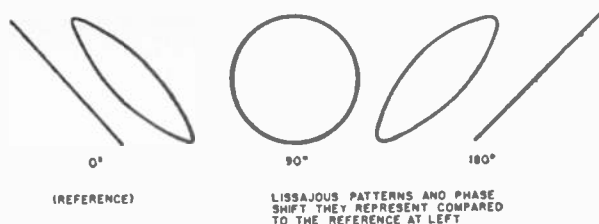

to catch the real meaning of what you are doing when you perform this test. Since our hypothetical tape recorder had 200 cycles of the 750 cycle tone recorded on the two inches of tape between the heads, it follows that our tape speed variation was 1/2 cycle out of 200 or .25%. This is about par for most tape recorders. Expressed as a formula, this becomes . . .

$$\text{Per-cent wow} = \frac{100 \times \text{Tape speed, ips}}{4 \times \text{recorded freq.} \times \text{distance, inches, between heads}}$$

This formula is valid only when the pattern "rocks" as described previously and it gives the total wow and flutter present in the machine. Many recorder manufacturers prefer to give the r.m.s. wow figures for their machines, which is simply the total wow figure just calculated multiplied by .707.

A triple exposure of the scope during a wow measurement. The audio signal generator was stopped when a circle pattern was formed. The circle shifted plus and minus 90 degrees to form the two lines as shown. This audio generator frequency was noted and used in the wow formula.

When making the test be sure to observe the rocking action carefully. Failure to observe the occasional, but sudden, change will result in a very pleasant but untrue wow figure. Commercial wow meters integrate or sum up these occasional wows and indicate their presence on a meter. We must do this visually. However the method is so basic, that it can't fail to give accurate results if the test is performed with reasonable care.

Of course, the accuracy of the test depends on the accuracy of the numbers used in the formula, which depends on the accuracy of the measurement of the distance between the recording and playback heads. The results also depend on the accuracy of the calibration of the audio oscillator. The amount of error in these measurements will be reflected directly as an error in the wow and flutter figure just determined. -30-

Measuring the exact distance between the record head and the playback head. An accurate measurement should be made between the gaps in the heads. Any error in the measurement will show up as error of similar magnitude in result obtained.

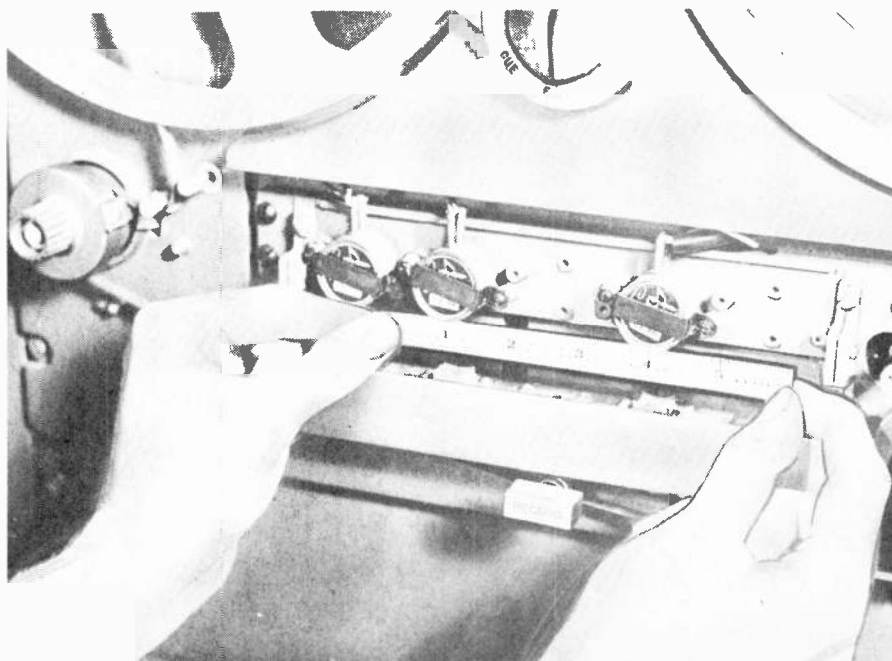
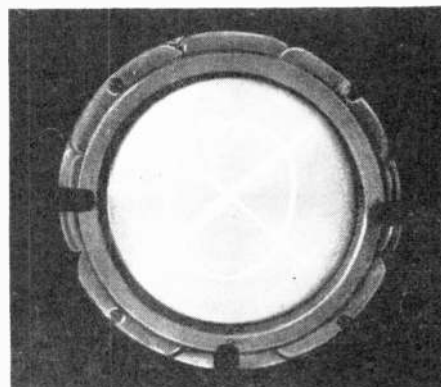

Microphones for Tape Recorders

By **NORMAN H. CROWHURST**

Tina Robin, recording star →
for Coral Records, makes a
tape on the Tandberg recorder.



A HOME tape recorder is probably one of the most versatile possessions one can have, both in providing entertainment or in doing many useful jobs. You may have bought it in the first place for the purpose of recording your own voice and that of your friends but it has many other uses. For example, this article is being dictated into a home recorder. The author also uses the same recorder quite frequently for "writing" letters to friends in different parts of the world.

Real fun can be had with a tape recorder at a party, either playing deliberate games built around the tape recorder or just leaving the recorder on to pick up random conversation. If you have some friends or members of the family who are musical, making recordings of their efforts can be an extremely interesting hobby. Recording junior's school graduation or, when friends or relatives get married, making a recording of the wedding ceremony as a present to the newlyweds will be much appreciated, both now and in the years to come.

The recording of local concerts, musical groups, or other functions, is something that will always be appreciated in the community. If you are a home movie fan, another thing you can do with your tape recorder is to make a recorded commentary as a "sound track" for your movies. This does not need accurate synchronization as a rule, if the commentary merely relates the events or background of the scenes being seen at the moment.

There are applications, such as recording programs off the air, which do

*Get more fun and greater use from your present
tape recorder by adding a better microphone.*

not require a microphone. But notice that all the uses we've just mentioned require the use of a microphone and proper technique in the use of the microphone is necessary if you are to get the maximum enjoyment from your home recorder.

All home recorders come with a small microphone, usually intended for close speaking and giving quite *recognizable* quality in the reproduction. With careful use this microphone can be made quite effective for several of the purposes just outlined. Recording people's voices, letter-writing, and many of the things you would want at a party, for example, can all make use

of the microphone that comes with the machine.

In a pinch it can probably be used for some of the other jobs too, but better results can be obtained by using a better microphone. The one that comes with the recorder is usually a low-cost unit, so the recorder can be sold at a competitive price. The recorder manufacturer does not expect only that microphone to be used. That is just "to get you started" and he knows once you have the recorder you will find it such an absorbing hobby you will

Electro-Voice Model →
el 667 dynamic mike.

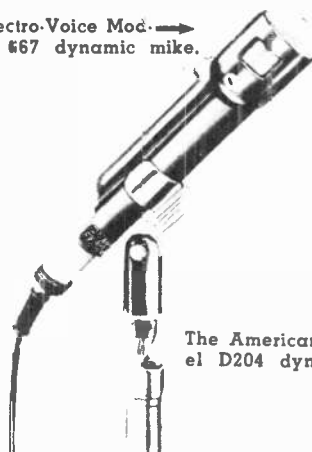

The Shure Model →
330 ribbon microphone.

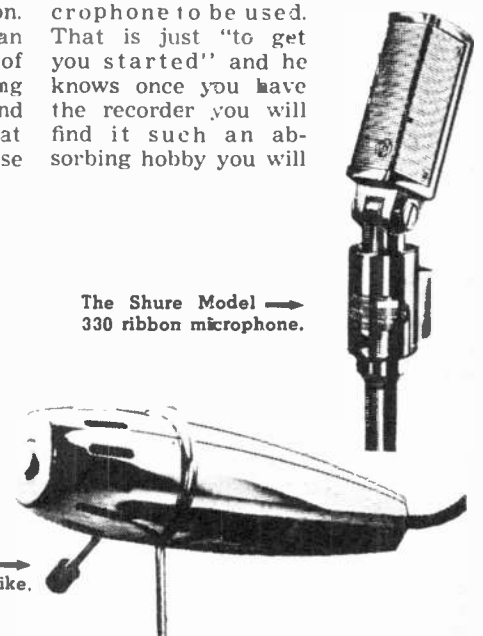

The American Model →
el D204 dynamic mike.

Altec Lansing Model 680A dynamic mike.



The Fen-tone "Rib-bonette" microphone.



Astatic Model M-332 crystal microphone.

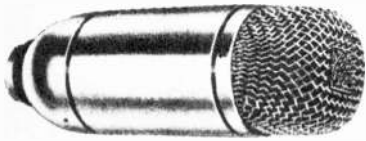
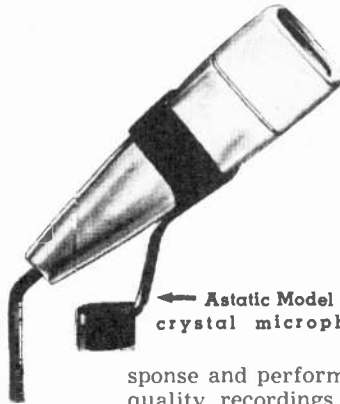

Telefunken Model ELA M410 dynamic mike.

probably go for a better microphone.

Home recorders do not come with better microphones for two reasons: (1) The extra cost would add to the price tag and make the buy uncompetitive. (2) Choice of a better microphone should be up to the user, for reasons we shall presently see. And when you buy a better microphone, the one you already have is not necessarily a dead loss. It still has its uses.

Usually the type of microphone that comes with the recorder has been chosen because of its good intelligibility. It may still be the best unit to use for letter writing, dictating, or recording people's voices close to. The better microphones are usually of more use in picking up at longer range, because it is in this sphere that the low-cost microphone does not perform so well (because of its usually irregular peaky response that causes it to be frequency selective in reverberation pick-up). They may also have improved re-

sponse and performance so that better quality recordings may be made. So you want to know how to choose a satisfactory microphone for the other jobs that the original microphone does not serve so well.

Mounting the Microphone

Probably the first thing to decide is the kind of mounting your microphone should have. Most professional microphones, and many of the lower cost ones suitable for the home user, come as a separate "head" that may be attached to any kind of mounting, such as a handle to hold in the hand, a table stand, desk stand, or floor stand, according to the use desired. Other microphones come complete with their mounting, such as a desk stand, a table stand, a hand mounting, or the lavalier type microphone that can be hung around the neck and worn on the chest, or complete with a floor stand.

Some come with a complete interchangeable arrangement, adaptable to two or three of these methods. The best thing to do is to figure out how many ways you want to use the microphone based on where you plan to use it and then buy one that will serve all of these purposes reasonably well. It can be very exasperating to take the tape recorder and microphone along with you somewhere to make a recording and then find you have nowhere to put

the microphone, no convenient "sky hooks" to hang it on!

Mike Technique

The microphone that comes with the recorder usually works best when a person speaks quite closely into it, at a distance of not more than 6 inches, for example. If you put the microphone down in a room somewhere, on a table or stand, and try to pick up sounds from all over the room, you will find you need to turn the volume of the recorder all the way up. Then sounds from all over the room may be audible when you play the tape back at the same level.

There may also be considerable hum because the recorder does not work as well when all the gain is used for both record and playback. It really means, too, that you are not getting enough onto the tape, to get background noise and hum reasonably below the sounds to which you want to listen.

But there is another thing you will probably notice if you use the microphone that came with the recorder in this way. The sounds all over the room are accompanied by a lot of echo that you don't notice listening to the sound in the ordinary way. This is because the listening faculty in our brain is able, by the use of our two ears, to differentiate the sounds picked up, and "listen" specifically to sounds you want to hear while rejecting others.

This means that, in normal listening, we subconsciously reject the reverberation of the room, the echo around the walls, and act as if it were not there. We can only do this because of our two-eared listening faculty that enables the brain to differentiate between the original sound we want to hear and its echo after having traveled around the room.

No microphone can discriminate in this way. It picks up the original sound together with its echo and, when recorded together on the tape, our listening faculty has lost the capability of separating. This is because, when played back, both groups of sound come out of the same loudspeaker to-

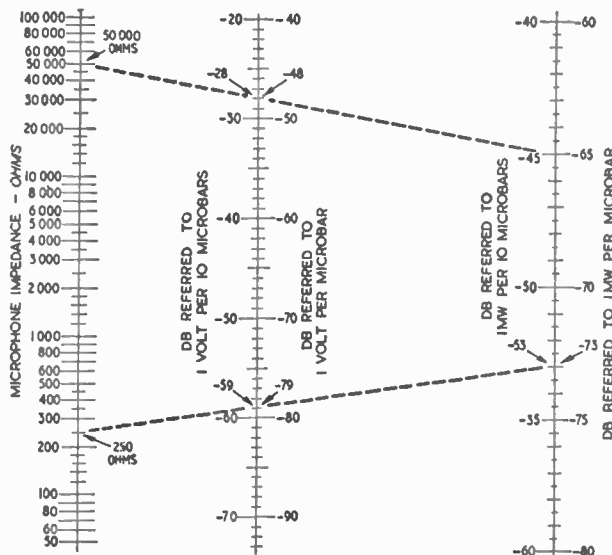

Fig. 1. Here is a nomogram that can be used to provide a quick translation of microphone sensitivity figures from one reference to another. Examples showing the use of this nomogram are given in the text.

gether. The original sound no longer comes directly from the voices of the people, or the musical instruments, or whatever it may be, while the reverberation comes from different walls of the room. All of it comes from the loudspeaker.

This is why we need some "microphone technique" to make the best use of the sound in recording. We need to get a realistic impression which requires that we pick up a "balanced" mixture of sound, so it plays back as near as possible a resemblance of the original sound. To do this with many microphones we either have to speak more closely to the microphone or have the microphone closer to the source of sound, the musical instrument or whatever it is.

The alternative is to use a microphone with a directional characteristic that "listens" more in the direction of the sound we want to pick up than in the various directions from which the echo may come.

Frequency Response

There is another difference between the low-cost microphone that came with the recorder and the high-quality one you should use for making recordings of music, or even other kinds of sound, where the microphone is at a greater distance from the source of sound. This is in the frequency characteristic of the microphone. For the small close-talking microphones, the design is usually made somewhat "peaky" or with resonances.

Skillful design in this way can give speech a "crisp" reproduction that makes it rather pleasant to listen to and gives a satisfactory and recognizable characterization of the person's voice. When the same microphone is used at a greater distance, with more amplification, the resonance of the microphone interacts with the echo from the room to produce a most unpleasant effect. That added crispness and a pleasant tone for picking up voice close to, now produces a hollow ringing sound to the echo components that are recorded along with the sounds you really want to hear.

To avoid this, the higher quality microphones have a much smoother frequency response and avoid the peaky method of gaining sensitivity as well as providing some discrimination in what they pick up.

Sensitivity and Impedance

There are two more important characteristics you need to know in buying a microphone to use with your tape recorder. These are its sensitivity and its impedance. Microphones differ widely in the sensitivity, that is, the amount of electrical output they provide for a given sound input. A less sensitive microphone may not give sufficient electrical output to work satisfactorily with your recorder.

The other thing—impedance—has to be right in order to make proper use of the electrical output that the microphone gives. If your recorder is de-

The Ronette → crystal mike.



The Electro-Sonic Type MC 4 dynamic mike.



Turner Model 142 dynamic microphone. →

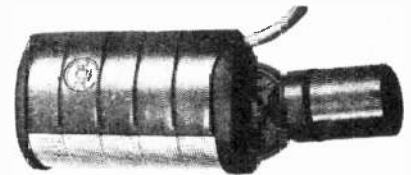
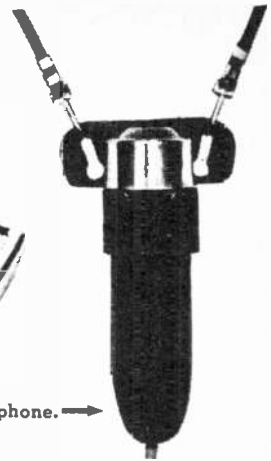

RCA Type SK-45B dynamic microphone.

signed to work with a high-impedance microphone, which is the usual arrangement, a low-impedance microphone will be almost "dead," even though it is sensitive enough with the right recorder input connections. If your recorder comes with a low-impedance input then a low-impedance microphone would be satisfactory.

Low-impedance microphones are used for professional work because they enable longer leads to be used between the microphone and the amplifier or recorder than are possible with high-impedance microphones. But for home recording use, the distance between the microphone and the recorder can usually be kept to not more than, say, 10 or 12 feet which is satisfactory for many high-impedance microphone applications.

Let's see what difference in sensitivity can mean. The standard microphone sensitivity, used for broadcasting purposes, gives an output rated at -55 db. This can mean two things according to whether the microphone is low or high impedance. For a high-impedance microphone -55 db means the output voltage for a sound pressure of 1 microbar is -55 db (about 2 mv.) relative to 1 volt electrical output.

A sound level of 1 microbar is quite a small sound—nothing like close-talk-

ing, so some manufacturers will list instead the output level for 10 microbars. If the same microphone, rated at -55 db for 1 microbar, is rated for 10 microbars, the rating becomes -35 db.

For a low-impedance microphone, the reference, instead of being 1 volt for a microbar of sound, is 1 milliwatt for 10 microbars. This is almost universal and the level corresponding to a sensitivity of -55 db, after an appropriate input transformer has been used in the recorder, comes out pretty much the same as -55 db referred to 1 volt per microbar from the high-impedance microphone.

The important thing in comparing sensitivity is to make sure of the reference level. A specification which merely says that the microphone has a sensitivity of -43 db means nothing unless you can find somewhere what the reference level is. Even then, of course, the use of so many different reference levels can make things quite

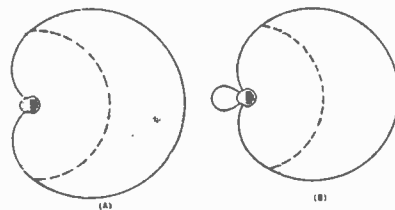

Fig. 2. Cardioid (A) and super-cardioid (B) directivity and useful area (shown shaded).

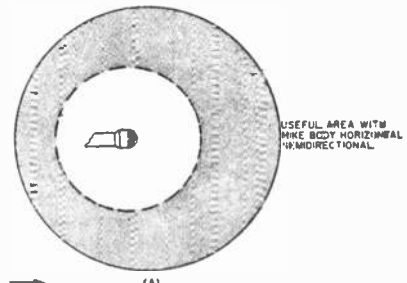

Fig. 3. Directivity, useful area (shaded) → of omnidirectional or semidirectional mikes.

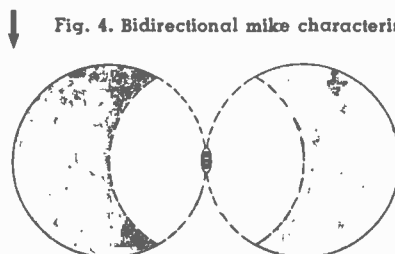
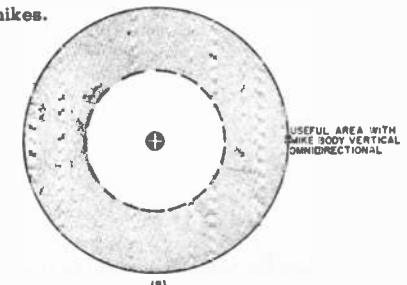

Fig. 4. Bidirectional mike characteristics.



USEFUL AREA WITH MIKE BODY VERTICAL BIDI-DIRECTIONAL

confusing. So to aid in making transfers from one method of reference to another, the chart of Fig. 1 can be a great help.

If a low-impedance microphone is rated in reference to 1 volt per microbar (as some are), its output with reference to 1 milliwatt per 10 microbars can be obtained by aligning its impedance on the left scale with the volt-per-microbar reading on the center scale and reading off the milliwatts-per-10-microbar rating on the right scale.

When looking for a new microphone you will need one at least as sensitive as the one that came with the recorder or else you will need a preamplifier to get sufficient amplification for the long distance pickup you intend to use with the better microphone. (*Editor's Note: Most home recorders require microphone sensitivities of -55 db or better in order that hum does not become a problem. With professional-type recorders a less sensitive microphone, -60 db or better, may usually be used.*) The first thing to do is to find out the sensitivity of the microphone you already have. This you can do by finding out whose microphone it is and then looking it up in the maker's catalogue.

You may find the microphone has a sensitivity of about -53 db (some even have a sensitivity as high as -45 db). If you have one of these high-sensitivity microphones (usually crystal), the only way to get better performance will be to use a preamplifier with a somewhat lower-sensitivity, long-range microphone. The best suggestion here is a small microphone preamplifier, transistor operated. A few of these have already become available and it is expected in the near future that many more of this type of preamplifier will appear on the market.

The transistor type is particularly good because it can be battery-operated. The drain on the battery is very low and the battery will last a long time. It is easy to make these preamplifiers hum free and of good, low distortion. Consequently transistorized

microphone preamplifiers are simple and inexpensive items to manufacture.

But once again you will need to make sure the input and output impedance are suitable for the microphone and the recorder input respectively. As a good many lower priced microphones come either in alternative impedance ratings or with an adjustment to make the same unit adaptable to both, this would be no problem as long as you make sure you have the right impedance.

Dynamic Types

Microphones are usually typed by the kind of transducer element—the thing that converts sound waves into electrical currents—that the microphone uses. A dynamic microphone uses a moving coil and is like a moving coil loudspeaker, only very much smaller. It has a low-impedance basic element which may be stepped up by means of a built-in transformer. The simplest type of dynamic microphone has what is known as an omnidirectional response—it picks up sounds coming from all directions almost uniformly, as shown in Fig. 3.

A good dynamic microphone, even of relatively low cost, has a fairly smooth frequency response and is better than the average microphone that comes with the tape recorder. From this viewpoint, however, because of its usually being omnidirectional, the sounds should never be more than about two feet away from the microphone otherwise it will tend to exaggerate echo effects from the room.

A small musical group could use one of these microphones by having the musicians arranged around the microphone so that all of them are fairly close to it. This is an unconventional arrangement for an orchestral group, but one that probably your friends may be prepared to adopt as a compromise in the interest of getting a good quality recording.

Dynamic microphones are also made in cardioid and other directional patterns. A cardioid response picks up

principally from the front, with a fairly wide "fringe" at the sides, represented by the pattern of Fig. 2A. Some directional microphones have a super- or ultra-cardioid pattern in which the compensation is re-adjusted so as to get a narrower frontal response, as shown in Fig. 2B.

These pickup patterns are more useful for most work where you do not want to have the microphone too close to the source of sound—the musical group or the people speaking. Just point the microphone in their general direction and this will automatically reduce the amount of pickup from other directions.

Crystal and Ceramic Types

Crystal and ceramic type microphones always come in high impedance only. So, if your recorder has only a low impedance input, do not consider this type. However, as most home recorders do have high-impedance inputs, crystal or ceramic microphones can be employed. Their response is not quite as uniform, as a rule, as the dynamic type, but a good crystal or ceramic type microphone can give very good results in combination with a home tape recorder and because of their inherently higher sensitivity any necessity for a preamplifier can often be avoided.

Crystal microphones have a higher sensitivity than the same model using ceramic, but for this loss in sensitivity with the newer type (about 5 to 8 db difference) ceramics can be designed with better response than crystals, and also ceramics are not so susceptible to excessive humidity and temperature extremes as are most crystals. Otherwise their properties are very similar.

Some of these microphones are produced with a cardioid response, which enables them to be directional and give the advantage of this particular characteristic. The cardioid construction with a crystal or ceramic device loses some of its inherent sensitivity, but a unit with "variable-D," or what the experts call constant-phase difference,

Table 1. Summary of a number of important comparative characteristics of the general types of microphones discussed.

TYPE	PRICE RANGE	DIRECTIONALITY	SENSITIVITY	IMPEDANCE	FREQUENCY		APPLICATION
					RANGE	SMOOTHNESS	
Dynamic	Low-medium	Omni- or semi-	Medium-high	Any	Fair	Peaky	General purpose, medium quality
	Medium	Omni- or semi-	Medium	Any	Good	Good	General purpose, better quality
	Medium	Cardioid	Low-medium	Any	Good	Good	General purpose, more amplification needed
	High	Omni- or cardioid	Uses associated preamp		Excellent	Excellent	Broadcast, general purpose, high-level output
Crystal or Ceramic (see text)	Low	Omni- or semi-	Very high	High	Fair	Peaky	Voice and announcements
	Medium	Omni- or semi-	Medium-high	High	Good	Fair	General purpose, lower cost
	Medium	Cardioid	Medium	High	Good	Fair	General purpose, medium quality
Condenser	Expensive	Omni- or semi-	Uses a built-in preamplifier		Excellent	Excellent	Professional top quality, all-purpose, needs polarizing
Ribbon	Medium	Bidirectional	Low-medium	Any	Excellent	Excellent	High quality music and dialogue
	High	Cardioid	Low	Any	Excellent	Excellent	High quality music and dialogue
Magnetic	Very low	Omni- or semi-	High	High	Fair	Peaky	Voice and announcements
Carbon	Very low	Omni- or semi-	Very high	Low	Limited	Peaky	Mobile announcements—needs polarizing

achieves a sensitivity in the normal range. For some tape recorders these mikes will require a preamplifier.

Magnetic and Carbon Mikes

Controlled reluctance or magnetic microphones come pretty much in the same category as the lower cost crystal microphones and are used almost interchangeably with the low-cost microphones that come with the recorder. Their principal usefulness is for close talking as we have already mentioned. Carbon microphones, which are generally the least expensive type, probably have the lowest fidelity of response and may be troubled with carbon "hiss" or "packing." For this reason this type is not generally used as a recording microphone despite the fact that its output sensitivity is the highest of all the types.

Condenser Types

Condenser microphones fall into the "high-cost" bracket and have a performance that is usually much better than warranted with a home recorder. After all, there is no point in buying a very expensive microphone that produces a response the recorder will not record unless, of course, you are prepared to spend a lot more money and go out and buy a professional tape recorder. While expense of this kind will produce professional quality results, most home users will consider it hardly worthwhile, because results obtained with much less expensive equipment can be quite good. The condenser microphone is basically a high-impedance device that requires a special matching preamplifier that delivers the polarizing voltage needed for operation.

Ribbon Microphones

The ribbon type microphone uses a piece of foil between a magnet gap instead of a complete circular coil as in the moving coil. As such, it is basically a very low-impedance device having a low output sensitivity. The simple ribbon microphone has what is known as a bidirectional characteristic. It picks up back and front, but not on the sides (Fig. 4). The older ribbon microphones had a rather poor frequency response and, in addition, they were not very sensitive. But modern improved designs in ribbon microphones may have a sensitivity comparable to a good dynamic microphone along with a very smooth frequency response. Early ribbon microphones were quite fragile and required care in handling. In later types this problem has been largely overcome, although it is still not recommended that a ribbon be used outdoors without some sort of suitable wind protection.

The ribbon microphone requires a little more care in use, because one has to make sure that the sounds to be picked up are either in back or in front of the microphone, or they can be both. For example, a ribbon microphone can easily be used for picking up dialogue. Two people talking one to the other can stand a reasonable distance, as

Now. Convert to stereo for only \$26⁵⁰ plus amplifier!

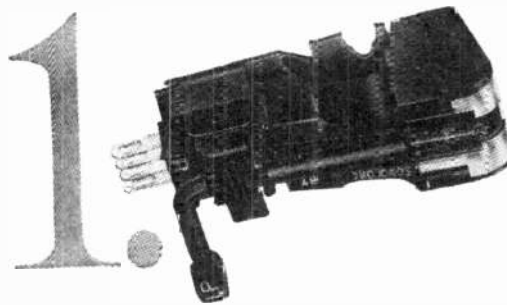

SPECIFICATIONS

Response Smooth from 20 to 12,000 cycles, gradual rolloff beyond
Output Voltage 0.3 volt
Compliance 2.0×10^6 cm./dyne
Recommended Load .. 1-5 megohms
Tracking Pressure ... 5-7 grams
Cartridge Weight ... 7.5 grams
Channel Isolation ... 20 decibels
Stylus Dual jewel tips, 0.7-mil microgroove and 3-mil 78 rpm.
Mounting Dimensions Standard 7/16 to 1/2 inch centers

Start with Sonotone BT ceramic cartridge to \$14⁵⁰ play both stereo and regular discs, costs only

- Plays all 4 speeds—does *not* obsolete your present equipment!
- Has Sonotone's unique, built-in vertical rumble suppressor so vital to stereo use! Doesn't need pre-amp!
- Famous Sonotone quality with top specifications!



Add a Sonotone WR-8 speaker—experts' choice for stereo, \$12⁰⁰ costs only

SPECIFICATIONS

Frequency Range ... 55 to 15,000 cycles
Resonant Frequency... 65 cycles
Power Input 8 watts
Impedance 8 ohms
Flux Density 12,000 gauss
Voice Coil Diameter... 1-inch

- Brilliant reproduction of full fidelity spectrum from 55 to 15,000 cycles!
- Perfect for second stereo speaker... gives amazing stereophonic fidelity!

New 8-inch speaker.

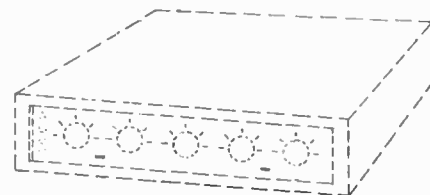

Choose the amplifier best for your set-up. You save on it, too, as Sonotone cartridge needs no extra rumble suppressor, no pre-amp!

Sonotone

CORP.

Electronic Applications Division, Dept. CNN-98

ELMSFORD, NEW YORK

save on hi-fi, ham radio,
other electronics devices by
using easy-to-
assemble
kits!



There's lots of fun and satisfaction—as well as big savings—in building electronics devices from kits. And now, for the first time, you can get a publication that tells you all you need to know about putting together your own hi-fi set, electronics laboratory, short-wave receiver, electronics accessories for car and boat, photoelectric eyes, pocket radios—dozens of practical, enjoyable electronics devices.

Whether you're an old hand at kit construction or have never used a soldering iron, you'll find this 160-page guide to **ELECTRONICS KITS** a windfall of valuable information. Edited by the Ziff-Davis Electronics Division, this new Annual contains 30 construction articles and 640 illustrations!

KIT BUILDERS GUIDE— Why build kits? What tools you should have. Contents of a typical kit.

FOR YOUR HI-FI— Assembling your kit-built hi-fi. Construction kits for typical hi-fi tuner. Integrated amplifier. Preamplifier. Power amplifier. Speaker enclosure. Turntable and pickup arm.

FOR YOUR SHOP— What type of test instruments should you buy? How to construct a vacuum tube voltmeter. A Multimeter. R.F. Generator. Condenser Checker. Audio Generator. TV Sweep Generator. Tube Tester.

KITS FOR THE HAM— How to build an All-Band Receiver. Variable Frequency Oscillator. Grid Dip Meter. CW Transmitter. Marker Generator. Modulator. CW and Phone Transmitter.

KITS FOR THE HOME— How to construct an Intercom System. Portable Radio. Burglar Alarm. Auto Ignition Analyzer. Games for Children.

PLUS: World's only complete directory of electronics kits, including specifications, prices and manufacturers' names.

This big, new builder's guide and directory to **ELECTRONICS KITS** goes on sale in October. Reserve your copy now at your favorite newsstand or radio parts store—only \$1.00.



ZIFF-DAVIS PUBLISHING CO. 434 S. Wabash Ave., Chicago 5, Ill.

much as four feet or so, apart and have the microphone between them. Provided you know what you are doing, this can be a more comfortable arrangement than using a unidirectional or cardioid microphone, where the two people speaking have to be much closer to one another, or else each has to step up to the microphone when he says something.

For musical work, too, the ribbon can be useful although it is usually on the expensive side. Arranging a few of the instrumentalists on each side (or rather back and front) of the microphone and keeping people away from the blank sides will accommodate more people in a group than some other methods. If you have a wind instrument, such as a cornet, that makes much more sound than the other instruments, a ribbon can be useful in toning this down, by having the cornet player almost on the "edge" position of the microphone. There are also some cardioid and other directional pattern microphones using a ribbon-type transducer, but their sensitivity is below that of "straight" ribbons.

There was a time when a microphone had to be big to be good—one might say, any good. But to achieve smooth response, particularly at the high frequencies, a microphone needs to be *small*. This is why the smaller modern dynamics and ribbons are usually so superior. But for the home recorder they are also less sensitive, so if you seek quality this good, you will probably need a preamplifier. Your problem is one of evaluating your needs to see if the expense is justified.

Most professional microphones come with an adapter for fitting to any particular type of stand that may be needed at the moment and also with a vibration shock mount that prevents the microphone from picking up vibration due to people walking across the floor and that kind of thing. This usually adds \$50 or so to the price of the microphone and is really something that the home user can do without. Simple precautions, such as standing the microphone on a foam rubber pillow, will serve the same purpose equally well and it is much less expensive.

With the wide range of microphones now available from a variety of manufacturers, there is no reason why anyone with a home recorder cannot have a lot of fun and expand the usefulness of his recorder, selecting a suitable microphone for the purpose at reasonably low cost. As an aid to the reader in summarizing some of the important characteristics of the microphones discussed, Table 1 is included. This table gives a number of important comparative characteristics of the various microphone types.

The foregoing suggestions, along with a little practice to get the "feel" of how things are done, will soon have you getting real fun and greater use and versatility from your present tape recorder.

Portable Tape Recorder Amplifier

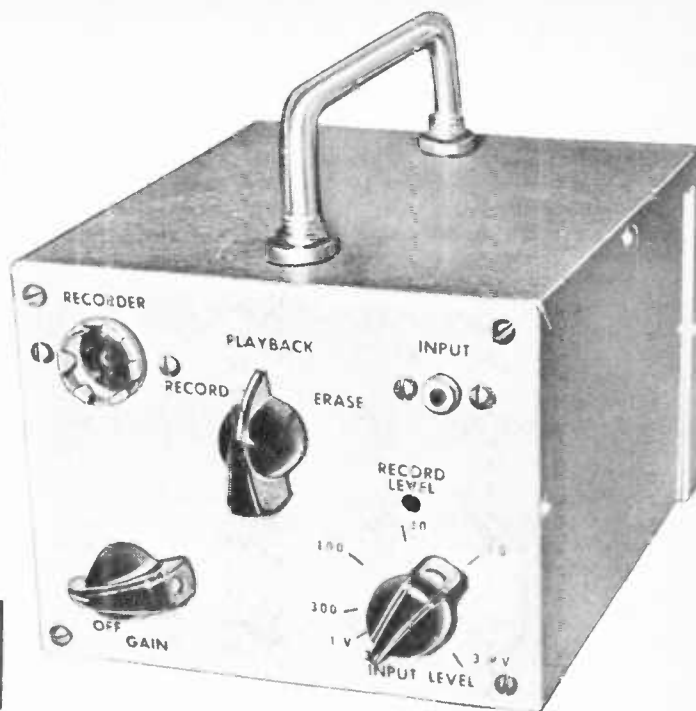

Fig. 1. Front over-all view of the transistorized portable tape recorder amplifier.

By J. E. PUGH, JR.

Transistorized circuit features simplicity of design, small size, lightweight, adequate tone for many uses.

THE current requirements as well as the impedance levels of the transistor and the tape recorder are of the same order of magnitude and, as a result, some interesting simplifications in the design of a recording and playback amplifier are possible.

The amplifier to be described was designed for portable use for voice and medium-quality music recordings with the aim toward simplicity, versatility, low battery drain, and small size and weight. It was designed for use with the Shure Model 815 combination record and erase head, but any other head can be used as it is a very simple matter to adjust the bias, record, and erase currents where the requirements are different.

A calibrated potentiometer at the input permits any input signal in the range from 1 millivolt to 3 volts to be recorded and thus includes practically all of the usual signal sources.

The maximum output level is approximately 100 milliwatts into a built-in 3" PM speaker. A jack is provided so that an external 3.2-ohm speaker can be used, and a second jack permits monitoring of the signal across the recording coil.

The current drain on B_1 is about 45

ma. for record and erase and about 5 ma. for playback. The "at rest" drain on B_2 is 7 ma. At full output it is increased to about 35 ma. (on peaks) by the class B output stage. With ordinary intermittent use the batteries should last at least 300 hours.

The entire system, including amplifier, speaker, and batteries, is housed in a "Fleximount" #29442 (4" x 5" x 6") aluminum case and weighs 3½ lbs. One pound of this weight is accounted for by the batteries.

Although the unit was designed to be used as a recording and playback amplifier, it makes an excellent general purpose amplifier as is. Simply turn it on and use it.

A shielded phono pin-jack on the front panel is used for the signal input, and a shielded 4-conductor jack is used to connect the recording and erase heads into the amplifier. This second jack, J_1 , is indicated in the schematic diagram by showing its terminal numbers, 1 to 4, on the ends of the recording and erase coils.

The function selector is a three-pole, three-position rotary switch with the three functions being "Record," "Playback," and "Erase." In the "Record" position the input jack, J_1 , is connected to the amplifier input, the erase

coil is energized by B_1 , and the recording coil is connected to the output of the amplifier.

In the "Playback" position the input jack is disconnected, the erase coil is de-energized, the recording coil is switched from the recording amplifier output to the playback amplifier input, and a resistive load is connected into the output circuit of V_2 to replace the recording coil.

In the "Erase" position the recording coil is disconnected, the amplifier input is grounded, the erase coil is once again energized, and the resistive load remains in the recording amplifier output circuit.

The recording and erase coils are both contained in the same head and are both energized with direct current. A d.c. bias and erase was selected for this application because of its simplicity and minimum battery drain. The very large power requirements for a.c. erase rule out this method for most portable applications. For example, the Model 815 head requires 1.5 watts at 25 kc. for a tape speed of 3.75 ips, which is increased to 3.9 watts at 50 kc. for a tape speed of 7.5 ips. For d.c. erase only 15 milliwatts are required.

In the case of the recording coil bias

Fig. 2. Bottom view of the completed unit with the bottom of the aluminum case removed to show the batteries and the general over-all layout.

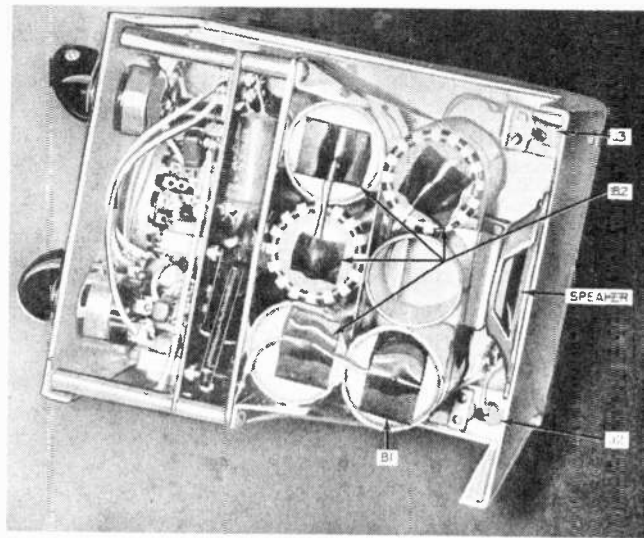

the a.c. power requirements are not so extreme but are still great enough to make d.c. bias desirable for many portable applications. For example, 55 milliwatts at 25 kc. are required for a tape speed of 3.75 ips and 160 milliwatts at 50 kc. for a speed of 7.5 ips. In contrast only 20 microwatts are required to meet the manufacturer's specifications for d.c. bias, although a power of 125 microwatts is used in this system for improved performance.

The erase current is determined by the B_1 voltage (1.5 volts) and R_{11} (22 ohms) in series with the d.c. resist-

ance of the erase coil (12 ohms). At full battery voltage this current will be 44 ma. and will drop to 30 ma. when the battery is down to 1 volt. This range is sufficiently close to the manufacturer's recommended value of 35 ma. for good erasure.

The recommended bias current for the recording coil is .35 ma. but much better results were obtained at .85 ma. using Reeves "Soundcraft" tape. The value of current required depends on both the recording head and the tape being used, and since the level is determined by the V_0 emitter current, it

can be adjusted by varying the ratio of R_{15} to R_{16} . This current ordinarily will not need to be changed except where a different model recording head is used. Bias stabilization is used on V_0 to hold the recording-coil bias current at a constant level.

The input signal to the amplifier—both external signal and the signal from the recording head—is applied to R_1 and R_2 . R_1 is a calibrated potentiometer and is used by setting it to the point corresponding to the level of the input voltage. When R_1 is set at this point, the input to V_1 will be just

Fig. 3. Complete schematic diagram of unit. Note the use of d.c. bias and erase for simplicity and minimum battery drain.

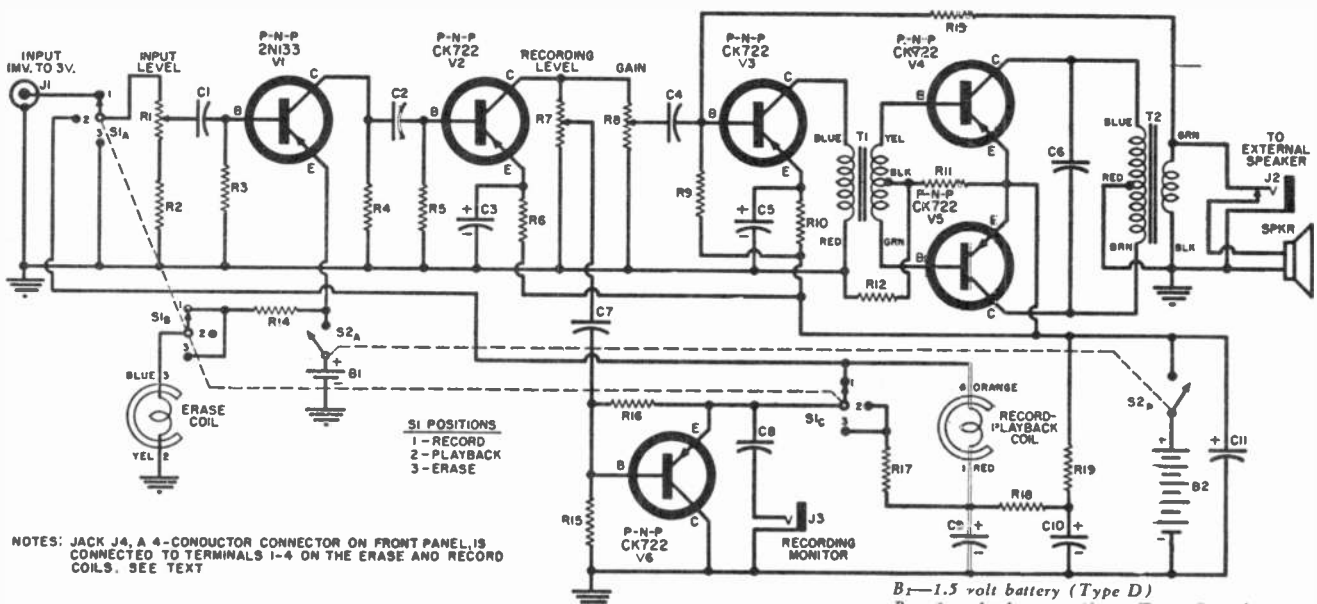

NOTES: JACK J4, A 4-CONDUCTOR CONNECTOR ON FRONT PANEL IS CONNECTED TO TERMINALS 1-4 ON THE ERASE AND RECORD COILS. SEE TEXT

- R_1 —50,000 ohm log taper pot (IRC PQ13-123, "Input Level Control")
- R_2 —47 ohm, $\frac{1}{2}$ w. res.
- R_3, R_7 —220,000 ohm, $\frac{1}{2}$ w. res.
- R_4, R_7, R_{11}, R_{12} —2200 ohm, $\frac{1}{2}$ w. res.
- R_5, R_{10} —1000 ohm, $\frac{1}{2}$ w. res.
- R_7 —10,000 ohm pot, slotted-shaft pot ("Recording Level Control")
- R_8 —10,000 ohm pot ("Gain Control")
- R_9, R_{11}, R_{16} —4700 ohm, $\frac{1}{2}$ w. res.
- R_{11} —150 ohm, $\frac{1}{2}$ w. res.
- R_{12} —18,000 ohm, $\frac{1}{2}$ w. res.
- R_{13} —22 ohm, $\frac{1}{2}$ w. res.
- R_{17} —33,000 ohm, $\frac{1}{2}$ w. res.

- C_1, C_2, C_3 —1 μ fd., 200 v. capacitor (Aerovox P82Z)
- $C_4, C_5, C_6, C_{10}, C_{11}$ —30 μ fd., 6 v. capacitor (Argonne)
- C_7 —.05 μ fd., 200 v. capacitor
- C_8, C_9 —.01 μ fd., 200 v. capacitor
- J1—Phono pin-jack
- J2—Two-circuit jack (Mallory "Midget" Type A2A)
- J3—Open-circuit jack (Mallory "Infant" Type A-1, "Recording Monitor")
- J4—Miniature 4-contact female shielded chassis connector (Amphenol 78-PCG-4 with matching plug 91-MPM4L. See text)

- B_1 —1.5 volt battery (Type D)
 - B_2 —6 volt battery (four Type D cells in series)
 - S1—3-pole, 3-pos. non-shorting switch (Mallory 3243J 4-pole, 3-pos. unit is suitable)
 - S2—D.p.s.t. switch (on R_8)
 - Spkr.—3" PM speaker (RCA Type 231-S1 or equiv.)
 - T1—Driver trans. (Argonne AR-109)
 - T2—Output trans. (Argonne AR-119)
 - V_1 —"p-n-p" transistor (Raytheon 2N133)
 - V_2, V_3, V_4, V_5, V_6 —"p-n-p" transistor (Raytheon CK722)
- Note: Combination "Record-Erase" head used by author is Shure Model 815. See text regarding substitutions.

below the value needed to saturate V_2 on both positive and negative peaks. Fixed resistor R_2 is 1/1000th the value of R_1 , and it limits the maximum usable signal to about 3 volts. This resistor makes adjustment to the 3 volt range easier because of the relatively small value of resistance involved. In addition, the use of a logarithmic taper for R_1 minimizes the problem of crowding at the low resistance end of the potentiometer.

The first two amplifier stages are used in both the recording and playback sections. The first, V_1 , uses a low noise transistor (a Raytheon 2N133 with a noise figure of 6 db) as a common emitter amplifier with a collector voltage of 1.5 volts at .3 ma. When used for playback R_1 will be set at the "top" position (3.0 mv.) in Fig. 3, and at this point the input impedance of the amplifier is 1700 ohms, which is a good match for the 1450-ohm impedance of the recording coil.

V_1 is RC-coupled to V_2 , a CK722 connected as a common emitter amplifier. The load for V_2 consists of two 10,000 ohm potentiometers in parallel. The first, R_7 , is used to adjust the signal level to V_6 , the final stage in the recording amplifier section, and it will ordinarily be adjusted to give the maximum undistorted recording level at the time V_2 is just approaching the saturation point. This stage (V_6) is connected as a common-collector amplifier to provide a current gain and coupling between V_2 and the recording coil. The current gain of this stage is about 23 with an input impedance of 34,000 ohms and an output impedance of 250 ohms—both of which are satisfactory.

The coupling capacitor C_7 is fairly small (.01 μ fd.) so as to reduce the low-frequency signal level into the recording coil. This is done to compensate for a characteristic of the recording head that causes distortion at a lower current at low frequencies than at the highs.

R_{17} is used as a load for V_6 to replace the recording coil during playback as otherwise the input circuit of V_6 will cause a change in the frequency characteristics of the playback amplifier—the degree of change depending on the setting of R_7 . The RC network consisting of C_6 , C_{10} , R_{11} , and R_{10} is used as a decoupling filter to prevent a low-frequency oscillation during playback.

When using a microphone for recording it may be necessary to reduce the speaker output to the point of being almost inaudible to prevent acoustical feedback, and occasionally it is desirable to make a check on the quality of the signal at the recording coil. For these reasons jack J_3 is provided so that a pair of high-impedance headphones can be used for listening.

The driver and output stages (V_8 , V_1 , and V_3) are conventional in most respects. Resistors R_9 and R_{13} are used for bias stabilization and R_{13} serves the additional function of negative feedback resistor. When the feedback network was added, a 100 kc. oscilla-

tion of fairly high level occurred in the driver and output stages. Placing C_3 across the primary of T_2 stopped this oscillation and since it is small (.05 μ fd.), it causes no noticeable change in the tonal quality of the playback amplifier.

The speaker is a good quality 3" unit that uses a 1.47-oz. magnet. A speaker using a smaller magnet can be used but ordinarily such a unit will be harder to drive.

Construction

The construction of this amplifier is based on turret-type terminal lugs mounted on a suitable insulator base. This type of construction has most of the advantages of printed circuits and, in addition, has a few of its own. For example, the printed circuit method permits only two conductor planes, the two surfaces of the insulator base, while this method permits several planes as can be seen in Fig. 4. Also the expense, effort, and construction time are all less for the turret-lug method, and while a well constructed printed circuit board probably has a

neater appearance than any other type of construction, the facilities for such excellence in construction are usually not available to most experimenters. On the other hand, it is possible to obtain excellent results with turret terminals using only a hacksaw, file, and hand drill.

Several types of inexpensive turret terminal lugs are available from Newark Electric Company, Chicago, and The Radio Shack, Boston, but only one type, the USECO 1300T (see Fig. 4), was used for this project. It is a double turret type with a 4-40 threaded portion on one end for mounting purposes. The mounting hole is made with a #33 drill—or $\frac{3}{64}$ " if fractional size drills are used.

Although any 4-40 nut can be used for fastening the lugs, the most compact arrangement is obtained by using nuts that are $\frac{3}{16}$ " across the flats. These nuts will permit a minimum spacing of $\frac{1}{4}$ " between terminal centers, and they are available in the Walsco package of 4-40 steel hex nuts (Item #8804-N). Where feedthrough to the lower side of the panel is re-

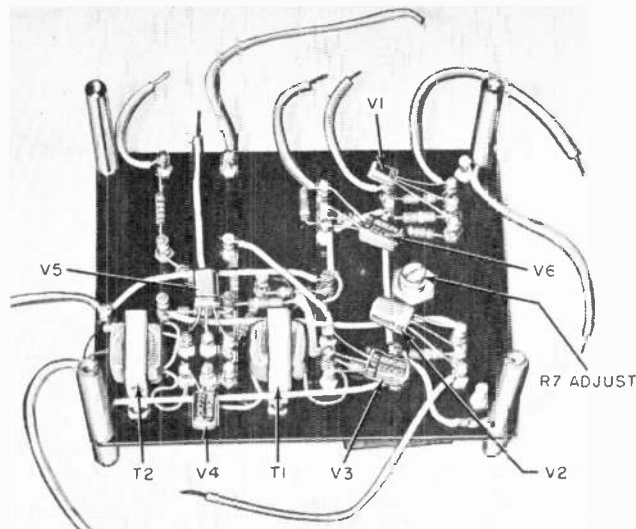

Fig. 4. Top view of completely assembled terminal board.

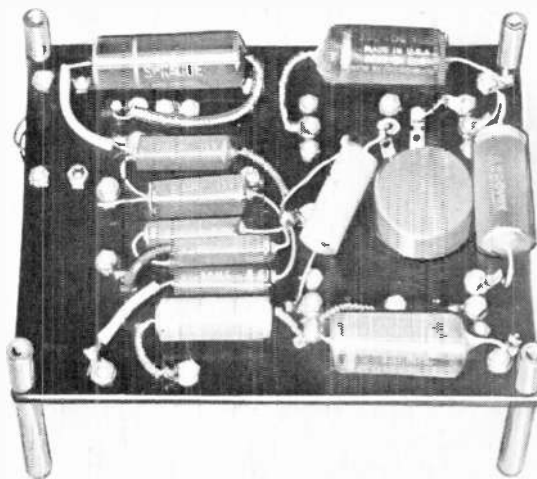

Fig. 5. Bottom view of board shows mounting of capacitors.

quired, a solder lug is placed under the nut (see Fig. 5). If available, use #4 solder lugs—otherwise #6 lugs can be used but will need to be trimmed with diagonal cutters in cases where the spacing between terminals is too close.

For a low-frequency, low-voltage application, such as this amplifier, the insulator boards can be almost any insulation material with a moderate strength, a high softening point, and a maximum thickness of $\frac{1}{8}$ ". Bakelite will be satisfactory and Masonite can be used with care. Polystyrene and Lucite have such low melting points that they are not recommended for this project.

Two such boards will be needed—one for mounting the terminal lugs and the other for mounting the batteries. They should be cut about $\frac{1}{8}$ " smaller than the inside dimensions of the case to allow wires to the batteries and speaker to pass between.

No attempt was made to obtain the extreme in miniaturization as can be seen from the layout in Figs. 4 and 5. By using all miniature parts, including batteries and speaker, and by crowding the components the case size probably can be reduced by about half. However, any reduction in battery size should be weighed carefully as the erase coil and the output stage (on peaks) both have fairly large current needs and will reduce battery economy considerably if low capacity batteries are used.

The layout shown in Figs. 4 and 5 was planned for simplicity and neatness and to give a minimum of long wires and crossover points. None of the dimensions is critical although the spacing between the closest lugs (transistor terminals) must be great enough to allow the hex nuts to be tightened.

The "Recording Level Control," R_7 , is of the slotted type for screwdriver adjustment. It is mounted on the terminal board and is adjusted through a small hole in the front panel since it ordinarily will not be touched once it is adjusted.

The speaker grille is made in the aluminum case by drilling a series of $\frac{1}{8}$ " holes over the area in front of the speaker cone. A neat arrangement can be obtained by making four rows, spaced 45° , across the diameter of the cone. An in-row spacing of $\frac{3}{16}$ " between holes will be sufficient to allow adequate passage of sound.

After all parts, except transistors, are wired to the terminal board and to the front panel of the case, the interconnecting wires should be added. These wires should be soldered to the terminal board first (see Fig. 4) and then to the parts mounted on the case, with the exception of the wire to the terminal in the lower right corner of Fig. 4. This wire is connected to the sliding contact on R_7 first and then to this terminal.

After the interconnecting wires have been soldered to the terminal board, the transistors can be soldered in

place. First melt a small amount of solder on the head of each of the lugs to which the transistor leads will be connected. Then cut the leads to a convenient length and solder rapidly to the correct lug holding each lead with long-nose pliers until the terminal lug is cool to the touch.

The long threaded spacers can be made from $1\frac{1}{8}$ " lengths of $\frac{1}{4}$ " diameter brass rod, such as the piece that remains after shortening a potentiometer shaft, or three "store-bought" $\frac{5}{8}$ " x $\frac{1}{4}$ " diameter spacers can be assembled using $\frac{9}{32}$ x $\frac{1}{2}$ " studs. These spacers and the short ones are mounted on the terminal board as shown in Figs. 4 and 5, and the whole assembly is mounted in the case after the interconnecting wires are soldered to the parts mounted in the case.

Next the batteries are taped to the second insulator board and wired together. A spacer, about $1\frac{1}{4}$ " diameter and $1\frac{1}{4}$ " long, is taped into the top layer of batteries as shown in Fig. 2. This leaves a gap for the speaker magnet frame with a battery on each side. After this, the wires from the battery switch (S_{2A} and S_{2B}) can be soldered to the batteries and the complete assembly mounted on the short spacers which have already been mounted on the terminal board.

Adjustment

First check that the gain of the first two stages is normal. To do this set R_1 (the "Input Level Control") at zero resistance (full counterclockwise) and with an oscilloscope connected to the V_2 collector see that the V_2 saturation point is reached with an input signal of approximately 3.5 volts r.m.s. This point will be indicated by a flattening of the positive and negative peaks of the waveform. Now connect the oscilloscope to the "hot" lead from the recording coil and set the input signal to 3.0 volts. Adjust R_7 until the waveform becomes distorted. Now vary the signal generator frequency and at the same time keep R_7 backed off to the edge of the distortion point until the frequency where distortion is peaked is found. This frequency will be close to 300 cycles using the Model 815 head. Back R_7 off until the signal across the recording coil is about 90% of the level at which distortion begins. This setting will be near the midpoint of R_7 .

The next step is to calibrate the "Input Level Control" (R_1). After the knob has been positioned and tightened the pointer position at the zero resistance end of the control is marked with a pencil. This will be the "3 volt" position. Rotate the control fully clockwise and this position will be labelled "3 millivolts." With an accurate ohmmeter measure the resistance from arm to ground. Now set the control to read 30% of this maximum resistance value and label this setting "10 millivolts." The 10% resistance point will be labeled "30 mv.," the 3% point "100 mv.," the 1% point "300

mv.," and the .3% point will be the "1 volt" position.

To Use

To use the amplifier, apply the signal to be recorded to J_1 and set R_1 to the point corresponding to the signal level. For example, if the signal is the output from a radio receiver, with a maximum amplitude of 1 volt, the control will be set at the "1 volt" position. Where the input voltage is unknown, adjust the gain control until the signal from the speaker is at a very low level so that the driver and output stages will not be overdriven when the following adjustment is made. Now adjust the "Input Level Control" until the signal just starts to sound distorted (due to overdriving V_2), back it off slightly, and start to record.

To operate on playback simply set the function switch to "Playback" and set the "Input Level Control" to about 3 millivolts. To use the amplifier as a general purpose amplifier, disconnect the recorder plug (to reduce battery drain), connect the signal source to the input jack, set the selector switch to "Record," and adjust the "Input Level Control" to correspond to the signal level.

Variations

Different operating conditions may make slight changes in the amplifier desirable. For example, if the input signal will normally be below the range of 1 to 3 millivolts, another stage of amplification will be needed. This stage can use a CK722 between V_1 and V_2 . R_1 and R_2 should be removed from the input circuit and connected across R_1 to regulate the input to the added stage. C_1 should now go directly to S_{1A} . To make space for this amplifier stage move R_7 toward the center of the terminal board (see Fig. 4) and place the terminal lugs between V_1 and V_2 .

In cases where a.c. bias for the recording coil is preferred to the d.c. system, a 25 or 50 kc. transistor oscillator using a pair of CK722's in push-pull can be located in the upper left corner of the panel shown in Fig. 4.

The power requirements for a.c. erase are too great for use in a system of this type, but in cases where large battery drain is permissible (for fixed and semi-portable uses) an oscillator using a power transistor can be used.

This system was intended primarily for recording the voice and medium-quality music and it is satisfactory for such uses. If better quality recordings are needed, the coupling capacitors should be increased to 10 μ fd. or greater, a treble boost network should be used in the recording amplifier, and a bass boost system should be added to the playback amplifier.

Bias stabilization is used only where necessary, but if the amplifier is to be used outdoors where temperature extremes are often encountered, it may be advisable to stabilize all stages to prevent loss of performance.

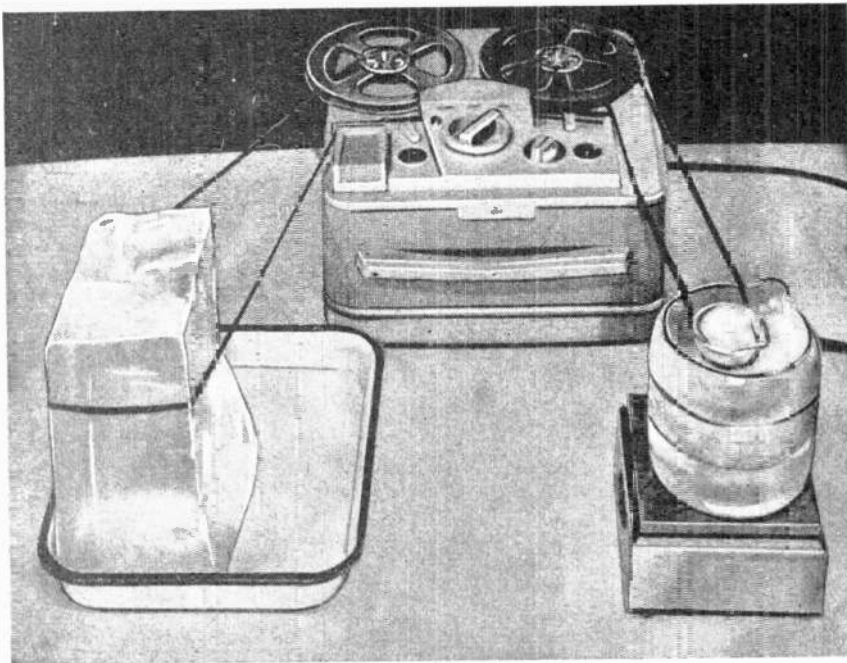

Tape made with "Mylar" is run from the recorder into boiling water and around a cake of ice. There is no change in strength, flexibility, or dimensional stability.

What Do You Know About Recording Tape?

By **HERBERT G. HARD**
Vice President, Research
ORRadio Industries, Inc.

MORE and more people are becoming interested in tape recording and the uses of tape in the home, in the school, in the church, and in industry. Growing interest in the magic of magnetic recording prompts a good many questions from the ever increasing number of tape recorder fans.

Every year ORRadio Industries receives hundreds of letters asking many interesting and important questions about recording tape. In this article we have tried to answer just a few of the most commonly asked questions.

1. How should tape be stored?

Tape should always be stored on the rewind or take-up reel. In the course of recording, or playback, the tape winds on the take-up reel forming a smooth and uniform pack. If it is rewound at fast speed onto the feed reel, it will almost invariably have an uneven pack. Tape should never be stored where it is likely to encounter extreme temperatures or humidity, like in hot attics or damp basements. Storage at ordinary room temperatures is usually satisfactory. Tape should be kept away from magnetic fields such as might be produced around large motors. Stored tape should be re-spooled in playback mode at least once every six months and preferably every 30 days. Frequent re-spooling also prevents "reel set." This is a more or less permanent deformation of the tape resulting from winding pressure over prolonged storage periods.

2. What is "print-through" and how can it be avoided?

"Print-through" is the transfer of the magnetic signal to adjacent layers on a reel of tape. In order to avoid "print-through" the following precau-

Here are expert answers to most commonly asked questions pertaining to magnetic recording tape.

tions should be observed. Do not over-record. When recording, set the record level as low as possible in order to get a noise-free signal. Rewind recorded tapes frequently. Store at room temperature since higher than normal temperatures accelerate "print-through."

3. What is meant by "single track" and "dual track"?

Single track recording is made with a full track recording head which is almost as wide as the 1/4-inch tape. Dual track recording is made with a half track head. It records only half the width of the tape. With a dual track head, the user can record first the bottom half and then the top half of the tape, thus gaining twice as much playing time on one reel of tape. Dual track tapes cannot be readily edited.

4. What types of film, or base, are used for recording tape? and what are the differences between the bases?

The two commonly used tape bases are cellulose acetate and "Mylar," which is DuPont polyester film. Each of the base materials has its advantages. Acetate has been the standard film of the recording industry for ten years. It is less expensive than "Mylar." When acetate breaks, it breaks clean and a neat splice can be made without losing any of the recording. "Mylar" is stronger than acetate and will not tear easily. It will take a greater pull before stretching. It also has a high resistance to extreme temperature and humidity.

5. How long will tape last?

The life of good quality recording tape is indefinite. Tests have shown such tapes can be recorded and played up to 10,000 times without appreciable loss of recorded material. A tape with a smooth surface will last longer because it has less oxide shedding due to head contact. "Mylar" tapes will last longer than acetate because "Mylar" does not become brittle with age.

6. Are any precautions necessary for the thinner tapes?

Ordinary care will suffice in the case of 1-mil tapes but certain precautions should be observed in using the half-mil double-play tape. A tape recorder, properly adjusted, exerts a pull of 6-9 oz. while running and 10-16 oz. in start or stop on rewind and fast forward modes. Half-mil tape has a stretch value of 32 oz. which ordinarily provides an ample safety margin. However, special care should be taken on fast forward and rewind. The tape must be taut between reels when starting and stopping. If the tape is slack, it will be snapped into motion and stretching is almost sure to result.

7. How is a tape splice made?

Take the two broken ends of tape, overlap them, and cut through the overlapped ends at a 45-degree angle. Place the two ends together, and lay over a piece of splicing tape. Be sure the splicing tape is not on the coated, or oxide, side of the tape. Trim the edges of the splicing tape with a slight inside curve. Pressure sensitive tape is not satisfactory for splicing, as it makes a "gummy" splice. The job is facilitated by using a splicer. -30-

FOR ADVANCED THINKING, PRECISION ENGINEERING
AND PURE, CLEAN ACCURATE SOUND REPRODUCTION

Nothing comes close to JBL precision transducers

JBL Signature loudspeakers embody feats of audio craftsmanship never duplicated. JBL extended range speakers are made with large voice coils of edge-wound aluminum ribbon for brilliant highs, crisp lows, rich mid-range, highest efficiency. Frames are rigid castings, dural center dome is attached directly to voice coil for clean sound, free of spurious resonances.

Left to right are the virtuoso 15" Model D130 with 4" voice coil; the versatile 12" D123, 3" voice coil; the singular 12" D131, 4" voice coil; precision miniaturized 8" D208, 2" voice coil.

Then, above, there are the famed JBL low frequency drivers, the 130 series with curvilinear cone, 4" voice coil, for 1200 cps crossover; and the fabulous 150-4 series with 4" voice coil and straight-sided cone for 500 cycle crossover.

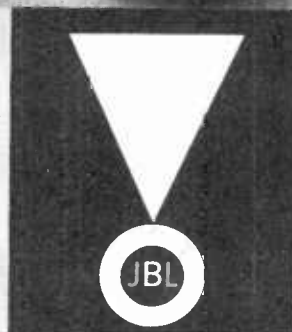
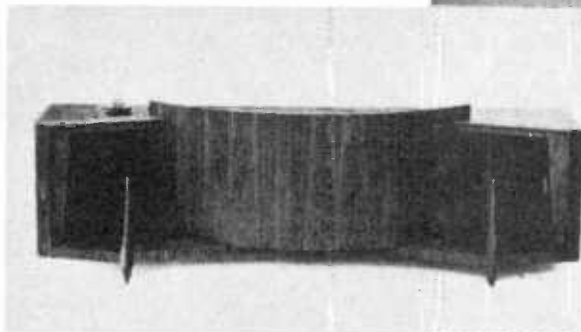
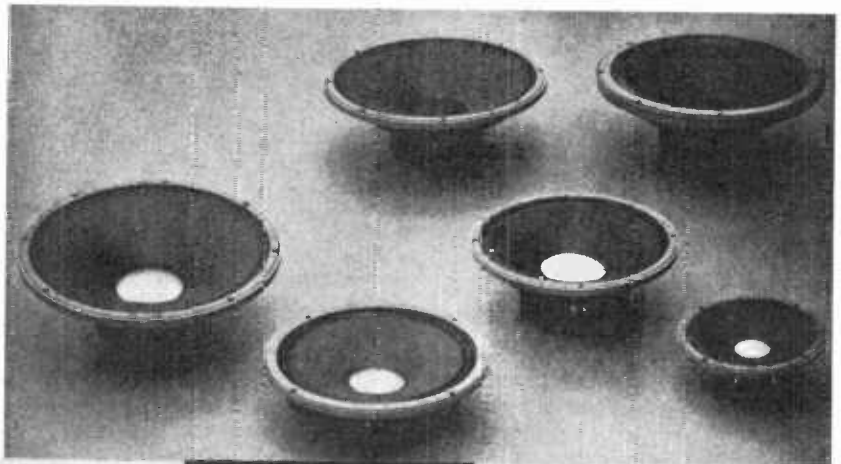

JBL acoustical enclosures are engineered for JBL transducers. Pleasingly proportioned, precision built, impeccably finished, there is one for every taste.

At top, the sensational Ranger-Paragon integrated stereophonic speaker system. Next, the mighty Hartsfield, universally acclaimed the finest of monaural speaker systems, and the extremely popular C40 Harkness back-loaded folded horn.

Below, the JBL C37—criterion for reflex enclosures, and the C39 Harlan corner reflex enclosure of provocative design and extraordinary versatility. Detailed prints for constructing the C37, C39, and C40 are available at \$3.00 a set from the factory.

Original concepts distinguish JBL high frequency units.

Greatest of all high frequency drivers is the massive, thirty-pound JBL 375. Of unsurpassed efficiency and faultless coverage, the 375 is designed for 500 cycle crossover. Used in the Hartsfield and Ranger-Paragon. Shown here with the 537-509 horn-lens combination which gives wide horizontal and narrow vertical coverage to minimize floor and ceiling reflections.

The JBL 175DLH assembly combines precision driver and complex phasing plug with machined aluminum exponential horn and the exclusive JBL acoustical lens which distributes highs evenly over a 90° solid angle.

The solid JBL 075 is made with the original ring radiator and annular exponential horn for immaculate reproduction of highs over 2500 cps.

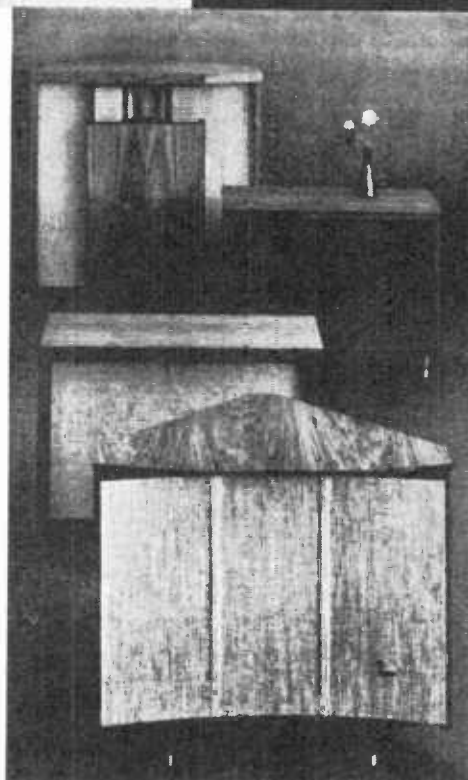

Write for free catalog, name of your JBL Dealer, and information on plans

JAMES B. LANSING SOUND, INC.

3249 Casitas Avenue, Los Angeles 39, Calif.

1
2
3
4
5
6
7
8
9
10
11
12
13
14
15
16
17
18
19
20
21
22
23
24
25
26
27
28
29
30
31
32
33
34
35
36
37
38
39
40
41
42
43
44
45
46
47
48
49
50
51
52
53
54
55
56
57
58
59
60
61
62
63
64
65
66
67
68
69
70
71
72
73
74
75
76
77
78
79
80
81
82
83
84
85
86
87
88
89
90
91
92
93
94
95
96
97
98
99
100

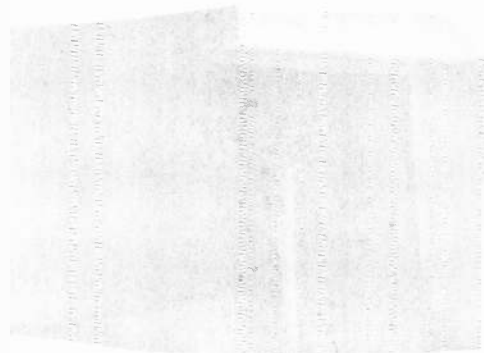
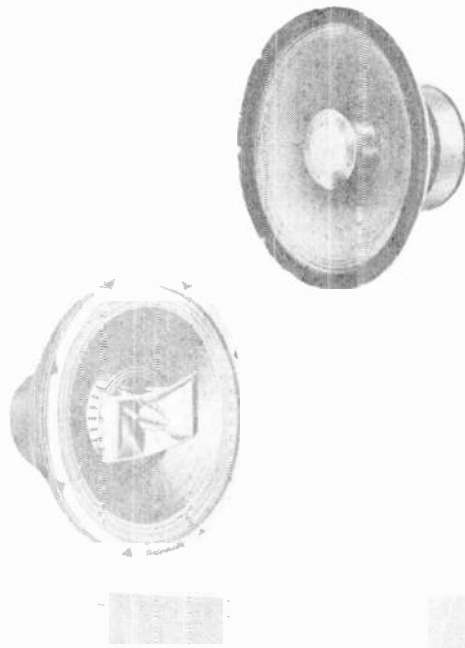

Section IV

Loudspeakers and Enclosures

Why Low Efficiency Speaker Systems?	82
Electrostatic Speakers	85
“Ultraflex” Speaker Enclosure	88
Choosing Your Crossovers	92
Speaker Damping With Series Resistor	96
The “Tiny Mite” Loudspeaker Enclosure	99

Why Low-Efficiency Speaker Systems?

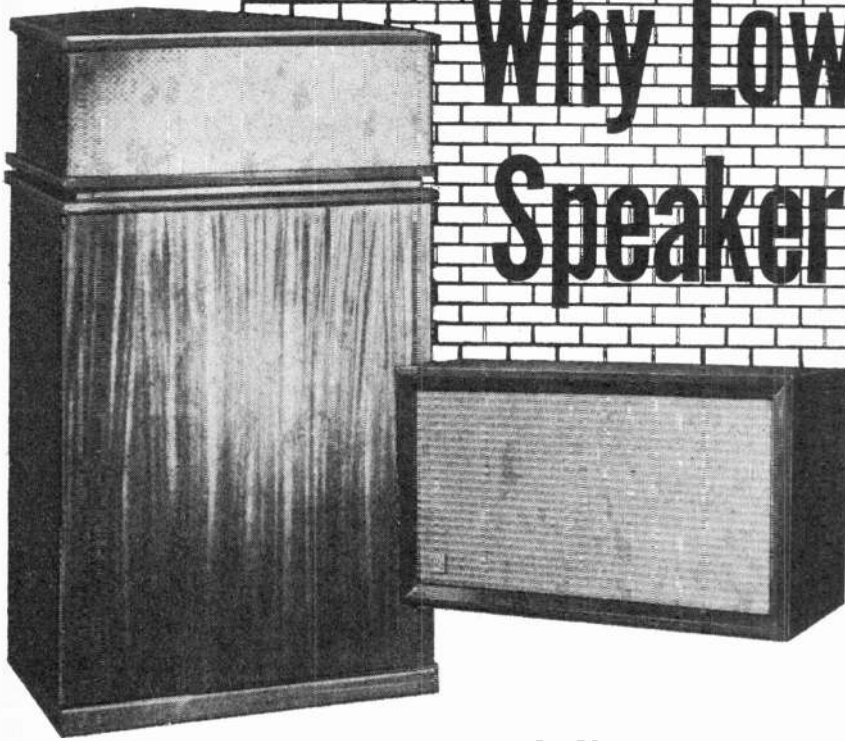

Two extremes in speaker system design—the Klipschorn, considered as having the highest over-all efficiency, and the Acoustic Research AR-1, which is rated as having the lowest over-all output efficiency.

By **EDGAR VILLCHUR**

Acoustic Research, Inc.

A leading proponent of the low-efficiency loudspeaker system discusses its characteristics and gives his reasons for the use of this type of system.

THERE has been a lot of recent interest in loudspeaker efficiency, particularly with regard to its side effects. It has been claimed, for example, that high efficiency is a necessary earmark of good transient response, or that only low-efficiency speakers are capable of musical quality. Neither claim is accurate, and some of the "old wives' tales" about this particular subject need clearing up.

First, let us examine the factors that actually determine the electro-acoustic efficiency—the relationship between acoustic power output and electrical power input—of a speaker. These are: (1) strength of the magnetic field, (2) amount of copper or other material in the gap, (3) mass and friction of the moving system, and (4) nature of the coupling between the voice-coil and the air which it drives.

These factors are not constant at all frequencies. Mid-range efficiency may be quite different from efficiency at the frequency extremes; for example, the speaker which has the lowest over-all efficiency of any on the high-fidelity market is rated¹ as one of the most efficient, if not *the* most efficient, in the frequency range below

30 cycles. Apparently it is necessary to dig a little deeper.

Strength of Magnetic Field

For a given magnetic structure, the size and strength of the magnet can be taken as an index of the magnetic flux in the gap. Yet a "replacement" type speaker, with an *Alnico V* magnet of 6.8 oz., may have much higher mid-range efficiency than a quality speaker whose magnet, made of the same material, weighs five times as much. The amount of magnetic flux is thus only a relative figure, without absolute significance unless all of the other factors are held constant.

Amount of Copper in Gap

One of the reasons why the strength of the magnetic field is not an absolute index of efficiency is that the relative amount of working copper (or other conducting material) in the gap may vary from speaker to speaker.

If we design the voice-coil with a view to keeping bass harmonic distortion as low as possible, we must allow the winding to overhang the gap, so that even with large excursions the entire length of the gap is filled with copper. Unless the voice-coil is longer

than the gap, each large excursion will remove some of the turns from the controlling field, and reduce the force generated by the signal; with voice-coil "overhang" the same number of turns is always immersed in the field, as shown in Fig. 1A. Here is a case where we must choose between efficiency on the one hand and reduced bass distortion on the other.

Fig. 2 is a comparison of performance, with regard to distortion, between a standard low-efficiency AR-1 speaker system (one-inch long voice-coil suspended in a half-inch long gap) and a non-production model of the same speaker, whose voice-coil length was purposely made the same as that of the gap. In the improperly designed, higher efficiency model *all* of the copper works to drive the speaker at mid-range frequencies, while in the standard model half of the signal voltage appears across non-active sections of the voice-coil. Ignoring fringing of the magnetic field, the sacrifice in mid-range efficiency would be by a factor of four, since power varies as the square of the voltage.

Mass and Friction

It is easy to understand intuitively

HI-FI ANNUAL & AUDIO HANDBOOK

that the heavier the vibrating cone and voice-coil and the greater the friction that must be overcome, the more electrical power will be required to set the speaker into motion at a given sound level. It might seem that the speaker designer should simply try for as light and frictionless a moving system as possible.

But here again there are complicating factors. When we go to light cones we must accept more violent cone flexure or "breakup," a phenomenon directly associated with harmonic distortion and with dips and peaks in the frequency response curve. Furthermore it is often desirable to deliberately introduce friction into the speaker's moving system, in the form of a viscous damping substance at the cone rim suspensions. This suppresses edge reflections and the attendant standing waves set up in the cone.

An additional element in avoiding too light a cone has to do with over-damping, which will be considered in more detail a little later.

Speaker-Air Coupling

The factors that have been discussed so far involve the speaker mechanism itself, exclusive of its enclosure. These factors indicate the reasons that, at the present state of the art, *all* loudspeakers in themselves are grossly inefficient. Probably the best that can be hoped for, from a loudspeaker in a simple baffle, is a general efficiency on the order of 10%. A more typical figure is 5%, and current low-efficiency units boast efficiencies of one or two per-cent. At best, we must throw away 90 per-cent of our amplifier power before we convert it into sound; at worst, 99% or more.

This should not be a surprising situation to those familiar with the electronic field. It is an accepted fact in circuit design, for example, that narrow-band, resonant circuits can be designed with high gain, while wide-band circuits must limp along with low gain. A TV amplifier stage, with 4 megacycle bandpass, is not expected to provide the gain of a comparable audio stage. The analogy is not exact, but it will serve. If a loudspeaker had only to reproduce a narrow band of frequencies, we would not have to spend so much electrical power on it.

We now come to the most important single element that influences speaker efficiency, and the crux of the problem. The type of coupling between the speaker and the air (once the cone area is fixed), as determined by the speaker enclosure, not only has a direct and important bearing on the efficiency figure, but also influences the kind of design that can be used in the speaker mechanism itself. It tells the speaker designer whether he should be building a speaker whose mid-range efficiency (before enclosure) is in the one to three per-cent category, or in the seven to ten per-cent bracket. The enclosure thus counts twice with regard to efficiency.

In spite of the many apparent varieties of speaker enclosures available on the market, there are only three basic types: the direct-radiator (infinite baffle, acoustic suspension, etc.), the resonant (bass-reflex, acoustical labyrinth, etc.) type, and the horn. The resonant enclosure and the horn have one characteristic in common: the cone is coupled to an increased volume of air at low frequencies, compared to that which it would engage

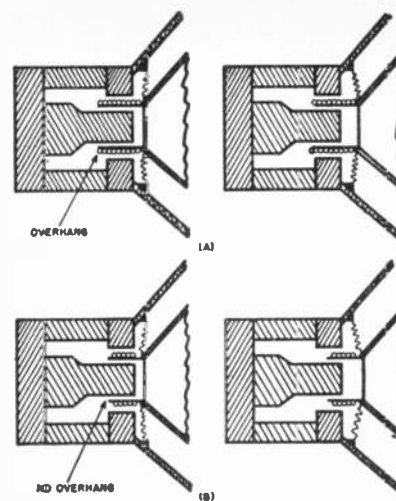
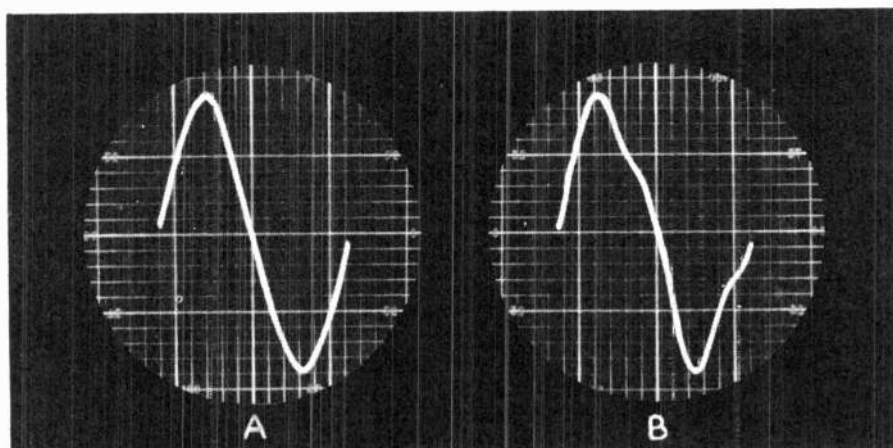

Fig. 1. A large voice-coil overhang keeps the number of turns in the gap constant, even on large cone excursions, but it results in a loss of efficiency.

directly, and a given bass sound level is associated with smaller cone excursions. This means (1) voice-coil overhang requirements are reduced, and (2) the problem of over-damping, which would attenuate the bass in the region of speaker resonance, is likewise reduced, due to compensation of the enclosure. Both of these results enable the speaker designer to work for maximum mid-range efficiency. And since horn loading also increases the efficiency directly, it is possible to end up with a transducer whose conversion losses are relatively small. Horn efficiencies as high as 50% have been claimed.

Fig. 2. (A) Acoustic output at 30 cycles, 39 watts to rated impedance, of a standard AR-1 speaker having a 1/2-inch voice-coil overhang. Output of the amplifier was adjusted for 1/2-inch cone excursions. (B) Acoustic output, at the same input frequency, of a special speaker system, identical to the AR-1 except for lack of voice-coil overhang. Only 23 watts were required for the same peak sound level at the microphone. (The actual 30-cycle level is less than that represented by the height of the waveform, because of the harmonic content.) A DuMont type 302 Polaroid oscilloscope camera and a type 401 oscilloscope were used for waveforms.



If we were to take a speaker mechanism designed for maximum over-all efficiency and mount it as a direct-radiator, we would be likely to get very disappointing results. The speaker would not be capable, either electrically or mechanically, of undergoing the large excursions required in the bass, and it would also be overdamped. The bass range would be attenuated and harmonic distortion at low frequencies would be high.

On the other hand, a speaker designed for use as a direct-radiator would have the necessary overhang of voice-coil winding, and freedom from over-damping, and would fall in the low-efficiency range. The direct-radiator baffling system counts twice here, too, this time against efficiency; once in directing the speaker designer to choose features that must sap efficiency, and again in giving up any aid in coupling the cone to the air, other than that of direct contact. One may wonder, then, why anyone would deliberately choose a direct-radiator over a horn or resonant system, with the former's inherent sacrifice in electro-acoustic efficiency.

The author believes that each of the design approaches just referred to are valid, and that successful results can be achieved with any of them. Since the author's own experience has yielded the most success with the low-efficiency, direct-radiator approach, its case will be outlined here.

The benefits sought by such an approach, in return for the sacrifice of efficiency, are decreased bass harmonic distortion (in spite of the increased voice-coil travel), better uniformity of frequency response (and the attendant improvement in transient response), and a more extended range of frequency response at the bass end.

A speaker is a resonant mechanical device, whether we like it or not, and much of the effort of the designer must be directed toward taming this resonance. The use of a horn, bass-reflex, or resonant-column enclosure adds greatly to the problem. Acoustical resonances, which produce response peaks and dips, and boomy, hollow sound, are very nasty and difficult to deal with, usually far more difficult than the primary resonance of the speaker itself. It is not theoretically impossible to tame acoustical resonance—bass-reflex ports can be damped, horns can be made with large enough mouth diameters to discourage sound reflections, etc.—but the task is a difficult and sometimes delicate one, possibly requiring critical adjustments.

For the properly designed direct-radiator system, the absence of acoustical resonance and the fact that the designer does not have to contend with an enclosure bass cut-off frequency (determined rigorously by horn theory) simplifies the task of working towards uniform, non-boomy

response. The fact that the enclosure does not "let go" below a given frequency also provides an opportunity to keep harmonic distortion at a minimum and to keep up relative bass efficiency, so that the absolute value of efficiency at very low frequencies may actually exceed that of the other systems. It is the author's opinion that of current speaker systems, the ones with the least bass distortion and most extended, uniform bass response are the direct-radiators.

Speaker Damping

The electrical damping of the speaker "motor" is a straightforward case of electro-magnetic damping, fully investigated and described in the literature, yet there is a great amount of general misunderstanding and legend about this subject.

If one were to take a typical unmounted, unconnected speaker, and gently work the cone back and forth, one would find the moving system springy but otherwise relatively free. If, however, the speaker terminals were connected together (the short representing the low internal resistance of a driving amplifier) the speaker, particularly if it had a heavy magnet, would act as though the voice-coil were being retarded by some viscous fluid. This would be due to the fact that the back e.m.f. generated by the coil in the magnetic field was forcing current to flow through the circuit (the d.c. resistance of the voice-coil itself in series with the external shorting wire)

The effect of this damping resistance—equivalent to mechanical friction—is to control speaker response in the region of resonance. Fig. 3 shows the theoretical response curves, as plotted by Beranek,² for different degrees of speaker damping, and Fig. 4 shows a set of actual measured response curves when the damping resistance is varied by changing the amplifier damping factor, for a direct-radiator speaker system.

The middle curves of Figs. 3 and 4 represent optimum damping, under which condition the steady-state response curve is the most uniform, and transient response is without hangover. The top, peaked curve represents an underdamped condition, with accentuated bass at the resonant frequency and hangover on transients. The bottom curve, representing an overdamped condition, keeps transients clean but introduces bass attenuation. We want the electro-magnetic system of the speaker and amplifier to be as "tight" as that associated with the middle curves, but neither tighter nor looser.

Increasing the flux of a speaker's magnetic structure, other factors remaining constant, raises both efficiency and the degree of damping. The danger of magnetic overdamping

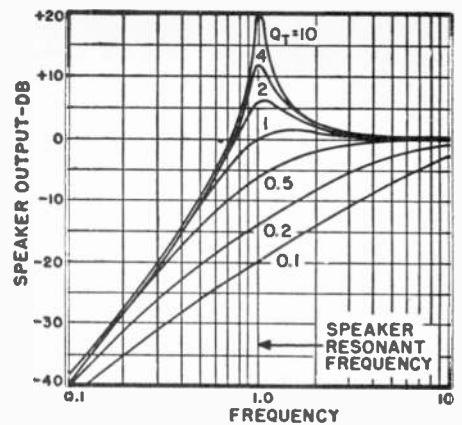

Fig. 3. Speaker response curves in the region of resonance for different values of total mechanical "Q" (Q_T). A condition of high "Q" is obtained with a small degree of damping (low amplifier damping factor), while low "Q" is obtained with a large degree of damping (high amplifier damping factor). Curves after Beranek, see reference.

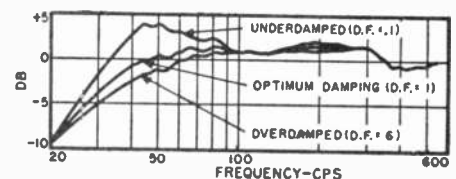

Fig. 4. Acoustic response curves of the AR-1 system, radiating into a solid angle of 180° , in the region of resonance (as recorded on an automatic level recorder, and corrected to calibration curves of the measuring equipment), for three values of amplifier damping factor shown in diagram.

therefore places a limit on efficiency for direct-radiators.

With the continuing advances in electronic circuitry and components, there has been a tendency to place more and more of the burden of high-fidelity reproduction on the electronic circuit. Low-output pickups (pickups with low mechanico-electric efficiency) and low-efficiency speakers are part of this picture. In testing and listening to such components and in comparing them with other, higher efficiency units, it is important that the necessary adjustments in electronic circuitry be provided; more preamplifier gain must be supplied for low-output pickups, and more amplifier output power for low-efficiency speakers.

REFERENCES

1. *Audio League Report, Volume 1, No. 11, January 1956, page 1*
2. *Beranek, Leo L.: "Acoustics," McGraw-Hill Book Company, New York, 1954*

Electrostatic Loudspeakers

Questions and Answers

By WARREN PHILBROOK

Just what is the story on the use of electrostatic speakers for hi-fi systems?

ELECTROSTATIC speakers is a subject about which there has been considerable controversy, especially at "the engineering level." The controversial atmosphere has been largely promoted by the fact that each engineer contributing to it works for a company which either does or does not make an electrostatic loudspeaker. This fact follows a natural human tendency which may affect the conclusion the engineer is likely to draw. But the net result to the laymen is that he finds himself confused about the whole issue. One writer convinces him an electrostatic loudspeaker is a complete waste of money and another convinces him he doesn't have a hi-fi system without one. Which is he to believe?

The truth must be somewhere between these extremes. So we will try to assess the merits of this kind of speaker by answering some of the pertinent questions that crop up from time to time, starting with the most obvious.

Question 1. *What will an electrostatic tweeter add to the reproduction of my hi-fi system?*

The simplest answer to this question, assuming that the electrostatic tweeter behaves as perfectly as one can behave, is that it will reproduce the range from well below 5000 to 20,000 cycles with very good uniformity. But to the layman, this statement sometimes gives the impression that the electrostatic tweeter is handling three-quarters of the frequency range, because 5000 to 20,000 cycles is numerically three-quarters of the range from zero to 20,000 cycles. This impression arises from lack of familiarity with what physicists call "Fechner's Law."

This can be explained quite simply by pointing out that the musical spectrum from 20 to 20,000 cycles consists of

about 10 octaves. Each octave is a musical interval that sounds like the same change in pitch to the ear and represents a change in frequency of two to one. Multiplying 20 cycles by 2 gives 40 cycles. Multiplying a second time gives 80 cycles, a third time 160 cycles, and so on. The tenth time brings us up to a little over 20,000 cycles. Each one of these steps represents the same "amount" of frequency range as far as the ear is concerned.

Equipment that gives uniform response from 40 to 10,000 cycles does not sound appreciably inferior to one that gives uniform response from 20 cycles to 20,000 cycles. This represents knocking off one octave from each end, leaving a range of 8 octaves instead of the original 10. If we take the 10-octave figure, then the electrostatic tweeter will handle the top 2 octaves or $\frac{1}{5}$ th of the audible range. If we take the 8-octave figure, the electrostatic tweeter handles the top octave, or only $\frac{1}{8}$ th of the most useful range. This gives a better assessment of how much the electrostatic tweeter will add to the over-all sound picture.

Although the electrostatic tweeter only adds the last one, or at most two, octaves, this band is important to a sense of realism or presence. But there is a danger of trying to assess it by comparative listening. You expect to hear something too "tangible." This last octave or so really adds "definition" to the picture, rather than giving it any additional "color" or "scenery." So don't listen with the object of hearing something you didn't hear before. It will not make audible any additional instruments that were not audible before. Listen rather for the clarity or sharpness of the things you already could hear.

The other particular thing to look

Typical high-quality electrostatics. Pickering unit is at left; JansZen at right. Such units should be considered more than simply tweeters as they operate well down into midrange.

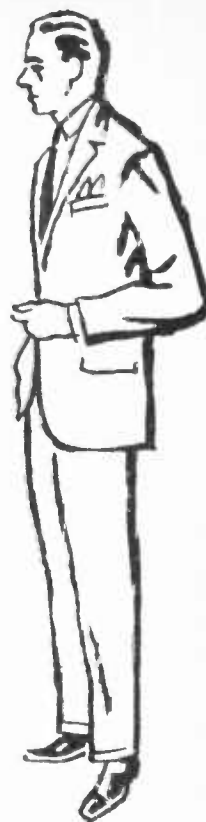
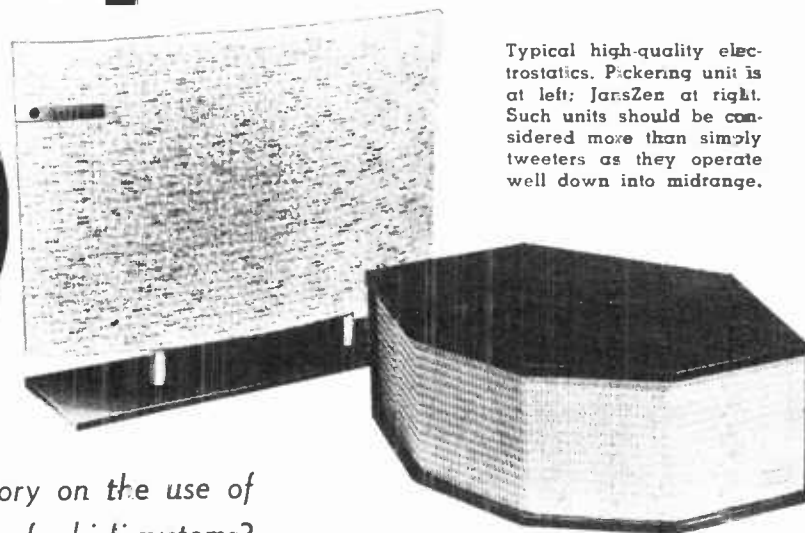

for in the performance of a tweeter is the way it distributes the frequencies within its range. It should not be highly directional, nor, on the other hand should it be extremely non-directional. Neither gives a good representation of the original sound pattern. The high-frequency radiator or tweeter should radiate these frequencies in a manner similar to those immediately below the same range, so one does not get the impression of the frequencies above 5000 cycles being squirted, or widely dispersed, in a manner quite different from the frequencies lower down.

Question 2. *How does the electrostatic tweeter compare with other types?*

There are three basic types of tweeter one can consider here. The electrostatic, the direct cone radiator, and the compression driver. These are shown in Figs. 1, 2, and 3. There are two bases for comparison: (1) the smoothness of frequency response; and (2) the directional pattern of the radiation.

A well-designed electrostatic tweeter has a smooth frequency response, because it avoids the problem encountered by each of the other units. The whole of the diaphragm is driven by the electric driving force and most of its surface area also radiates sound.

Sometimes the diaphragm is curved into a cylindrical shape and sometimes it is only slightly curved, almost flat. This will alter the radiation pattern considerably. The cylindrical or half cylindrical shape gives a wide angle distribution, almost uniformly. The shape coming nearer to flat tends to beam the sound in a comparatively narrow angle. Somewhere between these

two extremes is probably ideal for giving the best frequency distribution to match the rest of the system.

The direct radiator is really a miniature cone-type loudspeaker and this type may suffer from non-uniformity of frequency response, because the diaphragm inevitably "breaks up" at the high frequencies so one part is traveling forward while another part is traveling backwards. This not only may cause a non-uniformity in the frequency response, but also a non-uniformity in its directional characteristics.

The compression driver, on the other hand, has a much different type of distribution. Its horn loading of the diaphragm produces a good uniform response, comparable to that of the electrostatic. The different types of horn available will produce different radiation patterns similar to the effect of different shapings in the electrostatic diaphragm.

Question 3. *Announcements have been made about electrostatic loudspeakers with a wider range than just tweeters. What are the prospects for wide-range electrostatic loudspeakers?*

The basic problem here is quite an old one. The electric driving principle involves electric forces between the "plates." These forces are very small and quite insufficient to produce an acoustic drive unless the plates are placed very close together, but a very close spacing limits the possible travel of the diaphragm. The third factor in this department is the workable high-voltage polarization that can be used before ionization of the air takes place.

The combination of these design factors means that a certain air movement requires a definite area of diaphragm, much bigger than with the cone-type loudspeaker. It seems that, with the best design, the dimensions of the loudspeaker both ways (height and width) must be a little larger, at least, than the lowest wavelength to be radiated. So a loudspeaker to radiate down to 1000 cycles would need to be more than 1 foot wide and high. Going down to 500 cycles would need a loudspeaker with a dimension of considerably more than 2 feet in each direction, and so on.

These loudspeakers have been constructed and are appearing on the market, and they give an extremely uniform frequency response over the range they cover. Their directional characteristic is a subject of some controversy, however, because they do tend to radiate a wave that follows the shape of the diaphragm, whatever that may be, usually a slight curvature from flat.

Another thing to listen for in some electrostatic loudspeakers is something that does not show up too well on the frequency response. This is a certain coloration of the program due to a metal diaphragm being used. All vibrating metal parts tend to have a quality of their own, almost like a resonance. It is not a true resonance, because it is not concentrated on any one frequency. But it does produce a kind of coloration to the presentation,

that can be quite noticeable, as compared with the softer or more viscous materials like impregnated paper and certain classes of plastic, that are used as diaphragms for the cone loudspeakers.

The effects of these differences can only really be assessed by listening for individual choice.

Question 4. *A lot has been said about distortion in electrostatic speakers. Do they distort more than other types, and if so, is it possible for this distortion to be minimized?*

The reason for distortion in an electrostatic loudspeaker is illustrated in Fig. 4. The force of attraction between plates of an electrostatic loudspeaker is proportional to the square of the instantaneous voltage and inversely proportional to the spacing between them. By using a high polarizing voltage between plates, the change in voltage is kept relatively small and this will minimize the inherent distortion in the driving force provided the diaphragm does not move.

Suppose the peak audio voltage is 10% of the polarizing voltage. This means the force between plates will go up to 1.21 times the static force, and down to .81. So there is a peak fluctuation of 20% of the static force, with a harmonic component of 1% peak-to-peak. (Fig. 6.) This represents 2½% harmonic distortion. But notice the words in italics at the end of the last paragraph. We assumed the diaphragm does not move.

When the higher voltage is applied, the diaphragm moves closer to the fixed plate and so the driving force is increased even more. When the audio voltage reduces the static voltage momentarily, the plate moves farther away and so the driving force is reduced even more. So the practical distortion component will be even more than the theoretical, based on the assumption the diaphragm does not move.

The first step to overcome this consists of putting the diaphragm between two fixed plates and allowing the sound to radiate through holes in the fixed plates, as shown in Fig. 5. In this case the total driving force, due to the change in potential between the moving plate and both fixed plates, will be the same in both directions. This produces a great improvement towards linearity or freedom from distortion. Speakers of this type give extremely low distortion but, for

wide-range construction, will still produce some. This is because the diaphragm has to move. Consequently the plate to which the diaphragm happens to be nearest, at an instant, will momentarily exert more than its share of driving force.

What distortion this method leaves will be of a higher frequency, or harmonic order, than with the single-ended arrangement, because it is symmetrical. (Fig. 7.) This distortion is overcome by using a constant charge system. The diaphragm is maintained, not at constant potential, but at constant charge, relative to the other two

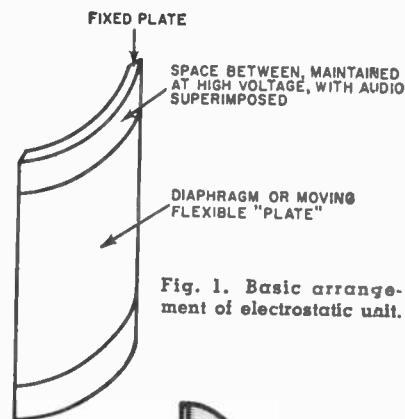

Fig. 1. Basic arrangement of electrostatic unit.

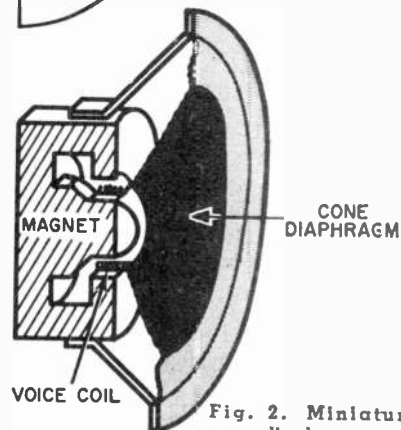

Fig. 2. Miniature cone diaphragm unit.

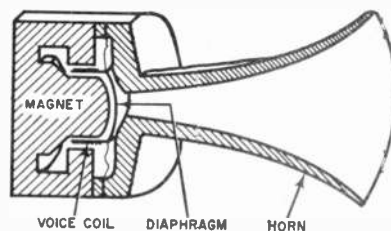

Fig. 3. Compression driver tweeter.

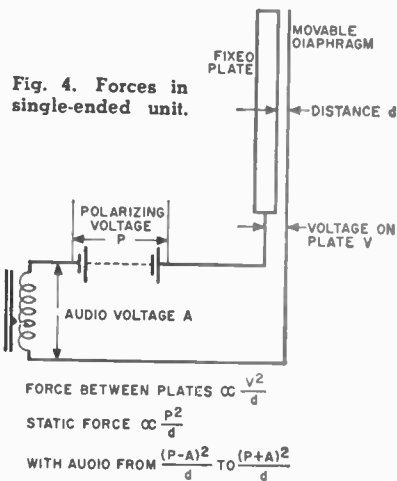
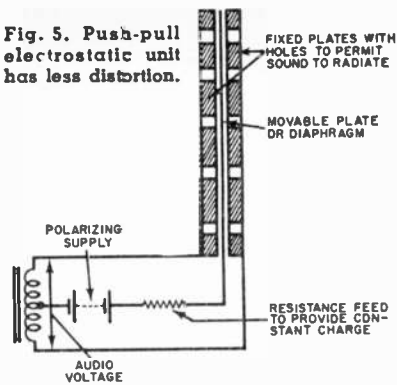

Fig. 4. Forces in single-ended unit.

plates. This neutralizes the distortion by changing the momentary voltage differences, to exactly offset the change in spacing as the diaphragm moves. The result is a driving force exactly proportional to the applied terminal voltage at all times, and not to the voltage differences occurring between the individual plates. The constant charge is maintained by feeding the voltage to the center plate or diaphragm through a resistance, sufficiently high so that the charge will

Fig. 5. Push-pull electrostatic unit has less distortion.



not have time to change during the audio fluctuation. (Fig. 5.)

The exact importance of the distortion discussed is somewhat affected by the frequency range handled by the unit. In the case of tweeters, which handle only from 5000 cycles up, the distortion from a single-ended type will be second harmonic, so the principal distortion from frequencies between 5000 and 10,000 cycles will be between 10,000 and 20,000 cycles. As these components are usually radiated at quite small magnitude, anyway, their distortion is often quite inaudible. Certainly distortion to frequencies between 10,000 and 20,000 cycles will *never* be audible. So, in practice, it would require a very good pair of ears to tell the difference between a single-ended tweeter and a push-pull one, for the range only from 5000 cycles up.

Question 5. *How about matching an electrostatic speaker to an amplifier? Do we need a special crossover, or how do we manage this?*

The basic impedance of an electrostatic loudspeaker is produced by a capacitance, not a resistance. A capacitance has the property that its reactance or impedance is inversely proportional to frequency. It may have a reactance of 20,000 ohms at 5000 cycles, 10,000 ohms at 10,000 cycles, and 5000 ohms at 20,000 cycles.

If the diaphragm were perfectly free to move at all frequencies following exactly the electric force applied to it, a constant voltage applied to the terminals of the loudspeaker would produce a constant magnitude of movement at all frequencies. In terms of audio pressure or velocity, this would be a rising characteristic of 6 db

per octave. However, the diaphragm does not have time for its movement to follow fully the voltages applied because it is mass controlled by the weight of air it has to drive. This means the voltage exerts a force that *tends* to move the diaphragm but it never has time to reach the extreme of its possible movement. These two effects interact in much the same way they do with a cone loudspeaker, to produce an approximately flat frequency response.

Thus we need a constant voltage applied to an impedance that falls off so the current taken is proportional to frequency. Matching is usually taken care of in the matching arrangement supplied with the tweeter or the electrostatic loudspeaker. A transformer is provided to match the capacitance of the loudspeaker so it will feed in conjunction with a normal resistance-type voice coil.

This does not mean, however, that the amplifier will no longer be supplying a capacitance load. The transformer does not magically change the kind of impedance produced by the tweeter, merely its relative value, to make it like a much larger capacitance.

Because of this you should not use the same kind of crossover you would with a dynamic-type tweeter. The dynamic tweeter provides a correct termination for a convenient crossover unit while the electrostatic does not.

The electrostatic unit, however, tends to make its own crossover, because the impedance rises below the frequency we are interested in, usually 5000 cycles, so the tweeter does not accept any energy below this point. This, in conjunction with the built-in matching transformer, and the fact that the low-frequency unit has an inductive voice coil, acts almost as a natural built-in crossover. Usually the circuit supplied by the tweeter manufacturer will provide adequate frequency separation.

Question 6. *Electrostatic speakers operated from different amplifiers, or with different loudspeaker systems, seem to give quite inconsistent results, unpredictably at times. Why should this be?*

This brings to light a fact not often recognized. The electrostatic loudspeaker as an amplifier load some-

times interacts with the performance of the amplifier. A feedback amplifier may be measured and found to have a flat frequency response to well beyond the limits of audibility. Independently, a tweeter may also be measured and found to have a flat frequency response over its intended range. But when the two are put together, the arrangement may become unstable, so some high frequency, possibly about 12,000 cycles, becomes extremely over-accentuated. This is *not* due to the amplifier or the electrostatic loudspeaker, but the combination of *both*.

This particular amplifier, due to its feedback arrangement, does not give the same performance when feeding an electrostatic loudspeaker as it does when feeding the resistance load used for testing it. Another amplifier, with identical characteristics under the test condition with a resistance, will give just as good results with the electrostatic loudspeaker and there will be no over-accentuation of a high frequency.

This deficiency is not unique to electrostatic tweeters. The moving coil or dynamic types often possess appreciable inductance at the extreme high-frequency end. So with different feedback amplifiers, compression driver-type tweeters, which may also have quite a good frequency response, can also show peakiness at the high end.

This erratic behavior of feedback amplifiers results in some very confusing and conflicting results, until the cause is understood. Unfortunately the effect is not one that can be conveniently specified in terms of the performance of an amplifier, because the exact amount of inductance or capacitance, contributed by either kind of tweeter, varies from type to type.

The only way to find out whether this kind of thing will happen with the combination you contemplate is to try it. So we recommend that, before purchasing either kind of tweeter, you try it on the amplifier you have in mind, either by arranging a trial of the unit on your own amplifier at home, or by listening to it in the showroom fed from an amplifier identical with the one you have at home. Failure to observe this precaution may well result in ultimate disappointment with the performance of the added speaker. —50—

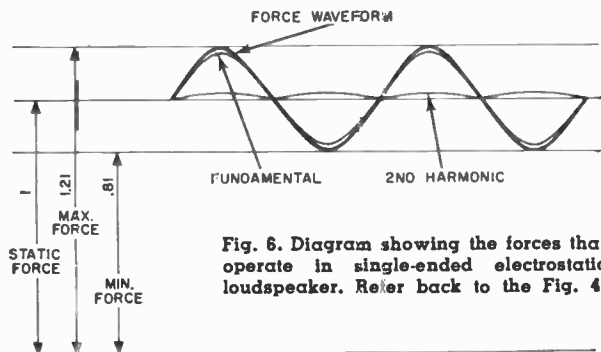
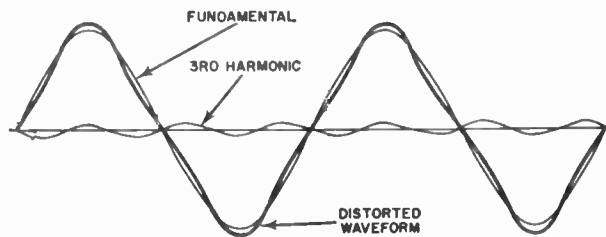

Fig. 6. Diagram showing the forces that operate in single-ended electrostatic loudspeaker. Refer back to the Fig. 4.

Fig. 7. Residual distortion of push-pull unit, due to the change of the speaker's capacitance with diaphragm movement.



"Ultraflex"

Speaker Enclosure

Views of the "Californian, Jr." showing the attractive "wrap-around" grille cloth styling. Rear view with back removed shows the tunnel plate which forms the ducted port.

By **MILTON S. SNITZER**
Technical Editor,
RADIO & TV NEWS

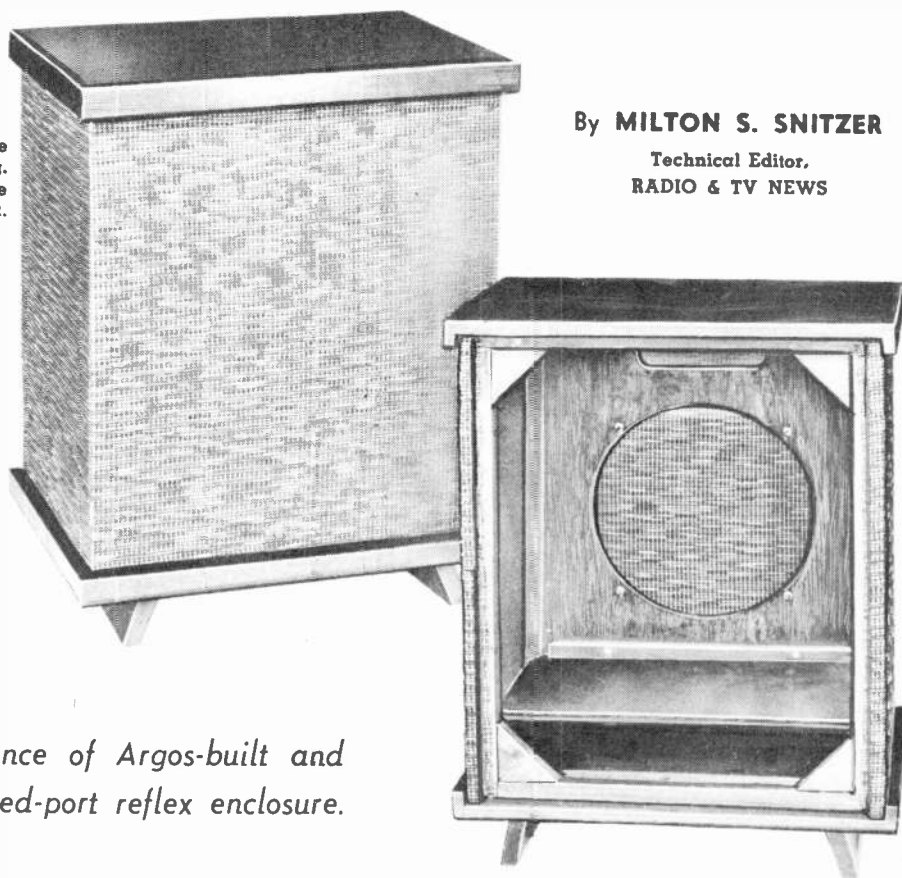

Construction and performance of Argos-built and Jensen-designed small ducted-port reflex enclosure.

IF YOU are looking for a compact, attractively styled, and well-designed enclosure for your 8- or 12-inch loudspeaker, the "Californian, Jr." is for you. Pre-built or available in kit form, this *Argos Products Co.* enclosure (Model DSE-2) is a *Jensen*-designed "Ultraflex," a special type of ducted-port reflex unit. A pair of these enclosures may be used for an inexpensive stereo system.

The actual volume of the "Californian, Jr." is only 2.5 cubic feet. In order that it may resonate at a fairly low frequency of 55 to 65 cps and so be suitable for use with speakers having this order of cone resonance, several expedients are followed. First, a fairly small port area of 24 square inches is used. This lowers the resonant frequency of the enclosure. However,

this usually results in a reduction of bass radiation from the port compared to that obtainable from a larger port-larger volume combination. Second, a 9-inch tunnel plate is installed just above the port in such a way that a duct, extending the entire width of the cabinet, is formed.

Effect of Duct

In order to see just how effective the duct is, we conducted a number of impedance measurements shown in Figs. 1 and 2. These measurements are actually voltage readings taken directly across the speaker voice coil. But since the speaker was isolated from the audio oscillator feeding it by means of a large resistor, the oscillator was, in effect, converted into a constant-current source. Then, as the speaker im-

pedance rises and falls while the current remains steady, the voltage across the voice coil also rises and falls in direct proportion to the impedance. Hence, although the curves are voltage curves, they are directly proportional to the speaker impedance.

First, a fairly low-priced 8-inch coax speaker (*Jensen K-80*) was used. The free-air cone resonance of the particular speaker checked was found to be close to 65 cps (curve 1, Fig. 1). Next the speaker was mounted in the enclosure but the tunnel plate forming the duct was not yet installed. Without the duct the typical double-peaked curve was produced with the peaks straddling the single free-air resonance peak of the speaker alone. Upon examination, though, it can be seen (curve 2, Fig. 1) that the two peaks

Fig. 3. Constructional diagrams for the Argos "Californian, Jr." Enclosure is a ducted-port reflex type which will accommodate a 12-inch speaker and a separate tweeter, if required. An 8-inch speaker may be used in place of the 12 by means of reducer ring shown below. Tunnel plate forms the ducted port required.

NOTES:

1. Mount sound absorbing material on inner surfaces of back, top and one side.
2. Glue and screw all joints except back which is only screwed on; use glue blocks as required.
3. Paint front and side surfaces black as these are to be covered with grille cloth.
4. Cover tweeter port if not used.
5. Feet or casters are added as desired.

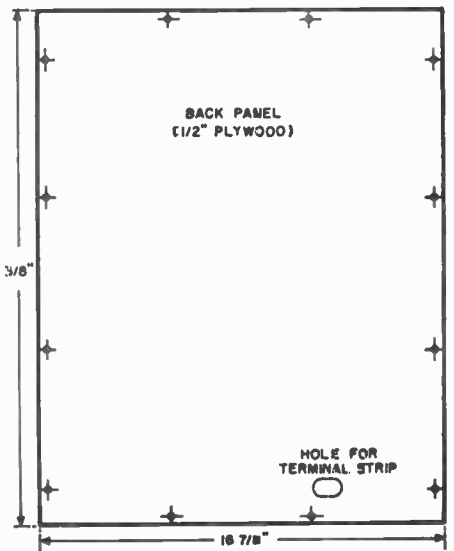
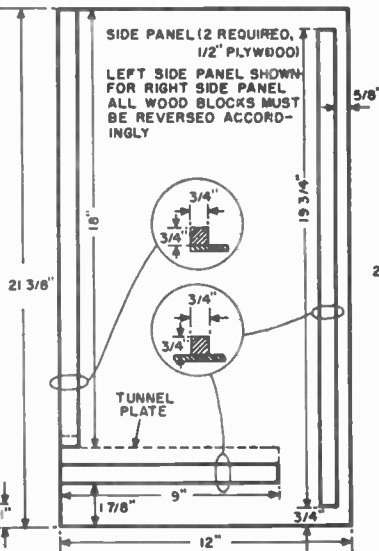
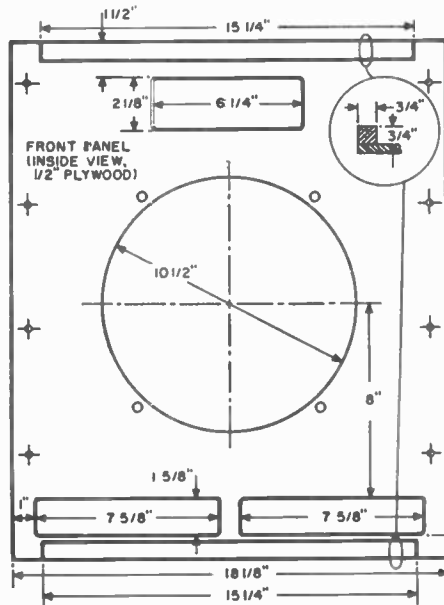
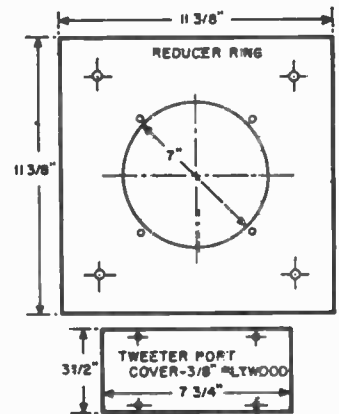
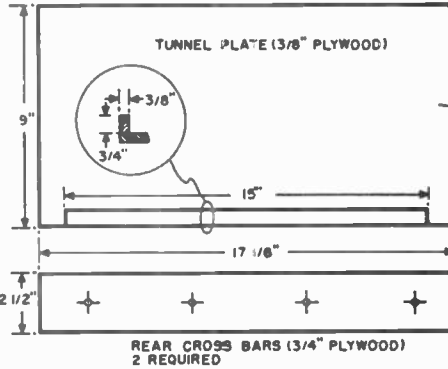
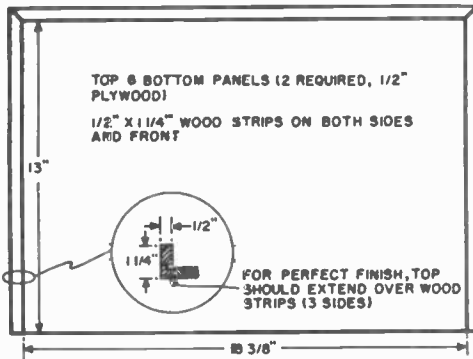
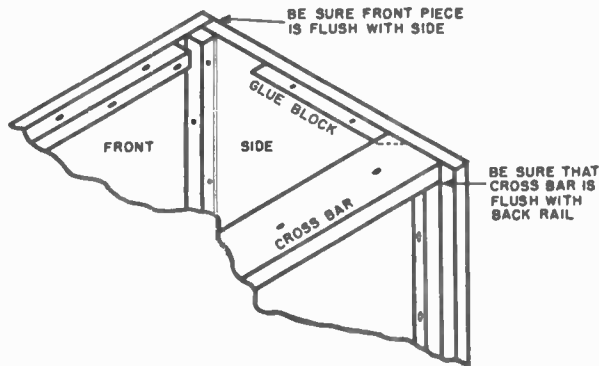
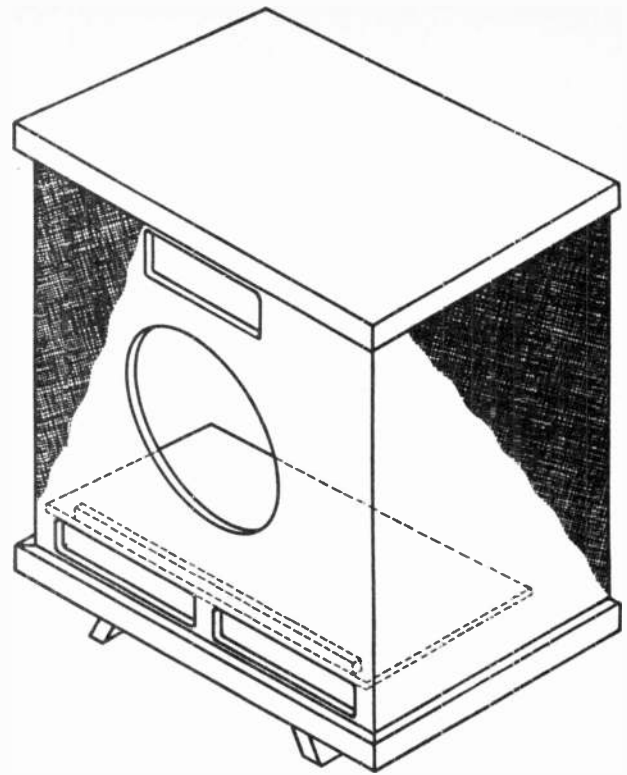

do not straddle the single peak evenly. What is more, the low-frequency peak is just about twice as high as the high-frequency peak and about two-thirds the amplitude of curve 1. This is characteristic of a reflex enclosure that is tuned *too high*. With the tunnel plate installed, note how the picture changes (curve 3, Fig. 1). Both peaks straddle the speaker resonance peak evenly and are of exactly equal amplitude. This indicates a properly matched condition that is the goal in the design of a reflex enclosure.

A moderately priced 12-inch coax speaker (Jensen H-222) was tried next. The speaker on hand was found to have a free-air cone resonance of 60 cps, as shown in curve 1, Fig. 2. With this speaker mounted in the enclosure from which the tunnel plate had been removed, the impedance curve shown as curve 2 results. The lack of symmetry about 60 cps and the greater amplitude of the lower frequency peak again indicated that the enclosure was tuned too high. Finally, the tunnel plate was permanently installed and the resultant curve (curve 3, Fig. 2) occurred. Both peaks have moved lower in frequency so that they now seem to straddle the speaker's resonant frequency quite well. The amplitude of the low-frequency peak has been reduced, but the high-frequency peak has become larger. Even with this increased height, note that the amplitude is only one-third the height of the free-air resonance curve. Curve 3 is usually produced in a reflex cabinet that is tuned too low in frequency; however, in such cases the two peaks do not straddle the single peak of the speaker alone as well as appear to be the case here.

From the foregoing it would appear that if the tunnel plate were not made quite so long, it would be possible to equalize exactly the amplitudes of the two peaks. In an effort to smooth out curve 3, a single, 1-inch thickness of Fiberglas was stretched temporarily across the port. This resulted in a reduction by one-third of both impedance peaks. The Fiberglas was not left in place as it was felt that this would impair the low-frequency output from the small port.

In studying the curves shown in Figs. 1 and 2, it appears that the enclosure would be a good match for any 8- or 12-inch loudspeaker having a cone resonance in the order of 60 to 65 cps.

Performance

Acoustic measurements were taken in an anechoic room with the 12-inch speaker installed in the enclosure. The output was found to be fairly smooth down to about 85 cps, below which the response fell off at a rate of about 12 db per octave. Measurements in a live room showed somewhat greater bass response.

When subjected to listening tests using a good quality 12-inch coax speaker, we found no evidence of boominess. What is more, there was no evidence of cabinet rattles or buzzes even

at high volume levels. Of course, it is possible to get more bass response from larger enclosures, but the output of a good speaker in this enclosure was pleasantly balanced.

Construction

Complete details concerning the construction of the speaker cabinet are shown in Fig. 3. Dimensions are given for all parts with the exception of the legs, which naturally do not affect the acoustic design, and for the glue blocks, which should be used where the sides meet the top and bottom. Not required when the enclosure is constructed at home are the triangular corner blocks that may be seen in the photograph of the inside of the unit. These are used in the factory-built version to prevent damage during shipping.

As the first step in the construction of the cabinet the wood strips, blocks, and rails should be glued to the top and bottom panels, the tunnel plate, the front panel, and the side panels as shown. This step is already done if the kit is obtained. Next the sides are glued and screwed to the front panel. The two rear cross bars are then added and the frame is now ready to be squared. When you are sure that the frame is perfectly square and true, you are ready to tighten securely all the bolts.

Next, fin-shanked or T-bolts are installed for the speaker. If an 8-inch speaker is to be used, the reducer ring is installed. Then acoustic grille cloth is tacked to the rear edge of one of the sides; it is then stretched tightly over this side, over the front, and over the other side, where it is tacked to the back edge. The top and bottom panels and the tunnel plate are then glued and screwed into place. Finally the feet are installed, soundproofing material is tacked to the inside surfaces, and the speaker is bolted into place. Speaker leads are connected to a terminal strip in the back panel, which can now be screwed tightly into place.

Since the entire front and both sides of the enclosure are completely covered with grille cloth, it is only necessary to finish the top surface and its edges, the edges of the bottom panel, and the legs. In the case of the kit or pre-built unit, this has already been done by the manufacturer. The finish supplied, either in blonde or mahogany, is a hard plastic, wood-grained material, which resists stains, burns, and scratches.

We were particularly pleased with the simplicity with which the kit could be assembled and with the professionally finished and attractive appearance of the enclosure that was apparent just as soon as the last screw holding the back on was tightened.

Fig. 1. Impedance curves obtained with 8-inch loudspeaker unit.

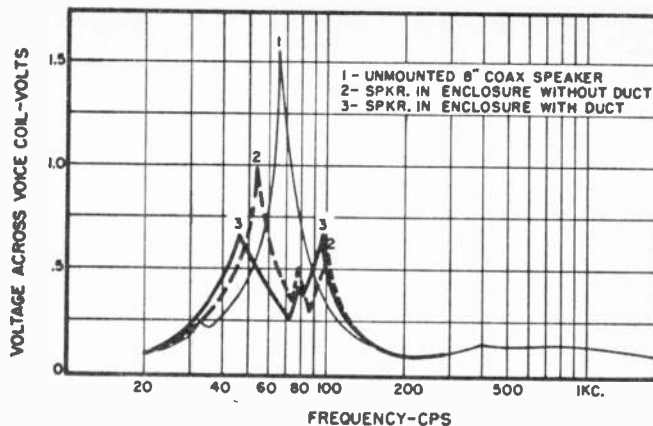
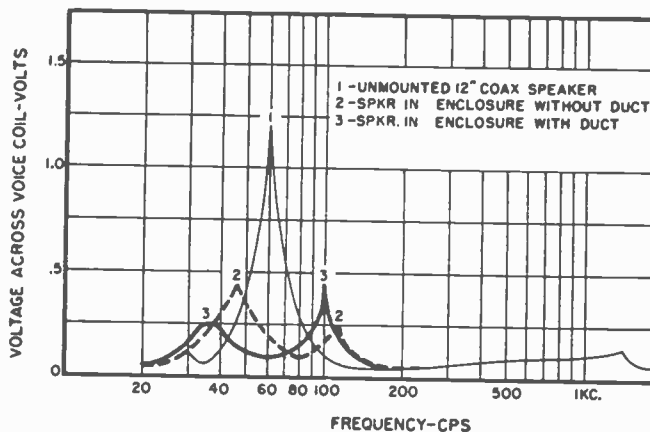
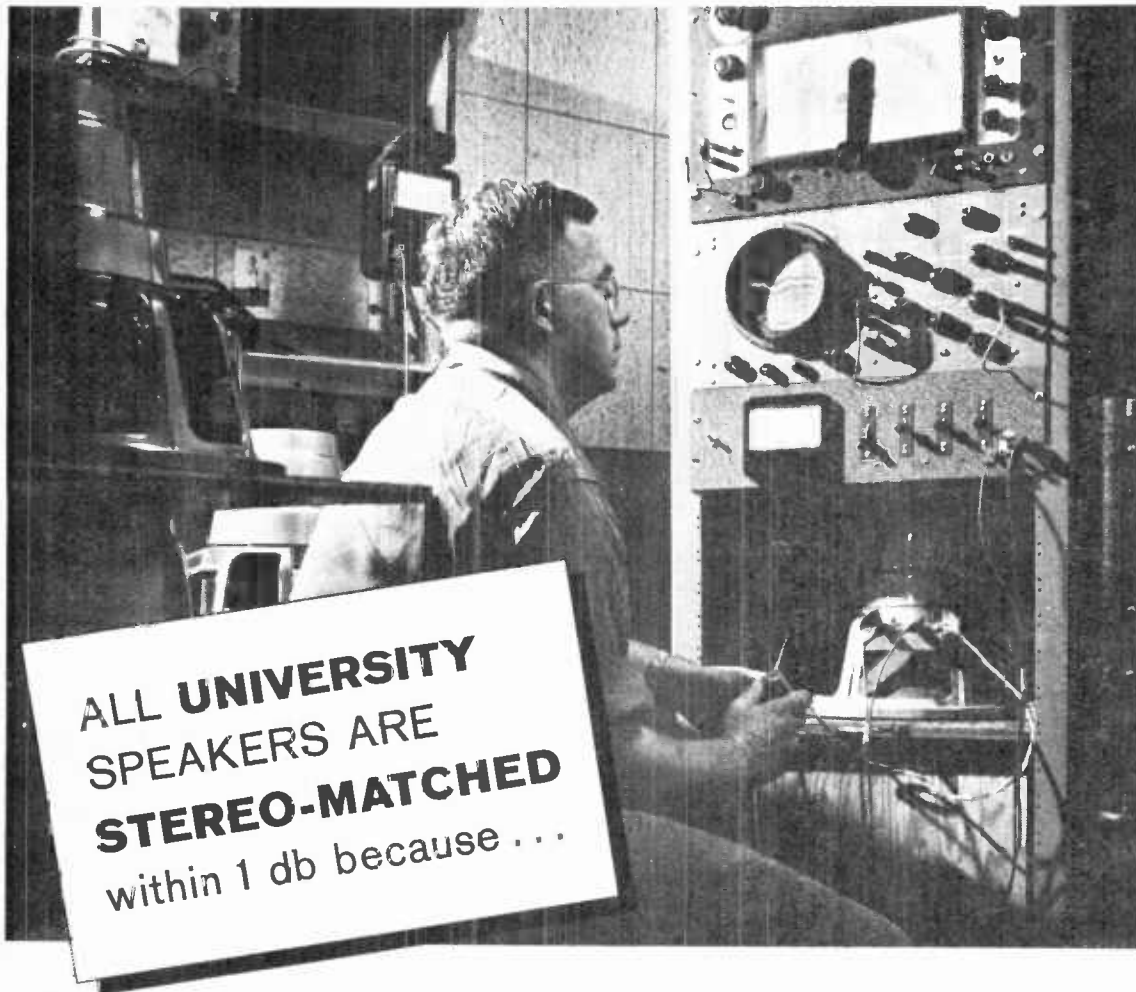

Fig. 2. Impedance curves obtained with 12-inch loudspeaker unit.



This is part of one of the four testing bays at University where each speaker that leaves the factory goes through a series of exacting tests. Here we see a Medel 315-C 15" 3-way Difaxial being tested for frequency response. As the speaker is "swept" through the entire frequency range, its audio output is fed via a sound box, microphone and amplifier to the oscilloscope where marker lines check that it conforms to laboratory standards within 1 db.



Only properly matched speakers... matched to produce the same frequency response, tonal balance and sound output level throughout their specified ranges... can achieve true high fidelity stereo. "Mismatch" in the all-important directional mid and treble ranges, can cause an unwanted shift of emphasis from one speaker to another. "Mismatch" in timbre or tonal balance becomes especially disturbing where the voice or instrument actually moves from one channel to another... as in opera, marching bands, or special effects. Also, the harmonic relationship between fundamentals and overtones must be reproduced identically so that both channels match in tone and timbre.

That's why engineers advise you to use matching speakers or speaker systems for stereo—preferably the same models from one manufacturer. But if production standards change if tight quality checks aren't maintained, even speakers in the same production run, with identical model numbers, may be mismatched. No problem with monaural. Bad for stereo. But a risk you need never take with University!

Every University speaker or system matches the frequency response and sound output level of any other of the same model within 1 db.

If you now have a University speaker, you are indeed fortunate, because you can go to any University dealer anywhere and get a speaker that matches perfectly for stereo.

If you are planning stereo from scratch, or starting with monaural for later conversion, University's famous P-S-E (progressive speaker expansion) plan gives you complete loudspeaker planning flexibility. Start with any two wide-range speakers to fit your budget... simply add complementary speakers whenever you wish to achieve your ultimate aspirations. Whatever your choice, you can be assured of perfect stereo performance.

...THAT'S WHY UNIVERSITY IS THE SAFEST, MOST LOGICAL CHOICE FOR STEREO!

For FREE LITERATURE on all University speakers, speaker systems, enclosures and kits — plus the full P-S-E story—write Desk W-27, University Loudspeakers, Inc., 80 South Kensico Avenue, White Plains, N. Y.



LISTEN

University sounds better



PERFECT FOR MONAURAL... PERFECTLY MATCHED FOR STEREO...

there's a University speaker or system to meet your space or budget requirements.

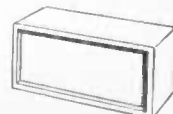
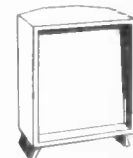
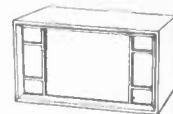
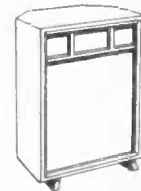
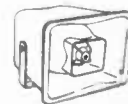
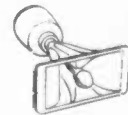
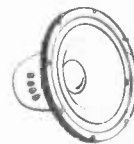
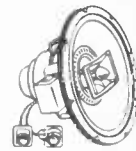

Choosing Your Crossovers

By
NORMAN H. CROWHURST

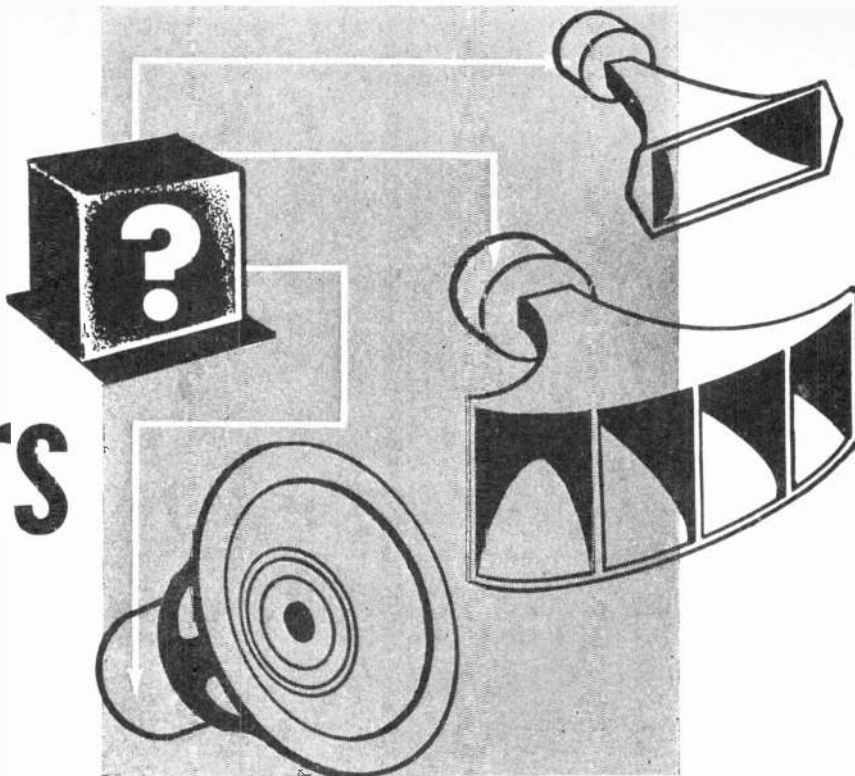

What crossover frequencies and circuits should you use in your 2-, 3- and 4-way hi-fi speaker systems?

WHEN you set out to choose your hi-fi loudspeaker installation, you probably do not choose the crossovers as a separate entity, it is true. But different systems offer quite a variety of different crossover frequencies and rates of roll-off, etc., so you will want to know what it is that governs this choice. How many crossovers (two-, three- or four-way system), what frequencies are used for crossing over, and how sharply do the crossovers act are questions to which each system gives different answers.

How Many?

On the question of how many crossovers, there are two extreme schools of thought. One of these favors no crossovers at all—a single extended range loudspeaker unit, that responds to all the frequencies in the audio range. According to protagonists for this approach, you will avoid all the phase shifts and all the problems that crossovers “get you into.” What you don’t avoid, however, is the problem of getting one loudspeaker unit to respond to a frequency range covering the ratio of 1000 to 1, from 20 cycles to 20,000 cycles. Even if you are content with a slightly less ambitious range, say from 40 cycles to 10,000 cycles, this is still a tremendous range of frequencies to cover with one vibrating system.

To radiate the low frequencies satisfactorily, it must inevitably have a large surface area exposed for radiation. To radiate the upper end satisfactorily it must be extremely light and rigid, to avoid the kind of break-up that causes erratic response to consecutive frequencies.

Another requirement is that it shall not introduce any distortion. If there

is any distortion in the way it handles the lower frequencies with the large movements they involve, this will also modulate the higher frequencies, besides causing distortion components to the low frequencies themselves. This intermodulation, as it is called, gives a “dithery” rendering of programs when low frequencies and high frequencies occur at the same time, and can be particularly noticeable on material like organ music.

It is practically impossible to make a loudspeaker unit with perfectly uniform response over a range of even 250 to 1 (let alone 1000 to 1) and also with absolutely no distortion, particularly of the lower frequencies. The use of crossovers proves to be a boon in helping out, both to achieve a uniform frequency response and minimize intermodulation distortion. This leaves us with the question, how many crossovers, and where?

Here the protagonists of the opposite extreme come in by pointing out that serious intermodulation distortion can only appear when more than one octave is handled by the same loudspeaker. Consequently it would be good to have 10 loudspeaker units, each covering an octave and thus completing the range from 20 cycles to 20,000 cycles. The first loudspeaker unit would cover from 20 to 40 cycles, the second 40 to 80, the third 80 to 160, the fourth 160 to 320, and so on, up to 20,480 cycles. This would necessitate nine crossovers between the 10 units.

Of course, there is no comparison between the effect of these two ex-

tremes on the budget requirement. However good a single extended-range loudspeaker unit is made, it would never approach the cost of 10 separate units, each made for its own frequency range, with nine crossovers. So it might appear that the number of crossovers you use depends on your budget. But before our millionaire readers proceed to order 10-way loudspeaker systems, it should be pointed out that this extreme is not the ideal either.

While, if well designed, it would certainly do a wonderful job of providing a smooth frequency response and freedom from IM distortion, this is not all that is required of a system. In fact, from some aspects, it is not even the most important thing required of a system.

Smooth frequency response, as measured by steady tone testing, is one thing, but a smooth frequency response, as judged by listening to program material, often proves to be quite a different matter. This is because our listening is much more dependent upon the transient response of the system than its response to the steady tones used for testing.

If you put a loudspeaker inside the voice box of a pipe organ and opened all the pipe valves, the frequency response of the system, measured with a continuous gliding tone, would come out pretty close to flat. But can you imagine what the loudspeaker would sound like? You’ve guessed it, like a program being heard through a mass of tuned pipes. A 10-way system, it is true, would not be quite as bad as this,

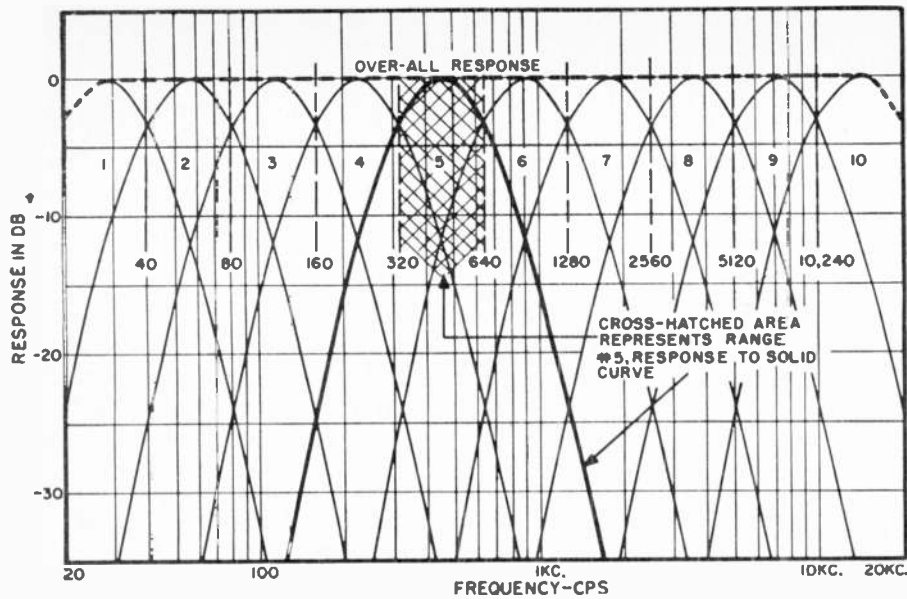

Fig. 1. Above curves show the division of the entire audio spectrum into ten octaves. This may be regarded as the very "ultimate" in the number of crossovers.

but it would follow the same general trend.

Each octave bandpass filter will need to have sharp cut-offs at each side if we are going to take full advantage of the way this system can minimize intermodulation distortion (Fig. 1). This would mean that tones in each band would set up a kind of ringing from the loudspeaker on the particular tone played, caused by the characteristics of the filter. It is true the "ring" would not be so pronounced as with a tuned pipe, but it would still result in reproduction with considerably more coloration than the simpler types of systems despite the fact that the steady tone response looks flat.

So there are disadvantages to both extremes. As a compromise, most loudspeaker systems now fall into the two-way or three-way classes, with a few going to four-way. Having narrowed down the number of crossovers to

choose, we can now take the next question.

Where?

If you pick a two-way system, the logical crossover frequency will be somewhere in the region of 600 cycles. Actually anywhere between 400 and 1000 cycles would be satisfactory. The reason for this is that, whether you consider you need the frequency response to be from 20 cycles to 20,000 cycles, or from 40 cycles to 10,000 cycles, the middle of the range comes out to about 630 cycles. Since both halves are 4 or 5 octaves, it is not critical, within half an octave or so, to have the frequency at precisely 630 cycles. Anywhere between 400 and 1000 cycles will divide the spectrum approximately into two equal parts (Fig. 2).

If you take a three-way system and consider the spectrum as extending from 40 to 10,000 cycles, which is more

like a reasonable extent, because there is very little audio "intelligence" in the 20 to 40 cycle range and in the 10,000 to 20,000 cycle range, dividing this part of the spectrum into three approximately equal parts will require crossovers at 250 cycles and 1600 cycles (Fig. 3).

This choice of frequencies brings an interesting fact to light: 250 cycles is approximately the frequency of "middle C." Frequencies below this correspond to the bass part of musical reproduction, while frequencies above this correspond to treble. So this division gives us one band in the bass and two for the treble. Actually the range from 250 to 1600 cycles could be regarded as the treble, while the extreme high-frequency range from 1600 to 10,000 or 20,000 cycles is principally occupied by overtones and transients that provide definition. In speech the principal components in this top range are the consonant sounds due to "s," "t," and "d."

Dividing the spectrum four ways would require crossovers at approximately 160 cycles, 630 cycles, and 2500 cycles (Fig. 4).

This consideration has been based entirely on a consideration of the frequency spectrum. If you consult loudspeaker catalogues you'll find few systems that conform to the figures just given. This is because there are other factors that complicate the choice. Wherever you divide the spectrum, by means of a crossover, the lower frequencies are going to be reproduced by one loudspeaker while the frequencies above this point come from another. In a musical program, it is inevitable that the fundamental tones and possibly some of the lower harmonics of certain instruments will be reproduced by one loudspeaker while other overtones or higher frequencies will come from another unit. This is one of the undesirable features of multi-way systems.

Another factor that needs some consideration is the distribution of the dominant sound energy through the frequency spectrum. This should not be confused with the apparent loudness of different frequencies. Most curves of average energy spectrums will show there is not much in either speech or music below 100 or 200 cycles. But here the word *average* is important, especially for music. Bass notes are only evident in comparatively few passages, which is why an average curve shows them low. However, when low notes are present, they have considerable energy, and the system has to reproduce this energy—not an average figure.

At the other end, there is not much energy in speech above 500 to 1000 cycles, but the small energy present is very important to intelligibility, to carry consonant sounds, particularly "s," "t," and "d." Musical energy, too, tails off above 1500 to 2500 cycles, except for short bursts from the percussion, which again do not show up on an average curve. So a system should

Fig. 2. When a two-way system is employed, the use of a crossover in the region of 600 cycles divides the entire audio spectrum into two equal portions.

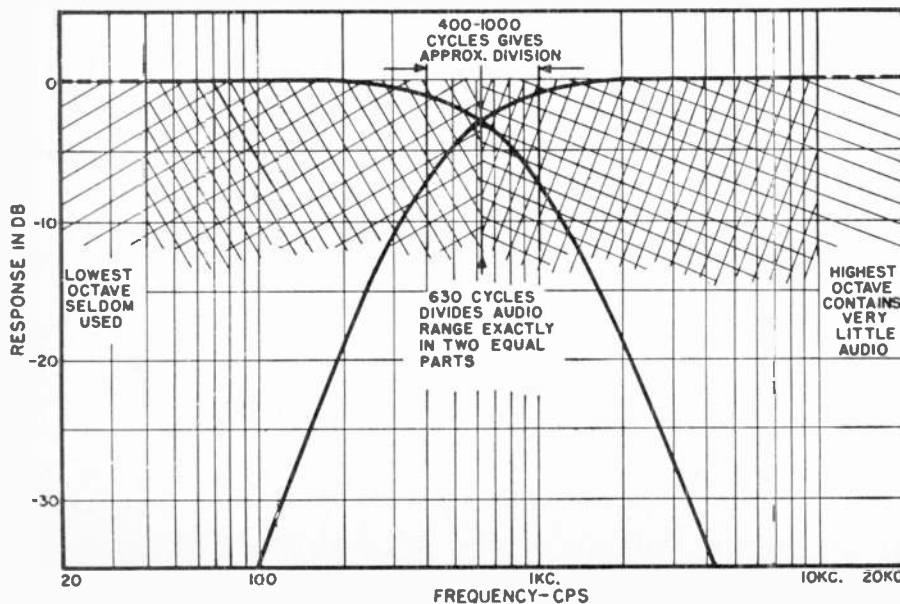

be able to handle more or less uniform power peaks over the range from about 40 to 2500 cycles, and should be reasonably flat in response (at lower levels) from 20 to 20,000 cycles or, as a secondary standard, from 40 to 10,000 cycles.

Consequently a more usual approach is to cover as much as possible of the frequency range with the mid-range unit. That is, we take as much as the mid-range unit can comfortably handle without running into difficulties with frequency response and intermodulation, then the part that the mid-range unit cannot comfortably handle is delegated, at the low end to the woofer and at the high end to the tweeter.

Fortunately this integration problem is not very important at the low-frequency end. By the time you get down to 250 cycles, the wavelength is four feet. As the biggest loudspeaker system doesn't usually exceed this dimension in one direction, you are not going to suffer noticeable lack of integration between frequencies below and above 250 cycles, or any similar crossover frequency for that matter. So, to maintain good integration, the usual practice is to use as low a crossover as possible without running into intermodulation problems.

How Much?

So much for the question of the different possibilities in frequency of crossovers. Next we come to the sharpness of the slope. Different crossovers employ different degrees of separation between the frequencies. The simplest kind of crossover uses just an inductance or a capacitance for each individual channel. This provides an ultimate roll-off of 6 db per octave beyond a frequency of about 2 to 1 each side of the crossover (Fig. 5).

As soon as you get into more complicated crossovers that produce an ultimate roll-off of 12 db, or more, per octave, there are phase shift problems and also the transient response is likely to suffer. With a 12 db per octave crossover (Fig. 6), the two voice coils should be connected in *opposite* phase, otherwise at the crossover frequency they will be moving in opposite directions and cancel, producing a "hole" in the frequency response.

This means that phase reversal occurs with this kind of crossover, through the transition from one side of the crossover frequency to the other. In theory this could convert a square wave into a triangular one. But demonstrations have shown that such a change makes no *audible* difference. The more important difference is in transient response. We begin to experience the effect described with the 10-way system. The transition from one unit to the other in the vicinity of crossover is less likely to be satisfactory.

So why use steeper slope crossovers? The only satisfactory reason is for minimizing the intermodulation distortion. Another reason that has been advanced is the possibility of interference between the frequency response

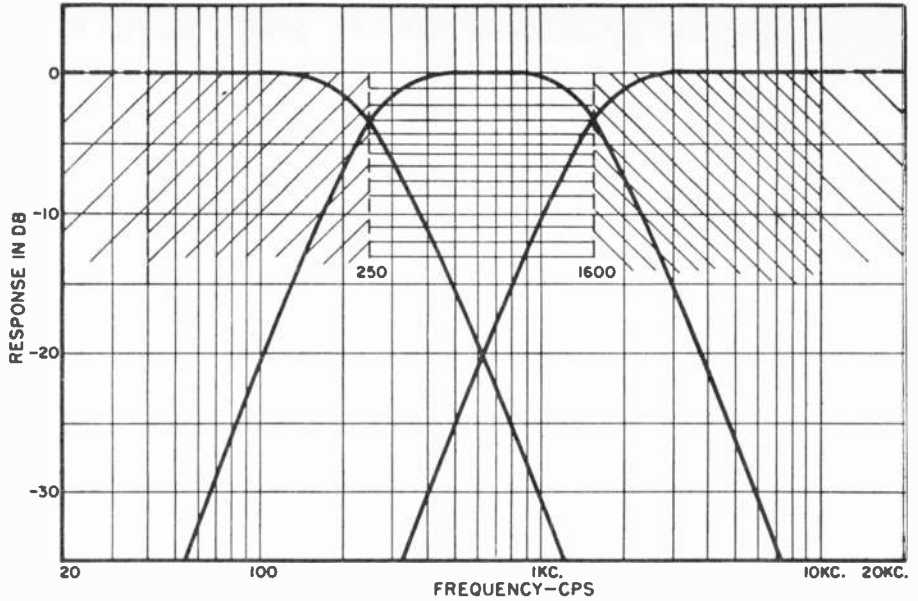

Fig. 3. If it is desired to divide the more useful part of the entire audio spectrum into three equal portions, crossovers would be required at the frequencies of about 250 and 1600 cycles. A three-way system would use such values.

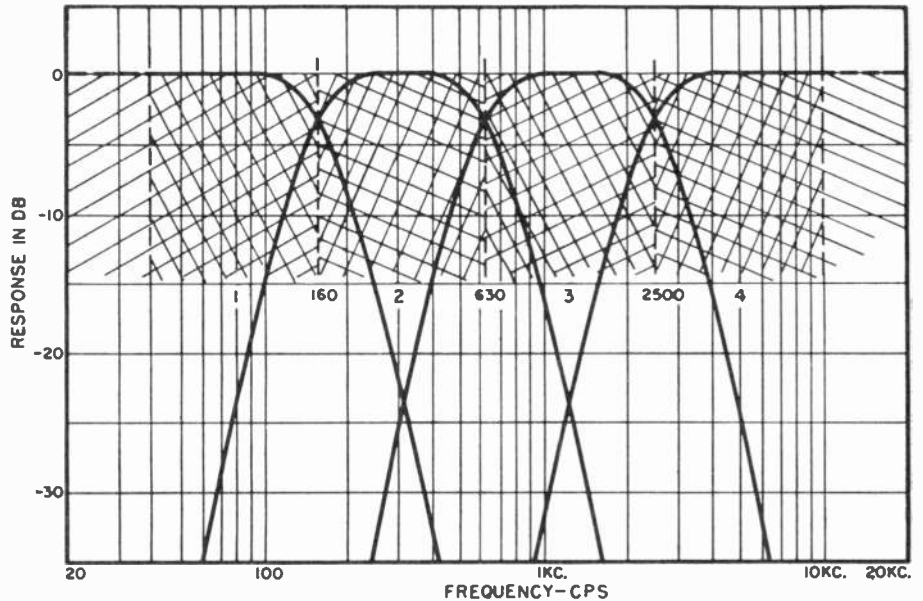

Fig. 4. With a four-way system, crossovers should be as shown. The lowest channel would then handle frequencies up to 160 cycles; channel 2 would cover 160-630 cps; channel 3, 630-2500 cps; and channel 4 would cover all above 2500 cps.

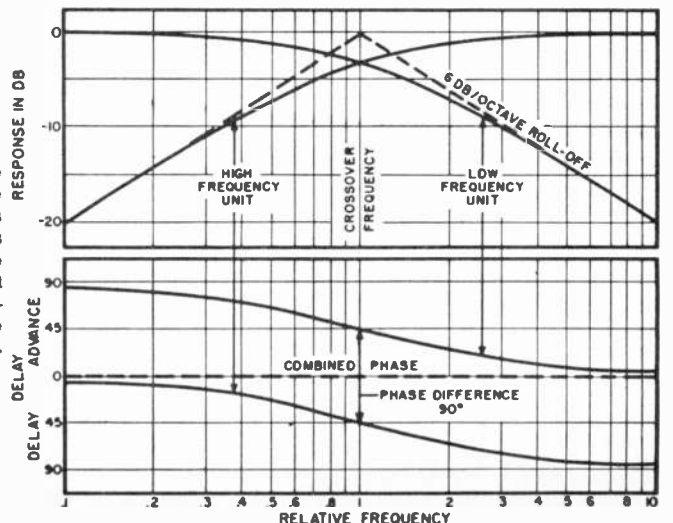

Fig. 5. Here are the amplitude and the phase response curves for crossover networks having a 6 db/octave slope. Note that at the crossover frequency the phase difference amounts to 90 degrees.

from the two units. This will only occur if the frequency response from one unit becomes quite erratic *immediately beyond the accepted frequency range.*

For example, a loudspeaker intended to reproduce up to 600 cycles might show some erratic peaks and valleys in the region of 1000 cycles. This could seriously interfere with the over-all response when combined with a separate high-frequency unit, if the crossover was of the simple type (See illustration Fig. 7).

The answer to this argument is that a unit that becomes erratic in its response so shortly beyond the accepted frequency range is probably not a very good unit *within* the accepted frequency range, although its response may look good. Its transient response will certainly not be as good as the steady tone response.

Not only does the crossover have to take care of delivering the right range of frequencies to each unit, with uniform coverage, but sometimes adjustment for balance is needed too. This is because often tweeters are more efficient than woofers or mid-range units. If the tweeter unit is twice as efficient, then feeding it straight-through from the crossover will make the tweeter give twice the acoustic output it should to maintain balance. To care for this, a good crossover should incorporate an attenuator, or balance control, so the output *in acoustic watts* can be balanced to take care of differences in efficiency between units.

This brings up another question—

what controls to look for on a crossover. In turn, this could lead into a much more complicated article, because there is such a variety of ways adjustments can be made; but let's keep it simple. Only electronic dividing networks have continuously variable controls, either of crossover frequency or slope of roll-off, and that's another subject. But some crossovers for use in loudspeaker circuits have adjustments that can be made in steps, either to change the slope or the frequency. This may be done by changing capacitor elements, or by changing taps on inductors, or both. If you buy a unit with these facilities, make sure it comes with sufficient instructions, so you know *exactly* what it can do. Don't be satisfied with a vague promotion statement, such as "this unit is adjustable to suit your system's exact requirements." Having three or four possible ways of connecting it will probably insure that one way will sound better than the others, but it does not insure that any of them are *right*.

You would do better to buy a unit with only one (right) way of connecting it, than a "versatile" unit with inadequate information, so you do not know what each position does. If it comes with complete information you will be able to check that it does provide facilities for crossing over where you want it to, and for feeding units at the impedance of your system (4, 8, or 16 ohms).

We have spoken about the question

of integration. A few more words of explanation might be in order here. By integration we mean the radiation of sound as if the whole frequency spectrum "belongs." This can perhaps best be illustrated by showing what results without it. If a loudspeaker consists of two units, say one handling below 600 cycles and the other above, and the low-frequency unit gives a good smooth response radiated uniformly into the room, while the high-frequency unit tends to eject its frequencies in a concentrated beam, away from the low-frequency unit, one can easily get the impression that the high frequencies in the audio spectrum are "squirted in" as an afterthought from the side.

This is quite unrealistic on musical reproduction, and on speech it can become distressing. The principal high frequencies in speech are due to the sibilants, "s's" and so on. Lack of good integration will give the impression that most parts of the voice come from the low-frequency unit, while the "s's" are added from some completely different direction. This is even more unnatural than the effect on musical programs.

To summarize, then, the question of choosing a loudspeaker system and what crossovers to utilize in it, depends to a considerable extent upon the rest of your system.

If you have a larger-than-average living room to supply with sound, or if you intend to operate at unusually high levels, with an amplifier of 50 watts or more, then intermodulation is likely to trouble you, and a three- or four-way crossover is advisable.

For more average sized living rooms and moderate levels of reproduction, a three-way crossover will certainly be adequate, and for smaller systems a two-way crossover is quite sufficient.

The best choice of crossover frequency(ies) and the sharpness of the crossover is dependent upon the types of units used. While there are broad principles, based on the frequency spectrum itself, these are modified to a considerable extent by the effectiveness of the units. In most instances, combinations put out by a single manufacturer usually incorporate the best crossover frequency for that combination.

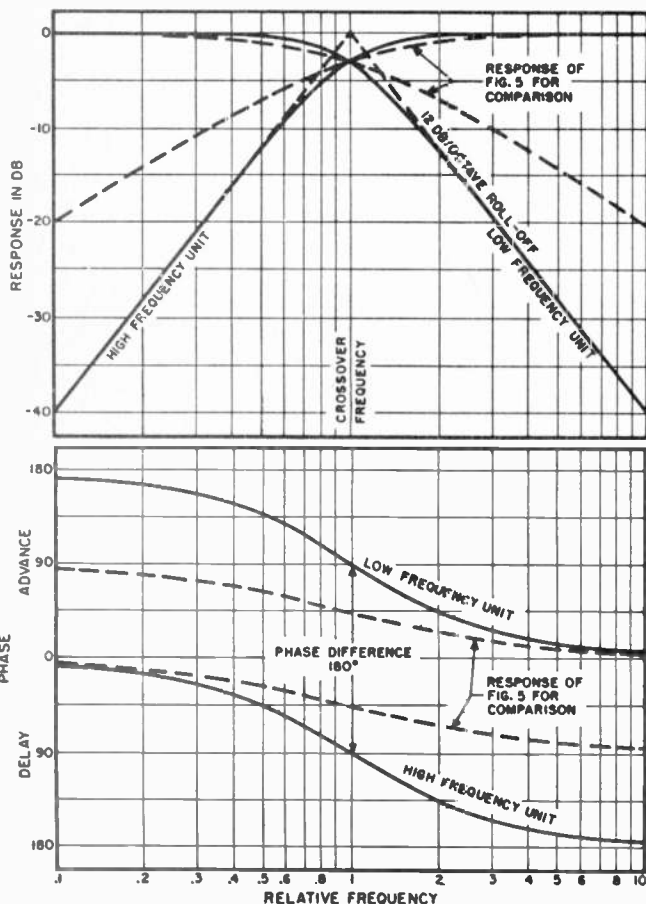

← Fig. 6. Relevant details of amplitude and phase response for the 12 db/octave crossover network compared with the 6 db/octave unit (dashed).

Fig. 7. These curves show why the response that exists beyond the accepted range (of the low-frequency unit in this case) can be important to the system. ↓

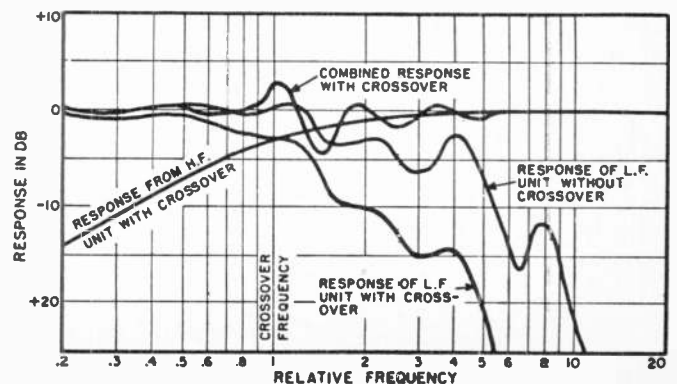

Speaker Damping

with Series Resistor

Effects on loudspeaker response when amplifier's effective damping is reduced by series resistor.

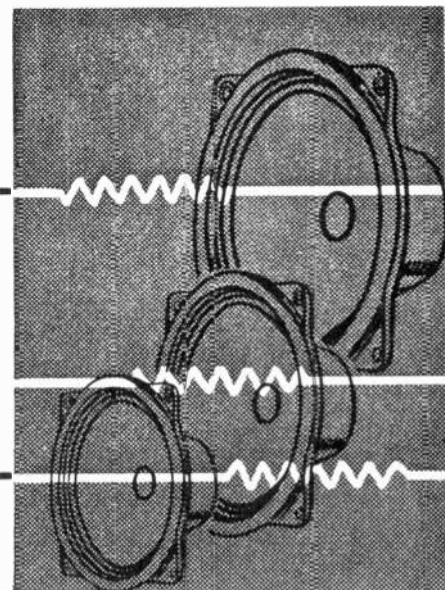

FAIRLY recently, the questions "What is an amplifier's damping factor?" and "What damping factor should be used with a particular loudspeaker system?" have become rather common. Some aspects of the damping factor question have been answered already, but there are a good many other factors which we are just beginning to probe. A thorough discussion of these factors would involve the amplifier used and its circuitry, particularly the output transformer, as well as the speaker used and its enclosure. This article will confine itself to only one small phase of the subject, and that involves the modifying of an amplifier's effective damping factor simply by the addition of a series resistor in the loudspeaker circuit.

As a result of our recent assembly of a Heathkit "Legato" speaker enclosure system, your editors became quite curious as to the purpose of a certain series resistor that the kit manufacturer included. This resistor has a value equal to the nominal input impedance of the speaker system and it was recommended that the resistor be inserted in series with the speaker system if it were to be used with a power amplifier that does not have variable damping.

Assume, for example, that our speaker is connected to the 16-ohm output tap of a certain amplifier and we find that the actual source impedance of the unit is 2 ohms. Then the damping factor of this particular amplifier is $16/2$ or 8. In general, as more negative feedback is used, the amplifier's source impedance falls, its damping rises, and its damping factor* increases. Modern tetrode amplifiers have damping factors on the order of 1 to 10, depending on the amount of feedback used. "Ultra-Linear" circuits may have damping factors ranging from 10 to 30.

Now what happens to our amplifier's damping factor when we insert a series resistor that is equal to the nominal impedance of the loudspeaker? Actually, we have not changed the am-

plifier itself so that one might say that its damping factor is unaffected. But as far as the loudspeaker load is concerned, the effect is just as though the damping factor of the amplifier has been reduced to just under 1. In the example just given, the effective damping factor with an added 16-ohm resistor is $16/(2 + 16)$ or about .9.

Following the kit manufacturer's instructions, then, would have produced a system with a damping factor of about 1. Note that the use of the resistor was not recommended when the speaker system is to be used with an amplifier having provision for variable damping. Under these conditions it would be possible to adjust the damping control for a damping factor of 1 without using an external series resistor. Readers familiar with the AR-1 speaker system will recognize that a similar arrangement is used there. A series resistor having a value that is close to the speaker's nominal impedance is used to lower the effective damping factor of the power amplifier used to drive the system.

In order to see (and hear) the effect of this series resistor, we made certain measurements which we have shown here. A fairly inexpensive 15-inch 8-ohm woofer mounted in a bass-reflex enclosure was used for all tests. No attempt was made to check the matching of enclosure to speaker (although the curves show that it was quite good). Nor were we particularly interested in the over-all response of the speaker itself. What we were interested in was strictly a comparison between the operation of the speaker both with and without a series 8-ohm resistor. In all cases the measurements were taken using an amplifier having a very high damping factor.

The curves shown in Fig. 1 represent the impedance seen by the ampli-

fier under the conditions of loading simply by the loudspeaker itself and then when loaded by the loudspeaker and a series resistor. Impedance measurements were made at the points marked "X" in the diagram. It can be seen that there are less impedance variations seen by the amplifier when the loudspeaker circuit employs the series resistor. When the resistor is not used, the ratio of impedances from peak to trough (bottom curve) is 64 to 8 or 8 to 1. When the resistor is inserted (top curve), the ratio of peak to trough impedances is 70 to 16, or less than 4.5 to 1. Thus, with the series resistor inserted in the loudspeaker circuit, the amplifier sees less variations in impedance. The reason for this difference in impedance is that in the trough area the speaker impedance is almost wholly resistive and, therefore, adding an 8-ohm resistor to the 8-ohm impedance of the speaker results in a total impedance of 16 ohms. However, in the peak areas, the impedance of the speaker is only partly resistive and has greater motional impedance. Therefore the effect of the rather small series resistor compared with the rather large peak impedance is markedly less.

The addition of the resistor actually unloads the amplifier and effectively reduces the damping factor. Without the resistor, the speaker sees the low internal impedance of the amplifier. With the resistor, it now sees a higher internal impedance and, therefore, the system is less heavily damped.

The voltage curves of Fig. 2 were obtained directly across the speaker itself. The top curve was obtained with no resistor in the circuit. Note that the voltage across the speaker is quite constant over the entire range. The amplifier is operating as a constant voltage source with a high damping factor. But with the resistor in the circuit (lower curve), quite a change occurs as a result of de-regulating the amplifier. Note that in the trough area around 200 cps the volt-

* The damping factor of an amplifier is defined as the ratio between the nominal output impedance and the actual measured output impedance seen by the load. Refer to the article "Control of Amplifier Damping Factor" by David Hafler in the July, 1955 issue.

age being applied to the speaker is only about one half of the input. This is to be expected since in this region the speaker impedance is about the same as the resistance of the series resistor so that the voltage divides equally between speaker and resistor. At the location of the two impedance peaks at 40 and 80 cps, however, the voltage applied to the speaker rises to practically the full value of the input. This is also to be expected since the speaker impedance has risen to a high value at these two frequencies. As a result, most of the applied voltage appears across the speaker while only a very small amount is lost across the series resistor. The voltage curve now shows two peaks corresponding to the impedance peaks in Fig. 1. Somewhat the same effect takes place at the higher frequencies. Above 1 or 2 kc. as the speaker impedance continues its gradual and normal rise with frequency, more of the applied voltage appears across the speaker and less voltage is lost across the series resistor. It can be seen, then, that the lower curve rises gradually toward the upper curve at the higher frequencies.

Speaker Response

Now what does all this mean as far as the final performance of the system is concerned? We might guess that in accordance with the lower curve of Fig. 2 there would be a loss of response by about 6 db at the mid-frequencies around 200 cps. This would result from the fact that only one half of the input voltage would be applied to the speaker. Then, at the frequencies of the impedance peaks, an increased output should occur. Examination of the curves of Fig. 3 shows that this is what actually takes place. The upper curve shows the acoustic output of the speaker without the resistor in place, while the lower curve shows the acoustic output using the resistor. Note that the curve with the resistor is about 6 db lower than the other curve at frequencies around 200 cps. Then at lower frequencies, on the order of 70 to 80 cps, the response rises to almost that value of output obtained without the resistor. Actually, if the upper curve is superimposed on the lower one such that the responses at 200 cps coincide, then it is easy to see the amount of "gain" in low-frequency response due to the series resistor. Much the same effect occurs at the higher frequencies, above about 1 kc. Since the speaker in use had no measurable output below 40 or 50 cps, no effects could be noted here.

The addition of a series resistor would thus seem to be quite useful when a heavily damped speaker is used since the bass output of such speakers is frequently quite low unless proper loading is supplied by the enclosure. The resistor would appear to be most useful when such speakers are installed in infinite baffles where the bass response is not particularly enhanced.

When the 8-ohm resistor is inserted

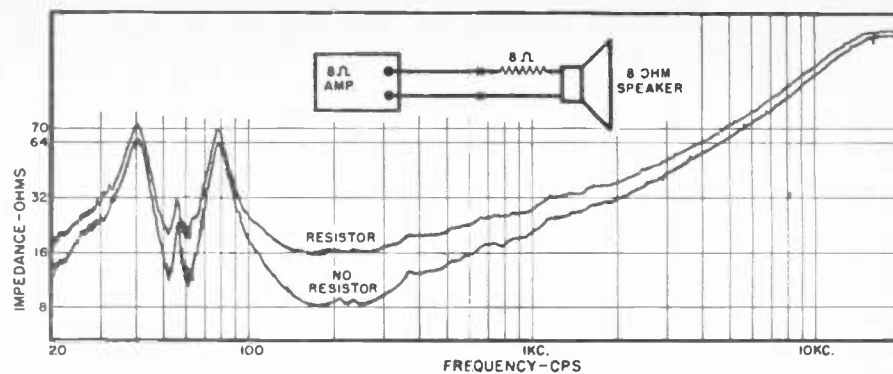

Fig. 1. Impedance curves of 8-ohm speaker in tuned baffle with series resistor.

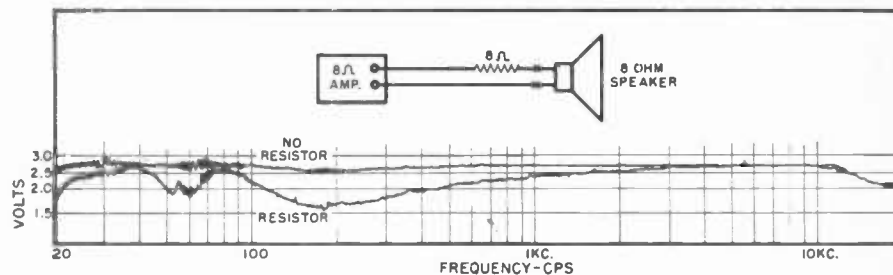

Fig. 2. Voltage delivered across the voice coil from a constant voltage source.

in series with the 8-ohm speaker, then the primary impedance of the output transformer is increased. As a result, there will be an impedance mismatch to the plate circuits of the output tubes. This means, then, that not only will there be a power loss in the series resistor itself, but there will also be a power loss due to the mismatch. To minimize the effect of this mismatch, it is recommended that when such an arrangement is used, connection should be made to the 16-ohm tap on the output transformer instead of the 8-ohm tap, which would be used for the speaker without the resistor. In the case of a 16-ohm speaker used with a 16-ohm resistor this would, of course, not be possible unless the output transformer had a 32-ohm tap. In this case, then, we would have to tolerate the added power loss. With amplifiers that

use a large amount of negative feedback, the change in power delivered due to the mismatch may not be too significant.

One final effect of an impedance mismatch should be considered and that is the change in distortion that would occur. In some cases, a rise in the primary impedance of the output transformer would result in more distortion, in other cases it would result in less distortion. What happens to the distortion depends on the circuit configuration and the operating conditions. In some circuits using push-pull pentodes operating class A or AB₁, distortion is apt to increase with an increase in load. On the other hand, with most circuits using push-pull triodes or push-pull pentodes operating class AB₂ or "Ultra-Linear," distortion will usually be reduced somewhat.

-30-

Fig. 3. Acoustic output response curves of speaker showing final performance characteristics with and without the series resistor. Since the speaker used in the tests was a relatively low-priced unit, its low-frequency response drops off rather rapidly, as was expected. In reporting these results and since a woofer type speaker was used, no attempt was made to show results at the high-frequency end. There is, however, a boost at this end as well as at low end.

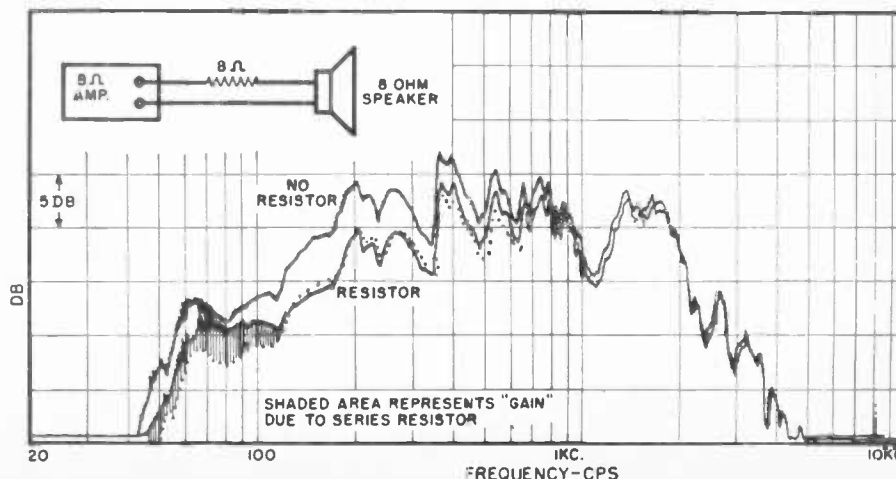

A SPECIAL OFFER TO MEN WHO KEEP PACE WITH ELECTRONICS

Whether you're a tyro or an electronics expert, you're sure to profit from the know-how and guidance in any or all of the Ziff-Davis electronics magazines. Right now, if you take advantage of this special offer, you can have these fine magazines at a rate that will give you more than 6 months free! (*)

18 MONTHS FOR ONLY \$3.85!

HI FI REVIEW...For informative coverage of hi-fi music and sound...read America's newest, most complete high fidelity magazine. Each month you get basic information in hi-fi installation, equipment, buying, techniques, developments and special features on stereo...Plus: more than 25 pages of expert record and tape reviews...entertaining picture features on concert and jazz personalities, and full coverage of the world of music.

POPULAR ELECTRONICS...For do-it-yourself construction projects and guidance...subscribe to the world's largest-selling magazine for electronics experimenters and hobbyists. Each issue carries clearly explained, fully illustrated and diagramed electronics projects, including hi-fi equipment, shortwave units, practical and entertaining devices for your home, job or hobby. POPULAR ELECTRONICS keeps you posted on the whole exciting electronics world—from computers to missiles and satellites...from hi-fi to exciting career opportunities.

RADIO & TV NEWS...Technical advice and valuable ideas for advanced fans...don't miss the nation's oldest and most widely read technical electronics magazine. If you can follow schematics and want expert guidance in every phase of electronics, including radio and TV servicing, high fidelity, communications, missilery, R/C, etc.—here's your magazine! Edited and written by the leading men in electronics, RADIO & TV News gives you top professional guidance. You get every development, every trend, exciting plans, and full coverage of the entire electronics industry.

(*)Take this special offer now! Regularly, any one of these Ziff-Davis electronics publications would cost you \$4 for a 12-month subscription. By acting right now, you receive 18 months for less than the regular cost of 12...actually giving you 6 extra issues at no extra cost. Use the postage-paid card facing this page today.

If someone has already made use of the card referred to above, you can still take advantage of this special offer by sending your order directly to the Ziff-Davis Publishing Company, 434 South Wabash Ave., Chicago 5, Ill. If you enclose payment with your order, saving us expensive billing costs, we will add two extra issues to your subscription, no matter which magazine you choose, making a whopping bargain of 20 issues in all for just \$3.85!



ACT NOW! 18 ISSUES FOR ONLY \$3.85

The

"TINY MITE"

Loudspeaker Enclosure

By
ABRAHAM B. COHEN
University Loudspeakers, Inc.

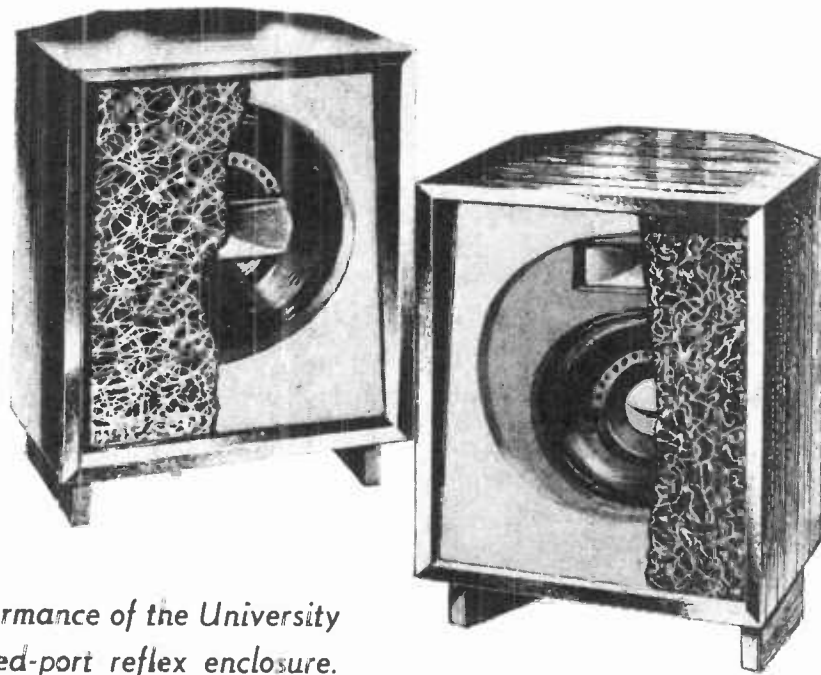

Construction data and performance of the University "Tiny Mite," a small, ducted-port reflex enclosure.

PATRONS of audio shows of the past will recall the outstanding performance of the original "Tiny Mite," housing the University "Diffusicone 8" speaker. Its wholehearted acceptance for small enclosure applications was so successful as to encourage the redesign of this enclosure to accommodate more speakers than just the "Diffusicone 8." The present design for the "Tiny Mite" embodies proven, small enclosure design techniques, and is specifically adapted to the original University system of Progressive Speaker Expansion whereby it is possible to enjoy basically satisfying reproduction from small hi-fi components which may, through the addition of other components at some future time, expand the original installation into a more versatile high-fidelity system.

It is not necessary to forego the pleasures of good listening where space is limited. To provide satisfactory listening in smaller areas, the "Tiny

Mite" enclosure, as described in this article, should provide more than adequate realization of high-fidelity listening, and at the same time give a substantially satisfactory basis for economical stereophonic installations.

Principle of Operation

The "Tiny Mite" is a modified bass-reflex enclosure utilizing a horn-like duct to couple the cabinet volume to the room. This duct is the channel made up of the base legs of the cabinet which completely close off the sides and back of the bottom and cause the port at the bottom to radiate into the room through the channel thus formed. When used for corner application, this duct is closely coupled to the very bottom of the corner of the room, which provides the optimum corner loading inasmuch as three corner planes are equally operative upon the duct. Thus the port becomes "horn loaded."

Due to the fact that this cabinet is

an intrinsically closed structure, except for the port duct, and specifically does not vent through the rear for corner loading, it may be used to advantage against a flat wall where there is no corner. In this instance the cabinet acts as a bass-reflex enclosure with the duct coupled directly to the floor plane. This bottom duct, then, functions in a dual fashion: (a) when placed in the corner it creates a horn-loaded port enclosure, which naturally enhances the lows and overcomes some of the limitations placed upon the loudspeaker because of the comparatively small enclosure design; (b) at the same time when placed against a flat wall, the presence of the pure duct loading of the bass-reflex enclosure causes the interior volume of the enclosure to perform acoustically in the manner of an enclosure about 40% larger than the actual physical volume. This latter condition likewise enhances the low-frequency response of the enclosure.

Constructional diagrams for the University "Tiny Mite" loudspeaker enclosure. This relatively small enclosure is a modified bass-reflex type employing a ducted port at the bottom of the unit. The "Tiny Mite" may be installed either in the corner of a room or along a wall, and it will accommodate any 12-inch loudspeaker directly or, by means of an adapter board, any 8-inch speaker with a separate tweeter.

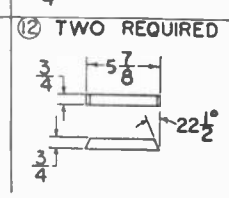
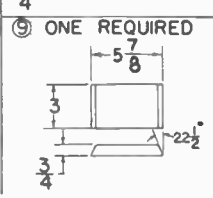
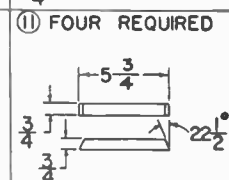
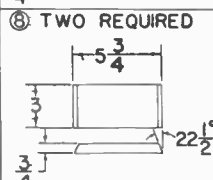
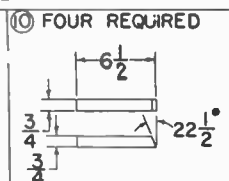
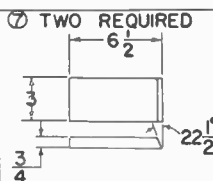
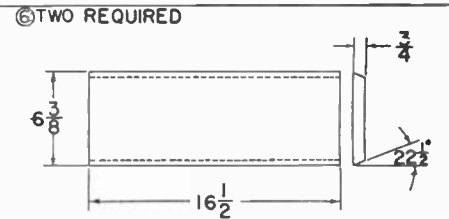
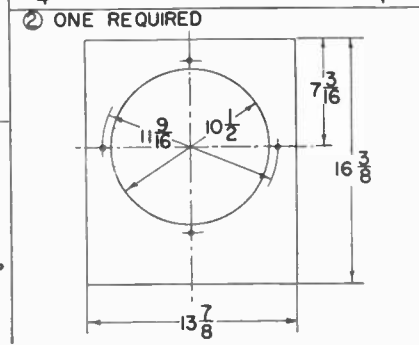
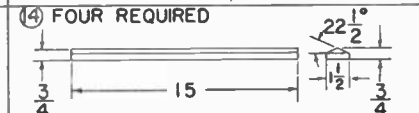
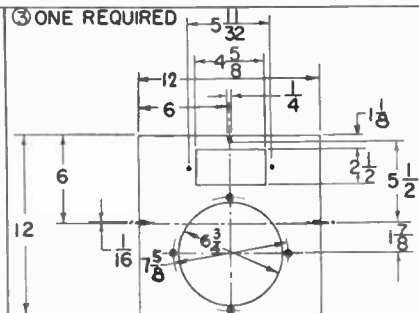
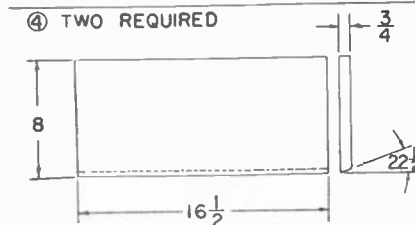
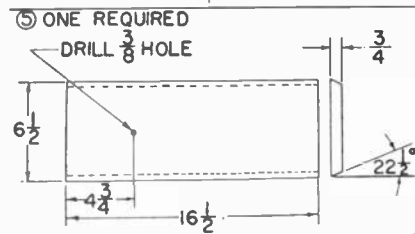
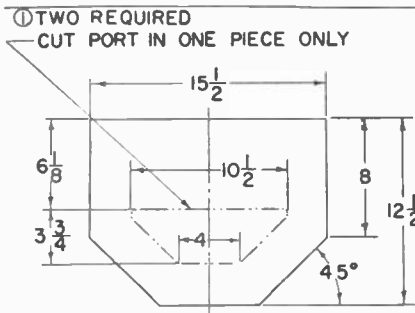
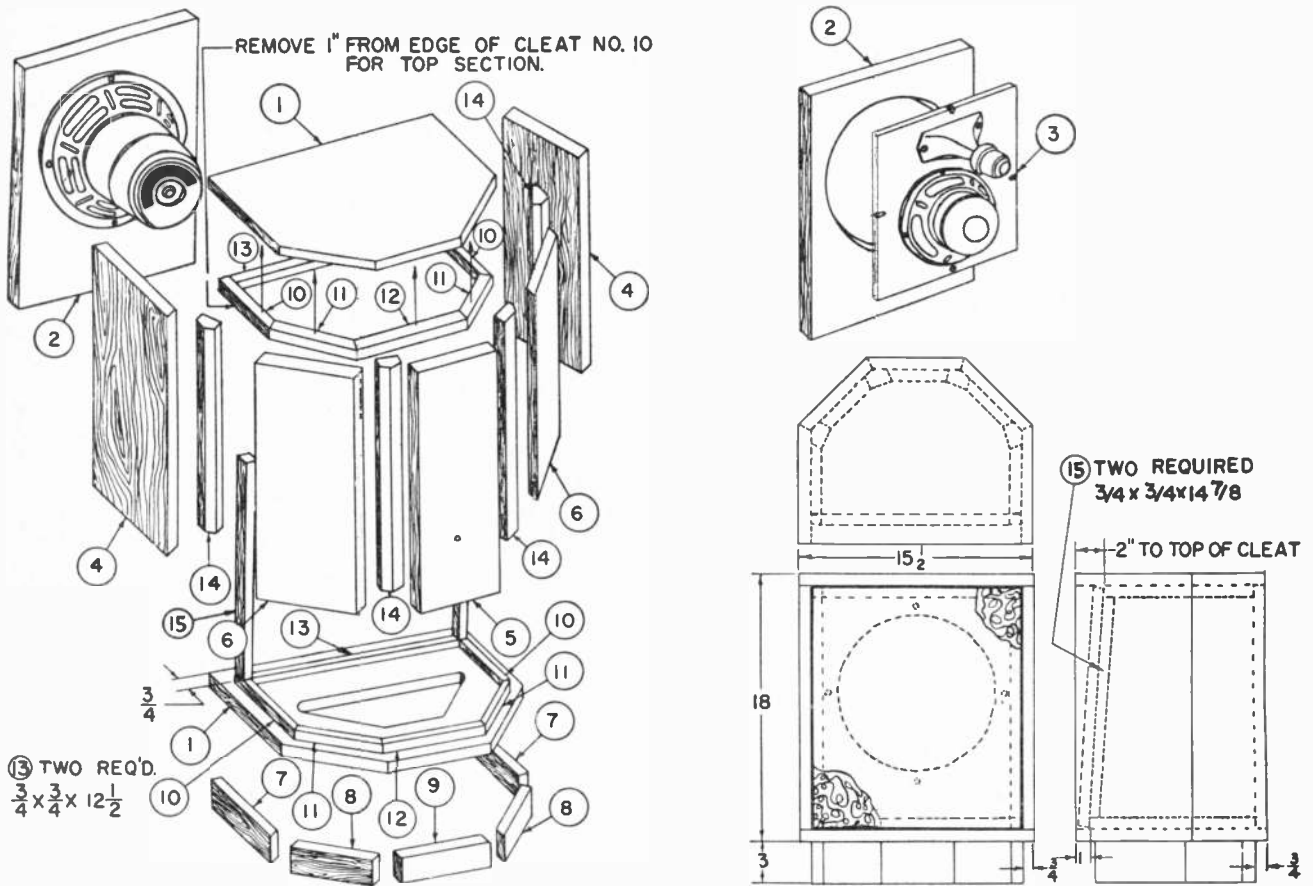

It is for the purpose of mutual coupling between the walls of the room and the loudspeaker itself that improved performance of an enclosure is obtained when situated in the corner of a room—the speaker couples itself to all three adjacent walls. Therefore, the closer the loudspeaker may be located to the walls, the better is the coupling. Thus, in the case of the present "Tiny Mite," the fact that the loudspeaker is actually so close to the floor of the room, both when located in the corner or when located against a non-corner type of wall, there is created an improved coupling condition between the loudspeaker and the wall and floor planes which aids the low-frequency response of the system.

The adaptability of the "Tiny Mite" to either corner or flat wall placement is, of course, due to the fact that this enclosure is completely sealed and does not vent through the back. This construction makes it versatile in placement and essentially independent of the actual acoustical conditions of the walls and their construction as far as room loading effects are concerned. A representative machine-run curve of performance of the "Tiny Mite" enclosure for low frequencies when utilizing a 12" speaker, such as the *University* 6201, for the two conditions of corner placement and flat wall placement is shown. Note that although there is a three to four db difference in the low-frequency response of the system from 80 cps down, there is quite good performance quality for the flat wall placement because the enclosure is an integrally complete structure in itself without specific dependence upon room placement.

The tilted front panel serves two purposes. It reduces internal reflections between the back of the cabinet and the back of the speaker, thereby minimizing erratic frequency response in the mid-frequency area. The correlation between the 45 degree corners of the cabinet and the tilted relationship between the front panel and the back panel of the cabinet go far towards reducing internal standing waves of high pressure amplitude which can create mid-frequency disturbances. This is especially desirable where high-efficiency speakers are used, because extremely high internal pressures are created within the enclosure and unless means are taken to prevent such internal reflections, then there will be irregularities in the mid-frequency response of the speaker.

Construction Specifications

It is naturally very desirable to insure that the cabinet itself should not be vibrated by the high sound pressures built up within it. Accordingly, every effort should be made to insure that the individual panels are of good stock and secured so that they will not vibrate. Even though this enclosure is diminutive in size, it is, however, built from $\frac{3}{4}$ " wood in order to fully withstand the high acoustic pressures built up within it (especially when used with high-efficiency speakers)

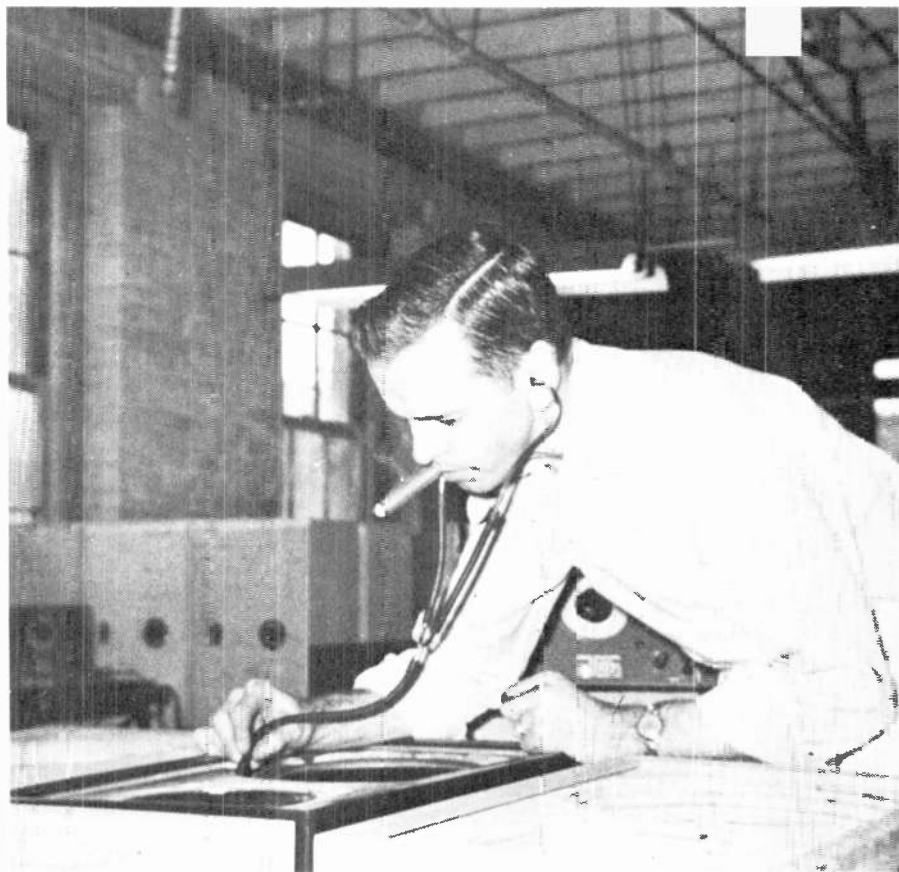

Robert Bell, assembly foreman at AR

FACTORY INSPECTION for AR SPEAKERS

A stethoscope is used in the production testing of every Acoustic Research speaker system, to detect possible air leaks in the cabinet. The speaker is driven by a twenty-cycle signal, and if there are any leaks a characteristic rushing sound can be picked up at the trouble spot.

This test procedure is necessary because the sealed-in air of an acoustic suspension enclosure is a basic working element of the speaker system. In conventional speakers the cone works against the springy stiffness of its mechanical suspensions; in AR speakers this stiffness is missing, and the cone works instead against the springiness of the enclosed air-cushion. Like the new air-suspension cars, the speaker literally rides on air.

The patented AR system requires a small cabinet, so that the enclosed air will be springy enough. And since the air-cushion does not bind or reach its elastic limit as do mechanical springs, the AR-1 has created new industry standards in the low-distortion reproduction of music. The "bookshelf" size of AR enclosures is associated with an absolute advance rather than a compromise in speaker bass performance.

AR speakers have been adopted as reference standards, as test instruments for acoustical laboratories, and as monitors in recording and broadcast studios. Their most important application, however, has been in the natural reproduction of music for the home.

The AR-1 and AR-2, two-way speaker systems complete with enclosures, are \$185 and \$96 respectively in either mahogany or birch. Walnut or cherry is slightly higher and unfinished fir is slightly lower in price.

Literature is available on request.

ACOUSTIC RESEARCH, INC. 24 Thorndike St., Cambridge 41, Mass.

Dept. Z

GREAT!



Photo by Hy Peskin, courtesy Sports Illustrated, © Time, Inc.

Summed up in this one picture is the dogged courage of a man grimly striving to hold his crown...the determination of an exhausted ex-champion...the brutality of a big-money fight.

It's a great picture—one of more than 300 selected by the Editors of Popular Photography for publication in the 1959 Edition of the PHOTOGRAPHY ANNUAL.

Sports, glamour, action, portraits, landscapes, children — in color or black-and-white — whatever your preference in pictures, you'll want to own a copy of the 1959 PHOTOGRAPHY ANNUAL. Or sale now — look for it at your favorite newsstand or camera store!

1959
PHOTOGRAPHY
ANNUAL

ANNUAL PUBLICATION
W. TUCKER SMITH, JR.
MONUMENTAL
ART-SCULPTURE STUDY



ONLY \$1.25 EVERYWHERE

and to consequently reproduce the total sound from the loudspeaker without itself absorbing any through panel vibrations. It is highly recommended that all the sections should be thoroughly glued together by means of the indicated glue blocks, that these joints be thoroughly sealed with glue during the assembly to prevent vibration of one edge of the panel against the other, and that re-enforcement by screws between panels and glue blocks be applied immediately upon glue application. This will squeeze the glue over the whole of the glueing surface and hold the parts in contact while the glue is setting without the use of cabinetmaker's clamps.

As much as possible of the interior of the enclosure should be lined with Fiberglas, Kimsul, Ozite, or other sound absorbing material.

Speaker Installation

Where the "Tiny Mite" is to be used with a 12" speaker, such as the *University* Model 6201 coaxial or the Model 312 three-way "Diffaxial," then the speaker is mounted directly onto the main baffle board as shown in the "exploded" view. If, however, the installation is to start with a more modest speaker such as the 8" "Diffusicone," then the adapter plate should be secured to the main baffle board and the speaker secured to the opening provided for it in the adapter plate. It will be noted that the position of the mounting hole for the 8" speaker is such as to permit the mounting, if required or desired, of a tweeter directly above it. There is ample space in this area to provide a cutout for the *University* Model HF206 or Model 4401 type tweeters, as indicated in the constructional details.

It will be recognized that this latter application conforms to the *University* Progressive Speaker Expansion principle whereby one may start a hi-fi system with a quality loudspeaker, although modest in size, and then build up to a more versatile system at some future date. A tweeter, such as the *University* HF206 or Model 4401, may be mounted at the cutout on the adapter board. A network should be used which will permit the control of the level of the tweeter to balance that of the "Diffusicone 8," which now

performs more as a woofer and mid-range unit. When a network such as the model N1 high-pass filter is used, it may be mounted on the side of the cabinet so that there will be easy access to the control for adjusting the level of the tweeter and the woofer for best balance between themselves and to room or program conditions. If the integral coaxial or three-way "Diffaxial" type speakers are used, then the volume control for the tweeters in these structures may also be mounted on the side of the cabinet.

Because of the compact size of the "Tiny Mite," it is especially suitable for use in stereophonic systems where it is not possible to use, or where it may not be economical to invest in, large and elaborate systems. With two such enclosures placed in adjacent corners in a listening room having average size, excellent low-frequency reproduction will be obtained with controlled dispersion of the highs feeding all parts of the room, yet providing the requisite localization of the two channels because of the separation of the two speakers. The corner response for this enclosure, shown in the curves, is indicative of the performance that may be expected from such a system when played in a corner by itself, where the properties of the room are conducive to good acoustic reproduction. In general, this enclosure meets the demand for a small, high-quality unit.

IMPROVING "MARK II" DYNAKIT

UP to the present time, all of the power amplifier kits produced by Dyna Company were designed with the cathodes of both EL34 output tubes connected to ground.

Recent reports from the company show that the intermodulation and harmonic distortion can be reduced substantially by adding a precision 12-ohm, 1-watt $\pm 1\%$ wirewound resistor from the cathodes of both EL34's to ground.

Proper grid bias adjustment can now be simplified. Just adjust the bias control until a d.c. voltage of 1.56 volts is obtained across the 12-ohm resistor. Optimum bias is obtained in this manner even though the grid voltage on the EL34's may measure anywhere from -35 to -42 volts.

Relative response curves of the Model 6201 12-inch two-way speaker mounted in the "Tiny Mite" enclosure. Curves show comparative response with the enclosure placed in the corner of a room and against a flat wall. The corner position gives a somewhat better bass response, but only by about 3 or 4 db. Note also how the relative response falls off below approximately 80 cps at a rate of close to 12 db per octave.

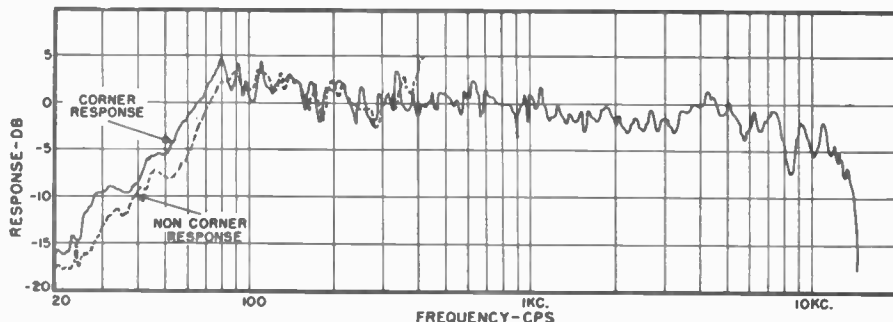



Section V
Stereo and FM

Stereo Balance and Gain Control	104
Stereo Control Center	107
Adding A Stereo Tape Head and Preamplifier	109
Speakers For Stereo	114
Testing FM Tuners	119
Testing FM Tuners At Home	123
Adding A FM Tuning Indicator	127
Hum Reduction	130

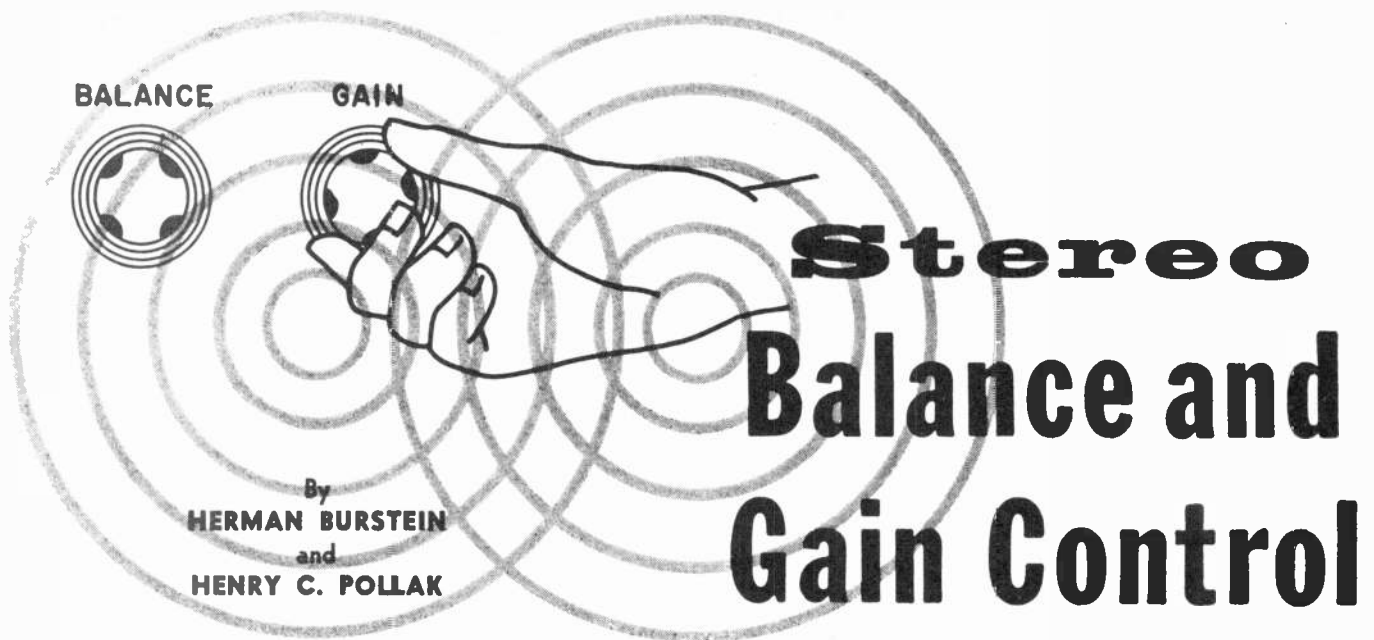

How to install and adjust the important controls that equalize and determine gain of stereo sound channels.

WHEN adding a second audio channel in order to enjoy the benefits of stereo sound—either from tape or from a joint FM-AM broadcast—one runs into a new problem area which concerns the amplitude relationship between the output of each channel. “Output” refers here to the level of sound emanating from each speaker system.

Of course each channel can be controlled individually as far as output level is concerned and with care one can obtain quite satisfactory balance of sound. However, such a procedure means that every time one plays stereo, for every change in gain, and quite possibly for different stereo sources, one must redetermine the points of best balance on the individual gain controls of the two channels. This situation is neither ideal nor workmanlike.

Preferably the stereo setup should be equipped with two controls that operate as follows: 1. A master gain control that simultaneously governs both channels, and 2. A control which changes the output level of each channel relative to the other without substantially altering their combined level. In other words, the left speaker output can be raised and the right speaker output proportionately reduced; or *vice versa*. This may be termed a balance control, although it is sometimes called a focus control.

For the master gain control to serve its purpose, it should meet the following requirement: As gain is varied, it should maintain the relative output of each channel within a satisfactory margin, perhaps as little as 1 db if possible. For example, if at maximum setting of the master gain control the two channels differ 6 db in level (whatever the reason), then at all other settings of the control the output levels should remain between 5 and 7 db of each other.

The balance control should meet the following two requirements: 1. It should be mounted with a numbered dial so that the user can readily return to points of balance that he has found suitable for various stereo sources, and 2. Equal output from the two channels should be obtained at a point in the middle of the dial.

Several reasons exist for a balance control, although, as will be discussed later, exact balance between the two channels can be obtained by proper adjustments within each channel. For one thing, this exact balance can easily be upset by such factors as the aging or replacement of tubes and other components. Just as important is the fact that stereo tapes do not always maintain equal level on the two channels, assuming that equal level is the most desirable condition. Thus the user may well find that on some tapes or other stereo program

material he obtains the best stereo by restoring equal output on each channel with the balance control.

It must be further considered that the stereo art still contains many imponderables, one of which is the lack of certainty that equal level on each channel will, in all cases, provide the best stereo illusion. It is quite possible that in some instances emphasis of the left or right channel may heighten the stereo illusion. Or this may bring out certain facets of the music which are most pleasing. For example, if most of the bass appears in the left channel, then emphasis of this channel may give the listener what he especially desires. Moreover, emphasis of one channel or the other, and varying degrees of emphasis, may produce different effects in one room than in another.

Finally, it should be taken into account that, at least today, the stereo listener can count himself within the ranks of experimenters and a balance control gives him something with which to experiment.

A suitable gain-balance circuit is shown in Fig. 3A. Essentially it is based upon that found in the *Bell* bin-aural amplifier, Model 3DT.

It may be seen in Fig. 3A that the dual balance control pots are connected so that as the resistance of one increases, the resistance of the other decreases. Each channel may be

varied over a range of 10 db. Theoretically, it would be desirable for mid-setting of the pot to represent a 5 db loss, so that turning the pot to either extreme would add or subtract 5 db. This, however, would require a special taper. A linear pot is satisfactory, with mid-setting representing a 6 db loss.

Dual control pots operated by a single shaft are available from most manufacturers of potentiometers. In the case of the *IRC* line, which permits great flexibility of pot combinations, the second pot comes separately without a shaft and is attached in "piggy-back" fashion to the first in a matter of moments, in a manner similar to that in which a line switch may be attached to a volume control.

Depending upon how fortunate one is in obtaining matched pots, the master gain control arrangement shown in Fig. 3A may result in a deviation of as much as 4 or 5 db between channels; that is, assuming the channels are exactly matched at maximum setting of the two pots, a significant mismatch can occur at lower settings. Although the balance control can take care of this deviation, one may improve the tracking of the master gain control sections by using the arrangement shown in Fig. 3B, using 500,000-ohm center-tapped pots rather than 250,000-ohm untapped ones.

Resistors R_1 and R_2 are about 20,000 ohms, the exact value of one of these being empirically selected for best tracking. Improved tracking is obtained as follows. Obviously the two pots are in exact agreement at maximum rotation and minimum rotation. If they are also in exact agreement at some appropriately chosen intermediate point, then tracking will be essentially good throughout the range. A value of about 20,000 ohms compared with 250,000 ohms (where the tap is located) represents a reduction somewhat above 20 db. Since the range within which a pot is ordinarily used is about 40 db, this means that exact tracking occurs roughly midway in the range.

Whether one owns an integrated control-power amplifier or separate

control amplifier and power amplifier, the logical place to put the balance and master gain controls is between the stereo source and the control amplifier. This assumes that the stereo source furnishes a high level signal, on the order of .5 volt (peaks) or more, which is almost always the case. Thus a tape recorder preamplifier usually puts out a signal of 5 volt or more, as do FM and AM tuners in general.

One might place the balance and gain controls between the control amplifiers and power amplifiers. But this has the disadvantage of causing the control amplifier to work harder than it has to. The relationship between the values of the balance and gain pots in Fig. 3A is such that there is a loss of 6 db per channel at mid-setting of the balance control. As a result, if the balance and gain controls were placed after the control amplifier, the latter would have to produce roughly twice as much voltage, which might of course contain increased distortion, quite possibly a substantial increase.

Fig. 1 shows a balance control circuit requiring only one potentiometer. However, the dual gain control would then have to be located at a different stage.

Balancing the Channels

As shown in Fig. 3A, there is about 10 db maximum loss within each channel. Unless the audiophile uses fairly identical speaker systems, power amplifiers, and control amplifiers, it is very easy for the difference in output between the channels to exceed 10 db by a considerable margin, so that the balance control, even at its extreme range, cannot achieve balance.

For example, assume that on channel 1 the following is true: control amplifier delivers 1 volt for .1 volt input; power amplifier delivers 50 watts for 1 volt input; speaker efficiency is 8%. And assume that on channel 2 the following is true: control amplifier delivers .5 volt for .1 volt input; power amplifier delivers 12.5 watts for 1 volt input (or 3.125 watts for 5 volt input); speaker efficiency is 2%. As a result of these differences between the channel 1 and

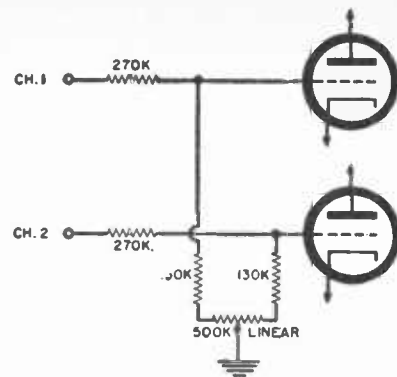

Fig. 1. Method of achieving balance.

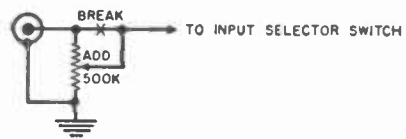

Fig. 2. Adding an input potentiometer.

2 units, there is a total difference of 18 db between their respective outputs, assuming equal input to each channel.

Consequently, unless the components of each channel are matched to a fairly close degree, it is necessary to take appropriate measures so that equal inputs to each channel produce more or less equal output from each speaker system.

If speakers of different efficiency are employed as well as power amplifiers of different wattage rating, it is usually advisable as a first step to use the more efficient speaker with the lower wattage amplifier. If the user is in doubt as to which is the more efficient speaker, he has only to place them, at the proper terminals, alternately across one of the power amplifiers as a signal (radio, phono, tape, etc.) is fed in. If his ears do not detect a perceptible difference in level, he

Fig. 3. (A) Gain and balance controls for system. (B) Improved tracking version.

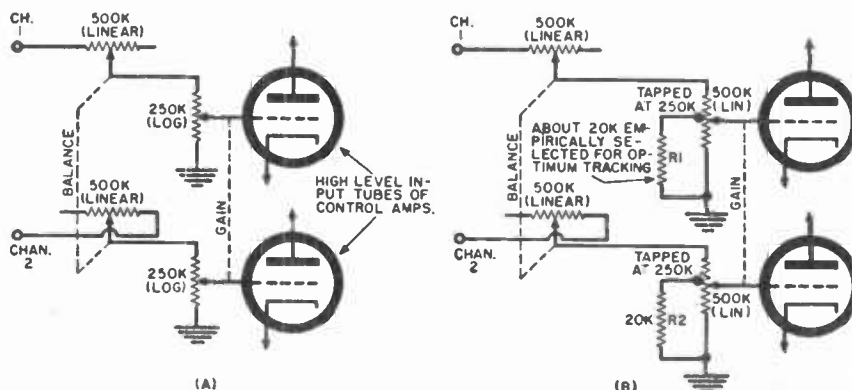

may assume that their efficiencies are reasonably similar.

If the speakers are of similar efficiency, the problem of matching components then boils down to matching control amplifier to power amplifier on each channel, so that equal input to the control amplifier will result in equal output from the power amplifier. This, of course, means taking into account the sensitivities of the four units involved. In the example cited at the opening of this section, it would be desirable to switch control amplifiers between the two channels. Now on channel 2 the control amplifier would have twice the sensitivity of the one on channel 1, thus compensating for the fact that the power amplifier on channel 2 has only half the sensitivity of that on the other channel. Remember, however, that it is now assumed the speakers have the same efficiencies, more or less.

Let us restore all the conditions of the original example, which means that one speaker system has 6 db more output than the other, the same being true for the control amplifiers and the power amplifiers. Now how would one go about achieving balance? To begin with, the 50-watt amplifier which, on the basis of the data in the example, also has twice as much sensitivity (12.5 watts for .5 volt input), would be coupled with the less efficient speaker. Thus each power amplifier-speaker combination would be balanced. It would remain then to balance the control units. This could be done by reducing signal either at the input or output of the more sensitive control unit. If the signal is reduced at the output, this has the possible disadvantage of significantly raising distortion in the control amplifier output because the control amplifier has to work that much harder for the same signal reaching the power amplifier. If the signal is reduced at the input, this has the possible disadvantage that there is not only greater amplification of the signal but also greater amplification of noise generated within the control amplifier. The eventual choice depends upon the individual control unit.

How can input signal to the control amplifier be conveniently reduced? Many control units contain input level potentiometers for high level signals, which can be adjusted in accordance with the user's needs. If not, such a

potentiometer can be installed, as illustrated in Fig. 2.

How can the output signal from the control amplifier be conveniently reduced? Many power amplifiers contain an input level control which can be used for this purpose. If not, a potentiometer can be substituted for the power amplifier's input grid resistor, as shown in Fig. 4.

Although the regrouping of control unit—power amplifier—speaker combinations may often achieve good balance between the two channels of the stereo system, this can happen at the expense of other desiderata. For example, the 50-watt amplifier, the more sensitive control unit, and the 8% efficient speaker may be superior components forming the principal audio system of the home. The other equipment system formed in part or total from the remnants of earlier days. In this case, changing the combination of system elements would not seem to be a very practical solution, particularly since most persons still do most of their listening to monaural sources.

Aligning Balance Control

It is to be assumed that when a set of master gain and balance controls is installed in a stereo system, all other gain controls in the system will be set at maximum position. It would be difficult to return to any other setting of such gain controls with the desired degree of exactness.

In order to align the balance control, that is, obtain equal output from each speaker system when the control is at a clearly identified point about mid-range, a fairly simple procedure is both desirable and feasible. The procedure should be a simple one because from time to time it will be necessary to relocate the point of exact balance due to aging or replacement of tubes and other components. Rather than try to adjust input level controls (on the control or power amplifier) so that a certain point on the balance control always indicates equal output, it may be suitable to simply identify the balance point on the dial after each alignment.

To align the balance of the two channels—so that equal output is obtained at about half-setting of the balance control—one may use a monaural signal source such as phonograph record, tape, or radio broadcast, pro-

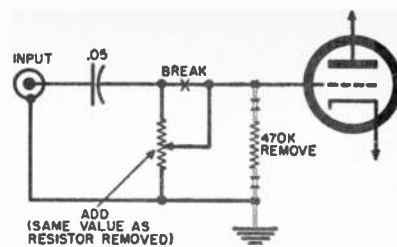

Fig. 4. Installation of an input level potentiometer in a power amplifier.

viding conventional musical material. This source should be fed into both channels. One side of the line going to each speaker should be connected to a double-pole, double-throw switch so that in alternate positions of the switch one speaker or the other is disconnected. This setup is illustrated in Fig. 5. Taking a midway position several feet from the speakers and switching back and forth between speakers one should back down on the input level control (in the control or power amplifier) of the channel which produces the higher output until one hears apparently the same level of sound from each speaker when the balance control is at mid-setting. (It may be necessary to also reduce gain in the weaker channel if there is excessive output at low settings of the master gain control.)

This procedure will produce balance within 1 db or less, which is quite satisfactory. Use of program material is superior to single tones, such as might be produced by an audio oscillator, test tape, or test record, because it averages the relative response of the speaker systems at various frequencies. In order to protect the output transformers of the power amplifiers against voltage surges when the switch is operated, it is advisable to place 50-ohm resistors across these transformers, as shown in Fig. 5.

It may be added that the procedure shown in Fig. 5 can be simplified a good deal by using as the signal source one of the special test tapes now available on the market, which furnishes the same signal alternately on each channel. This eliminates the speaker switching arrangement as well as the wiring necessary to feed one signal into two channels. By using a regular full-track tape as a source, one can eliminate the wiring task, although not the speaker switch.

Fig. 5. Setup described in text for balancing the channels of a stereo system.

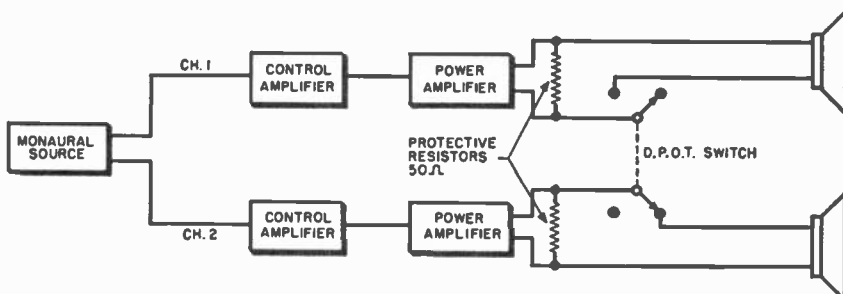

Stereo Control Center

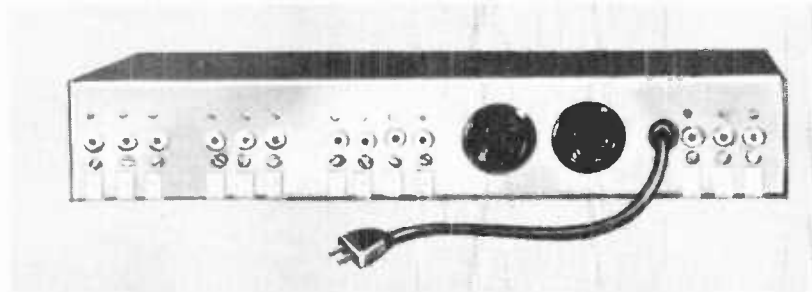
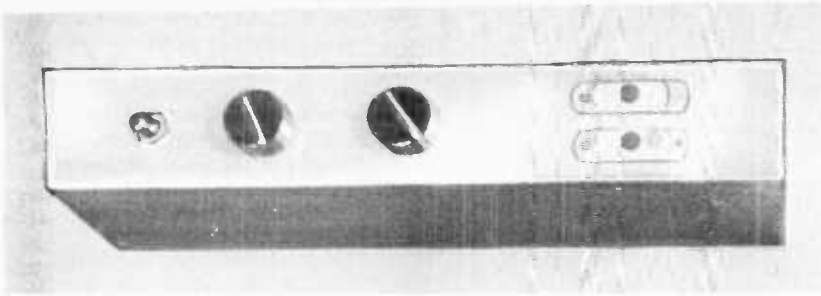
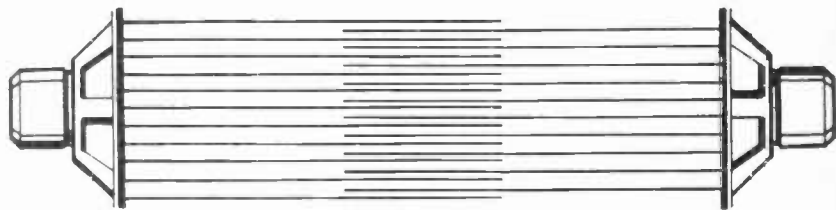

Fig. 1. Front and rear views of the stereo control unit described below.

By
IVAN FLORES



Only two controls to set up proper stereo inputs, connect speakers, turn on equipment, and provide gain adjustment.

WHEN the author first arranged his equipment for stereophonic operation, it was surprising how much trouble it was to get it set up properly. This is especially true if the equipment is not exactly centered between the two speakers. And how often is it possible to place it thus? It may not be a convenient arrangement for associated equipment, or your wife might object to this location.

Just suppose, after getting all set up, someone complains that the volume is too loud! Both channels must be reduced equally. This means an entirely new balancing procedure. When the "audiophobe" with the delicate ears leaves, another balancing process is required to restore the volume.

The device to be described will eliminate the balancing procedure. It is applicable to stereo tape deck output or a broadcast setup using two tuners. If you are lucky (or prosperous) enough to have both stereo tape and stereo broadcast systems, then this device will accommodate and equalize both systems. Of course, two complete amplifiers and two speaker systems are still required.

Some audiophiles derive a good deal of pleasure from the myriad of knobs, dials, and controls which require setting, even in a monaural setup. Stereo listening gives this person the added fillip of twice as many knobs and a complicated tuning procedure before proper listening can begin. On the other hand, if you belong to the "set

and forget" school, if you derive more pleasure from listening than fussing, this simplification should prove very gratifying. If you would like to simply switch one knob and manipulate one control and thereby completely set up your equipment for stereo listening, then this is it!

Of special interest is the dual potentiometer for level control of both channels. By presetting various volume controls, this potentiometer may be used for controlling both channels, whether the source of the input is broadcast or tape.

The device described has four switching positions, each of which will be discussed separately.

Normal Monaural Operation

In this mode of operation, most of the equipment is controlled by the preamplifier. The choice of input is made at the preamplifier, which, in this case, has push-button control for monaural tape, television, microphone, phonograph, or the FM tuner. Selection of input also turns the power on for the respective apparatus. The main amplifier is also turned on and its output is fed, properly terminated, into both speakers.

AM Monaural

Since separate AM and FM tuners are used in this system, it is necessary to have a position on the selector which allows the AM power to be turned on and the AM tuner output to be routed to the "tuner" input of

the preamplifier. The main amplifier and both speakers are on, as was the case before.

Broadcast Stereo

In this mode of operation, power must be fed to the main and auxiliary amplifiers. The output of the FM tuner is fed into the "tuner" input of the preamplifier while the output of the AM tuner is fed to the input of the auxiliary amplifier. The output of the main amplifier is now fed to the main speaker and the output of the auxiliary amplifier is fed to the second speaker.

Stereo Tape

In this mode of operation, power must be obtained externally for the auxiliary amplifier. Power for the main amplifier and tape recorder is supplied, as previously, through the preamplifier power receptacles. "Tape Track 1" of the tape recorder is fed to the tape recorder input of the preamplifier through the level control. It passes into the main amplifier and then to the main speaker. The second channel from the tape recorder is fed through the level control into the auxiliary amplifier and then to the second speaker.

A big part of the simplification achieved by this device is due to pre-setting of controls by indicating their proper position with little colored adhesive dots. Dots of red or green were placed on all controls which have to be preset before their use in the stereo setup. A green dot indicates control presettings for all equipment required for stereo broadcasts. A red dot indicates control presetting for equipment required for stereo tape use. The dots

were also placed on the pilot lights which must be lit in order that the appropriate auxiliary equipment be on at the time. They also act as an indication of the position of the selector switch. No numerals or other indications are required about the periphery of the selector switch. Thus, when the pilot lights with the red dots on them are lit and all controls with red dots on them are set to those dots, then stereo tapes may be played. The "dots" are obtainable in small packages from a good stationery store.

The many input and output jacks are numbered with "wire labels." A similar label appears on each end of the connecting wires. This makes for ease of removal and reconnection. The three jacks on the right and the toggle switch on the front are not strictly part of the unit. They are used to determine whether the tape recorder records from the tuner or the pre-amplifier. Shielded leads were used in some cases, even though this is not absolutely necessary.

Components

The components used in the construction will be described in order to aid the prospective builder in duplicating the author's unit. For those who do not wish to make an exact copy of the author's unit, the operation shown should produce some useful ideas.

The phono receptacles used in the equipment are of the miniature variety since so many of them were required. Those seen in the photograph may be placed as close as five-eighths of an inch between centers. Instead of permanently wiring the auxiliary amplifier and the AM tuner into the setup, it was felt that by supplying a.c. receptacles for each, the equipment could be used more flexibly and could be more easily maintained. The switch used is a six-pole, four-position rotary switch. Each of its positions and poles will be described later. The volume control consists of two 500,000 ohm, 2-watt potentiometers ganged together. Each potentiometer should have the same taper and should be of the audio taper variety.

Two flat-type neon bulbs were used to indicate power for the additional tuner and amplifier since they were easily visible. Also, the dot labels adhere well. The chassis height was such that it would fit into just the amount of space left when the pre-amplifier, in its own little cabinet, was placed within its cubby hole. The chassis was made from aluminum. All the holes were drilled before the aluminum was bent. The chassis was then bent to break. (This may be done in a machinist's vise.) Before the components were put in place on the chassis, it was sprayed with a gold paint, which comes in a spray can and is available in any hardware store. This was done so that the "control center" would match the other equipment.

The block diagram of Fig. 2 indicates the various functions of the unit and how they are switched. The "X's"

in this diagram indicate where switching is done.

The four positions of the switch in Fig. 3 are labeled as follows: *F* for the normal position using the FM tuner; *A* for the normal position using the AM tuner; *S* for the stereo broadcast position; *T* for the stereo tape position. The levels or poles of the switch are numbered from one to six. For example, the notation "A" indicates the third level in the normal AM tuner position. Fig. 3 gives, in compressed form, the entire diagram of the equipment. The "X's" in this diagram indicate that a closed circuit exists through the selector switch for the positions listed above and to the left of the "X." Thus, at the very top of the diagram, the first "X" has an "A" and an "F" above it. In these two positions a closed circuit exists through this contact. This occurs on level one. This is shown by the "1" which appears to the right of and above the "X" in the diagram. The first switching level is used to switch the second speaker from the main amplifier on monaural to the auxiliary output on stereo.

The second level is used to choose between the second channel of tape and the AM output on stereo operation. The arm of this level is fed to the rear potentiometer. The arm of this potentiometer, in turn, is fed to the auxiliary amplifier input.

The third switching level chooses between AM output, FM output, and the main tape output. This is applied by the arm of this level to the front potentiometer. The arm of this potentiometer is always connected to the tuner input of the preamplifier. Note here that during stereo tape operation the tape output is connected through the potentiometer to the tuner input of the preamplifier. This tuner input to the preamplifier, during stereo tape operation, should be open, as one would not use the tuner while listening to stereo tape; therefore, the connection is of no consequence.

Level four of the selector switch connects the tape input of the preamplifier directly to the tape output or connects it through the front potentiometer to the main output of the tape recorder. This is so because the level setting function is required for

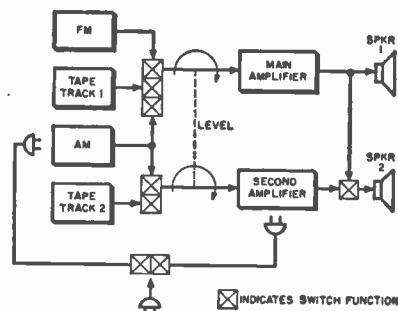

Fig. 2. Block diagram of entire system. The "X's" indicate where switching is done.

the tape recorder only during stereo operation.

The fifth level supplies power to the AM tuner in AM monaural and stereo broadcast operation. The sixth level applies power to the auxiliary amplifier during all stereo operation.

Associated Equipment

Now a word about the simplicity of setting the controls of the other equipment working into this selector. First, no gain control is required on the auxiliary amplifier. Second, the tuners do not require gain controls, since the preamplifier gain control may be used to equalize the tuners. In this particular setup separate controls were available for each tuner. These were used to equalize the inputs from the tuners with the other inputs and to equalize between the two tuners. Only one dot setting was required and this was made on the preamplifier to equalize the output of the two amplifier and speaker systems.

For the stereo tape orientation of the switch, no gain control is required on the separate tape outputs. Balance is obtained through the gain control on the preamplifier. In this application, where gain controls existed on the tape outputs, the "dots" were used to equalize stereo broadcasts and stereo tape. This means that one setting of the master level control will yield approximately equal volume from either stereo medium.

-30-

Fig. 3. Complete wiring diagram of the stereo control unit. A single 6-pole, 4-position switch is employed for the entire switching operation. A dual pot is used for gain control.

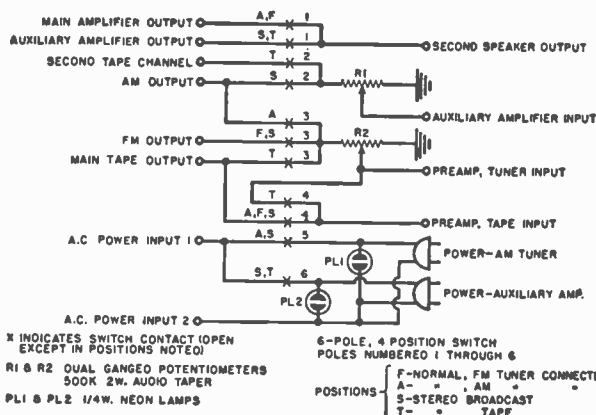

Adding a Stereo Tape Head and Preamp

By FRANCIS A. GICCA
Raytheon Mfg. Co.

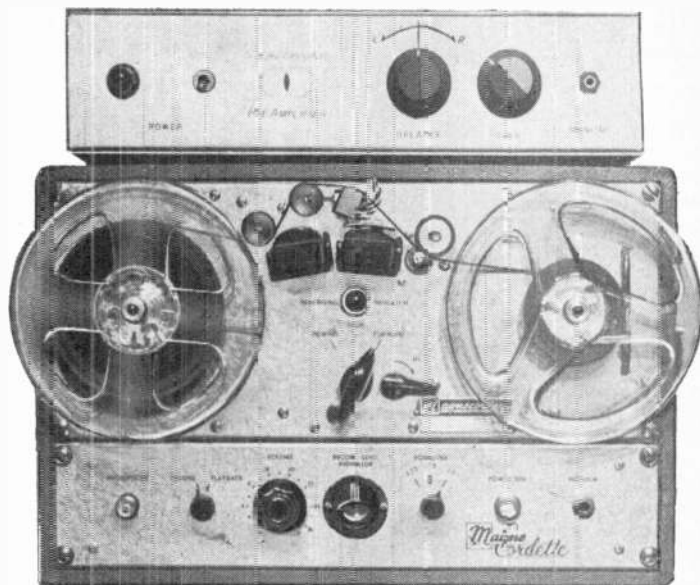

Over-all view of tape recorder with the stereo head mounted on the front panel. The companion preamplifier is located atop the tape recorder.

Enjoy stereo sound by adding another tape head and its companion hi-fi preamp to your present tape recorder.

UNTIL recently, the three-dimensional reproduction of sound was a spectacle to be marvelled at in high-fidelity shows. But time has changed all this. Last year RCA Victor reported increased interest in three-dimensional, or stereophonic, sound and increased sales of RCA stereo tapes. Actually, the entry of RCA into the recorded stereo tape market did much to increase interest in stereo. Today, a number of companies are actively producing stereo tapes, including RCA Victor, Westminster, Mercury, Sonotapes, Phonotapes, Concert Hall, HMV, and others.

However, the major deterrent to wide-spread public participation in stereo has been, and still is, the high cost of stereo tape players. About the only economical way to overcome this drawback is to add a stereophonic tape head and preamplifier to your present single-channel tape player or

recorder. Even this solution has been costly because of the expense of good quality stereo tape heads. Just recently, the Nortronics Company, 1015 South Sixth Street, Minneapolis, Minn. has begun selling its model TLD stereo head. This head makes it possible, for the first time, to add stereo playback to your present tape machine at low cost. The new "TLD" head is of the in-line type, which is destined to become standard; has excellent response characteristics; and sells for only \$23.50, audiophile net, from the manufacturer.

With a bit of ingenuity, this new head can be added to any good quality tape transport mechanism with excellent results. This article will describe how to add the "TLD" head to your recorder, and how to construct a high-fidelity stereo preamplifier for it.

(EDITOR'S NOTE: Other manufacturers, such as Dynamu, Viking, probably Brush, and Pentron also have

in-line stereo heads or conversion kits available. Although the author has confined his construction to the "TLD" head, the same general principles apply to the other heads. It is suggested that the manufacturers of these units be contacted for specifications and further details.)

Adding the "TLD" Stereo Head

If you own a medium-priced recorder such as the Viking, Pentron, Bell, or similar machines the "TLD" head can be used as a direct substitute for the existing head. Properly connected, the "TLD" head will perform as well or better, than your recorder's present head, as well as allowing stereo playback of tapes. To begin, simply remove the present head and substitute the "TLD" head in its place. As is the case with many heads used in medium-priced recorders, the "TLD" head mounts with a single 6-32 screw, making replacement easy. For proper

Fig. 1. Shown here is a typical recording circuit as is described in the accompanying text.

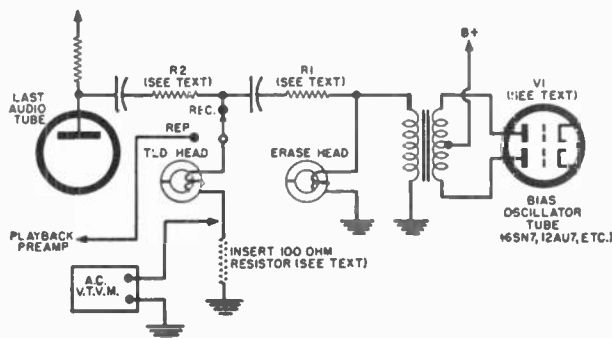

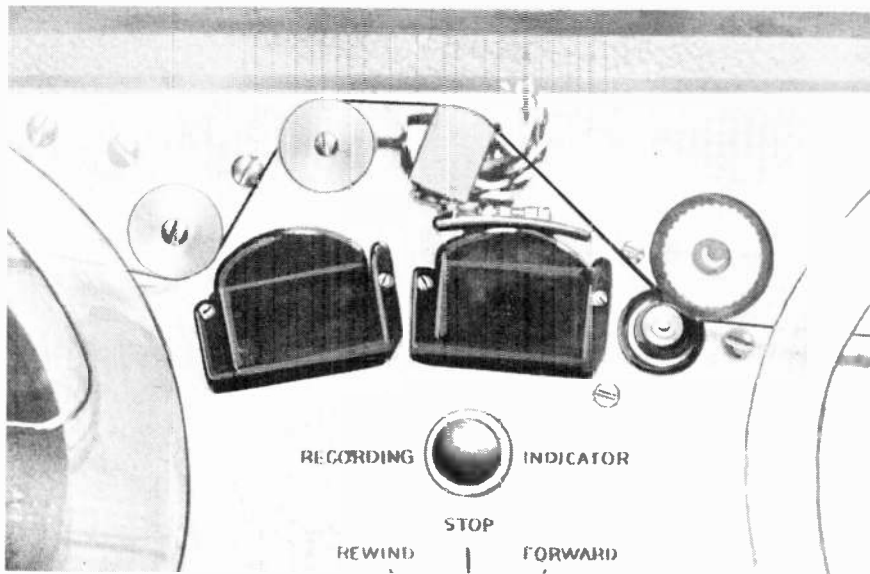

Closeup view showing stereo head mounting just above the recorder's original heads.

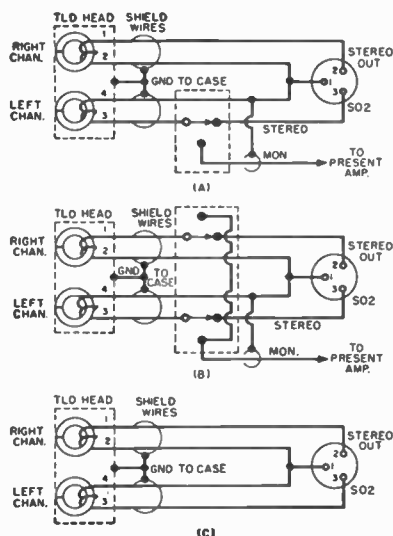

Fig. 2. (A) Connections for half-track recorders, (B) for full-track recorders, and (C) for professional recorders.

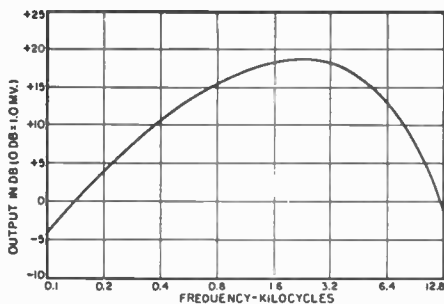
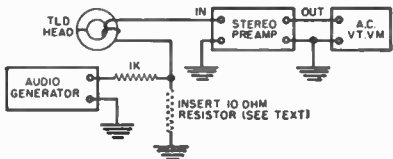

Fig. 3. "TLD" head's constant current characteristics at 7.5 ips, using 3M type 111 magnetic oxide recording tape.

Fig. 4. Setup that is employed for the stereo preamplifier adjustment procedure.



operation be sure to orient the "TLD" head's magnetic gap so that it's in the same relative position as the gap of the head replaced.

It will be necessary for you to install a switch between the stereo head and your present tape amplifier to allow you to switch the head from this amplifier to a stereo preamplifier (see Fig. 2). If your present recorder is a half-track machine, use the switching arrangement shown in Fig. 2A, and if your recorder is full-track, use the arrangement of Fig. 2B. For least hum pickup, wrap three #22 rubber-covered wires tightly together to form a cable. You'll need two such cables. Attach one wire of each cable to a ground lug and mount the lug under the 6-32 screw mounting the "TLD" head, if such a ground lug exists under your present head. If not, find a convenient screw near the head and place the ground lug under this screw. Connect the ground wire to this lug *only*. Do not connect this wire to SO_2 . The remaining two wires of each cable go to pins 1 and 2 and pins 3 and 4, respectively. Be extremely careful when soldering leads to the "TLD's" terminals. Heat can easily damage the head since a hair-thin wire is used for the head's pickup coils. The terminals also tend to loosen under heat and the head used by the author was almost ruined when the leads were soldered for just this reason. A pencil type soldering iron is strongly suggested or, better still, use terminal clips. The switch should be a ceramic-wafer type and it should be mounted inside a shielded case.

Amplifier Adjustments

To insure proper single-channel operation of your present recorder with its new stereo head, a few simple adjustments should be made to the record and playback circuits. Most medium-priced recorders contain recording circuitry similar to that shown in Fig. 1. As shown, insert a 100-ohm

resistor in the ground lead from the head. Turn the record level control to zero and switch the recorder to "Record." With an a.c. v.t.v.m. measure the bias voltage across the 100-ohm resistor. If your machine is half-track, the bias voltage across this resistor should be 0.06 volt r.m.s. If your machine is full-track, the bias voltage should be 0.12 volt r.m.s. In either case, adjust the value of resistor R_1 to achieve proper bias.

The next important adjustment is the setting of the record level. Leave the recorder in the "Record" position and remove the bias oscillator tube, V_1 . Connect an audio generator set to 1 kc. to your machine's "record" input and adjust the generator's output level and the record level control until the record level indicator indicates maximum record level (0 vu). At this point, the voltage across the 100-ohm resistor should be 0.005 volt r.m.s. for half-track machines and 0.01 volt r.m.s. for full-track machines. Resistor R_2 should be adjusted for this level. Remove the 100-ohm resistor and replace the bias oscillator tube.

For maximum high-frequency response from your recorder the "TLD" head's azimuth alignment should be adjusted so that the gap is perpendicular to the tape. The best way to make this adjustment is to use a standard tape recorded with a 10 kc. alignment signal. *Omegatape* demonstration tape D-1 (7.5 ips) contains such an alignment signal, as does the *Ampex* standard alignment tape A-1993 (15 ips). Connect an a.c. v.t.v.m. to the playback output of your recorder and play either of the alignment tapes. If your machine has such a control, adjust the azimuth control for maximum output when playing the alignment tape. If your machine does not have an azimuth alignment control, loosen the 6-32 nut mounting the "TLD" head slightly and rock the head back and forth until you find the point

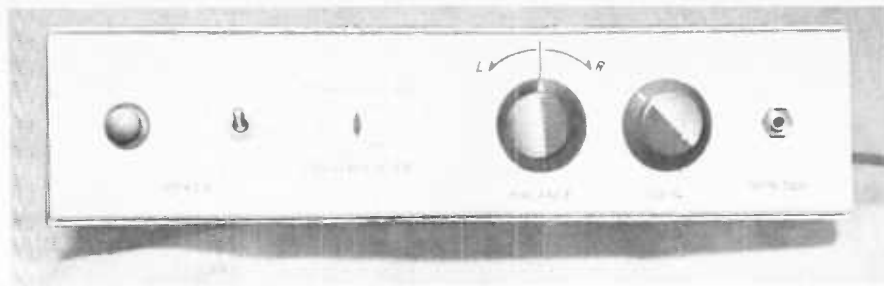

Front panel view of the stereo preamplifier with its balance and gain controls.

of maximum output. Using pieces of paper, shim the head in the position with maximum output and tighten the 6-32 mounting nut.

Professional Tape Recorders

The "TLD" stereo head should not be used as a direct replacement in professional recorders like the *Ampex*, *Magnecord*, and *Berlant* because of its relatively high impedance. For such recorders it is suggested that the "TLD" head be mounted either alongside the other heads or the tape re-routed for stereo playback as was done on the *Magnecord* PT6 mechanism shown in the photographs. Modifying the "Magnecorder" was easy because of the simplicity in re-routing the tape path to pass over the stereo head. In addition, the "Magnecorder" has a 6-32 screw in an ideal position for mounting a small block upon which the "TLD" head was fastened. The two *Magnecord* tape guide rollers should be reversed so that the roller with tape guide flanges is on top. This accurately positions the tape onto the "TLD" head. It is suggested that a third guide roller be added to the "Magnecorder" following the head to further guide the tape. This guide roller is *Magnecord* part 91A9 and may be obtained from the manufacturer for \$4.00. This extra roller has been ordered for the mechanism the author modified and will be added as soon as it arrives.

For other makes of professional recorders, a bit of ingenuity must be used in devising a new tape path so that it can pass over the stereo head.

The head should be located in a position where the tape can make contact with the head for 15 degrees on either side of the gap. Be sure to set the height of the "TLD" head so that the tape straddles the two pole-pieces. The pole-pieces come to the very edge of the tape so it is easy to see whether the head height is right by checking if either pole-piece extends beyond the tape. Where tape tension is rather accurately controlled, as it is on most professional machines, there is no need for pressure pads. Pressure pads should be added, however, if the tape output wavers up and down during playback, indicating insufficient tape contact with the head. Since there is no need to switch the head on a professional machine, modified as described, connect the "TLD" head as shown in Fig. 2C. Again, be very careful not to apply excessive heat to the head's terminals when wiring. Terminal clips are always best.

The Stereo Preamplifier

The "TLD" head has excellent constant-current characteristics (see Fig. 3) making it relatively simple to design a preamplifier capable of reproducing the entire audio spectrum. The physical gap of the "TLD" head is only 0.0002 inch, corresponding to a wavelength cut-off frequency of 37.5 kc. at 7.5 inches-per-second. The high-frequency response is therefore limited only by capacitative head losses of the "TLD" head. It then becomes very important that leads from the head to the preamplifier be kept extremely

short and low-capacitance shielded cable be used from the head to the preamp.

For optimum high-frequency response a low-to-high impedance input transformer would appear desirable for the preamplifier. However, this was ruled out because of the high cost of two good input transformers, and the problem of hum pickup by the transformers. It was decided to keep the preamp's input impedance high and keep the leads from the head as short as possible.

A triode was chosen as the preamplifier's input tube to keep tube noise at a minimum. However, a triode's higher input capacitance, when compared to a pentode, also dictates the use of short input wiring. To help keep hum and noise low the input 12AX7, V₁, should be a low-noise type, such as made by *Amperelex*, *Mullard*, or *Telefunken*.

Equalization in the preamplifier is obtained by a simple RC network in the plate of the second 12AX7. By adjustment of the two 10,000-ohm potentiometers, the standard NARTB playback curve can be obtained within 1 db, including the head's high-frequency losses. If desired, the two 10,000-ohm potentiometers may be ganged on a single shaft and used as an equalization control. On the preamplifier unit constructed by the author, the two pots were left as nominal adjustments within the case. They were set up to follow the NARTB curve, and then locked in position. Most pre-recorded tapes (with the exception of *HMV*) follow

View inside stereo preamplifier with top cover removed. See text for details.

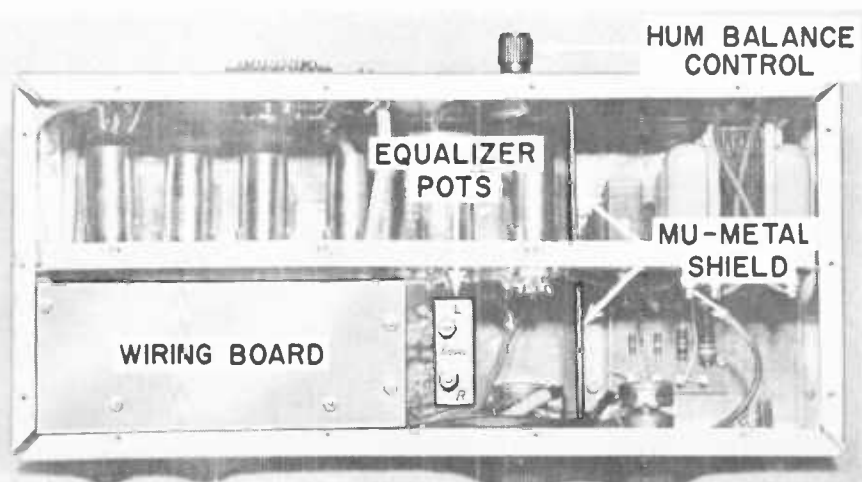

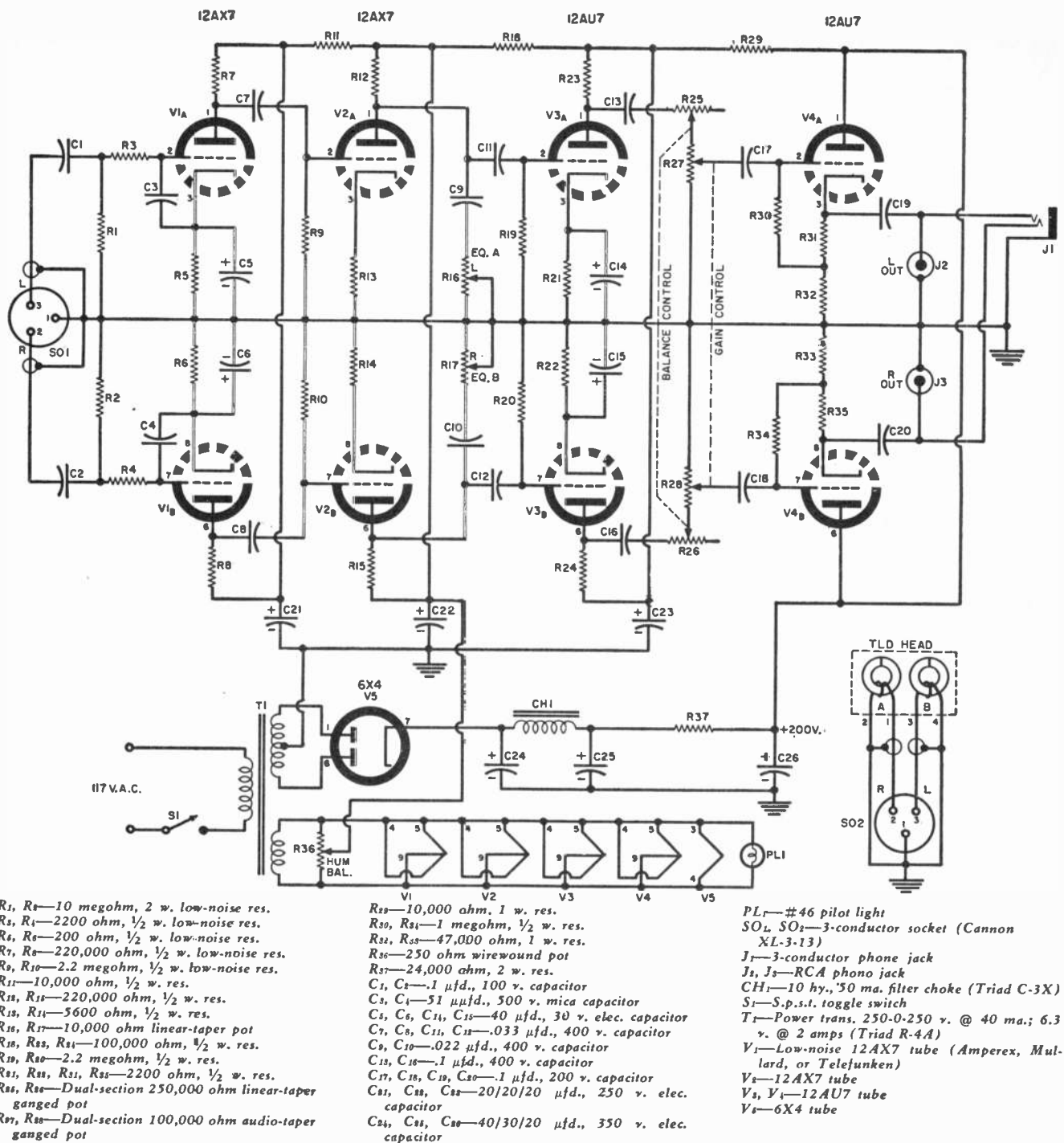

Fig. 5. Complete schematic diagram for the stereo preamp. The unit contains its own built-in power supply for a.c. operation.

the NARTB curve so that further adjustment is unnecessary unless the 10,000-ohm pots are to be used as "tone" controls to vary the equalization to taste. Either approach is acceptable, since it's the final listening that counts.

Two cathode-followers form the output stage of the preamplifier. The output impedance of these cathode-followers is about 500 ohms, so over a hundred feet of shielded cable may be used from the preamplifier to two power amplifiers. The preamp provides sufficient output to drive any power amplifier to full output and operate crystal headphones as a monitor.

The final circuit for the preamplifier is shown in Fig. 5. The preamp alone

has a flat frequency from 10 to over 30,000 cycles within 1 db, has a signal-to-noise ratio of 60 db, and has less than 0.5% distortion at full output.

Constructing the Preamp

The preamplifier built by the author uses two wiring panels for most of the circuitry. This method allows extremely short wiring leads and has worked very well. Point-to-point wiring with terminal strips can be used as well, as long as the wiring is kept short, especially to V_1 . Be sure to plan your layout so that the wiring for each channel is kept separated. The farther apart, the better, as long as the leads are kept short. Any cross-talk from one channel to the other will

reduce the stereophonic effect. The author's wiring was arranged with the two wiring panels opposite each other, about three inches apart, with the tube sockets mounted in the middle.

Keep the power transformer and filter choke on the end of the chassis farthest from the input 12AX7, V_1 . It is a good idea to place a Mumetal shield across the chassis separating the amplifier from the power supply. The largest amount of extraneous noise in this preamplifier is stray hum pickup from the power supply, so care should be taken to isolate all leads carrying power supply a.c. All filament leads should be twisted and run down the center of the tube sockets. Make these leads shielded, as

well. Connections to the power switch and pilot light should be made using two-conductor shielded cable.

Each channel's grounds should not be connected to the chassis, but should be connected to a ground wire connected to the chassis only at the input socket, SO_1 .

Low-noise wirewound or deposited-carbon types should be used for all resistors in the input stage or excessive thermal noise will result. An alternative is to use two-watt resistors. Two-watt resistors must be used for the two 10-megohm grid resistors (R_1 , R_2), since this value is not available as a wirewound or deposited-carbon type.

The balance control is a two-gang 250,000-ohm linear potentiometer that should be wired so that the resistance in the left channel increases as the resistance in the right channel decreases and *vice versa*. The gain control is also a two-gang potentiometer, a 100,000-ohm, audio taper type. The gain control should be wired so that the output of both channels increases together.

To prevent microphonics from reaching V_1 , shock mount the tube's socket by inserting two rubber grommets on the socket's mounting screws between the socket and the chassis. Remember to use a low-noise tube type for the 12AX7, V_1 .

Once completed, the entire preamp should be totally enclosed in a metal case. There is no need to provide holes or vents in the case, because very little heat is generated.

Adjustment of the Preamp

Connect the stereo preamp to the "TLD" head's output, SO_2 , using a short length of three-conductor shielded cable terminated in Cannon XL-3-14 plugs. Alpha type 1713 is an ideal cable for this application.

The preamp should now be adjusted so that its equalization follows the NARTB curve. To do this, insert a 10-ohm resistor in the ground lead from the "TLD" head, as shown in Fig. 4. Adjust the equalization first for the left channel. Connect an audio generator to this 10-ohm resistor through a 1000-ohm resistor, as shown. Connect an a.c. v.t.v.m. to the output of the left channel. Turn the preamp's gain control about half way up, set the generator to 1 kc., and adjust the generator's output so that the v.t.v.m. reads 0.1 volt r.m.s.

Set the audio generator to the frequencies listed on the graph of Fig. 6. By adjusting the equalization control, set the outputs to match those listed on the chart or on the curve. Each time the equalization control is adjusted, return the generator to 1 kc. and re-adjust its output for a reading of 0.1 volt r.m.s.

Remove the 10-ohm resistor and repeat the procedure for the preamp's right channel. The preamplifier is now adjusted to the standard NARTB playback curve.

If the "TLD" head has been added to a professional recorder, be sure to adjust its azimuth alignment by playing a standard alignment tape and shimming the head for maximum output in either channel. It is unnecessary to repeat this procedure if you have adjusted the head's azimuth alignment previously.

Stereophonic Set-up

This completes the preliminary adjustment of your stereophonic reproducer. Now all you need are two medium-power power amplifiers and two loudspeaker systems. For best results, the power amplifiers and speakers should be identical. This can easily prove to be expensive, which is why

the author is currently completing the construction of an extremely simple and inexpensive high-quality dual-channel power amplifier.

However, the high cost of two power amplifiers and speaker systems need not discourage you, for there is a simple interim solution. That is the use of headphones for binaural listening and the use of your current single-channel hi-fi system for listening to one channel of stereophonic tapes.

The Brush Model 205 "A-1" crystal headphones have excellent frequency response and sell for around \$14.00. Replace the headphone's cord with two single-headphone cords and a three-pin phone plug and you have an excellent, inexpensive binaural monitor.

Connect the stereophonic preamp to two power amplifiers and speakers, or headphones, and turn the preamp's gain control full on. Adjust the hum balance control for minimum.

If you are using loudspeakers, place the speakers in two adjacent corners in the listening room, keeping the speakers as flat against the wall as possible. At one time it was suggested that the speakers be angled toward the center of the room, but much better results are obtained with the speakers flat against the wall. A little experimentation will quickly determine the best position for your loudspeakers.

Now comes the most essential item . . . stereo tape. Load your "new" stereo tape player with a stereophonic tape and set the balance control in the center. If the sound appears too loud from either side, adjust the balance control until the sound is evenly distributed between the two channels.

If your tape lacks high-frequency response, either the "TLD" head's azimuth alignment has not been properly set or the preamp is not set to the NARTB playback curve. Check these two adjustments. If the sound has too much hum, either the hum balancing control has not been adjusted or the head itself is picking up hum from the recorder's motors. If the hum stops when the motors are turned off, the motors are causing your trouble. To correct this, you should install Mumetal shielding about the head. To determine the proper location of the shielding, connect a small piece of Mumetal to the preamplifier's case with a short piece of wire and experiment with this shielding until you find a location that yields minimum hum. Then mount a piece of Mumetal in this position permanently. The "TLD" head has built-in magnetic shielding, so you should not normally experience hum pickup problems.

There you have it! You have constructed a piece of equipment that will yield endless hours of enjoyment. The sound is truly fabulous. In no time at all you'll be spoiled and almost refuse to listen to single-channel sound again. It's that good. The sound has a depth, clarity, and spatial presence that cannot be duplicated by any single-channel system.

Fig. 6. Graph below shows the standard NARTB playback curve for tape recorders.

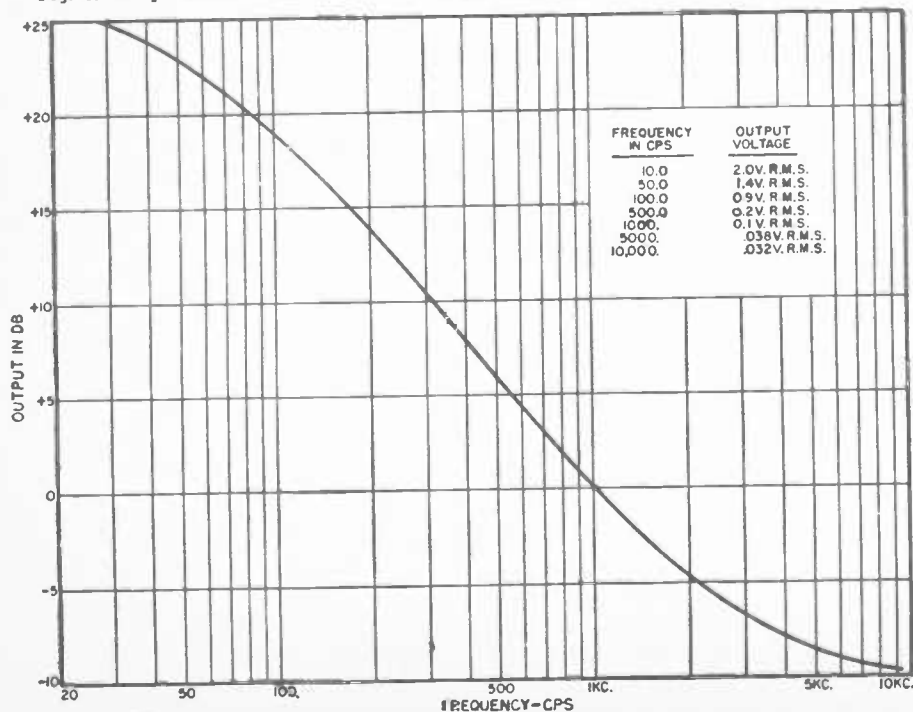

Speakers for Stereo

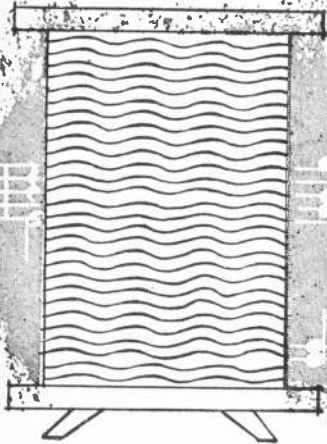

By HERMAN BURSTEIN

THE ability of stereo to improve the similitude between reproduced sound and the original has been effectively demonstrated at audio shows, high-fidelity salons, special demonstrations, and elsewhere. Progress in the art is reflected by the increasing availability of components needed to bring stereo to the home. Stereo tapes are steadily growing in number and quality, while machines to play them can be had in various brands at various prices. The stereo disc has already made its public debut. Some stereo cartridges are already on the market, with more soon to come. Moreover stereo broadcasts are increasing, by means of an AM and an FM channel, by two FM channels, or, experimentally, by a multiplexing system on a single FM channel.

Until recently it was generally thought that 3-channel sound was needed for a truly successful illusion, while 2-channel stereo, a necessary compromise in the interests of cost and space, was viewed as a watered-down version which is a good deal better than monaural but still appreciably short of the ultimate. However, recent developments indicate that with proper attention to microphone placement in recording and with proper attention to choice, placement, and use of speakers in reproduction, the difference between 3-channel and 2-channel sound can become negligible in the home.

To illustrate, some experiments conducted by personnel of Ampex Corporation showed that although 3-channel reproduction was superior in a large auditorium, the superiority was

What the "stereophile" must know about speaker placement, matching and quality of speakers, and reproduction level.

vastly reduced when the same material was played back in a small auditorium over a 2-channel system; it is to be expected that the small auditorium would more nearly parallel home listening conditions. "... the 3-channel tapes, upon review in a much smaller auditorium of nearly ideal acoustical characteristics, could be shown to have

EDITOR'S NOTE: Because of the great interest in stereophonic reproduction and because of the many differences of opinion as to the proper speaker arrangements to be used for optimum stereo effect, your editors feel that it is important to present as many of the facts as possible. In this article the author has analyzed the views and recommendations of four loudspeaker manufacturers as well as a tape recorder and stereo tape manufacturer in order to present to our readers some guidance concerning the optimum placement of speakers for stereo, the proper matching of speakers, the type and quality of speakers to be used, and the proper level of reproduction to be employed.

negligible advantage over 2-channel tapes. In this corollary experiment, switching apparatus was devised so that, in one position, the three channels were separately presented, while in a second instantaneously available position, identically the same over-all level of sound was presented through two stereophonic channels, the output of the former center channel being mixed equally into each of the two separate outer channels. With a succession of audiences, consisting of

trained musicians, engineers concerned with audio subjects, and lay individuals, no significant accuracy could be found in judgments of the distinction."³

Based upon a mixture of logic and empiricism, progress in the stereo art has reached the stage where desired results can be obtained. Today engineers know how to produce a stereo tape or transmit a live stereo broadcast which makes it possible for the listener to recreate the definition and spaciousness of the original. Completion of the illusion, however, rests very much with the listener. The "stereophile" must pay careful attention to (1) speaker placement, (2) matching of speakers, (3) quality of speakers, and (4) level of reproduction.

This article will deal with these four factors as well as with the factors that create the stereo illusion. This discussion owes a great deal to the opinions expressed by several leaders in the field of sound. Specific thanks are due to the R. T. Bozak Sales Company, Electro-Voice, Inc., James B. Lansing Sound, Inc., Jensen Mfg. Co., and RCA Victor Record Division.

The Stereo Illusion

What is it that enables a stereo set-up to endow the reproduced sound with a three-dimensional quality reminiscent of the original? As we are generally aware, a basic factor is that it

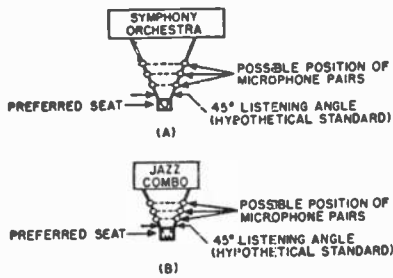

Fig. 1. Relationship between stereo microphones and sound sources in accordance with the "listening angle" principle.

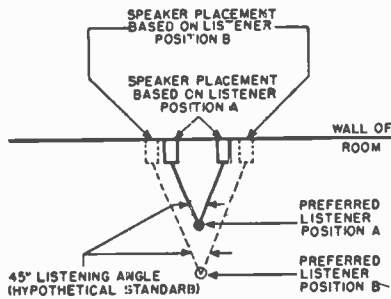

Fig. 2. Optimum placement of the stereo speakers in accordance with the position of the listener and "listening angle."

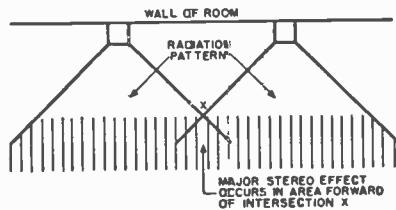

Fig. 3. The relationship of the radiation patterns of speakers to the stereo effect.

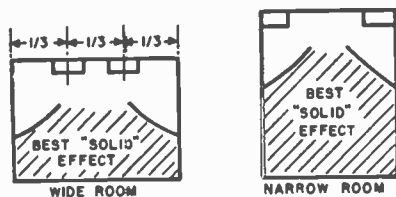

Fig. 4. The Electro-Voice recommendations for the optimum stereo speaker placement.

permits us to distinguish sounds on the left from those on the right, thus providing a dimension of breadth. But there is a good deal more than this to the illusion.

Surprising as it may seem, many of the factors that contribute to stereo are the same as those which enhance the quality of monaural sound, providing a desirable spaciousness, a seeming release of the origin of the sound from the confines of the enclosure. We know that on certain occasions the program material issued from a conventional sound system has a rounder and fuller character than at other times. Four factors have been listed as contributing to the "stereo" effect both on monaural and stereo systems:⁹

1. *High signal-to-noise ratio:* To provide virtually complete free-

dom from extraneous distractions, which can easily disrupt the illusion, a high signal-to-noise ratio is required. While a very effective ratio of 55 or 60 db can be attained with first rate equipment, the more usual figure, at least where tape is concerned, is around 40 or 45 db.

2. *Playback reverberation:* Ideally, music requires a reverberation period of about 1.5 seconds. However, few home environments supply this much, so that the listener is dependent, at least in part, upon reverberation supplied by the recording engineer, as discussed in the next point.
3. *Recording reverberation:* Today's trend is to compensate for the less-than-optimum reverberation time of typical listening rooms. Recording engineers are supplying the difference between ideal reverberation time and the estimated period found in the average home. Reverberation may be increased by moving the microphones back from the source, thus increasing the ratio of reflected (reverberated) to direct sound. Or it may be supplied by electronic or mechanical means, such as tape devices and echo chambers.
4. *Playback level:* Ideally, the playback level should approximate the original.

We turn now to that which distinguishes true stereo from monaural, namely the differentiation between left and right. A recent article by Hume⁴ on the subject points out that the ability of humans to locate a sound source has in the past been attributed to one or more of the following differences between the sounds reaching each ear: (1) time delay; (2) phase difference; and (3) amplitude difference. However, Hume has conducted experiments which lead him to state that the value of these differences "is, at best, in confirming a conclusion already reached by the brain. The difference in signals as received that does produce the stereo effect is a difference in waveshape. The head and external ear, because of their size and shape, shadow or filter out certain frequencies. . . . In the head, for example, the frequency is approximately 800 cps and above. The external ear shadows higher frequencies and, because of its angle, from a different direction. It is this shadowing process that produces a difference in waveshape in the signals received by the two inner ears and which is used by the

brain to make the perception of direction possible."

Irrespective of the extent to which Hume is correct, there appears to be substantial agreement that the stereo effect depends upon the higher frequencies. Hume refers to 800 cycles as the boundary. *Electro-Voice* attributes the effect to frequencies above 500 cycles.¹ Therefore, as will be seen, primary attention for stereo purposes must be given to that section of the speaker system which reproduces the upper mid-range and treble.

Speaker Placement

Optimum location of speakers for 2-channel stereo depends upon three factors: (1) microphone placement in recording; (2) shape of the listening room; and (3) listener's location in that room. Since there are an infinite number of positions that the recording microphones could occupy, it would seem that optimum speaker location would vary from one stereo program to another. Fortunately, it appears that the problem can be resolved by the "listening angle" principle, attributed to *Ampeax*, which postulates a systematic relationship between microphone, speakers, and listener, and permits standardizing this relationship.

"The theory is that the recording engineer sets up his various microphones in such a way that the angle from ideal listener location to the 2-channel pickup points is some generally agreed-on value. About 30-45 degrees seems to be the most common figure. In the reproducing system, the two loudspeakers are separated sufficiently so that a listener will see this same angular distance between the two speakers. Naturally, the farther the speakers are located from the normal listening location, the farther apart they must be . . . to maintain the same angular spread. This theory compensates both for speaker-listener distance and the fact that a symphony orchestra is spread over a much larger area than a small combo. Assuming that a normal concert listener would sit much farther from a symphony orchestra than a jazz lover would (sit) from a small combo in a crowded night club, the angular separation of the two sets of conditions remains fairly constant."¹⁰

The listening angle principle is illustrated in Figs. 1 and 2. Fig. 1A shows the relationship between a symphony orchestra and a listener in a preferred seat. It also shows several out of an infinite number of microphone locations which would maintain an agreed-on angle, say 45°, between lines drawn from preferred seat to microphones. If the microphones are too close to the orchestra, there is indeed a spreading of sound, but at the risk of losing part of the music issuing from the center of the orchestra. If the microphones are moved too near the listener, then the left-right separation decreases. In between is an optimum point which achieves realistic separation, good left-center-right balance, and a desirable blending of direct and reflected sound

Fig. 5. A corner placement of the stereo speakers is generally not recommended.

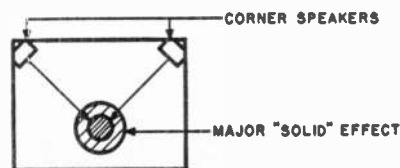

to provide the needed reverberation. Finding this advantageous location is the recording engineer's task.

Fig. 1B is similar to Fig. 1A except that the source is a small jazz group. Although the combo covers less space than the orchestra, the fact that the listener would typically sit much closer to the combo serves to maintain the same angular spread between listener and extremes of the source.

Fig. 2 takes into account the listener's preferred location in the listening room and shows how the speakers would be spaced to maintain a 45° angle between listener and speaker axes. If the listener preferred to sit farther back, then, as shown by dash lines, the optimum speaker location would change.

At this point it is well to interject that although the listening angle principle assumes only two microphones, corresponding to two speakers, some tape recording companies are using three microphones, the third being placed in the center. Subsequently, in preparing a 2-channel master tape, the center channel is mixed with the two outer ones. This enables the engineers to overcome a possible "hole in the center" effect, which has marred some stereo recordings. (Also, the 3-channel tape gives the company an ace in the hole should 3-channel stereo ever take hold to a substantial degree.)

The audiophile should not interpret the listening angle principle to mean that the only suitable listening position is the convergence of the lines forming a designated standard angle between listener and speakers. If the listener moves left, right, or back of the convergence point, the stereo effect will not be destroyed but changed, much as moving to another seat in the concert hall will alter his sensations. Moreover, there are factors which prevent the principle from being as exact in practice as in logic, such as differences between the microphone pickup patterns and the speakers' angular distribution of sound.

It seems fairly well agreed by a number of authorities that once the listener puts a certain distance between himself and the stereo speakers, he will enjoy the stereo effect in virtually any part of the room that maintains this distance. The idea is to get far enough back so that the listener is within the radiation pattern of both speakers, as illustrated in Fig. 3. Fig. 4 shows, as a general rule, how speakers may be positioned for rectangular rooms. Where the speakers face down the narrow dimension of a rectangular room, it is advised that they be spaced so that the axis of each speaker is one-third the distance between side walls. Where the speakers face down the long dimension, it is recommended that they be placed adjacent to each wall.³

In the early days of stereo it was thought advisable to place speakers in the corners of the room, as shown in Fig. 5. However, this principle today is generally frowned upon. Thus the

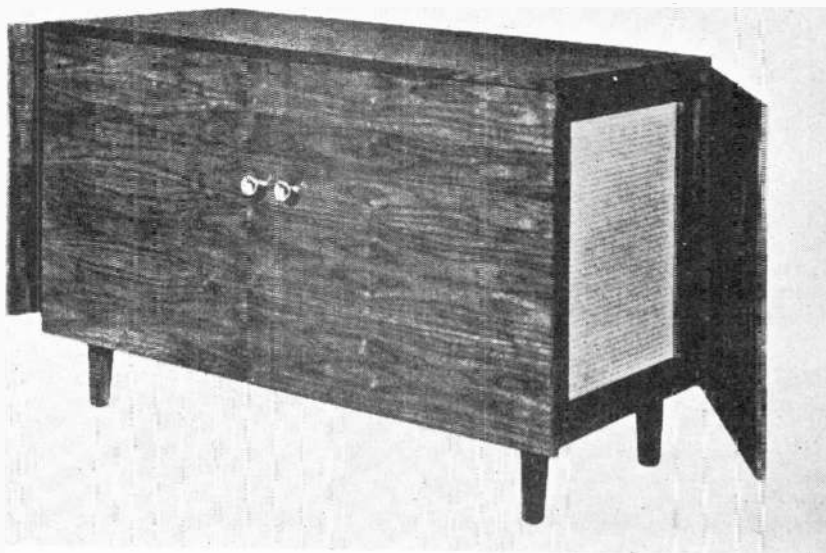

Fig. 6. The Bozak B-304 "Contemporary" complete stereo speaker system in which both stereo speakers are mounted in the same housing. In order to achieve optimum operation, Bozak mounts the speakers facing each side wall, that is, opposite each other, and reflects the sound off the partially open side doors as shown above.

R. T. Bozak Sales Company states, "We feel very strongly that corner placement is not good for stereophonic reproduction." As explained by *Electro-Voice*, "No speaker manufactured currently has perfect dispersion in the treble and high range so important to stereo. More power is always available down the axis. Therefore, speakers in the corner focus the sound at one point in the room. A . . . concentration of 3 db seems sufficient to localize the effect. . . . An effective means of distributing the sound throughout the listening area is to turn the corner speakers parallel to the side wall so that the treble and very-high frequencies traverse these walls at grazing incidence. This results in a multiplicity of focal points over the widest listening area. Note that considerable distribution in this case is effected by reflection. Perhaps the superior effects thus achieved are due to the even balance of the sound from the two speakers resulting from this diffusion."⁴

A number of speaker systems, among them some of the best, are specifically designed for corners and are out of joint physically and acoustically in any other spot, so that the objection to corner speakers for stereo raises a problem. Inasmuch as the stereo effect depends largely or wholly upon the treble range, the solution consists of turning just the treble unit(s) to face straight down the room instead of at a 45° angle to each wall. Thus the advantage of the corner is retained for best radiation of the important bass frequencies.

The ease of re-orienting the treble units of course depends upon the particular speaker system. For example, *Electro-Voice* has this to say about its "Centurion," "Georgian," and "Patrician," all corner units: "The treble horn and v.h.f. driver only need be rotated 45 to 50 degrees towards the wall adjacent to the listening axis.

This is accomplished with fair ease upon gaining access to the cabinet interior. The exception is the 'Patrician,' in which case the 6HD horn with its T25A driver and T35 tweeter must be extracted and placed at the proper angle (presumably in a decorative housing) on the top of the present cabinet."⁵ Fig. 7 shows the recommended arrangements for the "Georgian" and "Patrician."

Units have recently appeared, either complete audio systems such as the *Ampex* A423 or just speaker systems such as the *Bozak* B-304, which contain both stereo speakers in one housing. Since these housings are necessarily of limited width, the spacing between speakers is not sufficient to achieve a pronounced stereo effect by having the speakers face straight down the room. In a sense, both manufacturers' solutions are the same in that the sound is projected at 45° angles to the left and right of the front panel. But the means of achieving this solution are different. *Ampex* mounts the speakers in cater-corner fashion, as outlined in Fig. 8. *Bozak* mounts the speakers facing each side wall, that is, opposite each other, and reflects the sound off partially open side-doors, as shown in Fig. 6.

In concluding this section, it should be pointed out that not necessarily all views on stereo speaker placement have been represented and that those views which have been presented do not necessarily fit all circumstances. Thus the audiophile who embarks upon stereo reproduction should feel that it is definitely worthwhile experimenting with speaker placement in ways other than suggested here. It is even possible that in certain instances the best location will prove to be a corner one, although the rule says otherwise.

Matching of Speakers

The consensus is that matched

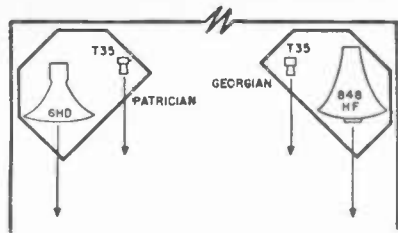

Fig. 7. Electro-Voice recommendations for the reorientation of the treble units in its corner systems for stereo use.

speaker systems are necessary for best stereo effect, although some subscribe to this statement with less emphasis than others. Perhaps the most compelling argument on behalf of matched speakers has to do with eliminating the "hole in the center" feeling that listeners sometimes get when listening to stereo. *Bozak* states, "We attach considerable importance to the use of matched speakers primarily because this is one of the big factors in producing a good center. This is self-evident since the sound that appears to emanate from the center is produced when the two sources are in perfect balance. The balance must be not only in intensity on an over-all basis, but at every individual frequency."⁹

James B. Lansing has additional reasons for recommending matched speakers: "In true stereo reproduction, we feel that consistently good performance can be achieved only with closely matched speaker systems. The idea that one speaker system may reproduce brasses best, while another is perfect for bass viols, is valid but there is no way to guarantee that the recording engineer had the peculiarities of such a combination in mind when he made the recording. Some material will sound excellent on such a mis-matched arrangement, but most of it will be degraded."¹⁰

However, *Electro-Voice* only goes along with these views with reservations, particularly taking exception as far as bass is concerned. "Identical speakers are not required. However, both speakers should be good ones. An exception can be accommodated relative to bass response if a reversing switch on the speakers is utilized so that the bass side of the orchestra can be switched to the larger, best bass-reproducing speaker. It goes without saying that the treble ranges of both speakers should be of equal quality, although not necessarily identical."¹¹ Presumably *Electro-Voice* has in mind such factors as smoothness, distortion, and angular distribution when referring to equal quality.

At the extreme are those who feel that matching is not only a matter of buying speakers of the same brand and model but also of selecting speaker units of equal characteristics, somewhat as one might match tubes for the push-pull output stage of a power amplifier. For example, a stereo editor has told the writer that he finds the

stereo effect varies substantially according to which pair of speakers he is using, even though they are all very high quality units of one brand and model (over \$150 per speaker, exclusive of enclosure).

Quality of Speakers

A developing art understandably breeds opinions which fuller experience proves wrong. In the field of stereo, one of these "primitive" beliefs was that stereo largely did away with the desirability of high quality, and necessarily expensive, speaker systems. It was thought that stereo masked distortion, ragged response, inadequate bass, and inadequate treble.

No matter how good a monaural speaker system may be, if we listen long enough we will certainly find flaws. (As a matter of fact, after a couple of hours or so one can grow weary of the live performance of a fine orchestra in a fine hall.) At all events, it appears that after one has lived with a stereo system for a while, one becomes just as conscious of speaker inadequacies as in the case of monaural listening. This is confirmed by *Bozak* and *Lansing*:

"It has been held by some workers in this field that many of the offensive effects of distortion are eliminated in stereo systems. This we do not believe to be the case. Conclusions such as those just cited are drawn because the spaciousness and directive qualities of stereo are such an improvement over low quality monaural sources that many of the flaws are overlooked; thus listening fatigue, which is developed subconsciously, is just as likely with low quality speakers in stereo as in monaural. The difference is primarily in incubation time."¹²

"It is just as important to use high quality units with a stereo system as it is with any single-source installation. But quality, of course, is not determined by price alone, and the buyer must carefully choose speakers which match his listening preferences and particular room acoustics."¹³

Speaker Level

Many audiophiles have found that on monaural systems they can enhance the illusion of reality by reproducing music at high volume. This is not merely a matter of equalling concert hall amplitude, for it is well known that some audiophiles operate their systems at levels actually above the original. High volume simulates reality by bringing out each voice in the orchestra and perhaps by setting up

Fig. 8. Here is the Ampex method of housing two stereo speakers within one cabinet.

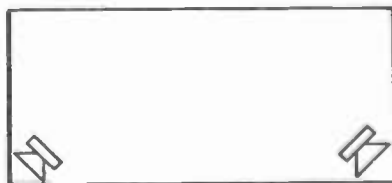

additional reverberation in the listening room.

Opinion seems to be somewhat mixed as to the volume level required for full satisfaction from stereo, although recommendations in the main point to a playback level equalling the original. On the one hand, *Bozak* states, "One advantage that stereo sound does offer over monaural sound is that loudness is not nearly as critical for faithful reproduction. Thus stereo need not be played as loud as monaural for complete musical satisfaction."¹⁴

However, this statement should not necessarily be interpreted as an endorsement that less than realistic levels will maintain the effectiveness of stereo. It simply says that stereo need not be played as loud as monaural, which is often played above original level.

A more positive case for high-level stereo reproduction is made by *Lansing*: "... the 3-D effect is sufficiently arresting to supply some of the 'oomph' which some people try to supply in ordinary systems by boosting the level of reproduction. It is certainly true that with stereo program material it is no longer necessary to boost the intensity above live concert level to hear fine details. But with stereo we feel it even more desirable that material be played at a natural listening level. Most listeners seem to feel that as volume is reduced, the 'realistic' quality vanishes even more quickly than with single channel reproduction. Some stereo recordings of symphonic works sound very much like single channel material until they are played very loud, and then suddenly the whole orchestra opens up and the effect is magnificent."¹⁵

In the matter of speaker level, there are indications that a woofer-tweeter balance which is suitable for monaural purposes may not be as good for stereo. For one thing, the difference in speaker placement may result in greater absorption of highs by room elements. Thus *Electro-Voice* makes the following recommendation with respect to use of its systems for stereo: "The settings on the treble and very-high frequency attenuators on *Electro-Voice* systems should be advanced to the full 'on' position for stereo reproduction. This is necessary for the preservation of bass-high balance, due to inordinate absorption of the highs by the walls' reflecting."¹⁶

Furthermore, in view of the fact that the highs play a major role in the stereo effect, the user may find it desirable to deliberately increase their relative level as a means of bringing out or accentuating this effect.

Conclusions

From what has been said herein it would appear that the individual who wants the utmost that stereo can offer today must go to substantial lengths. Not only must he have two of everything in the audio chain following the stereo source, but he must obtain

speakers that are of high quality and matched in their sound characteristics, he must place them properly in relation to the dimensions of his room and listening position, and he must operate them at suitably high levels in order to produce a three-dimensional illusion.

Yet this should not discourage those who would like to get into stereo on a modest, relatively inexpensive basis. Pleasing results can still be obtained with moderate-priced speakers, less than optimum placement, and reasonably reduced playing levels. It is a rule in audio that one pays a good deal for a slight improvement. Conversely, by accepting a tolerable sacrifice in performance, one can achieve a substantial saving.

The writer has long been among the skeptics who doubted that 2-channel stereo could match the stunning effect produced by binaural sound (via ear-phones), although he did not deny the superiority of stereo over monaural. However, what he has heard and seen in the past year cause him now to believe that a wholly convincing stereo effect can be achieved under the proper circumstances with only two speaker channels. The stereo art has emerged sufficiently from infancy so that it is now worthwhile for the audiophile to consider bringing stereo into his home.

True, the art is still quite young and no doubt the next two or three years

will bring considerable advances, some of which may revise today's thinking. But this does not seem to be a valid reason for putting off one's initiation into stereo, particularly on the part of those venturesome spirits who prefer to be active participants in a new development rather than mere on-lookers.

The writer is reminded of the early years of TV, the late 1940's, when some viewers paid a high price for a 7- or 10-inch screen and had little but wrestling and old cowboy movies to watch. Today's viewer typically watches a 21-inch screen and has a great variety of fare to draw upon, yet it is doubtful that TV addicts of the 1940's experienced any less a thrill than today's audience. Because stereo will be better in 1960 is not enough reason, for some, to postpone first-hand acquaintance with stereo, even though their speaker setups are not all that they might be.

REFERENCES

1. *Burstein, Herman*: "Stereo Tape Comes of Age," *Radio-Electronics*, November, December 1956.
2. *Slested, Walter T. & Snyder, Ross H.*: "Acoustical and Electrical Considerations in Symphony Orchestra Reproduction," *Audio*, January 1957.
3. *Electro-Voice, Inc.*: "Application of Electro-Voice Speaker Systems to Stereo Reproduction," *E-V Technical Bulletin No. 1*.
4. *Hume, Howard F.*: "A New Concept on the Physiological Aspect of Stereophonic Sound," *Audio*, March 1957.
5. *Correspondence from James B. Lansing Sound, Inc.*
6. *Correspondence from R. T. Bozak Sales Company.*

-30-

AMPLIFIER SWITCHING

By JAMES F. SUTHERLAND

WITH higher wattage hi-fi power amplifiers becoming more common, the ordinary methods of switching the system on and off with a switch incorporated in the volume control on the preamp panel may become inadequate.

An ideal switching system would eliminate all sources of hum noise in the preamp. One "humless" method of switching the incoming line current to the hi-fi power amplifier from a remote preamp panel is shown in the diagram below.

Closing the relay coil circuit momentarily with S_1 causes the relay contacts to energize the main power transformer. Pushing S_1 a second time turns the system off since RL_1 alternately opens and closes its contacts with each successive pulse.

Circuit for switching a high power hi-fi amplifier on or off without causing hum.

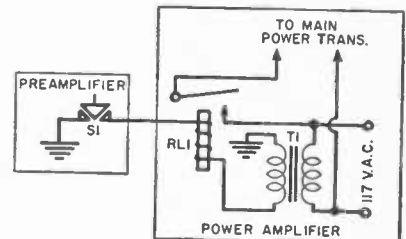

S1—MOMENTARY PUSH SWITCH (NO)
RL1—GUARDIAN IR-RC-24AR RATCHET RELAY
TI—TRANSFORMER, 24V. SECONDARY

STEREO AND MONAURAL...

the experts say your best buy is... **EICO®**



EICO FM TUNER HFT90
with precision "eye-ronic" tuning
KIT \$39.95* Wired \$65.95*
Cover \$3.95
*Less Cover, F.E.T. Included.

(The EICO FM Tuner provides) . . . non-critical tuning, low capture ratio (6db), close-station separation, and insensitivity to drift which are unique among FM tuner kits, to the best of our knowledge . . . one of the best buys you can get in high fidelity kits." — **AUDIOCRAFT Kit Report.**



EICO Master Control Preamplifiers
HF61A KIT \$24.95 Wired \$37.95
with power supply, HF61
KIT \$29.95 WIRED \$44.95

"(The EICO Master Control Preamplifier's) performance rivals that of the most expensive preamps . . . All in all, here is an example of a high level of engineering skill, which has managed to achieve fine performance with simple means and low cost." — **Joseph Marshall, AUDIOCRAFT.**

Concerning the EICO 60-watt Power Amplifier: "Listening tests confirmed the fine instrument test results without question. Our HF-60 produced firm, well-defined bass and clear, sweet treble on the finest speaker systems available. It clipped momentary overloads very well and recovered quickly, and this gave listeners the impression of tremendous reserve power. In our opinion, it is one of the best-performing amplifiers extant; it is obviously an excellent buy." — **AUDIOCRAFT Kit Report.**

"We believe the EICO HF 52 (50-watt Integrated Amplifier) should prove highly satisfactory for home music systems requiring a 50-watt amplifier. At its price, either in kit form or assembled, it represents an excellent value." — **Hirsch-Houck Laboratories.**

"For those who have been looking for a well-engineered yet inexpensive power amplifier, the newly-released EICO Model HF-20 unit might offer a simple solution to their problem. Not only does this unit provide 20 watts of power but the circuit incorporates a pre-amplifier and a variety of controls on a single chassis." — **William A. Stocklin, Editor, RADIO & TV NEWS.**

"... the EICO Standard (Speaker System) proved able to create a remarkable illusion of realism from all types of program material . . . String tone was reproduced with a smooth, gummy richness . . . Bass transients were well handled . . . never any sensation of two sound sources; the speakers blended faultlessly . . . an eminently musical reproducer . . . the EICO's compactness and dispersion characteristics would suggest unusual suitability for stereo application." — **J. Gordon Holt, Technical Editor, HIGH FIDELITY**

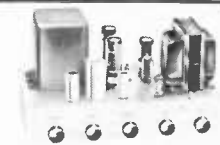

EICO 50-Watt Ultra-Linear Integrated Amplifier HF52
KIT \$69.95 Wired \$109.95

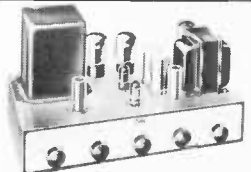

EICO 20-Watt Ultra-Linear Integrated Amplifier HF20
KIT \$49.95 Wired \$79.95

EICO Standard Speaker System HFS2

Completely factory built
Mahogany or Walnut, \$139.95
Blonde, \$144.95



EICO Stereo Preamplifier HF85
KIT \$39.95 Wired \$64.95



EICO Stereo Amplifier-Preamplifier HF81
KIT \$69.95 Wired \$109.95



EICO 60-Watt Ultra-Linear Power Amplifier HF60
with Acro TO-330 Output Transformer
KIT \$72.95 Wired \$99.95

IN STOCK

at 1900 neighborhood dealers throughout the U. S. Write for FREE catalog.
EICO, 33-00 Northern Blvd., L. I. C. 1, N. Y. ZA-581
Show me HOW TO SAVE 50% on 60 models of top-quality equipment (in box I have checked here: HI-FI TEST INSTRUMENTS HAM GEAR).
Send FREE literature and name of neighborhood EICO dealer.

NAME.....
ADDRESS.....
CITY..... STATE.....

add 5% in the West

Testing FM Tuners

By WALTER H. BUCHSBAUM

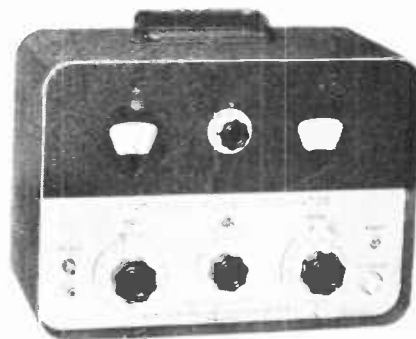
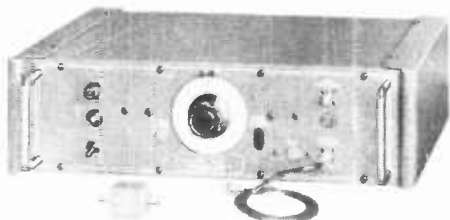

THERE are many FM tuners on the market today, in both kit and assembled form and each is offered with a set of electrical specifications which should determine its performance. These specifications are sometimes based on tests devised by the manufacturer but usually the published figures are obtained by standard test methods.

The Institute of Radio Engineers (IRE) publishes the findings of various groups, coordinated by the Standards Committee, and the reference on FM receivers is the publication "Methods of Testing Frequency Modulation Broadcast Receivers," 1947. In this standard all applicable tests are described and agreed methods for performing them are presented. Many of these tests deal with the acoustical portion of the FM set and therefore do not apply to FM tuners. Other tests, such as the one on masking interference or local oscillator radiation, are not important enough to the set owner to warrant specifications.

The technically minded purchaser of an FM tuner may wonder at the meaning of some of the specifications the manufacturer publishes or he might try to duplicate these results in his own performance tests. Conflicting claims of excellence may often be due more to varying test methods than actual electrical differences. This article describes twelve tests, listed in the IRE standards and usually performed in evaluating FM tuners. The reader must be warned, however, that the equipment required for most of these tests is usually available only in well equipped development or testing labs.

Standard Values

For FM tuners there are certain standard values which will be referred to many times and which are commonly used in all performance tests. The most important of these are: the standard input impedance which is 300 ohms; standard test frequencies which are 88, 98, and 108 mc.; and standard input voltages. These range from 11,

A review of the standard laboratory procedures that should be used to measure and check tuner specifications.

110, and 1100 microvolts up to 1.1 volts. The standard test modulation of the input signal is 400 cycles at 30% which means that the r.f. signal varies in frequency ± 22.5 kc.

Test Equipment

The most important piece of test equipment is the signal generator. In addition to being stable and having an accurately calibrated frequency dial, this generator must also have a number of other features. It must cover the 88 to 108 mc. frequency band and the adjacent ranges. To cover the 10.7 mc. i.f. band a second generator is usually used. A metered output attenuator, calibrated from 0.1 microvolt to 1.1 volts as well as frequency modulation, metered from zero to 100%, should be part of the generator. Either external or internal modulation from 30 to 15,000 cps should be possible and the modulator should contain the standard 75 microsecond pre-emphasis network, including a disabling switch for it.

To match the 300-ohm tuner input,

the generator should either have a balanced 300-ohm output or else a cable and termination must be used to change the 50-ohm output to a 300-ohm balanced system. The loss in this conversion must be accounted for in all output readings.

To check the output of the FM tuner a v.t.v.m. and an oscilloscope will be required. Since the IRE standards were written for complete FM receivers, all output measurements were made at the loudspeaker, hence the conventional audio distortion analyzers, power output meters, and dummy loads were used. In this respect some modification of the standards is necessary. Distortion will have to be measured either by analyzers or by eye on the oscilloscope and, in place of power output, the usual cathode-follower output signal will be metered.

One of the important items in measuring tuner performance is a dummy antenna. Fig. 1 shows the typical circuit of such a network as connected to the 300-ohm balanced generator. The resistors used should all be of the $\frac{1}{2}$ watt, 5% carbon type and all leads should be as short as possible.

Practically all FM tuners use 117-volt a.c. power and, in testing them, the line voltage should be measured and set to 117 volts at all times. Use of a metered Variac makes this convenient to arrange, otherwise the line voltage must be checked several times during each test.

Before proceeding with any of the following performance tests the tuner should be carefully aligned and tracked at several points in the band, but at least at the standard test frequencies already listed. For this alignment check it will be necessary to remove the tuner from the cabinet and all further tests will be done on the open chassis. Only if all tubes

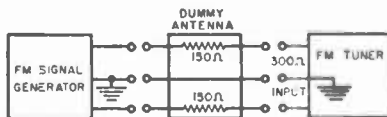
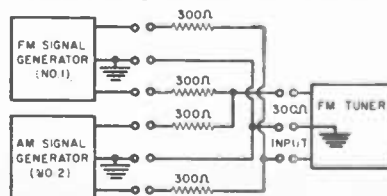
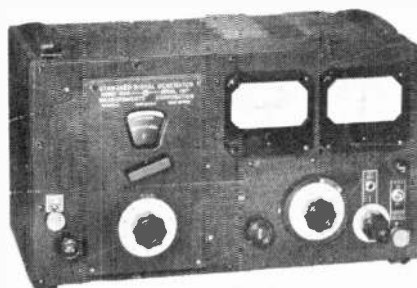
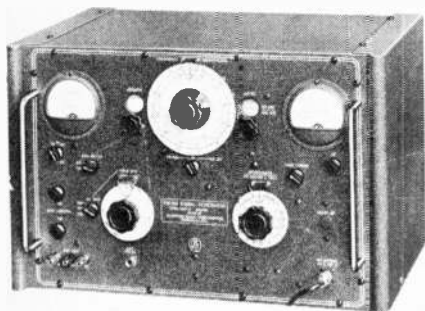

Fig. 1. Sensitivity is measured by connecting generator and tuner as shown.

Fig. 2. The AM suppression test described in the text may be made with this setup.



Some of the accurate and specialized lab test equipment used for testing.



are in place and the set is working properly with the regular antenna, can these tests be readily performed.

1. *Tuning Range Test*: First the tuner frequency control is checked for smooth operation over the band. Then connect the signal generator to the tuner through the dummy antenna as shown in Fig. 1 and set the tuner to the highest frequency. Connect the v.t.v.m. to the FM detector output and, with the generator at c.w. (unmodulated), tune the generator until the v.t.v.m. goes through zero. In the same way check the frequency at the low end of the tuner dial. All FM tuners should cover at least from 88 to 108 mc. preferably with a few megacycles at either end. If the FM tuner has a calibrated tuning dial, the dial reading should be compared to the generator reading at least at the standard test frequencies of 88, 98, and 108 mc.

2. *Sensitivity Test*: Three different sensitivity values can be considered as giving an indication of FM tuner performance and a fourth measurement is taken to give an indication of the audio stage limitations on the i.f. system.

(a). Maximum sensitivity is measured by connecting the generator and tuner as shown in Fig. 1 and connecting the v.t.v.m. to the audio output jack. To make the measurements exact, the oscilloscope or a distortion analyzer should also be connected to the tuner output. All tuner controls are set for maximum gain and then the tuner and generator are tuned, in turn, to each of the three test frequencies. The generator output should be set to the standard test modulation which is 400 cps at 30%, or 22.5 kc. deviation. In FM receivers the output is standard at 0.5 watt of audio power into a dummy load and for FM tuners the most widely used value is either 1 or 3 volts r.m.s. at the output jack, depending on the manufacturer's data. The purpose of the scope or analyzer is to make sure that the 400-cps signal is free from distortion. The signal

generator attenuator is adjusted to produce either 1 or 3 volts r.m.s. at the output jack and the microvolts thus supplied constitute the maximum sensitivity. Needless to say, correct tuning is essential. It may happen that receiver noise is so great at maximum gain that it obscures the signal. This should be noted and another reading can be taken for the generator setting where the received signal is twice as large as the noise. Usually the tuning position for minimum noise and minimum distortion coincides, but if two different spots on the frequency scale are involved, this should be noted.

(b). Maximum deviation sensitivity is measured with the signal generator set to 100% or ± 75 kc., but otherwise in the same manner as just described. The generator output is adjusted at each test frequency to give 10% distortion at the tuner output jack, as measured on the oscilloscope or distortion analyzer. Vary the generator output attenuator until the output is either 1 or 3 volts or until only 10% distortion is apparent, whichever is the higher generator output reading. This reading, in db below 1 watt or in microvolts, is the maximum deviation sensitivity.

(c). For the deviation sensitivity test the generator is set only to 98 mc., the output is set for 90 db below one watt or to 1100 microvolts and the deviation is varied from 0 up to that value which produces 1 or 3 volts

r.m.s. at the tuner. The value obtained is expressed either in kilocycles or per-cent.

(d). "Quieting signal sensitivity" gives an indication of the degree of internal receiver noise during moments when the received signal is not modulated. The generator is tuned, in turn, to the three test frequencies and, with 400 cps, 30% modulation, the attenuator is set for 1100 μ v. output. The modulation is then turned off and the tuner output reading is noted. With standard test modulation again, set the attenuator to a minimum value so that the tuner output reading is about 30 times (30 db to be exact) the reading with unmodulated input. This attenuator setting, in microvolts or db below one watt, is then the quieting signal sensitivity for 30 db quieting.

3. *AM Suppression Test*: This important test measures the degree to which a tuner can reject AM interference appearing together with the desired FM signal. Either a generator having simultaneous AM and FM available or two separate signal generators are required. In the latter instance connections should be made as shown in Fig. 2 and the output signals, as measured at the generator, will be half of the actual applied signal. At 98 mc. an FM signal, 1000 cps at 30% modulation, is fed through the dummy antenna at 1100 μ v. If the circuit of Fig. 2 is used, the generator should deliver twice the output voltage. Then the FM tuner volume control is adjusted to produce 1 or 3 volts r.m.s. output at the jack. Next the AM signal is introduced having a 400 cps, 30% amplitude modulation and the same generator output voltage. If two generators are used they must be tuned very precisely to avoid beat notes. The AM signal should be free from any FM content. Now it is necessary to insert a 1000-cps rejection filter at the tuner output jack. In many instances where a suitable filter is not available the 400-cps output can be measured on the scope, if

Fig. 3. Typical a.v.c. characteristic.

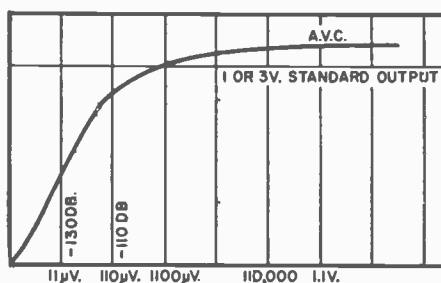

the scope is synchronized at 400 cps. The ratio of the undesired 400-cps output to the 1 or 3 volts standard FM output is the AM suppression in db. To indicate how the suppression characteristic varies with input level the measurement can be repeated at the other standard input signal levels such as, 11, 110 μ v., etc. Typical values of AM suppression with 1100 μ v. input are between 30 and 40 db.

4. *Harmonic Distortion Test:* With the FM tuner set at 98 mc. and the signal generator connected through the dummy antenna as shown in Fig. 1 several different indications of distortion can be obtained. Precise distortion measurements can best be made by means of a distortion analyzer, but for approximate readings visual observation on the scope may be enough.

(a). *Output variation.* With the signal generator set at 400 cps 30% modulation and 1100 μ v., vary the volume control to produce different output levels. Different degrees of distortion will be observed and they indicate the audio distortion due to the audio section.

(b). *Modulation distortion is measured* as previously described but the volume control is set for 1 or 3 volts r.m.s. output and the modulation percentage is varied at the generator from 10 to 100%. This measurement gives an indication of the r.f. and i.f. bandwidth and the linear response of the detector.

(c). *Input signal variation from 11 μ v. up to 1.1 volts, with both 30 and 100% modulation, indicates the action of the a.v.c. and bandpass response.* The output signal is kept constant at either 1 or 3 volts r.m.s. by adjusting the volume control.

(d). *Modulation frequency distortion is best checked with a generator having external modulation which is supplied by an audio oscillator.* This test can be performed by repeating the tests of (a) and (b), but with different audio frequencies ranging from 30 to 20,000 cps, at 30% modulation and standard input and output signal values.

5. *Maximum Undistorted Output:* This test has generally more meaning for complete FM and audio systems since in FM tuners the audio output voltage is not critical. The test for harmonic distortion listed in paragraph (4a) is simply modified by setting the volume control to that output level where the total harmonic distortion is just 10% (r.m.s. voltage) of the output signal. This signal voltage is then the maximum undistorted output.

6. *Maximum Output:* Again this test is useful mostly in evaluating a complete FM receiver and all it tells about the FM tuner is what the maximum output voltage of the cathode follower is, irrespective of distortion.

7. *A.V.C. Characteristics:* This is determined by setting the volume control to produce half the maximum

for Ultimate Fidelity

SHERWOOD*



*outstanding honors bestowed, unsolicited, by most recognized listening organizations.

No matter what your source of music—FM, your own discs, or tape—you will enjoy it at its best coming from Sherwood's complete home music center... most honored of them all! Sherwood tuners for example...

First to achieve under one microvolt sensitivity for 20 db FM quieting increases station range to over 100 miles. Other important features include the new "Feather-Ray" tuning eye, automatic frequency control, fly-wheel tuning, output level control and cathode-follower output.

Model S-2000 FM AM Tuner \$139.50 net

Model S-3000 FM (only) Tuner \$99.50 net

For complete specifications, write Dept. J-3

SHERWOOD

ELECTRONIC LABORATORIES, INC.

4300 N. California Ave., Chicago 18, Illinois

The "complete high fidelity home music center."

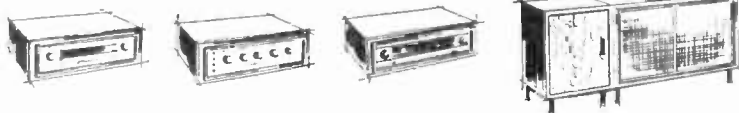

In New York, hear "Accent on Sound" with Skip Wesner, WBAI-FM, week nights, 9 P.M. In Los Angeles, KRHW-FM, 10 P.M.

possible output with each of the following generator settings: 11, 110, 1100, 11,000, 110,000 $\mu\text{v.}$ and 1.1 volts output, at 400 cps, 30% modulation at 98 mc. By plotting the values of output signal, in each instance, against the input voltage, a curve like the one of Fig. 3 is obtained and this represents the a.v.c. characteristic. Note that with increasing input signals the output of the FM tuner tends to remain constant, which is due to both a.v.c. and the limiting action of the limiter stage.

8. Spurious Responses: This test consists simply of tuning the signal generator over a wide frequency band to see if the FM tuner will pick up undesired frequencies. Certain known spurious responses are unavoidable, but their signal strength would have to be quite large to interfere. Each spurious frequency is noted first and then the test described in paragraph (2a), the maximum sensitivity test, is performed for each spurious frequency. Normally, all such undesired frequencies should have sensitivity readings at least 60 db below the desired response. There is one particular response that is inherent in the superheterodyne system and that is the image response. This occurs at a frequency 21.4 mc. above the desired signal and is due to the beat of the local oscillator with a signal 10.7 mc. higher. For most FM tuners the image response should be better than 45 db below the desired response. If, for example, the maximum sensitivity of the tuner is 11 $\mu\text{v.}$, the image sensitivity should be less than 3300 $\mu\text{v.}$

Another undesired frequency which will always be received is the i.f. itself. To check the receiver sensitivity for the 10.7 mc. i.f. a generator supplying this signal must be used.

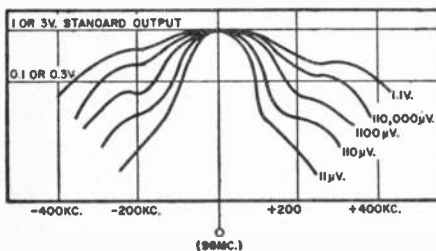
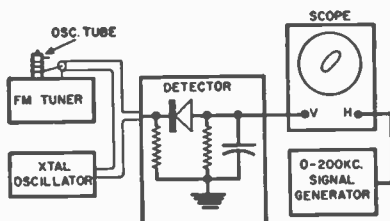

Fig. 4. Curves showing the over-all frequency response of an FM tuner at various signal levels. Note the wider over-all response at higher inputs.

Fig. 5. Method employed to check the drift of the oscillator in the FM tuner being checked. A crystal diode scope probe is used to detect the beat.



This generator is connected through the standard dummy antenna and the maximum sensitivity test is performed. Results should be better than the image response sensitivity.

9. Measurement of Hum: For complete FM receivers, the hum measurement provides an indication of the audio system quality as well as the tuner performance. When the audio section alone is tested for hum, the simplest way to check is to use the oscilloscope as an indicating device. The scope should be sensitive enough to show at least 0.01 volt peak at measurable amplitude. First, short the tuner antenna terminals together, set the volume control to minimum and the tone control for maximum hum. The scope is connected to the audio output jack and the horizontal sweep synchronized to the 60-cps power line. Hum voltages observed are peak values but, in specifications, hum is usually stated in r.m.s. so that the actual peak-to-peak reading has to be divided by 2.8. A second test which will check the entire tuner can be made with the tuner connected to the signal generator and tuned exactly for the 98 mc. test frequency with 1100 $\mu\text{v.}$ input. With the standard 30% modulation on, adjust the volume control for the standard 1 or 3 volts output. Then turn the modulation off and measure the hum signal on the scope. In this way the ratio of hum to signal can be determined. Most FM tuners will have less than .05 volt peak hum output.

10. Tuning Characteristic Test: This test gives some indication of the over-all frequency response of the FM tuner at different signal input levels. At the 98 mc. test frequency the tuner volume control is set for standard 1 or 3 volts output and the generator for one of the standard input levels, 11, 110, 1100 $\mu\text{v.}$, etc. Then the generator is detuned in 25 kc. steps above and below the 98 mc. center frequency. The output amplitude is then plotted on a graph against frequency, as shown in Fig. 4. A separate curve is taken for each level of input. As the input signal increases it is natural for the apparent bandwidth to increase as well.

11. Tuning Indicator Test: Many of the more expensive FM tuners have some type of tuning indicator. Where a tuning eye tube is used, the percentage of non-illuminated area is an indication of the error in tuning. When a meter is used, the needle deflection gives the same information. To test the accuracy of these devices the same test as in paragraph (10) is performed, but instead of recording the output signal variation the action of the tuning indicator is noted. The point where the tuning indicator shows completely "off station" should coincide with the 100 kc. above and below center points for accurate tuning.

12. Frequency Drift Test: The local oscillator drift can be ascribed to two

major causes. First is the inevitable warm-up drift and second is due to variations in line voltage and subsequent "B+" and filament changes. Warm-up drift is usually corrected, in some measure, by the addition of temperature compensating capacitors and in some FM tuners an automatic frequency control system is used. In that case these tests should be performed first with the system operating and then without any a.f.c. correction. The difference between results will give an idea of the efficiency of this circuit.

To check oscillator drift accurately another oscillator of the same frequency range is required. It should be a unit that is crystal controlled. The two oscillator signals are connected to a crystal diode as shown in Fig. 5 and their output is then the "difference frequency." If both oscillators are at the same frequency, zero beating is possible. As the FM tuner warms up the beat signals will increase in frequency. To measure the beat frequency connect the detected signal to the vertical terminals of the oscilloscope and drive the horizontal scope sweep from a calibrated audio generator going up to at least 200 kc. One minute after the FM tuner is turned on, adjust its local oscillator to zero beat, indicated by no vertical deflection at the scope. As the local oscillator varies in frequency the scope will show sine wave signals indicating the amount of frequency drift. Now the audio generator is adjusted to produce a single circle on the scope and the actual drift frequency is directly readable at the audio generator. Repeat measurements are taken every minute as the FM tuner warms up. After the first 10 minutes, readings are taken every 10 minutes for the first hour.

Oscillator drift due to voltage variation is measured in the same manner except that a Variac is used to change the line voltage. Usually the voltage is varied from 100 to 130 volts and the frequency drift is observed immediately after the voltage change. This frequency drift is expressed as the number of cycles of drift per 1% of line voltage change. Where an a.f.c. system is used, the drift due to changes in signal input level can be checked in the same manner. It is necessary to wait until the local oscillator has warmed up and then the signal generator, with standard modulation, is connected and the input level is varied in steps from 11 to 11,000 microvolts. The observed frequency drift is an indication of the interaction between a.f.c. and a.v.c. circuits.

A number of other tests can be made on FM tuners but since they are either quite complex to perform or else do not yield any data of interest to the user they are omitted here. It is safe to say that any tuner which has successfully passed the tests described will be a really good piece of equipment and will give very satisfactory FM reception. —50—

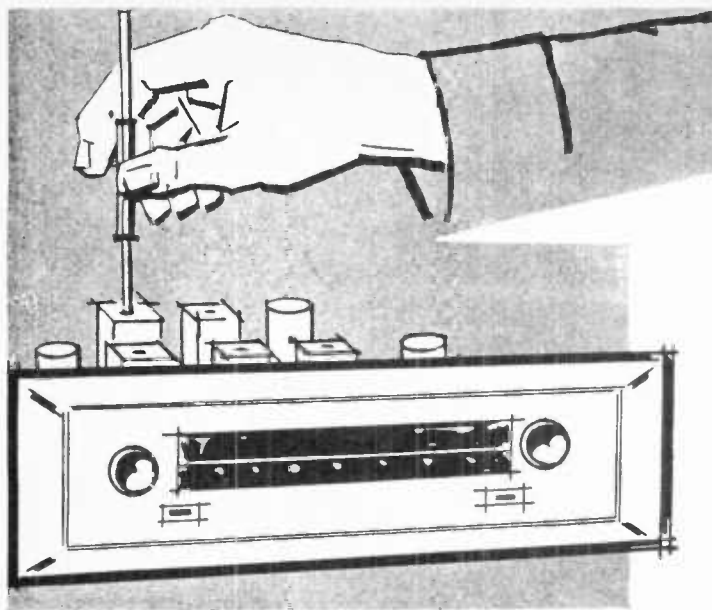

Testing FM Tuners at Home

By **JULIAN D. HIRSCH**
Audio Consultant

*Check and maintain your tuner's performance
without the use of elaborate test equipment.*

FM TUNER performance specifications may describe the tuner in terms of its quieting sensitivity, bandwidth, frequency stability, and distortion. Accurate determination of these performance factors requires considerable expensive laboratory equipment and is usually beyond the scope of the audiophile or radio technician.

The alignment and adjustment of an FM tuner may be performed with relatively inexpensive service instruments such as a signal generator, audio analyzer, v.t.v.m., and oscilloscope. Many users of FM tuners have one or more of these test instruments available and should be able to perform much of the adjustment and maintenance on their receivers at home.

However, the vast majority of users have no test equipment at their disposal. Without at least a v.t.v.m., it is next to impossible to check the performance of a tuner or to align it for optimum performance. However, a number of modern FM tuners have sufficient built-in metering, either in the form of signal and tuning meters or as "magic eye" tubes, so that considerable maintenance may be performed on them without additional test equipment. The eye, in effect, constitutes a built-in vacuum-tube voltmeter.

This article will describe some of the tests and procedures which may be followed at home in order to check and maintain the performance of an FM tuner without recourse to expensive laboratory-type test equipment. For some of these tests, one or two simple service instruments will be required. These may be purchased ready built, may be constructed from kits, or may be borrowed from a friend who is for-

unate enough to have them available.

Sensitivity Measurement

The sensitivity of an FM tuner is normally expressed as "X microvolts for 30 db quieting." This is defined as the minimum signal for which a 30 db increase in output is obtained when modulation percentage is changed from zero to 30%. Most tuners are advertised as having a sensitivity ranging from 1 to 10 microvolts. In most cases the actual sensitivity is not of great interest to the user. He merely wants to be able to receive his local FM stations with low background noise and distortion-free audio reproduction. The quieting sensitivity of an FM tuner is dependent, among other things, on the alignment of the i.f. transformers, the tracking and alignment of the r.f. and converter stages, and the transconductance of the tubes used in the r.f. and i.f. stages. It is normal for tubes to deteriorate with use and frequently the adjustment of the i.f. transformers will change with the passage of time, under conditions of variable temperature and humidity. These deteriorations usually occur very gradually and may not be noticed in day-to-day listening. The usual result is an eventual dissatisfaction with the receiver's performance without being able to pin-point the source of the trouble.

Fortunately, it is very simple to determine whether a receiver has lost some of its original performance if a system of periodic checking is instituted from the beginning. When the tuner is first put into service, and if it seems to be operating satisfactorily, the signal strengths of several local stations should be noted. If the tuner has

a signal strength meter, as many do, this may be used as a direct indicator of signal strength. If only a zero-center tuning meter, or no meter at all, is provided, it will be necessary to measure the limiter grid bias with a v.t.v.m. See Fig. 1. On tuners employing limiting followed by a Foster-Seeley discriminator, the limiter grid circuit is easily identified. If the receiver uses more than one stage of limiting, the measurement should be made at the grid of the first limiter.

If a ratio detector is used, without limiting, the output voltage of the detector is usually used for a.g.c. and may be used as a measure of signal strength. See Fig. 2 for a typical circuit employing a ratio detector. In either case a negative voltage will be read, whose magnitude increases with signal strength. This voltage is indicative both of the signal strength and the gain of the preceding r.f. and i.f. stages. If strong local stations are selected as reference signals, it may be expected that their strengths will not vary greatly with time. Sometimes one station may vary widely in strength due to transmitter or antenna difficulties or changes. However, using several check signals will permit easy detection of such an occurrence.

Assuming that the signal strengths of the check stations remain constant, any reduction in meter reading at a subsequent time indicates a deterioration in performance of the tuner. Since some meter circuits are sensitive to line voltage changes, it is a good idea to check line voltage if there is a sudden drop in meter readings. The loss of performance may be easily separated into that due to weak tubes and that due to mis-alignment. The alignment may be checked without use of additional instruments, using a strong local station as a test signal. Disable the a.f.c., either by switching it off or by grounding the

a.f.c. line. See Fig. 3. Tune in the station for maximum meter reading at the limiter or ratio detector. Using an insulated aligning tool, carefully adjust the top and bottom alignment screws on each i.f. transformer, starting from the one preceding the limiter and working toward the mixer stage. Only very slight adjustments should be made, to avoid seriously mis-aligning the tuner. If the alignment is correct, the meter reading will decrease in each case. Retune the transformer for the original maximum reading before proceeding to the next stage. If one or more transformers are found to give substantially higher meter readings when their settings are changed, it may be assumed that they were improperly aligned.

If this procedure does not result in an increased meter reading, it is probable that one or more of the tubes is weak. It is a good idea to have a spare for each type of tube used in the tuner, which may be substituted in the receiver until the defective tube is found. If the receiver has been in use a long time, it is likely that several weak tubes will be found.

This method of aligning an FM tuner, while not as good as the usual methods employing instruments, is likely to be quite satisfactory in most cases. If a service type signal generator is available, a more precise alignment may be accomplished. Fig. 4A shows the setup for the i.f. alignment of an FM tuner. The signal generator, set at 10.7 mc., is fed to the mixer grid. The i.f. transformers are peaked as described previously. Fig. 4B shows an alternate method which may be used when a signal generator covering the 88-108 mc. FM band is available. In this case, the signal is fed directly into the antenna terminals of the receiver through a resistance network which provides the proper driving impedance. The receiver in this case must be tuned to the generator frequency, which should be set at a point where no station is being received.

The alignment of the r.f. and mixer stages may be adjusted when the signal is introduced in this manner, but the details of this adjustment will vary somewhat with the particular receiver involved. Such r.f. alignment is not recommended for the relatively non-technical audiophile except for adjustment of the oscillator trimmer to calibrate the dial. Fortunately, the r.f. stages of an FM set are relatively broad and usually there is little loss of sensitivity from mis-alignment of these stages.

Detector Alignment

It is fairly common to find that the detector of an FM tuner is not aligned precisely on the center of the i.f. pass-band. This frequently causes distortion or high background noise level. If the receiver is equipped with a zero-center tuning meter or "magic eye" tube the alignment of the detector may be easily checked. The zero reading of the meter or the corresponding appearance of the eye tube should occur at the same fre-

quency for which the limiter or detector output meter reads a maximum. If it is necessary to detune from this maximum in order to center the tuning indicator, the detector is not properly aligned. The simplest way to correct this condition is to carefully tune the receiver for maximum voltage at the limiter grid (or maximum signal strength meter indication) and adjust the secondary tuning of the discriminator transformer for zero d.c. volts at the discriminator output or a center reading on a zero-center tuning meter or eye tube. The easiest way to adjust the primary tuning of the discriminator transformer is to listen to a station or a modulated FM signal generator, properly tuned in, and adjust the primary tuning of the transformer for maximum audio output.

The alignment techniques just described are, of course, crude by comparison to the usual methods employing sweep signal generators and oscilloscopes. However, they are capable of giving, for all practical purposes, the same order of performance and have the advantage that they may be applied without technical training or elaborate equipment.

In general, final alignment of a ratio detector requires the use of a sweep generator and oscilloscope. A v.t.v.m. can be used for approximate alignment of a ratio detector by observing the variation of d.c. voltage at the detector output (measured at the point marked "X" in Fig. 2) as the receiver is tuned through a signal. The voltage should swing equally far on both sides of the center reading. This assumes that the i.f. stages are properly aligned and that the center frequency corresponds to the maximum meter reading on the a.g.c. line. If the voltage swings on both sides of center are unequal, adjust the secondary of the ratio detector transformer for symmetry. The primary is adjusted for maximum output, as with the discriminator.

H.F. Oscillator Alignment

After extended periods of use, or sometimes even when new, the dial calibration of an FM receiver will be found to be in error, either at one end of the dial or possibly at all points. Assuming that no mechanical slippage of the dial pointer has occurred, the cause of this calibration error is an incorrect adjustment of the oscillator tracking. The usual procedure for alignment of a tuner requires that the inductance of the oscillator coil be adjusted at the low-frequency end of the tuning range and the small trimmer capacitor shunting the tuning capacitor be adjusted at the upper end of the range. It is sometimes a risky business for a novice to start squeezing or stretching coil turns on the local oscillator tuning coil and thus is not recommended unless the calibration error is great. In this case, it is a job best performed by a competent service technician.

A minor calibration error in the middle or upper end of the band can be easily corrected by setting the dial to

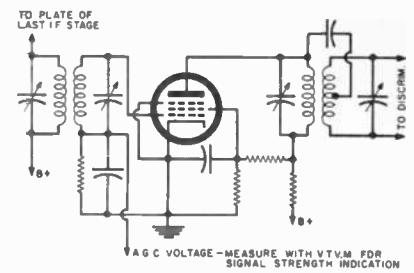

Fig. 1. Typical tuner limiter circuit.

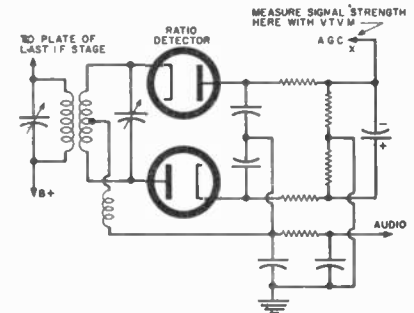

Fig. 2. Typical ratio detector circuit.

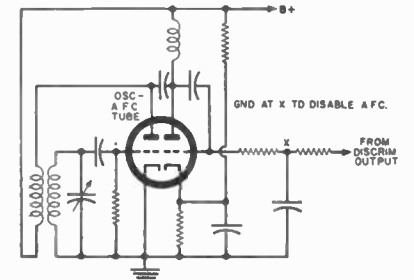

Fig. 3. Common oscillator-a.f.c. circuit.

the known frequency of a local station and carefully adjusting the oscillator trimmer capacitor until the station is tuned in correctly. Consult the schematic and instruction manual for the particular receiver to determine the location of this capacitor. In the absence of other information, the oscillator trimmer may be easily located since signals will be strongly detuned when the hand is brought near it.

Frequency Stability

Few things are more annoying than having to re-tune an FM receiver every

Fig. 4. I.f. and front end alignment setups.

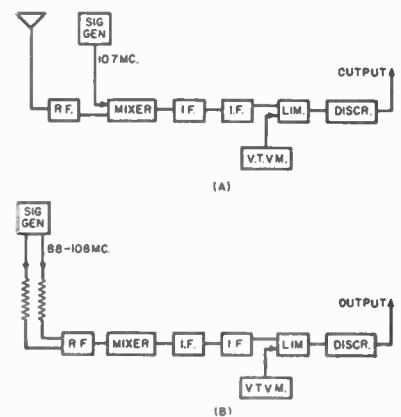

15 minutes or half hour due to a continuous frequency drift in the local oscillator. Many older sets suffered from this fault but it is fortunately uncommon in the more modern receivers.

The incorporation of automatic frequency control (a.f.c.) in most receivers has helped the situation considerably, but a.f.c. can only mask the effects of drift and is, in itself, no guarantee of long-term stability. The correct solution is temperature stabilization of the oscillator, which renders a.f.c. unnecessary or, at best, a convenience in tuning.

If a receiver has excessive drift during warm-up, there is little that can be done about it by the user on a relatively non-technical level. Establishing the existence of drift is simple, however. With a.f.c. switched off, turn on the receiver and tune in a strong station as soon as it warms up. Use the receiver's tuning meter or an external v.t.v.m. as a tuning indicator. In many receivers there will be some drift in the first ten minutes of operation, but this should not cause high distortion or signal loss. After ten minutes, retune the set, if necessary, and continue to observe the tuning indicator. Any appreciable drift after this point is definitely undesirable.

Another form of drift which has received less publicity than warm-up drift is that due to line voltage variation. In many locations, line voltage fluctuations are considerable during the evening hours and many tuners exhibit rather large drifts with changes in line voltage. Actual measurement of this effect requires equipment beyond the scope of the ordinary user, but its detection is simple. Supply power to the tuner through a length of inexpensive rubber-covered wire having a cube tap at one end, such as is frequently used as an extension cord. When the set has fully stabilized temperature-wise, tune in a station carefully. Plug an electric iron, broiler, or other high wattage appliance into the same cube tap supplying the tuner. This will usually drop the line voltage from 5 to 10 volts. Most tuners will show a noticeable drift under these conditions. The important thing to note is whether the station is detuned to the point of distortion or requires retuning to make the signal

useable. Of course, this test, as with all drift measurements, should be done with a.f.c. disabled.

Distortion

Distortion may be introduced in an FM tuner in two ways. Audio distortion occurs in the audio stages following the detector. Most tuners have little or no audio amplification and the signal levels are such that audio distortion is usually not significant. Most audible distortion comes from the detection process. Mis-alignment is a common cause of distortion. Assuming the receiver is properly aligned, the most likely causes of distortion are insufficient bandwidth in the detector or in the i.f. amplifier.

A fully modulated FM signal deviates 75 kc. each side of its center frequency. The discriminator must be linear over at least a 150 kc. bandwidth to give distortionless output from such a signal. Also, the i.f. bandwidth must be at least 150 kc. or the outermost components of the FM transmitted spectrum will be reduced in amplitude by the time they reach the detector. Discriminator performance is based on the signal having a constant amplitude and loss or reduction of the frequencies at the edges of the transmitted band will cause distortion exactly the same as inadequate discriminator bandwidth.

The effects of i.f. or detector bandwidth limitations cannot be measured without expensive test equipment, but they can easily be detected at home. If the receiver is well designed, a signal strong enough to "quiet" the receiver to a 30 db signal-to-noise ratio will sound clean and undistorted even though some background noise may be audible. If the receiver has insufficient i.f. bandwidth, a weak signal will sound distorted. If no weak signals are available, replace the antenna with a short wire to reduce the strength of a local station. If distortion becomes audible while the signal-to-noise ratio is still good, this is an indication of too much i.f. selectivity.

The reason for this can be seen in Fig. 5. The i.f. selectivity curve in Fig. 5A is typical of those found in low-priced FM tuners. A weak signal, not modulated very heavily, will be received without distortion, but as the

frequency deviation becomes larger, the signal falls below the limiting level and distorts. A signal must be strong enough so that its outermost components limit fully if distortion is to be avoided. This condition is shown by the upper curve in Fig. 5A.

Fig. 5B shows the i.f. response of the more expensive FM tuners. The "flat top" means that any signal strong enough to reach the limiting level will be received with little distortion.

If the discriminator bandwidth is too narrow, loud passages will sound distorted on strong stations as well as weak ones. On most receivers, the discriminator bandwidth is at least as great as the i.f. bandwidth so this is not too great a problem. If the discriminator and i.f. both have 150 kc. bandwidth, tuning is critical and a slight drift will cause distortion. Many better tuners now employ wide-band discriminators, several megacycles wide, which make tuning fairly non-critical.

Hum

Hum in an FM tuner can be introduced by frequency modulation of the local oscillator, usually by heater-cathode leakage in the oscillator tube or in the discriminator stage, for the same reason. If the receiver has an audio section, it may arise here as well.

A quick check is to remove the discriminator tube. If hum persists, it is in the audio section; if it disappears it is due to the earlier stages. The next step is to remove the limiter stage, or stages. Any hum remaining probably arises in the discriminator stage. If it disappears, the local oscillator is the most likely cause. Local oscillator hum only appears when a station is tuned in and is not present in the absence of a signal. The receiver hiss may mask hum when no station is received, but an oscilloscope across the audio output will disclose its presence.

It is worth remembering that many FM stations have appreciable amounts of hum in their audio systems. This will be indistinguishable from hum modulation of the receiver local oscillator. If hum is heard on some stations but not on others, the receiver is probably not to blame. If it is present on all stations, it is most likely the fault of the receiver.

The only practical treatment of hum arising from heater-cathode leakage in a receiver tube is replacement of the tube. Many receivers now use germanium diodes in the discriminator stage, which eliminates that possible source of trouble.

It is possible for the user of an FM tuner to make simple home checks of its performance, which will permit him to detect deterioration in its operation without the use of elaborate test instruments. Many simple tests and alignment procedures can be performed with no instruments other than the tuning indicators usually supplied with FM tuners. Practically all other service and test functions can be performed with simple, inexpensive equipment.

Fig. 5. Effect of bandwidth on distortion with (A) peaked and (B) flat-topped curves.

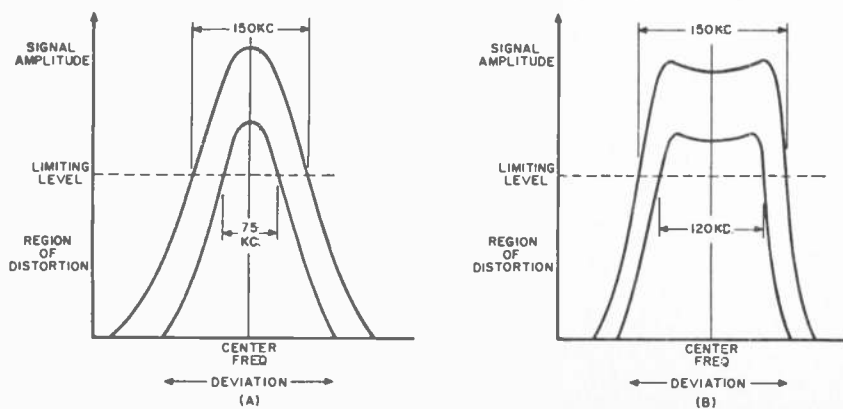

Free!

PICKERING \$29.85 VALUE
Stereo-cartridge
Model 371-.7D

282 412-1

SENSATIONAL STEREO OFFER . . .

With your purchase of the Fairchild 412-1 precision 33 1/3 RPM turntable (Net \$99.50) and new Fairchild 282 stereo arm (\$42.50), you will receive Pickering's new 371-.7D stereo cartridge . . . ABSOLUTELY FREE. Audiophile net \$29.85.

Your cost for arm, turntable and free cartridge, only \$142.00.

Base for above turntable in mahogany, walnut or korina, \$31.50 additional.

TERMS: Full payment or 25% dep., bal. C.O.D. All shipments F.O.B., N.Y.C. All units shipped in factory sealed cartons.

Write for our free new AUDIO DISCOUNT CATALOG A-10.

KEY electronics company
120 Liberty St., N. Y. 6, N. Y.
PHONE: Evergreen 4-6071

*shoot for
home movies
that look
professional!*

Learn how in the world's first HOME MOVIE MAKING ANNUAL (prepared by the Editors of Popular Photography)

HOME MOVIE MAKING

On sale in October—only \$1.00

Additional Notes on "Testing FM Tuners at Home"

More information with some limitations on the alignment instructions

OUR article "Testing FM Tuners at Home" by Hirsch has received some interesting comments which your editors feel have enough value and importance to bring to our readers' attention. The purpose of the original article was to help the owners of FM tuners perform a simple alignment without using elaborate test equipment. It was not expected that the owner of a properly operating, factory-aligned tuner would attempt to improve on its performance. We believe that most of our readers know when to "let well enough alone." After all, a good many of our readers who are professional technicians, know full well the havoc that can be wrought by the "screw diddler" who decides to service his own set by tightening up all the screws he sees. But in those cases where misalignment is clearly indicated, we feel that the information presented produces a definite improvement in operation that is certainly worth a trial.

This is not to say that the method described (which is, essentially, peak alignment) will produce results that are better or even equal to those obtained from an exact factory alignment using elaborate instruments. As a matter of fact, if we were to take a tuner that had just been accurately factory-aligned and change the alignment in accordance with the suggestions made in the article, the performance would certainly be impaired. But there are some tuners that are given just a cursory alignment at the factory, others that may have gone out of alignment after a period of use, and still others that may have been built by their users. All these may be improved by using the suggestions given in the original article.

Perhaps the author of our article was guilty of not having stressed strongly enough the limits of the simple method he described. We are indebted to D. R. von Recklinghausen, Chief Research Engineer of *H. H. Scott, Inc.* for having enumerated these in a recent letter. Following is a resume of some of Mr. von Recklinghausen's comments.

Limits of Simple Method

It is always a noble thought to try to test equipment in the home. The more suitable equipment that is used the better the results of the test will

be. The difficulty is that when trying to adjust or change the performance of an FM tuner there is grave danger ahead. It is one of the easiest things in the world to perform a misalignment.

Before any alignment is attempted, tubes should be checked and replaced where necessary. The presence of a single weak tube may so impair the tuner's performance as to make the user believe mistakenly that a re-alignment is needed when such may not be the case at all.

The use of a built-in tuning meter or eye may be a *cause* of misalignment. The indication given on these devices depends on signal strength, tuner sensitivity, line voltage, performance of indicator, and other factors. As such they are intended for use as tuning indicators having only a short time stability.

The use of radio stations as alignment signals may pose many problems. Reception from a weak station should be used in order to get peak performance. But the signal strength of such a station may vary rapidly over a range of as much as 100 to 1. Hence these would be quite difficult to use properly in any alignment procedure. Signals from local stations are too strong for alignment and even these vary over a period of time.

It is necessary that whoever performs the alignment knows exactly what he is doing and knows all the pitfalls of trying to connect various types of equipment to a tuner. It is very easy to find some form of misalignment just because a voltmeter lead happens to be draped along the wiring side of the tuner. Feedback of signal occurs through that lead from some high-level circuit to a low-level circuit. There are hundreds of other ways to have apparent malfunctioning of the tuner only because some piece of test equipment was not connected properly to the tuner.

If it is felt that alignment of a tuner is necessary, then the manufacturer's suggested alignment procedure should be followed as closely as possible.

The editors wish to thank Mr. von Recklinghausen for his interest and comments and for his reminder that most present-day hi-fi FM tuners are precision units that are designed to operate very close to the theoretical limits of sensitivity.



The FM tuning indicators shown here include the 6E5 and the 6AL7 tuning eye tubes along with a space-saving, side-indicating type tuning meter.

Adding an FM Tuning Indicator

Methods and circuits for incorporating various tuning eyes and meters in FM receivers or tuners.

HIGH QUALITY FM reception requires that noise and distortion be kept low. Both offending factors are held to a minimum when an FM tuner is set *exactly* at the carrier frequency of a station on the air.

Types of Indication

Tuning indicators provide either of two types of indication, and sometimes both. One type shows the relative magnitude of the tuned signal. Since in correctly aligned equipment the maximum signal corresponds to center-of-channel tuning, such a device is usually satisfactory.

The other type of indication goes directly to the matter and shows whether the tuner is below, above, or at the carrier frequency.

At high modulation levels, a slight departure of the tuner from center frequency can seriously increase distortion. Thus, particularly from the viewpoint of the audiophile who insists on utmost performance by his equipment, a center-of-channel indication is highly desirable. Some of the top-flight tuners have two meters, one for showing magnitude of the tuned signal and the other for center-of-channel indication.

Meter Versus Tuning Eye

For a long time the tuning eye has been the most popular type of indicator found in the general run of FM tuners, but there has been a recent trend toward meters. The indication provided by a meter, though not necessarily more accurate, is easier to read. Thus the maximum swing of a pointer or its swing to center-of-channel (mid-scale) is somewhat easier to identify with precision than the corresponding fluorescent images on an electron-ray tube. On the other hand,

the meter is more costly than the tuning eye.

The following discussion shows some of the methods that can be used for incorporating electron-ray tubes and meters as FM tuning indicators. Both maximum signal strength and center-of-channel indicators are discussed. In some cases, depending upon the available space and the owner's ingenuity, it may be feasible to install the indicator in the tuner. In other instances it will be necessary to mount the indicator "outboard," for example on a panel.

Signal Strength Tuning Eye

The 6E5 electron-ray tube, popular in varied applications, is often used as an FM tuning indicator. This tube presents a green fluorescent pattern, circular except for a pie-shaped shadow which varies from 90° to 0° depending on signal strength. The eye is open (maximum shadow) when no signal is received and the eye is partially or fully closed at maximum signal. The pattern sequence as one tunes a station is shown in Fig. 1.

Fig. 2 is a diagram showing how the 6E5 is used as an FM tuning indicator. The electron stream flowing from cathode to target produces a circular fluorescent pattern. A ray-control electrode deflects part of the electron stream to form a shadow in the pattern. This deflection electrode is also connected to the plate of a triode amplifier. When the plate goes more positive due to application of a negative voltage to the grid, the amount of

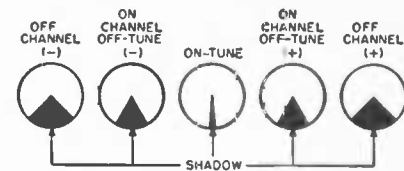

Fig. 1. Sequence of patterns produced on 6E5 as receiver is tuned through channel.

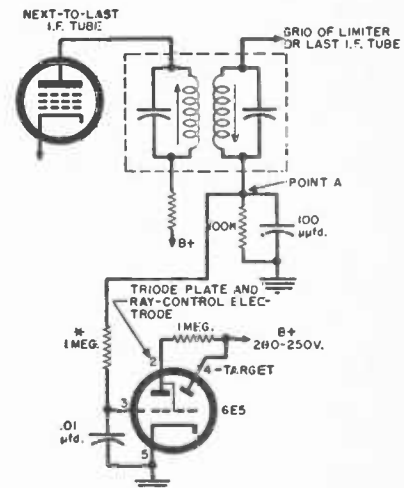

Fig. 2. Schematic diagram showing how 6E5 is connected for FM tuning indication.

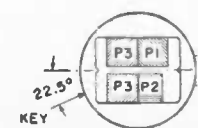

Fig. 3. Pattern areas P1, P2, and P3 are produced and controlled by 6AL7 deflection electrodes 1, 2, and 3. (Fig. 4.)

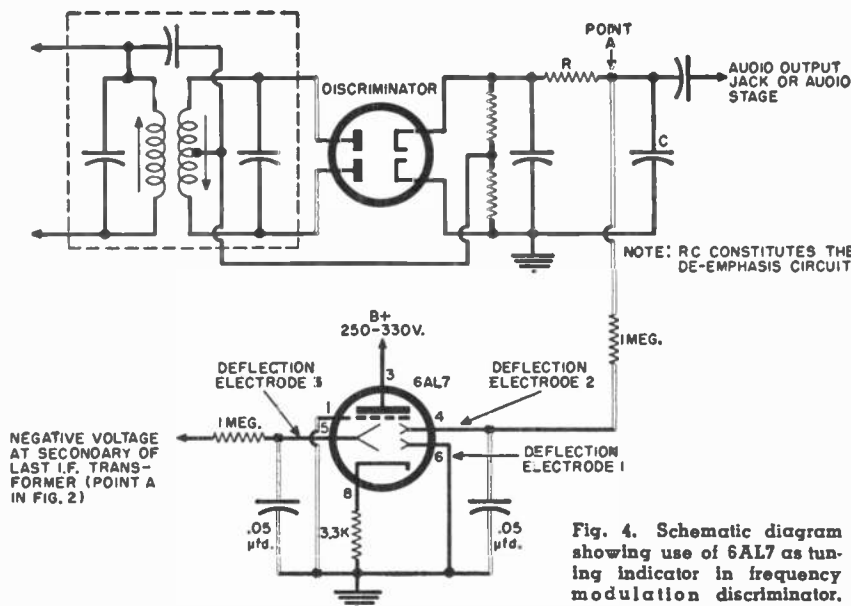

Fig. 4. Schematic diagram showing use of 6AL7 as tuning indicator in frequency modulation discriminator.

deflection is reduced, so that the shadow partially or completely disappears.

For a "B+" supply of 250 volts, about -8 volts is required at the grid to completely close the eye (no shadow). This negative voltage can be obtained at the secondary of the last i.f. transformer as shown in Fig. 2. Maximum negative voltage corresponds to maximum signal. If the eye fails to close sufficiently or if it closes too rapidly, the value of the 1 megohm resistor leading to the grid should be reduced or increased.

When an FM tuner has one or more limiter stages, ordinarily the negative voltage source is readily available, as shown in Fig. 2. However, in FM tuners employing a ratio detector the bottom of the secondary of the last i.f. transformer often goes directly to ground. By inserting a parallel resistor-capacitor combination between the secondary and ground, as shown in Fig. 2, one may obtain the voltage required to drive the 6E5. When this is done, the i.f. alignment and gain should be checked to see that they have not been adversely affected.

It should be pointed out, however, that a disadvantage of using this method is that on strong signals, the maximum voltage at the i.f. amplifier or limiter grid may not be sharply defined and exact tuning may be difficult.

Center-of-Channel Tuning Eye

The 6AL7 (or 6AL7-GT) electron-ray tube can indicate not only center-of-channel tuning but signal strength as well. Although the 6AL7 costs more than the 6E5, it is worth the difference. The customary net price (40% off list) is about \$2.45 for the 6AL7 and \$1.40 for the 6E5.

A hardware kit for mounting an eye tube (containing a socket with pigtail leads, mounting bracket, escutcheon, etc.) is available at radio supply houses for about \$1.60.

The elements of the 6AL7 are shown in Fig. 4. The plate serves as the target for the electron stream, while three deflection electrodes control the shape of the fluorescent pattern. Fig. 3

shows the pattern area affected by each electrode while Fig. 5 indicates the pattern sequence as tuning takes place. When the station is properly tuned in, assuming the tuner is accurately aligned, the two vertical bars are of exactly equal width, which indicates that the tuner is set at the carrier frequency. Also, the bars are of minimum width, which corresponds to maximum signal strength.

Fig. 4 also shows how a 6AL7 is connected to an FM tuner containing a Foster-Seeley discriminator. Electrode 3, which controls the left-hand side of both bars and thereby regulates their width, goes to a source of negative voltage, in this case the bottom of the secondary of the last i.f. transformer. Electrode 1 is grounded, and electrode 2 is controlled by the d.c. component at the discriminator output. An RC network filters out the a.c. component present at the discriminator. When the tuner is set at the carrier frequency, d.c. voltage at the discriminator is zero. Thus there is no voltage differential between electrodes 1 and 2, so that pattern area P_2 is the same as P_1 (Fig. 3), producing bars of equal width. When the tuner is off-frequency, either a positive or negative voltage appears at the discriminator, which means that electrode 2 goes positive or negative with respect to electrode 1, and pattern area P_2 becomes wider or narrower than P_1 .

Fig. 6 shows how a 6AL7 may be hooked up to a balanced ratio detector circuit of the type now in common use. The negative voltage for electrode 3 is obtained at the negative end of the large capacitor; electrode 1 goes to ground as before; and electrode 2 is connected to the audio output through an RC network that filters out the a.c., leaving the d.c. component, which varies from negative polarity to zero as one tunes through an FM channel.

Fig. 7 shows how a 6AL7 may be connected to one type of unbalanced ratio detector.

Fig. 9 shows another type of unbal-

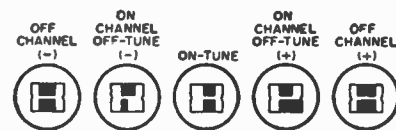

Fig. 5. Pattern sequence on 6AL7 as FM receiver is tuned through channel.

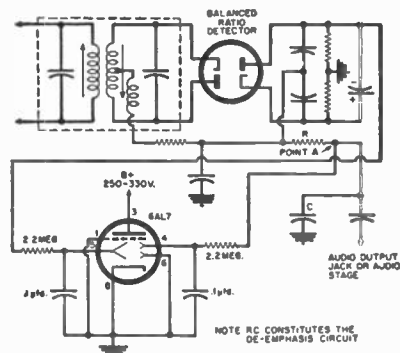

Fig. 6. Schematic diagram showing 6AL7 as tuning indicator in balanced ratio detector.

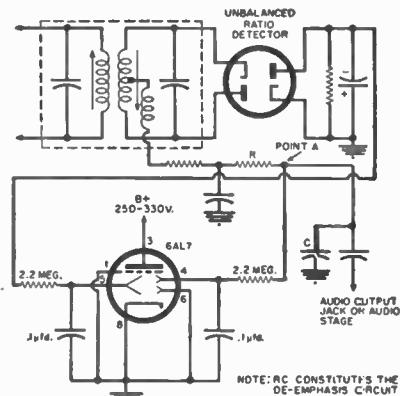

Fig. 7. Diagram showing 6AL7 as tuning indicator in unbalanced ratio detector.

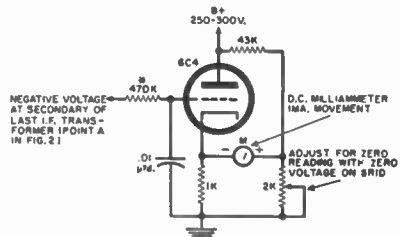

Fig. 8. Simple schematic diagram showing use of conventional d.c. milliammeter connected to driver tube for signal strength indication.

anced ratio detector and the recommended method of using a 6AL7. Note that the connections for electrodes 1 and 3 are substantially different than in the other diagrams and, accordingly, the tuning pattern sequence is also different. However, the conventional pattern sequence shown in Fig. 5 could be obtained by connecting the 6AL7 in the same manner as in Figs. 6 and 7, except that the negative voltage for electrode 3 (pin 5) would be obtained from the secondary of the last i.f. transformer, as shown in Fig. 4.

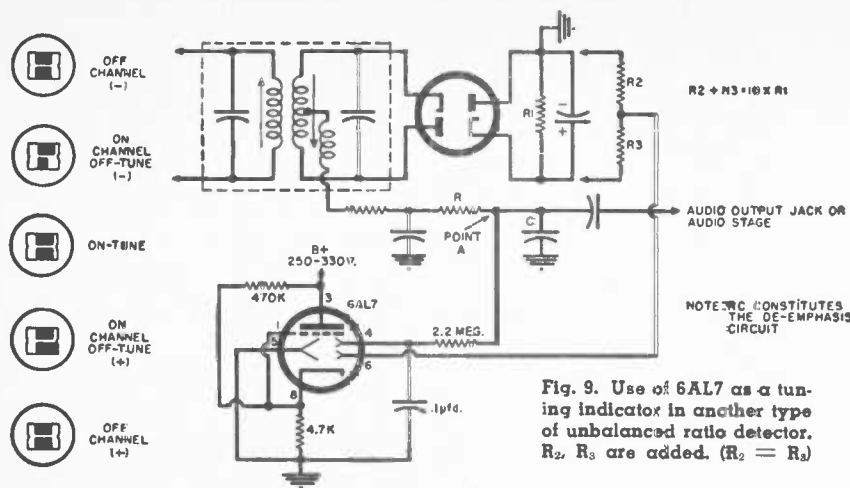

Fig. 9. Use of 6AL7 as a tuning indicator in another type of unbalanced ratio detector. R_2, R_3 are added. ($R_2 = R_3$)

For still other ratio detector configurations, information on using a 6AL7 may be obtained from the manufacturers of such tubes.

Signal Strength Meter

If it is desired to incorporate a signal strength meter, one way in which this can be done is shown in Fig. 8, the negative control voltage being derived from an i.f. stage in a fashion previously discussed. This hookup requires a tube to drive the meter, which can be a 1 ma. movement. A 6C4 or half of a 12AU7 is suitable. However, the reader should bear in mind the previously cited disadvantage of a simple signal strength (obtained in i.f. grid circuit) versus a center-of-channel indicator.

With zero voltage at the grid of the tube, the pot is adjusted so that the voltage at the high side of the pot equals that at the cathode. Thus there is no potential across the meter and no deflection of the pointer. When a signal is received, the grid goes negative, reducing the voltage at the cathode and producing a voltage drop across the meter. If the pointer is driven off-scale by strong stations, it is necessary to increase the value of the 470,000 ohm resistor in Fig. 8.

Center-of-Channel Meter

Fig. 10 shows how to incorporate a center-of-channel tuning meter. A 6C4 or half of a 12AU7 drives a zero-center meter, which may be a .5-0-.5 ma. movement.

With zero voltage at the grid, the balancing pot is adjusted so that the voltage at the high side of the pot equals that at the cathode, causing the zero-center meter to read mid-scale. The d.c. voltage at the audio output is applied to the grid of the tube. When the tuner is on-channel but off-tune, the voltage at the detector and therefore at the grid of the driving tube goes either positive or negative, and accordingly the meter pointer swings left or right. If insufficient or excessive drive is applied to the meter, it is

necessary to increase or decrease the value of the 1 megohm grid resistor, which forms part of a voltage divider.

Zero-center meters are not always available at radio supply houses. However, they can be had on direct order from most leading manufacturers of meters, such as *Simpson, Triplett, Weston*, etc. Prices range from about \$10 to \$15 for a 3" meter having a sensitivity of .5-0-.5 ma. Adding the cost of a tube and related components, it may readily be seen that the cost of installing a center-of-channel meter is about three to four times as great as that of installing a center-of-channel indicator in the form of a 6AL7.

By using a d.c. meter of greater sensitivity than a .5-0-.5 ma. movement, one can dispense with the driving tube. It is then merely necessary to connect the meter via a series resistor to audio output point A as shown in Figs. 4, 6, 7, and 9.

When a fairly sensitive FM tuner is de-tuned from the center frequency of a normal FM signal, without going completely off-channel, this produces ± 5 volts or more at the audio output; the voltage of course returns to zero when the tuner is dialed either to center frequency or off-channel. Given a meter of sufficient sensitivity, the varying d.c. voltage at the audio output can drive the meter directly. A tuner with poor sensitivity will require a relatively more sensitive meter.

The minimum value of the series resistor should be, in conjunction with resistor R in Figs. 4, 6, 7, 9, about 100,000 ohms, otherwise the low resistance of the meter will cause undue loading effects. Assuming an off-tune deflection of 5 volts, a current of 50 microamperes will flow through the 100,000 ohm resistance. Consequently a meter with a 50-0-50 microampere movement would suffice. In fact, a 100-0-100 microampere movement will provide enough pointer action for satisfactory tuning.

On the other hand, 100,000 ohms total resistance will load down the audio output circuit somewhat, as

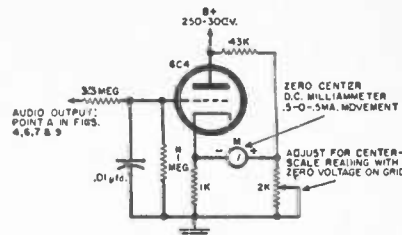

Fig. 10. Use of zero-center d.c. milliammeter as a center-of-channel indicator.

well as increase distortion slightly. The loading effects vary from tuner to tuner. In one tuner tried, the addition of a 100-0-100 microammeter in series with the 100,000 ohms resistance caused an output loss of about 3 db, while in a second the loss was 6 db. With respect to distortion, in both cases IM distortion went up something less than about 0.5%. In the case of the first tuner, which had optional a.f.c., output was reduced only 1 db in the a.f.c. position, while IM distortion increased only about 0.2%.

To avoid the possibility of loading effects, it is advisable that the meter series resistor be about 500,000 ohms (in conjunction with R in Figs. 4, 6, 7, 9). Assuming 5 volts d.c. at the audio output when off-tune, this would result in about 10 microamps of current for driving a center-of-channel meter. Meters of this sensitivity, that is, a 10-0-10 microampere movement, are available but costly, ranging from \$20 to \$30. A 25-0-25 microampere movement is somewhat less expensive and would still be effective. Such meters are seldom stocked by radio supply houses, but can be ordered directly from the manufacturer. Inasmuch as these are special order items, delivery may require from a few weeks to two or three months.

Some of the FM tuners on the market today use the compact and attractive side indicator. As far as the author knows such instruments are not available through regular jobber channels; however, the one shown in the photograph is available from *International Instruments Incorporated*, P. O. Box 2954, New Haven 15, Conn. The one illustrated is this firm's Model ASP-488, a 100-0-100 microampere unit, which sells for \$21.00. Side indicators of this type are used in the *Pilot AF-860 AM-FM tuner*.

Lovers of quality sound reproduction will find it well worth the time and money involved in adding a tuning indicator of some type to their FM tuners to insure on-the-nose reproduction of their favorite selections. —30—

HUM REDUCTION

SOONER or later the serious-minded audio experimenter runs into an exasperating problem, one that's often found while working with high-gain, low-level audio amplifiers and preamps, i.e., the reduction of hum amplification. How can it be effectively judged without resorting to expensive instruments?

It is rather widely known that changing the position of a single choke or transformer can work wonders in the matter of hum reduction. The orientation of transformers and chokes is a well known technique used in both experimental work and in commercial amplifier construction.

As an example, let us consider the situation where an amplifier using a transformer, or transformers, is picking up and amplifying a certain amount of hum. The induced hum voltages are being picked up due to the location—good or bad—of the various inductances. In theory at least, the effect of any given adjustment could be judged by using either a high-gain scope or a highly-sensitive type of a.c. vacuum-tube voltmeter. But, in practice, the cost of either of these instruments is likely to be far greater than the audio equipment being tested.

The solution which we have developed involves the utilization of nothing more expensive than an old power transformer. This is readily connected across the amplifier output terminals and used as a step-up device. For best results, it is advisable to locate this transformer a foot or so away from the amplifier being checked, as indicated in the diagram.

In this particular setup we were testing a home-built, high-gain intercom system. This had terrific sensitivity and low hum level when fed with an external supply but hum developed when we tried to connect the audio amplifier to an integral power supply. We effectively matched the low impedance of the secondary of the amplifier output transformer by feeding it into an unused 5-volt winding on the spare transformer. For maximum voltage step-up, we selected the high-voltage winding, feeding this into a v.t.v.m. on the low-range a.c. scale. Changes in the location of each component and their effect on hum can be easily followed on the v.t.v.m. scale.

In place of the v.t.v.m., a sensitive multimeter (20,000 ohms-per-volt) can be used. Earphones were found helpful in obtaining a favorable impedance match, the object being to obtain a high step-up ratio (in the spare power transformer) without actually loading down the amplifier too heavily.

Various combinations can be tried across the secondary of the output transformer, such as 6.3-volt winding, 5-volt winding, one-half of the 6.3-volt winding, and the normal 117-volt primary winding. The power transformer handles the hum waveshape efficiently since the major component of full-wave a.c. rectification is at 120 cycles, while direct hum pickup lies in the vicinity of 60 cycles.

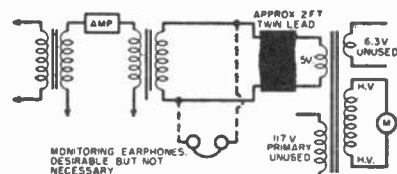

Setup for checking amplifier hum. See text.

INDEX OF ADVERTISERS Hi-Fi Annual & Audio Handbook 1959 Edition

ADVERTISER	PAGE NO.
Acoustic Research, Inc.	101
Acro Products	58
Airex Radio Corporation	47
Allied Radio	130
British Industries Corporation	6
Columbia LP Record Club	5
DeRO Electronics	130
EICO	118
Electro-Sonic Laboratories Inc.	41
Electronic Kits	74
Fisher Radio Corporation	32
General Electric Company	11
Hi-Fi Directory & Buyer's Guide	66
Hi-Fi Review Classified Adv. Information	46
Hi-Fi Review Subscription Information	98
Key Electronics Company	126
Lansing Sound Inc. James B.	80
Movie Annual	126
National Radio Institute	3
North American Philips Co., Inc.	Second Cover
ORRadio Industries, Inc.	Fourth Cover
Photography Annual	102
Popular Electronics Classified Adv. Information	46
Popular Electronics Subscription Information	98
Radio & TV News Classified Adv. Information	46
Radio & TV News Subscription Information	98
Schober Organ Corporation, The	47
Scott Inc. H. H.	25, 43
Sherwood Electronic Labs., Inc.	121
Shure Brothers Incorporated	60
Sonotone Corp.	73
Stromberg-Carlson	38, 39
University Loudspeakers	91
Vidaire Electronics Mfg. Corp.	47
Viking of Minneapolis	Third Cover
Ziff-Davis Annuals	53

FOR USEFUL
HI-FI, STEREO AIDS
LOOK

DeRO TO

SOUND-ORBITER List \$9.95

2-CHANNEL

Constant Impedance Speaker Control. Master switch permits operation of HI-FI set speakers independently of all remote loads. One crossover network services four sets of woofers and tweeters in any combination. Constant impedance maintained with dummy resistive loads. Completely wired. Screw terminals for all connections. No soldering.



Model HFS-4 (4 ohms)

Model HFS-8 (8 ohms)

Model HFS-16 (16 ohms)

VELVETONE Crossover Network



Extends high-frequency range of any amplifier and hi-fi system. Channels low frequencies to woofer and high frequencies to tweeter. Use on 4, 8 or 16 ohm systems. Model VT-2 List \$3.95

For more information see your local parts distributor or write

DeRO Electronics

Dept. HF

134 NASSAU ROAD, ROOSEVELT, N. Y.

save on hi-fi

see the best values in the 1959
ALLIED CATALOG



free
Send for it!

world's
largest choice
of systems and
components...
everything in
STEREO!

Here's your complete, money-saving guide to Hi-Fi! See how you save on ALLIED-recommended complete systems, including the latest in thrilling Stereo. Choose from the world's largest stocks of components (amplifiers, tuners, changers, speakers, enclosures, recorders, accessories). Want to build-your-own?—save up to 50% with our exclusive Hi-Fi KNIGHT-KITS! Easy terms available. For everything in Hi-Fi, for everything in Electronics, get the 452-page 1959 ALLIED Catalog!

ALLIED RADIO

America's Hi-Fi Center

ALLIED RADIO, Dept. 123-9
100 N. Western Ave., Chicago 80, Ill.

Send FREE 1959 ALLIED Catalog

Name _____

Address _____

City _____ Zone _____ State _____

Look to the
LEADER
to stay ahead!

Telephone:
TUxedo 1-2636

Viking OF MINNEAPOLIS

9600 Aldrich Avenue South, Minneapolis 20, Minnesota

Whether you are a stay at home listener, a roving recordist, or a meter-minded, evaluating, son-of-a-pro, you'll find something new, sparkling, and downright surprising at your nearby Viking dealer's.

HOW DID IT COME ABOUT? For three years Viking has led the parade as the largest manufacturer of tape decks and tape system components. For three years we've listened attentively as audiophiles and dealers told us the kind of tape equipment they would like to see. Now, at Viking dealers, you'll see the results of the research program you initiated.

FIRST, of course, you'll find the Viking "75" — virtually unchanged, as befits the deck that has won its place as the *work horse* of the industry; the *most used* deck in homes, language teaching, and secondary commercial applications. Front panel speed change is now standard.

NEW THIS YEAR, the sparkling "85." Featuring Viking's famous *flutter-filter* belt drive, but with two motors for high-speed fast forward and rewind and rotary controls for e-a-s-y and truly foolproof tape motion control. Room for five heads, including the new quarter-track heads for long play tapes.

PLUS THE NEW VIKING "95." Commercial in every respect. The "95" brings you *flutter-filter* belt drive, but with a hysteresis synchronous motor. The result: a new standard for tape transport performance. The "95" features 10½-inch reels, dynamic braking and tape tensioning, and typical Viking simplicity.

New stocks are now shipping to Viking dealers — see and hear the **BIG THREE** by Viking.

For a complete catalog and specifications on decks, recording amplifiers and accessories, write Viking's Customer Service Department.

Yours for the best of tapes,

VIKING OF MINNEAPOLIS

1959 TED

**if you think
that all brands of
recording tape are alike...**

**wait
till
you
try**

irish

BRAND



ferro-sheen

available wherever quality recording tape is sold



ORRadio Industries, Inc., Opelika, Alabama
Export: Morhan Recording Corp., New York, N. Y.
Canada: Atlas Radio Corp., Ltd., Toronto, Ontario