

**SPECIAL FEATURES ON TEST EQUIPMENT**

# **RADIO & TV NEWS**

**APRIL, 1959  
50 CENTS**

**OTHER FEATURES:**

- **LOUDSPEAKERS FOR STEREO**
- **NEW TV DESIGNS FOR 1959**
- **HI-FI CROSSOVER NETWORKS**
- **TV SCHEMATICS FOR 1959**
- **TRANSISTORIZED DSB XMITTER**
- **AUTOMATIC COMMERCIAL KILLER**

Next Month To Be

**ELECTRONICS**   
**WORLD**

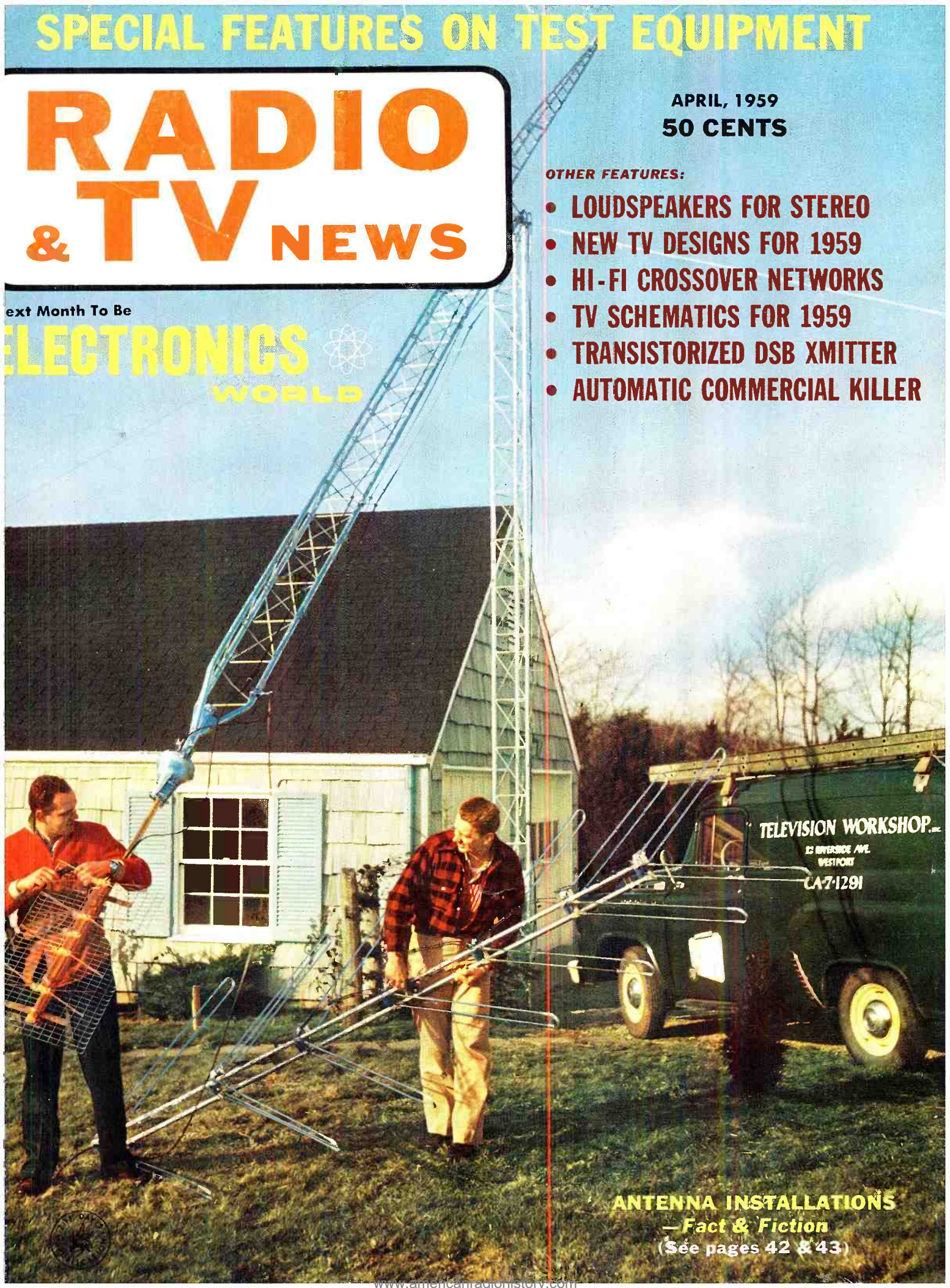

**ANTENNA INSTALLATIONS**  
**—Fact & Fiction**  
(See pages 42 & 43)

**Model EL 3516/G53  
Technical Specifications**

**Three Tape Speeds**— $7\frac{1}{2}$ ,  $3\frac{3}{4}$ , and  $1\frac{7}{8}$  ips

**Tracks**—Dual

**Heads**—Stacked

**Head-Gap**—0.0002 inches

**Frequency Response**—at  $7\frac{1}{2}$  ips; 50 to 16,000 cps  
at  $3\frac{3}{4}$  ips; 60 to 10,000 cps  
at  $1\frac{7}{8}$  ips; 60 to 5,000 cps

**Wow and Flutter**—0.15% at  $7\frac{1}{2}$  ips  
0.2% at  $3\frac{3}{4}$  ips  
0.35% at  $1\frac{7}{8}$  ips

**Volume Indicator**—Magic Eye (Type EM-84)

**Loudspeaker**—Integrated, heavy magnet,  
wide range

**Controls**—Piano-key pushbutton



**Fast Forward and Reverse**—Less than 2 minutes  
for 1200 ft. of tape

**Automatic Stop**—At ends of reel (with metalized  
strips)

**Program Indicator**—Built-in, adjustable

**Inputs**—(1) radio/phone; (1) microphone (with mixing  
facilities)

**Outputs**—(1) for external speaker; (2) for external  
amplifiers with controls; (1) for external amplifier  
without controls; (1) for headphone monitoring  
recording circuit

**Microphone**—High-Impedance Dynamic

**Tubes**—EF-86 (2), ECC83 (2), ECL82 (1), EZ90 (1),  
EM84 (1)

**Line Voltage**—117 volts AC 60 cycles

**Power Consumption**—80 watts

**Dimensions**— $15\frac{3}{4}$ " x 13" x 8"

**Weight**—32 lbs.

**Case**—Rugged, European-designed, portable carrying  
case (internally designed for optimum acoustic  
baffling)

A matching companion piece, identical in appearance, containing a second amplifier and speaker, is available to those who seek the convenience of a complete portable stereo-tape playback system

**THE *Norelco* T-7 SPEAKERS  
ARE HERE!**

Now, a complete new line of NORELCO 5" to 12" loudspeakers with TICONAL VII alloy magnet and standard EIA mounting holes. At your favorite HI-FI dealer, now!

YOU  
ARE LOOKING  
AT A

*Modern*  
Dutch  
Masterpiece

The  
STEREO  
version of the  
*Norelco* 'Continental'  
TAPE RECORDER  
Developed & Guild-Crafted  
by  
Philips  
of the  
Netherlands

We feel that the Stereo version of the Norelco 'Continental' is the ideal tape recorder for those recordists, high fidelity enthusiasts and music lovers who seek a professional quality machine at a truly modest price. The data listed here, represent painstaking, conservative and substantiated laboratory measurements. If you find that these data satisfy your technical requirements, and reflect those qualities that you consider mandatory in *your* stereo equipment, by all means listen to the Stereo version of the Norelco 'Continental' at your favorite HI-FI center or Camera store. There, we feel sure, you will agree with us that the Norelco Stereo 'Continental' is, indeed, a modern masterpiece . . .

For further descriptive literature write to:  
NORTH AMERICAN PHILIPS CO., INC.  
High Fidelity Products Division  
230 Duffy Avenue, Hicksville, L. I., N. Y.



# Learn Radio Television

## Servicing or Communications by Practicing at Home in Spare Time

N.R.I. SENDS kits with which you practice building circuits common to Radio and TV sets. You LEARN-BY-DOING to locate Radio-TV troubles. As part of N.R.I. Servicing Course, you build Vacuum Tube Voltmeter and AC-DC receiver. Use VTVM to conduct experiments, earn extra money fixing sets in spare time.

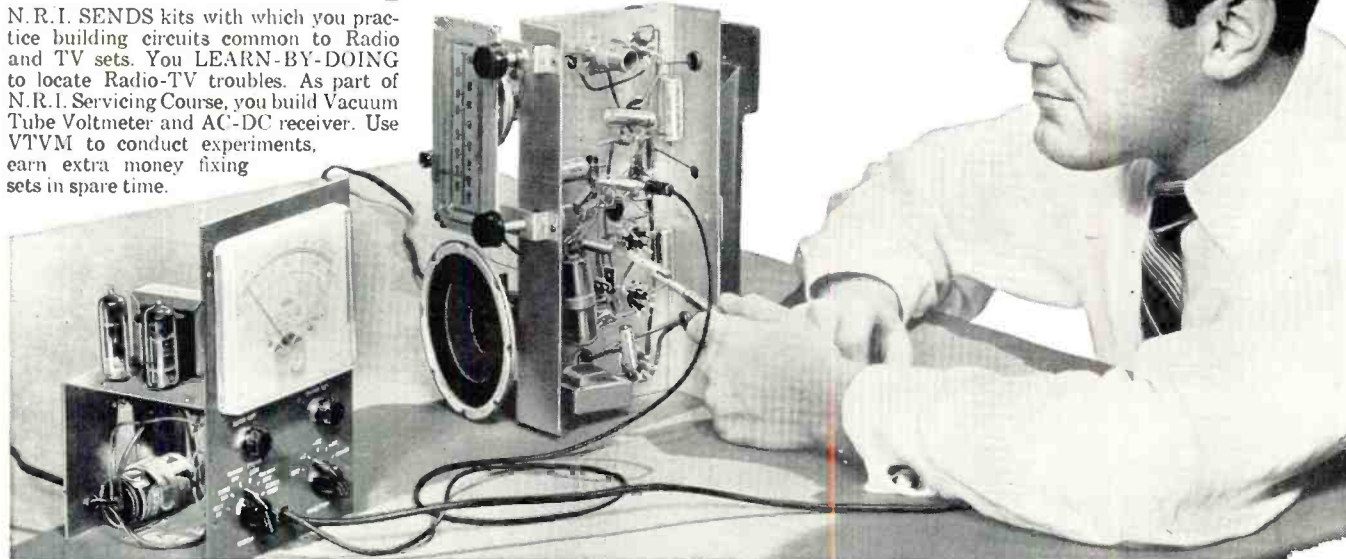

RADIO-TV BROADCASTING (see above) offers important positions as Operators and Technicians. RADIO-TV SERVICING Technicians (see below) needed in every community. Their services are respected, their skill appreciated.



## Fast Growing Field Offers You Good Pay, Success, Bright Future



J. E. SMITH  
Founder

Bigger than ever and still growing fast. That's why Radio-TV has special appeal to ambitious men not satisfied with their job and earnings. More than 4,000 Radio and TV stations. More than 150 million home and auto Radios, 40 million TV sets. Color TV promises added opportunities. For the trained man, there are good jobs, bright futures in Radio-TV Servicing or Broadcasting.

Training PLUS opportunity is the ideal combination for success. So plan now to get into Radio-TV. The technical man is looked up to. He does important work, gets good pay for it. Radio-Television offers that kind of work. NRI can supply training quickly, without expense of going away to school. Keep your job while training. You learn at home in your spare time. NRI is the OLDEST and LARGEST home study Radio-TV school. Its methods have proved successful for more than 40 years.

### Added Income Soon - \$10, \$15 a Week in Spare Time

Soon after enrolling, many NRI students start to earn \$10, \$15 a week in spare time fixing sets. Some pay for their training and enjoy extra luxuries this way. Some make enough to start their own Radio-TV shops. NRI training is practical—gets quick results. Easy to understand, well illustrated lessons teach you basic principles. And you LEARN-BY-DOING by practicing with kits of equipment which "bring to life" things you study.

### Find Out What NRI Offers

NRI has trained thousands for successful careers in Radio-TV. Study fast or slow—as you like. Diploma when you graduate. Mail coupon now. Paste it on a postcard or mail in envelope. ACTUAL LESSON FREE. Also 64 page catalog that shows opportunities, shows equipment you get. Cost of NRI courses low. Easy terms. NATIONAL RADIO INSTITUTE, Dept. 9DE, Washington 16, D. C.

### N.R.I. TRAINED THESE MEN FOR SUCCESS



"I was repairing Radios by 10th lesson. Now have good TV job." M. R. LINDEMUTH, Fort Wayne, Ind.



"Doing spare time repairs on Radio and TV. Soon servicing full time." CLYDE HIGGINS, Waltham, Mass.

"I had a successful Radio repair shop. Now I'm Engineer for WHPE." V.W. WORKMAN, High Point, N.C.



"There are a number of NRI graduates here. I can thank NRI for this job." JACK WAGNER, Lexington, N. C.



### VETERANS Approved Under G.I. Bills

RADIO & TV NEWS is published monthly by Ziff-Davis Publishing Company, William B. Ziff, Chairman of the Board (1946-1953), at 434 S. Wabash Ave., Chicago 5, Ill. Second-class postage at Chicago, Illinois. Authorized by Post Office Department, Ottawa, Canada, as second-class matter. SUBSCRIPTION RATES: one year U. S. and possessions, and Canada \$4.00; Pan American Union Countries \$4.50; all other foreign countries \$5.00.

### SEND FOR BOTH FREE

#### National Radio Institute

Dept. 9DE, Washington 16, D. C.

Mail me Sample Lesson and 64-Page Catalog FREE. (No salesman will call. Please write plainly.)

Name \_\_\_\_\_ Age \_\_\_\_\_

Address \_\_\_\_\_

City \_\_\_\_\_ Zone \_\_\_\_\_ State \_\_\_\_\_

ACCREDITED MEMBER, NATIONAL HOME STUDY COUNCIL



# RADIO & TV NEWS

Reg. U. S. Pat. Off.

First in radio-television-audio-electronics

Average Net Paid Circulation 236,101

Radio & Television News • Radio News • Television News Trademarks Reg. U. S. Pat. Off.

# CONTENTS

APRIL, 1959

VOL. 61 ■ NO. 4

**Publisher**

**OLIVER READ, D. Sc., WIETI**

**Editor**

**WM. A. STOCKLIN, B. S.**

**Technical Editor**

**MILTON S. SNITZER, W2QYI**

**Service Editor**

**SIDNEY C. SILVER**

**Associate Editor**

**P. B. HOEFER**

**Assistant Editor**

**J. JUSTER**

**Television Consultant**

**WALTER H. BUCHSBAUM**

**Art Editor**

**MILTON BERWIN**

**Art and Drafting Dept.**

**J. A. GOLANEK  
JAMES A. ROTH  
MILTON WHELPLEY**

**Advertising Director**

**JOHN A. RONAN, JR.**

**Midwest Adv. Manager**

**W. ROBERT WOLFE**

**Western Adv. Manager**

**JAMES R. PIERCE**



**ZIFF-DAVIS PUBLISHING COMPANY**  
William Ziff, President; W. Bradford Briggs, Executive Vice-President; Michael Michaelson, Vice-President and Circulation Director; Hershel B. Sarbin, Secretary; Howard Stoughton, Jr., Treasurer; Albert Gruen, Art Director.

Editorial and Executive Offices  
One Park Avenue  
New York 16, N. Y. OR. 9-7200



MEMBER INSTITUTE OF



**BRANCH OFFICES:** Midwestern Office, 434 S. Wabash Ave., Chicago 5, Ill.; Western Office, Room 412, 215 W. 7th St., Los Angeles 14, Calif.; James R. Pierce, manager.

**FOREIGN ADVERTISING REPRESENTATIVES:** D. A. Goodall Ltd., London; Albert Milhado & Co., Antwerp and Dusseldorf.

## ELECTRONICS—GENERAL

Spot News.....	Washington Editor	31
Electronics in Nigeria.....	Roger Penn	41
Recent Developments in Electronics.....		58
Calendar of Events.....		129
Technician's Crossword.....	Richard F. Crocker	161

## HIGH FIDELITY AND AUDIO

Hi-Fi Crossover Networks—General Principles (Part 1).....	Abraham B. Cohen & Paul D. Cohen	44
Hi-Fi Product Test Report (RADIO & TV NEWS Lab Tested).....		47
Loudspeakers for Stereo (Part 1).....	Norman H. Crowhurst	51
Complete Stereo Amplifier System (RADIO & TV NEWS Lab Tested).....		66
Hi-Fi—Audio Product Review.....		96
20 cps Tape Recorder Switch.....	Harold Reed	102
Drift & A.F.C. in FM.....	J. Richard Johnson	110
Certified Record Revue.....	Bert Whyte	118
Sound on Tape.....	Bert Whyte	122

## TELEVISION-RADIO

When Your Set Needs Service (Editorial).....	W. Stocklin	8
Defects in the Horizontal Oscillator.....	Walter H. Buchsbaum	40
Antenna Installations: Fact & Fiction.....	Jack Beever	42
Cover Story.....		43
Defects in the Sync Section.....	Walter H. Buchsbaum	50
New TV Designs for 1959.....	Walter H. Buchsbaum	54
Tube Inventory for Service Shops—1959.....	Murray Barlowe	57
Hints on Two-way Radio Service.....	Jack Darr	68
Create Your Business Personality.....	William Leonard	73
TV Schematics for 1959 (Motorola TS-552, General Electric U3, RCA KCS124C, D, E, F, H, J, K, & L Chassis).....		74-79
Mac's Service Shop.....	John T. Frye	80
New Picture Tube has Built-on Safety Glass.....		117
Service Notes.....		140
Service Industry News.....		142
Test Bench Puzzler: No. 6.....	Art Margolis	154

## TEST EQUIPMENT

Test Equipment for the Complete Shop.....	Robert Gary	37
Special Test Instruments.....		64
Test Equipment for the Basic Shop.....	John T. Frye	70

## AMATEUR

Transistorized Double-Sideband Suppressed-Carrier Transmitter.....		
.....	Don Stoner, W6TNS	48
Versatile Ham Transmitter Kit (RADIO & TV NEWS Lab Tested).....		62
J. M. J. Madey Named 1958 "Ham of the Year".....		108

## ELECTRONIC CONSTRUCTION

An Automatic "Talk Squelcher" for Your Radio.....	Marvin L. Gaskill	60
---	-------------------	----

## DEPARTMENTS

Letters from Our Readers.....	12	What's New in Radio.....	150
Within the Industry.....	26	Manufacturers' Literature.....	160

Copyright © 1959 by Ziff-Davis Publishing Company. All rights reserved.

**SUBSCRIPTION SERVICE:** Forms 3579 and all subscription correspondence should be addressed to Circulation Department, 434 South Wabash Avenue, Chicago 5, Illinois. Please allow at least four weeks for change of address. Include your old address as well as new—enclosing if possible an address label from a recent issue.

**CONTRIBUTIONS:** Contributors are advised to retain a copy of their manuscripts and illustrations. Contributions should be mailed to the New York Editorial Office and must be accompanied by return postage. Contributions will be handled with reasonable care, but this magazine assumes no responsibility for their safety. Any copy accepted is subject to whatever adaptations and revisions are necessary to meet the requirements of this publication. Payment covers all author's, contributor's, and contestant's rights, title, and interest in and to the material accepted and will be made at our current rates upon acceptance. All photos and drawings will be considered as part of the material purchased.

RADIO & TV NEWS

# EARN WHILE YOU LEARN

**NOTHING ELSE LIKE IT!**

See How DeVry Tech Prepares You for a Good-Paying Career in

## ELEVISION RADIO ELECTRONICS

Hundreds of men, 17 to 55, started to make money in the Electronics field before they even finished their DeVry Tech program. Many made the training pay for itself as they learned! Because DeVry Tech's program is so practical, YOU should be able to do the same. You work scores of projects; you learn by watching home training movies; you follow clear, step-by-step instructions. You really learn principles and master many skills. No wonder DeVry Tech men are found in so many real-pay, bright-future jobs in this great, growing field!



**A BIG DeVRY EXTRA!**

### Build Your Own 6-Speaker Stereophonic & Hi-Fi Sound System

NOW, you may build and keep your own top quality High Fidelity 6-Speaker Stereophonic Sound System, as shown below. You Learn-By-Doing for a BETTER JOB or to ADD TO YOUR PRESENT INCOME. As a bonus, you and your family can enjoy the thrills of this marvelous sound system for years to come.

Special **SHORT COURSE** in High Fidelity Sound Reproduction including Stereophonic Systems also available. Ideal for hobbyists, music lovers and men seeking **NEW OPPORTUNITY**. Mail coupon.

# GET A BETTER JOB OR BE BOSS OF YOUR OWN BUSINESS

## NO ADVANCED EDUCATION OR PREVIOUS TECHNICAL EXPERIENCE

**NEEDED!** At home in your spare time, you use the same basic method followed by students in our Chicago and Toronto laboratories. You learn to use tools, follow diagrams, when you build any or all of this valuable equipment: the STEREO SYSTEM . . . or a 5-INCH OSCILLOSCOPE and VACUUM TUBE VOLTMETER . . . or a 21-inch TV SET. You have many choices! DeVry Tech's program is so thorough that you will likely be surprised at your progress. Send the coupon for details.

### EMPLOYMENT SERVICE



Frequently, we simply don't have enough graduates available to fill all the jobs on our list! DeVry Tech has an Employment Service that really works. It is available to graduates without additional cost.

### MILITARY SERVICE

If you are subject to military service, you will find the information we have for you very helpful. Mail the coupon today and get the facts.

## GET TWO FREE Booklets!

"POCKET GUIDE TO REAL EARNINGS" and  
"ELECTRONICS AND YOU"



Electronics  
and YOU!

Real down-to-earth details are presented to help the man who wants to get ahead. Both booklets are yours FREE! Fill out coupon and mail today.

### MAIL TODAY FOR FREE FACTS

DeVry Technical Institute

4141 Belmont Ave., Chicago 41, Ill., Dept. RN-4-P

Please give me your two FREE booklets, "Pocket Guide to Real Earnings" and "Electronics and You," and tell me how to prepare to enter one or more branches of Electronics.

NAME \_\_\_\_\_ AGE \_\_\_\_\_  
PLEASE PRINT

STREET \_\_\_\_\_ APT. \_\_\_\_\_

CITY \_\_\_\_\_ ZONE \_\_\_\_\_ STATE \_\_\_\_\_

Check here if subject to military training.

DeVry Tech's Canadian Training Center is located at  
2051 626 Roselawn Avenue, Toronto 12, Ontario

# DeVRY Technical Institute

4141 BELMONT • CHICAGO 41, ILL. • Formerly DeFOREST'S TRAINING, Inc.

Accredited Member of National Home Study Council



"One of America's Foremost  
Electronics Training  
Centers"

# ONE OF THE BIGGEST OPPORTUNITY FIELDS OF THE CENTURY!

WHEN CUSTOMERS ASK—S

RCA provides you

**ALL-NEW**

## RCA Silverama®

SILVERAMA is RCA's premium picture tube—that means *tops* in the industry! Manufactured with all-new glass and parts, it's the finest picture tube made—for the customer who prefers and *expects* the very best.

Command premium price and profits! Sell RCA SILVERAMA with *assurance* that you are delivering a completely all-new picture tube.

### A CHOICE OF RCA PICTURE TUBES TO MEET THE DEMAND OF TWO MARKETS

If your customers want the best that money can buy, offer them RCA SILVERAMA...the picture tube that's ALL-NEW through and through. If they want the economy of a rebuilt tube, offer them RCA MONOGRAM...there's no finer rebuilt made. Either way, you provide the *quality* assurance of the RCA name...a real quality choice for your customers...a real opportunity for you to simplify both your buying and selling by offering the best in TV picture tubes.



GET FULL DETAILS FROM YOUR AUTHORIZED RCA DISTRIBUTOR TODAY

**IT NEW OR REBUILT?**

**with a positive answer!**

**FACTORY-REBUILT**

## RCA Monogram

RCA MONOGRAM...no finer rebuilt picture tube made. Factory-rebuilt by RCA to quality standards, this tube assures dependable performance and fewer call-backs. It is backed by a brand name *you sell* with confidence—a brand name *your customers buy* with confidence.

Yes, top rebuilt quality at economy prices makes RCA MONOGRAM your best buy for picture tube replacements where price is the primary consideration.

**BACKED BY THE GREATEST  
PRE-SELLING CAMPAIGN  
IN PICTURE TUBE HISTORY!**

To make sure your customers know the *full* story...and all the advantages of using either RCA SILVERAMA or RCA MONOGRAM for replacement in their TV set, there's a big, big advertising program scheduled by RCA. Hard-hitting ads that pre-sell for *you* are appearing in LIFE, SATURDAY EVENING POST and TV GUIDE. You'll see hard-selling commercials on top TV shows. You'll hear regularly-scheduled radio commercials. And your RCA distributor can supply you with everything you need...from window displays to your own ad mats.



**RADIO CORPORATION OF AMERICA**

Electron Tube Division

Harrison, N. J.

## FOUR NEW FM MOBILE RECEIVERS — TUNABLE OR CRYSTAL CONTROLLED SPAN ENTIRE EMERGENCY COMMUNICATIONS BAND

### FEATURES FOUND ONLY IN MUCH HIGHER PRICED EQUIPMENT:

- Double conversion for highest selectivity
- Built in 4" speaker
- Tuned RF stage
- Built in squelch
- Adjustable from front panel
- Readily installed
- Excellent sensitivity
- Well illuminated slide rule dial for easy, accurate tuning
- Housed in attractive cabinet only 4 1/2" x 6 1/2" x 8 3/4"
- Chassis easily removed for ease of service



### TUNABLE MODELS—M-40 and M-160 only \$99.50

Ideal for monitoring 30-50 and 152-174 MC bands. For police and fire departments, utilities, trucking and railroads, conservation departments—other governmental, municipal and industrial radio systems. Invaluable where 2 or more channels must be monitored.

### CRYSTAL CONTROLLED MODELS MC-40 and MC-160

Only \$114.50, including crystal. For continuous, positive monitoring of any specific frequency in the 30-50 or 152-174 MC bands. Model MC-40 (30-50 MC) Model MC-160 (152-174 MC). Power supply 12 VDC. Same fine features and specifications as Models M-40 and M-160.

SPECIFICATIONS:	MODEL M-40	MODEL M-160
Frequency Range:	30-50 MC	152-174 MC
Selectivity: (for 30 db quiet req.)	2 $\mu$ v or better	4 $\mu$ v or better
Selectivity:	± 40 kc at 20 db	± 40 kc at 20 db
Switch Operation:	1 $\mu$ v (adjustable)	2 $\mu$ v (adjustable)
Power Output: (for 10% distortion)	.8 w	.8 w
Power Supply	12 vdc	12 vdc

# monitor radio

Division of I.D.E.A., Inc.  
7500 Pendleton Pike • Indianapolis 26, Indiana

## ...for the Record

# ELECTRONICS WORLD



By **W. STOCKLIN**  
Editor

## When Your Set Needs Service

**E**VEN TV set owners not previously worried about the competence of those who service their receivers are "viewing with alarm" these days. The current vogue for articles blasting radio and TV service technicians has had an inevitable effect.

Without a doubt, some fire burns under all this smoke. Despite the efforts of ethical service dealers, as individuals or through associations, there will always be some "fast buck" operators. When your set needs service, you are entitled to protect yourself against them. But how is this done?

Understandably you would prefer not to learn through one or more expensive misadventures. To begin with, don't look for a service "bargain." There are abundant statistics to prove that it costs several dollars just to put a technician in your home and get him back, irrespective of what he does. To make a profit, any firm that advertises service for only two or three dollars a call "plus parts" may have to sell quite a few parts you don't need. You stand an excellent chance of paying such an outfit a larger final bill than you would get from an ethical man who places a more reasonable valuation on his time and ability.

You can also help yourself by taking a sensible attitude toward the man you have invited into your home. If he considers himself a trustworthy professional, don't tempt him to act like a thief by treating him like one. Think this over: you have made a sizable investment in your set. When it gives trouble, there may be some undercurrent of resentment over paying more money for something you already own. Is this coloring your attitude toward the technician? Remember, he didn't

cause the breakdown, to begin with.

Let him know you want an estimate *before* he goes to work, with the right to approve or veto the job. Also let him know—in advance—that you will expect an itemized bill showing parts and labor. A greater charge for labor than parts is not automatic proof of dishonesty. Time and know-how (both costly) are sometimes needed to locate a defect. If the set must go to the shop—which is sometimes necessary—and living without it is too much to bear, check on the availability of a set for loan. Some shops provide such a service. If your set is in repair for what seems like too long a time, you are entitled to know the reason. Intermittent breakdowns—those that come and go—or the need for getting a special part shipped from the manufacturer or a supply depot may be the legitimate cause, rather than incompetence.

If doubt remains after the repair, check with the local Better Business Bureau or grievance committee for handling consumer complaints on service, where one exists. Many of these boards have been set up by or with the cooperation of service-dealer associations concerned with their own long-range good and professional reputations. They are anxious to prevent questionable operators from giving their entire industry a black eye. In fact, many of the suggestions advanced here have been recommended or endorsed by such groups. In matters like these, they are likely to find themselves on your side of the fence.

No one can give you a guarantee against a swindler, but you can cramp his style with good sense, and possibly scare him off altogether.

-30-

## Next Month Watch for



# ELECTRONICS WORLD

**W**ITH this issue we have reached another milestone in the history of this publication and share with many of our readers a nostalgia for the past. As we pointed out earlier, this is the last issue which will reach you as RADIO & TV NEWS. Next month we adopt our new name, ELECTRONICS WORLD which we hope, in time, will come to be as respected a title as our old one.

RADIO & TV NEWS



# free! ALLIED'S 1959

## value-packed 452-page ELECTRONIC SUPPLY CATALOG

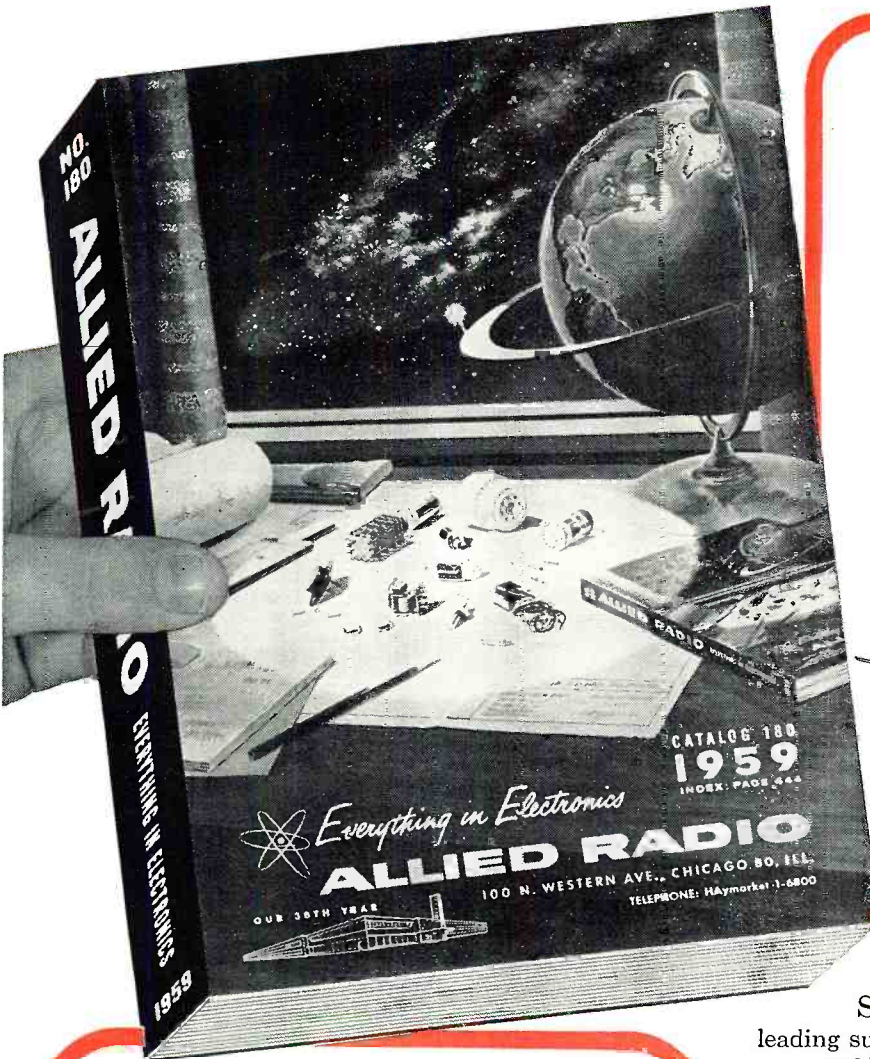

the only COMPLETE guide to everything in electronics

### WORLD'S LARGEST STOCKS

- Latest Stereo Hi-Fi Systems— Everything in Hi-Fi Components
- Money-Saving, Build-Your-Own KNIGHT-KITS—Latest Models
- Values in Recorders and Supplies
- Latest Public Address Systems, Paging and Intercom Equipment
- Amateur Receivers, Transmitters and Station Gear
- Test & Laboratory Instruments
- Specialized Electronic Equipment for Industrial Application
- TV Tubes, Antennas, Accessories
- Huge Listings of Parts, Tubes, Transistors, Tools, Books

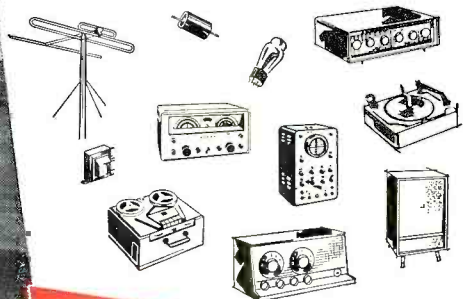

### featuring:

**MONEY-SAVING knight-kits:** Finest electronic equipment in money-saving kit form. Complete selection of latest Hi-Fi amplifier, tuner and speaker kits (new Stereo units); Hobbyist kits; Test Instruments and Amateur kits. KNIGHT-KITS are an exclusive ALLIED product.

**HI-FI! STEREO!** See the world's largest selection of quality Hi-Fi music systems and famous name components. First with the latest in STEREO! Save on ALLIED-recommended complete systems. Own the best in Hi-Fi for less!

**EASY PAY TERMS:** Only 10% down; available on orders of \$20 or more. Fast handling—no red tape.

## ALLIED RADIO

 our 38th year  
World's Largest Electronic Supply House

Send for ALLIED'S 1959 Catalog—it's the leading supply guide—452 pages packed with the world's largest selection of quality electronic equipment at lowest, money-saving prices. Get every buying advantage at ALLIED: fastest shipment, expert personal help, lowest prices, guaranteed satisfaction...

send for the leading  
electronic supply guide

**FREE!**

ALLIED RADIO CORP., Dept. 1-D9  
100 N. Western Ave., Chicago 80, Ill.

Send FREE 452-Page 1959 ALLIED Catalog

Name \_\_\_\_\_

Address \_\_\_\_\_

City \_\_\_\_\_ Zone \_\_\_\_\_ State \_\_\_\_\_

*designed by and for the technician*

**NEW  
1959  
EDITION  
\$1.85**



**This new Handbook** was designed especially for the technician. Planned for on-the-job use, it is compact, handy, rugged . . . lies flat when open. Its modern styling permits quick, easy reference. And, of course, it is up-to-the-minute, complete in one volume . . . with data for receiving, special and picture tubes as well as semiconductors. Get your copy today from your CBS-Hytron distributor.

*Reliable products through Advanced-Engineering*

**CHECK THESE FEATURES**

- 550 pages
- 1050 receiving tubes
- 390 TV picture tubes
- 270 special-purpose tubes and semiconductors
- Comprehensive data, popular types
- Reference data, seldom-used types
- Appendix especially for technicians

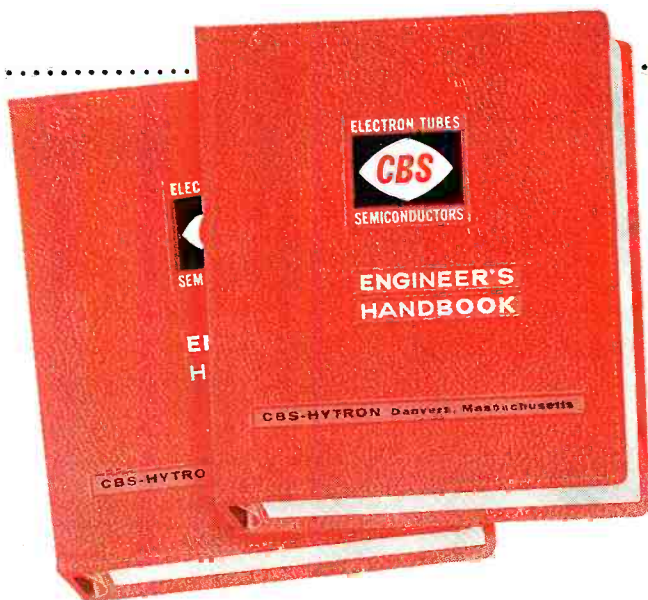

**Engineer's Handbook**

**NOW TWO VOLUMES . . . . . \$10.00**

**Additional hard-cover binders:**

**\$3.00 for 1, \$5.50 for 2.**

This modern Handbook has expanded into two volumes. It includes receiving, special and picture tubes and semiconductors. Features are: Complete EIA engineering design data on current tubes • tabulated quick-reference data for seldom-used types • 375 two-color design curves • over 700 pages, two colors • handy 8¼ by 9½ inches • sturdy hard covers • 16-ring metal binders • appendix • supplement service available. Order direct.

**CBS-HYTRON, Danvers, Massachusetts**  
A Division of Columbia Broadcasting System, Inc.

**WE'RE MAKING IT EASIER THAN EVER TO BECOME A WELL PAID  
RADIO-TELEVISION SERVICE TECHNICIAN**

**NOW - Just \$6 Starts You Training in  
RADIO-TELEVISION  
the SPRAYBERRY "Learn-by-Doing" Way...**

**25 BIG, COMPLETE KITS  
of PARTS & EQUIPMENT**

To help you learn *fast* the practical side of Radio-Television, we send you expertly engineered training kits to test and assemble for interesting, valuable shop-bench practice!



- The new Sprayberry Training Television Receiver, built and tested in 5 sections.
- Now offered... this fine modern oscilloscope.
- You build this powerful two-band superheterodyne radio receiver.

Big New  
**CATALOG**  
AND  
Sample Lesson  
**FREE!**

You build the new Sprayberry tester—a complete 18-range Volt-Ohm-Milliammeter test meter.

★ ★ ★ This great industry is begging for trained men... to step into good paying jobs or a profitable business of their own! Our new plan opens the doors of Radio-Television wide to every ambitious man who is ready to act at once!

Men by the thousands... trained Radio-Television Service Technicians... are needed at once! Perhaps you've thought about entering this interesting, top paying field, but lack of ready money held you back. Now—just \$6 enrolls you for America's finest, most up to date home study training in Radio-Television! Unbelievable? No, the explanation is simple! We believe Radio-Television *must* have the additional men it needs as quickly as possible. We are willing to do our part by making Sprayberry Training available for less money down and on easier terms than ever before. This is your big opportunity to get the training you need... to step into a fine job or your own Radio-Television Service Business.

**Complete Facts Free—Act Now; Offer Limited**

Only a limited number of students may be accepted on this liberal and unusual basis. We urge you to act at once... mail the coupon below and get complete details plus our big new catalog and an actual sample lesson—all free. No obligation... no salesman will bother you.

**HOME STUDY TRAINING IN SPARE TIME**

Under world-famous 27-year old Sprayberry Plan, you learn entirely at home in spare time. You keep on with your present job and income. You train as fast or as slowly as you wish. You get valuable kits of parts and equipment for priceless shop-bench practice. And everything you receive, lessons and equipment alike, is all yours to keep.

**LET US PROVE HOW EASILY YOU CAN LEARN!**

Radio-Television needs YOU! And Sprayberry is ready to train you on better, easier terms, that any ambitious man can afford. Just \$6 starts you! Mail coupon today... let the facts speak for themselves. You have everything to gain. Let us prove the kind of opportunity that's in store for you!

**SPRAYBERRY Academy of Radio-Television**  
1512 Jarvis Avenue, Dept. 25-T, Chicago 26, Illinois

**Mail This Coupon Now—No Salesman Will Call**

**Sprayberry Academy of Radio-Television**  
Dept. 25-T, 1512 W. Jarvis Ave., Chicago 26, Ill.

Please rush all information on your ALL-NEW Radio-Television Training Plan. I understand this does not obligate me and that no salesman will call upon me. Include New Catalog and Sample Lesson FREE.

NAME..... Age.....

ADDRESS.....

CITY..... ZONE..... STATE.....

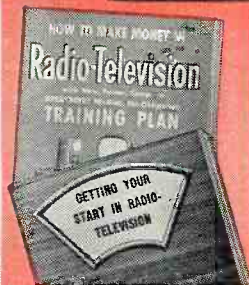



**Now YOU can get  
TUNERS  
repaired, or replaced,  
in a hurry!  
Send them to TARZIAN!**

● Sarkes Tarzian, Inc., announces a new tuner repair service and factory replacement program for Tarzian-manufactured tuners. Distributors, dealers and servicemen will welcome this direct factory service program which is designed to take delay and confusion out of the tuner repair business.

We're set up to offer a 48 hour service from the date of receipt to shipment to you.

Cost is reasonable, too. Only \$7.50 per unit (\$15 for UV combinations) and that includes ALL replacement parts! Both repaired—or exchange units if available from stock—carry a 90 day warranty against defective workmanship and part failure.

Replacements will be offered at these current prices\* on units not repairable:

- VHF 12 position tuner... \$17.50
- VHF 13 or 16 position tuner..... 19.50
- VHF/UHF combination. 25.00
- UHF only..... 15.50

\*Subject to change

When inquiring about tuner service, always refer to tuner by part number. When inquiring about direct replacements for tuners other than Sarkes Tarzian-manufactured, please indicate tube complement, shaft length, filament voltage, series or shunt heater. Use this address for quickest service:

**SARKES TARZIAN, Inc.**

**Attn: Service Mgr., Tuner Division  
East Hillside Drive  
Bloomington, Indiana**



TARZIAN Electronic Product and Services include TELEVISION TUNERS . . . SELENIUM AND SILICON RECTIFIERS . . . BROADCAST EQUIPMENT . . . AIR TRIMMERS . . . TV STATIONS WTTV and WPTA, and RADIO STATION WTTs.



**CUSTOMIZED DIAL PLATES**

To the Editors:

In reference to your January issue, I would like to add something to the fine article "Photoplastic Special Dials" by Ronald Ives.

A few years ago, a Cleveland corporation announced a photosensitive, anodized aluminum plate that could be exposed and processed with standard photographic solutions. Trimming and cutting is quite easy, as an ordinary paper trimmer or tin snips does the job quite well. For your custom dials you can select a color background.

Exposure is quite simple from an ordinary lithographic film, negative or positive. A simple contact printing frame or glass plate is used over the film and metal plate for good contact. I have found an electronic flash unit held 12 to 18 inches above the plate film glass sandwich gives excellent results.

J. W. ZIMERLE  
Dayton, Ohio

*The company referred to above is Metalphoto Corp., 6811 Superior Ave., Cleveland 3, Ohio. Samples of the plate, which we have examined, show that it would appear to be very suitable for the purpose suggested by Reader Zimerle.—Editors.*

\* \* \*

**RECHARGING FLASHLIGHT CELLS**

To the Editors:

In your February, 1958 issue, you have an article titled "Recharging and Storing Dry Batteries." I just recently saw the article, but am interested in the subject since Lockheed's Georgia Division is presently recharging and reusing over 6000 flashlight batteries each month.

Your information regarding a battery's capacity to be rejuvenated is certainly accurate, but we are experiencing a condition which you might possibly furnish us some answers to. Over half of the batteries coming back for recharging are not reacting to the recharge. These are batteries with less than 1.2 volts and 150 ma. remaining life.

Obviously, with several hundred aircraft mechanics using flashlights, we cannot control the point in the battery's life at which they will be exchanged. Nevertheless, we are getting a large number of batteries over 1.0 volt, but not rechargeable with our present procedure.

After extensive tests, we have established the recharge procedure of using 175 ma. for a six-hour cycle. With the batteries of less than 1.2 volts, the extension of the time cycle has an insig-

nificant effect on its ability to take a recharge, while a higher current only heats the series of batteries, causing some to burst the canister.

J. H. OLDEN  
Conservation Engineer  
Lockheed Aircraft Corp.  
Marietta, Georgia

*We wonder if the method of recharging, described in our October, 1957 issue might not be worth a trial. In this method, a.c. is superimposed on d.c. much as is done in the case of electroplating.—Editors.*

\* \* \*

**INDUSTRIAL TUBES**

To the Editors:

As counsel for the RF Heating Committee of the Society of the Plastics Industry, Inc., I was very interested in the article entitled "Industrial Tubes and Their Uses," which appeared in the January issue of your magazine. I found the article very interesting and exceptionally well done. Incidentally, it was called to my attention by a member of the staff of the Federal Communications Commission.

It occurred to me after reading your article that the members of my client's RF Heating Committee might well be similarly interested and, therefore, I am writing to inquire as to whether it might be possible to obtain approximately 40 reprints.

JEROME H. HECKMAN  
Dow, Lohnes and Albertson  
Washington, D. C.

*We appreciate Reader Heckman's comments on the article. We are making the reprints available, as requested.—Editors.*

\* \* \*

**TRANSISTORS ARE DIFFERENT**

To the Editors:

Referring to Ed Bukstein's "Transistors Are Different" in your December issue, there is one misconception that I feel should be cleared up. Ed says, "Incorrect polarity of collector voltage will damage the transistor."

While it is best not to reverse transistor power supply polarity, such reversal in common-emitter circuits will not, in general, cause an increase in collector or emitter current that will damage the transistor. In fact, a reversal of power-supply polarity will result instead in a drop of total currents drawn, and for quite a valid reason. Base bias is applied with reverse polarity, thus reducing or cutting off the collector current.

In the early days of point-contact transistors, such a precaution made sense, but with present junction tran-

# HOW TO PASS Your FCC Commercial LICENSE EXAMS\*

**We guarantee**  
to train you until you receive  
**Your FCC license**  
—or your money back

The Master Course in Electronics will provide you with the mental tools of the electronics technician and prepare you for a First Class FCC License (Commercial) with a radar endorsement. When you successfully complete the Master Course, if you fail to pass the FCC examination, you will receive a full refund of all tuition payments.

## “License and Good Job . . . Thanks”

“After finishing your Master Course, I passed the FCC exam for the 1st class license. I had my ticket for only one week and I got a job at WOC-TV, AM-FM. Incidentally, WOC is the oldest radio station west of the Mississippi. I sincerely feel that if it weren't for taking your Master Course, I would not have received my 1st class ticket. So I want to take this occasion to again thank you for such a fine, complete and composite study for electronics work.”

Francis J. McManus  
Davenport, Iowa

Cleveland Institute training results in job offers like these:

**Service Technician:**  
Man needed in Cleveland, Ohio to service and maintain electronic medical instruments and equipment. Must have a solid knowledge of electronic fundamentals. A car is required. Company benefits include retirement plan.

**Radio Operators & Technicians**  
American Airlines — Chicago, Detroit, St. Louis, Cincinnati and Cleveland—has openings for radio operators and radio mechanics. Operators must have a 2nd class FCC license and ability to type 40 wpm. Many company benefits.

### CLEVELAND INSTITUTE OF RADIO ELECTRONICS

Desk RN-28 4900 Euclid Ave. Cleveland 3, Ohio

## Mail Coupon Now and get all three FREE



We can train you to pass your License Exams if you've had any practical experience — amateur, military, radio servicing, or other. Our proven plan can help put you on the road to success.

\* Your FCC ticket will be recognized by employers as proof of your technical ability.

good training doesn't cost . . . it pays!

Accredited by the National Home Study Council

### Cleveland Institute of Radio Electronics

Desk RN-28, 4900 Euclid Ave., Cleveland 3, Ohio



Please send Free Booklets prepared to help me get ahead in Electronics. I have had training or experience in Electronics as indicated below.

- |   |   |
|---|---|
| <input type="checkbox"/> Military           | <input type="checkbox"/> Broadcasting       |
| <input type="checkbox"/> Radio-TV Servicing | <input type="checkbox"/> Home Experimenting |
| <input type="checkbox"/> Manufacturing      | <input type="checkbox"/> Telephone Company  |
| <input type="checkbox"/> Amateur Radio      | <input type="checkbox"/> Other _____        |

In what kind of work are you now engaged?

In what branch of Electronics are you interested?

Name \_\_\_\_\_ Age \_\_\_\_\_

Address \_\_\_\_\_

City \_\_\_\_\_ Zone \_\_\_\_\_ State \_\_\_\_\_

RN-28

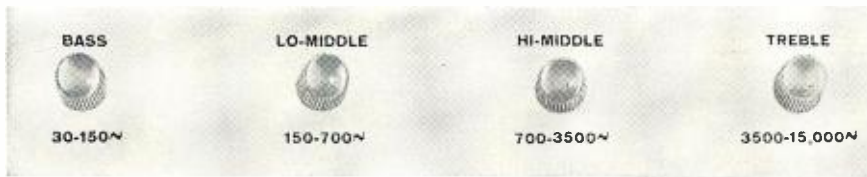

these 4 knobs provide  
unlimited control of  
frequency response



## NEW BLONDER-TONGUE MODEL A-1 HIGH FIDELITY AMPLIFIER

**A unique B-T Development!** The Model A-1 Audio Amplifier divides the audible spectrum into its *four* significant segments (BASS, LO-MIDDLE, HI-MIDDLE and TREBLE.) *Four* separate tone controls permit you to boost or attenuate any frequency range or combination of ranges. The result—a degree of tonal selectivity unobtainable *anywhere* in the amplifier field. Solo instrumentalists or vocalists may be drawn out of the orchestral background to take their places in front of the orchestra. Correction for poor room acoustics, or for deficiencies in associated equipment, is

instant and exact. Power output is 12 watts (music wave forms).

The Model A-1 gives you high fidelity performance you'd expect to find only in amplifiers costing considerably more! Frequency response is uniform within ½ db from 30 to 15,000 cycles; harmonic distortion, below 1% at 10 watts output. Inputs are provided for magnetic and crystal phono cartridges, with *automatic* RIAA equalization on both. Tape and tuner inputs add to its versatility. Complete function selection on front panel. Housed in a handsome, two-tone cabinet, the A-1 lists at **77.50**.

**MATCH THE A-1 WITH THESE BLONDER-TONGUE COMPONENTS FOR A COMPLETE, VERSATILE HI-FI SYSTEM COSTING LESS THAN \$160**



**Model T-88 FM-AM Tuner** — Amazing sensitivity on FM and AM. Frequency response, 20–20,000 cycles. Built-in FM antenna, with provision for external antenna. Built-in ferrite AM antenna. Simple, plug-in connection with A-1 amplifier for existing phonograph or TV receiver. Accurate and stable slide-rule tuning. **64.50**



**Model SS-2 Twin Speaker System**—Housed in an acoustically correct enclosure, the SS-2 Twin Speaker System includes two carefully matched 4" speakers with overlapping frequency ranges. Ideal for use as a multiple speaker system in a monaural installation or, as a second system for conversion to stereo. 16-ohm impedance. **15.95**



**Model R-98 FM-AM Radio** — For those who prefer the convenience of a complete FM-AM radio, *with no sacrifice in quality*, the R-98 provides superb reception, free from interference of every kind—even in critical areas. Amazing sensitivity on FM and AM. Accurate and stable slide-rule tuning. **64.50**

For complete details, write to Dept. RTN-4



### BLONDER-TONGUE LABORATORIES

9 Alling Street, Newark 2, New Jersey

sistors in the common-emitter configuration, this precaution is not required. The circuit may not work with reversed polarity, but the transistor will not be damaged.

LOU GARNER  
Silver Spring, Maryland

*We passed along Lou's comments as summarized above to Author Bukstein, who had the following to say.—Editors.*

To the Editors:

All the above comments from Lou Garner are quite valid within the limits of the frame of reference he has selected. Limiting one's thinking to the specific cases selected, one does indeed arrive at the conclusion that "incorrect collector-supply polarity" will not damage the transistor.

It is possible under some conditions for the collector-base junction to become biased in the forward direction even with correct collector polarity. This occurs in the grounded-emitter circuit when the transistor is driven to saturation. Under these conditions, collector current is maximum and most of the supply voltage is dropped across the collector load. As a result, the collector voltage drops to a value lower than the voltage at the base, and the collector-base junction is therefore biased in a forward direction. Although this does not produce any damage of the puff-of-smoke variety, it does impair the performance of the circuit by reducing the switching speed of the transistor.

ED BUKSTEIN  
Minneapolis, Minnesota

\* \* \*

#### DYNA TONE CONTROLS

To the Editors:

I am referring to the tone control portion of the *Dyna* preamp circuit shown in your September issue. In the illustration it appears that a 62,000-ohm and a 510,000-ohm resistor are connected in parallel from one end of a 750,000-ohm pot to ground. Is this correct?

I have been completely unable to analyze the circuit and I wonder if it has been correctly drawn.

A. R. SCHLEICHER  
Champaign, Illinois

*The above letter from Reader Schleicher was forwarded to Dave Hafner, head of Dynaco, Inc. for his comments. Here is a portion of his reply.—Editors.*

Dear Mr. Schleicher:

The schematic published, to the best of my knowledge, is correct. The paralleled resistors in combination with the following 500,000-ohm grid resistor of the associated amplifier provide a 47,000-ohm load for the preamp. Note that there is a 47,000-ohm resistor acting as a feedback resistor. The two resistors are used with a matched pair of .0075 µfd. capacitors to obtain matched time-constants in output and feedback circuits, a feature which insures flat frequency response when the bass tone control is set in centered

# NEW DIFILM<sup>®</sup> BLACK BEAUTY<sup>®</sup> MOLDED CAPACITORS

# BEAT THE HEAT AND HUMIDITY!

Now Sprague's new DIFILM BLACK BEAUTY MOLDED CAPACITORS have taken the steam out of heat and humidity problems. These capacitors are so good you can *boil 'em* for 24 hours without affecting their performance.

Unlike straight polyester film tubulars, these capacitors operate in a 105°C environment *without derating*.

And the heart of these new DIFILM capacitors can't be beat. It's a dual dielectric which *combines the best advantages of both Mylar\* polyester film and the highest grade of paper dielectric*. A rock-hard solid impregnant fills voids and pinholes in the film.

Talk about *reliability!* . . . these capacitors have it. DIFILM capacitors are actually low cost versions of the Sprague capacitors now being used in every modern military missile. The basic reliability and outstanding performance of missile-type Sprague capacitors are all yours in this outstanding new development. Why take chances when you can get the best—DIFILM BLACK BEAUTY MOLDED TUBULARS . . . at regular prices.

*For the complete DIFILM BLACK BEAUTY story, write for Bulletin M-759 to Sprague Products Company, 51 Marshall St., North Adams, Mass.*

\*DuPont trademark

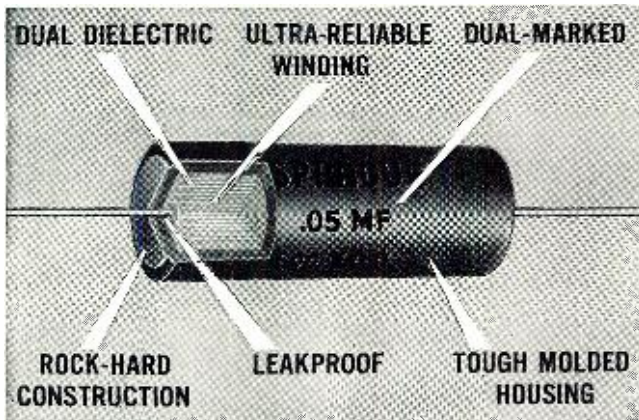

Look for the RED markings on the black case.

**The major capacitor improvements  
come from**

**SPRAGUE<sup>®</sup>**

*world's largest capacitor manufacturer*

**SPRAGUE RESEARCH IS CONSTANTLY PRODUCING NEW AND BETTER CAPACITORS FOR YOU**

## Integrated Data Processing For Military Weapons Systems

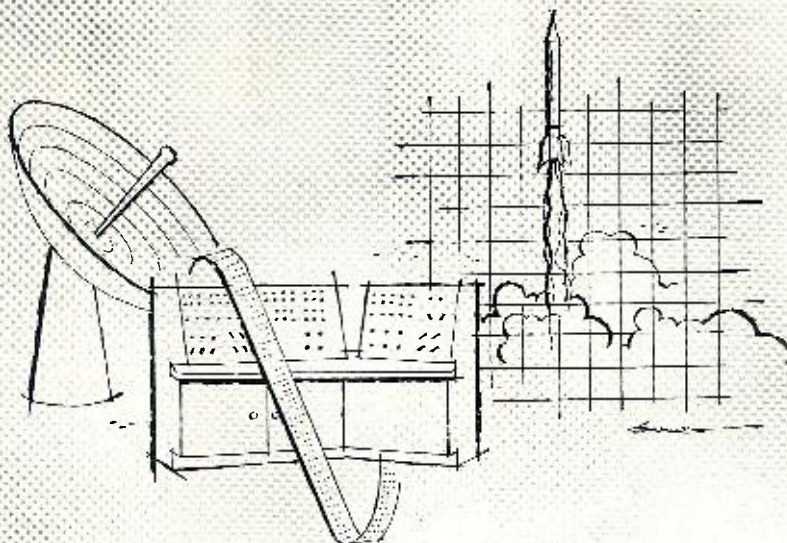

**Technicians** — An electronics future for you at BURROUGHS Military Field Service Division adds up to challenging work on important ATLAS and SAGE programs, advancement based on individual performance and a fine career in the field of tomorrow: Digital Computation.

BURROUGHS, consistent with its recognized leadership in equipment, skills and manpower, is providing the answers for complex military weapons systems through automatic suprahuman computation.

Qualified applicants will receive: 1) Formal 16 or 22-week training program in Data Processing Systems. 2) Starting salary commensurate with experience and ability. 3) Full salary while training. 4) Fine fringe benefits including educational assistance in addition to your training program. 5) Current field assignments include Western and Midwestern areas, when your training program is concluded.

If you are a graduate of an accredited Technical School and/or have military training in radar or communications equipment, plus at least 2 years' experience in electronics, you are invited to address your inquiries to Personnel Department, Military Field Service Division, Burroughs Drive, Radnor, Pa. (a suburb of Philadelphia).



**Burroughs Corporation**

"NEW DIMENSIONS" / in electronics and data processing systems"

position. If an amplifier with 250,000-ohm input impedance is used, snipping out the 62,000-ohm resistor will leave the termination at the 47,000-ohm value so that the equality of time-constants is preserved. This is covered in the instructions of the *Dynakit* preamp.

I believe that the tone control configuration is unique and I have applied for a patent on this arrangement, since it has inherent advantages of flat response and low distortion that are not realized by other methods this simple.

DAVID HAFLER  
Dynaco, Inc.  
Philadelphia, Pennsylvania

\* \* \*

### F1 MIKE-MOUNTING

To the Editors:

In your December "Letters" column, with reference to Reader Perry's trouble in mounting an F1 button into a T17B handset, I offer the following.

1. After soldering the F1 unit, wrap some *Scotch* electrical tape around the mouthpiece opening of the handset.

2. Take the original telephone mouthpiece cap and diaphragm cover. Insert the F1 unit as originally designed, and very gently screw the complete assembly into the *Scotch* tape. The threads in the cap will cut threads in the tape.

WALTER DODD, W8STX  
Adrian, Michigan

To the Editors:

The F1 transmitter unit is a component of a telephone subscriber instrument circuit introduced in the late 30's and now obsolescent. Newer instruments use a more compact, higher-output transmitter coded T1. This latter unit is the current standard.

If the housing of the T17B be bored out to a diameter of  $1\frac{3}{16}$  inches, a T1 unit will fit nicely. For optimum efficiency, additional holes should be drilled in the microphone cap before it is screwed back into place.

JAMES R. WYLIE  
Belvidere, Illinois

*We are still getting quite a few suggestions on mounting mikes into a T17B handset. Editors.*

\* \* \*

### TO TROUBLESHOOT—REMOVE TUBES

To the Editors:

In regard to the article "To Troubleshoot—Remove Tubes," I have used this method many times and found it worthwhile in locating defective parts.

But Mr. Glickstein fails to mention what would happen, for example, in an RCA KCS-102B if the horizontal oscillator tube were removed. He should also have pointed out that the horizontal output tube must also be pulled or the "B+" removed from its plate. Otherwise, the method won't do the output tube any good.

H. R. SWEITZER  
Lakewood, Ohio

*Your warning is, of course, valid. However, we did not feel it necessary to reiterate this fairly well known precaution.—Editors.*

—30—



**NOW!**  
at a price  
you can afford!

# MAKE MORE MONEY in TELEVISION RADIO-ELECTRONICS

**BETTER...MORE COMPLETE...LOWER COST...  
WITH NATIONAL SCHOOLS SHOP-METHOD  
HOME TRAINING!**

**BETTER...** Training that is proved and tested in Resident School shops and laboratories, by a School that is the **OLDEST** and **LARGEST** of its kind in the world.

**MORE COMPLETE...** You learn **ALL PHASES** of *Television-Radio-Electronics*.

**LOWER COST...** Other schools make several courses out of the material in our **ONE MASTER COURSE** . . . and you pay more for less training than you get *in our course* at **ONE LOW TUITION!**

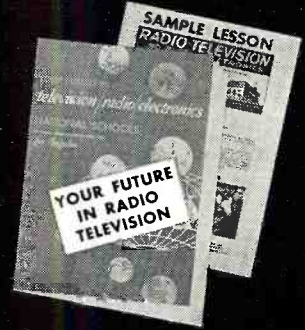
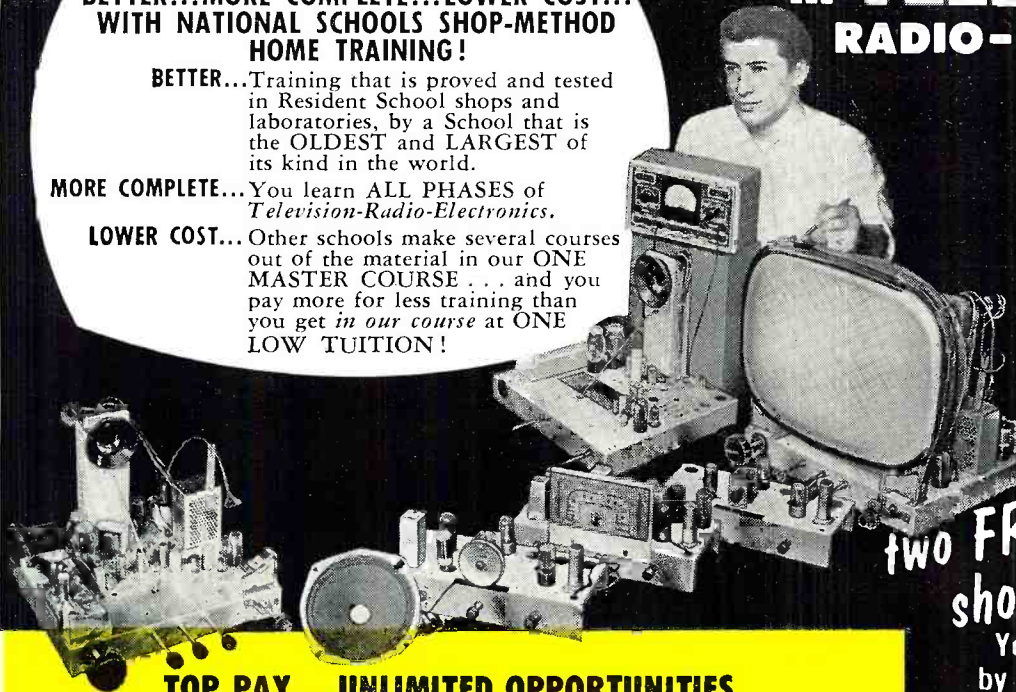

These **two FREE** books will show you how!

You get all information by mail . . . You make your own decision . . . at home! **NO SALESMAN WILL CALL**

## TOP PAY... UNLIMITED OPPORTUNITIES LIFETIME SECURITY CAN BE YOURS!

You are needed in the Television, Radio, and Electronics industry! Trained technicians are in growing demand at excellent pay—in **ALL PHASES**, including Servicing, Manufacturing, Broadcasting and Communications, Automation, Radar, Government Missile Projects.

**NATIONAL SCHOOLS SHOP-METHOD HOME TRAINING**, with newly added lessons and equipment, trains you in your spare time at home, for these unlimited opportunities, including many technical jobs leading to supervisory positions.

**YOU LEARN BY BUILDING EQUIPMENT WITH KITS AND PARTS WE SEND YOU.** Your National Schools course includes thorough *Practical* training—**YOU LEARN BY DOING!** We send you complete standard equipment of professional quality for building various experimental and test units. You advance step by step, perform more than 100 experiments, and you build a complete TV set from the ground up, that is yours to keep! A big, new TV picture tube is included at no extra charge.

**EARN AS YOU LEARN.** We'll show you how to earn extra money right from the start. Many of our students pay for their course—and more—while studying. So can you!

**LESSONS AND INSTRUCTION MATERIAL ARE UP-TO-DATE, PRACTICAL, INTERESTING.** Every National Schools Shop-Method lesson is made easy to understand by numerous illustrations and diagrams. All instruction material has been developed and tested in our Resident School Shops, Laboratories and Studios.

**SEND FOR INFORMATION TODAY . . .** it can mean the difference between **SUCCESS** and failure for you! Send for your **FREE BOOK** "Your Future in Television-Radio-Electronics" and **FREE Sample Lesson.** Do it **TODAY**, while you are thinking about your future. It doesn't cost you anything to investigate!

## GET THE BENEFITS OF OUR OVER 50 YEARS EXPERIENCE

Approved for  
GI Training



**NATIONAL SCHOOLS**  
Los Angeles 37, Calif.

## YOU GET...

- 19 Big Kits—**YOURS TO KEEP!**
- Friendly Instruction and Guidance
- Job Placement Service
- Unlimited Consultation
- Diploma—Recognized by Industry
- **EVERYTHING YOU NEED FOR SUCCESS!**

## SHOP-METHOD HOME TRAINING COVERS ALL PHASES OF INDUSTRY

1. Television, including Color TV
2. Radio AM & FM
3. Electronics for Guided Missiles
4. Sound Recording and Hi-Fidelity
5. FCC License
6. Automation and Computers
7. Radar & Micro-Waves
8. Broadcasting and Communications

## RESIDENT TRAINING AT LOS ANGELES

If you wish to take your training in our Resident School at Los Angeles, the world's TV capital, start **NOW** in our big, modern Shops, Labs and Radio-TV Studios. Here you work with latest Electronic equipment - - professionally installed - - finest, most complete facilities offered by any school. Expert, friendly instructors. Personal attention. Graduate Employment Service. Help in finding home near school - - and part time job while you learn. Check box in coupon for full information.

## NATIONAL TECHNICAL SCHOOLS

WORLD-WIDE TRAINING SINCE 1905

MAIL NOW TO

**NATIONAL SCHOOLS, Dept RH-49**  
4000 S. FIGUEROA ST. LOS ANGELES 37, CALIF.  
Rush free TV-Radio "Opportunity" Book and sample lesson. No salesman will call.

NAME \_\_\_\_\_ AGE \_\_\_\_\_  
ADDRESS \_\_\_\_\_  
CITY \_\_\_\_\_ ZONE \_\_\_\_\_ STATE \_\_\_\_\_

Check if interested **ONLY** in Resident School training at Los Angeles.  
VETERANS: Give date of Discharge \_\_\_\_\_

# Use Delco Radio Service Parts!

8-inch "Hi-Fi" speaker, No. 8007 offers the most highs, the most lows, the most watts in a medium-price speaker. Designed for replacement use and high fidelity audio systems.

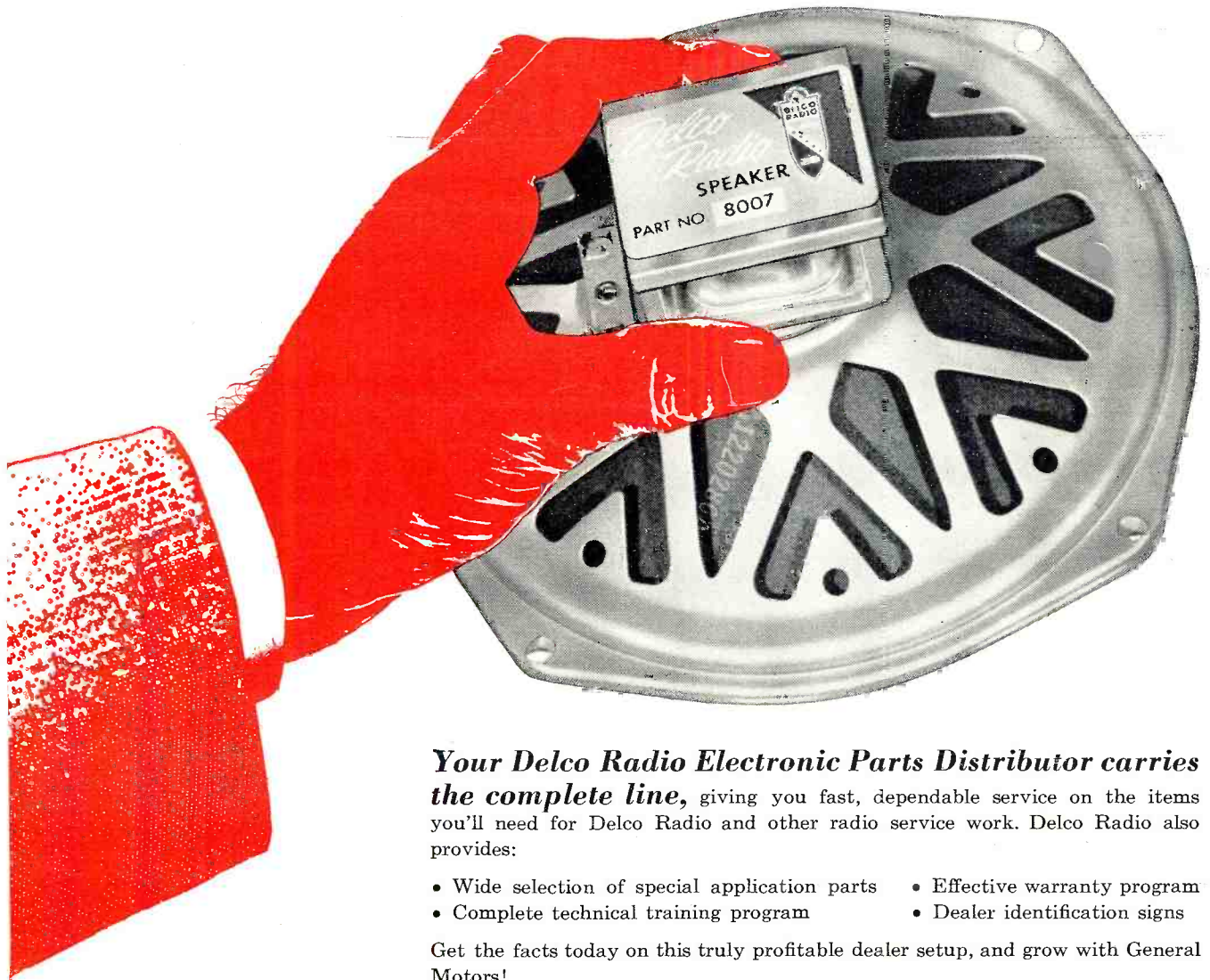

*Your Delco Radio Electronic Parts Distributor carries the complete line,* giving you fast, dependable service on the items you'll need for Delco Radio and other radio service work. Delco Radio also provides:

- Wide selection of special application parts
- Complete technical training program
- Effective warranty program
- Dealer identification signs

Get the facts today on this truly profitable dealer setup, and grow with General Motors!

Available everywhere through Electronic Distributors associated with . . .



## DELCO RADIO

DIVISION OF GENERAL MOTORS, KOKOMO, INDIANA

<p><b>TRANSISTORS</b></p>	<p><b>TUNER PARTS</b></p>	<p><b>TUBES</b></p>	<p><b>IRON CORES</b></p>
	<p><b>TRANSFORMERS</b></p>	<p><b>COILS</b></p>	<p><b>RESISTORS</b></p>
		<p><b>VIBRATORS</b></p>	<p><b>CAPACITORS</b></p>
			<p><b>CONTROLS</b></p>

**It's packed with career facts!**

**SEND FOR THIS  
FREE  
BOOKLET TODAY**



**Your  
future  
in the  
new world of  
ELECTRONICS**

**RADAR • GUIDED MISSILES • SERVO •  
COMPUTERS • AERONAUTICAL •  
BROADCASTING AM FM TV •  
MILITARY • NAVY • CAA •  
COMMUNICATIONS •  
MANUFACTURING**

**Turn  
this page**

**FREE BOOKLET! MAIL THIS POSTAGE-FREE POSTCARD TODAY**

**CAPITOL RADIO ENGINEERING INSTITUTE**  
ECPD Accredited Technical Institute Curricula • Founded 1927  
3224 16th St., N.W. Washington 10, D. C.

114-F

**RB<sub>2</sub>**

Please send me your course outline and FREE illustrated Booklet "Your Future in the New World of Electronics" . . . describing opportunities and CREI home study courses in Electronic Engineering Technology.

- CHECK FIELD OF GREATEST INTEREST
- Radar, Servo and Computer Engineering Technology
  - Electronic Engineering Technology
  - Broadcast (AM, FM, TV) Engineering Technology
  - Television Engineering Technology
  - Aeronautical Electronic Engineering Technology
  - Automation and Industrial Electronics Engineering Technology

Name ..... Age .....

Street .....

City ..... Zone ..... State .....

Check:  Home Study     Residence School     Korean Veteran

To obtain fast immediate service and to avoid delay it is necessary that the following information be filled in:

EMPLOYED BY .....

---

TYPE OF PRESENT WORK .....

---

EDUCATION:  
YEARS HIGH SCHOOL .....

---

OTHER .....

---

ELECTRONICS EXPERIENCE .....

---

**See what  
the rapidly  
expanding  
field of  
ELECTRONICS  
offers you**



# The data that launched thousands of careers is your **FREE**

## ▶ TELLS how you can be successful in **ELECTRONICS . . . including:**

Servomechanisms . . . Computers . . . Automation . . . Radar . . . Aeronautical Electronics . . . Broadcasting . . . Communications and Manufacturing, and the Electronic Principles Associated with Guided Missiles, Telemetry, Astronautics, and Instrumentation.

**Send for your Free Copy today!**

This is a brand new edition of the book which has launched thousands of men on good-paying careers in radio-TV-electronics.

It brings you completely up to date—answers important questions on newest career developments in electronics, including Radar, Guided Missiles, Servomechanisms, Computers, as well as Aeronautical Electronics, Broadcasting (AM, FM, TV), Military, Navy and CAA Electronics, Communications and Electronics Manufacturing.

This book, "Your Future in the New World of Electronics," also shows you how CREI Home Study leads the way to greater earnings in the booming electronics world.

However, CREI does not promise you a "snap." With accredited technical school curricula such as CREI offers, you must study to convert your ambition into technical knowledge which you can sell in the fabulous field of Electronics. Since its founding in 1927, CREI has provided thousands of professional electronics men with technical education. During World War II, CREI trained thousands

for the Armed Services. Leading firms recommend CREI training for their own personnel. Among them: All American Cables and Radio, Inc; Canadian Broadcasting Corporation; Columbia Broadcasting System; Gates Radio Company; Federal Electric Corp.; The Martin Company; Douglas Aircraft Co.; U.S. Information Agency (Voice of America); Canadair Limited; Trans-Canada Air Lines; United Air Lines. Their choice of training for their own personnel is a good cue for your choice of a school.

CREI alumni hold top positions in America's leading firms. At your service is the CREI Placement Bureau, which maintains constant contact with electronic industry, and cooperates with employers and graduates in making satisfactory placements. This free service is available to students, as well as graduates. Fill out the reply card below *completely* and mail it now. We'll promptly send you your free copy of "Your Future in the New World of Electronics." The rest—your future—is up to you!

CREI ALSO OFFERS residence training in Washington, D. C. . . . at the same high technical level. Day and evening classes start at regular intervals. Qualified residence school graduates earn degree as "Associate in Applied Science." Check coupon if you prefer residence or home study information . . . or write Capital Radio Engineering Institute, 3224 - 16th St., N.W., Wash. 10, D. C. You can qualify for CREI home study training if you have had electronic education, or experience in electronics—and realize the need of a high level technical knowledge to make good in the better electronic jobs. (Electronics experience is not required for admission to CREI Residence School.)

**ELECTRONIC TECHNICIANS**

Growing Peninsula Co. has openings for 1st class electronic technicians to work directly with engineering in development of new products. Only those with CREI or equal training and 3 years minimum commercial experience will be considered. Top salaries to qualified applicants. Call Mr. McQueeney, DA. 4-4733 for appointment. ALTO SCIENTIFIC Co., Inc. 855 COMMERCIAL ST. PALO ALTO

**ENGINEERING AIDES AND TECHNICIANS**

Immediate Positions Available

CREI or other formal electronic training desirable.

Experienced in reading schematics, breadboard construction of electronic circuits and chassis preparation.

**EMERSON RESEARCH**

1st Class  
Permit No. 288-R  
Washington, D. C.

**BUSINESS REPLY CARD**  
No Postage Stamp Necessary If Mailed in United States

4g Postage Will Be Paid By



3224 SIXTEENTH STREET, N.W.  
WASHINGTON 10, D. C.

**INDUSTRY CALLS FOR CREI TRAINING BY NAME . . . SO SHOULD YOU!**

Here you see actual help wanted ads—one from a San Francisco newspaper, another seen in Washington. They are just two of many which specify "CREI or equal" education. This shows that industry approves CREI training, even insists on it. Experience has taught many, many companies that CREI students are taught what industry needs and wants them to know. Let this be your cue when you choose your educational program.

**BRAND NEW COURSE ADDED: AUTOMATION AND INDUSTRIAL ELECTRONICS ENGINEERING TECHNOLOGY:**

Complete course, covers all phases of automation. Special emphasis on theory, functioning and applications of servo-mechanisms and computers. Also note-worthy: Lessons on machine control, instrumentation, data-processing and telemetry.

# ownership of a **PHOTOFACT** SERVICE DATA LIBRARY SPELLS SUCCESS FOR SERVICE TECHNICIANS

here's actual proof from the men who know

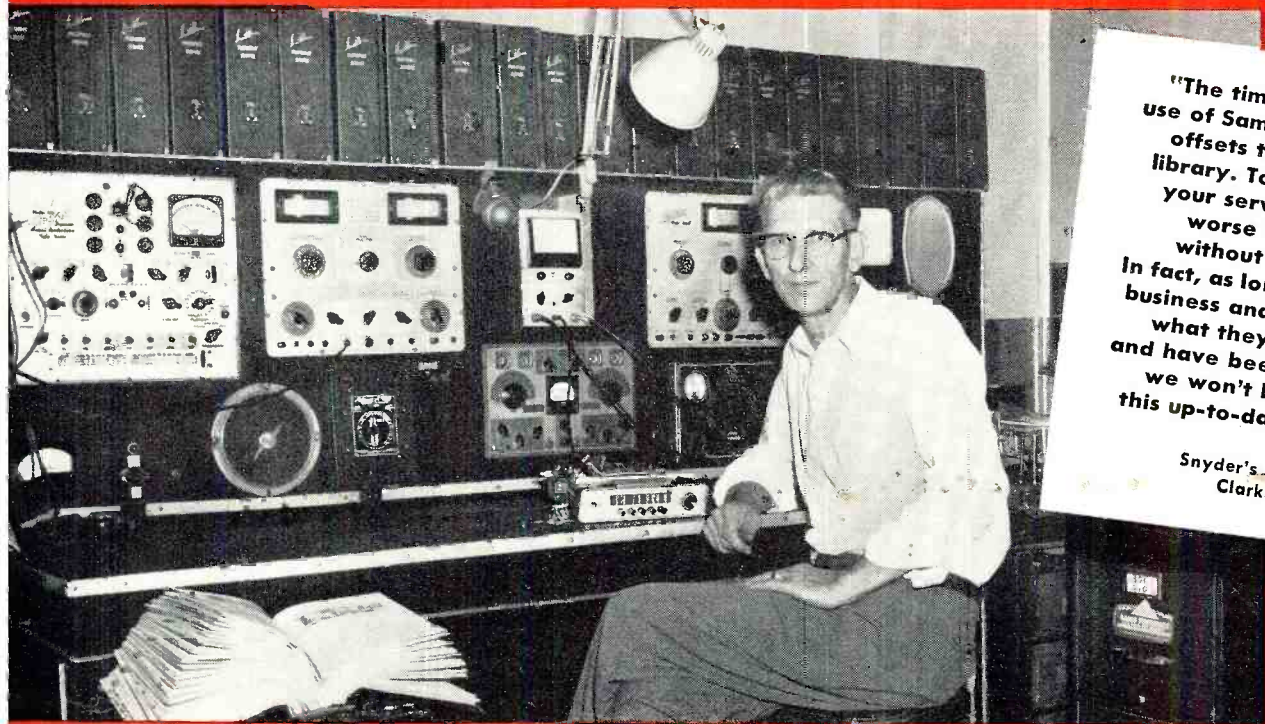

"The time saved by the use of Sams more than offsets the cost of the library. To do without your service would be worse than operating without a V.T.V.M. In fact, as long as we are in business and Sams remain what they are today and have been in the past, we won't be without this up-to-date service."  
—Frank Snyder,  
Snyder's Sales & Service,  
Clarksburg, West Va.

## HERE'S MORE PROOF...FROM COAST-TO-COAST

### ARIZONA

"I would not take anything for my valuable collection of Sams PHOTOFACT."

—Charles S. Cook,  
Winslow, Arizona

### IDAHO

"My PHOTOFACT library is an indispensable source of service information on the... TV sets serviced in our shop. Without this information, the time required to complete many repair jobs would be prohibitive."

—Richard Huntley,  
Craigmont, Idaho

### WISCONSIN

"With the PHOTOFACT file to back us, we have complete confidence that we can handle any service problem brought to the shop."

—Howard R. Olds,  
Darlington, Wis.

### TEXAS

"I don't see how anyone can run a shop without a set of PHOTOFACT. I would be lost without mine. They are a must on any bench job. You can do a faster job with the information in PHOTOFACT."

—T. A. Hopkins,  
Quanah, Texas

### OHIO

"PHOTOFACT speeds up my service on repairs and the file cabinets help dress up the shop."

—Ed Rahm, Toledo, Ohio

### SOUTH CAROLINA

"(With PHOTOFACT) I have a lot less time on the bench and I can do a more complete repair job on a customer's set and have less come-backs because of a perfect repair job."

—Glen Stewart,  
Pickens, S. Car.

### MASSACHUSETTS

"PHOTOFACT has been one of the mainstays in my service business. The PHOTOFACT library has cut my service time well in half and has more than paid for itself already. In the best words—PHOTOFACT kept my new business in the black."

—Benjamin L. Hall,  
Edgarton, Mass.

### PENNSYLVANIA

"They are just great. Cuts service time to a minimum."

—Virgil Franceschini,  
Barnesboro, Pa.

These are just a few of the hundreds of "Success with PHOTOFACT" letters in our files. Service Technicians everywhere are enjoying the profit-making advantages of a

complete PHOTOFACT Library. If you're not among them, see your Sams Distributor today, or write direct to Howard W. Sams for full details. Use coupon below.

**NEW EASY-BUY PLAN!** It's the money-saving way to build your complete profit-making PHOTOFACT Library!

NO INTEREST—NO CARRYING CHARGE—AS LITTLE AS \$10 DOWN

**FREE!** Valuable steel file cabinets for PHOTOFACT monthly subscribers and Library purchasers.



Valuable booklet shows you how PHOTOFACT boosts your profit-capacity

**FREE!**

Send for it!



**HOWARD W. SAMS & CO., INC.**  
2203 E. 46th St., Indianapolis 6, Ind.



- Send me Free booklet "Your Guide To Maximum Profits"  
 I'm a Service Technician:  full-time;  part-time

My Distributor is: \_\_\_\_\_

Shop Name \_\_\_\_\_

Attn. \_\_\_\_\_

Address \_\_\_\_\_

City \_\_\_\_\_ Zone \_\_\_\_\_ State \_\_\_\_\_

# MAJOR BREAKTHROUGH

## In Stereo Amplifier Design!

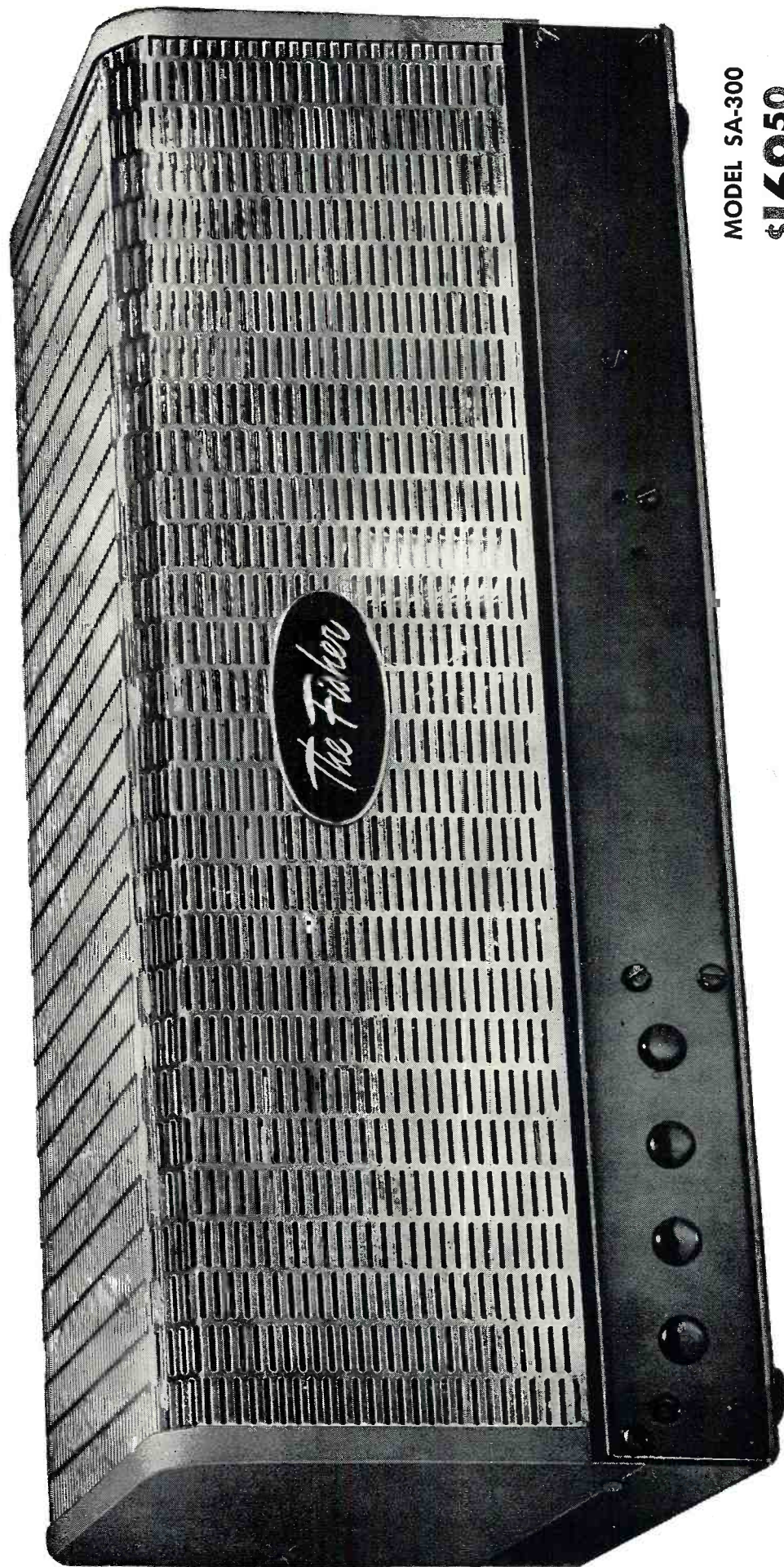

MODEL SA-300

**\$169.50**

*Slightly Higher in the Far West*

# THE FISHER

## SA-300

### Laboratory Standard Stereophonic and Monophonic 60-Watt Amplifier

HERE IS AN AMPLIFIER that will match *any* existing speaker, and supply the distortion-free power all speakers require for optimum results. When using low-efficiency, high-compliance systems, the SA-300 is an absolute *prerequisite* for professional sound reproduction! With this amazing instrument, even your choice of enclosures is less critical. The SA-300 actually permits you to obtain the damping factor your system requires! Complementing this FISHER exclusive is still another—TWO inputs for each channel (one for standard response, and one with controlled frequency response!)

Only FISHER could have conceived it. Only FISHER could have designed and produced so unique an instrument at such moderate cost. Ruggedly constructed, just as you would expect any FISHER product to be. The SA-300 is truly *the finest you can buy*.



#### FIRST STEREO AMPLIFIER TO GUARANTEE

- Distortion-free audio power at ALL listening levels.
- Hum and noise content less than 0.00001 part of full rated output (1/10000th of 1%!) What is more, the SA-300 will match all existing speakers including the lowest-efficiency types.



#### SPECIFICATIONS

- POWER: Conservatively rated at 60 watts (over 30 watts per channel) [The SA-300 can handle up to 160 watts on instantaneous peaks.]
- POWER BANDWIDTH: 15 to 30,000 cps (IHFV Standards.)
- HARMONIC DISTORTION: Better than 0.1% at full rated output,  $\pm 1$  db.
- IM DISTORTION: Less than 0.08% first-order difference tones (European CCIR standards) and less than 0.35% by SMPTE American standards.
- INPUTS: TWO for each channel. One for standard flat response. One with controlled frequency response to insure optimum performance with electrostatic speakers, and also to reduce sub-sonic transients (which cause voice coil breakup and distortion).
- FREQUENCY RESPONSE: Uniform from 20 to 20,000 cps, within  $\pm 0$  and  $-0.5$  db.
- HUM AND NOISE: Completely inaudible. More than 100 db below full-rated output.
- SPEAKER CONNECTIONS: 4, 8 and 16-ohm terminals, plus terminals for adding resistor to obtain speaker manufacturer's recommended damping factor.

WRITE TODAY FOR COMPLETE SPECIFICATIONS

FISHER RADIO CORPORATION • 21-38 44TH DRIVE • LONG ISLAND CITY 1, N. Y.

Export: Morhan Exporting Corp., 458 Broadway, New York 13, N. Y.





*get this great new*  
**TRANSISTOR RADIO DISPLAY**

**CHANNEL MASTER**  
**TV ANTENNAS**

Dealers sell more T-W's than any other fringe-area antenna—by far. The powerful T-W delivers the highest gains and front-to-back ratios of any all-channel VHF antenna. Its rugged construction provides more years of peak performance. And it's nationally advertised on network TV and in leading magazines. Recommend a T-W for your next installation—and help your business grow.

**CHANNEL MASTER T-W**  
*The World's Most Powerful TV Antenna*

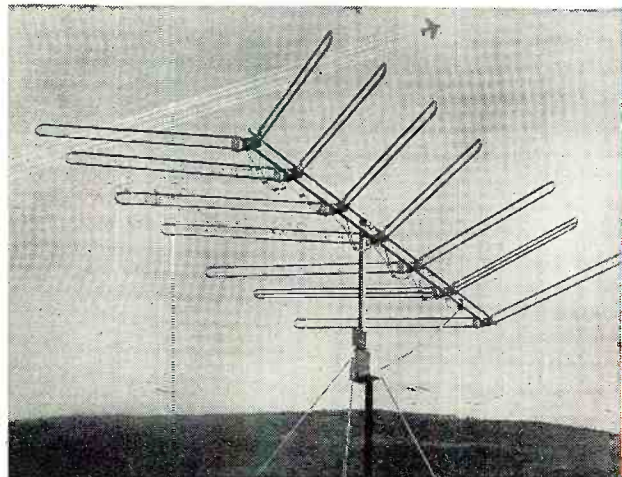

*this extra "salesman" really sells radios*



- A. model no. 6502 \$39.95 list
  - B. model no. 6506 \$49.95 list
  - C. model no. 6511 \$54.95 list
  - D. model no. 6512, Short Wave and Standard Broadcast, \$72.50 list
- also available: model no. 6514, Marine Band and Standard Broadcast \$74.95 list

Channel Master's colorful, pilfer-proof display lets your customers see, touch, and play these outstanding radios—wraps up more sales than ever before. Use it to set up **your own complete transistor radio center** in less than 1 square foot of shelf or counter space. Ask your Channel Master distributor for full details.

*Unmatched sensitivity, superb tone, handsome design, and low price have made Channel Master one of the country's largest-selling lines of transistor radios.*



# CHANNEL MASTER

works wonders in  
Sight and Sound

## New! CHANNEL MASTER HIGH FIDELITY COMPONENTS

New components with a new idea: the "Practical Approach!" Channel Master's new hi-fi line is designed to eliminate confusion by directing the customer's attention to the 5 basic, practical considerations which apply to the selection of any high fidelity system: Performance, Ease of Operation, Versatility, Styling, and Cost.

The Channel Master line eminently satisfies each of these requirements. These are instruments of superb quality and striking appearance, offered at moderate prices. They reproduce with astonishing accuracy the entire audible spectrum with an absolute minimum of manual controls. The result is a true high fidelity system which satisfies the most discriminating audiophile... and yet can be used and enjoyed by virtually everyone.

Available in Eastern Areas only

### Tiny Minstrel Speaker System brings concert hall realism to the home

Now, for the first time, full dynamic realism is achieved in a miniature enclosure only 9" x 9" x 16". Through the patented new "Acoustic Transformer" principle the entire air chamber becomes a phase matching air transformer which produces clear, undistorted sound from 50 to 15,000 cycles. The big sound and small size of Channel Master Minstrels make them ideal for flexible, space-saving, low-cost stereo installations.

audiophile net \$29<sup>95</sup>



### Monaural Amplifier Model No. 6620

audiophile net \$79<sup>95</sup> without cabinet

This superb 20 watt (40 watt peak) amplifier faithfully reproduces every sound audible to the human ear. Modern feed-back circuitry assures minimum distortion and full-frequency range. Special adapter jacks make conversion to a stereo system simple and economical. Solid brass face panel.



### Stereophonic Amplifier

Model No. 6600

audiophile net \$119<sup>95</sup> without cabinet

The Channel Master 6600 stereophonic amplifier is an instrument of flawless electronic craftsmanship, embodying every advanced technical feature for full-range stereophonic sound reproduction. 16 watts on each channel (32 watt peak). Solid brass face panel.

Cabinets available  
in wood or metal.

### AM/FM Tuner Model No. 6100

audiophile net \$84<sup>95</sup> without cabinet

This outstanding tuner provides fine performance, pinpoint station selectivity and effortless flywheel tuning. Automatic Gain and Volume Controls on FM and AM prevent overloading by strong signals and maintain constant sound levels. Special multiplex output permits tuner to be adapted for stereophonic FM broadcasting. Solid brass face panel.



for product literature contact your CM Distributor or write to

**CHANNEL MASTER CORP.**

ELLENVILLE, NEW YORK

get  
this  
brilliant,  
new



**Electro-Voice**®

Monaural and Stereo  
12 inch LP record

just  
\$1.50



Side one: *The ABC's of High Fidelity*  
Side two: *A Stereo Primer*

This tremendous demonstration record, produced by the foremost manufacturer of high-fidelity loudspeaker systems, explains briefly (and simply) the wonderful world of high-fidelity and the really easy-to-understand components required for the finest home music system. You'll be startled by the thrilling sounds on this record—many of them spectacular stereo "firsts."

Write for it now: Enclose either check or money order for \$1.50 and send to:

**Electro-Voice, Inc.**  
**Buchanan, Michigan**

Dept. EW-4

Enclosed is \$1.50. Please send your fascinating Stereo-monaural 12" LP record.

To:

NAME \_\_\_\_\_

ADDRESS \_\_\_\_\_

CITY \_\_\_\_\_ ZONE \_\_\_\_\_ STATE \_\_\_\_\_

# Within the Industry

**LARRY EUGENE** has joined *Electro-Voice, Inc.* as manager of the cartridge division. In this capacity Mr. Eugene will be responsible for all company activities pertaining to this component.



Mr. Eugene was formerly sales manager of *The Howard Company*, a subsidiary of *Howard W. Sams & Co., Inc.* Previously, he was advertising and sales promotion manager of *Permoflux Corporation*. Prior to this assignment, he was assistant sales promotion manager at *Allied Radio* for seven years.

**ASSOCIATION OF ELECTRONIC PARTS & EQUIPMENT MANUFACTURERS** has compiled a policy format to aid manufacturers in composing distributor policy with a check sheet of pertinent points and to offer some uniformity in the layout of such policies. This format has been sent to all of the Association's 132 member companies.

The report of the special committee on policy offered suggestions for a format which will enable a distributor to find the desired information on manufacturer policy with a minimum of searching. It was emphasized that nothing in the report is to be construed as a recommendation that all manufacturers have written policies or that such policies have any specific contents.

**WILLIAM E. JOHNSON** has been appointed to the position of dealer sales manager for the *Heath Company*. In his new capacity Mr. Johnson will be responsible for the development of national dealer organization to further the sale of the company's line of electronic technician and hobbyist kits.



Mr. Johnson joined the firm in 1958, after being associated with *Whirlpool Corporation* as an assistant advertising manager. A graduate of the University of Illinois, he spent two years in New York City with the Army Signal Corps.

**BELL TELEPHONE LABORATORIES** and the American Institute of Electrical Engineers have announced the establishment of an award for achievement in the field of telecommunications, to be known as the Mervin J. Kelly Award.

The award is named in honor of Dr. Kelly, former president and chairman of the board of *Bell Laboratories*, who retired recently after 41 years of serv-

ice with the organization. Dr. Kelly is a Fellow of the AIEE and has been active in Institute affairs for 33 years.

The Kelly Award will be made annually by the AIEE to an individual who has made an outstanding contribution to the advancement of the art of telecommunications. The prize will consist of a bronze medal, a cash award of \$1000, and a certificate. The first award will be made by the Institute in 1960. It is being sponsored by the *Laboratories* but will be administered solely by the Institute.

**JAMES J. SHALLOW** has been appointed vice-president of *CBS-Hytron*, a division of *Columbia Broadcasting System, Inc.* He will also serve as general manager of the company's phonograph department.



Prior to this appointment, Mr. Shallow was general manager of merchandising for the consumer products division of *Philco Corp.* He joined this firm in 1932 as automotive sales specialist for the motor parts company and, in June, 1958, received the appointment in the consumer products division.

**LAWRENCE J. EPSTEIN** is now vice-president in charge of sales for *United Audio Products Inc.* . . . *Heath Company* announces the appointment of **JOHN T. CAVIEZEL** to the position of dealer sales representative . . . **DR. MERVIN J. KELLY** has been elected a director of *Tung-Sol Electric Inc.* . . . **ABE MORIN** has joined *Bogen-Presto*, a division of *The Siegler Corporation*, as purchasing agent . . . *Harman-Kardon, Inc.* elected **JULIAN KERWIN** to the post of vice-president for operations and **FRED SAMUEL** vice-president for manufacturing . . . **JACK KARNS** has been elected president of *Qualitone Industries Inc.* . . . *Electro-Voice, Inc.* announces that **CHARLES MOLITOR** is now its chief industrial engineer . . . *Precision Apparatus Company, Inc.* has announced the following appointments and promotions: **SOL SPARER**, sales manager of the distributor sales division for the parent firm and its subsidiaries (*Pace Electrical Instruments Co., Inc.* and *PACO Electronics Co., Inc.*); **HARRY BRASSEN**, comptroller; and **ALAN D. MENTZER**, production manager of the *PACO* division . . . **LEWIS E. GILLINGHAM** has been named marketing director and advertising manager of *Altec Companies, Inc.* . . . *Packard-Bell Electronics Corp.* has named **H. S. CRAWFORD** to the position of purchasing agent for the technical

# why SYLVANIA TV

with the new

## LIFETIME ENGRAVED CIRCUIT

means years of dependable  
operation ...

more satisfied customers

### 1. DEMONSTRATED DURABILITY

One end of the rugged "LIFETIME ENGRAVED CIRCUIT" is being bent continually up and down a distance of over 3 inches. This has now gone on over a million times! Yet, the amazing LIFETIME ENGRAVED CIRCUIT keeps a clear and steady picture on the screen. There have been NO instances of loose or weakened connections, breakage, or failure of any kind!

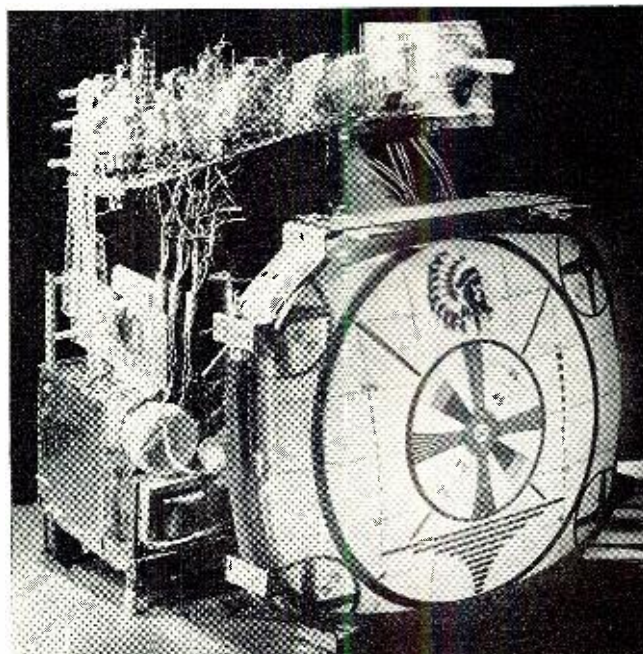

An actual unretouched photo of one of the toughest tests ever given an operating chassis—note clear picture.

### 2. LONG TUBE LIFE

Longer tube life is assured in all SYLVANIA sets by a "controlled warm-up" system. All tubes in series have the same warm-up time (approximately 11 seconds) despite varying heater voltages because tube heater resistance is carefully selected and manufactured. There is no danger of harmful surges and overheating damaging the lower voltage tubes.

### 3. COOLER OPERATION

Old-fashioned transformers, with bulky fins to transfer heat to the interior of the cabinet, raise the temperature of the low voltage power supply as much as 60° hotter than the new semiconductors used with the LIFETIME ENGRAVED CIRCUIT. A cooler operating chassis means greater life for all components.

**Recommend SYLVANIA TV**

**—every set has a "LIFETIME ENGRAVED CIRCUIT"**

RESIDENT SCHOOL COURSES



Industry needs Electronic Technicians!

# Let RCA train you in Advanced Electronics

This is the college-level training you need to work with professional engineers on research, development or production projects in such fields as: automation, guided missiles, radar, television, computers and other advanced electronic applications.

RCA Institutes Resident School in New York City offers this comprehensive course that prepares you for any field of electronics you may choose. Other courses in TV & General Electronics, Radio & TV Servicing, and Radio Telegraph Operating.

Classes start four times each year. Applications now being accepted. Approved for Veterans.



**RCA INSTITUTES, INC.**  
SCHOOL OF TELEVISION  
AND ELECTRONIC TECHNOLOGY  
A Service of Radio Corporation of America



RCA INSTITUTES, DEPT. RNR-49  
350 W. Fourth St., N.Y. 14, N.Y.

Please send me your FREE catalog of Resident School courses in New York.

NAME..... please print

ADDRESS.....

CITY..... ZONE..... STATE.....

For Home Study Courses see ad on opposite page

products division . . . **WENDELL R. SMITH** has been appointed director, marketing research and development, *RCA* . . . **DONALD B. DAVIS** is now vice-president of *Klipsch and Associates, Inc.*

\* \* \*

**RAYMOND T. LEARY**, sales manager of the distributor division of *Cornell-Dubilier Electric Corporation*, has been elected a vice-president of the organization.

Mr. Leary joined the corporation in 1946. He was a member of the Class of 1942 at Brown University and also attended Northwestern School of Commerce and the Graduate School of Business Administration at Harvard University.



During the Second World War Mr. Leary was a Lt. Commander and area commander, PT Boat Squadrons, in the Pacific Theater.

\* \* \*

**FISHER BERKELEY CORPORATION** has purchased **BENNETT LABORATORIES, INC.** of Redwood City, California. The two companies will remain separate entities but over-all management will come entirely from the parent company's personnel . . . **VARIAN ASSOCIATES** has completed negotiations, subject to final settlement of legal and accounting matters, whereby this firm and **BOMAC LABORATORIES, INC.** will combine operations through an exchange of common stock, with the former acquiring an 80% interest in the latter company and having an option to acquire the balance of the outstanding common stock . . . **REX CORPORATION** announces the formation of an electronic components department headed by James D. Kelly . . . **TRIO LABORATORIES, INC.** recently moved to new and larger quarters at Plainview, Long Island, N. Y. . . . The jobber division of **PYRAMID ELECTRIC COMPANY** has moved its offices and warehouse from North Bergen to 507 26th Street, Union City, New Jersey . . . The responsibility for high-fidelity phonograph components manufactured by the specialty electronics component department of **GENERAL ELECTRIC COMPANY** in Auburn, N. Y. is to be transferred to the firm's radio receiver department in Bridgeport, Conn.

\* \* \*

**WORLD RADIO LABORATORIES, INC.**, Council Bluffs, Iowa, has opened a branch store in Fremont, Nebraska. The branch, to be located at 205 North D Street, will be restricted entirely to dealer-service operation, with the wholesale supply of parts, tubes, accessories, and equipment to duly authorized dealers and service technicians for radio and television in that area.

With this move to Fremont, the company can now easily maintain immediate one-day shipment to this area.

\* \* \*

**GEORGE CHARLES DE HEVESY** is the recipient of the second Atoms for Peace Award. Created by the *Ford Motor Company Fund* as a memorial to Henry and Edsel Ford, the idea was conceived in response to President Eisenhower's address before the United Nations in which he urged the people of the world to harness the power of the atom for the peaceful service of mankind.

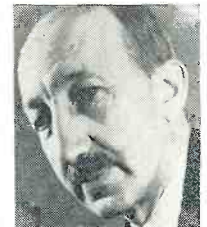

Professor de Hevesy was born in Budapest, Hungary in 1885 and has been associated with the Research Institute for Organic Chemistry at the University of Stockholm, Sweden, since 1934. The Award was presented in recognition of his pioneering efforts in the field of atomic science, as well as biology and medicine. The citation read in part, ". . . your discovery has been used to extend knowledge and to enhance the well being of people everywhere through almost every field of science, agriculture, and technology." The Award carries a grant of \$75,000.

Professor de Hevesy was awarded the Nobel Prize in Chemistry in 1934. In addition to many other international awards, he is the recipient of the Copley Medal of the Royal Society of London, the Faraday Medal, and the Bailey Medal.

-30-



# LET RCA TRAIN YOU IN ELECTRONICS

*RCA Institutes celebrates Fifty Years of Electronic Training by introducing its newest Home Study Course . . .*

## *ELECTRONICS FOR AUTOMATION*

. . . Now you have *four* comprehensive courses for your electronic training . . . from basic electronic theory to the more advanced principles of color TV and Automation.

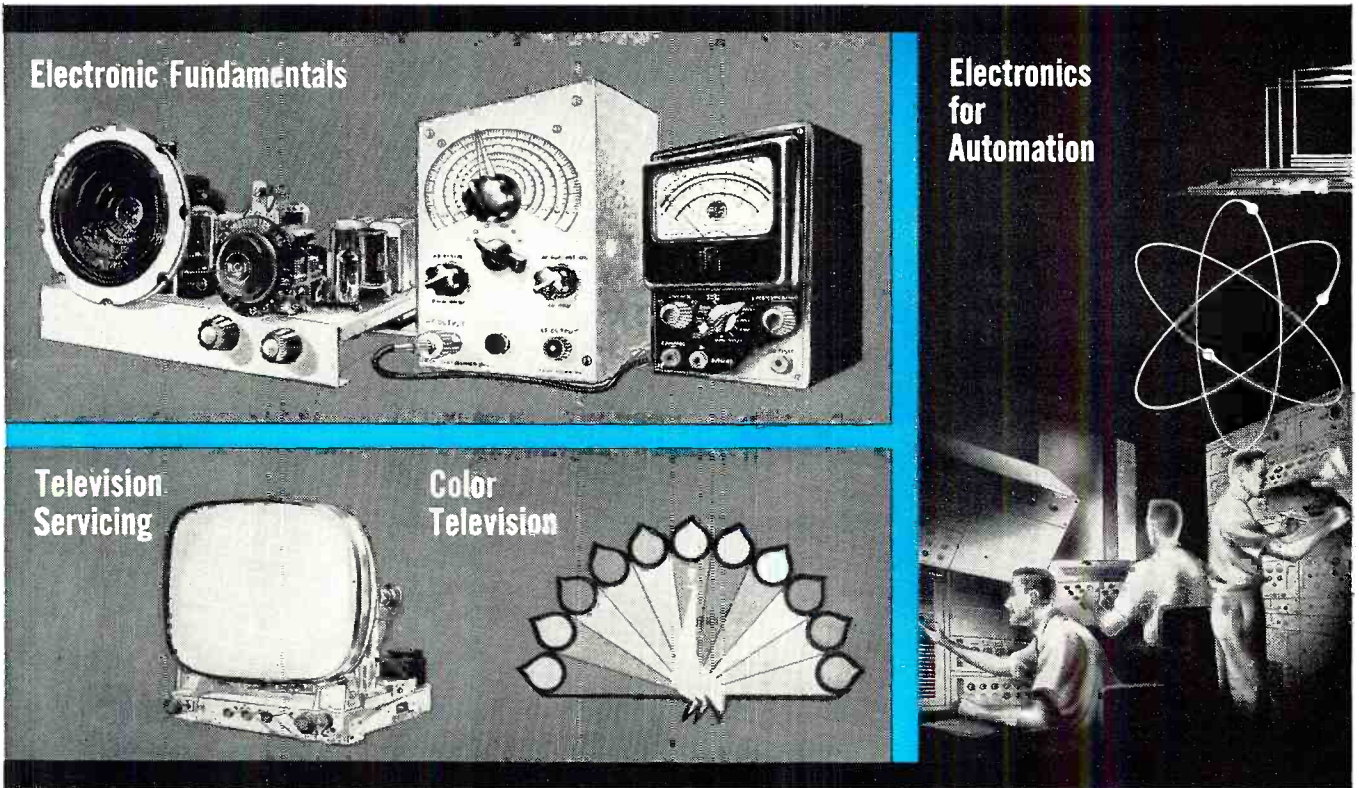

Send for our  
64 page Home  
Study Catalog

**FREE!**

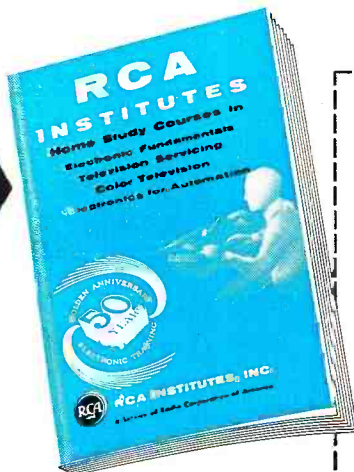

FOR RESIDENT SCHOOL  
COURSES SEE AD ON  
OPPOSITE PAGE

Practical work with the very first lesson. Pay-as-you-learn.  
You need pay for only one study group at a time.

### **RCA INSTITUTES, Inc.** Home Study School, Dept. RN-49

A Service of Radio Corporation of America  
350 West Fourth Street, New York 14, N. Y.

Without obligation, send me the FREE catalog of Home Study Courses. No salesman will call.

Name .....

Please print

Address .....

City..... Zone..... State.....

Korean Vets! Enter Discharge Date.....

**CANADIANS** — Take advantage of these same RCA courses at no additional cost. No postage, no customs, no delay. Send coupon to:

RCA Victor Company, Ltd., 5001 Cote de Liesse Rd., Montreal 9, Quebec

To save time, paste coupon on postcard.

**ONLY  
UNIVERSITY  
MAKES  
28  
DIFFERENT PUBLIC  
ADDRESS SPEAKERS  
5  
DIFFERENT PUBLIC  
ADDRESS DRIVERS**

**ONLY WITH  CAN YOU GET...**

**THE SPECIFIC SPEAKER YOU NEED**—no “all-purpose” compromises, but the right speaker for the right job—paging, explosion-proof, super-power, etc.—with several models in each class.

**THE RIGHT POWER YOU NEED**—from 5 watts to 600 watts. *Not* more than you need, *not* less than you need.

**THE SOUND DISPERSION YOU NEED**—deep or shallow penetration, narrow or wide, 360° horizontal... only with University can you put the sound where you want it.

**THE FREQUENCY RESPONSE YOU NEED**—your choice of high and low cut-offs as required—whether to cut

through extreme noise levels, or for true high fidelity music reproduction.

**THE ECONOMY YOU NEED**—lowest initial costs for planning and installation, lowest running costs, lowest repair and service costs.

... and only with University can you get the quality you need... every University speaker boasts exclusive design features, the finest of materials, exacting standards in construction and must pass rigid performance tests. All these are your assurance that University will do the job better, longer, and at lowest possible cost.

... THAT'S WHY UNIVERSITY IS THE UNIVERSALLY ACCEPTED NAME IN THE ENTIRE FIELD OF SOUNDCASTING

**How you can choose the right speaker for the specific application...**



Invest \$1 for the invaluable 64-page UNIVERSITY TECHNOLOG, the authoritative reference book for planning P. A. speaker systems

Only book of its kind... packed with the solid factual data you need to save time and money. Covers in detail: how to select the proper driver for the specific job, directional vs. wide-angle horns, best use of radial trumpets, high fidelity in P.A., coping with reverberation, methods of overload protection, etc. Includes specs, charts, diagrams, and the *exclusive* SOUND SYSTEM DESIGN CHART—effective guide for planning typical installations. Send \$1.00 to Desk S-12, University Loudspeakers, Inc., 80 So. Kensico Ave., White Plains, New York.



Send for FREE copy of Product Catalog

Contains information and specifications on all University public address speakers... directional, radial, wide-angle, paging and talk-back, submergence-proof, high fidelity weatherproof, super-power, explosion-proof, portable soundcasting, etc. Also, high fidelity cone speakers, enclosures and speaker systems suited for commercial installations.



**Latest Information  
on the Electronic Industry**

*Spot News*

By RADIO & TV NEWS'  
WASHINGTON EDITOR

**NEW CHANNELS FOR SPACE COMMUNICATIONS UNDER STUDY**—For the first time, specific channel provision for Earth-Space (radio communication between earth and objects in space) and Space (radio communication between objects in space) services is now being probed by the FCC. In an historic frequency-allocation proposal, which could eventually completely alter the radio regulations of the International Telecommunication Union, the Commission said we are now moving into a new era involving radio control of natural or artificial space objects embracing the moon, planets, satellites, and space vehicles beyond the earth. Bands taken from Government assignments (25.6-25.65, 100-150, 1700-1725, 1825-1850, 2275-2300, 8300-8400, 15150-15250, and 31500-31800 mc.) are being suggested for the space program to accommodate such functions as tracking telemetry, command (i.e., turning on or off transmitters aboard space vehicles from the earth or from other space vehicles), communications between earth and space vehicles, and for communications between space vehicles themselves. The FCC said that the space channels would not be used now for relaying third-party communications (aural or TV broadcasting) using space vehicles as either passive or active relay stations.

**MILLIONS ASKED FOR SPACE-SATELLITE PROJECT**—A fund of over \$100-million has been budgeted for a continuation of experiments with satellites serving as relays for intercontinental transmission of government messages, voice and television. A portion of the exploration tests will cover, it is said, research into wave propagation through ionized gas in space communications, determining functions in space science and engineering where we are concerned with navigation and guidance by radio, position-determination by radar, radio links for communication and control, telemetering, planetary radio mapping, radio astronomy, and interplanetary investigations by radio waves. One of the problems to be solved is electron density activity at great heights, about which very little is now known. Currently, scientists say that electron density moves up, in general, with increasing height, reaching a maximum in the 120- to 240-mile region.

**TWO ANTI-PAY-TV BILLS PRESENTED IN SENATE AND HOUSE**—Three members of Congress have introduced anti-toll-television measures . . . One, an interim resolution which would prohibit pay-TV (broadcast and wire) until Congress passes legislation detailing just how subscription television should be regulated, was offered by Representative Oren Harris, chairman of the House Interstate and Foreign Commerce Committee. The FCC would be authorized to conduct technical tests for a limited time under the Harris provision, but only one system at a time would be investigated. In the Senate, an anti-pay-TV measure was placed in the hopper by Senate Minority Leader Everett Dirksen and Senator William Langer. Like the Harris resolution, this bill also forbids an FCC pay-TV OK until and unless Congress issues permission, although under this plan the FCC would have authority to determine which pay system meets Government standards.

**COMMERCE DEPARTMENT ANNUAL SURVEY SEES BOOM FOR ELECTRONICS**—The Department of Commerce announced in its recent annual Business and Defense Services Administration survey that, spurred by military and industrial needs, the total electronic output in 1959 has been estimated at \$7.9 billion—a new record that exceeds the 1958 level by 14 per-cent. More than half of this, it was reported, will go to the military.

**GOVERNMENT AIDS FORMATION OF ELECTRONIC PRODUCTION POOL ON LONG ISLAND**—A new small business production pool, composed of four small firms located on Long Island, New York, has been formed with the assistance of the Small Business Administration. The pool, Electrodyne Industries, Inc., has a total of 169 employees and will seek contracts for production of devices relating to transmitting and receiving, navigation, radar and radiac equipment, guided missile assembly, and instrumentation. Members of the pool are Paromal Products, Inc., Holden-Massey Corp., Republic Electronic Industries Corp., and Microtran Co., Inc.

-30-

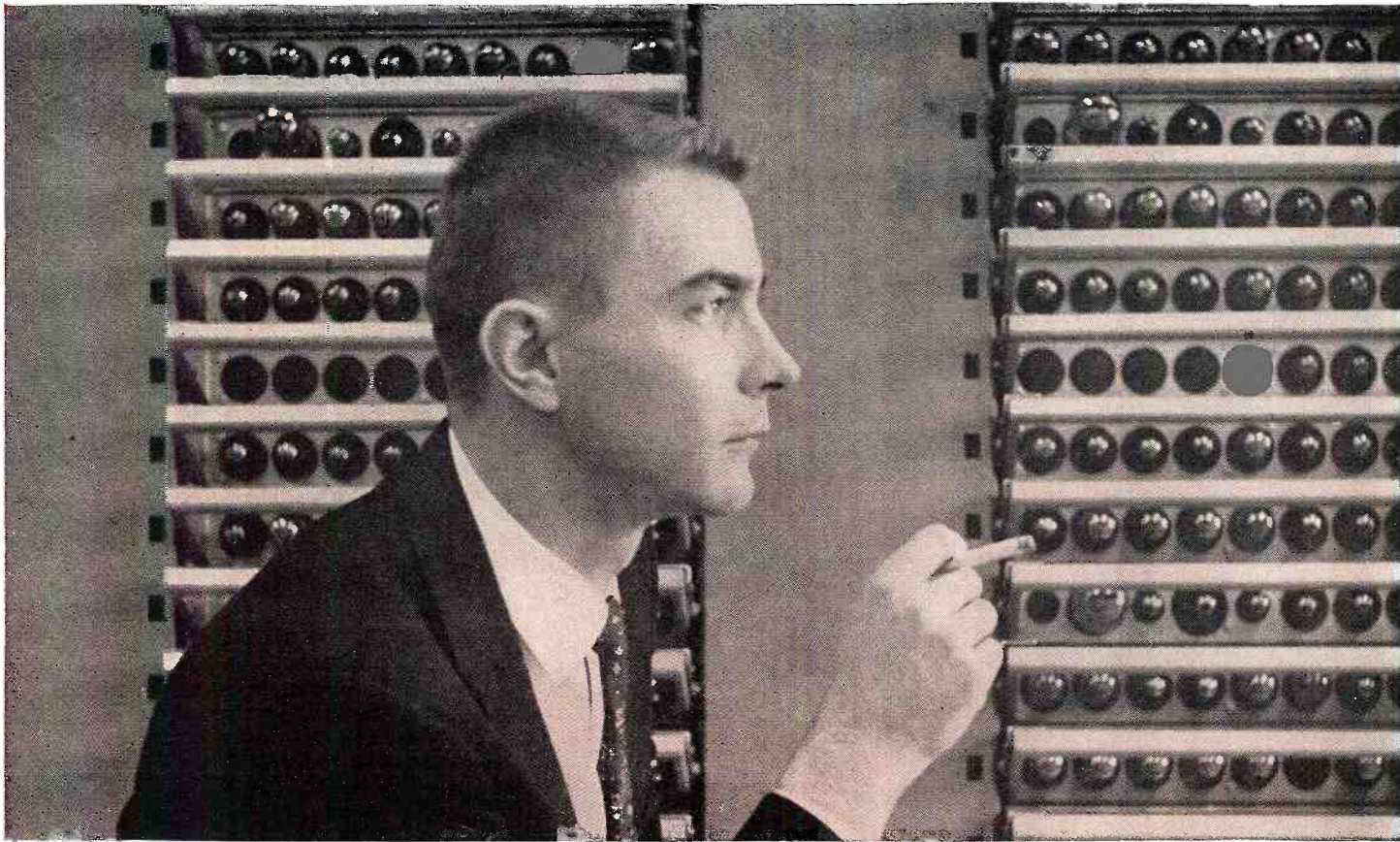

## How far can you go in electronics .

**“Just being called a Field Engineer—an impressive title for a man without a degree—that really gives me a lift.”**

This is Jim Pieratt talking. With a high school education and Navy Technical training behind him, Jim holds a key job in one of America's most important electronic projects. He's an IBM Computer Units Field Engineer on Project SAGE.

Jim is 25, lean, crew-cut and soft-spoken. He smiles modestly when you ask him about his accomplishments. We were curious to know whether he had been technically inclined when he was a youngster.

“The truth is that I didn't become interested in electronics until I joined the Navy,” says Jim. “Before that, the only technical thing I might have done was to take a couple of alarm clocks apart. I chose electronics in the Navy because I thought there was a future in it.”

### **Change of attitude**

“A lot of fellows may think, as I did, that a computer is too complicated for anybody but an Einstein to understand. It's not so. Even the largest computers like SAGE, which occupies space equivalent to a city block, can be comprehended by the ordinary man. But I didn't know this when I went for my employment interview—and I wondered if the algebra and trig I'd taken at Kalamazoo Central High would qualify me. Then my interviewer told me a little about computers . . . how they work and what my job would be after I finished IBM school. I made up my mind right then; I wanted this job.”

### **Training school**

Soon, Jim and 21 other fellows like himself started training in Kingston, New York, getting on real intimate terms with IBM's electronic giant. Marvel of complexity though it is, when it sits on the floor and you study it part by part, the computer loses its mystery. Little by little, you begin to understand the whole from the sum of the components.

“The 20 weeks I spent in training were very happy,” says Jim. “It's interesting all the way. They encourage you to think for yourself and your efforts are recognized. During the training period, I received a living allowance in addition to my salary.”

### **Strategic job on Project SAGE**

Jim is stationed in Virginia, near Richmond. His duties include installing, checking and testing out computer units. The giant electronic computers are the very heart and mind of Project SAGE (Semi-Automatic Ground Environment). To the in-pu-t section of the computer comes data from radar sites, ships, reconnaissance planes and ground observer posts throughout the country. The display consoles give a visual representation of the complete air defense situation. Jim's prime responsibility is to keep the display consoles running.

### **8 pleasant hours a day**

“I'm essentially my own boss and I'm encouraged to think for myself. For me, this is an ideal environment.



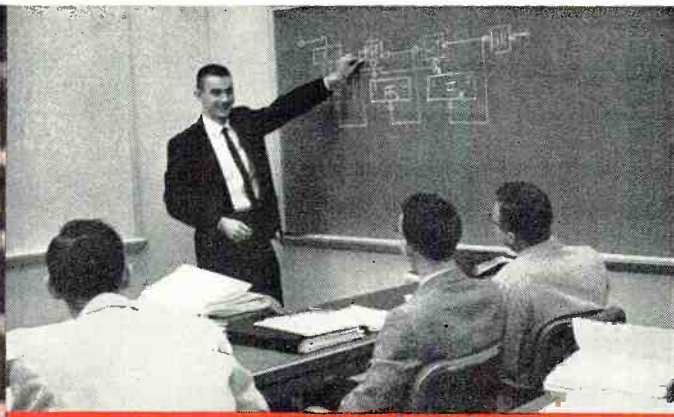

*Jim discusses block diagram in class*

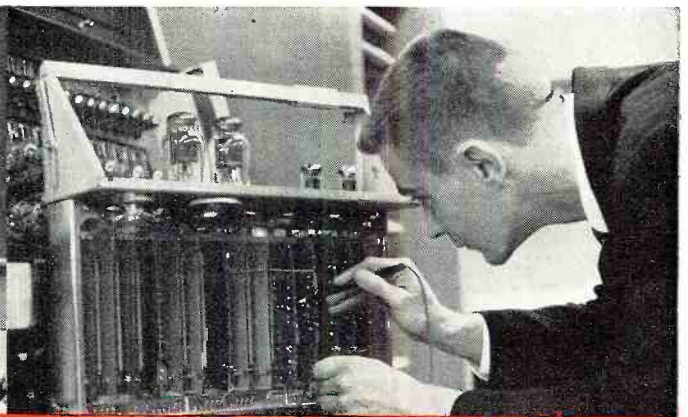

*He is testing a pluggable unit*

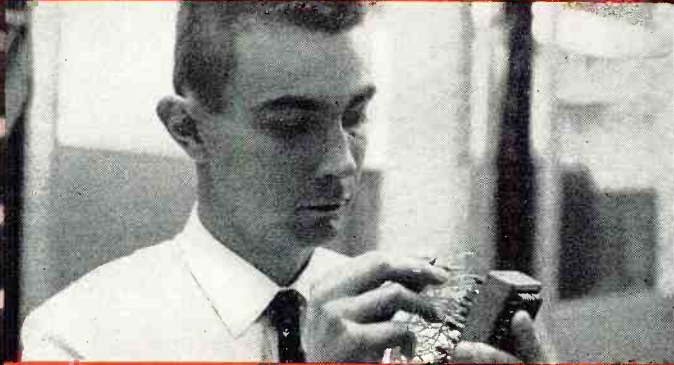

*He is programming a control board*



*Adjusting console photo cell*

## without a degree?

What do I like best about my job? Trouble-shooting, I think. I enjoy being able to repair anything that isn't working properly. As a Field Engineer, I have opportunities to assume other engineering functions. For instance, while I have nothing to do with design engineering, I do suggest changes for review by the Design Engineers. I also rewrite engineering procedures."

### **Where do you go from here, Jim?**

"There's plenty of room for me to grow at IBM. My next step up should be to Systems Engineer. This calls for more headwork. After that, if I display enough initiative, I may become a Group Supervisor."

### **Family, friends, recreation**

Jim, his wife and three-year-old daughter live in a pleasant ranch home, just a few miles from the site. Social life? "We've made quite a few friends here," says Jim. "Mostly among the IBM fellows and their wives. We play golf together."

### **Where do you go from here?**

Can you look ahead, as Jim Pieratt does, and see yourself as a man on the way up? Maybe you should give some thought to IBM Military Products and the Project SAGE program. Opportunities are greater than ever. IBM's long-range program will continue to grow in importance and vast sums will be invested in hiring the right men to accomplish its vital objectives.

If you have a minimum of 3 years' technical schooling—or equivalent experience—you may be eligible for advanced training for 20 weeks as a Computer Units Field Engineer. While training, you receive full pay plus living allowance before assignment to a permanent location. You are paid a salary, not hourly wages, plus overtime.

From then on, you can go as far as your abilities and ambition will take you. IBM is the leader in a field that offers you unlimited horizons. And, as you may already know, at IBM you receive company-paid benefits that set standards for industry today.

**Mr. N. H. Heyer**

**Dept. No. 650D**

**Military Products Division**

**IBM Corp., Kingston, N. Y.**

**WRITE TODAY TO:**

You'll get a prompt reply. Personal interviews arranged in all areas of the United States.

**IBM**  
®  
**MILITARY PRODUCTS**

# OUT OF THIS WORLD PERFORMANCE...

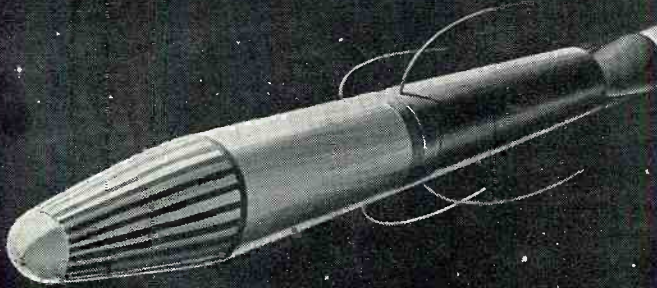

## with RMC Discap<sup>®</sup> Ceramic Capacitors

The same dependability that prompted the selection of RMC Discaps for the power supply of the Explorer IV satellite can now be yours for use in servicing TV and radio sets. These quality ceramic capacitors, favorite of original equipment manufacturers, will help cut time-consuming callbacks, and at the same time, brighten your profit picture.

RMC Discaps are available from your distributor in a handy 5-pack that prevents tangling of leads, and stores as easily as a file card.

® Trademark of Radio Materials Company, a division of P. R. Mallory & Co. Inc.



**Another veteran of outer space**—Mallory Mercury batteries. They've gone up with every U.S. satellite. In satellites or transistor radios, they can't be beat for long, fade-free life.



**FP Capacitors**—the original 85°C filter with the hum preventing etched cathode.



**Gem Capacitors**—tops in moisture proof design for buffer, by-pass or coupling.



**Gold Label<sup>®</sup> Vibrators**—unequalled performance and life . . . the quietest vibrator ever.  
\*Trademark

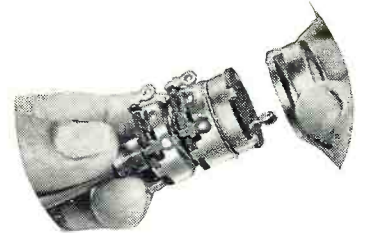

**Sta-Loc Controls**—design allows your distributor to custom-assemble in just 30 seconds, any of over 38,000 combinations.

**P. R. MALLORY & CO. Inc.**  
**MALLORY**  
 P. R. MALLORY & CO. Inc., INDIANAPOLIS 6, INDIANA

**STEREO  
STEREO  
AND  
MONAURAL**

the  
experts  
say...  
in HI-FI  
the best buys are



World-famous  
EICO advantages  
guarantee your complete satisfaction:

- Advanced engineering • Finest quality components
- "Beginner-Tested," easy step-by-step instructions
- LIFETIME service & calibration guarantee
- IN STOCK — Compare, then take home any EICO equipment—right "off the shelf"—from 1900 neighborhood EICO dealers.

**NEW STEREOPHONIC EQUIPMENT**

**HF85:** Stereo Dual Preamplifier is a complete stereo control system in "low silhouette" design adaptable to any type of installation. Selects, preamplifies, controls any stereo source—tape, discs, broadcasts. Superb variable crossover, feedback tone controls driven by feedback amplifier pairs in each channel. Distortion borders on unmeasurable even at high output levels. Separate lo-level input in each channel for mag. phono, tape head, mike. Separate hi-level inputs for AM & FM tuners & FM Multiplex. One each auxiliary A & B input in each channel. Independent level, bass & treble controls in each channel may be operated together with built-in clutch. Switched-in loudness compensator. Function Selector permits hearing each stereo channel individually, and reversing them; also use of unit for stereo or monophonic play. Full-wave rectifier tube power supply. 5-12AX7/ECC83, 1-6X4. Works with any high-quality stereo power amplifier such as EICO HF86, or any 2 high-quality mono power amplifiers such as EICO HF14, HF22, HF30, HF35, HF50, HF60. "Extreme flexibility . . . a bargain" — HI-FI REVIEW. Kit \$39.95. Wired \$64.95. Includes cover.

**HF86:** Stereo Dual Power Amplifier for use with HF85 above or any good self-powered stereo preamp. Identical Williamson-type push-pull EL84 power amplifiers, conservatively rated at 14W, may be operated in parallel to deliver 28W for non-stereo use. Either input can be made common for both amplifiers by Service Selector switch. Voltage amplifier & split-load phase inverter circuitry feature EICO-developed 12DW7 audio tube for significantly better performance. Kit \$43.95. Wired \$74.95.

**HF81:** Stereo Dual Amplifier-Preamplifier selects, amplifies & controls any stereo source — tape, discs, broadcasts—& feeds it thru self-contained dual 14W amplifiers to a pair of speakers. Monophonically: 28 watts for your speakers; complete stereo preamp. Ganged level controls, separate focus (balance) control, independent full-range bass & treble controls for each channel. Identical Williamson-type, push-pull EL84 power amplifiers, excellent output transformers. "Service Selector" switch permits one preamp-control section to drive the internal power amplifiers while other preamp-control section is left free to drive your existing external amplifier. "Excellent!" — SATURDAY REVIEW; HI-FI MUSIC AT HOME. "Outstanding quality . . . extremely versatile" — RADIO & TV NEWS LAB-TESTED. Kit \$69.95. Wired \$109.95. Includes cover.

**MONO PREAMPLIFIERS** (stack 2 for Stereo) HF-65: superb new design. Inputs for tape head, microphone, mag. phono cartridge & hi-level sources. IM distortion 0.04% @ 2V out. Attractive "low silhouette" design. HF65A Kit \$29.95. Wired \$44.95. HF65 (with power supply) Kit \$33.95. Wired \$49.95.

**MONO POWER AMPLIFIERS**  
(use 2 for STEREO)

HF60 (60W), HF50 (50W), HF35 (35W), HF30 (30W), HF22 (22W), HF14 (14W): from Kit \$23.50. Wired \$41.50.

**MONO INTEGRATED AMPLIFIERS**  
(use 2 for STEREO)

HF52 (50W), HF32 (30W), HF20 (20W), HF12 (12W): from Kit \$34.95. Wired \$57.95.

**SPEAKER SYSTEMS** (use 2 for STEREO)

**HF52:** Natural bass 30-200 cps via slot-loaded 12-ft. split conical bass horn. Middles & lower highs: front radiation from 8½" edge-damped cone. Distortionless spike-shaped super-tweeter radiates omni-directionally. Flat 45-20,000 cps, useful 30-40,000 cps. 16 ohms. HWD 36", 15¼", 11½". "Eminently musical" — Hot, HIGH FIDELITY. "Fine for stereo" — MODERN HI-FI. Completely factory-built: Mahogany or Walnut, \$139.95; Blonde, \$144.95.

**HF51: Bookshelf Speaker System**, complete with factory-built cabinet. Jensen 8" woofer, matching Jensen compression-driver exponential horn tweeter. Smooth clean bass; crisp extended highs. 70-12,000 cps range. Capacity 25 w. 8 ohms. HWD: 11" x 23" x 9". Wiring time 15 min. Price \$39.95.

**FM TUNER HFT90:** Surpasses wired tuners up to 3X its cost. For the first time, makes practical even for the novice the building of an FM tuner kit equal to really good factory-wired units. No alignment instruments needed. Pre-wired, pre-aligned temperature-compensated "front end" is drift-free — eliminates need for AFC. Precision "eye-tronic" DM-70 traveling tuning indicator, supplied pre-wired, contracts at exact center of each FM channel. Pre-aligned IF coils. Sensitivity 6X that of other kit tuners: 1.5 uv for 20 db quieting, 2.5 uv for 30 db quieting, full limiting from 25 uv, IF bandwidth 260 kc at 6 db points. Frequency response uniform 20-20,000 cps ± 1 db. Cathode-follower & Multiplex outputs. Flywheel tuning, automatic gain control, stabilized low limiting threshold for excellent performance from weaker signals, broad-band ratio detector for improved capture ratio & easier tuning, full-wave rectifier & heavy filtering, very low distortion. "One of the best buys you can get in high fidelity kits" — AUDIOCRRAFT Kit Report. Kit \$39.95\*. Wired \$65.95\*. Cover \$3.95. \*Less Cover, F.E.T. incl.

**NEW AM TUNER HFT94:** Matches HF90. Selects "hi-fi" wide (20c — 9kc @ —3 db) or weak-station narrow (20c — 5kc @ —3 db) bandpass. Tuned RF stage for high selectivity & sensitivity; precision "eye-tronic" tuning. Built-in ferrite loop, prealigned RF & IF coils. Sensitivity 3 uv @ 30% mod. for 1.0 V out, 20 db S/N. Very low noise & distortion. High-Q 10 kc whistle filter. Kit \$39.95. Wired \$69.95, incl. Cover & F.E.T.

**BEFORE YOU BUY, COMPARE.**

You may examine the complete EICO line at any of 1900 neighborhood EICO distributors coast to coast. Compare critically with equipment several times the EICO cost—then you judge. You'll see why the experts recommend EICO, kit or wired, as your best buy.

EICO, 33-00 NORTHERN BLVD., L. I. 1, N. Y.  
Fill out coupon on other side for FREE CATALOG



Stereo Preamplifier HF85



FM Tuner HFT90  
AM Tuner HFT94



Stereo  
Amplifier-Preamplifier  
HF81



Bookshelf  
Speaker System  
HF51



Omni-directional  
Speaker System HF52  
36" H x 15¼" W x 11½" D



Monaural Integrated Amplifiers:  
50, 30, 20, and 12-Watt  
(use 2 for Stereo)

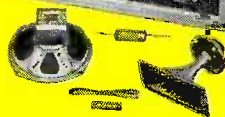

Monaural Preamplifiers:  
HF65, HF65A  
(stack 2 for Stereo)



Monaural Power Amplifiers:  
60, 50, 35, 30, 22 and 14-Watt  
(use 2 for Stereo)  
Stereo Power Amplifier HF86



Over 1 MILLION EICO instruments in use throughout the world.

Copyright 1958 by Electronic Instr. Co., Inc. 33-00 N. Blvd., L. I. C. 1, N. Y.

Add 5% in the West.

the specs prove it . . .  
your **BEST BUY** is

**EICO**®

for COLOR & Monochrome TV servicing

**FREE CATALOG**

shows you **HOW TO SAVE 50%**  
on 50 models of top quality  
professional test equipment.  
**MAIL COUPON NOW!**



**NEW!**  
**TV-FM SWEEP  
GENERATOR &  
MARKER #368**

**KIT \$69<sup>95</sup>**      **WIRED \$119<sup>95</sup>**

Entirely electronic sweep circuit (no mechanical devices) with accurately-biased inductor for excellent linearity. Extremely flat RF output; new AGC circuit automatically adjusts osc. for max. output on each band with min. ampl. variations. Exceptional tuning accuracy: edge-lit hairlines eliminate parallax. Swept Osc. Range 3-216 mc in 5 fund. bands. Variable Marker Range 2-75 mc in 3 fund. bands; 60-225 mc on harmonic band. 4.5 mc Xtal Marker Osc., xtal supplied. Ext. Marker provision. Sweep Width 0-3 mc lowest max. deviation to 0-30 mc highest max. dev. 2-way blanking. Narrow range phasing. Attenuators: Marker Size, RF Fine, RF Coarse (4-step decade). Cables: output, 'scope horiz., 'scope vertical. Deep-etched satin aluminum panel; rugged grey wrinkle steel cabinet.

**NEW! RF  
SIGNAL GENERATOR  
#324**

**KIT \$26<sup>95</sup>**      **WIRED \$39<sup>95</sup>**



150 kc to 435 mc with ONE generator! Better value than generators selling at 2 or 3 times its cost! Ideal for IF-RF alignment, signal tracing & trouble-shooting of TV, FM, AM sets; marker gen.; 400 cps audio testing; lab. work. 6 fund. ranges: 150-400 kc, 400-1200 kc, 1.2-3.5 mc, 3.5-11 mc, 11-37 mc, 37-145 mc; 1 harmonic band 111-435 mc. Freq. accurate to  $\pm 1.5\%$ ; 6:1 vernier tuning & excellent spread at most important alignment freqs. Etched tuning dial, plexiglass windows, edge-lit hairlines. Colpitts RF osc. directly plate-modulated by K-follower for improved mod. Variable depth of int. mod. 0-50% by 400 cps Colpitts osc. Variable gain ext. amplifier: only 3.0 v needed for 30% mod. Turret-mounted coils slug-tuned for max. accuracy. Fine & Coarse (3-step) RF attenuators. RF output 100,000 uv; AF sine wave output to 10 v. 50-ohm output Z. 5-way jack-top binding posts for AF in/out; coaxial connector & shielded cable for RF out. 12AU7, 12AV7, selenium rectifier; xmfr-operated. Deep-etched satin aluminum panel; rugged grey wrinkle steel cabinet.

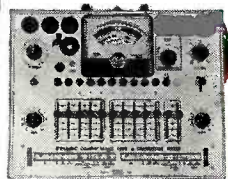

**NEW! DYNAMIC  
CONDUCTANCE  
TUBE & TRANSISTOR  
TESTER #666**  
**KIT \$69<sup>95</sup>**      **WIRED \$109<sup>95</sup>**

**COMPLETE with steel cover and handle.**

**SPEED, ease, unexcelled accuracy & thoroughness.** Tests all receiving tubes (and picture tubes with adapter). Composite indication of Gm, Gp & peak emission. Simultaneous sel of any 1 of 4 combinations of 3 plate voltages, 3 screen voltages, 3 ranges of continuously variable grid voltage (with 5% accurate pot). New series-string voltages: for 600, 450, 300 ma types. Sensitive 200 ua meter. 5 ranges meter sensitivity (1% shunts & 5% pot). 10 SIX-position lever switches; freepoint connection of each tube pin. 10 pushbuttons: rapid insert of any tube element in leakage test circuit & speedy sel. of individual sections of multi-section tubes in merit tests. Direct-reading of inter-element leakage in ohms. New gear-driven rollerchart. Checks n-p-n & p-n-p transistors: separate meter readings of collector leakage current & Beta using internal dc power supply. Deep-etched satin aluminum panel; rugged grey wrinkle steel cabinet. CRA Adapter \$4.50

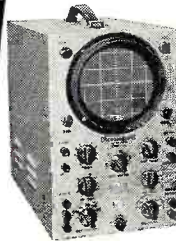

**COLOR**

**and Monochrome  
DC to 5 MC LAB & TV  
5" OSCILLOSCOPE  
#460**

**KIT \$79<sup>95</sup>**      **WIRED \$129<sup>50</sup>**

• **Features DC Amplifiers!**

Flat from DC-4.5 mc, usable to 10 mc. VERT. AMPL.: sens. 25 rms mv/in; input Z 3 meg; direct-coupled & push-pull thruout; K-follower coupling bet. stages; 4-step freq-compensated attenuator up to 1000:1. SWEEP: perfectly linear 10 cps-100 kc (ext. cap. for range to 1 cps); pre-set TV V & H positions; auto. sync. ampl. & lim. PLUS: direct or cap. coupling; bal. or unbal. inputs; edge-lit engraved lucite screen; dimmer; filter; bezel fits std photo equipt. High intensity trace CRT. 0.06 usec rise time. Push-pull hor. ampl., flat to 400 kc, sens. 0.6 rms mv/in. Built-in volt. calib. Z-axis mod. Sawtooth & 60 cps outputs. Astig. control. Retrace blanking. Phasing control. 5" PUSH-PULL Oscilloscope = 425: Kit \$44.95, Wired \$79.95. 7" PUSH-PULL Oscilloscope = 470: Kit \$79.95, Wired \$129.50.



**NEW! PEAK-to-PEAK  
VTVM #232 & UNI-  
PROBE (pat. pend.)**

**KIT \$29<sup>95</sup>**      **WIRED \$49<sup>95</sup>**

Half-turn of probe tip selects DC or AC-Ohms.

Uni-Probe - exclusive with EICO - only 1 probe performs all functions!

Latest circuitry, high sensitivity & precision, wide ranges & versatility. Calibration without removing from cabinet. New balanced bridge circuit. High Z input for negligible loading. 4 1/2" meter, can't burn-out circuit. 7 non-skip ranges on every function. 4 functions: +DC Volts, -DC Volts, AC Volts, Ohms. Uniform 3 to 1 scale ratio for extreme wide-range accuracy. Zero center. One zero-adj. for all functions & ranges. 1% precision ceramic multiplier resistors. Measure directly peak-to-peak voltage of complex & sine waves: 0-4, 14, 42, 140, 420, 1400, 4200. DC/RMS sine volts: 0-1.5, 5, 15, 50, 150, 500, 1500 (up to 30,000 v. with HVP probe & 250 mc with PRF probe). Ohms: 0.2 ohms to 1000 meg. 12AU7, 6AL5, selenium rectifier; xmfr-operated. Deep-etched satin aluminum panel, rugged grey wrinkle steel cabinet.



**NEW! Transistorized  
Power & Bias Supply  
#1020**  
Kit \$19.95      Wired \$27.95



**NEW! Battery-Powered  
Filament Continuity  
Tester #612**  
Kit \$3.95      Wired \$5.95

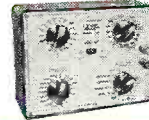

Series/Parallel  
R-C COMBINATION  
BOX #1140  
KIT \$13.95  
WIRED \$19.95



**TUBE TESTER #625**  
KIT \$34.95      Wired \$49.95  
• tests 600 mil series string type tubes  
• illuminated roll-chart

Pix Tube Test Adapter.....\$4.50



**6V & 12V BATTERY  
ELIMINATOR  
& CHARGER #1050**  
KIT \$29.95  
WIRED \$38.95  
Extra-filtered for transistor equipt.  
#1060 KIT \$38.95  
WIRED \$47.95



Miniaturized  
MULTI-SIGNAL  
TRACER #145A  
KIT \$19.95  
WIRED \$28.95



20,000 Ohms/Volt  
V-O-M #565  
KIT \$24.95      Wired \$29.95



1000 Ohms/Volt  
V-O-M #536  
KIT \$12.90  
Wired \$14.90

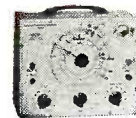

R-C BRIDGE & R-C-I  
COMPARATOR #950B  
KIT \$19.95  
Wired \$29.95  
Reads 0.5 ohms-500 meg.,  
10 mfd-5000 mfd,  
power factor



VTVM PROBES	KIT	Wired
Peak-to-Peak	\$4.95	\$6.95
RF	\$3.75	\$4.95
High Voltage Probe-1		\$6.95
High Voltage Probe-2		\$4.95
SCOPE PROBES		
Demodulator	\$3.75	\$5.75
Direct	\$2.75	\$3.95
Low Capacity	\$3.75	\$5.75

TURN PAGE  
FOR MORE  
EICO VALUES

**EICO**®

Send for  
**FREE CATALOG**  
now

Prices 5% higher on West Coast.

L.I.C. I, N.Y.

EICO, 33-00 Northern Blvd., L.I.C. I, N.Y. R-4  
Show me **HOW TO SAVE 50%** on  Test Instruments  Hi-Fi  Ham Gear. Send me **FREE** Catalog, name of neighborhood dealer.  
Name.....  
Address.....  
City..... Zone..... State.....

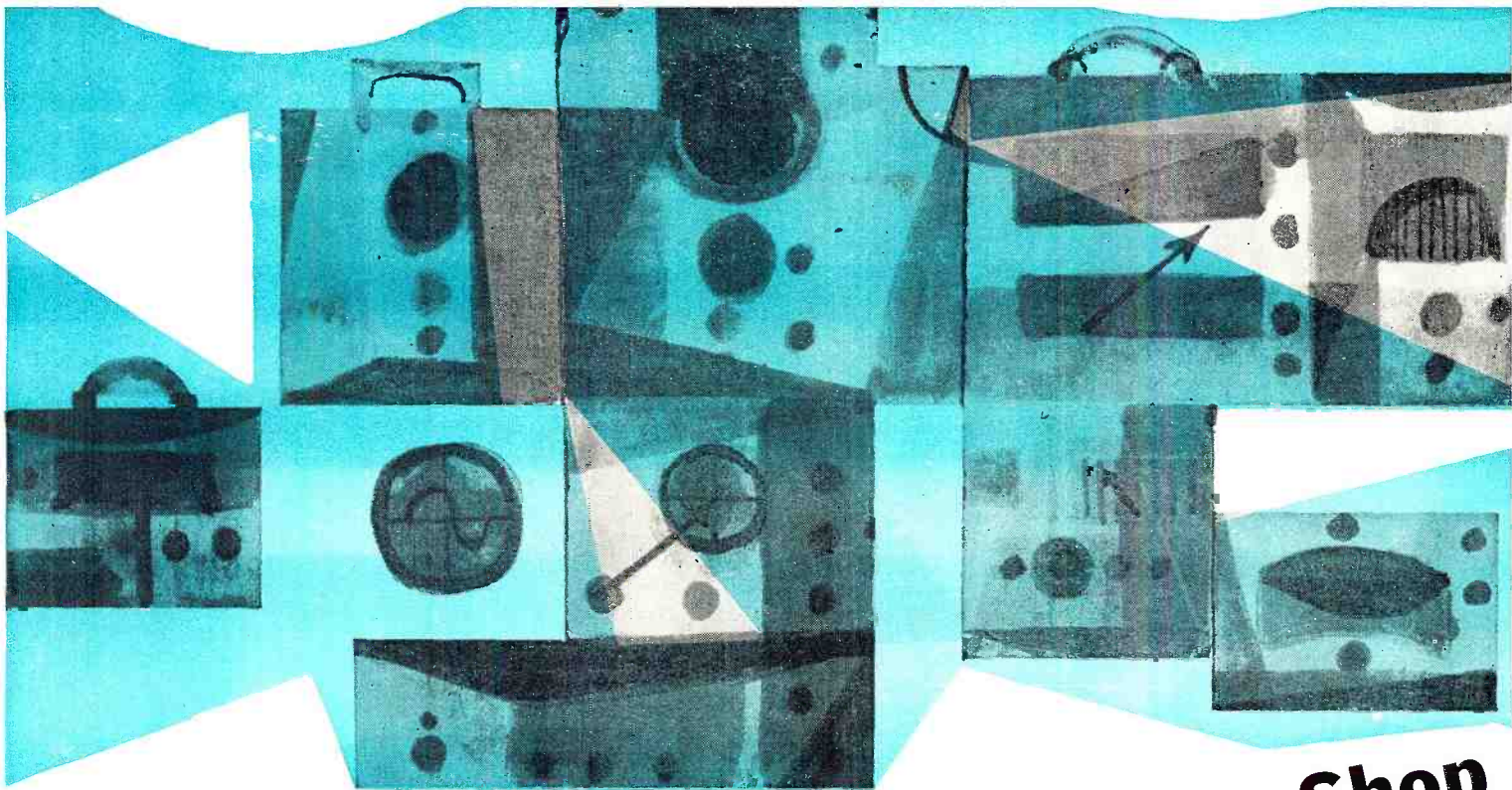

# Test Equipment for the Complete Shop

Additions to basic equipment called for by the growing shop or expanding needs.

By **ROBERT GARY**

**W**HEN a smaller service shop expands or when a larger organization re-assesses its own operation, one important question always arises: How much test equipment is needed? This query subdivides into several considerations. What types of instruments are essential? What instruments that are not absolutely essential nevertheless represent wise investment? What types should be available in duplicate? How much of the shop efficiency is directly connected with test equipment? What particular types of instrument contribute most to efficiency?

There are no simple answers to these problems. The individual circumstances vary so much from one firm to the next that each case must be examined on its own merits. However, there are some guide lines and practical pointers that may help a service dealer in reaching his own conclusions.

We have eliminated from this discussion all "specialized" test equipment. We also assume that the basic five test instruments, described elsewhere in this issue, are already at hand. The test instruments we will consider here are all suitable for several different purposes, yet are not among the basic, minimum equipment necessary for any service work. We assume that the complete service shop will deal with black-and-white TV, color TV, automobile radios, AM and FM sets, and high-fidelity equipment.

The reader will understand that, where the emphasis is on one particular type of service work, the instrumentation in that field will have to be more elaborate than in the others.

Since the v.o.m. rather than the v.t.v.m. has been included in the basic complement, the latter type of meter would be the first item to look for in the complete service shop. There are many different kinds of v.t.v.m. on the market and they are all useful in radio, TV, and audio work. A good unit should have at least four ranges to cover from 3 volts full-scale up to 500 volts full-scale. It should have a polarity-reversing switch so that the d.c. probe can be used for positive and negative voltages. Center-scale zero setting should be possible to facilitate tasks like FM detector alignment.

The ohmmeter ranges of the v.t.v.m. are usually accurate enough for troubleshooting. If the instrument is intended for use in audio work, the a.c. scale should be accurate to at least 5 per-cent down to the lowest voltage range. The v.t.v.m. should also have a flat frequency response up to 20 kc. and possess a  $\pm$  decibel scale.

For full utilization, three different probes should be included. A high-voltage probe, which extends the range of the meter up to at least 30 kv. is absolutely essential for color TV servicing and is also a great help in black-and-white TV work. Another useful

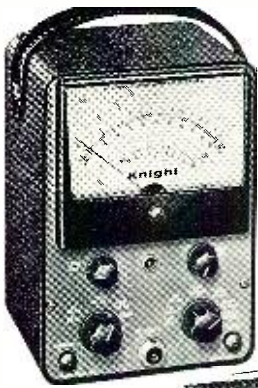

Allied "Knight-Kit" v.t.v.m.



Arkay's new VT-10 v.t.v.m.



RCA WV-77E VoltOhmyst.



RCA WO-91A wide-band oscilloscope.

EICO 460 wide-band d.c. oscilloscope.

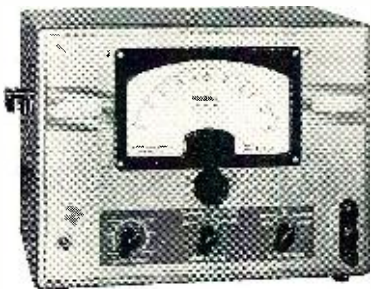
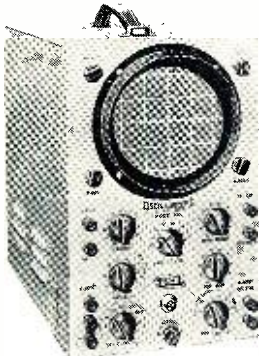

Jackson 655 audio oscillator.

"Knight-Kit" audio generator.

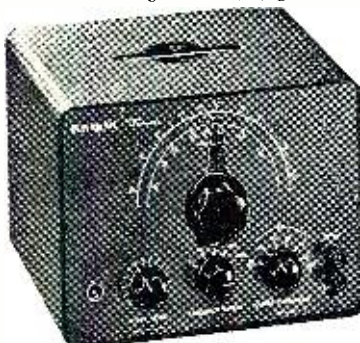

probe contains a crystal diode used to detect r.f. signals. This is very handy in checking for FM or TV signals and can also be used in conjunction with the oscilloscope for TV signal tracing. The third probe is a simple d.c. isolating probe, usually containing a high-value resistor in series with the "hot" lead so as to avoid loading down the grid circuits.

A question which often arises is whether it is worthwhile to provide a meter for every technician or to allow for the time wasted in shuffling meters among different men. Most progressive service groups will decide that each man should have either a v.o.m. or v.t.v.m. assigned to him to save exchange time and increase efficiency.

After the v.t.v.m., we must consider the oscilloscope. It is assumed that a narrow-band instrument already exists in the basic shop, but color TV servicing requires a wide-band unit. Probably the best solution is either to have several narrow-band scopes and one or two wide-band units (depending on shop size) or else to use a type of oscilloscope that can be switched to provide either extra sensitivity over a narrow bandwidth or less gain but a flat response up to about 5 mc. Irrespective of the type of scope or its features, a service shop employing several people will undoubtedly need more than one scope. It may not be necessary to provide one for each technician, but there should be at least one for every two men. Also, crystal-detector and high-impedance probes are essential to make the scope a really useful instrument.

Signal generators are among the five basic test instruments, but here again a complete shop will need more than one kind of generator. Just how many of which kind are needed depends on the size of the organization and in which field most of the servicing is done. If any hi-fi work is done at all, a signal generator covering the FM band and one covering the audio frequencies will be essential. If the service shop is located in a u.h.f. reception area, the u.h.f. TV bands must be covered by one of the signal generators. For color TV, a dot-pattern generator and a color-bar generator, possibly in a single unit, are required.

Even the basic generator that covers the AM broadcast band and up to 50 mc. on fundamentals may not be satisfactory for accurate TV work. For TV alignment and troubleshooting, two different signal generators are often used. One is the sweep generator which can generate an r.f. or i.f. signal varying at a 60-cps rate over a 10 mc. band or so. This sweep generator is useful when an oscilloscope is connected to the detected output; then the frequency-response curve of the circuit under test is displayed directly. It therefore makes sense to allot an inexpensive, narrow-band scope to each sweep generator.

To determine trap frequencies, half-power points, and various other alignment points accurately, marker signals are superimposed on the sweep signal.

In some sweep generators, the markers are already mixed in; in others, only certain fixed markers are available. In still others, only the sweep signal is furnished and a separate signal generator should be used, preferably one having a crystal-controlled oscillator to fix the frequency accurately. Generally speaking, the price of a good sweep generator having a built-in, crystal-controlled and variable marker is not much less than a separate marker and sweep generator. In either case the marker signals should cover not only the 20- to 47-mc. TV i.f. bands and channels 2 through 13, but also the 3.58-mc. color subcarrier, the 4.5-mc. intercarrier sound i.f., and, if possible, the FM band from 88 to 108 mc. Output amplitude should be adjustable from less than 10 microvolts up to about 0.1 volt r.m.s. across either 50 or 72 ohms.

In a u.h.f. area, it might be worthwhile to have a u.h.f. sweep generator but for many shops the expense of such a unit is out of proportion to its utility. In such establishments, any signal generator that covers the u.h.f. band (470 to 890 mc.) even on harmonics, is considered acceptable.

The audio generator used for hi-fi work should have an output amplitude of at least several volts and should be adjustable down to less than .01 volt r.m.s. Its output impedance usually will be either 75, 50, or 600 ohms. Some of the more expensive units have a variable output impedance which permits accurate matching to such inputs as line transformers, high-impedance connections, or special networks. The frequency range of the audio generator should go at least from 20 cps to 20 kc. To get full benefit from use of any audio generator, a well calibrated v.t.v.m. with an accurate a.c. scale and a

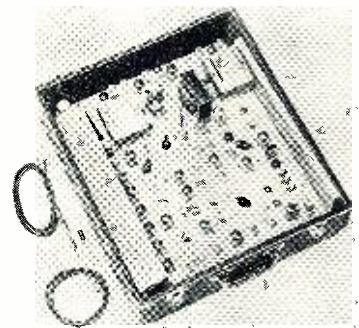

Hickok 656XC color-bar generator.

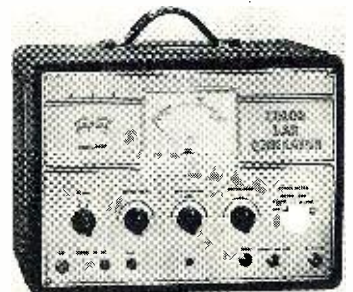

Triplet 3439 color-bar generator.

± db scale as well should be available.

It may seem like gilding the lily, but duplicate instruments, such as an extra v.t.v.m. or an extra scope pay for themselves in waiting time saved when such an instrument is tied up by another technician. It is cheaper to have some meters occasionally idle than to be short of meters when the work piles up.

For home and car radio troubleshooting, a very handy instrument is the well-known signal tracer. Before TV became so popular, most radio service technicians used a signal tracer to locate the majority of receiver troubles in home and car radios. Even though the oscilloscope, with a suitable detector probe, could be used to do the same job, separate signal-tracing equipment is usually preferred. A signal tracer—essentially a high-gain amplifier and a loudspeaker—is relatively inexpensive. It permits rapid isolation of a defective stage, after which it is often only a matter of checking resistance or capacity to locate the guilty component.

Where color TV servicing is performed, at least one special signal generator will be required to produce a color test signal, either in the form of discrete color bars or else in the rainbow pattern achieved by phase shift of the color subcarrier. There are a variety of color-bar generators on the market, each of which will furnish a 3.58-mc. color subcarrier and its modulation. Some of the color-bar generators also have provision for generating a dot or cross-hatch pattern. This pattern is used for convergence adjustments while the color bars serve to troubleshoot the color decoding and color sync sections. Both color bars

and monochrome dots should be available as modulated r.f. at the frequency of at least one unused TV channel and also as direct video signals.

The question of selecting either a generator having both color-bar and dot patterns or buying a separate generator for each type of signal will depend on individual preference. There are advantages and drawbacks to either choice. Separate generators permit one man to use the color-bar generator to troubleshoot color decoding circuits while a second technician uses the dot or cross-hatch pattern generator either to adjust convergence or horizontal and vertical linearity on another set. A single generator for both signals is handier for work in the customer's home, since final convergence and color balance adjustments can be made quickly and accurately, even if no color telecast is received.

It might be pointed out here that the wide-band oscilloscope discussed previously will probably be used mostly in conjunction with the color-bar generator or else with a color signal received over the air. However, a low volume of present color work does not obviate the need for a wide-band scope. It is a must for video detector-amplifier circuits and others involving peaked waveforms, and an investment in the future of color.

If a service shop does a good amount of installation work, it may be worthwhile to invest in a field-strength meter. Of course, if the reception conditions in the normal service area of the shop are uniform, a meter will not reveal anything new. Where reception conditions vary, however, as in a hilly fringe or near-fringe area, the field-

(Continued on page 144)



Aerovox ARD-15 resistor decade.  
Cornell-Dubilier capacitor decade.



Precision 111 Gm & emission tube tester.



TeleTest DM 888 automatic Gm tester.



Weston mutual-conductance tube tester.



PACO Z-80 audio-r.f. signal tracer.

Heathkit Model T-4 signal tracer.

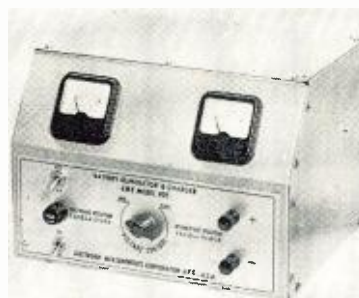

EMC 905 battery eliminator-charger.

EICO 1060 low-ripple eliminator-charger.



# DEFECTS IN THE HORIZONTAL OSCILLATOR

By **WALTER H. BUCHSBAUM**, Television Consultant, RADIO & TV NEWS

In the cases of horizontal oscillator trouble described below the assumption is made that the rest of the receiver works correctly. To isolate a defect to the horizontal oscillator section either the horizontal output and flyback section must have been checked, or else sync trouble must have been traced through the sync separator section. Loss of high voltage, insufficient width, and horizontal non-linearity are often caused by defects in the output circuits. Sync troubles can be due to faulty parts in many other circuits, but if correct sync is checked at the output of the sync separator, then the horizontal oscillator is at fault. We have also assumed that the reader has adjusted all controls correctly before determining that a defect appears to be in the horizontal oscillator section. The data given here applies, in general, to all types of horizontal oscillators and a.f.c. systems, but there are additional defects which can be peculiar to just one special type of circuit. For this reason manufacturer's literature should be consulted whenever possible.

SYMPTOM	CLUES	LIKELY TROUBLE AREA	CORROBORATIVE TESTS	REMEDY
No raster on screen; sound perfect.	Contrast and brightness control cannot bring any light on screen.	Horiz. oscillator tube dead, open oscillator coil, defective part in oscillator or coupling network.	Check h.v., then measure grid bias on horiz. output tube. Low bias indicates loss of horiz. saw-tooth.	Replace tube or other defective part.
Dim, narrow raster at max. brightness setting only; sound and video perfect.	Vertical deflection excessive, poor focus, width varies with horiz. hold control setting.	Weak horiz. oscillator tube, shorted turns on oscillator transformer, locking range trimmer shorted.	Measure grid bias on horiz. output tube. Check "E+" voltages and scope check waveforms in horiz. oscillator section.	Replace tube, open locking range trimmer, or other defective part.
Picture broken up into more than 10 strips which stand still.	Horiz. hold control just varies the number of strips slightly.	Open tuning capacitor or shorted portion of horiz. oscillator coil.	Adjusting horiz. frequency control reduces number of strips, but fails to bring picture in.	Check for wiring defect before replacing capacitor or coil.
Picture broken up into strips which weave back and forth.	Horiz. hold control can lock picture of 2 to 5 strips in only for a moment.	Oscillator control tube, diode detector or other part in a.f.c. circuit.	Scope check control tube or diode detector for presence of sync pulses. Measure voltages on oscillator tube.	Replace defective component.
Picture locked in only on strong signals and max. contrast.	Horiz. hold control is very sensitive.	Phase detector or error voltage filter network.	Scope check sync pulse amplitudes at both diodes, signal trace sync and saw-tooth signals.	Check and replace diodes, diode load resistors, or capacitors in a.f.c. circuit.
Picture locks in but sync is lost completely after warm-up.	Neither horiz. hold nor frequency control can bring picture into sync.	Oscillator tank circuit. Temperature compensated capacitor.	Scope check sync pulses at a.f.c. network. Compare adjustment of oscillator coil and trimmer on hot and cold set.	Check for intermittent and poor connection. Replace tuning capacitor, resistors and, as last resort, replace coils. Exact replacements required.
Horiz. sync unstable until after warm-up; then set works perfectly.	Adjustment of horiz. locking range and hold control helps during warm-up.	A.f.c. circuit and oscillator control section, slow heating control tube.	Measure error voltage as set warms up. Scope check for sync pulses at a.f.c. detector.	Replace tubes, carefully place soldering iron near suspected parts to see which is most heat sensitive.
Good picture but after warm-up width and brightness are reduced.	Adjusting drive control restores good picture.	Oscillator tube, plate or cathode resistors.	Measure oscillator voltages cold and after warm-up. Scope check amplitude of saw-tooth signal on output tube grid.	Replace tube, replace defective resistor with original value.
Loss of horiz. sync on scene changes, power line variation, etc.	Horiz. hold control locks picture in again, but is very sensitive.	Weak control tube, defective capacitor in a.f.c. circuit or shorted locking range trimmer.	Scope check sync pulses at a.f.c. detector. Check error voltage.	Replace tube, measure capacitors and resistors in a.f.c. circuit. Replace locking range trimmer.
Insufficient width and high voltage.	Width control, drive control, tubes are all working properly.	Oscillator cathode capacitor open or output coupling network defective.	Scope check amplitude of saw-tooth on output tube grid with drive trimmer set for maximum signal.	Replace cathode bypass capacitor or other defective part.
Picture is almost locked in, but horiz. hold control has no effect.	Adjustment of horiz. frequency control locks picture in.	Horiz. hold control.	Ohmmeter checks of hold control circuit.	Look for broken leads going to hold control, replace control.
Picture is compressed at the left, horiz. hold and other controls work correctly.	Linearity control does not correct this defect, but drive adjustment reduces its effect.	Saw-tooth wave shaping network, slightly gassy oscillator tube.	Scope check saw-tooth waveform on grid of output tube.	Replace oscillator tube, replace defective components.
Bright vertical bars at the right of the screen, horiz. hold OK.	Compression of drive control trimmer does not remove the bars.	Saw-tooth wave shaping network, open drive control trimmer.	Scope check saw-tooth waveform on grid of output tube.	Check for broken leads going to drive trimmer. Replace open capacitor or defective resistors.
Part of picture is folded over at either edge; horiz. hold and other controls OK.	Adjustment of horiz. hold varies location of foldover.	Phasing coil, saw-tooth wave shaping network, leaky coupling capacitor.	Scope check output of horiz. oscillator and compare with saw-tooth voltage on grid of horiz. output tube.	Align oscillator coils and other controls while checking waveforms. Replace all suspected capacitors.
Top of picture tends to tear or wavy edges and vertical lines run from the top down.	Horiz. hold control reduces tearing and smoothes wavy lines.	A.f.c. circuit, error voltage filter may have open capacitor.	Scope check error voltage at control tube grid. Check entire a.f.c. circuit for correct voltages.	Replace defective components.



By ROGER PENN

**What are technicians in Africa like? Compared to ours, they are a striking study in similarities and differences.**

A technician operating the audio console in his studio.

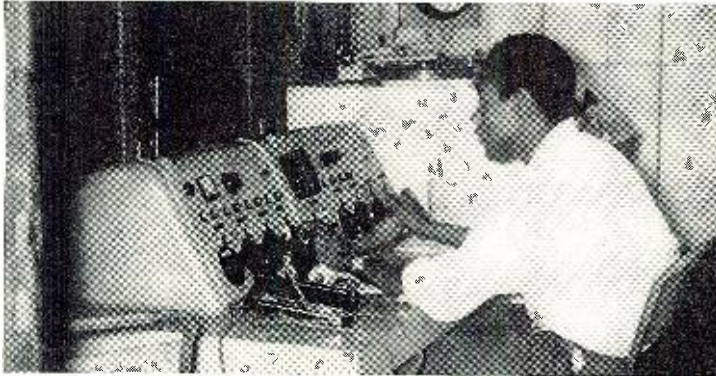

*EDITOR'S NOTE: Readers who remember liking "Electronic Service in Northern Mexico," which we ran some time ago, will find this account particularly worth reading. It is always fascinating to learn about our opposite numbers in other lands and to discover that there are common threads of interest even in cultural environments, like the one involved here, that are so different from our own.*

**A** TRANSISTOR portable radio aroused much excitement among technical students of the *Nigerian Broadcasting Corporation*. They laughed and could not believe that sound could be coming from such a small instrument. Their interest quickened when they looked inside and found, to their amazement, that there were no vacuum tubes. "How can it work without tubes?" Thus, at Yaba Technical Institute on the west coast of Africa, a discussion of the transistors in a U. S.-built portable radio began.

Nigeria has the largest population of all African countries, with over 32 million citizens. It is a British colony, soon to become an independent nation within the Commonwealth. It will have the same status as Canada and Ghana.

Electronics is not a new field in Nigeria, for radio has furnished communication with the outside world for over 30 years. Until 1950, however, the industry was limited to telephone and telegraph applications of electronics. Fewer than 50,000 radio receivers had been imported into the entire country before that time.

Since 1950 there has been rapid expansion in the use of electronic apparatus. Nigerian broadcasting has started operations on a nationwide scale; v.h.f. telephone relays link major cities; commercial and police radio has become common; and earth satellite tracking stations have been set up to track "Explorer" and "Vanguard" satellites. In addition, more than 100,000 new radio receivers have been im-

ported, along with phonographs, tape recorders, auto radios, and other electronic devices. Most of the equipment comes from European manufacturers, although Japanese and American equipment is also beginning to appear in the stores.

The satellite tracking stations just mentioned are part of Nigeria's contribution to the International Geophysical Year. The equipment has been furnished by the United States and is operated by the Physics Department of the University College at Ibadan. The project is of great interest to Nigerians with frequent reports being given in the local newspapers. Other uses of electronic equipment include seismic exploration for oil by commercial oil companies, airline applications of radar, and radio navigation.

The growth in the use of electronic equipment has been dramatic, but not without problems. The *Nigerian Broadcasting Corporation* serves as a good example of the industry in Nigeria. Since 1952 it has grown from almost nothing to an organization with over 100 technicians. Facilities have been expanded so that today there are four major transmission stations, each in a different part of the country. They operate on medium- and short-wave bands. There are also 15 small studio centers, which are being converted to medium-wave transmission stations using U. S.-built 250-watt transmitters.

Most of the development work has been done under the supervision of a few British engineers who are on loan from the *BBC* or on contract in Nigeria after working in other colonial areas. Operation, maintenance, and installation has been the work of a Nigerian technical staff, many of whom had no training or experience before joining the corporation. Finding suitable technical staff members is one of the major problems facing the electronics industry in Nigeria.



These two Nigerian technical students, working together on an r.f. amplifier, show their zest for electronics.

# Electronics in Nigeria

The need for technical help has been met, to some extent, by various training programs. The *NBC*, like other organizations using such equipment, has started a full-scale technical school. The period of training is five years, with three to four years of work as a trainee on a station, and one to two years in residence at the school. The level of training is roughly the same as in a U. S. technical school, with the emphasis on radio broadcasting theory and practice.

It has been found that training must be very practical in nature. This helps to make up for the lack of mechanical experience among students who, for the most part, have not had the opportunity to grow up in a mechanical environment. Half of the *NBC* training course time is directed toward laboratory work, where students carry out a logical series of experiments. These cover basic theory, use of tools and test equipment, building and testing of circuits, and finally, operation and adjustment of equipment. The experiments are paced to keep in step with lecture material.

Technical books are very scarce in Nigeria. For this reason, the *NBC* has started small libraries at each station. Some of the books have been contributed by the U. S. Information Agency; American texts are hard to buy, and

*(Continued on page 128)*

The control room of a Nigerian studio. It could just as well be in the U. S.

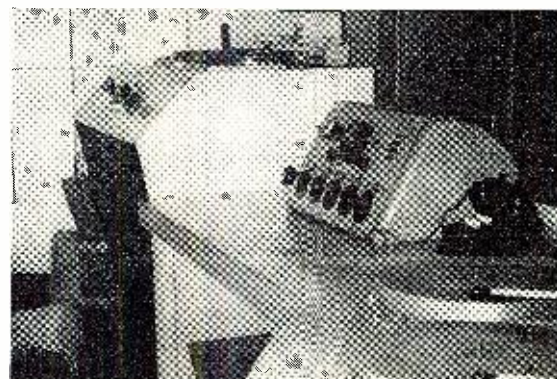

# An enna Installa ions: Fact & Fiction

By JACK BEEVER

Jerrold Electronics Corp.

How many of these common misconceptions and half-truths hamper your antenna work?

**C**ONSIDERING THAT antennas are daily familiars in the life of the average TV technician, it is quite surprising that they are also among the least understood items with which he deals. Some common misconceptions and half truths concerning them have come to the author's attention in the experience he has had with antenna installations. These misunderstandings can cause real trouble for the installer faced with decisions in a knotty problem involving signal interception. With respect to the common beliefs listed here, concerning how many do you know the full truth?

**FICTION:** *The front-to-back ratio of an antenna is the ratio between the sensitivity to a signal from a station in front of the antenna and the sensitivity to a signal from a station to the rear of the antenna.*

**FACT:** This half-truth can be a damaging one if it is taken literally. Strictly speaking, the front-to-back ratio is based upon reception of a single signal originating from one point. The antenna is first oriented so that it is picking up maximum signal from this source while facing it. Then the antenna is rotated through exactly a half turn—180 degrees—and pickup of the same signal is measured. The front-to-back ratio is the relationship between these two readings.

Antenna patterns are such that it is possible for a relatively small shift in orientation—say a shift of 10 degrees—to produce a very great apparent change in this ratio, often by as much as 5 to 20 times. These changes, depending on the particular radiation pattern and the installation, may be more important than an arbitrary ratio.

Another point to remember is that stated front-to-back ratios must be considered at specific frequencies, since antenna radiation patterns invariably change with frequency.

The technician can check this ratio himself if the antenna is mounted on a rotator, or can be conveniently rotated on its mast, and a steady signal is available. A word of caution: this method can only be depended on when no significant reflections are present, such as are caused by large metallic structures at some distance or small ones very close.

**FICTION:** *A yagi antenna has many times the gain of a tuned dipole, such as a pair of "rabbit-ears."*

**FACT:** If you call three times "many," then it's true. The best yagi antennas show gains no greater than 12 db over tuned dipoles, which is four times the voltage. The average cut-to-channel

yagi will have from 8 to 10 db gain which is from 2.5 to 3.16 times. The big advantage is often because the yagi gets put in a better place—up on the mast.

**FICTION:** *Impedance matching between antenna and load is not too important—you can't see the difference.*



**FACT:** If you have more signal than you need, you may not see the effects of mismatch in terms of signal strength, because the set has a.g.c. You may, however, see the secondary effects of mismatch, since a mismatch always causes reflections in the line. These reflections can produce line ghosts—close-in ghosts that may be so near the primary image as to look like smear.

Also, the tuner response will change when it sees a mismatch at the input, causing degraded picture resolution on monochrome and all kinds of difficulties in color reception.

**FICTION:** *It takes an antenna with a very narrow forward lobe to eliminate a ghost.*

**FACT:** Not so. The ghost elimination depends on the antenna pattern having a sharp null, which may be oriented to the ghost source, without moving the pickup lobe too far from the best reception angle. At the high band, for example, an ordinary broadband conical antenna may do better than a yagi type, because the conical has three major pickup lobes at the high band. (See radiation patterns, Fig. 1.) Also, there are several null points from which to choose. This permits considerable flexibility in orienting the antenna so that it may select the desired signal while rejecting the reflected one.

**FICTION:** *An antenna may be shielded from interference with a screen made of metal mesh or sheet metal.*

**FACT:** It won't work. Take the metal mesh—for instance, poultry netting—and place it between a radiation source and an antenna. The incoming radiation impinges on the screen and starts currents circulating in the latter. Since the screen is not loaded—no current is being taken from it—almost all the energy it intercepts is re-radiated—and it re-radiates on both sides of the screen. The idea of the screen is thus defeated.

If a solid sheet of metal is used as the screen, the edges of the sheet radiate, and the pattern of radiation is practically circular, so the same end result ensues. This is not mere theory. We have seen it tried more than once. In one case, a screen bigger than a billboard was erected to cut off co-channel interference. It actually seemed to make matters worse.

**FICTION:** *If you stack two antennas you'll get twice the signal voltage of one.*

**FACT:** If you manage to attain a perfect job of stacking two antennas, you'll gain only a 40 per-cent increase in voltage. What you actually double when you add another antenna is signal power. Double power across a fixed impedance, in this case almost always

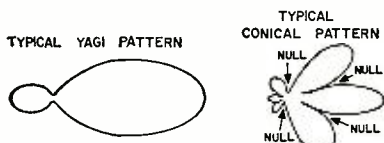

Fig. 1. Radiation patterns compared.

300 ohms, results in a voltage increase of 3 db, which is about 40 per-cent. Since it is almost impossible to get full efficiency, you'll do well to get 30 per-cent in practice.

To get another 30 per-cent on top of this, you'll have to stack four antennas. Therefore, with one antenna as the reference (0 db), two will gain 3 db, four will gain 6 db, eight will gain 9 db, and so on. Since 6 db is double voltage, you need *four* antennas to get *twice* the voltage of one.

**FICTION:** *As long as they aren't sensitive to the same channel, you can stack antennas close on the same mast without interaction between them.*

**FACT:** It's a myth. Any conductor placed in the field of a transmitting or radiating device will intercept some of the energy of the field. The conductor will re-radiate all of this energy except that part dissipated in "copper losses," that is, due to the resistance of the conductor. The coupling between these metallic elements and the phase shifts caused by re-radiation will have many peculiar effects.

The effects are worse when the conductors are spaced apart less than a half-wavelength at the operating frequency of either antenna. It does no good to argue that one antenna is at right angles to the other since even in this condition, the boom of one antenna is parallel to the other antenna. The boom picks up, too. The same arguments apply to guy wires, which should never run in front of, behind, or through the antennas.

**FICTION:** *Since parallel-wire lead-in, such as 300-ohm ribbon, has only about 2-db loss per hundred feet at the high channels, the lead loss can be ignored unless the lead is over a hundred feet long.*

**FACT:** The 2 db/100' loss at 200 mc. is an accurate figure—but *only* under free-space, dry-air conditions. Any substance other than dry air that comes in close contact with twin-lead increases its losses. This includes dust, chemical deposits from smoke, carbon, water, salt, stand-off insulators, feed-through tubes in walls, and window sills. Losses are apt to be, in actuality, three or four times the nominal cable-loss figure and the more cable involved, the greater the loss.

It's an interesting experiment to connect the down-lead from an antenna to a field-strength meter, and then grasp the wire. A 6-db drop is not unusual, which is a loss of half the voltage. This loss is caused by absorption of the energy contained in the fields between and around the conductors of the twin-lead.

**FICTION:** *Shielded twin-lead should be good for long leads in fringe areas,*  
(Continued on page 124)

# Cover Story

THE potential for TV reception in non-urban areas, seldom fully exploited, inspired this month's cover. Too many such opportunities for results gratifying to set owners and service dealers alike are left unexplored.

The scene is a suburban home in Wilton, Fairfield County, Conn. Like his neighbors, the owner was initially quite successful in obtaining good reception from the seven v.h.f. channels originating in New York City, about 40 miles southwest. However, this dedicated sports fan decided to do something about the fact that these stations are blacked out for many prime sporting events taking place in that city.

His starting point was other v.h.f. and u.h.f. transmitters, in different directions and at varying distances. The solution involved a ground-installed tower, a rotator, and two high-gain antennas, one each for v.h.f. and u.h.f.

The result: to pick up athletic events from non-black-out transmitters, he now has at his fingertips, in addition to the New York broadcasts, channel 3 in Hartford, approximately 55 miles to the northeast and almost exactly in the opposite direction from New York; channel 8 in New Haven, about 20 miles to the east and slightly north; channel 43, about 13 miles east in Bridgeport; and a few other u.h.f. transmissions.

The tower is the Rohn No. 25 "Fold-over." Its hinged design permits great ease and safety in installing (and subsequently servicing) antennas and rotators from the ground. Guyed at the hinge, the tower's completed height is 50 feet. If the antenna load is not too great,

up to 70 feet can be obtained by adding sections above and below the hinged portions. Flat-roof models are also available.

For u.h.f. coverage, TACO's 4-bay open bow-tie, #3034C, was chosen. Its open design minimizes vibration effects. Quality insulators are used for good dielectric characteristics and mechanical strength. A factory-designed stacking kit can be used to make an 8-bay version for higher gain and front-to-back ratios.

The Channel Master 7-element "Traveling Wave" antenna, model 350A, was used for high gain across the entire v.h.f. band. Interconnected through a carefully designed phasing harness, all elements but one are driven. Of these, none are conventional folded dipoles, all have different lengths and impedances. Performance is optimized by careful balancing of these factors. For less stringent gain requirements, 5- and 3-element versions of the "T-W" are available.

To handle the two antennas, the Cornell-Dubilier AR-22 Rotor was more than adequate. Using a heavy-duty motor, this weatherproof performer features sturdy precision gears in a re-inforced die-cast housing and a magnetically released mechanical brake. The associated control box permits accurate preselection of any of 60 positions, six degrees apart over a full circle. The user simply dials the desired position; the rotor then takes over, automatically stopping and locking in place.

Installation work was handled by Television Workshop Inc., Westport, Conn. —30—

(Cover photo by Dave Henderson)

Cornell-Dubilier's CDR AR-22 Rotor, a heavy-duty unit more than adequate for handling the load of the two antennas.

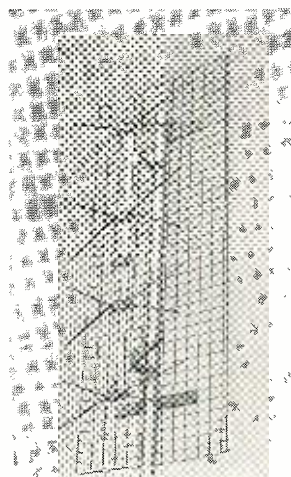
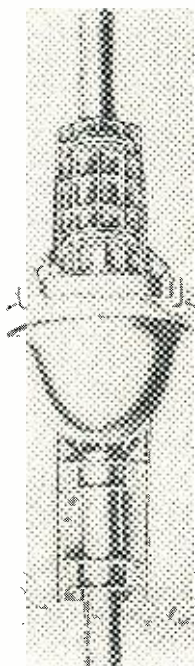

The TACO 3034C bow-tie, made by Technical Appliance Corp., was used for reception across the u.h.f. TV broadcast band.

Channel Master's 7-element "Traveling Wave" antenna, model 350A, provided high gain for v.h.f. TV.

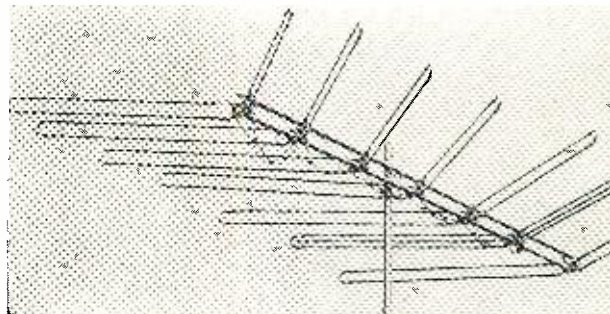

# Hi-Fi Crossover Networks

## General Principles

By **ABRAHAM B. COHEN & PAUL D. COHEN**  
Advanced Acoustics Co.

**Part 1. Here are the facts you need to know about these important circuits before building or buying.**

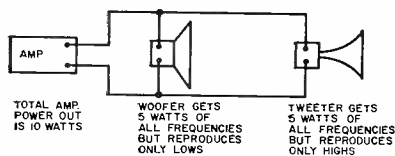
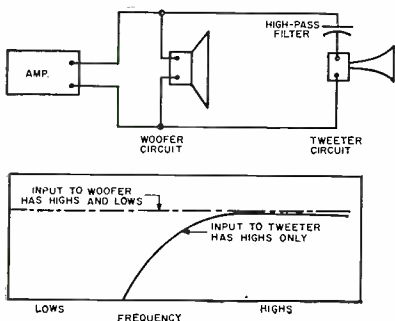

Fig. 1. Lack of network wastes power.

Fig. 2. Simple high-pass filter in tweeter circuit lets only highs into tweeter and provides tweeter protection, but does not keep high frequencies out of the woofer.



**A**UDIO dividing networks are essential components that ensure the proper functioning of multi-speaker systems. A well-designed audio dividing network, or crossover network as it is usually called, performs two functions. First, it is a traffic policeman that directs the various parts of the audio spectrum to the specialized speakers which are best able to handle specific bands such as the lows and highs. The secondary function of the crossover network is to protect the delicate tweeter mechanisms from low-frequency overload. The end result of these combined functions is better utilization of audio power available from the amplifier, cleaner reproduced sound from the loudspeaker, and more direct control over what comes out of the loudspeakers.

There are simple networks and there are complex networks, but they are all easily understandable when approached in a basic fashion. Before going into details of the design and construction of home-built precision networks, which will be covered in Part 2, a simple and quick recapitulation of the principles behind the network function will help the builder decide what network he should construct for his system.

### Speakers Without Network

Networks, of course, are used with multi-speaker systems. The simplest multi-speaker system consists of a woofer for the reproduction of low frequencies and a tweeter for the repro-

duction of high frequencies. Although it would be unrealistic to connect two components such as a woofer and a tweeter directly to an amplifier without benefit of a network, we will do just that to illustrate what happens to the over-all system; then we shall progressively add network elements to the system and observe their effect upon performance.

In Fig. 1 we have connected a woofer and a tweeter directly across a 10-watt amplifier. Assuming that the amplifier is a good high-fidelity type, we may then expect that it will have full-frequency-range output. Under this condition, the full-frequency range will be fed equally to both the woofer and tweeter. If both speakers are of the same impedance, the woofer will get half the power and the tweeter will get the other half. But in each case, the woofer and the tweeter will both receive the same full-frequency range. Under this condition, half of the high-frequency power available from the amplifier will appear at the voice-coil terminals of the woofer. But, being a woofer, it will not be able to reproduce these high frequencies. Consequently, all the high-frequency power that is fed to the woofer (half of the total high-frequency power) is entirely wasted.

At the tweeter terminals we find a similar condition of power available but with different results. Since half of the amplifier high-frequency power has already been lost in the woofer, the tweeter already has two strikes against

it. Only half of the high-frequency power from the amplifier is available to the speaker to be reproduced as useful sound. Of equal importance is the fact that half the amplifier's low-frequency power also finds itself at the tweeter terminals. Naturally this represents a waste of half the total low-frequency power that would normally go to the woofer. Since the tweeter cannot reproduce the low frequencies, then the lows that find themselves at the tweeter are a total loss as far as reproduction is concerned.

Of equal importance is the fact that the tweeter itself may become, physically, a total loss under these conditions. Tweeters are invariably small and delicately made so that the last drop of efficiency may be extracted from the feeble high-frequency signals. Tweeters are just not built to handle heavy low-frequency signals that should normally go to the woofer, either from a power handling capacity or from a diaphragm excursion standpoint. It might not take more than a few moments of good, loud playing of a system without a network, such as is shown in Fig. 1, to destroy the tweeter. Thus, even if one wanted to start a system in its simplest form, the use of some type of network is absolutely essential if only as far as tweeter life expectancy is concerned.

#### High-Pass Filter

The simplest way to protect the tweeter against low frequencies is by inserting a capacitor in its circuit—a procedure which would normally block low frequencies. In this case, as in Fig. 2, we get two effects for the price of one. Destructive low frequencies are kept out of the tweeter; and a *high-pass* filter effect is obtained. Actually, it is this high-frequency passband effect that prevents the transference of the low frequencies into the tweeter. The passband of the capacitor may be chosen to coincide with the actual high-frequency output of the tweeter itself so that only those frequencies that the tweeter will eventually reproduce will get into the tweeter. The effect of this

simplest type of "network" is the conservation of all the low-frequency power for utilization by the woofer and protection for the tweeter against damaging low-frequency power. It should be noticed, however, that in this simple system, since there is nothing in the circuit to prevent high-frequency power from getting into the woofer, that *half of the available high-frequency power is still lost in the woofer.*

It would be worthwhile to digress briefly at this point to discuss the effects of such a "high-pass network" on the listening results obtained with this two-way system. The degree of effectiveness of this type of system insofar as the high frequencies are concerned will be greatest when the main speaker is *poor* in high-frequency response. If the main speaker is truly a woofer, then despite all the high frequencies that are sent into it, it won't reproduce any high-frequency sound. Consequently, when the tweeter and its high-pass element are subsequently connected across the amplifier, highs will begin to emerge from the system only as a result of the tweeter being connected and there will be a distinct audible difference. On the other hand, there are many cases where a tweeter and a high-pass element are connected, in the fashion just described, to a main speaker which is of the "wide-range" class. This situation will arise where one has originally installed a single speaker system for good over-all reproduction and then, at some later date, decides to build "up" from it to a multi-speaker system. Since the original *single* speaker installation is generally a good wide-range unit, it will reproduce high frequencies with fair efficiency and output. If a tweeter and a simple high-pass element are now connected across this type of speaker, the high frequencies will again split between the main speaker and the tweeter. *Half of the high-frequency power will still be reasonably reproduced by the original speaker* while the other half will go to the tweeter. Thus the increased over-all audible effect of adding the tweeter to a speaker which

already reproduces highs will not have quite the impact as when connected to a woofer.

#### Full Two-Way Network

To overcome such a condition and to provide true *network* performance that will not only properly channel the various frequencies, but will improve overall cleanness of reproduction, we have to add a single element to the circuit of Fig. 2. Fig. 3 shows a full two-way system with both high- and low-frequency controlling elements: a capacitor in the high-frequency channel to block the low frequencies from the tweeter and a choke in the low-frequency circuit to keep the high frequencies from the woofer. The capacitor is a high-pass element and the choke is a low-pass element. The combination of the two, usually referred to as an *LC* network, provides an electrical crossover function apportioning all the low-frequency power to the *woofer* and all the high-frequency power to the *tweeter.*

The audible effects of this sort of combination will be readily apparent. In almost all cases there will be fairly clean separation between the bands of sound radiating from the tweeter and the woofer. Where the efficiency levels of the two speakers are of the same order, the output sound from the tweeter and the woofer at the *crossover frequency* will be equal. Above the crossover point the output of the tweeter will be dependent solely upon the performance characteristics of the tweeter itself. However, as far as the woofer is concerned, its output above the crossover point does not simply fall away. See Fig. 4. It will drop off in a manner determined *first* by the output characteristic of the woofer, or main speaker itself, as discussed in the previous paragraphs. Then it will be further attenuated by the "roll-off" characteristic of the high-frequency limiting element (the choke) in the woofer circuit. The converse of this situation will hold for those frequencies below the crossover point. The woofer output will now be determined

Fig. 3. Two-way network channels lows and highs to woofer and tweeter respectively.

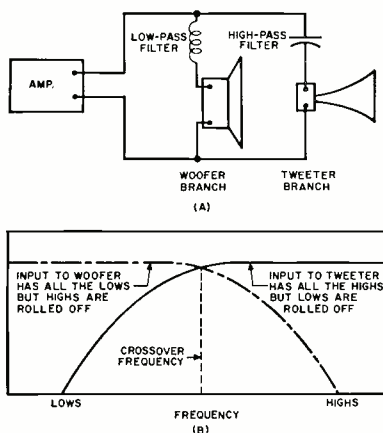
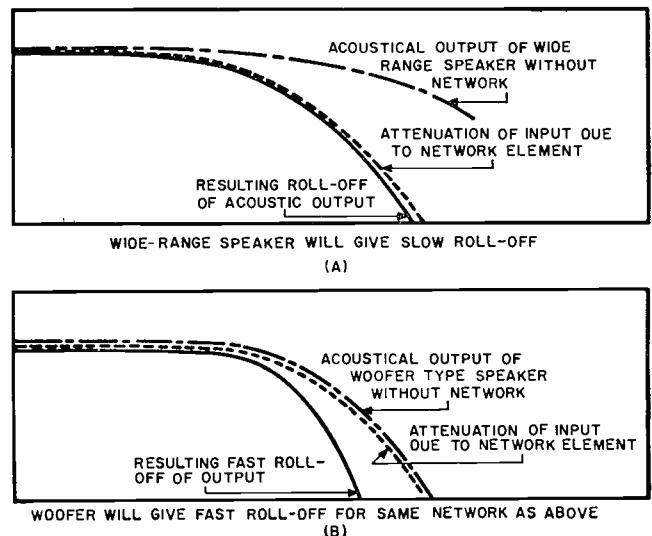
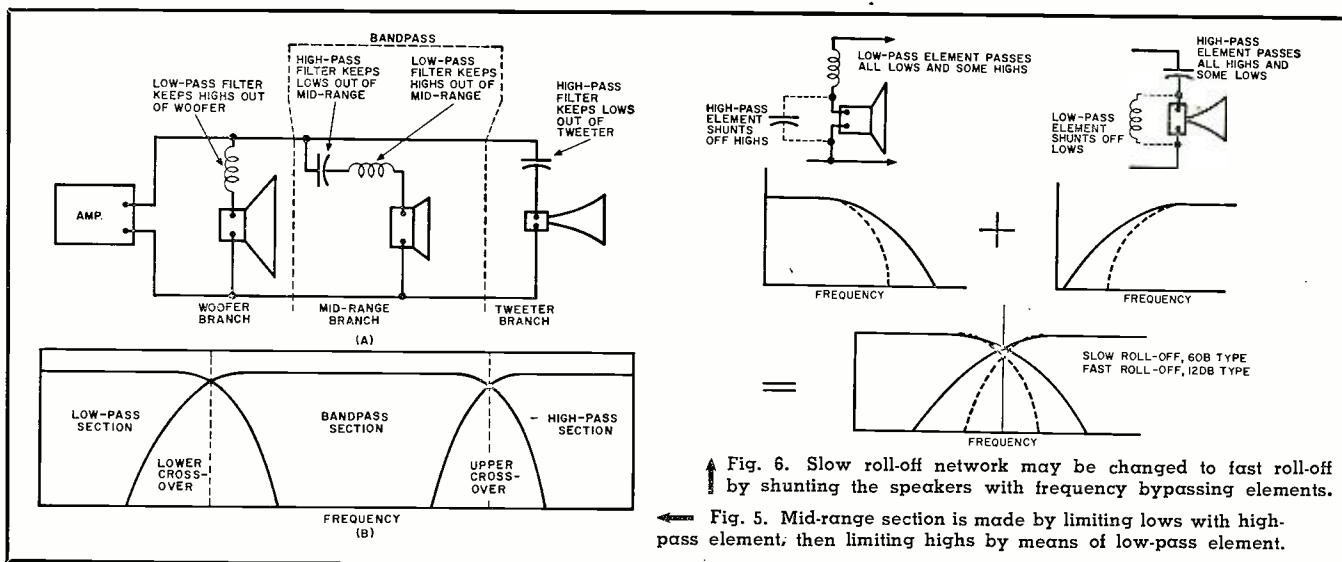

Fig. 4. The over-all system performance will be a function of both the performance of the loudspeaker and the network characteristic. Note the operation of the system with a wide-range speaker (shown at A) and with a woofer (shown at B).





entirely by the woofer performance characteristic while the tweeter performance will be controlled first by the output characteristic of the tweeter and then additionally modified by how the high-pass frequency element in its circuit rolls off the low frequencies. As shown in Fig. 4, the end result of the speaker network combination is a function neither of the network nor the speakers, but is controlled by both the electrical characteristics of the network and the acoustic output of the speakers.

### Intermodulation Distortion

How does a two-way network of this LC type provide improved audio performance beyond the simple unit of Fig. 1 without the network? First, complete audio power utilization from the amplifier is now feasible. If there are a full 10 watts of low frequencies available from the amplifier, they will all go to the woofer and be reproduced there without half of them being wasted in the tweeter. Alternately, when there are a full 10 watts of high frequencies available from the amplifier, they will all go to the tweeter and be reproduced without half of them being wasted in the woofer. Then, of course, there will be full protection for the tweeter against damaging low frequencies.

However, most important from a performance standpoint is the fact that the full two-way crossover network system will provide considerable improvement (reduction) of the intermodulation distortion of the system. With the elimination of the highs from the woofer and their being channeled instead to the tweeter, these high frequencies are no longer bounced around by the large excursions of the woofer diaphragm which would be the case if both highs and lows were to come from the main speaker. By thus providing a separate tweeter diaphragm entirely independent of the more violent excursions of the large woofer diaphragm, considerable reduction in intermodulation distortion is possible,

resulting in over-all cleaner sound.

### Spatial and Level Response

When frequency division of this sort is practiced it is possible to overcome another defect of single-speaker operation, namely high-frequency beaming. In any large speaker, such as a typical 12" or, especially, a 15" unit the high frequencies tend to concentrate in a rather sharp beam in front of the speaker and high-frequency response over a wide listening angle is thus deteriorated. When, however, the highs are not reproduced by the large cone but are instead reproduced by a separate rate branch, then wide-angle dispersion of the high frequencies may be obtained, either through the use of dispersing type horn tweeters or a bent array of cone-type tweeters. Level control of the treble frequencies may also be easily accomplished now that they have a channel of their own. Such controls are referred to as "brilliance" controls. They raise or lower the entire plateau of the tweeter band, thus maintaining the full-frequency range of the tweeter despite the over-all output level of the unit.

### Summary of Two-Way System

In summary, a two-way system with full two-way network provides complete utilization of audio power, reduction of intermodulation distortion, improvement in high-frequency spatial response, treble-balancing control, and complete protection of the tweeter against low-frequency damage or burn-out.

### Three-Way System

The principles of the two-way network may be readily extended to the popular three-way system. Such a system comprises a woofer, a mid-range unit, and a tweeter—speakers which reproduce, correspondingly, the low frequencies, the middle frequencies, and the treble frequencies. The same general attributes that were found for the two-way network system are now applicable to the three-way system but

with more definition of detail. Obviously, with three-band operation, the separation of the high frequencies from the lows is more efficiently accomplished and more readily audible. Where in the two-way system, for instance, a crossover of 2000 cps may have been chosen, in the three-way system an upper crossover of 5000 cps may be utilized. Those frequencies from 5000 cps down to perhaps 350 cps would be carried by the mid-range unit, while below that all the low frequencies would come from the woofer. With this sort of separation, there is no question at all as to which band is carried by the woofer and which by the tweeter. Audibly, the difference between the woofer cutting off at 350 cps and the tweeter starting at 5000 cps is as clear-cut as night and day. The mid-range unit, bridging these two extremes, has a characteristic personality all its own, again very distinct from the other two branches.

### Balance in Three-Way System

Psychological use is made of the mid-range tonal quality by referring to it as "presence." There are many who feel that reducing the level of the mid-range unit makes the performer recede somewhat in the background, while raising the mid-range level brings him forward—or increases his "presence." This controlling feature of mid-range "presence," along with the treble "brilliance" control, obviously makes the three-way system more versatile than the two-way set up.

Since there is greater separation of the frequency bands in the three-way system than in the two-way system, we should expect further reduction of intermodulation distortion.

### Mid-Frequency Controls

The filtering elements for a three-way network are actually a combination of the principles used in the design of two-way networks. The frequency controlling elements are, in the mid-range case, a capacitor to limit the low-

*(Continued on page 146)*

## E-V STEREO CARTRIDGE

**E**LECTRO-VOICE is one of the few companies making stereo cartridges today that has been in the field from the start. No doubt by now their stereo cartridge sales have set quite a record. However, we have not had the opportunity to run any tests on their cartridges until this last month.

The one we chose for review was the Model 26MDST, a turnover model for playing 78's and all LP's, monaural as well as stereo. It utilizes highly improved ceramic generating elements, plus an integral printed circuit that matches it to magnetic inputs. The miniaturized circuit, as we found out direct from *E-V*, consists of 4 resistors and 2 capacitors. It reduces the output level from 500 to 20 millivolts and changes the pre-equalized RIAA curve to a constant-velocity curve. Thus, when used in a magnetic input, the 26MDST "looks like" a magnetic cartridge to the input circuit.

For strictly LP operation, the *E-V* Model 21MD should be used. For ceramic inputs, there are models (without the "M" in the model number) that do not have the printed circuit adapter. We haven't checked any of these, but believe their performance is identical (when fed into 3-meg-ohm inputs) to the 26MDST that we did check.

*E-V* specifies a load of 22,000 ohms or higher. We were able to increase the load to 47,000 ohms without any noticeable variation in performance.

This cartridge is relatively flat,  $\pm 2$  db, from 30 to 15,000 cps, the limit of our test. The output for a 22,000-ohm load was .012 vol at 1000 cps (5 cm./sec. recorded velocity). Channel separation at 1000 cps was 26 db. All of these tests were made with 6 grams stylus pressure (*E-V* recommends 4 to 6 grams).

Difference in output voltage from one channel compared to the other was only .2 db at its maximum point. This is quite good in comparison to many other stereo cartridges that we have checked.

The plotted response curve showed a very slight rise (2 db) at 6000 and 11,000 cps. Reproduction proved to be pleasant to listen to. It was clean and crisp throughout its full range.

## "KNIGHT" FM TUNER

**T**HERE are many individuals who think solely of a phonograph when in the market for a high-fidelity system. This is rather unfortunate as no hi-fi system is really complete unless it has an FM tuner. In most cases these are fairly expensive items. However, occasionally one does run across a unit that provides high quality performance at a very attractive price. The "*Knight*" KN-140 basic FM tuner can be considered a very good buy. It is an ultra-compact unit measuring 2½ inches high, 9 inches wide, and 7½ inches deep. It covers the standard FM broadcast band of 88 to 108 mc. and incorporates automatic frequency control, flywheel tuning, and illuminated dial scale. One of its features is a tape recorder output jack that can be used for "off-the-air" recordings.

Our lab tests showed that the tuner has a maximum output of .57 volt r.m.s. undistorted. The a.f.c. has a pull-in range at 98 mc. of +8 mc. and -5 mc. The stability was exceptionally good as there was no discernible drift for a one-hour test period. The over-all audio response (obtained by modulating an r.f. signal generator connected at the antenna terminals) showed that the unit was flat from 100 to 15,000 cps. It was down 6 db at 50 cps with a 100,000-ohm load on the output. The tuner alignment was found to be exact on all coils at 108 mc. The sensitivity was found to be 4  $\mu$ v. at 98 mc. for .5 volt r.m.s. output. For 20 db of

(Continued on page 138)



## STEREO RECORD CHANGER KIT

**I**N putting together the *Heath* Model RP-3 stereo record changer, we had somewhat the same feeling that a novice might have who tackles his first big electronics kit. To one accustomed to constructing electronics kits, a mechanical assembly such as this poses its own peculiar problems. We had to identify all parts carefully and follow the construction manual closely.

The kit itself was not difficult to put together as much of the basic assembly was previously done by *Heath*. However, it was necessary to put together such units as the idler arm, drive wheel, spindle, muting switch, break arm, etc. The entire procedure was certainly rewarding in that when completed we did have a record changer that was well engineered and provided top-quality performance. Besides being attractively styled and providing a choice of 4-speed operation, this new changer has several operating features. The turntable itself comes to a complete stop during the change cycle and does not resume motion until the tone arm

is in position for the next record. When the change cycle is completed, the turntable is set in motion rapidly but smoothly, reaching proper speed within one-fifth of a turn. Both 33 and 45 rpm records (7, 10, and 12 inch) may be intermixed in any order and they will play at proper speeds. The tracking force varies approximately 1 gram from the first record to the tenth. This new changer also includes a muting switch and is available for use with monophonic or stereophonic systems.

Extensive listening tests were made, and we found that the tracking, wow, flutter, and record speeds were beyond criticism. The mechanical operation of the changer was smooth and precise. Rumble, which is always a serious problem with changers, was sufficiently low so that one would not find this of any serious consequence when used with the best hi-fi equipment.

If one wants the convenience of a changer, we recommend this one without reservations. When it comes to the utmost in performance one must, of course, resort to one of the many professional manual turntables that are on the market today.

-30-



# Transistorized Double-Sideband Suppressed-Carrier Transmitter

By DON STONER, W6TNS

A simple 100-mw. rig with a balanced crystal modulator driven by flea-power exciter on 10-, 15-, and 20-meters.

THE advantages of a double-sideband, suppressed-carrier transmitter over a regular AM transmitter have been described in various amateur radio publications. Most notable features of this system are: (1) the carrier is suppressed, which eliminates annoying heterodynes and selective fading due to carrier phase shift; (2) choice of sidebands—whichever has the least interference may be used; (3) more efficient use of power; and (4) ease of generation—no special components (phase-shifting networks, etc.) are required.

These same advantages will also apply to a DSB transmitter employing transistors. The experimenter, working with QRP transmitters (low power) must make the most of the r.f. power available. The efficiency of the DSB system combined with the efficiency of transistors make an unbeatable combination.

The rig to be described consumes 0.15 watt peak power from the batteries and will deliver approximately 0.1 watt (100 milliwatts) peak-envelope-power to an antenna system or vacuum-tube power amplifier. An auxiliary r.f. source, such as "The Mighty Milliwatt" (RADIO & TV NEWS September 1958 issue) will be required to drive the DSB transmitter. "The Semicon-

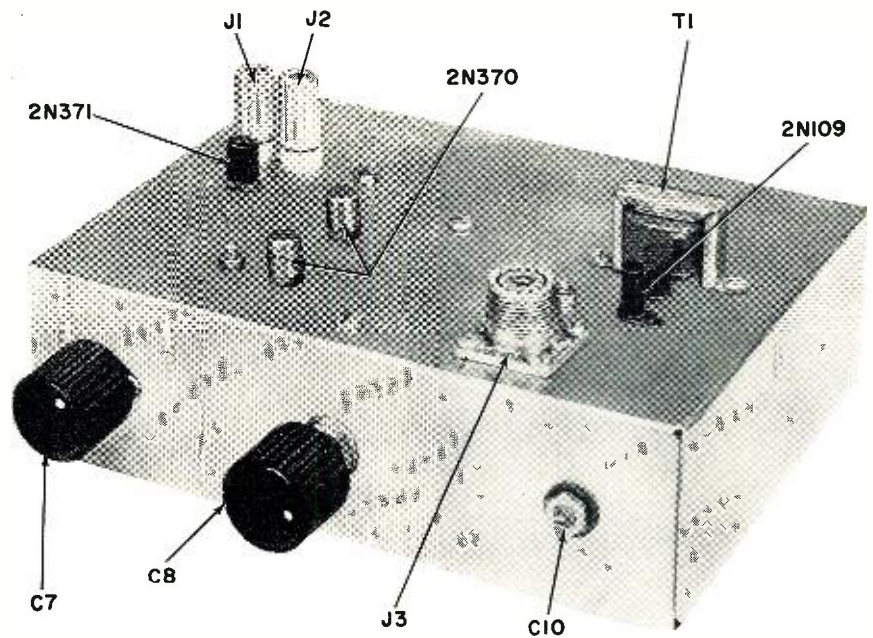

Over-all view of the simple transistorized double-sideband transmitter. The small unit at the right, behind the 2N109, is the modulation transformer.

Below-chassis view. Air Dux 806 coils were substituted for the units shown, after the photo was taken, to provide proper tuning of 20-, 15-, and 10-meters.

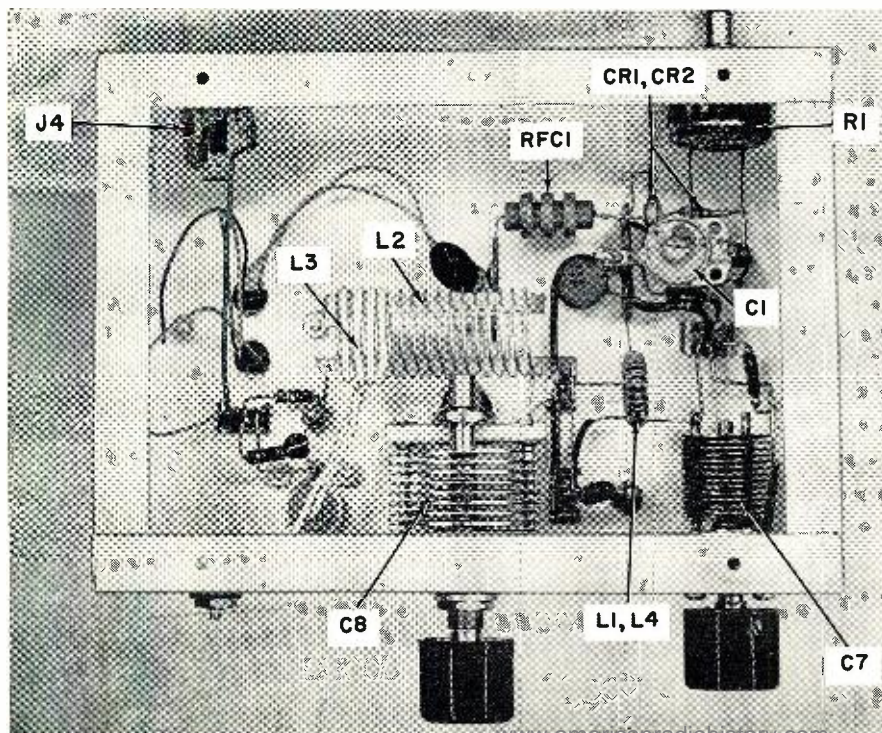

ductor Space Spanner" (POPULAR ELECTRONICS August 1958 issue) or even a lightly coupled grid-dipper can be used to drive the transmitter.

## Theory of Operation

As stated earlier, a DSB transmitter has no critical or expensive components. The DSB *transistor* transmitter is no exception as shown by the simplicity of the circuit (Fig. 1). A low power source of r.f. (25 milliwatts or so) is fed to  $J_1$ - $J_2$  through a link coil. A potentiometer, with the movable arm grounded, is connected across the link to simulate a center-tap and to provide a push-pull drive.

Potentiometer  $R_1$ , capacitor  $C_1$ , and the two diodes ( $CR_1$  and  $CR_2$ ) form a balanced modulator. A balanced modulator has the characteristic of providing no r.f. output until modulation is applied. It works in the following manner: r.f. is fed to input jacks  $J_1$  and  $J_2$  and a push-pull drive is simulated due



to the action of potentiometer  $R_1$ . If, at any given instant, the r.f. waveform at  $J_1$  is positive-going, then the r.f. at  $J_2$  will be negative-going. The upper diode is connected to rectify the positive half cycles and the lower diode rectifies the negative half cycles. Thus, the net result at the junction of the two diodes will be zero r.f. and d.c. Because no r.f. exists at this point, no signal is coupled to the driver, a type 2N371. This is what takes place, with no modulation. However, when audio is fed to the balanced modulator an entirely different condition exists. Audio output from the 2N109 ( $V_4$ ) is coupled to the balanced modulator through the r.f. choke. During a positive half cycle of audio the lower diode will conduct more and the upper diode will conduct less, thereby unbalancing the circuit. During the next half audio cycle (negative) the opposite condition exists, that is, the upper diode conducts more while the lower diode conducts to a lesser degree. Thus, output from the balanced modulator will occur when modulation is applied. This output consists of an upper- and lower-sideband, with the carrier still suppressed. The sidebands are the heterodyne beat difference and sum frequencies between the modulation and the r.f. applied to  $J_1, J_2$ . As an example, if you whistled a one-kilocycle note into the microphone and applied an r.f. signal, at 14,000 kc., to the input, a lower sideband on 13,999 and an upper sideband on 14,001 kc. would be generated.

Output from the balanced modulator is applied to the driver transistor, a 2N371, and the amplified signal appears across  $L_1$ . This signal serves to drive the parallel-connected 2N370's as a class B single-ended amplifier. The greatly amplified signal appears across  $L_2$  and is coupled to the antenna through link coil  $L_3$ . Capacitor  $C_{10}$  tunes out the link reactance and serves to vary the amount of antenna loading.

A 2N109 transistor ( $V_4$ ) serves as the modulator. Bias is applied to the base through resistor  $R_6$  and the carbon microphone is connected from base to ground. The varying resistance of the microphone changes the amount of bias and collector current. The amplified microphone voltage appears across the modulation transformer which, in turn, drives the balanced modulator. No meter is included in the circuitry since it is only required for initial testing. In operation, everything is tuned for maximum r.f. output except  $R_1$  and  $C_1$  which are set for a null in the output. All adjustments can be made by watching the receiver "S" meter.

### Construction

The entire transmitter is assembled on a 5" x 7" x 2" aluminum chassis. The input jacks, diodes, and carrier-balance control are mounted on the left side of the chassis along with the driver transistor and associated tuning circuit. The variable capacitors are units that were on hand and do not match. Any similar capacitor that will resonate the

coils on the 10-, 15-, and 20-meter bands will be satisfactory. The final tuning capacitor is located in the center of the chassis beside the tank coil. A coaxial connector is mounted on the top of the chassis near the loading capacitor,  $C_{10}$ . The modulator circuit is wired on the right side of the chassis near the microphone connector. A grommet in the center of the rear apron is provided for the battery leads. The "on-off" switch is located on the battery pack.

### Adjustment

Once the transmitter has been tuned up no meters are used to measure the operation of the various stages. Initial alignment consists of setting up the balanced modulator and the r.f. amplifier stages.

Connect a six-turn link (#22 plastic-covered wire) to the input terminals,  $J_1$  and  $J_2$ . The diameter of this link should be such that it will fit snugly over the coil in the driving sources. Set the balance potentiometer to one end and adjust the link coupling for approximately 0.2 volt at the junction of the diodes and the r.f. choke. Move the voltmeter to measure the voltage across  $R_5$ . Tune  $C_7$  for a maximum voltage across this resistor. Next, connect a dummy load consisting of a #49 pink-bead pilot lamp, to the output jack. Adjust  $C_8$  and  $C_{10}$  for maximum r.f. output. Now, insert a milliammeter (0-15) in the cold end of the collector lead (between  $L_2-C_6$  and the negative battery lead) and measure the current drawn by the parallel-connected r.f. amplifier stage. It should be

around 5 to 8 ma. Alternately adjust  $R_1$  and  $C_1$  for a null in the collector current reading. If it is not possible to get the current down to 0.5 ma. with these two adjustments, move capacitor  $C_1$  over to the other input jack and repeat the adjustments. This capacitor is used to counteract the capacitive unbalance that usually exists in such a circuit. It may not be necessary at all. If the best carrier null occurs at minimum capacity on either input terminal, then leave it out of the circuit.

Talking into the microphone will cause the collector current of the 2N370 stage to kick from less than 0.5 ma. to something more than 5 ma. The amplifier stage starts to flatten out at 7 or 8 ma. but you will have to talk into the microphone quite loudly to reach this condition. Use a normal speaking voice, or just a little louder than normal.

The alignment can be checked occasionally by using the receiver "S" meter. Adjust  $C_7, C_8$ , and  $C_{10}$  for maximum r.f. output and  $R_1-C_1$  for a null in the carrier energy. Make sure that the receiver is picking up the output from the DSB transmitter (and not the carrier source) or it may not be possible to detect a null.

When the band conditions are optimum, it is entirely possible to work clear across the country with this rig, particularly on the 10- and 15- meter bands. If desired, the little rig could be used to drive a vacuum-tube amplifier. Such an arrangement would be particularly useful in a mobile application where battery power is somewhat limited.

-30-

Fig. 1. Schematic diagram and parts listing for the double-sideband transmitter.

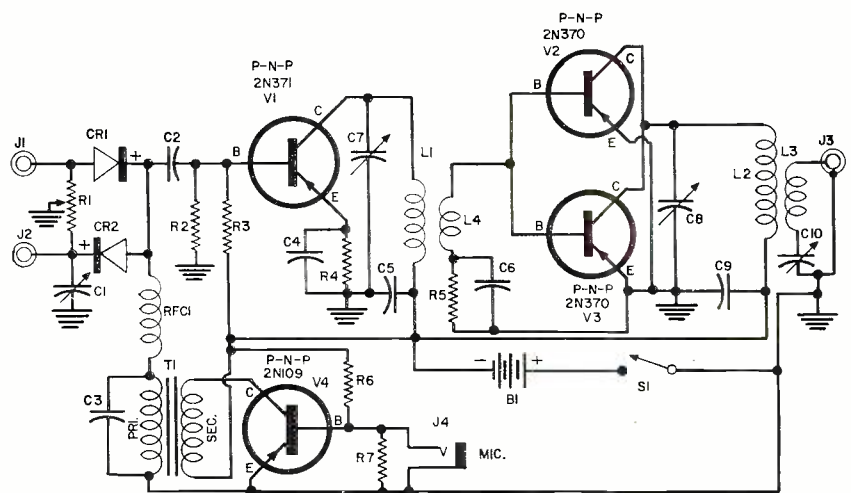

- $R_1$ —1000 ohm linear taper pot (Allen Bradley "J" type)
- $R_2$ —10,000 ohm,  $\frac{1}{2}$  w. res.
- $R_3, R_6$ —220,000 ohm,  $\frac{1}{2}$  w. res.
- $R_4$ —180 ohm,  $\frac{1}{2}$  w. res.
- $R_5$ —3300 ohm,  $\frac{1}{2}$  w. res.
- $R_7$ —22,000 ohm,  $\frac{1}{2}$  w. res.
- $C_1$ —7-45  $\mu$ f.d. rotary trimmer capacitor (Centralab Type 882)
- $C_2$ —0.1  $\mu$ f.d. disc ceramic capacitor
- $C_3, C_5, C_6, C_9$ —0.05  $\mu$ f.d. disc ceramic capacitor
- $C_4$ —0.01  $\mu$ f.d. disc ceramic capacitor
- $C_7$ —5-50  $\mu$ f.d. variable capacitor (E. F. Johnson 50J12)
- $C_8$ —6.5-50  $\mu$ f.d. variable capacitor (E. F. Johnson 50R12)
- $C_{10}$ —25-450  $\mu$ f.d. compression padder
- $J_1, J_2$ —Binding post

- $J_3$ —Coax connector, u.h.f. style
- $J_4$ —Jack to match carbon mike used
- $S_1$ —S.p.s.t. toggle switch
- $CR_1, CR_2$ —1N34A diode rectifier
- $RFC_1$ —2.5 mhy. r.f. choke
- $B_1$ —12-volt battery
- $L_1, L_2$ —8 t. #20 tinned wire,  $\frac{3}{4}$ " dia., spaced  $\frac{3}{32}$ " (1" Air Dux #608)
- $L_3$ —3 t. #20 plastic covered wire, wound at cold end of  $L_2$
- $L_4$ —4 t. #20 plastic covered wire, wound at cold end of  $L_1$
- $T_1$ —Interstage trans., 10,000 ohms to 2000 ohms (Triad TY-56X)
- 1—5" x 7" x 2" chassis
- $V_1$ —"p-n-p" transistor (2N371)
- $V_2, V_3$ —"p-n-p" transistor (2N370)
- $V_4$ —"p-n-p" transistor (2N109)

## DEFECTS IN THE SYNC SECTION

By **WALTER H. BUCHSBAUM**, Television Consultant, RADIO & TV NEWS

In all of the cases listed below we assume that the service technician has tried adjusting all of the controls in front and back of the set and that, aside from the symptoms listed, the rest of the set works correctly. If other defects are combined with trouble in the sync section, each suspected preceding stage of the receiver should be checked before the next one is tackled.

SYMPTOMS	CLUES	LIKELY SOURCE OF TROUBLE	CORROBORATIVE TESTS	REMEDY
Loss of vertical and horizontal sync irrespective of signal.	Vertical and horiz. hold controls can only sync picture for a moment.	Sync clipper and amplifier circuit.	Scope check at input of sync separator will show video signal but nothing will be fed to the vertical and horiz. oscillator.	Check and replace tubes, signal trace sync pulses to find the component where the sync disappears.
Loss of horiz. and vertical sync on weak signals only.	Vert. sync only locks on max. contrast control settings.	Weak tube in sync separator or amplifier.	Set horiz. and vert. hold controls exactly then vary contrast control.	Replace tube.
Loss of vertical sync irrespective of signal strength; horiz. sync is perfect.	Vert. hold control does not seem to "snap" picture in but slows it down for a while only.	Integrator network.	Replace tubes in vert. oscillator, sync separator. Scope check for presence of 60 cps sync pulse at vert. oscillator with that tube removed.	Replace defective component or entire network.
Loss of vertical sync on weaker stations; horiz. sync is perfect.	Picture background has uneven shading.	Incorrect i.f. response curve.	Use fine tuning control to improve vertical sync.	Re-align i.f. so that high i.f. frequency portion is flat enough.
Loss of vertical sync on less than max. contrast; horiz. sync is perfect.	Picture looks flat unless contrast control is set to max. and brightness is adjusted accordingly.	Low-frequency boost network in video amplifier.	Scope check: Amplitude of 60 cps sync will be much less than 15.7 kc. sync pulses at the input to the sync. separator.	Check and replace electrolytic capacitor connected to the plate load of the video amp.
Loss of horiz. sync irrespective of signal; vertical sync slips sometimes.	Horiz. hold control fails to lock picture in. Vert. hold control is critical. Sometimes vert. locks in on hum when sync is lost.	Sync separator, sync amplifier.	Adjust locking-range, horiz. frequency and phasing for momentary horiz. sync. Scope check sync pulse amplitudes.	Replace tubes. Check voltages and signal trace with scope to find defective component.
Loss of horiz. sync on weak signals.	Max. contrast helps to lock picture in.	Weak tube in sync separator, amplifier.	Scope check on output of sync section will show great amplitude difference between weak and strong stations.	Replace tube.
Bending of vertical lines on strong signals.	Reduction of contrast control setting helps to reduce this raster distortion.	A.g.c., sync clipper.	Scope check will show video signals at the horiz. sync pulse output of the sync separator.	Replace tubes; check clipper bias and RC network.
Top of picture bent, especially on strong signals.	Adjustment of horiz. hold does not eliminate this symptom.	Sync clipper or limiter.	Scope check on vertical sweep at the output of the differentiator for presence of equalizing pulses.	As above.
All vertical lines are bent in the middle of the picture.	Poor vertical hold on remote telecasts.	Hum in sync circuits.	Set vertical hold to let picture slip up slowly and observe movement of the distortion. Scope check the vertical sync output for 30- or 120-cps hum.	If 60-cps hum occurs in full-wave rectifier set, filament-to-cathode leakage in a tube is causing it. Otherwise check "B+," grounds, and wires for hum.
Loss of horiz. sync as set warms up; as scenes change; a.c. line varies, etc.; vertical sync is perfect.	Horiz. hold control is very sensitive, locking range control must be set for max.	Weak sync amplifier or defective differentiating network.	Scope check amplitude of horiz. sync pulses at output of differentiating network.	Replace sync amplifier tube, replace horiz. sync coupling capacitor
Loss of horiz. sync irrespective of adjustments; vertical sync is perfect.	Re-adjustment of horiz. frequency just about brings picture in, but no horiz. locking action is obtained.	Differentiating network or horiz. sweep signal feedback.	Scope check output of differentiating network and check if a feedback signal from the horiz. sweep is supposed to be present.	Signal trace with scope and replace defective component.
Picture tears on ignition or other noise.	Adjustment of horiz. hold and locking control does not prevent tearing.	Sync amplifier or limiter.	Scope check at limiter output will show noise pulses larger than sync pulses.	Replace tubes, check limiter bias and plate voltage to find defective component.
Pairing of horiz. lines; vert. and horiz. sync are perfect.	Pairing can be eliminated for a while by adjustment of the vert. hold control.	Vert. sweep signal is fed back to vert. sync pulse section.	Remove sync separator tube and scope check input and output of integrating network for vert. sweep signal.	Reroute vert. yoke wires, vert. output transformer leads, shield integrating network.

**S**TEREO is big news these days and naturally everyone wants "a piece of the cake." The gimmick artists are well in evidence. This is a pity, because stereo can get quite confusing enough if we stick to the strictly legit end.

"Hear your hi-fi in three dimensions!" is the substance of some stereo promotion, which carries the implication that, until now, our poor little ears must have been struggling along in only two—or that we have only been using one ear! The fact is that, for two-eared people, listening has been a stereophonic experience from birth. So what do we really expect stereophonic sound to add to high fidelity?

This is the first thing we should get straight. It will help us a lot in understanding how to pick and use loudspeakers to get the best from stereo program material. Single-channel high fidelity, nowadays called monaural (which admittedly is not a good name, because it means "one-eared") or monophonic, has the limitation that an original performance occupying four dimensions (waves in three-dimensional space and time) must be compressed into two (*magnitude of fluctuation with*

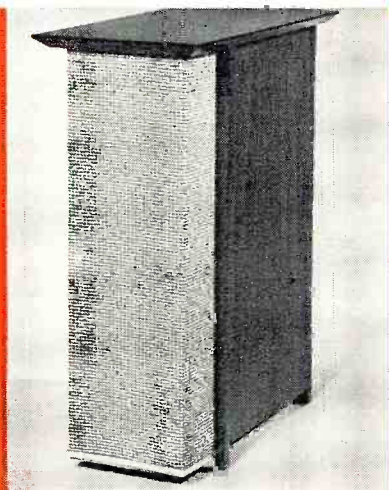

University "Stereoflex II"



Ampex Model A-423



Bozak Model B-304



General Electric A1-406

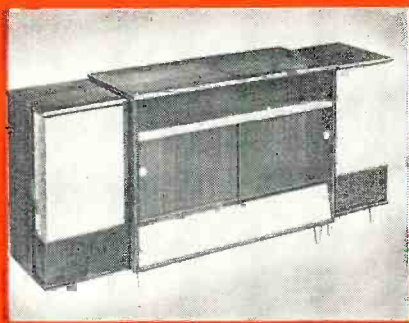

Heathkit SE-1 and SC-1's

## Loudspeakers for Stereo

By NORMAN H. CROWHURST

### PART 1 What speaker system should you use for stereo? This article will help you to make a choice.

*time*) for recording or transmission. This must lose some of its identity, although the reproducer puts it back in four dimensions again. But it is impossible, from the limited "data" that can be conveyed in a two-dimensional channel, to reconstitute the original with four-dimensional precision.

Our hearing faculty has acquired the capacity to give us a quite accurate impression of the four-dimensional events going on around us from an analysis of two "two-dimensional channels," one received by each ear. But analysis and synthesis are different things.

Our hearing faculty can give a wonderful sound picture of the world around us from this analysis; but it would be quite impossible to use this two-channel-transmitted sound picture to recreate the world of sound: a dummy head with the most complex electronics in the world could not *produce* the noise of an aircraft 5000 feet up! Nor can two loudspeakers project an orchestra. This idealized concept of



Hartley 217-Duo

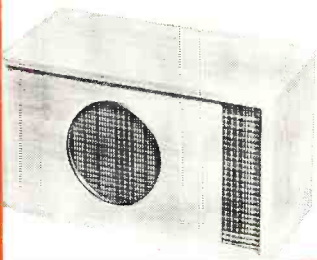

Sonotone "Ceprice"

stereo is certainly a basic fallacy.

The viewpoint that is more successful as an approach to stereo is that conveying the total sound on two channels gives us twice the potential that one does for achieving a realistic illusion. In particular, this potential lies specifically in the improvement of perspective.

So we should visualize stereo as a system in which, basically, we have two channels instead of the one used in mono. This may seem obvious, but it is the only thing that is *basic* in stereo. Beyond these two channels, the success of the illusion depends on what is done at their two ends: the microphone and recording technique at the input; and the playback and loudspeaker arrangement at the output.

Each of these variables provides the possibility for a wide variety of combinations. Microphones with at least three variations in directivity can be used in any number and placement, and their outputs combined in different ways to produce the final two stereo

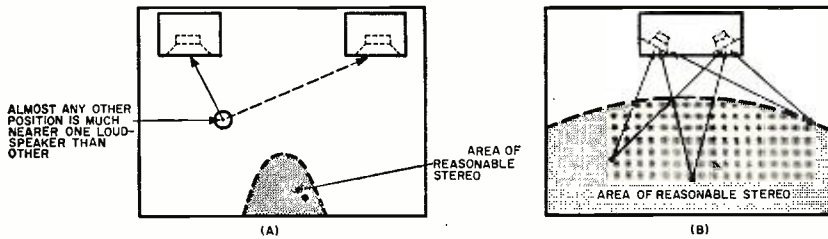

Fig. 1. Spaced speakers in a small room (A) may restrict the area of acceptable stereo. The composite system in a single enclosure (B) may do a better job here.

channels. There is an almost similar range of possibility for variation in the use of loudspeakers.

But we've said enough to show that stereo is not the simple thing some theorists have suggested. Instead of proceeding further on how complicated it can get, let's deal with some specific questions.

1. Some recommend a stereo system with two loudspeaker systems in a single enclosure, while others insist stereo can only be obtained with two speakers spaced apart along a wall. Which is best?

This depends. Each can be "best" in circumstances suited to it. Probably most important of these is room size. In a small room it is practically impossible to find more than a very small listening area where one is not much nearer to one speaker than the other, if

spaced units are used. (Fig. 1A). By using a single enclosure system, all parts of the room are at a commensurate distance from the two loudspeakers (Fig. 1B) and the stereo pattern is created in any location by the transverse component of the sound wave, caused by the *difference* in radiation from the two units (Fig. 3).

But in larger rooms the relative merit is almost exactly reversed. The transverse component of the wave only holds a reasonable strength for a very small distance from the composite loudspeaker system, so the successful listening area will be confined to a narrow line down the middle and a slight enlargement right at the front (Fig. 2A). On the other hand, the larger room dimensions enable spaced speakers to "push out" the stereo effect further and only comparatively small areas of the room are now uncomfort-

ably close to one speaker (Fig. 2B).

A secondary factor is the way the program was miked. This may be a deciding factor in medium-sized rooms—say about 15' by 20' or a little larger. The hearing faculty bases its analysis on the time difference of various sound components in the composite wave *reaching each ear*. But to maintain this correct time difference, without exaggerating or reducing it, proper proportion must be kept between time and intensity differences.

If widely spaced mikes are used for pickup, combined with widely spaced loudspeakers for playback, the time difference is going to get exaggerated at some listening locations in the room to the point where an echo, or double image, rather than perspective results. This would be particularly pronounced on material such as strings played *pizzicato*.

On the other hand, if time difference on the channels is small and intensity difference has been accentuated, either by using directional mikes close together but facing different directions or by using electronic mixing of mikes close in to individual instruments, the "projection" of the stereo illusion will be strictly a function of speaker spacing to "create" a time difference at the listener's ears.

Thus, within certain room size limitations, program made with a wide-spaced mike technique should use loudspeakers close together (in one cabinet) while program that used close-together (directional) mikes should be reproduced on widely spaced loudspeakers.

2. Different, and quite conflicting, statements have been made about the contribution made by various parts of the audio spectrum to the stereo illusion. Just what are the important "stereo" frequencies?

Unfortunately, a lot of work has been done using continuous steady tones, either fed through headphones or using multiple loudspeakers. From these experiments various deductions have been made as to the dependence of our sense of direction on intensity and phase differences at different frequencies. The deductions conflict because of different measurement techniques.

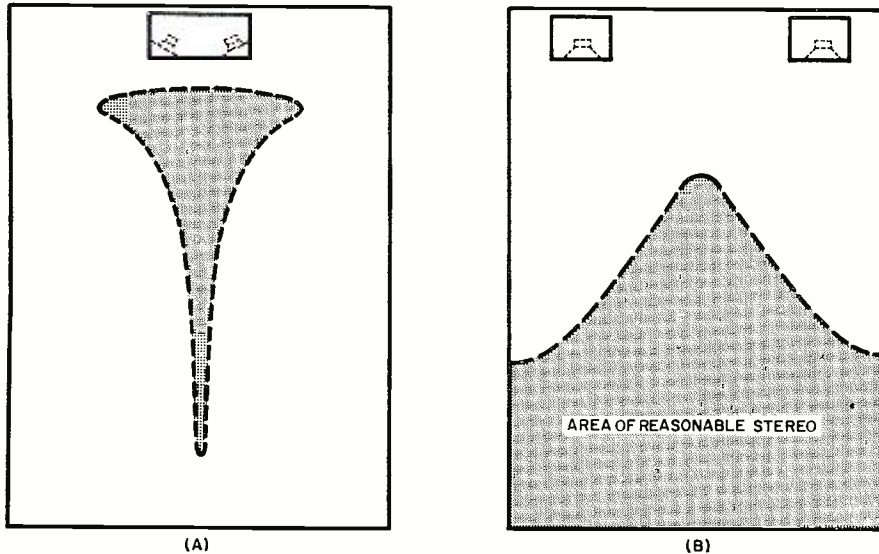
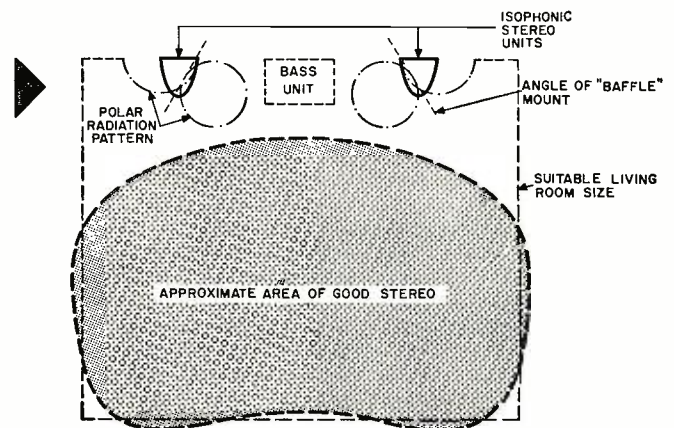
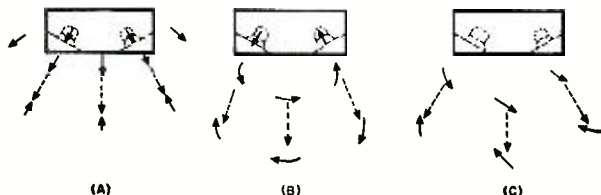

Fig. 2. Composite system (A) may be limited in coverage of larger room. Spaced speakers (B) may do a better job here.

Fig. 4. Coverage claimed for CBS "Isophonic" system.

Fig. 3. Synthesis of radiation with both units in-phase (A), out-of-phase (B), and when radiation represents a source to extreme left (C). Solid arrows are instantaneous motion due to sound wave; broken arrows are used to represent the progress of the sound waves in their composite development.



However, other work shows that these results are not relevant to the stereo illusion perceived on "live" sounds. A particularly effective demonstration of this fact occurred in work with the *Perspecta* system of stereo for theaters. If, for example, the initial beat of a drum is accurately located by the stereo illusion, it is practically impossible to tell that the follow-through "oing" shifts clear across stage, *even when you know it does.*

This is equally true of other types of sound. Only sounds generating transient components continuously, such as speech or a succession of different notes being played, enables a moving source to be followed. A tone containing repetitive sharp transients, such as an aircraft motor, will also make this possible.

The hearing faculty seems to identify the direction of the *composite* transient, rather than of individual *frequencies* it contains. If the time difference is identical for all these component frequencies, then the sense of "integrity," both of position and the sound itself, is improved.

But what does this mean, as applied to reproducers for stereo? The difference in conclusion largely concerns the higher frequencies, from 1000 or 1500 cycles up. It occurs because different methods are used to "generate" the right differences at the ears of the listener.

With the wide-spaced loudspeakers, difference in intensity of radiated sound produces a time difference at the ears, due to the obstacle effect of the head, that depends on frequency. At higher frequencies the difference is likely to be altogether greater than for lower frequencies, invalidating a proper association of the high-frequency components with the lower ones. So with this arrangement, it is not surprising that critical tests show that the very-high-frequency components do not contribute anything to the stereo illusion.

With speakers close together, and employing directional radiation, the higher frequency contribution to the stereo illusion is due to the precedence effect. A speaker directly facing the listener, and having the greater intensity, will localize itself as the source. If the higher frequencies come from the other speaker in greater intensity, however, the source will be delocalized and the hearing faculty will associate, by comparison, these components with the lower frequencies to which they belong. Thus use of a different type of speaker enables the higher frequencies to contribute a useful part to the stereo illusion.

3. *What about the statement that the same loudspeakers used on stereo show an improved frequency response?*

Common sense urges that this cannot be so—how can a loudspeaker "know" whether it is handling mono or stereo? And yet people who have experimented with it swear they can hear the difference.

Extension of apparent range at the

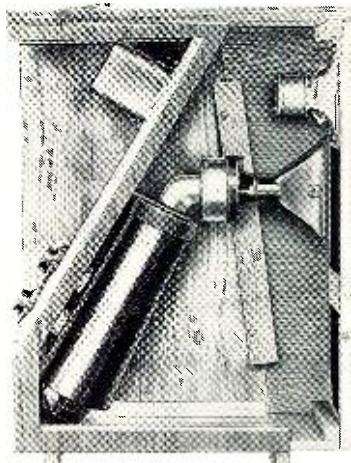

Electro-Voice "Stereon" interior

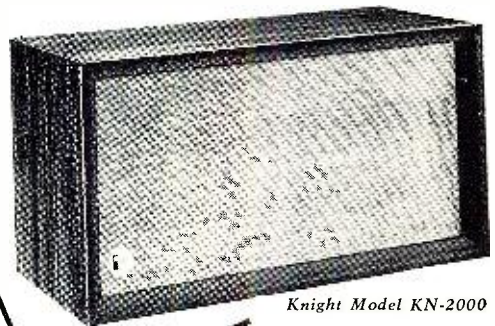

Knight Model KN-2000

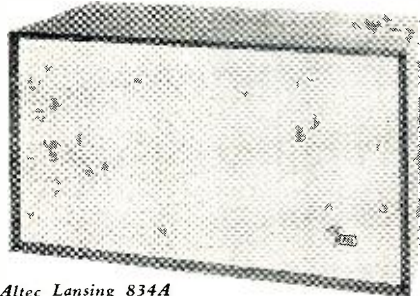

Altec Lansing 834A



EICO Model HFS-2

low end is relatively simple and there is little argument about it. Two units, even on the same program, will put out more bass than one, other things being equal. The same improvement in this direction naturally shows up on stereo. But this cannot be the reason at the high end.

Did you ever hear any audio components above 4000 or 5000 cycles? You've heard background hiss in this range and you've heard the improved clarity of certain instruments when this range is there, compared with when it is missing. But have you heard those components *by themselves*? This is the answer. You identify presence of these frequencies by the improved clarity they bring to individual instruments you could *hear* without them.

Stereo also does this, by a different means. It improves clarity of individual instruments by giving them separate localization. And because both effects serve the same purpose to the hearing faculty—improved clarity—it takes an unusually well-educated hearing to detect the difference. A definite illusion of improved high-frequency response—as we have become familiar with it—is obtained.

4. *What about the idea of using one speaker for all the bass with separate speakers for treble?*

Some say this can be done—in fact they do it, while others say separation of the lower frequencies into the two channels is definitely necessary to stereo. This question hinges on "lower than what?" What crossover is used? I asked one speaker manufacturer who took the second viewpoint what crossover he used. He had only tried it with

one of his regular units, using his regular crossover at a frequency of 1000 cycles.

There's your answer. The people who do it successfully use a crossover of 250 cycles—two octaves lower—or at the highest 400 cycles. This makes a tremendous difference. At 250 cycles the wavelength of sound in air is more than 4 feet; at 1000 cycles it is only just over 1 foot.

At frequencies far below 250 cycles (which in theory may be marginal, but those who use it have checked that it is a satisfactory transition point) the frequency content of both stereo channels is not only sensibly in-phase, there can also be little difference in intensity. So no noticeable "error" is involved by "putting the two together."

"But how about transients?," I have been asked. Now just what is a low-frequency transient? Some visualize a low frequency, below 250 cycles, that starts abruptly. But a low-pass filter, rolling off at 250 cycles, will not allow such an abrupt start. If a 250-cycle tone is keyed on, or started with a blast, this start will contain a range of components *above 250 cycles*, not below it. And the click, or burst, associated with the commencement of the 250-cycle tone, will identify its location quite successfully, even though the body of sound always comes from the center loudspeaker!

At one demonstration of a common-bass system, I went to within about two feet of one of the small speakers (they were over 20 feet apart) before my ears could tell the bass was coming from somewhere else. So it definitely works—at that frequency.

(Continued on page 100)

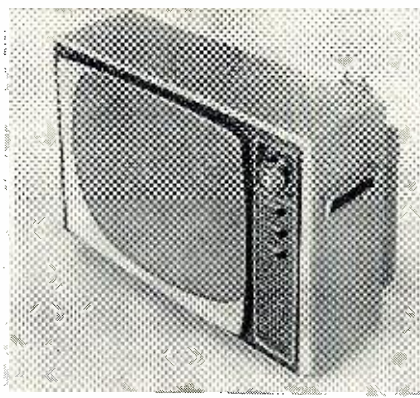

G-E 21T2425



# New TV Designs for

# 1959



By **WALTER H. BUCHSBAUM**  
Television Consultant, RADIO & TV NEWS

**A broad survey of innovations, trends, and new features for a roster of 15 set manufacturers.**

*EDITOR'S NOTE: Considering that really new design developments in TV circuitry are on the wane, there are a surprising number of features and trends worth noting in this year's receiver lines. Technicians interested in the latest circuits will also appreciate the complete schematics for some of the leading 1959 receivers, appearing on pages 74 through 79 of this issue.*

**A**S IN past years, we look at the new crop of TV receivers to find new features, spot major trends, and highlight what is of interest to the service technician. The 1959 models have many things in common but at the same time there are sufficient variations, special features, and unique circuits to warrant some discussion. Before looking into individual features, a few general observations are in order.

There are no startling developments in the form of new circuits or new principles. None of the manufacturers offers a transistorized TV receiver, none of them has perfected a truly flat picture tube, and the long-heralded breakthrough in color TV is still in the "heralding" stage. Actually, the growth of color TV is quite steady, if limited, and the most energetic manufacturer in this field, *RCA*, is gaining ground constantly. Unlike the advent of TV, color seems to infiltrate rather than flood the American home. Installations in clubs and other public places provide

**Sylvania "Dualette"**

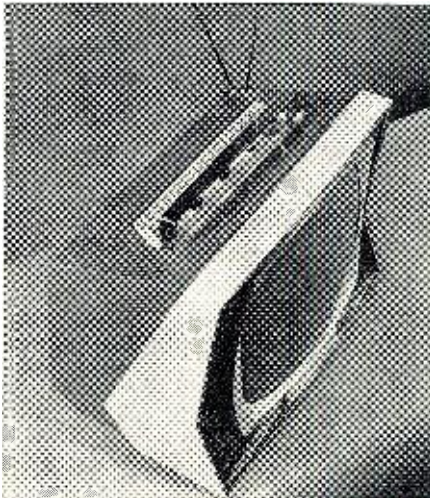

**Emerson 1452**

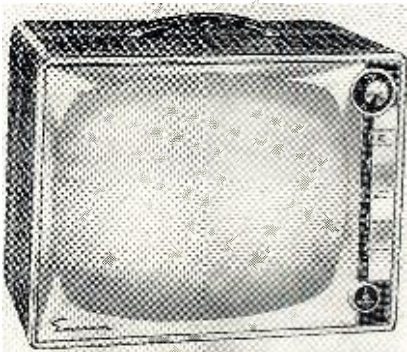

the potential customer with a preview of what he can get for his home. However, the purchase of a color set remains a "future project" with all too many prospects.

The design trend in 1959 TV receivers has continued in the direction predicted last year. The 110-degree picture tubes are used by a majority of manufacturers and at least two, *Philco* and *Sylvania*, have even managed to trim some depth off the already shortened tube. To further aid the trend toward slimmer TV sets, several manufacturers are offering contoured cabinets that give the impression of being much thinner than they actually are. Cabinets made of new, strong plastics or of steel are being used for almost all portable and table models. Wooden cabinets are favored mostly for the more expensive consoles.

For years service technicians as well as the service managers of the various manufacturers have stressed the need for "service-designed" TV sets. For the most part, 1959 will continue to hear such demands. While a few manufacturers have made some concessions to serviceability, the general trend towards more compact receivers has overruled many worthwhile service features. Being grateful for little things, we should, however, mention the designs where the chassis weight has

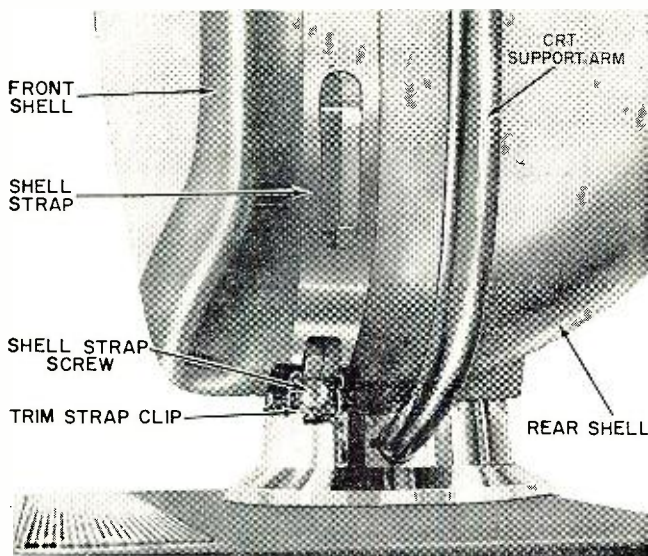

Fig. 1. Some mounting details for the unorthodox separate housing of the picture tube used in many Philco receivers.

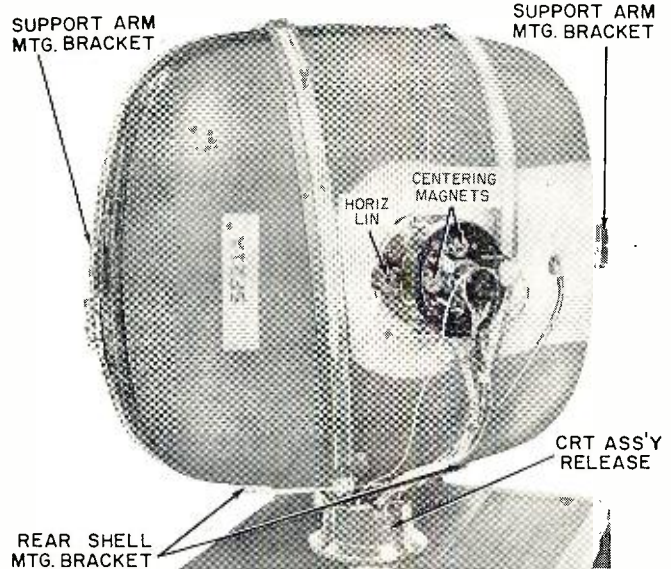

Fig. 2. Another view of the Philco CRT assembly, showing the points where the support arm attaches to the strap.

been reduced, where the picture-tube safety glass can be removed by unscrewing less than a dozen screws, and where part numbers are included on printed wiring to help the technician find his way in the labyrinth of the printed pattern.

As concerns new tube types, only the tube manufacturers can smile. Most receivers use new tube types, usually sufficiently different to require exact replacement, yet not really different enough to result in a new or vastly improved circuit. Typical of this is the case of the 1G3/GT, which is ostensibly a replacement for the 1B3. It fits into the same socket, has the same electrical characteristics, and the 1B3 can, in general, be replaced by the 1G3. In some sets, however, the 1G3 must be used because the 1B3 is just a little too long for a physical fit in tight quarters.

Surprisingly enough, a number of set manufacturers have retained (or returned to) power transformers even in their portable sets and use the familiar 5U4 as a rectifier. Only a few new sets use silicon or germanium rectifiers and there are still some models with selenium rectifiers. In the field of circuit design, practically every manufacturer uses some type of more advanced, more elaborate, or at least improved sync circuit. Horizontal-oscillator and fly-back sections remain basically unchanged, but more efficient component design provides the greater deflection power required for the 110-degree picture tubes. Second-anode potentials have been raised in most sets by 1 to 3 kv. to give more brightness and small spot size to improve definition. In the vertical-sweep circuit there is a continued trend away from use of a blocking-oscillator transformer. Most sets use some form of combination multivibrator and output amplifier.

The i.f. and video sections are also unchanged but there has been some improvement in TV tuners. Use of the "Fireball" or similar types of tuner is

Fig. 3. Subchassis layout conforms to CRT contours in the Philco portables.

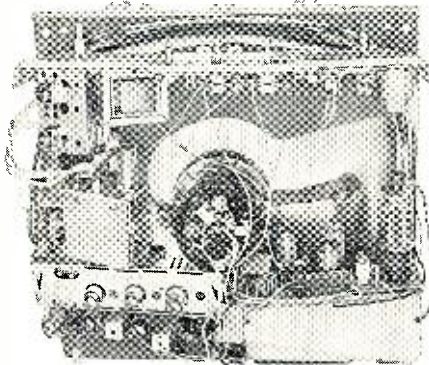

widespread and some sets use the relatively new miniaturized tuners. In the detailed discussion following, some automatic-frequency-control schemes are described. Almost every new TV set uses some form of the gated-beam or quadrature-type FM detector circuit in conjunction with a single audio-output tube. Despite persistent advertising of high-fidelity sound in TV receivers, very few manufacturers (*Hoffman* and *ATR* are two examples) go as far as using push-pull output. So much for the general trends.

### Philco

The new *Philco* models are by now well-known for their slim look and separation of picture tube and chassis. As far as the service technician is concerned, the disassembly procedure for this unorthodox receiver is more important than its depth. As shown in Fig. 1, the shell is held to the picture-tube assembly by two screws visible just below the rim of the picture tube. The support arm is attached to the main strap, as shown in Fig. 2. To change the picture tube, the two bolts on each side of the main strap must be loosened and the two rear support straps taken off. It is also possible to take the entire swivel socket off by loosening the screw ("CRT Ass'y Re-

lease") shown in Fig. 2. The chassis is mounted horizontally in the small cabinet below and, in order to even change a tube, the rear of the cabinet must be removed, the knobs must be pulled, the chassis mounting screws unscrewed, and the entire chassis pulled out. For the service technician, this arrangement can hardly be considered convenient.

In its portable models, *Philco* uses a number of subchassis, both printed-wiring and conventional, and these small units are located around the picture tube as shown in Fig. 3. This is not quite as convenient as a single-chassis structure, but the experienced service technician should find no particular difficulty with this arrangement. *Philco* uses series filaments, silicon rectifiers, and printed wiring on some of the sub-assemblies. Circuitry is essentially conventional, with no startling innovations to be found.

### RCA

This manufacturer is apparently playing a very conservative tune this year. All receivers use power transformers, even the portables. Printed wiring is used, as in previous years, and the over-all circuitry is also the same. After problems encountered in the disassembly of certain of its portable sets in past years, the new portables have been designed to be serviced rather easily. There is definitely more room and it is not necessary to dismantle several subchassis in order to change a tube.

Most *RCA* sets use either the 1B3 or the new 1G3 high-voltage rectifier tube. In some sets, the longer 1B3 doesn't fit so service technicians will have to start stocking the 1G3. (See "1959 Tube Inventory for Service Shops," page 57 of this issue.)

Wireless remote control for both monochrome and color TV receivers is one of the novel features offered by *RCA*. The transmitter unit is a transistor oscillator, operating around the 40-kc. region, with different specific

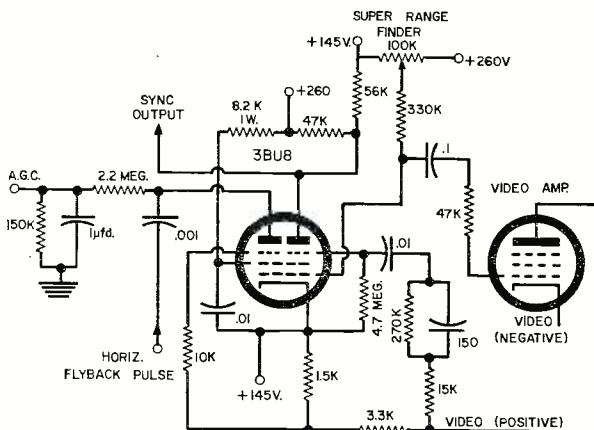
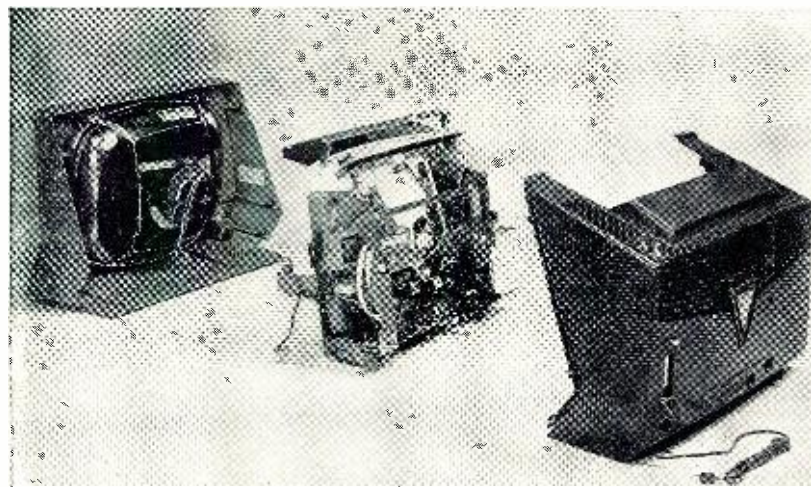

Fig. 7. Combined sync separator and noise gate, Admiral.

Fig. 4. Three-part disassembly of the Sylvania "Dualette" leaves the chassis separate (center) with convenient handle.



frequencies controlling specific functions. The black-and-white remote control transmitter uses three transistors and a 13.5-volt battery, while the color control transmitter employs a single power transistor and a 6.5-volt battery. Noteworthy in the color sets is a considerably improved convergence circuit.

### Sylvania

The major innovation by this company is its "Dualette" 17-inch portable which uses an injection-molded plastic cabinet, 110-degree picture tube, germanium rectifiers, and a single printed-wiring assembly for all the smaller circuitry. It is one of the few new receivers that uses a ratio detector and separate audio-driver stage. Otherwise the circuitry is not radical in any respect. Most of the other *Sylvania* models have been on the market for some months.

As to service accessibility, the "Dualette," intended to serve either as a portable or a table receiver, or both, has some noteworthy layout features. When the back cover is removed (just a few simple screws are involved), the vertically disposed chassis is readily available, with access to all tubes and most parts. For more involved bench work, the entire chassis may be easily separated from the picture-tube assembly, which remains with the forward portion of the cabinet. This three-part design is illustrated in Fig. 4. Furthermore, the carrying handle for the entire receiver remains connected to the middle section (chassis portion). Gripping the handle, the bench man can now maneuver the chassis into any position his work requires with a twist of the wrist and enjoy apparently good accessibility to any circuit.

A resettable thermal cut-out, instead of a fuse, is a convenience to the set owner and also to the service technician who is looking for a short circuit.

### Westinghouse

Like most set manufacturers, *Westinghouse* uses printed wiring, a pentagrid sync separator and noise-canceling scheme, and the gated-beam FM detector. It also uses silicon rectifiers

and an unusual "automatic fine tuning" circuit. Although this circuit has been described before in this magazine, it is still unusual in that it depends on amplifying the 4.5-mc. sound i.f. signal and operating on the peak of its response.

The *Westinghouse* design is noteworthy in two respects. Its remote control system appears to be the only one to rely on power-line carrier operations and it also features a resettable thermal cut-out. A range of carrier frequencies from 52 to 73 kc. is used, generated at the remote-control unit, and sent out via the a.c. power line to the set. This eliminates the need for radiating elements, such as a ferrite antenna or a transducer and receiving microphones. The thermal cut-out, shown in the functional drawing of Fig. 5, should be a real boon to the service technician. It does the same job as the fusible resistor, but it can be reset as often as necessary during a troubleshooting job.

### Zenith

This company, one of the few that

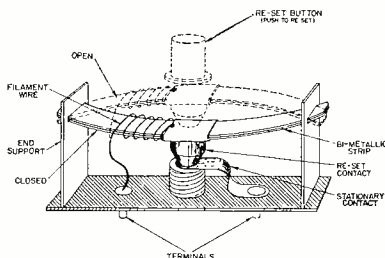
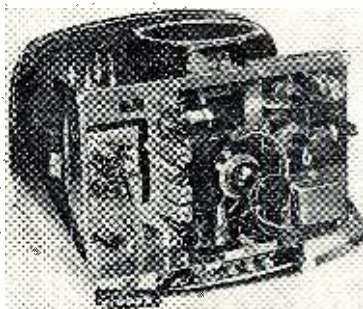

Fig. 5. Westinghouse thermal cut-out.

Fig. 6. Satchell-Carlson portables use two separate, vertical chassis.



has not adopted printed wiring, advertises this fact as a benefit to both the set owner and the technician. Certainly conventional wiring appeals to most technicians as being easier to service and the fact that *Zenith* uses all horizontal chassis, most with power transformers, is a further aid to the hard-pressed technician. In many other respects the *Zenith* chassis do not contain either radically new circuitry nor are the remote-control and automatic-tuning features radical departures from earlier versions.

### Motorola

This year, *Motorola* has also decided to swing over into the "no-printed-wiring" camp. It is also boasting of the use of "conventional wiring only" in its TV chassis. It continues to feature its well-received "Tube Sentry" which protects tubes and other parts against the sometimes damaging initial surges which occur when a receiver is first turned on. On the basis of this feature, plus the use of tubes said to be carefully selected after critical testing, this manufacturer is offering extended warranties.

An interesting innovation is the use of tube types normally found in series-heater circuits in conjunction with a power transformer that has a 6.3-volt filament winding. Two 3BZ6's, for example, appear in the video i.f. section. The heaters of these two are in series, but the pair is shunted across the 6.3-volt winding of the power transformer. The same is true of two other pairs of 3-volt tubes.

### Admiral

As one of the large volume manufacturers, *Admiral* offers a variety of different models. Most have power transformers and circuit features which are largely conventional. One unusual tube is the 3BU8 which acts as a noise gate and sync separator. As shown in the circuit of Fig. 7, this tube contains two separate suppressor grids and two separate plates with the rest of the tube elements common to both sections. One

(Continued on page 132)



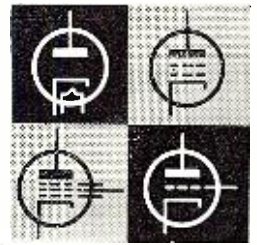

# Tube Inventory for Service Shops

Do you know which tube types to carry, or how many of each to keep in stock?

# 1959

**A**ND STILL they come. With no end in sight to the stream of new tubes, a well-planned inventory isn't easy. Our shop uses a perpetual check system based on the minimum quantity list shown here. Inventory should be compared to the list, every morning if possible, to determine the need for re-ordering types in short supply.

The quantity figures are, of course, relative. For example, a large enough shop might have to multiply by two. Variations may occur with differences between one locality and another, but needed adjustments are easy to make as you go along.

With the list geared to metropolitan shops in v.h.f. areas, u.h.f. tube types must be added where needed. Since the importance of industrial electronic(\*) and color TV(\*\*) service may vary widely, tubes involved have been marked as indicated.

Some tubes still active a year ago were deleted because demand vanished. These include several loctal and 117-volt types, as well as 6AQ7 and 25Z5. While the new list is only

slightly larger than that for 1958, such a comparison does not reflect the facts. Tubes dropped were older, low-quantity types, while additions and some holdovers are finding heavier use.

Also, some reduction has been achieved by doubling up. For example, the 25BQ6/25CU6 replaces both prototypes. Also the physically shorter 1G3 replaces the 1B3 (no longer listed separately), although reverse compatibility is not always physically possible.

Some relatively new types, like the 6BV8, have been dropped. They seem never to have "got off the ground," with no calls developing for them.

-50-

Type	Quan	Type	Quan	Type	Quan	Type	Quan	Type	Quan	Type	Quan
0A2*	2	5CG8	1	6BA8	1	6CR6	1	7B5	1	12L6	1
0B2*	2	5CL8	2	6BC5	6	6CS6	2	7B6	1	12SA7	2
0Z4	5	5CQ8	2	6BC7**	1	6CS7	1	7B7	1	12SG7	1
1AX2*	3	5J6	2	6BC8	2	6CQ8	1	7C5	1	12SH7	1
1G3/1B3	10	5R4GYA*	5	6BD4A**	1	6CUS	2	7E5	1	12SJ7	1
1R5	2	5T8	2	6BD6	2	6CZ5	1	7F7	1	12SK7	3
1S4	2	5U4GB	10	6BE6	5	6DE6	1	7F8	1	12SL7	1
1S5	2	5U8	2	6BF5	2	6DQ5**	1	7G7	1	12SN7	4
1T4	2	5V4G	3	6BF6	2	6DQ6	5	7H7	1	12SQ7	3
1U4	2	5X8	2	6BG6	6	6DS5	1	7N7	1	12V6GT	5
1U5	2	5Y3GT	4	6BH5	1	6DT6	1	7Q7	1	12W6	2
1V2	2	6AB4	4	6BH8	1	6E5	1	7X7	1	12X4	2
1X2B	5	6AC7	5	6BJ6	1	6H6	1	7Y4	1	17AV5	1
2D21*	2	6AG5	5	6BJ8**	1	6J5	3	9BR7	1	17AX4	1
3A2**	2	6AG7	3	6BK4**	2	6J6	6	10DE7	3	17DQ6	1
3A3**	2	6AH4	2	6BK5	2	6K6GT	6	12AL5	1	19AU4	2
3AL5	2	6AH6	3	6BK7A	3	6L6	1	12AQ5	1	19BG6	1
3AU6	2	6AK5	2	6BL4**	1	6M3**	1	12AT6	2	19T3	1
3AV6	1	6AK6	1	6BL7	3	6S4	4	12AT7	6	25AX4	1
3B2**	2	6AL5	10	6BN6	3	6S8GT	1	12AU6	1	25BK5	2
3BC5	2	6AL7GT	2	6BN8**	1	6SA7	3	12AU7	10	25BQ6/CU6	4
3BE6	2	6AM8	2	6BQ6/CU6	10	6SC7	2	12AV6	2	25CD5	1
3BN4	1	6AN8	4	6BQ7A	10	6SF5	1	12AV7	3	25DN6	2
3BN6	2	6AQ5	4	6BR8	2	6SG7	1	12AX4	5	25L6	4
3BU8	1	6AQ6	2	6BS8	2	6SH7	1	12AX7	3	25W4	3
3BY6	2	6AR5	1	6BU8	1	6SJ7	2	12AY7	1	25Z6	2
3BZ6	2	6AS5	2	6BX7	2	6SK7	3	12AZ7	1	35A5	2
3CB6	2	6AS6	1	6BY5	2	6SL7	3	12B4	3	35B5	3
3CF6	2	6AS7G*	1	6BY6	1	6SN7	10	12BA6	3	35C5	3
3CS6	2	6AT6	3	6BZ6	2	6SQ7	3	12BA7	1	35L6	4
3DT6	2	6AT8	3	6BZ7	3	6SR7	1	12BD6	2	35W4	5
3Q4	1	6AU4	4	6C4	2	6T8	3	12BE6	4	35Y4	1
3Q5GT	1	6AU5	3	6CB5**	2	6U8	6	12BF6	3	35Z5	4
3S4	2	6AU6	10	6CB6	10	6V3	2	12BH7	6	50A5	1
4BQ7A	5	6AU8	2	6CD6	5	6V6GT	6	12BK5	2	50B5	2
4BZ7	2	6AV5	1	6CF6	2	6W4	10	12BN6	1	50C5	2
5AM8	2	6AV6	4	6CG7	6	6W6GT	4	12BQ6/CU6	3	50L6	5
5AN8	2	6AV8	1	6CG8	3	6X4	2	12BY7	3	5642	2
5AQ5	2	6AW8	4	6CL5**	1	6X5	2	12BZ7	2		
5AT8	2	6AX4	6	6CL6	3	6X8	5	12CA5	1		
5AV8	1	6AX5	1	6CM6	1	6Y6	1	12CUS	3		
5BK7A	3	6AZ8	3	6CM7	2	7AU7	4	12D4	1		
5BR8	2	6BA6	4	6CN7	2	7B4	1	12DQ6	3		

\*Industrial electronic  
\*\*Color TV

# Recent Developments in Electronics

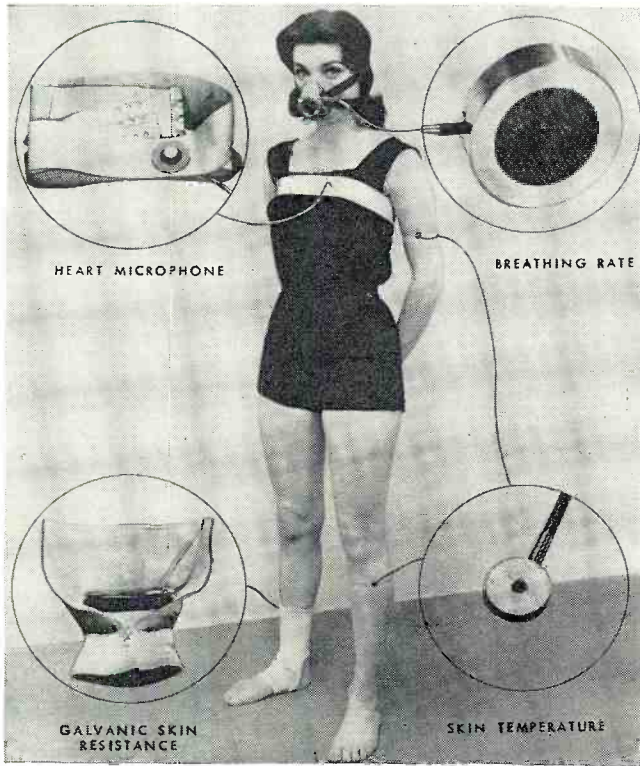

## Circuit Simulates Nerve Cell ▲

A network of electronic nerve cells is assembled by L. D. Harmon of *Bell Telephone Laboratories*, who initiated a project of simulating the functions of nerve cells with a simple transistorized circuit. This array of cells is used to imitate some functions of the nerves in the eye.

## ◀ New Medical Transducers

The well-dressed space pilot will wear many of the medical instruments demonstrated here by model who is undergoing an electronic physical examination. The outputs of these *Gulton* transducers are fed to telemetry gear.

## Electronically Controlled Missile ▼

A split second after firing, "Sparrow III," newest air-to-air guided missile in the Navy's arsenal, streaks to target for the kill. These missiles, produced by *Raytheon*, can be fired singly or in rapid series from fighter plane.



### Cold-Cathode Vacuum Tube ▶

Model is holding sample of revolutionary cold-cathode electron tube developed by Signal Corps and *Tung-Sol*. Tube is capable of self-sustained emission without heat and operates in same range as transistor. At bottom of display, hot-cathode tube at right uses same heater power as 10 cold-cathode tubes beside it.

### Ultraviolet Images Made Visible

John L. Burns (right), President of *RCA*, and R. G. Stou-denheimer examine a new electron tube which will be used for medical and industrial research. The tube, called an "ultrascope," can convert invisible ultraviolet images of human tissues into visible pictures that can be interpreted by medical research workers. The "ultrascope" is used as the "eye" of simple microscope attachment shown. ▼

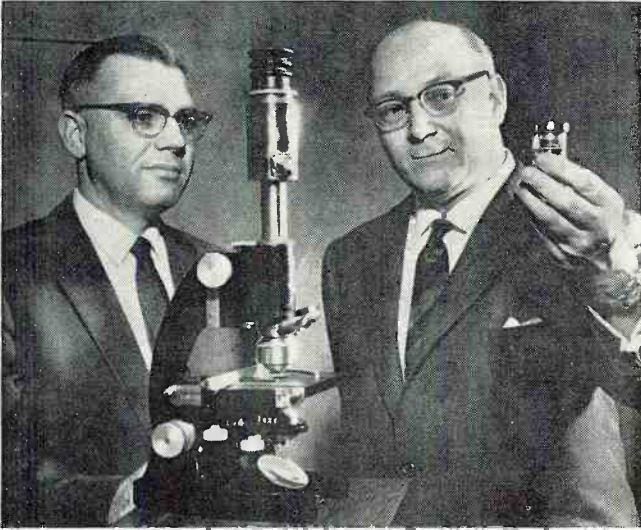

### Highly Instrumented "Polaris"

The "Polaris" AX-1 test vehicle placed in its launcher prior to test firing. The highly instrumented test missile contains a maze of electronic equipment which will transmit to ground receivers vital performance information concerning components being tested. At right is the umbilical tower from which cables are connected to the missile permitting the many ground checkouts required prior to the launch. ▼

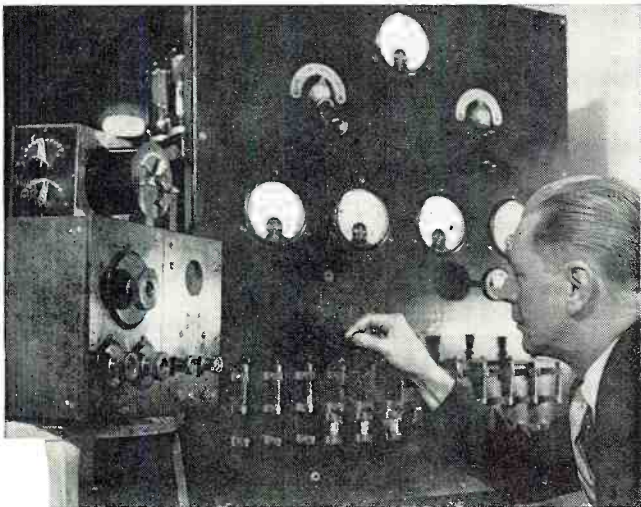

### Historic Radio Equipment ▲

Exact replicas of the historic radio equipment used in the first news broadcast of presidential election results have been donated to the Smithsonian Institution in Washington by the *Westinghouse Broadcasting Co.* Demonstrating the control board is Ted Kenney, chief engineer of *KDKA* in Pittsburgh, Pa., the station that used the gear.



# AN AUTOMATIC "TALK SQUELCHER" FOR YOUR RADIO

By **MARVIN L. GASKILL**

*This easy-to-build unit, adaptable to any home radio, will cut out just about all the voice announcements.*

**E**XPERIMENTERS, using parts found in the average "junk-box," may wish to build this radio "Talk Squelcher" and then relax to soothing music punctuated only by interludes of silence automatically replacing the announcer's voice. The Talk Squelcher is easy to construct, is adaptable to any home receiver, and is completely effective in suppressing 95% of voice broadcasts.

All components of the squelcher are mounted on a 2" x 3" x 5 1/4" "Minibox" chassis which encloses all circuit elements except the three tubes and filament transformer. There are only two controls: a 50,000-ohm potentiometer,  $R_s$ , for adjusting the sensitivity of the unit; and the "on-off" toggle switch,  $S_1$ , connected in the primary of the 6.3-volt filament transformer. Refer to the photographs below (Figs. 1 and 2).

Circuitry consists of a 6SQ7 audio amplifier and rectifier, a 6C4 relay tube, and a 6C4 control tube. Plate voltage of 100-150 volts d.c. for these stages is obtained from the radio receiver to which the unit is connected. Since in most cases plate voltages of less than 100 volts are inadequate to

operate the plate-current relay, it is not practical to use the squelcher with most battery-operated portable receivers.

## Simple Operating Principle

In contrast to other speech-music discriminators employing frequency differentiating circuits, the Talk Squelcher takes advantage of the aperiodic nature of speech and the voltages it produces. Speech is frequented by pauses between words and sentences; while the character of most musical selections is such that sound is present almost continuously. The inherent pauses in speech, some of which are too short to be detected aurally, provide a practical means for developing a control voltage to silence the output of the receiver during speech intervals. Since the device is virtually independent of frequency response, its use is not limited to the more expensive home receivers.

Fig. 3 is the schematic diagram of the squelcher and shows points of connection to a typical home receiver. As shown, the grid of the 6SQ7 audio amplifier and rectifier is connected by a

shielded lead through a .006  $\mu$ fd. capacitor to the top end of the volume control in the receiver 2nd detector. The cathode of the control tube is connected to the a.f. amplifier plate, and plate voltage is obtained by a connection to the screen of the receiver output tube. Although it is possible to obtain sufficient audio voltage from the moving arm contact of the volume control it is undesirable because the performance of the squelcher will then be dependent upon the setting of the control. Also, plate voltage can be obtained ordinarily from the output of the receiver power-supply filter, but in the receiver used by the author the screen dropping resistor ( $R$ ) served as part of the filter, and when connection was made to the bottom end the hum level was too high.

In operation, audio voltage from the receiver is amplified and rectified by the 6SQ7 and then applied as negative bias to the grid of the 6C4 relay tube. This bias prevents the relay tube from drawing plate current and the relay remains in a de-energized condition with its contacts open. However, if for any reason the audio voltage being supplied

Fig. 1. Photo shows 3 tubes used in unit, with filament transformer, sensitivity control, power switch, and connecting leads.

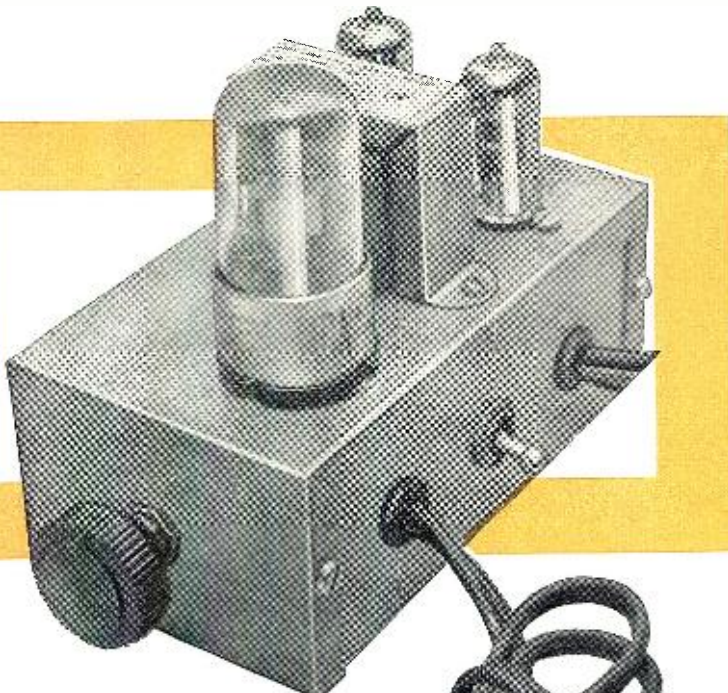
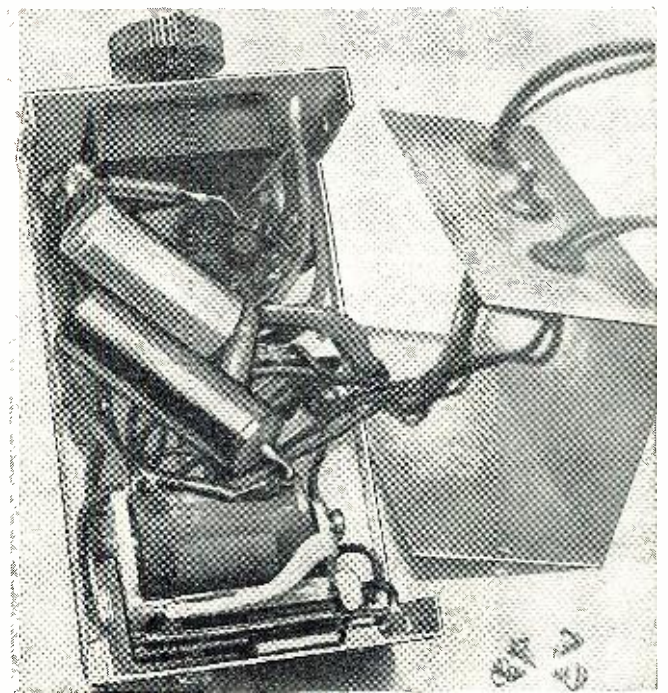

Fig. 2. With the chassis cover removed, the sensitive plate-current relay and other components may be clearly examined.



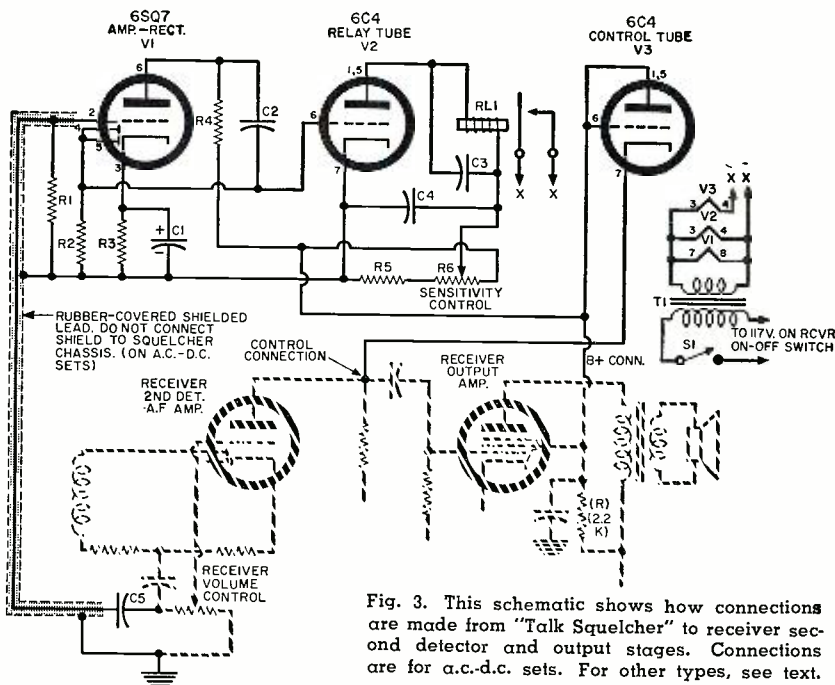

Fig. 3. This schematic shows how connections are made from "Talk Squelcher" to receiver second detector and output stages. Connections are for a.c.-d.c. sets. For other types, see text.

- R—2200 ohms, 1/2 w. res. (screen dropping res. see text)
- R1—2 megohm, 1/2 w. res.
- R2—1 megohm, 1/2 w. res.
- R3—2700 ohm, 1/2 w. res.
- R4—250,000 ohm, 1/2 w. res.
- R5—50,000 ohm, 1 w. res.
- R6—50,000 ohm wirewound res. ("Sensitivity Control")
- C1—25  $\mu$ d., 50 v. elec. capacitor

- C2—.01  $\mu$ d., 400 v. capacitor
- C3—1  $\mu$ d., 400 v. capacitor
- C4—1  $\mu$ d., 400 v. capacitor
- C5—.006  $\mu$ d., 400 v. capacitor (see text)
- RL1—Telephone-type, plate-circuit relay, 5000 ohms, 2-3 ma., normally open (see text)
- S1—S.p.s.t. switch ("on-off")
- T1—Fil. trans., 6.3 v. @ 1 amp. (see text)
- V1—6SQ7 tube
- V2, V3—6C4 tube

to the unit is interrupted, as through a pause in program sound (or through detuning of the receiver), the relay tube will draw plate current and close the relay contacts which are connected in series with the heater of the 6C4 control tube. When the heater circuit of this tube is closed for a sufficient length of time, or for short successive intervals, the control tube becomes conductive, and because of its lowered internal resistance effectively short-circuits the audio-output voltage at the plate of the a.f. amplifier. Thus it can be seen that the plate current of the control tube and hence the output level of the receiver is a function of the relay contact frequency as well as the duration of contact.

In natural talking, the audio voltage produced by speech will go to zero on an average of several times per second. This means that with proper adjustment of the sensitivity control the relay contacts will close frequently enough to cause the control tube to keep the receiver output below audible levels. This seldom happens during the transmission of music. If the frequency response of the receiver is reasonably good, background sounds produced by various instruments maintain the audio voltage at a fairly high level and the receiver output normal at all times. It can be seen that speech accompanied by any type of background sound will not be suppressed.

The speed of squelch control is dependent upon the setting of the sensitivity control,  $R_6$ . Advancing the control toward maximum raises the cur-

rent through the relay, decreases the sensitivity, and increases the squelch speed; while turning the control in the opposite direction increases the sensitivity and decreases the squelch. The optimum setting can be reached quite easily by tuning the receiver to an unoccupied frequency in the band and then slowly advancing the control from zero to the point where the relay closes, as evidenced by a clicking sound or lighting of the 6C4 control tube. If the relay fails to close, it is probably due to an inadequate source of d.c. voltage. Possible remedies are described in connection with receiver circuit variations.

#### Receiver Circuit Variations

As mentioned earlier, the squelcher will operate with any type receiver except battery-operated portables, but because of the variations in circuitry for different receivers it may be necessary to depart from the method of interconnection shown for an a.c.-d.c. set in Fig. 3.

If the set to be used is a transformer-powered type with d.c. supply voltages of 250-350 volts, the "B+" connection for the squelcher should be made through a 50,000-ohm, 1-watt resistor to the main source of supply in the receiver, as shown in Fig. 4, rather than to the screen of the output tube, which may be fed through a high resistance.

In some receivers the cathode of the 2nd detector is connected to ground through a high value of resistance. With this type circuit excellent control

can be obtained by connecting the cathode of the control tube directly to the cathode of the detector, provided the a.v.c. circuits are not included in the network. A typical 2nd detector of this type is shown in Fig. 5.

When making connections to the receiver that are different from those shown in the diagrams, it must be kept in mind that the source of audio voltage for the squelcher must precede the movable arm of the volume control, and that control voltages should not be applied to stages preceding the source of audio; the latter making it impractical to apply control to the a.v.c. circuits of the receiver.

Other tube types can be substituted with equally good results. For the control tube, an indirectly heated cathode type always should be used rather than a directly heated type in order to obtain smooth control. The filament supply in transformer-powered sets can be utilized for the squelcher tubes, eliminating the squelcher filament transformer. In this case, a switch must be inserted in the "B+" line so that the squelcher can be turned off while the receiver is operating, if desired.

The plate-current relay is a telephone-type relay with a coil resistance of 5000 ohms and adjusted to close at 2 ma. Any sensitive plate-current relay with departures of as much as 50% in coil resistance and with closing current ratings as high as 8 ma. should perform satisfactorily.

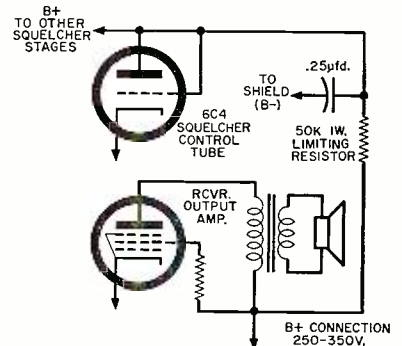
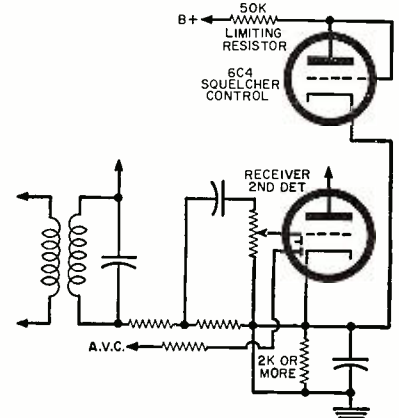
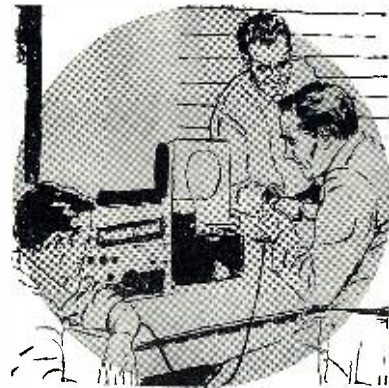

Fig. 4. Circuit showing use of the limiting resistor when the "B+" connection is made to a 250 to 350 volt d.c. power source.

Fig. 5. Method of control tube connection used to second detectors that employ cathode resistors of 2000 or more ohms resistance.





# Versatile Ham Transmitter Kit

RADIO & TV NEWS  
LAB TESTED

*A top quality bandswitching 180-watt c.w.-phone rig with built-in v.f.o. within a compact desk-top cabinet.*

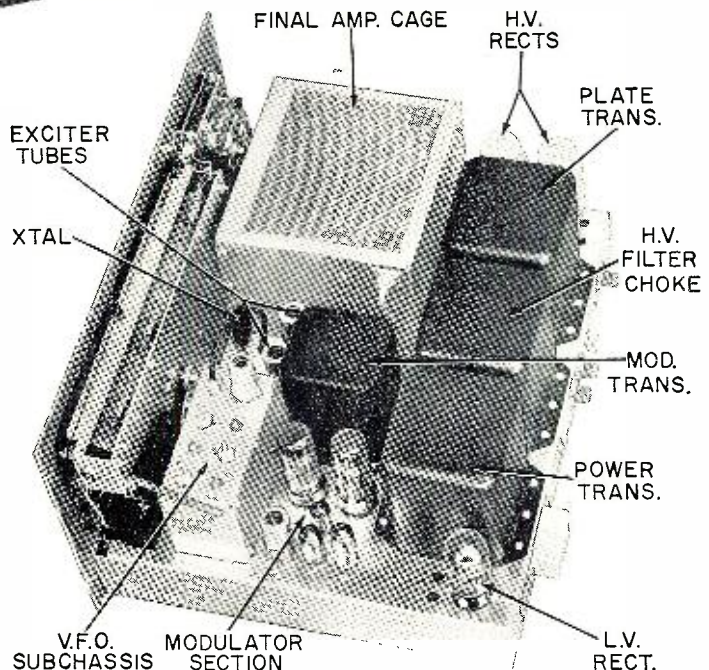

Front-panel and inside views of the new transmitter kit are shown above. Note that not much space is wasted in layout.

**W**E really have to hand it to the Heath Co. for this one. The "Apache" is a lot of transmitter in a compact, desk-top cabinet measuring only about 20 x 12 x 16 inches deep. The transmitter kit has been styled so that it is a dead-ringer for the matching "Mohawk" ham receiver kit. (See "Advanced Ham Receiver in Kit Form" in our December, 1958 issue.) As a matter of fact, from across the room, one would be hard-pressed to say which is which, unless you look pretty closely. Compact as it is though, we certainly would not want to move this one around more than we have to since all the husky transformers and chokes mounted on the chassis bring its weight up to just under a hundred pounds.

The over-all design of the rig is really tops and quite a bit of ingenuity was displayed in linkages and dial drives in order to get the front panel layout to match the "Mohawk." The kit is fairly elaborate and even the experienced

ham will have to spend quite a few hours in assembling it. In our case, a total of 65 hours was required for the entire job; and this includes the 8 hours needed for unpacking, checking parts, and after the wiring was done, calibrating the v.f.o. and making all other adjustments. Nothing comes pre-assembled in this kit except for the interconnecting wiring harness and a small component board for the modulator. In this circuit, the six tubes used are quite close together and the component board simplifies what otherwise might have been some pretty tight wiring.

## Construction

A major reason for the ease with which the kit went together was the 108-page instruction manual, a model of clarity and accuracy. As a matter of fact, except for one or two minor typographical errors (to which editors may be overly sensitive), this manual

is just about perfect in every detail.

Anything as elaborate as this transmitter requires a logical and systematic construction plan. In the case of this rig, the 1-tube v.f.o. sub-assembly was completely put together first. Then all the parts were mounted on the main chassis top plate, which was then fastened to the chassis itself. The chassis is subdivided by partitions into five separate compartments. These are worked on individually just as though one were wiring separate components.

Work is started on the power supply compartment. Then, we proceed to the modulator compartment, the exciter compartment, and the final amplifier compartment. The remaining front panel assembly compartment is wired up last after assembly and installation of the dial mechanism.

By the time both power transformers, both filter chokes, the modulation transformer, v.f.o. filament transform-

*(Continued on page 158)*

The complete schematic diagram of the Heathkit "Apache" transmitter.

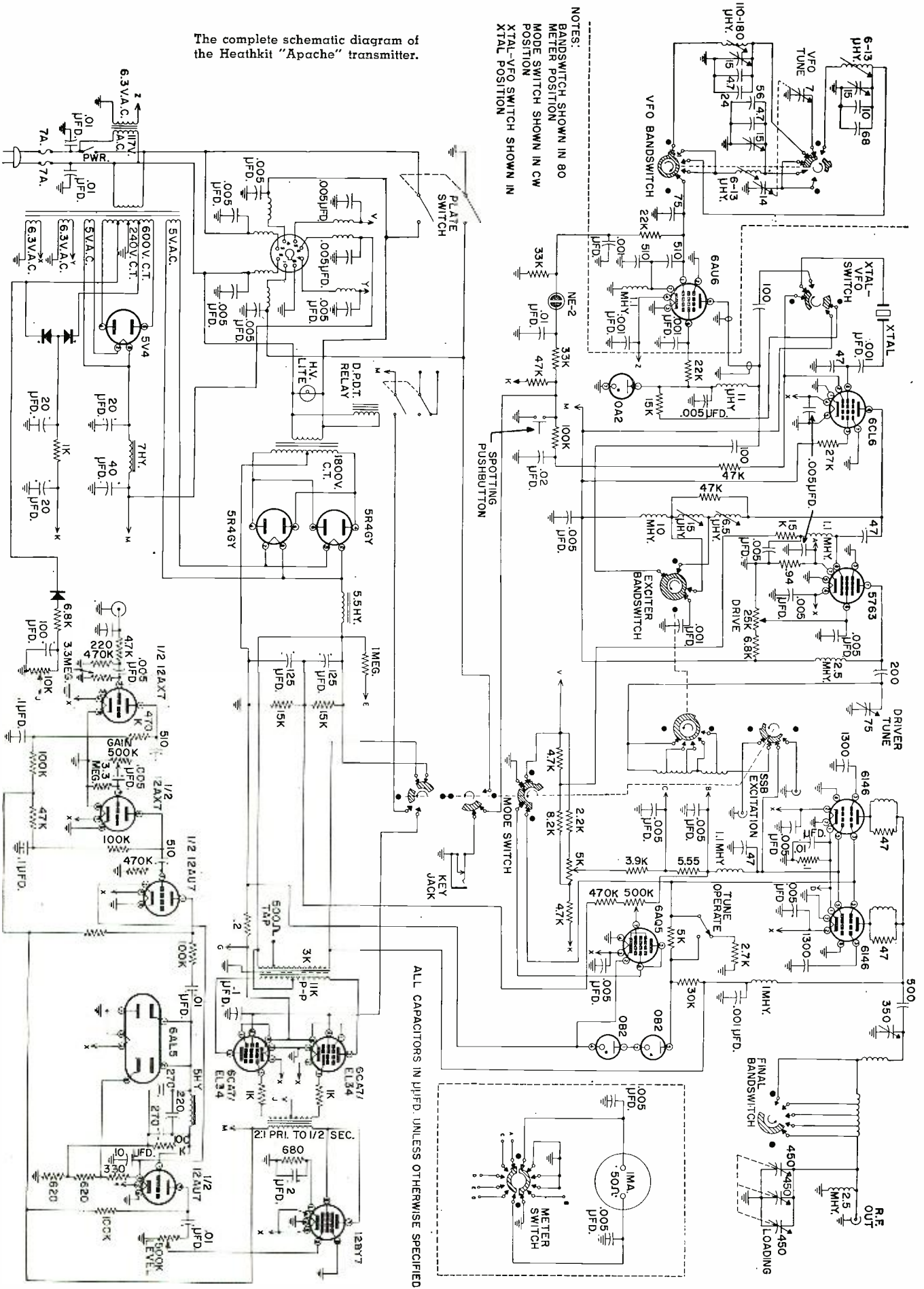

NOTES:  
 BANDSWITCH SHOWN IN 80  
 METER POSITION  
 MODE SWITCH SHOWN IN CW  
 POSITION  
 XTAL-VFO SWITCH SHOWN IN  
 XTAL POSITION

ALL CAPACITORS IN UJFD. UNLESS OTHERWISE SPECIFIED

# Special Test Instruments

Providing specialized checks or enabling new techniques, these clever designs are often regarded by their users to be as invaluable as more conventional units.

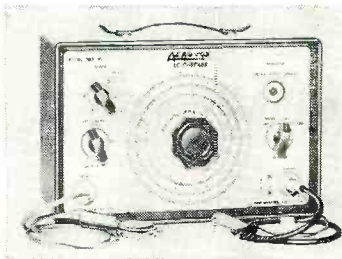

▲ The Aerovox Model 97 LC Checker, a popular component analyzer.

Capacitor-Resistor Analyzer CRA-2 is one of 2 such by Pyramid. ▶

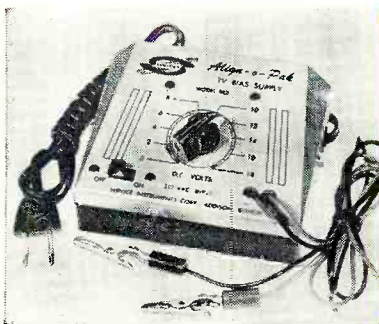
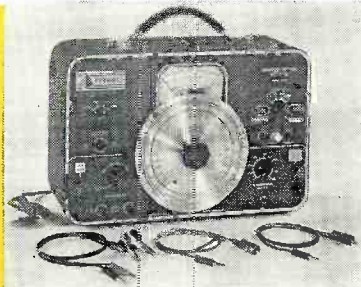

◀ Sencore Align-O-Pak provides variable d.c. from 0 to -18 volts.



▶ Lampkin 205A FM Modulation Meter, for 2-way mobile service.

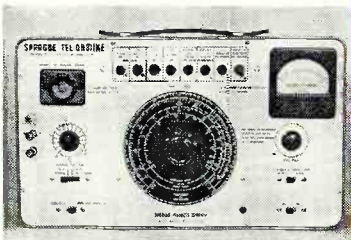

◀ Sprague Tel-Ohmike, capacitor and turns-ratio bridge.

Lampkin Frequency Meter, harmonic generator added. ▼

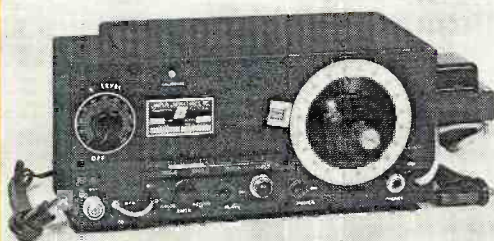

**A**BOUT twenty years ago, the chief test instrument of many a radio repair technician was his wet thumb. With conventional AM receivers as virtually their only challenge, many of these fellows managed to accomplish quite a bit of fault localization *via* this crude check for "live" circuits.

The present variety and complexity of electronic equipment not only calls for far greater training on the technician's part, it also makes mandatory a large and diversified complement of test equipment. Few would argue the need of such broad-application instruments as meters, oscilloscopes, and various generators as fundamental instruments with almost infinite uses. Yet even such types have left noteworthy gaps in the troubleshooter's artillery.

Thus recent years have seen a boom in special types of equipment. Not easy to define, this category includes some types that have been around for years but are assuming increased importance because the equipment serviced and service itself are more sophisticated. Others in this class cleverly adapt old techniques to new circuits and new components. Still others open up new techniques. Some combine standard test facilities in new, ingenious ways to streamline service.

In this era, *time* has become the most precious ingredient in any service job. Perhaps the single factor setting off all the instruments discussed here is that they strive, in one way or another, to make the most of this valuable commodity. The high degree of acceptance they have already won from progressive service dealers testifies to their validity and heralds the day when many of them will be regarded as indispensable, standard instruments.

Among the old-timers gaining much new favor are the various bridges and analyzers that can check specific, important characteristics of certain key components. Their popularity increases as the day of the clear-cut fault in components wanes. With a capacitor, for example, it is frequently not enough to know whether it is simply shorted or open. In critical circuits, such factors as exact capacitance, leakage current, insulation resistance, changes in behavior when subjected to specific voltages, power factor and relative "Q" may be important. The type of capacitor involved, whether it be an original circuit component or a potential replacement that must be evaluated, can also be significant. A reliable check is surer and quicker than hit-or-miss methods.

Analyzers that provide detailed information about capacitors, and usually perform like functions for other types of components, are now more widely available than ever. Conspicuous in this field are units made by companies not ordinarily considered test-instrument manufacturers, the producers of capacitors. The Aerovox "LC Checker," Model No. 97, can also be used to check inductances, as a signal generator, to determine unknown resonant points, and for precision alignment.

The Sprague "Tel-Ohmike Analyzer," Model TO-5, provides a wide range of capacitor measurements and can also be used for measuring the turns ratio or impedance ratio of such laminated-core transformers as audio and power transformers. Pyramid Electric Co. offers a choice of two "Capacitor-Resistor Analyzers," Models CRA-2 and RC-1. The former, in addition to the conventional functions, provides rapid in-circuit testing for shorted, open, or intermittent capacitors. In this role, it tends to overlap with another type of instrument, to be discussed later, used exclusively for in-circuit tests. Model RC-1 can also be used





Superior CR Bridge & Signal Tracer.



Seco Flyback-Inductance Analyzer.



Cornell-Dubilier In-Circuit Capacitor Checker.

to obtain the turns ratio of a transformer. Another in this general family of instruments is the *Cornell-Dubilier* "Capacitor-Resistor Bridge," Model BF-60.

Another old-timer with renewed value is the modest, variable, low-voltage d.c. supply. Many a subtle, elusive fault in the video or sync systems of TV receivers conceal themselves in the a.g.c. system. Substitution of a known negative voltage for a.g.c. output and observation of receiver behavior as this voltage is varied can lead to quick fault disclosure. One such d.c. supply is the *Sencore* "Align-O-Pak TV Bias Supply," Model BE3, variable from 0 to 18 volts negative. Suitable for use with all types of a.g.c. systems, it is also a great convenience in standard alignment procedures, in which a fixed bias takes the place of normal a.g.c. The importance of these devices has increased with the advent of color, as color receiver circuits also require such fixed, negative voltages in alignment and troubleshooting.

Frequency meters and FM modulation meters, like other instruments noted thus far, have also been around for many years. However, their use in the service shop has been limited until the present. Today, one of the fastest-growing areas of electronics is two-way mobile communications, with most of the equipment operating on FM. Also with many service shops entering this profitable field, the need for qualified maintenance and service stations is far from filled. Modulation and frequency meters are essential for such work. Such units as the *Lumpkin* "Frequency Meter," Type 105B, and the same manufacturer's "Modulation Meter," Type 205A, are important in the adjustment of transmitters as prescribed by the FCC.

Among relatively new types of testers, we find some that have come into existence because of the particular nature and high replacement cost of some components used in TV sets. When a conventional tube is suspected of being defective, for example, there is no problem in checking with a replacement that can be plucked right off the shelf. When a picture tube or flyback transformer is in question, the correct replacement, a rather costly item, is not so likely to be handy. Even if it is, substitution is time-consuming.

To the rescue, in the case of the picture tube, comes the CRT checker. In addition to providing a much more accurate evaluation of the large tube than conventional checking allows, many of these units provide such additional facilities as restoration of emission, where this is possible. Among the latter is the *B&K* "Cathode Rejuvenator Tester," Model 400. In addition to measuring cathode emission and checking the cut-off characteristic of a CRT, it reveals shorted or open electrodes specifically and provides a life-expectancy test. Often picture-tube defects such as inter-electrode shorts and low cathode emission can be eliminated, returning the tubes to normal operation. Accordingly, circuits for removing such shorts and rejuvenating cathodes are included in this unit.

Even less standardized than picture tubes and more difficult to check by substitution are the flyback transformers and their associated inductances, such as the deflection coils. Also, faults in which they are involved are most difficult to pinpoint. One or a few shorted turns in the low-resistance windings of such inductances, for example, seldom show up on straight resistance measure-

(Continued on page 147)



Seco VT Grid Circuit Tester, Model GCT-8.



Century In-Circuit Tester CT-1.

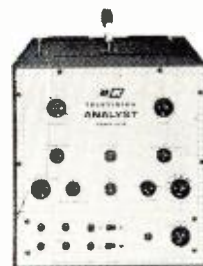

B&K Television Analyst for signal injection.



Kingston EA-1 portable Absorption Analyzer.

B&K CRT Tester and Cathode Rejuvenator.



Century's Model SRT-1 tests semiconductor rectifiers in-circuit.





The over-all view of the Harman-Kardon Model A250 stereo amplifier.

# Complete Stereo Amplifier System

RADIO & TV NEWS  
LAB  TESTED

An integrated system that provides for hi-fi performance at a reasonable price.

**Y**OUR Editor spent several days last month at the *Harman-Kardon* plant on a general inspection tour—during which time emphasis was placed on analyzing the firm's methods of testing equipment and in determining corporate philosophy in the matter of good sound reproduction.

We were especially impressed by the importance that the company attaches to the continuous inspection and testing of production units as they move from pre-assemblies to completed equipment.

Like many other audio equipment plants we have visited, *Harman-Kardon* is a busy and optimistic place—with the recent strong swing to stereo responsible for the stepped up activity.

The company, of course, has always been a factor in the hi-fi component field but within the past year recognition has become more widespread. The firm's philosophy has evolved into one of fairly conservative design with all tubes and components operating well within their stated ratings.

*Harman-Kardon's* success has been largely due to two major factors—good engineering and careful planning. Its equipment is designed for the individual who wants high quality yet feels no need to spend the extra money for the more flexible and higher powered systems that could be made up with separate power amplifiers and preamps.

During our visit we picked up one of the company's most popular units—the Model A250 integrated stereo amplifier—for test purposes. This amplifier

was taken from stock at random and with no special inspection or tests being run so that the unit would be as typical as possible. In addition to the usual controls such as treble, bass, loudness, balance, and rumble and scratch filters, this new design incorporates an unusual feature. It is possible with this unit to hook up two entirely different stereo speaker systems. For example, one could arrange a speaker system in the living room and then another in the den. Controls are provided so that the two systems can be operated independently or simultaneously.

The function switch provides for the selection of five different inputs—three individual high-level inputs and either a ceramic or magnetic phono, plus provisions for a tape machine. The mode switch provides for straight stereo operation, reverse channel, monophonic, and right and left channel. Monophonic operation is, of course, used when playing monophonic records while the right and left channel positions are used to apply any input signal in either channel to both speakers. As mentioned previously, this unit is in the medium-price range. It includes all the basic functions and many additional features that are incorporated in its more expensive counterparts available today. The unit does not include phase reversal provision, level indicators, special pilot lights, microphone input, or third-channel output as would be found, for example, in some separate component systems.

This particular model is rated as a dual 25-watt unit for stereo operation or 50 watts when the channels are in parallel for monophonic applications. This rating is based on a 120-volt power-line input and, since this is above the average, we felt it more than proper to make all of our tests using a customary line voltage of 117 volts. In view of the lower input voltage, we were unable to obtain the 25 watts per channel. We would actually rate this unit as a dual 20-watt amplifier under these conditions and all of our tests were made on this basis.

## Test Results

*Sensitivity* (at 1000 cps and for 20 watts maximum): Tape head input, .002 volt; magnetic cartridge, .0023 volt; ceramic cartridge, .0495 volt; and the three high-level inputs, .105 volt.

*Hum and Noise* (average for both open and shorted input conditions): -58.3 db for high-level inputs, and -42 db for all low-level inputs. These figures are with respect to 2 watts output across the 8-ohm voice-coil windings.

*Frequency Response*: ±1 db from 23 to 21,000 cps at a 2 watt output level.

*Rumble Filter*: -13.8 db at 30 cps. It is a rather effective filter in that response drops off sharply, as it should, below 100 cps.

*Bass Control*: ±16 db at 30 cps using 1000 cps as a reference.

*Treble Control*: -13.5 db, +16 db at 15 kc., using 1000 cps as a reference.

We found that for both the bass and treble controls the "flat" positions oc-

currred at the mid-position points of the knobs.

**Scratch Filter:** At 6 kc., -8.8 db; at 10 kc., -15 db; and at 15 kc., -14 db with respect to 1000 cps.

This scratch filter functions only when the unit is operating in conjunction with a phonograph.

**Channel Separation:** -46 db at 1000 cps.

**Equalization:** For RIAA input the equalization was within  $\pm 2$  db from 30 to 15,000 cps from the standard curve.

**Harmonic Distortion:** At 1000 cps, below .5% for any output from 1 to 20 watts. At 30 cps, 2.15% at 1 watt, rising to 2.60% at 5 watts and then dropping to 1.28% at 20 watts. At 15 kc. the distortion rises steadily from minimum of .078% at 1 watt to 2.48% at 20 watts.

Minimum harmonic distortion is always an extreme test for any amplifier when we are taking measurements at a frequency as low as 30 cps and as high as 15 kc. We consider that 2% is the minimum amount of harmonic distortion that the most critical ear can discern. Although the figures exceeded the 2% mark slightly on some conditions of measurement, on the whole the results were gratifying.

**IM Distortion:** For .5-volt input, the IM distortion varied from a minimum of .72% at 6 watts to 1.72% at 20 watts. At 15 watts the percentage figure was 1.02%. For 1-volt input the IM distortion varied from 2.02% at 2 watts and then down to a minimum of 1.16% at 10 watts, steadily rising to 2.08% at 20 watts. These figures are slightly higher than what we would have liked to have seen since we feel that 1% is about the minimum point at which one would detect this type of distortion. There is a possible reason for these results. The design engineer of this unit feels that the performance at minimum hum and noise condition and with volume control turned well down, is most important. Therefore, the unit has the volume control placed after the first high-level input stage. There is no doubt that the minimum hum figure is extremely low, but, as a result, the input stage runs at a fixed high input level.

(Continued on page 153)

Complete schematic diagram of the Model A250 stereo amplifier system.

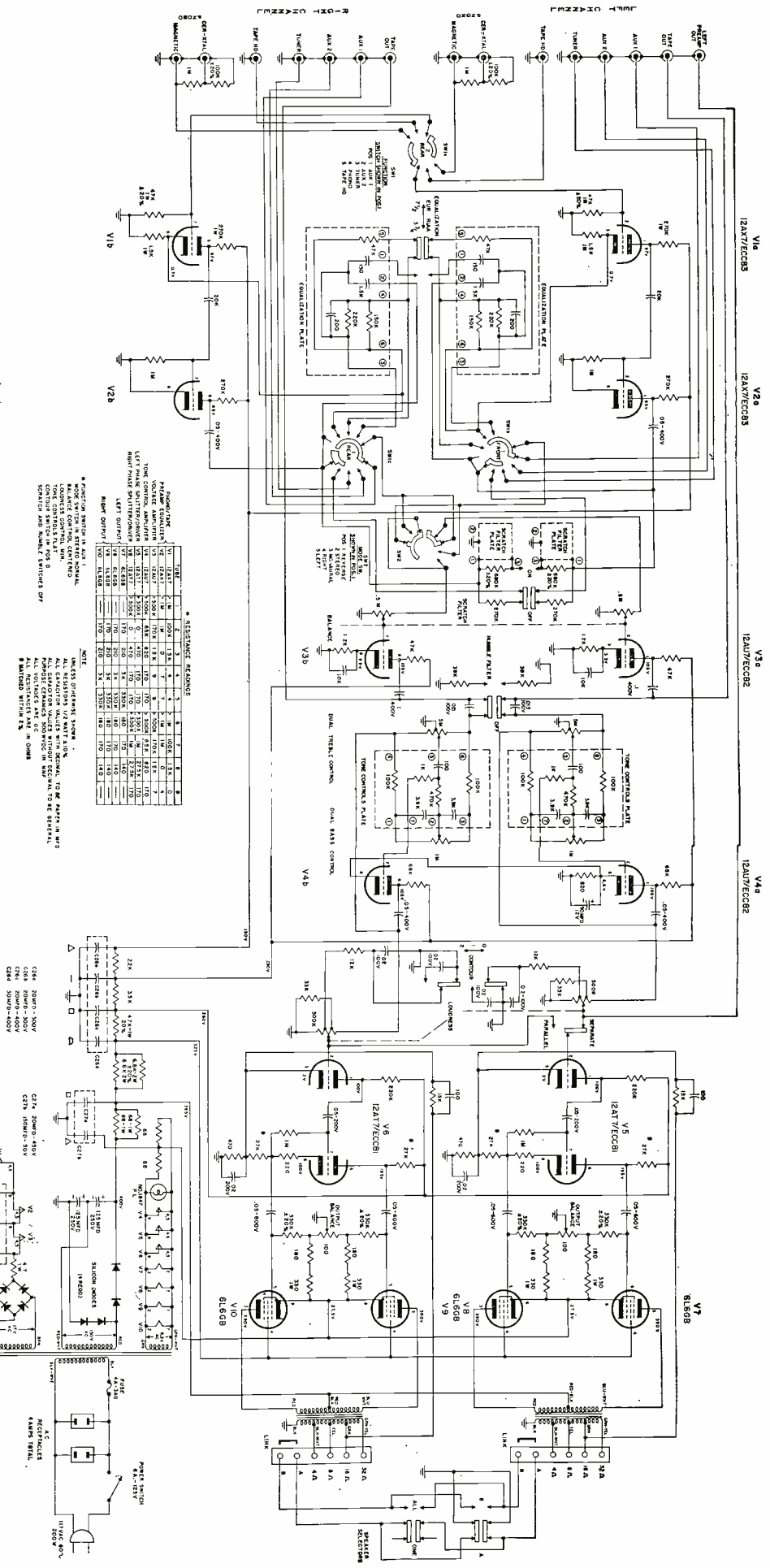

# Hints on Two-way Radio Service

By  
JACK DARR

Is maintenance in this field new to you? Here are practical hints from an experienced hand.

**Q**UITE frankly, this article is written for the benefit of the radio or TV technician who is intending to enter the field of two-way communications radio servicing for the first time rather than for the more experienced man. The writer often wished fervently for some such source of information when he entered the field many years ago. It is intended to clarify some of the more puzzling aspects of this type of work. These include the actual meaning of some of the FCC requirements as to measurements, records and logs, and practical information on keeping these records in an acceptable form. Later on we'll discuss some shortcuts to servicing and outline several economical test instruments for practical work.

## Technician Qualifications

As qualification for this kind of work, the Federal Communications Commission requires that a technician hold either a First or Second Class Commercial Radio Operator's License. These licenses are granted without charge upon successful completion of the examination requirements. Such tests are given at least twice a year in numerous cities, especially state capitals, and may be taken at any time in one of the many cities in which an FCC Field Office is located. A "Study Guide" for the examinations may be obtained from the Superintendent of Documents, Washington 25, D. C., for a small fee. Other useful publications may be obtained from the same source. It would be a good idea to write for the index of available publications, wait until you can see just what is needed, then make up a single order. Copies of certain FCC Rules and Regulations, known as the "R & R," are required to be kept in your files. These include the "R & R" pertaining to the particular branch of communications in which the user is engaged. Part 17, for in-

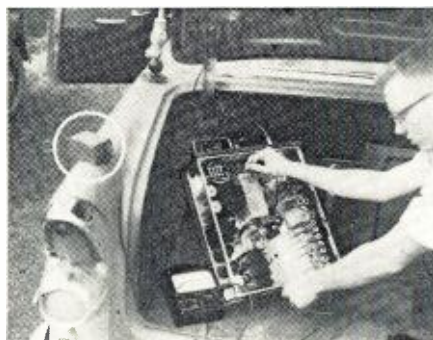

Fig. 1. A detector box (circled) is handy for antenna peaking adjustments.

stance, covers Highway Trucking, Part 16, Power Utilities, and so on; these are changed from time to time. In fact, by the time this article appears, there may have been some changes, but a copy of the latest index to FCC publications will list correct numbers.

Operators' licenses, granted for a period of five years, may be renewed at the end of that time without the necessity for taking another examination. The old license may be sent in for renewal at any time during the year preceding its expiration date. (Just a moment: I want to check *mine* to be sure that it isn't about to expire! Ahh! Still got two years to go.) To renew a license, send the original, together with the verification card (the pocket-size card which should be carried on the person at all times) to FCC, Washington 25, D. C. with a completed copy of FCC Form 212W. The carbon copy of the application for renewal is then posted in the shop in lieu of the license. It will take the place of a license until the latter arrives in a month or two.

In the past it was necessary to serve as a broadcast engineer for a license to be renewable. Now licenses may be renewed if the ticket is used for two-way radio maintenance work. This information should be placed on the re-



Fig. 2. Filling out forms and records with readings taken from the equipment.

newal form where it is called for.

While actually performing maintenance work, the technician is required to carry his "veri-card" with him at all times. When obtaining your original license, simply check the box on the application, "Verification Card Requested," and one will be sent to you.

The service engineer is expected to keep track of the expiration dates of the licenses of the radio stations he is servicing. A word of advice at this point; write up a list of all stations you deal with, together with their license expiration dates, and post this in a very conspicuous place! Station licenses differ from operators' licenses; the FCC requires that the former be sent in during the *last* month of their period, just before expiration. If sent in too much earlier, they may be returned.

Renewal of a license is much simpler now than before; it requires the filling out of FCC Form 405-A-1 which is short and does not require the sending in of the old station license. The card is filled out with name, call letters, location, and expiration date, and mailed in to the FCC in Washington.

Obtaining a station license for a new network is also simpler than it used to be. The easiest way is to make the salesman who furnishes the equipment do it: these men usually carry a large assortment of the proper forms and are experts at filling them out. If their services are not available, the new Form 400 is used: it is self-explanatory

and the FCC will send you a booklet of instructions for filling it out, along with your supply of forms.

When setting up a new network, be sure to obtain a large supply of FCC Form 753-1's. This is required for every operator of the proposed radio system; the truck drivers, policemen, and others who will actually use the sets. Once again, it is a simple form. It comes back with part of it torn off, the remaining portion is the operator's license itself. This is called a "Restricted Radiotelephone Operator's Permit" and authorizes the holder to transmit messages but under no circumstances to make any repairs or adjustments on the equipment.

The beginner in two-way radio will find that there is a certain amount of extra test equipment needed. An approved make of frequency meter and a modulation meter, for measuring the



Fig. 3. Transmitter check with combined frequency-deviation meter (upper left).

frequency of transmitters and their deviation or modulation, will be required. The instruments must be one of the types accepted by the FCC as accurate enough for this work and they must be checked for accuracy of calibration at least once a year. There are several firms in the country specializing in this kind of calibration work and their traveling engineers will make these measurements for you at a nominal fee.

There are several makers of authorized types of test and measurement equipment in the country: *Lampkin, General Radio, Doolittle, Hewlett-Packard*, are some. In addition, several set makers, including *Motorola* and others, have special test equipment which, although primarily intended for use with their own sets, will test others as well.

Almost all of the radios used in communication work today are FM. Thus, the center frequency of the carrier must be measured, as well as the deviation or degree of change to which this frequency is driven by the applied modulation. Common frequency meters make use of the discriminator principle, similar to that found in the FM sound circuits of TV sets. The incoming carrier beats against a carefully calibrated crystal, usually 5 mc. away from the carrier frequency and the resultant beat is fed into the discriminator circuit. The latter has been previously calibrated by a self-contained 5-mc. crystal. Thus any deviation from the proper frequency is indicated on a zero-

center meter. The meter is calibrated in kilocycles above and below the carrier, usually  $\pm 15$  kc. (Incidentally, the 5-mc. crystal may be easily checked for accuracy by beating it against the 5-mc. signal from WWV, using any communications receiver.)

Deviation due to modulation is read on a similar circuit, the major difference being that the meter does not read "above-and-below" the carrier, but gives readings in terms of the deviation to either side, in kilocycles. Deviation must not be over 7.5 kc.; the frequency band allotted to each station is 15 kc. wide at present, although this may be cut down soon because of the crowded condition of these bands. Modulation which results in more than 7.5-kc. deviation will cause "monkey chatter" or interference in adjacent channels.

Another undesirable effect of over-modulation, if the systems are

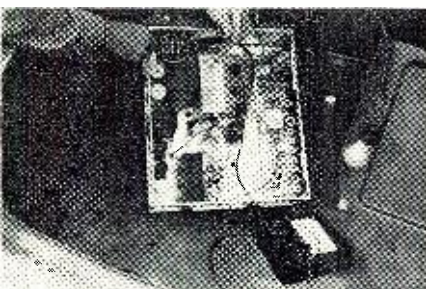

Fig. 4. Making antenna adjustments with a dummy load (bulb at right).

equipped with narrow-band receivers, will be the driving of the carrier completely out of the passband. This will result in a severe drop in readability. Refer to Fig. 5. Fig. 5A shows normal transmitter modulation: the frequency swing is within the limits of the receiver's bandpass. Fig. 5B shows an overmodulated condition with a large portion of the total signal outside the receiver's response, hence lost. This makes voice transmissions "choppy" and garbled and may result in loss of intelligibility.

### Frequency Meters

There are two basic types of frequency meters, although each uses the same circuit, in effect. The type just described is often found in combina-

tion with the deviation meter. Such an instrument is shown in use in Fig. 3. This one uses individual crystals for each channel, each ground to a frequency 5 mc. above the carrier. (Actually, on the high frequencies used, the crystals are ground to operate on lower frequencies, for greater stability, and the 4th or 6th harmonics are used.) These crystals should be checked at least once a year for accuracy. They are the major disadvantage of this type of frequency meter due to their high cost.

A simpler type of meter utilizes the familiar "zero-beat" principle. The meter itself is basically a continuously tunable signal generator, with a mixer circuit to combine the carrier of the transmitter with the locally generated signal. The resultant audio beat is heard through earphones. For calibration, the dial reading is checked against a self-contained crystal and against WWV. These are less expensive than the combination types with the disadvantage that a separate deviation meter must be purchased.

### Power Determination

The only remaining problem is measuring the r.f. power output of the transmitters. Accurate determination of the quantity is quite complicated; it would require measurement of the d.c. power input, antenna impedance, transmission-line current, efficiency factor of the final stage, and other things—all of which lie far beyond the scope of shop equipment. Fortunately, the FCC does not require such measurements to be made; only the power input to the "final" is needed. This is simply the d.c. plate current multiplied by the plate voltage: in other words,  $EI = W$ .

All communications transmitters provide some easy means of making this measurement: some use a jack in the cathode circuit or in the plate return circuit where a milliammeter may be used to read the current directly; some insert very small resistors in series with cathode or plate and read the drop across these in millivolts, using a microammeter. If desired, this shunt may be opened and a meter inserted in the circuit to read the actual current: the reading obtained may

(Continued on page 155)

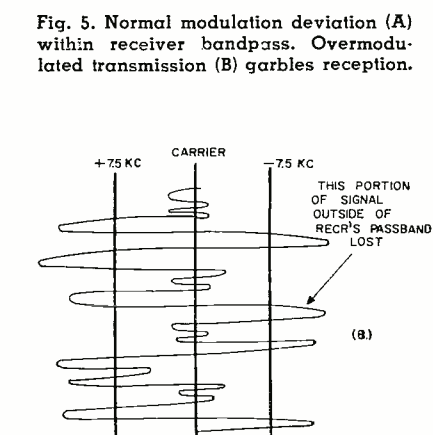
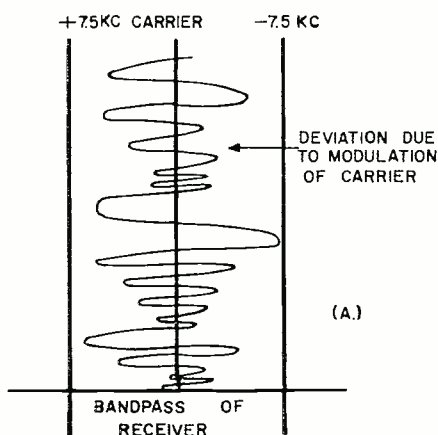
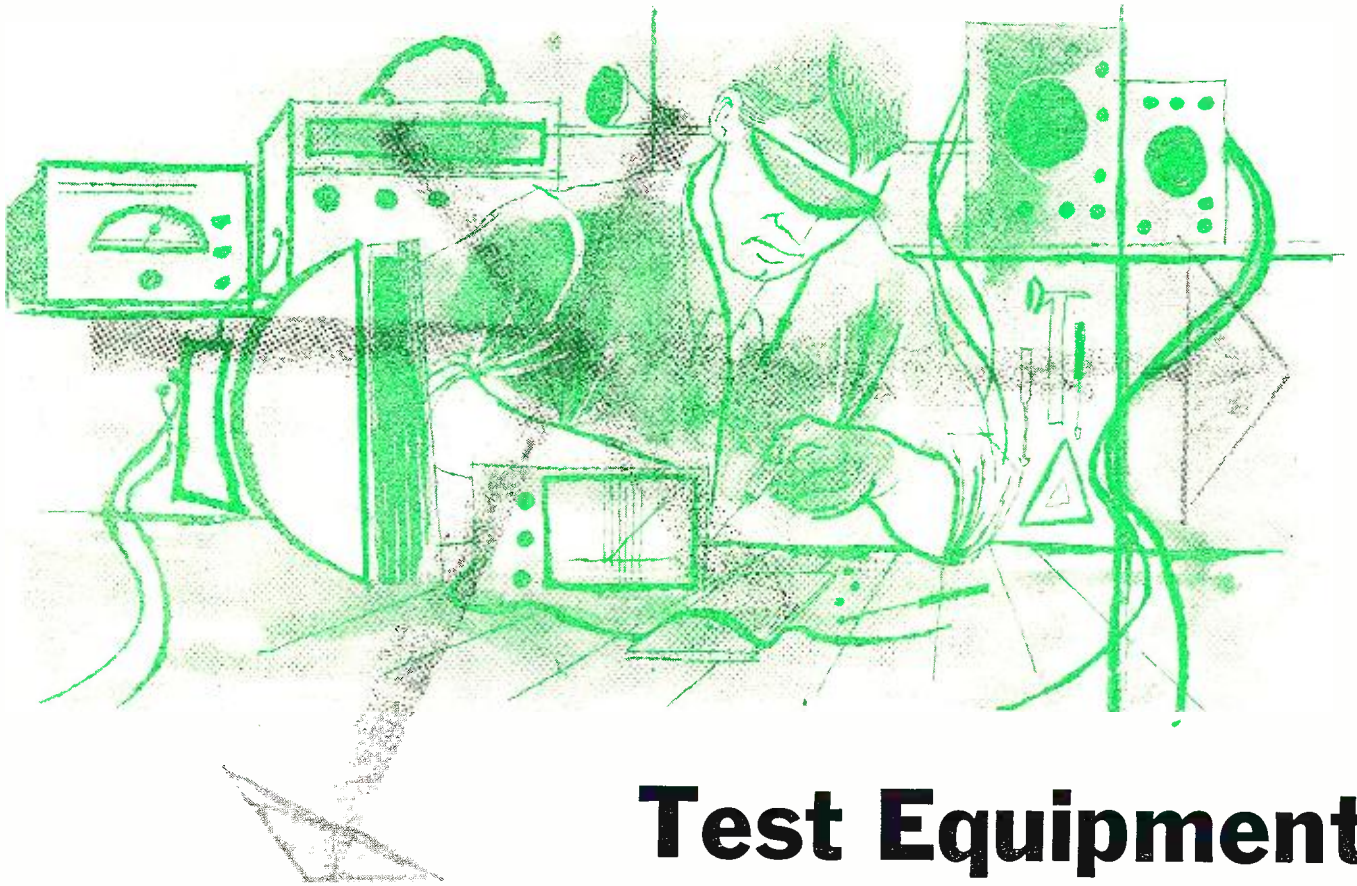

Fig. 5. Normal modulation deviation (A) within receiver bandpass. Overmodulated transmission (B) garbles reception.



# Test Equipment

**What you must have to count yourself "in business," what features to look for, and what you must spend.**



The "Knight-Kit" general-purpose scope.

Heathkit OM-3 general-purpose scope.

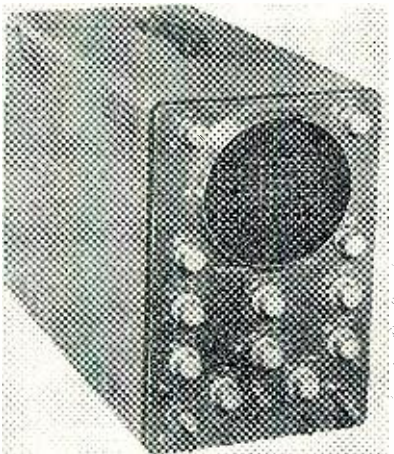

**W**HAT INSTRUMENTS must you have to operate a small radio and TV service shop? What features should each instrument possess? How much will they cost?

These important questions face every service technician who plans to start his own service business. It is the aim of the writer to draw upon his observation and experience and try to answer the questions as thoughtfully and honestly as possible.

The shop visualized is a one-man affair soliciting only house-radio and black-and-white TV service. Later, of course, car radio, color TV, and hi-fi maintenance can be added; but the specialized instruments required in these fields are being omitted from this discussion of the fundamental shop complement.

The author is keenly aware that the beginning service technician is likely to have very limited funds early in his career; furthermore, not all his capital can be spent on service instruments. Hand tools, service literature, parts stock, advertising, and a backlog to take care of the overhead during critical months all have a claim on his slim resources. Every dollar spent for instruments must be carefully justified.

Deciding whether the first instrument should be a v.o.m. or a v.t.v.m. was not an easy choice, but the v.o.m. finally won for this reason: its long-

term accuracy is inherently better than that of the v.t.v.m. The technician needs one instrument around the shop in which he can place implicit faith year after year and against which he can check all other instruments. A good v.o.m. handled with reasonable care fulfills this requirement. The writer still has a v.o.m. that reads exactly the same now as it did when purchased twenty years ago!

The main advantages of the v.t.v.m.—lighter loading of circuits under test, especially on the lower ranges, and the isolation provided by the probe resistor—can be partially duplicated by employing a sensitive v.o.m. on as high a range as will give a reasonable reading and by using an isolating resistor of 100,000 ohms or so in series with the probe in checking circuits—such as the grid voltage developed by an oscillator—where the capacity of the probe would affect the reading and where knowing the exact value of the voltage measured is less important than determining whether or not any voltage is present.

These are typical characteristics of a good v.o.m.: it has a sensitivity of 20,000 ohms-per-volt on d.c. voltage measurements and 1000-5000 ohms-per-volt on a.c. There are from six to eight voltage ranges. Full-scale value of the lowest range may be anything from .25 to 3 volts; the highest, from 1000

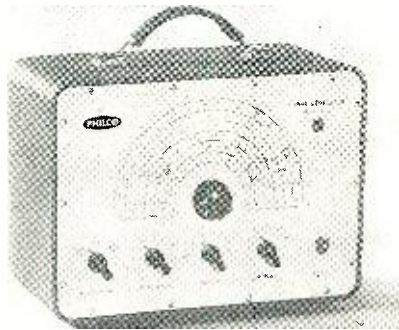
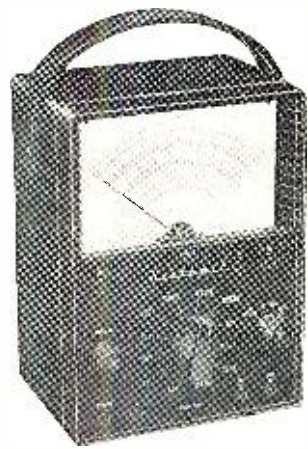
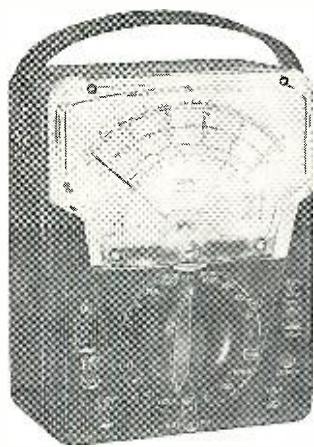
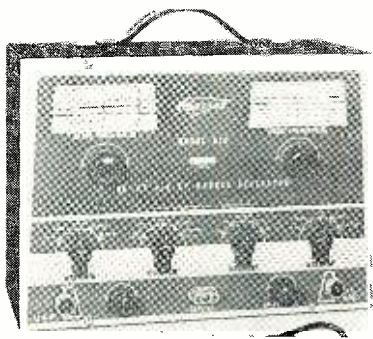

The v.o.m.: two of the many units available are the Triplett 630 (above) and the Heathkit Model MM-1 (upper right).

Among the r.f. signal generators are the Precise 630 (upper left), which includes a full-range audio generator, the Philco 7200 (lower left), and the Precision E-200C (lower right).

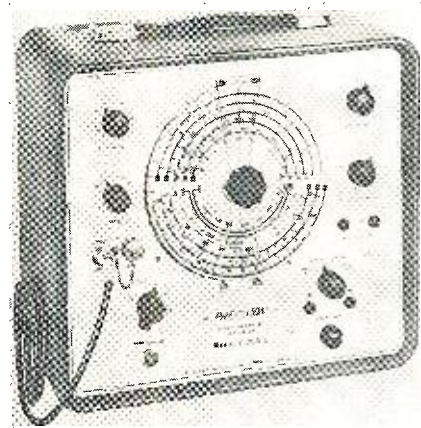

# fo the Basic Shop

By JOHN T. FRYE

to 7000 volts. The ohmmeter reads up to at least 20 megohms in three to five ranges. Direct currents of from 50 or 100 microamperes up to 10 or 15 amperes can be read. "Output" ranges will be from -15 or 20 db to +40 or 60 db. Probably the guaranteed accuracy will be 3 per-cent of full-scale value on d.c. and 5 per-cent on a.c., but you may safely expect the actual accuracy to be considerably better. The instrument will cost somewhere between \$35 and \$65.

Commercial units will be found with such extra features as a dual sensitivity range, resistance readings up to 100 megohms, sensitivity of 100,000 ohms-per-volt, overload cut-out protection, mirror scales to avoid parallax, 1 per-cent accuracy, and a "transit" position of the range switch that heavily damps the meter movement and prevents the pointer from swinging wildly back and forth in such a way as to damage itself while the meter is being transported. It is up to the purchaser to decide whether or not he wishes to pay the extra cost of such features.

An oscilloscope is an absolute necessity for anyone attempting TV service; furthermore, a good scope in the hands of a technician who knows its capabilities can take the place to some extent, of many other costly specialized instruments, such as an a.c. voltmeter, signal tracer, distortion analyzer, frequency

meter, and other such instruments.

A basic shop oscilloscope should have these typical characteristics: the screen should be 5 inches in diameter for easy viewing of fine detail from a reasonable distance. Vertical amplifier sensitivity should be at least 50 mv. r.m.s. per inch of deflection. This amplifier should be essentially flat in frequency response from 10 cycles to 1.5 megacycles. The lower limit is essential in sweep alignment; the upper, for the proper display of sync pulses and similar waveforms. The horizontal amplifier should have a sensitivity of at least .75 volt/inch and a frequency response to 200 kilocycles or better. The sweep oscillator will cover a minimum range of 15-75,000 cycles, and the sweep *will be very nearly linear throughout its range*. Either the CR tube will be shielded or the parts so carefully placed that the trace is moved *only* by voltages delivered by the amplifiers, and not by magnetic fields from the scope transformer, filter choke, or other components.

Many oscilloscopes offer one or more of the following desirable features: vertical amplifier range extending down to d.c. and up to five megacycles or so; dual-duty vertical amplifiers that give a choice of either high sensitivity or broad frequency response; either direct- or capacity-coupled amplifiers; vertical retrace blanking; in-

put for Z-axis modulation; easy access directly to deflection plates; built-in voltage calibration; and variable-phase, line-frequency signal.

An oscilloscope with the minimum characteristics can be purchased for less than \$150. Before buying, though, consider this: when you start color TV servicing, you are going to need an oscilloscope with good frequency response through the color-burst frequency of 3.58 mc. If you have the funds, it might be well to buy an instrument adequate for color TV servicing right in the beginning rather than having to buy a second scope later. That way you will be accumulating experience, confidence, and dexterity in the use of this particular, important instrument right from the start.

On the other hand, if you do not have the extra money that a high-sensitivity, wide-band scope may cost, the lower-cost instrument can always be put to good use around the shop after you do get the new one; moreover, the experience you will gain with the first oscilloscope will provide a much clearer idea of the features you will ultimately want in the more expensive unit.

An r.f.-a.f. signal generator is the next piece of essential shop equipment. A representative signal generator will cover a range from 100 kc. to 50 mc. *on fundamental frequencies*. This will be

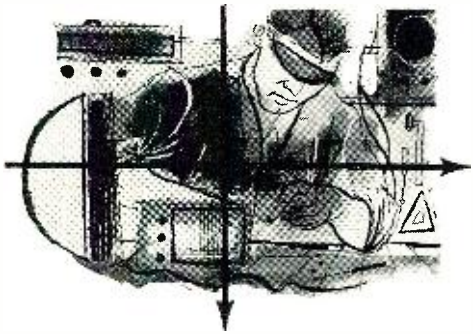

EICO 368 sweep and marker generator.

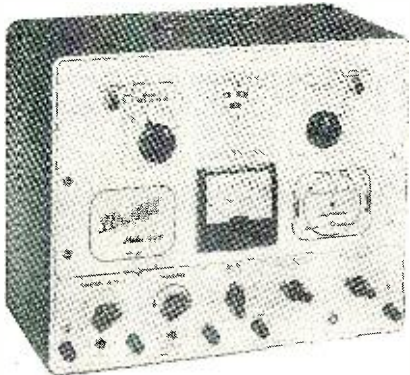

Hickok 695 sweep-alignment generator.

achieved in several bands. The more ranges, the better will be the band-spread. The r.f. output will be modulated, when desired, with an audio frequency, usually of 400 cycles. Maximum output should be around .1 volt, and the shielding and attenuators must provide complete control of the output. The test of a good signal generator is not only how much output can be had, but to what low level the output and leakage can be reduced.

A vernier dial and proper dial markings should permit the pointer to be set very close to any desired frequency. The audio signal should be available by itself for use in signal tracing. Dial calibration should be within 1 per-cent to start with, and adjustments should be available at both ends of each band for correcting any drift. Fifty dollars should buy a reliable r.f.-a.f. signal generator with these characteristics. It will be used to align radio receivers, including the communication type, completely. The higher ranges will make it useful as a marker generator for TV i.f. alignment, and harmonics can be used for markers on the TV channels. It will be employed for sig-

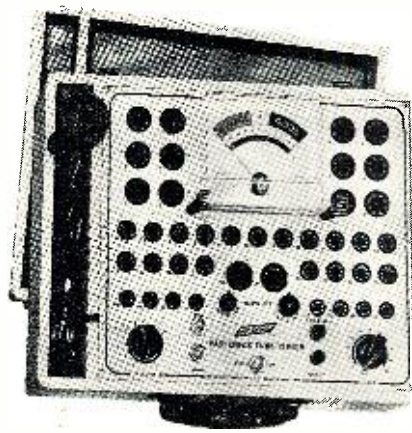

Century multi-socket FC-2 tube tester.



Superior TW-11 lever switch tube tester.

nal injection in both radio and TV service. Next to the v.o.m., it will be called on most often in the shop.

No one can claim he is doing TV service unless he is equipped to do a good job of aligning a TV receiver and that calls for a sweep generator. The output of such a generator should cover a range of from 3-4 mc. through 220 mc., all on fundamentals. The sweep width should be smoothly variable from 0 to at least 12 mc. on all frequencies above 20 mc. Most important of all, the output of the generator should be nearly constant over a frequency sweep of at least six megacycles. This is particularly important in the vicinity of the 21- and 41-mc. intermediate frequencies. The generator should provide retrace blanking and a horizontal sweep for the scope with a phasing control.

It is a great help if the generator also includes built-in variable and crystal marker generators. A 4.5-mc. crystal permits precise alignment of the sound channel of an intercarrier TV set and its harmonics provide check points for the variable marker as well as pips every 4.5 mc. on the i.f. response curve. However, if these features cost more than the buyer can afford, he can still use his r.f.-a.f. generator as a marker generator. In fact, it will be used anyway for creating extra markers.

There is a wide range in the cost of sweep generators, probably justified by how much effort is made to attain nearly-perfect linear sweep, linear output, and accurate markers; but we are assuming the beginning technician needs a sweep generator primarily to do a good job of TV i.f. alignment and front-end touch-up. Precise tuner alignment, requiring laboratory-type equipment to do a first-class job, will not be attempted. Such jobs will be farmed out. A sweep generator adequate for TV i.f. and FM receiver alignment should be available for less than \$150.

The last piece of shop equipment needed is a tube tester. An ideal tube tester would check tubes for emission, transconductance, leakage, gas, noise,

filament current, and reverse grid current—and it would cost several hundred dollars. Fortunately, a tester that will check only a few of these qualities will serve our technician, and one can be purchased for \$100 or less.

Money spent for a tube tester will bring the quickest direct return of all the instruments. Tube sales provide the easiest income a technician makes, and a good tube tester will reveal tubes needing replacing to him *and to his customer* that otherwise would be overlooked.

The tube checker may test either the emission or  $G_m$  of a tube. It should also make short and leakage tests. It ought to indicate proper filament current for the popular series-string TV tubes. An adapter should enable it to check picture tubes.

The tester may also have provision for checking transistors, selenium rectifiers, semiconductor diodes, pilot lamps, and batteries; but the essential thing is that it be able to check all tubes presently used in radio and TV receivers and detect about 95 per-cent of the defective tubes. The other 5 per-cent can be spotted by tube substitution. This kind of tube tester can be bought for around \$100.

With careful buying, \$500 should purchase the v.o.m., scope, r.f.-a.f. generator, sweep generator, and tube tester. By assembling his own kit instruments, the technician can reduce this figure materially. Several manufacturers offer well-designed kits of all five service instruments that will give excellent service if carefully assembled according to instructions.

However, whether kits or manufactured units are purchased, the technician should spend his money carefully and thoughtfully, comparing features, matching prices, and considering manufacturers' reputations. With five good, honest instruments of the kind described to help him, the service technician can keep the doors of his shop open with confidence that he has the instruments needed to do a dependable, workmanlike job of house-radio and black-and-white TV service. —30—



# Create Your Business Personality

By WILLIAM LEONARD

Careful planning of this important factor, rather than haphazard development, will aid your growth.

EVERY business has its own distinct "corporate" personality. It may exude a warm, friendly atmosphere that serves as a magnet to draw new customers and to keep old ones. Or it may leave the impression of cold indifference, relying entirely on the need for its products or services to keep its customers. Most service businesses have evolved "personalities" that lie somewhere between these two extremes.

Select a half dozen electronic service shops at random from a directory, call on each of them, and you will find the only thing they have in common is the type of work they do. They will differ in outward appearance, in interior store and shop layout, and in the "personality impact" they have on their customers. This indicates that the personality characteristics of service businesses are seldom the result of careful planning. They frequently reflect the technical leanings of the owner, who has failed to grasp the importance of creating a "corporate image" for his business.

The complexities of modern living have compelled people to patronize types of business they have been "educated" to recognize. Take, for example, the five-and-ten-cent stores. While each chain has its own color scheme and a few distinguishing characteristics in its store fronts, there is a strong family resemblance in both the exterior and interior appearances of all five-and-ten-cent stores.

The same trend toward standardization has occurred in the development of supermarkets and chain drug stores. Outward appearances make customer identification easy. Interior arrangements follow a standard pattern to simplify product selection. Modern merchandising management



strives to create confidence through appearance and to simplify the buying process through carefully planned product displays.

The progressive development of a service business requires time and thought. It needs planning that is the result of unfettered and objective thinking. It needs the guiding hand of an owner who can detach himself from his activity to visualize all facets of his business through the eyes of the general public. It requires a carefully conceived, long-range program to help it fulfill the growth requirements that are essential to continued business existence in our economy.

The management responsibilities of the small dealer who aims to build a stable and substantial business for himself in electronic service are big and exacting. They are deserving of and must have his undivided attention at those specific times that should be allotted for handling management responsibilities. He must find ways and means of hanging up an "in conference" sign to shut out distractions in order to give his business the merchandising thought it must have to prosper.

An electronic service business is an all-absorbing activity if the owner allows it to control *him*. Business-wise, it will drift with the tide. Successful dealers, however, have found ways to adjust their daily routines to give them the time to make plans and crystallize ideas. Some dealers, for instance, maintain separate offices in their homes where they can work away from the distraction of shop activities.

In appraising his own service business, a dealer's first objective should

be to determine the kind of personality his business has acquired. Is it the kind of personality that will attract new business? Is it the type of personality that will hold old customers?

When a set owner phones for service, does the telephone personality that greets her make her feel welcome? Does it leave the impression that she is in contact with a reliable, competent firm? Good telephone answering practices are vitally important in developing the right kind of service business image.

Most TV service businesses are like Topsy. They were not born. They just grew. A large percentage of them came into existence at a time when the demand for TV service was high and the available facilities were unreliable or inadequate. The foundation of these businesses was honesty and technical competence. Their basic weakness was the failure to comprehend TV service

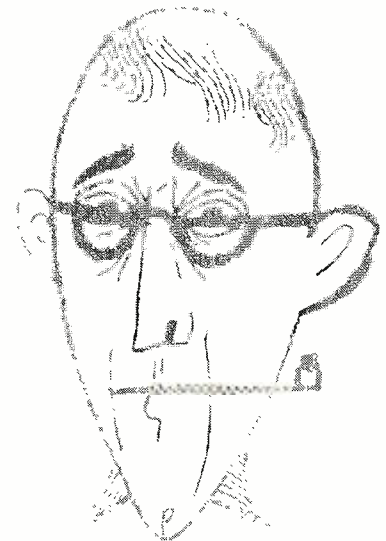

as a "selling" business in a normal market. They failed to recognize the need to merchandise their facilities in order to grow. The end result is that many service businesses are stuck at dead center with an average operating income that is too low for the amount of time the owner has to give to his business.

The next element that plays an important part in the personality of a service business is the exterior appearance of the store or premises where it is located. Does it *look* like a successful business? Will it inspire confidence in a customer who is searching for competent, trustworthy service?

TV service is an intangible product. In watching a service technician an-

(Continued on page 109)



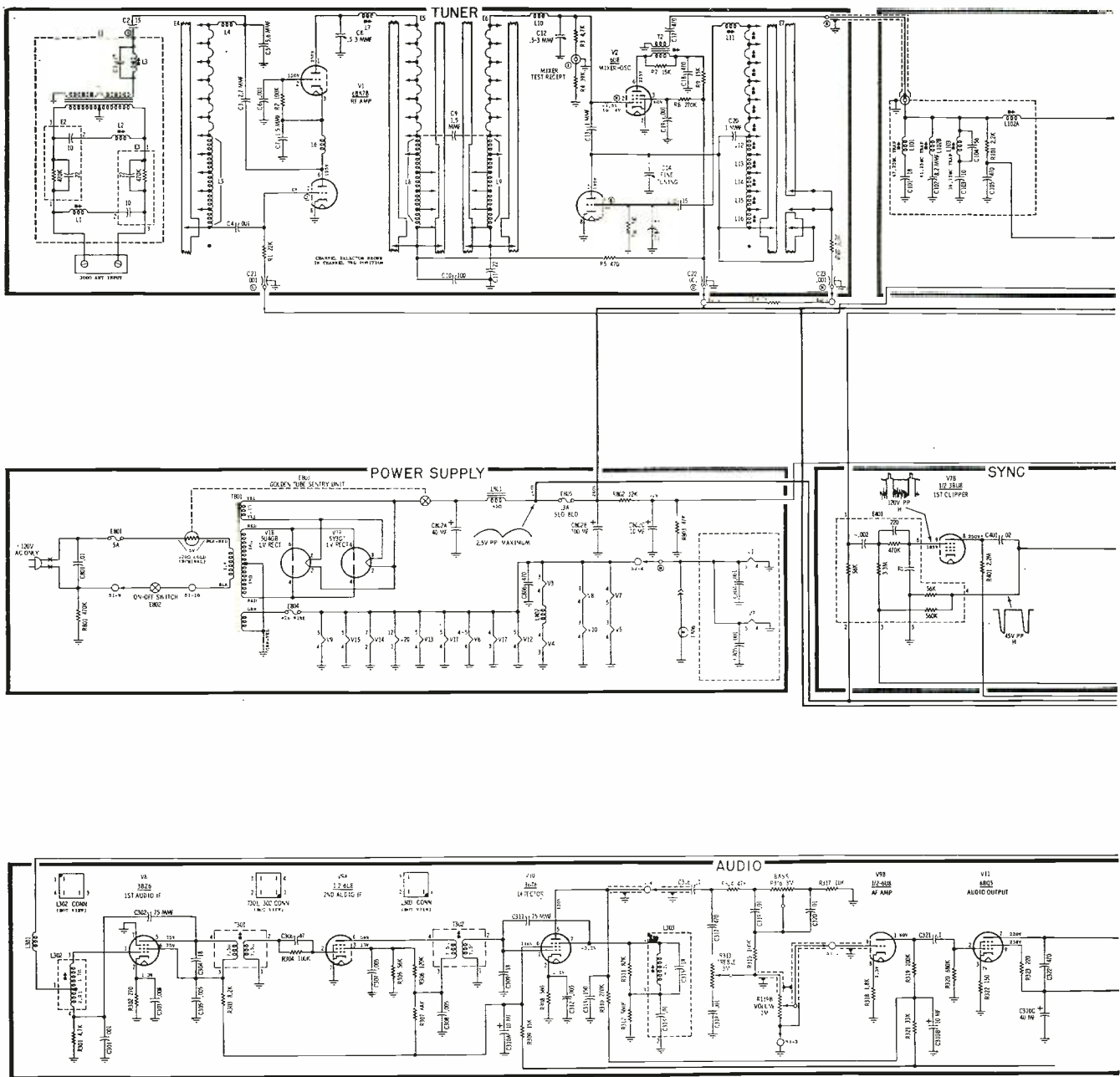

Complete schematic for chassis TS-552

# TV Schematics for 1959

## Motorola Chassis TS-552

### Models:

21K104B, Y21K104B,  
21K104M, Y21K104M,  
21K104W, Y21K104W,

21K105B, 21K105MC  
21K105W, 21K108W  
21K109M, 21K110W

The problem of keeping up with the service data for all TV receivers as they reach the market has no easy solution. However, the reader bonus on these six pages is a long step in that direction. The editors have chosen schematics and supplementary information covering popular 1959 chassis used in a wide range of models. Each manufacturer represented is high on the list of best-selling brands. Thus, this data is applicable to an impressive proportion of new sets coming into use this year. For comprehensive coverage of what to look for in the new lines of fifteen leading manufacturers, see "New TV Designs for 1959" in this issue.

VIDEO

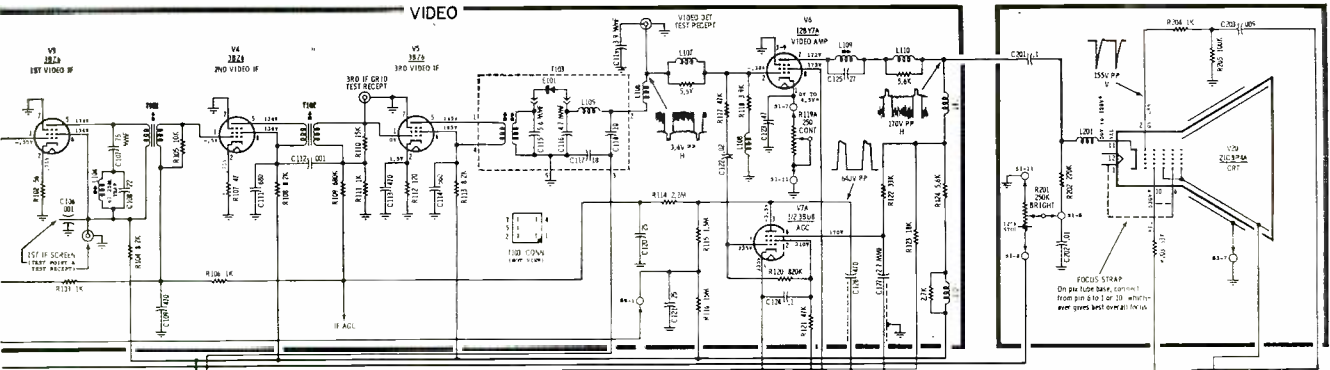

HORIZ SWEEP & H.V.

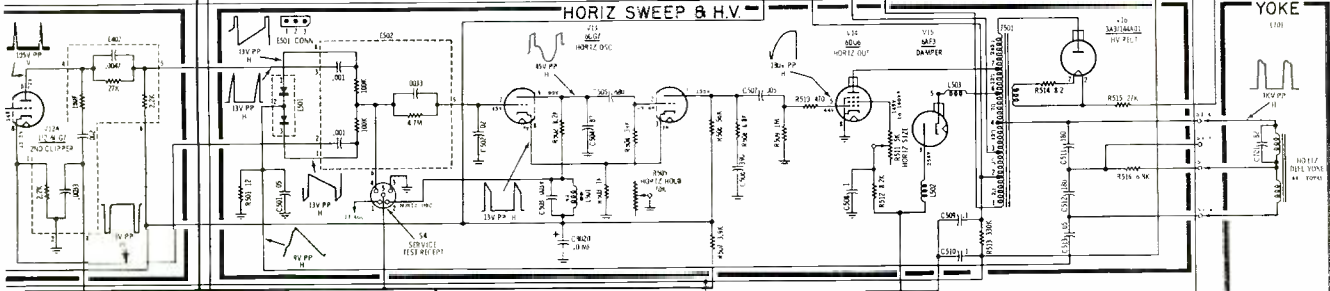

VERT SWEEP

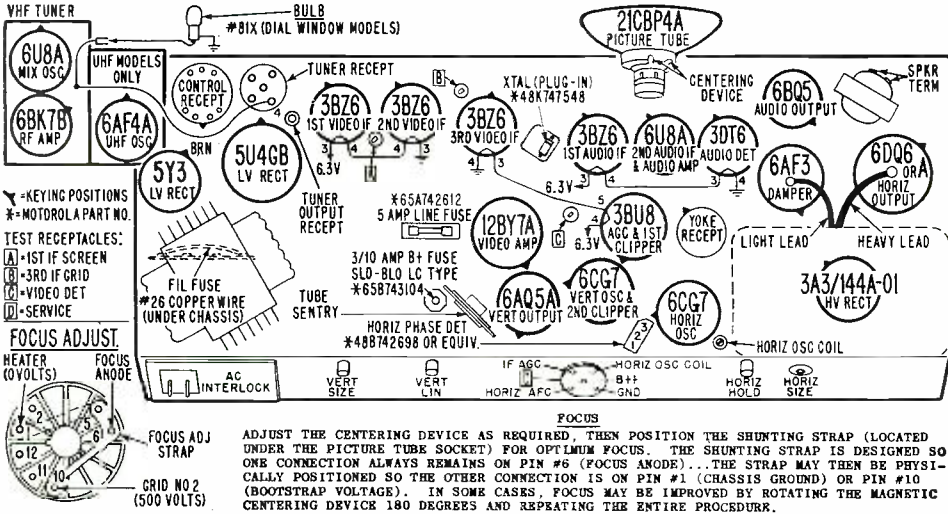
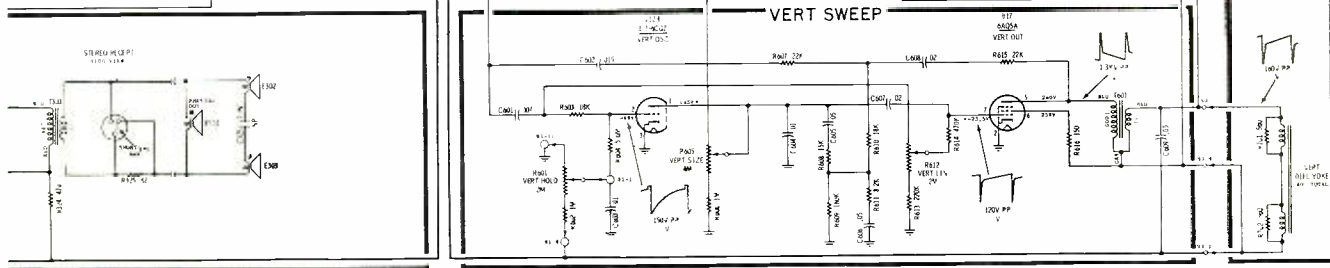

NOTES: Chassis is vertically mounted. The layout to the left is as viewed from the back of the receiver. Models with prefix letter "Y" include added u.h.f. tuner (TT-89), for which the manufacturer has a separate service manual. Stereo receptacle permits use of the TV speaker system as an add-on audio channel.





TUNER UNIT-KRK79U/80J

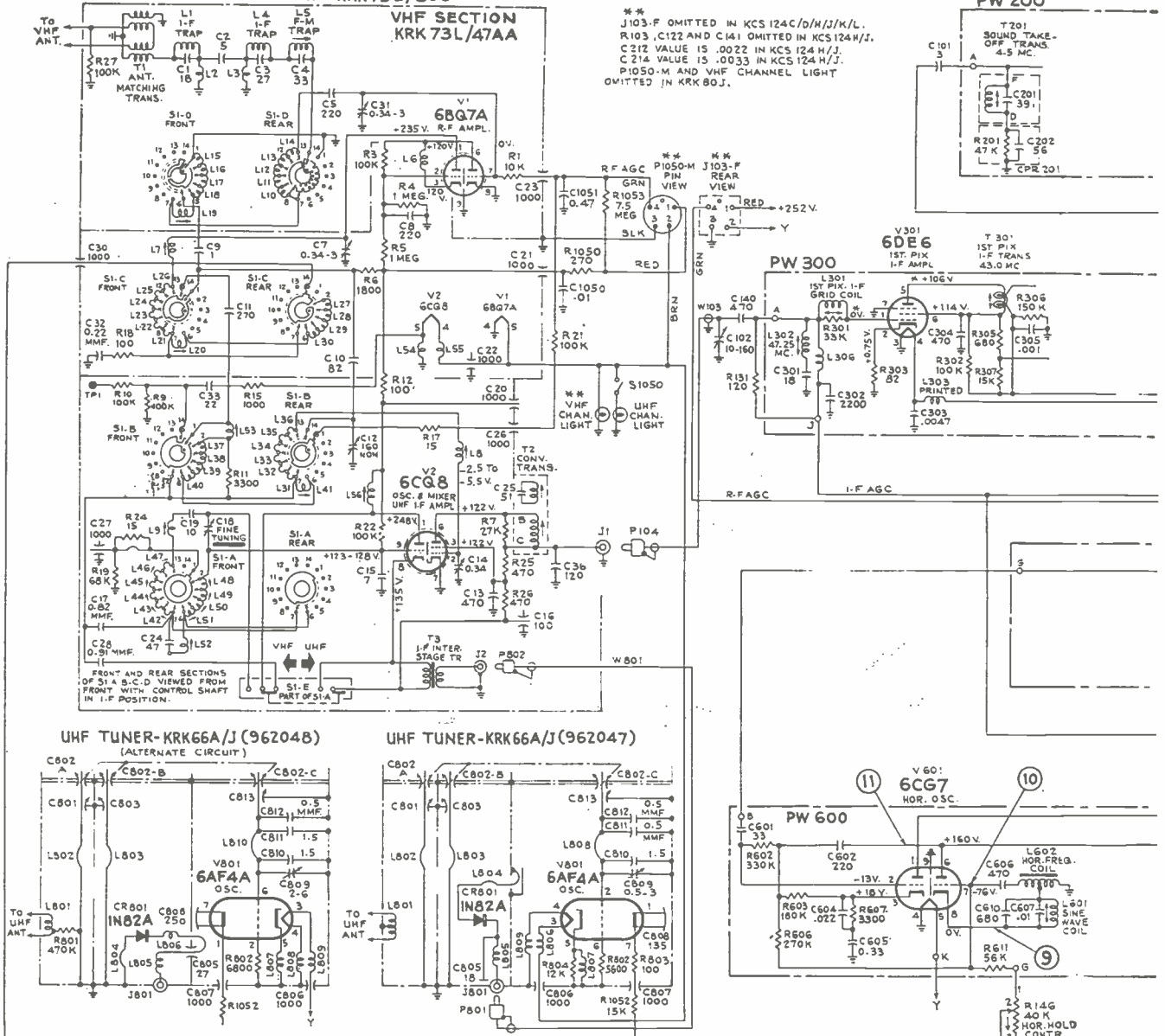

Balloons ① ② etc., shown on schematic above, indicate points of observation of the waveforms shown below.

All capacitance values less than 1 in Direction of arrows at controls indicate MF and above 1 in MMF unless otherwise noted.

Direction of arrows at controls indicates clockwise rotation.

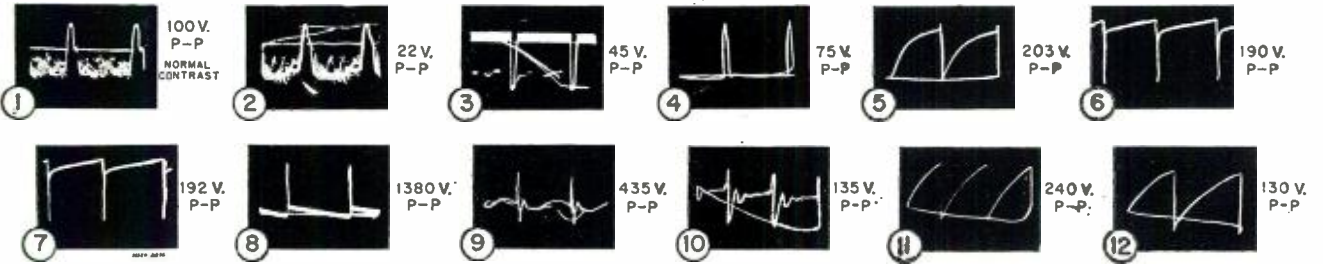

# TV Schematics for 1959

RCA Victor Chassis KCS124C, D, E, F, H, J, K, & L

Models: 21-T-9125(U), 21-T-9127(U), 21-T-9265(U), 21-T-9266(U), 21-T-9267(U), 21-T-9275(U), 21-T-9276(U), 21-T-9277(U), 21-T-9345(U), 21-T-9347(U)

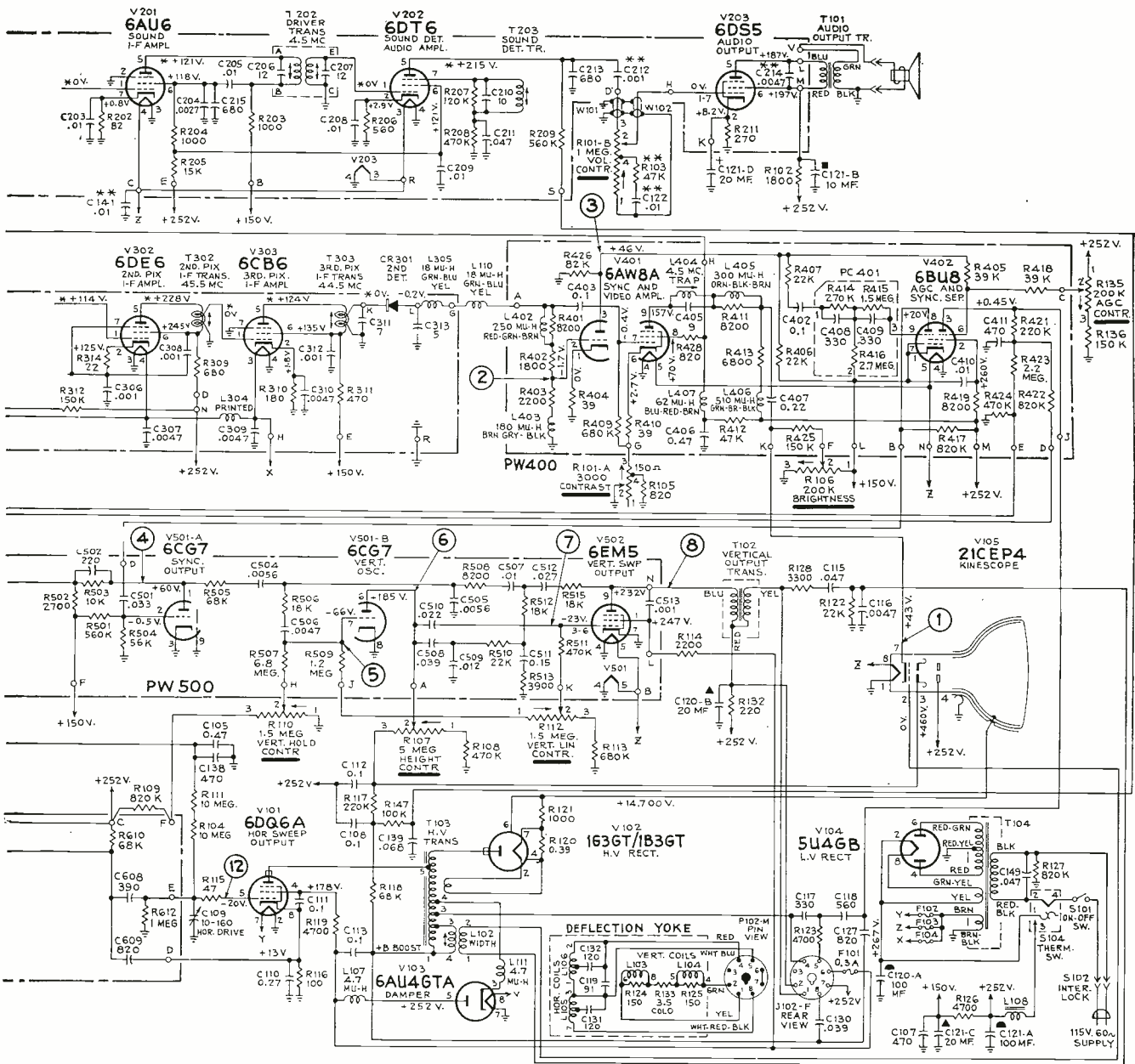

All resistance value in ohms. K = 1000.

\*Measured with 1 megohm 1/2 watt resistor in series with meter probe.

NOTES: Layout of the vertical chassis, shown to the right, is the tube-side view, as seen from the back of the receiver.

The suffix letter "U" following the model number indicates a receiver equipped for u.h.f. reception.

Instead of the tuner complement shown in the main schematic, u.h.f./v.h.f. chassis KCS124D and KCS124J use tuner KRK80F/81J. The v.h.f. portion of this assembly is KRK71D/E, using a 6CY5 tetrode as r.f. amplifier and a 6CQ8 oscillator-mixer. The u.h.f. portion (KRK66J/P) is essentially one of the two shown in the main schematic.

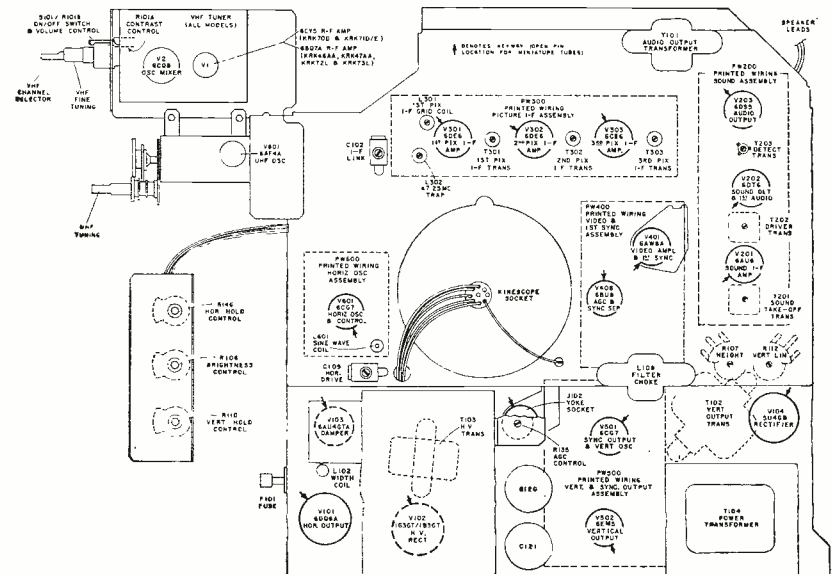



By JOHN T. FRYE

## TALKING BOOKS

THE calendar said April, but the mercury sulking in the bottom of the thermometer didn't believe it. Snowflakes brushed the windows of Mac's Service Shop and spread a chilly, discouraging blanket over the timid, advancing army of new grass and its brave but foolhardy leaders, the jonquils and the hyacinths. Mac was not surprised to hear his red-headed assistant, Barney, charging through the front door. Anyone would be in a hurry to get in out of that weather.

But apparently it was an idea, not the weather, that was spurring Barney. He marched straight to the shelf where the various chemicals used in service work were kept and picked out the pressurized can of acrylic spray. With great drama he opened a cupboard door, placed the can inside, and shut the door firmly.

"Even madmen have their reasons," Mac quoted questioningly.

"I've got a reason, and a darned good one," Barney retorted. "I've just witnessed a horrible catastrophe; and I'm making sure it doesn't happen here, especially to me."

"Give!" Mac commanded.

"After lunch I decided to drop by and see my friend, Speed, who works at Acme Radio and TV Service. We're supposed to double-date tonight and I wanted to work out a couple of little financial matters in advance, without the girls around. You dig?"

"I dig," Mac said with a grin; "go on."

"Well, the boss was out, and Speed was keeping the store. While we talked, he was trying to snow me with a demonstration of how fast he could service sets. First he ran through a couple of real 'tough' troubleshooting jobs of locating burned-out tubes in a.c.-d.c. receivers; then he slapped an all-wave chassis on the bench. It would intermittently develop noise and cut out. Working the bandchange switch stopped this; so Speed tells me, as though I wasn't real bright: 'Here we have an example of a bandchange

switch with dirty and corroded contacts. We can fix that in a sec. All we have to do is pick up a can of contact cleaner and spray all the wafers of the switch liberally, like so. Then we work the switch vigorously back and forth a few times—'

"All at once he stopped talking and started to turn pale. At the same time he began sniffing the air like a fireman on his day off getting a whiff of shingle smoke. Then he looked down at that can he had been using with the same expression of horror he would have had if it had been a rattlesnake that had just bitten him. I already knew by the smell it was acrylic spray. He grabbed that switch and began working it back and forth like mad to keep the gunk from setting up on the contacts and locking the switch. At the same time he started squirting contact cleaner on the wafers. I quietly tiptoed out of there and I'll bet he hasn't missed me yet. Now you know why I moved that acrylic spray out of easy reach. It and the contact cleaner are in the same sort of can and it would be very easy to get hold of the wrong one as Speed did."

"That's using the old hatrack," Mac applauded as he turned back to the record player on the bench.

"Hey, ain't that a kind of funny-looking record player?" Barney asked.

"In a manner of speaking, yes. It's actually a Talking Book Reproducer used by a sightless person. These special players were developed by the American Foundation for the Blind. Various books and magazines—everything, in fact, from *Reader's Digest* and current novels to Shakespeare and the Bible—are read onto long-playing records by professionally trained voices; then, through the agency of the Library of Congress and other organizations interested in the blind, these records and this reproducer are made available on a loan basis to sightless persons. 'Talking Books,' as the records are called, even go through the mails without charge."

"That looks more rugged than the average portable record player. I suppose the metal guides are to allow the blind person to put a record on the turntable quickly without being able to see; and this one allows him to lower the stylus onto the record at the right point."

"You're right. This lever permits a choice of either 33½ or 16⅞ rpm. Between these two positions, the drive wheel is disengaged from the turntable so that it will not develop flat spots. A speaker is in the hinged lid. This is cut out when phones are plugged into this jack for personal listening."

"What's the thing doing here?"

"The owner says he can't hear it. He is hard of hearing as well as blind, and he was afraid the reproducer did not normally put out enough volume. After all, it is brand new and the first one he has ever used. But a letter from the Talking Book people assured him there should be ample output, especially through the earphones, to compensate for any except the most severe loss of hearing. They suggested he take it to a competent electronics service shop for repair rather than return it to them. This is a change of policy. They used to insist a defective machine be returned for repair. This resulted in such long delays and in such frequent shipping damage that now they suggest the sightless person have it repaired locally."

As he talked Mac turned on the amplifier with the switch on the tone control. After a few seconds he used the switch on the gain control to turn on the turntable motor. When the stylus was lowered onto the record, the voice could be heard very faintly through the speaker. It was still faint through earphones plugged into the jack on the motor board. The volume control had to be all the way on for useful sound.

Working with unusual care, Mac took out the screws around the edge of the motor board and then removed two others that went in through the bottom of the case. When the motor board was lifted out, the amplifier chassis could be seen fastened to the front edge of the board.

"Wow!" Barney exclaimed. "Look at that amplifier! That thing is really built. I'll bet it has more parts in it than most a.c.-d.c. radios. It does a guy good to see something like that after you are used to seeing some of the amplifiers—often just one-tube jobs—that are used in cheap portable record players. Say, isn't that a power transformer?"

"Yep. This is no a.c.-d.c. job. The designer knew the sightless user would spend hours at a time listening to it. After all, 'reading' a book usually requires listening to both sides of twenty to thirty long-playing records. To listen for long periods of time without undue fatigue means that distortion, hum, and other distracting and extraneous sounds must be kept to an absolute minimum. That's why we see

(Continued on page 94)



Simply by checking  
all the tubes in the TV set with

**B&K DYNA-QUIK**

# YOU CAN INCREASE YOUR INCOME

## FAST AND ACCURATE

- Tests complete set in minutes
- Wins customer's confidence
- Saves costly call-backs
- Sells more tubes on-the-spot
- Avoids substitution testing
- Makes more money every day

**\$50\***  
**PER WEEK**

\*ACTUAL EXPERIENCE SHOWS  
TV SERVICEMEN AVERAGE

**2 extra tube sales  
PER CALL**

**5 calls per day in  
5 days equal \$50**

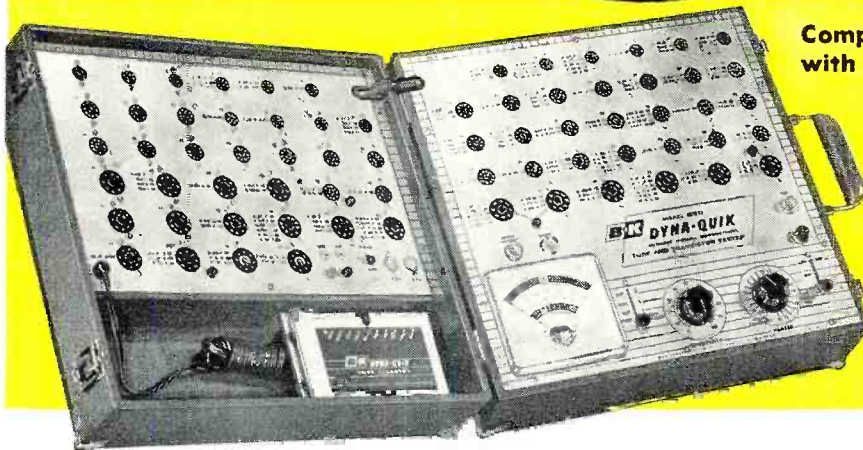

Completely test each tube  
with laboratory accuracy!

## Model 650 DYNA-QUIK

Today's Fastest,  
Most Complete Portable

**TUBE AND  
TRANSISTOR  
TESTER**



Professional-type tester  
used by more service  
technicians every day.

## MEASURE TRUE DYNAMIC MUTUAL CONDUCTANCE

Thousands of technicians are doing a better servicing job and are making more money today with the famous B&K DYNA-QUIK. Completely tests each tube in seconds, with laboratory accuracy, in home or shop. *Measures true dynamic mutual conductance.* Shows tube condition on "Good-Bad" scale and in micromhos. No multiple switching or roll chart. Quickly detects weak, short-life, or inoperative tubes. Shows customer the true condition and life-expectancy of tubes in the set; sells more tube replacements per call. Assures customer satisfaction and protects the service guarantee.

## Model 650 Dyna-Quik improves servicing, quickly pays for itself

Checks over 99% of the tubes most widely used in television receivers, plus popular home and portable radio tubes. Tests over 500 tube types. Lists over 125 most commonly used tube types, with settings, on socket panels for maximum operating speed. Complete listing in fast telephone index type selector. Tests each section of multiple tubes separately for Gm, Shorts, Grid Emission, and Life. Tests each tube for Gas Content. Provides instantaneous Heater Continuity check. Includes 16 spare sockets and sufficient filament voltages for future new tube types. Transistor Section checks junction, point contact and barrier transistors, germanium and silicon diodes, selenium and silicon rectifiers.

Net, \$169.95

See Your B&K  
Distributor or

Send Now for  
Bulletin ST21-N

## ANOTHER PROVED MONEY-MAKER



## Deluxe Portable CRT 400

Tests and Repairs  
Picture Tubes  
Makes New Tube  
Sales Easier

Checks and corrects most TV picture tube troubles in a few minutes, right in the home, without removing tube from set. Restores emission. Checks leakage. Repairs shorts and open circuits. Life Test checks gas content and predicts useful life.  
Net, \$59.95

Adapters for Models 400 and 350 CRT's  
Model C40 Adapter. For standard 6.3 volt filament 110° tubes and color tubes. Net, \$9.95  
Model CR48 Adapter. For the new 110° tubes with 2.34, 2.68 and 8.4 volt filaments. Net, \$4.95



**B & K MANUFACTURING CO.**

3726 N. Southport Ave. • Chicago 13, Illinois

Canada: Atlas Radio Corp., 50 Wingold, Toronto 10, Ont.

Export: Empire Exporters, 458 Broadway, New York 13, U.S.A.

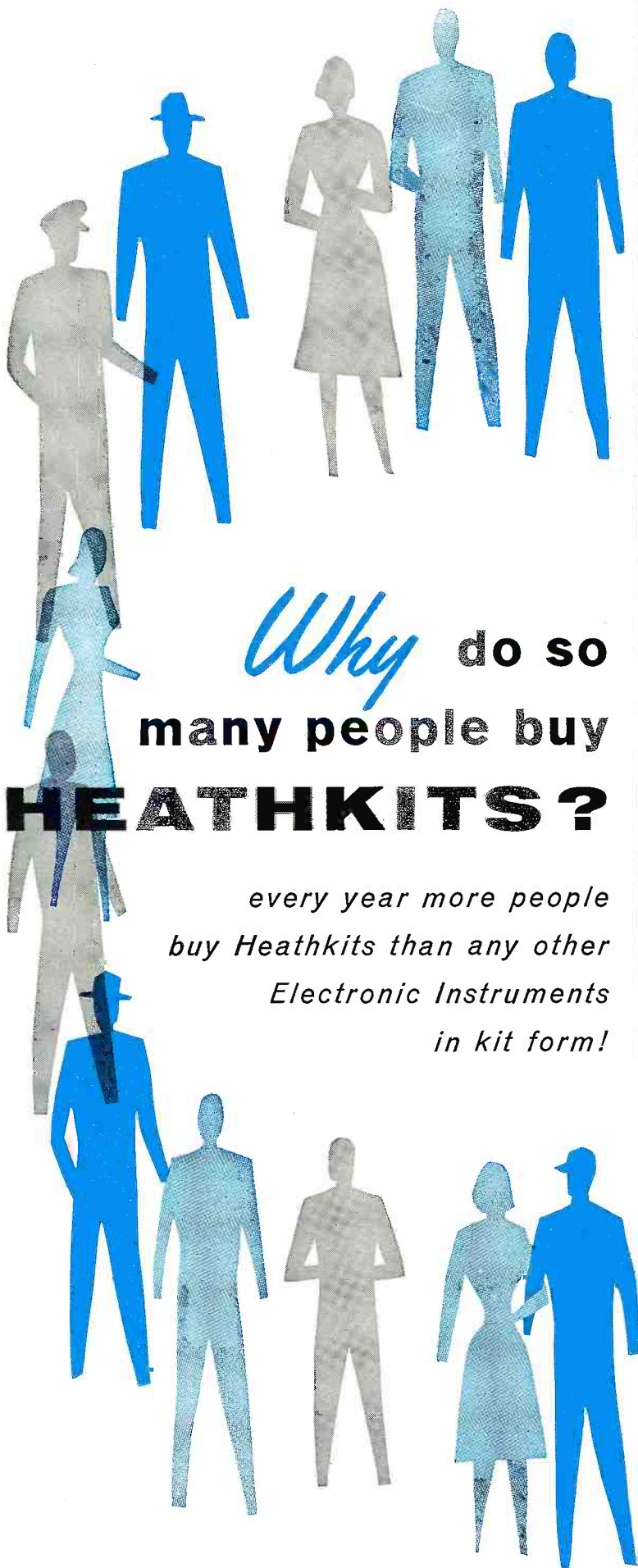

*Why* do so  
many people buy  
**HEATHKITS?**

*every year more people  
buy Heathkits than any other  
Electronic Instruments  
in kit form!*

**Here are a few  
reasons why...**

**EASY TO BUILD**

Heathkits are engineered for easy kit construction. You need no electronic or kit building experience whatsoever to successfully complete your own kit. Use of printed circuit boards and pre-wired, pre-aligned assemblies cut construction time. Manuals are carefully prepared, employing step-by-step instructions written in simple, non-technical language. Large pictorial diagrams and photographs show you exactly where each part goes.

**LASTING QUALITY**

Only top quality components go into Heathkits, assuring you of a finished product that is unsurpassed in performance, dependability and endurance. Rigid quality control standards are maintained at the Heath factory to see that each component lives up to its advertised specifications. Heathkits are conservatively rated. No performance claims are made that are not thoroughly proven and tested under the most stringent laboratory conditions.

**ADVANCED ENGINEERING**

Progress in electronics engineering never stands still at Heath. The latest developments in circuit design and components are exploited by Heath engineers, offering you superior performance at lower costs. New advances in all fields of electronics are carefully watched by Heath engineers to keep abreast of the rapidly growing industry. The modern, up-to-date styling of Heathkits make them a handsome addition to your home or workshop.

**WORLD-WIDE REPUTATION**

A pioneer in do-it-yourself electronics, Heath Company, over more than a decade, has established public confidence in its products both in the United States and abroad. Today, as the world's largest manufacturer of electronic kits, Heath stands as the leader in its field.

**GREATER SAVINGS**

Do-it-yourself Heathkits save you up to 1/2 the cost of equivalent ready-made equipment. Direct factory-to-you selling, eliminating middle-man profit, plus the tremendous Heath purchasing power mean even further savings to you. And the convenient Heath Time Payment Plan allows you to use and enjoy your Heathkit NOW, while you pay for it in easy installments.



**HEATH COMPANY**  
Benton Harbor 15, Michigan

 a subsidiary of Daystrom, Inc.

## TRANSISTOR PORTABLE RADIO KIT

Fun for the whole family, this easy-to-build 6-transistor portable radio is ready to go wherever you go. The modern molded plastic case with pull-out carrying handle and fully enclosed back add beauty and convenience to this splendid kit. Six name-brand (Texas Instrument) transistors are used for good sensitivity and selectivity. The 4" x 6" PM speaker with heavy magnet provides "big set" tone quality. Use of this large speaker and roomy chassis make it unnecessary to crowd components adding greatly to the ease of construction. Transformers are prealigned making the radio ready for use as soon as kit is assembled. A built-in rod-type antenna assures good reception in all locations. Six standard flashlight batteries are used for power, providing extremely long battery life (between 500 and 1,000 hours) and they can be purchased anywhere. Stylish cabinet is two-tone blue molded plastic with gold inlay and measures 9" L. x 7" H. x 3 3/4" D. Shpg. Wt. 6 lbs.

**MODEL XR-1L:** Identical to XR-1P except in handsome leather case instead of plastic case. Leather carrying strap included. Shpg. Wt. 7 lbs.

**LEATHER CASE:** Can be purchased separately if desired. Fits all XR-1P and earlier XR-1 chassis. No. 93-1. Shpg. Wt. 3 lbs. **\$6.95.**

HEATHKIT  
MODEL XR-1P  
**\$29<sup>95</sup>**



MODEL XR-1L **\$34<sup>95</sup>**

## NAVIGATE BY PORTABLE RADIO



HEATHKIT  
MODEL DF-2  
**\$69<sup>95</sup>**

## 2-BAND TRANSISTOR PORTABLE RADIO DIRECTION FINDER KIT

Enjoy the safety, convenience and entertainment of this self-contained, self-powered, six-transistor superheterodyne radio direction finder. It receives aeronautical and marine beacons as well as standard band broadcasts with startlingly clear tone reproduction over a long range. Covering the beacon band from 200 to 400 kc and broadcast band from 540 to 1670 kc, the DF-2 is designed to take directional "fixes" on both aircraft and marine beacons as well as standard broadcast stations, while providing the entertainment of a high quality transistor portable radio. You are able to receive aircraft weather reports every thirty minutes and constant Coast Guard beacons on the 200 to 400 kc band. A dial light is provided for night operation. Power is supplied by six standard flashlight batteries which will last you up to one year under normal operation. Shpg. Wt. 9 lbs.

## POWER CONVERTER KIT

Now you can operate your TV set, radio, razor, and other AC electrical equipment directly from your 12-volt boat or car battery. With the Heathkit Power Converter you can enjoy the convenience of home electricity whether boat cruising or on automobile trips. Two power transistors are employed for years of trouble-free, dependable service. No moving parts to wear out, no tubes to replace. Shpg. Wt. 8 lbs.



MODEL PC-1  
**\$24<sup>95</sup>**

## ELECTRONIC IGNITION ANALYZER KIT

Ideal for use on automobiles, boats, aircraft engines, etc., the IA-1 checks ignition systems with the engine in operation (400 to 5,000 RPM). Shows the condition of coil, condenser, points, plugs and ignition wiring. Shows complete engine cycle or just one cylinder at a time. Two test leads are supplied, each 10' long, which will enable you to reach either the breaker points or the spark plug wires. Shpg. Wt. 20 lbs.

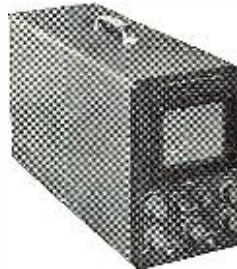

MODEL IA-1  
**\$59<sup>95</sup>**

## ELECTRONIC TACHOMETER KIT

Useful on inboard and outboard boats, as well as in automobiles, the TI-1 operates directly from the spark impulse of the engine. Use on any spark ignited 2 or 4 cycle engine of any number of cylinders. Completely transistorized, it works with 6, 8, 12, 24 or 32 volt DC systems. Indicates revolutions-per-minute from 0 to 6,000. Calibration control provided for adjusting to engine type. Easy-to-build and easy-to-install. Shpg. Wt. 4 lbs.



MODEL TI-1  
**\$25<sup>95</sup>**

## PROFESSIONAL OSCILLOSCOPE KIT

Everything you could possibly want in an oscilloscope is found in the new Heathkit model OP-1. Featured are DC coupled amplifiers and also DC coupled CR tube un-blanking. The triggered sweep circuit will operate on either internal or external signals and may be either AC or DC coupled. The polarity of the triggering signal may also be selected, and any point on the waveform may be selected for the start of the sweep by using the "triggering level" control. An automatic position is also provided, in which the sweep recurs at 50 cycle rate, but can be driven over a wide range of frequencies with no additional adjustment. Prewired terminal boards are used for rapid, easy assembly of all critical circuits. Power supply is transformer operated utilizing silicon diode rectifiers and is fused for protection. Handsome cabinet features silver anodized front panel with red and black lettering and matching knobs. Shpg. Wt. 34 lbs.

HEATHKIT  
MODEL OP-1

**\$179<sup>95</sup>**



## VARIABLE VOLTAGE REGULATED POWER SUPPLY KIT

Invaluable in experimental and design work, the PS-4 eliminates the need for building up a separate power supply for each new circuit tried. It provides a convenient source of variable regulated B+, variable bias voltage and filament voltage for labs and work shops. The PS-4 supplies regulated B+ output continuously variable from 0 to 400 volts DC at up to 100 ma, bias voltage variable from 0 to -100 volts DC at 1 ma, and filament voltage of 6.3 volts AC at 4 amps. Separate panel meters continuously monitors voltage and current output. Rugged, top-rated components used throughout for long, reliable service. Shpg. Wt. 16 lbs.



HEATHKIT  
MODEL PS-4

**\$54<sup>95</sup>**

Your best  
dollar value...



**HEATH COMPANY** • Benton Harbor 15,  
Michigan  
a subsidiary of Daystrom, Inc.

## "EXTRA DUTY" 5" OSCILLOSCOPE KIT

Laboratory quality at utility scope price makes this instrument an unusual value. The Heath patented sweep circuit functions from 10 CPS to better than 500 kc in five steps, giving you five times the usual sweep obtained in other scopes. Vertical frequency response extends from 3 CPS to 5 mc +1.5 db -5 db without extra switching. An automatic sync circuit with self-limiting cathode follower provides excellent linearity and lock-in characteristics. Extremely short retrace time and efficient blanking action are characteristic of this scope. Frequency response of the horizontal amplifier is within ±1 db from 1 CPS to 200 kc. Horizontal sensitivity is 0.3 volts RMS-per-inch. Construction is simplified through the use of two etched metal circuit boards and pre-cut, cabled wiring harness. Complete step-by-step instructions and large pictorial diagrams are supplied for easy assembly. An ideal scope for all service applications as well as in standard or color TV servicing. Shpg. Wt. 22 lbs.

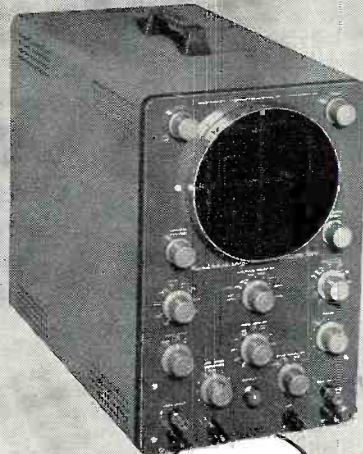

HEATHKIT  
MODEL O-12

**\$65<sup>95</sup>**



HEATHKIT  
MODEL TO-1

**\$16<sup>95</sup>**

## TEST OSCILLATOR KIT

Provides the test frequencies most often used by servicemen in repairing and aligning modern broadcast receivers. Five fixed-tuned frequencies (262 kc, 455 kc, 465 kc, 600 kc and 1400 kc) are quickly selected for troubleshooting or alignment of the IF frequency and high and low end of the broadcast band for proper tracking. Shpg. Wt. 4 lbs.



MODEL SG-8 **\$19<sup>50</sup>**

## RF SIGNAL GENERATOR KIT

A "must" for any beginning serviceman, this indispensable instrument is used for aligning tuned circuits quickly and tracing signals in faulty RF, IF and audio circuits. Covers 160 kc to 110 mc on fundamentals in five bands and from 110 mc to 220 mc on calibrated harmonics. Coils are pre-wound and calibrated. Complete with output cable and instructions. Shpg. Wt. 8 lbs.



MODEL AG-9A **\$34<sup>50</sup>**

## AUDIO SIGNAL GENERATOR KIT

This unique generator uses three rotary switches to select two significant figures and a multiplier to determine audio frequency, allowing return to the exact frequency previously measured when making multiple frequency measurements. Covers 10 CPS to 120 kc with less than .1 of 1% distortion between 20 and 20,000 CPS. Shpg. Wt. 10 lbs.



MODEL TS-4A **\$49<sup>50</sup>**

## TV ALIGNMENT GENERATOR KIT

TV service technicians will appreciate the outstanding features found in this sweep generator. Provides essential facilities for aligning FM, monochrome TV or color TV sets. The all-electronic sweep circuit employs a trouble-free controllable inductor which varies frequency by magnetic means. An unusual buy at this low price. Shpg. Wt. 16 lbs.



MODEL CD-1 **\$59<sup>95</sup>**

## COLOR BAR AND DOT GENERATOR KIT

The CD-1 combines the two basic color servicing instruments, a color bar and white dot generator in one versatile and portable unit, which has crystal controlled accuracy and stability for steady lock-in patterns. (Requires no external sync leads.) Easy-to-build and easy-to-use. No other generator on the market offers so many features at such a great price saving. Shpg. Wt. 13 lbs.

## ETCHED CIRCUIT VTVM KIT

Time proven for dependability, accuracy and overall quality, the V7-A is one of the wisest investments you can make for your electronic workshop or lab. Its multitude of uses will make it one of the most often used instruments in your possession. Use it to measure all operating voltages and potentials such as B+ and AC-DC, or straight AC power supplies, filament voltage, bias voltage, AVC voltage, line voltage, etc. Ideal for measurements in all types of AM, FM and TV circuits. Checks discriminator or detector operation, AVC or AGC performance, while the ohmmeter may be used to measure circuit continuity, circuit resistance, to test out individual components with resistance measurement, or to trace circuit wiring through cables or chassis openings. Front panel controls consist of rotary function switch and a rotary range selector switch, zero-adjust and ohms-adjust controls. Precision 1% resistors are used in the voltage divider circuit for high accuracy and an etched circuit board is employed for most of the circuitry. The circuit board not only simplifies assembly but permits levels of circuit stability not possible with ordinary conventional wiring methods. Shpg. Wt. 7 lbs.

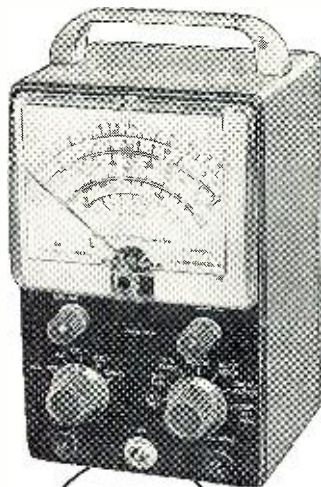

HEATHKIT  
MODEL V7-A

**\$25<sup>95</sup>**



HEATHKIT  
MODEL M-1

**\$17<sup>95</sup>**

## HANDITESTER KIT

Ideal for use in portable applications when making tests away from the work bench or as an "extra" meter in the service shop. The combination function range switch simplifies operation. Measures AC or DC voltage from 0 to 10, 30, 300, 1,000 and 5,000 volts. Direct current ranges are 0 to 10 ma and 0 to 100 ma. Ohmmeter ranges are 0 to 3,000 and 0 to 300,000. Top quality, precision components used throughout. Small and compact, take it with you wherever you go. Very popular with home experimenters and electricians. Test leads and 1½ volt size C battery are included with the kit. Shpg. Wt. 3 lbs.



HEATHKIT  
MODEL MM-1

**\$29<sup>95</sup>**

## 20,000 OHMS/VOLT VOM KIT

Portable and accurate, this kit features a 50 ua 4½" meter and 1% precision multiplier resistors for high accuracy. No external power required. Provides a total of 25 meter ranges on a two-color scale. Sensitivity is 20,000 ohms-per-volt DC and 5,000 ohms-per-volt AC. Measuring ranges are 0-1.5, 5, 50, 150, 500, 1,500 and 5,000 volts AC and DC. Measures direct current in ranges of 0-150 ua, 15 ma, 150 ma, 500 ma and 15 a. Resistance multipliers are X 1, X 100 and X 10,000. Covers -10 db to +65 db. Housed in an attractive bakelite case with plastic carrying handle. Batteries and test leads included. Shpg. Wt. 6 lbs.

## TUBE CHECKER KIT

Brand new in every respect, the TC-3 features outstanding performance and ease of operation. Sockets are provided for 4-pin, 5-pin, 6-pin, 7-pin, large, 7-pin miniature, 7-pin sub-miniature, octal, loctal, and 9-pin miniature tubes. Protection against obsolescence is provided by a blank socket to facilitate modification for checking newly added tube types. A 10-lever switch makes it possible to connect any element to any other element regardless of the pin numbers involved. A neon bulb indicator shows filament circuit continuity and leakage or shorts between elements. A specially designed spring loaded roll chart mechanism permits the roll chart to run freely throughout its entire length without binding. Thumb wheel drive knobs are provided on both sides of the panel to accommodate the left handed operator. Compact and small in size, the TC-3 is ideally suited for portable applications. Both the roll chart and the meter are illuminated to facilitate use in darkened areas. Shpg. Wt. 12 lbs.



HEATHKIT  
MODEL TC-3

**\$39<sup>95</sup>**



MODEL AV-3  
**\$29<sup>95</sup>**

## AUDIO VTVM KIT

This vacuum tube volt meter emphasizes stability, broad frequency response and sensitivity for accurate measurement of critical AC voltages. Features a large 4½" 200 ua meter with increased damping in the meter circuit for stability in low frequency tests. Measures AC from a low value of 1 millivolt to a maximum of 300 volts AC (RMS). Voltage ranges are: 0-.01, .03, .1, .3, 1, 3, 10, 30, 100 and 300 volts. Db ranges cover -52 to +52 db. 1% precision multiplier resistors used for maximum accuracy. Frequency response is essentially flat from 10 CPS to 200 kc. Shpg. Wt. 6 lbs.



MODEL BE-5 **\$39<sup>95</sup>**

## LOW RIPPLE BATTERY ELIMINATOR KIT

Completely up to date the BE-5 will power all the newest transistor circuits requiring 0 to 12 volts DC, and the new hybrid automobile radios using both transistors and vacuum tubes. An extra low-ripple filter circuit is employed holding AC ripple down to less than .3%. Doubles as a battery charger or marine converter. Shpg. Wt. 21 lbs.



MODEL T-4  
**\$19<sup>95</sup>**

## VISUAL-AURAL SIGNAL TRACER KIT

New in every respect the T-4 features a built-in speaker and electron beam "eye" tube for signal indication, and a unique noise locator circuit. Ideal for use in AM, FM and TV circuit investigation. Transformer operated for safety and high efficiency. Complete with test leads and informative construction manual. Shpg. Wt. 5 lbs.



MODEL C-3 **\$19<sup>50</sup>**

## CONDENSER CHECKER KIT

Check unknown condenser and resistor values quickly and accurately as well as their operating characteristics with this fine instrument. All values are read directly on a calibrated scale. An electron beam "eye" tube indicates balance and leakage. A valuable addition to any service shop or lab. Shpg. Wt. 7 lbs.



MODEL CT-1 **\$7<sup>95</sup>**

## IN-CIRCUIT CAPACITOR TESTER KIT

This handy kit checks capacitors for "open" or "short" right in the circuit. Detects open capacitors from about 50 mmf, not shunted by an excessive low resistance value. Checks shorted capacitors up to 20 mfd (not shunted by less than 10 ohms). Checks all bypass, blocking and coupling capacitors of the paper, mica or ceramic types. (Does not detect leakage nor check electrolytic condensers.) Electron beam "eye" tube is used for quick indication. A 5-position function switch is featured which controls the power to the instrument and selects the test being made. Easy to build and easy to use. Test leads included. Shpg. Wt. 5 lbs.



HEATHKIT  
MODEL TX-1  
**\$23495**

- Built-in cooling fan
- Rotating Slide Rule Dial
- Compact, Stable, VFO
- Provision for SSB Adapter

\$50.00 required on C.O.D. orders. Shipped motor freight unless otherwise specified.

## "APACHE" HAM TRANSMITTER KIT

This beautifully styled transmitter has just about everything you could ask for in transmitting facilities. The "Apache" is a high quality transmitter operating with a 150 watt phone input and 180 watt CW input. In addition to CW and phone operation, built-in switch selected circuitry provides for single-sideband transmission through the use of a plug-in external adapter. A completely redesigned, compact and stable VFO provides low drift frequency control necessary for SSB transmission. A slide rule type illuminated rotating VFO dial with full gear drive vernier tuning provides ample bandspread and precise frequency settings. The bandswitch allows quick selection of the amateur bands on 80, 40, 20, 15 and 10 meters (11 m with crystal control). This unit also has adjustable low-level speech clipping and a low distortion modulator stage employing two of the new 6CA7/EL34 tubes in push-pull class AB operation. Time sequence keying is provided for "chirpless" break-in CW operation. The final amplifier is completely shielded for greater TVI protection and transmitter stability. A formed one-piece cabinet with convenient access hatch provides accessibility to tubes and crystal socket. Die-cast aluminum knobs and front panel escutcheons add to the attractive styling of the transmitter. Pi network output coupling matches antenna impedances between 50 and 72 ohms. A "spotting" push button is provided to allow tuning of the transmitter before switching on the final amplifier. This feature also enables the operator to "zero-beat" an incoming frequency without placing the transmitter on the air. Equip your ham shack now for top transmitting enjoyment with this outstanding unit. Shpg. Wt. 110 lbs.

*New Styling...  
New Features*



**HEATH COMPANY**  
Benton Harbor 15, Michigan

a subsidiary of Daystrom, Inc.



HEATHKIT  
MODEL SB-10  
**\$8995**

## SINGLE SIDEBAND ADAPTER KIT

Designed as a compatible plug-in adapter for the model TX-1 it can also be used with transmitters similar to the DX-100 or DX-100-B by making a few simple circuit modifications and still retain the normal AM and CW functions. Easy to operate and tune, the adapter employs the phasing method for generating a single sideband signal, allowing operation entirely on fundamental frequencies. The critical audio phase shift network is supplied, completely pre-assembled and wired in a sealed plug-in unit. Features include single-knob band-switching for operation on 80, 40, 20, 15 and 10 meters, an easy-to-read panel meter, built-in electronic voice control with anti-trip circuit. Enjoy the advantages of SSB operation by adding this fine kit to your ham shack now. Shpg. Wt. 14 lbs.



MODEL  
DX-100-B  
**\$18950**

\$50.00 deposit required on C.O.D. orders. Shipped motor freight unless otherwise specified.

### DX-100-B PHONE & CW TRANSMITTER KIT

The same fine performance of the time proven DX-100 is retained in the DX-100-B with improvements in the crystal and loading circuits. The one-piece formed cabinet has convenient access hatch for changing crystals, etc. and the chassis is punched to accept sideband adapter modifications. Features a built-in VFO, modulator and power supply, complete shielding to minimize TVI, and a pi network output coupling to match impedances from 50 to 72 ohms. RF output is in excess of 100 watts on phone and 120 watts on CW. Covers 160 through 10 meters. Single-knob bandswitching and illuminated VFO dial and meter face. RF output stage uses a pair of 6146 tubes in parallel, modulated by a pair of 1625's. Designed for easy assembly. Measures 11 1/2" H. x 19 1/2" W. x 16" D. Shpg. Wt. 107 lbs.



MODEL DX-40 **\$6495**

### DX-40 PHONE & CW TRANSMITTER KIT

Operates on 80, 40, 20, 15, 11 and 10 meters, using a single 6146 tube in the final for 75 watt plate power input CW, or 60 watts phone. Single-knob band-switching, pi network output, complete shielding, provision for three crystals and VFO. D'Arsonval movement panel meter. Shpg. Wt. 25 lbs.



MODEL DX-20 **\$3595**

### DX-20 CW TRANSMITTER KIT

This fine unit covers 80, 40, 20, 15, 11 and 10 meters with single-knob bandswitching. Features a 6DQ6A tube in the final for 50 watt plate power input, pi network output, complete shielding to minimize TVI. Easy to build with complete instructions supplied. Shpg. Wt. 19 lbs.

## "MOHAWK" HAM RECEIVER KIT

Designed for ham band operation and for maximum stability and accuracy, the Heathkit "Mohawk" receiver will let you enjoy ham activities to the utmost. This 15-tube receiver features double conversion with IF's at 1682 kc and 50 kc and covers all the amateur frequencies from 160 through 10 meters on seven bands. An extra band is calibrated to cover 6 and 2 meters using a converter. The "Mohawk" is specially designed for single-sideband reception with crystal controlled oscillators for upper and lower sideband selection. A completely pre-assembled, wired and aligned front end coil/bandswitch assembly assures ease of construction and top performance. Many more important features are provided in this outstanding receiver for dependable and effective amateur communications. Ruggedly constructed with well rated components throughout. Shpg. Wt. 66 lbs. Matching accessory speaker kit; optional extra. Model AK-5. \$9.95. Shpg. Wt. 8 lbs.

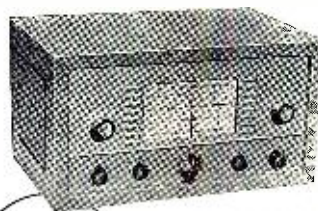

HEATHKIT  
MODEL AR-3

**\$29<sup>95</sup>**

(LESS CABINET)

### ALL-BAND RECEIVER KIT

A fine receiver for the beginning ham or short wave listener. Frequency coverage is from 550 kc to 30 mc in four bands. Features include bandswitch, bandspread tuning, phone-standby-CW switch, antenna trimmer, noise limiter, RF and AF gain controls and head-phone jack. Easy to build. Shpg. Wt. 12 lbs.

- Prewired and Aligned Coil/Bandswitch Assembly
- Crystal Controlled Oscillators for Drift-Free Reception

HEATHKIT  
MODEL RX-1

**\$274<sup>95</sup>**



MODEL  
QF-1

**\$9<sup>95</sup>**

### "Q" MULTIPLIER KIT

Use with any receiver with IF frequency between 450 and 460 kc to add additional selectivity for separating two signals or to reject one signal and eliminate heterodyne. A great help on crowded phone and CW bands. Not for use with AC-DC type receivers. Simple to connect with cable and plugs supplied. Shpg. Wt. 3 lbs.

## "SENECA" VHF TRANSMITTER KIT

Brand new in every respect, the model VHF-1 "Seneca" is the latest addition to our line of ham transmitters. This self-contained 6 and 2 meter transmitter features built-in VFO, modulator, and dual power supply. A pair of 6146 tubes are employed in the push-pull final amplifier stage and features up to 120 watts input on phone and 140 watts input on CW in the 6 meter band. Slightly less in the 2 meter band to prolong amplifier tube life. Panel controls allow VFO or crystal control, phone or CW operation on both amateur bands. Four switch-selected crystal positions. Complete RF shielding to minimize TVI. Spotting push-button provided. The VFO slide rule type dial features edge-lighting and vernier tuning. An ideal transmitter for the ham who wants to extend operation into the VHF region. Shpg. Wt. 36 lbs.

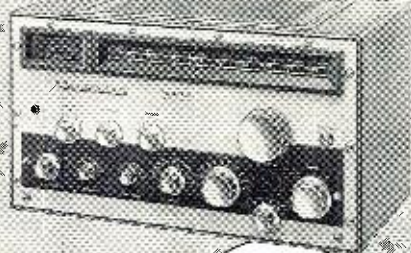

HEATHKIT  
MODEL VHF-1

**\$159<sup>95</sup>**

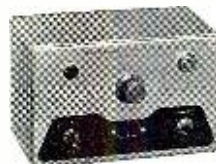

MODEL  
CA-1

**\$13<sup>95</sup>**

### "AUTOMATIC" CONELRAD ALARM KIT

This easy-to-build device gives instant warning and cuts AC power to your transmitter when a monitored station goes "off-the-air". Use with any radio receiver having an AVC circuit. A sensitivity control adjusts to various AVC levels. Incorporates a heavy duty six-ampere relay and manual "reset" button to reactivate the transmitter. Complete instructions provided for connection to receiver. Shpg. Wt. 4 lbs.



MODEL AM-2 **\$15<sup>95</sup>**

### REFLECTED POWER METER KIT

Check the match of your antenna transmission system by measuring the forward and reflected power or standing wave ratio from 1:1 to 6:1. Handles a peak power of well over 1 kilowatt and may be left in antenna feed line. No external power required. 160 through 6 meters. For 50 or 75 ohm lines. Shpg. Wt. 3 lbs.



MODEL B-1 **\$8<sup>95</sup>**

### BALUN COIL KIT

Unbalanced coax lines can be matched to balance lines of either 75 or 300 ohms by using this balun coil kit. Use without adjustment from 80 through 10 meters at power up to 200 watts. May be located any distance from transmitter or antenna. Protective cover included. Shpg. Wt. 4 lbs.



MODEL VX-1 **\$23<sup>95</sup>**

### ELECTRONIC VOICE CONTROL KIT

This unique device lets you switch from receiver to transmitter merely by talking into your microphone. Provision is made for receiver and speaker connections and also for a 117 volt antenna relay. Adjustable to all conditions by sensitivity and variable time delay controls provided. Shpg. Wt. 5 lbs.



MODEL VF-1 **\$19<sup>50</sup>**

### VARIABLE FREQUENCY OSCILLATOR KIT

Far below the cost of crystals to obtain the same frequency coverage this VFO covers 160, 80, 40, 20, 15, 11 and 10 meters with three basic oscillator frequencies. Better than 10 volts RF output on fundamentals. Requires only 250 volts DC at 15 to 20 ma, and 6.3 VAC at 0.45 a. Illuminated dial reads direct. Shpg. Wt. 7 lbs.

Beautifully Styled With Plenty of  
Room For The Most Complete  
Stereo System



MODEL SE-1 (center unit) **\$149<sup>95</sup>** Shpg. Wt. 162 lbs.

MODEL SC-1 (speaker enclosure) **\$39<sup>95</sup>** each Shpg. Wt. 42 lbs.

**STEREO EQUIPMENT CABINET KIT**

This superbly styled cabinet ensemble is designed to hold your complete home stereo hi-fi system, consisting of a "stereo equipment center" flanked by two individual "stereo wing speaker enclosures". The unit has room for all the components required for stereo sound. Although designed to hold Heathkit stereo components, it is not frozen to this arrangement. The kit is supplied with mounting panels precut to accommodate Heathkits, but interchangeable blank panels are also furnished so you can mount any equipment you may already have. The precut panels accommodate the Heathkit AM-FM tuner (PT-1), stereo preamplifier (SP-1 & 2), and record changer (RP-3). Record changer chassis pulls out easily for convenient loading and unloading. Adequate space is provided for record storage and a pair of matching Heathkit power amplifiers (from 12 to 70 watts). The stereo wing speaker enclosures are open backed, cloth grilled cabinets designed to hold the Heathkit SS-2 or similar speaker systems. The cabinets are available in beautifully grained 3/4" solid core Phillipine mahogany or select birch plywood suitable for the finish of your choice. The matched grain sliding tape deck access door on top pops-up flush when closed. Entire top features a shaped edge. Hardware and trim of brushed-brass and gold finish. Rich toned grille cloth is flecked in gold and black. No woodworking experience required. All parts precut and predrilled for easy assembly. Maximum overall dimensions (all 3 pieces): 82 3/4" W. x 36 1/2" H. x 20" D. Center Cabinet: 47 1/2" W. x 36 1/2" H. x 20" D.

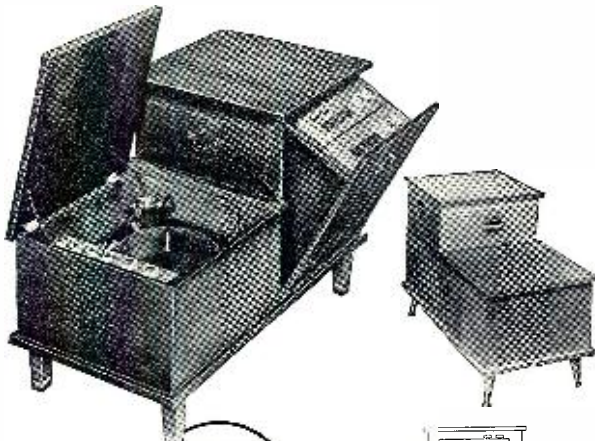

HEATHKIT  
MODEL CE-1  
**\$43<sup>95</sup>**  
each

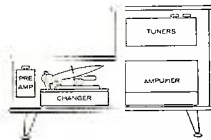

**CHAIRSIDE ENCLOSURE KIT**

Combine all of your hi-fi equipment into one compact control center and, at the same time add a beautiful piece of furniture to your home. The CE-1 is designed to house AM and FM tuners (BC-1A and FM-3A) and the WA-P2 preamplifier along with the majority of record changers which will fit in the space provided. Changer compartment measures 17 3/4" L. x 16" W. x 9 5/8" D. Adequate space is provided in the rear of the unit to house any of the Heathkit amplifiers designed to operate with the WA-P2. Good ventilation is achieved through properly placed slots in the bottom and back of the enclosure. Overall dimensions are 18" W. x 24"H x 35 1/2" D. All parts are precut and predrilled for easy assembly. The Contemporary cabinet is available in either mahogany or birch, and the Traditional cabinet is available in mahogany suitable for the finish of your choice. Beautiful hardware supplied. Shpg. Wt. 46 lbs.

Plan your own  
Hi-Fi System...

**HEATHKIT**

**HEATH COMPANY** • Benton Harbor 15,  
Michigan  
a subsidiary of Daystrom, Inc.

HEATHKIT  
MODEL RP-3  
**\$64<sup>95</sup>**



**HIGH FIDELITY  
RECORD CHANGER KIT**

Every outstanding feature you could ask for in a record changer is provided in the Heathkit RP-3, the most advanced changer on the market today. The unique turntable pause during the change cycle saves wear and tear on your records by eliminating the grinding action caused by records dropping on a moving turntable or disk. Record groove and stylus wear are practically eliminated through proper weight distribution and low pivot point friction of the tone arm. Clean mechanical simplicity and precision parts give you turntable performance with the automatic convenience of a record changer. Flutter and wow, a major problem with automatic changers, is held to less than 0.18% RMS. An automatic speed selector position allows intermixing 33 1/3 and 45 RPM records regardless of their sequence. Four speeds provided: 16, 33 1/3, 45 and 78 RPM. Changer is supplied complete with GE VR II cartridge with diamond LP and sapphire 78 stylus, changer base, stylus pressure gauge and 45 RPM spindle. Shpg. Wt. 19 lbs.



## "BASIC RANGE" HI-FI SPEAKER SYSTEM KIT

The popularity of this modestly priced speaker system attests to its high fidelity performance. The SS-2 provides an ideal basic speaker for your home hi-fi system. Flexibility of design allows it to be used as a table top model or as an attractive consolette with optional legs. May also be used as a supplementary speaker in more advanced systems or as replacement speaker for TV sets, etc. The specially designed tweeter horn rotates 90 degrees allowing you to use the speaker in an upright position if desired, as in the Heathkit stereo wing speaker enclosures. Total frequency range is from 50 to 12,000 cycles-per-second. An 8" mid-range woofer covers from 50 to 1,600 CPS while a compression-type tweeter with flared horn covers 1,600 to 12,000 CPS. Both speakers are by Jensen. A variable balance control allows level adjustment of the high frequency speaker. Power rating is 25 watts. Constructed of 1/2" veneer-surfaced plywood suitable for light or dark finish. All wood parts are pre-cut and predrilled for simple, quick assembly. An added feature of the SS-2 is that, although an outstanding performer in its own right, it may be combined with the SS-1B "range extending" speaker system later to extend the frequency range at the high and low ends of the audio range. Build in just one evening for many years of listening enjoyment. Shpg. Wt. 26 lbs.

**ATTRACTIVE BRASS TIP ACCESSORY LEGS** convert SS-2 into handsome consolette. 14" legs screw into brackets provided. All hardware included. Shpg. Wt. 3 lbs. No. 91-26. **\$4.95.**

Assemble it in

Just One Evening



HEATHKIT  
MODEL SS-2

**\$39<sup>95</sup>**

OPTIONAL LEGS  
NO. 91-26 **\$4.95**

## DIAMOND STYLUS HI-FI PICKUP CARTRIDGE

MODEL MF-1 **\$26<sup>95</sup>**

Replace your present pickup with the MF-1 and enjoy the fullest fidelity your library of LP's has to offer. Designed to Heath specifications to offer you one of the finest cartridges available today. Nominally flat response from 20 to 20,000 CPS. Shpg. Wt. 1 lb.



## "RANGE EXTENDING" HI-FI SPEAKER SYSTEM KIT

Designed exclusively for use with the SS-2, the SS-1B employs a 15" woofer and a super tweeter horn to extend the range of the SS-2 to an overall response of  $\pm 5$  db from 35 to 16,000 CPS. When used together the two units form an integrated four-speaker system and are designed to combine into a single piece of attractive furniture. Impedance of the SS-1B is 16 ohms and power rating 35 watts. A control is provided to limit the output of the super tweeter. Constructed of beautiful 3/4" veneer-surfaced plywood suitable for light or dark finish of your choice. All parts are pre-cut and predrilled for simple assembly. No woodworking experience required. All hardware included. Shpg. Wt. 80 lbs.

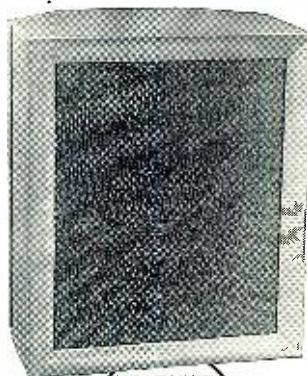

HEATHKIT  
MODEL SS-1B

**\$99<sup>95</sup>**

Extended  
Frequency Range  
for Your SS-2

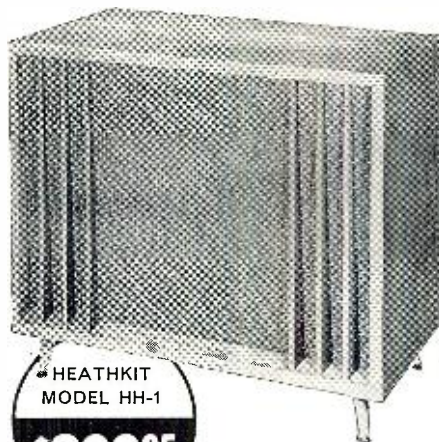

HEATHKIT  
MODEL HH-1

**\$299<sup>95</sup>**

## "LEGATO" HI-FI SPEAKER SYSTEM KIT

It is difficult to describe in words the performance of this magnificent speaker system. You may never find absolute perfection in reproduced sound, but the Legato comes as close to achieving it as anything yet devised. Perfect balance, precise phasing, and adequate driver design combine to produce the superb quality of reproduction inherent in this instrument. The crisp, clear high frequencies and rich full bass engulf you in a sea of life-like tone. Two 15" Altec Lansing low frequency drivers cover frequencies from 25 to 500 CPS while a specially designed exponential horn with high frequency driver covers 500 to 20,000 CPS. The unique crossover network is built-in making electronic crossovers unnecessary. The Legato emphasizes simplicity of line and form to blend with modern or traditional furnishings. Constructed of 3/4" veneer-surfaced plywood in either African mahogany or white birch suitable for light or dark finishes of your choice. All parts are pre-cut and predrilled for easy assembly. Shpg. Wt. 195 lbs.

Easy to buy...

Easy to build

Easy to use...



**HEATH  
COMPANY**

Benton Harbor 15,  
Michigan

High Fidelity AM  
and FM reception  
in a Single Set



### Professional Stereo-Monaural AM-FM Tuner Kit

Enjoy stereophonic broadcasts as well as outstanding individual AM and FM radio reception with this deluxe 16-tube AM-FM-stereophonic tuner combination. Features include three etched circuit boards for high stability and ease of construction, prewired and prealigned FM front end, built-in AM rod antenna, tuning meter, FM-AFC (automatic frequency control) with on-off switch, and flywheel tuning. A multiplex jack is also provided. AM and FM circuits are tuned individually making it ideal for stereo applications since both AM and FM can be used at the same time. A switch selected tuning meter functions on either AM or FM. Cathode follower outputs with individual level controls are provided for both AM and FM. Other features include variable AM bandwidth, 10 kc whistle filter, tuned-cascode FM front end, FM AGC and amplified AVC for AM. Anywhere from 1 to 4 limiters or IF's assure smooth, non-flutter reception on weak or strong stations alike. The silicon diode power supply is conservatively rated and is fuse-protected assuring long service life. Flywheel tuning combined with new edge-lighted slide-rule dial provide effortless tuning. Use of three printed circuit boards greatly simplifies construction. Vinyl-clad steel cover is black with inlaid gold design. Shpg. Wt. 20 lbs.

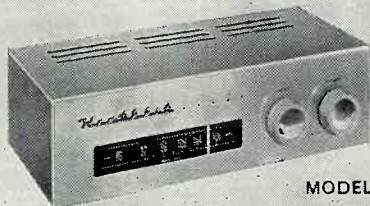

MODEL FM-3A  
\$26.95

### HIGH FIDELITY FM TUNER KIT

The Heathkit FM-3A Tuner will provide you with years of inexpensive hi-fi enjoyment. Features broad-banded circuits for full fidelity and better than 10 uv sensitivity for 20 db of quieting. Covers the complete FM band from 88 to 108 mc. Stabilized, temperature-compensated oscillator assures negligible drift after initial warmup. Employs a high gain cascode IF amplifier and has AGC. Power supply is built-in. IF and ratio transformers are prealigned as is the front end tuning unit. Two outputs provided, one fixed, one variable, with extra stage of amplification. Shpg. Wt. 8 lbs.

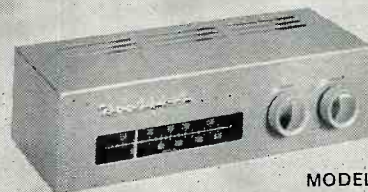

MODEL BC-1A  
\$26.95

### HIGH FIDELITY AM TUNER KIT

The BC-1A incorporates many features not usually expected in an AM circuit particularly in this low price range. It features a special detector using crystal diodes and broad band-width IF circuits for low signal distortion. Audio response is  $\pm 1$  db from 20 CPS to 9 kc with 5 db of pre-emphasis at 10 kc to compensate for station rolloff. Covers the complete broadcast band from 550 to 1600 kc. Prealigned RF and IF coils eliminate the need for special alignment equipment. Incorporates AVC, two outputs, two antenna inputs and built-in power supply. Shpg. Wt. 9 lbs.



MODEL W-6 \$109.95

### "HEAVY DUTY" 70 WATT HI FI AMPLIFIER KIT

Designed for "rugged duty" called for by advanced hi-fi systems and P.A. networks. Silicon diode rectifiers assure long life and heavy duty transformer provides excellent power supply regulation. Variable damping control provides optimum performance with any speaker system. Quick change plug selects 4, 8 and 16 ohm or 70 volt output and the correct feedback resistance. Shpg. Wt. 52 lbs.



MODEL W-5 \$59.75

### 25 WATT HI FI AMPLIFIER KIT

Enjoy the distortion-free high fidelity sound from one of the most outstanding hi-fi amplifiers available today. Features include a specially designed Peerless output transformer and KT66 tubes. Frequency response is  $\pm 1$  db from 5 to 160,000 CPS at 1 watt and within 2 db 20 to 20,000 CPS at full 25 watts output. Hum and noise are 99 db below 25 watts. Shpg. Wt. 31 lbs.

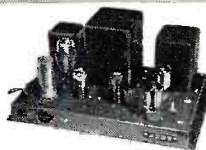

MODEL W-4AM \$39.75

### SINGLE CHASSIS 20 WATT HI FI AMPLIFIER KIT

A true Williamson-type high fidelity circuit, the W-4AM features 5881 push-pull output tubes and a special Chicago-Standard output transformer to guarantee you full fidelity at minimum cost. Harmonic distortion is 1.5% and IM distortion is below 2.7% at full 20 watt output. Hum and noise are 95 db below full output. Taps for 4, 8 or 16 ohm speakers. Shpg. Wt. 28 lbs.



MODEL W-3AM \$49.75

### DUAL CHASSIS 20 WATT HI FI AMPLIFIER KIT

Another famous Williamson-type high fidelity circuit, the W-3AM features the famous Acrosound TO-300 "ultralinear" output transformer and 5881 tubes. The power supply and main amplifier are on separate chassis for installation flexibility. Harmonic distortion is less than 1% and IM distortion is less than 1.2% at 20 watts. Shpg. Wt. 29 lbs.



HEATHKIT  
MODEL SP-2  
(STEREO)  
**\$56<sup>95</sup>**

**Monaural-Stereo Preamplifier Kit  
(2-Channel Mixer)**

This unique kit allows you to purchase it in the monaural model if desired and then add the second or stereo channel later. The SP-2 features 12 separate inputs, six on each channel, with input level controls. Six dual concentric controls consist of: two 8-position selector switches, two bass, two treble, two volume level and two loudness controls, a scratch filter switch and a 4-position function switch. A separate on-off switch is provided. The function switch provides settings for stereo, 2-channel mix, channel A or B for monaural use. Inputs consist of tape, mike, mag phono and three high-level inputs. NARTB equalization and RIAA, LP, 78 record compensation are provided. A remote balance control is included. Printed circuit boards for easy assembly. Built-in power supply. Shpg. Wt. 15 lbs.



MODEL SP-1 (MONAURAL)  
**\$37<sup>95</sup>** Shpg. Wt. 13 lbs.

MODEL C-SP-1 (CONVERTS SP-1 TO SP-2)  
**\$21<sup>95</sup>** Shpg. Wt. 5 lbs.

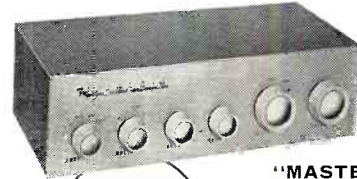

HEATHKIT  
MODEL WA-P2  
**\$19<sup>75</sup>**

**"MASTER CONTROL"  
PREAMPLIFIER KIT**

Control your hi-fi system with this compact unit. Features 5 switch-selected inputs to accommodate a record changer, tape recorder, AM tuner, FM tuner, TV receiver, microphone, etc., each with level control. Provision also for a tape recorder output. Equalization for records through separate turnover and rolloff switches for LP, RIAA, AES and early 78's. Shpg. Wt. 7 lbs.

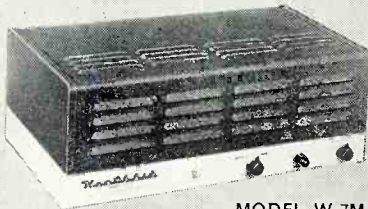

MODEL W-7M  
**\$54<sup>95</sup>**

**"EXTRA PERFORMANCE" 55 WATT  
HI FI AMPLIFIER KIT**

Enjoy this high fidelity power amplifier at less than a dollar per watt. Full audio output and maximum damping is conservatively rated at 55 watts from 20 CPS to 20 kc with less than 2% total harmonic distortion throughout the entire range. Features famous "bas-bal" circuit, EL-34 output tubes and special 70 volt output. Shpg. Wt. 28 lbs.



MODEL  
XO-1  
**\$18<sup>95</sup>**

**ELECTRONIC  
CROSSOVER KIT**

This unique instrument separates high and low frequencies and feeds them through 2 amplifiers into separate speakers. Located ahead of the main amplifier, it virtually eliminates IM distortion and matching problems. Note: Not for use with Heathkit Legato speaker system. Shpg. Wt. 6 lbs.



MODEL UA-1  
**\$21<sup>95</sup>**

**"UNIVERSAL" 12 WATT HI FI  
AMPLIFIER KIT**

The versatility and economy of this fine kit make it a truly "universal" hi-fi amplifier. An ideal basic amplifier for any hi-fi system or a perfect addition to gear your present hi-fi system to stereo sound. Uses 6BQ5/EL84 push-pull output tubes for less than 2% harmonic distortion throughout the entire audio range. Shpg. Wt. 13 lbs.



MODEL A-9C **\$35<sup>50</sup>**

**GENERAL-PURPOSE  
20 WATT AMPLIFIER KIT**

Designed for home installation as well as for PA requirements, the A9-C combines a preamplifier, main amplifier and power supply all on one chassis. Four switch-selected inputs are provided as well as separate bass and treble tone controls offering 15 db boost and cut. Detachable front plate allows for custom installation. Shpg. Wt. 23 lbs.



MODEL SW-1 **\$24<sup>95</sup>**

**SPEEDWINDER KIT**

A real timesaver, the SW-1 leaves your tape recorder free for operation while rewinding tape at the rate of 1200 feet in 40 seconds. Prevents unnecessary wear to the tape and recorder. Handles up to 10 1/2" tape reels. Handles 800' reels of 8 and 16 millimeter film as well. Automatic shutoff prevents whipping at end of rewind. Shpg. Wt. 12 lbs.



NO. 401-6  
**\$7<sup>50</sup>**

**12" UTILITY SPEAKER KIT**

Replace inferior speakers in radio or TV sets to obtain better tone quality or set up an auxiliary speaker for testing purposes with this convenient, high quality speaker. The speaker will handle up to 12 watts with a frequency response of ±5 db from 50 to 9,000 CPS. Speaker impedance is 8 ohms and has a 6.8 oz. magnet. An outstanding dollar value. Shpg. Wt. 7 lbs.



MODEL TK-1 **\$9<sup>95</sup>**

**COMPLETE TOOL SET**

These basic tools are all you need to build any Heathkit. The pliers, diagonal side cutters, 2 screwdrivers, and soldering iron are all of top quality case hardened steel for hard duty and long life. Pliers and side cutters are equipped with insulated rubber handles for safety. A good example of just how easy Heathkit building really is. Shpg. Wt. 3 lbs.

## HIGH FIDELITY TAPE RECORDER KIT

The model TR-1A tape deck and preamplifier combination provides all the facilities you need for top quality monaural recording /playback with fast forward and rewind functions. 7½ and 3¾ IPS tape speeds are selected by changing belt drive. Flutter and wow are held to less than 0.35%. Frequency response at 7½ IPS ±2.0 db 50-10,000 CPS, at 3¾ IPS ±2.0 db 50-6,500 CPS. Both units may be mounted together or separately affording high flexibility in every application. Features include NARTB playback equalization—separate recording and playback gain controls—cathode follower output and provision for mike or line input. Signal-to-noise ratio is better than 45 db below normal recording level with less than 1% total harmonic distortion. A filament balance control allows adjustment for minimum hum level. Complete instructions provided for easy assembly. Overall dimensions of tape deck and preamp is 15½" W. x 13½" H. x 8" D. Shpg. Wt. 24 lbs.



Includes tape deck assembly, preamplifier and roll of tape.

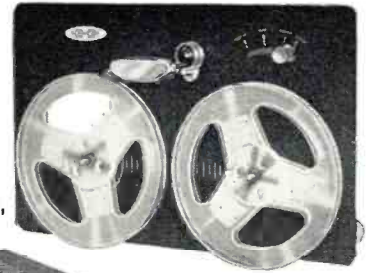

HEATHKIT  
TE-1  
\$39.95

Tape preamplifier sold separately if desired. Shpg. Wt. 10 lbs.



## Many more Heathkits to choose from

**hi-fi:** Amplifiers—Preamplifiers—Speaker Systems—AM/FM Tuners—Equipment Cabinets—Record Player—Tape Recorder—Electronic Crossover—Stereo Equipment.

**test:** Oscilloscopes—Voltmeters—RF Signal Generators—AF Generators—Analyzers—Battery Eliminators—Tube Checkers—Condenser Checkers—Computer—Color Bar & Dot Generator—Sweep Generator—Impedance Bridge—Power Supplies—Probe Kits—R/C Decade & Substitution Kits.

**ham radio:** Transmitters—Receivers—Antenna Accessories—Voice Control—Conelrad Alarm—Variable Frequency Oscillator—SSB Adapter—"Q" Multiplier.

**marine:** Direction Finders—Marine Converter—Rudder Position Indicator—Fuel Vapor Detector—Charge Indicator—Power Meter.

**general:** Tool Set—6-Transistor Portable Radio—Radiation Counter—Electronic Timer—Crystal Receiver—Superheterodyne Receiver.

*Send for Catalog* describing over 100 easy-to-build electronic instruments in kit form. Complete specifications and detailed information on Hi-Fi—Test—Ham and Marine kits.

**Save with Heathkits...the quality name in kit form electronics.**



**"BOOKSHELF" 12 WATT  
AMPLIFIER KIT**

Here are a few of the reasons why this attractive amplifier is such a tremendous dollar value. You get rich, full range, high fidelity sound reproduction with low distortion and noise . . . plus "modern styling". The many features include full range frequency response 20 to 20,000 CPS  $\pm 1$  db with less than 2% distortion over this range at full 12 watt output—its own built-in preamplifier with provision for three separate inputs: mag phono, crystal phono, and tuner—RIAA equalization—separate bass and treble tone controls—special hum control—and it's easy-to-build. Complete instructions and pictorial diagrams show where ever part goes. Cabinet shell has smooth leather texture in black with inlaid gold design. Cabinet measures 12 1/2" W. x 8 3/8" D. x 4 3/8" H. Output transformer has taps at 4, 8 and 16 ohms to match the speaker of your choice. An ideal unit to convert your present hi-fi system to stereo sound. Shpg. Wt. 15 lbs.

An Amplifier, Preamplifier  
all in one!



HEATHKIT  
EA-2  
**\$28<sup>95</sup>**

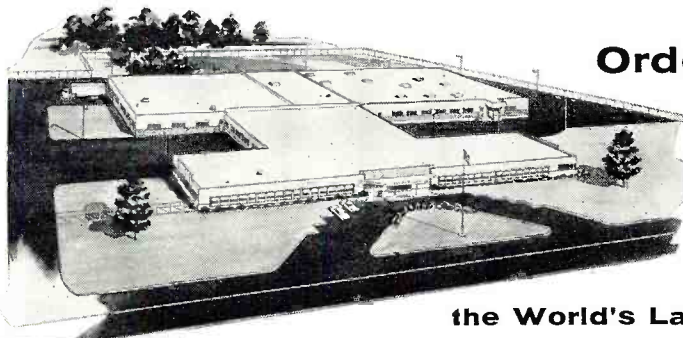

**Order direct by mail...**

Save 1/2 or more over equivalent ready-made products by buying direct and assembling them yourself. Heathkit Style, Performance and Quality are unsurpassed!

**the World's Largest Manufacturer  
of Electronic Instruments in Kit Form**



**HEATH COMPANY BENTON HARBOR 15, MICH.**

**D** a subsidiary of Daystrom, Inc.

*NOTE: all prices and specifications subject to change without notice.*

Enclosed find ( ) check ( ) money order. Please ship C.O.D. ( )

*On Express orders do not include transportation charges—they will be collected by the express agency at time of delivery.*

On Parcel Post Orders include postage for weight shown. All prices are NET F.O.B. Benton Harbor, Michigan, and apply to Continental U.S. and Possessions only. 20% Deposit required on all C.O.D. orders.

Name \_\_\_\_\_  
Address \_\_\_\_\_  
City & Zone \_\_\_\_\_ State \_\_\_\_\_  
(PLEASE PRINT)

SHIP VIA  
 Parcel Post  
 Express  
 Freight  
 Best Way

QUANTITY	ITEM	MODEL NO.	PRICE
<input type="checkbox"/> SEND FREE HEATHKIT CATALOG		POSTAGE	
		TOTAL	

**HEATHKITS are also available at your Dealer**

see listing  
on next page



Authorized

HEATHKIT

Dealers



Convenient "over-the-counter" delivery is now available through any of the Authorized Heathkit Dealers listed below. Although you will find the price of Heathkits slightly higher when buying locally, we're sure you'll agree that this increase is justified. Your dealer absorbs all transportation charges, carries a complete stock of kits for immediate de-

livery, provides demonstration facilities, offers you a reliable source for parts and fast service... and stands ready to counsel or advise you on any problem that might arise.

This new service does not affect your continued privilege to buy directly from Heath Company if you prefer.

NOW READY TO SERVE YOU...

CALIFORNIA

- BAKERSFIELD: Kiesub Corporation, 2615 "F" Street
BERKELEY: zacKIT Corporation, 2002 University Avenue
CHICO: Dunlap Radio & TV, 928 Main Street
EL CAJON: Telrad Electronics, 182 East Main Street
FRESNO: Dunlap Radio & TV, 2617 Tulare Street
LONG BEACH: Kierulff & Company, 1501 Magnolia
LOS ANGELES: Kierulff Sound Corporation, 12024 Wilshire Boulevard
LOS ANGELES: Kierulff Sound Corp. (Capkit), 820 West Olympic Boulevard
LOS ANGELES: Kierulff & Company, 6303 E. Corsair
MARYSVILLE: Dunlap Radio & TV, 5th & "J" Street
MERCED: Dunlap Radio & TV, 234 West 17th Street
MODESTO: Dunlap Radio & TV, 419 10th Street
NATIONAL CITY: Telrad Electronics, 639 National
ONTARIO: Kiesub Corporation, 124 N. Benson
OXNARD: Kierulff & Company, 508 E. Date Street
PALO ALTO: Zack Electronics, 654 High Street
SACRAMENTO: Dunlap Radio & TV, 1800 22nd Street
SAN BERNARDINO: Kierulff & Company, 390 South Mt. Vernon
SAN DIEGO: Telrad Electronics, 3453 University Avenue
SAN FRANCISCO: Zack Electronics, 1422 Market Street
SANTA BARBARA: zacKIT Corporation, 513 State Street
STOCKTON: Dunlap Radio & TV, 27 North Grant Street
TARZANA: Kierulff Sound Corporation, 18841 Ventura Boulevard
VAN NUYS: Kierulff & Company, 14511 Delano
VISALIA: Dunlap Radio & TV, 1725 Mooney Avenue
DELAWARE
WILMINGTON: Radio Electric Service Co., Third & Tannal Streets
FLORIDA
COCOA: Thuro Distributors, Inc., 540 St. Johns Street
MIAMI: Thuro Distributors, Inc., 1800 Northwest 23rd Street
INDIANA
INDIANAPOLIS: Golden Ear, Incorporated, 24 West Washington
WEST LAFAYETTE: Golden Ear, Incorporated, 108 Northwestern

KENTUCKY

- LOUISVILLE: Golden Ear, Incorporated, 610 Third Street
LOUISIANA
LAFAYETTE: Sterling Radio Products, Inc., 1005 Cameron Street
MARYLAND
SALISBURY: Radio Electric Service Co., 738 South Salisbury Boulevard
MASSACHUSETTS
BOSTON: Audionics, Incorporated, 1348 Boylston Street
MICHIGAN
ALLEN PARK: Volta Electronics, 6716 Park Avenue
DETROIT: High Fidelity Workshop, 16400 West Seven Mile Road
MINNESOTA
MINNEAPOLIS: Audio King Company, 913 West Lake Street
NEW JERSEY
ATLANTIC CITY: Radio Electric Service Co., 452 North Albany Avenue
CAMDEN: Radio Electric Service Co., 513 Cooper Street
MOUNTAINSIDE: Federated Purchaser, Inc., 1021 U. S. Route #22
NEWARK: Federated Purchaser, Inc., 114 Hudson Street
NEW YORK
BELLEROSE: Cross Island Electronics, Inc., 247-40 Jericho Turnpike
BROOKLYN: Acme Electronics, Incorporated, 59 Willoughby Street
FARMINGDALE: Gem Elec. Distributors, Inc., 34 Hempstead Turnpike
FOREST HILLS: Beam Electronics, Incorporated, 101-10 Queens Boulevard
HICKSVILLE: Gem Elec. Distributors, Inc., 236 Broadway
MINEOLA: Arrow Electronics, Incorporated, 525 Jericho Turnpike
MT. VERNON: Davis Radio Distributing Co., Inc., 70 East Third Street
NEW YORK
ARROW: Arrow Electronics, Incorporated, 65 Cortland Street
NEW YORK
HARVEY: Harvey Radio Company, 103 West 43rd Street
NO. CAROLINA
CHARLOTTE: Southeastern Radio Supply Co., 1200 W. Morehead Street
GREENSBORO: Southeastern Radio Supply Co., 404 N. Eugene Street
FAYETTEVILLE: Southeastern Radio Supply Co., 525 Gillespie Street
KINSTON: Southeastern Radio Supply Co., 408 N. Heritage Street
RALEIGH: Southeastern Radio Supply Co., 414 Hillsboro Street

OREGON

- PORTLAND: Eccles Electric Company, 237 North Broadway
SALEM: Cecil Farnes Company, 440 Church Street, Northeast
PENNSYLVANIA
ALLEN TOWN: Federated Purchaser, Inc., 1115 Hamilton Street
EASTON: Federated Purchaser, Inc., 925 Northampton Street
PHILADELPHIA: Austin Electronics, Inc., 1421 Walnut Street
PHILADELPHIA: Radio Electric Service Co., 701 Arch Street
PHILADELPHIA: Radio Electric Service Co., 3412 Germantown Avenue
PHILADELPHIA: Radio Electric Service Co., 5930 Market Street
WILLOW GROVE: Radio Electric Service Co., 29 York Road
YORK: Radio Electric Service Co., 1114 Roosevelt Extension
RHODE ISLAND
PROVIDENCE: Audionics, Incorporated, 790 North Main Street
TEXAS
BEAUMONT: Sterling Radio Products, Inc., 1160 Laurel Street
BRYAN: Sterling Radio Products, Inc., 2615 Texas Avenue
DALLAS: Hillcrest Records, Inc., 6309 Hillcrest Avenue
HOUSTON: Sound Equipment, Incorporated, 2506 Crawford Street
HOUSTON: Sterling Radio Products, Inc., 1616 McKinney Avenue
LUFKIN: Sterling Radio Products, Inc., 428 Atkinson Street
VIRGINIA
ARLINGTON: Key Electronics, Inc., 126 South Wayne Street
WASHINGTON
SEATTLE: Seattle Radio Supply, Inc., 2117 Second Avenue
WISCONSIN
MADISON: Hi-Fi Corner, 401 State Street
MADISON: Saterfield Electronics, Inc., 1900 South Park
MILWAUKEE: Hi-Fi Center, 4236 West Capitol Drive
MILWAUKEE: Netzow's, 2630 North Downer Avenue

Careful selection of reliable qualified dealers is a slow process... so please bear with us if your area has not been covered. Thank you.

Mac's Service Shop (Continued from page 80)

a heavy-duty motor and turntable to keep wow to a minimum at the slow speeds; a power transformer, full-wave rectifier, and lots of filter to reduce hum below the audible level; and the employment of negative feedback in the three-stage amplifier to reduce distortion."

"And glory be!" Barney exclaimed as he peered over Mac's shoulder. "Right there glued in the bottom of the case is a complete wiring diagram showing the values of all components and giving the normal voltages measured at the socket terminals."

"Suppose we use that to see what's wrong," Mac suggested.

He started measuring the voltages at the socket of the output tube. All at once he stopped with a puzzled expression. "Where's the cathode lug?" he asked Barney as he stared at a blank spot on the socket where this lug should be.

"There it is floating in the air. It has broken off up inside the socket," Barney pointed out.

He was right. The missing lug was supported by the leads of the cathode resistor and bypass capacitor a good inch from the socket.

"Mmmmm! Changing that socket isn't going to be a snap," Mac observed.

"You ain't gotta change it!" Barney said quickly and ungrammatically. "I run into this fairly often in hamming because I use the same sockets over and over again in experimenting. All you have to do is punch out the broken lug and replace it with a lug taken from an identical socket."

Mac stared at his assistant for a few seconds, and then a pleased grin flashed across his face. "You're right! How stupid can a man be? If you hadn't spoken up, I'm sure I'd have been dumb enough to change the whole socket."

Carrying out Barney's suggestion took only a little longer than it did to make it and in a few minutes the new lug was in place and the floating connections were soldered to it. When the record player was turned on, volume from the speaker filled the whole shop; and the quality was excellent. Mac looked the amplifier over carefully to make sure nothing else had been broken or shaken loose in shipping; then he carefully replaced the motor board and put back the screws.

"Hey, Boss," Barney said quizzically, "do I imagine it or are you being even more careful and gentle than usual with that piece of equipment?"

Mac's forehead wrinkled a moment in thought, and then he said slowly: "I didn't realize it, but you're probably right. This isn't the first Talking Book I've serviced and returned to the user. If you could see the loving way those sensitive fingers explore every square inch of the repaired instrument, you'd know it is much, much more than just

HEATH COMPANY Benton Harbor, Mich. A Subsidiary of Daystrom, Inc.

a record player to them; and you'd hate as much as I would to let a slipping screwdriver put a gouge in that leatherette. What's more, you'd want to be absolutely certain the Talking Book was putting out the topnotch performance of which it's capable."

As Mac prepared to set the needle down on the record, Barney broke in with another question: "Is that a turn-over cartridge? I see a little lever sticking out the side. Do they use one stylus for 33½ and another for 16⅝?"

"No, the same diameter stylus is used for both records; but this is a special cartridge with a spare stylus built in. As you can see, the cartridge is held in the arm by a simple spring clip. The little 'tongue' bearing the sapphire stylus comes straight out the end. There are two sapphire styli on opposite sides of this little tongue. When one is worn out, the sightless person, guided only by his sense of touch, can remove the cartridge from the clip, turn it over and replace it so the new needle is brought into service. The position of the little arm indicates which stylus is in use."

The player was started, and the beautifully modulated voice of Alexander Scourby reading "Conversation with the Earth" by Hans Cloos filled the service shop. As he talked, Mac and Barney could see the great dark continent of Africa rising up out of the sea like the surfacing of some monster of the deep.

"Man, this is the way to read!" he finally announced. "A book sounds a lot more interesting when read aloud by someone who knows how to read. I can't imagine my picking up a book written by a German geologist and translated into English and wading through a whole chapter picked at random; but when Mr. Scourby reads that same chapter aloud, he makes me determined to get that book and read the rest of it. When I consider what electronics means to those sightless people, it makes me feel kind of good that I'm a small part of electronics."

"That makes two of us," Mac said softly.

### "OLD TIMER'S NITE"

**T**HE Delaware Valley Radio Association has scheduled its 14th Annual Old Timer's Nite Round-Up and Banquet for Saturday, April 18th, at the Hotel Stacy-Trent, Trenton, New Jersey.

A turkey dinner will be served promptly at 6:30 with the evening given over to a talk by A. H. Waite, Jr., W2ZK, on his experiences with "Operation Deep-Freeze."

Awards will be made to those holding the oldest amateur and commercial tickets with the "Grand OM" Silver Cup Award going to the operator present with the longest service in the wireless game. Resumé's for individuals eligible for the award are to be submitted by April 15th, in writing, to Ed G. Raser, W2ZI, 19 Blackwood Dr., Trenton 8, N. J., general chairman of the event.

Banquet tickets should be reserved by April 13th to get the benefit of the \$6.00 price tag. Latecomers will have to pay \$7.00 at the door. As usual, the affair is stag!

# NOW THERE ARE 9 RIDER 'PICTURE-BOOK' COURSES

NEW — Heralding the role of Electronics in the space age  
BASICS OF MISSILE GUIDANCE & SPACE TECHNIQUES By Marvin Hobbs

Electronics is playing a vital role in the race to achieve mastery of outer space and send manned missiles rocketing to the moon and beyond. You can learn and easily understand the fundamentals of the important electronic areas that will contribute to the conquest of space with this 2 volume picture book course. It is divided into two broad parts. Volume 1 covers the elements of control and guidance. Extensive coverage is given to radio and radar command links, guide beam, doppler and homing methods, fundamentals of gyroscopies, inertial and celestial navigation, computer applications,

and actuators as well as their related components. In the second volume, devoted to radio telemetry and space techniques, testing and telemetering, space exploration by optics and electronics are covered. There is a fascinating coverage of satellite theory and practice, satellite monitoring and tracking, and applications of earth satellites. Navigation in space along with components and power sources for space applications are discussed. #229, 2 vols., soft covers, \$7.80 per set; #229-H, 2 volumes in single cloth bound edition, \$9.00.

**BASICS OF DIGITAL COMPUTERS** by John S. Murphy. If you have a knowledge of the fundamentals of electronics, you can master the basics of digital computers and understand the details of any specific digital computer with this new 3 volume picture book course. #196, 3 volumes, soft cover set, \$7.50; #196-H, all 3 volumes in single cloth binding, \$8.50.

**BASIC PULSES** by Irving Gottlieb, P.E. Pulses direct the high speed operation of all types of computers; underlie the function of radar systems; guide industrial operations that require split-second timing for mass production; in fact, the application of pulses recognizes almost no boundaries in the field of electronics. You can learn all about pulses with this one volume picture book training course. #216, \$3.50.

**BASIC ELECTRICAL POWER DISTRIBUTION** by Anthony J. Pansini, P.E. #187, 2 vols., soft cover set, \$4.80.

**BASIC TELEVISION** by Alexander Schure, Ph.D. Leading editors, businessmen and educators have declared this to be the clearest presentation of the fundamentals, operation and circuitry of black and white television ever published. #198, 5 volumes, soft cover set, \$10.00; #198-H, 5 vols. in one cloth binding, \$11.50.

**BASIC ELECTRICITY** by Van Valkenburgh, Nooger & Neville, Inc. #169, 5 volumes, soft cover set, \$10.00; #169-H, 5 vols. in single cloth binding, \$11.50.

**BASIC ELECTRONICS** by Van Valkenburgh, Nooger & Neville, Inc. #170, 5 volumes, soft cover set, \$10.00; #170-H, 5 vols. in single volume, \$11.50.

**BASIC SYNCROS AND SERVOMECHANISMS** by Van Valkenburgh, Nooger & Neville, Inc. #180, 2 volumes, soft cover set, \$5.50; #180-H, 2 vols. in single cloth binding, \$6.95.

**BASIC PHYSICS** by Alexander Efron, Ph.D. #195, 2 vols. in single cloth binding, \$7.60.

## 6 NEW RIDER BOOKS... EXCITING CODE COURSE

**DESIGN OF TRANSISTORIZED CIRCUITS FOR DIGITAL COMPUTERS** by Abraham I. Pressman, M.S. Using "worst-case design, this book explains how switching time and drive capabilities and requirements of all the essential digital computer building blocks may be calculated, and how these blocks may be assembled in chains to perform computer-type logical operations. Methods for performing computer logic to obtain maximum operating speed and pyramiding factor are analyzed in detail. #215, \$9.95.

**FUNDAMENTALS OF HIGH FIDELITY** by Herman Burstein. How to select the best hi-fi equipment for the money you have to spend—and how to achieve the best performance—are the purposes of this book. The emphasis is not so much on what an amplifier is, rather than on what an amplifier (and the rest of your high fidelity system) should provide, and how you can choose the best equipment to fit your pocketbook. #226, \$2.95.

**FUNDAMENTALS OF NUCLEAR ENERGY AND POWER REACTORS** by Henry Jacobowitz. After presenting basic concepts in atomic and nuclear physics essential to understanding the operation of nuclear reactors, the book discusses the construction, principles of operation, cost and power output of specific plants. Experimental reactors and the forerunners of the units now under construction are covered. Numerous carefully selected illustrations support the text and show what the various installations actually look like. #218, \$2.95.

**FUNDAMENTALS OF RADIO TELEMETRY** by Marvin Tepper. Telemetry makes possible the collection of data on which the improvement of existing rockets, missiles and aircraft is based. This exciting book explains its purpose and explores its techniques. Special sections are devoted to missile and satellite telemetry and hardware, and to data recording and processing. Specially prepared illustrations. #225, \$2.95.

**BUILDING THE AMATEUR RADIO STATION** by Julius Berens, W2PIK. If you intend to buy the equipment for an amateur radio station, or build one, you will find this volume indispensable. This book is the next step for the amateur radio enthusiast who has earned his operating license. An all-inclusive guide for construction of the novice and general ham stations. Also includes instructions for receiver and transmitter on-the-air operation. #221, \$2.95.

**EXPERIMENTAL ELECTRICITY FOR BOYS** by Willard Doan. Youth between 12 and 16 all over the world has displayed a tremendous inquisitiveness for the workings of electricity. Here is a book that teaches the marvels of electricity through demonstration.

The mystery of magnetism and electricity are unmasked in dramatic style, yet with complete accuracy. The reader is shown how to build numerous electrical devices—a compass, a telegraph system—a Tesla coil, a Winshurst machine, and other exciting electrical equipments. Highly informative, easy-to-grasp illustrations—many in color—illustrate the text. #222, 128 pp. 8 x 11", Stiff cover, \$3.45.

### Fastest, Easiest Way to Learn Code SOUND-N-SIGHT CODE COURSE by Lewis Robins & Reed Harris

You can learn code faster, easier than ever before thanks to a scientific breakthrough called REINFORCED LEARNING—a psychological principle proved successful by the Armed Forces in teaching code. It is the first code training course combining sound and sight to teach you to hear the signal correctly; identify the correct letter for each signal pattern; finally, to recognize the signal and immediately identify it. What's more, an imaginary instructor is on hand to speed your learning.

#### Three Individual Courses

- (1) Complete Course covers all amateur licenses up to commercial (0-20 words per minute)—Six 10" LP records, 47 identification cards. #REC-020, \$15.95.
- (2) Novice Course (0-8 words per minute)—Three 10" LP records, 47 identification cards and book. #REC-08, \$9.50.
- (3) Advanced Course for general, amateur extra, commercial license (9-20 words per minute)—Three 10" LP records and book. #REC-920, \$8.95.

Records prepared in collaboration with the N. Y. Institute of Technology and mfd. by Decca Records.

At your jobber or book store, or order direct.

RTN-4

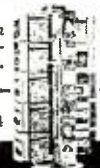

JOHN F. RIDER PUBLISHER, Inc. 116 West 14th Street, New York 11, N. Y.

In Canada: Charles W. Pointon, Ltd. 6 Alcona Ave., Toronto, Ontario



**"So Smooth & Clean-**  
 is the response of the Atlas WT-6 that we demonstrate in our high-fidelity Audio-Torium," says Anton J. Schmitt, Harry Radio Co., Inc., New York, N. Y.

**New ATLAS**  
 COAX-PROJECTOR WT-6

WT-6 NET \$34.50  
 support stand only,  
 SS-4 NET \$12.60

**ALL-WEATHER**— install it, forget it! —  
**HIGH-EFFICIENCY . . . COMPACT . . .**

True **HIGH FIDELITY TWO-WAY** system — not just a "compromise" of two horns coupled to a single diaphragm. The WT-6 comprises a weather-proof cone type driver (with 6-inch throat) coupled to its individual woofer horn; a separate pressure-type driver loaded to its separate tweeter horn. The built-in crossover electronic filter supplements the electro-mechanical frequency-limiting characteristics of the 2 individual reproducers — providing for smooth frequency division as each speaker functions within its engineered range of frequencies.

Universally adjustable "U"-type rugged steel mounting . . . finished in high temperature baked modern beige enamel.

<b>Power Rating</b>	15 watts continuous
<b>Freq. Resp.</b>	140-15,000 cps
<b>Impedance</b>	8 ohms
<b>Dispersion</b>	120°
<b>Dimensions</b>	Bell opening 15", overall depth 12"

See the WT-6 at your local distributor.  
 Send for complete catalog. RN-4

**ATLAS SOUND CORP.**  
 1449-39 St., Brooklyn 18, N. Y.  
 Atlas Radio Ltd., Toronto, Canada

**Hi-Fi-Audio**  
**Product Review**

**STEREO CONTROL CENTER KIT**  
*Quality Electronics, Inc., 319 Church St., New York 13, N. Y.* has just introduced a new stereo control center as its Model STA-24.

The new kit will handle stereo tapes, stereo records, stereo FM-AM tuners, and FM multiplex broadcasts. The circuit includes two separate preamps and two separate 12-watt power amplifiers. The unit may also be used as a

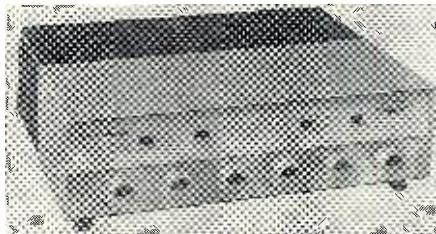

complete stereo preamp and a 24-watt monaural amplifier to adapt an existing monaural amplifier to stereo.

All controls are located on the front panel of the amplifier for easy operation and maximum convenience. The amplifier features dual ganged bass, treble, and loudness controls. The stereo balance control automatically adjusts the volume level between two speakers for equal channel volume at any part of the listening room. A mode switch allows instantaneous selection of stereo normal or reverse and monaural left or right. The selector switch permits the choice of tape high or low, phono high or low, tuner, and auxiliary.

The unique speaker selector switch for local and remote speaker systems permits the listening to stereo in two locations in the home at the same time. Filter circuits reduce turntable rumble, record scratch, and tape hiss. Tape output permits the recording of any program material.

The amplifier contains identical Williamson-type power amplifiers with specially designed output transformers multi-tapped at 4, 8, and 16 ohms.

**CERAMIC DISC VOICE-COILS**  
*The Mullenbach Division of Electric Machinery Mfg. Co., 2100 E. 27th St., Los Angeles 54, Calif.* has announced the development of a new electrostrictive ceramic which is said to eliminate the need for heavy magnets or coils in loudspeakers.

Baked in the form of thin discs, a few thousandths of an inch thick, the ceramics are sophisticated compounds of barium titanate. They respond to minute and rapid fluctuations in electrostatic fields, contracting radially with increases in the applied field.

Bonded to a larger titanium disc, they produce a cupping action that, in turn, drives a speaker cone.

In one experimental loudspeaker built by the company, the ceramic wafers are 1" in diameter and the metal disc 1½". A titanium diaphragm .006" is used. The company envisions smaller, lighter radios and other audio devices as the result of this new development.

Further details will be supplied by the developer on request.

**CONDENSER MICROPHONE**  
*Durant Sound Equipment Co., 80 W. 55th Street, New York 19, N. Y.* is importing the "Teladi" condenser microphone from West Germany for distribution in the U. S.

The "k-125" features variable output range from -40 db to -95 db and sufficient gain to be connected into a phono input. Output impedance is either 200 ohms balanced or 10,000 ohms unbalanced. Frequency response is 30 to 18,000 cps. The microphone has switch-

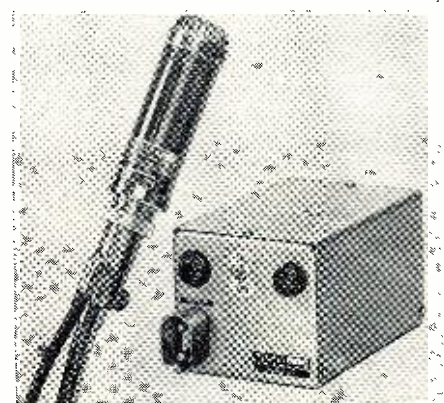

controlled non-directional or cardioid pattern. Harmonic distortion at 1000 μbar is less than 1%.

The unit measures 15/8" x 5 1/2" and weighs 10.4 ounces. A separate shielded power supply operates from 110 volts a.c., 40-60 cps. It measures 8" x 3 3/4" x 4 1/4" and weighs 4 pounds. The power supply incorporates an "on-off" switch, hum balance control, and output level control. The unit comes complete with 18 feet of shielded rubber-jacketed cable and a standard Cannon XL-3-14 output plug.

**PILOT STEREO PREAMP**  
*Pilot Radio Corporation, Long Island City 1, N. Y.* has added a professional stereo preamp to its line of audio components and designated it as the SP-216.

The new unit is a two-channel pre-amp featuring two illuminated vu



meters and recording level controls. It incorporates a new, front-panel lever switch which in one position measures the tape output level as adjusted by the

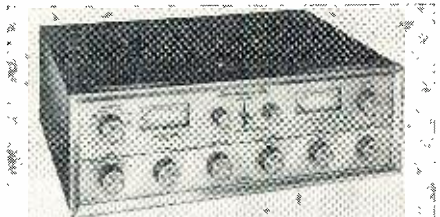

recording level controls while in the other position the vu meters measure the main audio output level as adjusted by the balance and volume controls.

The SP-216 also features 12 inputs for stereo and monophonic signal sources, three of them being high-level inputs and including inputs for a multiplex adapter for FM-FM stereo; five-position loudness contour control to provide full-range reproduction at all listening levels; and unique automatic equipment switch to turn off the entire system after the last record has been played. A "Quadri-Volume" control having four volume controls with a single knob, provides synchronized attenuation and assures maximum signal-to-noise ratio for all listening levels.

A spec sheet giving all of the electrical characteristics of this new preamp is available from the manufacturer.

#### A.F. TRANSISTOR

The RCA Semiconductor and Materials Division, Somerville, N. J. has announced the development of a new germanium *n-p-n* alloy-junction transistor which has been designed especially for use in audio amplifiers.

The 2N1010 is suited for use in the input stages of audio equipment such as high-fidelity preamps, tape recorders, microphone preamps, and hearing aids in which low noise factor is an important design consideration.

The transistor features a noise factor of only 5 db with a generator resistance of 1000 ohms and an integrated noise bandwidth of 15 kc. The typical small-signal current gain is 35 while the *alpha* cut-off frequency is 2 mc.

#### NEW CBS CARTRIDGES

CBS-Hytron of Danvers, Mass. has announced the availability of four ver-

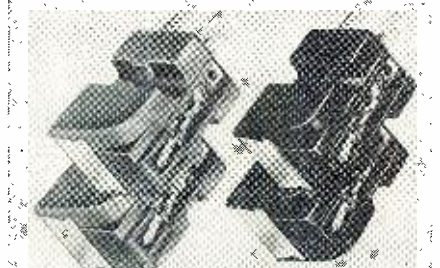

sions of its Constant Displacement Stereo Cartridge.

The basic twin-ceramic cartridge can be purchased with either a diamond or sapphire stylus and in either the "in-phase" or "out-of-phase" connection. The in-phase cartridge provides con-

THE INCOMPARABLE ARGOS

*Catalina*

**\$24.95** Audiofile Net

Model TSE-15—Ducted Port Hi-Fi Enclosure  
with TWO Speakers

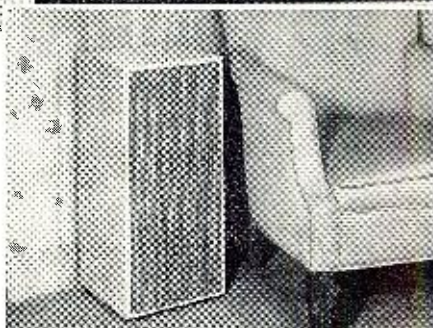
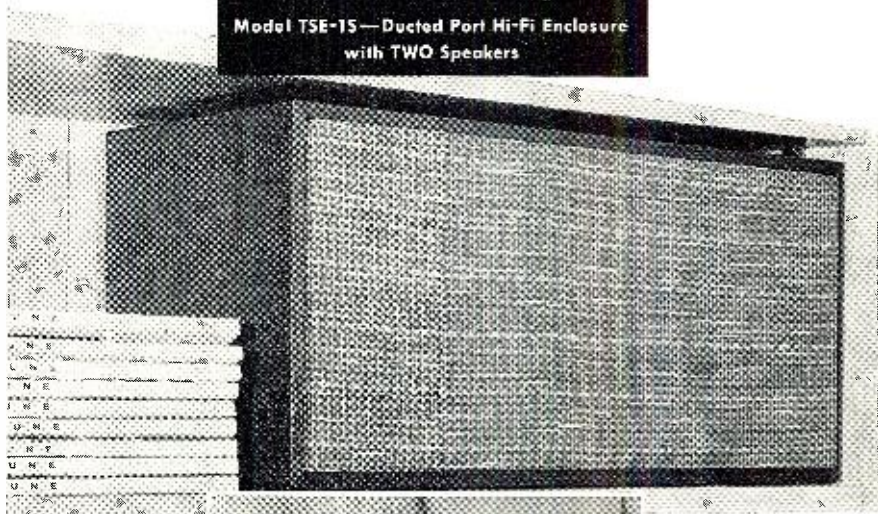

*Never before such thrilling tone quality in this size at this price!  
Response 40 to 17,000 cycles.*

**USE** in adding Stereo to your present Hi-Fi system

**USE** two together in new Stereo Hi-Fi system

**USE** as Hi-Fi extension speaker in other rooms

**USE** on bookshelf or floor (space-saving size 24 x 11 x 10½ in.)

**ASK** at your radio parts distributor or Hi-Fi store or write direct for **FREE** catalog.



DEPT. R, 301 MAIN ST., GENOA, ILL.

*Craftsmanship in Cabinets*

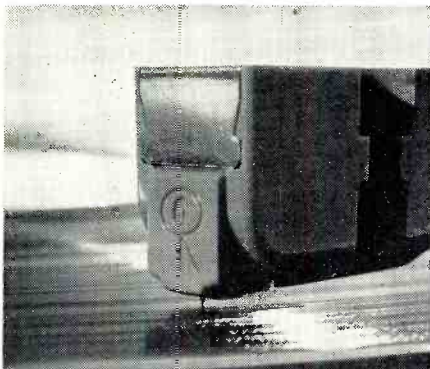

# FREE HOME TRIAL

proves Columbia CD stereo cartridge sounds better

Now you can prove it to yourself. The Columbia CD is the better stereo cartridge. We believe this so strongly that we have arranged with your CBS-Hytron distributor for you to test the Columbia CD... free in your own home.

We are sure you will agree this cartridge does sound better than any other ceramic or magnetic stereo cartridge. It is superior in linearity... separation... compliance... low mass... freedom from hum... output level... ruggedness. Your ears will tell you quickly what elaborate curves, facts and figures prove. The Columbia CD simply sounds better.

Make sure by your own tests that you invest in the better stereo cartridge. This offer is for a limited time only. Ask your CBS-Hytron distributor to let you try the Columbia CD, Model SC-1D, today!

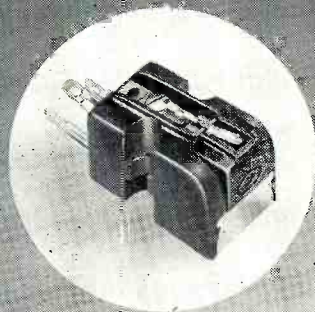

**COLUMBIA** 

Model SC-1D

Cost \$24.25

**CBS-HYTRON**, Danvers, Massachusetts  
A Division of Columbia Broadcasting System, Inc.

ventional phasing of the output signals for each channel. This permits use of the cartridge with either stereo or monaural records in any dual amplifier or conventional stereo amplifier system—or it can be used in monaural systems by connecting the cartridge outputs in parallel.

Stereo amplifiers which employ a single push-pull stage for handling both channels are accommodated by the out-of-phase polarity available at the cartridge terminals of the second type being offered.

The in-phase units have been designated as the SC-1D and SC-1S for diamond and sapphire styli respectively while the out-of-phase cartridges have been cataloged as SC-2D and SC-2S.

## STEREO PREAMP-AMPLIFIER

*Bogen-Presto*, Division of *The Siegler Corporation*, Box 500, Paramus, N. J. has added the AC210-A stereo preamp-amplifier to its budget-priced "Challenger" line of audio equipment.

The new unit may be used as a regular 20-watt monophonic amplifier, as

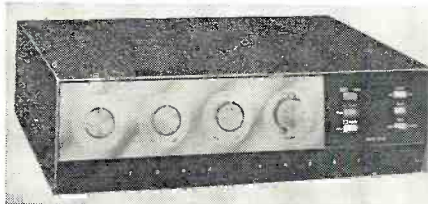

a dual-channel 10-watt stereophonic amplifier, or as a 20-watt second channel plus dual preamp for a stereophonic system. Features include a panel switch to permit full control of the inputs for tape recording, stereophonic or monophonic records, FM-AM radio, or auxiliary units. The "speaker phasing switch" eliminates the hole-in-the-middle effect.

The preamp-amplifier comes in custom-mounting form with an optional enclosure available at a small additional charge.

## STEREO CONTROL KIT

*Allied Radio Corporation*, 100 N. Western Ave., Chicago 80, Ill., has added a universal stereo control unit to its "Knight-Kit" line of assemble-it-yourself audio kits.

This stereo accessory provides com-

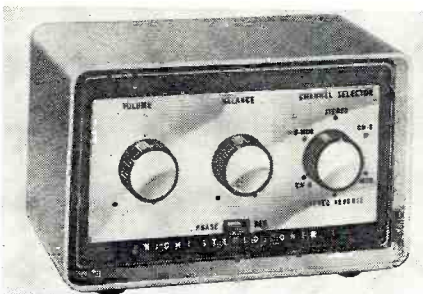

plete centralized control of stereo hi-fi systems employing separate amplifiers for each channel. Controls include: volume, balance, and function selector (stereo, stereo-reverse, A-channel, B-channel, A-monophonic, B-monophonic). In addition, there is a phase re-

verse switch. These controls permit the balancing of volume in each speaker, control over-all volume, play either channel through one speaker or through both speakers, provide channel reversal, and control speaker phase for optimum stereo performance.

Housed in a French grey metal case with contrasting aluminum and ebony-trimmed panel, the unit is supplied complete with all parts, case, wire, solder, and assembly instructions. The case measures 4½"x7¾"x4".

## "FRAMELOK" TUBE FOR AUDIO

*Sylvania Electric Products Inc.*, 1740 Broadway, New York 19, N. Y. has announced the development of a new electron tube for use in high-fidelity audio amplifiers.

The new tube, a dual-pentode designed for output stage use, utilizes the company's "Framelok" design and construction and offers maximum uniformity and stability of electrical characteristics.

Designated as the Type 6DY7, the new tube consists of two identical pentodes in a single envelope. It can thus take the place of two conventional audio output tubes and deliver the same output. When operated class AB push-pull between its own pentode section at 250-volt conditions, Type 6DY7 is capable of delivering 11 watts of output at 2.5% total harmonic distortion. At 400-volt conditions, the tube will deliver 20 watts of output at 2% distortion. When operated class A, one section can deliver 5 watts output at 9% distortion.

The manufacturer will supply full specifications on request.

## RECORD CLEANER

*C & D Products Co.*, Old Marlboro Road, East Hampton, Conn. is now of-



fering a handy and easy-to-use record cleaner to audiophiles and music lovers.

The "Stardust" record cleaner performs two functions—it permits the record to be washed in running water without damage to either label or record and serves as an airtight container for a cellulose or synthetic sponge, kept wet and used for repeated wiping and dampening of records just before playing.

Washing the record eliminates dust, dirt, and static. The slight film of moisture left on the record reduces the possibility of future static buildup and improves actual reproduction, tonal quality, and realism of the record, according to the company.

The unit further affords a method of holding the record during washing and wiping without allowing direct contact of fingers on the playing surface. The

WIDE LATITUDE  
**SONORAMIC**  
RECORDING TAPE

**THE CASE FOR BETTER SOUND**

Why settle for ordinary tape when Sonoramic gives you so many exclusive extras—brilliant reproduction, permanent plastic container, 3-way indexing system with pressure sensitive labels and V-slot self threading Selection Finder reel.



ON WALL FOR QUICK ACCESS

STORES LIKE PRECIOUS BOOKS

**FREE** Tape-time ruler. Gives you footage and recording time on reel. Write Dept. N4

**Ferrodynamics CORPORATION,**  
LODI, NEW JERSEY

**PURCHASING A HI-FI SYSTEM?**

Send Us Your List of Components For A Package Quotation

WE WON'T BE UNDERSOLD!

All merchandise is brand new, factory fresh & guaranteed.

**AIREX RADIO CORPORATION**  
64-R Cortlandt St., N. Y. 7, CO 7-2137

**PARTIAL LIST OF BRANDS IN STOCK**

Altec Lansing  
Electrovoice  
Jensen  
Hartley  
University  
Acoustic Research  
Janszen  
Wharfedale  
Karlson  
Viking  
Concertone  
Bell • G.E.  
Weathers  
Harman-Kardon  
Eico • Pilot  
Sherwood  
Acrosound  
Fisher  
Bogen • Leak  
Dynakit  
H. H. Scott  
Pentron  
Ampro • VM  
Revere  
Challenger  
Wollensak  
Garrard  
Miracord  
Glaser-Steers  
Rek-O-Kut  
Components  
Norelco  
Fairchild  
Pickering • Gray  
Audio Tape

Full Line of Cabinets

two plastic halves of the record cleaner screw together with the record in between. When not in use the wet circular sponge is kept inside.

A descriptive circular on this new device is available from the manufacturer.

**ISOLATION TRANSFORMER**

Triad Transformer Corporation, 2055 Redwood Ave., Venice, Calif. has developed a new isolation transformer which eliminates ground-loop feedback in stereophonic sound systems where either amplifiers or preamplifiers use a common ground.

Providing a 1:1 impedance ratio at 0 dbm from 20 to 20,000 cps, the A-210P is supplied with a standard plug and socket for immediate installation at the input connection on either preamp. The stereo head plug, which is normally inserted into the preamp input socket, plugs directly into the transformer. No other connecting or mounting is necessary. The primary and secondary windings have separate grounds and are shielded.

These new isolation transformers are now available at all of the company's distributors or from the manufacturer direct.

**AUDIO CATALOGUES**

**TAPE CROSS-REFERENCE**

ORRadio Industries, Inc., Shamrock Circle, Opelika, Ala. has made available a cross-reference chart on recording tape which it is offering to its dealers without charge.

The chart shows the comparable catalogue number of each type of tape made by the four leading manufacturers of magnetic recording tape. On the reverse side is a playing time chart which gives the playing time for all size tape reels and lengths at all playing speeds.

Dealers wishing a copy of this chart should address a postcard to Nat Welch, Sales Manager, asking for "Irish Tape Cross Reference Chart." It will be mailed without charge.

**TAPE FOOTAGE RULER**

Ferrodynamics of Lodi, New Jersey is offering free of charge a new tape-recorder ruler that measures the footage remaining on open tapes.

Introduced as an easy guide for tape recorder owners, this "Sonoramic Tape-Time Ruler" achieves the maximum recording time without waste, and effectively aids in better planning of recording sessions and helps avoid interruptions.

Made from cut-out board, the ruler is fitted over the reel spindle on top of the revolving reel. The tape edge and the reel numbers are aligned and the owner can then calculate the footage and time remaining from one of the three charts on the ruler. Different colored, these charts are used for the three basic tape thicknesses.

When writing for this free ruler, please address your request to Dept. N-13 of the company.

**EXCITING NEW TWEETER COMPONENTS FOR ADVANCED HI-FI**

Advanced Acoustics Band Extender components meet the highly diversified need for top performance in the middle and treble regions. These Extenders—Three, Two and Top Bands—bring new presence, brightness and brilliance to speaker systems... serve individual needs of frequency extension, system efficiencies, and mounting considerations. For your own fine system, use Advanced components. Three Band Extender \$10.95; Two Band and Top Band \$10.55 each.



THREE BAND EXTENDER — Model 24

Most versatile reproducer of lower middle, middles and high frequencies. Full three acoustic channels, flared horns and aperture radiation, with network element, complement any size quality speaker component... provides wide angle radiation from 1 Kc. to inaudibility. Mounts directly on 12" speaker, or independently on main baffle.

ADVANCED ACOUSTICS CO. • 1875 CARTER AVENUE • NEW YORK 57, N. Y.

**TWO BAND EXTENDER Model 25**

Ultra compact, new design for mid-range and treble response. Rear phase balanced, and front radiation covered dual range from 700 cps. to 18 Kc.



**TOP BAND EXTENDER — Model 26**

Compression driven, wide angle horn radiator. Features improved phase correcting and throat loading element for maximum cleanliness at top efficiency. Covers 2 Kc. to above 18 Kc.



DEALER INQUIRIES INVITED

**NOW 2 ASSEMBLE-IT-YOURSELF**

**SAVE HALF  
NO SPECIAL SKILLS  
PAY KIT-BY-KIT**

**Schober ELECTRONIC ORGANS**

Now you can afford an electronic organ. Whether you choose the full Concert model or the smaller Consolette, you have an organ equal to any made by the foremost manufacturers. In addition, you save over 1/2 the cost because you assemble it yourself...and you enjoy the thrill of achievement. Too, you purchase each kit only when you are ready for it.

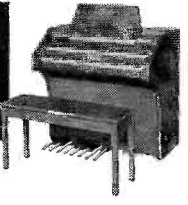
<p><b>2 different MODELS</b> <b>2 different SIZES</b> <b>2 different PRICES</b></p>	
 <p><b>CONCERT MODEL</b></p>	 <p><b>CONSOLETTE MODEL</b></p>
<ul style="list-style-type: none"> <li>☆ TWO FULL SIZE PIPE-ORGAN MANUALS, 122 KEYS</li> <li>☆ OCCUPIES 3/5" x 4/7" FLOOR SPACE</li> <li>☆ 26 STOPS AND COUPLERS</li> <li>☆ 32 BASS PEDALS</li> <li>☆ ASSEMBLED CONSOLE</li> <li>☆ CONFORMS TO AMERICAN GUILD OF ORGANISTS SPECIFICATIONS FOR PIPE ORGANS</li> <li>☆ COMPLETE STEP-BY-STEP INSTRUCTIONS</li> </ul>	<ul style="list-style-type: none"> <li>☆ OCCUPIES ONLY 2' x 3/2" FLOOR SPACE</li> <li>☆ TWO FULL SIZE PIPE-ORGAN MANUALS, 122 KEYS</li> <li>☆ 22 STOPS — ABOVE-KEYBOARD TABS</li> <li>☆ 13 HEEL-AND-TOE BASS PEDALS</li> <li>☆ 7 FULL OCTAVES OF TONE (DOWN TO 32 CPS)</li> <li>☆ BUILT-IN SPEAKERS OPTIONAL</li> <li>☆ ASSEMBLED CONSOLE</li> <li>☆ COMPLETE STEP-BY-STEP INSTRUCTIONS</li> </ul>

**10" LP RECORD DEMONSTRATING BOTH MODELS  
AVAILABLE FOR \$2, REFUNDABLE UPON PURCHASE**

**FREE NEW 1959 EDITION OF 16 PAGE ILLUSTRATED BOOKLET ON REQUEST**

Write Now — See What Fine Instruments You Get At Such Great Savings

The **SCHOBERS ORGAN Corporation** • 2248-A BROADWAY • NEW YORK 24, N. Y.

SCHOBERS KITS ALL OVER THE WORLD

☆ Designed by Richard H. Dorf.

**Speakers for Stereo**  
*(Continued from page 53)*

5. When a center speaker is used for common-bass, with side stereo speakers, can some of both channels also be combined and fed to the center location, to give "center fill"?

This is a "loaded" question. A paper presented by *CBS Labs* at the fall AES Convention stated that using any such center fill would destroy proper stereo, while the *Stephens* "Stereodot" system actually mixes program from both side channels to feed to the center.

But a closer look shows there is good reason for the apparent contradiction. The *CBS* system—and they only said this in reference to that system—uses what they term an *Isophonic* loudspeaker for the side locations. This is a small unit mounted on an open baffle, pointing inwards at an angle of 60° (Fig. 4). For esthetic purposes it is housed in an enclosure that makes it look as if it points toward the front.

This system, above 250 cycles, uses the special shaped radiation pattern produced by the open-backed speaker (a figure of 8, of which only part of the front "lobe" is used). Correct sense of "location," in this system, depends on the way the radiation from just the two side "Isophonic" speakers combines. So use of a center fill unit would upset this combination.

"Stereodot," like some systems recommended by other manufacturers, uses small "pressurized" units (with sealed backs) for the side speakers, above the common-bass crossover frequency. This far, the system is conventional, and quite different from the special distribution pattern of the *CBS Labs* system. So it will no more invalidate stereo to use center fill here than it does in any basic two-speaker stereo system, such as the *Klipsch* "Heresy."

I didn't want to mention names in this part of the article, but it seemed unavoidable here. However, my reason for using this information is that it illustrates how using a different type of loudspeaker radiation pattern can completely change things.

6. Some have asserted that a basic requirement for good stereo is an omnidirectional loudspeaker, while others deliberately use the directional characteristics of loudspeakers to obtain "best stereo effect." Which is best?

The basis for this difference has already been touched on in answer to the previous questions. The second part of this article will go into more details about actual systems. But the basic facts we can state here.

When the two stereo speaker systems are contained in the same cabinet (or are that close together), the radiation of the middle and upper frequencies must be directional for successful stereo. On the other hand, with a certain so-called "ideal" spacing for stereo speakers (which depends on room size, incidentally), best results will be obtained if the units are diffused to the

*From the pioneer in ceramics for electronics*



Approx. Twice Size

**STEREO**  
the new single ceramic element  
**Stereophonic cartridge**

**DYNAMIC BALANCING MAKES THE DIFFERENCE**

DYNAMIC BALANCING during manufacture provides full stereo reproduction. SINGLE ELEMENT DESIGN offers balanced outputs; excellent separation of 20 db over full audio-frequency range, with equal outputs from both channels. Compatible with stereo and monophonic discs.

**SPECIFICATIONS**

**RESPONSE:** 20 to 16,000 cps. **OUTPUT VOLTAGE:** 0.5 vrms at 1 KC each channel. **COMPLIANCE:** 3 x 10<sup>-6</sup> cm/dyne, vertical & lateral. **RECOMMENDED LOAD:** 2 megohms. **RECOMMENDED TRACKING PRESSURE:** 5-6 grams. **CHANNEL SEPARATION:** 20 db. **STYLII:** Dual tip; 0.7 mil diamond or sapphire, and 3 mil sapphire. **MOUNTING DIMENSIONS:** EIA Standard 7/16" & 1/2" centers.

For additional information, see your Authorized ERIE Distributor

  
**ERIE RESISTOR CORPORATION**  
 MAIN OFFICES: ERIE, PA., U. S. A.

# Now! The Most Important

## Product Announcement

### in the History of H. H. Scott!

point of an omnidirectional radiation. But when you don't have a room that suits this "ideal," it needs individual consideration for its particular needs.

#### 7. Which is the best system to buy?

This question is put here to stop some readers who might, in their enthusiasm, sit right down to write and ask me that. In Part 2 of this article, to be published next month, we will evaluate different systems, as regard their suitability for various room configurations. Included will be—with the cooperation of the manufacturers—a listing of available systems together with details showing specifically how they fit into the pattern we have discussed. (Concluded next month)

### GHOST KILLER

by A. V. J. MARTIN

WHEN television reception is degraded by ghosts due to reflections from obstacles in the path of the wave or by "moire" effects due to adjacent-channel interference, the only solution to the problem is the installation of a better antenna. Even a high-directivity, high-front-to-back ratio antenna may not solve the problem completely.

A clever circuit was published in the February 1958 issue of "Funkschau." In the article it was suggested that two antennas be used, one directed toward the wanted station and the other toward the source of interference, e.g., adjacent-channel station for "moire" or natural obstacle for ghost.

A fraction of the signal picked up by the second antenna, suitably adjusted in amplitude and phase, is mixed with the signal coming from the first antenna, thus cancelling the interference.

The actual circuit is given in the diagram below. It uses a symmetrical transmission line made up of two 1/4" brass rods with a center-to-center spacing of 1" and a half wavelength long. Such a line has an impedance of 240 ohms. This line section is inserted between the normal antenna lead-in and the receiver.

In addition, the compensating antenna, through the attenuator network, is connected to a double sliding contact on the line. The resistance values have been chosen to insure a good match, whatever the adjustment, both for the line and for the compensating antenna.

The two sliding contacts are moved through a small insulating strip which also carries the resistors and pots. To adjust, set the potentiometers halfway up. Move the contacts until the interference is at a minimum and then adjust the potentiometers for cancellation. If there is no minimum, but a maximum, reverse the connections to one of the antennas.

If the minimum occurs at one end of the line, shorten or lengthen one of the antenna feeders by a foot or two. —30—

Schematic of ghost killer described above.

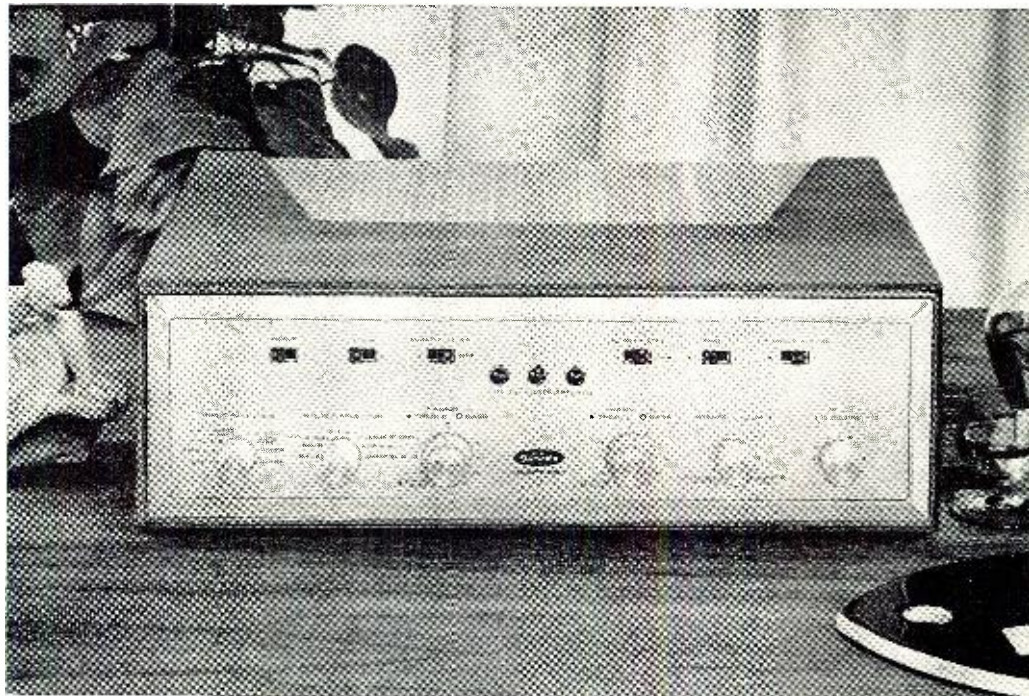
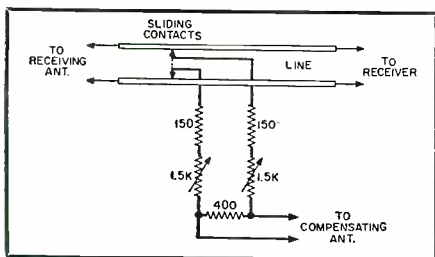

Here are the exciting details on

## The Stereo Amplifier that sets the Standards for the Next Decade!

The H. H. Scott engineering laboratories proudly introduce the new Model 299 40 watt stereophonic amplifier and control center. It contains many advance features that not only meet the needs of today's stereophonic program sources, but anticipate the requirements of the future. Check the details of this new amplifier, and see for yourself why the new 299 is superior to any other amplifier available.

tape heads. 4 Phase reverse switch to compensate for improperly phased tape recordings or loudspeakers. 5 Special balancing circuit for quick and accurate volume balancing of both channels. 6 Separate record scratch and rumble filters. 7 Unique visual signal light control panel. Instantly indicates mode of operation. 8 Can be used as an electronic crossover (bi-amplifier). 9 Special compensation for direct connection of tape playback heads without external preamp. 10 Special switching lets you use your stereo pickup on monaural records. 11 You can play a monaural source such as an FM tuner through both channels simultaneously effectively doubling power. 12 Loudness compensation. 13 Stereo tape recorder output. 14 D.C. filament supply for preamp to virtually eliminate hum (80 db below full power output). 15 Distortion (first order difference tone) less than 0.3%.



Size in accessory walnut case: 15 1/2" w x 5" h x 12 1/4" d. Price \$199.95. (West of Rockies \$204.95)

Write for complete technical specifications and new catalog R-4.



H. H. SCOTT, INC.

111 POWDERMILL RD., MAYNARD, MASS.

EXPORT: TELESKO INTERNATIONAL CORP.

36 W. 40TH ST., N. Y. C.

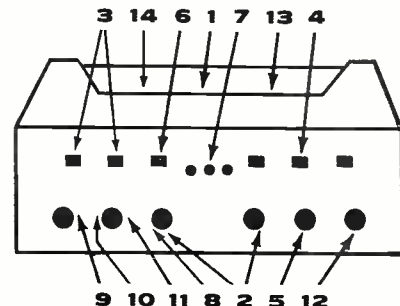

1 40 watt power stage consisting of dual 20 watt power amplifiers. You need this much power to meet the requirements of today's speaker systems. 2 Completely separate Bass and Treble controls on each channel so that different speakers may be matched. 3 Provision for connecting both a stereo phono cartridge and stereo

By HAROLD REED

Listening to tape playback and editing with aid of the switch, which is being operated by 20 cps pulses on the tape itself.



# 20 cps Tape Recorder Switch

Use low-frequency signal recorded on tape to operate power circuits through this automatic switching unit.

**A**LTHOUGH designed primarily for operating a relay by means of a low-frequency signal recorded on magnetic tape, this device may be used to operate a relay for control applications when any 20-cycle, or lower, signal is applied to its input. It may be used to stop the recorder actually being used to play back the tape, to start or stop another recorder, to control a motion picture projector, in fact to control any electrical device or electric lamps in demonstration applications.

The control signal can be obtained from any audio oscillator capable of supplying the low-frequency signal. This signal may be used to actuate the device directly or it can be recorded on magnetic tape and the unit operated during tape playback once, or as many times as desired and for any time duration.

The filter has a sharp cut-off characteristic above 10 cycles, therefore, a control signal between approximately 10 and 20 cycles will operate the switch, but voice, music, and sine-wave signals of higher frequencies will not trigger the unit. This makes it possible to feed the output of a tape recorder to the unit and only the low-frequency control voltage will cause the switch to operate and only at each point that this control signal is recorded on the tape.

A self-contained germanium diode power supply is included but the circuit may be operated from a 22½-volt battery if desired.

## Circuit Description

The device employs a low-pass filter in the input circuit, as shown in Fig. 1. This filter was designed to operate at the lower end of the audio band, that is, 20 cycles or below. Using a low frequency makes it possible to record this signal on a magnetic tape along with

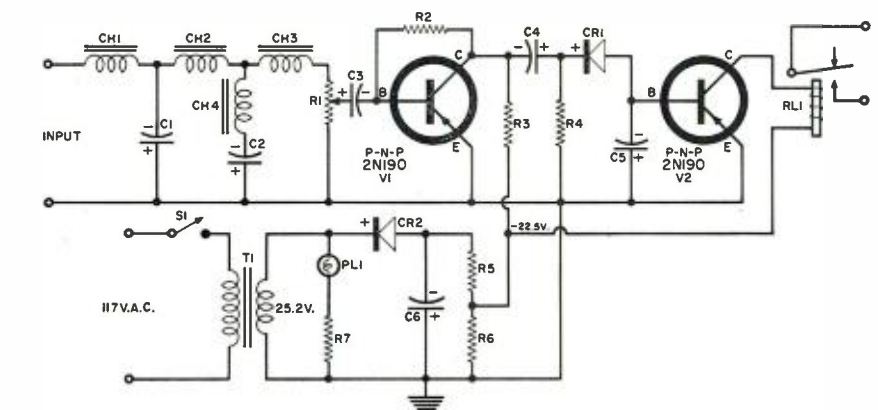

- |   |  |
|---|--|
| <i>R<sub>1</sub></i> —1000 ohm pot                                  | <i>CH<sub>1</sub></i> —4.5 hy. choke   |
| <i>R<sub>2</sub></i> —150,000 ohm, ½ w. res.                        | <i>CH<sub>2</sub></i> —8 hy. choke   |
| <i>R<sub>3</sub></i> —10,000 ohm, ½ w. res.                         | <i>CH<sub>3</sub>, CH<sub>4</sub></i> —2.5 hy. choke                         |
| <i>R<sub>4</sub></i> —470 ohm, ½ w. res.                            | <i>PL<sub>1</sub></i> —#47 pilot light (optional, see text)                  |
| <i>R<sub>5</sub></i> —100 ohm, ½ w. res.                            | <i>S<sub>1</sub></i> —S.p.s.t. switch  |
| <i>R<sub>6</sub></i> —600 ohm, ½ w. res.                            | <i>T<sub>1</sub></i> —Fil. trans. 25.2 v. @ 1 amp. (Stancor P6469 or equiv.) |
| <i>R<sub>7</sub></i> —150 ohm, 5 w. res. (optional, see text)       | <i>RL<sub>1</sub></i> —8000-ohm relay (Sigma 4F)                             |
| <i>C<sub>1</sub>, C<sub>5</sub></i> —25 µfd., 25 v. elec. capacitor | <i>CR<sub>1</sub></i> —1N34 crystal diode (Raytheon)                         |
| <i>C<sub>2</sub></i> —16 µfd., 12 v. elec. capacitor                | <i>CR<sub>2</sub></i> —1N38A crystal diode (Sylvania)                        |
| <i>C<sub>3</sub>, C<sub>4</sub></i> —10 µfd., 25 v. elec. capacitor | <i>V<sub>1</sub>, V<sub>2</sub></i> —“p-n-p” transistor (G-E 2N190)          |
| <i>C<sub>6</sub></i> —16 µfd., 50 v. elec. capacitor                |  |

Fig. 1. Schematic diagram and parts listing of the transistorized 20 cps switch.

voice or music and the low-frequency control signal will trigger the relay but will be inaudible in the loudspeaker. Mathematical equations used in designing the filter are discussed later. Unless the constructor is especially interested, or wishes to design the filter for another frequency or impedance, he may ignore such design data.

A common-emitter transistor audio amplifier follows the filter section. This amplifier works into a germanium diode rectifier. Direct-current output from the diode is applied to a transistor d.c. amplifier with the sensitive relay connected in its collector circuit.

Voltage divider *R<sub>5</sub>* and *R<sub>6</sub>* allows for adjustment of the power-supply output to -22.5 volts. These resistors also

provide a bleeder load for the power supply. Since the circuit was designed for this supply voltage, it is possible to build the unit with either or both an a.c. and a 22.5-volt battery supply and switch in either as required. As there is no 6.3-volt winding available, the power pilot lamp is connected across the 25-volt winding in series with dropping resistor *R<sub>7</sub>*. The pilot lamp and resistor may be omitted.

Although two relays are employed in the unit shown, the sensitive relay, *RL<sub>1</sub>*, can be used alone to operate the recorder motor or other device. It has a contact rating of 2 amperes. The second relay, *RL<sub>2</sub>* of Fig. 2, is an ordinary 117 volt a.c. type. It is wired to provide a self locking-in action, elimi-

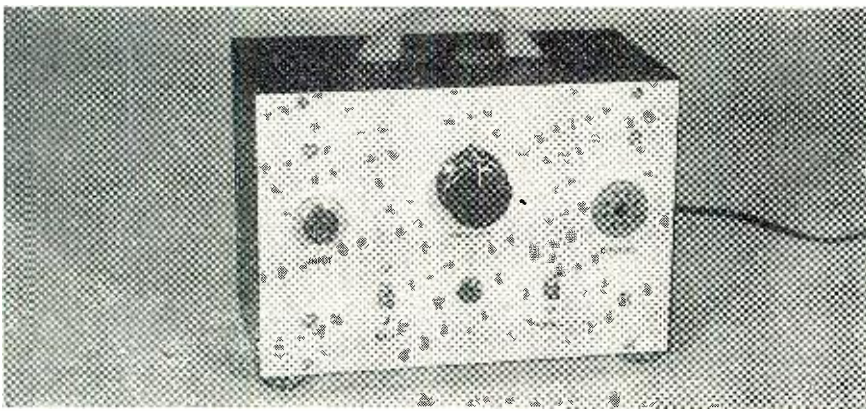

Front-panel view of the completed unit shown in its metal case.

nating the need for a more expensive latching-type relay. Release of the relay to the normal, or open, condition is easily accomplished with reset switch,  $S_2$ . Thus, relays  $RL_1$  and  $RL_2$  may be used to start or stop any device and  $RL_2$  may be selected to handle greater loads.

The value of the sensitivity control at the input of the amplifier was selected so that it would be at about midway position when a control signal of 1 volt was applied to the filter input. A 1000-ohm potentiometer proved to be about right for this purpose.

Impedance mismatch at the filter output varies with movement of the sensitivity control. For this application, however, we are not concerned with precise impedance matching as long as we obtain a low-frequency signal of sufficient amplitude at the base of  $V_1$ . A more expensive constant-impedance attenuator could be used here but was not considered necessary.

### Construction

Although a standard 5" x 6" x 9" metal box was used to house the device, it could be built into a much smaller container. The size shown, however, will provide room for a battery and change-over switch, if both battery and a.c. operation are desired, with space to spare.

The input connector, control connector, power and reset switches, pilot lamp, and sensitivity control are mounted on the front panel. The low-pass filter section, power supply, relays,

transistor sockets, and other component parts are assembled on a 7½" x 4½" sub-panel which is attached to the main panel by means of screws and four spacer posts. These posts may be of any suitable material. The author used threaded ceramic insulators.

Stand-off terminal strips were mounted on the inside of the sub-panel under the machine screws holding the chokes, etc., as required. Capacitors, resistors, and the crystal diodes were soldered to these terminals between the sub- and front panel. Miniature transistor circuitry capacitors were used. All wiring on the sub-panel must be completed first and then the interconnecting leads between it and the front panel soldered in place just before the sub-panel is installed. The constructor need not follow this type of layout, however, since parts placement is non-critical.

Both panels are aluminum sheets and the front panel was etched and provided with identifying decals under the controls and connectors. The box was fitted with a plastic handle and four rubber feet. Most of the items used in the unit shown in the photos were found in the junk box. The parts list gives commercial components that will provide equivalent results.

Incidentally, after cutting transistor leads to a short length, it is difficult to plug them into the socket. The author found that if after the leads are cut, they are filed lightly with a fine file to taper the lead ends, they can be inserted into the sockets quite easily.

As mentioned previously, the following design data is given for the benefit of the reader interested in constructing filter networks with characteristics other than those of the author's "model."

The filter consists of a constant- $k$  "T" section and an  $m$ -derived "T" section. The equations for the constant- $k$  section are:  $L_k = R/\pi f_c$  and  $C_k = 1/\pi f_c R$ . The circuit diagram is shown in Fig. 3A. Equations for the  $m$ -derived sections are:  $L_1 = m L_k$ ,  $L_2 = (1 - m^2/4m) L_k$ , and  $C_1 = m C_k$ . Refer to the diagram of Fig. 3B. In the foregoing equations,  $L$  is in henrys,  $C$  is in farads,  $R$  equals the characteristic impedance,  $\pi$  is 3.14,  $f_c$  is the cut-off frequency,  $m$  is 0.6. The  $m$  value of 0.6 is commonly used in practical filter design. Its value is found by  $m = \sqrt{1 - (f/f_\infty)^2}$  where  $f_\infty$  is a frequency of high attenuation. The inductance  $L_k$  in the output leg of the constant- $k$  section and the input inductance  $L_1$  of the  $m$ -derived section are combined, that is, the total value of these two inductances is furnished by a single coil. This is shown in Fig. 5 which is the schematic diagram of the complete filter as designed from the preceding equations.

For extremely efficient filter operation and in critical applications, top quality parts are required. The resistance of the coils should be low and the "Q" of the coils and capacitors high. However, for this application and at the low frequency involved, the author found ordinary iron-core choke coils and electrolytic capacitors to be satisfactory. Commercially available choke coils and capacitors having inductance and capacitance values as close as possible to the values derived from the equations were chosen. These are given in Fig. 1 and in the parts list. Note how close the values of the commercially available items come to the filter design values. A response curve of the filter, using the specified parts, is shown in Fig. 6. Measured values are given in Table 1.

Two methods for checking the filter response are presented in Fig. 4. When a 600-ohm, high-output oscillator is available, the filter can be checked as shown in Fig. 4A. The oscillator output voltage must also be constant over the frequency range. If the oscillator out-

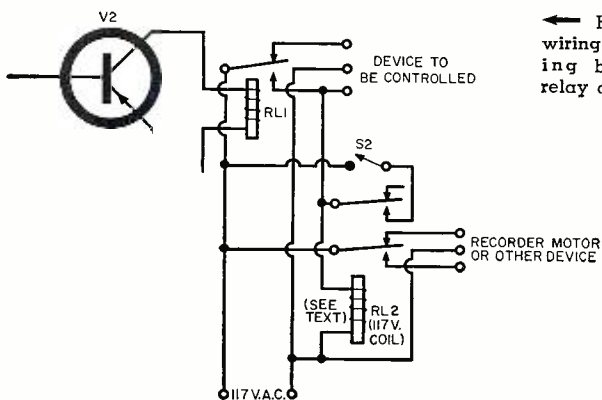
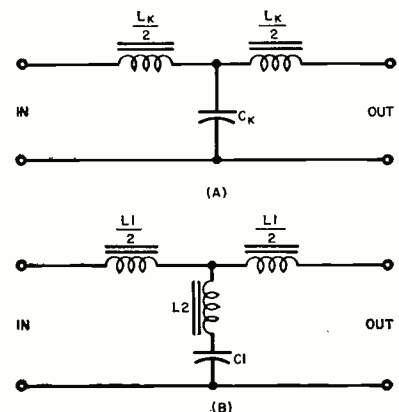

Fig. 2. Schematic wiring diagram for using both sensitive relay and lock-in relay.

Fig. 3. (A) Configuration of constant- $k$  "T" section and (B)  $m$ -derived "T" section.



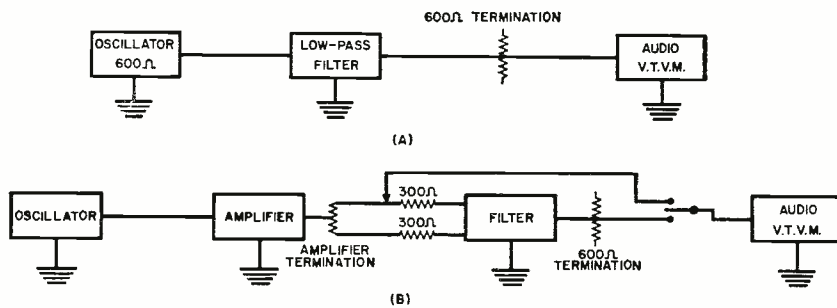
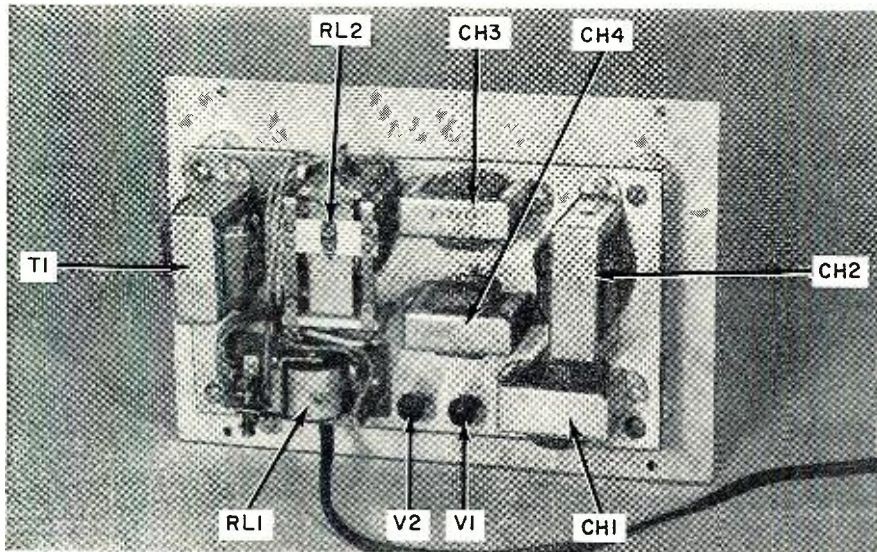

Fig. 4. Checking filter response with (A) high and (B) low output oscillator.



Rear view showing sub-panel attached to main panel of the unit.

put is too low for this arrangement, the test setup of Fig. 4B may be used. The input voltage to the filter is held constant by switching in an audio vacuum-tube voltmeter for each test frequency. If the amplifier output is known to be completely flat over the frequency range, the voltmeter switch is not required. If the amplifier has an output impedance of 600-ohms it may be worked directly into the filter without the series resistors shown in Fig. 4B.

#### Voltage and Current Data

The following test data was taken when using an audio control signal of 20 cycles. With the sensitivity signal of wide open, that is, maximum sensitivity, the relay closed with an audio input signal of 0.17 volt at the filter input and opened when this signal voltage was reduced to 0.15 volt. With the sensitivity control at about midway position, the relay closed at 1 volt of audio signal to the filter input and opened when the signal was reduced to 0.7 volt.

$V_1$  collector voltage measured -5.6 volts and collector current was 1.7 ma. The  $V_2$  collector voltage read -21 volts with no audio signal and -15 volts with the relay closed (1 ma. current flow).  $V_2$  collector current with no audio signal was 0.2 ma., with 1 volt audio signal (sensitivity control midway) it was 1 ma. With the sensitivity control at

maximum and an audio input signal of 0.5 volt, the  $V_2$  collector current ran 2 ma.

#### Operating Data.

To use this device with a tape recorder, the 20-cycle control signal is recorded on the tape at any spot at which it is desired to have the control device operate. This signal may be recorded separately or simultaneously with other recorded material and it may be recorded on the tape at as many points as desired. The control signal may be obtained from any oscillator and recorded on the tape through one of the regular recorder input channels.

The control unit is then connected to the output of the tape recorder. When the tape is played back, relay  $RL_1$  will close at any time and for any time duration that the 20-cycle control signal is reproduced from the tape. This may be a single short pulse to momentarily operate the relay or it may be a prolonged signal to hold the relay closed for a definite period of time. When operating in this manner, switch  $S_2$  may be in the "off," or open, position, so that  $RL_2$  will open or close in consonance with  $RL_1$ . Thus, any device may be started or stopped momentarily or for prolonged periods, depending on duration of the 20-cycle control signal recorded on the tape.

Another mode of operation is to

have relay  $RL_2$  lock-in upon operation of  $RL_1$ . For this action, switch  $S_2$  must be "on" or closed. Now a 20-cycle pulse applied to the input will actuate both relays as before, but  $RL_2$  will latch in and remain closed even after the control signal has been removed. In this way, any controlled device may be started or stopped and will remain in this condition until relay  $RL_2$  is reset by opening switch  $S_2$ .

If the mechanism of the recorder driving the tape that supplies the control signal is powered through relay  $RL_2$ , it too may be stopped automatically. This is a convenience in editing tapes. As an example, during the recording process a 20-cycle pulse may be superimposed on the other recorded material at any point where it is desired to make changes or to splice in other tape material. Then when the tape is played back for editing it will stop at each spot containing the low-frequency control signal and remain stopped until switch  $S_2$  is reset.

Only several applications for the device have been suggested although it can be employed in numerous ways, not only by the audio experimenter and hobbyist, but commercially as well.

-30-

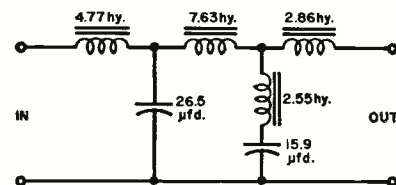

Fig. 5. Complete filter designed from text.

Fig. 6. Response of the filter network.

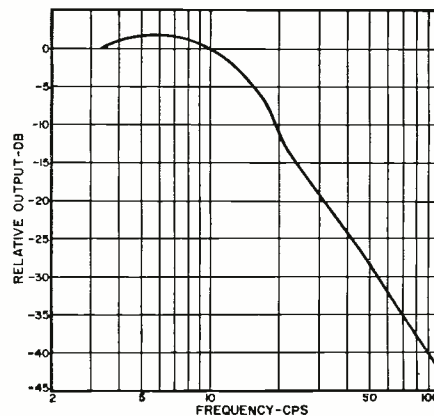

Table 1. Listing of relative outputs.

FREQUENCY (cps)	RELATIVE OUTPUT (db)
100	-42
90	-40
80	-38
70	-35
60	-32
50	-29
40	-24
30	-19
20	-11
10	0



# 'REALISTIC-ALLY' SPEAKING

## Here's Why RADIO SHACK'S 1959 SOLO Speaker Is Worth Twice Our Price!

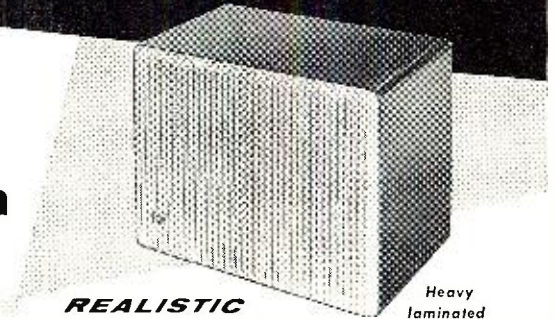

**REALISTIC  
"SOLO"  
\$15.95**

Heavy laminated mahogany cabinet

2 for Stereo \$29.50

If made in this country, Radio Shack's exclusive "SOLO" speaker system would cost more than twice its low price. Here at last is a VERY SMALL SPACE HI-FI speaker with real lows and clean highs. It's designed by the same Radio Shack engineering staff that created the world famous ELECTROSTAT-3 tweeter. And its magnificent performance is matched in appearance by its handsome furniture-finished dark mahogany enclosure with blending grill.

Size 14 1/2" x 11" x 10 1/2" deep; 8 ohms to match any hi-fi amplifier, console or TV set; sealed back with terminal strip; cabinet finished on four sides for horizontal, vertical or suspended use; 2 runners of matching mahogany included; response is 50-14,000 cps. Quality-wise, space-wise and budget-wise... there's no other speaker to compare with our "SOLO"!



"SOLO" Interior Photo

Ultra-compliant suspension cone speaker consisting of a woofer with a coaxially mounted "whizzer"

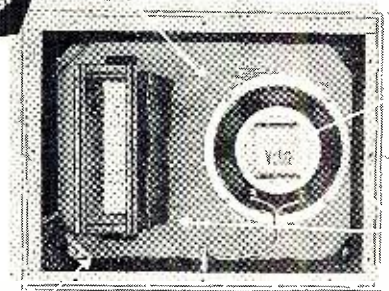

Extra heavy Alnico magnet

Acoustic lining throughout for clean sound

Tuned, vented, duct-type enclosure... Helmholtz resonator... especially designed to extend the range of the SOLO with REAL lows

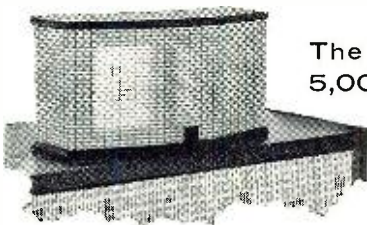

The World Famous  
5,000-25,000 cps  
TWEETER

**REALISTIC  
"ELECTROSTAT-3"  
\$27.50**

Radio Shack's REALISTIC ELECTROSTAT-3 adds a new acoustic brilliance to any speaker system. smooth, silky response from 5,000 cps to beyond the range of human hearing. It's the tweeter that's been getting the rave notices... the tweeter the whole world wants most, regardless of price. Mahogany, blond or walnut finish. Size 11 7/8" wide x 5 7/8" high x 4 1/2" deep.

REALISTIC ELECTROSTAT-3 CROSSOVER NETWORK KITS include coils, condensers and L pad, complete with simple assembly instructions. Either 8 or 16 ohm kit... each \$4.95

**REALISTIC  
"TRIO"  
\$44.50**  
2 for Stereo  
\$79.50



Radio Shack's REALISTIC "TRIO" is a magnificent 3-speaker system that compares brilliantly with \$100 systems... and includes features no other speaker system has... such as the patented center-mounted acoustic cut-off filter in the 8" woofer. This provides clean lows without h-f interference. The superbly engineered dual tweeters have a smooth wide range and are mounted at offset angles for dispersing the sound uniformly in all directions. In addition to being solidly encased, they are so mounted that they may be rotated 90° for maximum effectiveness in either upright or lowboy positions. Dual hi-pass filter; response 35-17,500 cps; 8 ohms; laminated dark mahogany furniture-finished on 4 sides; size 22 1/2" x 13" x 11 1/2" deep; complete with 2 separate, matching runners.

Ask for our 64-page  
HI-FI BUYING GUIDE



# RADIO SHACK CORPORATION



STORES 167 Washington St., Boston 8, Mass.  
730 Commonwealth Ave., Boston 17, Mass.  
230-240 Crown St., New Haven 10, Conn.

RADIO SHACK CORPORATION, Dept. 4F  
730 Commonwealth Ave., Boston 17, Mass.

Please send me the following:

Quan.	REALISTIC	Sh. Wt.	Order No.	Sale
	SOLO Speaker	12 lbs.	90LX250	\$15.95
	TRIO Speaker	25 lbs.	90LX210	44.50
	ELECTROSTAT-3	7 lbs.	36CX017Y	27.50
	8-Ohm X-Over	2 lbs.	91L500	4.95

Radio Shack 1959 Hi-Fi Buying Guide  
 Check     Money Order     C.O.D.  
 Name \_\_\_\_\_  
 Address \_\_\_\_\_  
 City \_\_\_\_\_ Zone \_\_\_\_\_ State \_\_\_\_\_

# build this great new **kn ght k t** A PRODUCT OF ALLIED RADIO

never before such performance...such styling at so low a price...



tremendous value at only

**\$44<sup>50</sup>**  
only \$4.45 down

SAVE UP TO 50%...COMPARABLE IN EVERY WAY TO WIRED AMPLIFIERS COSTING TWICE AS MUCH

*Includes two built-in preamplifiers for magnetic cartridges...*

*Single selector switch for instant choice of desired operation...*

*Separate bass and treble controls with boost and attenuation...*

*Concentric volume control adjusts balance on each channel—plus overall volume...*

*DC on all preamp filaments for hum-free operation...*

*Dual push-pull output circuitry for smooth, clear high-fidelity output...*

## **knigh-kit 20-watt stereo hi-fi amplifier**

Newest complete stereo high-fidelity amplifier at an amazing low \$44.50—the most sensational value ever offered in a stereo amplifier kit. It's a pleasure to assemble. It's a truly fine instrument—the worthy heart of the finest stereo hi-fi music system. Ideal for use with newest stereo records or stereo radio broadcasts. Delivers 10 watts per channel into each of two speaker systems for 20 watts of stereo—or 20 watts into one or more speakers for monaural use. Includes two fully integrated built-in preamps to accommodate magnetic cartridges. Single switch selects phono, tuner or auxiliary stereo inputs, plus stereo reverse on each; also switches monaural input to both amplifier channels. Has separate bass and treble controls with both boost and attenuation for complete control of tonal color. Special clutch-type concentric volume control permits individual channel balance adjustment, plus overall volume control. RIAA equalized for stereo discs. Has four pairs of stereo inputs: magnetic cartridge, ceramic cartridge, tuner and auxiliary. With switched AC accessory outlet for added convenience. Response is 20-20,000 cps,  $\pm 1.5$  db. Hum and noise, better than 85 db below full output. Distortion less than 1½%. Simple point-to-point wiring for easy assembly—even without previous electronic experience. Custom cabinet attractively finished in French gray; aluminum front panel with ebony trim; 4¼ x 13¼ x 9". With case, tubes, all parts, wires, solder and instructions. Shpg. wt., 27 lbs.

**Model Y-773. Knight-Kit 20-Watt Stereo Hi-Fi Amplifier Kit. Net only. \$44<sup>50</sup>**  
*Easy Terms: Only \$4.45 Down*

order from **ALLIED RADIO**  
*the world's largest electronic supply house*

# stereo hi-fi amplifier

enjoy building the very best

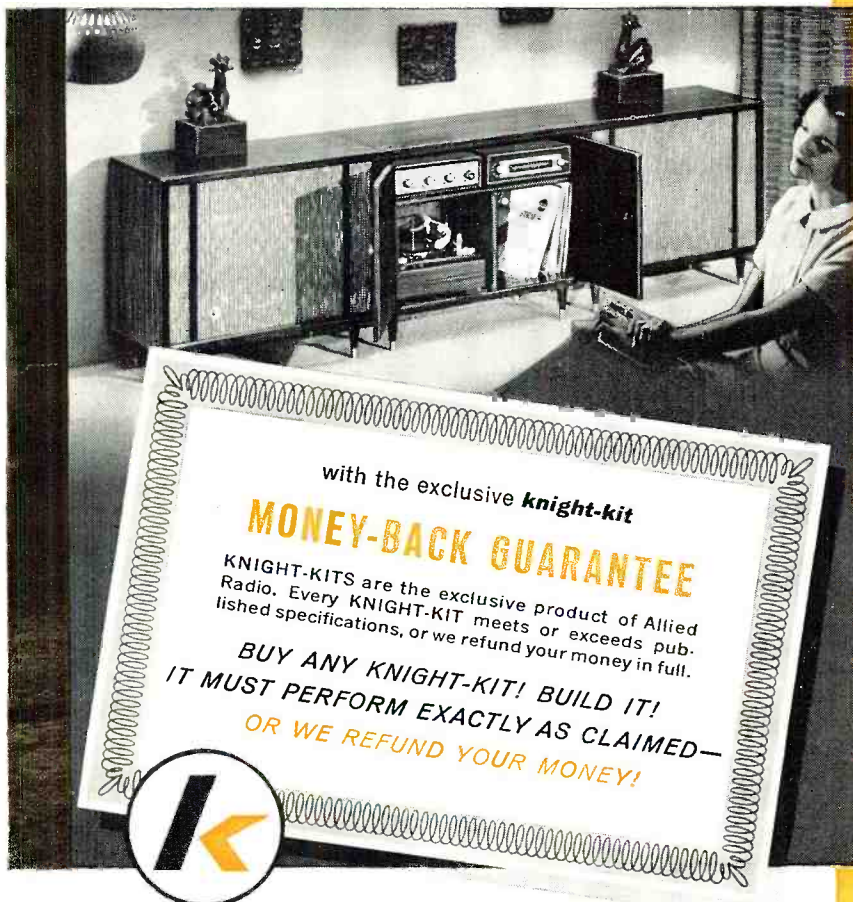

only **knight-kits** have  
**"CONVENIENCE ENGINEERING"**  
 for easiest building...no previous  
 electronic experience needed

Exclusive in all Knight-Kits, "convenience engineering" means special attention to every detail: resistors are carded and numbered for ease of selection...all parts and hardware are packaged in clear plastic bags for easy identification...wire is precut, stripped and color-coded to save time. Finally, Knight-Kits are world-famous for their step-by-step instructions and wall-sized picture diagrams —assembly is a marvel of simplicity. Your final reward is proud enjoyment of the superior performance designed into your Knight-Kit.

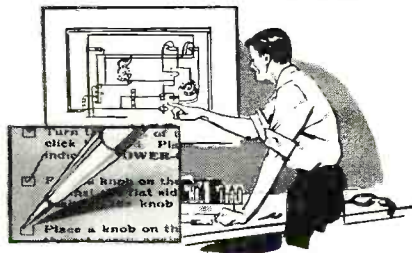
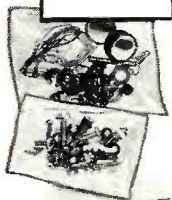
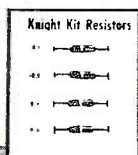

38 years of experience in electronic kit design



see over 50 other fine  
**knight-kits** in the 1959  
 Allied Catalog...send for it

**FREE**

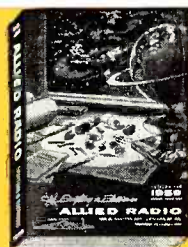

### HI-FI KITS

- Stereo Deluxe Preamp
- 60-Watt Stereo Amplifier
- Stereo Control
- 30-Watt Amplifier
- 25-Watt Basic Amplifier
- 18-Watt Amplifier
- 12-Watt Amplifier
- FM-AM Tuner
- FM Tuner
- Hi-Fi Preamp
- Speaker Systems, etc.

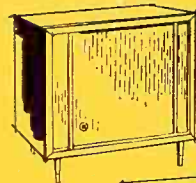

### HOBBY KITS

- "Span-Master" 4-Band Receiver
- "Space-Spanner" Receiver
- "Ranger" Radio
- Clock-Radio
- Radio-Intercom
- "Ocean Hopper" Radio
- 5-Transistor Portable
- 2-Transistor Pocket Radio
- 1-Transistor Radio
- Electronic Lab Kits
- Photoelectric System, and many others

### INSTRUMENT KITS

- VTM
- VOM's
- Tube Checkers
- Oscilloscopes
- RF Signal Generator
- Signal Tracer
- Audio Generator
- Sweep Generator
- Capacity Checker
- R/C Tester
- Transistor Checker
- Flyback Checker
- Battery Eliminator
- Sub Boxes, etc.

### AMATEUR KITS

- Communications Receiver
- 50-Watt Transmitter
- Self-Powered VFO
- 100 kc Crystal Calibrator
- RF "Z" Bridge
- Code Practice Oscillator

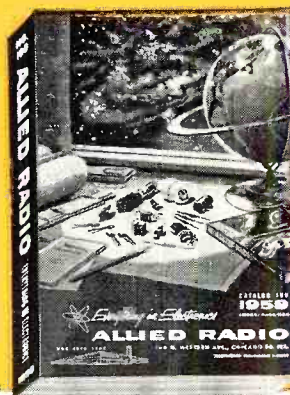

**FREE**

**452-page 1959 ALLIED CATALOG**

Send for this value-packed catalog featuring the complete KNIGHT-KIT line, as well as the world's largest stocks of everything in Electronics. Write today for this leading, money-saving Buying Guide.

**ALLIED RADIO CORP., Dept. 155-D9**  
 100 N. Western Ave., Chicago 80, Ill.

Ship me Model Y-773 20-Watt Stereo Hi-Fi Amplifier. \$\_\_\_\_\_ enclosed

Send FREE ALLIED 1959 Catalog.

Name \_\_\_\_\_

Address \_\_\_\_\_

City \_\_\_\_\_ Zone \_\_\_\_\_ State \_\_\_\_\_

Save time and effort . . .  
simplify your work



## MAGNEFORMER

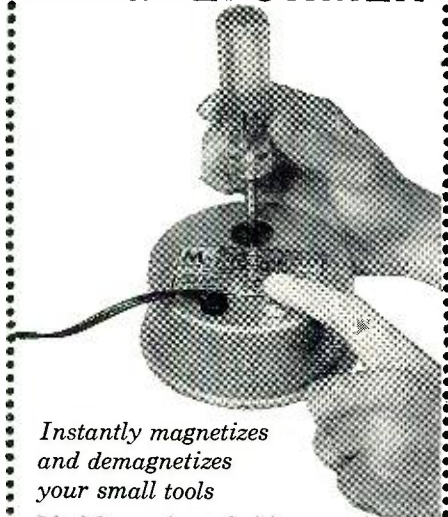

Instantly magnetizes  
and demagnetizes  
your small tools

Ideal for service technicians, repairmen, engineers, and hobbyists. MAGNEFORMER is indispensable to anyone who works with small parts. With this specially developed device, you can quickly magnetize a screwdriver, hex wrench, or nut runner, easily remove screws and nuts without fear of dropping into inaccessible places. Use it, too, for demagnetizing tools or iron or steel parts. Easy to operate (simple instructions are supplied) and fully guaranteed. You'll wonder how you ever got along without it.

MODEL F-100, LIST PRICE \$7.50

Return full picture height  
and width



## 300 WATT TV VOLTAGE REGULATOR



You can easily correct picture distortion caused by low or high line voltage. PERMA-POWER TV Voltage Regulator boosts 10 volts, lowers 10 volts, or feeds line through, eliminates intermittent sync and oscillator drift. Simply plug in; turns on and off automatically with set. Reduces tube failures, increases set sensitivity, lets set operate at optimum efficiency. MODEL D-101, LIST PRICE \$6.95

Engineered for quality . . . and fully guaranteed



3108 N. ELSTON AVE., CHICAGO 18, ILL.

108

# M. Madey Named 1958 "Ham of the Year"

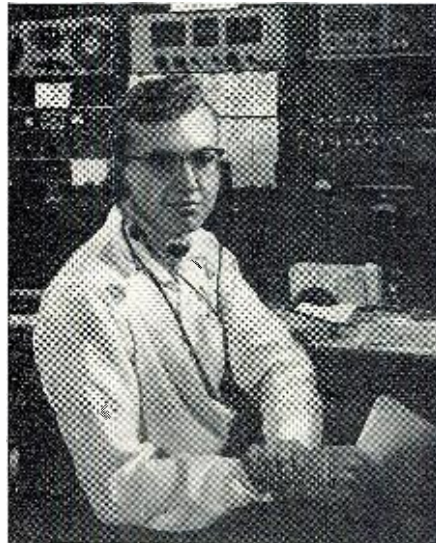

Eighteen-year-old ham from New Jersey cited for services to personnel at isolated polar posts.

THE Edison Radio Amateur Award, given annually by *General Electric Company* to the ham whose public service contributions have been adjudged outstanding, goes to Julius M. J. Madey, an 18-year old of Clark, New Jersey who is one of a family of four licensed radio amateurs.

The 1958 trophy and \$500 cash award was presented to Madey for handling thousands of messages for personnel at isolated Antarctic, Arctic, and South Pacific Posts. He spends an average of 90 hours a week at his station, K2KGJ, and is reported to have transmitted more than 12,000 messages during the past several years.

Two years ago he received a special citation for this work in the Edison Award program and last year he received an Edison Award commendation certificate and a public service award from the Navy.

Judges for the Edison Award were FCC Commissioner Rosel Hyde; E. Roland Harriman, chairman of the board, American National Red Cross; and G. L. Dosland, president of the ARRL.

Evidence of young Madey's public service submitted in connection with the award was a copy of a personal letter of appreciation from Rear Admiral George Dufek, commander, U. S. Naval Support Force, Antarctica.

During the 1958 Christmas season he relayed, for the isolated personnel, orders for nearly \$2000 worth of flowers to be sent to members of their

families who are in the United States.

Madey will matriculate at Rutgers University next year with a view to entering a career of research in medical electronics. He won student science fair honors several years ago for inventing an ultrasonic drill which created somewhat of a stir among engineers.

Three special citations were also awarded: Kenneth M. Blaney, 54, W6-PIV, of Sacramento, California for handling messages and contributing data on satellite movements; Andrew C. Clark, 35, W4IYT, of Miami Springs, Florida for participating in the Florida weather reporting network, civil defense, Red Cross, and youth training activities; and Loyd A. Peek, W7BA, Seattle, Wash. for transmitting messages for overseas military personnel, participating in civil defense communications, and serving in the civilian Air Force and Army affiliate radio systems.

Presenting the award and commendations at the Awards Banquet held in Washington, D. C. was L. Berkley Davis, general manager of the *General Electric* electronic components division and chairman of the award council. J. S. Parker, *G-E* vice-president for employee and public relations, served as master of ceremonies at the banquet.

Principal speaker at the event was "Father Dan" Linehan, S. J., chairman of the department of geophysics at Boston College—a radio amateur who spent some time in the Antarctic in the IGY program.

-30-

RADIO & TV NEWS

## Your Business Personality (Continued from page 73)

alyze a set, there is no way a set owner can tell whether he is a good, bad, or indifferent operator. It is an activity that must be founded on faith. In selecting a shop to call for TV service, there is no way a customer can appraise its trustworthiness, competence, and honesty, except through conversation and appearance.

People are inclined to rate a business on the basis of what they see. If they see an attractive store front with clean and interesting window displays, they will consider it to be a successful business. If, on the other hand, the shop is located in a building with a dingy-looking front and the windows are filled with a jumble of cartons and meaningless equipment, they will be inclined to look on it as a fringe business.

Average people prefer to deal with successful businesses. This is especially true when they have to buy an intangible product like service. They know that a dishonest, unscrupulous, or incompetent technician can prove very costly to them. They will buy the appearance of success because it connotes stability, competence, and reliability. The appearance of the dealer's store and shop is a vital element in the personality of his business.

One figure prominent in the inde-

pendent service industry estimates that, of the large number of organizations actively engaged in electronic service, there are about thirty thousand full-fledged businesses with an average investment of ten-thousand dollars or better each. This would mean that facilities with a value of well over three-hundred-million dollars are provided by the independent service industry to install, maintain, and service electronic products. Practically all of the businesses in this group are owned and operated by competent technicians who, dollar-for-dollar, are giving the public exceptionally good value for the money spent on TV service.

Unfortunately, the public does not realize that such a vast network of businesses, with the tremendous investment involved, has been built up to handle the servicing of TV sets and other electronic equipment. One of the reasons for this public ignorance of the independent service industry is the lack of a standard "business personality" for independent service shops. If as little as twenty-five percent of the TV service shops now in existence adopted a common front format and converted their businesses to conform to this standard, the public-relations impact would be phenomenal. It would give the general public a concrete idea of the scope of this vast industry of small businesses that has been created to give top-quality service on TV and other electronic products used in the home.

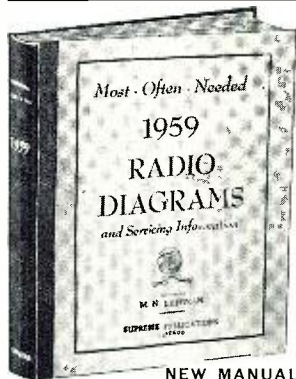

Be prepared to repair quickly all new 1959 radio sets. In this big volume you have easy-to-use, large schematics, needed alignment data, printed plates views, parts lists, voltage values, and information on transistors, location of trimmers, and dial stringing, for almost every 1959 radio. Includes auto radios, stereo, portables, and all types and makes of home sets. Giant in size, 8 1/2 x 11"; manual style, sturdy binding. Price, only **\$2.50**

# New SUPREME 1959 Radio Manual

Now you can benefit and save money with Supreme amazing scoop of 1959. This one giant volume has all the service data you need on all recent radio sets. A full year of models of all popular makes, home and auto sets, portable radios, stereo, combinations, all included. The full price for this mammoth 1959 manual is only \$2.50, nothing else to buy for a whole year. Other popular Supreme radio service volumes for previous years (mostly at \$2) are described below. Separate TV manuals are listed at right.

## SUPREME RADIO MANUALS FOR PREVIOUS YEARS

Use Supreme manuals to repair all radios faster, easier; save time and make more money. Here is your lowest-priced service data. Covers all years, from 1926-38 to 1959 models, in 19 volumes. Used by 174,000 shrewd servicemen. Most volumes only \$2 each, see coupon. Average volume 190 large pages, 8 1/2 x 11 inches. Quality printing, easy to use, manual-style binding. Amazing values. Be wise, use these manuals to get all needed diagrams, voltages, alignment facts, and service hints, at the smallest cost. See your jobber or send no-risk trial coupon. →

## SUPREME TELEVISION SERIES

Here is your complete source of TV service data at lowest prices. Supreme manuals at only \$3 each are amazing bargains and defy competition. Each annual manual covers a whole year of models, using original factory material. Include giant double-spread circuits and blueprints, alignment procedure, waveforms, voltage charts, factory revisions, and helpful service hints. Select volumes from list below and send no-risk coupon.

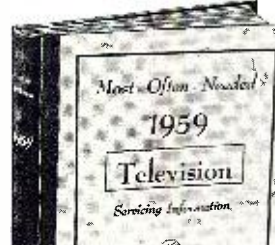

- 1959 TV Manual, \$3
- 1958 TV Manual, \$3
- 1957 Early TV, \$3
- 1957 Late TV, \$3
- 1956 TV Manual, \$3
- 1955 Early TV, \$3
- 1955 Late TV, \$3
- 1954 TV Manual, \$3
- 1953 TV Manual, \$3
- 1952 TV Manual, \$3
- 1951 TV Manual, \$3
- 1949 TV Manual, \$3
- 1948 TV Manual, \$3

## NO-RISK TRIAL ORDER COUPON

### SUPREME PUBLICATIONS, 1760 Balsam Rd., Highland Park, ILL.

Rush today TV manuals checked  below and Radio manuals at left. Satisfaction guaranteed.

- 1959 Radio Manual, \$2.50
- 1958 Radio Diagrams, \$2.50
- 1957 Radio Manual, \$2.50
- 1956 Radio Diagrams, \$2.50
- 1955 Radio Manual, only \$2
- 1954
- 1953
- 1952
- 1951
- 1950
- 1949
- 1948
- 1947
- 1946
- 1942
- 1941
- 1940
- 1939
- 1926-1938 Manual, \$2.50
- Radio & TV Master INDEX, 25c

These annual RADIO volumes specially priced at only **\$2.50** each...  
**THIS GROUP ONLY \$2 EACH**

- New 1959 Television Servicing Manual, only... \$3.
- 1958 Television Manual, \$3.
- Additional 1957 TV, \$3.
- Early 1955 TV, \$3.
- 1954 TV, \$3.
- 1953 TV, \$3.
- 1951 Television Manual, \$3.
- 1948 TV, \$3.
- New Television Servicing Course, complete, . . . \$3.

- I am enclosing \$..... Send postpaid.
- Send C.O.D. I am enclosing \$..... deposit.

Name: .....  
Address: .....

## TELEVISION SERVICING COURSE

Let this new course help you in TV servicing. Amazing bargain, complete only \$3. full price for all lessons. Giant in size, mammoth in scope, topics just like a \$200.00 correspondence course. Lessons on picture faults, circuits, adjustments, short-cuts, UHF, hints, alignment facts, antenna problems, troubleshooting, how to use test equipment, fault-finding hints, picture analysis. Special, only **\$3**



# Supreme Publications

Sold by All Leading Parts Jobbers

By  
**J. RICHARD JOHNSON**

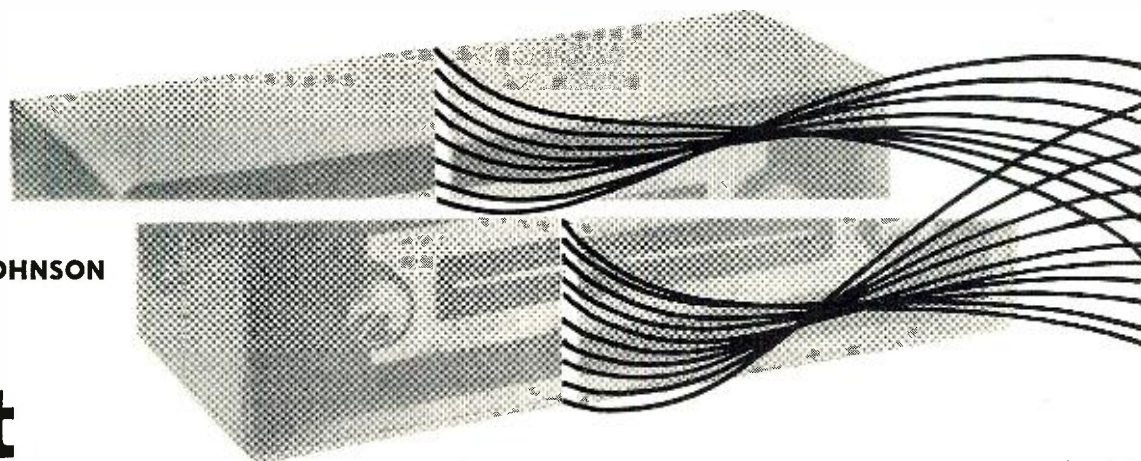

# Drift & A.F.C. in FM

**A clear picture of what goes on inside the set can speed up troubleshooting when oscillator stability is involved.**

**EDITOR'S NOTE:** *With experience, most technicians get to do some servicing by memory, without having to think out what is happening. This is fine for frequently encountered faults and circuits. However, FM sets with drift problems don't show up on the bench every day, and brainwork must take the place of automatic techniques. This thoughtful re-appraisal of what happens and why will help greatly.*

**O**NE OF THE ETERNAL problems with FM receivers is that of oscillator drift, although compensating capacitors and a.f.c. have gone a long way toward minimizing the trouble. While such measures make life more pleasant for the receiver owner in normal use, they can, when trouble develops, complicate things for the technician. In the popular AM-FM types, the interrelationship between circuits used for both modes of operation doesn't help matters either. Before tackling problems in FM stability, the technician should know some pertinent things about the receiver circuitry.

The detector in an FM receiver demodulates the i.f. signal. The center frequency of the i.f. signal must stay close to the center of the amplitude-

frequency characteristic of the detector. One of the reasons is illustrated in Fig. 1. In each of the three diagrams, the frequency-modulated i.f. signal is shown on the lower, vertical axis in such a way that it can be projected to the detector characteristic shown above it. The a.f. signal that results from demodulation is shown along the horizontal axis to the right of the detector characteristic. With this arrangement, the input-signal values can be projected geometrically through the detector characteristic to the a.f. output signal waveform. In each of these diagrams, the input signal is assumed to be modulated by a sine wave.

Fig. 1A illustrates the condition of perfect tuning. The center frequency of the i.f. signal corresponds exactly to the center frequency of the detector characteristic. Within the limitations of a small, inevitable amount of curvature in the actual characteristic, the modulating sine wave is faithfully reproduced.

Fig. 1B illustrates what happens with a small amount of detuning. Because the positive excursions of the input signal now reach into the substantially-curved portion of the detector

characteristic, one half of the a.f. signal is flattened, and the signal is thus noticeably distorted.

Fig. 1C illustrates what happens with a large amount of detuning. Positive excursions of the input signal extend beyond the edge of the detector characteristic. The result is extreme distortion, as shown.

The lower the amplitude of the modulation signal, the less the FM signal deviates from its center frequency, and the less likely it is to swing past the detector's linear portion. Thus, one characteristic of detuning distortion is that it gets worse as modulation-signal amplitude increases. In some cases, only the high-level peaks of the program material distort. Even when the detuning is small and the signal is within the so-called "linear" portion of the detector characteristic, the fact that slight non-linearities are not symmetrical about the received signal center frequency adds to distortion.

It thus becomes clear that, for full-quality FM reception, the tuning should be kept as nearly perfect as possible. The i.f. signal center frequency should be within a few kc. of the detector's center frequency.

**Fig. 1.** In properly tuned FM set (A) linear detection results in undistorted audio output. Detuning (B, C) distorts audio.

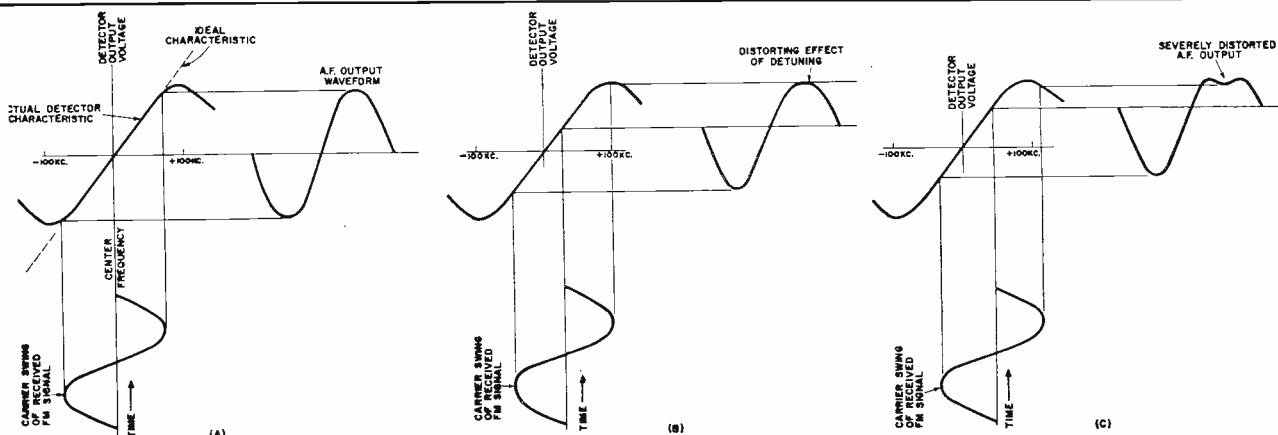

The i.f. center frequency is determined by the local oscillator. Ordinarily the i.f. is the difference between the oscillator frequency and the (lower) FM carrier being received. For example, with the receiver tuned to 90 mc., the oscillator should be at 100.7 mc. The difference, 10.7 mc., is the generally used i.f. for FM receivers. When the local oscillator in the front end drifts as little as 20 or 30 kc., the corresponding shift of the i.f. band can result in annoying distortion and noise interference. The problem of noise arises sometimes even before distortion is noticed, because detuning during drift reduces the signal amplitude to the limiter. In cases in which the signal is weak enough to be just on the threshold of adequate limiting, drift allows such noises as automobile ignition pulses to be serious obstacles to quiet listening.

### Reasons for Instability

The local oscillators of FM receivers are much more susceptible to drift than their AM receiver counterparts. The main reason is that the values of inductance and capacitance used in FM circuits for tuning are very much lower than those in AM circuits. These reactances are so low in FM that they do not greatly exceed those of tube and stray circuit capacitances. The latter vary considerably during temperature changes and thus change the resonant frequency of the oscillator tuned circuit.

At the same time, the physical dimensions of the oscillator coil change due to thermal expansion. Since a temperature rise tends to increase the size of most components, and thus also increase the values of inductance and capacitance, the frequency of the oscillator tends to drift downward.

Of course the greatest drift occurs when the receiver is warming up from a "cold" start, as this is when the greatest temperature change takes place. Most FM receivers do tend to drift during the first 15 minutes or so after being turned on from a cold start. After that time, the oscillator should "settle down" and be relatively stable. However, if the oscillator is not carefully designed, or if there is a defect in its circuit, drift may continue indefinitely, causing distortion and excessive noise due to mistuning. It will also be subject to frequency change as a result of line voltage fluctuations.

### Temperature Compensation

Some FM receivers use *negative-coefficient* capacitors to compensate for drift during the warmup period and for general stability. A negative-coefficient capacitor is one whose capacitance becomes *less* as its temperature increases, thus reversing the usual trend. If connected in a tuned circuit, such a capacitor causes the resonant frequency to become *higher* as temperature increases.

As previously noted, ordinary oscillator circuits tend to drift downward in resonant frequency during warmup, so

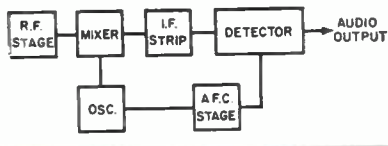

Fig. 2. How a.f.c. locks oscillator.

the negative-coefficient capacitor tends to compensate for this drift. Such capacitors are manufactured in several standard ratings. The receiver designer attempts to choose the capacitance and coefficient that will most nearly cancel the normal uncompensated drift in the circuit.

As an example of the ratings of negative-coefficient capacitors, one of the most popular coefficients is 750 parts-per-million per degree centigrade, designated as "N750." This means that this capacitor changes capacitance by 750 millionths of its value for each change of one degree centigrade in its temperature. The "N" stands for negative, indicating that the capacitance changes in a direction opposite to that of temperature change. In other words, if the temperature rises the capacitance goes down, and if the temperature falls the capacitance rises.

It is important that the technician be familiar with such data because, if a temperature-compensating capacitor is to be replaced, the replacement must be correct. Otherwise, bad oscillator drift may result.

### A. F. C. Circuits

Another device that helps combat tendencies toward oscillator drift is the automatic frequency control (a.f.c.) circuit. This circuit probably came into use mainly to aid in providing less critical tuning to the receiver owner. However, in so doing, it overcomes the effects of oscillator drift within limits.

The basic principle of a.f.c. is illustrated in the block diagram of Fig. 2. The FM detector develops a d.c. control voltage. This voltage is normally zero when the front end is correctly tuned, but becomes plus or minus when the front end is off tune one way or the other. The control voltage is applied to the "a.f.c. tube," which has the more general name of "reactance tube." The reactance tube converts the variations of d.c. control voltage into variations of *reactance* across the oscillator tuned circuit.

The reactance thus applied to the oscillator becomes part of its tuned circuit, and helps to determine the resonant frequency. If, through temperature drift or line voltage variation, the oscillator should shift frequency so the receiver is out of tune, the detector control voltage changes the reactance exhibited by the reactance tube. This, in turn, changes the resonant frequency of the oscillator in such a way that this frequency shifts back toward what it should be for proper receiver tuning.

A basic reactance-tube is shown in Fig. 3. This circuit simulates and applies capacitance to the oscillator at terminals A and B. When an a.c. volt-

age is applied to a capacitor, the ensuing current *leads* the voltage by 90 degrees; this is a basic characteristic of a capacitor. The reactance-tube circuit does the same thing: when an a.c. voltage (such as an oscillator signal) is applied to terminals A and B, the resulting current leads the voltage 90 degrees. The oscillator tuned circuit, to which these terminals are connected, cannot tell the difference between the reactance-tube circuit and a capacitor. It thus reacts in the same way as though a real capacitance were present across A and B.

Now let's look into how the reactance tube sets up this voltage-current relationship:

1. The a.c. voltage from the oscillator is applied to points A and B, and thus also to C and R in series (Fig. 3).

2. The capacitance of C is deliberately made small enough so that its reactance in the circuit will be much higher than the resistance of R. Thus the series circuit composed of these two elements, consisting of a large reactance and a negligible resistance, is almost entirely capacitive. Therefore the alternating current that flows through this combination *leads* the voltage applied to it (at terminals A and B) by almost 90 degrees.

3. The voltage across a resistor is in phase with the current passing through it. Thus the *leading* alternating current applied to the resistor develops an in-phase voltage across this component. Furthermore, this new, developed voltage must then lead by 90 degrees the original a.c. voltage applied through terminals A and B.

4. Since R happens to be the grid resistor of the tube, we may now say that the a.c. voltage applied to the grid (voltage across R) leads the a.c. voltage at the plate (applied by the oscillator).

5. The plate *current* of a tube is directly controlled by and in phase with

(Continued on page 116)

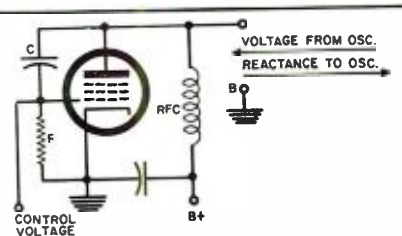
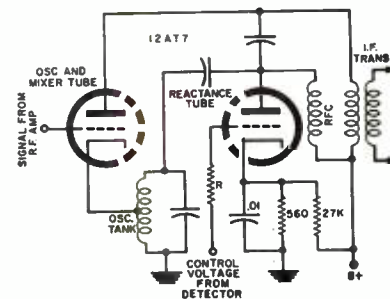

Fig. 3. Basic reactance-tube circuit.

Fig. 4. A typical a.f.c. and oscillator circuit, using a twin triode.



# VACUUM TUBE VOLTMETER

## WITH NEW 6" FULL-VIEW METER



**Model 77—VACUUM TUBE VOLTMETER . . . Total Price \$42.50—Terms: \$12.50 after 10 day trial, then \$6.00 monthly for 5 months if satisfactory. Otherwise return, no explanation necessary!**

- Compare it to any peak-to-peak V. T. V. M. made by any other manufacturer at any price!
- ✓ Model 77 completely wired and calibrated with accessories (including probe, test leads and portable carrying case) sells for only \$42.50.
  - ✓ Model 77 employs a sensitive six inch meter. Extra large meter scale enables us to print all calibrations in large easy-to-read type.
  - ✓ Model 77 uses new improved -SICO printed circuitry.
  - ✓ Model 77 employs a 12AU7 as D.C. amplifier and two 9006's as peak-to-peak voltage rectifiers to assure maximum stability.
  - ✓ Model 77 uses a selenium-rectified power supply resulting in less heat and thus reducing possibility of damage or value changes of delicate components.
  - ✓ Model 77 meter is virtually burn-out proof. The sensitive 400 microampere meter is isolated from the measuring circuit by a balanced push-pull amplifier.
  - ✓ Model 77 uses selected 1% zero temperature coefficient resistors as multipliers. This assures unchanging accurate readings on all ranges.

**AS A DC VOLTMETER:** The Model 77 is indispensable in Hi-F<sup>1</sup> Amplifier servicing and a must for Black and White and color TV Receiver servicing where circuit loading cannot be tolerated.

**AS AN AC VOLTMETER:** Measures RMS values if sine wave, and peak-to-peak value if complex wave. Pedestal voltages that determine the "black" level in TV receivers are easily read.

**AS AN ELECTRONIC OHMMETER:** Because of its wide range of measurement leaky capacitors show up glaringly. Because of its sensitivity and low loading, intermittents are easily found, isolated and repaired.

Model 77 comes complete with operating instructions, probe and test leads. Use it on the bench—use it on calls. A streamlined carrying case, included at no extra charge, accommodates the tester, instruction book, probe and leads. Operates on 110-120 volt 60 cycle. Only . . . . .

**SPECIFICATIONS**

• DC VOLTS — 0 to 3/15/75/150/300/750/1,500 volts at 11 megohms input resistance. • AC VOLTS (RMS) — 0 to 3/15/75/150/300/750/1,500 volts. • AC VOLTS (Peak to Peak) — 0 to 8/40/200/400/800/2,000 volts. • ELECTRONIC OHMMETER — 0 to 1,000 ohms/10,000 ohms/100,000 ohms/1 megohm/10 megohms/100 megohms/1,000 megohms. • DECIBELS — 10 db to + 18 db, + 10 db to + 38 db, + 30 db to + 58 db. All based on 0 db = .006 watts (6 mW) into a 500 ohm line (1.73v). • ZERO CENTER METER — For discriminator alignment with full scale range of 0 to 1.5/7.5/37.5/75/150/375/750 volts at 11 megohms input resistance.

**\$ 42<sup>50</sup> NET**

# 20,000 OHMS PER VOLT ALLMETER

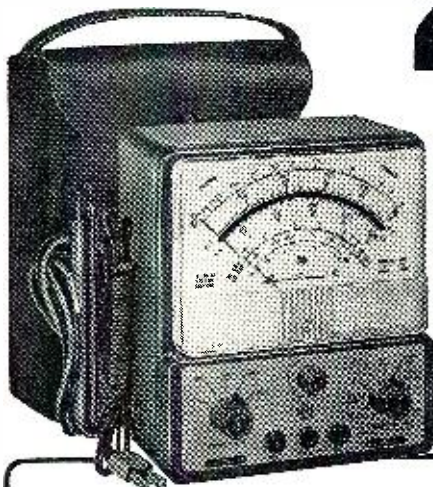

**Model 80 — ALLMETER . . . Total Price \$42.50—Terms: \$12.50 after 10 day trial, then \$6.00 monthly for 5 months if satisfactory. Otherwise return, no explanation necessary!**

**THE ONLY 20,000 OHMS PER VOLT V.O.M. SELLING FOR LESS THAN \$50 WHICH PROVIDES ALL THE FOLLOWING FEATURES:**

- ✓ **6 INCH FULL-VIEW METER** provides large easy-to-read calibrations. No squinting or guessing when you use Model 80.
- ✓ **MIRRORED SCALE** permits fine accurate measurements where fractional readings are important.
- ✓ **CAPACITY RANGES** permit you to accurately measure all condensers from .00025 MFD to 30 MFD in addition to the standard volt, current, resistance and decibel ranges.
- ✓ **HANDSOME SADDLE-STITCHED CARRYING CASE** included with Model 80 Allmeter at no extra charge enables you to use this fine instrument on outside calls as well as on the bench in your shop.

**SPECIFICATIONS:**

- 7 D.C. VOLTAGE RANGES (At a sensitivity of 20,000 Ohms per Volt) 0 to 15/75/150/300/750/1500/7500 Volts.
- 6 A.C. VOLTAGE RANGES: (At a sensitivity of 5,000 Ohms per Volt) 0 to 15/75/150/300/750/1500 Volts.
- 3 RESISTANCE RANGES: 0 to 2,000/20,000 Ohms. 0-20 Megohms.
- 2 CAPACITY RANGES: .00025 Mfd. to .3 Mfd., .05 Mfd. to 30 Mfd.
- 5 D.C. CURRENT RANGES 0-75 Microamperes, 0 to 7.5/75/750 Milliamperes, 0 to 15 Amperes.
- 3 DECIBEL RANGES: -6 db to + 18 db, + 14 db to + 38 db + 34 db to + 58 db

**FEATURES:**

- A built-in Isolation Transformer automatically isolates the Model 80 from the power line when capacity service is in use.
- Selected, 1% zero temperature coefficient metalized resistors are used as multipliers to assure unchanging accurate readings on all ranges.

Model 80 Allmeter comes complete with operating instructions, test leads and portable carrying case. Only . . . . .

**\$ 42<sup>50</sup>**

**NOTE:** The line cord is used only for capacity measurements. Resistance ranges operate on self-contained batteries.

**SHIPPED ON APPROVAL  
NO MONEY WITH ORDER—NO C.O.D.**

Try for 10 days before you buy! If completely satisfied, send down payment after trial and pay balance at indicated monthly rate — NO INTEREST OR FINANCE CHARGES ADDED. If not completely satisfied, return to us, no explanation necessary.

**See page 115 for complete details**

**MOSS ELECTRONIC, INC.**

**3849 TENTH AVE., NEW YORK 34, N. Y.**



For the first time ever: **ONE TESTER PROVIDES ALL THE SERVICES LISTED BELOW!**

**SUPERIOR'S NEW  
MODEL 76**

# A PURPOSE BRIDGE



Model 76 Bridge...Total Price \$26.95—Terms: \$6.95 after 10 day trial, then \$5.00 monthly for 4 months if satisfactory. Otherwise return, no explanation necessary!

**IT'S A  
CONDENSER BRIDGE**

with a range of .00001 Microfarad to 1000 Microfarads (Measures power factor and leakage too.)

**IT'S A  
SIGNAL TRACER**

which will enable you to trace the signal from antenna to speaker of all receivers and to finally pinpoint the exact cause of trouble whether it be a part or circuit defect.

**IT'S A  
RESISTANCE BRIDGE**

with a range of 100 ohms to 5 megohms

**IT'S A  
TV ANTENNA TESTER**

The TV Antenna Tester section is used first to determine if a "break" exists in the TV antenna and if a break does exist the specific point (in feet from set) where it is.

**SPECIFICATIONS:**

**CAPACITY BRIDGE SECTION**

4 Ranges: .00001 Microfarad to 1000 Microfarads. Will also locate shorts, and leakages up to 20 megohms. Measures the power factor of all condensers from .1 to 1000 Microfarads. (Power factor is the ability of a condenser to retain a charge and thereby filter efficiently.)

**SIGNAL TRACER SECTION**

With the use of the R.F. and A.F. Probes included with the Model 76, you can make stage gain measurements, locate signal loss in R.F. and Audio stages, localize faulty stages, locate distortion and hum, etc. Provision has been made for use of phones and meter if desired.

**RESISTANCE BRIDGE SECTION**

2 Ranges: 100 ohms to 5 megohms. Resistance can be measured without disconnecting capacitor connected across it. (Except, of course, when the R C combination is part of an R C bank.)

**TV ANTENNA TESTER SECTION**

Loss of sync., snow and instability are only a few of the faults which may be due to a break in the antenna, so why not check the TV antenna first? 2 Ranges: 2' to 200' for 72 ohm coax and 2' to 250' for 300 ohm ribbon.

Model 76 comes complete with all accessories including R.F. and A.F. Probes; Test Leads and operating instructions. Nothing else to buy. Only

**\$26<sup>95</sup>  
NET**

**SUPERIOR'S NEW MODEL TV-50A**



Model TV-50A GENOMETER... Total Price \$47.50—Terms: \$11.50 after 10 day trial, then \$6.00 monthly for 6 months if satisfactory. Otherwise return, no explanation necessary!

# GENOMETER

## 7 Signal Generators in One!

- ✓ R.F. Signal Generator for A.M.
- ✓ Bar Generator
- ✓ R.F. Signal Generator for F.M.
- ✓ Cross Hatch Generator
- ✓ Audio Frequency Generator
- ✓ Color Dot Pattern Generator
- ✓ Marker Generator

A versatile all-inclusive GENERATOR which provides ALL the outputs for servicing:  
**A.M. Radio • F.M. Radio • Amplifiers • Black and White TV • Color TV**

*Specifications*

**R. F. SIGNAL GENERATOR:** The Model TV-50A Genometer provides complete coverage for A.M. and F.M. alignment. Generates Radio Frequencies from 100 Kilocycles to 60 Megacycles on fundamentals and from 60 Megacycles to 180 Megacycles on powerful harmonics.

**VARIABLE AUDIO FREQUENCY GENERATOR:** In addition to a fixed 400 cycle sine-wave audio, the Model TV-50A Genometer provides a variable 300 cycle to 20,000 cycle peaked wave audio signal.

**BAR GENERATOR:** The Model TV-50A projects an actual Bar Pattern on any TV Receiver Screen. Pattern will consist of 4 to 16 horizontal bars or 7 to 20 vertical bars.

**THE MODEL TV-50A comes absolutely complete with shielded leads and operating instructions.**

**CROSS HATCH GENERATOR:** The Model TV-50A Genometer will project a cross-hatch pattern on any TV picture tube. The pattern will consist of non-shifting, horizontal and vertical lines interlaced to provide a stable cross-hatch effect.

**DOT PATTERN GENERATOR (FOR COLOR TV)** Although you will be able to use most of your regular standard equipment for servicing Color TV, the one addition which is a "must" is a Dot Pattern Generator. The Dot Pattern projected on any color TV Receiver tube by the Model TV-50A will enable you to adjust for proper color convergence.

**MARKER GENERATOR:** The Model TV-50A includes all the most frequently needed marker points. The following markers are provided: 189 Kc., 262.5 Kc., 456 Kc., 600 Kc., 1000 Kc., 1400 Kc., 1600 Kc., 2000 Kc., 2500 Kc., 3579 Kc., 4.5 Mc., 5 Mc., 10.7 Mc., (3579 Kc. is the color burst frequency)

**\$47<sup>50</sup>  
NET**

**SHIPPED ON APPROVAL  
NO MONEY WITH ORDER—NO C.O.D.**

Try for 10 days before you buy! If completely satisfied, send down payment after trial and pay balance at indicated monthly rate — **NO INTEREST OR FINANCE CHARGES ADDED.** If not completely satisfied, return to us, no explanation necessary.

See page 115 for complete details

**MOSS ELECTRONIC, INC.**

**3849 TENTH AVE., NEW YORK 34, N. Y.**

SUPERIOR'S NEW MODEL TW-11

# STANDARD PROFESSIONAL

# UBE ESTER



- ★ Tests all tubes, including 4, 5, 6, 7, Octal, Lock-in, Hearing Aid, Thyatron, Miniatures, Sub-miniatures, Novals, Sub-minars, Proximity fuse types, etc.
- ★ Uses the new self-cleaning Lever Action Switches for individual element testing. Because all elements are numbered according to pin-number in the RMA base numbering system, the user can instantly identify which element is under test. Tubes having tapped filaments and tubes with filaments terminating in more than one pin are truly tested with the Model TW-11 as any of the pins may be placed in the neutral position when necessary.
- ★ The Model TW-11 does not use any combination type sockets. Instead individual sockets are used for each type of tube. Thus it is impossible to damage a tube by inserting it in the wrong socket.
- ★ Free-moving built-in roll chart provides complete data for all tubes. All tube listings printed in large easy-to-read type.
- ★ NOISE TEST: Phono-jack on front panel for plugging in either phones or external amplifier will detect microphonic tubes or noise due to faulty elements and loose internal connections.

**Model TW-11—TUBE TESTER . . . Total Price \$47.50**—Terms: \$11.50 after 10 day trial, then \$6.00 per month for 6 months if satisfactory. Otherwise return, no explanation necessary!

### EXTRAORDINARY FEATURE

SEPARATE SCALE FOR LOW-CURRENT TUBES. Previously, on emission-type tube testers, it has been standard practice to use one scale for all tubes. As a result, the calibration for low-current types has been restricted to a small portion of the scale. The extra scale used here greatly simplifies testing of low-current types.

The Model TW-11 operates on 105-130 Volt 60 Cycles A.C. Comes housed in a beautiful hand-rubbed oak cabinet complete with portable cover.

**\$47<sup>50</sup>**  
**NET**

SUPERIOR'S

NEW MODEL 83

# C.R.T. TESTER

## Tests and Rejuvenates ALL PICTURE TUBES

### ALL BLACK AND WHITE TUBES

From 50 degree to 110 degree types—from 8" to 30" types.

### ALL COLOR TUBES



**Model 83—C.R.T. TUBE TESTER . . . Total Price \$38.50**—Terms: \$8.50 after 10 day trial, then \$6.00 monthly for 5 months if satisfactory. Otherwise return, no explanation necessary!

Model 83 comes housed in handsome portable Saddle Stitched Texon case—complete with sockets for all black and white tubes and all color tubes. Only .....

**\$38<sup>50</sup>**

Test ALL picture tubes—in the carton—out of the carton—in the set!

- ✓ Model 83 is not simply a rehashed black and white C.R.T. Tester with a color adapter added. Model 83 employs a new improved circuit designed specifically to test the older type black and white tubes, the newer type black and white tubes and all color picture tubes.
- ✓ Model 83 provides separate filament operating voltages for the older 6.3 types and the newer 8.4 types.
- ✓ Model 83 employs a 4" air-damped meter with quality and calibrated scales.
- ✓ Model 83 properly tests the red, green and blue sections of color tubes individually—for each section of a color tube contains its own filament, plate, grid and cathode.
- ✓ Model 83 will detect tubes which are apparently good but require rejuvenation. Such tubes will provide a picture seemingly good but lacking in proper definition, contrast and focus. To test for such malfunction, you simply press the rej. switch of Model 83. If the tube is weakening, the meter reading will indicate the condition.

Rejuvenation of picture tubes is not simply a matter of applying a high voltage to the filament. Such voltages improperly applied can strip the cathode of the oxide coating essential for proper emission. The Model 83 applies a selective low voltage uniformly to assure increased life with no danger of cathode damage.

## SHIPPED ON APPROVAL

### NO MONEY WITH ORDER—NO C.O.D.

Try for 10 days before you buy! If completely satisfied, send down payment after trial and pay balance at indicated monthly rate — **NO INTEREST OR FINANCE CHARGES ADDED.** If not completely satisfied, return to us, no explanation necessary.

See following page for complete details

MOSS ELECTRONIC, INC.

3849 TENTH AVE., NEW YORK 34, N. Y.

SUPERIOR'S NEW MODEL 82A

Multi-Socket Type

# TUBE TESTER

**TEST ANY TUBE IN  
10 SECONDS FLAT.**

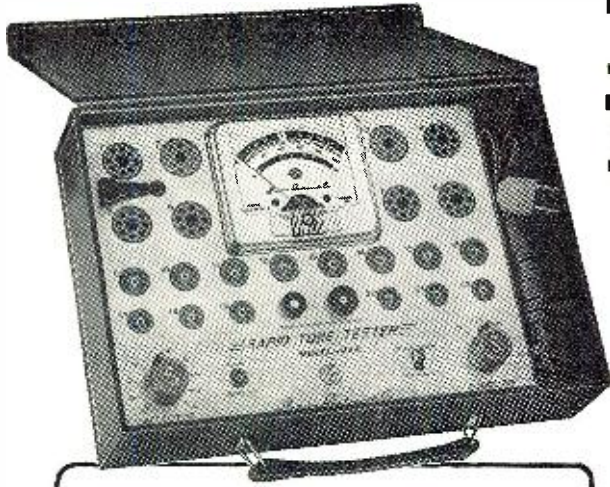

- ① Turn the filament selector switch to position specified.
- ② Insert tube into a numbered socket as designated on our chart (over 600 types included).
- ③ Press down the quality button —

**THAT'S ALL!**

Read emission quality direct on "BAD-GOOD" meter scale.

*Specifications*

- Tests over 600 tube types
- Tests OZ4 and other gas-filled tubes
- Employs new 4" meter with sealed air-damping chamber resulting in accurate vibrationless readings
- Use of 22 sockets permits testing all popular tube types and prevents possible obsolescence
- Dual Scale meter permits testing of low current tubes
- 7 and 9 pin straighteners mounted on panel
- All sections of multi-element tubes tested simultaneously
- Ultra-sensitive leakage test circuit will indicate leakage up to 5 megohms

Model 82A comes housed in handsome, portable Saddle-Stitched Texon case. **\$36<sup>50</sup> NET**  
Only.....

**Model 82A — TUBE TESTER . . . Total Price \$36.50 — Terms: \$6.50 after 10 day trial, then \$6.00 monthly for 5 months if satisfactory. Otherwise return, no explanation necessary.**

Production of this Model was delayed a full year pending careful study by Superior's engineering staff of this new method of testing tubes. Don't let the low price mislead you! We claim Model 82A will outperform similar looking units which sell for much more — and as proof, we offer to ship it on our examine before you buy policy.

To test any tube, you simply insert it into a numbered socket as designated, turn the filament switch and press down the quality switch — THAT'S ALL! Read quality on meter. Inter-element leakage if any indicates automatically.

## **SHIPPED ON APPROVAL NO MONEY WITH ORDER — NO C. O. D.**

<p><b>MOSS ELECTRONIC, INC.</b> Dept. D-589 3849 Tenth Ave., New York 34, N. Y.</p> <p>Please send me the units checked on approval. If completely satisfied I will pay on the terms specified with no interest or finance charges added. Otherwise, I will return after a 10 day trial positively cancelling all further obligation.</p> <p>Name .....</p> <p>Address .....</p> <p>City ..... Zone..... State.....</p> <p style="text-align: center;"><small>All prices net. F.O.B., N. Y. C.</small></p>	<ul style="list-style-type: none"> <li><input type="checkbox"/> Model 77 ..... Total Price \$42.50 \$12.50 within 10 days. Balance \$6.00 monthly for 5 months.</li> <li><input type="checkbox"/> Model 80 ..... Total Price \$42.50 \$12.50 within 10 days. Balance \$6.00 monthly for 5 months.</li> <li><input type="checkbox"/> Model 76 ..... Total Price \$26.95 \$6.95 within 10 days. Balance \$5.00 monthly for 4 months.</li> <li><input type="checkbox"/> Model TV-50A ..... Total Price \$47.50 \$11.50 within 10 days. Balance \$6.00 monthly for 6 months.</li> <li><input type="checkbox"/> Model TW-11 ..... Total Price \$47.50 \$11.50 within 10 days. Balance \$6.00 monthly for 6 months.</li> <li><input type="checkbox"/> Model 83 ..... Total Price \$38.50 \$8.50 within 10 days. Balance \$6.00 monthly for 5 months.</li> <li><input type="checkbox"/> Model 82A ..... Total Price \$36.50 \$6.50 within 10 days. Balance \$6.00 monthly for 5 months.</li> </ul>
--	---

Operate your...

- tape recorder
- P. A. system
- portable TV set
- hand tools

FROM YOUR CAR, Boat or Plane!

with



## INVERTERS

FOR CHANGING YOUR STORAGE BATTERY CURRENT TO

A.C. HOUSEHOLD ELECTRICITY ANYWHERE... in your own CAR, Boat or Plane!

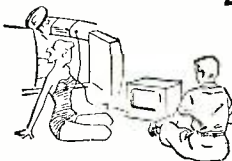

OPERATES PORTABLE TV SET directly from your car!

### OPERATES

- TAPE RECORDERS
- DICTATING MACHINES
- PUBLIC ADDRESS SYSTEMS
- ELECTRIC SHAVERS



MAKE YOUR CAR, BOAT OR PLANE "A ROLLING OFFICE!"



### OPERATES

- RADIOS
- RECORD PLAYERS
- MIXMASTERS, ETC.

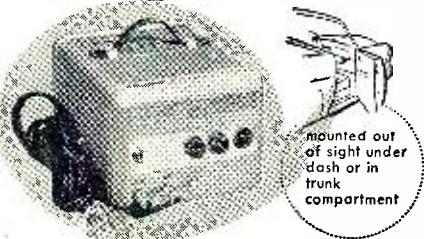

## ATR UNIVERSAL INVERTERS

Especially designed to change 6 or 12 volt D.C. to 110 volt A.C. 60 cycles.

for...

- EXECUTIVES
- SALESMEN
- OUTDOOR MEN
- POLICEMEN
- REPORTERS
- FIREMEN

• PUBLIC OFFICIALS

MODELS 6U-RHG (6 volts) 125 to 150 watts. Shipping weight 27 lbs. List price... \$89.95

DEALER NET PRICE... \$59.97

12U-RHG (12 volts) 150 to 175 watts. Shipping weight 27 lbs. List price... \$89.95

DEALER NET PRICE... \$59.97

Write for literature on other Sizes and Models of ATR INVERTERS, priced as low as \$9.95 list.

SEE YOUR JOBBER OR WRITE FACTORY

- ✓ NEW MODELS
- ✓ NEW DESIGNS
- ✓ NEW LITERATURE

- "A" Battery Eliminators
- DC-AC Inverters
- Auto Radio Vibrators



AMERICAN TELEVISION & RADIO CO.

Quality Products Since 1931

SAINT PAUL 1, MINNESOTA, U. S. A.

## Drift & A.F.C. in FM

(Continued from page 111)

the signal voltage applied at the grid. Thus the alternating current at the plate of the reactance tube that results from the a.c. voltage at the grid also leads the a.c. voltage at the plate by 90 degrees.

6. With current leading voltage, the circuit has the properties of a capacitor. Since the output of the reactance tube (plate to ground) is connected across the oscillator's resonant circuit through terminals A and B, the reactance tube simulates a capacitor added to the oscillator tank to help in tuning it.

It is worth mentioning that some reactance-tube circuits are designed to act as inductors. However, the capacitive type described here is the more usual case. Also, while we have established the nature of the circuit as capacitive, we have said nothing about the amount of capacitance that is simulated.

In order to readjust oscillator frequency as needed, we must be able to vary the amount of simulated capacitance used for retuning. At this point, we may consider the role of the control voltage also applied to the grid of the reactance tube in Fig. 3. The more positive this d.c. voltage becomes, the greater will be the plate current. Since more current will flow through a larger capacitor (less capacitive reactance) than through a smaller one, a relatively positive control voltage will increase the simulated capacitance applied to the oscillator tank. This will lower oscillator frequency.

Obviously, the circuit must be so wired that, when local-oscillator frequency drifts too high, the corresponding d.c. imbalance in the detector's output must be applied in the positive direction as a control voltage. Conversely, if the oscillator goes lower in frequency, control voltage from the detector becomes more negative. This reduces the reactance tube's plate current, decreasing the simulated output capacitance (increasing reactance), and oscillator frequency is tuned back up to where it should be.

In many modern FM tuner circuits, a triode is used as the reactance tube. This makes it convenient to use one section of a dual triode for this purpose while the other section is used for another function, usually that of oscillator.

One typical modern circuit is shown in Fig. 4. A dual triode (12AT7) is used for the oscillator, mixer, and a.f.c. (reactance) tube. No external capacitor is shown for the function of C (in Fig. 3). It happens that the triode's grid-to-plate capacitance is large enough to assume this role. Notice that quite a bit of positive voltage is applied to the cathode of the reactance tube through a 27,000-ohm resistor. This biasing prevents loading of the oscillator circuit from becoming excessive.

# RADIO Handbook

- AC & DC Circuits
- VT Principles
- Transistors & Semi-Conductors
- VT Amplifiers
- High Fidelity
- RF VT Amplifier
- Oscilloscope
- Radiation, Propagation & Transmission Lines
- Antennas
- HF Amplifiers

Fifteenth Edition  
800 PAGES

- Receivers
- Low Power Transmitters & Exciters
- HF Power Amplifiers
- Speech & AM Equipment
- Transmitter Construction
- Power Supplies
- Workshop Practice
- Electronic Test Equipment
- Radio Mathematics & Calculations
- Generation
- RF Feedback
- Amplitude Modulation
- FM & Radio Teletype
- Transmission Sideband
- Transmission
- Transmitter Design
- TV & BC Interference
- Transmitter Keying

\$750 BUY FROM YOUR FAVORITE DISTRIBUTOR

### TEST EQUIPMENT

Frequency meter, BC 221, or LM, with Orig. Cal. book.....	\$69.00
Frequency meter, TS-173/UR with Orig. Cal. book.....	169.00
LM Freq. meter power supplies for 110 V. A.C.....	14.00
V.T.V.M. Hickok 202B-S44.....	15.00
RCA Rider Chanalyzer, makes many tests.....	49.00
Navy 131 Sig. Generator 100 KC to 90 M.C. & Mod. Cont.....	17.00
Eico Sig. Generator 150 K.C. to 102 M.C.....	18.00
Signal Tracer, Eico model 145.....	19.00
F.M. Signal Generator, Federal 104A, 25 to 50 M.C. & 148 to 174 M.C. 6V DC and 115V A.C. power—new.....	65.00

### SCOPES

Dumont 168, 5-inch.....	\$49.00	Eico 425, 5-inch.....	\$39.00
RCA 160B 5-inch.....	49.00	Navy RCA 3-inch.....	35.00
Dumont 208 5-inch.....	69.00	Dumont 224 3-inch.....	69.00
Dumont 304 H 5-inch.....	150.00	Western Electric 80 A.....	79.00

### RECEIVERS

Super Pro. 779, with 110 V. A.C. supply.....	\$95.00
RBM 2-20 M.C. with 110 V. A.C. supply.....	65.00
RBM 200 KC—2 M.C. with 110 V. A.C. supply.....	50.00
Gonsel Superceiver and Super Sig. H.Q. 129.....	\$135.00
HRO Senior S-27 or 36, AM-FM.....	95.00
SX 71, 110V A.C.....	69.00
BC 342, 110V A.C.....	95.00

### XMITTERS

Johnson Viking I.....	\$135.00	Gonsel 6 Mtr. Comm.....	\$139.00
Johnson Ranger.....	185.00	Eldico 2 Mtr. 115V Sup.....	49.00
Gonsel Comm. 111 2 Mtr.....	219.00	Gonsel Commander II.....	75.00
Eldico TR-75-TV.....	29.00	1.75-54 M.C. 60 W.....	75.00

All the above Xmitters, Receivers and test equipment in good working order.

### TRANSFORMERS & CHOKES

3750-0-3750-250 Ma.....	\$19.00	10 Hy. 250 MA.....	\$2.50
500 V.—200 Ma.....	3.95	10 Hy. 300 Ma.....	2.95
15 V. CT, 30 Amp.....	7.50	25 Hy. 100 Ma.....	2.00
5 V. 10 Amp.....	2.75	15 Hy. 100 Ma.....	2.00
2.5 V. 10 Amp. 10 KV.....	2.95	Dual 9 Hy. 100 Ma.....	2.50
32 V. 2 Amp.....	6.50	and 10 Hy. 75 Ma.....	2.50
2600 V. 2800 V., 3000 V., 300 Ma.....	14.95		
3750 V. CT or 3100 V. CT, 550 Ma.....	15.00		
850 V. CT 140 Ma., 5 V., 3 Amp., 6 V., 5 Amp.....	3.95		
File Tapped at 9, 10, 11, 12, 13 V., 5 Amp.....	3.50		
Sola Constant Voltage 115 V., 3 KVA.....	150.00		
1 KVA \$95.00; 500 W—\$35.00			

### MISCELLANEOUS

Teletype, page Printer, Mod. 26.....	\$75.00	Model 15.....	\$145.00
T.V. Camera CFN-59 A&E.....	75.00		
T.V. Transmitter for above.....	25.00		
B.C. 375 with 5 T.U.'s—new.....	49.00		
A.T.D. 2-16 Mc. phone & C.W.....	50.00		
G.F. 11, with 3 coil sets.....	12.00		
B.C. 610 with speech Amp.....	250.00		

### WE BUY—TRADE—SELL

WANTED—Commercial Receivers, Xmitters, Test Equip. REPAIR SERVICE—We repair and calibrate the above. Enclose sufficient postage. (Excess returned.) 25% with COD orders. FOB Hempstead.

### ALGERADIO ELECTRONICS CO.

236 No. Franklin St. Ph. IV. 9-8088 Hempstead, N. Y.

# New Picture Tube Has Built-on Safety Glass

*Squarer Sylvania CRT also larger than current types.*

TV RECEIVER manufacturers are now reviewing samples of a new 23-inch picture tube by *Sylvania Electric Products Inc.* The tube manufacturer reports several features for this latest CRT that may make it more desirable than those now in use.

To the technician, the most noteworthy feature of this 110-degree tube may be the fact that the panel of safety glass, normally installed as a separate item on the cabinet directly in front of the CRT, is an integral part of the "bonded-shield" design, being affixed to the faceplate. Since a separate glass will not be necessary, elimination of the dead space normally allowed between tube and safety glass will enable manufacturers to make their cabinets even shallower than has become possible in recent years.

With this innovation, the problem of removing the safety glass (or the greater annoyance of taking the chassis entirely out of the cabinet, as is often necessary) to clean away the films of dust electrostatically picked up on the rear of the safety glass and the CRT faceplate, is eliminated. In fact the set owner can now handle the job himself, if he wishes. Also benefiting the set owner is the reduction in glass surfaces present. This cuts down undesirable reflections from sidelights, resulting in clearer pictures with increased light output.

With models available using the new "tripotential focus" electron gun, which also cuts down CRT neck length, cabinet depth can be brought to a new minimum. Picture area, on the other hand, is increased. Although image size remains the same as for conventional models, the new tube has been squared off somewhat more (see photo), recovering about 20 square inches of picture area normally lost in the corners. This change also increases the diagonal measurement of the tube. For example, the equivalent of popular 21-inch tubes is now 23 inches. Also, the relatively flatter faceplate permits a wider viewing angle with less distortion than on current tubes.

Set manufacturers are also getting 18-inch versions of the "bonded-shield" tubes, equivalent to conventional 17-inch rectangular ones.

New 23" (right) and old 21" CRT.

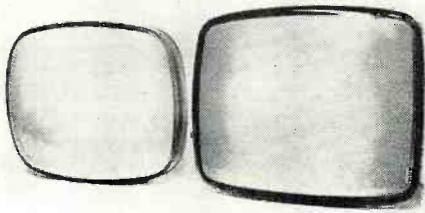

RADIO • TELEVISION • INDUSTRIAL ELECTRONICS

# THIS professional TRAINING IS THE KIND THAT Really Pays Off!

... and it costs only a fraction of what you might expect to pay!

**FIX ANY RADIO OR TV SET EVER MADE...easier...better...faster**

Backed by the how-to-do-it methods so clearly explained in this one big 822-page book, you'll be prepared for fast, accurate service on any radio or television receiver ever made.

Radio & Television TROUBLESHOOTING AND REPAIR by Ghirardi & Johnson is far and away the world's most modern, easily understood guide. Step by step, it takes you through each service procedure... from locating troubles with less testing to repairing them promptly by fully-approved professional methods... the kind that enable you to handle tough jobs as slick as you now do the easy ones.

Best of all, the cost is only \$7.50 (or see money-saving combination offer in coupon).

### COMPLETE SERVICE TRAINING

For beginners, this giant book is a complete training course. For

experienced servicemen it is the ideal way to develop better methods and to find fast answers to tough jobs.

Here are just a few of the subjects covered: Components and Their Troubles; Basic Troubleshooting Methods; "Static" and "Dynamic" Testing; Practical Troubleshooting Tips and Ideas; AC/DC, 3-way Portable and Battery Set Troubleshooting Problems; Servicing Communications Receivers; a Complete Guide to Television Service; AM, FM, and TV Realignment Made Easy; Resistor, Capacitor, Inductor and Transformer Problems; Servicing Tuning, Selector and Switching Mechanisms; Loudspeakers; Servicing Recorders and Record-playing Equipment... and dozens more! 417 illustrations. Read TROUBLESHOOTING AND REPAIR for 10 days AT OUR RISK!

**LEARN BASIC CIRCUITS FULLY...and watch service "headaches" disappear**

It's amazing how much easier and faster you can repair radios, television sets and even industrial electronic equipment when you know all about circuits and what makes each one "tick."

You locate troubles in a jiffy because you know what to look for and where to look.

You make repairs lots faster, better and more profitably!

Actually, there are only a comparatively few BASIC circuits in modern equipment. Radio & Television RECEIVER CIRCUITRY AND OPERATION by Ghirardi & Johnson gives you a complete understanding of these as well as their variations. It teaches you to recognize them... to under-

stand their peculiarities and likely "troublespots"... and shows how to eliminate useless testing and guesswork in making repairs.

### A COMPLETE GUIDE TO RADIO-TV CIRCUITS

Throughout, this 669-page book with its 417 clear illustrations gives you the kind of above-average professional training that fits you for the better, big pay jobs in either servicing or general electronics.

Covers all circuits in modern TV and radio receivers, amplifiers, phono-pickups, record players, etc.

Price only \$6.75... or see money-saving offer in coupon. Examine it 10 days at our risk!

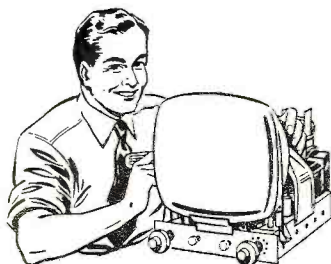

These books explain SERVICE PROCEDURES

so you can really understand them!

Almost 1300 pages and over 800 pictures and diagrams in these two new books explain things so clearly it's next to impossible for you to go wrong.

## FREE EXAMINATION...easy terms

Dept. RN-49, RINEHART & CO., INC.  
232 Madison Ave., New York 16, N. Y.

Send books indicated for FREE EXAMINATION. In 10 days, I will either remit price indicated plus postage or return books postpaid and owe you nothing.

Radio & TV TROUBLESHOOTING AND REPAIR (Price \$7.50)       Radio & TV CIRCUITRY AND OPERATION (Price \$6.75)

COMBINATION OFFER... Both books only \$13.00 (Regular price separately \$14.25... you save \$1.25)

(Combination offer is payable at rate of \$4 (plus postage) after 10 days if you decide to keep books, and \$3 a month thereafter until \$13 has been paid.)

Name \_\_\_\_\_

Address \_\_\_\_\_

City, Zone, State \_\_\_\_\_

OUTSIDE U.S.A. ... \$8.00 for TROUBLESHOOTING & REPAIR; \$7.25 for CIRCUITRY & OPERATION; \$14.00 for both books. Cash with order, but money refunded if you return books in 10 days.



CLAUDIO ARRAU  
tapes his own  
recordings on



That alone is not  
the reason why  
you should use



Here's why  
you should use



It's the best-engineered tape in the world... gives you better highs... better lows... better sound all around! Saves your tape recorder, too—because the **irish FERRO-SHEEN** process results in smoother tape... tape that can't sand down your magnetic heads or shed oxide powder into your machine. Price? Same as ordinary tape!



Available wherever quality tape is sold.  
ORRadio Industries, Inc., Opelika, Alabama  
Export: Morhan Exporting Corp., New York, N. Y.  
Canada: Atlas Radio Corp., Ltd., Toronto, Ontario



## CERTIFIED RECORD REVUE

By  
**BERT WHYTE**

**T**HERE are many facts about stereo disc production which are not generally known to the public and from the writings of some critics, it would appear that they are in the same boat. While, admittedly, stereo discs can still be broadly categorized as "experimental," time and experience has revealed engineering data which has been widely applied throughout the recording industry.

Like most critics, I read the reviews and opinions of my worthy peers in the various media devoted to hi-fi and records. Lately I have seen a number of reviews in which a recording company is taken to task for "cutting into the middle of a movement at the end of the first side and continuing it on the flip side"; they ask why the material couldn't be encompassed on the first side; they complain that this or that recording should not require two discs, because they "just know the monophonic version only required one disc"; they ask plaintively why bass response and dynamics are restricted on a particular recording.

Well, friends, the plain fact of the matter is that too many people are still trying to apply monophonic standards and practices to stereo discs. It is perfectly true that many monophonic discs are cut with as much as 28-30 minutes of music per 12 inch side and with reasonably low distortion. There have been a number of LP's which managed to squeeze 33 to 35 minutes of music on one side. Desirable though this may be, it just cannot be done with stereo discs. At least not with the present design of stereo cutter-heads. For one reason we have the fact that the 90-degree included angle of the standard 45-45 stereo cut requires a somewhat wider groove than its monophonic counterpart. Then the complex motion and velocities of the vertical/lateral stereo cut imposes severe restrictions on bass response and dynamic range when an attempt is made to crowd this signal on a high lines-per-inch ratio, in order to extend the playing time of the record.

The hard cold reality of stereo disc cutting is that with the present state of the art it is not possible to obtain more than 25 minutes of music per side, without greatly diminishing the bass response, dynamic range, and overall volume levels. Believe me, even the accomplishment of 25 minutes is no mean feat and this is usually possible only through extensive modification of the stereo cutter and associated equipment.

It is easy to understand that music being what it is, the length of various works and movements or sections within those works varies tremendously, and many times it is not possible to "mold" or cut the music to fit the arbitrary confines of 25 minutes-per-side stereo discs. When an engineer is confronted with the absolute necessity of going a bit beyond the 25-minute barrier, he must decide

from a number of unhappy alternatives, what to do . . . if he feels that he must preserve his dynamic range and keep his over-all volume levels on a par with monophonic discs, then he must drastically cut his bass response. If he decides that he must maintain a good bass response, then he must reduce the dynamic range and the over-all volume levels.

With some companies who have neither the finances nor facilities (or engineering "know-how") to permit modification of their stereo cutting channels, these cutting problems exist even within the 25 minute limitation. I am not exaggerating at all, when I tell you that the extent of some of these alternatives is staggering. If I had a nickel for every stereo disc where the bass response was cut at 60, 80, and even 100 cycles, I would be driving a Ferrari! High frequencies often suffer too. Some of this is also design limitation, but since it is not easy to obtain a smooth high end, there is much deliberate cutting and you would be shocked to learn how many stereo discs haven't got a squeak past 8000 cycles! If the decision is made to try and maintain full bass response, then level and dynamics are anywhere from 6 to 12 db below the same signal on a monophonic disc.

It looks like a pretty bleak picture, doesn't it? But there are bright spots . . . other companies are venturing into stereo cutter-head design and experience with the present equipment is revealing possibilities for modifications that can cope with these problems. There are a few record companies who seem to have successfully met the challenges of stereo disc cutting and up to 25 minutes, and sometimes just a shade beyond this, their product has all the desirable sonic attributes of the best monophonic discs. That the tyranny of this time limitation must end is obvious. I can tell you that I've had a peek into several laboratories where much progress towards this goal is being made and perhaps by the first of next year some of this new equipment can be utilized. In the meantime, you will have to be very discriminating in your choice of stereo discs and also a little forgiving if the format of the recording doesn't follow the accepted norm.

Returning from a month and a half in Europe, I find a nice fat pile of discs, with many worthwhile items. So I'll try and squeeze in as many as space permits.

### MOUSSORGSKY MELODIES

**Boris Christoff, bass. Angel Mono 3575D/LX. Price \$19.98. Four discs,**

Probably only the most dedicated of Christoff and Moussorgsky fans will be willing to lay out twenty dollars for this magnum

The opinions expressed in this column are those of the reviewer and do not necessarily reflect the views or opinions of the editors or the publishers of this magazine.

album. For those in this category I can tell you that you'll get your money's worth. This is presumably a complete compendium of all the songs Moussorgsky wrote, and while there are some that do not do justice to his talent, for the most part they are a continuing source of amazement for the scope and inventiveness of his writing.

Most of the songs are accompanied by piano and a few by the Orchestre National de la Radiodiffusion Francaise under George Tzipine. Christoff is Christoff, a magnificent instrument whose superb vocalizing makes obvious his devotion to this music. The sound is generally very smooth and well balanced between piano/orchestra and voice. For aspiring bassi, a study of this would appear to be a must!

#### CHAUSSON

##### SYMPHONY IN B FLAT

Detroit Symphony Orchestra conducted by Paul Paray. Mercury Stereo SR-90017. Price \$4.98.

This disc has appeared previously on a Mercury stereo tape, so here is yet another opportunity to compare. It is evident by now that Mercury is reaching a high level of consistency in its stereo discs and they go a step further by coming as close to their taped versions as any company I have yet encountered.

This has superb fullness and a fine sense of depth. The percussion is as vigorous as it was on the tape, the brass in addition to being clean and bright, has considerable weight. The directionality and instrumental separation was excellent, and the instruments which are supposed to be in the center of the orchestra, were indeed there, *via* the fine "ghost channel" fill. The performance has long been considered definitive. With superb stereo at \$4.98, need I say more?

#### ROUSSEL

##### THE SPIDER'S FEAST CONCERTO FOR PIANO AND ORCHESTRA

Claude Helffer, pianist with Cento Soli Orchestra of Paris conducted by Rudolph Albert and Serge Baudo. Omega Stereo OS-15. Price \$5.95.

Omega is to be commended for eschewing "war horse" duplication and bringing us these two interesting works of Roussel. Roussel's music is a rather strange bird, owing little allegiance to classical romanticism nor, on the other hand, to the devices of modernism, and yet indefinably tinged with the color of both. At any rate it is highly listenable and enjoyable. Helffer seems to me a quite facile talent with good firm tone and a good sense of rhythm and he acquits himself most excellently. Both conductors handle their chores with good solid competence if not brilliance.

The "Cento Soli Orchestra" (orchestra of one hundred soloists) is evidently a "pick-up" recording orchestra, but in spite of the name (!) play quite well and with cohesion.

As far as I can tell, this was recorded on two-channel stereo and, as such, the job is well done. There is a good balance between detail and reverb, which results in good depth effects. Directionality was tastefully handled and despite the two channels the "hole-in-the-middle" was not objectionable.

Unhappily I must report that all this good work is for naught . . . the problem being background noise. It is quite high in hiss content and there seems to be an inordinate amount of that old bug-a-boo d.c. nodule noise. And I don't think I got a bum copy because in the unmodulated grooves beginning and ending the record, I could hear the noise begin and end over the quieter background of the vinyl surface. A shame, for the repertoire is most welcome and, in general, the sound is good. In all fairness, I would say that on

# *dynakit* FOR THE AUDIO PERFECTIONIST!

- Products which excel in design, in component quality, and in sound
- Superior for monophonic use and fully compatible with stereophonic requirements

## DYNAKIT MARK III



Mark III

Mark III also available with added 70 volt output.  
Mark III-70 \$84.95\* net

- ★ Ease of assembly due to uniquely simple circuitry and printed circuit construction with factory-mounted parts.
- ★ Highest stability suitable for all loudspeaker systems including electrostatic.
- ★ Dyna Biaset (patent pending) for simplified adjustment and complete freedom from effects of unbalanced components.
- ★ Dynaco Super-Fidelity output transformer. This is the finest available transformer of its type for the most critical audio uses.

★ 60 watts \$79.95\* net.

MARK II 50 Watts  
\$69.75\* net

## DYNAKIT PREAMPLIFIER

- ★ Finest quality available of circuitry and components.
- ★ Lowest distortion and noise.
- ★ Easiest assembly using pre-assembled printed circuit.
- ★ Handsome styling—selected for display at Brussels World's Fair.
- ★ Only \$34.95\* net.



Power supply available for 2 pre-amplifiers PS-1 Kit \$8.95\* net

## DYNAKIT STEREO CONTROL



Stereo control with two preamps

- ★ Adds complete stereo control to two preamps without noise or distortion.
- ★ Unique blend control fills in "hole in middle."
- ★ Level, balance, loudness, channel reverse, and dual tape monitor controls.
- ★ Only \$12.95\* net.

## NEW DYNAKIT STEREO 70

- ★ 2 independent power amplifiers — 35 watts continuous, 80 watts peak on each channel.
- ★ Unconditional stability using new DYNACO A-470 Super Fidelity output transformers.
- ★ All the features of the renowned Dynakit Mark III, including exclusive Dyna Biaset, highest quality conservatively rated components, superb listening quality and handsome appearance.
- ★ Can be assembled in 4 hours, through use of factory wired printed circuit assembly.
- ★ Only \$99.95\* net including cover.



Available from leading Hi-Fi dealers everywhere. Descriptive brochure available on request. \*Slightly higher in West

DYNACO INC. 617 N. FORTY-FIRST STREET PHILADELPHIA 4, PA. U.S.A.  
EXPORT DIVISION 25 WARREN STREET NEW YORK 7, N. Y.

# BOGEN

The sound way  
to better stereo

## IT'S TRUE WHAT THEY SAY ABOUT STEREO

Any stereo set-up—no matter what the cost—is only as good as the quality of the components that go into it. To put it another way, the quality you want can only be supplied by a company with the experience in sound engineering that the manufacture of superior stereo components requires.

Everyone agrees that the making of high-fidelity sound equipment is an extremely technical, highly specialized phase of the electronics industry. And that years of experience are required before a high degree of manufacturing excellence can be achieved. For over twenty-five years, Bogen has been making special sound systems of proven excellence for schools, theatres, offices and industrial plants—as well as hi-fi components.

Here is the business end of a typical Bogen school sound system.

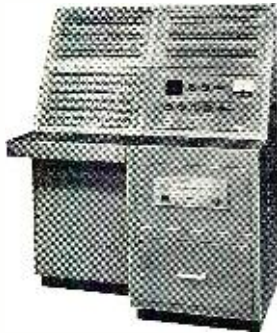

Wherever professional sound quality is needed—you'll find Bogen, the sound equipment made by professionals. Best of all, the same sound quality that engineers and musicians insist on is yours to supply—and enjoy—with Bogen stereo high-fidelity components.

ILLUSTRATED BOOKLET: 64-page explanation of hi-fi and stereo, "Understanding High Fidelity-Stereo Edition". Enclose 25c. BOGEN-PRESTO CO., Paramus, N. J. A Division of the Siegler Corporation.

**BOGEN**  
HIGH FIDELITY COMPONENTS



many systems this noise would not be noticed, but on a good sensitive wide-range stereo system it could not be tolerated.

### SCHUBERT SYMPHONY #9 IN C MAJOR ("THE GREAT")

Cento Soli Orchestra of Paris conducted by Ataulfo Argenta. Omega Stereo OSL-12. Price \$5.95.

Much the same could be said about this disc as the Omega reviewed above. The sound for the most part is clean and the stereo effects well handled. And on this disc the noise level, while still higher than one would like, it less than in the Roussel works.

I had always thought the late Argenta was strictly an exclusive London Records artist, but whatever, Omega pried him loose for this recording. For once the usually versatile and reliable Argenta is out of his conductorial depth. The "C Major" Schubert requires a preceptiveness and a maturity which were not yet apparent in his conducting. So mark a big "E for effort" for the performance which is competent but hardly definitive.

In reference to my prefatory notes to this column, this recording furnishes a prime example of the problem I discussed. The first two movements taken at Argenta's fairly normal tempi occupy almost 27½ minutes, the last two on the flip side a little over 22 minutes. Resisting the temptation to break the 2nd movement which is laudable from a musical standpoint, this decision cost Omega heavily in the engineering aspects. Taking a sort of middle-of-the-road approach, the result is that the over-all volume level is diminished, and the bass response has been cut in order to accommodate so much time on one side of the disc.

### HAYDN SYMPHONY #100 ("MILITARY") SYMPHONY #101 ("CLOCK")

Vienna State Opera Orchestra conducted by Mogens Woldike. Vanguard Stereo SRV109SD. Price \$1.98.

If you are looking for a good bargain in a stereo disc, you can't go wrong on this special Vanguard demonstration disc. The performances by Haydn scholar Woldike are exemplary and the playing of the orchestra (which is the Vienna Philharmonic under a pseudonym) magnificent. Add to this a stereo sound which has fine directivity and spaciousness coupled with vanishingly low distortion and you have a sure winner.

The famous "Turkish March" in the "Military" abounds in sparkling transients, but contrary to the ideas of some other conductors, Woldike does not overly emphasize the cymbals and tympani, preferring to retain the dynamic markings as indicated in the score.

### BEETHOVEN SYMPHONY #3 ("EROICA")

Minneapolis Symphony Orchestra conducted by Antal Dorati. Mercury Stereo SR90011. Price \$5.95.

Columbia Symphony Orchestra conducted by Bruno Walter. Columbia Mono M15320. Price \$3.98.

Beethoven's great masterpiece heard in stereo and monophonic and in two quite divergent readings. Let it be said at once, that those who feel that the "classical" repertoire gains little in the stereophonic process, should hear the difference between these two discs. Even though the Dorati disc is not faultless, it is just "no contest" as the stereo gives you a slice of "almost reality" while the monophonic is like an out-of-focus picture, blurred and formless in comparison to the living sound. Of course the same is undoubtedly true in Columbia's stereo version of Dr. Walter's performance which I have not yet had the pleasure of hearing.

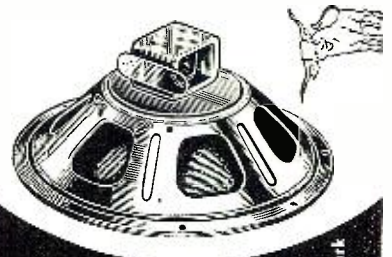

## SPEAKERS for SOUND INSTALLATION

Regardless of your application . . . P.A., Inter-com, outdoor, extended range . . . OXFORD is the SPEAKER for you. Our very complete line includes speakers that will meet your every need . . . quality . . . delivery. Write for our new catalog today.

Leading distributors carry OXFORD.

COMPONENTS, INC.  
556 West Monroe Street  
Chicago 6, Illinois

Export: Roburn Agencies, New York  
In Canada: Atlas Radio, Toronto

## OXFORD

OXFORD BRANDS: Supreme Transformers, Hudson Lamps, Tempo Hi-Fi, Oxford Speakers & Rear Deck Kits.

# CROWN

Professional Tape Recorder

## GOLD CROWN

# STEREO-X

Records and plays Professional Stereo 2 or 4-track heads. All-aluminum construction.

FREQUENCY RESPONSE	IPS	FLUTTER & WOV	NOISE RATIO
± 2 db 30-30000 CPS	15	.06%	57 db
± 2 db 20-20000 CPS	7½	.08%	54 db
± 3 db 20-11000 CPS	3¾	.18%	44 db

(Recording quality for 4-track slightly less)

**\$695** Less Case

Write for Catalog RN-59

Standard and Stereo models

INTERNATIONAL RADIO & ELECTRONICS CORP.  
ELKHART, INDIANA





you can  
hear the  
quality of  
a

# QUAM

*Adjust-a-Cone*®

## SPEAKER

When you install a Quam speaker, listen to it carefully.

Your ears will tell you why Quam Speakers have earned the reputation of "the Quality Line."

No other replacement speaker offers you all these important quality features: patented Adjust-a-Cone® suspension, U-shaped pot, heavier magnetic structures, 4 threaded holes in coil pot, transformer brackets, universal mounting brackets, factory packaging, listing in Howard Sams' Photofacts.

For happier customers,

*ask for QUAM, the quality line for all your speaker needs*

### QUAM-NICHOLS COMPANY

238D East Marquette Road  
Chicago 37, Illinois

# SOUND ON TAPE

By BERT WHYTE

BY THE time you read this the San Francisco and Los Angeles High Fidelity shows what it is, I will not be able to report any tape developments coming out of the show until the next (or May) issue. However, my spies in various spots have tried to give me a little advance poop on what may be new and nifty.

Unless something goes very wrong in the next week (as I write this) it looks like the 4-channel tape will finally get off the ground. The activity may be for the most part centered in reel-type machines and tapes, rather than the cartridge concept, but according to "a usually well-informed source," at least one machine manufacturer is supposed to have a reliably working model with production facilities geared for fast marketing if there is enough interest.

Among newcomers to the tape machine field will be the well-known amplifier manufacturer, the *Newcomb Audio Products Company*. The firm will reportedly be displaying a new unit, reel type, which can be had for either stereo recording or stereo playback/monophonic recording. The price bracket is supposed to be competitive with the *Ampex* home machines. Any cartridge plans don't seem to be in the offing for this company at this time.

One item that could be a boon for quality minded recordists with slim wallets, is a Japanese condenser-type mike with reportedly *Telefunken*-like specifications at a reported price of "under 90 dollars!"

In the tape battle, it appears that some of the companies who were producing recorded stereo tapes and who sold out when the stereo disc reared its head, are contemplating re-entering the market, since many have found a brisk mail order business has been springing up from the many people who own stereo tape machines and who have been unable to get tapes directly from dealers.

Another new and not altogether unexpected tape development is that at least one company intends to offer 7½-ips tape in the stereo 4-channel format. The reasoning is that, at the old standard speed, equalization is easier and a wide frequency range easier to maintain despite the smaller total gap areas in the 4-channel heads. With the advantage of the 7½-ips speed, the problem of the signal-to-noise ratio in the smaller heads is not so formidable. From an economic standpoint, the big news is, of course, that twice the amount of music can be contained on one reel and this will reflect in much cheaper tape prices.

In the area of straight 7½-ips, two-

## DEPENDABLE TV-RADIO TUBES

**ZALYTRON**

Tubes for TV-Radio Servicemen, Dealers, Experimenters.

Nationally sold ZALYTRON Tubes are BRAND NEW Tubes,

- NOT USED
- NOT REJECTS
- NOT PULLED from equipment, but ZALYTRON'S First Quality! Why pay more? Try them once, you'll buy them always. Every tube we ship is covered by our Full Refund Guarantee. YOU be the Judge! Send today for new Price List "RN"

1-YEAR  
GUARANTEE

## BE YOUR OWN BOSS RUN A SELF-SERVICE TUBE BUSINESS

Get This Modern Sturdy Tube Tester

**FREE**

with "Package Deal" order for nationally sold ZALYTRON Quality-Brand Receiving Tubes. We'll show you how to start a successful Tube Tester Route, and get YOUR share of today's Big Profits in Self-Service Tube Sales! This is no "Get-Rich-Quick" scheme but a solid, proven business that will reward you well — if you WORK at it. But, INVESTIGATE before you INVEST! Get full details on the best "Deal" now being offered, send today for our Booklet "R"



**ZALYTRON TUBE CORP.**  
220 West 42nd St.,  
New York 36, N. Y.

channel stereo tapes, a newcomer to the field, *Everest Records*, has announced a policy whereby the entire contents of any of its pop or classical disc recordings will be offered at a single \$10.95 price. This will afford from 35 to 50 minutes of music per reel, reflecting quite a reduction in cost from what has heretofore been charged for standard stereo tapes! So there is life in the old tape girl still and those would-be pallbearers may have to strike their colors and face up to this fact! I hope I'll be able to confirm all or at least a goodly portion of these "previews" in the next column.

One sad note which for the time being affects this column is that after a long wait in which almost every recording company decided to enter the stereo tape field, *Angel* finally brought forth its stereo tapes. By the time it did, the tape business was in the disc doldrums and after a small initial distribution, the tapes were withdrawn from the market. I had hoped to be able to review some of these for you, and there were many splendid items among them . . . but I guess we'll just have to wait for the tape market to return to robust health before this can be accomplished. There have been announcements from some of the companies about the release of new tapes, but I have yet to receive any, so regretfully, this month's tape cupboard is still pretty bare!

#### STRAVINSKY

##### THE RITE OF SPRING

New York Philharmonic Orchestra conducted by Leonard Bernstein. Columbia LMB 24. Price \$12.95.

In these days of very lean tape releases, this is a bright and shining spot. The work, of course, is Stravinsky's masterpiece and literally tailor-made for stereo and is productive of some of the most exciting hi-fi heard in many a month. Bernstein has made a specialty of this score and his performance is absolutely supercharged . . . a reading of tremendous vitality and drive. He emphasizes the dynamic elements in the score and brings it to a pitch of savage fervor.

In this almost demonic reading, he elicits some of the best playing from the Philharmonic heard in a long time. The stereo sound is recorded fairly close, with detail of the intricate instrumentation nicely highlighted. The directionality is excellent and the middle ghost channel well filled. The dynamics are properly wide as is frequency response and about the only thing I would take slight issue with is that I think a shade too much reverb was allowed. But this is minor and detracts little from the enjoyment of this stereo spectacular. A comparison with the stereo disc is weighted very heavily in favor of the tape on all points.

I am indeed sorry to only whet your appetite with the Stravinsky but there were only two tapes for me to review and the second review I prepared will have to be held over until next month due to a lack of space for this department in this issue.

-30-



Buy four 7-inch reels of *RCA Sound Tape*...and get one RCA Victor pre-recorded stereo tape for just \$1.00 more!

Here's your chance to stock up on the world's finest magnetic recording tape...and receive a *fabulous bonus at the same time!* *RCA Sound Tape* is famous for superb high-fidelity reproduction, long life and dependability. With the purchase of every four 7" reels of this premium quality tape you will receive a coupon. This coupon is worth \$3.95 toward the cost of a popular \$4.95 value RCA Victor tape recording in "Stereo Orthophonic" High-Fidelity Sound.

BETTER HURRY! Offer is for a limited time only. Selections are listed

on the coupon. Simply mail the coupon with \$1.00 to RCA Victor Records. The Stereo Tape of your choice will be forwarded to you by return mail.

For the finest in magnetic recording tape, RCA makes available a wide selection of *Sound Tape* on the popular 5" and 7" reels, on splice-free Mylar\* and acetate bases. Also look for these popular tape recording accessories: Tape Storage Chest, Splicer, Leader and Timing Tape. Available wherever superior tape recording products are sold.

\*DuPont Reg. TM



**RADIO CORPORATION OF AMERICA**  
Electron Tube Division

Harrison, N. J.

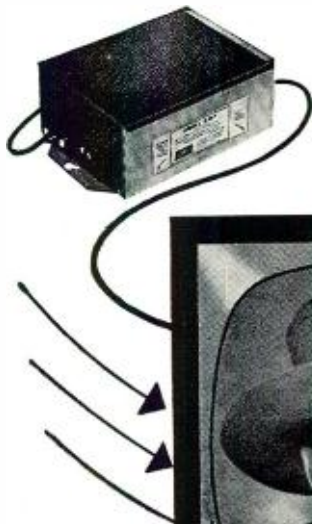

# SNOW, SNOW, go away—



## EROLD makes clear pictures pay

with **NEW HSA-46 Home Amplifier!**

Jerrold's HSA-46 is a VHF Pre-amplifier that incorporates 2 two-stage neutralized triode amplifiers designed specifically for low noise figure (ability to work with small signals) and flat response (to avoid picture degradation, especially on color) over the entire TV and FM range.

Features 15 db gain; 300 ohm input and output; max. input signal 30,000 uv per ch. on 7 chs.; 24 hr. continuous operation; 110 V. AC., 18 watt power consumption.

**EXTREMELY LOW NOISE FIGURE DELIVERS SUPERIOR RECEPTION TO ONE OR MANY TV AND/OR FM SETS!**

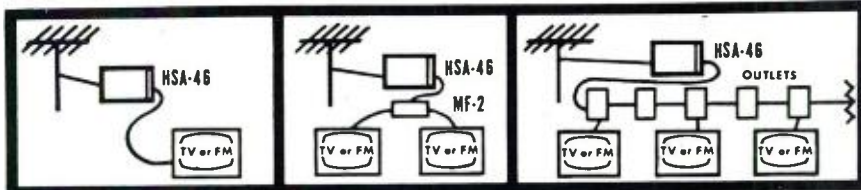

Delivers high signal strength (6 times antenna signal) to single receiver.

Used with Jerrold's MF-2 Coupler delivers 3 times antenna signal to each of two receivers.

Used with Jerrold's new Home System outlets provides excellent reception at any number of plug-in outlets throughout a home.

**DEMONSTRATE IT—YOU'LL SELL IT!**

Write today for special applications literature.

**JERROLD**

**ELECTRONICS CORPORATION**  
Dept. PD 145, The Jerrold Building, Philadelphia 32, Pa.  
Jerrold Electronics (Canada) Ltd.  
Export Representative, CBS International, New York 22, N.Y.

**LOOK TO JERROLD FOR AIDS TO BETTER TELEVIEWING**

**Antennas: Fact & Fiction**  
(Continued from page 43)

since noise is so much more of a problem in fringe areas.

**FACT:** Shielded twin-lead has excellent capabilities for bringing signals through areas of high ambient noise—but *not* where the signals are very weak. The presence of the metallic shield makes the loss of this type of cable higher than the unshielded types. This loss can rarely be tolerated in fringe areas.

**FICTION:** Coaxial lead should never be used for down-lead because it has very high losses.

**FACT:** The nominal losses in twin-lead run between 2 and 2.7 db/100' at channel 13 (the worst v.h.f. case) and are almost invariably higher in actual use. The losses in RG-11/U coaxial cable are 3 db/100' at channel 13, *no matter how used*. The new foam dielectric cables have less loss than the solid-dielectric types and can actually show figures equal to twin-lead. These latter cables may be taped to masts, run through conduit, or buried without affecting their loss characteristics adversely. They have been used to cure some knotty problems in color reception caused by direct pickup on twin-lead down-leads. However, one requirement must be met: the antenna must be matched to the cable and the cable to the set by means of matching transformers.

**FICTION:** You can always get better signals to the set by going higher with the antenna.

**FACT:** The greatest increase of signal usually occurs in the first 40 feet above ground or when you clear surrounding obstacles. After this, the increase is slow. On the other hand, as you go up, you increase the length of the down-lead. The increase of down-lead losses quite frequently offsets the increase in signal!

The net result is that you may get more signal at the antenna, but not at the set. The only way to get around this difficulty is with a mast-mounted preamplifier.

**FICTION:** When probing for signal in a fringe area, move the antenna up and down until you get the strongest signal, then mount the antenna permanently in the resultant position. This will always be the best place for the antenna.

**FACT:** This will be the best place for the antenna at this time and for this channel only. The fact is that this point of "best signal" can change with the weather and the season.

The reason for the "hot-spot" is that some refracted radiation is arriving at the particular spot in-phase with some reflected radiation. The reflected radiation may be from an upper-atmosphere boundary layer, which varies with weather and sunlight, or from a ground reflection, which varies according to the condition of vegetation or precipitation. You can't depend on these hot spots.

—50—

# Brand New!

Get top performance  
from your hi-fi system  
with this complete  
**STEREO-MONOPHONIC  
TEST RECORD**  
produced by the editors of  
**RADIO & TV NEWS**

Special to  
our readers  
for only...



As a man who is seriously interested in hi-fi, you will certainly want to be among the first to take advantage of this new and important test record. It will enable you to know your system inside-out. As a result, your listening enjoyment will be even greater than ever before.

Here are some of the questions  
this record will answer for you!

- ✓ How good is my stylus? Is it worn? Will it damage my records?
- ✓ What about my stereo cartridge? Does it have enough vertical compliance so that it won't ruin my expensive stereo records?
- ✓ Is my turntable running at the right speed? Is it free of rumble, wow, and flutter?
- ✓ What sort of standing waves do I get in my listening room?
- ✓ Are my speakers hooked up correctly? Are they phased properly, and is the correct speaker connected to the right stereo channel?
- ✓ How perfectly is my system equalized?
- ✓ What about separation? Is it adequate?

You'll get on-the-spot answers to these and many other questions when you use this stereo-monophonic test record. It's the most complete test record of its kind—contains the widest range of essential check-points ever incorporated into one test disc! And, best of all, you need no expensive test equipment when you use this record! Just listen and get the thorough results you want—all checks can be made by ear!

You can immediately see the extraordinary 2-way value you get from this

special test record. First, it guides you in evaluating the quality of reproduction your equipment now produces. Second, it specifies the adjustments necessary to get the best recorded sound you have ever heard! Add up the advantages! Check the special low-price! This is the value of the year for everyone who owns a hi-fi monophonic or stereo system!

Supply limited—Order your Test Record for just \$1 now!

This stereo-monophonic test record has been produced as a service for readers of *Radio & TV News*. It will only be sold to you by mail, at the special reader-price of just \$1. You can be sure that it comes as close to perfection as is humanly possible, because the editors of *Radio & TV News* have poured their

**Special Features of RADIO & TV NEWS Stereo-Monophonic Test Record**

- Four bands for stereo checks only—plus three bands for checking stereo or monophonic equipment!
- Non-breakable!
- Made of top-quality virgin vinyl for long wear!
- Specially-reinforced center resists warping!
- Delivered in special polyethylene envelope—dust and dirt are sealed out!
- Fully guaranteed!

accumulated know-how into this project for a period of many, many months. But the supply is limited, so it will have to be *first-come, first-served!* Avoid disappointment—place your order right now. Fill in and mail the coupon, together with your check (\$1 per record) *today!*

**RADIO & TV NEWS • P.O. Box 211, New York 46, N. Y.**

Please send me \_\_\_\_\_ test records at \$1 each. My check (or money order) for \$ \_\_\_\_\_ is enclosed. I understand that you will pay the postage and that each record is fully guaranteed.

Name \_\_\_\_\_ Please print

Address \_\_\_\_\_

City \_\_\_\_\_ Zone \_\_\_\_\_ State \_\_\_\_\_

SORRY—no charges or C.O.D. orders!

# NEW! "Do-It-Yourself" LAFAYETTE Kits



**LAFAYETTE'S  
1959 CATALOG**

**260 GIANT-SIZE  
PAGES**

**FREE!**

Complete listings of the **NEWEST** in Stereo and Monaural Hi-Fi, Short Wave, Audio, Transistor, and many other Lafayette electronics kits as well as thousands upon thousands of standard brand nationally advertised kits and electronic parts and components are described in LAFAYETTE'S GIANT NEW 260-PAGE CATALOG. SEND FOR IT—IT'S FREE! Just fill in coupon below and present it at any Lafayette store, or paste it on a postcard and send it to us. THAT'S ALL YOU HAVE TO DO to get your FREE 1959 LAFAYETTE CATALOG!

## LAFAYETTE RADIO ELECTRONIC KITS

- Include the very latest electronic advances.
- Are constantly being modernized by Lafayette's own Engineering Department, by a leading consulting engineering firm, and by your own recommendations.
- Are a product of Lafayette's 38 years of Electronic Leadership.

## EDUCATIONAL



**SUPER-SENSITIVE PHOTOCCELL  
ELECTRONIC RELAY ... KT-133 12.95**

**"EXPLOR-AIR" 4-BAND  
RECEIVER ... KT-135 18.50**

**5-WATT PUSH-PULL AC-DC HI-FI  
AMPLIFIER KIT ... KT-92 10.95**



**3 TRANSISTOR SUPERHET  
POCKET RADIO  
... KT-116 14.95**



**4 TRANSISTOR TELEPHONE  
PICKUP AMPLIFIER ... KT-131 17.95**



**6 TRANSISTOR SUPERHET  
RECEIVER ... KT-119A 27.50**



**3 TRANSISTOR HI-FI  
PREAMPLIFIER  
... KT-117 16.95**



**15-IN-1 TRANSISTOR  
EXPERIMENTER'S KIT  
... KT-134 14.95**

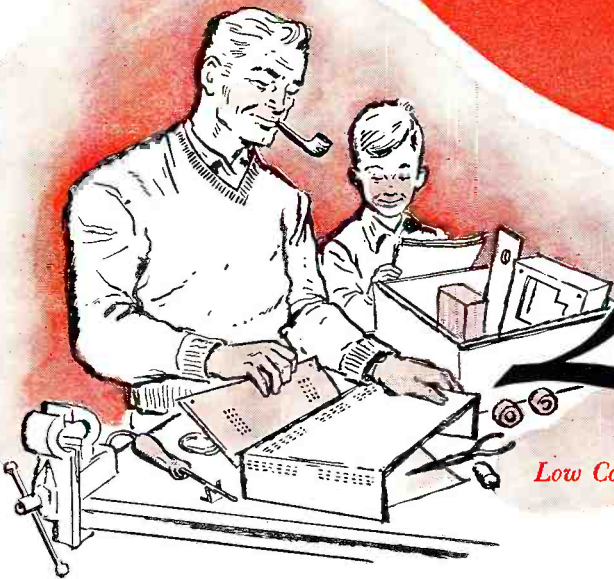

*Low Cost Kits For Everyone!*

# Lafayette Radio

# LAFAYETTE Kits Are FUN To Build!

## LEARN ELECTRONICS BY BUILDING A LOW COST LAFAYETTE KIT

**KITS FOR BEGINNERS** • 10-In-1 Lab Kit • Transistor Code Practice Oscillator • AC-DC Broadcast Receiver • 3-Way Broadcast Receiver • 5-Watt Push-Pull AC-DC Amplifier • 7-In-1 Radio Lab Kit • 2-In-1 Kit • Germanium Diode Radio • 1-Transistor Pocket Radio • 2-Transistor Pocket Radio

**HI-FI KITS** • Stereo Master Audio Control Center & Preamplifier • Stereo Remote Control Center—Electronic Stereo Adapter • 36-Watt Basic Stereo Amplifier • AM-FM Stereo Tuner • Preamp-Audio Control Center • 70-Watt Power Amplifier • 4-Watt Stereo Amplifier • Speaker Enclosure Kits

**ADVANCED KITS** • Broadcast-Shortwave Receiver • Electric Brain Kit • 10-Watt Push-Pull Hi-Fi Amplifier • 15-In-1 Transistor Experimenter's Kit • 4-Band Broadcast-Shortwave Receiver • Photocell Electronic Relay • 6-Transistor Superhet Receiver • 3-Transistor Pocket Radio • 3-Transistor Hi-Fi Preamplifier • 2-Transistor Reflex Radio with Sun Battery • Transistor Code Practice Oscillator • Radio Control Transmitter • Transistor-Diode Checker • Multitester Semi-Kit • 4-Transistor Telephone Pickup Amplifier

## PRACTICAL

## EASY-TO-BUILD LAFAYETTE KITS

Enjoy and Save

**LAFAYETTE KITS SAVE YOU REAL MONEY.** You save up to 50% or more when you build a low-cost Lafayette kit as against factory-wired units of equal or even lesser quality. You save also because Lafayette manufactures these kits and sells them *direct to you*, eliminating the usual dealer's markup.

**LAFAYETTE KITS ARE YEARS AHEAD.** Every latest advance in electronics finds its way into educational and practical Lafayette Kits. Lafayette was **FIRST** in **TRANSISTORS**, and Lafayette is now **FIRST** in **STEREO HI-FI!**

**LAFAYETTE KITS ARE EASY TO BUILD.** Whether you are a beginner or an engineer, a novice or advanced amateur, there are Lafayette kits you can build, learn from, and use. Detailed instructions with clear, large blow-ups and dozens of illustrations describe minutely every step of the kit assembly so that there are seldom any questions.

LAFAYETTE KITS ARE AVAILABLE ON OUR EASY PAY PLAN. SEE OUR FREE GIANT-SIZED 260-PAGE 1959 CATALOG FOR DETAILS.

ASK FOR THE FREE 260-PAGE GIANT NEW 1959 LAFAYETTE CATALOG

Fill in and present the coupon below at any Lafayette store for your FREE Catalog, or simply paste the coupon on a postcard and mail it to the address on the coupon. Our catalog is FREE for the asking!

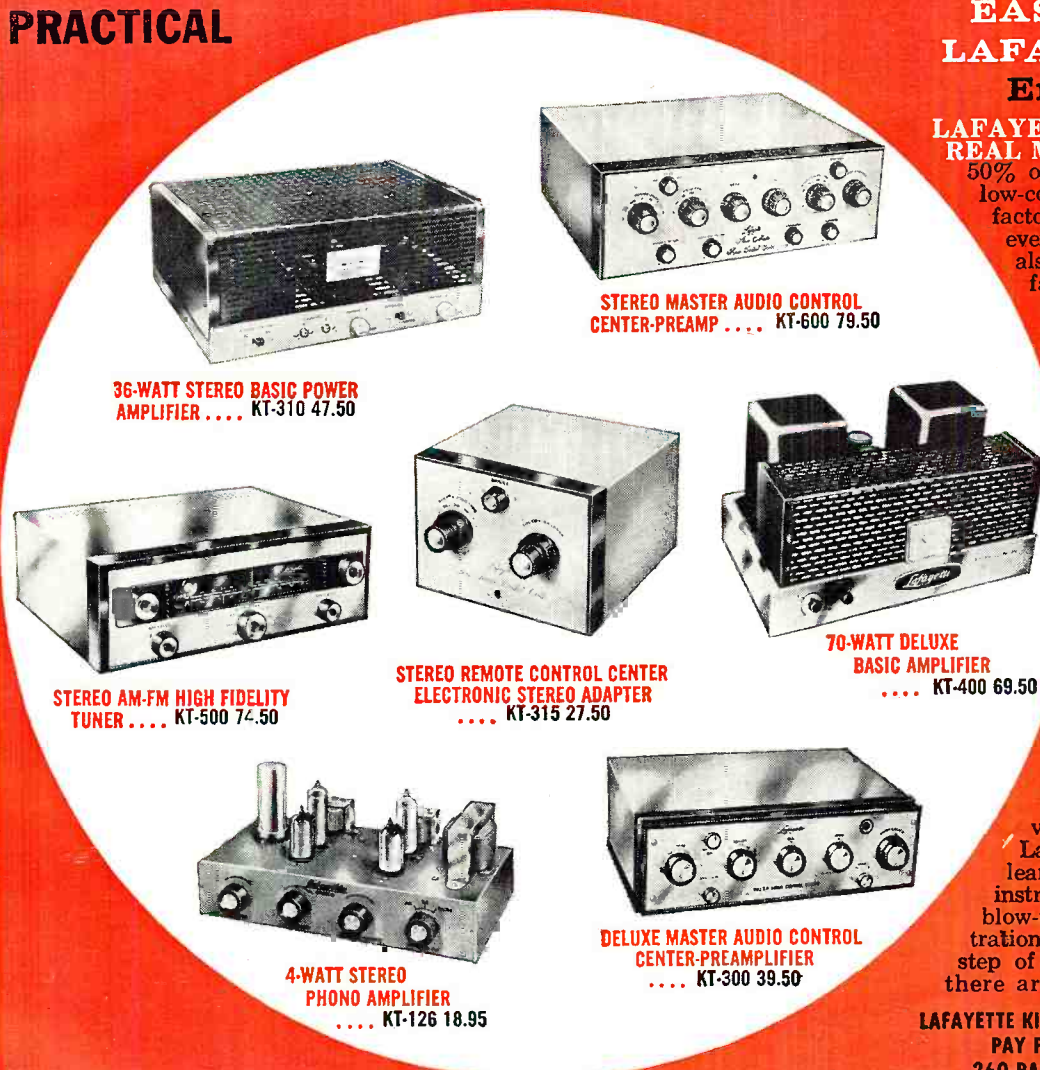

**36-WATT STEREO BASIC POWER AMPLIFIER .... KT-310 47.50**

**STEREO MASTER AUDIO CONTROL CENTER-PREAMP .... KT-600 79.50**

**STEREO AM-FM HIGH FIDELITY TUNER .... KT-500 74.50**

**STEREO REMOTE CONTROL CENTER ELECTRONIC STEREO ADAPTER .... KT-315 27.50**

**70-WATT DELUXE BASIC AMPLIFIER .... KT-400 69.50**

**4-WATT STEREO PHONO AMPLIFIER .... KT-126 18.95**

**DELUXE MASTER AUDIO CONTROL CENTER-PREAMPLIFIER .... KT-300 39.50**

### LAFAYETTE RADIO STORE LOCATIONS

**JAMAICA 33, N. Y.**  
165-08 Liberty Ave.  
AXtel 1-7000  
Open FRIDAY  
'till 8:45 P.M.

**NEW YORK 13, N. Y.**  
100 6th Ave.  
WOrth 6-5300  
Open THURSDAY  
'till 8:45 P.M.

**BRONX 58, N. Y.**  
542 E. Fordham Rd.  
FOrdham 7-8813  
Open THURSDAY  
'till 8:45 P.M.

**NEWARK 2, N. J.**  
24 Central Ave.  
Market 2-1661  
Open WEDNESDAY  
'till 8:45 P.M.

**PLAINFIELD, N. J.**  
139 W. 2nd St.  
Plainfield 6-4718  
Open THURSDAY  
'till 8:45 P.M.

**BOSTON 10, Mass.**  
110 Federal St.  
Hubbard 2-7850  
Open MON.-WED.  
'till 8:45 P.M.



**FREE**

CUT OUT AND PASTE ON POST CARD

**LAFAYETTE RADIO, Dept. RD9**  
P.O. Box 511, Jamaica 31, N. Y.

SEND FOR THE WORLD'S LEADING ELECTRONICS, RADIO, T.V., INDUSTRIAL, AND HI-FI GUIDE

Send FREE LAFAYETTE Catalog 590

Name .....

Address .....

City..... Zone.... State.....



If you're particular about your service . . . be particular about the capacitors you use. Aerovox offers you a complete line of rugged, dependable and versatile ceramic capacitors in every case style for every replacement application.

Choose from a wide selection of disk types in bypass-coupling, general purpose, hi-voltage and temperature compensating. Three tubular types are available from general purpose to temperature compensating to hi-voltage units. For these special applications you have cartwheels, standoffs and feedthrus in all sizes and values.

Your local Aerovox Distributor is your one-stop source of supply. Call on him today for any and all your capacitor needs. Ask him for your personal copy of the latest Aerovox Servicemen's Catalog.

**BUY 'EM BY THE KIT. . .** two disk ceramic kits (AK-200 and AK-201HS) of popular replacement types in special 3 x 5 metal file drawers now available at your Aerovox Distributor. Pay for only the capacitors and get the file cabinet FREE.

**AEROVOX CORPORATION**  
DISTRIBUTOR DIVISION  
NEW BEDFORD • MASSACHUSETTS

**Electronics in Nigeria**  
(Continued from page 41)

highly thought of by Nigerian technicians.

The typical electronic workshop in Nigeria looks just about the same as one in the U. S. Most of the test equipment is British; so it appears strange, at first, to an American. Installation, wiring, and troubleshooting (the Nigerian would say "faultfinding") is much the same, too, but tubes are called "valves," and the "valve" type numbers adhere to the British and European systems rather than to the EIA system used in this country. For example, what we call the 12AX7 would be recognized as the ECC83. However, Nigerian practice in these matters is no stranger than European usage.

There are two particular problems encountered with the use of electronic equipment in Nigeria. The biggest one is that untrained personnel unwittingly damage equipment. It is not uncommon to find a knob shaft broken off because it has been turned beyond the stop. The other problem is humidity; the climate is tropical, and the air saturated most of the time. It has been found essential to apply power at least once a day to keep moisture out of electrical cabinets. Air conditioning helps, but the price of electricity is so high that it is not in general use at the present time.

Electronic parts and supplies are difficult to obtain. Some of the large radio dealers stock parts, but the selection is very limited. Most electronic supplies must be specially ordered, which takes about two months including freight time. For this reason, most firms lay in a good stock of those components that are most likely to need replacement on short notice. These include meters, tubes, relays, transformers, and other items of this type. Stock-keepers are kept busy!

Technicians in Nigeria fall into three groups. There are those who have no experience or training, but are employed to operate equipment and expected to learn the job on their own. Then there are those who, after many years on the job, have gained technical skill but know little theory. Finally there are the technical school graduates who have completed a course with one of the Nigerian companies offering electronic training. This last group, along with the trained engineers, makes up Nigeria's most important pool of technical electronic manpower.

Nigerian technical pay is low by U. S. standards, but the cost of living is lower, too. A high school graduate who is lucky enough to land an appointment as an engineering trainee makes about 35 dollars a month. After five years in the job, including successful training and performance, he may make as much as 100 dollars per month. This is a good salary in Nigeria.

Job promotions are tied, for the most

**SPECIAL! RCA Factory Sealed GARAGE DOOR RADIO CONTROL SYSTEM**

Crystal controlled freq. range 27.255 Mc. Choice of 10 "code" frequencies. Package consists of Trans., Rec., Cables, Antenna. Universal operation 6 or 12 V. Unbelievable value—**\$35.00** worth \$125

Additional Trans. for above system. Can also be adapted for many other uses. Limited quantity. \$13.50

Mobile Radio Equip.—Recond.—Mfd. by Link (Mobile literature available on request.)

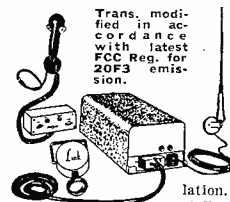

**MODEL 2210**  
152-162 MC  
FM MOBILE TRANS. & REC.—6 VOLTS

Complete with antenna, cables, control head, mike & crystals ground to your specific frequency. Ready for immediate installation. Specially priced

**\$139.50**  
MODEL 2210—12V. operation. . . . . \$162.50

**MODEL 2365 FM MOBILE TRANS. & REC.**

As above covering 23-40 or 30-50 Mc. 6 V. . . . . **\$119.50**  
MODEL 2365—12V. operation. . . . . \$149.50

**MODEL FMTR 30-50 MC FM MOBILE TRANS. & REC.—6 VOLTS**

Unit complete with Peak Modulation control head, mike, antenna, cables & crystals ground to your specific frequency. . . . . **\$109.95**  
MODEL FMTR—12V. operation. . . . . \$149.95

**SPECIAL! Link 30-50MC Receiver SPECIAL!**

152-174 MC Receiver  
Above receivers crystal control complete with crystals, control head, cable & speaker. To your frequency. Commercial-type. Reconditioned. 6V—\$69.50 12V—\$78.50

**BC-221 FREQUENCY METER**

Like new. Range 125-20,000 KC with crystal check points in all ranges. Complete with crystal & tubes. . . . . **\$99.50**  
MODULATED-TYPE . . . . . \$139.50  
MODULATED-TYPE with AC Power Supply. \$159.50

**SPECIAL! 17 LBS. of Assorted RADIO PARTS. A giveaway at. . . . . \$1.59**

Include 25% deposit with order—balance C.O.D. 50c handling charge on all orders under \$5.00. All shipments FOB our warehouse, NYC.

**PLATT ELECTRONICS CORP.**  
20 Murray St., N. Y. 7, N. Y., COrtlandt 7-2575

**terado Trav-Electric MOBILE POWER CONVERTERS**



Give You **110 A.C. HOUSE CURRENT ANYWHERE**  
You Drive or Cruise

**NO INSTALLATION**  
Just plug into cigar lighter on dash of car, truck, or boat—and away we go

- OPERATE PORTABLE TV
- SMALL DO-IT-YOURSELF
- TOOLS WHEREVER NEEDED

One of the great conveniences of our electronic age

**101 USES**

- ALL ELECTRIC SHAVERS
- DO-IT-YOURSELF HOBBY TOOLS

**terado COMPANY**  
DESIGNERS & MFRS. OF ELECTRONIC EQUIPMENT SINCE 1927  
1058 RAYMOND AVE., ST. PAUL 14, MINNESOTA  
IN CANADA: ATLAS RADIO CORPORATION LTD. ONTARIO



part, to educational qualifications. Degrees are required for many supervisory positions, which makes it difficult for a self-trained technician to get a good job with chances for promotion.

Working conditions are quite good for the Nigerian technician. Most employers furnish canteens, bathroom facilities, and a reasonably comfortable working space. One of the most important fixtures to be found in most rooms is the ceiling fan, a wonderful device for keeping cool during a hot Nigerian day. Tools and parts are sometimes in short supply, but somehow the work always gets done, even if a bit behind schedule.

The use of electronic equipment in Nigeria continues to grow. Import figures show that there is constantly increasing demand for consumer goods of all kinds. Television, a sure development in the near future, will create a whole new segment of the industry, with new needs for technical help and new problems.

This is the story of electronics in Nigeria—a story, just beginning, that promises to be a long one, that dramatizes the change from a way of life we regard as primitive to one more like our own, and that still carries the contrast between the two as electronics helps bring "light" to the Dark Continent.

—30—

Sun	Mon	Tue	Wed	Thu	Fri	Sat
			1	2	3	4
						5
						12
						19
						26

**CALENDAR  
of EVENTS**

**APRIL 5-10**

*Fifth Nuclear Congress.* Sponsored by IRE, Instrument Society of America, and EJC, Cleveland, Ohio. Program information from L. W. Nierman, 141 W. Jackson Blvd., Chicago 4, Ill.

**APRIL 16-18**

*Southwestern Regional Conference.* Sponsored by Region 6 of the IRE. Dallas Memorial Auditorium and Baker Hotel, Dallas, Tex. Program information from Frank Seay, Texas Instrument Co., 6000 Lemmon Ave., Dallas 9, Texas.

**APRIL 20-21**

*New Techniques in Electronic Industrial Instrumentation.* Sponsored by PGIE, PGI, and AIEE, Philadelphia, Pa. Information on program available from Dr. E. Mittelmann, 549 W. Washington Blvd., Chicago 6, Illinois.

**MAY 3-7**

*Symposium on Electrode Processes.* Sponsored by AFOSR's Chemistry Div. and The Electrochemical Society, Inc., Philadelphia, Pa. Additional information, A. F. Office of Scientific Research, Washington 25, D. C.

# KIT-OF-THE-YEAR!

A new  
**RCA-WV-77E(K)**  
**VoltOhmyst**  
for only  
**\$29.95\***



Also available factory-wired and calibrated—**RCA-WV-77E VOLT OHMYST**—only \$49.95\* \*User Price (optional)

**FREE**—New Booklet, "Servicing Is Easy With An RCA VoltOhmyst" offered with the purchase of a WV-77E(K) or WV-77E (\$1 value).

Hams! Hobbyists! Service Technicians!—Here's the new RCA VoltOhmyst Kit you've been hearing about... combining dependable electronic performance and ease of assembly!

Look what you get—ohms-divider network protected by fuse—ultra-slim probes and flexible leads for getting into those tight spots—leads, probes, and power cord can be stored in sleeve attached to handle for increased portability—separate scales for 1 1/2 volts rms and 4 volts peak-to-peak maintain instrument accuracy on low ac measurements—all lettering on front panel acid-etched to last the life of the unit!

You can get the new RCA VTVM Kit at your local RCA Test Equipment Distributor today—it's available "off-the-shelf"! For literature, visit your nearest RCA Distributor, or write RCA Commercial Engineering, Section D-41-W Harrison, N. J.

**SPECIFICATIONS**

**Measures:**  
DC Volts—0.02 volt to 1500 volts in 7 overlapping ranges  
AC Volts (RMS)—0.1 volt to 1500 volts in 7 overlapping ranges  
AC Volts (peak-to-peak)—0.2 volt to 4000 volts in 7 overlapping ranges  
Resistance—from 0.2 ohm to 1000 megohms in 7 overlapping ranges. Zero-center indication for discriminator alignment  
**Accuracy**—±3% of full scale on dc ranges; ±5% of full scale on ac ranges  
**Frequency Response**—flat within ±5%, from 40 cycles to 5 Mc on the 1.5, 5, and 15-volt rms ranges and the 4, 14 and 40-volt peak-to-peak ranges  
**DC Input Resistance**—standard 11 megohms (1 megohm resistor in probe)



**RADIO CORPORATION OF AMERICA**  
Electron Tube Division  
Harrison, N. J.

# SHIPPED ON APPROVAL

## an IN-CIRCUIT CONDENSER TESTER THAT DOES THE WHOLE JOB!

The CT-1 actually steps in and takes over where all other in-circuit condenser testers fail. The ingenious application of a dual bridge principle gives the CT-1 a tremendous range of operation . . . and makes it an absolute 'must' for every serviceman.

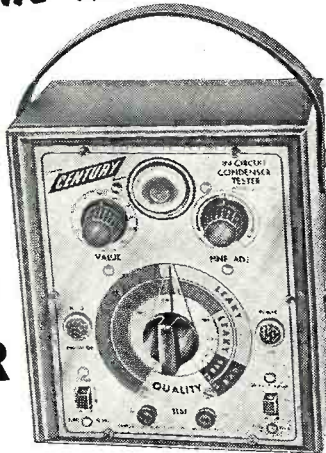

## IN-CIRCUIT CONDENSER TESTER Model CT-1

Model CT-1—housed in sturdy  
hammer-tone finish steel case  
complete with test leads...only  
**\$34.50** Net

### in-circuit checks:

- ✓ Quality of over 80% of all condensers even with circuit shunt resistance present . . . (leakage, shorts, opens, intermittents)
- ✓ Value of all condensers from 200 mmfd. to .5 mfd.
- ✓ Quality of all electrolytic condensers (the ability to hold a charge)
- ✓ Transformer, socket and wiring leakage capacity

### out-of-circuit checks:

- ✓ Quality of 100% of all condensers . . . (leakage, shorts, opens and intermittents)
- ✓ Value of all condensers from 50 mmfd. to .5 mfd.
- ✓ Quality of all electrolytic condensers (the ability to hold a charge)
- ✓ High resistance leakage up to 300 megohms
- ✓ New or unknown condensers . . . transformer, socket, component and wiring leakage capacity

### OUTSTANDING FEATURES

- Ultra-sensitive 2 tube drift-free circuitry
- Multi-color direct scale precision readings for both quality and value . . . (in-circuit or out of circuit)
- Simultaneous readings of circuit capacity and circuit resistance
- Built-in hi-leakage indicator sensitive to over 300 megohms
- Cannot damage circuit components
- Electronic eye balance indicator for even greater accuracy
- Isolated power line

## Check all power rectifiers in-circuit

whether SELENIUM,  
GERMANIUM,  
SILICON, etc.

with the

## IN-CIRCUIT RECTIFIER TESTER Model SRT-1



Model SRT-1—housed in sturdy hammer-tone finish steel case complete with test leads . . . only  
**\$29.50** Net

With the growing trend towards compactness, portability and low price, TV manufacturers are resorting more and more to producing series-string TV sets employing selenium, germanium or silicon power rectifiers. Now the need for an in-circuit rectifier tester is greater than ever.

### THE SRT-1 CHECKS ALL POWER RECTIFIERS IN-CIRCUIT AND OUT-OF-CIRCUIT WITH 100% EFFECTIVENESS FOR:

- ✓ Quality ✓ Fading ✓ Shorts ✓ Opens ✓ Arcing ✓ Life Expectancy

### OUTSTANDING FEATURES

- Checks all types of power rectifiers rated from 10 ma. to 500 ma. (selenium, germanium, silicon, etc.) both in-circuit or out-of-circuit.
- Will not blow fuses even when connected to a dead short.
- Large 3" highly accurate multi-color meter . . . sensitive yet rugged.
- Separate meter scales for in-circuit and out-of-circuit tests.
- Cannot damage or over heat rectifier being tested.

### SIMPLE TO OPERATE

Just clip SRT-1 test leads across rectifier under test right in the circuit without disconnecting rectifier from circuit. Press test switch and get an instant indication on the easy-to-read three-color meter scales . . .

### ALL CENTURY INSTRUMENTS ARE GUARANTEED FOR ONE FULL YEAR

The extremely low prices are made possible because you are buying direct from the manufacturer.

## TRANSISTOR TESTER Model TT-2

Every day more and more manufacturers are using transistors in home portable and car radios . . . in hearing aids, intercoms, amplifiers, industrial devices, etc. Since transistors go bad the need for TRANSISTOR TESTER is great. They can

develop excessive leakage, poor gain, shorts or opens.

The TT-2 is an inexpensive quality instrument designed for accurate and dependable tests of all transistors and diodes — quickly and accurately.

### OUTSTANDING FEATURES

- Checks all transistors, including car radio, power output, triode, tetrode and unijunction types for current gain, leakage, opens, shorts, cut-off current
- Checks all diodes for forward to reverse current gain
- All tests can be made even if manufacturers' rated gain is not available
- Less than half a minute required for tests of either transistors or diodes
- Large 3" meter is extremely sensitive yet rugged . . . with multi-color scales designed for quick easy readings
- Power is supplied by an easy to replace 6-volt battery — current drain so small, service life almost equal to shelf life. Battery cannot be drained due to accidental shorting of test leads
- Cannot burn-out its own meter or damage transistor or diode under test
- Long test leads and insulated test clips enable tests without entirely removing transistor from circuit
- Test leads are identified by E.I.A. color code so that connection to the correct terminal is assured
- Comes complete with replaceable transistor set-up chart that fits into a special rear compartment.

**IMPORTANT FEATURE:** The TT-2 cannot become obsolete as the circuitry is engineered to enable you to check all new type transistors as they are introduced. New listings will be furnished at no cost.



Model TT-2—housed in sturdy hammer-tone finish steel case complete with test leads . . . only  
**\$24.50** Net

**EASY TO BUY IF SATISFIED**   
see order form on facing page

# FOR 10 DAY FREE TRIAL

try them for 10 days before you buy . . . only then, when satisfied, pay in easy-to-buy monthly installments — without any financing or carrying charges added.

## STILL THE BEST SELLING TUBE TESTER IN THE FIELD FAST-CHECK TUBE TESTER

Model FC-2

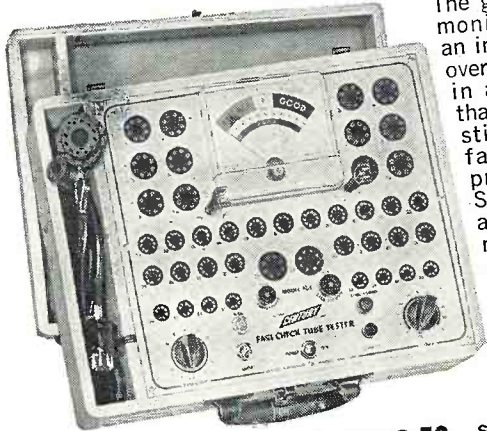

The greatest testimonial ever paid an instrument . . . over 20,000 sold in a little more than a year—and still selling as fast as we can produce them. See for yourself at no risk why so many servicemen choose the FAST-CHECK above all other tube testers — regardless of price.

Model FC-2 — housed in hand-rubbed oak carrying case complete with CRT adapter . . . only **\$69.50** Net

SIZE: W: 14 5/8" H: 11 1/4" D: 4 3/8"

Just 2 settings on the FAST-CHECK TUBE TESTER tests over 700 tube types completely, accurately — AND IN SECONDS!

### PICTURE TUBE TEST ADAPTER INCLUDED WITH FAST-CHECK

Enables you to check all picture tubes (including the new short-neck 110 degree type) for cathode emission, shorts and life expectancy . . . also to rejuvenate weak picture tubes.

No other tube tester made at any price can match the value of the FAST-CHECK.

### RANGE OF OPERATION

- ✓ Checks quality of over 700 tube types, employing the time proven dynamic cathode emission test. This covers more than 99% of all tubes in use today, including the newest series-string TV tubes, auto 12 plate-volt tubes, OZ4s, magic eye tubes, gas regulators, special purpose hi-fi tubes and even foreign tubes.
- ✓ Checks for inter-element shorts and leakage.
- ✓ Checks for gas content.
- ✓ Checks for life-expectancy.

### IMPORTANT FEATURES

- No time consuming multiple switching . . . only two settings are required instead of banks of switches on conventional testers
  - No annoying roll chart checking . . . tube chart listing over 700 tube types is located inside cover. New listings are added without costly roll chart replacement
  - Checks each section of multi-section tubes and if only one section is defective the tube will read "Bad" on the meter scale
  - 41 phosphor bronze beryllium tube sockets never need replacement
  - 7-pin and 9-pin straighteners mounted on panel
  - Large 4 1/2" D'Arsonval type meter is the most sensitive available, yet rugged — fully protected against accidental burn-out
  - Special scale on meter for low current tubes
  - Compensation for line voltage variation
  - 12 filament positions
  - Separate gas and short jewel indicators
  - Line isolated — no shock hazards
  - Long lasting etched aluminum panel.
- NOTE: The Fast-Check positively cannot become obsolete . . . circuitry is engineered to accommodate all future tube types as they come out. New tube listings are furnished periodically at no cost.

## NEW . . . For those looking for a real ECONOMY MULTIPLE SOCKET TUBE TESTER without sacrificing ACCURACY, SPEED and VERSATILITY MINI-CHECK TUBE TESTER

Model MC-1

Here is a multiple socket tube tester designed to meet limited budgets. Although low in price it boasts a unique circuitry that enables you to check over 600 tube types — and has a range of operation that far exceeds others in its price class.

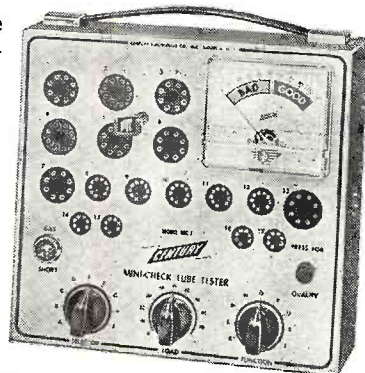

Model MC-1 — housed in sturdy wrinkle finish steel case . . . only **\$39.50** Net

SIZE: W: 9" H: 8 1/2" D: 2 3/4"

### OUTSTANDING FEATURES

- Checks emission, inter-element shorts and leakage of over 600 tube types. This covers OZ4s, series-string TV tubes, gas regulators, auto 12 plate volt, hi-fi and foreign tubes
- 3 settings enable a test of any tube in less than 10 seconds
- Employs dynamic cathode emission test principle
- 3 1/2" D'Arsonval type meter — most accurate type available . . . its greater sensitivity means more accuracy . . . its jewel bearing means longer life
- 17 long lasting phosphor bronze tube sockets
- Combination gas and short jewel indicator
- 9 filament positions
- Handy tube chart contained in special back compartment
- New tube listings furnished periodically at no cost
- Detachable line cord

plus these BONUS FEATURES . . . found in no other low price tube tester

- ✓ Checks for cathode to heater shorts
- ✓ Checks for gas content
- ✓ Checks all sections of multiple purpose tubes . . . will pickup tubes with one "Bad" section
- ✓ Line isolated — no shock hazard
- ✓ Variable load control enables you to get accurate results on all tubes
- ✓ Positively cannot become obsolete as new tube types are introduced.

## CONVENIENT TIME PAYMENT PLAN — NO INTEREST OR FINANCING CHARGES

# CENTURY ELECTRONICS CO., INC.

### CHECK INSTRUMENTS DESIRED

- Model CT-1 In-Circuit Condenser Tester . . . \$34.50 \$9.50 within 10 days. Balance \$5 monthly for 5 months.
- Model SRT-1 In-Circuit Rectifier Tester . . . \$29.50 \$4.50 within 10 days. Balance \$5 monthly for 5 months.
- Model TT-2 Transistor Tester . . . \$24.50 \$4.50 within 10 days. Balance \$5 monthly for 4 months.
- Model FC-2 Fast-Check Tube Tester . . . \$69.50 \$14.50 within 10 days. Balance \$11 monthly for 5 months.
- Model MC-1 Mini-Check Tube Tester . . . \$39.50 \$9.50 within 10 days. Balance \$6 monthly for 5 months.

Prices Net F.O.B. Mineola, N. Y.

111 Roosevelt Avenue, Dept. 204, Mineola, New York

Please rush the instruments checked for a 10 day free trial. If satisfied I agree to pay the down payment within 10 days and the monthly installments as shown. If not completely satisfied I will return the instruments within 10 days and there is no further obligation. It is understood there will be NO INTEREST or FINANCING charges added.

Name \_\_\_\_\_  
Address \_\_\_\_\_  
City \_\_\_\_\_ State \_\_\_\_\_  
Please print clearly

# WALTER ASHE SAYS— WE NEED YOUR USED\* EQUIPMENT RIGHT NOW!

Today's king size Walter Ashe "Surprise" Allowances prove you get the deal of a lifetime . . . if you trade now!

\*Made since 1945

Tell us what you want . . . and what you have to trade! The coupon brings our top "Surprise" Allowance on the newest models of famous brand equipment!

Your used equipment is just like money in the bank . . . only now it's worth a lot more in trade with Walter Ashe. Choose any item you want from the brand new 1959 Ashe catalog . . . your choice of Amateur Equipment, Test Equipment or High Fidelity. But whether you have a trade or not . . . you can always count on worthwhile savings when you "order from Ashe." Make us your "One Stop Supermarket" for everything in Radio, Television and Electronics. Our stocks of replacement or original parts, receivers, transmitters, amplifiers and associate equipment were never more complete. Of course, our experienced staff is always ready to help you and speed along your orders.



## FREE! 1959 Catalog

New 144-page catalog ready now . . . mail the coupon for your FREE copy! You'll find everything you need at lowest money saving prices. Here are the very latest in receivers, transmitters, tubes, books, test instruments, amplifiers and components . . . in stock for prompt shipment. Send today for your complete Radio-TV-Hi-Fi Buyers Guide Catalog!

### AMATEUR GEAR



The newest from Collins, Hammarlund, National and all the other top names. Best terms, always!

---

### TEST EQUIPMENT

We've been servicemen's equipment headquarters for over 37 years. See all the latest Radio-TV Test equipment first in our new Catalog.



---

### HI-FI COMPONENTS



Trade your present speakers, amplifiers or tuners for new monaural or stereo equipment. Ask for our big "Surprise" Allowance.

## New TV Designs for 1959 *(Continued from page 56)*

control grid receives the video signal from the grid of the video amplifier but its grid bias is determined by the "super range finder" or a.g.c. control. One suppressor grid is driven by a portion of the video-amplifier output in such a fashion that this tube section can amplify only during the horizontal sync-pulse period. The other tube section acts in a similar manner, except that its plate is connected as a rectifier and develops the a.g.c. signal.

*Admiral's* remote-control system uses resonant bars, which are struck when a button is depressed. At the receiver a separate remote-control receiver chassis contains the necessary amplifiers, filters, and relays. *Admiral* is also unusual in offering a special chassis and front assembly for built-in installations.

### ATR

This company continues to manufacture highly conservative sets, using power transformers, no printed wiring, and conventional circuitry. On one of the models it even offers a push-pull audio output, with connections for phono or other input.

### Emerson

Aside from following the main trend in circuitry, as shown by the use of a quadrature FM detector and a pentagrid sync separator, *Emerson* has again demonstrated concern for the service technician. In these models only the back need be removed to render all tubes accessible. The lighter circuitry is contained on a single printed-wiring board, with the component number etched right on the board next to each part. This certainly helps the technician locate components and identify portions of the circuit with ease.

The deflection circuits and the power supply, with power transformer, are on the main steel chassis. All interconnections between the main chassis and such separated elements as the printed-wiring subchassis, the deflection yoke, and the speaker are by means of connectors. Removal of the safety glass and the mask for cleaning purposes is achieved by taking out only five screws, a regular feature in *Emerson* designs.

### General Electric

The new *G-E* receivers are available, in some models, with a wired remote-control system. Console models also feature a large 9" x 21" oval speaker and a 4" tweeter. This combination is driven by a diode ratio detector, audio driver, and single-ended 6AQ5 audio-output tube.

An interesting tube used in this TV receiver series is the 6BW8, which combines a pentode (used as a 4.5-mc. amplifier-limiter) and a single-cathode, dual-plate diode (used as a phase detector in the horizontal a.f.c. circuit).

ASK ABOUT TIME PAY PLAN

### "SURPRISE TRADE-IN" COUPON

TRADE BIGGER—TRADE NOW

Walter Ashe

RADIO CO.

ONE STOP SUPERMARKET

1125 Pine Street—St. Louis 1, Mo.

WALTER ASHE RADIO CO.  
YOUR ONE-STOP SUPERMARKET  
Dept. R-4-59 • St. Louis 1, Mo. In Our 37th Year

Rush New Catalog  
 Send latest lists of guaranteed Used Equipment  
 Rush "Surprise Trade-in" offer on my \_\_\_\_\_

For \_\_\_\_\_  
(Show make and model of equipment desired)

Name \_\_\_\_\_  
Address \_\_\_\_\_  
City \_\_\_\_\_ Zone \_\_\_\_\_ State \_\_\_\_\_

servicemen everywhere insist on the GENUINE

"NO NOISE"

big 3

Beware Of Cheap Substitutes!

NO-NOISE NEW RUBBER COAT SPRAY



- Insulates where applied
- Protects indefinitely
- Prevents arcing, shorting, corrosion
- Waterproofs thoroughly
- Non-inflammatory
- Contains no plastic

6 Oz. Spray Can  
\$325

Net To Serviceman

NO-NOISE TUNER-TONIC With PERMA-FILM



- Economical—a little does a lot.
- Cleans, lubricates, restores all tuners, including water type.
- Non-toxic, non-inflammatory
- Use for TV, radio and FM

6 Oz. Aerosol Can  
\$325

NET To Serviceman

NO-NOISE VOLUME CONTROL and CONTACT RESTORER

- Cleans
- Protects
- Lubricates
- NOT A CARBON TET SOLUTION



2 Oz. Bottle  
\$100

Net To Serviceman



6 Oz. Spray Can  
\$225

Net To Serviceman

ELECTRONIC CHEMICAL CORP. 813 Communipaw Avenue Jersey City 4, N. J.

# TELEMARINE—FOR OUTSTANDING ELECTRONIC SURPLUS

## BC-611 WALKY-TALKY

### COMPLETE WITH CASE

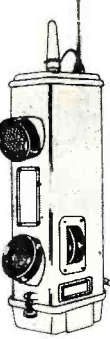

Now, for the first time, Telemarine offers the BC-611 Hand-Field Walky-Talky in complete form. Nothing extra to buy, except batteries which are readily available from most radio distributors. The BC-611 is a crystal-controlled transmitter-receiver covering the frequency range of 3.5 to 6.0 mc. Any good radio technician could easily modify this unit for operation in the 2.0-3.0 mc. Marine Band where it can ideally serve as an emergency transmitter (on 2182 KC) on boats too small for regular radiotelephone installation. Excellent for many other emergency situations because of its compactness (measures 1 5/8" H. x 3 3/8" W. x 5 3/4" D.) and light weight, only 5 1/2 lbs., complete with batteries. Supplied complete with coils (plug-in type, installed), crystals (one for "transmit," one for "receive") for 1 frequency in the 3.5 to 6.0 mc. range (no selection of frequency permitted on "used" sets), tubes, and "A" Battery Adaptor which permits use of 2 conventional 2 Flashlight cells in place of special "A" battery. "B" battery required is special 803 volt 600 mg. rectangular unit, mid.

by Burgess Battery Co. **XX-60**  
**BC-611 WALKY-TALKY**, as described. Used-Very Good Condition (not tested), pre-set for 1 frequency within 3.5 to 6.0 mc. (no selection of frequency). Includes less batteries. Shpg. wt. 1 1/2 lbs. **EACH**... **\$49.50**  
**BC-611 WALKY-TALKY, COMPLETE, NEW**, as described above but NEW, TESTED, and preset to any one desired frequency from 3.5 to 6.0 mc. **EACH**... **\$74.50**

**BC-611 WALKY-TALKY CHASSIS, NEW!** Excellent, new, Spare Chassis for above, priced so low that in the event of trouble it would be cheaper to insert a new BC-611. Also excellent for the Amateur or Technician who prefers to make his own style of Walky-Talky. Supplied less tubes (1-1R5, 1-1R5, 1-1T4, and 2-284 tubes required), and less plug-in coils and RF Ant. Coils, less crystals. Supplied with Schematic Wiring Diagram. Shp. wt. 8 lbs. **EACH**... **\$6.95**  
**EACH CHASSIS**, as described... **\$1.25**  
**PAIR OF COILS**, for above, **RF ANT. & OSC.**... **\$1.25**

## SENSATIONAL BARGAIN!! TCS TRANSMITTERS, RECEIVERS, AND ACCESSORIES

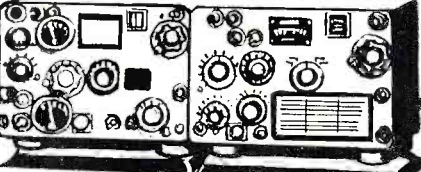

You've never seen TCS Transmitters and Receivers priced so low! This communications "work horse" of the Navy and Coast Guard and Civilian is priced for less than \$300. per set (Acq. cost over \$4000.00 per set). It's ideal for mobile or fixed station use; precise, trouble-free, and consistent in performance. The TCS-2 Transmitter and Receiver, certain front panel controls on Transmitter are removed, after pre-selling of frequency requirements regarding second harmonic radiation, since the transmitter uses a buffer stage, plus (variable) link coupling between the final RF Tank and a pi-network which couples to the antenna of receiver. This reduces harmonic radiation to absolute minimum. Other features of TCS Transmitters and Receivers are: \*complete coverage 1.5 to 12.0 mc. all band switching, 4 channels, crystal-control, plus optional manual tuning (in transmitter precision VFO). \*uses 1625 instant heating filament tubes (equivalent to Type 807) in chassis and Mod. sections of transmitter to minimize drain. \*Rated at 40 watts CW and 20 watts phone output when transmitter plate voltage is 425 V. but this power can be easily doubled by using 600 volt plate supply. \*Transmitter or Receiver designed to operate from either 12, 24, 110 V. DC, or 110/220 V. AC power supplies. \*Level Supply Diagram. \*Receiver is super-sensitive, superb, with excellent sensitivity & selectivity characteristics, and includes BFO circuit for CW reception. Units priced below complete with tubes, good clean condition but untested. **TCS-5 (to 9) TRANSMITTER**, with all tubes, schematic diagram and power supply diagrams, as outlined above. Shpg. wt. 60 lbs. **EACH**... **\$39.95**  
**PRICE EACH**... **\$39.95**  
**TCS-9 (to 14) TRANSMITTER**, same as above but has minor modifications which make these models more desirable. **EACH**... **\$59.95**  
**TCS-5 (to 14) RECEIVER**, complete with tubes and schematic diagram, as described above. Shpg. wt. 50 lbs. **EACH**... **\$99.95**  
**WRITE FOR PRICES ON OTHER TCS ACCESSORIES.**

**TCS ANTENNA LOADING COIL**, Used with above equipment to obtain maximum performance with short whip antenna. Has variable sections of inductance, plus switch for various lengths of antenna. In metal housing 6 1/2" H. x 9 1/2" W. x 1 1/2" D. Shpg. wt. 6 lbs. **EACH**... **\$7.95**

## REMOTE CONTROL FOR MOBILE OR MARINE USE

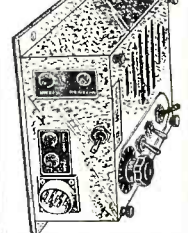

This is the popular Navy type TCS Remote Control, which includes a heavy-duty loudspeaker. Ideal for mobile (ham, taxi, truck, etc.) or Marine application either as a local or Remote Control Unit. Includes 3 toggle switches, one for tuning, "Transmit" on or off, one for tuning "etc." on or off, and one for selection of "speaker" or "Phone" reception. Additional toggle switch permits Remote or Intercom usage. 2 pair of Microphone and phone jacks are provided and connections are made through a Cannon receptacle connector (complete Schematic provided). Also provided is a 3-band Volume Control, on front panel, for regulating audio volume in speaker or phones. All units are NEW. Dim: 6 1/2" H. x 9 1/2" W. x 1 1/2" D. Shpg. wt. 10 lbs. **PRICE EACH**... **\$6.95**  
**CANNON PLUG CONNECTOR**, to fit above, each... **\$1.65**

## TG-34 CODE PRACTICE SET

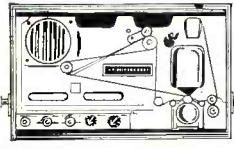

Learn to copy code, or improve your speed with this unit. Individually controlled, complete, portable automatic unit for reproducing audibly (built-in Loud-speaker) code signals recorded on ink on paper tape. Pre-recorded tapes, less than 15 (on 15 reels), available from many other surplus houses. Also usable for practicing "sending" by means of internal oscillator keyed by external hand key. Operates from 90 to 120 V. or 190 to 240 Volts. 60 Cycles AC. Units are Used-Very Good condition. Shpg. wt. 54 lbs. **SPECIAL**... **\$18.95**  
**TG-34-AS ABOVE, NEW-UNUSED**... **\$22.95**

## BC-603 MOBILE FM RECEIVER 20-27.9 MC



20 to 28 MC Red-Hot receiver that can be easily modified for new Citizens' Band (AV-FM) or 40-50 MC monitoring. See Sept. and Oct. 58 issues of CQ! Used—Clean unit with 2 Flashlight cells, built-in loudspeaker and 12 V DC. Dynamotor. Shpg. wt. 45 lbs. **EACH**... **\$16.95**  
**NEW-UNUSED, BC-603 with 12 VDC. Dynamotor.**... **\$21.95**  
**EACH**... **\$21.95**

**BC-604 FM TRANSMITTER, 10-Channel** Companion to Above. 10-Channel crystal controlled; power output with DM-35 Dynamotor 25 to 30 Watts. NEW UNITS, complete with tubes less DM-35 Dynamotor. Shpg. wt. 65 lbs. **EACH**... **\$7.95**  
**DM-35 DYNAMOTOR FOR ABOVE**, For 12 V DC operation. **EACH, NEW UNITS**... **\$9.95**

## 250 WATT BEACHMASTER AUDIO AMPLIFIER

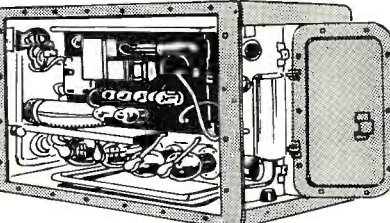

**SUPER-POWER** complete amplifier. Designed by Bell Tel. Labs. All self-contained in waterproof metal case, with blower system for ventilation, weatherproof receptacles, etc. Ideal for large auditoriums, sports, baseball parks, etc. or easy to convert to modulator for 500 Watt Transmitter. Operates from 110 V. 50/60 cycles AC. Uses total of 14 tubes, including 2-205 triodes in push-pull power stage and 1-6E5 multiplier tube to indicate gain. Like-new condition equipment. Dim. 26 1/2" x 16 1/2" x 19". Shipping weight, complete with tubes, 190 lbs. Supplied with tube and schematic diagrams. **PRICE EACH, SLASHED TO**... **\$169.50**

## FM TRANSCIEVER 29-39 MC



Signal Corps BC-659, part of popular SCR-609/610 V-heterodyne. Combination Transmitter and Receiver for FM communications. 2 channels, with crystal-controlled. Transmitter use not recommended except for military or special applications, but receiver is ideal for monitoring 28.9 to 38.9 mc (can be extended by removing a few coil turns). Incorporates built-in loudspeaker, and construction is such to permit easy, unobtrusive mounting to permit complete access to front panel controls. Separate power supply required to provide 90 to 150 volts "B" supply, and 1.5 volts "A" supply. The PE-117 or 120, available separately, supplies these voltages from either a 6, 12 or 34 volts DC source, but batteries or other supply can be easily adapted. Dim. of Transciever 16" L. x 13" W. x 7 1/2" H. Supplied complete with all tubes and Schematic Diagram. **PRICE PER SET, BRAND NEW, UNUSED, SLASHED TO**... **\$10.95**  
**Price—PE117 or 120 (Specify which), Power Supply for above, Used—Good**... **\$14.95**

**10% DISCOUNT, "CASH & CARRY"**  
 Save 10% on the low prices quoted in this ad, by paying us the shipping expense! Visit our store at this address, make your purchase and carry away the merchandise, and we will allow this 10% discount on all material quoted in this ad. This discount does not apply to mail orders!

All Above Material Subject to Prior Sale. 25% Minimum Deposit with All C.O.D.'s. Min. Order —\$5.00. All Prices F.O.B. Our Address.

—TELEMARINE—  
**COMMUNICATIONS CO., INC.**  
 140 WEST B'WAY, NEW YORK 13, N. Y.  
 COland 7-5444  
 Cable Address: Telemarine N. Y.

## ELECTRIC DEFROSTER FOR CAR OR TRUCK

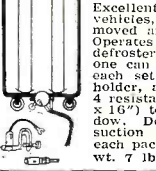

Excellent for passenger cars, commercial vehicles, in stormy weather. Easily removed and stored away when not needed. Operates from electric 6V. DC (use two defrosters—in series—for 12V. DC systems. One can be installed on rear window and each set is complete with switches, fuse holder, and necessary wire. Defroster has 4 resistance wires running inside glass (3" x 16") to produce heat for defrosting window. Defroster is held to window by 4 suction cups. NEW, INXU condition, each packed in metal case. Shpg. wt. 7 lbs. **EACH**... **\$7.95**

## BC-1306 TRANS-RECEIVER FOR MARS, HAMS, ETC.

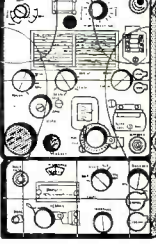

For MARS application. 3800 to 6500 KC. MO or Crystal Control. Includes Crystal Calibration and Net Controls. Operates in NEW UNITS, with all tubes except Final RF 2E22 tube. Shpg. wt. 10 lbs. **EACH**... **\$22.50**  
**PE-237 POWER SUPPLY**, For Above BC-1306. Supplies all necessary voltages and current for both transmitter and receiver sections. Operates from 6, 12, or 24 Volts DC. "LIKE-NEW" units. Shpg. wt. 15 lbs. **EACH**... **\$14.95**

## LIMITED QUANTITY BARGAINS

**BC-312 RECEIVER**, Well known Signal Corps Communications Receiver. 1500 KC to 18.0 MC. For 12 V DC operation. Used—Excellent condition. Tested. Shpg. wt. 75 lbs. **EACH**... **\$60.00**  
**RA-20 POWER SUPPLY**, To convert above Receiver to 110 V AC operation. Used—\$14.95 ea. **NEW UNITS**, \$17.95 ea. **BC-342 RECEIVER**, Same as BC-312 except includes Crystal Filter and Phasing Control and for 110 V AC operation. Used—Tested. **EACH**... **\$84.50**

**NEW UNITS BC-342**, with operating spares and Export packed. Shpg. wt. 100 lbs. **EACH**... **\$110.00**  
**BC-221 FREQUENCY METER**, The best instrument possible for determining frequency of transmitter or receiver, alignment, testing, etc. Laboratory Precision! Range 25 KC to 20,000 MC. Complete with Calibration Crystal, tube meter, Calibration Book. Tested. Used—Excellent. Shpg. wt. 65 lbs. **EACH**... **\$14.50**

**30-40 MC DE-LUXE FM TRANSCIEVER**, Model R-237/VRC-2 Single-Channel. Double Conversion Superhet, with features such as double limiter, squelch circuit, crystal-control, both 1st and 2nd IF stages, 6E5 built-in 6 V DC Power Supply, etc. Dimensions 11 1/2" x 10" x 15". Used—Excellent condition units, with tubes, less crystals or control unit and disassembled. Schematic diagrams. Shpg. wt. 65 lbs. **EACH**... **\$25.95**

**TRANSMITTER COMPANION TO ABOVE**, Model T-193/VRC-2 Power Output 25 Watts. Crystal-controlled single channel unit with built-in 6 V DC Power Supply. Can be used for NB FM amateur transmissions, or may be applicable to Fire, Police, and other applications. Used—Excellent condition units. With schematic. Shpg. wt. 65 lbs. **EACH**... **\$19.95**

**BC-791 CODE RECORDER**, Consists of Amplifier and Recorder of code signals on paper tape, with ink writing stylus. Similar to McElroy Model RRD-900. For operation on 110 V AC. Less tape puller. Flouso in original case, all NEW Units. Shpg. wt. 40 lbs. **EACH**... **\$10.95**

**6 or 12V, DC VIBRATOR POWER SUPPLY**, Type PE-104, operates from either voltage and supplies completely filtered voltages as follows: 1.5, -45 (bias), and 90 volts DC. Uses synch. vibrator, no tubes. Ideal for mobile or fixed transceivers, etc. Ditch pack. Includes NEW UNITS. Shpg. wt. 12 lbs. **EACH**... **\$9.95**

**12V, DC, 1/12 HP DC MOTOR**, Make electric car or tractor for kiddies. Rated at 12 HP at 1725 rpm, but with built-in reducing gear assembly actually develops more power at final speed of 43 rpm! 7 heavy brass worm gear, variable separator for 2 1/2" rpm. NEW material. **MOTOR, EACH**... **\$12.95**  
**WORM GEAR, 7" for 2 1/2 rpm**... **\$2.75**

**BRITISH-TYPE INFRA-RED IMAGE (SNOOPERSCOPE) TUBES**, Used in British "Tabby" for seeing in the dark for "snooper" or "sniper" scopes. Will detect objects at night illuminated by "dark" infra-red rays. Requires power supply of 8000 to 4000 volts at a few microamperes. Screen size is 1 3/8" dia. All tubes checked before shipment. **Price**... **3 for \$10.00**

**FRONT END LENS ASSEMBLY**, For above. Speed F1.9, f.4, 91.44 mm. Outside dia. at one end 60 mm. Length of mount 64 mm. **EACH**... **\$7.00**  
**12V, DC SOLENOID RELAY**, Starting relay for transmitter dynamotors on mobile or marine rigs. SILT type. Both silver contacts 3/2" x 1/2" x 1/2". continuous duty, contacts completely enclosed to make relay explosion-proof. Dim: 2 1/2" H. x 1 3/4" Dia., with bottom ring. 2 1/2" hole center. 2-11 1/2" apart. Mid. by Struthers-Dunn. **NEW UNITS, TWO (2) FOR**... **\$5.00**

**MINIATURE STORAGE "A" & "B" BATTERIES**, For Waite-Rates and other Portables, Radio-Controlled devices, Radio-Sondes, or equivalent meteorological devices. Supplied as a set of 3—"B" batteries of 36 volts each, and 1—"A" battery of 6 volts. Batteries dry-charged, less electrolyte, and packed in a hermetically sealed vacuum metal container which prevents possibility of deterioration or loss of efficiency until opened and ready for use. Both "A" battery (BB-51) and "B" battery (BB-52) are 7/8" deep x 1 1/2" high x 3 1/2" long, with 2 connection pins of 1/8" length protruding from each battery. Hypodermic needle required for acid-water filling (1280-1350 specific gravity). Full instructions supplied with each set of batteries for filling and charging. NEW UNITS, TESTED. Shpg. wt. 4 lbs. **PER SET (4 Batteries)**, as described... **\$3.95**  
**CASE OF 24 SETS OF BATTERIES**, each set as described above, but including one special plunger-cutter for opening each vacuum container and simultaneously filling each battery with requisite electrolyte, plus one hypodermic for refilling batteries when necessary. Shpg. wt. per case 55 lbs. **PER CASE 24 SETS BATTERIES** \$79.50

APRIL SHOWER OF SAVINGS  
FOR ALL LEKTRON SHOPPERS!

# CASH DISCOUNT SALE!

**FREE!**  
FULL YEAR'S  
SUBSCRIPTION  
TO LEKTRON'S 24-PG.  
"Family Shopper"  
Electronics • Tools  
Jewelry • Novelties  
Hi-Fi • Housewares  
Write Today!

- MINI-RADIO KIT**  
World's smallest! 2 x  
1 x 1". Loopstick, jacks,  
diode, etc. w/instructions.  
1 lb. Reg. \$3. **88¢**
- 40-RECORD CADDY**  
Wrought iron. Holds 40  
records & albums. **88¢**  
2 lbs. Reg. \$2.95.
- 8 SUB-MINI SOCKETS**  
Mica-filled. For **88¢**  
transistors, too.
- 40 SUB-MINI COND'S**  
For transistor, printed  
circuit work. 1 lb. **88¢**  
Reg. \$7.
- 8-SCREWDRIVER SET**  
8 asstd. drivers with  
wall rack. Plastic  
handles. 1 lb. List **88¢**  
\$3.50.
- 60 PLUGS/RECEPTCLES**  
Audio, power, line, bat-  
tery, spkr. 3 lbs. **88¢**  
Reg. \$7.
- \$25 SURPRISE PACK**  
Large, varied assort-  
ment radio, TV **88¢**  
parts. 3 lbs.
- 6 SILICON DIODES**  
Sylvania 1N32. **88¢**  
1N23. Reg. \$36.
- 0-6 AMP. MINI-METER**  
AC. 1 3/4" diameter. **88¢**  
1 lb. Reg. \$3.
- 8-PC. NUTDRIVER SET**  
\$3 value! Plastic  
handle. 3/16" thru  
7/16" socket wrenches. **88¢**  
1 lb.
- TV PIC BOOSTER**  
Parallel. 6-wire. Ex-  
tends picture tube **88¢**  
life. 1 lb.
- 15 VOLUME CONTROLS**  
Incl. dials; some w/  
switch; to meg. **88¢**  
2 lbs. Reg. \$12.
- 70 ONE-WATTERS**  
Asstd. value carbon **88¢**  
resistors. 5% tol.
- 35 POWER RESISTORS**  
WW. 5 to 50W to  
10,000 ohms. Vitre-  
ous, too. 3 lbs. Reg. **88¢**  
\$15.
- 40 HI-Q CONDENSERS**  
Finest porcelain; NPO's  
too! 1 lb. Reg. **88¢**  
\$6.

NOTE TO BONUS CARD HOLDERS—If you wish, purchases may be credited toward free Poly-Paks as usual. In that case, discount does not apply.

## Lektron's Exclusive POLY-PAKS SAVINGS FROM \$3 TO \$35 AND MORE! 88¢ EACH!

- 8 GERMANIUM DIODES**  
Glass sealed, w/long  
leads. For all hob. **88¢**
- 30 DISC CONDENSERS**  
Water-thin; to .01  
mf. Reg. \$5. **88¢**
- 40 PRECISION  
RESISTORS**  
1%. 1/2 & 1 W; car-  
bonoloy & WW. 100  
ohms to 1 meg. Reg. **88¢**  
\$17.
- 10 POLY BOXES**  
Clear plastic, hinged,  
w/snap locks. **88¢**  
Asstd. sizes. 1 lb.
- 40 TUBE SOCKETS**  
4 to 9-pin; ceramic,  
mica, shield-based **88¢**  
incl. 2 lbs. Reg. \$10.
- 100 CERAMIC  
CONDENSERS**  
Hi-Q discs, tubulars; to  
.01 mf. 2 lbs. Reg. **88¢**  
\$12.
- "1-POUNDER" HAMMER**  
Claw; 16-oz. steel, w/  
14" formed handle. **88¢**  
Reg. \$2.50.
- 16-END-WRENCH SET**  
For home and auto.  
Box and open; 15/64  
thru 7/16". 16 sizes. **88¢**  
Reg. \$2.50.
- 30 PILOT LITES**  
Pop. flashlite size; mini  
bay. type. Reg. \$9. **88¢**  
1 lb.
- 5 ROLLS MICRO WIRE**  
±24 thru 32; for trans-  
istor, sub-mini cir. **88¢**
- 2 MIKE XFMRs.**  
Carbon, 100 to 100K  
ohms impedance. Leads;  
encased. 1 lb. Reg. **88¢**  
\$10.
- 100 RADIO PARTS**  
Wide variety resistors,  
condensers, pots, **88¢**  
forms. 3 lbs.
- SYLVANIA TV MIRROR**  
10 x 12" stainless  
steel. 2 lbs. Reg. **88¢**  
\$4.
- HOBBY BENCH VISE**  
Clamp types. Fits  
tables too. Steel. **88¢**  
1 lb.
- 70 HI-Q RESISTORS**  
Carbon, IRC, Ohmiter;  
1%, tol. 1/2 & 1 W,  
10 ohms to 10 megs. **88¢**  
2 lbs. Reg. \$13.
- HEARING AID PHONE**  
Crystal, w/cord set. **88¢**  
& plug. Reg. \$5.
- 4 OUTPUT XFMRs.**  
50L6 etc. 3 lbs. **88¢**  
Reg. \$8.
- POSTAGE STAMP MIKE**  
Crystal, 100 to 8,000  
cps. 1 lb. Reg. **88¢**  
Reg. \$7.
- 75-FT. TV TWINLEAD**  
300 ohm. Handed,  
tinned. 3 lbs. Reg. **88¢**  
\$3.50.
- 10 ELECTROLYTICS**  
Radio, TV. 10-500 mf  
to 450 VDC. 3 lbs. **88¢**  
Reg. \$12.
- 60 RADIO-TV KNOBS**  
Asstd. colors, insula-  
tion. Some worth  
\$1 ea. 2 lbs. Reg. **88¢**  
\$3.
- 4 POWER WOOD BITS**  
Hi-Q steel. 3/8, 1/2, 3/4",  
1". 5" long. Reg. **88¢**  
\$3.
- 10 TUBULAR ELECTROS**  
Asstd. paper types. AC  
DC. Hobby, 3 lbs. **88¢**  
Reg. \$15.
- 20 ARTISTS' BRUSHES**  
100% pure bristle;  
sizes 1-6. Reg. **88¢**  
\$2.50.
- 75 MICA CONDENSERS**  
.00025 to .01 to 1200  
values. Reg. \$28. **88¢**
- 15-PC. DRILL SET**  
1/16" thru 1/4" by  
case. Reg. \$3. **88¢**
- 75 RESISTOR SPECIAL!**  
WW, precision, car-  
bon, variable, mini  
types. 3 lbs. Worth **88¢**  
\$15.
- 60 CONDENSER SPLCI**  
Molded, paper, ceramic,  
oil, mica, discs. **88¢**  
variable. 2 lbs.
- 7 ROLLS WIRE**  
25-ft. each. ±18 thru  
22. Asstd. stranding,  
insulation, colors. 2 **88¢**  
lbs. Reg. \$5.
- 1500 PCS. HARDWARE**  
Nuts, screws, washers,  
etc. 1 1/2 lbs. Reg. **88¢**  
\$6.
- 6-PC. HACKSAW SET**  
Six assorted blades. **88¢**  
1 lb.
- 70 TERMINAL STRIPS**  
Solder lug & bind-  
ing; to 20 terms. **88¢**  
2 lbs.
- 60 COILS, CHOKES**  
IP, RF, ant., slug-  
tuned, too. 3 lbs. **88¢**  
Reg. \$15.
- 300-FT. HOOKUP WIRE**  
Tinned, asstd. sizes,  
colors. 2 lbs. Reg. **88¢**  
\$5.
- 100 HALF-WATTERS**  
Asstd. value carbon re-  
sistors, incl. 5% **88¢**  
Reg. \$12.
- 30 MOLDED COND'S**  
Asstd. Finest made! **88¢**  
Wt. 2 lbs.
- 15 ROTARY SWITCHES**  
Asstd. gangs. 3 **88¢**  
lbs. Reg. \$12.
- 5-IN-1 DRILL BIT**  
Reams, saws, copes,  
shapes, drills. Hand **88¢**  
or power drill.
- 15 INSTR. KNOBS**  
Knurled black bakelite,  
w/pinter; brass in-  
serts. set-screws. Reg. **88¢**  
\$3.
- 10 PANEL SWITCHES**  
Asstd. 115VAC, power,  
multi-circuit & SPST.  
DPST, DPDT. 2 lbs. **88¢**  
Reg. \$5.
- 20 SUB-MINI RESISTORS**  
1/4" long. 20 values;  
1/4" SW to 10 megs. **88¢**  
Reg. \$6.
- 5" HOBBY SPEAKER**  
For radios, code osc.,  
integrators. 2 lbs. **88¢**  
Reg. \$3.
- TEN 3-SECOND TIMER**  
Mechanisms; Precision  
geared. 2 lbs. Reg. **88¢**  
\$30.
- 2 TRANSISTOR IFS**  
Double-tuned. Only  
1/4" square. 456kcs. **88¢**  
Reg. \$3.
- 2 N-P-N TRANSISTORS**  
In many pop. **88¢**  
make radios. Worth \$3.
- 2 P-N-P TRANSISTORS**  
Popular market dozens  
of hobby uses. \$5 **88¢**  
value.
- 2 VARI-LOOPSTICKS**  
Adj. 540-1500 kcs.  
Transistor radios, **88¢**  
etc. 1 lb.
- RADIATION DETECTOR**  
World's smallest, 100's  
of Atomic and Ra-226  
diation uses. Reg. \$21. **88¢**
- 0-60 MINUTE TIMER**  
For darkroom, lab.  
shop, kitchen. Loud  
alarm. 2 lbs. Reg. \$6. **88¢**
- 0-15 VAC MINI-METER**  
Hundreds of uses! Only  
1 1/2" diameter. **88¢**  
lb. Reg. \$3.50.
- 70 TUBULAR COND'S**  
Paper, molded, oil,  
porc.; to .5mf to **88¢**  
1000V. 2 lbs. Reg. \$14.
- WIRE STRIPPER**  
Strips & cuts hook-up  
wire ±16 thru **88¢**  
±22. Wt. 1 lb.
- 10 RCA PLUG-N-JACK**  
SETS, matched. Most  
pop. amps, tuners. **88¢**  
phones.



Some G-E receivers use power trans-  
formers, but the portable models, fea-  
turing the "Slim Look," are series-  
filament receivers. These sets are  
modeled somewhat after the contours  
of the picture tube, narrowing con-  
siderably in the back.

Hoffman

This manufacturer distinguishes one  
of his models, the type 424 chassis, by  
using two EL84 push-pull audio-output  
tubes. The rest of the audio section  
has other features which should pro-  
vide improved TV sound quality on  
that particular model. While some of  
the 1959 Hoffman models use a power  
transformer, others use silicon rectifi-  
ers in the conventional voltage-doubler  
circuit. A vertical chassis is used. On  
some of the more expensive models,  
power tuning is featured. The sync  
circuits deserve mention because they  
are quite elaborate, using three tubes,  
including a 3BY6 pentagrid noise-can-  
celling and sync-separating circuit. In  
most other respects, the circuitry fol-  
lows no distinctive trend.

Setchell-Carlson

This manufacturer is continuing use  
of its well-known "unitized" chassis.  
Designed to provide easier servicing,  
this assembly consists of separate sub-  
chassis for each major receiver section,  
so that each can be serviced or re-  
placed by itself. In addition to using  
power transformers throughout the  
line, Setchell-Carlson also has silicon  
rectifiers, replacing the 5U4 found in  
most transformer-type sets. Some are  
available with push-pull audio-output  
sections, as well as with audio sub-  
chassis adaptable for stereo use.

Of interest to service technicians is  
a flyback transformer that plugs into a  
socket. While this simplifies testing  
and replacement, the special flyback  
may not be too easy to procure, except  
through the manufacturer.

In its 17-inch portable, Setchell-Car-  
lson uses two separate, vertical chassis,  
as shown in Fig. 6. One of these holds  
components for the low- and high-  
voltage circuits.

Other Manufacturers

With the exception of its 17-inch  
receivers, Magnavox is featuring pow-  
er transformers this year. Also, some  
models are available with remote-con-  
trol units—some of the wired type and  
others wireless.

All the latest Olympic models incor-  
porate power transformers and, al-  
though printed wiring is not used, a  
great many packaged circuits are  
found. A rather unusual feature is the  
"local-distance" switch. Instead of ad-  
justing the a.g.c. circuit, as is con-  
ventionally done, this switch connects  
an attenuator between the antenna and  
tuner input in the "local" position.

Packard-Bell is one of the few manu-  
facturers not using a version of the  
gated-beam (quadrature) tube as FM  
detector, continuing to rely on the  
ratio detector instead. Power trans-  
formers, conventional point-to-point

**HOW TO ORDER:** Check items wanted. Return entire  
ad w/check or M.O. including suffi-  
cient postage; excess returned. C.O.D. orders, 25% down;  
rated, net 30 days. Print name, address WITH POSTAL  
ZONE NO., amount money enclosed, in margin. (Canada  
postage, 48c 1st lb., 28c each add'l lb.)





**SEND  
RADIO &  
TV NEWS  
EVERY  
MONTH**

Check one:  3 years for \$10  
 2 years for \$7  
 1 year for \$4

In the U. S., its possessions, and Canada.

Foreign rates: Pan American Union  
countries, add .50 per  
year; all other fore-  
ign countries, add  
\$1.00 per year.

name \_\_\_\_\_  
address \_\_\_\_\_  
city \_\_\_\_\_ zone \_\_\_\_\_ state \_\_\_\_\_

Mail to: **RADIO & TV NEWS**  
Dept. R-49  
434 S. Wabash Ave., Chicago 5, Ill.

### BC-929 3-INCH SCOPE



Low cost station monitor and/or bench scope. Has Horiz., focus, sweep, intensity controls. Tubes: 2-6SN7, 2-6H6, 1-6X5, 1-6G6, 1-2X2, 3BP1 CR Tube. Voltage req. 115V 400 cy. and 24VDC. Complete with tubes, exc. **\$9.95** used **\$12.95** BRAND NEW **\$12.95** Conversion instructions for 110V 60 cyc AC. **65¢**

### ARC-5/R28 RECEIVER



2-meter Superhet. 100 to 156 Mc in 4 crystal channels. Complete **\$24.45** with 10 Tubes. BRAND NEW **\$24.45** 110V AC Power Sup. Kit for above **\$9.75**

### ARC-5/T-23 TRANSMITTER

100-150 Mc Includes 2-832A, 2-1625 Tubes. BRAND NEW **\$21.50** SPECIAL Limited quantity ARC-5/T23 xmitters. OFFER! BRAND NEW, less tubes **\$7.95** Excellent Used **\$5.95** MD-7 MODULATOR for T-23, complete with 4 tubes. LIKE NEW **\$9.95**

### ARC-5 MARINE RECEIVER-TRANSMITTER

Navy Type Comm. Receiver 1.5 to 3 Mc BRAND NEW with 4 tubes **\$16.95** Navy Type Comm. Transmitter 2.1-5 Mc BRAND NEW with 4 tubes and Xtal MODULATOR for above, new with tubes **\$12.45** **\$4.95**

### LORAN R-65/APN-9 RECEIVER & INDICATOR



Used in ships and aircraft. Determines position by radio signals from known xmitters. Accurate to within 1% of distance. Complete with tubes and crystal. Exc. used. Value \$1200.00. Our Price **\$79.50**

### BC-620 FM TRANSCEIVER, 20-28 Mc.

BRAND NEW **\$11.95** PE-120 6-12V POWER SUPPLY, with Tubes and Vib. **\$8.95** Shock Mt. Rack, NEW **\$2.95**

### LORAN APN-4 FINE QUALITY NAVIGATIONAL EQUIPMENT

Determine exact geographic position of your boat or plane. Indicator and receiver complete with all tubes and crystal. INDICATOR ID-6B/APN-4, and RECEIVER R-9B/APN-4, complete with tubes. Exc. used **\$42.50** Receiver-Indicator as above, BRAND NEW **\$59.50** Complete Kit of Accessories for Above: PE-206 Inverter, Set of Plugs, Vib. for Indicator, and Operation Manual. ALL BRAND NEW **\$49.50**

### LORAN APN/4 OSCILLOSCOPE



Easily converted for use on radio-TV service bench. COMPLETELY ASSEMBLED LIKE NEW! Supplied with 5" Scope, type SCPI only **\$14.95** Brand New **\$19.50**

### DYNAMIC BOOM MIKE M-33/AIC.

Low Impedance. With mounting bracket for attachment to headsets. A REAL VALUE at **\$3.95** DYNAMIC HANDMIKE, with "Press-to-talk" Switch on handle, cord and plug—BRAND NEW, only **\$2.95** DYNAMIC HANDMIKE, aircraft, made by Telephonics Corp. Press-to-talk switch on mike. BRAND NEW **\$4.95**

### HI-FI DYNAMIC HEADSET with Cushions

Freq. Range: 40-14000 CPS. No Distortion. BRAND NEW **\$7.85**

### MICROPHONES

Model	Description	Used	NEW
T-17	Carbon Hand Mike	\$4.75	\$6.95
T-30	Carbon Throat Mike	.34	.74
T-45	Army and Navy Lip Mike	1.25	1.25
T-24	Carbon Mike	5.95	5.95
TS-9	Handset	3.88	3.88
RS-38	Navy Type	2.69	4.75

### HEADPHONES

Model	Description	Used	NEW
HS-23	High Impedance	\$2.19	\$4.65
HS-33	Low Impedance	2.69	4.65
HS-30	Low Imp. (featherwt.)	1.15	1.89
H-16/U	High Imp. (2 units)	3.75	7.95

HEADPHONES—300 Ohm Low Impedance HEADSETS, BRAND NEW, PER PAIR **\$3.25** CD-307A Cords, with PL65 plug and JK26 Jack **.99** Earphone Cushions for above—pair **.50**

FL-5 FILTER **.79** FL-8 Filter **\$2.45**

### WILLARD 6-VOLT MIDGET STORAGE BATTERY



3 Amp. Hour. BRAND NEW. 3 5/8" x 1-13/16" x 2 3/8". Uses Standard Electrolyte. Only **\$2.69**

### 2 VOLT BATTERY "PACKAGE"

1-2V. 20 Amp. Hr. Willard Storage Battery **\$2.79** 1-2V. 7 prong Synchronous Plug-in Vibrator **1.49** 1-Quart Bottle Electrolyte (for 2 cells) **1.45** ALL BRAND NEW **\$5.45** Combination Price

### AN/ART-13 100-WATT XMTR



### 11 CHANNELS 200-1500 Kc 2 to 18.1 Mc

# \$48.50

Complete with Tubes

Famous Collins Autotune Aircraft Transmitter, AM, CW, MOW. Quick change to any of ten pre-set channels or manual tuning. Speech amplifier/clipper uses carbon or magnetic mike. Highly stable, highly accurate VFO. Built in Xtal controlled calibrator. EP811s modulate 813 in final up to 90%, class "B." A Real "HOT" Ham buy at our low price! Orig. cost \$1800. **\$48.50** Exc. Used **7.95** 0-16 Low Freq. Osc. Coil for ART-13 **7.95** 24V Dynamotor for ART-13 **11.95**

### AN/APA-38 PANORAMIC ADAPTER

And Wave Analyzer. 30 Mc Center Frequency, 2Mc Band Width. Total scan 10 Mc at one clip. Regular saw-tooth sweep. Variable sweep freq. control 1600 cycles. Use it as regular service scope! Including 11 tubes and 3" scope tube type 3DP1. BRAND NEW **\$19.50**

### ASB-5 SCOPE INDICATOR



BRAND NEW, including all tubes, together with 5 BP1 Scope Tube. Originally used in Navy Aircraft RADAR equipment. Easily converted for AC operation. VALUE \$250.00! OUR LOW PRICE **\$15.95**

### BC-733 VHF 10-TUBE AIRCRAFT RECEIVER.

6-channel xtal control. Freq. 108.3 to 110.3 Mc. Dual filter range. Easily converted for tracking Sputniks! Exc. used **\$9.95** BRAND NEW **\$12.95** Dynamotor for above 12/24 V.—New **\$5.95**

### AN/ARN-5A AIRCRAFT RECEIVER.

11 tube superhet, 3-crystal control UHF for static-free reception. Exc. used with tubes **\$16.95** BRAND NEW **\$19.95**

### STANDARD TUBES

Removed From Brand New Govt. equipment

155	..35	6A5	..45	6X5	..35	813	..95
304	..35	6AK5	..35	6E5	..35	813	..65
6AG5	..35	6CA	..25	6AC7	..35	826	..44
12AT7	..45	6X4	..32	716	..32	970	..70
12X4	..35	6AL5	..33	6BA6	..35	1625	..25
12AX5	..45	614	..59	6AS6	..35	1629	..29

MINIMUM TUBE ORDER: 6 TUBES (6 of a number or 2 assorted).

### SYNCHRONOUS SELSYNS

Transformer, AC Synchronous, for 115 V 60 cycles. Wt. 4 1/2 lbs. Brand New, Each. **\$3.95**

### BC-645 XMTR RECEIVER



15 Tubes 435 To 500 Mc Can be modified for 2-way communication, voice or code, on ham band 420-450 mc. citizens radio 460-470 mc, fixed and mobile 450-460 mc. television experimental 470-500 mc. 15 tubes (tubes alone worth more than sale price!) 4—7F7, 4—7H7, 2—7E6, 2—6F6, 2—9E5 and 1—WE316A. Now covers 460 to 490 mc. Brand new BC-645 with tubes, less power supply in factory carton. **\$29.50** Shipping weight 25 lbs. PE-101C DYNAMOTOR for BC-645, has 12-24V input (easy to convert for 6V battery operation) **\$7.95** UHF ANTENNA ASSEMBLY, for BC-645. Complete set of 10 Plugs for BC-645 **\$5.50** CONTROL BOX for above **\$2.25** SHOCK MOUNT for above **1.25** CONVERSION BOOKLET, Instructions for most useful surplus rigs. **\$2.50**

### BC-659 TRANSMITTER & RECEIVER

27 to 38.9 Mc F.M. Two preselected channels crystal controlled. 5 to 10 watts. Complete with speaker, tubes. Brand New **\$11.95** Exc. Used **7.95** Vibrator Supply for 6-12-24 Volts. NEW **\$9.95** Please include 25% Deposit with order—Balance C.O.D. 50c Handling Charge on all orders under \$5.00. All shipments F.O.B. Our Warehouse, N.Y.C.

## G & G Radio Supply Co.

Telephone: CO 7-4605  
51 Vesey St., New York 7, N. Y.

### BC-923A FM Receiver



Terrific buy for Mobile Hams! 27 to 39 Mc on 4 easily preset channels. Has built-in loudspeaker, xtal calibration, squelch control, sensitivity control. Operates from 12V DC and includes dynamotor. Schematic diagram on case. BRAND NEW, with tubes **\$32.50**

### SCR-522 2-METER RIG!

Terrific buy! VHF Transmitter-Receiver, 100-156 Mc. 4 channels. Xtal-controlled. Amplitude modulated voice. They're going fast! Excellent condition. SCR-522 Transmitter-Receiver, complete with all 18 tubes, top rack and metal case. COMBINATION **\$32.32** Special

Receiver only, with all tubes **\$19.50**  
Transmitter Only, with all tubes **\$22.25**  
Accessories for above available.

### ARB Receiver 4 band 195-9050 Kc.

with all Tubes, Like New **\$17.95**  
Brand New, with Tubes and Dynamotor **\$34.50**

### MOBILE-MARINE DYNAMOTOR

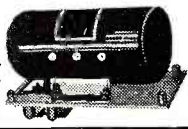

Input 12V DC. Output: 625 V DC @ 225 Ma, for press-to-talk intermittent operation. 5 1/2 lbs. OUR LOW PRICE **\$6.45**

### OTHER DYNAMOTOR VALUES: Excellent BRAND

Type	Input	Output	Used	NEW
DA-19-A	28V 11A	400V .400A	\$4.99	\$6.75
DM-28	28V	224V .07A	2.75	4.75
DM-32A	28V 1.1A	250V .05A	2.45	4.45
DM-33A	28V 5A	575V .16A	1.95	3.75
	28V 7A	540V .25A	1.95	3.75
DM-34D	12V 2A	220V .080A	4.15	5.25
DM-53A	28V 1.4A	220V .080A	3.75	5.45
PE-73C	28V 20A	1000V .350A	7.95	10.50
PE-86	28V 1.25A	250V .050A	2.75	4.95

### SCR-274 COMMAND EQUIPMENT

ALL COMPLETE WITH TUBES

Type	Description	Used	Like NEW
BC-433	Receiver 190-350 KC.	\$14.50	\$16.50
BC-454	Receiver 3-6 Mc.	9.45	12.45
BC-455	Receiver 6-9 Mc.	10.45	12.45
BC-450	3-Receiver Control Box	1.29	1.75

110 Volt AC Power Supply Kit, for all 274-N and ARC-5 Receivers. Complete with metal case, instructions. **\$6.95** Factory wired, tested, ready to operate. **\$10.50** SPLINED TUNING KNOB for 274-N and ARC-5 RECEIVERS. Fits BC-453, BC-454 and others. Only **49c**

BC-457 TRANSMITTER—4-5.3 Mc. complete with all tubes and crystal. BRAND NEW **\$7.85** BC-458 TRANSMITTER—5.3 to 7 Mc. Complete with all tubes and crystal. BRAND NEW **\$7.85** BC-459 TRANSMITTER—7-9.1 Mc. complete with all tubes and crystal. BRAND NEW **\$12.75** ARC-5/T-14 TRANSMITTER—3 to 4 Mc. BRAND NEW complete with all tubes & crystal **\$8.85** BC-456 Receiver 190-350 KC. USED **5.45** NEW **5.95** BC-451 Transmitter Control Box 1.25 NEW **1.49** POWER SUPPLY KIT, for All Command Transmitters. Provides all needed voltages. A quality kit, only **\$29.50**

### BC-906 FREQ. METER—SPECIAL!



Cavity type, 145 to 235 Mc. BRAND NEW, complete with antenna. Manual included. OUR LOW PRICE **\$9.88**

### BC-603 FM RECEIVER

10-channel push button tuning or continuous tuning, 20-28 Mc. Complete with speaker, tubes, **\$19.95** squelch. BRAND NEW **\$19.95** 32 or 24V Dynamotor for Above Exc. Used **\$4.25** Brand New **\$5.50**

### AC POWER SUPPLY FOR BC603, 683

Interchangeable, replaces dynamotor. Has On-Off Switch. NO RECVR. CHANGE NEEDED. Provides 220VDC @ 50 Ma, 24VAC @ 2 Amps. Complete kit, with easy instructions. **\$7.45** Wired **\$9.49** Complete 240-page Technical Manual for BC-603, 604 **\$2.95**

### BC-221 FREQUENCY METER

SPECIAL BUY! This excellent frequency standard is equipped with original calibration charts, and has ranges from 125 Kc to 20,000 Kc with crystal check points in all ranges. At our smashing low price it's FIRST COME FIRST SERVED! Hurry, quantity is limited! Like New **\$189.50** BC-221 Modulated Type **\$129.50** Original 1000 Kc Crystal for BC-221. BRAND NEW **\$8.45**

### MIDGET FAN MOTOR



1 3/8" square x 2" long. 1 1/2" shaft extends 1/2" 10,000 RPM. 24V DC. Input. Complete with fan **\$2.19**

SCHEMATIC DIAGRAMS For any equipment on this page, each **65c**

# LAMPKIN METERS + FCC LICENSE = HIGHER INCOME!



Over a million mobile-radio installations need regular, high-grade maintenance and measurements per FCC regulations!



**LAMPKIN 105-B MICROMETER FREQUENCY METER**

Range 0.1 to 175 mc. (to 3,000 mc. by checking multipliers). Gives error from assigned frequencies. VHF CW signal generator. Weight 13 lbs., width 13", \$220.00

**LAMPKIN 205-A FM MODULATION METER**

Reads peak FM voice deviation  $\pm 12.5$  kc. and  $\pm 25$  kc., tunes 25-500 mc. in one band. Relative field-strength meter. Speaker. Jack for oscilloscope. Weight 13 lbs., width 12". \$240.00.

**LAMPKIN LABORATORIES, INC.**  
BRADENTON, FLORIDA

This means money... steady income... right in your own area.

**LAMPKIN METERS are the preferred test equipment!**

Send for free booklet... "HOW TO MAKE MONEY IN MOBILE-RADIO MAINTENANCE". No charge... just use coupon below.



LAMPKIN LABORATORIES, INC.  
MFM Division, Bradenton, Florida

At no obligation to me, please send

Free booklet  Data on Lampkin meters.

Name \_\_\_\_\_

Address \_\_\_\_\_

City \_\_\_\_\_ State \_\_\_\_\_

**PRICES ARE BORN HERE  
RAISED ELSEWHERE**

**RS-A/ARN-7 COMPASS RECEIVER**  
Aircraft Radio Compass Receiver. 4 Band Superhet. 100 KC to 1750 KC. Ideal for Boats or Planes. Exc. Used Cond. **\$65.00**

**APN-1 TRANSCEIVER**  
400-MC. Allmeter Transceiver. Ideal for 420 MC Band. Contains 14 Tubes and Y 101 Oscillator unit and 24 VDC Dynamotor. Exc. Used Condition with Tubes and Y 101. **\$9.95**  
Less Tubes with Y 101. **\$4.95**  
Wgt. 20 Lbs.

**MAGNETS**  
H. Power Radar Magnets. Approx. 2000 Gauss. Alnico V. Can be taken apart and used separately or together. Will lift 5 times its own weight. All New **\$7.50**

**RDZ RECEIVER**  
200-400 MC Narrow or Broad Band I.F. and Narrow or Broad Band A.F. 115 V., 60 Cy. operation. 10 Pre-set channels tuned automatically by motor driven mechanism for rapid frequency change. One of the BIGGEST Buys on Surplus. Approx. Weight **\$24.95**  
150 lbs. In excel. condition.

**INTERPHONE AMPLIFIER**  
Type BC 677-A real Parts Buy! Contains 2-6V6 Tubes; a 24 V. Dynamotor; Audio Transformers; Condensers; Switches; Etc., Etc. Complete in a steel box measuring 9" x 9" x 4 1/2". Wgt. 25 lbs. **\$1.50**  
Excel. condition.

**PARABOLIC MIRROR**  
12" Diameter, Optical Glass, manufactured by Bausch & Lomb. 2" Depth with 4" Diam. Hole in center. Ideal for Solar Furnace or Audio Reflector. **\$3.95**  
Wgt. 16 lbs. All New.

**MID RANGE DRIVER**  
Racon Revux-B similar to PM 615 Operating Watts 30; Peak Watts 60; Frequency Response 90-7000 cycles, 15 ohm VC Imp., 1 7/16 mounting **\$9.95**  
bushings. \$50.00 Value. All New.

**SYNCHRONOUS GEAR MOTOR**  
Haltzer-Cahot 60 RPM Geared Motor. 115 V., 60 Cy. 100 Oz. in Torque reversible motor, 4" square mounting. Shaft 1/4". All NEW... **\$9.95**

See our previous ad for Special Surplus Items. All prices F.O.B. S. F., Calif. orders add 3% Sales Tax. 50% Dep. on all C.O.D.'s. Purchases under \$5.00 send full amount. Items subject to prior sale.

**STANDARD SURPLUS**  
1230 Market St., San Francisco 3, Calif.  
Telephone HEMlock 1-3106

**Amazing New Handbook  
Takes The "Headache"  
Out of TV Trouble Shooting**



**Pin Point  
TV TROUBLES  
IN  
10 MINUTES**

**SAVES TIME...  
ELIMINATES GUESSWORK!**

Now, a simple, practical way to accurately spot the cause of trouble in any TV set. FAST! Quick, easy-to-understand tests tell you in which of 5 TV set sections to find the cause of trouble. Fool-proof Check Charts help you locate the exact trouble spot at once, from as many as 700 possibilities. Book fits easily into your tool kit for handy on-the-job use. Over 300 spiral bound fast reference pages with 50 time-saving Check Charts; dozens of easy to understand diagrams and tests; explanations of circuits and designs. The hours and aggravation this amazing handbook can save you on a single servicing job more than pay its low price!

**USE IT ON 7 DAYS FREE TRIAL!**

Send no money, just the coupon. We'll rush your copy on FREE TRIAL. After 7 days, send only \$3.95 plus postage or return the book and owe nothing. Act NOW!

**MAIL COUPON NOW!**

Educational Book Publishing Div.  
COYNE ELECTRICAL SCHOOL, Dept. 49-RT  
1501 W. Congress Pkwy., Chicago 7, Ill.

Rush TV handbook for 7 days FREE TRIAL per offer.

Name \_\_\_\_\_ Age \_\_\_\_\_

Address \_\_\_\_\_

City \_\_\_\_\_ Zone \_\_\_\_\_ State \_\_\_\_\_

Check here if \$3.95 enclosed. We pay postage. 7-day money-back guarantee.

wiring, and established circuitry mark this manufacturer's sets as quite conservative in design. A cable-connected remote control device is available on some of the new models.

**Conclusion**

Another year has brought few really novel designs, but there have been quite a few changes (many of them improvements), including greater variation than last year within the separate lines of individual manufacturers. Such long-heralded developments as truly flat picture tubes, fully or partially transistorized TV sets, and a sharp upswing in color continue to be exciting prospects for the future. For the technician, 1959 is not the year for startling new requirements in technique, fundamental knowledge, or test equipment. For 1960—who knows?

**DAYTON "HAMVENTION"**

THE Dayton Amateur Radio Association, Inc. has scheduled this year's "Hamvention" for May 9th at the Dayton Biltmore Hotel in Dayton, Ohio.

Each year representatives of the ham "fraternity" in the U.S. and Canada convene in Dayton to learn what is new and to meet friends and see new equipment.

Last year some 2500 hams were registered and an even larger turnout is expected this year. Registration will take place on Saturday morning and the event will wind up with a gala banquet Saturday evening.

For further details on this amateur event, write to Robert E. Wilcox, 2438 Westport Dr., Dayton 16, Ohio, or call him on K8EJL.

**SSB GROUP ELECTS**

THE SSB Amateur Radio Association has named a new slate of officers and directors which will serve during 1959.

S. Edwin Piller, W2KPQ of NBC, was named president with Irving Binger, W2CMM, vice-president; Alexander MacDonald, W2PRB of Metropolitan Broadcasting Co., secretary; and Irving Richter, W21VW, treasurer.

The board of directors includes Edward Gundrum, W2BXY of NBC; Frank A. Gunther, W2ALS of Radio Engineering Lab; Herman G. Mustermann, W2TP of U.S. Rubber Co.; Norman L. Rowe, K2DFW; Benjamin H. Russ, W2QZ of CBS; Stewart W. Seeley, W2ZE of RCA; Irving L. Strauber, K2HEA; and Harry Whiting, W2JXH.

"Hold-over" directors include: George W. Bailey, W2KH, of the IRE; Robert W. Gunderson, W2J10, Braille Technical Press; John F. Rider, W2RID, publisher; and M. B. Kahn, W2KR, ARRL director.

The Association meets each month in the NBC studios in the RCA Building in New York City. It publishes a monthly newsletter and sponsors the SSB Dinner in New York City each year during the I.R.E. Convention. Arrangements are being made to set up chapters in principal cities throughout the U.S.

Among the prominent individuals holding membership in the organization are: General Curtis LeMay, K4RFA; Herbert Hoover, Jr., W6ZH; General Francis H. Griswold, K0DWC; and Brig. General E. Earle Cook, W4FZ.

A letter to the president at 157-32 20th Avenue, Whitestone 57, New York, will bring full details.



**NOT USED, NOT PULLED OUT OF OLD SETS**

# Brand New TUBES

**BETTER  
THAN  
70%  
OFF!**

**BETTER  
THAN  
70%  
OFF!**

**and RAD-TEL'S FIRST QUALITY!  
REMEMBER... ALL RAD-TEL TUBES  
GUARANTEED ONE FULL YEAR**

**Ask for Types Not Listed - Send for New Free Tube & Parts Catalog**



**RAD-TEL TUBES**

Individually Boxed!  
NOT USED, NOT PULLED  
OUT OF OLD SETS  
Every Rad-Tel Tube Is  
**BRAND NEW**  
Guaranteed 1 Full Year!

Type	Price	Type	Price	Type	Price	Type	Price	Type	Price	Type	Price
1AX2	.62	5BQ7	.97	6BC5	.54	6CU6	1.08	12AF6	.49	12V6GT	.53
1B3GT	.79	5CG8	.76	6BD6	.51	6CY7	.71	12AQ5	.52	12W6	.69
1S5	.51	5CL8	.76	6BE6	.55	6DE6	.58	12AT6	.43	17AX4	.67
1U4	.57	5J6	.68	6BF6	.44	6DG6GT	.59	12AT7	.76	17BQ6	1.09
1U5	.50	5T8	.81	6BG6G	1.66	6DQ6	1.10	12AU6	.50	19AU4	.83
1X2B	.82	5U4GB	.60	6BH8	.87	6DT6	.53	12AU7	.60	19BG6	1.39
2AF4	.96	5U8	.81	6BK7	.85	6J5GT	.51	12AV6	.41	19T8	.80
2BN4	.60	5V6	.56	6BN4	.57	6J6	.67	12AV7	.75	25BQ6GT	1.11
3AL5	.42	5X8	.78	6BN6	.74	6K6GT	.58	12AX7	.63	25C5	.53
3AU6	.51	5Y3GT	.46	6BQ/		6L6	.84	12AZ7	.86	25CD6	1.44
3AV6	.41	6AB4	.46	CU6	1.25	6S4	.48	12B4	.63	25CU6	1.11
3BZ6	.55	6AC7M	.96	6BQ5	.65	6SK7GT	.74	12BD6	.50	25L6	.57
3BY6	.55	6AF4	.97	6BQ6GT	1.05	6SN7GT	.65	12BE6	.53	35C5	.51
3CB6	.54	6AG5	.65	6BQ7	.95	6T4	.99	12BH7	.73	35Z5GT	.60
3CF6	.60	6AH6	.99	6BR8	.78	6T8	.80	12BQ6GT		50B5	.60
3DT6	.50	6AK5	.95	6BY6	.54	6U8	.78		1.06	50C5	.53
3V4	.58	6AL5	.47	6BZ6	.54	6V6GT	.54	12BY7	.74	50L6GT	.61
4BN6	.75	6AM8	.78	6BZ7	.97	6W4GT	.57	12C5	.56		
4BQ7	.96	6AN8	.85	6C4	.43	6W6GT	.69	12CU5	.58	All Tube Prices	
4DT6	.55	6AQ5	.50	6CB6	.54	6X4	.39	12CU6	1.06	Subject To Change	
4BZ7	.96	6AT6	.43	6CD6	1.42	6X8	.77	12DQ6	1.04	Without Notice!	
4CB6	.59	6AT8	.79	6CF6	.64	6Y6G	.65	12F8	.66	<b>NOT</b>	
5AM8	.79	6AU4GT	.82	6CG7	.60	8AU8	.83	12K5	.65	<b>AFFILIATED</b>	
5AN8	.86	6AU6	.50	6CG8	.77	8AW8	.93	12L6	.58	<b>WITH ANY</b>	
5AQ5	.52	6AU8	.87	6CM7	.66	11CY7	.75	12SA7M	.86	<b>OTHER MAIL</b>	
5AT8	.80	6AV6	.40	6CN7	.65	12A4	.60	12SK7GT	.74	<b>ORDER</b>	
5BK7A	.82	6BA6	.49	6CS6	.57	12AD6	.57	12SN7GT	.64	<b>TUBE CO.</b>	

**RAD-TEL TUBE CO.** Est. 1945 **55 Chambers Street  
Newark 5, N. J.  
Mitchell 2-3147**

TERMS: A 25% deposit must accompany all orders—balance C.O.D. All shipments F.O.B. Newark warehouse. Orders under \$5-50c Handling Charge. Subject to prior sale. No C.O.D.'s outside continental U.S.A.



**STOP!**  
Demand the finest in Electronic Test Equipment—EMC, of course. You get the most quality per measurement dollar!

**NEW! EMC Model 301 Speedi Tube Tester**

Checks tubes in seconds. Checks shorts, leakages, and quality. Over 375 tubes, including OZ4, now listed. New listings available. Checks and rejuvenates Picture Tubes with Model PTA (Picture Tube Adaptor), at only \$4.50. Model 301P (illustrated),



with 4½" meter & oak. Carrying case .....\$47.50  
Kit ..... 33.20  
Model 302C, (with 7½" meter) ..... 62.90  
Kit ..... 47.90



**NEW! EMC Model 108 Handi Tester**

The only appliance and auto battery tester in its price class to use a D'Arsonval, instead of an iron vane type meter. Gives exclusive advantages of maximum accuracy and scale length, and minimum battery replacement cost . . . at no added charge. Complete with test leads and instruction manual.

Wired .....\$15.95 Kit ..... 12.95

**NEW! EMC Model 905-6A Battery Eliminator, Charger, and Vibrator Checker**

A MUST for auto radio service. Features continuously variable voltage output—in either 6 or 12 volt operation. Checks all 6 or 12 volt vibrators.



Wired .....\$67.90 Kit ..... 44.90

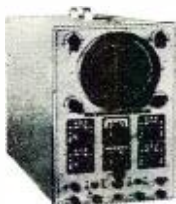

**NEW! EMC Model 601, Wide Band Oscilloscope for Color & Monochrome TV**

Features full 5 mc band with push-pull vertical amplifier with sensitivity .02 volts per inch, retrace blanking amplifier for clearer pictures, and multivibrator sweep from 15 cycles to over 75 kilocycles. Wired and tested ...\$117.90

**NEW! EMC Model 206P Dynamic Mutual Conductance Tube Tester**

The lowest priced mutual conductance tube checker on market. Checks tubes for microhm value and gas content. Completely flexible switching. Your best buy in a quality tube tester. (Hand rubbed Carrying Case) ...\$83.50



Yes, tell me more, send me—FREE—RN-4-59 a detailed catalog of the complete EMC line.

NAME \_\_\_\_\_  
STREET \_\_\_\_\_  
CITY \_\_\_\_\_ STATE \_\_\_\_\_



Electronic Measurements Corp.  
625 B'way • New York 12, N. Y.  
Ex. Dept. 370 B'way, N. Y. 13

**Hi-Fi Test Report**  
(Continued from page 47)

quieting, at least 11  $\mu$ v. input is needed. The tuner is supplied with a built in line-cord antenna which proved entirely satisfactory for use within a reasonable distance from the stations. For fringe area reception this antenna does not provide the best results. It would be necessary to use an outdoor antenna system.



Over-all view of stereo remote control.

**STEREO REMOTE CONTROL**

**A**N extremely novel and useful stereo center remote unit has just been announced by *Lafayette Radio*. It is their Model KT-315 and is available only in kit form. This is the first time that we have had an opportunity to check a system of this sort that uses tubes. Previous units checked were passive in that no tubes were used. It is surprising how many various functions and how flexible such a compact unit can be. In addition to conventional stereo reproduction one can operate monophonically through both speakers from either of the two channels. The unit provides for reverse channel, reverse phase, and then a combination of both reverse phase and channel. It has individual volume controls. However, they are of the clutch type and, when engaged, both channel controls rotate together. A third channel output is provided which is basically a 50% mixture of both of the channels. This output level is variable and therefore can be adjusted to an individual's likes.

One of the main features of this unit is the incorporation of what is called a "calibrate" adjustment. Its main purpose is to provide equal output levels when you switch through the various operations. The method by which this is done is rather unique. It is accomplished by using a monophonic record, or any single channel source, and passing the signal from one of the channels

through a phase inverter and comparing the output with the other channel. When the gains of both channels are identical (by adjustment of gain controls on the preamplifiers) the signals will be equal in amplitude and since they are 180 degrees out-of-phase, they will cancel and produce a null in the sound output.

Another feature which we haven't run across in any of the other units we have tested is a "bridge" control which, in effect, reduces any tendency toward "hole-in-the-middle." With a measured channel separation of 48.5 db it is possible, if the speakers are placed too far apart, to obtain an extreme "ping-pong" effect. With proper positioning of the bridge control it is possible to reduce the channel separation to any desired degree, even to zero, which would then provide a monophonic reproduction effect.

Two considerations should be kept in mind when deciding to use any central type of control unit. One is its specific application and the other is its performance in that such a unit should not add any coloration to the response and its hum and distortion should be extremely low. As to the performance of this particular unit, all we can say is that the engineer who designed it did a remarkably good job. The frequency response is perfectly flat from 30 to 15,000 cps. The IM distortion (4:1 ratio, 60 and 6000 cps) with 1 volt in

Circuit diagram of the KT-315 stereo control center. Two tubes are used.

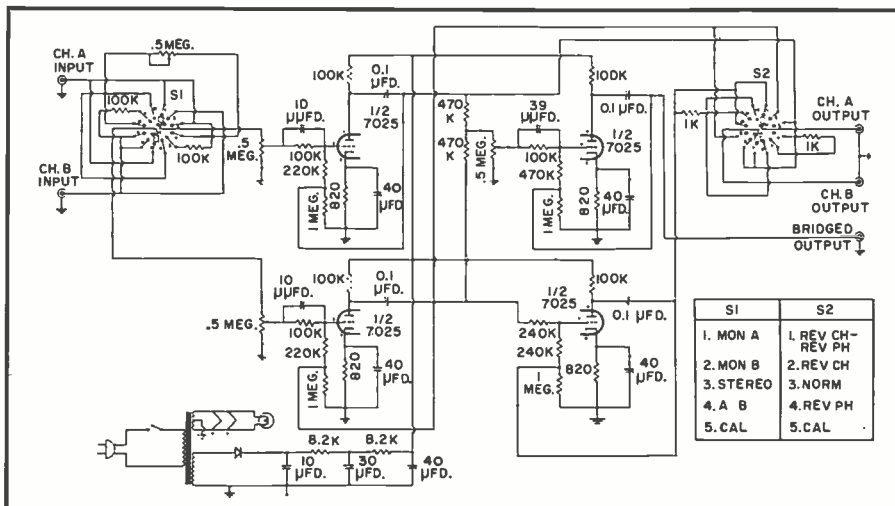

**A**.... Always  
**B**.... Buy  
**C**.... Columbia

**WHY BUY ELSEWHERE WHEN...  
 COLUMBIA UNDERSELLS EVERYBODY!!!**

**PE-103 DYNAMOTOR!**  
 Columbia rolls back prices to 1946!  
 6 or 12 V. input; output 500 VDC @ 160 mls.  
 will handle 200 mls. Complete with filter,  
 condensers, mounting base, circuit breakers,  
 and two 8 ft. heavy duty battery cables. **\$12.50**  
 Excl. (Ship. Wt. approx. 100 lbs.)

**ARC-1 TRANSMITTER-RECEIVER**  
 100-150 mc, 10-channel, crystal controlled.  
 Built-in 24 VDC dynamotor. Mfg. by Collins.  
 F.B. for aircraft, CAP, mobile, etc. **\$49.95**  
 Good cond.

**BC-659 & BC-620 ACCESSORIES**  
**PE-117 VIBRATOR POWER SUPPLY:** 6 or  
 12 V. Like new. Only **\$3.95**  
**SPARE TUBE KIT:** Includes 8 tubes!  
 New **3.95**  
**MAINTENANCE KIT:** Includes crystals!  
 New **1.95**  
**TELEPHONE HAND SET:** New. Only **3.95**

**COLUMBIA SLASHES PRICE—  
 ON MEASUREMENTS CORPORATION  
 MODEL 84 SIGNAL GENERATOR!!!**  
 Freq.: 300-1000 MC in one band. Direct  
 reading dial. Freq. accurate to  $\pm 0.5\%$ .  
 Output voltage continuously variable from  
 0.1 to 300,000 microvolts! Output im-  
 pedance 50 ohms. Modulation 0 to 30%.  
 Choice of 400, 1000 to 2500 cycles.  
 Pulse freq.: 60 to 100 kc in 3 ranges;  
 60-1,000, 600-10,000, and 6,000-100,000  
 pulses per second. Power supply 117 V., 50-  
 60 cycles. **ORIGINAL COST WAS \$1,900.00!**  
 Dim.: 13 x 26 x 12 1/2". Excel-  
 lent cond. Wt. 55 lbs. **ONLY \$195.00**

**MEASUREMENTS CORP.  
 MODEL 80 SIGNAL GENERATOR**  
 Freq.: 2-400 MC in 6 bands, accurate to  
 $\pm 0.5\%$ ! Output voltage continuously vari-  
 able from 0.1 to 100,000 microvolts. Am-  
 plitude mod. is continuously variable from  
 0 to 30%. Power input 117 V., 50-60  
 cycles. 70 W. **ORIGINAL COST WAS**  
**\$625.00!** Dim.: 11 1/2 x 19 3/4 x 11 3/8".  
 Excellent cond. Wt. 75 lbs. **\$295.00**  
 ONLY

**POWER TRANSFORMER**  
 2,000 VCT @ 300 ma. Continuous 2,000 VCT  
 @ 500 ma on CW. 115 V. 60 cycles, pri.  
 potted smfr. Mfg. by Chicago for **\$6.95**  
 Collins Radio. Brand Name. ONLY

**Excel! ARC-5 TRANSMITTERS With tubes!**  
**T-18/ARC-5:** 2.1-3 Mc. ONLY **\$4.95**  
**T-19/ARC-5:** 3-4 Mc. Special at... **4.95**  
**T-20/ARC-5:** 4-5.3 Mc. Reduced to... **3.95**  
**T-21/ARC-5:** 5.9-7 Mc. ... **3.95**  
**MD-7/ARC-5 MODULATOR:** For above.  
 Excel. With tubes. **7.95**

**PERMA-FLUX DYNAMIC HI FI HEADSET!**  
 Plastic fiber cones PLUS padded chamomile ear  
 muffs. 600 ohms. Monaural or bin-  
 aural type. (Specify which) **\$9.95**

**SCR-522 TWO METER POWERHOUSE!**  
 VHF Xmtr-Recvr. Has all components! 100-  
 150 MC. 4-channels, amplitude modulation,  
 crystal controlled. WITH DYNAMOTOR, con-  
 trol box, some plugs and all 18 **\$24.50**  
 tubes! Excellent cond. ...  
**RA-62 AC POWER SUPPLY** for above. Like  
 new **\$24.95**

**SCR-625 (Metal) MINE DETECTOR**  
 SCR-625. Locate that leaky pipe or hidden  
 treasure! Complete in carrying case.  
 Excellent condition **\$19.95**

**RCA AUDIO OSCILLATOR**  
 Model 154. Freq.: 30-15000 cps. Output im-  
 ped. 250, 500 and 1,500 ohms.  
 Excel. cond. **\$14.95**

**RC-312 COMMUNICATION RECEIVER**  
 1.8-18 MC in 6 bands. 2 stages RF. **\$39.95**  
 12 VDC. Good condition.

**LM FREQUENCY METERS** Excellent.  
 125-20,000 kc. With modulation. **\$39.95**  
 Complete with calibration book. None  
 better—or lower priced! Ea.  
 All Orders FOB Los Angeles. 25% deposit re-  
 quired. All items subject to prior sale. NOTE:  
 MINIMUM ORDER \$3.00. WRITE TO DEPT. R.

**Columbia ELECTRONICS**  
 2251 W. WASHINGTON BLVD.  
 LOS ANGELES 18, CALIFORNIA

**Electronics Engineering  
 Degree in 27 Months**

Realize your dream. Become a graduate engineer. Share rewards awaiting college men... higher income, rapid advancement. Important firms visit Tri-State to interview seniors. Approved for veterans.

**Electronics or Power Major**

Bachelor of Science Degree in 27 Months in Electrical, Mechanical, Civil, Chemical, Aeronautical Engineering. In 36 Months a B.S. in Business Administration (General Business, Accounting, Motor Transport Management majors). For earnest, capable students. Small classes. Enrollment limited. More professional class hours. Mature students. Well-equipped labs. Modest costs. Beautiful campus. Year-round operation. Enter June, Sept., Jan., Mar. Write J. H. McCarthy, Director Admissions, for Catalog and "Your Career" Book.

**TRI-STATE COLLEGE**  
 1649 College Ave. Angola, Indiana

April, 1959

and 1 volt out was .0097%. The harmonic distortion was .06% measured anywhere between 30 and 15,000 cps. The hum with controls set for normal stereo operation is down 84 db from 1 volt.

If one were to consider buying a complete hi-fi system, it would certainly be best to plan on using conventional stereo preamplifiers, whether they are integrated with the power amplifiers or not. However, there are many hi-fi enthusiasts today who have complete monophonic equipment and hesitate to scrap any part of it. Then the central remote control idea, plus the additional channel equipment, is feasible. Those who have sufficient equipment for dual monophonic systems certainly will be far ahead dollar-wise by simply obtaining a remote control unit and converting the original sound source to stereo.

**TAPE RECORDER  
 STROBE**

ONE of the simplest methods to check the speeds of tape machines is by means of ORRadio's new stroboscope. When used it is to be held lightly but firmly against the surface of the mov-

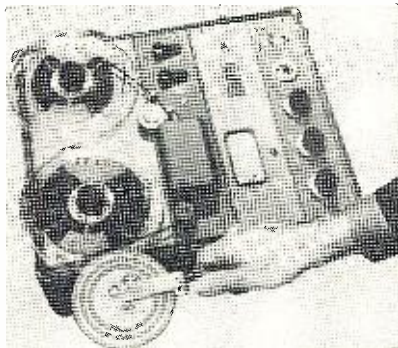

ing tape, preferably on the supply reel. Its principle of operation is identical to that of conventional strobe discs to check turntable speeds. In this case it will accurately check recording speeds of 3 3/4, 7 1/2, and 15 ips. -30-

**MARS SCHEDULES  
 FOR APRIL**

HERE is the April schedule for the First Army MARS SSB Technical Net. Transmission are on Wednesday evenings, 9 p.m. (N. Y. time) on 4030 kc. upper sideband.

April 1—"Variable Reactance (Parametric) Amplifiers" by Dr. Sidney Deutsch, associate professor electrical engineering, Polytechnic Institute of Brooklyn.

April 8—"Electro-Mechanical Filters" by Oscar P. Olson, department head research and development, Collins Radio Company.

April 15—"Phosphors and Electro-Luminescence" by Dr. Paul Goldberg, engineering specialist, Sylvania Electric Products Corp.

April 22—"Atlas-Score Communications System" by S. P. Brown, deputy director, Transmission Facilities Div., U. S. Army Research and Development Lab., Fort Monmouth.

April 29—"Interchanging Scientific Information by Multi-Lateral Radio Communication" by S. Edwin Piller, W2KQP/A2KPO, Director, First U. S. Army MARS SSB Technical Net. -30-

**UNBEATABLE!**

**SPAULDING**

**"STRATO-TOWER"**

FEATURING THE

**ALL NEW  
 SCREW  
 ANCHOR  
 BASE**

1. No Concrete Necessary
2. Completely Self-Supporting
3. Unconditionally Guaranteed (Base more satisfactory than concrete or your money back)
4. Absolutely No Hole To Dig
5. Fast Installation... Base in 15 Min., Tower in 90 Min. (2 men)
6. One Base Fits All Tower Sizes To 48 Ft.
7. Tower Completely Galvanized
8. All Riveted Construction
9. Beaded Channel Leg (Will not rust inside like tubular type towers)

**No. X40B (ILLUSTRATED)**  
 40 FT. HIGH

**\$99.95**

LIST

OTHER MODELS FROM 8 FT. TO 64 FT.

U. S. Patent No. 2806560

How  
 Tower  
 Mounts  
 On  
 Screw  
 Anchor  
 Base

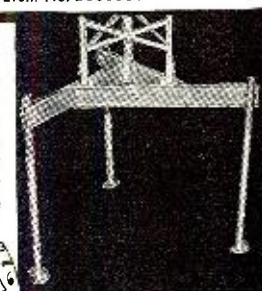

**WRITE**

today for complete literature and details on where to get Spaulding Strato-Towers for TV—Ham—Civil Defense—Industrial Communications.

**SPAULDING PRODUCTS COMPANY**

550 West Barner Street

Frankfort, Indiana

IN CANADA: Delhi Metal Products Co., Delhi, Ontario

# Now Service Any TV Set Like a "PRO"!



Brand-New Edition of Famous Shop Manual Will Lick "Tough Dogs," Save You Time, Increase Your Income 25% to 65%!



MAN, if you've ever cussed over a tough repair . . . if you've ever wanted more money . . . if you've ever wanted your business and reputation to grow . . . here's a powerful shove in those directions—the new *Television Receiver Servicing!* Everything . . . and that means every new idea, every technique, every profitable practice . . . collected from little repair shops, part-time servicemen, big research centers . . . all the "red meat" of TV maintenance, repair and service has been collected into this big 300-page guide and manual.

## Huge . . . Yet So Easy to Use!

You want quick facts on how to deal with tough antenna installations and ghost problems? Turn to Chapter 1 and get many field tested suggestions. What frequency an antenna should be cut to? Turn to page 6 and get 4 columns of clear explanation, with examples. What does an ideal video amplifier response curve look like? Page 127 illustrates it for you. What should you know about servicing color television receivers? Read the simple text from page 281 to page 300. Antennas (30 pages) . . . installing TV receivers (12 pages) . . . test equipment (27 pages) . . . RF, IF and video detector stages (45 pages) . . . video amplifiers (12 pages) . . . AGC systems (10 pages) . . . picture tubes, test patterns, deflection systems (83 pages) . . . receiver alignment (20 pages) . . . UHF . . . Color (32 pages) . . . there's even an easy-reference trouble-shooter's chart, and end-of-chapter questions, plus a complete, subject-by-subject index to put everything at your fingertips fast! With all this material, 421 pictures, 15 chapters, explained in A-B-C fashion, it's no wonder that TV Receiver Servicing is the "Bible" of the industry!

## 10-Day FREE Examination for Readers of This Magazine

Use this for ten full days at our expense. Put its good sense to work on your toughest problems. If you're not 100% sure it's the biggest profit-making and time-saving friend you ever had, return it. You owe nothing. But mail coupon now. Once this printing is gone, it will take months to rush out another.

**D. VAN NOSTRAND COMPANY, INC.**  
Dept. 374, 120 Alexander St., Princeton, N. J.

Mail This for Free-Use Copy

**D. VAN NOSTRAND COMPANY, INC.**  
Dept. 374, 120 Alexander St., Princeton, N. J.

Please send me—for 10 days' FREE USE—a copy of the new 4th Edition of *Television Receiver Servicing*. If I'm not completely sure it will increase my income by at least 25%, I'll return it within 10 days and owe nothing. Otherwise I'll pay \$2.50 down, plus small delivery charge, then \$2.00 a month for two months as full payment.

Name   
Street   
City  Zone  State   
 SAVE POSTAGE by enclosing \$6.50 with this coupon. Same return privilege, money back if not completely satisfied.  
(In Canada: 25 Hollinger Rd., Toronto 16)

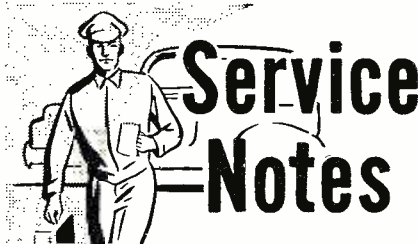

## OLYMPIC FLYBACKS

When the horizontal-output transformer on an *Olympic* receiver that is several years old must be replaced, the problem of obtaining a suitable unit is eased somewhat by the fact that there is a certain amount of interchangeability among the earlier flybacks. For example, if a few simple precautions are observed, types TR2615, TR2092, and TR2293 are sufficiently similar so that any one in this group may be used for another. On type TR2092, the black lead for the plate of the horizontal-output tube is fitted with a spring clip to match the cap of a 6BG6. This same lead on type TR2293 or TR2615 uses a clip that fits the plate cap of a 6BQ6

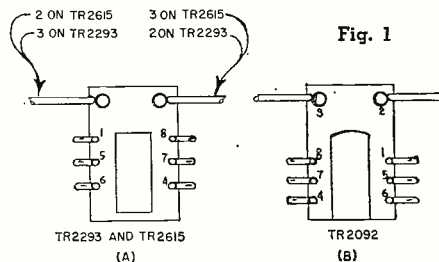

instead. If the replacement unit does not have the correct spring clip, the clip on the defective transformer being removed may be substituted.

The location of connections on the transformers differs physically, too. The information that follows may be used in conjunction with Fig. 1 to determine how connections should be made. The black lead for the plate cap of the horizontal-output tube is on the right-hand side of the terminal board of the TR2615; whereas this same lead appears on the left on types TR2092 and TR2293. A similar situation applies with respect to the red lead for the plate of the high-voltage rectifier. It appears to the right on the TR2615, but to the left on the TR2092 and TR2293. Also terminals 1, 4, 5, 6, 7, and 8 are positioned in one way on TR2092 and in another on TR2293 and TR2615, as shown in Fig. 1. When interchanging, transfer all leads to the same terminal numbers. Do not transfer to the same physical locations.

## WESTINGHOUSE: AFT FAULT

In connection with chassis V-2372 using Automatic Fine Tuning, instances have been reported where, during initial warm-up, a.f.t. does not pull in on the proper channel. The cause will generally be slow heating in the horizontal-output and/or damper tubes. When this happens, the keying pulse required by the a.g.c. tube for proper operation is not available, and

- ★ 0-500 Microamps (Basic Movement) 3/4 Aircraft Meter. Marked Fuel Air Ratio mfd. Cambridge instrument. . . . . 2 for 3.00; 1.59 ea.
- ★ Heavy Duty Power Trans PRI. 220 V 60 cye (can be tapped for 115V) Sec. 3800 VCT/350 MA. Mfd. by W. E. Co. For 400 h x 9 lg. x 9 lg. . . . . for 30.00
- ★ POWER TRANS PRI. 115v or 220v 60 cye. Sec. 1400. VCT 300 MA (Conservative) 6.3v-4A/6.3v-1A/5V-4A. Mfd. by W. E. Co. Body Dim 7 21/32 h x 6 23/32 lg. 5 15 16 wd. . . . . for 15.00
- ★ HEAVY DUTY CHOK. 13.7 Hy 450 MA (600MA Conservative) Mfd. by Merit. 3200 VRMS 120 ICR. 6.95
- ★ Radio TRANSMITTER T-59/GEN. New 14.95
- ★ PLUG-IN TUNING UNIT. A unit of Model GP-7 Freq. Range 800-1500 KC. . . . . New 4.95
- ★ GLOBAR non-inductive resistor 600 ohms 1/8 Watts. . . . . NEW .98 ea. 12 for 10.00
- ★ PORTABLE AMPLIFYING MEGAPHONE. Complete w/ electric megaphone and microphone, pistol grip and mirror switch additional hand microphone and switch portable tripod stand comb. amplifier and battery case. . . . . BRAND NEW 39.95
- ★ FILTER CHOKE 3HY. 500 ma. 91 ohms DCR. HI POT 2000 VRMS (small) . . . . . 2.95
- ★ AMPLIFIER RC-688-A unit line termination . . . . . 19.95
- ★ SORENSON REGULATOR input 195-130 volts output 115 at 1 KVA. . . . . Used 59.95
- ★ VERTICAL FLIGHT GYRO type C-1 Autopilot. . . . . 29.95
- ★ BC-645 XMTR RECEIVER WITH 19.95
- ★ TUBES 435 to 500 mc. . . . . BRAND NEW 5.95
- ★ PE-101 DYNAMOTOR . . . . . BRAND NEW 5.95
- ★ VARIABLE CAPACITOR. Glass Dielectric Concentric Type 1-8 MMFD. . . . . 6 for 1.00; 100 for 15.00
- ★ ZAPI tube w/socket. . . . . 1.95
- ★ DYNAMOTOR-EICOR. 6 Volts in-output 600V 150 MA. . . . . NEW 6.95-2 for 13.00
- ★ POWER SUPPLY UNIT PE-110-B 115V/60 cye. (used with BC-689) . . . . . Like New 49.95
- ★ TEST SET Echo Box 1150 T 1350 mc w/accessories & Manual. . . . . 39.95
- ★ BC-652 Receiver 2 6mc w/tubes & dyn. Like new 14.95
- ★ Less Tubes & Dyn. Good Cond. . . . . 7.95
- ★ BC-1306 XMTR Receiver. Complete w/tubes 3800 6500 KC CW Voice. . . . . 29.75
- ★ BC-638A Freq. Meter 100-156 mc Comprises fixed crystal controlled oscillator, calibrating Receiver BC-639. . . . . NEW 24.95
- ★ RM-52 REMOTE CONTROL UNIT . . . . . used for AM or FM Patch circuit. . . . . 1.95
- ★ Auto Pilot formation stick U. S. Air Force TYPE C-1 can be used for remote control, etc. . . . . new 4.95
- ★ DROPPING VOLTAGE Resistor 12 to 6 volts 125 W. . . . . NEW .98
- ★ CAVITY BC-1132 w/721B Tube. . . . . New 1.98
- ★ AUDIO TRANS output Pri 8500 ohm Sec ct 15, 8, 4 ohms Rly included 1 1/3/16 x 2 1/2" . . . . . New 1.49
- ★ NEON INDICATOR LIGHTS Dialed type 937-clear w/ built in resistor for ne-51. . . . . New 59c 2 for 1.00
- ★ TELEGRAPH KEY J-47 . . . . . New 1.39

LARGE QUANTITY OF LATEST COMPONENTS IN STOCK  
SEND LIST WILL QUOTE—LARGE OR SMALL  
**SPARKS RADIO SUPPLY**  
194 GENESEE ST., BUFFALO 3, N.Y.  
PROMPT DELIVERY ASSURED

# WOW!

- ★ HANDY TALKY Army BC611, like new! checked OK. Less batteries. 45.95
- ★ Mini TRANSMITTER—Radiosone 390-410 MC. w/2 tubes in small box 2 1/4" x 2 1/2" x 4 3/4" . . . . . 1.50
- ★ 75 Watt PHONE TRANSMITTER—Army BC191. . . . . 19.95
- ★ RELAYS: Tmv Sigma 11P 10,000 ohm, Sens. . . . . .95
- ★ Peanut-Size 6 Volt SPDT. . . . . 1.45
- ★ Hi-V Relay: Contact Rating 480A peak. 6A average @ 12kvdc. Coil voltage 115V 60CPS. . . . . 7.95
- ★ Solenoid 110V AC or 24V DC. 34" push. . . . . 1.95
- ★ RELAY CONTROL UNIT incl. sens. 10,000 ohm Sigma Relay (1 1/2 Ma) Thermal Bi-Metal Strip. Heating element Hi-Z Audio Choke, mimi Alnico magnet, neon lamp, resistors, capacitors. . . . . .99
- ★ METERS: 2"; 0-1/2 Ma \$3.95; 0-1 Ma \$3.65; Ma \$5.25; 0-50 Ma \$1.85; 0-1/2 RP Amps. \$1.95
- ★ Mini 1" Size \$4.95 Ea. 0-1 Ma; 0-5 Ma; 0-10; 0-50. 400 Cycle FREQ. METER: JBT in Bakelite case. . . . . 9.95
- ★ BC-224 FREQUENCY METER: Complete, Like New! 59.95
- ★ DYNAMOTORS: 12V-300V @ 100 Ma. . . . . 6.95
- ★ PE-101—New, 12V-600V @ 75 Ma. . . . . 3.95
- ★ 12/24 DC GENERATOR Mobil or Marine, pulley-driven, filtered, 2 1/2/50 amps (600 watts). . . . . 29.95
- ★ Inverter CONVERTER 100 WATT DC 4.3A, 64V AC, 60 cycles, 5.5A KVA.350 (Ganetto) . . . . . 12.95
- ★ RADAR Range Calibrator TS102A. Rep. Rate 400-2000. incl: 5-6ACT, 2-6AG7, 2-5Y3, 1-6SN7. . . . . 14.95
- ★ TRANSFORMERS: FIL. 5VCT & 6A; Pri 115; 230V; 50-60 cycle, cased . . . . . 1.95
- ★ CURRENT TRANSF. (doughnut) 50/5 ratio, 2VA. . . . . 2.95
- ★ PLATE: 1420VCT @ 400 Ma, with caps at 710VCT also 650 VCT @ 400 Ma, cased. . . . . 16.95
- ★ MISC.: Scope Shield 5" Mu Metal. . . . . 1.95
- ★ Vertical Sectional Whip ANTENNA 92 ft. with base . . . . . 4.95
- ★ Line Noise FILTER for Cars, Boats, etc. 6/12/24 @ 100 amps. . . . . .99
- ★ Coiled PHONE CORD: 4-conductor, stretches to 6 ft. . . . . 2.50
- ★ Phono MOTOR & TURNTABLE 78 RPM, 115V AC. . . . . 2.50

**RADIONIC**  
36 WALKER STREET, NEW YORK 13, NEW YORK

# TAPE RECORDERS

HI-FI COMPONENTS SLEEP LEARN KITS  
MERITAPE  
Low cost, high quality recording tape, in boxes or cans. . . . . 1959 Catalog  
DRESSNER, 69-02 RA, 174 St., Flushing 65, N.Y.

a.g.c. voltage is not developed during warm-up.

Without a.g.c. action, the i.f. amplifiers operate at maximum gain for a longer period than is normal and, as a result, an incorrect a.f.t. control voltage is developed. This erroneous voltage, in turn, pulls the tuner oscillator

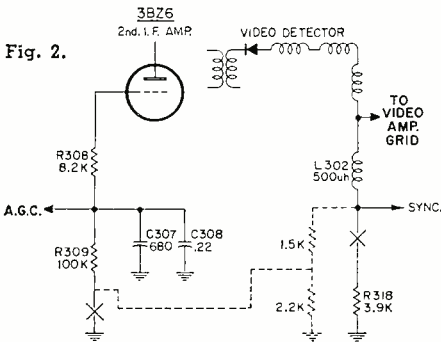

down in frequency by about 3 or 4 mc., causing it to lock in on a spurious signal developed within the receiver.

Changing the slow-heating tubes will, of course, correct this condition. However, a simple circuit change (Fig. 2) will prevent this problem from developing altogether. It involves coupling a small negative voltage into the a.g.c. line, independent of regular a.g.c. action, to prevent excessive i.f. gain during warm-up. Resistor  $R_{318}$  is removed and replaced with two others—a 1500-ohm unit and a 2200-ohm unit, with the latter nearest to ground. Then the ground end of  $R_{309}$  is unsoldered, and this lead is connected to the junction of the two new resistors. The broken line in Fig. 2 shows the new circuit wiring and added components.

#### CROSLY: CRT VARIATION

In some of the early G-21 models, a 21ALP4 picture tube was used instead of a 21ATP4. However, if replacement becomes necessary, an ordinary 21-ALP4 may not serve the purpose. This is due to the fact that the Aquadag coating on the conventional 21ALP4 is smaller in area than the coating on the 21ATP4. As a result, the receiver may develop a tendency to poor interlace. The 21ATP4 will thus generally be a more reliable replacement.

#### NOISE IN AUTO RADIOS

If a relatively small amount of motor noise begins to be heard in an auto radio of the hybrid type using the 12DL8 tube and this becomes a service problem, this tip from *Motorola* may save you troubleshooting time. Specifically, the symptom was noted on *Mo-Par* Model 853, designed for the 1958 *DeSoto* autos.

It has been found that this motor-noise condition starts developing when the 12DL8 tube begins to go defective. Replacing the tube with a good one of the same type can, of course, get rid of the difficulty. However, for a more certain cure that will help avoid recurrences, use a 12DV8 as the replacement instead of the 12DL8.

# NEW SKL TV-900 EQUIPMENT LINE

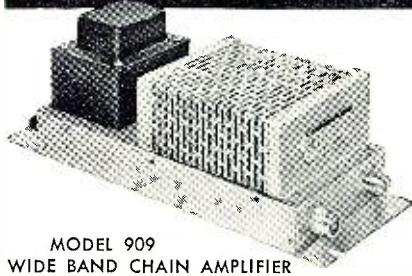

MODEL 909  
WIDE BAND CHAIN AMPLIFIER

Model 909 Wide Band Chain Amplifier. Bandwidth 20-220 mc. Gain 28 db at Channel 13. Manual gain control range 10 db. Recommended multi-channel output level 46 dbmv. Input and output impedance matched to 75 ohms. Integrated power supply. Distributed circuit permits continued operation even after tube outage. No realignment necessary with tube aging or replacement. **\$235.00 LIST.**

- SKL's TV-900 Line also includes:
- Single channel amplifiers
  - Channel pass filters
  - Channel combiners with plug-in attenuators
  - Hi-Lo combiners
  - Hybrid splitters
  - Directional coupler line taps

SETS THE STANDARDS OF  
TOP QUALITY — TOP RELIABILITY

In TV Distribution Systems for  
Hotels, Hospitals,  
Apartments, Stores,  
Housing Developments

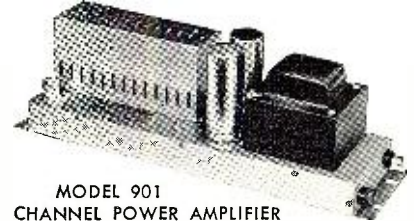

MODEL 901  
CHANNEL POWER AMPLIFIER

Model 901 Channel Power Amplifier. 10 volts maximum output; 5 volts with less than 1% distortion. Minimum 35 db gain. Impedance matched to 75 ohms at input and output. Full 6 mc bandwidth. Available for Channels 2-13. Self-contained power supply. Delivers full fidelity monochrome or color pictures for all high level signal requirements. **\$325.00 LIST.**

Write today  
for full information

SKL

**SPENCER-KENNEDY**  
LABORATORIES, INC.  
1320 SOLDIERS FIELD ROAD  
BOSTON 35, MASS.

#### TX PORTABLE STATION

A complete portable station (Transmitter/receiver), complete with all operating accessories. Self-contained in portable field chest. Transmitter: 9 watts CW, 3 watts phone. 837 in final.

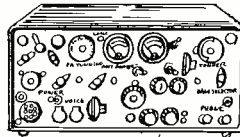

Freq. range: 2,000 kc to 4525 kc. VFO or crystal controlled. Receiver, AM or CW, 2,000 to 3,000 kc. Complete with hand generator for emergency operation. Ideal for field day, and for use as an emergency standby station. New, with instruction book, **\$59.50** antenna, all accessories.....  
EL-2 Power supply for reerr unit only. 115 vac operation .....\$9.50

#### RU-17 RADIO SET

Complete airborne set, compact and lightweight. Transmitter covers 2,000-4525 kc and 6,000-3050 kc. Power output on all bands is 15 watts. AM-CW-MCW. Receiver covers 198-13,950 kc. All tuning is done with plug-in tuning units. Transmitter is VFO and uses a pair of 837's in final. RF ammeter in antenna circuit. Receiver is a 4-stage TRF with built-in BFO. Set is complete with all tubes, tuning units, 24VDC dynamotor, plugs, control boxes, instruction book. The only items not supplied are: mike, headset, and inter-unit cabling. Schematic **\$32.50** on request. Shdg. wt. 125 lbs. New...

#### AN/ART-13 TRANSMITTER



**100 WATTS**  
**2-18 MC.**  
**PHONE**  
**CW-MCW**

Designed to provide radio communication by voice, (MCW) or CW telegraphy. Class "B" audio modulator system capable of modulating the carrier at least 90% on voice or MCW. Incorporates automatic tuning mechanism which may be used to select any one of 11 frequencies, range 2000 KC to 18,100 KC. Frequencies 200 KC to 1500 KC range is provided by addition of oscillator 0-16/ART-13A. **\$45.00** Excellent.....

All prices are FOB Brooklyn, N. Y.  
Send check or M.O. Shipping charges COD.

**COMMUNICATIONS EQUIP. CO.**  
343 Canal St., New York 13, N. Y.  
Phone: WOrth 6-4045

GET INTO ELECTRONICS  
TODAY'S TOP OPPORTUNITY FIELD

**ELECTRICITY**  
— ELECTRONICS  
**TELEVISION**  
RADIO — ELECTRONICS

TRAIN IN THE NEW SHOP-LABS OF

**COYNE** OLDEST, BEST  
EQUIPPED SCHOOL  
OF ITS KIND IN U.S.

in Chicago—Electronic Center of the World. Prepare for a better job and a successful future in TOP OPPORTUNITY FIELD. Train on real equipment—no advanced education or previous experience needed. Lifetime employment service to graduates. Finance Plan—enroll now, pay most of tuition later. Part time employment help to students.

**FREE BOOK**—Mail Coupon or write to address below for Big Free Illustrated Book—"Guide to Careers." Whether you prefer **ELECTRICITY-ELECTRONICS, TELEVISION-RADIO ELECTRONICS OR COMBINED ELECTRONICS TRAINING**, this book describes all training offered.

Information comes by mail. No obligation and NO SALESMAN WILL CALL.

B. W. Cooke, Jr., Pres. Founded 1899  
**COYNE ELECTRICAL SCHOOL**  
Chartered as an Educational Institution Not for Profit  
1501 W. Congress Pkwy., Chicago 7, Ill., Dept. 49-6A

Coyne Electrical School  
New Coyne Building, Dept. 49-6A  
1501 W. Congress Pkwy., Chicago 7, Ill.  
Send FREE book "Guide to Careers" and details of all training you offer.

Name \_\_\_\_\_  
Address \_\_\_\_\_  
City \_\_\_\_\_  
State \_\_\_\_\_  
(I understand no Salesman will call)

## WORLD'S GREATEST SURPLUS BARGAINS, IN CATALOG F-59

### UHF CONVERTER

#### NEW ITEM

100 to 225 MC Western Electric Converter—Plug in unit. Covers Freq. 100 to 225 MC with 30 MC resultant freq.; & tuneable dial. Shielded in cast aluminum. Size: 7/4 x 3 1/2 x 9 1/2". AM-913/TRC.....New: **\$34.95**

AFC + or - control, using 1/6J4 & 1/5670 tubes. Price: **\$12.95** Each 2 for **\$25.00**

### SPEAKER DRIVER UNIT

#### NEW ITEM

25 Watt 15 Ohm—5" x 4 1/2" with 1 1/2" x 24 Mtg. Nipple. Unit-  
Price: **\$12.95** Each 2 for **\$25.00**

Many Other New Items In Catalog F-59

### RECEIVERS:

BC-779 Super Pro. Receiver.....Used: \$69.95  
RA-94 Super Pro. Rec., AC Power Supply...Used: 14.95  
ARB-Receiver—190 to 9050 KC.....Used: 17.95

BC-453 454 455 1206 229 312 348  
and Many More in Stock! See New Catalog F-59.

## COLLINS ART-13 TRANSMITTER \$49.50

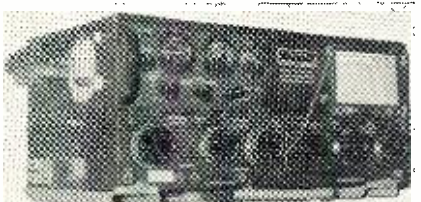

2 TO 18.1 MC—100 WATT—PHONE, CW, MCW  
The most desired Set on the surplus market—Easily converted to 10 Meters (See Surplus Conversion Manual No. 2—\$2.50). Automatic Tuning for selection of 11 Channels in the Freq. Range. Tube Line-Up: 1/837, 1/813, 2/1625, 1/12S17, 2/6V6, 2/811, 2/12SL7, 1/12SA7. AC Power Supply requirements: 28 VDC/10 A, 400 VDC/225 MA & 1250 VDC/250 MA. Size: 23 1/2" x 16" x 11 1/2". Wt.: 70 lbs. Price: USED: \$49.50  
Price—Same as above—except. Less Tubes..... 30.00  
DY-12/ART-13 24 V. Dyn. w/Filter & Relays—U: 12.95

SCR-522, RT-18/ARC-1, BC-191, BC-375, BC-1306, BC-604, & Command Equipment—  
See Catalog F-59!

### KEYERS, TELEPHONES, HEADSETS, MICS.

TS-9 Handset.....Used: \$2.95—New: \$ 3.95  
TS-13 Handset, w/PL-55 & PL-68.U: \$2.95—N: 3.95  
T-17 Microphone.....Used: \$3.95—New: 6.95  
CM-1-SC Hand Carbon Mic.—Mobile type.....New: 6.95  
EE-8 Field Telephones.....Used: \$12.95—Recond.: 16.95  
BD-71 Switchboard—6 Line. U: \$14.95—New: 24.95  
BD-72 Switchboard—12 line. U: \$24.95—New: 34.95  
RM-29 Control Unit.....New: \$6.95—W/Handset 8.95  
RM-52 Control Unit (Patch Found.) U: \$1.95—N.: 2.95  
H-16/U Headset—8000 ohm.....U: \$1.95—New: 2.95  
HS-33 Headset—300 ohm.....U: \$4.95—New: 7.95  
TG-34 Keyer F/Code Practice.....Re-New: 22.95  
Code Practice Tapes, Linked Paper—15 to Set. N.: 16.95  
J-45 Tel. Key with cord and plug.....New: 1.50

Many Other Items In Stock—See Catalog F-59

### HIGH FREQUENCY RECEIVER

Used for Remote Control in the 65.9 to 2.3 MC Band. Variable Condenser for tuning 4 pre-set Channels. Complete with Tubes: 6/6AG5, 3/6J6, 1/6AL5; 24 VDC Dynamotor—output 250 VDC 60 MA. Relays, Band Filter, etc. Size: 10 x 12 x 6". USED: **\$6.95**; UNUSED: **\$8.95**

### RADAR SETS—OSCILLOSCOPES:

AN/APS-4 Radar Set—3 CM.....New: \$ 69.50  
AN/APS-3 Radar Set—3 CM.....New: 150.00  
1D-169B/APN-12 Radar Oscilloscope, w/tubes...U: 12.95

### POWER SUPPLIES • DYNAMOTORS:

PE-120 Power Supply F/BC-659, BC-620.Re-New: \$ 7.95  
AC Power Supply F/BC-603-683  
Kit: \$10.00—Wired: 14.95  
PE-237 Power Supply F/BC-1306.....Used: 14.95  
CD-2045 Vibrator Pac—12 VDC/300 VDC  
100 MA.....N: 7.95  
DM-34 Dynamotor.....Used: \$2.95—Re-New: 7.95  
DM-35 Dynamotor.....Used: \$7.95—Re-New: 9.95  
100 Different Dynamotors & Power Supplies  
in Stock—See Catalog F-39

### LARGEST VARIETY OF SURPLUS

EVER OFFERED! See CATALOG F-59!  
New Catalog F-59 now in the mail. If you did not receive it, please write! Items previously advertised still in stock!

Address Dept. RN • All Prices F.O.B., Lima, Ohio.  
Minimum Order \$5.00, & 25% Deposit on all C.O.D.'s

**FAIR RADIO SALES**  
192 SOUTH MAIN ST. • LIMA, OHIO



WITH THE NEW year well under way, results of elections from service associations all over the country are coming in steadily. If your group has neglected to let us know who its new officers are, get the roster to us as soon as possible. Keeping the record straight is invaluable when individuals or associations wish to correspond with other groups concerning items that appear in these columns. Help us help you. Some election results follow.

### FRTSAP Elections

Dave Krantz, owner of the *Philadelphia Television Service Corporation*, 1298 Cheltenham Ave., Philadelphia, Penna., was elected president of the Federation of Radio and Television Service Associations at the association's annual meeting. He succeeds Bert Bregenzler of *Penn Radio & Sound Service*, Pittsburgh, who was named to the new post of chairman of the Inter-Industry Relations Committee.

Mr. Krantz, who is a director of the Television Service Association of Delaware Valley, was one of the founders of the Pennsylvania State Federation when it was organized twelve years ago. He served as chairman of the FRTSAP for six years after its formation.

The Keystone State Federation is reputed to be the first statewide organization of local radio and television service associations formed in the electronic service industry. Its organizers were staunch supporters of the philosophy that the industry could best be served by a national association composed of strong statewide federations of local groups.

Wayne Prather, president of the Electronic Service Association of Mid-State Pennsylvania and owner of *Wayne Electric* in Harrisburg, was elected vice-president of FRTSAP. Adam Deets of the Luzerne County Service Association was named recording secretary; Leon Helk, Carbondale, Penna., representing the Lackawanna County Television Service Association, was re-elected corresponding secretary; and L. B. Smith of Hershey, Penna., who is a member of the ESDA of Mid-State, was re-elected treasurer.

### NATESA and IDEA

The National Alliance of Television & Electronic Service Associations, speaking through Executive Director Frank J. Moch, clarifies some details in the promulgation of the IDEA program at the convention of the Indiana Electronic Service Association, as reported in this space in January and elsewhere. Listed among "association

officials who participated in the informal discussions at the Indianapolis meeting" were Vincent Lutz and Frank J. Moch of NATESA.

While the two officials named were indeed present, Moch reports that neither he nor Vin Lutz participated in the development of the IDEA program. "IDEA was presented without previous notice as a *fait accompli*, complete with full set of rules, dues structure, and a chairman, and no discussion took place," says Moch. He adds that, in the interests of unity, he feels the founders of IDEA should have approached NATESA officials for preliminary discussions. He emphasizes that the IDEA movement does not speak for NATESA in any way.

### Annual Texas Fair

The annual Electronic Service Clinic and Fair sponsored by the Texas Electronic Association will be held in San Antonio in August, with members of the San Antonio Radio & Television Association serving as hosts. The intense competition among the four major Texas cities that rotate the sponsorship of this widely acclaimed annual event has led to a steadily mounting record of attendance at the three-day affairs. Al Niehaus of San Antonio, president of TEA, recently stated that the San Antonio association will develop the largest turn-out of service dealers and technicians ever registered at a service clinic in the southwest.

### IDEA Progress

Representatives from electronic service associations in thirteen states recently gathered in Chicago for the first general national meeting of the Independent Dealers Electronic Activities Committee. The all-day session, under the chairmanship of Robert M. Sickels of Indianapolis, heard reports from the chairmen of the subcommittees, elected a slate of officers, and formulated plans for an intensive grass roots campaign to counter the activities of set manufacturers who are engaged in factory and captive service.

Tilman Babb of *Wilshire TV*, Dallas, Texas, the original temporary chairman of the IDEA Committee, gave a detailed report on the service plans and activities of the ten set manufacturers that had replied to a letter mailed by the Committee to a total of twelve manufacturers.

The IDEA Committee letter said, in part:

"The purpose of this letter is to request a statement from you as to whether you do now (or plan to in the near future) supply repair service on

# get more enjoyment out of your Hi-Fi for only \$1.00!



photo courtesy Electro-Voice, Inc.

Now—just \$1 can show you how to get more listening pleasure from your hi-fi set! That's the cost of the new 1959 edition of the HI-FI GUIDE & YEARBOOK—the authoritative Ziff-Davis Annual that covers every facet of high fidelity enjoyment. Besides telling you how to use your equipment for the best possible reproduction, the 1959 HI-FI GUIDE & YEARBOOK presents a round-up of the trends in the hi-fi fields . . . tells you how to save on repairs . . . guides you in the selection of records . . . gives you tips on tapes. It's actually like getting two big books for the price of one!

## GUIDE

Section 1: IMPROVING YOUR HI-FI—Strange Allergies of hi-fi. Square Waves Check Tone Controls. Give Your Pickup a Chance. Getting the Most from Your Tweeters. MX means Multiplex. Your Stereo Listening Area.

Section 2: INSTALLING YOUR HI-FI SYSTEM—Hinging the Fi to the Suburbs. Index Your Music. Ceiling Mounted Speaker.

Section 3: TAPE RECORDING—Getting the Most from Your Tape Records. Tips and Techniques. Don't Let Your Tapes Hiss at You. Make Your Own Stereo Tape Recordings.

## YEARBOOK SECTION

TRENDS IN HI-FI: developments in 1958 and what the future holds.

CRITICS' CHOICE OF RECORDINGS: a conductor, a music critic, and a sound engineer tell what records (classical and jazz) they would select—and why.

THE ULTIMATE IN FM STATIONS: here's how an FM station in Chicago really caters to its hi-fi listeners—in what could be a nationwide trend in programming! Also gives you a listing of FM stations throughout the country.

STEREO: the latest report on what is happening in this big, exciting field. PLUS a photo story showing what can be done to fit more equipment into less space.



All told, the HI-FI GUIDE & YEARBOOK brings you a wealth of information to help you get the most out of your hi-fi listening hours. Only \$1.00 (\$1.25 outside U.S.A.), it's a fabulous buy! On sale now—make sure you pick up your copy at your newsstand.

**ZIFF-DAVIS PUBLISHING COMPANY**

434 South Wabash Avenue, Chicago 5, Illinois

April, 1959

home television receivers directly to the user or consumer. If such service is supplied, in what areas?

"The Independent Service Dealers feel that this type of service is unfair competition—competition against which they cannot compete on an equal basis. If it continues, the independent service shop is in jeopardy and could face extinction."

Mr. Babb read each of the replies in its entirety at the Chicago meeting. The lengthy compilation of these answers is available in photostatic form from Jack Barton, chairman of the IDEA Communications Subcommittee, 8225 Woodward Ave., Detroit 2, Mich.

John Hemak of the Minnesota Television Service Engineers Inc., Minneapolis, chairman of the Legal and Legislative Studies Subcommittee, gave an interesting resumé of the steps taken by dealers in other industries to curb the restrictive practices of manufacturers in their fields that were harmful to them.

Jack Barton of TSA of Michigan, chairman of the Subcommittee on Communications, gave a report on a plan to keep members informed on developments that directly affect service dealers. Robert Steers, of the Television Service Association of Connecticut, chairman of the Subcommittee on Finances, outlined the financial requirements of the IDEA program.

Karl Heinzman, president of TSA of Michigan, was elected to the post of chairman of the national IDEA Committee. Al Niehaus, 520 West Hildebrand Street, San Antonio, Texas, dynamic president of the Texas Electronic Association, was selected for the job of vice-chairman; John Perez, *Ohio TV Service*, 829 East Main Street, Columbus, Ohio, was named to the post of secretary; and Don F. Wilson, *A & B Video Service*, 3310 North High Street, Columbus, Ohio, was appointed treasurer.

The members in attendance voted for the next general meeting to be held in July in a centrally located city, to be selected by IDEA committee officers. Communications center for the movement is IDEA Communications, 8225 Woodward, Detroit 2, Michigan.

## San Antonio Elections

In San Antonio, Texas, the members of the San Antonio Radio & Television Association, Inc., 810 East Commerce Street, San Antonio, elected Kurt Wertheim, of *Kayser TV*, to head the organization as its president for the coming year. Those named to serve with him include Sam Negrilli of *Olmos Radio & TV*, vice-president; Leonard Zalman of *Best TV*, secretary; and Tom Boyd of *Boyd's Radio Service*, treasurer.

In addition to the officers, the association's Board of Directors will include Donald VanDerBrugen, *Sight & Sound of San Antonio*, and C. W. Schertz of the *Lone Star TV Center*.

Concurrently with the SARTA elections, the ladies' auxiliary of the San Antonio chapter of the Texas Elec-

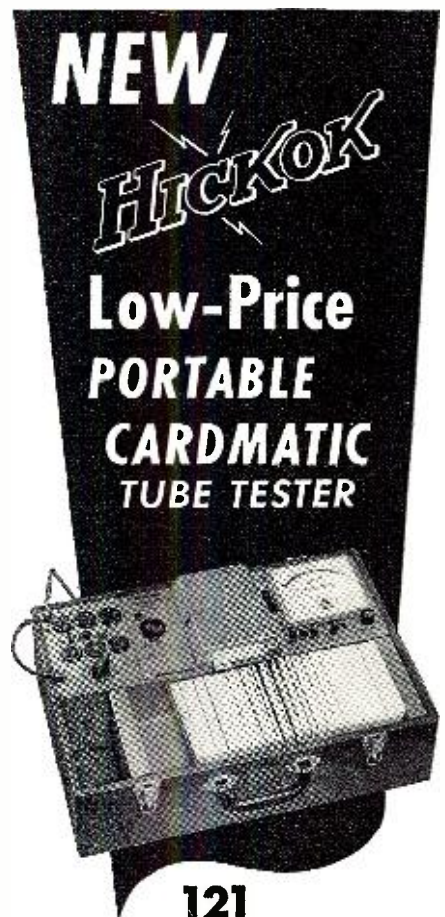

**121**

*Fully Automatic*

Tests any tube, transistor or semiconductor diode in 8 to 12 seconds . . . including handling of tube test data card.

Here is the new, low cost version of the famous Hickok Cardmatic so popular with leading lab engineers. Especially designed for high speed service work, this new 121 is high quality in a lightweight portable . . . and the price is low, too.

The Hickok Cardmatic switch sets up all tests automatically and eliminates fussing around with adjustments. You can accurately check a tube for dynamic mutual conductance, controlled emission, cutoff point "Knee" point, shorts, leakage, gas and voltage drop . . . and rectifier tubes at their rated loads. Any way you look at it, this new automatic tube testing machine will be helpful to you in your work. It will pay for itself in a very short time . . . and give you many years of accurate dependable service.

**\$299<sup>50</sup>**  
**NET**

(includes 342 cards)

**Now is the time to . . .  
TRADE UP TO A HICKOK**

Ask for a demonstration of the new 121  
or write for descriptive literature.

**THE HICKOK ELECTRICAL INSTRUMENT CO.**

10521 Dupont Ave. • Cleveland 8, Ohio

# You learn more from SAMS BOOKS

OVER 1,200,000 IN USE

JUST OUT!



## "101 Ways to Use Your Oscilloscope"

by Bob Middleton

A practical and invaluable guidebook for anyone using oscilloscopes. Covers all standard uses of this instrument as well as many uncommon ones. Describes connections required, equipment needed, proper test procedures and evaluation of results for each scope use. Over 400 illustrations of waveforms and test setups are included. Invaluable for technicians, engineers, students and experimenters. 180 pages, 5 1/2 x 8 1/2". Only .....\$2.50  
(Companion to Middleton's "101 Ways to Use Your Sweep Generator")

## "Tape Recorder Manual"—Vol. 3



Complete analysis of 22 tape recorders produced in 1957-58, including Ampex, Geloso, Knight, RCA, Revere, Silvertone, Webcor, Wilcox-Gay, Wollensak. Includes general description, operation data, troubleshooting and maintenance facts, parts lists, diagrams, etc. Has special editorial section on basic types of tape transport mechanisms; with cumulative index. 160 pages, 8 1/2 x 11". Only .....\$2.95

## "Servicing Hi-Fi" Series



**SERVICING HI-FI AM-FM TUNERS.** Complete service data analysis of 18 AM-FM tuners produced in 1957-58. Thorough coverage: diagrams, photo views, troubleshooting, parts lists, etc. Includes special editorial section "Highlights on FM", covering FM signal, AFC circuits, alignment. 160 p., 8 1/2 x 11". Only .....\$2.95



**SERVICING HI-FI PREAMPS AND AMPLIFIERS.** Covers 33 leading models made in 1957-58. Full technical analysis of each model (schematic, photos, charts, parts lists); special section on "Service Facts About Preamps and Amplifiers." 160 p., 8 1/2 x 11". Only .....\$2.95

## HOWARD W. SAMS & CO., INC.

Order from your Sams Distributor today, or mail to Howard W. Sams & Co., Inc., Dept. D-19 2201 E. 46th St., Indianapolis 6, Ind.

Send me the following books:

- "101 Ways to Use Your Oscilloscope" (TEM-2)
- "Tape Recorder Manual" (TR-3)
- "Servicing Hi-Fi AM-FM Tuners" (HF-3)
- "Servicing Hi-Fi Preamps & Amplifiers" (HF-4)

\$. . . . . enclosed.  Send Free Book List

Name.....

Address.....

City.....Zone.....State.....

(outside U.S.A. priced slightly higher)

tronic Association named Louise Niehaus as its president. Other officers of the auxiliary include Elza Bohman, vice-president; Jean McCoy, secretary; Evelyn Mueller, treasurer; and Jean Schertz, director.

## New Chicago Officers

The Television Electronic Service Association of Chicagoland recently named John Cahill, of *Arjay TV*, to the post of chairman of its Board of Directors. He succeeds Frank J. Moch, *Aide Sound and Radio Service Corp.*, who asked to be relieved of the responsibilities of the office because of the pressure of his duties as executive director of NATESA.

Sam Maksimuk of *North-West Radio Service*, was named to succeed Mr. Cahill as president of TESA-Chicagoland. Other officers elected at the association's annual meeting included William Franz of *Best TV*, vice-president in charge of external affairs; William Hamada, *Yhoco TV*, vice-president in charge of membership; Marshall Ruehrdanz, *North Shore TV*, vice-president in charge of training.

Officers re-elected for another term included Angelo Chrysogelos of *Tele-Video*, secretary; Joseph Issak of *General Radio*, treasurer; Frank Spearman of *Frank's TV*, sergeant-at-arms; and Joseph Blink of *BTS Electronics* re-named NATESA director.

## Indiana Licensing

A bill to license electronic service technicians was presented for consideration by the Indiana State Legislature during its current biennial session. The proposed law represents the fruition of several years' study and work on the part of the officers of member groups within IESA. The license measure, recommended by IESA, was widely publicized throughout the state by the association to acquaint technicians and other elements of the electronic replacement industry with its provisions.

The legal work involved in developing the measure was financed by voluntary contributions from technicians and service dealers interested in the establishment of legal standards for their activity.

## Raytheon Defends Service

In response to an article in the January 3 issue of *TV Guide*—another "exposé" of TV service—J. T. Thompson of *Raytheon* has sent a letter to that publication saying, in part: "The service dealer article . . . is sure to hurt many thousands of honest and capable service dealers. All of the fine print will not offset the headlines and illustrations which brand all service dealers as racketeers. As manufacturers who believe in the integrity of the vast majority of TV service dealers . . . we urge you to use more discretion in handling this type of editorial. A more positive approach . . . would still have benefited your millions of readers without casting a shadow on the honest service dealers." —30—

## Complete Test Equipment

(Continued from page 39)

strength meter can make the difference between a successful installation and one that requires additional work later on.

It is customary to use at least two or three different antennas to survey a particular location with the field-strength meter. If a simple dipole and reflector cannot produce signals of more than 50 microvolts, a more adequate antenna should be tried. A field-strength meter should be portable and cover all TV channels being received in the technician's area. Most meters operate from the power line and it is, therefore, necessary to carry a long extension cord as well as about 100 feet of lead-in wire. The meter may have one or more ranges but the lowest should go down to at least 50 microvolts. Channel selection and fine tuning should be possible.

Another item to be found in any complete service shop will be a tube checker. The emission-type tube tester already recommended for the basic establishment can often be used on the counter in direct consumer service when the shop expands sufficiently to warrant the purchase of a second, more elaborate checker. The second unit should preferably measure transconductance and have accessories to check picture tubes as well. For the busy shop one of the automatic or semi-automatic instruments now on the market may be worthwhile since it permits checking a particular tube type simply by inserting a corresponding punch card. As home and automobile radios, audio amplifiers, and eventually TV receivers start using transistors more widely, it will be worthwhile to consider the purchase of a transistor tester in addition to the tube testing equipment. While at first a rather simple type of unit will be sufficient, the day can be envisioned when complex, punch-card-operated transistor testers will find their way into service shops.

In addition to the "true" test equipment, there are a number of other items which, while not exactly instruments, provide services that are nonetheless a vital part of any complete service shop's equipment. The most important among these is the provision for a.c. isolation, voltage control, and metering in combination. Some manufacturers offer a single package that has an isolation transformer and an a.c. voltmeter as well as a switch for selecting various taps on the transformer to simulate high and low line-voltage conditions.

In a fairly busy shop it is good practice to provide a separate isolation transformer for each technician so that he need not be concerned over whether a set is "hot" or has its own transformer. Some of these transformers can be connected to a step switch or, better yet, a variable-voltage auto-transformer that permits setting the



isolated line voltage to a wide range of values. If a separate meter is not provided, the a.c. scale on the v.o.m. or v.t.v.m. can be used to monitor the line voltage, but this again ties up an important instrument. Usually TV sets will be tested at line voltages down to 105 volts and up to 130 volts.

Where any amount of auto-radio service work is expected, a battery eliminator will be required. These units, not very expensive, are available from a number of manufacturers. Any battery eliminator should have a metered output, adjustable over at least  $\pm 2$  volts from the nominal value and should provide both a 6- and a 12-volt output. Most of the battery eliminators can also be used to charge up automobile batteries. This feature is sometimes handy when either a customer's battery has run down or the shop's own car needs some battery recharging.

The resistance and capacitance substitution boxes also fall into the category of necessary and helpful equipment, although not really "test instruments." There are many instances where such a substitution box saves a great deal of work and time. Typical is the case where a resistor is completely charred and the exact circuit diagram is not available so that the technician must try different values of resistors to find the correct one. When the resistance substitution box is connected in place of the doubtful resistor and the set is observed as various values are switched in, the correct value may be approximated quickly.

Without the substitution box the technician would have to solder and unsolder one resistor after another, each time waiting for the set to warm up. The capacitor substitution box performs a similar service, and also provides a simple check for smaller capacitors that might be open or leaky.

Most test instruments are sold together with all the special probes and leads, but somehow these test leads have a way of disintegrating, disappearing, or becoming defective. For this reason many manufacturers sell test leads and various types of probes separately. Some of these items such as clip leads, simple attenuators, terminations, etc. can be hooked up by the individual technician. Most experienced service operators will agree that test leads and such accessories are very important tools. Technical literature such as service data, diagrams, handbooks, and parts catalogues round out the technician's knowledge and virtually no service organization would think of doing without at least a fairly complete selection of such literature.

The importance of good test equipment cannot be overemphasized, but even the best test gear alone does not make for an efficient or profitable service shop. The technician's understanding of his equipment, as well as of the sets he services, makes the difference between success or failure. However, this knowledge alone is still not enough. To be harnessed, it must be intelligently applied to the proper equipment.

**New! an EASY WAY**  
to understand the  
uses and components  
of digital computers



## Fundamentals of DIGITAL COMPUTERS

By MATTHEW MANDL

Well-known writer on Electronics

Ideal for technicians and engineers without previous training in the computer field: ultra-simplified explanations make advanced math or electrical training unnecessary.

Covers amplifiers, circuits, fundamentals of applications, binary counting, codes, storage systems, programming, etc. Describes, illustrates representative available computers. Discusses servicing and maintenance. 135 schematic diagrams, photos, close-ups of parts. 160-entry glossary. Each passing day sees computers become more important. Post yourself, now!

Prentice-Hall, Inc., Dept. CEK-EG-70  
Englewood Cliffs, N. J.

Send copy of Fundamentals of Digital Computers by Mandl. At end of 10 days I'll either send payment of \$7.95, or return book and owe nothing.

Name \_\_\_\_\_  
Company \_\_\_\_\_  
Address \_\_\_\_\_

# MICRO

## ELECTRON TUBE

INTRODUCES FOR THE FIRST TIME  
ANYWHERE A SELECT STOCK OF USED  
TUBES AT A FABULOUS LOW PRICE

# 37¢

ea.

FOR any TUBE LISTED

**\$35** PER  
HUNDRED  
ASSTD.

ALL TUBES SENT POSTAGE PAID  
Please send 25¢ handling for orders under \$5 Send 25%  
deposit on C.O.D. orders. Send approximate postage on  
Canadian and foreign orders.

# MICRO

ELECTRON TUBE CO. P.O. BOX 55 Park Station, Paterson 3, N. J.

- Each and every tube is tested in our own laboratory for mutual conductance and life test.
- We guarantee FREE replacement for one year of any tube purchased from us which fails to function efficiently under any or all operating conditions. Prompt refunds are made on any defective merchandise.
- The advertised tubes are not necessarily new, but may be electrically perfect factory seconds or used tubes—each is clearly so marked.

0A2	5X8	6BH6	6SF5	7Z4	19BG6G
0Z4	5Y3GT	6BJ6	6SF7	12A8	1916
1A7GT	5Y4G	6BK5	6S17	12A8	1918
1B3GT	6A7	6BK7	6SK7	12A9S	24A
1H4G	6A8	6BL7GT	6SL7GT	12AT6	25AV5
1H5GT	6AB4	6BN6	6SN7GT	12AT7	25BQ6
1L4	6AC7	6BQ6GT	6SQ7	12AU6	25DN6
1L6	6AF4	6BQ7	6SS7	12AU7	25L6GT
1N5GT	6AG5	6BY5G	6T4	12AV6	25W4GT
1Q5GT	6AG7	6BZ6	6T8	12AV7	25Z5
1R5	6AH4GT	6BZ7	6U8	12AX4GT	25Z6
1S5	6AH6	6C4	6V6	12AX7	26
1T4	6AK5	6C5	6V6	12AZ7	26
1U4	6AL5	6C6	6W4GT	12B4	35A5
1U5	6AL7	6CB6	6W6GT	12BAG	35B5
1V2	6AM8	6CD6G	6X4	12BA7	35C5
1X2	6AN8	6CF6	6X5	12BA7	35L6GT
2A3	6AQ5	6CG7	6X8	12BE6	35W4
2AF4	6AQ6	6CL6	6Y6G	12BF6	35Y4
3BC5	6A07GT	6CM6	7A4/XXL	12BH7	35Z5GT
3BN6	6AR5	6CM7	7A5	12BQ6	37
3BZ6	6AS5	6CN7	7A6	12BR7	39/44
3CB6	6AT6	6CS6	7A7	12B7	42
3CF6	6AT8	6CU6	7A8	12CA5	43
3CS6	6AU4GT	6DE6	7B4	12J5	45
3LF4	6AU5GT	6DQ6	7B5	12K7	50A5
3Q4	6AU6	6F6	7B6	12L6	50B5
3S4	6AUB	6H6	7B7	12M7	50C5
3V4	6AV5GT	6J4	7B8	12SA7	50S5
4BQ7A	6AV6	6J5	7C4	12SG7	50L6GT
4BZ7	6AW8	6J7	7C5	12S7	50X6
5A58	6AX4GT	6K6GT	7C6	12S17	56
5AT8	6AX5GT	6K7	7C7	12SK7	57
5AW4	6B8	6K8	7E6	12SN7GT	58
5BK7	6BA6	6L7	7E7	12SQ7	71A
5J6	6BC5	6M7	7F7	12V6GT	75
5T8	6BC8	6N7	7F8	12W6GT	76
5U4G	6BD6	6O7	7H7	12X4	80
5U8	6BE6	6P4	7N7	12Z3	77
5V4G	6BF5	6S8GT	7Q7	14A7/12B7	78
5V6GT	6BF6	6SA7	7X7/XXFM	14B6	84/624
	6BG6G	6SC7	7Y4	14Q7	117Z3
				19A4GT	117Z6

SEND FOR OUR FREE COMPLETE LIST OF TUBES  
& SPECIAL PURPOSE TUBES

**"TAB" Tubes Tested, Inspected, Boxed**

**Six Months Guarantee!! No Rejects!**  
**NEW & Used Gov't & Mfgs. Surplus!**

Orders \$10 or more. Recv. types only pnd. 48 states.

0A2	.80	6B16	.72	12A7B	.59	1851	1.00
0B2	.72	6B17	.98	12A7T	.89	11726	1.10
0C3	.84	6B1L	1.95	12A9B	.68	4-65A	16.00
0D3	.80	6B16	.66	12A9C	.68	11727	.68
0Z4	.50	6B06	1.19	12A7X	.79	3D23	5.00
1A7	1.00	6B27	1.25	12BA6	.65	717A	5/81
1B3	.72	6B14	.59	12A7	1.00	2A5	3.00
1R5	.78	6C5	.89	12B6	.59	4-250	35.00
1S4	.78	6CB6	.80	12BE6	.59	4E27	.59
1T4	.78	6DC6	1.19	12SK7	.94	4PR60	25.00

Send 25c for catalog!

1U4	4/S1	6H6	.59	12BH7	.99	4X150	7.50
1U5	.68	6J5	.59	12BY7	1.29	6X250	35.00
1X2A	.68	6J6	.59	12BZ7	.99	4X500	38.00
304	.68	6K6	.59	12CUG	1.45	5B11	4.98
305	.68	6K7	.59	12CUG	1.45	5B11	4.98
3V4	.68	6L6	1.19	12G7	.89	35T	4.00
5R4	.99	6SA	.59	12SH7	.89	100T	7.00
5R4	.59	6SA7	.69	12SK7	.94	388A	1.00
5V4	.89	6SB7	1.19	12SQ7	.96	418A	14.00

Wanted surplus electronics from Schools & U.

5Y3	.59	6SC7	.39	198G6	2.15	450T	43.00
6AB4	.59	6SC7	.79	19T8	1.16	807	1.29
6AC7	.79	6SK7	.69	25B06	1.39	808	1.00
6AC7	.79	6SK7	.69	25B06	1.39	808	1.00
6AH6	.99	6SK7	.72	25W4	.77	4-400A	\$42
6AK5	.69	6SL7	.89	25Z5	.72	811	3.00
6AL5	.59	6SN7	2.91	6SN7	3.49	813	3.00
6AQ5	.68	6SQ7	.74	EL34	3.49	813	3.00
6AS7	3.00	6SR7	.79	EL37	2.49	814	2.45
6AT6	.45	6T6	1.19	6T6	1.19	815	3.95

Wanted 30ATL Tubes: TOP \$\$\$ Paid

6AU4	1.29	6U8	.98	35W4	.52	829B	8.00
6AU5	1.29	6V6	1.98	35Z5	.74	866A	1.75
6AU6	.69	6W4	.79	35Z5	.74	866A	1.75
6AX4	.79	6W6	.89	50A5	.69	6146	4.00
6BA6	.59	6X4	.69	50A5	.69	6146	4.00
6BA7	1.00	6X5	.49	50A5	.69	5881	2.70
6BD6	.69	6Y6	.89	50L6	.69	6550	3.90
6BE6	.59	7N7	.59	7N7	.59	6420	11.00
6BE6	1.50	12AL5	.59	75	.59	5654	1.00
6BH6	.79	12A05	.75	80	.59	5894	12.00

**TUBES WANTED! WE BUY! SELL & TRADE!**

**NEW "TEKSEL" SELENIUM FULL WAVE BRIDGE RECTIFIERS ONE YEAR GTD!**

AMP CONT.	18VDC	36VDC	72VDC	144VDC
1AMP	\$ 1.30	\$ 2.00	\$ 4.90	\$ 9.45
2AMP	2.15	3.00	7.45	14.40
3AMP	2.90	4.00	8.60	16.75
6AMP	4.15	6.00	18.75	36.15
10AMP	6.15	10.00	24.00	48.00
15AMP	9.90	15.00	40.00	66.60
24AMP	15.00	24.45	57.50	108.45

NEW SILICON 500MA/100°C/280VAC /400 p.i.v. Rectifier H'mt Sealed, \$1.50 @ 5 for \$6.50, 40 for \$46, 100 for \$105.

**KITS! "TAB" THE BEST KITS!**

- All Kits Contain Most Popular Values & Sizes
- Kit 2 Eng. Parallel Rules
- Kit 35 Precision Resistors
- Kit 10 Switches
- Kit 75 Resistors 1/2, 1, 2W
- Kit 150 Carbon Resistors
- Kit 25 Panel Lamps
- Kit 12 Electrolytic Cond's
- Kit 15 Volume Controls
- Kit 56 Tube Sockets
- Kit 65 Tubular Condensers
- Kit 500 Lugs & Eyelets
- Kit 10 Bathub Oil Cond's
- Kit 5 lbs. Surprise Package
- Kit 10 Xmttr. Mica Cond's.
- Kit Gylptal & Cement
- Kit 3 Phone Patch Xfms
- Kit 4 AN/Reflector Lites
- Kit 6 Inst'd Tuning Tools
- Kit 6 AN plugs & cncntrs
- Kit 3 Searchlights
- Kit Circular Slide Rule
- Kit 12 Alligator clips asstd
- Kit 2 Bakelite Panels 6x12"
- Kit 5 Pcs. Wrench Set
- Kit 40 5/8" Sub-Win Tubes
- Kit 35 Power Resistors
- Kit 10 Mica Condensers
- Kit 5 Ceramic Cond's
- Kit 100 Fuses, Assorted
- Kit 50 Coil Forms
- Kit 5 FT243 Xtal Holders
- Kit 6 Inductors & Coils
- Kit 5 Metal Switches
- Kit 10 Wheat Lamps
- Kit 8 X25 Ft Hookup Wire
- Kit 4 Xtal Osc-Blanks
- Kit 4 Asstd Rectifiers
- Kit 25 Ft Hookup Wire
- Kit 100 Self-Tapping Screws
- Kit 8x25 Ft Hookup Wire
- Kit High Gain XTAL Mike
- Kit 100 Phone Plugs, Jaks
- Kit 6 ea. Phone Plugs, Jaks

BUY 10 KITS—GET ONE FREE! EACH KIT 99c

**NEW DC POWER FOR TRANSISTORS!!**

New low-cost 25 volt one amp filtered 1% Ripple Power Supply. Same as specified in Transistor Power Supply, RCA, CBS. Ideal for powering transistor circuits, rugged & small in size! Pre-assembled kit \$22.50, CK \$10. or assembled B25-TACB \$12.

Filtered Power Supply Kit. Delivers 12VDC at 2 AMPS. Filtered less than 0.5% ripple or 25VDC at 1A TPSK2 Kit \$18; TFS2W assembled & wired \$24.

115VAC Input Transformer & Full Wave Bridge Rectifier for 12VDC @ 2AMPS, or

RECTRAN KIT R100 \$4.50  
 RT1W Assembled & Wired \$7.50

**BATTERY CHARGER KIT 2 to 4 Amps. Charges 2-4-6 & 12 Volt Batteries. KIT \$CK-1 \$11, Built \$12.75, Chgr. 6&12Volt at up to 2AMPS \$9.**

**SELENIUM RADIO & TV RECTIFIERS! GTD.**

65Ma 45c @ 5 for \$2.10; 100Ma 50c @ 10 for \$5.10; 545; 250Ma 79c @ 10 for \$7.90; 560; 300Ma 88c @ 10 for \$8.80; 570; 400Ma \$1.10 @ 10 for \$11.00; 585; 500Ma 10 for \$11.00; 590.

Orders of \$10 or more, Postpaid 48 states!

AN-APP2 Revr less tubes. Gnd Parts \$1.89  
 RDZ 2000/400Mc's Super/Super less tubes... \$30.00  
 RAN Revr 4bands/1.5 to 9Mc's with tubes... \$24.00  
 AN/ART13 Xmttr/100 Watt less tubes... \$39.00  
 New photoflash condens. 523mf @ 450wv \$6 @ 2/\$16  
 ARC3/BC696/3 to 4Mc's Xmttr with tubes... \$5.95  
 5" Test Picture Tube with Adapter... \$3.49

**"ERIN" FINEST HI-FI RECORDING TAPE**

SO GOOD! WE CANNOT USE MFGS TRUE NAME!  
 1200 Ft.—7" Reel \$1.45 ea. of 3  
 Money Back Gtd. Lots of 3

Singly \$1.59. Add 15c each Postpaid 48 States  
 New 1st Quality "Mylar" 2400 Ft.—7" Reel Ferro  
 Erin Sheen Process Recording tape \$4.49, 3 for \$12

**TRANSISTORIZED "TABSTAT" kit**

or built hi-efficiency DC to 12VDC  
 To 450VDC continuous duty power supply!  
 Output 450TAP 250VDC at up to 130MA/UP to 70 Watts 50% efficiency; Ripple 0.2%; Low idle current 1AMP silicon rectifiers, oil condensers, transf. fused & short circuit proof. Regulation 3% at 20to100% load!  
 Small in size! Quiet! Light Wgt!  
 Low Priced GTD "TABSTAT" TR1245CB built \$35.  
 Pre-Assembled U-Built kit TR1245CK ONLY \$30.  
 For 250V at 100Ma TR1225CB \$27.

**"TAB"** TERMS: Money Back Guarantee! Our 14th year. \$2 min. order F.O.B. N.Y.C. Add ship charges or for C.O.D. 25% Dep. Prices shown subject to change.  
 111-GR LIBERTY ST., N.Y. 6, N.Y.  
 Send 25c PHONE: RECTOR 2-6245 for Catalog

**Hi-Fi Crossover Networks**

(Continued from page 46)

frequency input to the speaker unit, in series with a choke to subsequently limit the high-frequency input to the same unit, as shown in Fig. 5. In this instance, the mid-range section is a *bandpass* type of filter, whereas the low-frequency section is a *low pass* and the high-frequency section is a *high pass*.

**6 db and 12 db Networks**

The electrical structures shown in Figs. 3 and 5 for the two-way and the three-way networks respectively are representative of the popular "6 db-per-octave attenuation" type. They are the simplest types to construct and provide an "easy" type of roll-off, that is, a gradual falling off of the frequencies. Where it is desired to provide sharper electrical attenuation of the signals going into the speakers, then a 12 db system may be designed by doubling up the filter elements—not two capacitors where one exists, but instead pairing off an inductance with an already existing capacitor, and a capacitor with an existing inductance. (The initial value of these *pairs* will not be the same for the 12 db as for the 6 db network. This will be discussed in detail in Part 2.) As an illustration of the conversion of a 6 db to a 12 db network, let us again consider the case of the two-way system of Fig. 3 which is a 6 db-per-octave network, the slow type, and examine the tweeter section. The capacitor passes high frequencies to the tweeter, as determined by the normally decreasing impedance of the capacitor as the frequency is increased. There is no sharp "yes and no" line of demarcation where the capacitor passes and where it does not pass power on to the tweeter. The manner in which this power is transferred to the tweeter is a *gradual one* determined by the value of the capacitor in series with the

tweeter. Some low frequencies below the crossover point will inevitably be transferred to the tweeter.

We can, however, *bypass* these low frequencies from the tweeter by shunting it with a choke, a *low-pass* element which has low impedance at low frequencies. Thus, if we have a tweeter in series with a capacitor, we may put a *choke across* the tweeter for faster roll-off of the low frequencies from the tweeter terminals, as shown in Fig. 6. As the frequency goes up, however, so will the impedance of the choke and the high frequencies that get passed on to the tweeter through the capacitor will not be bypassed from the tweeter by the choke.

In a similar manner, if a capacitor were to be put across the woofer terminals, it would bypass any high frequencies that might get through the choke to the woofer terminals and the high-frequency roll-off at the woofer would thus be faster than that provided by the choke itself. At the low frequencies the capacitor shunted across the woofer terminal would be relatively ineffective. It is thus possible to design a "fast" 12 db-per-octave network from a "slow" 6 db-per-octave network by simply adding, across each loudspeaker unit, a reactance element opposite in nature to that normally found in that particular branch of the circuit as a 6 db-per-octave network (but altered in value). Fig. 7 shows 12 db-per-octave counterparts of the simpler 6 db-per-octave networks.

We have intentionally avoided reference to numerical values for these reactive elements because it was desirable to first establish a general speaking acquaintance with the principles behind these common network systems. We have indicated why they were necessary; we have briefly discussed how they function; and the general nature of the differences among the various types. We are now ready to assign values to the components used in the various filter elements—a subject which we will cover in full in Part 2. (To be concluded)

Fig. 7. A 6 db network is transformed to a 12 db network by adding into each filter circuit an opposite type of filter element. Values will be altered—see text.

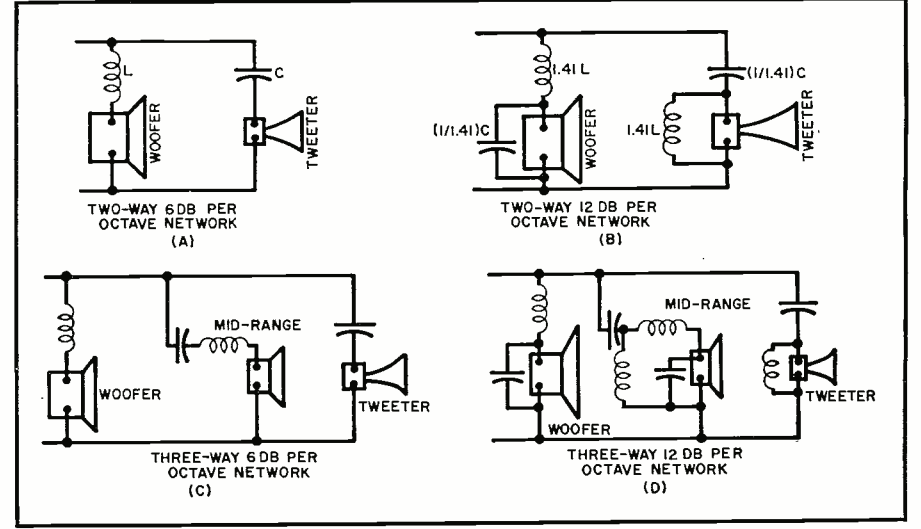

**AN/ART-13  
100 WATT TRANSMITTER**

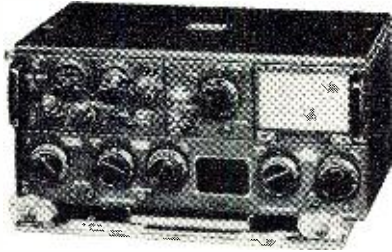

Designed to provide radio communication by voice, (MCW) or CW telegraphy. Class "B" audio modulator system capable of modulating the carrier at least 90% on voice or MCW. Incorporates automatic tuning mechanism which may be used to select any one of 11 frequencies range 2000 KC to 18,100 KC. Frequencies 200 KC to 1500 KC range is provided by addition of oscillator 0-16/ART-13A.

**\$44.95**  
Excellent..... 39.50  
Used, good..... 29.50  
Used, Less Meters..... 29.50  
0-16 Low frequency oscillator coil for ART-13. Excellent..... 9.95  
24 Volt dynamotor for ART-13..... 14.95

**UHF-VHF**

**AN/APR-4 38-4000 MC RECEIVER.** This is a precision receiver covering 38-4000 mc. The set utilizes 5 tuning units which direct reading dials in megacycles. The receiver has a wide and narrow band-width 30 mc I.F. strip which may be selected at will. An output meter is provided to measure signal strength. Outputs are provided for a pulse analyzer and pan adapter. 110 V AC. 60-2600 cycle. With 3 tuning units 38-1000 mc. Excellent **\$159.50**

**R 44/ARR-5-AM OR FM RECEIVER** 27 to 143 MC Military Version of Hallicrafter S-27. Less Power Supply. EXC.....\$59.50  
Less Tuning Meter..... 44.50

**HI-FI HEADSET.** 600 OHM. NEW.....\$7.95  
**H5-23-2000 Ohm Headphones.** NEW..... 4.95  
**CD-307-Extension Cord** for above..... .97

**LM-20 Frequency Meter Heterodyne,** crystal calibrated. Modulated covering frequencies from 125 KC to 20,000 KC continuously. This equipment provides accuracies of .02 per cent in the 2000 to 20,000 KC band. Shipping wt. 30 lbs. Brand new.....\$59.50  
**LM-13-Frequency Meter.** Used. Excellent. 39.50  
New ..... 59.50

**TA-12 XMTR,** 100 Watt. EXC.....\$19.95  
**MP-28 MODULATOR** and 28 V. DC Power Supply for above. EXC..... 14.95

**Meter-3"-0-5 Ma.** 270° Indication-by pass shunt and add scale. Excellent condition .....\$ 1.25  
5 for..... 5.00

WRITE FOR LATEST FLYER

**R W ELECTRONICS**

2430 S. Michigan Ave., Dept. N  
Phone CAUmnet 5-1281 Chicago 16, Ill.

**GET INTO  
ELECTRONICS**

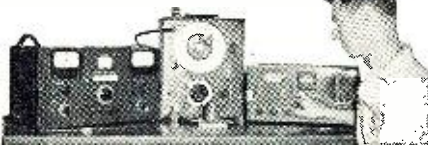

V.T.I. training leads to success as technicians, field engineers, specialists in communications, guided missiles, computers, radar and automation. Basic and advanced courses in theory and laboratory. Associate degree in electronics in 29 months. B.S. in electronic engineering obtainable. ECPD accredited. G.I. approved. Graduates in all branches of electronics with major companies. Start September, February. Dorms, campus. High School graduate or equivalent. Catalog.

**VALPARAISO TECHNICAL INSTITUTE**  
Dept. RD Valparaiso, Indiana

**Special Test Instruments**  
(Continued from page 65)

ments, but circuit operation may change radically.

A number of available testers check horizontal-circuit inductors either in or out of the circuit. One of the versatile instruments in this group is the *Seco* "Flyback Interval and Inductance Checker," Model FB-4. In addition to a quick check of the horizontal-output circuit without the disconnection of any leads—which itself often settles the issue quickly—separate, more detailed evaluation of transformers, deflection coils, and other inductors is possible. A transformer-yoke matching test, valuable when replacement becomes necessary, is also available.

Time no longer must be squandered in disconnecting capacitor leads to test them. Rapid, in-circuit checkers take care of this problem. They generally incorporate oscillators that are shunted across the suspected components. The extent to which the capacitor under test does or does not load the oscillator is used to provide indication as to whether the component is open, shorted, or intermittent. The *Cornell-Dubilier* "Handicheck," Model BF-90, is one such unit. The *Century* "In-Circuit Tester," Model CT-1 is another.

A family of elusive defects involving the control grids of tubes gave rise to the necessity that mothered another type of tester. With many circuits used in TV receivers, as well as those in other types of equipment, there is special sensitivity to some tube conditions that would not cause trouble in other circuits. For example, marginal defects in r.f. or i.f. tubes biased from an a.g.c. line, or hard-to-find troubles in sync, sweep, or oscillator circuits, may originate with deviations in one tube that are hard to show up with ordinary tube testers.

The trouble involved often shows up in TV as poor contrast range, coarse definition in the picture, twisting or pulling of the picture, sync instability, and drift. Quite often, the cause is in the control grid of one tube in the related chain of circuitry. In the wrong function, a tube with a small amount of gas, slight control-grid emission, or slight leakage between the control grid and some other electrode can give rise to these brain-twisters. The *Seco* "VT Grid Circuit Tester" GCT-8 was designed to meet these problems head on.

This device provides a number of simultaneous tests of the grid itself and of the grid in relation to other tube elements. Immediate indication of defectiveness occurs when the tube fails to pass any one test. Checks for filament continuity and other inter-electrode shorts can also be made. The same manufacturer offers a complete tube tester, Model 107, which incorporates the grid test circuit.

A radical departure in TV service technique becomes possible with the *B&K* "Television Analyst," Model

prepare for your career in

**ELECTRONICS  
RADIO-TV  
COMPUTERS**

and other fields of

**ELECTRICAL ENGINEERING**

At MSOE, you can equip yourself for a career in many exciting, growing fields: **MISSILES RADAR • AUTOMATION RESEARCH • DEVELOPMENT ELECTRICAL POWER AVIONICS • ROCKETRY**

When you graduate from the Milwaukee School of Engineering, you are prepared for a dynamic career as an Electrical Engineer or Engineering Technician. Under a faculty of specialists, you gain a sound technical education in modern, completely equipped laboratories and classrooms. As a result, MSOE graduates are in great demand and highly accepted by industries nationally.

At MSOE you will meet men from all walks of life and all parts of the country — some fresh out of high school or prep school, others in their twenties — veterans and non-veterans.

You can start school in any one of four quarters and begin specializing immediately. Engineering technicians graduate in 2 years with an Associate in Applied Science degree. For a Bachelor of Science degree in Engineering, you attend 4 years. A 3-month preparatory course also is available.

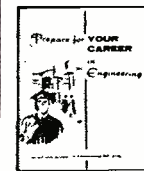
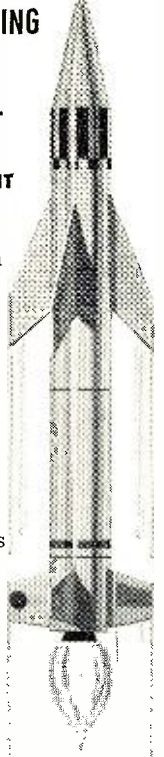

**FREE CAREER BOOKLET!**  
If you're interested in any phase of electronics, radio or television, be sure to look into the programs of study offered by the Milwaukee School of Engineering. Just mail the coupon.

**MILWAUKEE SCHOOL OF ENGINEERING**

Dept. RT-459, 1025 N. Milwaukee St. Milwaukee, Wisconsin

Please send FREE Career Booklet. I'm interested in  Electronics  Electrical Power  Television  Mechanical Engineering  Radio  Electrical Engineering  Computers  Industrial Electronics

PLEASE PRINT

Name.....Age.....

Address.....

City.....Zone.....State.....

I'm eligible for veterans education benefits. MS-123

## T-47/ART-13 TRANSMITTER

100 watt 2-18 MC autotune exec. \$59.00  
cond. with tubes.

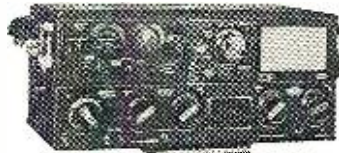

**FOB CONN.—MICH.**  
Will ship from your nearest point (Full payment with your order please)  
**LIMITED QUANTITIES—GET YOURS NOW**

## SCR-274 COMMAND EQUIPMENT

ALL COMPLETE WITH TUBES  
Type Description Used NEW  
BC-453 Receiver 100-550 KC. \$14.95 \$16.95  
IC-454 Receiver 3-6 Mc. 9.95 12.95  
BC-455 Receiver 6-9 Mc. 10.95 13.50  
IC-450 3-Receiver Control Box. 1.49 1.95

BC-457—TRANSMITTER—4-5.3 Mc. complete with all tubes and crystal. BRAND NEW. \$6.95  
BC-458 TRANSMITTER—5.3 to 7 Mc. Complete with all tubes and crystal. BRAND NEW \$6.95

BC-459 TRANSMITTER—7-9.1 Mc. complete with all tubes and crystal. BRAND NEW \$10.00

ARC-5/T-19 TRANSMITTER 3 to 4 Mc. BRAND NEW complete with all tubes & crystal \$7.95

## ARC-5/R28 RECEIVER

2-meter Superhet. 100 to 156 Mc in 4 crystal channels. Complete with 10 Tubes. BRAND NEW \$24.45

## ARC-5/T-23 TRANSMITTER

100-150 Mc Includes 2-832A, 2-1625 Tubes. BRAND NEW \$21.50

## ARC-5 MARINE RECEIVER

Navy Type Comm. Receiver 1.5 to 3 Mc BRAND NEW with 6 tubes. \$16.95

AN/ARC-1 Airborne radiophone ground to plane Receiver, 10-channel xtal controlled, easily converted to 20 or 50 channel. VHF 100 to 156 Mc AM. Complete with tubes, mtg rack, dynamotor. BRAND NEW. OUR LOW PRICE \$59.00

## SCR-522 2-METER SET

Terrific buy! VHF Transmitter-receiver, 100-156 Mc. 4 channels. Xtal-controlled. Amplitude modulated voice. They're going fast! Excellent condition. SCR-522 Transmitter-Receiver, complete with 18 tubes, top rack and metal case. COMBINATION Special \$29.50

SCR-522 AC-POWER SUPPLY parts consisting of genuine original power xformer and copper oxide rectifier and receptacles as on RA-62 schematic furnished. \$17.50

I-152-AM SCOPE indicator. Has 3" CRT tube with associated amplifier as new... \$13.00

## RECEIVER MICROWAVE R-111/APR-5

Frequency range 2000-4000 mc, fully metered power 110v/60/1 ph. set contains one unit with all used, exc. \$49.00

**GREATEST SURPLUS BARGAINS! —SEND for FREE CATALOG**  
\$5.00 Order Minimum, & 25% Deposit on C.O.D.'s • Prices are F.O.B. New Haven, Conn.  
133 HAMILTON ST. NEW HAVEN, CONN.

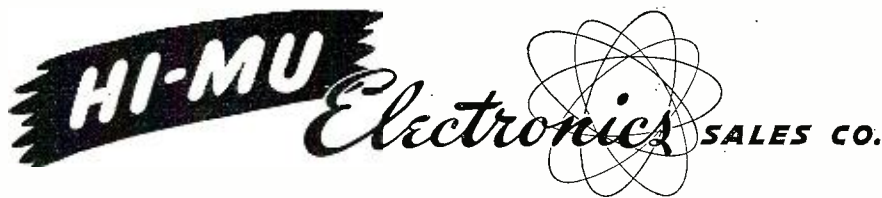

## MICROPHONES

Model	Description	Excellent Used	BRAND NEW
T-17	Carbon Hand Mike	54.95	57.45
T-30	Carbon Throat Mike	.39	.79
T-45	Army and Navy Lip Mike	1.33	1.73
T-24	Carbon Mike	3.95	8.95
F-3	Handset	8.00	8.00
RS-38	Navy Type	2.79	4.95

## HEADPHONES

Model	Description	Excellent Used	BRAND NEW
HS-23	High Impedance	52.25	54.75
HS-33	Low Impedance	2.79	4.75
HS-30	Low Imp. (featherwt.)	1.25	1.99
H-16 U	High Imp. (2 units)	7.95	7.95

TELEPHONICS—600 ohm HEADSETS  
BRAND NEW, PER PAIR \$3.45  
CD-307A Cords, with PL35 plug and JK26 Jack. .99  
Earmone Cushions for above—pair. .50  
HI-FI HEADSET. Rubber Ear pads to obtain spacing for correct acoustical load. GIVES FINEST MUSIC REPRODUCTION! Imp.: 300 Ohms per unit or 600 ohms when wire series.  
Brand New \$7.95



## MOBILE-MARINE DYNAMOTOR

Input 12V DC. Output: 625 V DC @ 225 MA., for press-to-talk intermittent operation. Shpg. wt. 14 lbs.  
DM-35 NEW... \$14.95

OTHER DYNAMOTOR VALUES:

Type	Input	Output	Excellent Used	BRAND NEW
DA-19-A	28V 11A	400V .400A		\$6.95
DM-28	28V	224V .07A	\$2.95	4.95
DM-32A	28V 1.1A	250V .05A	2.95	4.95
DM-33A	28V 5A	575V .16A	3.95	
DY-21	28V 7A	540V .25A	15.00	35.00
DM-34D	12V 2A	220V .080A	4.25	5.50
DM-37	25.5V 9.2A	625V .225A	5.95	8.95
DM-53A	28V 1.4A	220V .080A	3.95	5.95
PE-73C	28V 20A	1000V .350A		11.50
PE-86	28V 1.25A	250V .050A	2.95	5.24
PE-186	28V 11A	400V .400A		6.95
DY-1	14V 2.4A	250V .060A		5.95

## MOBILE DYNAMOTORS

WINCHARGER 4156 regulated, Input 13v/13a. Output ±1: 240v/60ma—Output ±2: 300v/225 ma. Regulation zero load to full load, appr. 5%, extremely stable, brand new... \$14.95  
WINCHARGER 5055, Input 12v/15a; output 400v/200 a., can also be used on 24 volts, brand new \$14.95



## SYNCHROSCOPE MODEL TS-34/AP

Utilizes a 2" cathode ray tube with an optical magnifier. It may be used for observing pulsed information of 1/4 microsecond to 30,000 microseconds duration. May also be used for observing sine waves from 30 cycles to 1 megacycle. This unit is supplied with carrying case and accessory cables. Condition is excellent. All equipment has been checked out. \$95.00

1075. This unit provides complete facilities for dynamic troubleshooting and fault isolation by making available all the test signals one needs for signal injection in any TV receiver section. Kindred signal-injection devices and techniques were used for AM broadcast receivers many years ago, but the diversity and complex nature of signals found at different points in TV receivers complicate the design of such a device for TV.

The "Television Analyst" provides its own test pattern. Video signals derived therefrom are available directly (positive or negative, with variable amplitude), or modulated onto a choice of i.f. or r.f. carriers for insertion anywhere in the video chain. An audio signal is available directly or on a frequency-modulated 4.5-mc. i.f. carrier. Composite sync or separate vertical or horizontal driving pulses are also provided. For color TV, there are white-dot, crosshatch, and color rainbow patterns.

Detailed oscilloscopic analysis of TV receivers without direct connections—even with the chassis still in its cabinet—may now be achieved with such devices as the Kingston "Absorption Analyzers." Models EA-1 and VS-5, portable units with built-in cathode-ray tubes, use probes to pick up signals electrostatically from tubes. High sensitivity and tuning over a broad range permits displays even from signals picked up in r.f. and i.f. circuits. Model PO-1 is an auxiliary unit that adapts a conventional scope to this technique. The Wintronix "Induced Waveform Analyzer," Model 850, is a scope adapter that works on a similar principle.

Along with the increasing use of semiconductor devices, there is a flock of associated testers. No clear-cut pattern has yet developed among transistor and crystal-diode checkers, but Century Electronics Co. has done something interesting about semiconductor rectifiers. Its "In-Circuit Selenium Rectifier Tester," Model SRT-1, which also makes out-of-circuit tests, is quickly adjustable to rectifiers of different ratings and applicable to silicon and germanium units as well.

Combining different test facilities in a single unit often provides high versatility and speed. For example, the Superior "All-Purpose Bridge," Model 76, is basically a capacitor and resistor analyzer akin to those mentioned at the beginning of this article. However, it uses available circuitry to double as a signal tracer and provide a rapid check of antenna systems at the receiver end of the transmission line.

Another interesting multi-function device is the Precise "Power Lab," Model 713. In addition to a useful isolation transformer, it provides a wide range of variable a.c. and d.c. voltages, metered, available at sufficient currents for virtually any use.

If already available special instruments don't meet all of your special needs—be patient. Equipment manufacturers are probably working on the solution already.

## Hi-Fi Living Stereo COMPONENTS—TAPE RECORDERS TAPE and Records ALL STANDARD BRANDS AT TREMENDOUS DISCOUNTS

Quotations by Return Mail • Wholesale Catalog Free •

### AUDIO FAIR

1799N 1st Ave. New York 28, N. Y.

**WIRE SENDING SPEED**  
**WIRE RECEIVING SPEED**

Be a "key" man. Learn how to send and receive messages in International Morse code. Communicate with operators around the globe. Learn at home quickly through famous Candler System. Used by best operators. Quality for Amateur or Commercial License. Write for FREE BOOK.  
CANDLER SYSTEM CO., Dept. 2-D, Box 9226, Denver 20, Colo., U.S.A.

## THERMO-ELECTRONICS

Successor to Thermo-electricity

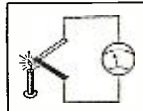

Change heat to electricity DIRECTLY—no acids, chemicals, liquids, sunlight or moving parts! Build or buy a thermoelectric battery. Information and sample thermoelectric alloy...25¢ Heat Battery Fundamentals (paper)...\$1.00 Both, ordered at the same time...\$1.00

## HERMON E. COTTER

Dept. P

15766 Blackstone, Detroit 23, Michigan

# AN ELECTRONICS WORLD

YOU'LL  
WANT TO  
EXPLORE!

stengoff

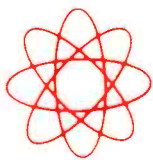

**ELECTRONICS**   
**WORLD**

FORMERLY  
**RADIO  
& TV NEWS**



Beginning next month, the title of RADIO & TV NEWS changes officially to ELECTRONICS WORLD. And appropriately, the magazine has rarely carried such diverse, exciting features for everyone interested in the world of electronics. You'll want to explore these articles in depth:

**INDUCTION HEATING**—Here's an up-to-the-minute report on a process that affects thousands of consumer products and pieces of industrial equipment! Learn how radio waves are used for electronic brazing, soldering, and hardening in this article that is sure to be of interest to anyone who knows and loves electronics!

**HI-FI CROSSOVER NETWORKS**—Part Two of the feature in this issue. In May, you'll see how to design and put together home-built precision networks for two- and three-way speaker systems. Along with this material is a valuable gatefold featuring a master chart of physical winding data for network chokes, an auxiliary chart to determine correct capacity values, a chart of the actual inductance values of network chokes—plus schematics of typical two-way 6 and 12 decibel-per-octave networks!

**ELECTRIC SHOCK: FACT & FICTION**—Everyone who works on electrical or electronic equipment will be interested in this article on the effects of electrical shock on the human body. For instance, you'll find out why even low-voltage shocks can harm you!

**EXPERIMENTAL TRANSISTOR MOTOR CONTROL**—Construction details on a simple, inexpensive circuit for the direct or remote control of various models of small motors.

**PLUS:** a new feature on Recent Developments in Electronics...Part Two of Loudspeakers for Stereo...Ultra-Stable OTL Hi-Fi Amplifier...Generating Test Signals with Crystals...plus all usual monthly departments.

At newsstands, look for the May issue carrying the new title, ELECTRONICS WORLD, on sale April 28.

Better still, why not subscribe right now to ELECTRONICS WORLD? You can still take advantage of low, low subscription rates. As you'll see on the cover, this magazine now costs 50c per copy at newsstands. Figure the savings of a subscription for yourself—using the rates below. You'll find subscribing to ELECTRONICS WORLD a real bargain. So, act today!

**CURRENT SUBSCRIPTION RATES:**

**\$4 one year, \$7 two years, \$10 three years**

**ELECTRONICS WORLD**

434 South Wabash Avenue, Chicago 5, Illinois

Get  
Your First Class Commercial  
**F.C.C. LICENSE**  
**QUICKLY**

**MORE JOBS THAN WE CAN FILL**—Jobs in radio-TV-electronics are going begging. A commercial FCC license is your ticket to higher pay and more interesting employment. We train you quickly—then help you find the job you want.

**GRANTHAM TRAINING PREPARES YOU**—Grantham School of Electronics specializes in preparing students to pass F.C.C. examinations. The Grantham Communications Electronics Course prepares you for a *FIRST CLASS* F.C.C. license by **TEACHING** you electronics. Each point is covered simply and in detail, with emphasis on making the subject easy to understand. The organization of the subject matter is such that you progress, step-by-step, to your specific objective—a first class F.C.C. license.

**CORRESPONDENCE OR RESIDENCE CLASSES**—Grantham training is available by correspondence or in resident classes. Either way (residence or correspondence), we train you quickly and well.

**Here's Proof:** A few recent graduates, the class of license they got, and how long it took them:

Name	License	Weeks
Roy E. Alexander, Pikeville, Kentucky	1st	12
W. R. Smith, 1335 E. 8th St., Long Beach, Calif.	1st	12
John W. Dempsey, Box 55, Rising Sun, Md.	1st	12
Donald H. Ford, Hyannis RD, Barnstable, Mass.	1st	12
Richard J. Falk, 2303 Holman St., Bremerton, Wash.	1st	22
Odie B. Perry, Jr., Rt. #3, Zebulon, N. C.	1st	12
Milton C. Gee, Rt. #1, Washington, N. J.	1st	11

**THREE COMPLETE SCHOOLS:** To better serve our many students throughout the entire country, Grantham School of Electronics maintains three complete schools—one in Washington, D. C., one in Hollywood, Calif., and one in Seattle, Wash. All schools offer the same rapid courses in FCC license preparation, either home study or resident classes.

**MAIL COUPON FOR FREE BOOKLET:** Our free booklet, *Careers in Electronics*, gives details of how you can prepare quickly for your FCC license. For your free copy of this booklet, clip the coupon below and mail it to the Grantham School nearest you.

**WASHINGTON D.C.** Grantham School of Electronics  
821-19th Street, N. W.  
Washington 6, D. C.

**HOLLYWOOD CALIF.** Grantham School of Electronics  
1505 N. Western Avenue  
Hollywood 27, California

**SEATTLE WASH.** Grantham School of Electronics  
408 Marion Street  
Seattle 4, Washington

(Mail in envelope or paste on postal card)

**GRANTHAM SCHOOL OF ELECTRONICS**  
821 - 19th, NW 1505 N. Western 408 Marion  
Washington • Hollywood • Seattle

Please send me your free booklet telling how I can get my commercial F.C.C. license quickly. I understand there is no obligation and no salesman will call.

Name \_\_\_\_\_ Age \_\_\_\_\_

Address \_\_\_\_\_

City \_\_\_\_\_ State \_\_\_\_\_

I am interested in:  Home Study,  Resident Classes  
96-D

# What's



# New in Radio

## PLIERS FOR ELECTRONICS

Champion DeArment Tool Company of Meadville, Penna. has recently introduced four precision-made pliers especially designed for all types of electronics work as new items in its "Channellock" line.

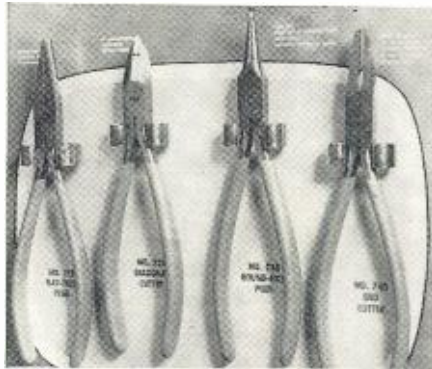

The distinctive design features include slender, long-reach jaws and handles, precision-matched jaws and points, hand-honed specially hardened cutting edges, and easy-to-handle blue plastic-coated grips.

The new line includes a flat-nose plier, a diagonal cutter with wire-stripping notch, a round-nose plier, and long-reach end cutter. The pliers are forged from high-grade, heat-treated steel and have a full-polished finish.

The manufacturer will supply additional details and prices upon request.

## MOBILE HAM TRANSMITTER

Heath Company, Benton Harbor, Mich. is now offering a mobile ham transmitter in kit form as the "Cheyenne."

Using carrier-control modulation, up to 90 watts input is obtained on modulation peaks. At all other times the unit is idling, allowing low battery drain and eliminating the necessity for special heavy-duty generators and battery.

The new unit features up to 90 watts input on phone and covers 80, 40, 20, 15,



and 10 meters. It features built-in v.f.o., modulator, four r.f. stages, a 6146 final amplifier, and pi-network output coupling. Power requirements are 500-600 volts d.c. at 150 ma. and 300 volts d.c. at 100 ma. All necessary power can be supplied by a companion

power supply catalogued as the MP-1. The "Comanche" mobile receiver has been designed as a companion piece and is housed in a cabinet identical to the transmitter.

Write the manufacturer direct for technical specifications on any one or all three of these new mobile equipment items.

## NEW HICKOK TUBE TESTER

The Hickok Electrical Instrument Company, 10524 Dupont Ave., Cleveland 8, Ohio is now marketing a new, low-cost dynamic mutual-conductance portable tube tester which will also serve to check transistors and diodes.

The new instrument will check leakage between tube elements up to 10 megohms and test filament continuity on series-string tubes. A push-button control reverses the meter for testing special tubes such as 117N7 types. Tube

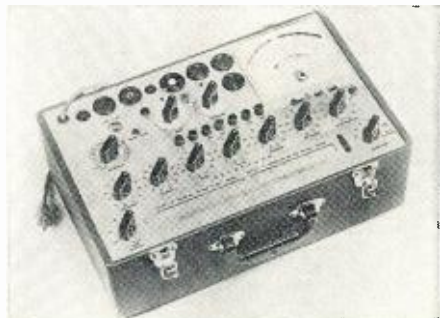

sockets for 4-, 5-, 6-, and 7-pin, octal, loctal, noval, and 7-pin miniature are provided. Top cap jacks are built into the panel and leads are included.

A 5-inch rectangular meter with multi-colored, multi-scale dial is used. The meter window is anti-static coated and of wrap-around design to increase light and allow a wide scale that is easy to read at reasonable distances.

The Model 800 tests tubes under simulated operating conditions and accurately evaluates all popular tubes normally encountered in electronic service work. A time-saving tube reference chart carries test data on all popular tubes.

## CLOCK-RADIO KIT

Allied Radio Corporation, 100 N. Western Ave., Chicago 80, Ill. is now offering a low-cost clock-radio in its "Knight-Kit" line of build-it-yourself equipment.

The "Ranger" is in modular form and features an efficient superhet radio which covers the entire broadcast band. In addition it has a luminous *Telechron* clock with "sleep switch" plus an automatic radio wake-up/alarm switch. Module plug-in circuits and a printed

# RADIO ELECTRONIC SURPLUS

## BC683 FM RECEIVER



27-39 mc. Equipped with 10 push buttons for selecting channels. Cont. variable tuning over the entire range. Unit complete with tubes, built-in loud speaker, squelch circuit, head phone jacks, schematic diagram on bottom of case. Approx. weight 34 lbs. \$19.95 12- or 24-volt D.C. Dynamotor ..... each \$3.95

## BC603 FM RECEIVER

Same description as BC683 except that range is 20-27 mc. This unit complete with tubes. Like New ..... each \$9.95 Manual with schematic for BC603 & BC604 ..... \$1.00 each **CRYSTALS** (set of 80) for BC604 transmitter. . . \$5.00

## RCA 18-WATT AMPLIFIER

Input 105-125 volts A.C., 50/60 cycles, 180 watts. Output with 117 volts an 120 volt tap, power trans. 5% max. R.M.S. harmonic distortion at 400 cycles, 18 watts. Available amp. loading impedance 4, 8, or 15 ohms. Tube complement: input 6J7, voltage amp. 6J5, amplifier-phase inverter 6N7, output 2 6L6, rectifier 5U4G, field supply rectifier 5U4G, oscillator 6F6. This is high quality amp., built to Gov't. specs., used normally with 16mm sound projector. Case is steel pointed black. Approx. dim. 9" x 20" x 8". Schematic furnished. Shipping wt. approx. 50 lbs. .... \$24.95 ea.



## TEST SCOPE—SYNCHROSCOPE—PULSE ANALYZER



ID-59/APA-11. Late production. Modular subassembly construction. Video amplifier is flat to 4 mc. 3BP1 presentation. Test-scope sawtooth 25-20,000 cy. Has all normal test-scope controls. As synchroscope and pulse analyzer, accepts positive or negative pulses. Video delay circuit permits leading edge of pulse to be seen. Calibrated-dial horizontal shift measures pulse durations from 0.5 to 100 microseconds. Sine-wave-oscillator calibrator measures recurrence rates from 200 to 6000 pps accurate within 0.4%. Built-in power supply requires 115v, 400 cy, 196 watts. External 60 cy power supply may be made to furnish plus 350 and -1300 vdc and 6.3 voc. In excellent condition, with all 19 tubes, schematic with parts values, parts-location pictures, operating instructions, theory explanation, and maintenance charts. Shipping weight 60 lbs. Used, good. Price each \$16.95

## HALLICRAFTER 536

27.8 to 143 mc frequency range in 3 bands; 110 volts 50/60 cycle single phase; 80 watts. Approx. dimen. 21" L. x 15" W. x 10" H. Used, in excellent working condition. Price \$69.50 Limited quantity

## RG8A/V COAX CABLE

52 ohm, approx. 15 1/2 ft. long with PL259 plugs on each end. \$1.50 each, postpaid.



## 30-40 MC FM RECEIVER R-435/VRC-2X



Single channel, crystal controlled, covering police and fire department freq. Double conversion superhet (455 kc and 4.3 inc. I.F.'s); both oscillator and crystal control. Noise squelch, double limiter stages, loud speaker output. Contains vibrator supply, operates on 24 volts

D.C. Removable cover. Approx. dimensions: 9" X 12" X 15". Unused, good condition. Price..... \$19.50

## PE120 POWER SUPPLY

6, 12 or 24 volt (specify voltage) Used with BC659 and 620..... \$6.95 each

NO C.O.D.'s. REMIT FULL AMOUNT WITH ORDER. ALL PRICES F.O.B. PASADENA.

## C & H SALES CO.

2176 E. Colorado St. • Pasadena 8, Calif.

circuit board make assembly remarkably easy. The builder simply plugs completed modularized circuits into the board and makes a few solder con-

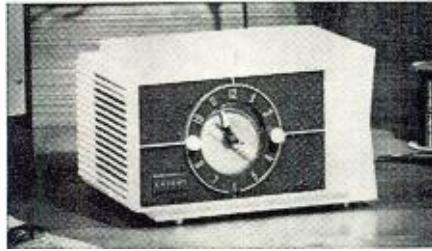

nections—there is no need to solder individual components in place.

The case is finished in blue and white and measures 6" x 9 5/8" x 5 3/8". The kit comes complete with case, tubes, all parts, wire, solder, and instructions. It is catalogued as Stock No. 83 Y 737.

## GONSET "COMMUNICATOR"

Gonset, a division of Young Spring and Wire Corp., 801 S. Main Street, Burbank, Calif. is now offering a new Citizens Band 2-way radio for use on the 21 channel allocations within the 26.96-27.23 mc. band recently released by the FCC for this service.

The G-11 "Citizens Communicator" is a complete, two-way voice trans-



mitter-receiver and power supply in a single compact unit. The transmitter provides 5 watts input, the maximum allowable power for this type of service.

Both the transmitter and receiver are crystal-controlled. Operating frequency is thus unaffected by jarring or vibration and tuning controls are eliminated. After a brief warm-up period, operation is controlled by the push-button on the microphone. Adjustable "squelch" control on the receiver reduces background noise while the set is in standby condition.

The unit features compact, rugged construction, is 6 3/4" wide, 5 1/4" high, and 6 3/4" deep. For mobile or vehicular operation, a built-in 12-volt d.c. power supply is furnished. For fixed station service, a 117-volt a.c. power supply can be specified. Quartz crystals for one channel and the press-to-talk microphone are standard equipment.

A booklet giving complete information on the G-11 will be forwarded by the company on request.

## NC 400 COMMUNICATIONS RECEIVER

National Company of Malden, Mass. has recently released a new 18-tube communications receiver which is catalogued as the Model NC 400.



# BUY EICO HAM KITS AT HARVEY

## 90-Watt CW Transmitter Model 720



The new EICO Model 720 is a very "clean" 90 watt CW, 80 through 10 meters bandswitching amateur transmitter. Some important design features are: one-knob band switching; tune and operate switch; final amplifier grid drive control without detuning oscillator; oscillator keying for break-in operation, a "novice limit" calibration (75 watts) on the meter.

**SPECIFICATIONS**—Power input: 90 watts CW (novice limit calibration on meter); 65 watts AM-phone with EXT plate modulation. Output Impedance: 50-1000 ohms. Band Coverage: 80, 40, 20, 15, 11, 10 meters.

KIT \$79.95 WIRED \$119.95



## GRID DIP METER MODEL 710

An exceptionally versatile, stable, rugged, compact design. Basically a VFO with a microammeter in its grid circuit, it determines frequency of other oscillators or tuned circuits; has a sensitivity control and phone jack to facilitate "zero beat" listening. Also excellent as an absorption wave meter. Ham uses: pre-tuning and neutralizing transmitters, power indication, locating parasitic oscillations, antenna adjustment, correcting TVI, etc., including complete set of coils for full band coverage.

KIT \$29.95 WIRED \$49.95

**MAIL ORDERS SHIPPED SAME DAY AS RECEIVED**  
Include with your payment a generous allowance for shipping charges — the excess will be promptly refunded.

**HARVEY** Estab. 1927  
**RADIO CO., INC.**  
103 West 43rd Street New York 36, N.Y. JU 2-1500

# Here's how to GET MORE WORK OUT OF YOUR Oscilloscope!

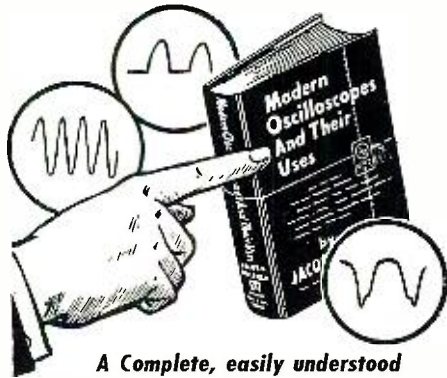

A Complete, easily understood guide to using the handiest service instrument of them all

## MODERN OSCILLOSCOPES AND THEIR USES

By Jacob H. Ruiter, Jr.

### Enlarged 2nd Edition

... contains the latest data ... everything you need to know about 'scopes!

### MORE THAN 30 NEW PICTURES

... plus 50 more pages including data on quantitative measurements—the slickest method of diagnosing many color TV troubles and aligning sets properly.

it gets right down to "brass tacks" in explaining how oscilloscopes operate. Then you learn exactly how to use them in lab work and on all types of AM, FM and television service—from locating troubles to handling tough realignment jobs.

### 'SCOPES ARE "GOLD MINES" When You Learn to Use Them Right!

Each operation is explained step by step. You learn to determine just where and how to use the 'scope on specific jobs; how to make connections and adjust circuit components; how to set the controls; and HOW TO ANALYZE OSCILLOSCOPE PATTERNS fast and right.

370 illustrations including dozens of pattern photos make things doubly clear.

No other type of specific service training can mean so much to you in boosting your efficiency and earning power! Send coupon NOW for 10-day examination!

Oscilloscopes are gold mines for servicemen who learn to use them fast, fully and accurately on all types of work—and here is a new, enlarged 2nd edition of THE BOOK THAT REALLY SHOWS YOU HOW.

In clear, easily understood terms, it teaches you when, where and exactly how to use the oscilloscope ... how to interpret patterns ... how to use your 'scope to handle tough jobs easier, faster, and better.

It contains no involved mathematics—no complicated discussions. Instead, it explains in plain, "brass tacks" terms how to use the 'scope on specific jobs; how to make connections and adjust circuit components; how to set the controls; and HOW TO ANALYZE OSCILLOSCOPE PATTERNS fast and right.



'SCOPE EXPERTS get better jobs ... bigger pay!

### PRACTICE 10 DAYS—FREE!

Dept. RN-49, RINEHART & CO., Inc.  
232 Madison Ave., New York 16, N. Y.

Send MODERN OSCILLOSCOPES AND THEIR USES for 10-day FREE EXAMINATION. If book is satisfactory, I will then send you \$6.50 (plus postage) promptly in full payment. If not, I will return book postpaid in good condition and owe you nothing. (SAVE! Send \$6.50 cash with order and we pay postage. Same 10-day return privilege with money refunded.)

NAME .....

ADDRESS .....

CITY, ZONE, STATE .....

OUTSIDE U.S.A. \$7.00 cash only. Money back if you return book within 10 days.

The new radio covers a frequency range of 540 kc. to 31 mc. in seven bands. It has an extreme selectivity range of 16 kc. to 150 cps with i.f. and the crystal filter supplied. With accessory mechanical filters it has a selectivity range of 16 kc. to 500 cps. Sensitivity is approximately 1  $\mu$ v. for a 10 db signal-to-noise ratio.

Frequency stability is .002% long-term drift after warm-up. Instant side-band selection is provided by means of passband switching and provision is made for use of mechanical single-side-band filters which may be selected by means of a front-panel switch. Five crystal sockets in the high-frequency oscillator circuit are available for fixed-channel operation. These channels are selectable from the front panel. Also available is a special diversity modification which makes it possible to use the receiver in a system either as a master controlling receiver or as a slave receiver driven by other oscillator sources.

The NC 400 is housed in a two-tone metal cabinet of modern functional design. All operating controls and indicators are located on the front panel and all external connections and test jacks are located on the rear panel.

Write the manufacturer for a detailed spec sheet and prices on the receiver and its accessory units.

### 4-INCH "UNIMETER"

The Triplett Electrical Instrument Co. of Bluffton, Ohio has announced the development of a 4-inch "Unimeter" which affords a new means of obtaining a variety of panel meters at low cost by combining any number of dial component sections with a separate basic movement section.

All 4-inch "Unimeters" are provided with mirror scales to eliminate parallax and provide highest accuracy in reading. The meters are available with or without a practical quick-change instrument stand.

The "Unimeter" permits a highly flexible, low-cost meter inventory by

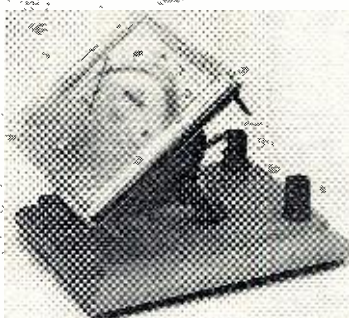

stocking the minimum number of basic meter movements and a maximum quantity of inexpensive dial components. The assembly process is error-proof. Simply slide the two sections together and lock with a thumbscrew at the back.

Other features of the new series include self-shielded, bar-ring movements, a.c. and d.c. linear scales, extreme accuracy, and dustproof con-

**RUNNING TIME METER**  
BRAND NEW—Made by Industrial Timer.  
0-9,999.9 Hours. 110V-60 cy. Ea. ... **\$9.50**  
Write for quantity prices

### HEADPHONES

Brand new Murdock phones. Hi-Impedance 10,000 ohm, with standard phone plug. .... Ea. **\$3.45**

### POWER TRANSFORMER

Pri. 110V. 60 Cy. Sec. 300-0-300 V. 125 Ma. 12 Volt CT @ 3 Amps; 12 Volts @ 3 Amps; 5V @ 2 Amps/Replacement Transf. for EC 342 Rec. (also for 24V. Ins.) **\$2.50**  
Pri. 115V. Secs. 320-0-320V. @ 150 Ma. 5V. @ 2 Amps 6.3V. @ 3 Amps. Pri. 115 or 230V. Secs. 450-0-450 @ 250 Ma. 5V. @ 3 Amps. 6.3V. @ 8 Amps **\$5.95**  
Write for quantity prices

### FILAMENT TRANSFORMERS

Prim. 115V. 60 cy. Sec. 6.3V. @ 20 Amps. H-41/2" x W-4" x D-3 1/2" ... Ea. **\$3.50**  
Primary 110V. 60 cy. Sec. 5V. @ 10 Amps. Ins. 10,000 V. Small size, 2 for \$7.50 **\$1.50**  
Pri. 115 V. or 230 V. 60 cy. sec. 6.3 V. @ 5 amps. .... **\$3.95**  
Primary 110 volts 60 cycle. Secondary 2 1/2", 10 Amps @ 10.0V. Insulating. Suitable for pair of 866 tubes. .... **\$3.95**

### CHOKE—FULLY CASED

10 HENRY 80 Mil (unshielded) ..... 90c  
6 HENRY 150 Mil ..... \$1.50  
5 HENRY @ 200 Ma ..... 1.95  
5 HENRY @ 250 Ma ..... 2.25  
12 HENRY 60 Mil ..... 4.95  
4 HENRY 900 Mil ..... 12.95  
6 HENRY 600 Mil ..... 8.95

### BRAND NEW OIL CONDENSERS

2 MFD 600 VDC .50	4 MFD 1500 VDC 1.95
3 MFD 600 VDC .60	1 MFD 2000 VDC .85
4 MFD 600 VDC .75	2 MFD 2000 VDC 1.50
5 MFD 600 VDC .80	4 MFD 2000 VDC 3.50
6 MFD 600 VDC .85	1 MFD 3000 VDC 1.85
8 MFD 600 VDC .95	8 MFD 2000 VDC 5.95
10 MFD 600 VDC 1.19	2 MFD 3500 VDC 2.50
12 MFD 600 VDC 1.50	1 MFD 4000 VDC 1.85
3x8 (24 MFD) 600 VDC ..... 2.50	2 MFD 3000 VDC 3.50
1 MFD 1000 VDC .60	4 MFD 3000 VDC 6.95
2 MFD 1000 VDC .85	1 MFD 4000 VDC 2.25
4 MFD 1000 VDC 1.35	2 MFD 4000 VDC 6.25
8 MFD 1000 VDC 1.95	4 MFD 4000 VDC 13.95
10 MFD 1000 VDC 2.50	1 MFD 5000 VDC 6.95
12 MFD 1000 VDC 2.95	5 MFD 7500 VDC 2.95
15 MFD 1000 VDC 3.50	1 MFD 12,500 " 24.95
1 MFD 1200 VDC .45	1 MFD 15,000 " 34.50
1 MFD 1500 VDC .75	1 MFD 15,000 " 38.50
2 MFD 1500 VDC 1.10	1 MFD 25,000 " 49.50
	10 MFD 330 AC. 1.95
	15 MFD 440 AC. 2.50

### REDMOND BLOWER

110V. 60 cy. .3 Amp. 1600 Rpm. 3 3/4" Blower wheel—Outlet 2" Diameter. .... **\$7.95**  
2 for \$15.00

### SIGMA 5F RELAY

16,000 ohm in dual 8,000 ohm coils. (Can be paralleled) SPDT ag. 16 contacts. Adjustable armature tension. Operates on 500 microamperes or less. .... Ea. **\$3.95**  
Write for quantity prices.

### RELAYS

Allied Relay 110 V. AC DPST ..... Ea. **\$1.35**  
Allied 110V. AC 4PDT 10 amp contacts ..... **\$2.50**  
Claire Telephone Type 11,300 ohm coil SPDT cont. 10 amp 125V. Sealed contacts. Hermetically Sealed Relay Coil 110V AC 60 cy SPDT Contacts 5 Amps. .... Ea. **\$1.50**  
Sigma Sems, Plug-in H. S. 16,000 ohms 1 mil. #1 pole SPDT, #2 pole SPST. .... **\$1.95**  
6 Volt DC DPDT H.S. .... **99c**  
12 Volt DPDT DC Relay ..... Ea. **\$1.35**  
G.E. Plug in Relay 5 prong 10,000 ohm coil 1 mil. SPDT. .... Ea. **\$2.50**  
G.E. Relay control, contains 8,000 ohm relay, sensitivity 2 mils. 10 for \$9.25. Ea. **\$1.10**

### MINIATURE MICROAMMETER

1 1/2" Square D-100 Micro. Suitable for grid dipper field strength, 5 meter. .... Ea. **\$3.95**  
A BARGAIN AT ..... Ea. **\$2.95**  
1 1/2" Square. .... Ea. **\$2.95**  
0-1 Mil. .... Ea. **\$2.95**

### PANEL METERS

G.E. WESTINGHOUSE, W.E. SIMPSON, etc.	
<b>2" METERS</b>	0-1 Mil DC
0-50 Micro (0-5 scale) ..... 4.95	0-3 1/2 KV scale) 3.95
0-500 Micro DC ..... 3.50	0-10 Mil DC ..... 3.95
0-300 Mil DC ..... 2.95	0-50 Mil DC ..... 3.95
0-500 Mil DC ..... 2.95	0-100 Mil DC ..... 3.95
0-10 Amps DC ..... 2.95	0-150 Mil DC ..... 3.95
0-25 Amps DC ..... 2.95	0-12 Volts AC ..... 3.95
18-36 Volts DC ..... 1.99	0-50 Volts DC ..... 3.95
0-150 V. AC ..... 3.49	0-500 Volts DC ..... 4.50
0-4 Amps RF ..... 2.95	0-800 Volts DC ..... 4.50
	0-2.5 KV DC ..... 5.50
<b>3" METERS</b>	0-3.5 KV DC ..... 7.50
0-50 Micro ..... 5.95	0-4 KV DC ..... 7.50

### MISCELLANEOUS SPECIALS

SPERTI VACUUM SWITCH-CYS24163 Replacement in Antenna Unit ART13. .... Ea. **\$2.95**  
NEW, BOXED ..... Ea. **\$1.00**  
N.E. 51 NEON LAMPS, Box of 10 ..... Ea. **\$1.00**  
36 OHM 50 Watt Globar Non-Ind. Res. 2 for \$1.00  
3-12 MMF Erie Ceramic Trimmers ..... 21c  
Replacement 6' phone cord for Standard Headsets ..... 2 for \$1.00 ..... Ea. **59c**  
UTC QUINCY TRANS. Pri. 100 ohm. Sec. 125,000 ohm. Ideal for mike or phone patch—2 for \$1.00 ..... Ea. **29c**  
CUTLER-HAMMER TOGGLE SWITCH SPDT (ST42D) 4 for \$1.00 ..... Ea. **29c**  
Write for quantity prices on all special items

All merchandise sold on a 10 day money back guarantee basis

Min. Order \$3.00—25% with Order—F.O.B. New York

# PEAK

ELECTRONICS COMPANY  
66 W. Broadway, New York 7, N. Y., WO-2-5439



struction. The manufacturer will supply additional details upon request.

### MOBILE MONITORS

The *Monitor Division of I.D.E.A., Inc.*, 7900 Pendleton Pike, Indianapolis 26, Ind. has announced the availability of two new crystal-controlled mobile FM receivers for the continuous monitoring of any single frequency in the 30-50 or 152-174 mc. bands.

The Model MC-40 (30-50 mc.) has a sensitivity of 2  $\mu$ v. or less while the Model MC-160 (152-174 mc.) is rated at 4  $\mu$ v. or less. Both have  $\pm$  40 kc. selectivity at 20 db, have 1  $\mu$ v. adjust-



able squelch operation, have output power of .8 watt, and operate from 12-volt d.c. sources. Both draw 3.9 amps at 12.6 volts, measure 4 1/2" x 6 1/2" x 8 3/4", and weigh 9 pounds.

The units are housed in well-ventilated blue-grey cabinets which can be installed easily in a car or truck. The chassis are readily removable from the cabinets for servicing.

Designed for use by volunteer firemen, special police officers, utility workers, etc., the units feature double conversion, r.f. stage, built-in squelch, and a 4" PM speaker. The units come complete with crystal. -30-

### Stereo Amplifier System

(Continued from page 67)

With this type of design it would be best to use as low an input signal as possible. With an FM tuner, many have volume control adjustments that can be used to reduce output. There is no difficulty when using a magnetic or ceramic cartridge since their outputs are usually low and there is little danger of overloading.

The circuit itself is not too unusual as one can note by checking the accompanying schematic diagram. The output tubes are 6L6GB's. Two 32-ohm outputs are provided so that, when both channels are connected in parallel, a 16-ohm speaker can be used. A separate bridge circuit is used to supply well filtered d.c. to the low-level filament circuits. Silicon rectifiers in the power supply provide the low impedance needed for good supply voltage regulation. The feedback loop encompasses a minimum number of stages operating with a large stability margin. In addition, some comment is in order regarding the ceramic input circuit. Most designs we have checked use a 100- $\mu$ fd. capacitor in series with the cartridge and then apply the output to the magnetic input. However, in this case a resistive voltage divider network was used to accomplish the same purpose. We found that this performed extremely well below 1000 cps but the high end dropped off, at the most, about 6 db at 6000 cps. For those who want extended high-frequency response, it would be advisable to boost the treble control slightly to compensate for this drop. -30-

## KEEP CANDEE HANDEE!

### SPRING MOBILE BARGAINS!

#### ARC-5 COMMAND EQUIPMENT

T-19 TRANSMITTER: 3-4 MC. Excel. cond. \$5.95  
T-20 TRANSMITTER: 4.5-3 MC. Excel. cond. 3.95  
T-21 TRANSMITTER: 5.3-7 MC. Excel. cond. 3.95  
FAMOUS Q-5'er RECVR. 190-550 KC. . . . . 12.95  
MD-7 PLATE MODULATOR: Excel. . . . . 6.95  
BC-442 ARC-5 ANTENNA RELAY. Excel. . . . . 1.95

#### R-435/VRC-2X FM RECEIVER

Crystal controlled, single channel, covers fire, police freqs. Double conversion superhet. 4.55 kc & 4.3 inc. IP's. Noise squelch, double limiter stages, loud speaker output. Complete with 24 VDC vibrator supply, tubes, less crystal. \$14.95  
Special . . . . .

#### APN-4B LORAN EQUIPMENT

Marine or air. Long range navigational gear to determine position of ship or plane up to 1200 miles from base. Complete with scope, receiver, tubes, crystals. ONLY \$39.95

#### AN/APN-9 LORAN SYSTEM

Used in ships and aircraft. Determines position by radio signal from known transmitters. Accurate to within 1% of distance. Complete with \$88.88 tubes and crystal. Like new.

#### TELEPHONIC 600 OHM HEADSET

Brand new! Mfr. by Telephonics. \$3.95  
Type TH37

#### G.E. PYRANAL OIL-FILLED CONDENSERS

Cat. No. 18P209, 120 MFD @ 3,000 VDC. F.B. for hams. Makes good component for arc welder. Excellent cond. Sold at fraction of original \$69.95 cost. ONLY

GUDEMAN COND. 60 mfd. @ 4,000 VDC. \$49.95  
Excel.

#### HICKOK MOD. 547-A TUBE CHECKER

Mutual conductance. With chart. Also tests special purpose tubes. A honey of a buy! \$69.95  
Excel.

#### T85/APT-5 TRANSMITTER

Has lighthouse tube 3C22 oscillator in tunable cavity modulated by two type 829B tubes powered by 0.51 noise generating photocell. Output approx. 30 W. CW @ 115 V, 400 cycles. \$49.95  
Excellent cond.

#### RAX-1 RECEIVER

4-band, 4 1/2" dial, AVC, MCW, CW, phone jack and volume control. Voltage required 24VDC and 200V @ 80 ma. Complete with 7 tubes. Excellent. \$17.95  
200-1500 kc. Each

110 VAC POWER SUPPLY: For BC-603 and BC-683 Recvrs. All wired. No conversion needed. \$11.95  
Just plug in. Brand new. Special!

All items FOB. Burbank, Calif., subject to prior sale. In Calif. add 4%. Min. order \$3.95.

### J. J. CANDEE CO.

Dept. R  
509 No. Victory Blvd., Burbank, Calif.  
Phone: Victoria 9-3053



## LOOK

NO FURTHER . . . IF YOU'RE UNHAPPY WITH "HI" HI-FI PRICES. WRITE FOR OUR UNUSUAL AUDIO CATALOG. KEY ELECTRONICS CO. 120-C Liberty St., N.Y. 6. Phone EV 4-6071

## NOW YOU CAN SECURE A HIGH SALARIED • TOP PRESTIGE CAREER IN ELECTRONICS IN ONLY ONE YEAR!

ELECTRONICS is the fastest growing industry in America today, creating unlimited opportunities for high salaries, with rapid advancement in INDUSTRY AND THE ARMED FORCES for Bailey Trained electronic engineering technicians.

LARGE CORPORATIONS from coast to coast, and BRANCHES OF THE ARMED FORCES send recruiters to visit each graduating class at Bailey Tech, offering unusually high starting salaries.

BAILEY GRADUATES ARE BEING HIRED for such fascinating and interesting work as technical salesmen, research and development of guided missiles, electronic business machines and automatically controlled manufacturing plants, etc., also good RATINGS IN THE ARMED FORCES.

UP TO SEVEN TECHNICIANS are needed for every engineer . . . this, plus superior training is why Bailey Graduates are being paid more to start, and are advancing more rapidly than many men who have spent four years in training.

Resident training is easier and costs less than you may think! We provide housing and part-time jobs while in school, plus free nationwide employment service for graduates. If you want to quickly enter America's fastest growing and most exciting industry, write for free booklet . . . no obligation.

Veteran Approved

### BAILEY TECHNICAL SCHOOLS

1651 S. Grand • St. Louis 4, Mo.

This Minneapolis-Honeywell system controls hundreds of automatic manufacturing operations. Experience on live equipment is emphasized at Bailey and is another reason for the tremendous backlog of high pay positions waiting BAILEY GRADUATES.

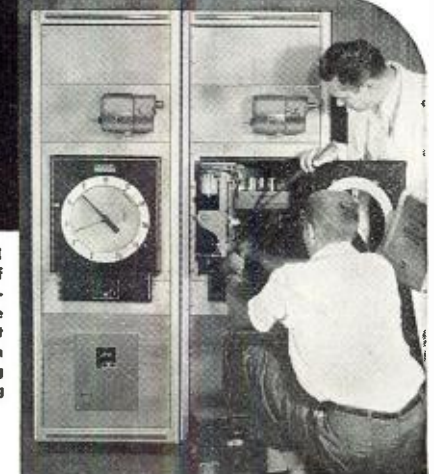

### MAIL TODAY

Please mail immediately this free booklet without obligation

Name \_\_\_\_\_

Address \_\_\_\_\_

City \_\_\_\_\_

State \_\_\_\_\_



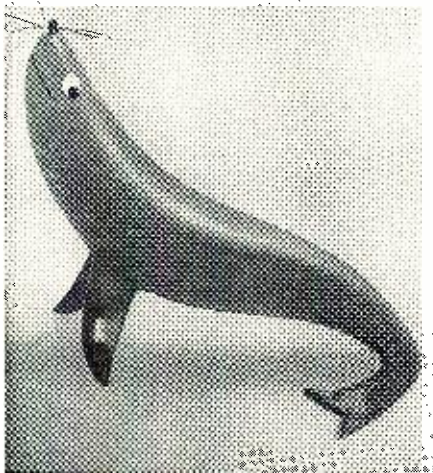
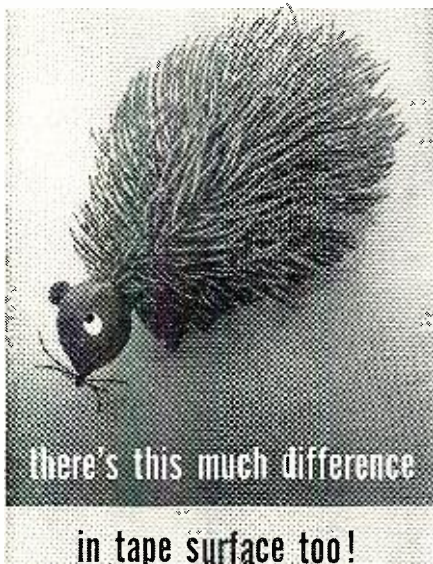

## ONLY SOUNDCRAFT TAPES ARE MICROPOLISHED SMOOTH

Unpolished tape surfaces contain microscopic irregularities which prevent intimate tape to head contact. It takes about 10 plays before these irregularities are smoothed out. During this period you lose high frequencies and force your recorder head to do the job of polishing the tape surface. This results in excessive head wear. Only Soundcraft Tapes are MICROPOLISHED to assure a mirror-smooth surface. The tape makes immediate intimate contact with your recorder head, guaranteeing high frequency response right from the first play! Only Soundcraft Tapes are MICROPOLISHED for your protection. Buy Soundcraft Tape—write for free catalog RS58-10R.

Ask About Soundcraft's 2-Reel Premium Pack—at your dealer now!

REEVES  
**SOUNDCRAFT**  
CORP.

Dept. RT, Great Pasture Rd., Danbury, Conn.  
342 N. La Brea, Los Angeles 36, Calif.  
Canada: 700 Weston Rd., Toronto 9, Ont.

# Test Bench PUZZLER: No. 6

By ART MARGOLIS

*A straightforward analysis, based on voltage readings, will give you the answer to this one.*

WHENEVER TV technicians get together, they will invariably spend hours quizzing each other on interesting bench jobs. Here is a recent one that came up in just such a session.

The star in this little drama was an Emerson TV set using the 120123-B chassis. The audio was only fair, and the video was in good shape to start out with. However after about half an hour from the time the set was turned on, defocusing would become evident to an annoying degree. By then, sharpness of the picture had deteriorated to the degree shown in Fig. 1.

A voltage measurement was made at the point where the focus coil joins the plate winding of the audio-output transformer (point 1 in Fig. 2). The reading was 115 volts, instead of the 125 volts called for. Another reading was made on the "B+" side of the dropping resistor,  $R_{25}$ . This supply source, point 2, correctly checked out at 265 volts.

Since the sound output, although acceptable, left something to be desired and since supply voltage for the plate of the audio-output tube, coming from point 1, was already determined to be low, it was decided to direct further checks to this stage. A d.c. reading was then taken at the plate of  $V_7$ , point 3. Here we found 105 volts instead of the prescribed 115. However, this was scarcely unexpected.

The next check (point 4) was at the grid of the audio-output tube. Here -5 volts was noted instead of -8. At the  $V_7$  cathode (point 5), 3 volts of d.c. was

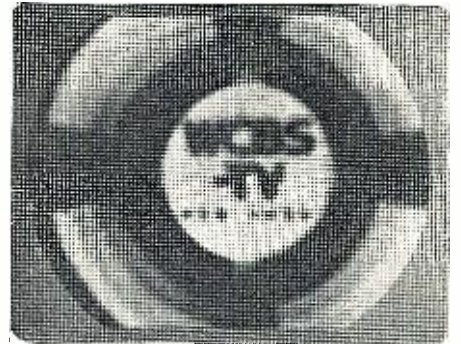

Fig. 1. This is how the defocused picture looked after half an hour.

noted instead of the anticipated 2.5 v.

That was the extent of the voltage readings. The next step was a static check of all components in the related circuitry. This didn't turn up a clue. However, that made sense in view of the fact that the defect didn't become noticeable until half an hour after the set was turned on: the villain was obviously playing good until under load for a while.

However, this game of hide and seek wasn't regarded as much of a complication. A simple analysis of the voltage readings was considered enough to give a good idea of what was going wrong. The remedy based on this conclusion turned out to be right. Which part, shown in Fig. 2, do you think was responsible?

*This one shouldn't be too tough. However, you can make sure by simply turning to page 162.*

Fig. 2. The circuit, with normal voltage readings, in which the fault lay.

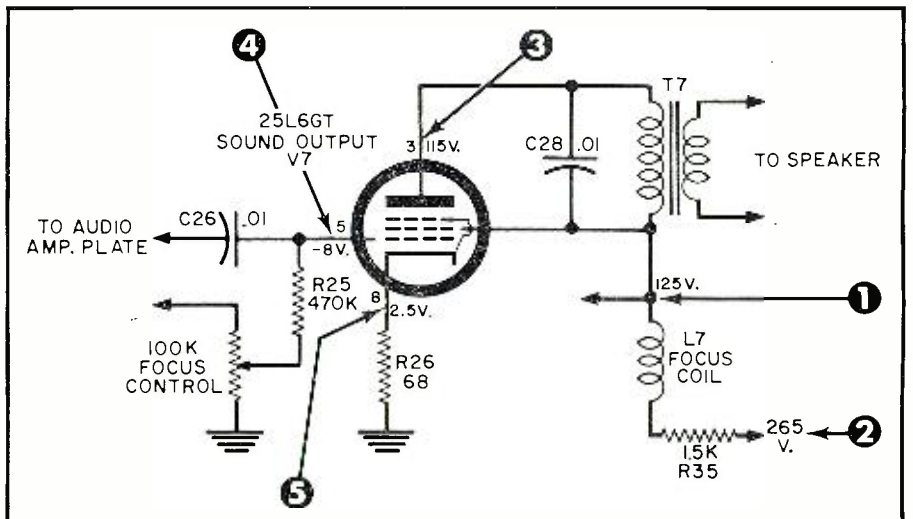



### SUITS NEED PRESSING— MERIT DEFLECTION YOKES DO NOT!

Merit deflection yokes are cosine wound TO FORM, not pressed. Pressing can lead to distortion and poor focusing. Pressing after winding frequently causes breakdown.

### MERIT COILS AND TRANSFORMERS HAVE "BUILT-IN" ADVANTAGES.



Each Merit yoke is  
100% LIVE TESTED

COMPARE IT WITH  
**MERIT**  
MERIT COIL AND TRANSFORMER CORP.  
MERIT PLAZA • HOLLYWOOD, FLORIDA

### "Data-Prints" Still Available

A recent inventory check reveals that we have on hand a limited quantity of RADIO & TV NEWS "Data-Prints" (numbers 2 and 3) which originally appeared in this magazine during 1952.

Data-Print #2, entitled "Loud-speaker Enclosure Design Data," covers complete how-to-do-it details on constructing your own high fidelity speaker enclosure.

Data-Print #3, entitled "Television Signal Strength Calculation Charts," gives complete details on how one can predict the signal strength from a TV station. This Data-Print also includes a nomograph for determining multi-layer coil inductance.

Since our supply is limited this offer is open on the basis of first-come, first-served. In requesting these reprints include 10¢ per copy to cover the cost of handling and postage. Address your requests to Radio & TV News, Box 2045, Church Street Station, New York 8, New York.

### Hints on 2-Way Service (Continued from page 69)

then be checked against the indication on the microammeter across the shunt. The correlation between the two is then recorded and may be used for taking readings in the future.

If the meter is in the cathode circuit, the reading will include both screen grid and control-grid currents. These must be deducted when filling out the report forms. A typical set of readings might be as follows: total cathode current, 218 ma.; screen-grid current (by measurement of voltage drop across screen resistors), 15 ma.; and grid current, 4 ma. Correlating these, we get an actual plate-current reading of 199 ma. Multiplying this by the plate voltage, 400 v., we get 199 x 400 or an input power of 79.6 watts.

For routine testing of the previous circuits of the transmitter, built-in metering points are provided on all makes. These are usually in the form of special resistors in the grid-return circuits of each stage. Leads from these are brought out to a special metering socket or to individual pin jacks on the chassis. Connecting a microammeter or v.t.v.m. to each in turn enables reading the grid current developed in each stage and measurement of the preceding stage's output and tuning. The custom-built test instruments mentioned previously have plugs to fit their own test sockets and are provided with test leads so that other makes may be tested as well.

A standard v.o.m. with a 50-microampere scale and a 500-milliamperere scale for direct reading of plate currents and a resistance of 20,000 ohms-per-volt, will make a good test meter for practically all types of two-way radio service work. One such unit is shown in use in all the photographs accompanying this article.

Special adapter fittings may be fabricated to make the job easier. One of these is shown in use in Fig. 4. Here an 11-pin plug has been used to fit the Motorola T-51 transmitter test socket. Leads are connected to pins 7 and 8 to read the final plate current on the 0-500 ma. scale of the meter. Another lead to pin 9 terminates in a clip, hidden by the technician's right hand in the photo; this is used to key the transmitter for testing. He is grounding the clip on the frame of the chassis while adjusting the antenna trimmer with his left hand.

Also shown in Fig. 4 is another inexpensive yet very useful item. This is a dummy load made from a short piece of RG/8U cable, a plug, and a lamp socket. In this case the incandescent lamp is a 60-watt size as that is the output rating of the transmitter. This unit, which takes the place of an expensive r.f. wattmeter, does a very good job. (If the transmitter will light a 60-watt lamp to full brilliance, it is definitely putting out 60 watts of r.f.!) For 30-watt transmitters, a 25- or 40-watt

### Advance POWER SUPPLY KIT BARGAIN!

Primary 115V, 60 Cy. Sec., 400-0-400 V. @ 200 Ma., 6.3 VCT @ 4 Amp., 5 VCT @ 2 Amp std. mounting plus 8 Hy 200 Ma chokes and \$7.50  
Two 8 Mfd. 600 V. oil condensers. Kit \$7.50  
DC Power Supply Kit 24 VDC—2 amp output, \$3.95

### BUYS . . . RELAYS . . . BUYS

110 VAC	SIGMA 41F,	24VAC of 6VDC \$1.49
2 PDT, Ward	w/switch for	
Locostat	110 VAC . . . . .	1.89
5 PST hvy duty	SIGMA 4F,	5,000-ohm plate
Dunco . . . . .	pull-in @ 2 Ma 2.45	
12 PDT Dunco . . . . .	SIGMA 5F	15,000-ohm plate
6 VDC, P&B,	pull-in @ 1/2 Ma. 1A	& 1C contacts \$3.95
DPS	12 VDC DPDT plus	
10 amp contact 1.35		

### LARGE STOCK AC, DC RELAYS

\*\*\*\*\*Solenoids\*\*\*\*\*  
A-B #B200 \$2.95 115V 60 Cye cont. duty.  
(2 for \$5.50) 18 Lb. pull. \$5.50  
(2 for \$10.00)  
24V & 230V SORENG IN STOCK!

### STEPPING RELAYS

Resettable type, 3 deck, 10 pos, 24 VDC. ea. \$8.95  
2 deck, 44 pos, no reset ea. \$6.95  
5 deck, 23 pos, no reset ea. \$7.50  
16 deck, 22 Pos. \$22.50

### CHOKES FULLY CASED

6 hy, 100 Ma. \$1.09	Signal Corps Earphones
8 hy, 100 Ma. 1.49	Hi-Impedance Dual Headset, complete w/ headband & Cord. Used—terrific Value \$1.79
8 hy, 200 ma. 1.89	Per Set . . . . . 2 for \$3.25
10 hy, 150 Ma. 2.19	
20 Hy, 300 Ma. 8.95	
22 hy, 100 Ma. 2.59	

### \*\*\*\*\*Transformers\*\*\*\*\*

6.3 V FILAMENT 12V, 2 Amp. \$1.19  
35 Amp. . . . . \$7.50 24 V 2 Amp. . . . . 1.29  
20 Amp. . . . . 3.95 2 1/2 V Sec. 10 Amps.  
1 Amp. . . . . 1.89 Etc. for pr. of . . . . .  
1 Amp. . . . . 1.29 866's . . . . . \$3.95

### 1 1/2 INCH DUAL FREQUENCY METER!

J81 model. 15-FHAC. Indicates at 60-cyc. and 400-cyc. Used as frequency standard. \$7.95

### SCOOP! RG-8/U CO-AX CABLE

52-ohm impedance, 100-ft. length . . . \$6.75  
RG-59A/U (72-ohm) with male and female connectors. 50-ft. coils. \$2.45 ea.

### OIL CONDENSER BARGAINS

2 Mfd 600 VDC .45	8 Mfd 1500 VDC \$2.95
4 Mfd 600 VDC .75	10 Mfd 1500 VDC 3.75
8 Mfd 600 VDC .90	16 Mfd 1500 VDC 2.95
10 Mfd 600 VDC 1.10	2 Mfd 2000 VDC 1.50
12 Mfd 600 VDC 1.35	8 Mfd 2000 VDC 2.75
20 Mfd 650 VDC 2.75	1 Mfd 3000 VDC 1.85
1 Mfd 1000 VDC .60	2 Mfd 4000 VDC 5.75
2 Mfd 1000 VDC .75	2 Mfd 5000 VDC 6.95
4 Mfd 1000 VDC 1.25	1 Mfd 6000 VDC 5.95
8 Mfd 1000 VDC 1.60	1 Mfd 7500 VDC 6.95
10 Mfd 1000 VDC 2.50	2 Mfd 10000 VDC 3.45
15 Mfd 1000 VDC 2.45	1 Mfd 12500 VDC 24.50
4 Mfd 1500 VDC 1.75	2 Mfd 12500 VDC 32.50

### \*\*\*\*G. E. RELAY CONTROL\*\*\*\*

(Ideal for Model Controls, Etc.)  
Contains a sigma midget 8,000 ohm, relay (trips at less than 2 MA), high impedance choke, bimetal strip, neon pilot and many useful parts. The sensitive relay alone is worth much more than the total low price of . . . . . \$1.10 Each 10 for \$9.75

### SPECIAL! PANEL METERS

0-200 Micro . . . . . \$3.95	0-20 Microamps. \$5.45
0-1 Ma . . . . . 3.50	0-100 Microamps. 5.45
2" METERS	0-200 Microamps. 5.45
0-1 Ma . . . . . \$3.25	0-8 VDC . . . . . 4.45
0-15 amps RF . . . . . 2.95	0-150 VAC . . . . . 4.45
0-3 amps RF . . . . . 2.95	0-1 Ma . . . . . 4.45
0-5 amps RF . . . . . 2.95	0-1 Ma . . . . . 3.45
0-200 Micro, rubber mt. . . . . 2.95	0-30 Ma . . . . . 3.45
0-30 Ma . . . . . 3.25	0-100 Ma . . . . . 3.45
0-300 VAC . . . . . 3.25	0-250 Ma . . . . . 3.45
-10.0 to +6 DB (Weston) . . . . . 4.50	200-200 VDC. 3.45
0-2 KV DC, w/shunt. . . . . \$5.95	0-5 amp. AC. . . . . 3.45
0-15 KV DC, 3" w/shunt. . . . . 6.25	0-300 DC amps, with shunt. . . . . 6.50
0-31 KV, 3" w/shunt. . . . . 6.25	0-100 Microamps. 5.45
2" 75 Microamps Null Indicator. . . . . 5.75	0-100 Microamps. 5.45

### 115 V. 60 cye. SELSYNS

High torque. Useful as antenna indicators, etc. 0-9999.9 hrs., 110 V, 60 cye. \$5.95 each (\$10.50 pr.)

### RUNNING TIME METER

0-9999.9 hrs., 110 V, 60 cye. \$9.50

### SELENIUM RECTIFIERS

FULL WAVE BRIDGE 30-36 VAC input, 24-28 VDC output, 2 Amps. \$2.19  
1/2 Amp. \$1.19  
150 Ma. \$1.29  
1 1/2 Amp. \$5.19

### Special on . . . POWER SUPPLIES!

All Wired—Ready to use.  
PRI—115 V AC; SEC.—940-0-940 V @ 30 Ma; 5.4 & 15 V @ 6 Amps; CT, 12 V @ 5 Amps; 40 V @ 50 MA; 6.3 V CT @ 7 Amps;  
12 Hy Choke @ 300 Ma 4 10 Mfd. 600 V Cap. 3 5U4's \$21.95  
PRI—115 V AC; SEC.—940-0-940 V @ 30 Ma; 2 1/2 V CT @ 4 Amps; 1-6.3 CT @ 4 Amps; 10 Hy choke @ 250 Ma. 2-6 Mfd. 1500 V Cap. 2 #836's \$23.95

### \*\*\*\*\*GR-VARIACS\*\*\*\*\*

110/220 AC in 0-270 V AC 2 Amps. NEW. Fully Cased. w/ Knob, Dial, 6 FT. Line Cord, Receptacle; And On/Off Switch. Original Ctns. \$16.95

Min. Order \$3.00—25% with order F.O.B. New York 10 DAY GUAR. PRICE OF MDSE. ONLY

**Advance Electronics**  
6 West Broadway • New York 7, N. Y. • Rector 2-0270



pere charger, will handle all power-supply requirements for the average shop. A d.c. ammeter should be inserted in one of the leads for monitoring current drawn. A 0-30 ampere meter is ample as current drain seldom runs over this amount. Higher momentary surges will not harm the meter.

### Records and Reports

The FCC requires that complete service records be kept on each transmitter in every system. This responsibility usually falls to the service engineer as part of his job. Such records must cover all service work done on each transmitter, all parts replaced as well as the results of the biennial measurements required by the FCC; frequency, deviation, and power input.

Some manufacturers, like *Motorola*, provide forms on which these reports may be entered, also special service log forms. The report forms have spaces for every detail about the transmitter—requiring only checking of the appropriate boxes and entry of the figures. Spaces are furnished for entering a full set of meter readings for both transmitter and receiver, for comparison with previous measurements. These are particularly valuable to the technician. Fig. 2 shows one of these forms being filled out while taking the readings from the set.

If prepared forms are not used, a standard 4" x 5" file card will do, with the necessary details filled in for each reporting period. These are *not* sent in to the FCC but must be kept available for inspection by an FCC field engineer when he calls upon you. Failure to fill out in detail all required information can earn a small stack of "brownies" (Reports of Violation)! These records can also provide an easy source of bookkeeping information; at the end of each month, each card is checked and all parts and labor can be charged out to the user from them.

For the technician just entering the field, the most expensive items will be the frequency and modulation meters. As noted, these may be purchased separately or in combination. Local circumstances should help you decide on which type would be the best choice. As for the other test equipment, the average TV-radio shop should have enough test and measuring equipment to handle most of the work: signal generators, oscilloscopes, tube testers, and the like. As for special test equipment, such as the mock-ups and output devices mentioned, they are limited only by the ingenuity of the technician himself. The main criterion as to any service gadget's worth should be, "Does it save time?" If it does, it's worth money. Mock-ups may be built for about \$5.00 apiece on the average. Much "junk" material may be used in their construction, such as discarded radio speakers, cabinets, and controls.

Two-way radio servicing work can be most interesting and a very profitable line of endeavor for the qualified man. Take the word of this "old hand" at the game!



"Can't beat it for sensitivity and selectivity... a beautiful receiver... this is it."

J. P. Broderick, 151 W. 105th, N. Y. City

"The receivers are indeed an excellent buy."

Dr. H. W. Curtis, E. E. Dept., Dartmouth

"This is truly a sensational receiver..."

Bob Elmore, 524 E. Markham, Little Rock, Ark.

#### Specifications:

6 bands: .55-1.6, 1.6-3, 3-5.8, 5.8-11, 11-21, 21-43 mc. Large translucent back-lighted dial. Verifier knob takes plenty turns per mc; or switch motor on and let it tune slowly back and forth. You set automatic-reversing limit stops. Drift: Manual says less than 1% from cold start, but it's really much less. The separate 6SA7 osc. gets regulated voltage from a VR-150. Sensitivity: Manual says better than 10 uv at 10 db S/N on all bands for 50 mw out; actually is much better. 6AB7 and 2 6SK7's amplify RF; separate 6SA7 mixer; and 2 6SK7's are 455 kc I.F. Add Hallicrafters know-how. Selectivity: Manual shows curves ranging from

100 cy to 10 kc pass; 3 crystal and 3 I.F.-pass (6 total) switch positions. Also Crystal Phasing control, S-Meter; 6 db/unit; adjustable. AVC-WVC switch and separate AF and RF Gain controls. CW-MCW switch; Separate 6J5 osc. Pitch Control on panel. Audio: 6H6 det-avc-noise limiter, Noise Limiter switch on panel. 6SQ7 amp. 6V6 feeds 600 to 8000 ohm phones. Video: 50 plug from Cathode Follower in 6V6 ckt shows sound on any test scope. Panoramic: 50 plug feeds any 455 kc Panadapter. Case: 10 7/16" wd, 19 3/4" deep, 7 3/4" high. Power supply 5" wd, 8 1/4" ht, 1 3/4" dp. With schematic and illustrated alignment and adjustment instructions.

BRAND NEW HALLCRAFTERS ALL-BAND COMMUNICATIONS RECEIVER R-45/ARR-7

In Factory-Sealed Overseas Cartons. Factory Aligned and Ready to Use. With 120V, 50/60 cy Power Supply Furnishing All Voltages, Including DC for the Automatic Tuning Motor. Gov't Cost \$750.00. OUR **\$149.50** CASH PRICE only (80 lbs. fob. Stockton, Cal.) Or on Time-Pay Plan: SEND US **\$14.95** ONLY... and pay \$12.55/mo. for 12 mos.

### a TERRIFIC BARGAIN in a 2.3 KVA

GENERAL ELECTRIC CONSTANT-VOLTAGE TRANSFORMER Ends fluctuating line voltage! Buy At Tremendous Discount!

BRAND NEW and boxed ready to ship domestic or foreign. Input 100-135 volts at 57-63 cy. Output voltages link-switch selected 113/115/117 volts ± 2 1/2% at constant frequency, at 0.85 PF load; a few volts higher (but equally constant) at resistive load. G.E. Cat. No. 69G351. Static-magnetic type; no tubes or moving parts. 29 3/4" lg, 16" wd, 49" hgt. Net 505 lbs. As boxed, gross 594 lbs., 14.8 cu. ft. FOB Seattle, Wash. Only... **\$19.50**

### SCHEMATICS—CONVERSIONS FOR SURPLUS GEAR

Send stamped addressed envelope for NEW List E; has many new items. Includes many Tech Manuals. Add 25¢ for chart explaining AN Nomenclature. DO IT TODAY!

### 400 CY WITH TUNING-FORK ACCURACY

American Time Products wired modular subassembly with two 6AU6 in a Varistor-compensated circuit with the \$90.00 sealed fork. Frequency accuracy .001 to 0.25% depending on voltage stability, etc. Requires 150 v dc, 20 ma, easily stabilized by a VR150, and 6.3 v ac, .6 A. Output 6 v at top of precision resistor divider, 1 v at tap. Checked and certified. With schematic. Shpg. wt. 5 lbs. fob. Los Angeles. Only... **\$27.50**

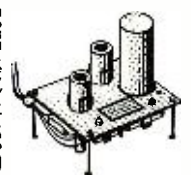

Very sharp, very hot. In exceptionally clean used condition. With schematic, step-by-step conversion instructions, and instructions for re-stringing the heater ckt. FOB Los Angeles. Shpg. wt. 30 lbs. Lowest price anywhere. While they last... **\$14.95**

### ARB RECEIVER \$14.95

CRV-46151 RCA's BuAer Receiver. Bands: 195-560, 560-1600, 1600-4500, and 4500-9050 kc. AM Voice, CW, and MCW. 1.25F IF, 1.25A7 converter, 2-12S7's IF, 12S7F det-avc-bfo-AF, and 12A6 output to 600 or 4000 ohm phones. Requires external power supply for ac use. A great favorite for Marine. Use the 24 v dynamotor in it or change to a 12 v and rewiring the heater string.

California Buyers Add 4% Sales Tax

**R. E. GOODHEART CO. P. O. BOX 1220-A BEVERLY HILLS, CALIFORNIA**

IF YOU PRIZE IT... KRYLON-IZE IT!  
Completely seals electronic parts with no delay



### KRYLON CRYSTAL-CLEAR ACRYLIC SPRAY

Radio, TV and hi-fi equipment need Krylon Crystal-Clear, the protective coating with high dielectric strength and weatherproof qualities that seal the surface indefinitely.

- Prevents corona in high voltage section
- Keeps lead-in connections tight
- Prevents rusting and pitting of antenna
- Goes on in seconds—DRIES IN MINUTES

At your favorite radio-TV repair shop.

Use Krylon Spray Paints (22 colors) for quick, easy, professional touch-up jobs

IF YOU PRIZE IT... KRYLON-IZE IT!



Only from famous COYNE do you get this modern up-to-the minute TV Home Training. Easy to follow instructions—fully illustrated with 2150 photos and diagrams. Not an old Radio Course with Television tacked on. Includes UHF and COLOR TV. Personal guidance by Coyne Staff. *Practical Job Guides* to help you EARN MONEY QUICKLY IN A TV-RADIO SALES AND SERVICE BUSINESS—part time or full time. COSTS MUCH LESS—pay only for training—no costly "put together kits."

SEND COUPON FOR FREE BOOK SEND COUPON BELOW for Free Book and full details including EASY PAYMENT PLAN. NO COST OR OBLIGATION—NO SALESMAN WILL CALL.

B. W. COOKE, Jr., Pres. **COYNE ELECTRICAL SCHOOL** FOUNDED 1899

CHARTERED AS AN EDUCATIONAL INSTITUTION NOT FOR PROFIT 1501 W. Congress Pkwy., Dept. 49-H6, Chicago 7, Ill.

COYNE Television Home Training Div. New Coyne Building, Dept. 49-H6 1501 W. Congress Pkwy., Chicago 7, Ill.

Send FREE BOOK and details of your Television Home Training offer.

Name \_\_\_\_\_  
Address \_\_\_\_\_  
City \_\_\_\_\_ State \_\_\_\_\_



Leo J. Meyerson . . . says

## for the really Big Signal

I'd Recommend the  
hallicrafter's  
**HT-33A**



**\$800** Down **\$3460** Per Mo  
or \$795.00 Ham Net.



### With These Top Feature Points!

- Maximum legal input.
  - Certified for FCCA matching funds.
  - Third and fifth order distortion products down in excess of 30 db.
  - Passive grid circuit, 50 to 75 ohms input.
  - Built-in r.f. output meter to simplify tune up.
  - Complete coverage of 80 thru 10 meter amateur bands.
  - Pi-network for maximum harmonic suppression.
  - Variable output loading.
  - All important circuits metered.
  - Circuit breaker assures protection of power supply.
- 25 Hams to Serve You
  - Top Trades Always
  - Latest Serial Numbers
  - Nation's Leading Lines in Stock

### Free 1959 Catalog

Jam packed with bargains —  
everything in Radio, TV, and  
Hi Fi — for Handyman, Ham,  
Experimenter or Serviceman!

LEO: Please Send  Free Catalog, and Quote Top Trade



for my \_\_\_\_\_ on the HT-33A

Name: \_\_\_\_\_

Address: \_\_\_\_\_

City & State: \_\_\_\_\_

## SURPLUS BUYS

### Variable Condensers with Shafts

140 Mmfd—(Hammar) . . . . . 3 for \$2.00  
25 Mmfd—(Hammar) . . . . . 2 for 1.00  
25 Mmfd—(Hammar) . . . . . 2 for 1.00

POWER SUPPLY (115VAC-60 Cy) for MAR equipment.  
Complete with 1 case of Brand New spares. (40 lbs.).  
Brand New—Special . . . . . \$12.95

### RELAYS

115 V AC—Allied #RKA-A DPST—10 A. Cont. \$1.95  
115 V AC—Allied #RPT—10A. Cont. New. . . . . 3.50  
5-6 V AC—Allied AS3A—SPDT . . . . . 1.50  
12 V DC—Allied Isolantite Insul. 3 PDT. 10 A.  
Cont. New. Boxed. A Super Value . . . . . 2.50  
12 V DC Auto Elec. DPDT. Hold Contact. . . . . 1.00

POWER FILAMENT XFORMER—Pri.—105/115V-60 Cy.  
Sec. 300-0-300V—100 Ma; 12.6 VCT-3A; 12.6V-3A;  
3.0V-3A. Open Frame—Compact—Useful as 12 or 24  
Volt Transf. for Surplus Gear (U/W Ra-20 P.S.)  
New . . . . . \$2.49

COAX SWITCH—Manual—Type SA-23/APR-4-6 Output  
Position—Each containing one UG22/U. Conn. throt-  
tle bar switching arrangement. One of the nicest  
surplus items we've seen. 8 lbs.—New . . . . . \$2.95

### MINIATURE METERS

1 1/2" Sq. DeJur—New—Boxed—Orig.  
Scale. 0-100 Microamps \$3.95.  
0-500 Microamps \$2.95.

TRANSTAT—Mfg. by Amertran for W.E.—0-150 VAC  
—1 Kw.—New . . . . . \$19.95

### New Oil Condensers—Complete Stock

1 Mfd—	1 Mfd—	1 Mfd—
600 VDC \$ .40	1 Kv . . . \$ .59	2 Kv . . . \$ .85
2 Mfd—	2 Mfd—	4 Mfd—
600 VDC .50	4 Mfd—	2 Kv . . . 3.50
4 Mfd—	10 Mfd—	8 Mfd—
600 VDC .75	1 Kv . . . 1.35	2 Kv . . . 6.00
8 Mfd—	10 Mfd—	
600 VDC .95	1 Kv . . . 2.50	
10 Mfd—	15 Mfd—	
600 VDC 1.15	1 Kv . . . 3.50	
4 Mfd—3 Kv . . . \$ 6.95	1 Mfd—12.5 Kv. \$24.95	
1 Mfd—4 Kv . . . 3.50	1 Mfd—15 Kv . . . 35.00	
2 Mfd—4 Kv . . . 6.25	1 Mfd—25 Kv . . . 45.00	
4 Mfd—4 Kv . . . 13.95		

Many others in Stock—WRITE TODAY.

HEADSET—New, boxed—8,000Ω Murdock . . . \$3.49  
RUNNING TIME METER—115 VAC—60 Cy. Indus-  
trial—3" Rd. Panel Mt. . . . . Special \$8.95

### VACUUM CONDENSERS

25 Mmfd—10 Kv. \$2.25 10 Mmfd—32 Kv. \$7.95  
50 Mmfd—5 Kv. . . 2.25 12 Mmfd—32 Kv. 4.95  
SPERTI Vacuum Switch—(As used in ART-13) New,  
boxed  
REMOTE CONTROL Unit—P.O. ARTS/20A—Housed in  
beautiful small cabinet w/1-12AUF, 1-12AX7, 4-  
2 lb. shock mts. etc., 4 lbs. New . . . . . \$3.95

### Panel Meters 2 1/2" Round Bakelite

GE—0-300 Mills . . . . . \$2.95 Trip—0-500 . . . \$2.95  
DC . . . . . Microamps . . . . .

**REX** RADIO SUPPLY CO.  
88 Cortlandt St.  
New York 7, N. Y.  
In the Heart of New York's Radio Row

## NEW! ON THE SPOT CHECK OF HORIZONTAL OUTPUT CIRCUIT!

—ends most common  
cause of callbacks!

**SECO HC-6  
CURRENT  
CHECKER**

- PLACE IN CIRCUIT IN SECONDS —  
NO DISCONNECTING OF CATHODE
- FAST, ACCURATE WAY TO ADJUST  
HORIZONTAL DRIVE AND LINEARITY

This new, low-cost current checker provides a positive, on-the-spot method of checking and adjusting TV horizontal output circuits — eliminates one of the most common causes of callbacks. Can be placed in circuit in seconds — without disconnecting cathode — immediately indicates whether horizontal output tube cathode current is within manufacturer's recommended limits. Insures proper picture focus, width, and stability with minimum cathode current — helps prevent premature failure of horizontal output transformer and in some cases failure of power transformer and rectifiers. HC-6 is valuable as a fast, accurate indicating device when adjusting horizontal drive and linearity. A "must" on all TV horizontal tube, transformer, or yoke replacement jobs — may also be used to balance hi-fi audio output tubes. Compact — inexpensive — easy to use — the HC-6 is a time-saving, money-making addition to your service kit.

**\$12.95**  
NET

See your distributor . . . or write to:

**SECO MANUFACTURING CO.**  
5015 Penn Ave. S., Mpls., Minn.

## Ham Transmitter Kit (Continued from page 62)

er, and modulator driver transformers are all mounted, the chassis weighs almost 70 pounds. Luckily the construction is arranged so that there is a minimum of chassis turning and handling.

### Circuit Features

Space limitations prevent us from covering thoroughly all the features that show up in the transmitter's circuit (refer to page 63). But briefly, let's take a look at it. The v.f.o. is a stable Clapp oscillator with regulated "B+" whose output is fed to a buffer which also doubles as the crystal oscillator. These stages are sequence-keyed by means of a neon lamp and two RC networks, to provide an output without clicks or chirps. A spotting push-button permits the exciter stages to be zero-beat against an incoming signal or it allows driver tuning to be done with high voltage off. Driver output is pi-coupled to a pair of paralleled 6146's operating with an input power of 180 watts on c.w. and 150 watts on phone. Output from these tubes is coupled to the antenna through another pi-network. The 6146's are protected from loss of excitation by a clamp tube. For SSB these tubes are operated class AB<sub>1</sub> and screen voltage is obtained by way of a couple of VR tubes. A "tune-operate" switch reduces screen voltage so that the output tubes are protected from large off-resonance currents during tune-up. Extensive shielding, filtering, and bypassing are used to minimize interference.

In the audio section use is made of frequency response limiting and speech clipping in order to get maximum modulation efficiency. A pair of push-pull EL34's, operating class AB<sub>2</sub>, easily deliver about 75 watts of audio which is then applied to the plates and screens of the 6146's. When not operating on phone, the screen voltage is removed from the modulators and the secondary of the modulation transformer is shorted out.

The power supplies are conventional. The low-voltage supply delivers 350 volts at 175 ma. to the low power audio and r.f. stages and modulator screens. A full-wave selenium rectifier is used for driver and final amplifier fixed bias and a half-wave selenium rectifier is used for modulator fixed bias. The high-voltage supply, using paralleled 5R4GY's with choke-input filter, delivers 750 volts at a normal load of 250 ma. to the 6146's and 50 to 125 ma. (on peaks) to the EL34's.

### Operation and Adjustment

After spending so many hours in assembling and wiring the rig, we wanted to be pretty sure that everything was in order before applying power. Although we had checked the wiring in each of the separate portions of the rig after work had been com-

At Your Service...  
at big savings

# arkay

Hi-Precision  
**TEST INSTRUMENTS**  
Kits and Wired

Designed and engineered in the Arkay tradition of highest professional quality at lowest cost.

**NEW!** ARKAY VT-10 6-INCH  
MULTI-PURPOSE  
VACUUM TUBE VOLTMETER



Advanced design and precision features make the Arkay VT-10 a truly sensational buy, unmatched at this price. You get exclusive larger 6-INCH 400 ua meter movement, within 2% accuracy, and edge-lighted for easier reading. 1% precision multiplier resistors are used throughout the range switch. There are 7 AC (RMS) and DC ranges, 0 to 1500 volts; also 7 AC (peak-to-peak) ranges, 0 to 2000 volts. Resistance of 0 to 1000 megohms, db and other essential ranges also included. Circuitry features 12AU7 for DC ranges, 6AL5 for AC, meter diodes rectifiers, and transformer operated selenium rectifier. Handsome durable plastic case.

Easy-to-build Kit **\$25.95**  
Wired and tested **\$47.95**



ARKAY AV-20 6-INCH  
AUDIO VTVM  
PRE-AMPLIFIER

An Audio Vacuum Tube Voltmeter of extreme sensitivity, engineered for accurate measurements of RMS voltages.

Easy-to-build Kit **\$29.95**  
Wired and tested **\$49.95**



ARKAY AW-30 6-INCH  
DIRECT READING  
AUDIO WATTMETER

Measures Audio Power Output with speed and precision 0 to 500 watts in 6 ranges. For laboratory and general use.

Easy-to-build Kit **\$29.95**  
Wired and tested **\$49.95**



ARKAY CAP-40 6-INCH  
DIRECT READING  
CAPACITY METER

1% precision calibration capacitors and 6-inch 200 ua meter movement provide accurate readings. 0 to 1 mfd. in 6 ranges.

Easy-to-build Kit **\$29.95**  
Wired and tested **\$49.95**



ARKAY MT-50 6-INCH  
20,000 OHMS  
PER VOLT METER

A completely portable multitester of high accuracy. Sensitivity is 20,000 ohms per volt DC, 5,000 ohms per volt AC.

Easy-to-build Kit **\$29.50**  
Wired and tested **\$42.95**

All prices 5% higher west of Mississippi

See ARKAY completely wired Test Instruments at your dealer. Write for detailed specifications and catalog, Dept. RT

**arkay** **PACE**  
88-06 Van Wyck Expressway Richmond Hill 18, N.Y.

pleted on that portion, we double-checked the whole job at the end. Small bits of wire and solder were cleaned out carefully to make sure there were no shorts. The several terminal strips that carry the high voltage were then sprayed with anti-corona dope. All tubes and pilot lamps were then inserted. Finally all resistance measurements given in the manual were checked over. There are only about a dozen of these to make; the time spent is certainly worthwhile. After all this was done, we were able to turn on the power switches with some confidence.

With a 40-meter crystal inserted in the holder and low voltage applied, the spotting push-button was depressed. The final grid drive of 6 ma. was easily obtained with driver tuning peaked and excitation control at only about its one-quarter setting. The v.f.o. drive was then checked and it was found to be about the same as that obtainable with the crystal.

Next, high voltage was applied and the final bias and clamp controls were adjusted. When the plate tank was resonated and the output coupling was stepped up, we began to fear for the 100-watt lamp we were using as our dummy load. So a second 100-watt lamp, paralleling the first, was screwed in to take some of the r.f. output. From the brightness of the single lamp, the output power appeared to be in excess of 100 watts on 80 meters, just about 100 watts on 40 meters, and somewhat less than 100 watts on the three higher bands.

Modulator adjustments were then made. These include modulator bias and clipping level. The five circuits monitored by the rig's meter were then checked and all readings were in complete accord with those given in the manual.

Finally, the v.f.o. was carefully calibrated. This was done with the aid of the crystal calibrator in the "Mohawk" receiver. Even though the calibration points were at the very ends of the dial scales, readings checked all along the dial were quite close to crystal check points. The buffer coils were then touched up, although they had to be detuned slightly because we had more than enough drive.

Now that all the adjustments worked out so well, we were anxious for an on-the-air check of the rig. To the antenna fitting we connected a 55-foot inverted-L antenna, which we had been using for receiving. A good water-pipe ground was connected to the ground binding post. There was no problem at all in loading up this antenna to the full 250 ma. final plate current on all five bands. One of the early QSO's from New York City turned out to be a three-way with a couple of W9's in Indianapolis. One of them was also using an "Apache" into a simple doublet and it was interesting to hear how the rig performed "from the other end." All agreed that the excellence of performance was well worth all the time and effort that had gone into assembling this transmitter kit. -30-

Pleasure Unlimited  
... WHEN YOU BUY IT  
... BUILD IT ... HEAR IT

# arkay

## STEREO

TODAY'S GREATEST VALUE IN  
HI-FI KITS AND WIRED

Comparison proves Arkay is the best value on the market today for advanced hi-fi engineering, styling and performance. Arkay means STEREO at its best, within your budget.

**NEW! MUSIC MASTERPIECE!**



ARKAY CS-28 STEREO AMPLIFIER  
STEREO PRE-AMPLIFIER  
COMPLETE CONTROL CENTER

Presenting... the ultimate in total-stereo! The versatile CS-28 is a superb product of Arkay's 20 years of advanced electronic engineering with beauty of design that won the Fashion Foundation's coveted Gold Medal.

Identical dual 14 watt amplifiers convert to 28 watts for monaural operation. Full 28 watts, at flick of a switch, may be joined with an existing monaural amp for extended stereo, operate with the dual pre-amplifier.

"Reverse Stereo" switch interchanges channels. Balance Control compensates each channel for speaker system, room acoustics, etc. Gain Control operates both channels simultaneously.

Power Rating: 28 watts (two 14 watt channels); 60 watts peak. Frequency Response: 20-20,000 CPS. IM Distortion, 4 to 1. Harmonic Distortion, less than 1%. 30-20,000 CPS. Pre-amp. Outputs: 2V. Tape Recorder Outputs: 10V. Speaker Outputs: 4, 8, 16 and 32 ohms.

Wired and tested **\$99.95** Easy-to-build Kit **\$64.95**

PERFECT COMPANION FOR THE CS-28



ARKAY ST-11  
AM-FM  
STEREO TUNER

Unmatched by units costing twice the price, the Arkay ST-11 provides wide-range AM and FM tuning of remarkable clarity and drift-free stability. "Miracle Ear" sensitivity in FM channel, 4 uV. (2 uV. in AM) for 20 db quieting. Two distinctive receivers in one, for use singly in monaural reception or simultaneously for stereo broadcasts.

Wired and tested **\$74.50** Easy-to-build Kit **\$49.95**



ARKAY CS-12  
STEREO PRE-AMP  
AND AMP

12 watts of clean power. Operates from ceramic or crystal cartridge, tape, tuners, auxiliary equipment.

Easy-to-build Kit **\$35.95**



ARKAY SPA-55  
STEREO AMP

Two 27 1/2 watt distortion-free hi-fi amplifiers. Or use as 55 watt monaural amplifier.

Easy-to-build Kit **\$64.95**  
Wired and tested **\$79.95**

ARKAY SP-6  
STEREO  
CONTROL CENTER



Completely self-powered sensitive dual pre-amp with unparalleled flexibility. Reverse position, hi lo filters, etc. Prices less cover.

Wired and tested **\$62.95** Easy-to-build Kit **\$39.95**

All prices 5% higher west of Mississippi

See and hear completely wired ARKAY Kits at your dealer. Write for detailed specifications & catalog. Dept. RT

**arkay**  
88-06 Van Wyck Expressway Richmond Hill 18, N.Y.

Now! the fastest, easiest way to master the 'scope!

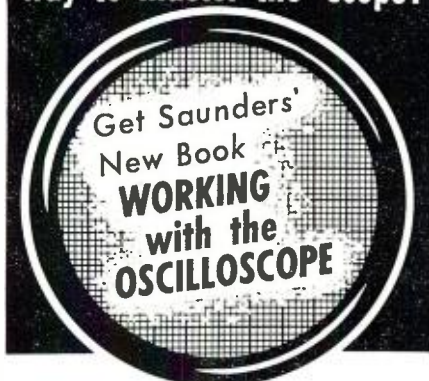

SEE HOW FAST YOU LEARN with BLOCK-O-MATICS!

Saunders' exclusive new look in schematics shows you how to master electronics' most versatile instrument quickly, easily.

SAUNDERS SHOWS YOU HOW STEP BY STEP with 26 Projects, 200 Diagrams

Actually demonstrating the 'scope's many uses in radio, TV, transistors, vacuum tubes, other work.

USE IT AT YOUR BENCH! Complete Working Manual!

Oscilloscope Checks, Calibration Procedures, Wave Form Analysis, Circuit Tests, Frequency Measurements, Crystal Diode and Transistor Analysis, etc. . . .

40 Years Oscilloscope Experience! NOTED AUTHOR-LECTURER, A.C.W.SAUNDERS

President, Saunders Radio & Electronic School, Boston. Author of CBS Transistor Course, Black & White and Color TV, Basic Points, numerous magazine articles.

SPECIAL INTRODUCTORY PRICE LIMITED TIME

only \$4.00 including postage

Order Now! Mail this Coupon Today!

ELECTRONIC TECHNICAL PUBLISHING CO.  
P.O. BOX 306, ASTOR STATION RTNA9  
BOSTON 23, MASS.

Enclosed is \$\_\_\_\_\_ for \_\_\_\_\_ copies @  
\$4.00 of "Working with the  
Oscilloscope".

NAME \_\_\_\_\_  
STREET \_\_\_\_\_  
CITY \_\_\_\_\_ STATE \_\_\_\_\_



ANTENNA GAIN BOOKLET

National Bureau of Standards has issued its Circular 598, "Techniques for Accurate Measurement of Antenna Gain." This may be ordered from Superintendent of Documents, U. S. Government Printing Office, Washington 25, D. C. at a cost of 15 cents per copy.

This ten-page Circular describes techniques developed at the Bureau to minimize the experimental error and thereby increase the reliability of measurements of antenna gain. Special features of the instrumentation, including methods for minimizing and measuring matching losses, are described in some detail.

The measurement of antenna performance has been of steadily growing importance in recent years. Although the principles of measurement are well known, practical difficulties are encountered in carrying them out which may introduce errors in the results unless suitable precautions are observed. Comparison of published results of experimental measurements, particularly of antenna gain, reveal apparent discrepancies on the order of one or more decibels.

WELDING CATALOGUE

Vacuum Tube Products, 2020 Short Street, Oceanside, Calif., has prepared a short-form catalogue describing its line of precision electronic welding equipment.

The four-page brochure carries cabinet and bench welders, as well as accessories.

When ordering, write to the firm on your company stationery.

NEW SNYDER CATALOGUES

Snyder Mfg. Co., Philadelphia 40, Pa., has re-designed virtually all of its catalogue sheets and will distribute them during the coming months to introduce 1959 lines of its products.

The new sheets, all die cut for handy filing, will be multi-colored and will be completely new. New catalogue sheets are being completed for auto antennas, indoor television antennas, X-Aust X-Tensions, TV tables, and other products.

OHMITE RELAYS

Ohmite Manufacturing Company, 3679 Howard Street, Skokie, Illinois, has released its new Bulletin No. 160 covering a series of relays. A free copy is available direct from the company.

The firm's Models TT and TS are the units described in the brochure. Complete specifications for these relays are given, along with sensitivity details.

TV PICTURE TUBES At Lowest Prices

10BP4	\$ 7.95	17BP4	\$10.95	21AMP4	\$19.95
12LP4	8.95	17CP4	17.00	21ATP4	20.95
14B/CP4	9.95	17GP4	17.60	21AUP4	20.95
16DP4	14.95	17HP4	13.60	21EP4	14.95
16EP4	15.90	17LP4	13.60	21FP4	15.95
16GP4	15.90	17QP4	11.95	21WP4	17.30
16KP4	10.95	17TP4	19.30	21YP4	15.95
16LP4	10.95	19AP4	19.30	21ZP4	14.95
16RP4	10.95	20CP4	13.90	24CP4	23.95
16WP4	15.20	20HP4	17.95	24DP4	26.95
16TP4	10.95	21AP4	22.10	27EP4	39.95
17AVP4	15.20	21ALP4	20.95	27RP4	39.95

1 Year Warranty  
Aluminized Tubes \$5.00 more than above prices. Prices include the return of an acceptable similar tube under vacuum.  
These tubes are manufactured from reprocessed used glass bulbs. All parts and materials including the electron gun are brand new.

ALL PRICES FOB CHICAGO, ILLINOIS. Deposit required, when old tube is not returned, refundable at time of return. 25% deposit required on COD shipments. Old tubes must be returned prepaid. Tubes shipped Rail Express.

WRITE FOR COMPLETE LIST.

PICTURE TUBE OUTLET

3032 MILWAUKEE AVE.  
CHICAGO 18, ILLINOIS  
Dickens 2-2048

The Battery That's Used in Guided Missiles Now Released as Government Surplus

For Photography, Aircraft, Models, Searchlights, Radios, etc. \$1.95 ea. Postpaid



Sintered-plate Nickel-Cadmium alkaline storage batteries designed for "NIKE" Missile and now surplus due to design change. A lifetime battery with no known limit of service (over 5000 recharges on test without loss of capacity). Other features: Virtually indestructible, compact & lightweight, withstands heavy shock and vibration. Flat voltage curve during discharge retains charge year or more, high discharge rate up to 50 amps. for this cell, no corrosive fumes to harm clothing or equipment. Spillproof construction, discharge in any position, indefinite storage without deterioration, operates in temperature range -60° F. to +300° F. Each cell is approx. 10 ampere hour capacity. Nominal voltage per cell is 1.2 volts. (A 6 V. battery requires 5 cells.) Cell size 6" H. x 2" W. x 1/2" T. Wt. 6 oz. ea. Uses Potassium-Hydroxide (30%) electrolyte. Negligible loss during lifetime service. Add only distilled water once a year. A fraction of Government cost.

Used Test Cells.....\$1.95 ea. Postpaid  
Brand New Cells..... 2.95 ea. Postpaid  
All cells guaranteed to your satisfaction or money refunded (less postage).

ESSE RADIO COMPANY

42 W. South Street Indianapolis 25, Indiana

For the tops in value and the best trade-in on High Fidelity equipment.

Check with Arrow!

**ARROW** ELECTRONICS INC.  
DEPT. R

65 Cortlandt Street, New York 7, N. Y. • Digby 9-4730  
525 Jericho Turnpike, Mineola, N. Y. • Pioneer 8-8686

ENGINEERING B.S. DEGREE IN 27 MONTHS

Prepare for unlimited opportunities of the Electronic Age!

Students study engineering under accelerated program leading to B.S. degree in 27 mo. or standard 4-yr. program leading to B.E. degree in 36 mo. B.S. degree (36 mo.) in Math., Chem., Physics. Your-round classes. Comprehensive training in electronics, television, advanced radio theory and design, math., nuclear physics and elec. engineering. Also prep courses. Low rate. Earn board. G.I. approved. Enter June, Sept., Dec., March. Catalog.

INDIANA TECHNICAL COLLEGE

949 E. Washington Blvd., Fort Wayne 2, Indiana  
Please send me free information on B.S. ENGINEERING DEGREE IN 27 MONTHS as checked.

Electronics  Chemical  Aeronautical  
 Civil  Mechanical  Electrical

B.E. DEGREE IN 36 MO. in:  
 Aeronautical  Mechanical  Electrical (Power or Electronics)  
 Civil  Metallurgical

B.S. DEGREE IN 36 MO. IN  Math.  Chem.  Physics

Name \_\_\_\_\_  
Address \_\_\_\_\_



# Technician's Crossword

By RICHARD F. CROCKER

HERE'S a "not-too-tough" crossword puzzle that you can do during your coffee-break. Although some of the definitions will take some head-scratching, most of the answers are in the lighter vein. (Answer on page 162)

## ACROSS

1. The shop that got the business did this.
9. Not hooked up (Abbr.).
11. Your "third hand."
12. Sole.
13. This reptile can put the "squeeze" on you.
14. It goes into the outlet.
16. "Even Stephen."
18. Total resistance (Abbr.).
19. What to do when you grab hold of the 2nd anode.
20. This has "downs" but no "ups."
22. This man's brains are responsible for your success.
23. Red-hot fiddle player.
26. What the technician did when his hand truck broke down.
27. Neutralizing capacitor (Abbr.).
28. To put a 1/2-watt resistor in a 2-watt circuit.
29. Lightning and high-voltage are supposed to strike you just \_\_\_\_\_.
31. Masculine pronoun (Fr.).
32. Size of a 1/2-watt resistor.
33. What the careless technician left behind.
38. What you hear when you use a 50-volt capacitor in a 100-volt line.
39. What the voltage in the TV transformer did.
42. Used for greasing bread-pans not tuners.
44. Collected data.
45. What your wife does to keep you in stitches.
47. The state of a stripped chassis.
49. YYYYYYYY.
50. Easiest way to work on a set (Dial.).
51. Plea from a customer (Abbr.).

## DOWN

1. A crooked raster.
2. Condition of a part after cooking with a heat lamp.
3. Practical unit of e.m.f.
4. Threnody.
5. Direction taken by a closing switch.
6. Easy come, easy go.
7. When I string a dial, it does this.
8. Use these to check position of ion trap.
9. Negative co-ordinate.
10. Nearest thing there is to a filament.
15. Likewise.
17. Technician who bleeds over his work.
21. Some CRT's have \_\_\_\_\_ housings.
24. Network (Latin).
25. A hot iron on a diode will do this.
26. Tellurium (Abbr.).
27. There should be a few "dead ones" in every TV set by now.
28. That is (Latin abbr.).
30. Simple speaker cone repair.
33. Filament voltage (Abbr.).
34. What happened to the bugs in high-voltage cage.
35. Where to go on your vacation.
36. Respiratory ailment.
37. Simple.
40. Luck (Irish).
41. 1000 watts (Abbr.).
43. Load side of circuit (Abbr.).
46. Your city map has lots of these (Abbr.).
48. Prefix denoting the reversal of an action.

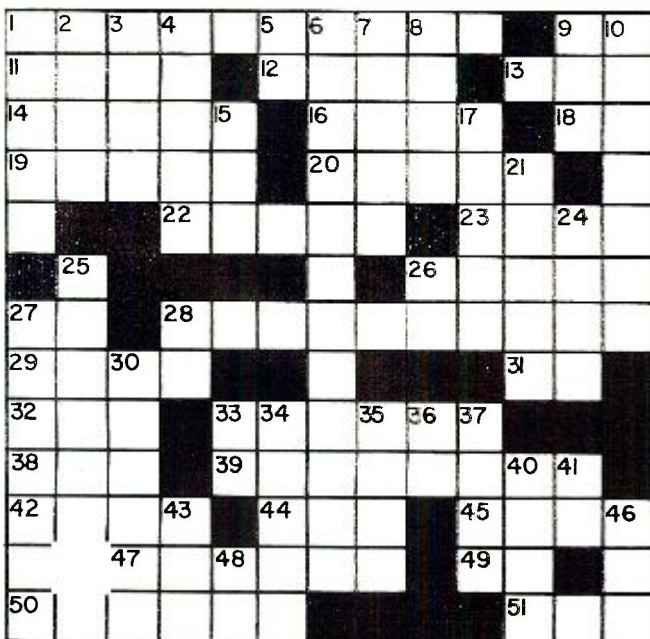

The specs are the proof...now your best buy in ham equipment is **EICO**

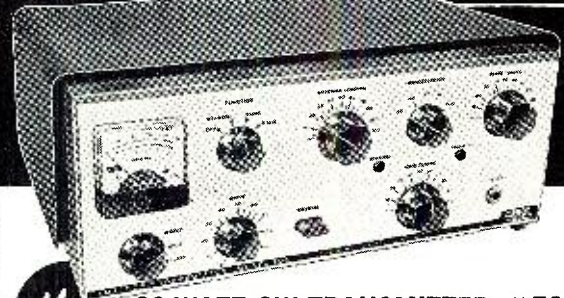

**New** 90-WATT CW TRANSMITTER #720  
KIT \$79.95 WIRED \$119.95

Conservative, highly efficient design plus stability, safety, and excellent parts quality. Covers 80 thru 40, 20, 15, 11, 10 meters (popular operating bands) with one knob band-switching. 6146 final amplifier for full "clean" 90W input, protected by clamper tube circuit. 6CL6 Colpitts oscillator, 6AQ5 clamper, 6AQ5 buffer-multiplier, GZ34 rectifier. "Novice limit" calibration on meter keeps novice inside the FCC-required 75W limit. No shock hazard at key. Wide range, hi-efficiency pi-network matches antennas 50 to 1000 ohms, minimizes harmonics. EXT plate modulation terminals for AM phone modulation with 65W input. Excellent as basic exciter to drive a power amplifier stage to maximum allowable input of 1KW. Very effective TVI suppression. Ingenious new "low silhouette" design for complete shielding and "living room" attractiveness. Finest quality, conservatively rated parts, copper-plated chassis, ceramic switch insulation 5" H 15" W 9 1/2" D



**NEW UNIVERSAL MODULATOR-DRIVER . . . . . #730**  
KIT \$49.95 WIRED \$79.95 Cover E-5 \$4.50

Superb, truly versatile modulator at low cost. Can deliver 50 watts of undistorted audio signal for phone operation, more than sufficient to modulate 100% the EICO #720 CW Transmitter or any xmitter whose RF amplifier has a plate input power of up to 100W. Multi-match output xfrm matches most loads between 500-10,000 ohms. Unique over-modulation indicator permits easy monitoring, precludes need for plate meter. Low level speech clipping and filtering with peak speech frequency range circuitry. Low distortion feedback circuit, premium quality audio power pentodes, indirectly heated rectifier filament. Balance & bias adjust controls. Inputs for crystal or dynamic mikes, phone patch, etc. Excellent deluxe driver for high-power class B modulation. ECC83/12AX7 speech amplifier, 6AL5 speech clipper, 6AN8 amplifier driver, 2-EL34/GCA7 power output, EM84 over-modulation indicator, GZ34 rectifier. Finest quality, conservatively rated parts, copper-plated chassis. 6" H, 14" W, 8" D.

**NEW GRID DIP METER . . . . . #710**  
KIT \$29.95 WIRED \$49.95 including complete set of coils for full band coverage.

Exceptionally versatile. Basically a VFO with micro-ammeter in grid; determines freq. of other osc. or tuned circuits; sens. control & phone jack facilitate "zero beat" listening. Excellent absorption wave meter. Ham uses: pre-tuning & neutralizing xmitters, power indication, locating parasitic osc., antenna adj., correcting TVI, de-bugging with xmitter power off, determining C.L.Q. Servicing uses: alignment of filters, IF's; as sig. or marker gen. Easy to hold & thumb-tune with 1 hand. Continuous 400 kc - 250 mc coverage in 7 ranges, pre-wound 0.5% accurate coils. 500 ua meter movement. 6AF4(A) or 6T4 Colpitts osc. Xmfr-operated sel. rect. 2 1/4" H, 2 3/8" W, 6 1/2" L. Satin deep-etched aluminum panel; grey wrinkle steel case.

Copyright 1958 by Electronic Instr. Co., Inc.



**IN STOCK!** Compare and take them home —right "off the shelf"—from 1900 neighborhood EICO dealers. For free catalog mail coupon. Over 1 MILLION EICO instruments in use throughout the world. (Add 5% in the West)

Send for **FREE CATALOG** now **R-4**  
EICO, 33-00 Northern Blvd., L.I.C. 1, N. Y.  
Show me HOW TO SAVE 50% on 60 models of top-quality equipment (in box I have checked here:  HAM GEAR  HI-FI  TEST INSTRUMENTS. Send **FREE** literature and name of EICO dealer.

NAME.....  
ADDRESS.....  
CITY..... STATE.....

See EICO's Hi-Fi and Test Equipment ads on Pages 35 and 36.

**WRITE FOR LATEST TUBE CATALOG FREE!**  
Receiving, transmitting, special purpose tubes, diodes, transistors, etc. We have a large, diversified stock at sensible prices. Tube cartons and stackers always in stock.

- **TRIMM No. 157 COMMERCIAL HEADSETS.** Highest quality lightweights—double headsets—17,000 ohms impedance (Reg. net \$17.60)—only \$6.50 ea. in orig. cartons—unused.
- **SNIPERSCOPE.** See in dark! (attach to rifle) Mfd. by Amer. Optical—Model M-3. w/orig. pwr. supply & cables. Also w/infra-red light source & filter—orig. box. (Orig. cost about \$2000.00) Special ..... \$120.00
- **RAYTHEON POWER SUPPLY** Input 6 Volts DC. Output: 117 VAC under load @ 1/2 to 3/4 Amps AC (50 watts plus) new—original cartoned—heavy-duty unit—best parts (Original cost over \$100.00) Price ..... \$16.95
- **NATIONAL NC-60 RECEIVER**—Brand New—Sealed factory carton..... \$59.95
- **HER. SEALED FILAMENT XFMRI15 VAC TAPPED SEC. 5V at 10 A. Hi-Volt. Ins.—Cat. #F90132. Price..... \$3.00**
- **UNIVERSITY LABS 10 WATT OUTDOOR LOUDSPEAKER,** 8 Ohms—300 5000CPS—Brand New Boxed—with Mounting Bracket and 10 Foot Rubber Cord and Amphenol Connector made for Navy—Black finish—finest construction—Excellent for portable Megaphone Amplifier ..... \$12.95
- **HEAVY-DUTY TEST LEADS.** Tests to 10 KV for TV, etc. Red & Black Leads. ICA #4317. Price ..... \$1.25
- **SIGNAL TRACER PROBE FOR VTVM, Etc.** ICA #4310. Price ..... \$1.75
- **ICA 5 WAY BINDING POSTS** (Black or Red) Price ..... 22¢ Each
- **BLK. OR RED BANANA PLUGS FOR ABOVE,** Etc. 3" Long. (Specify Color) Price... 15¢ Each
- **TEST LEADS. STD. SET OF RED & BLK. LEADS W/Banana Jacks & 5" Probs.** ICA #312. Price..... 50¢ Each
- **WESTERN ELECTRIC MERCURY RELAY.** WE#D171584. SPDT. Mercury-pressure sealed. 4500 Ohm coil. Standard octal base. Best relay available for use in electronic keys, etc. SPECIAL ..... \$4.95
- **RUSSELL ELECTRIC 3/16 H.P. MOTOR.** 3450 RPM—1.8 Amps continuous duty. Operates on 115 Volts D.C. (Also will operate on 115 A.C.). Weighs 20 1/2 lbs. NEW, in original cartons. Very low price, \$5.95 ea. In lots of 10 ONLY ..... \$4.95 Each
- **SIMPSON 0 TO 50 DC MICROAMMETER**—2 3/4" high x 3" wide mounted in deluxe 6" x 3" x 2 1/4" bakelite instrument case with 12 position rotary switch. Stock #TM-30-1—Special ..... \$4.95
- **STEPPER-RELAY MFD. BY PRICE ELECTRIC CORP. TYPE #8507-1.** 7 1/2 Ohms coil resistance. 3 Decks. 15 contacts (on last deck). Can be used for many stepper applications. Worth \$6.50 surplus. Our price only \$3.50. Unused in original manufacturer's cartons.
- **G.E. STEP-DOWN TRANSFORMER.** Pri: 110 or 220 at 50/60 CPS. Sec: 20 1/2 Volts Tapped down at 19 1/2 and 18 1/2 Volts. Will handle 1.52 Amps conservatively. Weight: 5 lbs. Catalog #CG 301114. Size: 3 1/2" H x 3 1/2" W x 3 1/2" D. Price ..... \$2.50
- **FTR MINIATURE CHOKE.** Brand new! Hermetically Sealed. 2 Hys. at 130 Ma. 2 3/4" H x 1 1/2" W x 1" D. Stock No. 3C315-127. Price. 40¢
- **CARTER DUO-VOLT DYNAMOTOR.** Operates from 6 or 12 Volts DC input. Medium size unit puts out 400 Volts DC at 375 Ma. \$15.95. Large size unit puts out 620 Volts DC at 280 Ma. \$19.95. All units are brand new genuine Carter Dynamotors.
- **GENERAL RADIO VARIAC.** Type 200-CUH—2 Amperes—115 or 230 VAC 50 to 60 Cycles. Brand new in original sealed G.R. cartons. (Less knob and dial)—\$11.95. W/knob & dial ..... \$12.95.

Authorized factory distributors for: ADJUST-A-VOLT, B & W, DRAKE, EIMAC, GELOSO, GENERAL ELECTRONICS, GLAS-LINE, GONSET, HAMMARLUND, HEXACON, E. F. JOHNSON, NATIONAL CO., NATIONAL ELECTRONICS, PENTA LABS, STACO, TECHNICAL MATERIAL CORP., TOBE, WESTINGHOUSE, VOCALINE, and others.

All prices F.O.B. N.Y.C. Specify method of shipment. All merchandise insured and guaranteed for cost of mds. only. Send 25c for 1959 green sheet.

Open Monday to Saturday—come in and browse—we are near Prince St./BMT Station—Spring St./IRT Station. 1 flight up—20,000 sq. feet of values. Thousands of unadvertised specials. Phone: Walker 5-7000.

**BARRY ELECTRONICS CORP.**

512 Broadway, Dept. EW, N.Y. 12, N.Y.

**A. F. WESTERN NET**

**THE U. S. Air Force MARS Western Technical Net** schedule for April (Sundays 2-4 p.m., PST, 7832.5 and 3295 kc. and 143.46 mc.) is as follows:

April 5—"Automatic Multipurpose Electronic Checkout System for Military Weapons Systems or Industrial Systems" by Larry Mast and Col. Frank Shannon, USAF (ret.), Packard-Bell.

April 12—"Compressor Amplifiers, Transistorized Telephone Repeater Amplifiers and 24-Volt Power Supplies for A. F. 'Quick Fit' Program" by John K. Hilliard, Altec Lansing.

April 19—"Silicon Rectifiers" by H. S. Katzenberger, Audio Devices Inc.

April 26—"Equipment Utilization and Conversion Information" by USAF MARS W.T.N. Members. -30-

**SOLUTION TO BENCH PUZZLER NO. 6**  
(See page 154)

WITH the focusing system and the audio-output stage tied together as they are, the key to the solution, of course, lies in the "only fair" audio. Voltage on the V<sub>1</sub> plate was lowered because the tube was drawing excessive current. This current, passing through the focus coil, was responsible for the fuzziness of the picture. The culprit was C<sub>26</sub>, the .01-μfd. grid blocking capacitor. Under load it began to leak a little. Not much—just enough to shift grid bias from -8 volts to -5, resulting in the condition of excess current.

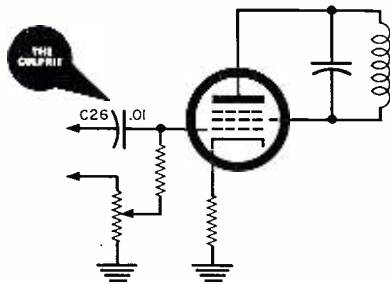

**PHOTO CREDITS**

Page	Credit
58 (top)	Bell Telephone Laboratories
58 (top left)	Gulton Industries
58 (bottom)	Raytheon Mfg. Co.
59 (top)	Tung Sol Electric Inc.
59 (center), 78, 79	Radio Corporation of America
59 (bottom left)	Westinghouse Electric Corp.
59 (bottom right)	Lockheed Aircraft Corp.
74, 75	Motorola Inc.
76, 77, 108	General Electric Company
117	Sylvania Electric Products Inc.

Answer to Puzzle (page 161)

A	D	V	E	R	T	I	S	E	D	N	C
T	O	Q	L	O	N	L	Y	B	O	A	
I	N	L	E	T	T	I	E	D	R	T	
L	E	T	G	O	E	P	S	O	M	H	
T	Y	O	U	R	S	N	E	R	O		
A	M	T	O	T	E	D					
C	N	I	N	C	I	N	E	R	A	T	E
O	N	C	E	T	L	E					
W	E	E	S	T	A	T	E				
B	A	M	F	L	E	W	B	A	C	K	
O	L	E	O	A	N	A	S	E	W	S	
Y	N	U	D	I	T	Y	S	T			
S	I	T	T	E	N	S	O	S			

**CRYSTAL CONTROLLED CONVERTERS**

POLICE • FIRE • COMMERCIAL



For use with  
12 V. Transistor type  
car radios—  
26-50 MC.

**\$24.50**

Can be self installed in seconds. Other models for 152-162 MC available. Also complete line of conventional powered converters, tuners and receivers.

A practical converter for emergency use with powered home or auto sets. Tuneable over 8 MC. 26-50 MC or 108-174 MC. **\$13.95**



Also available in easily assembled KIT form \$10.95.

ORDER OR WRITE FOR LITERATURE TODAY

**KUHN ELECTRONICS**  
20 GLENWOOD CINCINNATI 17, OHIO

**NOW AVAILABLE**

**BUILD-IT-YOURSELF KITS for the NEW 27 mc CITIZEN'S BAND TRANSCEIVER**

See MARCH RADIO TV NEWS pg 49 for details

**DELUXE KIT** of all parts, tubes, chassis, etc. .... 34.95

**SUPER DELUXE MODEL** for operation from 12 V. DC. .... 39.95

Either Model wired-tested ready for use, labor... 19.95

**SPECIAL MODEL** for portable operation, powered from self contained rechargeable cell, wired... 59.95

**DELUXE** type battery charger, will recharge many types of cells/batteries, wired/ready to use... 8.95

**HEAVY DUTY** vibrator power supply, 12 volt input. 150 & 250 volts output at 160 ma, super value... 14.95

**ESSCO—NEW YORK** 58 Walker St., NYC 13, N. Y.

**NEW VOLT-OHM-MILLIAMMETER**

- PORTABLE
- JUST 5" wide x 3 1/8" high x 1 1/2" deep
- HANDIEST TESTER YOU CAN OWN



D.C. VOLTAGE RANGES: 0-10, 50, 250, 500 & 1000  
A.C. VOLTAGE RANGES: 0-10, 50, 250, 500 & 1000  
D.C. CURRENT RANGES: 0-1 & 0-500ma  
RESISTANCE: 0-100KΩ  
DECIBEL: 20 to 0m+36db (2 ranges)

Model TS-55A  
**JUST \$9.95 ea.**

ORDER DIRECT OR FROM YOUR NEAREST DISTRIBUTOR

**ALCO ELECTRONICS MFG. CO.**  
Dupl. D-1 B Wolcott Ave., Lawrence, Mass.

Hot Off The Press!

**NEW 68-PAGE ARROW SALES CATALOG NO. 118**

Thousands of electronic items at terrific moneysaving prices!

ORDER YOUR FREE COPY TODAY!

**ARROW SALES, INC.**

Mailing address: BOX 3007  
NORTH HOLLYWOOD, CALIFORNIA  
Western: 7035 Laurel Canyon, No. Hollywood, Cal.  
Central: 2534 So. Michigan Ave., Chicago 16, Ill.

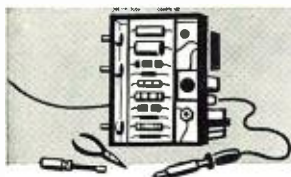

# ELECTRONICS MARKET PLACE

RATE: 50¢ per word. Minimum 10 words. May 1959 Issue closes March 9th. Send order and remittance to: RADIO & TV NEWS, One Park Ave., N. Y. C. 16, N. Y.

## RADIO ENGINEERING

**ELECTRONICS!** Associate degree—29 months. Technicians, field engineers, specialists in communications, missiles, computers, radar, automation. Start September, February. Valparaiso Technical Institute, Dept. N, Valparaiso, Indiana.

## FOR SALE

**RADIO & TV Tubes** at manufacturers prices. Guaranteed—Send for free price list. Edison Electronic Tube Co., Menlo Park, N. J.

**GOVERNMENT Sells**—Surplus Electronics; Walkie-Talkies; Transceivers; Test Equipment; Oscilloscopes; Radar; Voltmeters; Misc.—Fraction of Army costs—Buy direct now from U. S. Government—"Depot List & Procedure" \$1.00—Brody, Box 8-RT, Sunnyside 4, New York.

**TUBES**—TV, Radio, Transmitting And Industrial Types At Sensibly Low Prices. New, Guaranteed, 1st Quality, Top Name Brands Only. Write For Free Catalog or Call WALKER 5-7000, Barry Electronics Corp., 512 Broadway, New York 12N, N. Y.

**TELEVISION Sets** \$11.95. Plus shipping. Jones TV, Sanatoga, Pa.

**TELEVISION & Radio Tubes, Parts and Supplies** Guaranteed. Hi-Quality Tube Co., Inc., 284 Lafayette St., Rahway, New Jersey.

**GOVERNMENT Surplus Snooperscopes**, parabolic reflectors, Receivers, Transmitters. Picture list 5¢. Meshna, 580 N. Lynn, Malden 48, Mass.

**WHOLESALE Prices** transistor supplies, Stereo, Hi-Fi amplifiers, changers, speakers, Eico kits, tubes. Schaak Electronics, 3867 Minnehaha Ave., Minneapolis 6, Minnesota. PA 9-8382.

**MILITARY communications receivers** such as 388's, 389's, 390's, 51J's, both sold and serviced. Gizmos & Such, Still River, Massachusetts.

**TRADE-IN TV** \$6 up, Also Color. Write, Justis, Newport, Delaware.

**DIAGRAMS** for repairing radios \$1.00. Television \$2.00. Give make, model. Diagram Service, Box 672-RN, Hartford 1, Conn.

**ELECTRONIC Projects**—Organs, Timers, Counters, Etc., \$1. each. List Free—Parks, Box 1665A, Lake City, Seattle 55, Wash.

**PROFITABLE!** Make, Repair, Service Fluorescent Fixtures—Free Catalog. Shoplite, 650N Franklin, Nutley 10, New Jersey.

**\$50 TRANSISTOR Radio** \$23.95, Soldering Gun \$8.95 C.O.D., Hypnotizer \$19.95. Transworld Export, Box 929, Indio, California.

**LABORATORY Instruments, Surplus Electronics, Engineering, Farhills, Box 26X, Dayton 19, Ohio.**

**YOUR tubetester modernized**, checks latest series string tubes accurately. Simple instructions. 1.00. Adams Laboratory, 68-77 218 Street, Bayside 64, N. Y.

**SAVE Money!** Don't Buy until you get Our price list! All types Radio & TV tubes at Mfrs. prices! 100% Guaranteed! 24-Hour Service! Write United Radio Co., Newark, New Jersey.

**304TL TUBES** \$7.95; Four \$28.95; JRJRCO, 201 Fernwood, Evansville, Ind.

**YOUR classified message** placed right here will attract the attention of more than 250,000 electronics fans. You'll get fast results. For full details, write to Martin Lincoln, Radio & TV News, One Park Avenue, New York 16, New York.

**TAPE Deck** for instrumentation and audio application—Independent reel and drive motors, 10 inch reel capacity, optional head arrangement. Units priced from \$185.00. Complete descriptive literature available upon request. Orange County Instrument Company, P.O. Box 1081, Whittier, California.

**SYLVANIA Television Oscilloscope 400**, perfect, used little. Make offer. Oliver Johns, 128 Berteau Ave., Elmhurst, Illinois.

**BUY Surplus Jeeps, tractors, winches, pumps, tools, hydraulics, electronics, boats, typewriters, generators** wholesale direct from government. List and procedure \$1.00. Aviation Surplus, Box 8-2D, Thomasville, Penna.

**5 INCH Test CRT W/adaptor** \$3.95 postpaid. CRT tester and reactivator guaranteed satisfaction in thirty days or money back. \$29.95. Crystal Electronics, 95-07 101 Ave., Ozone Park, 16, N. Y.

**FREE! Surplus Choke.** Dime Postage. Hinz Videolab, 833 7th Ave., Sacramento 18, California.

**BC779 Super pro receivers**, checked out and guaranteed, \$74.50. Gizmos & Such, Still River, Mass.

**IMPEDANCE Matching Transformer Cost Government** \$11.20 your cost new, 57¢ each. 2 for \$1.00 postpaid. Ralph Villers, Box 1, Steubenville, Ohio.

**RECONDITIONED Used Television 17", 21", 24" & 27"** Table Model & Console. 150 sets to choose from. Wholesale prices—For list Write to Horn's Radio & TV, 1621 California Street, Columbus, Indiana.

**IMPEDANCE matching transformer cost Government** \$11.20. Your cost new 57¢ each. 2 for \$1.00 Postpaid. Ralph Villers, Box 1, Steubenville, Ohio.

**5 INCH test CRT W/adaptor** \$3.95 Postpaid. CRT tester and reactivator guaranteed satisfaction in thirty days or money back—\$29.95. Crystal Electronics 95-07 101 Ave., Ozone Park 16, N. Y.

**FOREIGN Auto Radio Distributor, FM-AM and AM, trade discount.** Square Electronics, 150-60 Northern Blvd., Flushing, N. Y.

**RADIO CONTROL: Handie Talkie**—Basic Transmitter/Receiver Chassis. New, Wired, with tube \$7.65; (Specials: 5" Mu. Metal Scope Shield \$2.25; Teletype Governor Motor 110 Volts, 60 Cycle \$5.95; Push-Pull Solenoid 110 Volts, 60 Cycle or 24 Volts DC \$2.45.) Send for Free Catalog N: Gyro Electronics Company, 36 Walker Street, New York, N. Y.

## WANTED

**CASH Paid!** Sell your surplus electronic tubes. Want unused, clean transmitting, special purpose, receiving, TV types, magnetrons, Klystrons, broadcast, etc. Also want military & commercial lab test and communications gear. We swap too, for tubes or choice equipment. Send specific details in first letter. For a fair deal write, wire or telephone. Barry, 512 Broadway, New York 12, N. Y. WALKER 5-7000.

**CYLINDER and old disc phonographs.** Edison, Conqueror, Idelia, and Oratorio models. Berliner Gramophones and Zono-o-phones, Columbia cylinder Graphophones, and coin-operated cylinder phonos. Want old catalogues and literature on early phonos prior to 1919. Will pay cash or trade late hi-fi components. Classified Box 50 % Radio & TV News, 1 Park Ave., N. Y. C. 16, N. Y.

**LABORATORY Quality Equipment and Military Surplus Electronics** bought, sold. Engineering Associates, 432 Patterson Road, Dayton 9, Ohio.

**WANTED, ARN-14c, ARN-30, ARC-15, OMNI Sets, and components.** CRT-3 Victory Girls, AS313B Loops, ARC-12, 51R2-3, 17L3-4, 18S2-3, R-388/URR, R-390/URR, BC-348, Testsets, "Top Dollar Paid." Bill Slep, W4FHY, Box 178, Ellenton, Florida.

**WANTED! Special Purpose Vacuum Tubes; Klystrons, Magnetrons, Power Tubes; Lab Test Equipment: X, S, K bands, Signal Generator, Slotted Lines; Aircraft Communication Equipment.** We Pay Top Prices fast! RRepublic 5-0215 Robert Sanett, 2053 W. Venice Blvd., Los Angeles 6, Calif.

## TAPE & RECORDERS

**RECORDERS, Tape Decks, Stereo, Tapes, Accessories, Excellent Values, Catalogue.** Efsco, 270S Concord, West Hempstead, N. Y.

**RECORDERS, HiFi, Tapes, Free Wholesale Catalog.** Carston, 215-R East 88 St., N. Y. C. 28.

**AMPEX, Concertone, Crown, Ferrograph, Presto, Tandberg, Pentron, Bell, Sherwood, Rek-O-Kut, Dynakit.** Others. Trades. Boynton Studio, 10RT Pennsylvania, Yonkers, N. Y.

**TAPE Recorders, Hi-Fi Components, Sleep Learning Equipment, Tapes. Unusual Values. Free Catalog.** Dressner, 69-02F, 174 St., Flushing 65, N.Y.

**LEARN While Asleep** with amazing new Electronics Educator endless tape recorder. Details free. Research Association, Box 24-S, Olympia, Wash.

## HIGH-FIDELITY



**DISGUSTED with 'Hi' Hi-Fi Prices? Unusual Discounts** On Your High Fidelity Requirements. Write. Key Electronics, 120 Liberty St., New York 6, N. Y. EVERgreen 4-6071.

**Hi-Fi Haven, New Jersey's Leading Sound Center.** Write for information on unique mail order plan that offers professional advice and low prices. 28 Easton Ave., New Brunswick, New Jersey.

## REPAIRS and SERVICING

**ALL Makes High Fidelity Speakers Repaired.** Amprite, 70 Vesey St., N. Y. 7, N. Y. BA 7-2580.

**SCHEMATIC, Repair Instructions, HiFi's, T.V.'s, Radio's, Phonographs, Tape Recorders, 99¢ Send Make, Model Number.** "Radio Coop," Box 5938, Kansas City 11, Missouri.

## RECORDS

**PHONOGRAPH Records** cheap, postpaid. Catalogue. Paramount, Box 242-N, Williamsport, Penna.

**RECORDS & Tapes—Factory Fresh—All Labels—Discount Prices—Free Catalog.** Good Turn Records Service, Box A-102, Wantagh, N. Y.

**LP Records, Stereodiscs, Stereotapes, 20% Discount.** Catalog 30¢. SWRS, 1108 Winbern, Houston, Texas.

## INSTRUCTION

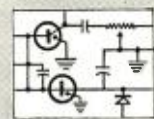

**PHOTOGRAPHY** For Pleasure or profit. Learn at home. Practical basic training. Long established school. Free booklet. American School of Photography, 835 Diversey Parkway, Dept. 2254, Chicago 14, Illinois.

**ENGINEERING Degrees** Earned through Home Study. Electronics, Electrical, Mechanical, Civil, Physics. When writing, specify course desired. Pacific International College of Arts and Sciences, primarily a correspondence school. Residence classes also carried. 5719-C Santa Monica Blvd., Hollywood 38, California.

USED Correspondence Courses and Books sold and rented. Money back guarantee. Catalog Free. (Courses Bought). Lee Mountain, Pisgah, Alabama.

COMPLETE Your High School at home in spare time with 62-year-old school. Texts furnished. No classes. Diploma. Information booklet free. American School, Dept. X436, Drexel at 58th, Chicago 37, Illinois.

CALCULUS, Practical, First four easy lessons \$1. Mathco, 4256 Minnor, Cincinnati 17, Ohio.

LITERATURE to help you pass FCC Phone Exams. Free Information. Wallace Cook, 1614 B Morson Road, Jackson 9, Miss.

## HELP WANTED

**MEN-Women Agents:** sensational new money-makers—Beautifully hand-painted plastic personalized photo enlargements, compacts, rings, bracelets, lockets, etc. Simply take orders, pocket 40% commission—we deliver and collect. Sales outfit free. Novelco, 3341 North Ave., Chicago 47.

**AMERICAN Overseas Jobs.** High Pay. Men, Women. Transportation Paid. Free information. Write: Transworld Information Service, Dept. AZ, 200 West 34th St., New York 1.

**YOUR classified message** placed right here will attract the attention of more than 250,000 electronics fans. You'll get fast results. For full details, write to Martin Lincoln, Radio & TV News, One Park Avenue, New York 16, New York.

**FLORIDA** needs Technicians, Engineers. Paying high wages. Direct information on companies employing, living conditions, etc. Latest Service Directory. Only \$2.00 Satisfaction Guaranteed. Sampey Company, 5411 Ira Street, Orlando, Fla.

## BUSINESS OPPORTUNITIES

**FRANCHISES** available in selected areas to operate radio, television and electronics schools. Nominal investment, annual potential \$50,000 to \$200,000. Box 569, % Radio & TV News, One Park Avenue, New York 16, N. Y.

**TV Picture Tube** rebuilding plant and training program still available for many territories. Investment \$8,000-\$11,000. Annual volume \$25,000 to \$100,000. Windsor Co., 999 N. Main St., Glen Ellyn, Ill.

**EARN Extra money** selling advertising book matches. Free samples furnished. Matchcorp, Dept. MD-49, Chicago 32, Ill.

**EARN Extra Cash!** Prepare advertising postals. Langsons, Box 41107Z, Los Angeles 41, California.

**\$30-\$60 WEEKLY** Addressing Envelopes at Home. In-structions \$1 (refundable). Reiss, 210 Fifth Ave., Suite 1102-M, New York 10.

**MAILMAN** Brings Us \$150 Daily. Operate Home Mail Order Business. Write Publicity, Box 727ZE, Kalamazoo, Michigan.

**MAKE \$25-\$50** Week, clipping newspaper items for publishers. Some clippings worth \$5.00 each. Particulars free. National, 81-DG, Knickerbocker Station, New York.

**DETECTIVES**—Experience unnecessary. Detective Particulars, Wagoner, 125-Z, West 86th, N. Y.

**AMATEURS** And Professionals—Extra Cash from your photos. Become a Member of our World-Wide Photo Agency and enjoy innumerable benefits. Send your 8x10 Photos for Presentation to World Markets and only \$1.00 for Membership number and informative letter. Limited Offer. Photo-World, 538 North Federal, Fort Lauderdale, Florida.

**YOUR Own home-operated business!** Take over your area as our Service Distributor keeping stores supplied. Nationally advertised 28-year-old line pays you 66 2/3% mark-up. Less than \$100 for merchandise, starts you. For samples, highly successful plan, write Novo, Inc., 1168-P Milwaukee, Chicago 22, Ill.

## MISCELLANEOUS

**DECALS**—Trademarks, Service, Sales, etc. Write Allied Decals, Inc., 8378 Hough, Cleveland, Ohio.

## SHOPPING GUIDE Classified

A HANDY GUIDE TO PRODUCTS, NOT NECESSARILY ELECTRONIC, BUT OF WIDE GENERAL INTEREST.

## PHOTOGRAPHY—FILM, EQUIPMENT, SERVICES

**FREE**—Lance Photographers register now. No obligation. For application write: Accredited Press, Inc. Lawrence 6, New York.

**5000 8mm.-16mm.** Films, Equipment. Free catalogues. International Greenvale, New York.

**FREE!** Blackhawk's big sale catalog 8mm., 16mm. movies, 2 1/2" color slides. Biggest selection anywhere! Projectors, cameras, supplies—big discounts! Get free, every month, 24-page newspaper-size bargain list! Blackhawk Films, Davenport 25, Iowa.

**ABSOLUTELY** highest quality professional double weight enlargements at dealers' prices. 5x7, 32¢; 8x10, 39¢; 11x14, 85¢. No extra charge for cropping or dodging. New negative from your photo 60¢; minimum order \$1.00. 25% discount on Kodacolor processing. 20% discount on Developing by Kodak. Foto Portrait Co., 1172-R Ogden Ave., New York City 52.

**COLOR Economy!** Anscochrome, Ektachrome film developing, 80¢ (20 exp. 35mm. rolls mounted). Color prints from transparencies—2 1/2x3 1/2 six for \$1.00, 3 1/2x5 six for \$1.50, 5x7 each 75¢, 6x10—\$1.50. Lee-Jan-Lab., Box 382, LaGrange, Illinois.

**HOBBIES, Industries, Sports, Travel!** Meston's 35mm Color Slides of over 16,000 subjects. Send \$1.00 for Exciting Preview Package four slides hermetically sealed in plastic plus 80 page catalog. Meston's Travels, Dept. RN, 3801 N. Piedras, El Paso, Texas.

## STAMPS & COINS

**COIN Magazine.** 200 pages. Sample 40¢. Scrapbook, 7328 Milwaukee, Chicago 48.

**77 DIFFERENT U.S., 100 Different China, 25 Different Czechoslovakia,** all 60¢ approvals. Leonards, 11437 North Keeler, Chicago 51.

**U.S. Stamps.** Giant Bargain Catalog—15¢. Raymax 35-VZD Maidenlane, NYC 38.

**UNITED Nations.** Five Different 10¢. Approvals. Anderson, 1112 Harrison, San Francisco 3, Calif.

**NEW!** 1959 Bargain American Coin Catalogue! Revised Prices! Only 25¢. Write: Sullivan, 128 EC East Fourth St., St. Paul 1, Minnesota.

**508 DIFFERENT Worldwide** from Madagascar, Macao, Guinea, etc., cataloging over \$15.00 on 35¢. Approvals. Littleton Stamp Company, Littleton Q17, New Hampshire.

**1000 DIFFERENT Worldwide Stamps** \$1.25. Valued over \$20.00. Universal, Box 6, Kenosha 18, Wisconsin.

**100 LARGE U.S. Commemorative**—only 25¢ with approvals. Wm. Rice, 87 Washington Ave., Kingston 43, N.Y.

**GIGANTIC Collection Free!** Includes triangles, early United States, animals, commemoratives, British Colonies, high value pictorials, etc. Complete collection plus big illustrated magazine all free. Send 5¢ for postage. Gray Stamp Company, Dept 22, Toronto, Canada.

**307 WORLDWIDE** Different stamps only 35¢. Approvals. Niagastamp, St. Catharines 690, Ontario.

## MISCELLANEOUS

**FLYING Saucers** Latest Reports, Articles. Subscribe for "The Saucerian" magazine. Six issues \$2.00. Saucers, Dept. 4, Box 2228, Clarksburg, West Va.

**WHY** not be the person you wish to be, realizing the fulfillment of your desires? Good things are attracted to you when you know and apply the rules. Read: Man, God's Helpmate \$1.25; Using the Magnetic Forces of Your Mind \$3.00 postpaid. I.P. Society, Dept. Z, P.O. Box 42187, Los Angeles 42, California. (In Calif. add 4% sales tax.)

**THE Law of Life Revealed** and How to Apply it, \$1.00. The Open Way, Celina, Tennessee.

**BARBELLS, Courses, Apparatus.** Catalogue 10¢. Good Barbell Co., Dept. D, Siloam Springs, Arkansas.

**ENGINES** OHV V8's. All Popular Makes 1956, 1959. Ledbetter Enterprises, 1015 West 17th, Texarkana, Texas.

**PRINTING** Presses, Type, Supplies, List 4¢. Turnbaugh Service, Mechanicsburg, Pa.

**"WINEMAKING; Beer, Ale Brewing."** Illustrated. \$2.00. Many others. Eaton Books, Box 1242-TC, Santa Rosa, California.

# INDEX OF Advertisers

APRIL  
1959

While every precaution is taken to insure accuracy, we cannot guarantee against the possibility of an occasional change or omission in the preparation of this index.

ADVERTISER	PAGE NO.	ADVERTISER	PAGE NO.	ADVERTISER	PAGE NO.	ADVERTISER	PAGE NO.
Advance Electronics	155	Cleveland Institute of Radio Electronics	13	Indiana Technical College	160	Rad-Tel Tube Co.	137
Advanced Acoustics Co.	99	Columbia Electronics	139	International Radio & Electronics Corp.	120	Radio Corporation of America	6, 7, 123, 129
Aerovox Corporation	128	Communications Equip. Co.	141	Jerrold Electronics Corp.	124	Radio Shack Corporation	105
Airex Radio Corporation	99	Cotter, Herman E.	148	Key Electronics Co.	143	Radiconic	140
Alco Electronics Mfg. Co.	162	Coyne Electrical School	136, 141, 157	Krylon	157	Reeves Soundcraft Corp.	154
Algeradio Electronics Co.	116	Delco Radio	18	Kuhn Electronics	162	Rex Radio Supply Co.	158
Allied Radio Corp.	9, 106, 107	DeVry Technical Institute	5	Lafayette Radio	126, 127	Rider Publisher, Inc., John F.	95
American Television & Radio Co.	116	Dressner	140	Lampkin Laboratories, Inc.	136	Rinehart & Co., Inc.	117, 152
Argos Products Company	97	Dynaco Inc.	119	Lektron	134	Sams & Co., Inc., Howard W.	21, 144
Arkay	159	Editors and Engineers Ltd.	116	Malloy & Co., Inc., P. R.	34	Sarkes Tarzian, Inc.	12
Arrow Electronics, Inc.	160	EICO	35, 36, 161	Merit Coil and Transformer Corp.	155	Schober Organ Corporation, The	100
Arrow Sales, Inc.	162	Electro-Voice, Inc.	26, FOURTH COVER	Micro Electron Tube Co.	145	Scott Inc., H. H.	101
Ashe Radio Co., Walter	132	Electronic Chemical Corp.	132	Milwaukee School of Engineering	147	Seco Manufacturing Co.	158
Atlas Sound Corp.	136	Electronic Measurements Corp.	138	Monitoradio, Division of I.D.E.A.	8	Sonotone Corp.	121
Audio Fair	148	Electronic Technical Publishing Co.	160	Moss Electronics, Inc.	112, 113, 114, 115	Sparks Radio Supply	140
B & K Manufacturing Co.	81	Eric Resistor Corporation	100	National Radio Institute	17	Spaulding Products Company	139
Bailey Technical Schools	153	Esco	162	National Schools	17	Spencer-Kennedy Laboratories, Inc.	141
Baltimore Technical Schools	156	Esse Radio Company	160	North American Philips Co., Inc.	SECOND COVER	Sprague Products Company	15
Bary Electronics Corp.	162	Fair Radio Sales	142	ORRadio Industries, Inc.	118	Sprayberry Academy of Radio-Television	11
Blonder-Tongue Laboratories	14	Ferrodynamics Corporation	99	Oxford Components, Inc.	120	Standard Surplus	136
Bogen Presto Recording	120	Fisher Radio Corporation	22, 23	Peak Electronics Company	152	Supreme Publications	109
Brooks Radio & TV Corp.	156	G & G Radio Supply Co.	135	Perma-Power Company	108	Sylvania Electric Products Inc.	27
Burrhoughs Corporation	16	Goodhart Co., R. E.	157	Picture Tube Outlet	160	TAB	146
CBS-Hytron	10, 98	Grantham School of Electronics	150	Platt Electronics Corp.	128	Telemarine Communications Co., Inc.	133
C & H Sales Co.	151	H & H Electronic Supply, Inc.	156	Prentice-Hall, Inc.	143	Terado Company	147
Candee Co., J.	153	Harvey Radio Co., Inc.	151	Quality Electronics	156	Thoreson	THIRD COVER
Candor System Co.	148	Health Company	82, 83, 84, 85	Quam-Nichols Company	122	Tri-State College	139
Capitol Radio Engineering Institute	19, 20	Hi-Mu Electronics Sales Co.	148	Quietrol Company	109	University Loudspeakers, Inc.	147
Carston Studios	156	Hickok Electrical Instrument Co.	143	RCA Institute, Inc.	28, 29	Valparaiso Technical Institute	147
Century Electronics Co., Inc.	130, 131	IBM Corp.	32, 33	R W Electronics	147	Van Nostrand Company, Inc., D.	140
Channel Master Corp.	24, 25					World Radio Laboratories	158
						Zalytron Tube Corp.	122

**new**  
**THORENS KIT**  
**"TD"**



*easily assembled  
 in half an hour with  
 no special tools...*

Now for the first time you can get a Thorens TD transcription turntable in kit form—at big savings to you.

It's the new TDK-101 featuring the same precision Swiss craftsmanship that made the now-famous TD-124 an immediate success on the American market. Just examine the mirror-finished machining on this kit turntable (or for that matter on any of the Thorens "TD" units) and compare with that of any other make of turntable. You'll see the reason for the TDK's extremely low rumble, wow and flutter. See the TDK-101, newest member of the TD family of fine turntables, at your Thorens hi-fi dealer's.

**Features:**

Same compliant belt-plus-idler drive as on more expensive TD units; provides complete motor isolation. Single, retained, ball-thrust bearing, plus mirror-finished main bearing, for absolute minimum of rumble, both vertical and horizontal—so necessary for stereo. Single-speed 33 $\frac{1}{3}$ . Adjustable speed ( $\pm 3\%$ , a total of about one musical semitone). Built-in strobe allows setting to exact speed. Automatic disengagement of idler when unit is switched off. Drive mechanism completely enclosed—no "string" belts or external belt shields. Accessory wooden base is available in walnut, blond, or mahogany; \$9.00 net.

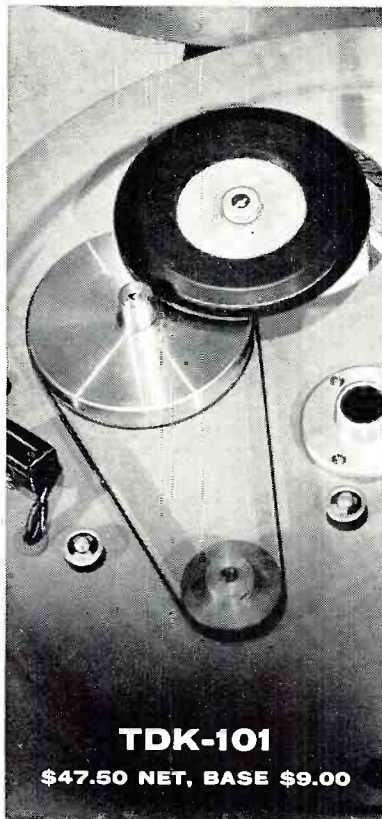
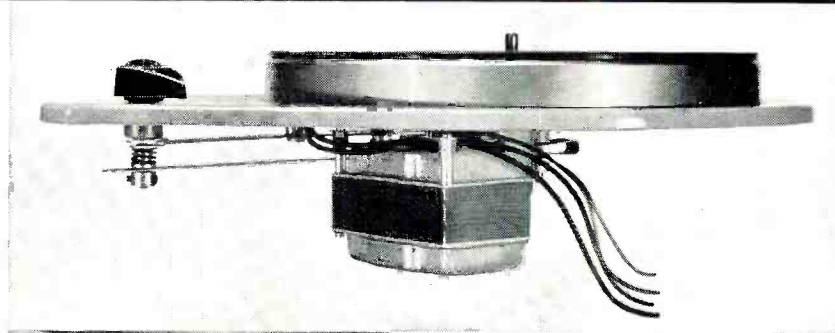

**TDK-101**

**\$47.50 NET, BASE \$9.00**

*And these precision "TD" units  
 ... completely assembled*

**TD-124.** Absolute tops for stereo or mono records . . . quietest, smoothest, most exact. 11 $\frac{1}{2}$  lb. table; clutch for fast, noise-free starts with needle in groove. 4 speeds, all adjustable ( $\pm 3\%$ ) for perfect pitch; built-in illuminated strobe; built-in level. All assembled TD turntables are 100% tested electronically and aurally for wow, rumble and flutter before shipment. \$99.75 net. Base \$9.00.



**TD-184.** This 4-speed high-quality turntable with integral arm has same precision-machined adjustable speed drive as Thorens TD-124. Semi-automatic operation—one dialing motion selects 7", 10", 12" record size. Arm literally floats down to record on air. Absolutely no connection between arm and table. \$75.00 net. Base \$6.00.



**TD-134.** 4-speed turntable with integral arm for manual operation. Same high-performance tone arm as used on TD-184 equals tracking performance of arms costing as much as half the price of this entire unit. Same adjustable speed drive mechanism as on more expensive units. \$60.00 net. Base \$6.00.



9.5

Write Dept. R-4 for catalog on complete Thorens hi-fi line.



**THORENS**

**SWISS MADE PRODUCTS**  
 MUSIC BOXES • HI-FI COMPONENTS  
 SPRING-POWERED SHAVERS • LIGHTERS  
 NEW HYDE PARK, NEW YORK

# NOW... AN *Electro-Voice*<sup>®</sup> PUBLIC ADDRESS SPEAKER FOR ANY APPLICATION

For SUPERIOR SOUND . . . CONTROLLED COVERAGE

See Electro-Voice public address projectors. They offer perfect voice penetration and full-range "musicasting." They're weatherproof, splashproof and blastproof.



**\$75.00**  
LIST

Model 848 30-Watt CDP\* (With 1000-cycle concentrating horn). For projecting intelligible, extended-range sound over great distances.

\*CDP (Compound Diffraction Projection) Design Patent 169,904. Additional Patent Pending.

Model 844 30-Watt Paging Unit. Compact, economical unit for quality, high-efficiency voice reproduction.

**\$34.50**  
LIST



**\$80.00**  
LIST

The New Electro-Voice Musicaster. Rugged, weatherproof high-fidelity speaker system for high-quality music reproduction.



Model 848 30-Watt CDP. For wide-angle coverage and extended range. Standard of the industry.

**\$75.00**  
LIST



Model 847 25-Watt CDP. Smaller version of Model 848.

**\$46.33**  
LIST



Model LS-12. For interior installations requiring full-range response.

**\$32.50**  
LIST



Model LS-8. Smaller version of Model LS-12.

**\$30.00**  
LIST

THESE ELECTRO-VOICE MICROPHONES ARE  
ESPECIALLY OUTSTANDING FOR PUBLIC ADDRESS



**\$85.00**  
LIST  
Model 664 Cardioid Dynamic. Broadcast-quality for every public address installation.



**\$49.50**  
LIST  
Model 951 Cardioid Crystal. Excellent, wide-range, all-purpose microphone.

The Sound of Electro-Voice . . . Assures Superior Installations, Customer Satisfaction, Your Reputation!

**Electro-Voice**<sup>®</sup>

ELECTRO-VOICE, INC.  
BUCHANAN, MICH.

In Canada: E-V of Canada Ltd., 73 Crockford Blvd., Scarborough, Ontario  
Cables: ARLAB