

THE MAGIC OF STEREOPHONIC SOUND

MAC

RADIO & TV NEWS

World's Leading Electronics Magazine

MARCH
1958
35 CENTS

Receiving U. S. Satellite Signals

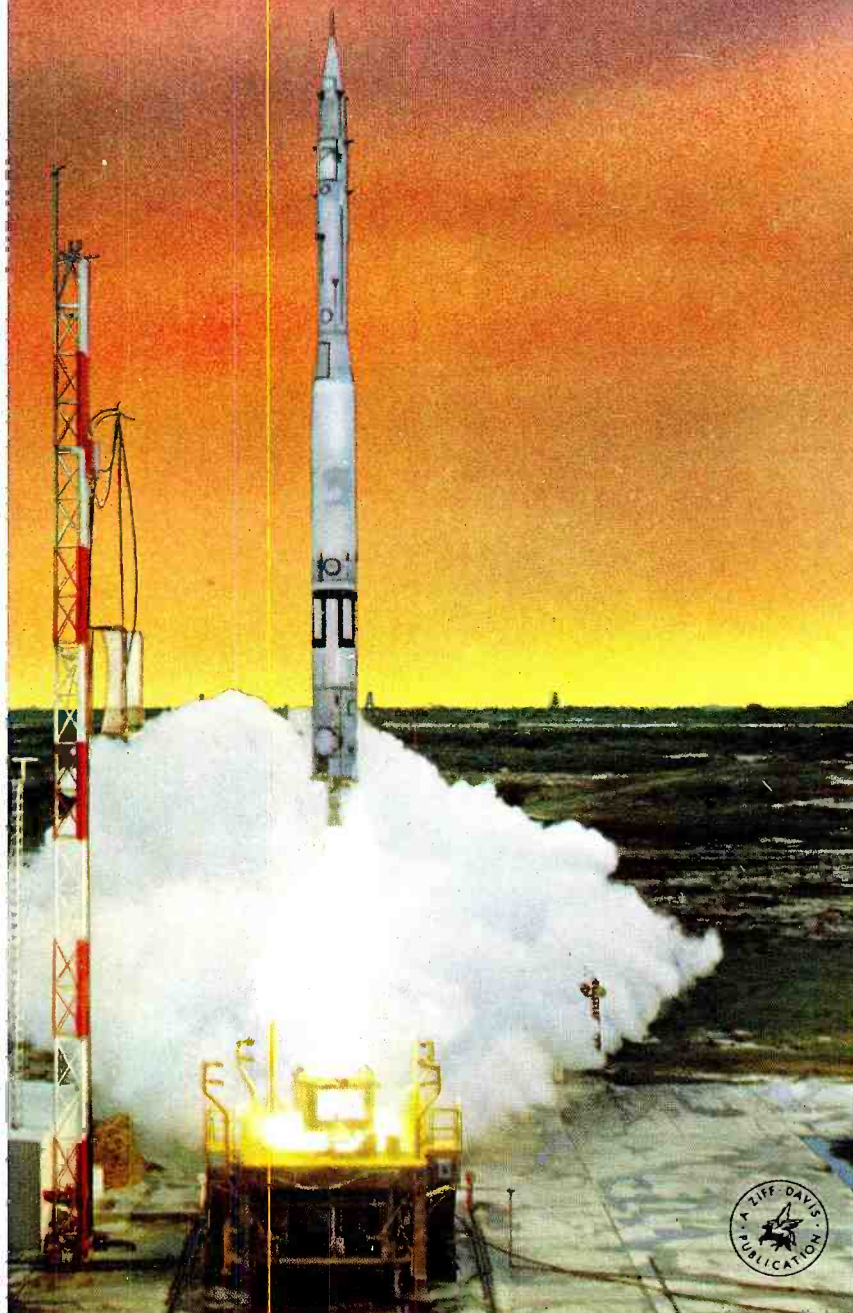

MONITOR YOUR TONE
AND FREQUENCY
MAINTAIN AND REPAIR
YOUR OWN SCOPE
SERVICING
COMMUNICATION RECEIVERS



Mr. Service Dealer:



Helps you to maintain a profitable, **INDEPENDENT** position in the Servicing Industry



Raytheon makes available to you all the Technical Data, Shop Helps, Signs, Sales Builders, and Advertising Aids you need for a successful TV-Radio Service operation. This, plus a most complete line of finest quality TV and Radio Tubes, makes Raytheon first choice of Independent Service Dealers.

NEW!

1958 Edition of the Raytheon Receiving Tube Data book. 1000 types — 600 individual basing diagrams — all you need to know about Receiving Tubes.

TECHNICAL DATA



Technical Data — Receiving Tube Data Book; Semiconductor Products Books; Picture Tube Books

SIGNS



Signs — Indoor, outdoor, illuminated, metal, thermometers, "Will Return" Signs, clocks.

ADVERTISING HELPS



Advertising Helps — Advertising Mats and Post Card Mailers — Television and Radio Spots, Dummy Tube Cartons, Door Knob Hangers.

DISPLAYS



Displays — Counter, Window, Transparent Banners, and Window Streamers, Decals.

SHOP AIDS



Shop Aids — Uniforms, Tube Carrying Cases, Triplicate Invoice Sets and Pocket Cases, Job Repair Tags, Clocks, Tape and Dispensers, Stationery, Matches, Labels and Holders, Rubber Stamps and Pads, Drop Cloths, TV Screen Polishing Cloths, Tube Shelf Labels, Phone Call Registers.

All these profit building items are available through your Raytheon Tube Distributor. Ask him for a free copy of Raytheon Business Builders booklet that describes them in detail.



RAYTHEON MANUFACTURING COMPANY

Receiving and Cathode Ray Tube Operations

NEWTON 58, MASS. 55 Chapel Street CHICAGO, ILL. 9501 Grand Ave. (Franklin Park) ATLANTA 6, GA. 1150 Zonolite Rd. N.E. LOS ANGELES 7, CALIF. 2419 So. Grand Ave.

Raytheon makes all these Receiving and Picture Tubes, Reliable Subminiature and Miniature Tubes, Semiconductor Diodes and Transistors, Nucleonic Tubes, Microwave Tubes.



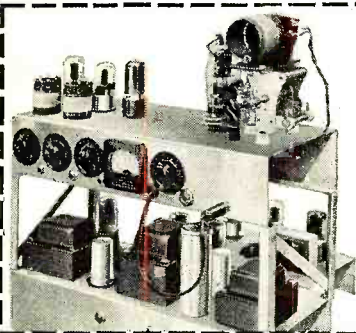

YOU BUILD Broadcasting Transmitter

As part of N.R.I. Communications Course you build this low power Transmitter; use it to learn methods required of commercial broadcasting operators, train for FCC license.

YOU BUILD Signal Generator

N.R.I. sends kits of parts to build this Signal Generator. You get practical experience, conduct tests to compensate Radio frequency amplifiers, practice aligning a typical I.F. video amplifier in TV circuit, many other experiments.

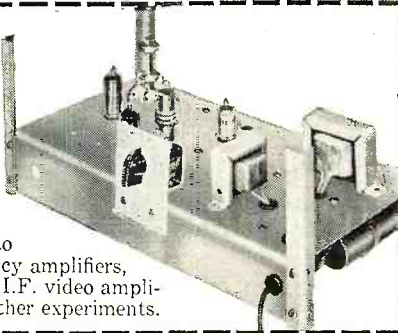

YOU BUILD Vacuum Tube Voltmeter

Use it to get practical experience, earn extra cash fixing neighbors' sets in spare time, gain knowledge to help you work in Radio, Television, Color TV. With N.R.I. training you work on circuits common to both Radio and TV. Equipment you build "brings to life" things you learn in N.R.I.'s easy-to-understand lessons. 64 page Catalog FREE, shows all equipment you get.

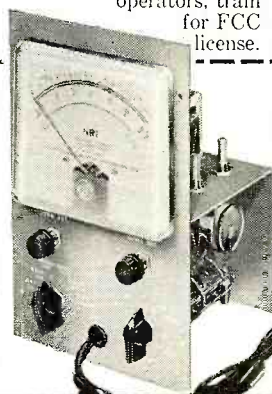

YOU BUILD AC-DC Superhet Receiver

N.R.I. servicing training supplies all parts, everything is yours to keep. Nothing takes the place of practical experience. You get actual servicing experience by practicing with this modern receiver; you learn-by-doing.

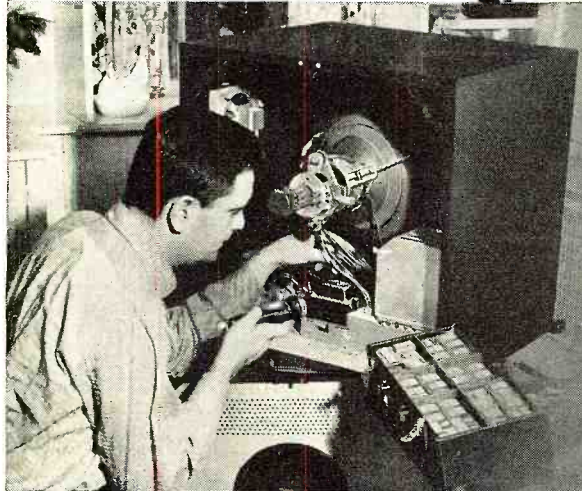

Learn RADIO TELEVISION by Practicing at Home

WHAT GRADUATES DO AND SAY

Chief Engineer

"I am Chief Engineer of Station KGCU in Mandan, N. D. I also have my own spare time business servicing high frequency two-way communications systems." R. BARNETT, Bismarck, North Dakota.



Paid for Instruments

"I am doing very well in spare time TV and Radio. Sometimes have three TV jobs waiting and also fix car Radios for garages. I paid for instruments out of earnings." G. F. SEAMAN, New York, N. Y.



Has Own TV Business

"We have an appliance store with our Radio and TV servicing, and get TV repairs. During my Army service, NRI training helped get me a top rated job." W. M. WEIDNER, Fairfax, South Dakota.



NEED FOR TECHNICIANS INCREASING Fast Growing Field Offers Good Pay, Bright Future

Today's OPPORTUNITY field is Radio-Television. Over 125 million home Radios plus 30 million sets in cars and 40,000,000 Television sets mean big money for trained Radio-TV Technicians. More than 4,000 Radio and TV Broadcasting stations offer interesting and important positions for technicians, operators. Color television, portable TV sets, Hi-Fi, other developments assure future growth.

It's the trained man who gets ahead. The fellow who uses his spare time to develop knowledge and skill gets the better job, drives a better car, lives in a better home, is respected for what he knows

and can do. So plan now to get into Radio-TV.

Keep your job while training with N.R.I. You learn at home in your spare time. N.R.I. is oldest and largest home study Radio-TV School. Our methods have proved successful for more than 40 years, provide practical experience.

Soon after enrolling, many N.R.I. students start to earn \$10, \$15 a week extra in spare time fixing sets. Many open their own full time Radio-TV shops after getting N.R.I. Diploma. Find out more. Mail Coupon. Cost is low, terms easy; includes all equipment. Address: **National Radio Institute, Dept. 8CE, Washington 16, D. C.**

Send for
LESSON
and **CATALOG**
FREE

VETERANS
Available under
G.I. Bills

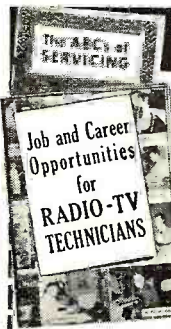

MAIL COUPON NOW

NATIONAL RADIO INSTITUTE
Dept. 8CE, Washington 16, D. C.

Mail me Sample Lesson and 64-Page Catalog, FREE. (No Salesman will call. Please write plainly.)

Name _____ Age _____

Address _____

City _____ Zone _____ State _____

ACCREDITED MEMBER, NATIONAL HOME STUDY COUNCIL

RADIO & TV NEWS is published monthly by Ziff-Davis Publishing Company, William B. Ziff, Chairman of the Board (1946-1953), at 64 E. Lake Street, Chicago 1, Ill. Entered as second-class matter July 21, 1948, at the Post Office, Chicago, Ill., under the act of March 3, 1879. Authorized by Post Office Department, Ottawa, Canada, as second-class matter. **SUBSCRIPTION RATES:** one year U. S. and possessions, and Canada \$4.00; Pan American Union Countries \$4.50; all other foreign countries, \$5.00.

March, 1958



Reg. U. S. Pat. Off.

First in radio-television-audio-electronics

Average Net Paid Circulation 255,915

Radio & Television News • Radio News • Television News Trademarks Reg. U. S. Pat. Off.

CONTENTS

MARCH, 1958

VOL. 59 ■ NO. 3

Publisher

OLIVER READ, D. Sc., W1ET1

Editor

WM. A. STOCKLIN, B. S.

Technical Editor

MILTON S. SNITZER

Service Editor

SIDNEY C. SILVER

Associate Editor

P. B. HOFER

West Coast Editor

EDWARD A. ALTSHULER

Assistant Editor

J. JUSTER

Television Consultant

WALTER H. BUCHSBAUM

Art Editor

HERBERT ASCHER

Art and Drafting Dept.

J. A. GOLANEK
JAMES A. ROTH
MILTON WHELPLEY

Advertising Director

JOHN A. RONAN, JR.

Advertising Manager

MURRAY GOLDMAN

Midwest Adv. Manager

ROBERT WOLFE

Western Adv. Manager

JOHN E. PAYNE



ZIFF-DAVIS PUBLISHING COMPANY
William Ziff, President; H. J. Morganroth, Vice-President; W. Bradford Briggs, Vice-President; Michael H. Froelich, Vice-President; Michael Michaelson, Vice-President and Circulation Director; Victor C. Stabile, Treasurer; Hershel B. Sarbin, Secretary; Albert Gruen, Art Director.

Executive Office: 366 Madison Ave.
New York 17, N. Y. MU 7-8080
Editorial Office: One Park Ave.
New York 16, N. Y. OR. 9-7200



MEMBER INSTITUTE OF



BRANCH OFFICES: Midwestern Office, 64 E. Lake St., Chicago 1, Ill., John A. Ronan, Jr., manager; Western Office, Room 412, 215 W. 7th St., Los Angeles 14, Calif., John E. Payne, manager.

INDUSTRY NEWS

For the Record... W. A. Stocklin 8
Spot News... Washington Correspondent 21
Receiving U. S. Satellite Signals... Whitney Matthews 35
Missile Master Air Defense System... 54
Facsimile Signals Bounced From Meteor Trails... 116
Calendar of Events... 131
Five Months of IGY Disclose Space Secrets... 159

HIGH FIDELITY AND AUDIO

The Magic of Stereophonic Sound... Louis E. Garner, Jr. 42
Upgrading the Hi-Fi Amplifier... Herman Burstein 50
RC Filter Tone Controls... H. Alan Schwan 61
All About Audio and Hi-Fi—Speaker Mounting (Part 9)... G. A. Briggs 64
Certified Record Revue... Bert Whyte 90
Hi-Fi—Audio Product Review... 108
Sound on Tape... Bert Whyte 132
The "Mark III"... 138
Feedback... Paul W. Klipsch 140

SERVICING

Television-Radio

Hidden Bypass Action... James A. McRoberts 39
Intermittents Can Be Licked... Ralph D. Sappe 40
Servicing Communication Receivers... B. Van Sutphin 46
Facts About Vertical-Sweep Circuits... Warren Philbrook 52
Service Salesmanship... William Leonard 56
Mac's Service Shop... John T. Frye 72
Basic Electronic Counting... Ed Bukstein 122
Antenna News... 135
Service Industry News... 144
Service Notes... 152

Test Equipment

A Flyback Tester... Bob Eldridge 48
Maintain and Repair Your Own Scope... Walter H. Buchsbaum 57

AMATEUR AND COMMUNICATIONS

The "Control Master"—A Crystal Dialing Unit... Gene Brizendine, W4ATE 49
Monitor Your Tone and Frequency... Leon A. Wortman, W2LJU 66
FM Receiver Conversion for U. S. Satellite Signals... C. B. House 160

ELECTRONIC CONSTRUCTION

Twelve Volts-Heater and Plate... Howard Burgess 68
Transistor Heat Sinks... Paul Penfield, Jr. 70

DEPARTMENTS

Letters from Our Readers... 12
Within the Industry... 28
What's New in Radio... 128
Sales Aids... 164
Technical Books... 166

Copyright © 1958 by Ziff-Davis Publishing Company. All rights reserved.
SUBSCRIPTION SERVICE. All communications concerning subscriptions should be addressed to Circulation Dept., 64 E. Lake St., Chicago 1, Ill. Subscribers should allow at least four weeks for change of address. Include your old address as well as new—enclosing, if possible, an address label from a recent issue of this magazine.

CONTRIBUTIONS: Contributors are advised to retain a copy of their manuscripts and illustrations. Contributions should be mailed to the New York Editorial Office and must be accompanied by return postage. Contributions will be handled with reasonable care, but this magazine assumes no responsibility for their safety. Any copy accepted is subject to whatever adaptations and revisions are necessary to meet the requirements of this publication. Payment covers all author's, contributor's, and contestant's rights, title, and interest in and to the material accepted and will be made at our current rates upon acceptance. All photos and drawings will be considered as part of the material purchased.

MEN 17 to 55



DeVry Tech's Electronic Training

has helped Men like these Get Better Jobs or Shops of their own...

How about YOU?



**No Advanced
Education
Required**

NO PREVIOUS TECHNICAL EXPERIENCE NEEDED

Men from practically every walk of life have won better jobs or businesses of their own through DeVry Tech's program. Many of these men, like thousands of others, had no previous technical experience. They prepared either in our well-equipped Toronto or Chicago laboratories, or at home in their spare time without interfering with their regular jobs.

The "Electronic Age" is here! Opportunities for men 17 to 55 are great! Fill in coupon below for **FREE** details! Act now!

Get **FREE** Facts!

Here are some of the many Electronic opportunities DeVry Tech's program will fit you for:

- Communications • Television • Radio
- Guided Missile Control • Computers •
- Radar • Micro-Waves • Instrumentation
- Automation Electronics

Sample Booklet **FREE!**

We'll give you a free copy of an interesting booklet, "Electronics and YOU." See for yourself how you may take advantage of the opportunities in this growing field.



LIVE-WIRE EMPLOYMENT SERVICE

DeVry Tech's Placement Department is in contact with some of the best-known employers in the Electronics field. The service is free to all graduates—and DeVry Tech's record in helping to place men has been outstanding.

DRAFT AGE? We have valuable information for every man of draft age; so if you are subject to military service, be sure to check the coupon.

DEVRY *Technical* **INSTITUTE**
Chicago 41, Illinois
Formerly DeForest's Training, Inc.

"One of North America's Foremost Electronics Training Centers"



MAIL COUPON TODAY!

DeVry Technical Institute
4141 Belmont Ave., Chicago 41, Ill., Dept. RN-3-0

Please give me your **FREE** booklet, "Electronics and YOU," and tell me how I may prepare to enter one or more branches of Electronics as listed above.

Name _____ Age _____
(PLEASE PRINT)

Street _____ Apt. _____

City _____ Zone _____ State _____

Check here if subject to Military Training.

DeVry Tech's Canadian Training Center is located at
2036 626 Roselawn Avenue, Toronto 12, Ontario.

Accredited Member of National Home Study Council

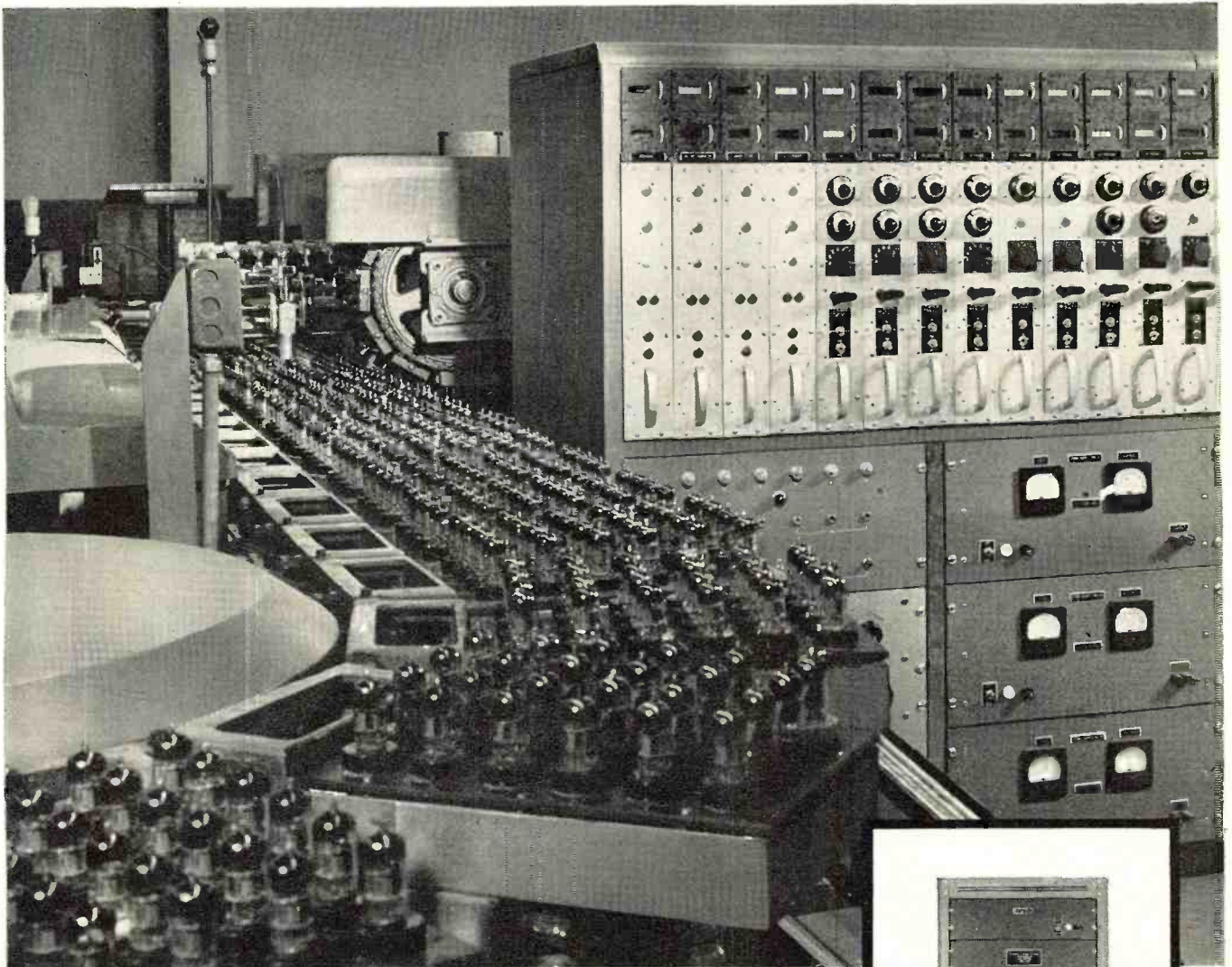

CBS tubes are mechanically transferred from the aging conveyor (left) to the automated tester (right) where they undergo up to 27 characteristics tests controlled by adjustable plug-in units.

Quality is Automatic with CBS

LET IT CUT YOUR CALL-BACKS AUTOMATICALLY

These automated test stations are part of a plan that makes quality automatic with CBS. They check CBS tubes and semiconductors more precisely, more completely. And they eliminate human error. To you, this advanced engineering means quality you can depend upon to cut your call-backs . . . automatically. Start using CBS tubes and semiconductors. Prove to yourself that automation does make a difference.

*Reliable products
through Advanced-Engineering*



tubes • semiconductors

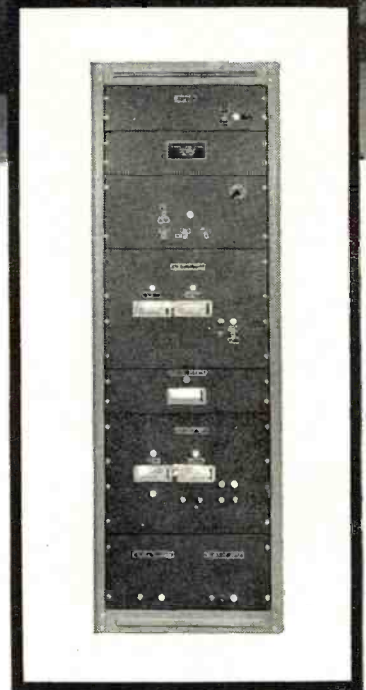

IN SEMICONDUCTORS, TOO! Matched to CBS mechanized diode production, this meterless test station double-checks automatically the quality built in by CBS automation.

CBS-HYTRON, Danvers, Massachusetts
A Division of Columbia Broadcasting System, Inc.

FOR THE BEST IN ENTERTAINMENT TUNE TO CBS

RADIO & TV NEWS

NOW—A Faster Way to Reach the Top in TV SERVICING

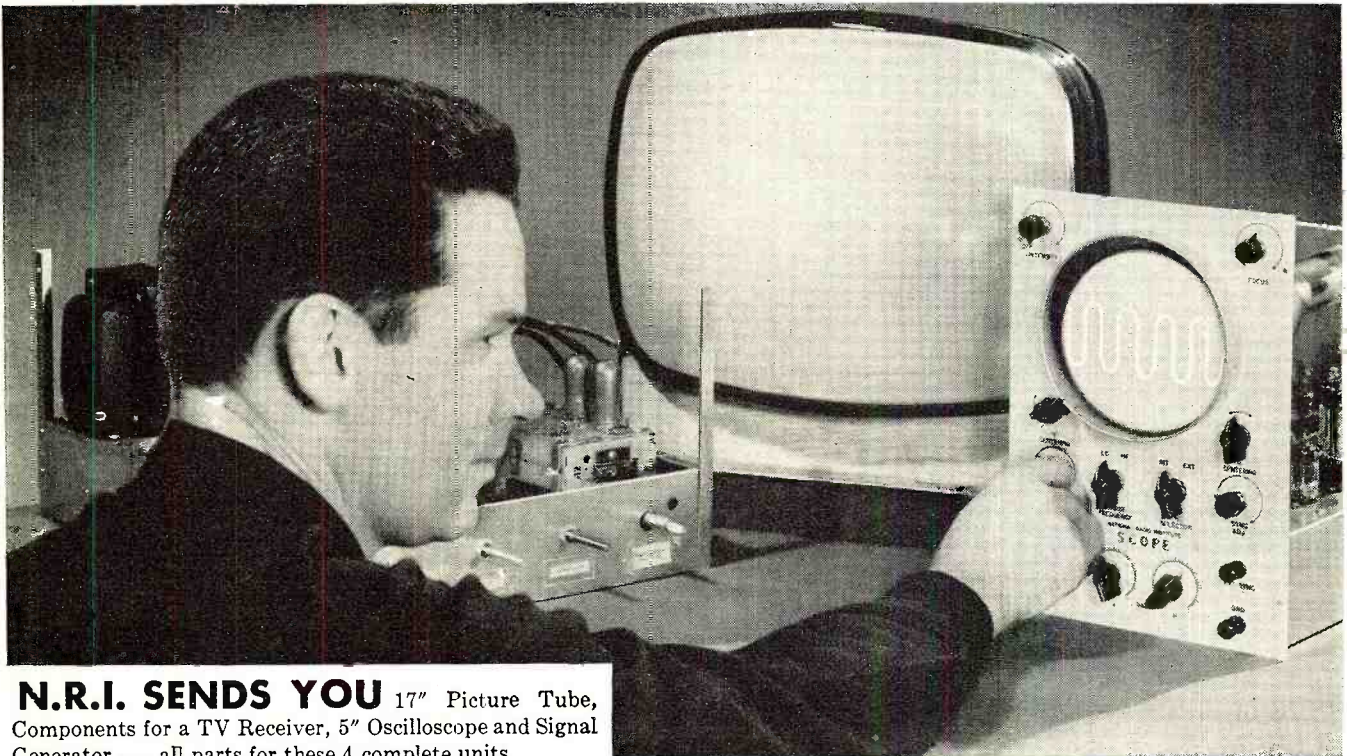

N.R.I. SENDS YOU 17" Picture Tube, Components for a TV Receiver, 5" Oscilloscope and Signal Generator . . . all parts for these 4 complete units.

N.R.I. All-Practice Method Trains You at Home in Spare Time to Fix TV Sets Quickly, with Confidence

The man who knows the answers—the Professional TV Technician enjoys the prestige, gets the better jobs, the higher pay. Here is the learn-by-practice training to be a Professional TV Technician. It shows you the way to be the boss, to earn top pay. Television Servicing needs more well trained men. If you have a basic knowledge of radio and electronics you can make some Television repairs simply by trial and error. But sooner or later you will face TV Service problems you can not solve. And you can't get the training you need while customers wait.

N.R.I. Is Oldest and Largest Home Study Radio-TV School

Over forty years experience and the record and reputation of N.R.I. back up this learn-by-doing Professional TV Servicing Course. Instead of just reading about TV problems, you build and conduct experiments on circuits in a TV receiver. You learn methods, "Tricks of the trade" proved by top TV Servicemen. You learn to fix any set, any model with confidence.

You Get COLOR TV Textbooks Early

The day you enroll, N.R.I. sends you special Color-TV books to speed your knowledge and understanding of this vast, growing phase of Television.

Many full color pictures and diagrams help you recognize defects and help you learn how to correct them quickly and properly. To cash in on the coming Color TV boom, you'll need the kind of knowledge and experience this N.R.I. training gives.

This is 100% learn-by-doing, practical training. Here is a course for men who know basic theory, either from Radio or TV Servicing experience or planned training but realize the need for more knowledge to forge ahead. Here is what one graduate, G. G. Stethem of Belpre, Ohio, says, "I can not praise N.R.I.'s Professional TV Course highly enough. I have my own

spare time shop and all the Radio-TV work I can handle."

Another graduate, Edward Ravitsky of Northumberland, Pa., says, "I have taken your course in Professional TV Servicing. It takes the kind of experience you offer to really learn." If you want to go places faster in TV Servicing, make your future more secure as the industry develops, we invite you to find out what you get, what you practice, what you learn from N.R.I.'s Course in Professional TV Servicing. Mail the coupon now. There is no obligation. NATIONAL RADIO INSTITUTE, Dept. 8CET, Washington 16, D. C.



Send for
FREE BOOK

NATIONAL RADIO INSTITUTE

Dept. 8CET, Washington 16, D. C.

Please send FREE copy of "How to Reach the Top in TV Servicing." I understand no salesman will call.

Name.....Age.....

Address.....

City.....Zone.....State.....

ACCREDITED MEMBER NATIONAL HOME STUDY COUNCIL



TWO NEW TRIAD CATALOGS

Fresh from the printer are your new 1958 TRIAD reference books: the TRIAD GENERAL CATALOG TR-58, containing specifications and prices on 940 TRIAD transformers, including over 100 new items...and the TRIAD TELEVISION REPLACEMENT GUIDE TV-58. Get your complimentary copies from your distributor—or write...



Visit our Booth #2244 at the IRE Show
 4055 REOWOOD AVENUE, VENICE, CALIFORNIA
 812 EAST STATE STREET, HUNTINGTON, INDIANA

A SUBSIDIARY OF LITTON INDUSTRIES



ELECTRONICS IN OUR ECONOMY

THE "Space Age," launched on the fourth of October last year with the orbiting of the first sputnik, also heralded a new and important era for electronics. Rockets, guided missiles, supersonic aircraft, early warning systems, atom subs, etc. could not have been developed nor would they be operable without electronics. Electronics is slated for an even more vital role as the Space Age moves into high gear. Although over 2 billion dollars was spent on guided missiles last year this sum will be increased substantially in 1958 with a healthy chunk of the business going to makers of guidance and control equipment. It has been estimated that up to 17% of all military expenditures last year was for electronic gear.

Important as the government is as a consumer of electronic products (about 50% of the dollar volume), the private citizen and the business man contribute substantially to the health and prosperity of the industry. Although last year's television receiver sales were down about 4% from 1956, the industry expects that this year approximately 7 million sets will move into the hands of the public. The replacement market is expected to account for approximately 3 to 4 million sets.

Radio, that stepchild of the age of the cyclops, has staged a remarkable rebirth with people everywhere discovering that an enlightened sense of hearing is well worth cultivating. The improvements and conveniences incorporated in the new tuners, amplifiers, phonographs, and other basic audio gear have wooed an entirely new following for high-fidelity equipment. The public bought some 14.7 million radio receivers and 5 million phonographs last year and is expected to up its purchases quite substantially this year.

With some 47 million TV sets and 135 million radios in use, the business of keeping this equipment in good working order has become an impressive one. Replacement parts, including tubes, amounted to almost a billion dollars last year and shows promise of topping its own record in 1958.

All in all, 1957 was a good year for the electronics industry with sales at the factory level exceeding 7 billion dollars, an increase of over 1 billion over the previous year.

It can be stated without successful contradiction that electronics is one of the most dynamic industries in the United States today. Not only are new uses being found for existing

equipment and techniques but new products are pouring out of the research laboratories at an almost unbelievable rate. Who, ten years ago, would have envisioned a 2½ times increase in the production of transistors in a single year? Printed circuitry? Automatic assembly of radio and TV sets as well as more elaborate electronic devices? Long life and rechargeable batteries of minute size? Electronic devices deriving their power from the sun, or failing this, artificial light? The list is growing larger every day.

When the roll of these new miracle brain children is added to the improvements that have been made in some of the more familiar products—new shorter picture tubes, a technique for producing audio tubes which reduces microphonics, methods for controlling the accuracy of turntable rotation to eliminate wow and flutter, etc.—the over-all picture is certainly truly impressive.

As with the economy as a whole, the electronics industry has hit some soft spots which has resulted in temporary cutbacks and the shut-down of some production lines with the furloughing of workers, but the consensus of most economists is that the situation in the electronics industry is transitory. The speeding up of the national defense program, the acceleration of the missile and space programs, and the increased application of electronics in both the heavy and light manufacturing fields will soon provide the necessary shot in the arm to get the electrons flowing again. In the meantime and until the full electronics program shifts into high gear, the audio equipment segment of the industry moves forward steadily, garnering a greater and greater percentage of the consumer's "recreational" dollar for a staggering total of \$200 million last year—an increase of some 188 million since 1950!

Thus, while some persons are encountering temporary set-backs in their chosen field of electronics, due to some extent to regional situations affecting business as a whole, the over-all projection seems to indicate that while the "patient" may be under the weather at the present time, the disease is far from fatal and the essential vigor of the patient can be counted upon to effect a complete recovery—and then some. You can always count on our industry to invent its own "electronic bootstraps" to meet the current need. And the current need is tremendous and shows no signs of abatement. . . . W.S.

FREE!

ALLIED'S 1958 CATALOG

404 value-packed PAGES

the only COMPLETE catalog for everything in electronics

Get ALLIED'S 1958 Catalog—it's complete, up-to-date—404 pages packed with the world's largest selection of quality electronic equipment at lowest, money-saving prices. Get every buying advantage at ALLIED: fastest shipment, expert personal help, lowest prices, guaranteed satisfaction...

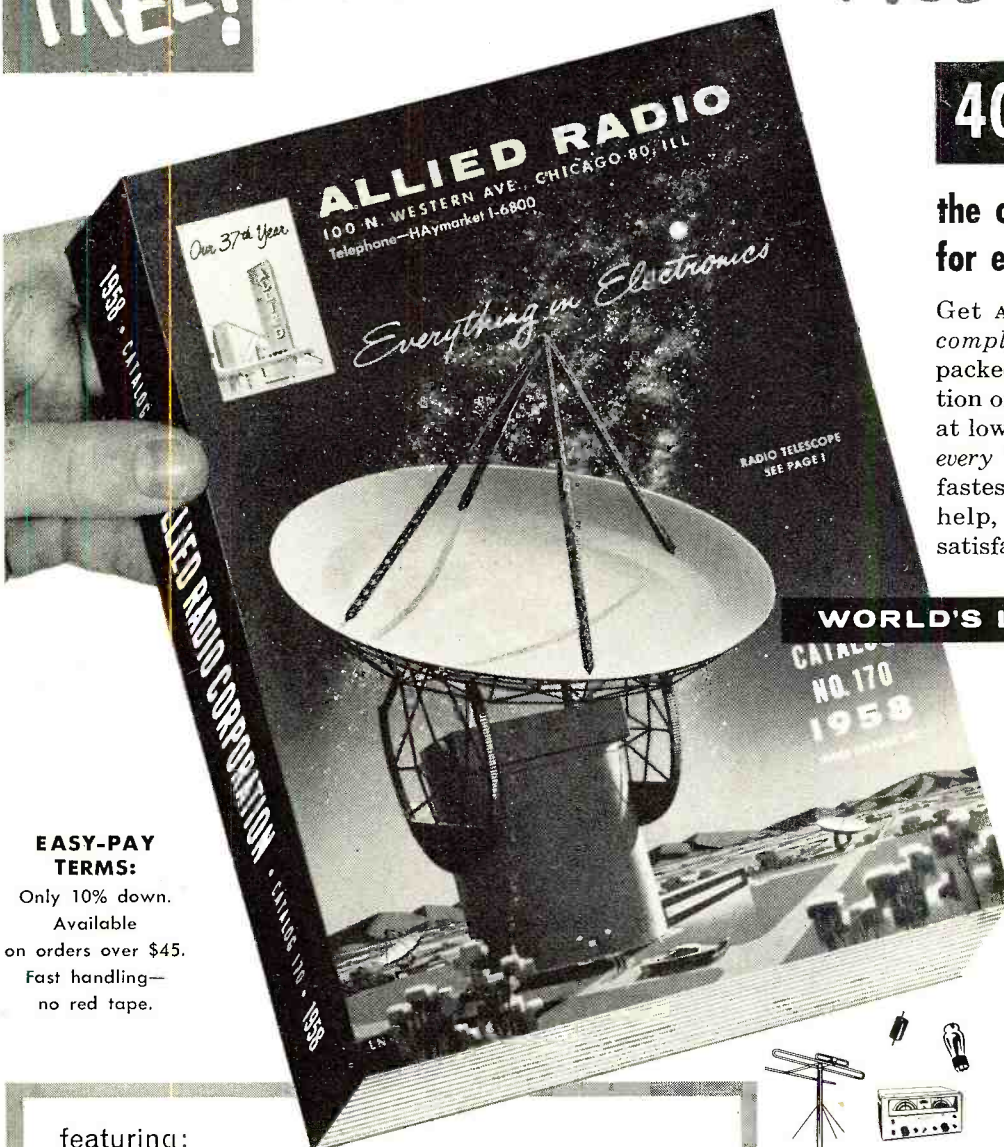

WORLD'S LARGEST STOCKS

- Latest Hi-Fi Systems and Components
- Money-Saving, Build-Your-Own KNIGHT-KITS
- Recorders and Supplies
- Public Address Systems and Accessories
- TV Tubes, Antennas and Accessories
- Amateur Receivers, Transmitters, Station Gear
- Test & Lab Instruments
- Specialized Industrial Electronic Equipment
- Huge Listings of Parts, Tubes, Transistors, Tools, Books

EASY-PAY TERMS:

Only 10% down.
Available on orders over \$45.
Fast handling—no red tape.

featuring:

ALLIED'S money-saving knight-kits:

Finest electronic equipment in money-saving kit form. Over 50 quality kits available—Hi-Fi amplifier, tuner and speaker kits, Hobby kits, Test Instruments, Ham kits (see our KNIGHT-KIT values elsewhere in this publication). ALLIED KNIGHT-KITS are easiest to build and they SAVE YOU MORE.

EVERYTHING IN HI-FI

World's largest selection of quality Hi-Fi components and complete music systems—available for immediate shipment from stock. Save on exclusive ALLIED-Recommended complete systems. Own the best in Hi-Fi for less!



send for the leading electronic supply guide

FREE!

ALLIED RADIO CORP., Dept. 1-C8
100 N. Western Ave., Chicago 80, Ill.

Send FREE 404-Page 1958 ALLIED Catalog

Name _____

Address _____

City _____ Zone _____ State _____



Our 37th Year

ALLIED RADIO

World's Largest Electronic Supply House

March, 1958

Thermo-compression bonding—

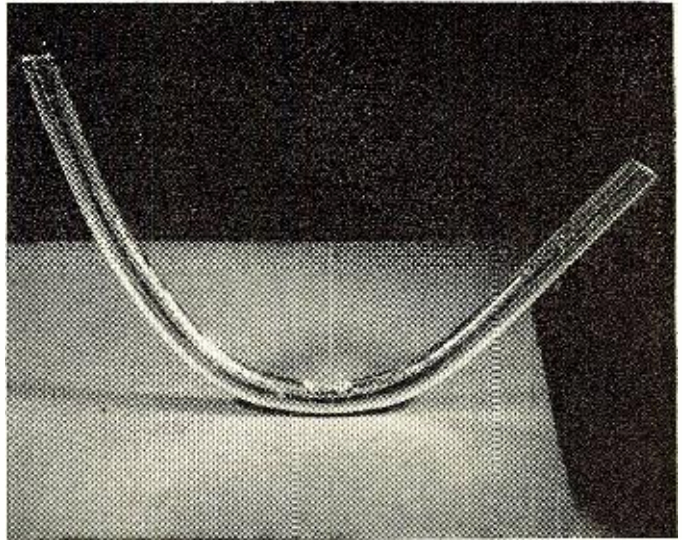

Wire bonded to germanium by thermo-compression technique (enlarged). Wires only 1/10 the breadth of a human hair have been successfully anchored to germanium wafers only three hairs thick. The bond may be an ohmic contact or rectifying contact by adding suitable impurities to the wire and the semiconductor.

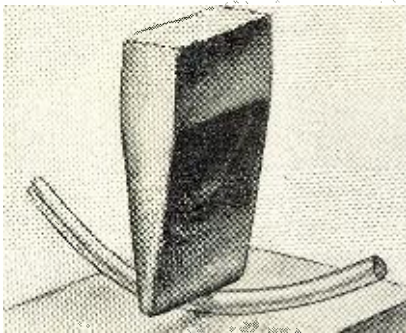

One method of thermo-compression bonding. A heated wedge presses a wire against a heated semiconductor with enough force to deform the wire. Adhesion occurs in seconds.

new way to join metal to semiconductors

Thermo-compression bonding provides a new way to attach a wire to a semiconductor. It calls for heat and pressure—nothing else. The wire and the semiconductor are moderately heated, then pressed together under moderate pressure. The resulting bond is very strong—stronger actually than the wire. No chemical flux or molten metal is required.

Eliminating molten metal provides an enormous advantage in fixing electrical connections to transistors. That's because molten metal tends to spatter and spread uncontrollably over the surface of

a semiconductor. And it may alloy with the semiconductor to alter its all-important crystalline structure and chemical purity. Thermo-compression bonding easily and quickly makes a strong permanent electrical connection without damaging the semiconductor. Furthermore, the lead may be attached to microscopic areas and precisely positioned, a most valuable aid in the construction of high-frequency transistors.

Thermo-compression bonding will speed the production of transistors . . . the transistors needed to fill all the new jobs Bell Lab-

oratories finds for them in the quest to provide still better telephone service to our growing country.



At Bell Labs Howard Christensen and Orson Anderson discuss their discovery of new bonding principle with Peter Andreach, Jr., who collaborated in the studies.

BELL TELEPHONE LABORATORIES

WORLD CENTER OF COMMUNICATIONS RESEARCH AND DEVELOPMENT



FREE! from **HOWARD W. SAMS...**

these valuable all-steel file cabinets with your purchase of

PHOTOFACT *the world's finest TV-Radio Service Data*



NOW—FOR PHOTOFACT

SUBSCRIBERS! You can get these File Cabinets ABSOLUTELY FREE from Howard W. Sams if you are a regular subscriber to PHOTOFACT and buy each Set as issued monthly...

NOW—FOR PHOTOFACT LIBRARY PURCHASERS!

You can get FREE File Cabinets as you complete your PHOTOFACT Library. What's more, you can own the PHOTOFACT Library the **NEW EASY-BUY WAY:** There's no interest. There's no carrying charge. And Howard W. Sams will give you **ABSOLUTELY FREE** all the steel file cabinets you'll need for your Library.

Take advantage of this money-saving opportunity. See your Sams Distributor today, or write to Howard W. Sams for full details...



HOWARD W. SAMS & CO., INC.
2203 E. 46th St., Indianapolis 5, Indiana

Send me full details on your FREE File cabinet offer and EASY-BUY Plan.

I'm a Service Technician: full time; part time

My Distributor is: _____

Shop Name: _____

Attn.: _____

Address: _____

City _____ Zone _____ State _____

FREE file cabinets

NEW easy-buy plan

get the
details
NOW

**HUM DITY
PROOF.**
...in any climate...
and for sound reasons

**GOOD-ALL
600 UE
CAPACITORS**

The Dielectric of the 600UE is **Dupont's MYLAR*** highly resistant to moisture penetration even with no external protection.

The molded case of the 600UE is **Shell's EPON**** a very tough durable epoxy, known for its long life and superior moisture resistance.

Save money for yourself and your customer, use the best, the **Good-ALL 600 UE**. The cost is surprisingly low! Leading distributors are now carrying a complete stock.

*MYLAR® is DUPONT'S trademark for their space-saving polyester film.

**EPON® is SHELL'S trademark for their epoxy resin plastic molding compound.

GOOD-ALL ELECTRIC MFG. CO.
Distributor Division
26 Rittenhouse Pl. Ardmore, Pa.

Letters

from our Readers

After some years of absence we are once more running a "Letters" column. So many of our readers have urged us to reinstate this feature in order that they might have a chance to express their views not only to us personally and privately but also to our many other readers, whom we feel sure would be interested. So if you have any constructive and worthwhile comments that you feel would be of general interest, please drop us a line. We can't guarantee to print all your letters because of space limitations, but we would like to hear from you.—Editor.

C.O.D. SERVICE

To the Editors:

As a customer, the man who pays the bill, I am commenting on the article "Strategy for C.O.D. Service" in the December issue.

While from the standpoint of the service shop operator, C.O.D. service may be advantageous, it is not always so for the customer. Perhaps, for example, the person present when the work is done in the home is not the person who will pay the bill. Also, many quite solvent families work on close budgets. When a bill is exceptionally large, an extension of credit into the following month may be desirable. If refused—or even if granted after a lot of hemming and hawing—the customer is apt to be resentful.

We customers have been educated to ask for credit when we want it. "Your credit is good!" "Open an account!" "Pay the painless way!" Here in the San Francisco Bay area perhaps the toughest competition for the independent service shops are two large department stores which aggressively push TV servicing, the charges for which may of course be added to the customer's regular bill.

WETHERBY BOORMAN
San Bruno, California

Our article presented one viewpoint that's useful to many service shops. We don't doubt that the view expressed above would be shared by other shops.—Editor.

* * *

SOUND TUNER "GIMMICK"

To the Editors:

In your November, 1957 issue there is an article "FM and TV Sound Tuner" by Bruce Morrissette. This is a very interesting circuit but it does not explain one important item and that is what is a "gimmick." I have spent much time and have exhausted all the local talent trying to decipher "a 2 μ fd. twisted wire gimmick."

J. W. BETHARD
San Diego, Calif.

Our "old-timer" readers certainly could answer this one, since "gimmicks" were widely used in some of the old broadcast sets. The "gimmick" is simply a very small capacitance, say a

couple of μ fd., that is made up by taking two pieces of insulated wire and twisting them together for a few turns. In the case of the circuit referred to, all you would have to do is to simply wrap a couple of turns of one of the leads around the other as shown in the diagram. This will produce the required capacitance.—Editor.

* * *

COLOR TV INFO

To the Editors:

Your magazine is one of the best that we receive. This is especially true because of your information on color TV. This material is very welcome to us since we are now leading this area in sales of color-TV receivers, having sold about 55 sets since we started to handle them about 14 months ago. Thanks for your fine help in this matter.

CHESTER M. BENSON, W9IFB
Richmond's Television Center
Richmond, Indiana

Thanks for the compliments. To some color-TV is still a big question mark, but others are going full steam ahead with it.—Editor.

* * *

SERVO SPEAKER SYSTEM

To the Editors:

From your description of the new Integrand hi-fi speaker system (October 1957 issue) it would appear that this unit is just what I have been waiting for. But where can I hear one of the units in actual operation so that I can judge for myself if it sounds as good as it should? Also you promised us some further information on the system. I would very much like to know more about the system, especially about the speakers themselves.

J. W. KLINGENSMITH
Toronto, Ontario

We, too, feel that the system is quite unique; so much so that we have planned to run some more information on it. However, because of the very unusual design, the manufacturer is finding it difficult to obtain large enough supplies of components and transistors that conform to the tight tolerances required. Just as soon as this problem has been ironed out the systems will be put into production. At first a few of the units will be shipped to the major

ATR PRODUCTS FOR MODERN LIVING

NOW ENJOY . . . Household Electricity Anywhere! . . . Anytime! . . . in your own CAR, Boat or Plane!

NO INSTALLATION! . . . MOST MODELS JUST PLUG INTO CIGARETTE LIGHTER RECEPTACLE!



INVERTERS
for changing storage battery current to A.C. Household Electricity Anywhere . . . in Car, Boat, or Plane!

Electronic Tube PROTECTOR
protects ALL Electronic Tubes in TV or Hi-Fi, Amplifier and other Electronic Equipment. Will double or triple tube life including TV Picture Tube.

Auto Radio VIBRATORS
for both Auto Radio and two-way communication receiving sets; featuring Ceramic Stack Spacers for long lasting life.

Portable BATTERY CHARGERS
for keeping the storage battery fully charged right the Car, Truck, Boat, or Plane! A storage battery necessity—makes motor starting easy!

ATR Universal INVERTERS*



- Operates Standard A.C.
 - TAPE RECORDERS**
 - TV Sets
 - Dictating Machines
 - Radios
 - Public Address Systems
 - Electric Shavers
 - Record Players
 - Food Mixers
 - and Emergency Lighting
- MODELS**
- 6U-RHG (6 volts) 125 to 150 watts, Shipping weight 27 lbs. **DEALER NET PRICE \$59.97** List Price . . . \$89.95
 - 12U-RHG (12 volts) 150 to 175 watts, Shipping weight 27 lbs. **DEALER NET PRICE \$59.97** List Price . . . \$89.95

ATR Plug-in Type Portable INVERTERS*



- Operates Standard A.C.
 - DICTATING MACHINES**
 - Small Radios
 - Record Players
 - Electric Shavers
 - Heating Pads, etc.
- MODELS**
- 6-RMF (6 volts) 60 to 80 watts, Shipping weight 12 lbs. **DEALER NET PRICE \$30.00** List Price . . . \$45.00
 - 6C-RMF (6 1/2 volts) 60 to 80 watts, Shipping weight 12 lbs. **DEALER NET PRICE \$33.00** List Price . . . \$49.50
 - 12T-RME (12 volts) 90 to 125 watts, Shipping weight 12 lbs. **DEALER NET PRICE \$28.33** List Price . . . \$42.50

ATR Plug-in Type Portable MIGHTY MIDGET INVERTERS



- Operates Standard A.C.
 - SMALL DICTATING MACHINES**
 - Small Record Players
 - Electric Shavers, etc.
- MODELS**
- 6-DME (6 volts) 30 to 40 watts, Shipping weight 5 lbs. **DEALER NET PRICE \$13.30** List Price . . . \$19.95
 - 6C-DME (6 1/2 volts) 30 to 40 watts, Shipping weight 5 lbs. **DEALER NET PRICE \$15.67** List Price . . . \$23.50
 - 12-DME (12 volts) 40 to 50 watts, Shipping weight 5 lbs. **DEALER NET PRICE \$13.30** List Price . . . \$19.95

ATR SHAV-PAKS



- Keep Clean-Shaver! Plugs into Cigarette Lighter Receptacle—Keeps in Glove Compartment
- Operates Standard A.C.
 - ELECTRIC SHAVERS**
 - Small Timing Devices . . . in CARS, Buses, Trucks, Boats, or Planes.
- MODELS**
- 6-SPB (6 volts) 15 watts, Shipping weight 2 1/2 lbs. **DEALER NET PRICE \$6.63** List Price . . . \$9.95
 - 12-SPB (12 volts) 15 watts, Shipping weight 2 1/2 lbs. **DEALER NET PRICE \$6.63** List Price . . . \$9.95

ATR Electronic Tube PROTECTORS



- WILL DOUBLE OR TRIPLE THE LIFE OF ALL TYPES OF ELECTRONIC TUBES, INCLUDING TV PICTURE TUBE.**
- ATR Electronic Tube Protectors are available in two models: automatic in operation, for use with any electronic equipment having input wattage of 100 to 300 watts. Fuse protected, enclosed in metal case for rugged construction and long life.
- MODELS**
- Model 300 (Floor Model) as illustrated above. 115 volts A.C. Shipping weight 2 lbs. **DEALER NET PRICE . . . \$4.63** List Price . . . \$6.95
 - Model 250 (Wall Model) 115 volts A.C. Shipping weight 1 lb. **DEALER NET PRICE . . . \$3.30** List Price . . . \$4.95

* ADDITIONAL MODELS AVAILABLE

ATR "A" Battery ELIMINATOR



For Demonstrating and Testing Auto Radios—TRANSISTOR or VIBRATOR OPERATED!

Designed for testing D.C. Electrical Apparatus on Regular A.C. Lines—Equipped with Full-Wave Dry Disc-Type Rectifier, assuring noiseless, interference-free operation and extreme long life and reliability.

MAY ALSO BE USED AS A BATTERY CHARGER

- MODELS**
- 610C-ELIF . . . 6 volts at 10 amps. or 12 volts at 6 amps. Shipping weight 22 lbs. **DEALER NET PRICE . . . \$42.95**
 - 620C-ELIT . . . 6 volts at 20 amps. or 12 volts at 10 amps. Shipping weight 33 lbs. **DEALER NET PRICE . . . \$59.95**

ATR Auto-Radio VIBRATORS



By every test ATR Auto-Radio Vibrators are best! . . . and features Ceramic Stack Spacers—Instant Starting—Large Oversized Tungsten Contacts—Perforated Reed—plus Highest Precision Construction and Workmanship.

There is an ATR VIBRATOR for every make of car!

Ask your distributor for ATR's Low Price type 1400, 6 volts 4-prong Vibrator, and 1842, 12 volts 3-prong or 1840, 12 volts 4-prong Vibrator. THE WORLD'S FINEST!

FREE! Write for ATR 8-page Vibrator Flyer today!



ATR Auto Plug-in Home-type Portable BATTERY CHARGERS

NO INSTALLATION . . . JUST PLUG INTO CIGARETTE LIGHTER RECEPTACLE!

KEEPS CAR BATTERY FULLY CHARGED IN YOUR OWN GARAGE! NEEDED MORE NOW THAN EVER BEFORE—MAKES MOTOR STARTING EASY! OPERATES DIRECTLY FROM STANDARD 110 VOLTS A.C. CURRENT.

- MODELS**
- A-12CA3 (3 amp.) 12 volts, Shipping weight 5 lbs. **DEALER NET PRICE \$11.96** List Price . . . \$15.95
 - C-12CA6 (6 amp.) 12 volts, Shipping weight 9 lbs. **DEALER NET PRICE \$17.96** List Price . . . \$23.95
 - E-12CA10 (10 amp.) 12 volts, Shipping weight 9 lbs. **DEALER NET PRICE \$24.71** List Price . . . \$32.95
 - B-612CA4 (4 amp.) 6/12 volts, Shipping weight 6 lbs. **DEALER NET PRICE \$14.21** List Price . . . \$18.95
 - D-612CA6 (6 amp.) 6/12 volts, Shipping weight 6 lbs. **DEALER NET PRICE \$20.96** List Price . . . \$27.95
 - F-612CA10 (10 amp.) 6/12 volts, Shipping weight 10 lbs. **DEALER NET PRICE \$27.71** List Price . . . \$36.95

ORDER TODAY! FOR THE NAME OF YOUR NEAREST ATR ELECTRONIC PARTS DISTRIBUTOR, PLEASE COMMUNICATE WITH YOUR NEAREST ATR REPRESENTATIVE LISTED BELOW.

- REPRESENTATIVES:**
- CALIF.:** Frank A. Emmet Co., 2837 W. Pico Blvd., Los Angeles 6, Phone—REpublic 1-7211
 - Territory: Ariz.; S. Calif.
 - CALIF.:** Legion Sales, 154 Eleventh St., San Francisco 3, Phone—HEmlock 1-0652
 - Territory: N. Calif.; Nev.
 - COLO.:** A. J. Nelson Co., P. O. Box 5502, Denver 17, Phone—RE 4-6751
 - Territory: Colo.; Idaho; Mont.; N. M.; W. Neb.; El Paso, Texas; Utah; Wyo.
 - ILL.:** Saffro & Gettleman Co., 5205 N. Campbell Ave., Chicago 25, Phone—JUrbler 1-0905
 - Territory: Ill.; Gary & Hammond, Ind.; Wis.
 - IND.:** Wright Engineering, P. O. Box 807, 4241 Welbourne Rd., Indianapolis 44, Phone—Humboldt 8800
 - Territory: Ind. excl. Gary & Hammond
 - IOWA:** Koenig Sales Co., 6359 Antioch Ave., Bertram, Phone—Valentine 7523
 - Territory: Iowa; Kans.; Mo.; E. Neb.
 - MD.:** Morris F. Taylor Co., P. O. Box 111, 431 Georha Ave., Silver Springs, Phone—JUmpier 9-4002
 - Territory: Ala.; D. C.; Del.; Fla.; Ga.; Md.; N. C.; Ohio counties of Jefferson, Mahoning & Trumbull; Pa.; S. C.; Tenn.; Va.; W. Va.
 - MASS.:** Gerber Sales Co., 48 Pearl St., Brookline 46, Phone—BEacon 2-2425
 - Territory: New England.
 - MICH.:** American Television & Radio Co., 300 E. 4th St., S.E. Paul 1, Minn. Phone—Capital 2-3791
 - Territory: Mich.
 - MINN.:** H. M. Richardson Co., 9 E. 22nd St., Minneapolis 4, Phone—FEderal 6-4078
 - Territory: Minn.; N. D.; S. D.
 - N. Y.:** Lee Roche, Newhope Corp., 6 E. 39th St., New York 16, Phone—LExington 2-7372
 - Territory: N. J.; Metropolitan N. Y. Incl. 5 boroughs; counties of Staten Island, Long Island, Westchester & Putnam.
 - N. Y.:** Frank W. Taylor Co., Box 222, De Witt, Phone—SYracuse 72-5138
 - Territory: Upper N. Y.
 - OHIO:** John O. Olson, 16201 Shaker Blvd., Cleveland 20, Phone—WYoming 1-2624
 - Territory: Ky.; Ohio, except counties of Jefferson, Mahoning & Trumbull.
 - TEXAS:** Berthold Sales Co., 4411 Maple Ave., Dallas 19, Phone—LAKeside 6-8329
 - Territory: Ark.; La.; Miss.; Okla.; Texas, excl. El Paso.
 - WASH.:** James J. Backer Co., 221 W. Galer, Seattle, Phone—ALder 6470
 - Territory: Ore.; Wash.; Alaska.
 - CANADA:** R. C. Kahnert Sales Co., New 73 Crookford Pl., Scarborough, Ontario, Phone—REdfern 7078
 - Territory: Canada.
 - CANADA:** Charles L. Thompson, Ltd., 3093 Woodbine Dr., N. Vancouver, Phone—YOrk 2597
 - Territory: W. Canada.
 - HAWAII:** Gene Piety, 12030 Home Rule St., Honolulu 17
 - Territory: Hawaii.

ATR AMERICAN TELEVISION & RADIO Co.
Quality Products Since 1931
SAINT PAUL 1, MINNESOTA—U. S. A.

Gentlemen:

The name and address of my nearest electronic parts distributor is

NOTE:—If distributor cannot supply you, feel free to order direct for factory, or ATR representative nearest you, as listed to the left

Send additional literature and price list on _____ as illustrated above

NAME _____

ADDRESS _____

CITY _____ ZONE _____ STATE _____

a quarter-century
of **PRECISION**
know-how
is now yours...in

P A C O

quality test
instruments
in kit form

...the only line of test instrument
kits engineered and produced
under the auspices of a major
test equipment manufacturer...
and conveniently available directly
from your local electronic
parts distributor.

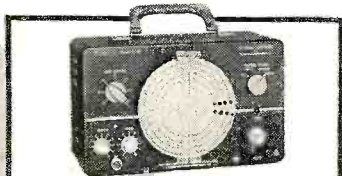

Model G-30
RF SIGNAL GENERATOR KIT
• 160 Kc to 240 Mc in 8 bands
• 120 Mc fundamental output
Net Price: \$28.50
Model G-30-PC:
Same as Model G-30 but
with pre-calibrated front end.
Net Price: \$35.50



Model C-20
RESISTANCE-CAPACITY-RATIO BRIDGE KIT
• 10 mmfd to 2000 mfd
• 1/2 ohm to 200 megohms
Net Price: \$20.95



Model Z-80
RF-AF SIGNAL TRACER KIT
• High gain RF & AF Amplifier
• Visual and Audible Indicator
Net Price: \$29.50

Available and
on display at
leading electronic
parts distributors.
▶ Write for
free descriptive
bulletin.

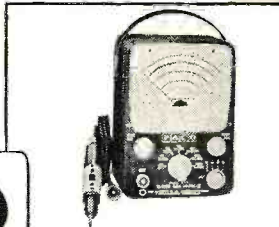

Model V-70
VACUUM TUBE VOLTMETER KIT
• wide-range • peak-to-peak.
Net Price: \$31.50



Model B-10
BATTERY ELIMINATOR KIT
• less than 0.3% ripple
• no external filter adaptors required
Net Price: \$41.95

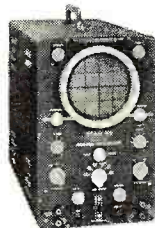

Model S-50
5" CATHODE RAY OSCILLOSCOPE KIT
• push-pull vertical and
horizontal amplifiers.
Net Price: \$49.50



Model T-60 **TUBE CHECKER KIT**
• full free-point lever selector system
Net Price: \$38.75
Matching, hinged, removable cover:
Net Price: \$3.95



Model M-40
HIGH-SENSITIVITY V-O-M KIT
• 20,000 ohms/volt DC
• 10,000 ohms/volt AC
Net Price: \$31.50

P A C O ELECTRONICS CO., INC.

70-31 84th Street, Glendale 27, L. I., N. Y.

A DIVISION OF **PRECISION Apparatus Company, Inc.**

Export: 458 Broadway, New York 13, U.S.A. Canada: Atlas Radio Corp., Ltd., 50 Wingold Ave., Toronto 10

hi-fi centers throughout the country so that they may be heard. When this occurs, we will cover the system more fully. In the meantime, further information can be obtained from the manufacturer, the *Integrand Corp.*, 662 Main St., Westbury, Long Is., N. Y.—Editor.

STEREO GAIN CONTROLS

To the Editors:

Regarding our article "Stereo Balance and Gain Control" (December, 1957 issue), the circuit shown in Fig. 3B would perform better if tapped linear controls rather than log controls are used for gain adjustment. The commonly available log pots reach 250,000 ohms at about 75 per-cent rotation rather than at 50 per-cent. With linear controls now being recommended having taps at 250,000 ohms, the addition of R_1 and R_2 effectively changes the linear taper into one that closely approximates a log taper.

HERMAN BURSTEIN
Wantagh, New York

HIGH-STABILITY OSCILLATOR

To the Editors:

I have received many letters from hams who are very interested in the "High-Stability Oscillator Circuit" which I described on page 142 of the June, 1957 issue. The oscillator will actually perform better than was indicated in the article, but I felt better being on the conservative side. However, the oscillator will not perform properly with poor coils, especially at lower frequencies, although some coils hastily wound on old tube bases worked rather well. In order to reduce the necessity for extremely high quality coils, two changes are suggested. Capacitor C_2 in the schematic was changed from 5100 μ fd. to 3000 μ fd. and resistor R_1 was changed from 1 meg. to 2 meg.

The circuit as given (with the above minor changes) operated throughout the frequencies of 640 kc. to 11.8 mc. with no changes other than the number of turns on the coil. The coil form used was 1 1/4 inch diameter. You can see from this that the circuit is not at all critical and a much greater range may be obtained by winding coils with the correct length/diameter/spacing ratio in accordance with good coil winding practices.

May I suggest an easy method of determining whether or not the circuit is oscillating correctly? Disconnect the oscillator from the buffer amplifier so that it is operating with no load. Connect a 20,000 ohms per volt meter across the 10,000 ohm cathode resistor. You will get a reading somewhere around 10 or 20 volts. Place your grid-dip oscillator (in oscillating condition) near the v.f.o. coil and tune the g.d.o. through the frequency of operation. When the g.d.o. and the v.f.o. are operating on the same frequency, the voltmeter in the cathode circuit will show a great increase in voltage, depending to a great extent on the degree of coupling between the coils.

ROBERT J. ROPES, W9PAP
Kokomo, Indiana -30-

ENTER THE EXCITING RCA "MYSTERY SHOPPER" CONTEST!

You Can Win One of 192 Big Awards!



- 8 MGA SPORTS ROADSTERS
- 24 COLOR-TV SETS
- 80 HI-FI PHONOGRAPHS
- 80 TRANSISTOR RADIOS

...and every TV service-dealer and technician who enters this exciting "contest" receives a gift—just for entering!

Here's How:

1. To enter the contest, write a statement of 50 words or less telling how you think RCA's promotion of "National Television Servicemen's Week" benefits the independent TV service industry. The contest is open to all radio-television service dealers and their service employees, in the continental U. S., Alaska, and Hawaii, without any obligation on their part.
2. Your entry must be made on an official entry blank and must be submitted in your own name describing your own opinions in connection with "National Television Servicemen's Week"—March 24th to 29th, 1958. You may prepare your own entry blank, or you can ask your RCA Tube Distributor Salesman to help you prepare your entry blank. If your distributor salesman does help you, be sure to have him countersign your entry blank—he is also eligible for a prize if you win. Official entry blanks are available from your Authorized RCA Tube Distributor and from RCA Electron Tube Division advertisements. Only one entry per person is permitted.
3. Mail your entry, using adequate postage to: RCA Electron Tube Division, P.O. Box 551, New York 46, N. Y.

All entries must be postmarked on or before midnight, March 15, 1958. No general correspondence should be sent to this address.

4. The entries will be judged by Advertising Distributors of America, Inc., an impartial, independent contest judging organization, on the basis of originality, sincerity, and aptness of thought. Decision of the judges is final. All entries become the property of Radio Corporation of America, and none will be returned. Entry in the contest constitutes permission to RCA to use your name and entry in any way it sees fit.
5. The contestants will be ranked in each region, in the order of the merit of their entries, as determined by the judges as provided above. They will be visited in person or phoned, in succession, sometime between the period of April 1, 1958 and April 30, 1958, by a "Mystery Shopper". The "Mystery Shopper" will ask a question about the product features of RCA Silverama Picture Tubes or RCA Receiving Tubes. The first service dealer or service technician in each region who answers the question correctly will be presented with the grand award. The next 3 dealers or their service employees in each region

who answer the question correctly will be awarded one of the beautiful, new RCA Victor color TV sets. An additional 10 contestants in each region who answer the "Mystery Shopper" question correctly will receive one of the exquisite RCA Victor High Fidelity Sets. And 10 additional contestants in each region who answer the question correctly will receive an RCA Victor Transistor Radio. All contestants will receive a token of recognition.

6. The "Mystery Shopper" is the name applied to a group of impartial employees of Advertising Distributors of America, Inc., located throughout the nation. The "Mystery Shopper" will visit or phone contestants in the guise of a consumer, and will not divulge his or her identity unless the contestant supplies the correct answer to the question asked by the "Mystery Shopper".
7. Only one award will be made per person. Duplicate awards will be made in the event of a tie. This contest is subject to state and local regulation. Void if taxed, restricted or forbidden by law. A list of award winners may be obtained after April 30, 1958 by sending a stamped, self-addressed envelope to the address given above.

OFFICIAL ENTRY FORM

Mail to:
RCA ELECTRON TUBE DIVISION
P.O. Box 551, New York 46, N. Y.

C-41

**ALL ENTRIES MUST BE POSTMARKED ON
 OR BEFORE MIDNIGHT MARCH 15, 1958**

Complete this statement in 50 words or less:

As a service dealer, this is how I think RCA's promotion of "National Television Servicemen's Week" benefits the independent TV service industry:

SIGNED _____
 (Signature of Dealer or Technician)

_____ FIRM NAME

_____ ADDRESS

_____ CITY _____ ZONE

_____ STATE



RADIO CORPORATION OF AMERICA
 Electron Tube Division
 Harrison, N. J.

See your Authorized RCA
 Tube Distributor now for
 additional details!

YOUR INSTALLATION VOLUME CAN BE GREATER!

If you're *not* a Channel Master Dealer you are probably not getting your share of the *really profitable* antenna installation business. Hundreds of dealers have doubled and even tripled their antenna sales *in less than one year* when they

switched to Channel Master and featured the famous T-W antenna. In fact, far more T-W antennas are bought than any other fringe area antenna. There must be good reasons for this. Below are listed but a few of them.

How much installation business are you losing every week? ...because you don't feature the CHANNEL MASTER® T-W

Put these extra selling advantages to work for you!

Superior PERFORMANCE! Outperforms any all-channel antenna ever made! Revolutionary "Traveling Wave" design delivers highest front-to-back ratios (better than 10:1) — top gain over the entire VHF range.

Stronger CONSTRUCTION! Super-strong in every detail of construction: Twin-Boom — the only antenna with 2 full length crossarms; 2 Super-Nests — the most powerful grip that ever held an antenna to the mast; Line-Lok — absorbs all transmission line tension; 7/16" dia. elements.

Bigger NATIONAL ADVERTISING! More than 75,000,000 advertising messages in America's leading national magazines. Now saturation coverage with big-space ads blanketing 173 prime outdoor antenna markets.

LIVE LEADS galore! Tens of thousands have already responded to Channel Master's Free "Antenna Check-Up Kit" offer — repeated in new national ads. Based on experience, 50% — and more — of these leads are converted into actual sales.

Local CO-OP ADVERTISING! The most liberal advertising allowance in the industry — so you can run your own local promotions. Channel Master dealers have the widest array of mats, radio and TV spots, and display materials.

Promoting ANTENNA REPLACEMENTS! Channel Master's national advertising hammers home the theme of antenna obsolescence — opening new markets for you!

Call your Channel Master distributor now!

© Reg. U.S. Pat. Office and Canada

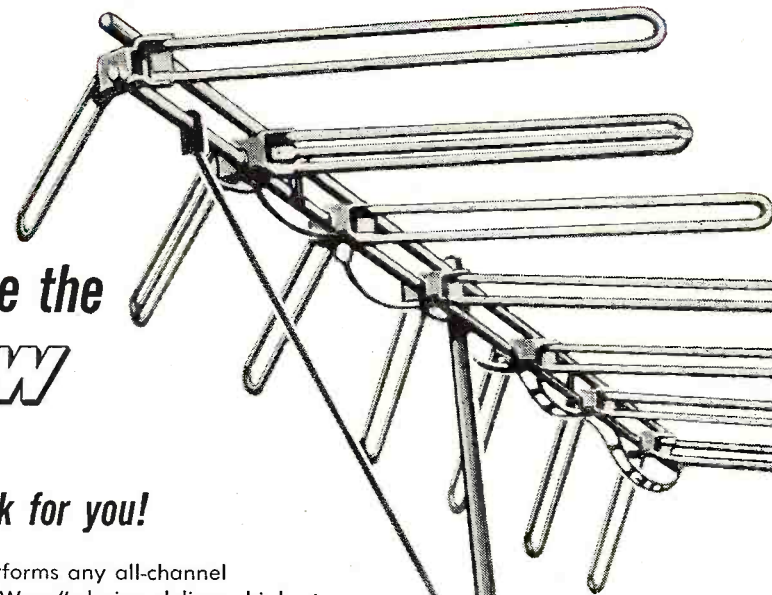

7-element
model no. 350
5-element
model no. 351
3-element
model no. 352



**model no.
354-1**

including: • 2-element T-W
• Combination 4 ft. x 1 1/4" aluminum mast and Universal Tripod Mount • 3 Mounting Nails with Neoprene sealing washers • 50' 80 mil wire • 6 - 3 1/2" Standouts • 1 Standout Strap.

A COMPLETE ANTENNA

IN ATTRACTIVE 3-COLOR DISPLAY CARTON

NEW "INSTALL-IT-YOURSELF" ANTENNA KIT featuring new 2 ELEMENT T-W ANTENNA

Designed for top performance in suburban and metropolitan areas. Powerful "Traveling Wave" principle provides the 2-element T-W with better all around performance than a stacked conical.

Promotionally Priced at \$29⁹⁵ list



CHANNEL MASTER CORP.

ELLENVILLE, N. Y.

copyright 1952 Channel Master Corp.

WORLD'S LARGEST MANUFACTURER OF TV ANTENNAS AND ACCESSORIES

Get into

TELEVISION RADIO-ELECTRONICS

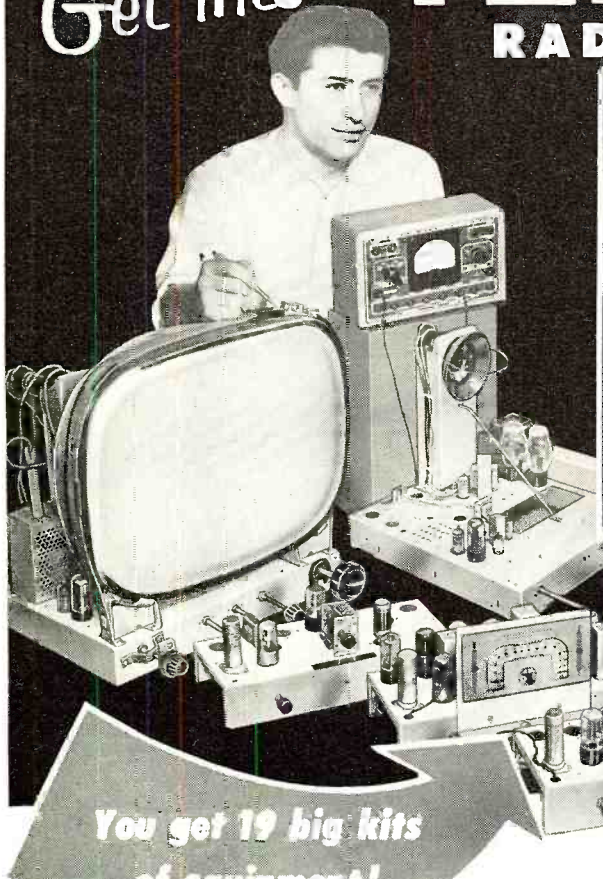

LEARN ALL 8 PHASES OF THE INDUSTRY BY SHOP METHOD HOME TRAINING

1. Television . . . including Color TV
2. Radio . . . AM, FM
3. Industrial Electronics
4. Communications
5. Sound Recording & Hi-Fidelity
6. Automation
7. FCC License Preparation
8. Radar & Micro Waves

Let National Schools of Los Angeles, a Practical Resident Technical School for over 50 years, train you at home by Shop-Method for unlimited opportunities in All phases of TV, Electronics, Radio.

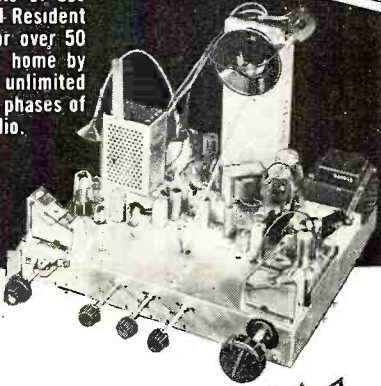

You get 19 big kits of equipment!

GOOD JOBS . . . MORE MONEY SECURITY . . . ALL CAN BE YOURS

YOU are needed in the great modern Television-Electronics industry. Trained technicians are in growing demand, at excellent pay, in sales and service, manufacturing, broadcasting, telecasting, communications, research, and many other important branches of the field. National Schools Master Shop-Method Training, with newly added lessons and equipment prepares you in your spare time right in your own home for these fascinating opportunities. **OUR OUTSTANDING METHOD IS PROVED BY THE SUCCESS OF GRADUATES ALL OVER THE WORLD!**

YOUR TRAINING IS ALL INCLUSIVE

We prepare you for a long list of job opportunities. Thousands of TV and Radio receivers are being sold every day—more than ever before. And, now, Color TV is here. Applications of Electronics in industry—**AUTOMATION**—are growing in tremendous strides. The whole field is alive—opening up new, important jobs rapidly. National Schools complete training program qualifies you in all phases of the industry.

YOU EARN WHILE YOU LEARN

Many students pay for their entire training—and more—with spare time earning. We'll show you how you can, too! Early in your course you receive material that shows you how to earn extra money servicing TV and Radio receivers, appliances, etc., for friends and acquaintances.

YOU GET EVERYTHING YOU NEED

Clear, profusely illustrated lessons, shop-tested manuals, modern circuit diagrams, practical job projects—all the valuable equipment shown above—many other materials and services—consultation privilege with our qualified staff, and Graduate Employment Service. **EVERYTHING YOU NEED** for outstanding success in Electronics.

INDUSTRY NEEDS YOU. NATIONAL SCHOOLS WILL TRAIN YOU. SEND FOR FACTS TODAY NO OBLIGATION.

YOU LEARN BY SHOP METHOD . . . you do servicing, circuit analysis, and do over 100 down-to-earth experiments. You build a Superhet Receiver and a modern TV Receiver, from the ground up, including a new, big screen picture tube. You also receive a professional, factory-made **MULTI-TESTER**. All of this standard equipment is yours to keep . . . at just one low tuition.

RESIDENT TRAINING AT LOS ANGELES

If you wish to take your training in our Resident School at Los Angeles, the world's TV capital, start NOW in our big, modern Shops, Labs and Radio-TV Studios. Here you work with latest Electronic equipment—professionally installed—finest, most complete facilities offered by any school. Expert, friendly instructors. Personal attention. Graduate Employment Service. Help in finding home near school—and part time job while you learn. Check box in coupon for full information.

Approved for GI Training



NATIONAL SCHOOLS
LOS ANGELES 37, CALIF.

FREE! VALUABLE BOOK & SAMPLE LESSON—Just Send Coupon!

SAMPLE LESSON RADIO TELEVISION

YOUR FUTURE IN RADIO TELEVISION

NATIONAL SCHOOLS
TECHNICAL TRADE TRAINING SINCE 1905
LOS ANGELES 37, CALIFORNIA

GET FAST SERVICE—MAIL NOW TO NATIONAL SCHOOLS, DEPT. RH-38
4000 S. FIGUEROA ST. LOS ANGELES 37, CALIF.

Rush free TV-Radio "Opportunity" Book and sample lesson. No salesman will call.

NAME _____ AGE _____
ADDRESS _____
CITY _____ ZONE _____ STATE _____

Check if interested ONLY in Resident School training at Los Angeles.
VETERANS: Give date of Discharge _____

THERE IS A DIFFERENCE IN P. A. SPEAKERS

you get a lot more to sell with

Electro-Voice®

CDP® SPEAKERS

Yes, Electro-Voice gives you more to sell and more help in selling P. A. speakers. Hard-hitting, sales-pulling ads pre-sell architects, buyers in schools, universities, colleges, industry and all your prime P. A. prospects. They are told the CDP story . . . and what a terrific story it is. To tell it is to sell them!



Model 848 for the bigger jobs.
25 watts. 16 ohms. Response, 175
—10,000 cps. crossover at 1000
cps. RETMA sensitivity rating, 52
db. Size, 10½" x 20½" x 20."
Wt., 12 lbs. List. \$75.00.

Model 847 CDP for smaller areas.
12 watts. 16 ohms. Response, 250
—10,000 cps. crossover at 1500
cps. RETMA sensitivity rating, 51
db. Size, 11¾" x 7¾" x 10½."
Wt., 6½ lbs. List. \$46.33.

HERE'S WHY CDP SPEAKERS ARE SO SUPERIOR, SO MUCH EASIER TO SELL THAN CONVENTIONAL P. A. HORNS . . .

High frequencies require one throat size and one horn taper rate; low frequencies require a different throat size and a different taper rate. The Electro-Voice CDP gives you a large horn (A), for lows and a second, smaller horn (B), coaxially mounted, for highs working from both sides of a single diaphragm (C). The Electro-Voice CDP gives you 2½ more octaves of sound reproduction . . . frequencies up to 10,000 cps. These 2½ octaves are indispensable for highest intelligibility. See the curve, compare response and efficiency. In addition, Electro-Voice CDP speaker disperses sound through a solid 120° angle for the widest coverage available in P. A. speakers.

You can hear the difference.

1 This is a CDP Speaker with its two coaxially mounted diffraction horns.

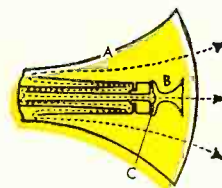

2 This is the frequency response curve of a CDP.

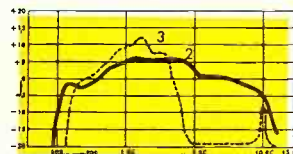

3 This is the frequency response curve of a conventional P. A. horn.

Conventional reentrant horns using single throat (D) and single horn (E) transmit highs along the same circuitous path (F) as required for lows. As a result, the highs become attenuated, sharply decreasing intelligibility. Electro-Voice gives you P. A. speakers with a large horn for lows and a second, smaller horn, coaxially mounted, for highs. **There is a difference and you can hear it.**

4 This is a conventional reentrant-type P. A. horn.

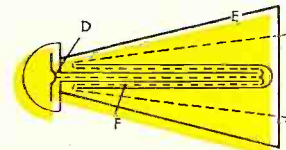

Electro-Voice

ELECTRO-VOICE, INC., BUCHANAN, MICHIGAN

EXPORT: 13 East 40th Street, New York 16,
U. S. A. CABLES: ARLAB.

CDP speakers are weather-proof, blast-proof and splash-proof, virtually indestructible. They're molded of fiber-glass for better acoustical properties and extra strength.

Sell CDP Speakers . . . the speakers that sell because they are clearly superior. See your Electro-Voice Distributor TODAY. Get the facts and start selling the most revolutionary speakers in P. A. history . . . the Electro-Voice CDP.

Send for bulletin 195-N83

RCA VICTOR and Book-of-the-Month Club

ANNOUNCE THE FORMATION OF

The RCA Victor Society of Great Music

... its common-sense purpose is to help serious lovers of music build up a fine record library *systematically* instead of haphazardly. By doing so, they can save **ALMOST ONE THIRD** of what they would pay otherwise for the same RCA VICTOR Red Seal Records.

MOST MUSIC-LOVERS, in the back of their minds, certainly intend to build up for themselves a representative record library of the World's Great Music. Unfortunately, almost always they are haphazard in carrying out this aspiration. The new Society is designed to meet this common situation, sensibly, by making collection more systematic than it now is in most cases.

★ Because of *more systematic* collection, operating costs can be greatly reduced, thus permitting extraordinary economies for the record collector. The remarkable

Introductory Offer at the left is a dramatic demonstration. It represents a 45% saving the first year.

★ Thereafter, continuing members can build their record library at almost a **ONE-THIRD SAVING**. For every two records purchased (from a group of at least fifty made available annually by the Society) *members will receive a third RCA Victor Red Seal Record free.*

★ A cardinal feature of the plan is **GUIDANCE**. The Society has a Selection Panel whose sole business it is to determine "must-have" works for members. Members of the panel are as follows:

DEEMS TAYLOR, composer and commentator, Chairman

SAMUEL CHOTZINOFF, General Music Director, NBC

JACQUES BARZUN, author and music critic

JOHN M. CONLY, editor of *High Fidelity*

AARON COPLAND, composer

ALFRED FRANKENSTEIN, music critic of *San Francisco Chronicle*

DOUGLAS MOORE, composer and Professor of Music, Columbia University

WILLIAM SCHUMAN, composer and president of Juilliard School of Music

CARLETON SPRAGUE SMITH, chief of Music Division, N. Y. Public Library

G. WALLACE WOODWORTH, Professor of Music, Harvard University

HOW THE SOCIETY OPERATES

EACH month, three or more RCA Victor Red Seal Records will be announced to members. One will always be singled out as the *record-of-the-month*, and unless the Society is otherwise instructed (on a simple form always provided), this record will be sent to the member. If the

member does not want the work he may specify an alternate, or instruct the Society to send him nothing. For every record purchased, members will pay only \$4.98, the nationally advertised price of RCA VICTOR Red Seal Records (plus a small charge for postage and handling).

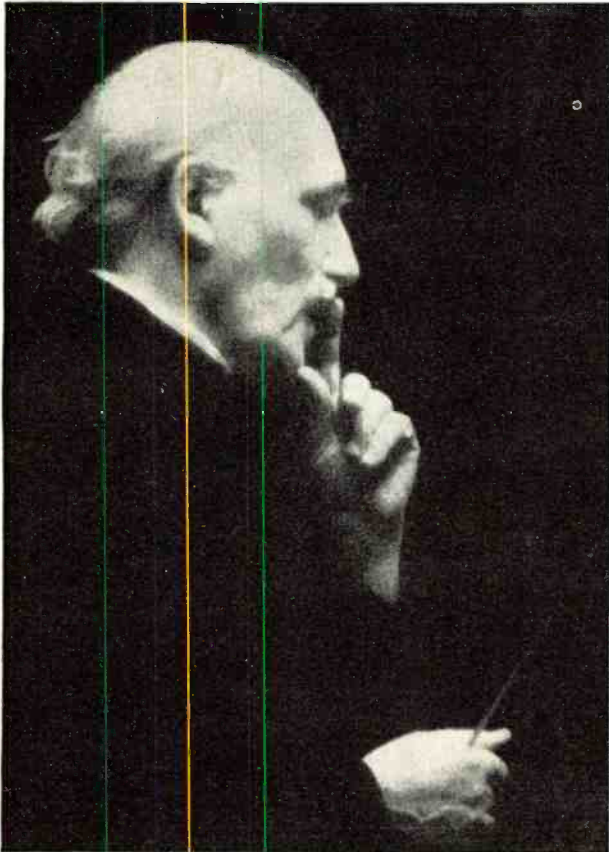

AS THE HEART AND CORE OF A LIFETIME RECORD LIBRARY

BEGINNING MEMBERS WHO AGREE TO BUY SIX RCA VICTOR RED SEAL RECORDS FROM THE SOCIETY DURING THE NEXT YEAR WILL RECEIVE

The Nine Beethoven Symphonies



Arturo Toscanini

CONDUCTING THE NBC SYMPHONY ORCHESTRA IN AN ALBUM OF SEVEN 12-INCH LONG-PLAYING RECORDS FOR

\$3.98

—plus a small charge for mailing

Nationally advertised price \$34.98

RCA VICTOR Society of Great Music, c/o Book-of-the-Month Club, Inc., 345 Hudson St., New York 14, N. Y. Please register me as a member and send me the seven-record *Toscanini-Beethoven Album* under the conditions stated at the left billing me \$3.98, plus postage. If I continue, after buying six records, for every

two records I purchase from the Society, I will receive a third RCA VICTOR Record, free. To maintain membership after the first year, I need buy only four records from the Society in any 12-month period.

MR. _____
MRS. } _____
MISS } _____
ADDRESS _____ (Please print plainly)

CITY _____ ZONE _____ STATE _____

NOTE: If you wish to enroll through an authorized RCA VICTOR dealer, please fill in here:

DEALER'S NAME _____

ADDRESS _____

CITY _____ ZONE _____ STATE _____ V166-3

... for bigger sales,
the big new

Super "8"

It's brand new! Extra heavy. The King-size "8" Ball, for today's king-size market . . . but at a regular price! Popular, proved ball mount . . . adjusts up to 35°. Sleek and modern for today's cars. Triple chrome plated. 4 sections extend to 57". 54" lead cable. Outside, one-man installation. Boost your profits with this King of new antennas. Order the Model TCF-4 Super "8" today!

watch



**WARD
PRODUCTS
CORP.**

1148 Euclid Avenue, Cleveland 15, Ohio
Division of The Gabriel Company
In Canada: Atlas Radio Corp., Ltd.,
50 Wingold Ave., Toronto, Ontario



**Latest Information
on the Electronic Industry**



**By RADIO & TV NEWS'
WASHINGTON EDITOR**

OVER \$2-BILLION SPENT FOR REPLACEMENT PARTS AND REPAIR DURING '57—
A new high in component sales and service income was recorded during 1957. According to year-end records of the Electronic Industries Association in Washington, well over \$1-billion was spent for installation, maintenance, and service, while nearly \$1-billion went for repair parts, including tubes. For details on the 'state of the industry,' see page 8.

HI-FI BOOM SOARING RADIO-PHONO SALES—The radio-phono market, once pronounced killed by television, has made a striking recovery, thanks to the revived interest in sound and the evolution of popular hi-fi. Industry sold 14.7-million radios in 1957, compared to 13.3-million in '56. And an all-time record of 5-million phonographs were sold during '57; a substantial gain is forecast for '58.

SEMICONDUCTOR SALES MOUNTING—The future potential for semi-conductors looks almost unbelievable; industry specialists predict an increase of 33% for both transistors and diodes for '58, with the record-breaking 1957 income of \$143-million rising to about \$200-million.

THOUSANDS OF NEW HAM STATIONS OKED DURING '57—Over 160,000 amateur transmitters are now registered with the FCC, according to the Commission's annual report issued recently in Washington. . . . Commercial use of 2-way radio also jumped during the past year; some 40,300 aircraft are now radio equipped. In addition, there are over 105,000 transmitters in use by taxicabs; 51,300 two-way setups are being used by railroads, and nearly 4000 communications systems are in operation on bus lines. The fire departments of the nation are also extensive users of 2-way radio according to the Commission; there are now 50,000 transmitters in operation, and almost three times as many are being used by the police.

FCC, AIR FORCE, WEATHER BUREAU ADOPT CONELRAD FOR STORM WARNINGS—The Federal Communications Commission, U.S. Air Force, and the Weather Bureau in Washington have announced that they will use the Conelrad national defense alerting system as a weather-warning tool for seasonal hurricanes, inland tornadoes, and floods. . . . All broadcasters (AM,FM,TV) will participate in the weather-emergency program.

TOLL-TV OPPOSED BY LABOR—A resolution opposing toll-TV was passed recently by the second constitutional convention of AFL-CIO. This vote re-affirmed the stand that the body took two years ago at its first meeting.

PHILLY U.H.F. STATION FILES FIRST PAY-TV APPLICATION WITH FCC—Channel 29 WSES in Philadelphia recently entered the first request for permission to charge for TV programs. . . . The station told the Commission that it proposes to use the Skiatron system of punch-card decoders, especially for sports telecasts. The rate structure, it was noted, would include a \$30 yearly fee for each receiver connection, plus \$1.00 for each program. Commercial establishments, such as bars, clubs, etc., would be charged \$100 yearly, and \$5 for each program. In addition, there would also be small charge established for installation of the decoding system.

NEARLY 500 COMMERCIAL TV STATIONS ON THE AIR—The FCC records now show that 497 TV stations are operating, with 414 using the very-high bands and 83 the u.h.f. channels. As we went to press, the following received authorizations to telecast: Central Minnesota Television Co., Alexandria, Minnesota—channel 7 (174 - 180 mc.) with a visual e.r.p. of 26.3 kw.; Beehive Telecasting Corp., Provo, Utah—Channel 11 (198-204 mc.) with a visual e.r.p. of 3.029 kw.; Greenwood Broadcasting Co., Greenwood, Mississippi—channel 6 (82-88 mc.) with a visual e.r.p. of 30.4 kw.—30—

Proved by use in all branches of the Army, Navy and Air Force



UNIVERSITY LOUDSPEAKERS CERTIFIED BY FCDA* FOR CIVIL DEFENSE

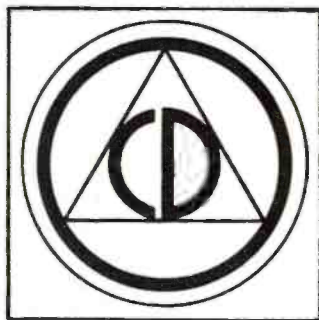
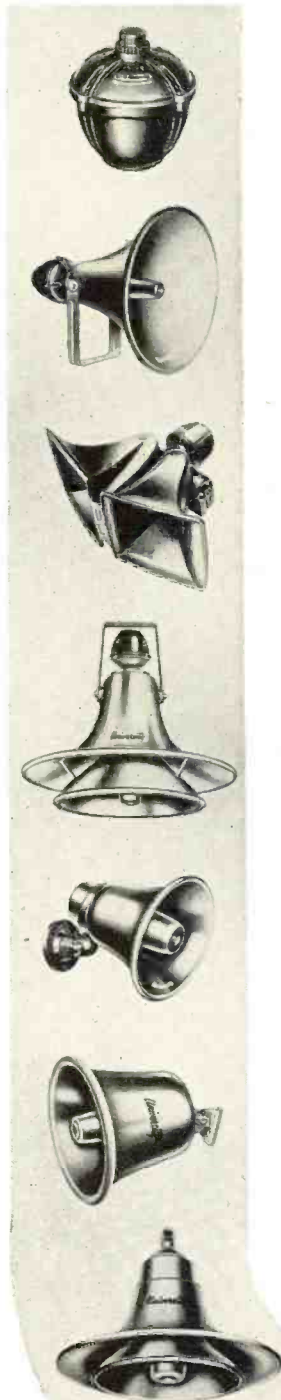

*Federal Civil Defense Administration



For latest
Product Catalog
containing full
technical data
write to:
Desk S-1
University Loudspeakers, Inc.
80 South Kensico Avenue
White Plains, N. Y.

SPECIFY THE BEST... SPECIFY UNIVERSITY

LISTEN *University sounds better* 

University products are protected by U.S. Patents: 163,616; 2,494,134; 2,532,413; 2,532,414; 2,538,026; 2,545,961; 2,546,343; 2,546,344; 2,550,359; 2,641,329; 2,690,231; 2,746,558; 2,751,996; 2,755,343; and other patents pending.



Learn PRACTICAL RADIO-TV
with **25 BIG KITS**

of equipment I send you while
you train with me... for valuable
shop bench experience...

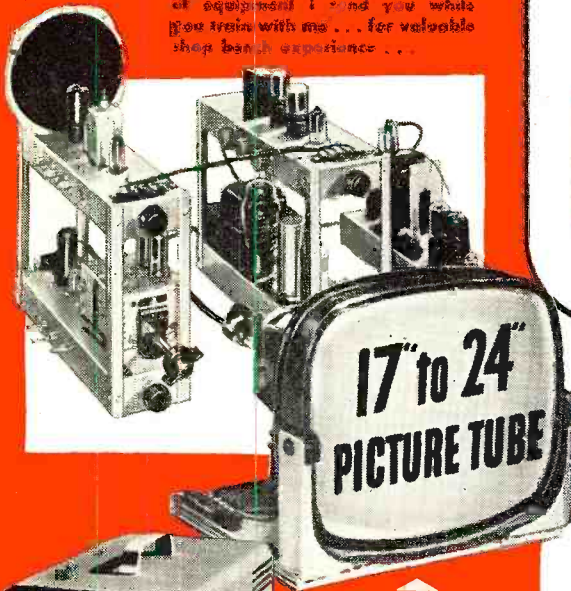

This is the new Sprayberry Training
Television receiver, built and tested
in sections for graded instruction
value.

I now offer this fine modern oscil-
lograph to help you learn practical
television servicing.

You will build this powerful short-
wave and broadcast superhet radio
receiver for valuable shop instruc-
tion practice.

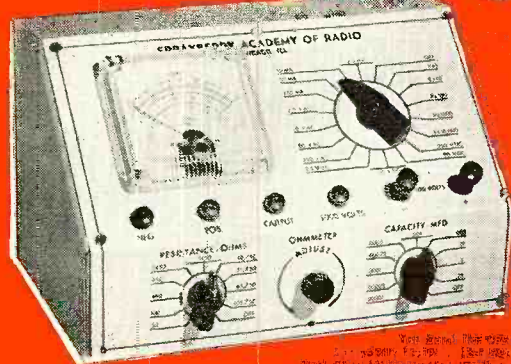
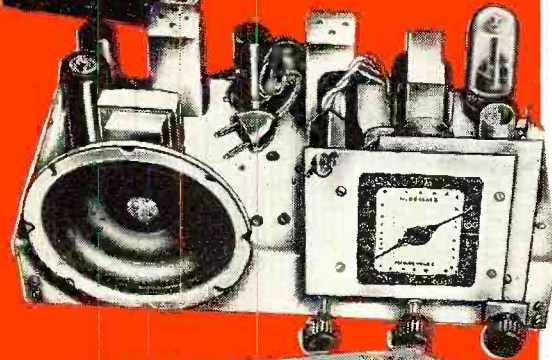

This brand, the only
one in the world, is the
only one that has been
tested and approved by
the Federal Bureau of
Investigation.

Average cost per lesson
ONLY \$3.42

Including Kits and Equipment

Clip and Mail the Coupon Below—Now!

**Train in Spare Hours at Home
for the Best Jobs and Big Pay in**

Radio-Television

—my new, faster way!

**Want Proof? Send for my
big FREE CATALOG and
Sample Lesson. Let the facts
speak for themselves!**

Why wait—get into Radio-Television fast! I will train you in as little as 10 months to step into the top paying Radio-Television field as a much-needed Service Technician! You will train entirely at home in your spare time... which means you can train as fast or as slowly as you like. You have a choice of THREE Sprayberry Training Plans... one exactly suited to your needs. My easier-than-ever payment terms make it possible for you to get set for the good jobs in Radio-Television without the slightest strain on your budget! Get the true facts... just mail the coupon for my big new 56 page fact-filled catalog plus actual sample lesson—both FREE.



Frank L. Sprayberry
Educational Director

REALLY PRACTICAL TRAINING—NO PREVIOUS EXPERIENCE NEEDED

My students do better because I train both the mind and the hands. Sprayberry Training is offered in 25 individual training units, each includes a practice giving kit of parts and equipment... all yours to keep. You will gain priceless practical experience building the specially engineered Sprayberry Television Training Receiver, Two-Band Radio Set, Signal Generator, Audio Tester and the new Sprayberry 18 range Multi-Tester, plus other test units. You will have a complete set of Radio-TV test equipment to start your own shop. My lessons are regularly revised and every important new development is covered. My graduates are completely trained Radio-Television Service Technicians.

NEWEST DEVELOPMENTS

Your training covers U H F, Color Television, F M, Oscilloscope Servicing, High Fidelity Sound and Transistors.

MAIL THE COUPON—See what's ahead in Radio-TV... No Salesman Will Call On You!

The coupon below brings you my big new catalog plus an actual sample Sprayberry Lesson. I invite you to read the facts... to see that I actually illustrate every item in my training. With the facts in your hands, you will be able to decide. No salesman will call on you. The coupon places you under no obligation. Mail it now, today, and get ready for your place in Radio-Television.

SPRAYBERRY ACADEMY OF RADIO-TELEVISION

1512 Jarvis Avenue, Dept. 25-E, Chicago 26, Illinois

Mail This Coupon For Free Facts and Sample Lesson

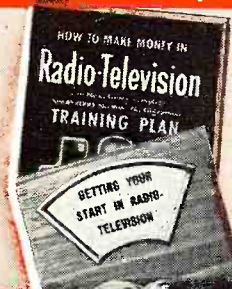

SPRAYBERRY ACADEMY OF RADIO-TELEVISION
Dept. 25-E, 1512 Jarvis Avenue, Chicago 26, Ill.

Please rush all information on your ALL-NEW Radio-Television Training Plan. I understand this does not obligate me and that no salesman will call upon me. Include New Catalog and Sample Lesson FREE.

Name _____ Age _____

Address _____

City _____ Zone _____ State _____

**NEW,
LOW
PRICE**



HICKOK

high-speed
**PORTABLE
CARDMATIC
TUBE TESTER**



MODEL
121



\$249.50
(Includes 300 cards) NET

Fully Automatic

Tests any tube in 8 to 12 seconds . . . including handling of tube test data card. Here is the new, low cost version of the famous Hickok Cardmatic so popular with leading lab engineers. Especially designed for high speed service work, this new 121 is high quality in a lightweight portable . . . and the price is low too. The Hickok Cardmatic switch sets up all tests automatically and eliminates fussing around with adjustments. You can accurately check a tube for dynamic mutual conductance, controlled emission, cutoff point "Knee" point, shorts, leakage, gas and voltage drop . . . and rectifier tubes at their rated loads. Any way you look at it, this new automatic tube testing machine will be helpful to you in your work. It will pay for itself in a very short time . . . and give you many years of accurate dependable service.

SPECIFICATIONS

- 320 heater voltages.
- 140 fixed bias potentials.
- 640 plate voltages.
- 640 screen voltages.
- 100 self-bias settings
- 1000 quality-value sensitivity ranges
- Instant shorts indication.
- ALL AUTOMATICALLY!**
- Active card magazine holds over 600 cards instantly available with time saving automatic filing feature.
- SEE THE 121 TODAY!**

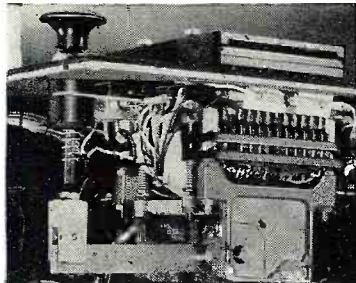

The new 121 incorporates a fully automatic mechanism actually incorporating 187 individual switches providing an almost unlimited number of voltage combinations to any tube element. This mechanism has been life tested in a cycling process over 100,000 times—without fail, and has proven superior to all other switching arrangements.

**Now is the time to . . .
TRADE UP TO A HICKOK**

Ask for a demonstration of the new 121
or write for descriptive literature.

THE HICKOK ELECTRICAL INSTRUMENT CO.
10524 Dupont Avenue • Cleveland 8, Ohio

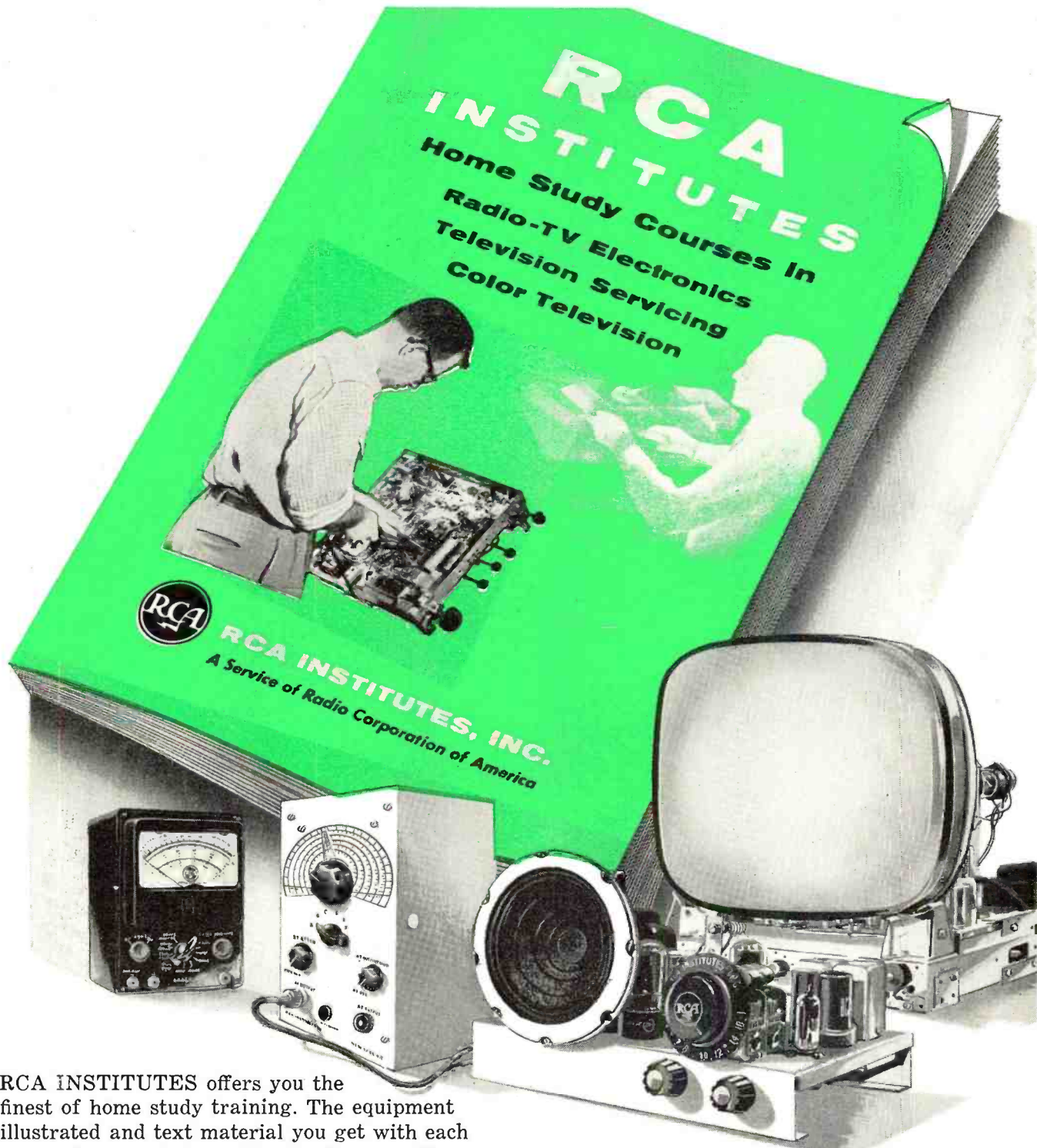

RCA INSTITUTES offers you the finest of home study training. The equipment illustrated and text material you get with each course is yours to keep. Practical work with very first lesson. Courses for the beginner and the advanced student. Pay-as-you-learn. You need pay for only one study group at a time.

**Send for this
FREE Book Now** ▶

[RESIDENT SCHOOL courses in New York City offer comprehensive training in Television and Electronics. Day and evening classes start four times each year.
Detailed information on request]

RCA INSTITUTES, Inc. Home Study Dept. N-38
350 West Fourth Street, New York 14, N. Y.

Without obligation, send me FREE 52 page CATALOG on Home Study Courses in Radio, Television and Color TV. No salesman will call.

Name..... please print

Address.....

City.....Zone.....State.....

Korean Vets! Enter discharge date.....

In Canada — RCA Victor Co., Ltd.
5001 Cote de Liesse Rd., Montreal 9, Que.
To save time, paste coupon on postcard.

The magnetic tape that can't be copied!



Others try to imitate it...but no tape equals **SCOTCH** 200 Tensilized Double-Length Tape!

This is the original no-break, no-stretch tape that plays twice as long . . . and you can't buy better! "SCOTCH" Brand waited until it had perfected an extended play tape of unmatched quality. Now, here it is—"SCOTCH" 200 Tensilized Double-Length Tape—first to give you a Polyester backing with an ultimate tensile strength of 6.8 lbs! And it's the only tape of its kind that offers silicone lubrication, genuine built-in protection for your recorder head. Why settle for imitations when the original and best costs no more? Today, see your dealer for a reel of "SCOTCH" 200 Tensilized Double-Length Tape, newest of the "Tapes you can trust".

MINNESOTA MINING AND MANUFACTURING COMPANY

...WHERE RESEARCH IS THE KEY TO TOMORROW



The term "Scotch" is a registered trademark of 3M Company, St. Paul 6, Minn. Export: 99 Park Avenue, New York. Canada: London, Ontario. © 3M Co., 1958.

Now you can order precise KITS BY MAIL... from Your Local Parts Distributor!

HI-FI... by Precise

AM-FM TUNER



Precise Model **TUMK** Kit Form.....\$49.95
 Precise Model **TUMW** Factory Wired.. 69.95

40-WATT AMPLIFIER



Precise Model **AM40K** Kit Form.....\$69.95
 Precise Model **AM40W** Factory Wired 89.95

Precise Engineered **POWER LAB**

For all your electrical needs!

For the first time in the industry, one instrument takes the place of more than 11 pieces of equipment... Here's what you get:

- A BATTERY ELIMINATOR for 6v and 12v radios
- A BATTERY CHARGER up to 24 volts
- A HIGH CURRENT LINE VOLTAGE VARIAC - up to 10 amperes
- AN AC LINE VOLTAGE METER
- AN AC LINE AMMETER
- AN AC LINE WATTMETER
- AN AC LINE ISOLATION TRANSFORMER - 100w or 300w
- A LOW VOLTAGE, HIGH CURRENT AC SUPPLY - 24v at 10 amperes
- A DC LINE VOLTAGE VARIABLE SUPPLY
- A DC HIGH CURRENT AMMETER
- AN AGC BIAS BOX



Precise Engineered

5" SCOPE

UP to 9 mc
 FLAT to 5 mc
 for color work

After you've built this 'scope, you'll be amazed at its versatility. No other 'scope below a \$100.00 can meet all of its specifications. Design features include push-pull vertical and horizontal... high sensitivity... 5CP1 tube with post acceleration... frequency compensated stepping attenuators for both vertical and horizontal... focus, intensity and astigmatism controls... and calibration output voltage. Vertical amps are flat through 5 mc ± 8 db through 9 mc. Sensitivity is 10 mv/cm. Horizontal amps within ± 6 db through 500 kc, have frequency compensated stepping attenuator input and cathode follower to assure linear horizontal trace. Hard vacuum sweep frequencies with sufficient expansion to see color bursts clearly, and a sensitivity approximately 40 mv/cm, made this instrument the exceptional buy of the year.

Precise Model **3151K** Kit Form\$ 59.95
 Precise Model **3151W** Factory Wired 109.95



Precise Model		Isolation
711K	KIT FORM	\$49.95 100w
711W	FACTORY WIRED	64.95 100w
713K	KIT FORM	62.95 300w
713W	FACTORY WIRED	79.95 300w

You benefit from faster delivery, lower price, postage savings, and the personal local service of your nearby parts distributor when you order by mail... if you are close enough, drop by and see the top quality parts included in each kit. Here are 8 of the many PRECISE distributors who are ready to serve you. Use the handy coupon to order your PRECISE kit by mail.

DAVIS ELECTRONICS

204 Main Street
 Hempstead, New York

FEDERATED PURCHASER

11275 Olympic Blvd.
 Los Angeles, Calif.

BOULDER DISTRIBUTING

1840 - 24th Street
 Boulder, Colorado

VARIETY ELECTRONICS

Bloomfield Ave. at State St.
 Bloomfield, New Jersey

FISTELLS ELECTRONIC SUPPLY CO.

1001 Bannock Street
 Denver 4, Colorado

WARREN RADIO

1002 Adams Street
 Toledo, Ohio

- ★ Printed-Circuit
- ★ Voltage-Regulated
- ★ Peak-to-Peak

**ALL-
 NEW**

VTVM featuring the TILTING METER MOVEMENT and MAGIC LEAD SWITCH



Here's another all-new precise-engineered instrument, designed with you in mind... to make it easier and convenient as you test. Along with the all-new features of voltage regulation, printed circuitry and etched front panel... you have the exclusive Meter Movement Tilt, which permits you to turn the meter face to your eye level for more accurate readings no matter where on the bench you place the VTVM... plus the MAGIC LEAD SWITCH that permits you automatically to short and open leads for zero or infinite adjust without removing the leads from the circuit under test. Compare this meter with any other available today, and you'll know that precise-engineered means engineered to give you your dollars worth.

- Frequency Range: Up to 250 mc with Precise Model 912 Probe (available at extra cost)
- Voltage Range: Up to 30,000 V with Precise 999 HV Probe (available at extra cost)
- Special true zero alignment scale for FM and TV discriminators
- Burn-out proof Meter Circuit
- Complete with test leads and internal battery
- RUGGED Oversize 4 1/2" TILT Meter
- Reads p-p and RMS voltages

RANGES:

DC: 0-1.5-5-15-50-150-500-1500 V.
 AC: (RMS) 0-1.5-5-15-50-150-500-1500 V.
 AC: (P-P) 0-4, 14, 40, 140, 1400 V.
 OHMS: Rx1x10x100x1000x10,000x100,000 Meg from .2 ohms to over 1 Billion ohms.
 Input Impedance of DC = 11 Megohms

Tube Complement: 12AU7, 6AL5, Selenium Rectifier Transformer Supply

Precise Model **904K** Kit Form\$34.95
 Precise Model **904W** Wired Form\$49.95

Mutual Conductance and Emission TUBE TESTER

Here is a tester that actually checks a tube for its applications, not whether it is just good or bad.

On the Model 111, GM and Emission are checked separately.

It is the first and only device that measures 600-mil tubes on a meter Sweeps from 0 through the normal testing range when making measurements, which gives an average evaluation for the tube over an extended range of operation. Connects test voltages to each tube element. Uses a single rotary switch to check each element against every other element for shorts, whether they're hot or cold. Measures tube bias directly on a meter. Features a no-backlash roll chart. Includes provisions for testing all prong types. Cathode-Ray tubes may also be checked with the use of an adaptor. An exceptional instrument for the shop, one that has won an impartial independent scientific survey hands down.

Precise Model **111K** Kit Form.....\$ 79.95
 Precise Model **111W** Factory Wired..... 139.95



Mr. Precise Distributor:

I would like to order the following Precise kits:

- | | | |
|-------------------------------------|-------------------------------------|-------------------------------------|
| <input type="checkbox"/> 904K | <input type="checkbox"/> Model 711K | <input type="checkbox"/> Model 111K |
| <input type="checkbox"/> 904W | <input type="checkbox"/> Model 711W | <input type="checkbox"/> Model 111W |
| <input type="checkbox"/> 3151 Kit | <input type="checkbox"/> Model 713K | <input type="checkbox"/> Model 116K |
| <input type="checkbox"/> 3151 Wired | <input type="checkbox"/> Model 713W | <input type="checkbox"/> Model 116W |

Please send kits COD Bill my account
 Remittance Enclosed, Ship Prepaid

Print Name Clearly _____

Street Address _____

City & State _____

See your dealer for a complete
 test equipment bench engineered by Precise.

For a tight grip
in tight places...



The "Mighty Widget"

CHANNEL LOCK
No. 424

This "mighty widget" is a natural for a tight grip on small work in hard-to-get-at places. Only 4-1/2" long... drop forged from high grade steel. Four exclusive Channellock precision-grooved jaw adjustments... capacity to 1/2". Skilled mechanics say it's one of the handiest pliers in their kits. You'll say so, too!

**CHAMPION DEPARTMENT
TOOL COMPANY**

MEADVILLE, PENNSYLVANIA

ASK YOUR TOOL SUPPLIER
FOR A CHANNELLOCK No. 424

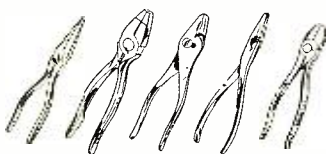

Be sure it's a genuine CHANNELLOCK
Look for the trademark on the handle

Within the Industry

LOWELL S. ("LOU") PELFREY, who has been active in the development program at *International Rectifier Corporation* since 1953, has been named director of research and development.



Mr. Pelfrey was graduated from the University of Kentucky in 1937 and has been active in the semiconductor field since 1944. With the company, he has performed much work in the purifying of germanium and silicon and in the production of single crystals of these materials.

His developments have led to the introduction of several new devices, such as high temperature germanium diodes, germanium mixer diodes for television, and several types of silicon diodes for radar.

* * *

HI-FONIC MUSIC SYSTEMS, INC., Palo Alto, Calif., has changed its name to **ALTO FONIC MUSIC SYSTEMS, INC.**... **ELECTRO-CONTACTS, INC.** of Oyster River, Mass. has entered the slip ring field... **DIAMOND CALK HORSESHOE CO.** has changed its name to **DIAMOND TOOL AND HORSESHOE CO.** The year 1958 marks the 50th Anniversary of the firm... Announcement is made of a new organization in the electronics industry under the name of **QUANTUM TECH LABORATORIES**. The firm is located at 236 Mt. Kemble Avenue, Morristown, New Jersey and will produce a line of electronic instruments and measuring equipment for laboratory and industrial use, including power supplies and special purpose amplifiers. John M. van Beuren is general manager, Alan P. Stansbury is chief engineer, and Fred R. Stampfli is business manager of the new organization.

* * *

INSTITUTE OF RADIO ENGINEERS, INC. has appointed six members to the Board for 1958.

Reappointed as treasurer of the group is W.R.G. Baker, vice-president for research of Syracuse University and former vice-president of electronics, *General Electric Company*. Haraden Pratt has been appointed to his sixteenth term as secretary and John D. Ryder, Dean of Engineering, Michigan State University, is now editor of the IRE.

Appointed as directors are Alfred N. Goldsmith, consulting engineer and editor emeritus of the Institute; D. B. Sinclair, vice-president of engineering, *General Radio Corp.*; and Ernst Weber, president of the Polytechnic

Institute of Brooklyn and president of *Polytechnic Research and Development Company*, Brooklyn, N. Y.

* * *

RTTY has announced that its fourth annual dinner will be held in New York City on Monday, March 24, 1958. This dinner is held each year during the IRE show so that amateur radioteletypers from across the nation can attend.

The guest of honor will be Bruce H. Rowlings, ZL1WB, from New Zealand and one of the first overseas amateur operators to use radioteletype.

An attendance of 70 is expected and reservations for the dinner must be made in advance (\$7.00). These may be obtained from Clayton Cool, W2EBZ, editor of the ARTS bulletin, 443 West 47th St., New York 36, N. Y.

* * *

FRANK RANDALL has been appointed president of *Amperex Electronic Corporation*, Hicksville, Long Island, New York. The company manufactures electron tubes and semiconductors for defense, communications, and industry.



Mr. Randall had been vice-president and general sales manager for the organization prior to his new appointment.

His promotion was announced by Mr. Pieter van den Berg, chairman of the board of directors.

* * *

MERIT COIL & TRANSFORMER CORP. is planning a new building in Hollywood, Florida. This 12,000 square foot addition to the firm's Florida plant will provide warehousing facilities to serve Southeastern distributors... **JOHNSON ELECTRONICS INC.** has moved to a new, modern building in Casselberry, Florida... Announcement has been made by **UNITED ELECTRODYNAMICS**, Pasadena, Calif., of the opening of a new facility to be called the **UNITED TESTING LABORATORIES**. This move represents a separation and expansion of the research and commercial testing operations carried on by the company for a number of years... **PIC DESIGN CORP.** has announced the establishment of an office at 7335 Van Nuys Blvd., Van Nuys, California for the convenience of its West Coast customers... **FOTO-VIDEO LABORATORIES, INC.** announces that it has acquired a new 10,000 square foot plant in Cedar Grove, New Jersey as part of a general expansion program... Shrewsbury, Mass. will be the new home of the **PHALO PLASTICS CORPO-**

The data that launched thousands
of careers is yours FREE

◀ **TELLS how you can be successful in
ELECTRONICS . . . including:**

Guided Missiles . . . Radar . . . Instrumentation . . . Com-
puters . . . Automation . . . Astronautics . . . Servomechanisms
. . . Aeronautical Electronics . . . Telemetry . . . Communi-
cations . . . Manufacturing . . . Television . . . Broadcasting

Send for your Free Copy today!

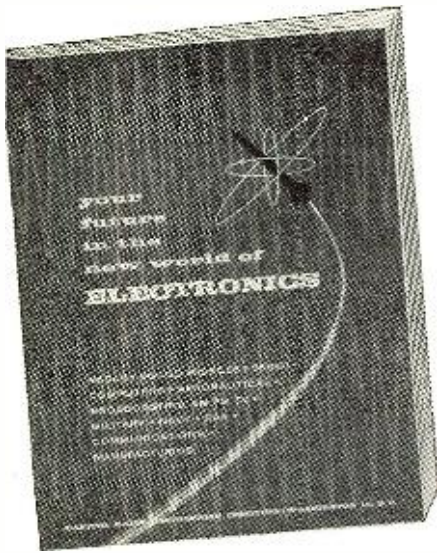

This is a brand new edition of the book which has launched thousands of men on good-paying careers in radio-TV-electronics.

It brings you completely up to date—answers important questions on newest career developments in electronics, including Radar, Guided Missiles, Servomechanisms, Computers, as well as Aeronautical Electronics, Broadcasting (AM, FM, TV), Military, Navy and CAA Electronics, Communications and Electronics Manufacturing.

This book, "Your Future in the New World of Electronics," also shows you how CREI Home Study leads the way to greater earnings in the booming electronics world.

However, CREI does not promise you a "snap." With accredited technical school curricula such as CREI offers, you must study to convert your ambition into technical knowledge which you can sell in the fabulous field of Electronics. Since its founding in 1927, CREI has provided thousands of professional electronics men with technical educations. During World War II, CREI trained thousands for the Armed Services. Leading firms recommend CREI training for their own personnel. Among them: United Air Lines, Canadian Broadcasting Corporation, Trans-Canada Airlines, Douglas Aircraft Co., The Martin Co., Columbia Broadcasting System, All-American Cables and Radio, Inc., Gates Radio Co., Canadair, Ltd., Federal Electric Corp., and U. S. Information Agency (Voice of America).

CREI courses are prepared by recognized experts, in a practical, easily understood manner, and constantly revised to meet the new electronic challenges of our time. You get the benefit of time-tested study assignments under the personal supervision of a CREI staff instructor. Your studies are accomplished on your own time, during hours selected by you, and controlled by your own will power. This complete training is the reason that graduates find their CREI diplomas keys-to-success in even the most advanced of electronic applications. CREI alumni hold top positions in America's leading firms. At your service is the CREI Placement

Bureau, which helps to find positions for advanced students and graduates, although CREI does not guarantee jobs. Fill out the coupon below *completely* and mail it now. We'll promptly send you your free copy of "Your Future in the New World of Electronics." The rest—your future—is up to you!

NOT FOR BEGINNERS

If you have the equivalent of a high school education, and are good at mathe-

matics, if you have *some* electronics experience (advanced amateur, military or industrial),—and realize the need of high-level technical knowledge to make good in the better electronic jobs—you can qualify for CREI home study training. (Electronic experience is not required for admission to CREI Residence School). Mail coupon today, or write Capitol Radio Engineering Institute, Dept. 113-E, 3224 16th St., N.W., Washington 10, D. C.



CREI ALSO OFFERS RESIDENCE TRAINING at the same high technical level in Washington, D.C. Classes start at regular intervals. Qualified residence school graduates earn degree, "Associate in Applied Science." Check coupon if you prefer residence study.

VETERANS: If eligible for training under the new G.I. Bill of Rights, check the coupon for full information.

**INDUSTRY CALLS FOR
CREI TRAINING
BY NAME . . .
SO SHOULD YOU!**

◀ Here you see an actual help wanted ad from the *San Francisco Examiner*, one of many which specify "CREI or equal" training. This shows that industry approves CREI training, even insists on it.

FILL OUT AND MAIL TODAY—BEFORE YOU FORGET IT!

CAPITOL RADIO ENGINEERING INSTITUTE

ECPD Accredited Technical Institute Curricula—Founded 1927
Dept. 113-E, 3224 16th St., N.W., Washington 10, D. C.

Please send me your course outline and FREE illustrated Booklet "Your Future in the New World of Electronics" . . . describing opportunities and CREI home study courses in Electronic Engineering Technology.

- CHECK FIELD OF GREATEST INTEREST
- Radar, Servo and Computer Engineering Technology
 - Electronic Engineering Technology
 - Broadcast (AM, FM, TV) Engineering Technology
 - Television Engineering Technology
 - Aeronautical Electronic Engineering Technology

Name _____ Age _____
Street _____
City _____ Zone _____ State _____
Check: Home Study Residence School Korean Veteran

To help us answer your request intelligently, please give the following information:

EMPLOYED BY _____
TYPE OF PRESENT WORK _____
EDUCATION: YEARS HIGH SCHOOL _____
YEARS COLLEGE _____
ELECTRONICS EXPERIENCE _____

RATION. The building will include 110,000 square feet of space and the new address will be 530 Boston Turnpike . . . **REEVES SOUNDCRAFT CORPORATION** is building a new magnetic tape plant in Danbury, Conn. . . . **WESTINGHOUSE ELECTRIC CORPORATION** has opened a new apparatus office in Compton, California . . . A new 22,000 square foot engineering building has been opened by **GENERAL PRECISION LABORATORY INCORPORATED**, Pleasantville, N. Y. . . . **MAGNETIC RESEARCH CORPORATION** announces the formation of the firm's new Stablvolt division at 200 Center St., El Segundo, Calif. . . . **ACOUSTICA ASSOCIATES, INC.** has opened its fourth plant at 11601 West Jefferson Blvd., Culver City, Calif.

* * *

RADIO CORPORATION OF AMERICA has awarded thirty undergraduate scholarships and one graduate fellowship in a new program to encourage students to prepare for science teaching careers.

The first Science Teacher Scholarships have been established at twenty colleges and universities in sixteen states where a survey by the corporation's education committee showed the shortage of such teachers to be most critical.

The first Science Teacher Fellowship, valued at \$3000, has been established at Purdue University, West Lafayette, Indiana.

* * *

JOSHUA GINSPARG has been named chief industrial engineer of *Shure Brothers, Inc.*

Mr. Ginsparg has been associated with the company for eleven years. For the past five years he has been the superintendent of assembly departments. Previously he was a methods engineer and supervisor of assembly departments.



He attended Tufts College and did post-graduate work at the Stevens Institute of Technology. He is a member of the American Society of Quality Control.

* * *

HOWARD W. SAMS, head of the Indianapolis electronic engineering and publishing firm bearing his name, has resumed the presidency of *Waldemar Press, Inc.* . . . **J. C. MAXWELL** has been elected to the board of directors of *General Precision Equipment Corp.*

. . . **SAMUEL B. FISHBEIN** has been appointed assistant general sales manager of the military operations department of *Allen B. Du Mont Laboratories, Inc.* . . . **ALBERT BOYD**, Major General, retired, U.S. Air Force, has joined *Westinghouse Electric Corp.* as consultant and advisor to the group general manager, defense products . . .

ROBERT H. WEEKS, JR. has been named assistant division manager for the Edison storage battery division, *Thomas A. Edison Industries, McGraw-Edison*

(Continued on page 148)

How to Pass

An FCC License can be

Get Your FCC License

We Guarantee
to train you until you receive
Your FCC License

Completion of the Master Course (both Sections) will prepare you for a First Class Commercial FCC License with a radar endorsement. Completion of Section I only of the Master Course will prepare you for a Second Class Commercial FCC License. We guarantee to train and coach you, without any additional cost, until you receive the FCC License as indicated above. This guarantee is valid for the entire period of your enrollment agreement.

Cleveland Institute Training Results in success with commercial FCC examinations . . . easily . . . and quickly.

every month our trainees get jobs like these:



Boyd Daugherty:

"I recently secured a position as Test Engineer with Melpar, Inc. A substantial salary increase was involved. My Cleveland Institute training played a major role in qualifying me for this position."

*Boyd Daugherty
105 Goodwin Ct., Apt. C
Falls Church, Va.*

Top Grade Employers Like These Look

- Bendix Radio:** "We shall look forward to receiving completed applications from your students."
- Philco:** "We have employed a great number of well qualified electronics personnel who were graduates of Cleveland Institute."
- Westinghouse:** "We would appreciate your listing our current openings in your monthly Job Opportunities."

(Commercial)

FCC License Exams

your Guarantee of Success in Electronics

in a Minimum of Time

mail
coupon
NOW!

here's proof . . .

Name and Address	License	Time
Walter Eggers, Pacific Grove	1st	12 weeks
Paul Reichert, West Salem, Ohio	2nd	10 weeks
Harold Phipps, La Porte, Indiana	1st	28 weeks
John H. Johnson, Boise City, Okla.	2nd	12 weeks
James Faint, Johnstown, Pa.	1st	26 weeks

Get Both FREE

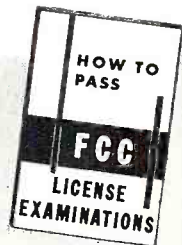

James Glen:



When Jim enrolled, he was a temporary employee of the City of Tacoma, Washington. In the space of 14 months, he completed the Master Course and received his first class license. He is now installing and maintaining mobile and microwave equipment.

*James S. Glen, Jr.
2920 Knob Hill Road
Tacoma, Washington*

Accredited by National Home Study Council

Cleveland Institute of Radio Electronics

Desk RN-15, 4900 Euclid Ave., Cleveland 3, Ohio

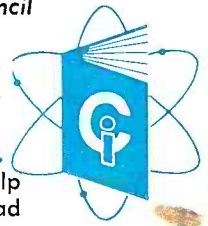

Please send Free Booklets prepared to help me get ahead in Electronics. I have had training or experience in Electronics as indicated below:

- | | |
|---|---|
| <input type="checkbox"/> Military | <input type="checkbox"/> Broadcasting |
| <input type="checkbox"/> Radio-TV Servicing | <input type="checkbox"/> Home Experimenting |
| <input type="checkbox"/> Manufacturing | <input type="checkbox"/> Telephone Company |
| <input type="checkbox"/> Amateur Radio | <input type="checkbox"/> Other |

In what kind of work are you now engaged?

In what branch of Electronics are you interested?

Name Age.....

Address

City Zone..... State.....

Special Tuition Rates to Members of Armed Forces Desk RN-15

To Cleveland Institute

Aerojet-General
American Airlines
American Telephone & Telegraph Co.
Bendix Radio
Braniff Airways
Burroughs Corp.
Capital Airlines
Continental
Air Lines, Inc.
Convair
General Electric
Glenn L. Martin Co.

Goodyear Atomic Corp.
IBM
International Telephone & Telegraph Co.
Mohawk Airlines
Motorola
North American
Aviation, Inc.
Northwest Airlines
Philco
RCA
Ryan Aeronautical Co.
**Plus many others*

Now—See How to Save Hundreds of Dollars,
Get More Fun Out of High Fidelity!

New

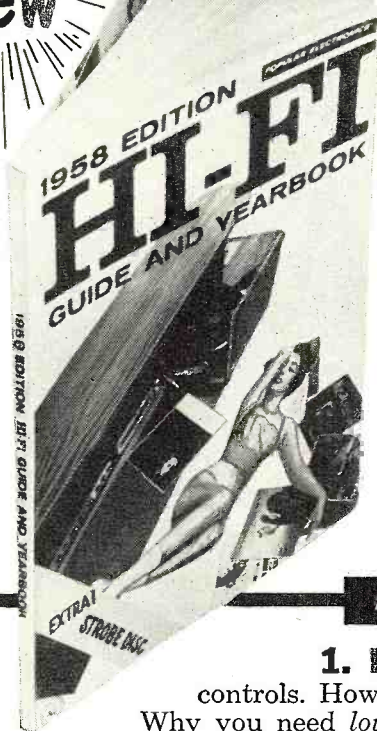

1958 Edition HI-FI GUIDE AND YEARBOOK

Latest Ideas for Buying, Improving, Using Hi-Fi Systems & Components ☆ Ways to Make Monaural & Stereo Tapes ☆ Best Records ☆ Rolloff, Turnover Settings ☆ FM Stations & Listings ☆ "Do-it-Yourself" Techniques ☆ New Inventions & Improvements in Speakers, Amps, Preamps, Tuners, Crossovers, Tape, Stereo, Controls, Turntables, Heads ☆ FREE Strobe Test Disc ☆ Where to get Free Hi-Fi Literature ☆ 164 Pages ☆ Hundreds of Pictures!

Actually 3 Books in 1

1. IMPROVING YOUR HI-FI. How to use *tone* controls. How *crossovers* work. Ways to boost *speaker* performance. Why you need *loudness* controls, how to add them. How to add *extra* speakers to your rig. How to add a *spotlight* with presence control . . . tricks of accenting a vocalist or soloist by accenting the *middle sound* frequencies. Effects of variable *damping* in amplifiers. How to check your phono's *pickup* and keep it working at peak efficiency. Ways to check a *stylus*.

2. TAPE TECHNIQUES. How to get the most out of *tape*. How to keep tape in top *shape*. How to tape *programs* directly off the air . . . step-by-step instructions and pictures. Expert hints and *shortcuts* on making good tape recordings. How to check a tape recording *head* to ascertain *alignment*. Complete guide to tape *splicing* for interesting *effects*.

3. GETTING INTO STEREO. What stereo is. Latest *advances*. What the different stereo *systems* are. What stereo equipment is *available*. How to *add* stereo to your present rig. *Merits* and drawback of different systems. What they *cost*. *Tricks* of the trade.

A RICH SOURCE OF PRACTICAL INFORMATION

Many thousands of hi-fi fans knew a good thing when they saw the first edition of the *Hi-Fi Guide and Yearbook*. Newsstands were cleaned out in a matter of days and the book became a collector's item.

The new *1958 Edition* of the *Hi-Fi Guide and Yearbook* is on sale now everywhere. It contains completely new material on every facet of high fidelity . . . from an advance report on 16 $\frac{2}{3}$ rpm ("The Fourth Speed"), to guidance on adding stereophonic sound to your present set-up.

This new *Hi-Fi Guide and Yearbook* will return many times the \$1 you pay for it . . .

by showing how to shop wisely for equipment, how to save on repairs, which records are best, and money-saving techniques and ideas available nowhere else.

It will be a continually entertaining companion . . . providing you with fascinating, useful lore, showing you how to get more pleasure out of hi-fi, helping you explore the different worlds of high fidelity and music.

This new edition is selling fast. So get your copy today. Don't miss the *1958 Edition of Hi-Fi Guide and Yearbook*, a handsome and practical book you're sure to enjoy.



ON SALE NOW at Newsstands
and Radio Stores ☆ Only \$1
Ziff-Davis Publishing Co., 64 E. Lake Street, Chicago 1, Ill.

the experts say... in High Fidelity the best buys are **EICO**[®]

EICO
KITS and WIRED

BETTER ENGINEERING Since 1945 EICO has pioneered the concept of test instruments in easy-to-build kit form — has become world-famous for laboratory-precision instruments at low cost. Now EICO is applying its vast experience to the creative engineering of *high fidelity*. Result: high praise from such authorities as Canby of AUDIO, Marshall of AUDIOCRAFT, Holt of HIGH FIDELITY, Fantel of POPULAR ELECTRONICS, Stocklin of RADIO TV NEWS, etc. — as well as from the critical professional engineers in the field.†

SAVE 50% Mass purchasing, and a price policy deliberately aimed to encourage mass sales, make this possible.

EASY INSTRUCTIONS You need no previous technical or assembly experience to build any EICO kit — the instructions are simple, step-by-step, "beginner-tested."

DOUBLE 5-WAY GUARANTEE Both EICO, and your neighborhood distributor, guarantee the parts, instructions, performance . . . as well as *lifetime* service and calibration at nominal cost . . . for any EICO kit or wired unit.

BEFORE YOU BUY, COMPARE At any of 1200 neighborhood EICO distributors coast to coast, you may examine and listen to any EICO component. Compare *critically* with equipment several times the EICO cost — then *you* judge. You'll see why the experts recommend EICO, kit or wired, as best buy.

† Thousands of unsolicited testimonials on file.



HFT90 FM Tuner with "eye-tronic" tuning



HF61 Preamplifier

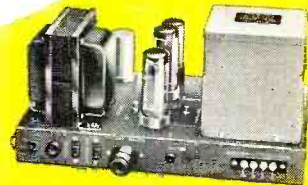

HF60, HF50 Power Amplifiers

HF52 Speaker System



HF52 Speaker System: Uniform loading & natural bass 30-200 cps achieved via slot-loaded split conical bass horn** of 12-ft. path. Middles & lower highs from front side of 8½" cone, edge-damped & stiffened for smooth uncolored response. Suspensionless, distortionless spike-shaped super-tweeter radiates omni-directionally. Flat 45-20,000 cps, useful to 30 cps. 16 ohms. HWD: 36", 15¼", 11½". " . . . rates as excellent . . . unusually musical . . . really non-directional" — Canby, AUDIO. "Very impressive" — Marshall (AUDIOCRAFT). Walnut or Mahogany, \$139.95. Blonde, \$144.95.

HFT90 FM Tuner equals or surpasses wired tuners up to 3X its cost. New, pre-wired, pre-aligned, temperature-compensated "front end"—drift-free. Sensitivity, 1.5 uv for 20 db quieting, is 6X that of other kit tuners. DM-70 traveling tuning eye. Response 20-20,000 cps ± 1 db. Cathode follower & multiplex outputs. Kit \$39.95*. Wired \$65.95*. Cover \$3.95. *Less cover, excise tax incl.

HF61A Preamplifier, providing the most complete control & switching facilities, and the finest design, offered in a kit preamplifier, ". . . rivals the most expensive preamps . . . is an example of high engineering skill which achieves fine performance with simple means and low cost."—Joseph Marshall, AUDIOCRAFT. HF61A Kit \$24.95, Wired \$37.95. HF61 (with Power Supply) Kit \$29.95. Wired \$44.95.

HF60 60-Watt Ultra Linear Power Amplifier, with Acro T0-330 Output Transformer, provides wide bandwidth, virtually absolute stability and flawless transient response. ". . . is one of the best-performing amplifiers extant; it is obviously an excellent buy."—AUDIOCRAFT Kit Report. Kit \$72.95. Wired \$99.95. Matching Cover E-2 \$4.50.

HF50 50-Watt Ultra-Linear Power Amplifier with extremely high quality Chicago Standard Output Transformer. Identical in every other respect to HF60 and same specifications up to 50 watts. Kit \$57.95. Wired \$87.95. Matching Cover E-2 \$4.50.

HF30 30-Watt Power Amplifier employs 4-EL84 high power sensitivity output tubes in push-pull parallel, permits Williamson circuit with large feedback & high stability, 2-EZ81 full-wave rectifiers for highly reliable power supply. Unmatched value in medium-power professional amplifiers. Kit \$39.95. Wired \$62.95. Matching Cover E-3 \$3.95.

HF-32 30-Watt Integrated Amplifier Kit \$57.95. Wired \$89.95.

HF52 50-Watt Integrated Amplifier with complete "front end" facilities and Chicago Standard Output Transformer. Ultra-Linear power amplifier essentially identical to HF50. The least expensive means to the highest audio quality resulting from distortion-free high power, virtually absolute stability, flawless transient response and "front end" versatility. Kit \$69.95. Wired \$109.95. Matching Cover E-1 \$4.50.

HF20 20-Watt Integrated Amplifier, complete with finest preamp-control facilities, excellent output transformer that handles 34 watts peak power, plus a full Ultra-Linear Williamson power amplifier circuit. Highly praised by purchasers, it is established as the outstanding value in amplifiers of this class. Kit \$49.95. Wired \$79.95. Matching Cover E-1 \$4.50.

Prices 5% higher in the West

HF12 12-Watt Integrated Amplifier, absolutely free of "gimmicks", provides complete "front end" facilities & true fidelity performance of such excellence that we can recommend it for any medium-power high fidelity application. Two HF12's are excellent for stereo, each connecting directly to a tape head with no other electronic equipment required. Kit \$34.95. Wired \$57.95.

HF51 Two-Way Speaker System, complete with factory-built cabinet. Jensen 8" woofer, matching Jensen compression-driver exponential horn tweeter. Smooth clean bass; crisp extended highs. 70-12,000 cps ± 6 db. Capacity 25 w. Impedance 8 ohms. HWD: 11" x 23" x 9". Wiring time 15 min. Price \$39.95.

THE HI-FI EXPERTS SAY:

"For those who have been looking for a well-engineered yet inexpensive power amplifier, the newly-released EICO Model HF20 unit might offer a simple solution to their problem. Not only does this unit provide 20 watts of power but the circuit incorporates a preamplifier and a variety of controls on a single chassis."

William A. Stocklin, Editor, RADIO TV NEWS

"The new EICO 'standard' speaker system . . . produces sound that to my musical ears rates as excellent, from high top to clean low bottom."

Edward Tatnall Canby, AUDIO Magazine

Fill out coupon on other side for FREE CATALOG

** Patents pending by Hegeman Laboratories

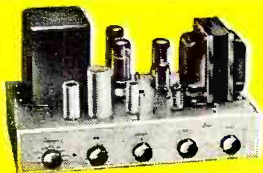

HF52, HF20 Integrated Amplifiers



HF12 Integrated Amplifier



HF30 Power Amplifier



HF51 Speaker System



33-00 Northern Boulevard, L. I. C. 1, N. Y.
Over 1 Million EICO instruments in use the world over.

the specs prove it...
your BEST BUY is

EICO®

for COLOR & Monochrome TV servicing

FREE CATALOG

shows you HOW TO SAVE 50%
on 50 models of top quality
professional test equipment.
MAIL COUPON NOW!

NEW!
**TV-FM SWEEP
GENERATOR &
MARKER #368**



KIT \$69⁹⁵ **WIRED \$119⁹⁵**

Entirely electronic sweep circuit (no mechanical devices) with accurately-biased inereductor for excellent linearity. Extremely flat RF output: new AGC circuit automatically adjusts osc. for max. output on each band with min. ampl. variations. Exceptional tuning accuracy: edge-lit hairlines eliminate parallax. Sweep Osc. Range 3-216 mc in 5 fund. bands. Variable Marker Range 2-75 mc in 3 fund. bands; 60-225 mc on harmonic band. 4.5 mc Xtal Marker Osc., xtal supplied. Ext. Marker provision. Sweep Width 0-3 mc lowest max. deviation to 0-30 mc highest max. dev. 2-way blanking. Narrow range phasing. Attenuators: Marker Size, RF Fine, RF Coarse (4-step decade). Cables: output, 'scope horiz., 'scope vertical. Deep-etched satin aluminum panel; rugged grey wrinkle steel cabinet.

**NEW! RF
SIGNAL GENERATOR
#324**



KIT \$26⁹⁵ **WIRED \$39⁹⁵**

150 kc to 435 mc with ONE generator! Better value than generators selling at 2 or 3 times its cost! Ideal for IF-RF alignment, signal tracing & trouble-shooting of TV, FM, AM sets; marker gen.; 400 cps audio testing; lab. work. 6 fund. ranges: 150-400 kc, 400-1200 kc, 1.2-3.5 mc, 3.5-11 mc, 11-37 mc, 37-145 mc; 1 harmonic band 111-435 mc. Freq. accurate to ±1.5%; 6:1 vernier tuning & excellent spread at most important alignment freqs. Etched tuning dial, plexiglass windows, edge-lit hairlines. Colpitts RF osc. directly plate-modulated by K-follower for improved mod. Variable depth of int. mod. 0-50% by 400 cps Colpitts osc. Variable gain ext. amplifier: only 3.0 v needed for 30% mod. Turret-mounted coils slug-tuned for max. accuracy. Fine & Coarse (3-step) RF attenuators. RF output 100,000 uv; AF sine wave output to 10 v. 50-ohm output Z. 5-way jack-top binding posts for RF in/out; coaxial connector & shielded cable for AF out. 12AU7, 12AV7, selenium rectifier; xmfr-operated. Deep-etched satin aluminum panel; rugged grey wrinkle steel cabinet.

**NEW! DYNAMIC
CONDUCTANCE
TUBE & TRANSISTOR
TESTER #666**



KIT \$69⁹⁵ **WIRED \$109⁹⁵**

COMPLETE with steel cover and handle.
SPEED, ease, unexcelled accuracy & thoroughness. Tests all receiving tubes (and picture tubes with adapter). Composite indication of Gm, Gp & peak emission. Simultaneous sel of any 1 of 4 combinations of 3 plate voltages, 3 screen voltages, 3 ranges of continuously variable grid voltage (with 5% accurate pot). New series-grid voltages: for 600, 450, 300 ma types. Sensitive 200 ua meter. 5 ranges meter sensitivity (1% shunts & 5% pot). 10 SIX-position lever switches: freepoint connection of each tube pin. 10 pushbuttons: rapid insert of any tube element in leakage test circuit & speedy sel. of individual sections of multi-section tubes in merit tests. Direct-reading of inter-element leakage in ohms. New gear-driven rollehart. Checks n-p-n & p-n-p transistors: separate meter readings of collector leakage current & Beta using internal dc power supply. Deep-etched satin aluminum panel; rugged grey wrinkle steel cabinet. CRA Adapter \$4.50

NEW!
**COLOR
and Monochrome
DC to 5 MC LAB & TV
5" OSCILLOSCOPE
#460**



KIT \$79⁹⁵ **WIRED \$129⁵⁰**

• Features DC Amplifiers!
Flat from DC-4.5 mc, usable to 10 mc. VERT. AMPL.: sens. 25 rms mv/in; input Z 3 megs; direct-coupled & push-pull thruout; K-follower coupling bet. stages; 4-step freq-compensated attenuator up to 1000:1. SWEEP: perfectly linear 10 cps-100 kc (ext. cap. for range to 1 cps); pre-set TV V & H positions; auto. sync. ampl. & lim. PLUS: direct or cap. coupling; bal. or unbal. inputs; edge-lit engraved lumite graph screen; dimmer; filter; bezel fits std photo equip. High intensity trace CRT. 0.06 usec rise time. Push-pull hor. ampl., flat to 400 kc, sens. 0.6 rms mv/in. Built-in volt. calib. Z-axis mod. Sawtooth & 60 cps outputs. Astig. control. Retrace blanking. Phasing control.

**NEW! PEAK-to-PEAK
VTVM #232 & UNI-
PROBE (pat. pend.)**



KIT \$29⁹⁵ **WIRED \$49⁹⁵**

Half-turn of probe tip selects DC or AC-Ohms.
Uni-Probe - exclusive with EICO - only 1 probe performs all functions!
Latest circuitry, high sensitivity & precision, wide ranges & versatility. Calibration without removing from cabinet. New balanced bridge circuit. High Z input for negligible loading. 4 1/2" meter, can't burn-out circuit. 7 non-skip ranges on every function. 4 functions: +DC Volts, -DC Volts, AC Volts, Ohms. Uniform 3 to 1 scale ratio for extreme wide-range accuracy. Zero center. One zero-adj. for all functions & ranges. 1% precision ceramic multiplier resistors. Measure directly peak-to-peak voltage of complex & sine waves: 0-4, 14, 42, 140, 420, 1400, 4200. DC/RMS sine volts: 0-1.5, 5, 15, 50, 150, 500, 1500 (up to 30,000 v with HVP probe & 250 mc with PRF probe). Ohms: 0.2 ohms to 1000 megs. 12AU7, 6AL5, selenium rectifier; xmfr-operated. Deep-etched satin aluminum panel, rugged grey wrinkle steel cabinet.

**5" PUSH-PULL
OSCILLOSCOPE
#425**



KIT \$44.95
Wired \$79.95

**7" PUSH-PULL
OSCILLOSCOPE
#470**

KIT \$79.95
Wired \$129.50

**TUBE TESTER
#625**



KIT \$34.95
Wired \$49.95

- tests 600 mil series string type tubes
- illuminated roll-chart

Pix Tube Test Adapter \$4.50

**6V & 12V
Battery Elim
& Charger
#1050:**



KIT \$29.95
Wired \$38.95

For transistorized eqpt, #1060:
KIT \$38.95, Wired \$47.95

**Sup. hi-gain RF
& lo-gain audio
inputs.
Special noise
locator. Calibra-
ted wattmeter.**



KIT \$24.95
Wired \$39.95

DELUXE MULTI-SIGNAL TRACER #147



**20,000 Ohms/Volt
MULTIMETER #565**

KIT 24.95
Wired \$29.95

**1000 Ohms/Volt
MULTIMETER
#536**

KIT \$12.90
Wired \$14.90

**Reads 0.5 ohms
-500 megs, 10
mmfd-5000 mfd,
power factor.**



KIT \$19.95
Wired \$29.95

**R-C BRIDGE & R-C-L COMPARATOR
#950B**

VTVM PROBES **KIT * Wired**

Peak-to-Peak \$4.95 \$6.95

RF \$3.75 \$4.95

High Voltage Probe-1 \$6.95

High Voltage Probe-2 \$4.95

SCOPE PROBES

Demodulator \$3.75 \$5.75

Direct \$2.75 \$3.95

Low Capacity \$3.75 \$5.75

TURN PAGE
FOR MORE
EICO VALUES

EICO®

Send for
FREE CATALOG
now

EICO, 33-00 Northern Blvd., R-3
L.I.C. 1, N. Y.

Show me HOW TO SAVE 50% on Test Equipment and Hi-Fi. Send me FREE Catalog and name of neighborhood distributor.

Name.....

Address.....

City..... Zone..... State.....

Prices 5% higher on West Coast.

L.I.C. 1, N.Y.

Receiving U. S. Satellite Signals

By **WHITNEY MATTHEWS**

Head, Applications Br., Solid State Div.
U. S. Naval Research Laboratory

Satellite with upper hemisphere removed is shown here. The complete electronic package with all its modules labeled is below.

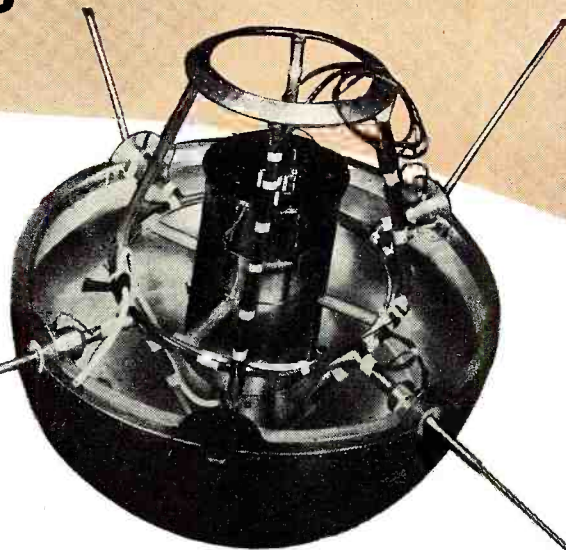

- MINITRACK RADIO TRANSMITTER
- LYMAN-ALPHA PEAK MEMORY UNIT
- TELEMETERING ENCODER
- METEORITIC COLLISION AMPL. AND COUNTER
- LYMAN-ALPHA ELECTROMETER
- SMALL BATTERY PACK
- LARGE BATTERY PACK



The complete, authoritative story about the radio signals that the U. S. satellite will broadcast.

ELECTRONIC technicians and hobbyists have an opportunity to make valuable contributions to the scientific effort of the current International Geophysical Year. Plans for launching instrumented artificial earth satellites have been announced by the United States and the U.S.S.R. Signals from these vehicles can be received by radio amateurs, hi-fi enthusiasts, or electronic technicians without great difficulty. Extensive participation of amateur observers would make available potential sources of valuable data which would be prohibitively costly by means of primary recording stations. Numerous amateur tracking stations will be in operation using either visual or radio tracking methods. Technical data for the construction of such stations has been published previously. Amateur stations for the collection and recording of scientific data are much less complex than tracking stations.

Not all of the satellites to be launched by the United States will provide continuous transmission of scientific data. Early satellites may be placed in orbit as a part of the launching vehicle test program. These possible early satellites would carry unmodulated radio transmitting equipment intended primarily for radio tracking. While not regarded as true instrumented satellites, they would be capable of providing temperature information by accurate calibration and

measurement of transmission frequencies. Several designs of fully instrumented scientific satellites are being prepared which will carry aloft, in succession, various combinations of scientific instruments. As presently planned, the first two instrumented satellites to be launched will provide continuous transmission of scientific data. It is these which would be of most interest to amateur observers. Designs for later launching will provide data transmission only when initiated by powerful ground transmitters. This technique is used where power required by scientific instruments prohibits continuous transmission or where it is necessary to play back and erase information recorded on magnetic tape. Amateur observers can participate in collecting the intermittently transmitted data only when located sufficiently close to a primary recording station to receive signals when data is being transmitted.

Receiving Satellite Signals

The U. S. satellite will be launched from the Patrick Air Force Base at Cape Canaveral in Florida. The satellite will circle the earth approximately once each 90 minutes. The plane of the orbit will make an angle of approximately 35° with respect to the

equatorial plane of the earth. Due to the rotation of the earth, each successive orbit will receive an apparent shift westward of about 1200 miles. The general character of the path of the satellite over the surface of the earth is shown in Fig. 1. Eventually the satellite will rather thoroughly traverse the unshaded portion which represents nearly two thirds of the earth's surface area. Near overhead transits of the satellite would thus be available to observers between 35° N and 35° S latitudes. Reception of signals outside this zone would be determined by receiver sensitivity, antenna gain, and height of the satellite above the earth. The orbit of the satellite is expected to be elliptical with altitudes between 200 and 1500 miles.

Provision for an adequate number of official recording stations to permit continuous radio reception of satellite signals would be prohibitively costly. Primary recording station locations are also shown in Fig. 1. A chain of stations is located roughly along the 75th meridian down the east coast of the United States and the west coast of South America. These stations provide a "picket fence" coverage which the satellite must cross once each orbit. Two stations at Antigua, B.W.I. and San Diego, California provide data

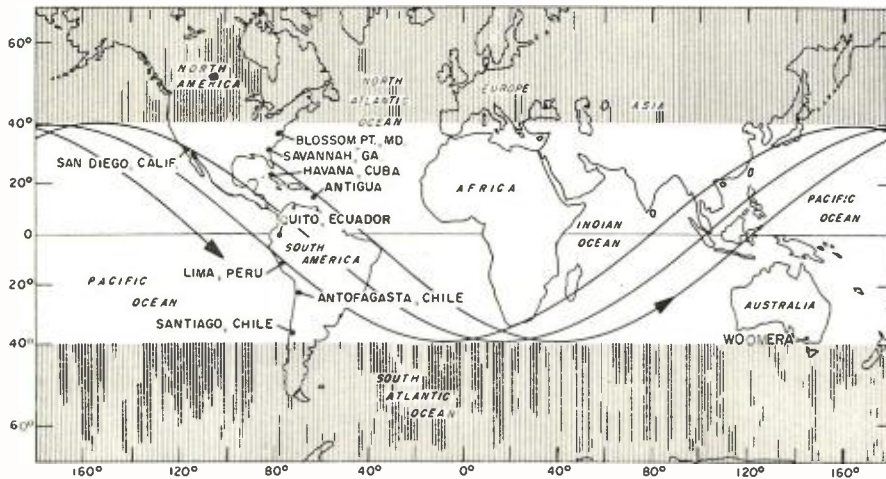
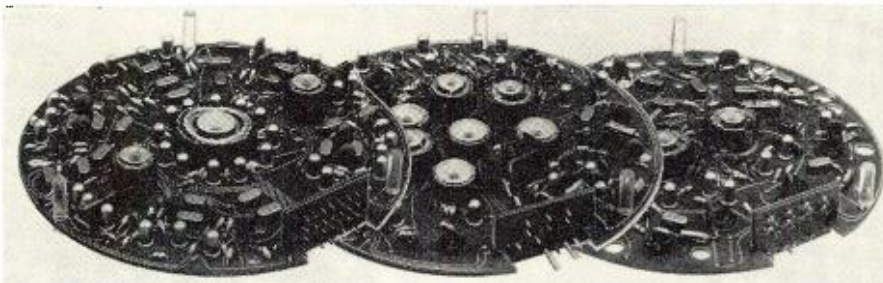

Fig. 1. Some typical paths of artificial earth satellite over the earth's surface.

Fig. 2. Satellite airborne telemetry encoder is at left. Center unit is the meteoritic collision electronics with its amplifier and three decimal digit counter. Unit at right is Lyman-alpha peak memory electronics including orbital switch for reset once each orbit. Circuits are printed and extensive use is made of transistors and magnetic amplifier coils. Units later covered with plastic foam.



early in and before completion of the first orbit. One additional station at Woomera, Australia will provide frequent data at approximately half orbital periods from other stations for the benefit of scientific experimenters. Orbital parameters will be calculated from tracking data and made available to news wire services. Contact with local newspapers, television or radio stations should provide adequate information to permit amateur observers to know when to seek these signals. Possibilities of visual observation of the satellite are limited to times just before dawn or after dusk. The sun must be sufficiently below the horizon to provide a dark sky yet sufficiently near to illuminate the satellite.

All scientific data will be transmitted by means of the "Minitrack" radio tracking transmitter in the satellite. This transistorized, crystal-

controlled transmitter operates on a carrier frequency of 108.00 megacycles and is amplitude modulated (AM) for data transmission. Peak operating power is about 100 milliwatts with 100% modulation. Batteries carried by the satellite are expected to provide between three and four weeks' active life. Airborne telemetry equipment is used to accept inputs from the various scientific instruments and combine them into a single coded electrical signal for transmission to the ground receiving stations.

Telemetry signal frequency components are in the audio frequency range and within the recording capability of many high-fidelity home magnetic tape recorders. Maximum frequencies of 15 kc. are used with signals rarely exceeding 12.5 kc. Two alternatives are available to persons not now having equipment to receive 108-mega-

cycle AM signals who wish to observe the satellite with their present equipment. Converters are available or can be built by owners of communications type receivers. This method offers the advantage of being able to use a beat-frequency oscillator to detect passage of a satellite transmitting an unmodulated carrier. The second method requires the addition of a simple AM detector circuit to a high-fidelity FM tuner. Commercially available antennas designed for fringe area reception of FM broadcast signals should provide ample gain for all but the most unfavorable reception conditions. Desirable mounting of such an antenna would be in a generally skyward direction for latitudes of 35° or less. Simple means could be provided for rotation of the antenna in a direction to permit adjustment in advance for best reception of the next anticipated transit.

Many of the scientific phenomena to be studied occur infrequently and at random. These very facts prevent their systematic study by high-altitude research rockets. Most desirable would be the occurrence of one of these events as the satellite signal was being recorded at a primary receiving station. Such an observation would provide a detailed record of instantaneous measurements as a function of absolute time. Although possible, unfortunately the chances for an official receiving station to record such an event are quite remote. An adequate number of properly located amateur observers would make certain the availability of the desired records. Airborne equipment will include memory devices for storing a limited amount of information concerning these events for later transmission to official ground stations. These signals will provide meager data on all such events viewed by satellite instruments but will be far less informative than a properly made amateur recording obtained during the event itself.

Recordings of amateur observers offer many possibilities of obtaining valuable data other than observation of specific events. This is particularly true of data obtained during the early life of a satellite. Obviously such data would be of utmost value in case of a short active life of a satellite or any of its scientific experiments. Such records would also be of value in case of errors in the predicted rate at which phenomena being studied are expected to occur. Details regarding potential value of amateur recordings will be presented later in the discussion of each experiment.

The Lyman-Alpha Satellite

One of the first fully instrumented scientific satellites planned for launching by the United States will be devoted to two general types of measurements. One group of measurements will study ultraviolet radiation from the sun in the region of the solar spectrum known as Lyman-alpha. The second group of experiments designed

THIS MONTH'S COVER

THE top half of the first fully instrumented U. S. satellite is carefully being put into place. The 20-inch, 21.5-pound shiny ball will then be mounted within the nose of the three-stage Vanguard rocket, shown blasting off on our cover. The rocket is then expected to rise vertically at first and then gently turn in the direction of its planned orbit. After successive burnout of the three stages, the tiny ball should be hurtling around the earth at about 18,000 miles per hour. (Photos: U. S. Naval Research Laboratory.)

to study the satellite environment includes measurement of temperatures and various types of information relative to collision between the satellite and small particles (micrometeorites) in space. Equipment in the satellite will include a telemetry encoder system. This equipment converts measurements made by the various airborne instruments into a single signal for transmission to ground receiving stations. The desired scientific information may be extracted from the received signal by appropriate decoding.

All information will be transmitted in the form of a series of high-frequency (5 to 15 kc.) bursts carrying information on the frequency of these bursts, time duration of each burst, and the time interval between bursts. Thus three information channels are associated with each burst. Each frame or scan of all information channels will consist of a sequence of sixteen such bursts for a basically 48-channel telemetry system. The airborne telemetry encoder system used to produce these signals is shown in Fig. 2. This unit is 5½ inches in diameter, ¾-inch high, and weighs about 3½ ounces. It operates on 2.7 volts with a current drain of 3 to 4 milliamperes. A new frame will begin immediately upon completion of each scan. Thus the exact scanning rate will be a variable quantity determined by the values of input signals which control burst duration and spacings. Signal values are expected to lie in a range which provides three to four frames of telemetered data per second.

Of the measurements being made, some will undergo only insignificant short time changes while others will be changing rapidly with time. For example, outer shell temperatures will rise slowly as the satellite heats up when in sunlight and slowly drop as the shell cools when in the earth's shadow. Thus, temperature changes during one telemetry frame are of no

★
 Fig. 3. Here the entire electronics package is being installed in the satellite. The electronic circuits are encased in a foam-in-place plastic material.
 ★



great importance. On the other hand, measurements of inputs such as the Lyman-alpha radiation do undergo significant changes during a single telemetry frame. For this reason, several channels in each frame are devoted to frequent repetition of these rapidly changing signals. Such signals are also transmitted as a burst frequency to permit measurement of changes during the burst interval.

An oscillogram of a complete typical telemetry frame is shown in Fig. 4. Photographic resolution at the scanning rate used to present a full frame does not permit distinction between cycles in each high-frequency burst. This oscillogram, together with Table 1, will permit ample description of channel assignments to permit amateur observers to seek out any desired signal for study. It will be noted that all channels carrying information in the form of the burst frequency are identified by a single letter. Channels whose data is presented as a burst duration are designated by a letter

followed by the numeral 1. Similarly information contained in a burst spacing carries a letter identification followed by the numeral 2.

Each telemetry frame may be conveniently regarded as being divided into two sequences of eight high-frequency bursts each. Each such half frame is distinguished by six initial bursts containing an alternate rhythmic repetition of long and short bursts carrying data on instantaneous solar Lyman-alpha radiation and solar aspect (orientation of the satellite with respect to the sun). Thus each half frame can be seen to start with the burst channel sequence A-B-A-B-A-B in Fig. 4 or Table 1. Identification of these channels is relatively easy in any display medium whether it be audible listening, oscillographic presentation, or photographic reproduction. The remaining two high-frequency bursts in each half-frame scan will carry data readout of satellite memory units. The two final bursts of successive half-frames will thus alternately

Fig. 4. Typical Lyman-alpha satellite scientific telemetry signal with all components of signal properly labeled.

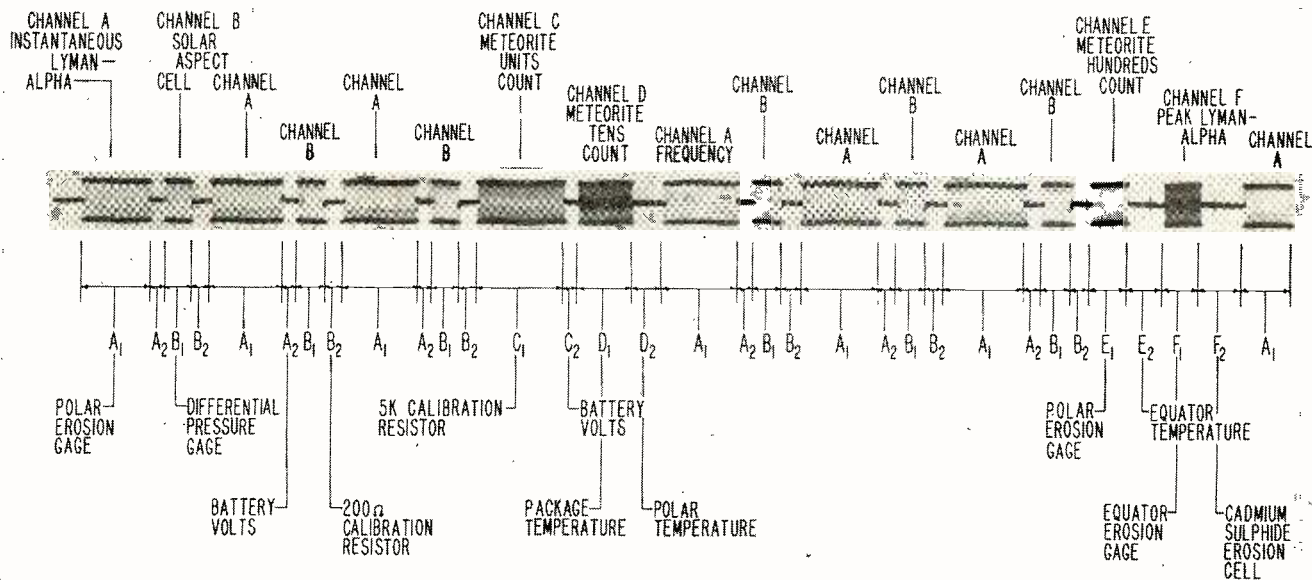

HIGH-FREQUENCY BURST		BURST-DURATION		INTERVAL BETWEEN BURSTS	
Channel	Function	Channel	Function	Channel	Function
A	Instan. Lyman alpha	A1	Polar erosion A	A2	Battery volts
B	Solar aspect	B1	Differ. pressure	B2	Short calibrate
A	Instan. Lyman alpha	A1	Polar erosion A	A2	Battery volts
B	Solar aspect	B1	Differ. pressure	B2	Short calibrate
A	Instan. Lyman alpha	A1	Polar erosion A	A2	Battery volts
B	Solar aspect	B1	Differ. pressure	B2	Short calibrate
C	Meteor count, units	C1	Long calibrate	C2	Battery volts
D	Meteor count, tens	D1	Package temp.	D2	Polar skin temp.
A	Instan. Lyman alpha	A1	Polar erosion A	A2	Battery volts
B	Solar aspect	B1	Differ. pressure	B2	Short calibrate
A	Instan. Lyman alpha	A1	Polar erosion A	A2	Battery volts
B	Solar aspect	B1	Differ. pressure	B2	Short calibrate
A	Instan. Lyman alpha	A1	Polar erosion A	A2	Battery volts
B	Solar aspect	B1	Differ. pressure	B2	Short calibrate
E	Meteor count, hundreds	E1	Polar erosion B	E2	Equator skin temp.
F	Peak Lyman alpha	F1	Equator erosion	F2	Cadmium sulphide cell

Table 1. Telemetry channel assignments for Lyman-alpha-environmental satellite.

present information on (1) units digit and tens digit of the cumulative meteoritic collision count (channels C and D) or (2) hundreds digit of the meteoritic collision count and orbital peak value of solar Lyman-alpha radiation.

Positive identification of alternate half-frames is provided by appropriate control of burst and spacing durations. Thus the duration of the meteoritic collision count units digit burst (channel C) is used to present the long calibration channel (C1). This burst duration remains essentially un-

changed and is always of greater duration than any other burst. This long calibration channel is followed immediately by the shortest burst spacing in the frame (channel C2). This shortest burst spacing monitors the telemetry battery voltage. This identification of the telemetry signal half-frames is evident from an examination of Fig. 4. The long calibration channel C1 in the first half-frame is obviously longer than its counterpart channel E1 in the second half-frame. Similarly the succeeding channel C2

is much shorter than is channel E2. Methods used by amateur observers to study records made will be determined, to a great extent, by the equipment available. Experience has shown that, with practice, a simple listening test can reveal valuable information. Listening tests are greatly enhanced when original recordings are made at a high tape speed and played back at a lower speed. This technique reduces the high frequencies for improved audibility and at the same time increases burst durations and spacing for easier resolution.

Approximate calibration curves for the various information channels are shown in Fig. 5. These charts should be regarded as general guides only since variations can be expected between various telemetry assemblies. Precise measurements can only be made by use of individual calibration for the specific equipment flown in any satellite. Obviously this cannot be known until a satellite is launched since last minute equipment substitution may be required. The curves shown should however prove adequate for most needs of amateur observers.

The Scientific Experiments

Solar Lyman-Alpha Radiation: Lyman-alpha radiation from the sun refers to a very limited portion of the ultraviolet region of the solar spectrum. Measuring devices sensitive only to this radiation are carried. The earth's atmosphere is quite opaque to such radiation and thus prohibits its measurement from ground based stations. Satellite or rocket vehicles must therefore be used in any such studies. Much has been learned by means of research rockets but this technique for rockets to reach altitude and the short time they remain aloft have effectively hampered study of transitory Lyman-alpha phenomena.

Telemetry signals will contain two types of presentation of data relative to solar Lyman-alpha radiation. The first type of presentation will transmit an instantaneous value of this radiation at all times. Study of these signals will permit study of this radiation from a quiescent sun. Short time variations in this signal are of great importance. Not only may short term changes take place in the signal from the sun but will additionally be varying due to spin of the satellite itself. Thus the detectors will spend approximately two thirds of each spin period in the shadow of the satellite and the telemetry signal will be that indicating no input to the detector. Adequate study thus requires a great portion of the telemetry time to be devoted to instantaneous values of solar Lyman-alpha data. From Fig. 4 it can be seen that this is accomplished in two ways. First, this signal (channel A) is repeated six times in each telemetry frame. Second, each presentation is continued for a comparatively long period of time. Any single such dis-

(Continued on page 154)

Fig. 5. Some typical Lyman-alpha satellite calibration curves are shown here.

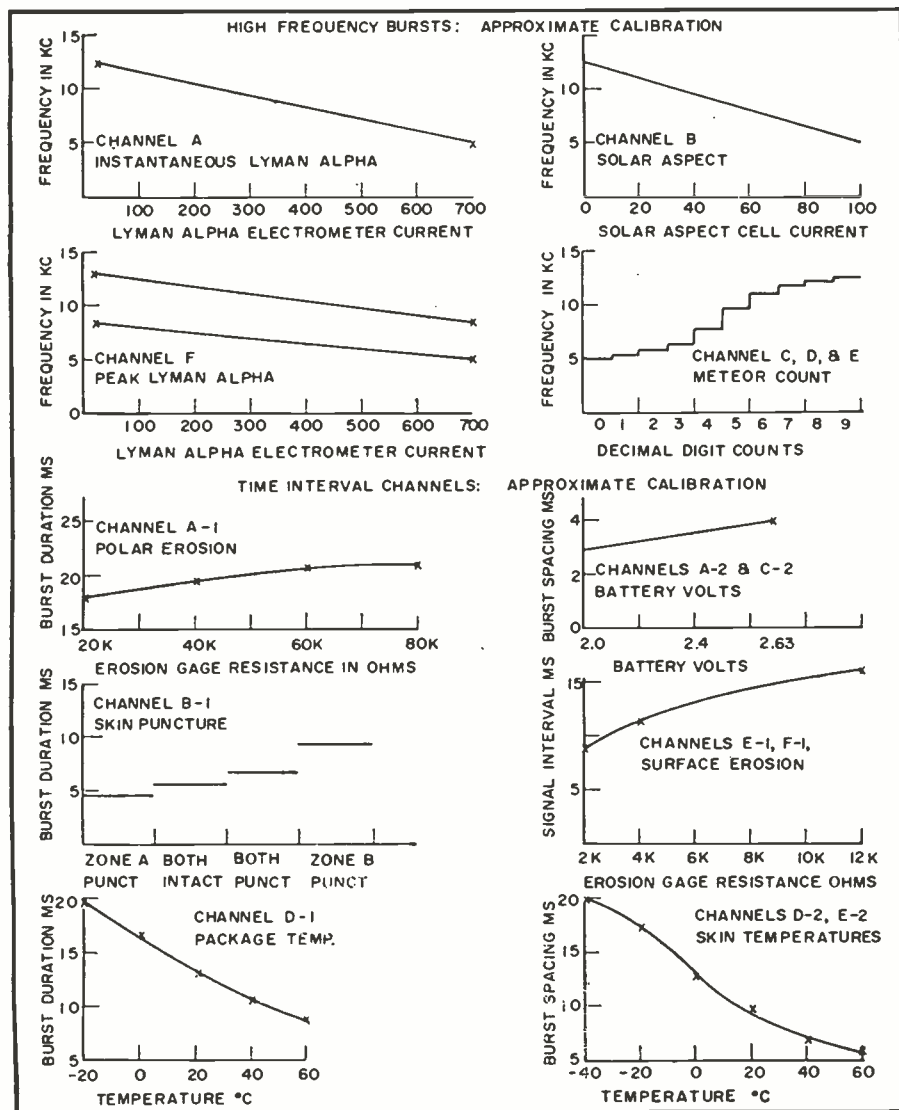

Hidden Bypass Action

By JAMES A. McROBERTS

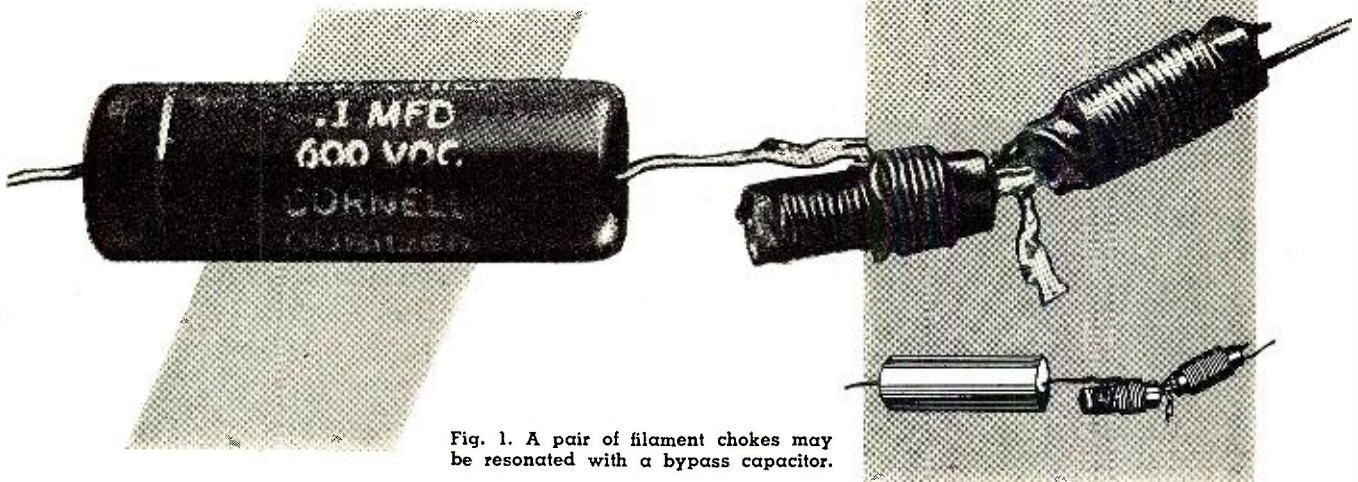

Fig. 1. A pair of filament chokes may be resonated with a bypass capacitor.

THE USE of bypass capacitors throughout the average TV receiver, radio, or other item of electronic equipment is no news to anyone in electronics. However, there is also frequent use of *series-resonant* bypass action, although only a capacitor may be obvious in the circuit. Commercially available self-resonant capacitors are used not only by set manufacturers, but also after manufacture in cooling down "hot" sets. Hence, some information on this subject is desirable.

Ordinary bypass of the screen grid to ground, by way of capacitor C_{sg} , is shown in Fig. 2. The capacitor presents a low-impedance path to the a.c. voltage present at the screen grid. The same is true for cathode bypass action and for the bypass capacitors on the "B+" and a.v.c. or a.g.c. lines. However, a capacitor alone is not a perfect bypass. It also presents some impedance to the flow of the unwanted signal current to ground. For most cases, the bypass impedance is low enough so that regeneration and other troubles do not occur.

With increasing gain, the rule for "most cases" may not hold true. Sufficient unbypassed a.c. voltage may remain present to cause trouble. Increase in size (capacitance) of the bypass capacitor will lower the unbypassed voltage; but there is a limit to the size of

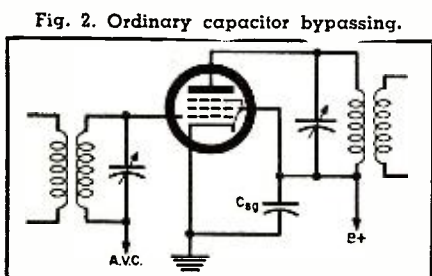

Fig. 2. Ordinary capacitor bypassing.

Lead dress, special components, and other factors may supply circuit action not shown schematically.

the bypass capacitor, both physically and economically. As a result, series-resonant bypass action may be required.

By placing an inductor (L_{sg} in Fig. 3) in series with the bypass capacitor, the circuit may be made to resonate at some particular frequency. This can be the frequency to be bypassed, such as the i.f. of a radio set. With a sufficiently low "Q" an entire band of frequencies can be bypassed. *Westinghouse* is one TV manufacturer that has used series-resonant bypassing with low "Q" circuitry to bypass in a TV i.f. circuit.

Radio Applications

A set that has become an annoying "whistler" or "squealer" will probably be the most common case in radio service where it will be desirable to incorporate series-resonant bypass action. Special capacitors for this purpose are manufactured by *Sprague* (LP series) and *Aerovox* (RC series). The bandwidth of these units is broad enough to cover the commonly used intermediate frequencies in the vicinity of 455 to 470 kc. In operating on a radio troubled with whistling or squealing, such a capacitor is experimentally shunted across the "B+" line, the a.v.c. line, at each screen grid, and at each cathode, in turn. It is probable that the annoying regeneration originates, for the most part, at just one of these points. When the special capacitor is put in the right place, the symptom should vanish.

If the special units are not readily at hand and there is some inconven-

ience in obtaining them, they can be fabricated in the shop without great difficulty. An ordinary bypass capacitor may be combined with a suitable coil. In the i.f. range for radio sets, the inductor may be made up of a pair of TV filament chokes in series. Such a combination is shown in Fig. 1. One of the chokes has had about three-quarters of its winding (by trial and error) removed while the other choke is fully wound. In place of the two filament chokes, a 43-mc. TV i.f. coil with an adjustable slug may also be used. The resonant bypass works well when either type of choke is used.

The capacitive reactance of a .1- μ fd. bypass capacitor at 455 kc. is approximately 3.5 ohms. Including a small amount of resistance, the total a.c. impedance is slightly higher than that figure. When this capacitor is made series-resonant by the addition of an inductor of the proper value, there is no reactance; and total impedance, which is purely resistive, will usually be a trifle under .2 ohm. This means

(Continued on page 117)

Fig. 3. Coil added to bypass circuit.

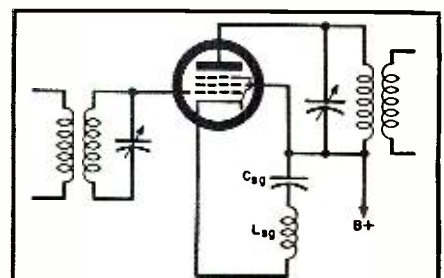

Intermittents Can be Licked

Fig. 1. Slight flexing of a printed board will often reveal a hairline crack, like the one shown, that has been responsible for a puzzling effect.

By
RALPH D. SAPPE

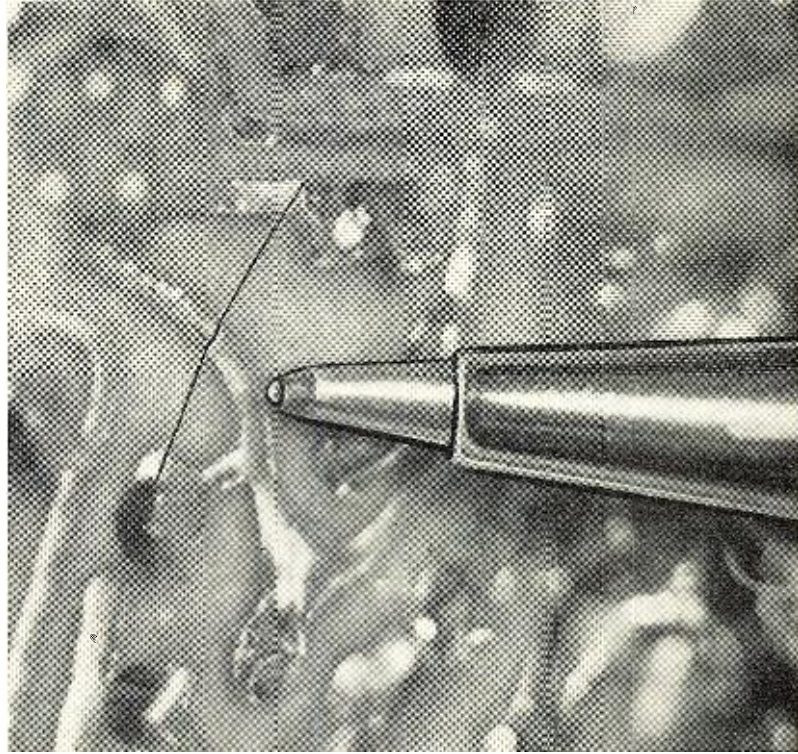

Take some of the guesswork out of finding faults that won't stay put; use persistence and method.

LITTLE exasperates a service technician more than an intermittently operating receiver. This type is almost always branded with the title of "dog," since it can and usually does result in loss of time and profit. Many shops are reluctant to service an intermittent but are more or less forced to do so in order to preserve good customer relationships.

In many instances, the section in which the intermittent component is located can be isolated in much the same way as in a set which is not intermittent. For example, if a TV receiver loses vertical deflection intermittently, you would check into the vertical oscillator, vertical output stages, and deflection yoke. If there is intermittent sound, you would check the sound section and speaker. If there is intermittent video and sound, you would check the tuner and all stages up to the point where the sound is taken off.

However, there are some cases in which the faulty section cannot be readily localized. For example, an intermittent raster could be caused by a fault in the picture tube, high-voltage rectifier, damper tube, horizontal-output tube, horizontal-oscillator tube, horizontal-a.f.c. tube, or any of these associated circuits. In some sets, a defective video amplifier will also kill the raster. An intermittently over-driven picture could be caused by any stage in the tuner or video i.f. strip, video amplifier, or in the a.g.c. circuit. In the case of intermittently operating radio receivers, the trouble could

be in the r.f. amplifier, the oscillator, mixer, i.f. tube, detector, voltage amplifier, power amplifier or rectifier—in other words, just about anywhere in the set.

There are a few commercial intermittent analyzers on the market which are of great value in localizing the defective stage. Some of them can be connected to more than one circuit at the same time and, when the intermittent occurs, they will indicate what circuit the trouble is in.

After we think we have localized

EDITOR'S NOTE: *You know all about heat lamps, elevated-voltage techniques, cold-solder joints, and the other mumbo-jumbo pertaining to intermittents? Good: but we think this reprise will be well worth your time anyhow. The key to successful intermittent service, after all, is not so much uncanny skill combined with great inspiration as it is the dogged and thorough application of conventional techniques. How many of the last few "dogs" you tackled turned out to be something that you would have come across much sooner than you did, if you had been more thorough or systematic? The hints catalogued here, though they may be nothing more than reminders to you, may help break the next tough one.*

the circuit or circuits which are intermittent, with commercial analyzers or by other means, how do we go about finding the faulty component? There are various methods. Three of the most common ones are tapping tubes and suspected parts, applying heat to suspected parts, and increasing the operating voltage of the receiver under test with the use of a variable-voltage transformer.

If tapping a tube brings on the

trouble, the only sure way of testing that tube is to insert one which is known to be good in its place, since a tube may not show up as intermittent under the particular conditions of operation in a tube tester.

If tapping the new tube still causes intermittent operation, the tube-socket contacts may be loose or dirty or there may be a bad solder connection on any of the socket pins. A word about solder connections: it is a good idea to go over *all* of them in a suspected stage or, in the case of a radio, to go over all solder connections in the set, paying particular attention to ground connections. This procedure has been found to cure a good number of "dogs." Cold solder connections may look good, but could very well be the cause of your hair-pulling. Also look for lumps of solder which are extremely close to other contacts or the chassis that have been left by careless service technicians or even factory assembly workers. Heat may cause expansion of these sloppy joints and an intermittent short might result.

If the trouble is not a tube, dirty tube-socket contacts, or poor solder connections, it can be an intermittent resistor, capacitor, transformer, coil, worn insulation of a wire, dirty switch contacts, or, in the case of printed circuits, a microscopic break in the wiring.

Capacitors may often open intermittently after they become warm. Pushing and pulling on the component and its leads (Fig. 2) will reveal if this is the cause. An intermittent bypass or coupling capacitor can be the cause of oscillations or howls. Be especially watchful of small trimmer capacitors, like those used in the horizontal-drive circuits of some sets.

The thin mica dielectric may be cracked or split thereby causing intermittent operation.

Probing and tapping resistors, coils, and transformers with a nonmetallic instrument will sometimes reveal the trouble.

If probing components reveals nothing, a variable-voltage transformer may be used to increase the operating voltage from a normal 117 volts to about 130 volts. This will cause any faulty component which is on the borderline of breakdown to surrender, thus making possible the use of routine troubleshooting methods to locate the guilty component. However, do not, under any circumstances, increase the operating voltage to more than 130 volts, as this may also cause breakdown of good components and you will add new troubles to the ones already present.

When a receiver is on the bench for repairs, an intermittent which occurs due to the build-up of heat may be less likely to manifest itself, since the chassis is not enclosed in the cabinet. A box can be placed over the chassis while it is on the bench in order to simulate the relatively poor ventilation of actual operating conditions. Another method is to apply external heat to the particular suspected parts. This can be done with the aid of a soldering gun or with a heat lamp. The soldering gun is held close to (but not touching) the suspected component (Fig. 3) to see if the application of heat causes that component to become intermittent. When using a heat lamp, a paper funnel should be used, as in Fig. 4, to aim the heat directly at one component at a time. Be careful not to apply too much heat for too long a time, for the object of this test is to locate the bad component and not to ruin the good ones.

In the case of printed circuits, if pressure on the printed circuit board

causes the intermittent trouble to occur, try to locate a break in the printed wiring by flexing the board slightly. Do not overdo this. A cracked board that was exposed in just such a fashion is shown in Fig. 1. If flexing the board shows nothing, try sweating all connections on the board. If the circuit is still intermittent, the costly but rapid method of replacing the entire printed board can be used. It could turn out to be the least costly method after all.

Watch for any wires which are run close to the chassis or which may be touching a contact or tube-socket pin. See Fig. 5. Check to see whether insulation is worn off or has been accidentally burnt off by the soldering gun of a previous technician who was perhaps a little careless. Clean the contacts on all doubtful switches with contact restorer (Fig. 7) and check them with an ohmmeter.

If the trouble is intermittent sound, do not overlook the speaker itself. One of the fine wires of the voice coil may be broken and intermittently making contact. Check this with an ohmmeter also. Make a continuity check while pressing lightly on the cone, as in Fig. 8.

Don't forget that a fault in one stage may be causing intermittent operation of another stage. For example, a heater-to-cathode short in one tube in a heater string may be robbing another tube of heater voltage, but still allow seemingly normal operation of all other tubes in its string—including the defective tube itself. With a heater-to-cathode short in tube "B" of Fig. 6, for example, tube "A" will receive no heater voltage, but tubes "C" and "D" will.

Before pulling a set for intermittent loss of sound and picture or intermittent snow, be sure that the trouble is in the set itself and not in the antenna. A badly rusted antenna or a

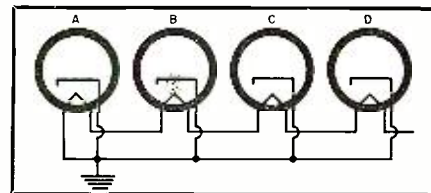

Fig. 6. A defective tube in a string will affect voltage supply to other tubes.

broken lead wire may be causing the trouble. If the fault did lie in the antenna and this were overlooked by the technician, it might take a few days of testing and waiting in the shop before this conclusion would finally be reached.

Above all, be sure that you have found the actual cause of intermittent operation of the set before returning it to the customer. Nothing can be more damaging to your reputation than returning a set with the same trouble it had originally. After making the repair, let the receiver play for a few hours *in the cabinet* so that you can be sure it is working properly. In the event a customer insists on having the set before you are satisfied with it, tell him that you cannot be sure of it unless you make additional tests. *Never* tell him that you *think* it's OK, or that you *hope* it's all right.

When you have repaired an intermittent "dog" you get a great deal of personal satisfaction as well as a boost in your reputation with the customer, especially when you have successfully tackled one where someone else has failed. Yet, in order to do this, you need more than just skill alone or "inspiration." A great deal of success with intermittents, or any tough service problems, depends on patience and perseverance—the willingness to employ approved service techniques and conventional test equipment properly, systematically, and insistently.

-30-

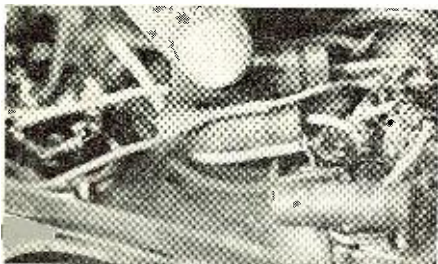

Fig. 2. Sometimes capacitor leads make contact with the inner foil intermittently.

Fig. 3. A soldering gun being used to apply heat to suspected components.

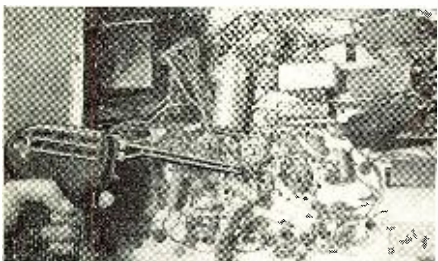

Fig. 4. To concentrate heat from a lamp in a restricted area, use a paper funnel.

Fig. 5. Check for burned or frayed insulation on wires run close to chassis.

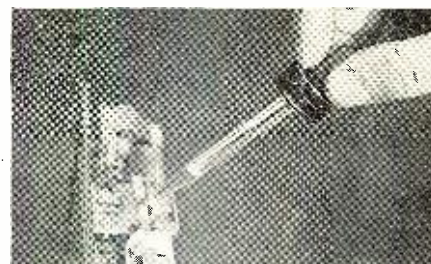
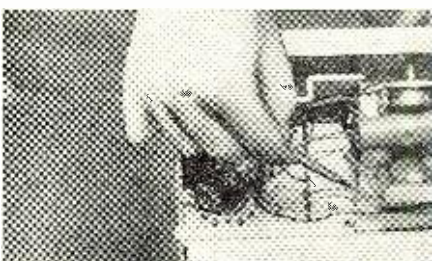
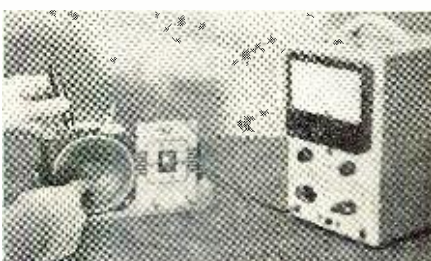

Fig. 7. To play safe, clean any doubtful switches with a contact restorer.

Fig. 8. Press on cone during continuity check to spot intermittent voice coils.



TRY to imagine the *ultimate* in a sound reproducing system . . . a perfectly matched preamp, power amplifier, loudspeaker system, and speaker enclosure with a frequency response flat beyond the limits of audibility, with an imperceptible level of intermodulation and harmonic distortion, and with a dynamic range capable of reproducing every signal from the softest whisper to the crashing thunder of a full symphony orchestra playing at peak volume.

Then take that ultimate system and install it in a room acoustically designed for it . . . with the right number of draperies, rugs, and other sound-absorbing material and with the exact amount of properly located sound reflecting or "live" surfaces.

Such a system in such a location should, and would, give a performance unequalled in quality. The most discriminating audiophile, the advanced audio engineer, the skilled musician, all would be thrilled and proud to own such a system.

But while every standard audio test instrument might indicate that the music played through such an audio system is identical to the music picked up at a "live" performance, this system would *still* lack an important quality of realism. It would lack a quality that would permit even the lowliest untrained ear to distinguish between the music played through it and the music which the listener hears at a live performance. This missing quality is *direction*.

Our ability to distinguish sound directions because of the slight differences in the sound picked up by our two ears is closely akin to our ability to perceive depth by mentally combining the two separate images picked up by our two eyes. Thus, many individuals feel that techniques which add *direction* to our sound perception is essentially the same as adding *depth* to sound.

Binaural Sound Reproduction

If we wish to reproduce sound mechanically while retaining the realistic quality of direction, it follows, then, that we must use *at least two* channels, one carrying the sound signals for the *left* ear and another carrying the sound heard by the *right* ear. Such

The **MAGIC** of

STEREOPHONIC SOUND

By **LOUIS E. GARNER, JR.**

Here's how you can step into the wonderful world of stereo and prove to yourself that stereo is fun.

a system is referred to literally as a "two-eared" or "binaural" system.

Let us consider a simple sound transmission system that would use such a technique. At the concert hall we could place an "artificial head" in the ideal position for a listener, say "10th row center." The artificial head may be made up of two microphones having response characteristics similar to a human ear and spaced about the same distance apart, say six inches, with a mass of some material separating them.

The sounds picked up by the microphones would be fed to two separate *but identical* audio amplifiers and from there to a pair of tightly fitted headphones on the head of the ultimate listener. The sound picked up by the *left* microphone, after amplification and transmission, would be fed only to the *left* earphone. Similarly, the sound picked up by the *right* microphone would be applied only to its corresponding earphone.

If the amplifiers, earphones, and microphones all had perfect reproduction characteristics, then *the listener would be unable to distinguish between the mechanically reproduced sound and that heard "in person" at the concert hall.*

Stereophonic Sound Reproduction

There is still another technique by which sound can be reproduced while retaining the quality of direction. To understand how this second technique works, let us consider that our listener is at his seat in the concert hall listening to a large orchestra.

Suppose, now, that an invisible wall is placed between the orchestra and the listener. This imagined wall will completely shut off the sound.

If small ideal microphones were placed at every point on this wall facing the orchestra, and these microphones, in turn, fed perfect amplifiers which drove ideal loudspeakers on the "listener" side of the wall . . . with a separate amplifier and loudspeaker for each microphone, and the loudspeakers located at points corresponding to the microphone positions, the sound reproduction on the "listener" side of the wall would be identical to that picked up on the "orchestra" side. *The listener would be unable to distinguish the reproduced music from that of the "live" orchestra.*

Theoretically, such a technique would require an infinite number of microphones, loudspeakers, and amplifiers, but, in practice, close to perfect results can be obtained with a smaller number of audio channels, provided the microphones (and reproducing loudspeakers) are widely spaced.

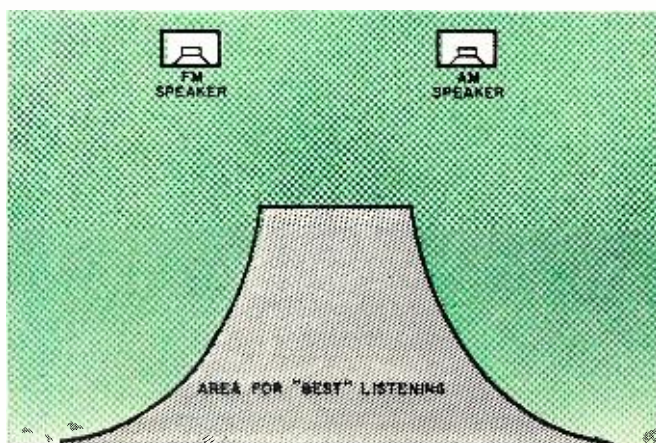

Fig. 1. Typical placement of loudspeakers for listening to stereophonic broadcasts. Probably the best point is a position on a vertical line between the two loudspeakers.

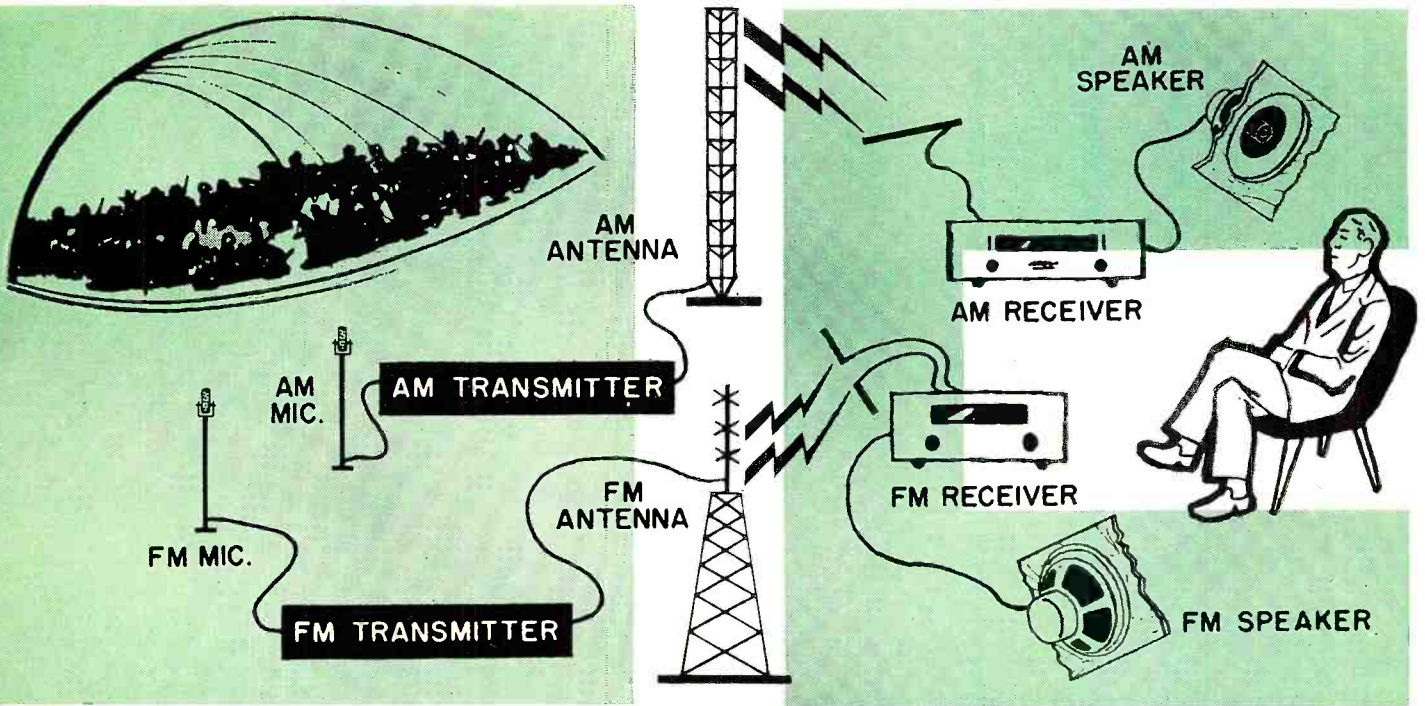

Fig. 2. This is the basic arrangement that is employed for a stereophonic broadcast. Note that two separate pickups (microphones) along with two separate channels (one AM and the other FM) are used in this setup.

Such a system, using widely spaced pickup microphones and similarly spaced reproducing loudspeakers, as well as *two or more separate channels* (amplifiers, etc.) is called a *stereophonic* ("solid sound") system and is analogous to the *stereo* (3-dimensional) system of using two pictures to give the illusion of depth to a reproduced image.

A *pure* binaural system, since it requires headphone operation, is suitable only for a limited number of listeners. In home applications it is common practice to use *two* channels, with the loudspeaker reproduction method of the stereophonic system. The results obtained give a real illusion of direction and are quite thrilling to hear.

Hi-Fi and Stereo

High fidelity audio equipment is designed for low distortion, wide fre-

quency response, and a good dynamic range, irrespective of whether it is used for single channel or multiple channel reproduction.

Stereophonic equipment is simply multiple channel equipment and *need not necessarily be built to hi-fi standards*. It can be, of course, and should be if the best quality in sound reproduction is to be achieved.

Stereophonic Broadcasts

The basic technique used in stereo broadcast is illustrated in Fig. 2. Two wide-spaced microphones are employed. One is coupled, through the necessary amplifiers and networks, to one transmitter. The other is similarly coupled to another transmitter. Separate receivers are used for reception.

Since it is essential that the two channels be kept separate from the pickup (microphone) to the reprodu-

cer (loudspeaker or earphone), two complete broadcast channels must be used. These may be two AM channels, two FM channels, an AM and TV audio channel, an FM and a TV audio channel, or any similar combination. By far the most popular technique uses one AM and one FM broadcast channel, however. As a matter of fact, there are available special dual receivers for stereo with completely separate AM and FM channels that may be used.

Most of the stereophonic broadcast work to date has been carried on by local stations; sometimes on a regular, but more often on an experimental, basis. Generally, local "good music" stations pioneer in such work.

The program material usually features "concert" performances of some type . . . symphony orchestras, choirs, and so on, since solo performances do not carry the same realistic impact

Fig. 3. "Simulated" or "synthetic" stereo effects may sometimes be obtained by using separate receivers to pick up the same program (note single mike), or by using "echo" equipment as shown at the right.

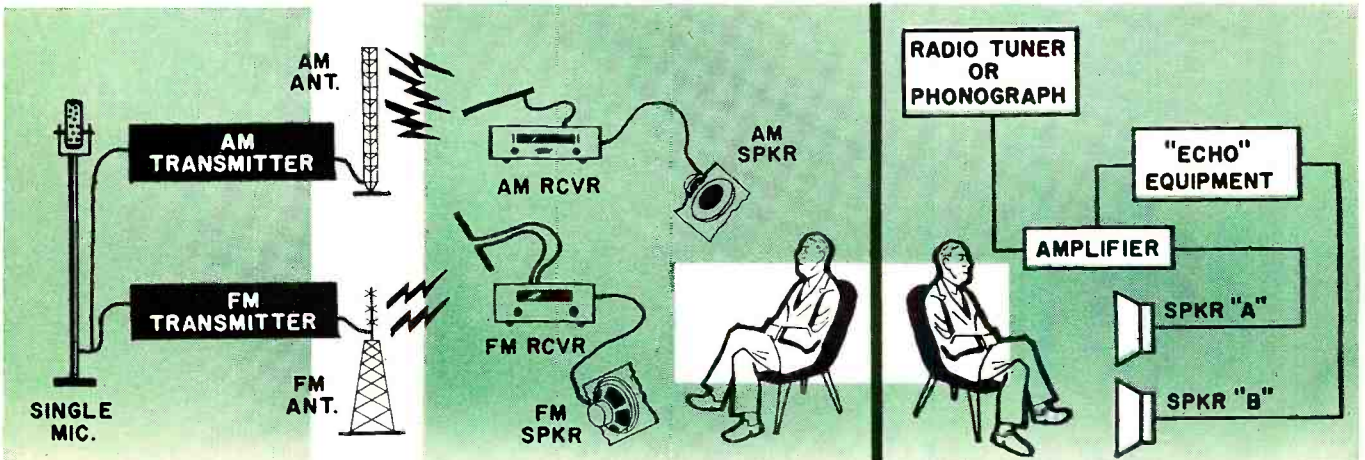

that the stereophonic reproduction of a full orchestra can bring to the listener. Both "live" (using microphone pickups) performances and recorded magnetic tapes serve as sources of program material. When stereo tapes are used, the results may be true stereo; while with live broadcasts, compromises may be resorted to so as not to degrade either channel.

Setting Up for Stereo Reception

If stereophonic broadcasts are available in your area, you can "set up" for reception quite easily. As a start, all you need are two receivers capable of receiving the two channels used. In most cases these will be an AM broadcast band and an FM broadcast band receiver. Chances are you already have one of these.

While you may want dual hi-fi amplifiers, radio tuners, and loudspeaker and enclosure systems for your eventual "ideal" set-up, at the beginning

feet in the case of small rooms (length about ten feet) to 2½ feet in the case of medium sized rooms (length 14 to 16 feet) to as much as 10 feet in the case of a large room (60 feet long). These measurements are to the "center" of the speaker enclosure.

Best listening is obtained when the audience is not more than twice as far from one loudspeaker as from the other, and when their distance from a line joining the two loudspeakers is, in general, *not under* five feet. The area for best reception is shown shaded in Fig. 1.

Once you have the necessary equipment properly arranged, check your local program schedules and carefully tune your two receivers to the proper stations. Adjust the volume controls for approximately equal sound levels. Then relax in an easy chair (placed in the shaded area, Fig. 1), and you'll enjoy a real thrill in radio reception.

stations broadcast the *same* program material (using a single pickup or microphone for both stations). This method is shown in Fig. 3 (left). Two receivers are used to pick up the AM and FM programs, with their outputs fed to separate loudspeakers spaced on either side of the listener.

Although identical program material may be broadcast by both the AM and FM stations, the signal path traveled by the two signals is different. Not only are there circuit differences in the two transmitters and the two receivers, but chances are that a different number of stages are used in each. These differences may result in *small* phase differences in the reproduced audio signal, particularly at higher audio frequencies. This, coupled with the use of multiple loudspeakers, will often give the listener an interesting illusion that is "semi-stereo" in character.

Still another technique which may give the effect of "depth" to the reproduced program material is the use of an "echo" device. This is an electrical or mechanical system which slightly *delays* audio signals sent through it.

The delayed signal, fed through a separate loudspeaker, adds an echo-like quality to the reproduced material. This basic technique is illustrated in Fig. 3 (right).

Stereophonic Recording

Although some of the methods described above may give good stereo, for the ultimate in home stereo reproduction at the present time the use of stereo tape is a must.

Without question, it has been the ready availability of good quality long playing phonograph records that has given the hi-fi hobby its greatest impetus. It would seem, then, that the ready availability of "stereo" phonograph records could do the same for the interest in stereophonic techniques.

Unfortunately, recording a stereo program on a record is quite a chore. Remember that two *separate* channels are required. If we use two separate records (discs), with identical turntable and pickup arms, we run into the almost insoluble problem of properly synchronizing the two records, and of starting the pickup arms in the right place.

Quite acceptable stereo discs have been "cut" in the past, however, by recording *both* channels on a *single* disc. A *dual* pickup head (on a single arm) is used for playback. But this technique offers a serious disadvantage; it cuts the available recording surface in half, and reduces the length of program that can be recorded by a similar amount. As a result, these stereo disc recordings have never achieved any real degree of popularity.

Two stereo disc systems have recently been introduced in which two channels are recorded in a single groove. Special pickups, which are already available on a limited basis pro-

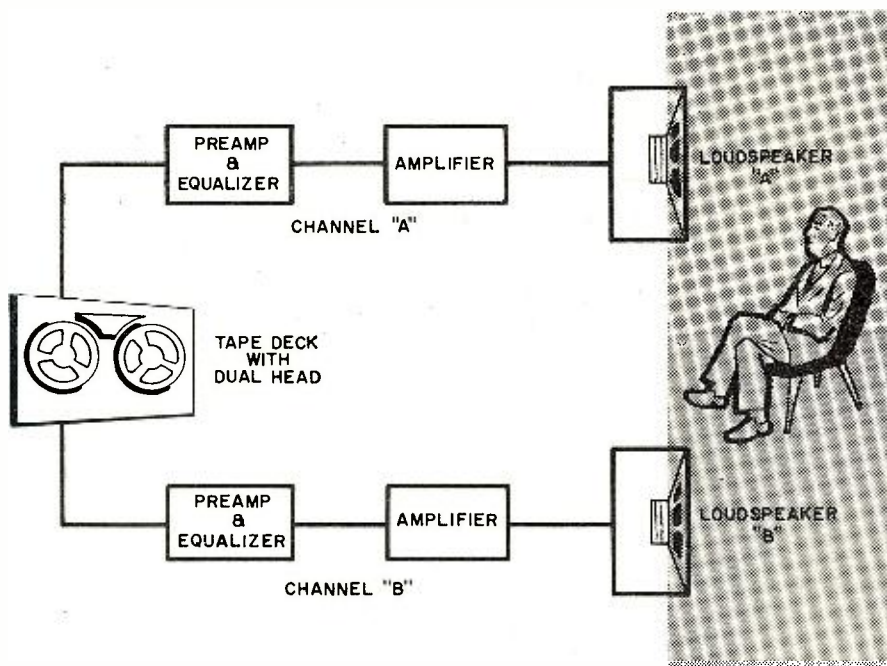

Fig. 4. A basic stereo tape playback setup is shown in this illustration.

you can obtain quite good results by using standard table model receivers.

Loudspeaker (or receiver) placement is extremely important. Since there is, as yet, no set "standard" accepted by all stations, you'll find it best to check with your local broadcast station for their recommendations.

However, a typical loudspeaker arrangement (suggested by WCRB, Boston) is shown in Fig. 1. The FM loudspeaker (or receiver) is placed to the left, the AM loudspeaker to the right, of the listener. Both speakers are spaced along the *length* of the room, and face the listener.

A corner location for the loudspeakers is *not* recommended. Instead, the speaker enclosures should be located with their backs close to (but not against, except in the case of small rooms) the wall, and spaced in from the side walls, from as little as 1½

Two (or more) *separate* channels are required to obtain a realistic directional effect in the reproduction of music or similar program material. But quite interesting audio "illusions" can be obtained by the use of multiple loudspeakers and a single channel.

"True" vs "Synthetic" Stereo

Perhaps the simplest technique is to connect two or more loudspeakers, particularly with differing frequency coverages, to the output of a single radio receiver or hi-fi amplifier. These speakers may be spaced around a room more or less equidistant from the listener. With this set-up the listener is immersed in sound although he does not hear the true stereo directional effect produced by the true stereo set-up.

Another technique may be used in those areas where both AM and FM

duce the two outputs. These systems will bear watching in the near future.

Stereo Tapes

Magnetic tape recording is almost ideal for stereo program material. Several channels can be recorded side-by-side on a single tape, and these channels are kept in perfect synchronism as the tape is played back. Today, recorded *stereo tapes* are used extensively by broadcast stations and a large variety of taped programs are available for *home use*. These are obtainable from many of the larger recording companies as well as several of the smaller ones.

The basic arrangement used for the playback of stereo tapes is illustrated in Fig. 4. The tapes used in broadcast stations and home use generally have *two channels*, with one recorded near each edge (top and bottom) of the tape.

The tape is fed through a tape deck very similar to a conventional single channel (monaural) tape mechanism except that *two pickup heads* are provided. The output signal obtained from one head is fed through a pre-amplifier and equalizer circuit to a standard audio amplifier, and from there to one loudspeaker. The output signal obtained from the second head is handled in a similar manner by a separate audio channel.

Types of recorded tapes. With the variety of program material available, including symphonies, concertos, and other classical works, recorded magnetic tapes are available in two basic types, depending on the recording technique used and the playback technique required. Both basic types are illustrated in Fig. 5.

The older *staggered* tapes have been recorded with separate magnetic heads and are designed for playback on machines having two completely separate pickup heads, as shown in Fig. 5A. Since the two heads are displaced linearly, corresponding parts of the program material must be recorded at similarly displaced positions (that is, "staggered") along the tape.

This technique, and the use of such recordings, came about as a natural result of converting older "single channel" tape recorders to "dual" channel stereo recording by the simple expedient of adding a second magnetic head.

The more modern *stacked* (or *in-line*) tape is shown in Fig. 5B. Here, the two stereo channels are recorded at corresponding positions (that is, one directly "above" or "stacked" on the other) along the tape. A single *dual* pickup head is used for playback.

When recorded tapes are purchased, it is *essential* that the proper type of tape (*staggered* or *stacked*) be obtained for the machine on which the tape is to be played back. At present, most tapes employ the stacked or in-line method.

Setting up for stereo tape playback. You can enjoy the startling realism of stereophonic sound reproduction by

using a stereo tape recorder (or playback) unit and recorded magnetic tapes. If you don't now own a tape recorder, you have several choices available. You can either purchase one of the new stereo tape recorders offered by leading tape recorder manufacturers or you can obtain a basic stereo tape deck with appropriate pre-amplifier-equalizers.

While some stereo tape recorders are equipped with dual audio channels, the majority of medium to low-priced units are equipped with but a *single* built-in audio channel, with a separate amplifier output jack. This is connected to a separate, external, audio amplifier and loudspeaker system.

If you prefer to obtain a basic stereo tape deck, then you'll also want to obtain matching preamplifier-equalizers for each head. And you'll have to provide *both* audio amplifier-loudspeaker channels. For the ultimate in sound reproduction, the amplifiers should be hi-fi units and should be identical in performance, as should the loudspeakers and enclosures used.

On the other hand, if you already have a tape recorder equipped with a single playback head, you needn't worry. Most large tape recorder manufacturers now offer special stereo conversion kits for modifying an older tape recorder for stereophonic playback. These kits include the extra pickup head, mounting hardware, and, in many cases, a preamplifier-equalizer. If the particular kit you obtain does not include a preamp or equalizer, you may have to obtain a separate unit to handle this job.

Once an older tape recorder is modified for stereo playback, you'll have to provide the "extra" audio channel; the built-in audio amplifier and loudspeaker used in the original recorder serve as one channel.

Whether you are using a new stereo tape recorder which requires an external audio channel or a "converted" old recorder, you can obtain the additional audio channel from any of a number of sources. Several suggestions are shown in Fig. 6.

First, of course, if you have a home hi-fi system, you can connect the output of the second pickup head to the tape input jack of the master control preamp used in the system. In many cases, the preamplifier will already be equipped with an equalizer circuit for the magnetic head and you won't need an extra preamplifier or equalizer.

If you don't have a home hi-fi system, you can connect the additional head through a preamplifier-equalizer to the phono input of an AM or FM receiver or to the input terminal of any standard phonograph amplifier. Shielded cable should be used for all equipment interconnections.

When setting up your final system, you should follow the tape recorder manufacturer's suggestions regarding loudspeaker placement . . . or, if no instructions are furnished, you can use the basic layout suggested for the

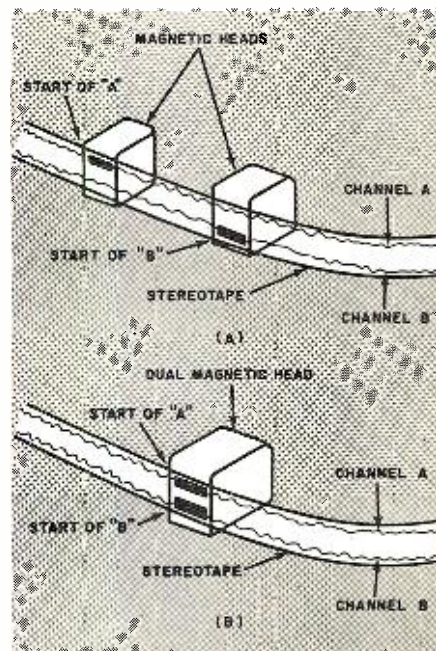

Fig. 5. (A) "Staggered" and (B) "in-line" or "stacked" stereo tapes are shown here.

reception of stereophonic radio broadcasts (see Fig. 1).

In addition, you'll want to adjust the volume and tone controls of your two audio channels for as near to identical performance as you can obtain. To aid in this, special recorded test tapes are available. By playing such a tape through your system, and following the instructions outlined by the manufacturer, you can obtain the most from your stereo system.

One final tip—once you're set up for stereo and have a collection of stereo tapes, keep it a secret. Otherwise, you may "go broke" buying refreshments for visiting friends and neighbors. Stereo is fun!

Fig. 6. A tape recorder or deck with dual head can be employed with various systems.

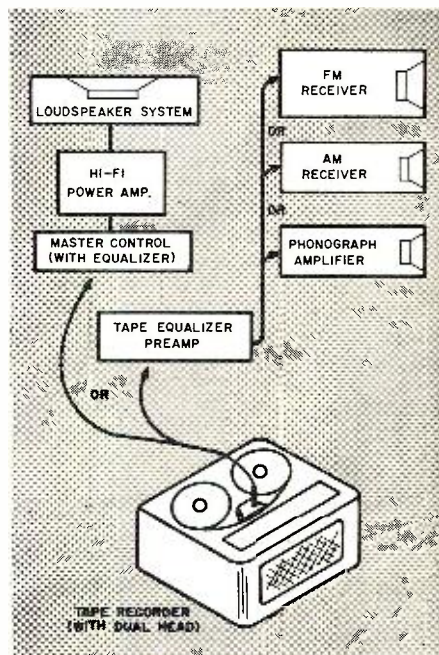

SERVICING

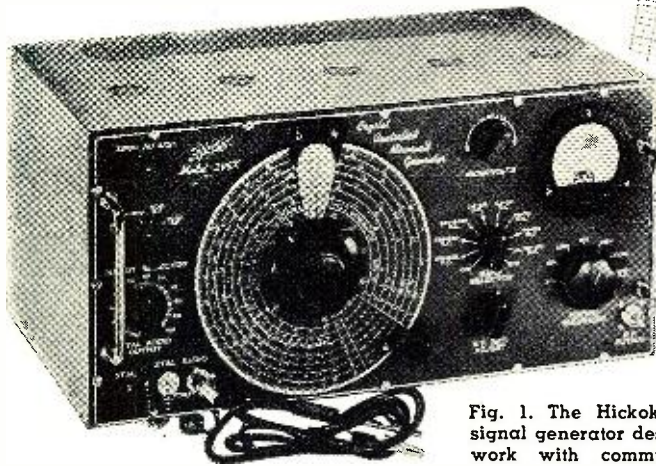

Fig. 1. The Hickok 295X is a typical signal generator designed especially for work with communication receivers.

Communication Receivers

Here's extra income for established technicians, useful data for new hams and unlicensed DX fans.

WHAT IS a "communication" receiver? How does it differ from the common type of set used for home entertainment? How are these differences important to the service technician?

A "communication" receiver is one designed for communication service, other than the commercial bands, where original performance must be of a high order and that performance is to be maintained for the life of the equipment. Perhaps the most evident difference is the number of controls. While most home-entertainment sets have only two controls—tuning and volume—even the simplest communication receiver may have 5 or 6 controls. The more complex will have more.

Electrically, the communication receiver must tune a wider range (more bands) thus, a bandswitch must be provided. On the crowded short-wave bands, a bandspread tuning control is necessary to allow easier separation of stations. For reception of code (c.w.) signals, a beat frequency oscillator (b.f.o.) and a means of "killing" the a.v.c. voltage are necessary. In addition to the normal audio volume control, a separate control for regulating the gain of the r.f. and i.f. stages is often provided.

Selectivity controls are provided on the more expensive models: these work in conjunction with crystal filters or "Q" multipliers, an electronic means of increasing the "Q" of a tuned circuit in the i.f. amplifier and thereby sharpening the over-all response curve. A signal-strength meter, called an "S" meter, may appear on costlier ones. More sensitivity, selectivity, and stability are the rule.

All communication receivers are superheterodynes—some are double-superheterodynes. In the double-superheterodyne, the incoming signal is conventionally mixed or heterodyned with the output from a local oscillator to form a new signal, the i.f. signal, having the modulation characteristics of the original signal. After amplification, this i.f. signal is mixed with the output from still another local oscillator to form another i.f. signal which, following further amplification, is fed to the detector and audio circuits.

A number of advantages are gained with this arrangement. The i.f. used following the first conversion is generally high—1500-2000 kc.—so that undesired image signals will be considerably removed from the desired signals. The i.f. used following the second conversion is low so that high selectivity can be obtained. The sensitivity and selectivity of receivers employing this principle is significantly greater when compared with receivers using a single-frequency conversion process.

Voltage regulation is frequently used in the "B+" circuits of certain critical stages. This, in addition to special temperature-compensating components, helps prevent drift. The remaining circuits of a communication receiver are generally similar to their counterparts in more conventional sets except that improved electrical and mechanical stability are stressed.

The service problems encountered in communication receivers are generally the same as those with any other piece of electronic equipment, such as defective tubes, defective resistors and capacitors, and the like.

The methods of locating the defective part are also familiar. Signal injection, signal tracing, and voltage-resistance tests are just as useful in servicing these receivers as in servicing a.c.-d.c. sets. There is one important difference, however: correct service information must be available when working on a communication receiver. Technicians who can easily repair most a.c.-d.c. sets without consulting schematics should not attempt this with a communication receiver.

The replacement part installed in a communication receiver must be of the highest quality. Since some of the parts may have special characteristics, always consult the service data before installing a new part in a critical circuit. A particular example is the oscillator circuit where the individual capacitors must have the specified temperature coefficients if drift is to be prevented. Tolerance of individual parts is also important; if a 5% resistor is specified, there is a reason. Use the stated tolerance.

In terms of the technician, one of the greatest problems is the few special parts that must be ordered from the receiver manufacturer. In communication receivers more often than home sets, special parts that must be replaced with an exact duplicate are used. When this problem comes up, the best way to handle it is by explaining to the customer that the part needed is of special design and an exact factory replacement is necessary to restore peak operating efficiency. Generally, the customer will appreciate your extra trouble.

Alignment

Because of the extreme sensitivity, selectivity, and calibration accuracy of communication receivers, proper alignment is very important. Even the stable circuits in a communication re-

ceiver will drift over a period of time, and realignment is sometimes necessary following extensive repairs. This is particularly true if the repairs involved replacing parts in any of the tuned circuits.

The effects of improper alignment are the same that would be noticed with any other receiver: incorrect dial calibration, decreased sensitivity, and/or decreased selectivity. This type of set is generally operated under somewhat demanding conditions and such failings in performance are quickly noticed. (By the same token, improvements are noticed just as quickly.)

Complete alignment is a complicated job; therefore, the technician must have a clear idea of just what is needed before beginning. Proper pre-testing is important to determine accurately just what part of the over-all alignment is most affected and where the greatest care must be exercised in aligning the receiver. When only the dial calibration is off, realigning the oscillator, mixer, and r.f. stages is often sufficient without the necessity for going to the i.f. section.

To determine whether the receiver needs alignment, first check the dial calibration, paying careful attention to the high-frequency end of each range. If the customer has indicated that he uses one band or tuning range more than the others, be sure to check that one very carefully. Most communication receivers have a separate bandspread tuning control that must be set to a certain position to attain correct calibration of the main tuning control. The correct position will be indicated in the service information.

On the broadcast band, the signals from nearby broadcast stations can be used in checking the calibration. On the higher bands, a 100-kc. crystal calibrator checked against WWV is convenient. As these tests are carried out, mark down the results so that you can be sure to re-check the calibration after alignment at points previously noted to be incorrect.

For checking the r.f. amplifier and mixer circuits having exposed coils without upsetting the alignment more than it was originally, a tuning wand is convenient. This is a tube of insulating material with a powdered-iron tip at one end and a brass tip at the other. Bringing the powdered-iron tip close to a coil increases its inductance, tuning the circuit to a lower frequency. Bringing the brass tip close decreases the inductance, tuning the circuit to a higher frequency. If bringing either end close to a coil increases the volume, the circuit containing that coil needs to be aligned. If both ends decrease the volume, the circuit is properly aligned. A tuning wand is most effective on the higher frequencies where the coils are smaller and better coupling can be obtained.

If no crystal filter or "Q" multiplier is used in the i.f. circuits, check the selectivity by tuning across a signal and noticing how sharp this tuning is

required to obtain most accurate results. A better method involves the use of a narrow-range sweep generator (wobbulator) and an oscilloscope to actually look at the response curve. A drawing of the correct response curve is often in the service data.

Checking the selectivity of a receiver using a crystal filter is most easily done with the help of the wobbulator-oscilloscope combination which allows visual examination of the response curve; but it can be done by listening tests. To check the "broad" positions of the selectivity control, tune in a broadcast station transmitting speech. Advance the selectivity control: sideband clipping with consequent distortion of the voice should become evident. Also, the signal should tune more sharply. To check the "sharp" positions of the selectivity control, turn the a.v.c. off, the b.f.o. on, and the audio gain control all the way up (use the r.f. gain control to regulate volume). Tune across one of the amateur bands—the range between 7.0 and 7.3 megacycles is ideal—to find a c.w. station with severe interference from another station. Advancing the variable selectivity control should decrease the interference. By adjusting the phasing control, you should be able to reduce the strength of the interfering signal while maintaining the desired signal.

If the controls in the crystal filter circuit do not respond as they should, the i.f. amplifier must be realigned to match the crystal. Even slight misalignment can make quite a difference in receiver performance.

Some receivers include a "Q" multiplier instead of (and sometimes in addition to) a crystal filter to improve the selectivity. This is actually a sort of extra, adjustable i.f. stage. Others have a separate "Q" multiplier added by the owner as an "outboard" accessory. Either way, the "Q" multiplier must be checked. The separate ones generally provide two modes of operation: "peak" and "null." Some of those built into receivers provide only the peak function. The testing method is similar in each case.

Tune in a station; adjust the "Q" multiplier for peak operation and turn the peak control up slightly. As you tune the frequency control of the "Q" multiplier, an increase in response should be obtained at one setting. Further advancement of the peak control should further sharpen the response, ultimately causing sideband clipping, distortion, and, finally, oscillation. If

the frequency control cannot be adjusted to peak the signal, this indicates that either the i.f. amplifier in the receiver or the tuned circuits in the multiplier are far off frequency. Check alignment of both.

Next, adjust the "Q" multiplier for null operation. As the null control is advanced, the received signal should become weaker and weaker. Again, check the operation of the frequency control to be sure it moves the null to each side of the desired signal.

Incorrect results in any of these tests indicates either the need for realignment of the receiver i.f. strip, realignment of the "Q" multiplier, or the need for repairs in its circuit.

A word about test equipment. The signal generator for use in aligning a communication receiver must have extremely low stray output, otherwise, it would be impossible to reduce the input signal sufficiently during the final stages of alignment. In many cases, the leakage output from a standard service-shop signal generator is so high as to make it useless in aligning a sensitive communication receiver. A signal generator designed especially for communication service is best.

Let's examine one of these, the Hickok Model 295X shown in Fig. 1, for a moment. The most important feature is one not obvious from visual examination. Inside the cabinet, the generator circuits are completely shielded by silver-plated copper sheets. The a.c. input leads are filtered to prevent r.f. leakage over that path. All this results in low stray output.

The dial is arranged for high accuracy with approximately 300° of scale for each band. A vernier control plus a scale calibrated in very small divisions assures high accuracy in setting the dial to precise frequencies. Metered output down to 0.1 microvolt and up to 100,000 microvolts is provided. Knowing the exact input-signal value is important in checking the receiver sensitivity. A separate crystal oscillator is provided for use as a frequency standard in conjunction with a 100-kc. crystal calibrator. Every technician working on communication equipment should have a 100-kc. crystal calibrator. Of course, separate audio output is included.

When aligning the i.f. amplifier and all other circuits except the receiver front end, extraneous signals can be kept from interfering by disconnecting the antenna and shorting the receiver input. In the final stages of alignment

(Continued on page 150)

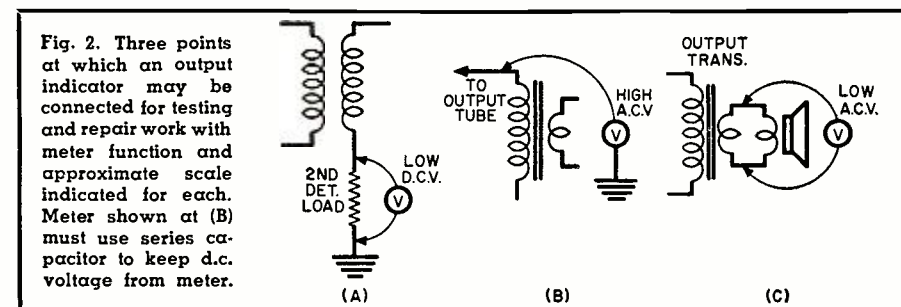
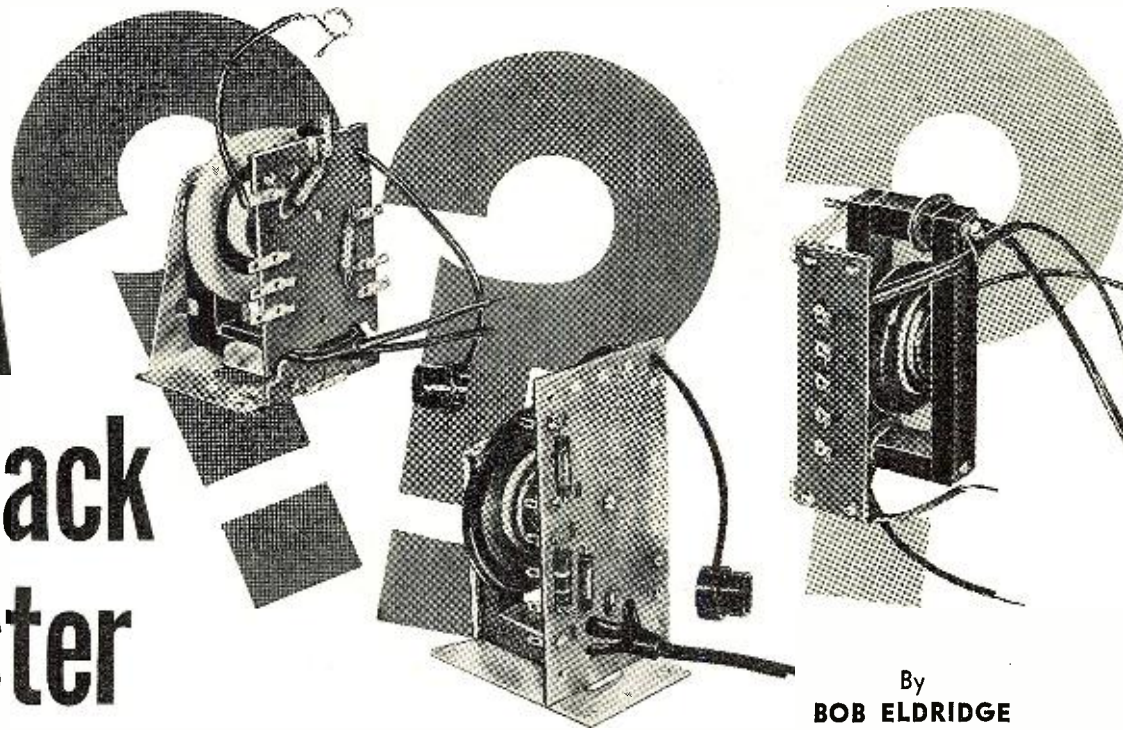

Fig. 2. Three points at which an output indicator may be connected for testing and repair work with meter function and approximate scale indicated for each. Meter shown at (B) must use series capacitor to keep d.c. voltage from meter.

A Flyback Tester



By
BOB ELDRIDGE

Horizontal-output transformer condition may be determined quickly and reliably with this unit.

WHEN everything around the horizontal section appears to check out normally, but there is still no deflection or high voltage, the technician is faced with the need to make a decision on the condition of the flyback transformer. He generally approaches this necessity with reluctance, after having first investigated every other possibility; for this important component that is the key to the entire horizontal-sweep section can be quite baffling.

The width coil can be checked merely by disconnecting it. The horizontal windings of the deflection yoke can be checked by substitution: almost any yoke that happens to be available can be tacked into place temporarily. However, few jobs are more tedious than that of unsoldering and dismantling one flyback transformer and then making all the connections necessary to put in another one.

There is a surprisingly simple and

Fig. 1. The completed test unit.

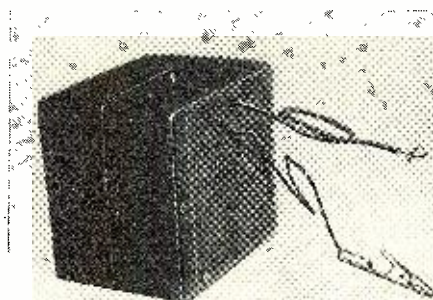

inexpensive way to get around this problem. It involves a method that sometimes proves more conclusive than a test with the type of flyback tester that checks transformer "Q." The basic requirement for the technique is another flyback transformer. The best thing is to buy one specifically for this purpose. A small one of the type used in direct-drive circuits, where the horizontal coils of the yoke are wired in series with transformer primary, as shown in Fig. 2A, is the most convenient to use. This type is inexpensive and is not cluttered with a number of confusing terminations. The filament winding for the high-voltage rectifier, involving only two leads, is not used. The three leads of interest to us are the ones for the high-voltage rectifier plate, the plate of the horizontal-output tube, and the connection for "B+" or boosted "B+."

If you wish to do the job at virtually no expense at all, any old flyback can be used in the same manner, but first disconnect and remove from the core any shorted portions of the primary winding. For safety, as well as for keeping out of harm's way any windings that are not used, the unit should be installed in a box, as shown in Fig. 1 and clarified in Fig. 2B. The lead that normally goes to the plate of the horizontal-output tube is brought out of the box and terminated in a suitable clip. The lead that normally goes to "B+" or boosted "B+," whether directly or through the yoke, is terminated in an alligator clip. The lead that normally would go to the plate of the

high-voltage rectifier is brought out to an externally available contact button or other termination—which is, of course, insulated from the case.

If you wish to be fancy, a neon bulb can be mounted adjacent to this top terminal, to indicate the presence or absence of r.f. This step, if it is performed, concludes the rather simple construction of the device. Now for the method of operation:

1. Disconnect the plate clip from the output tube in the set.
2. Connect the plate clip from your test box to the plate of the output tube.
3. Connect the alligator clip from your test box to a "B+" point in the set, preferably the boosted "B+" input terminal of the suspected flyback.
4. Switch on the set and attempt to draw an arc from the top terminal of the test box (or, in the fancy version, look for glow in the neon indicator). See Fig. 3A.
5. If no r.f. is present, and "B+" exists at the appropriate terminal, there is something wrong with the horizontal-output stage other than the flyback. (It is assumed a check has already demonstrated the oscillator to be providing drive to the output tube.)

If r.f. is present, this shows the stage is operating with a substitute plate load. (The arc may only be about half

(Continued on page 141)

Fig. 2. (A) Type of flyback recommended for test unit and (B) its box mounting.

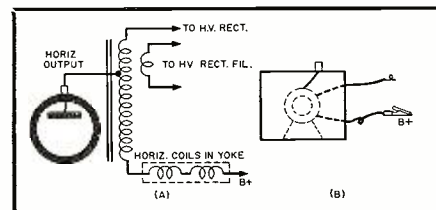

The "Control Master"

Dialing unit being used with transmitter.

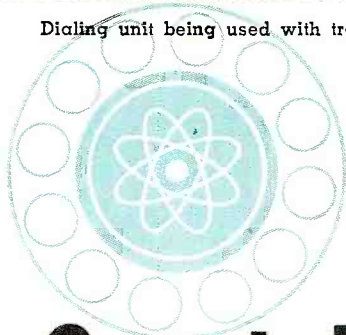

A Crystal Dialing Unit

By GENE BRIZENDINE, W4ATE

Provides real convenience in the dialing of transmitter or signal generator frequencies.

INSTANT frequency selection is provided by this compact, crystal-dialing accessory. Finger-tip control of ten crystal, plus v.f.o., frequencies is made available, right next to the receiver. For Civil Defense, mobile, or amateur station operation, it is useful where the transmitter is two feet or less from the operating position. The circuit of the "Control Master" includes eleven crystal sockets, an eleven-position, single-pole rotary switch, and output leads.

Only three sheet-metal pieces are used. The panel portion is easily bent to shape, using a small vise. Assembly is by solder-spotting the mating edges *inside* the cabinet. Finally "flow" a bead of solder along each inside corner. Any excess solder on the outside may be dressed away with a file. Drill the switch mounting hole in the panel. Next, spot four large 6-32 nuts inside each lower corner, using a hot soldering tip. These are for later attaching the rubber feet. Two right-angle strips are

(Continued on page 98)

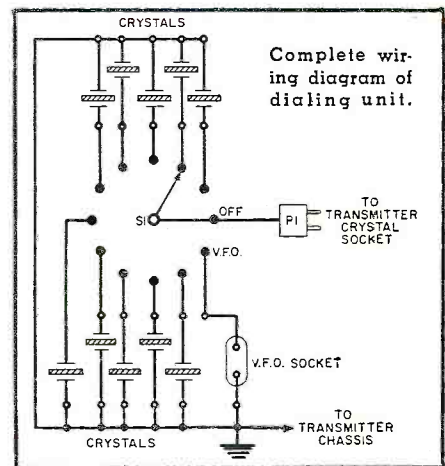

The over-all view of the "Control Master" is shown below.

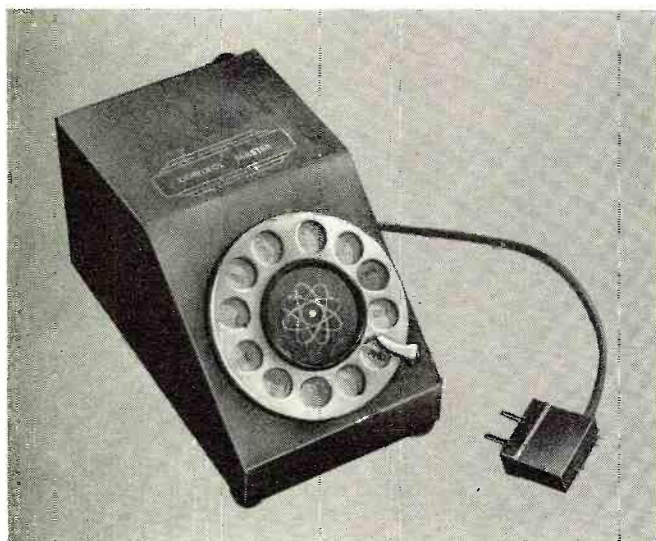

Inside view shows the wiring of 10 crystals and the switch.

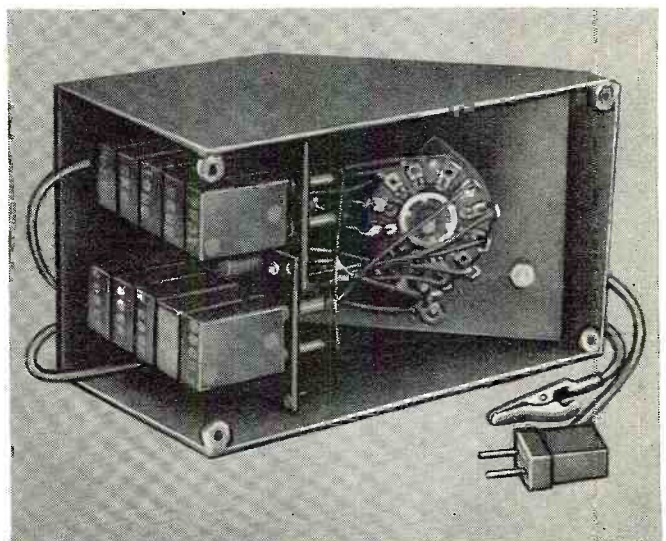

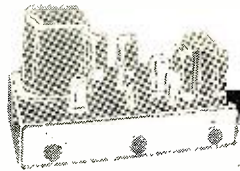
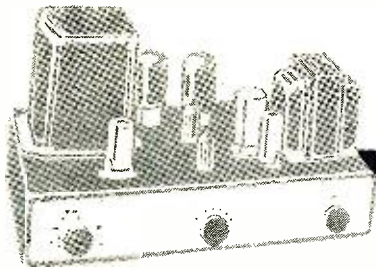
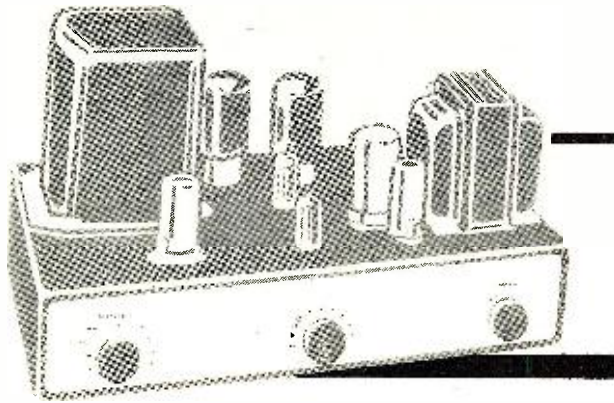

By **HERMAN BURSTEIN**

A step-by-step search for a really clean 15 watts output by slight changes in basic Williamson circuit.

STATEMENTS frequently appear in the audio literature that IM distortion below 1 or 2% cannot be detected by the ear. Yet in listening to several power amplifiers operating at moderate level, where no more than 1-watt equivalent sine-wave power is produced on peaks, a good ear will readily note that some amplifiers sound cleaner than others, even though in all cases the measured IM is below 1% at moderate level. This has been the cause of some concern to many listeners.

It would seem, therefore, that maximum permissible IM distortion is still open to question. In discussing this matter with various individuals in the audio field, some have indicated that the 1 or 2% limit should be radically revised downward. One, an engineer, stated that in a series of tests made with a number of power amplifiers, the findings of his ears inevitably correlated with the IM distortion found by instrument, even though the distortion was but a fraction of 1% at the test levels. On the other hand, it is possible that the differences among amplifiers are not actually due to distortion products, but rather to some other characteristic, and that the amount of IM is an index to this characteristic.

Desiring to do a little research on this question, the author recently borrowed a highly regarded 50-watt am-

plifier to compare with his 10-watt Williamson, vintage 1950. At quite modest reproduction levels, the 50-watter had a slight but definite advantage in terms of clarity, purity, and seeming ease. The initial temptation was to heave out the Williamson in exchange for a good 50-watter. On second thought, it was decided to have a go at the Williamson to see if it could be brought up to the quality of the comparison amplifier. The author's speaker system is relatively efficient; hence it was reasonably certain that the difference in performance of the two amplifiers was not due to power capacity, particularly since comparisons had been made at moderate listening levels.

The eventual result was that the Williamson was not tossed out — at least not yet. The events that took place serve as an illustration that, with the aid of a few readily available improvements, one can significantly improve the quality of an existing amplifier. There are still many 10- or 12-watt Williamsons around, as well as other amplifiers of similar wattage and not too different circuitry, which may be susceptible of such improvement. The audiophile or technician with access to the few necessary instruments can undoubtedly obtain results similar to those achieved by the author. The equipment used included an audio

Upgrading the Hi-F Amplifier

oscillator and a *Heath* Audio Analyzer, which combines in one package an IM distortion meter, a highly sensitive a.c. v.t.v.m., and a wattmeter. Such units, which but a few years ago were seldom found outside the laboratory, today are available in kit form at truly low cost. Since they are very popular items, one has a good chance of being able to borrow them from an engineer or technician friend or perhaps rent them from a service shop. Or, of course, the unit may be built from a kit.

Before departing for parts unknown, the author decided to check where he had been and obtained the readings given in Table 1A on IM distortion in the Williamson.

Then began the search for improvements. The first two steps were virtually barren. These were to precisely balance the d.c. current through the output tubes and to replace each tube in the amplifier (again balancing d.c. current when the output tubes were exchanged). Each of the remaining steps, however, was fruitful.

1. The original Williamson circuit employed triode operation of the output tubes. The author decided to try a switch to "Ultra-Linear" operation, or rather an approach to it. The output transformer in the amplifier is a *UTC* LS-63, which has intermediate taps between the "B-plus" and plate taps, although not at a point representing about 18.5% of the impedance as called for in true "Ultra-Linear" operation. Nevertheless, by connecting these intermediate taps to the screen grids of the output tubes, definite improvement was achieved. Figure 1 shows the

change in connections. Table 1B shows the results.

The improvement was an obvious one. The "Ultra-Linear" form of connection produced as little or slightly less distortion at low levels and decidedly less at high levels. An amplifier which barely qualified as a 10-watter was converted into a very satisfactory 15-watter.

(It should be mentioned that in checking IM distortion at various output levels, the wattmeter reading was always multiplied by 1.47, which is the customary thing to do, in order to convert the average power reading of the wattmeter into equivalent sine-wave power. The IM test employs a low-frequency voltage and a high-frequency voltage in the ratio of 4:1. These are fed into the power amplifier under test. Accordingly, the amplifier actually produces a total power proportional to $4^2 + 1^2$, which is 17, and this is what the wattmeter reads. However, the output of the amplifier is not a true sine wave, for it consists of one frequency superimposed on another. A sine wave with the same peak as the actual output would contain more power—designated as equivalent sine-wave power. Since the test voltages are proportional to 4 and 1, they add up to a peak voltage proportional to 5. A sine wave with a peak voltage proportional to 5 would produce a sine-wave power output proportional to 25, because power is proportional to voltage squared. Thus the ratio of equivalent sine-wave power to actual power output is 25/17, or 1.47.)

2. As shown in Fig. 1, the author's version of the Williamson included a cathode bypass capacitor across the common cathode resistance of the output tubes. According to the literature at the time, this capacitor served to improve low-frequency response. Upon removal of this component, IM distortion went down slightly but significantly, no doubt because of the current feedback produced by the unbypassed cathode resistance. A check of 20-cycle response (minimum frequency of the available oscillator) showed no deterioration in the response at low or high levels.

3. Next the author tried changing grid bias, by altering the value of cathode resistors in the various stages preceding the output tubes. Only in one case, at the input tube, did this measure help. Increasing the cathode resistor here from 470 to 870 ohms led to an appreciable drop in distortion.

4. The last measure was to adjust the amount of feedback from the secondary of the output transformer to the cathode of the input tube. Even after increasing the cathode resistor of this tube, it was found that feedback was only 14 db, whereas the design permits 20 db with stability. Using a pot as a temporary feedback resistor, it was adjusted for 20 db feedback. To determine amount of feedback, a very low signal input at 1000 cycles was used and amplifier output with and without the feedback resistor con-

IM DISTORTION BEFORE CHANGES		IM DISTORTION IN QUASI "ULTRA-LINEAR" MODE		IM DISTORTION AFTER ALL CHANGES	
Equiv. Sine-Wave Power (watts)	IM%	Equiv. Sine-Wave Power (watts)	IM%	Equiv. Sine-Wave Power (watts)	IM%
15	11	15	3.50	15	1.75
10	3.20	10	.72	10	.21
5	.33	5	.40	5	.13
2	.22	2	.21	2	.08
1	.16	1	.14	1	.07
.5	.12	.5	.12	.5	.066
.1	.09	.1	.08	.1	.063
(A)		(B)		(C)	

Table 1. Improvements in IM distortion resulting from simple circuit changes.

nected was measured. When the setting of the pot was such as to produce a power ratio of 1:100, this signified 20 db feedback. Again there was improvement, owing to 6 db more feedback.

Table 1C shows the final results, incorporating the benefits of all four steps.

Below 10 watts, this performance compares with or excels that of some very highly regarded modern amplifiers, although the power capacity of the latter may extend to 30 or more watts. It should be noted that below 5 watts the IM distortion is probably less than indicated in the table inasmuch as the residual reading of the IM tester used, without an amplifier under test, was about .06%.

To make sure that the changes had not adversely affected frequency response or unduly altered sensitivity and other characteristics, these were checked. Response was found to be perfectly flat from at least 20 cycles (low end of the oscillator) to 25,000 cycles, dropping gradually thereafter in relatively smooth fashion; it was 3 db down at 40,000 cps and 6 db down at 100,000 kc. Sensitivity proved to be suitable: 1.7 volts input required for 10 watts output. Here it is appropriate to mention that two watts equivalent sine-wave power is the very most the author's relatively efficient speaker system can use. A calibrated oscilloscope has been placed across the power amplifier from time to time when feeding in various kinds of program material *via* FM, tape, and phono, and only at painfully loud levels did the scope show as much as the equivalent of a two-watt reading. Accordingly, it can

be estimated that the most voltage required to drive this power amplifier is slightly under .6 volt.

No instrument check was made of signal-to-noise ratio, because with the amplifier connected to the speaker system absolutely no noise or hum was audible right at the speaker. In the matter of low hum content, it is of interest to note that the author's Williamson was built in the old-fashioned way, with *two* chokes in the power supply.

Before returning the power amplifier to use, it was decided to also check out the control unit, which was one of the very best in its day about seven years ago, although since outdone. IM distortion measured about 1.5% at 1.5 volts output (equivalent sine-wave voltage obtained by multiplying actual volts by 1.212), about 1% at 1 volt, about .5% at .5 volt, and proportionately less at reduced output. A couple of slight changes reduced IM to about .3% at 1.5 volts output and to less than .1% at normal levels. The modifications, shown in Fig. 2, consisted in part

(Continued on page 162)

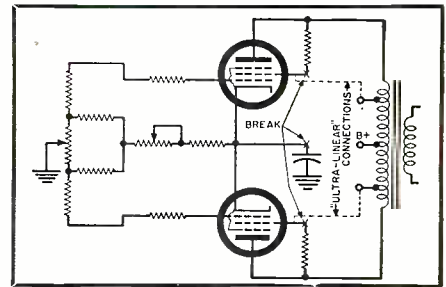

Fig. 1. Amplifier output stage changes.

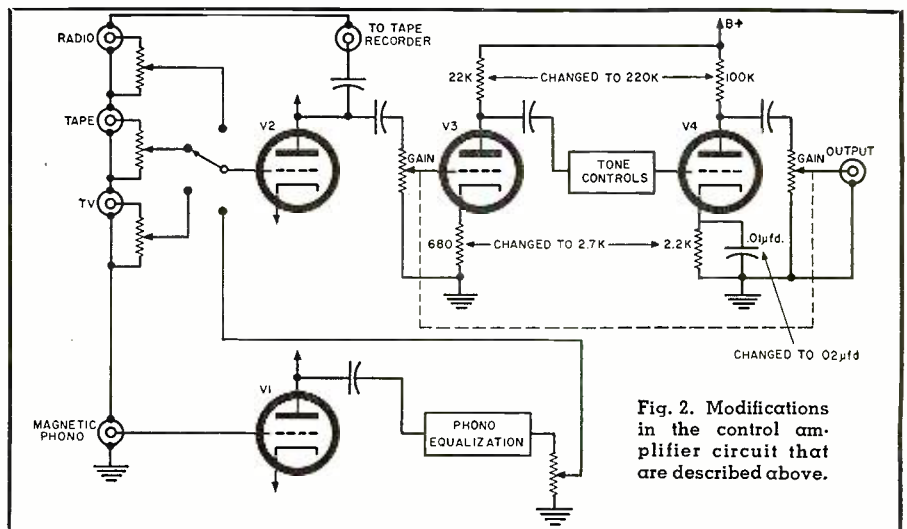

Fig. 2. Modifications in the control amplifier circuit that are described above.

By
WARREN PHILBROOK

FACTS

About

Vertical-Sweep Circuits

An experienced bench man highlights the troubles, ordinary and unusual, that occur in this circuit.

COMPARED to the horizontal-deflection section of the TV chassis, there are relatively few complications or difficulties in the servicing of the stages concerned with vertical sweep. However a more than usually difficult job arises now and then in this part of the set. Then, because he has previously taken the vertical very much for granted, the technician may find himself out on his own in strange country. The most difficult problems are those involving incorrect linearity or size, rather than complete absence of scan.

Compression at the Bottom

This is one of the most frequent vertical faults. One of the more difficult things to do in a TV set is to produce and maintain a saw-tooth waveform which is of correct amplitude and at the same time perfectly linear throughout its entire length. It is particularly difficult when using magnetic deflection, owing to the fact that the yoke inductance has a great effect on the nature of the current waveform within the winding. To produce a saw-tooth of current in the coil, it is necessary to impress across it a voltage waveform consisting of a sawtooth and a pulse combined. It is essential to bear in mind that, although the saw-tooth part of the waveform in the oscillator or output stage may look linear enough, this does not necessarily mean that the raster itself will be linear. The current waveforms in the yoke are illustrated in Fig. 5, the waveform corresponding to compression at the bottom of the raster being that of Fig. 5B.

The most frequent causes of com-

Fig. 1. Compression at bottom with stretching at the top, as caused by slight leakage through the capacitor coupling to the output-tube grid.

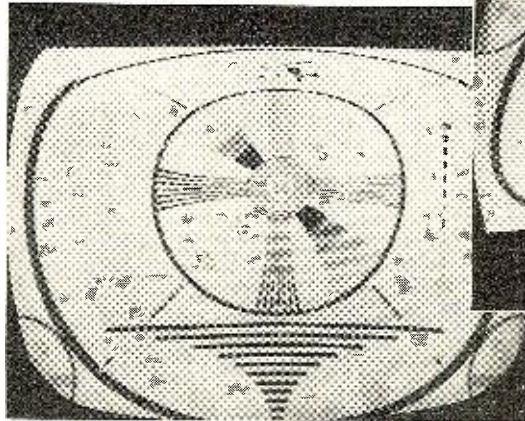
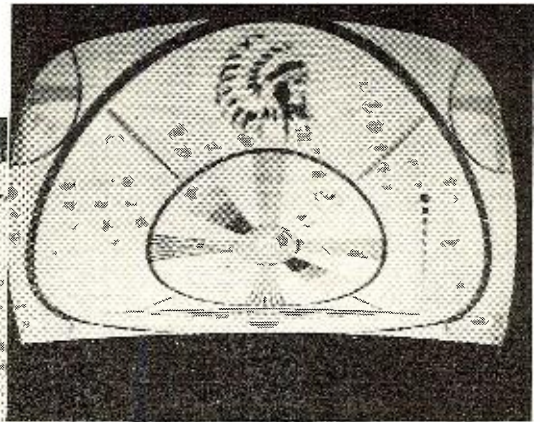

Fig. 2. Compression at the top of the raster, as caused by excessive bias on the vertical-output tube cathode.



pression at the bottom are lack of drive from the oscillator stage or lack of bias on the output stage. One reason for the low drive could be lack of "B+" at the source. Because the oscillator circuit usually needs a high plate load resistance, the "B+" is often derived from the boost supply, so this is the first place to check. However, the most likely trouble is a rise in resistance of either the height control (4.7 megohms in Fig. 3) or the oscillator plate load resistor (2.2 megohms). This can most easily be checked by a straightforward resistance measurement—first opening up one end of the circuit to remove any voltage effect from charged capacitors which would tend to cause a false reading on the ohmmeter.

A less frequent cause of bottom compression is leakage or change of value of the capacitor in the oscillator discharge network (.03 μ fd. in Fig. 3). The two components shown here as .03 μ fd. and 15,000 ohms play a very important part in determining both the shape and the amplitude of the waveform going into the 6W6. The purpose of the series combination of resistor and capacitor is to form the familiar sawtooth-plus-spike waveform illustrated in Fig. 5D. Within reason, non-linearity due to irregularities elsewhere in the circuit can often be corrected by manipulating the values of the resistor and capacitor whilst watching the effect on a test pattern. Replacing the network with a resistor substitution box and a capacitor substitution box in series, and trying various combinations of values while watching the screen, will often make

it possible to straighten up a linearity problem in just a couple of minutes. Slight leakage in the capacitor in this circuit sometimes causes the raster to creep up at the bottom as the set gets warmer and warmer in operation.

A slightly leaky coupling capacitor between plate of oscillator and grid of output tube (.1 μ fd.) will produce a somewhat similar effect (Fig. 1), due to a positive voltage reaching the grid and causing a decrease in bias. Naturally, when bias is reduced by any means, the output stage conducts more heavily; thus when this fault occurs, the compression at the bottom is usually accompanied by excessive stretching at the top of the raster as shown.

Actual foldover at the bottom will result from an appreciable amount of leakage in the grid coupling capacitor. A more elusive cause of foldover is low "B+" to the output stage. The chain of events here is a little more complex. When the output stage has insufficient "B+," the vertical linearity control has to be cranked up to achieve full sweep at the top of the raster. This reduction of bias, combined with reduction of "B+," makes the output tube work at a nonlinear portion of its characteristic, and a current sawtooth somewhat like that of Fig. 5C results in the yoke. It is useful to bear in mind that, as a last resort, more "B+" can be obtained for the vertical-output stage by drawing it directly from the rectifier, instead of from a filtered point. Fig. 4 illustrates one such case, where take-off may be transferred from point B to A.

Compression at the Top

In some models, loss of capacity of the filter capacitor (C_f in Fig. 4.) will cause compression at the top of the raster (Fig. 2), as also will loss in the

100- μ fd. filter at the cathode of the output stage. The importance of the latter capacitor depends on how much resistance is in the circuit when the linearity control has been set up.

The resistor (470 ohms in Fig. 4) in series with the vertical-linearity control is inserted to insure that the stage cannot be adjusted to zero cathode bias. If a short circuit or gas develops in the output tube, excessive conduction for a short time may damage the limiting resistor while leaving the linearity control itself undamaged. If overheating of the resistor has resulted in an increase of its resistance, this will cause compression at the top of the raster.

Change of Oscillator Speed

Apart from tube faults, the most frequent reason for the oscillator frequency becoming incorrect is a change in the value of the grid resistance (shown as 1 megohm in Fig. 3). If this resistor is replaced, select a value which will lock the picture at half-way rotation of the vertical-hold control. A word of caution: do *not* re-establish correct oscillator frequency by replacing the series resistor with a value totally different from that in the original design. If this seems necessary, there is probably another fault at the root of the trouble. The writer recently encountered a case where a technician had made a vertical oscillator work at 60 cps by adding an extra 1-megohm unit in series with the existing resistors. The next day, the set again became uncontrollable. The real trouble was gas in the oscillator tube. Thus when a good tube was plugged in, the extra resistor had to be removed to get back to 60-cps oscillation again.

Slight leakage in the vertical-oscillator grid-coupling capacitor will cause a somewhat similar effect, due to a change of bias resulting in variation of frequency.

Frequency Drift

Drift due to heating is not often

Fig. 6. Appearance of normal vertical-sync pulse in the blanking bar. Contrast is reduced to make pulse visible.

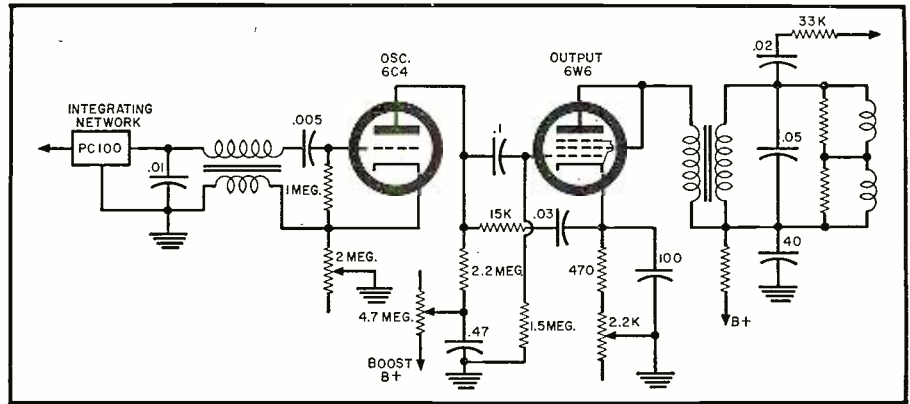
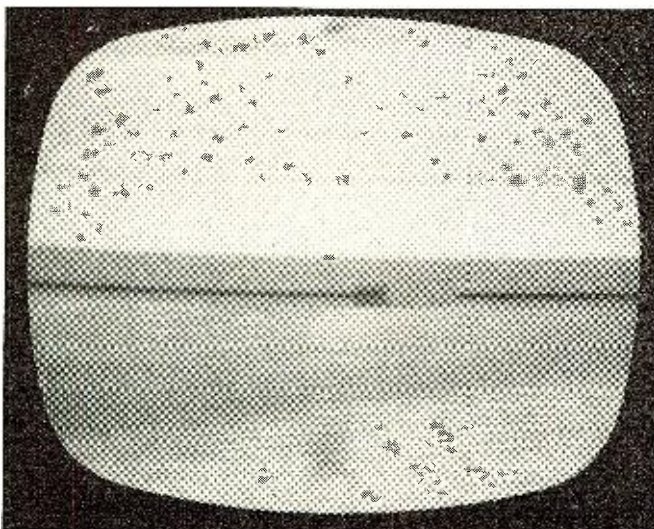

Fig. 3. A typical vertical oscillator and output strip using a blocking oscillator. Controls, from left to right, are hold, height, and linearity.

caused by resistor trouble in the oscillator grid circuit as, under normal operating conditions, practically no grid current flows. The most likely offender is the grid coupling capacitor, which should be of a zero- or low-coefficient type. In a multivibrator oscillator, the plate-to-grid feedback capacitor is also likely to develop an allergy to warmth and this component too must be replaced with a good stable type, a good quality molded-mica unit for example.

Occasionally, frequency drift is encountered due to poor impregnation of the windings of a vertical blocking transformer.

Completely Wrong Frequency

One fault which never fails to puzzle the technician who meets it for the first time is an open circuit in the oscillator discharge network. At first glance, the trouble seems to be in the horizontal rather than the vertical section. There is a ringing noise from the yoke, the picture is apparently way out of horizontal sync, and straggly white lines appear on a black strip at the top of the picture.

An examination of Fig. 3 will show that the discharge circuit is effectively in parallel with the oscillator plate-load resistor, as far as plate-load im-

(Continued on page 124)

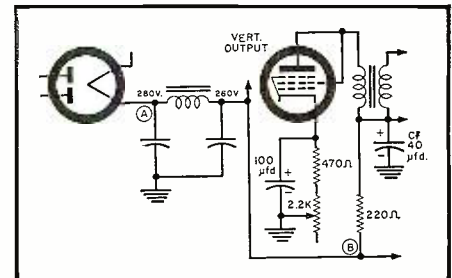

Fig. 4. If higher plate voltage is needed to obtain linear output from the vertical-output stage, "B+" may be taken from the input of the d.c. filter.

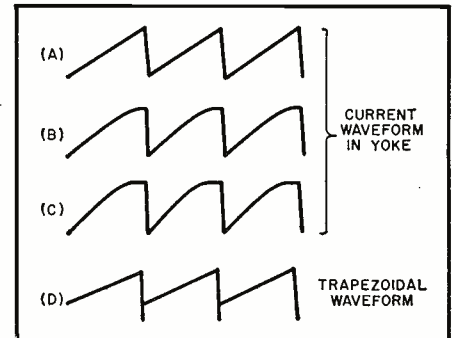
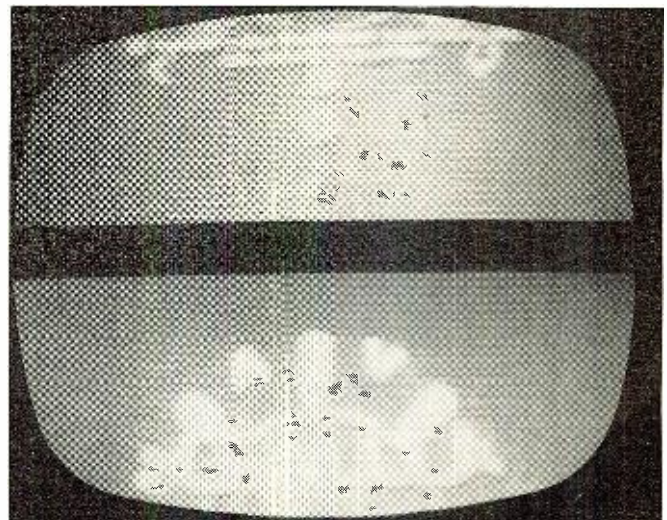

Fig. 5. Normal (A) and abnormal (B, C) current waveforms measured in the yoke. Oscillator output (D) voltage waveform.

Fig. 7. When contrast and brightness are in proper adjustment, both pulse and blanking bar should be equally black.



Missile Master Air Defense System

The first fully operational electronic system operated by Army at Ft. Meade.



↑ Here is a view of some of the radar tracking equipment used. The system was developed by the U.S. Army Signal Engineering Laboratories at Fort Monmouth, N. J. in conjunction with The Martin Co. of Orlando, Florida. Principal subcontractors were the Airborne Instruments Laboratory of Mineola, Long Island, N. Y., and the American Machine and Foundry Company, located in New York, N. Y.

↓ A few of the racks of electronic gear needed to operate the Missile Master system. Each one of the racks has its own power regulator, telephone jack, and line outlet.

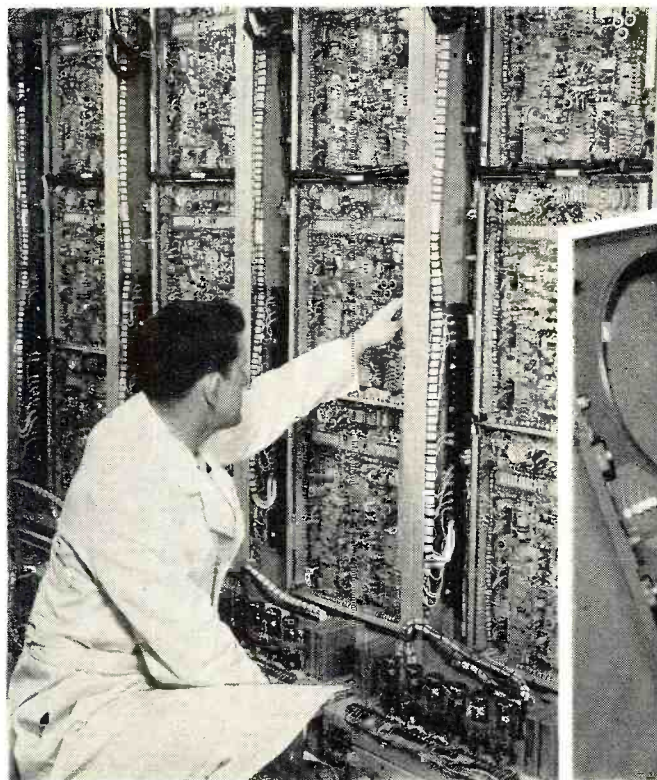

↓ "Friendly protector" console is in foreground. Operator's task is to insure that known friendly aircraft are not fired on by our batteries. Operator in background is handling the tactical director's console.



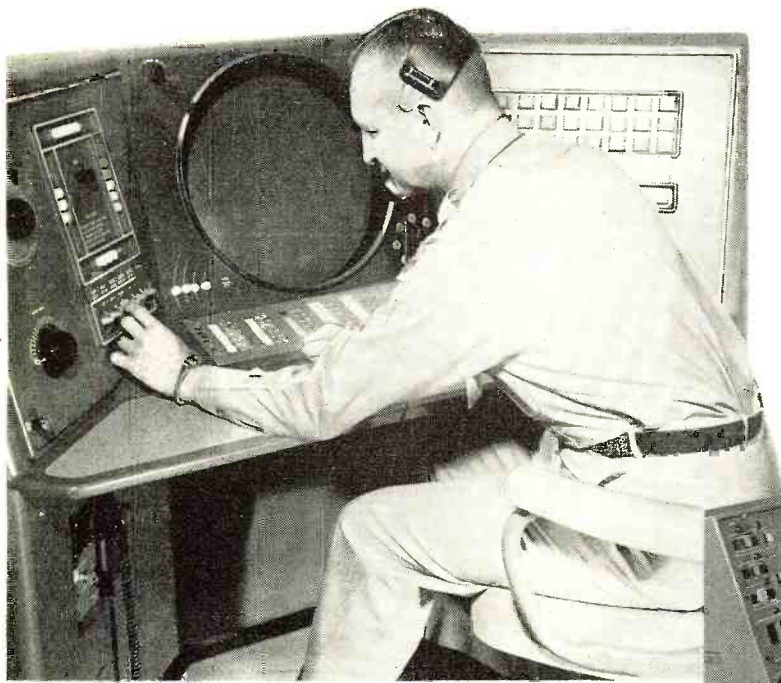

← Col. Jukas Hoska, Executive Officer of the 35th Antiaircraft Artillery Brigade, monitors the defense action from the defense commander's tactical console at the Ft. Meade Missile Master installation. The defense commander coordinates the related activities at the Antiaircraft Operation Center with adjacent AAOC's and the Air Force's Air Defense Direction Center in order to insure optimum use of the missile batteries which are at his disposal.

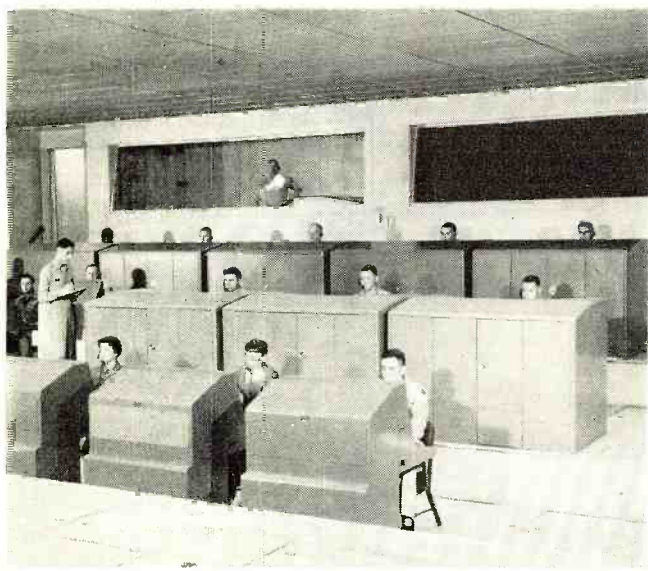

↓ Manning the tracking consoles which are used to monitor early warning information received by the Missile Master system at Fort George G. Meade, Maryland, are personnel of the 35th Antiaircraft Artillery Brigade. The over-all system concept originated at the U. S. Army Signal Engineering Laboratories, Fort Monmouth, New Jersey. Experience with a test system installed in 1954 enabled the development of a production system for operational use in relatively short time.

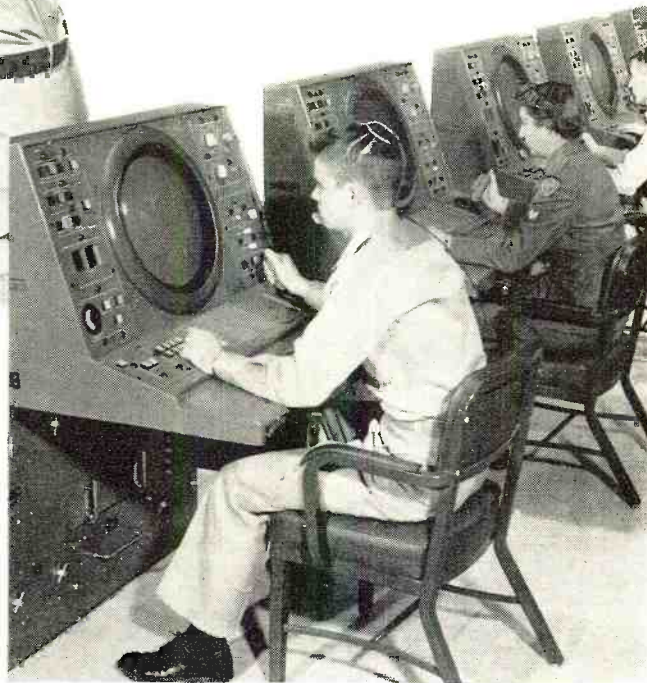

← The Antiaircraft Operations Center (AAOC) of the installation is shown manned by personnel here. In the foreground enlisted personnel are seated at tracking consoles monitoring early warning information. Gun teller consoles, surveillance and entry consoles, and range-height indicator console operators are in the second row. The third row has a "friendly protector" console, three tactical monitor consoles, and a tactical director's console. The defense commander's room may be seen at the top rear.

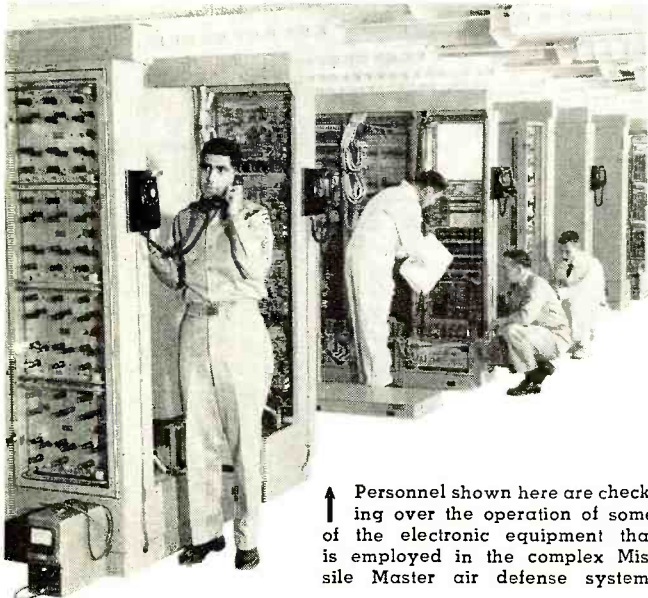

↓ Major elements of the Missile Master. System can also be coordinated with Air Force SAGE aircraft control.

↑ Personnel shown here are checking over the operation of some of the electronic equipment that is employed in the complex Missile Master air defense system.

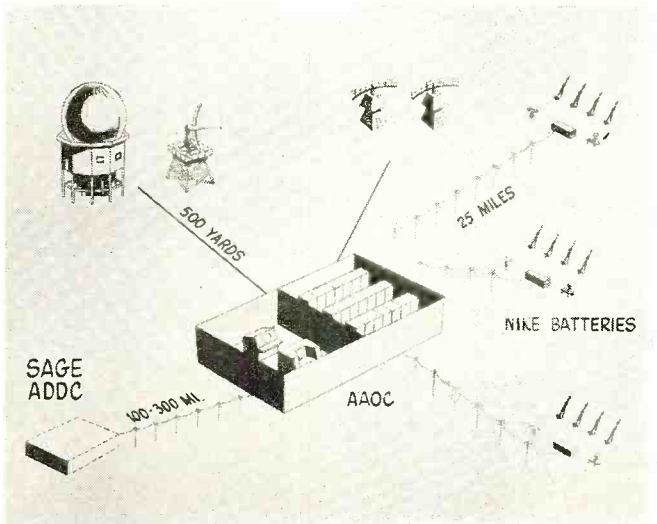

SERVICE SALESMANSHIP

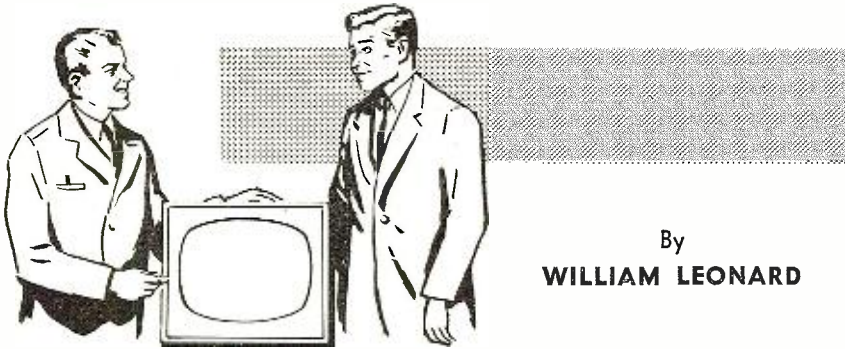

By
WILLIAM LEONARD

The need for improved public acceptance makes it perilous to rely on technical performance alone.

A WHALE of a lot of copy has been written about the dire need for better public and customer relations for the independent service industry. With the threat of expanding factory and distributor service hovering constantly over the service activity, a higher level of respect and confidence on the part of the set owner is sorely needed by TV service dealers.

A continuation of the unfavorable reputation the independent service industry has acquired can easily force set manufacturers to provide consumer service on their products—even though they would prefer *not* to be involved in retail product service. The public's confidence in brand-name service will impel them to pay higher prices for manufacturer-managed service if it is promoted, even though equal or better service is available from competent but relatively unknown local independent service shops.

Many people feel that a broad, national public-relations program is needed to create confidence in the independent service industry. They feel that, if the public is "educated" in the complexities of TV service through magazine, newspaper, radio and TV advertising, it will automatically raise the prestige of independent service shops.

While service is a commodity that must be merchandised and sold like a tangible product, the personal element that involves the technician who does the work presents a specialized selling problem to service management. Service is an intangible commodity. It is impossible for a lay person to measure its merit or value. Consequently, a set owner's reaction to and respect for the quality of the work done on his set will hinge on his opinion of the technician who did the work.

While the idea that independent service shops are competent, honest, and trustworthy can be promoted through national and regional advertising, the success of any such campaign would be determined by what individual customers think of individual technicians. In short, service

will always be a man-to-man relationship, with the customers' opinions based solely on their reactions to the technicians who handle the service on their TV sets.

This highly individual nature of consumer acceptance of both service charges and technical competence makes it advisable for the service industry to start its public relations activities at the grass roots of the industry. The grass roots of the service industry are the field service technicians—the men who *are* the independent service industry in the eyes of the public. Set-owner respect for the independent service industry would rise rapidly if every field-service technician would study and apply the simple fundamentals of good salesmanship in all his contacts with set owners.

What are those principles as they would apply to service selling?

The first principle of good salesmanship is the studied use of *showmanship*. This application of the word showmanship does not mean that a technician should put on a three-ring circus act for his customers. It refers especially to his personal appearance; his bearing; the exterior and interior appearance of his tube caddy; the respect he shows for the customer's property by using drop cloths to protect rugs and furniture; his ability and willingness to explain circuit failures in simple terms and to offer helpful advice on how to get the best pictures and service from a set. All of these factors enter into the application of showmanship to TV service in the home.

Consider first the matter of personal appearance. If you managed a retail store and dumped a quality product on the counter without displaying it in a fancy package, your customers would buy it only if you offered it at a bargain price. Dress this same product up in a striking package, present it in an attractive display, and it will sell at a premium price.

The same selling psychology applies to personal service. A neatly dressed, clean-shaven technician inspires con-

fidence in the customer. She is inclined to feel that he is a competent, trustworthy individual. If he carries a well-kept tube caddy, it creates the impression that he is efficient.

Family life now revolves around the TV set. Regardless of its make, the owner is proud of it. All of the furnishings in the room where it is located were carefully selected by the housewife. The chances are, it took some financial sacrifice to buy them. She is proud of them and is inwardly pleased when a technician shows respect for them by protecting them from possible damage. When a technician puts his tube caddy and everything he works with on a drop cloth, he is using the finest kind of service showmanship.

The job is completed and the set is back in operation. The bill is presented to the customer. A good salesman would buffer the normal feeling of antipathy toward having to pay for service by offering some advice on the care of the set at the time he presents the service ticket for payment. Quite often a compliment about the TV set or some piece of furnishing in the room, made at the time the service bill is presented, will serve to cushion a customer's resentment against needing service and then having to pay for it.

The second factor that is very important in effective salesmanship is to have a thorough knowledge of your product. This is also true of service salesmanship, with the added requirement that the technician should be able to explain TV circuit operation and breakdowns in simple language that the average person can understand. Even the simplest electronic and electrical terms are confusing to many people. Recently an elderly lady took her small radio to a shop to find out why it quit working. "It has a short circuit," the technician told her. "How much will it cost to lengthen it?" she replied.

A third factor that is involved in good salesmanship is one that every electronic service technician should try to cultivate. That factor is a sincere interest in and liking for people. In the early days of radio, dealers spent more time "servicing the imaginations" of their customers than they did in repairing sets.

Some of the most successful TV service dealers today built their businesses on their sincere interest in people. As one dealer put it, "If a TV technician really likes people and enjoys dealing with the general public, he will find service work both pleasant and profitable. If he likes people, he will find something interesting and likeable about every customer he calls on. When people feel you are really interested in them, they just naturally like you and consider you tops as a TV serviceman."

Showmanship, knowledge and a liking for people: those are the three key factors in effective service salesmanship. All of the necessary tools are available to do these things successfully. All a man needs to do is to get them and use them.

Maintain and Repair Your Own Scope

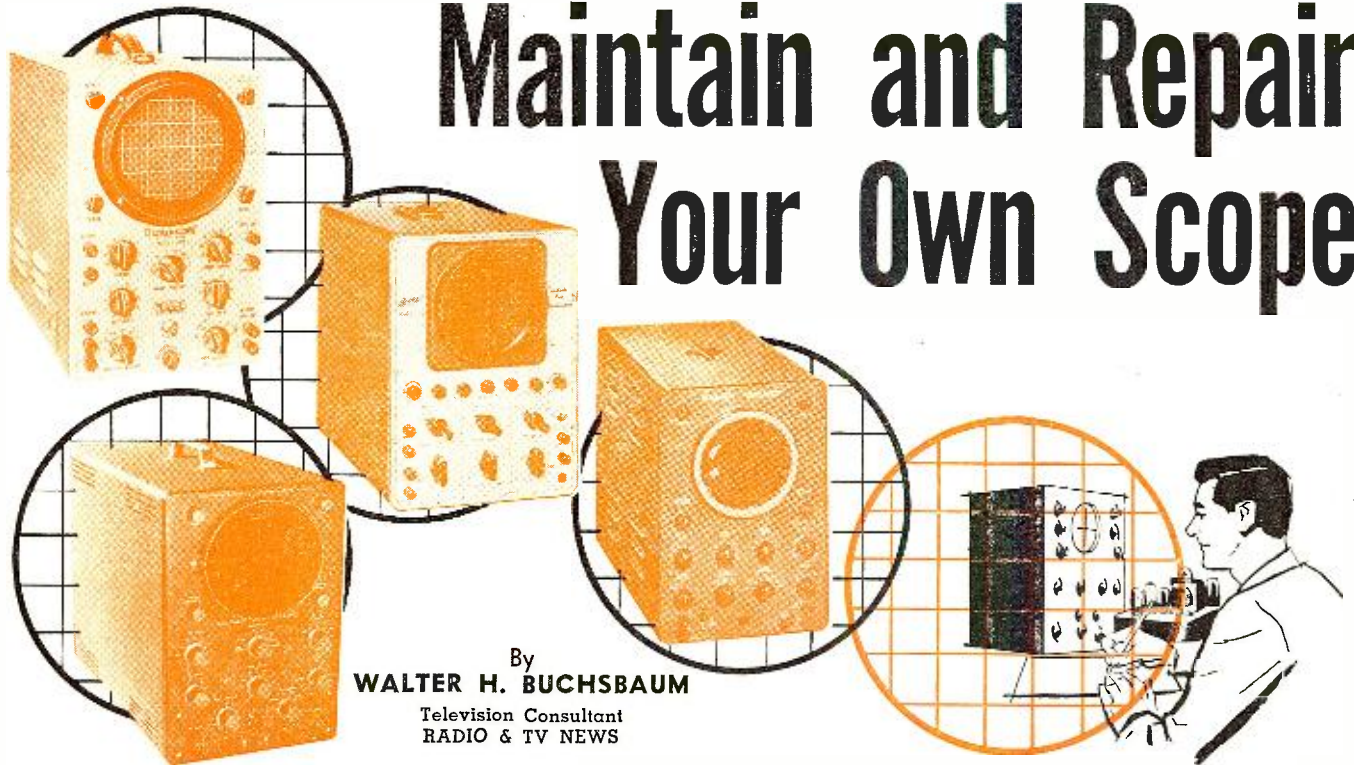

By
WALTER H. BUCHSBAUM
Television Consultant
RADIO & TV NEWS

TODAY it is almost impossible to imagine a TV repair shop which does not have at least one oscilloscope. Many alignment and troubleshooting procedures require the use of the scope and, for any bench troubleshooting, it is a vital tool. There is a large variety of oscilloscopes on the market both in kit and wired form and many manufacturers offer different applications. Oscilloscopes range from the basic, small-screen, narrow-band models to large-screen models having such special features as variable display time, black writing, millimicrosecond sweeps, and bandwidths up to 100 mc. Prices range from less than \$100—for a simple kit—to over \$5000 for a laboratory instrument with special features. Irrespective of price, however, all scopes have one problem in common. When they are not in working order, they are worthless. The \$5000 dolly-mounted, precision laboratory unit is just as much of a liability when it keeps blowing its fuses as the amateur experimenter's \$50 model.

This article deals with the various troubles which are likely to occur in oscilloscopes and with the problems of calibrating and maintaining the type of scope usually found in radio and TV service shops, but the principles discussed here apply to scopes in general.

Basic Scope Circuitry

Some scopes contain built-in calibrators, special time-base generators, r.f. demodulators and features which, although useful for some applications, are not really a part of the scope function. The basic operation of the instrument is to trace out a line across the horizontal axis of the screen while the displayed signal is simultaneously

Don't suffer the loss of this important instrument when it is "out." There are many things you can do to keep it in shape or handle specific defects.

moving the beam vertically. In this manner the waveform of the signal becomes visible. It is important to remember that, in most applications, the horizontal axis represents time and vertical axis voltage.

To display the signal "standing still," the horizontal motion must be in synchronism with the repetition rate of the signal. If the horizontal sweep is slower than the repetition rate, the displayed signal will appear several times. If the displayed signal is, for example, the 15-kc. horizontal-deflection signal from a TV receiver, the scope sweep would have to be at a 7.5-kc. rate to display *two* saw-tooth waves. When the scope sweep is faster than the displayed signal, then the signal will appear cut into strips and superimposed as in Fig. 1. The original sine-wave input signal is shown at the top of Fig. 1A. Underneath it are the 3 cycles of horizontal deflection that break the sine wave into the sections shown in Fig. 1B.

The basic elements of the scope are the cathode-ray tube, the vertical amplifier, and the horizontal-sweep section. Actually, as can be seen from Fig. 2, there are a few refinements which are necessary to make the scope versatile enough to display weak signals and to operate over a wide range of sweep frequencies and synchronizing levels. While representative, Fig. 2 is specifically based on the *Heath O-11*.

The attenuator in series with the vertical input acts together with the

gain control to regulate the signal level at the vertical amplifiers so that vertical deflection on the scope does not exceed the height of the screen. The horizontal-sweep signal is generated by either a gas-tube type relaxation oscillator or by a multivibrator. This generator is synchronized by a portion of the vertical signal, if desired, or else it can be synchronized from some external source or the 60-cps line frequency. The sweep-oscillator frequency is adjustable by means of a range switch and a fine-frequency control and its output is applied to the horizontal-sweep amplifiers. In some applications, it is desired to supply the sweep signal externally through a selector switch, which permits using either the internal sweep-generator circuit, or some external signal, or, in some TV scopes, the internal 60-cps sine-wave signal can be used directly. This latter connection is for use with a TV alignment sweep generator. To avoid displaying the return trace of the beam, a blanking signal is applied to the control grid of the CRT during the retrace period. This signal is usually derived directly from the sweep generator circuit and consists of the shorter portion of the saw-tooth wave.

In addition to these circuits, the CRT must also get its filament and d.c. operating voltages, for which a conventional power supply is used. In scopes, the deflection plates and second anode are kept at a relatively low d.c. potential, while the cathode is

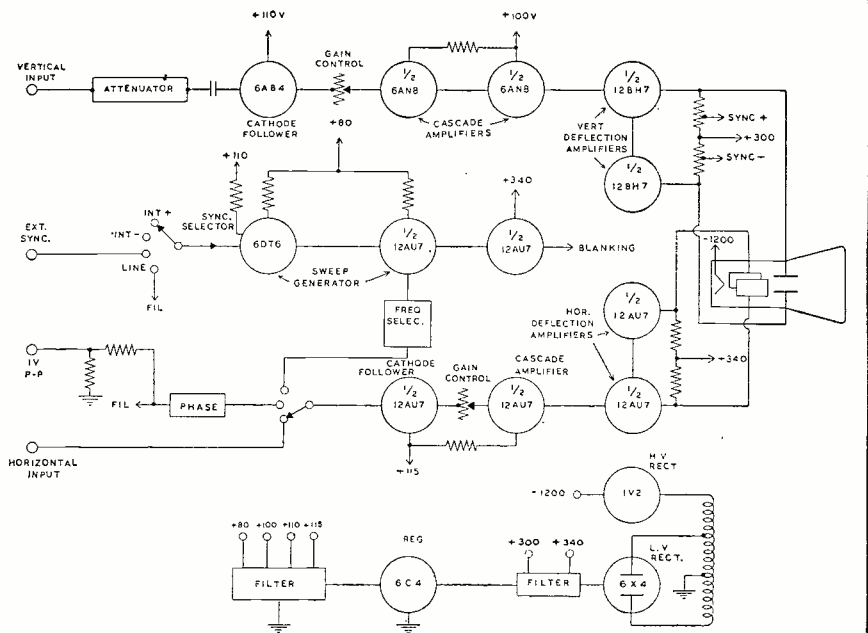
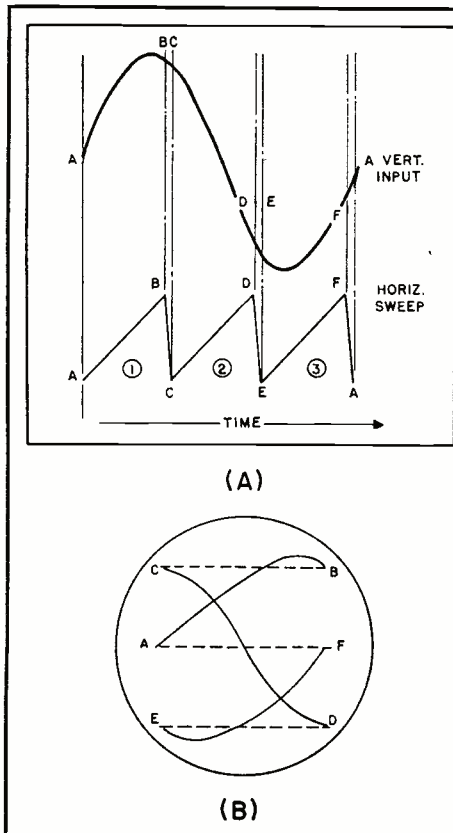

↑ Fig. 2. This functional block diagram, although it is based specifically on the Heath Model O-11, is typical of modern, wide-band, service scopes.

← Fig. 1. When scope sweep is adjusted to be faster than the signal to be displayed (A), that signal will be shown "cut into strips" (B) by the sweep.

operated at about 1200 to 1500 volts negative. This means that the CRT filaments are supplied from a separate winding and are usually tied to the cathode.

Troubleshooting

From the description of the basic functions of the scope, it will be apparent that, except for the power supply, we are dealing with pulse circuits in both the vertical and horizontal sections. In fact, these sections are very similar in operation to the video amplifiers found in TV receivers and the vertical and horizontal deflection systems. To trace defects through these circuits, another oscilloscope might be necessary. Many defects can be located by voltage and ohmmeter tests, but some troubles can only be verified with another scope and this can be a real problem in a small service shop. In a later paragraph a method is shown using a TV set to check some scope troubles—an interesting reversal of the usual relationship!

Table 1 (page 60) lists common defects which may beset a scope and the probable trouble for each symptom is arranged in the order of likelihood as well as simplicity of checking. For example, in the case of "no vertical deflection," the simplest check is to measure the input cable and terminal for short circuits. Only if this checks is it necessary to remove the instrument from its cabinet, and then the next step is possible tube failure.

The operation of the low-voltage power supply can easily be checked with the volt-ohmmeter, as can the

continuity of the vertical-attenuator switch. Only if some particular component in the vertical-amplifier circuit is defective may it be more efficient to use another scope to locate it. Even for this troubleshooting procedure, it is possible to use a known input signal, such as one from an audio generator, and trace it through the amplifier with an earphone or signal tracer.

In the case of Items 7, 11, or 12 of Table 1, signal tracing will not be very effective, although it is theoretically feasible to locate bandwidth or sync troubles by injecting a signal of known frequency and amplitude and following it. Bandwidth problems can often be pinpointed by ohmmeter measurements of the components in the frequency compensating networks.

Fig. 5 shows the vertical-output amplifiers of the *Hycon* Model 617 and this circuit is typical of many TV service scopes now on the market. Two 6CL6 pentodes are connected in a cathode-coupled push-pull circuit having both low- and high-frequency compensation in the plate leads. Low-frequency compensation is provided by R_{48} and C_{39-A} at one plate and R_{39} and C_{39-B} at the other. These networks present additional plate load at very low frequencies, and thus compensate for low-frequency losses due to the increased impedance of the grid coupling capacitor. High-frequency peaking is provided by two sets of series and parallel video peaking coils similar to those found in the video stages of most TV receivers. Note that the deflection plates of the CRT are directly connected to the plate circuit. Thus, the d.c. potential of the two plates with

respect to each other determines the centering of the electron beam on the screen. The vertical-centering potentiometer controls the relative d.c. bias on the two tubes and, therefore, regulates the relative d.c. voltage at the deflection plates.

If defects occur in the frequency-compensating networks, or some other portion of the vertical channel which seriously affect the over-all bandpass characteristic, this will become apparent in the waveforms displayed on the screen. Fig. 3 illustrates the appearance of various types of bandwidth defects when a square-wave signal is viewed. Of course, it is essential that we know the waveshape of the test signal. This can be checked with another scope, connected directly in parallel with the suspected unit. Sometimes the input impedance of a scope can ruin a waveshape. Using a high-impedance probe may help, provided that this probe is itself properly compensated. In judging bandpass troubles we must remember that the waveform of Fig. 3D can be due to a small, external series capacitance while the one of Fig. 3C can be caused by excessive shunt capacitance.

It is possible to use a good TV receiver to check for correct bandwidth in the vertical or horizontal scope amplifiers, if a source of pulses or square waves is available. First, check the scope manufacturer's data for the bandwidth specified. Assuming that it is 5 mc. within ± 3 db, we should be able to see square waves with a rise time up to .2 microsecond, which is shorter than most generators found in service shops can produce. If a 100-kc.

square wave is used, the slope of the vertical line should be less than 4% of the width between vertical lines (which is half a cycle of the 100-kc. square wave). This time between vertical lines is 5 microseconds. To see if the output of the square-wave generator really is that sharp, connect it to the grid of the last video-amplifier stage of a good TV receiver and adjust generator frequency until vertical bars appear on the screen. These bars should stand out sharply, and the width of black sections and white sections should be equal to each other.

If the TV set is locked to 15,750-cps horizontal sweep and 7 bars appear, the square-wave generator is actually operating at a shade above 110 kc. A more accurate bandpass check can be made on the scope with either a signal generator which goes up to 5 mc. and a v.t.v.m. or else with a video sweep-frequency generator, such as is used for TV alignment work, and another scope. The vertical or horizontal amplifier sections of the scope are treated just as the video section would be in a TV set. The bandwidth of the horizontal section is usually considerably less than the vertical.

Another defect which occurs occasionally and is not too easily located is horizontal nonlinearity. When saw-tooth signals or pulses are observed, this defect may not become apparent but may instead give the impression that the signal is distorted. To check for correct horizontal linearity on all sweep ranges, sine-wave signals are displayed, usually furnished by an audio signal generator. If the frequencies are known fairly accurately, these sine-wave signals can also be used to calibrate or check the range switch and vernier control settings. In Fig. 4, a typical display of this type is shown together with some commonly available frequencies and their meaning in terms of sweep time on the scope.

First, adjust the vertical gain until the signal fills the two large center

boxes of the screen's calibrated overlay grid, as shown. Then set the sync-selector switch to its "internal" position. Adjust the range and vernier controls to obtain an image like the one shown in Fig. 4. In order to space the signal evenly across the vertical grid lines, it may be necessary to adjust the horizontal-gain control also. Note that the horizontal spacing of each cycle should be measured from each zero or center point to the next, rather than from one sine-wave peak to the next. Since the peaks tend to be broad, accuracy would be difficult. If a square-wave generator is available, it may be easier to use this type of signal for the test instead of the sine-wave signal. In the case of the square-wave signal, the distance is measured from one vertical line of the waveform to the next, or the portion of each horizontal portion of the waveform is measured.

If neither a suitable sine-wave nor square-wave generator is at hand, the vertical and horizontal sync pulses from a TV receiver can be used for some tests. To use these sync pulses, connect the scope input to the output of the first sync clipper in the TV receiver, or else to the output of the video amplifier directly. The only frequencies available in this way are 60-cps and 15,750-cps. However, other frequencies can be checked by counting multiples on the scope display.

Even relatively expensive scopes will not produce a sweep which is perfectly linear over the entire screen; some compression must usually be accepted at the edges. It is good to know, however, just how far from the center the sweep is linear, so that future waveform measurements can be made accordingly.

Horizontal nonlinearity will become apparent in that the sine waves will appear either compressed or expanded at the point of trouble. Such a symptom can sometimes be due to a gassy tube, a leaky capacitor, or some other

"near-defect." Signal tracing with a second scope through the horizontal-sweep section will reveal the point at which the saw-tooth voltage becomes nonlinear. Usually, careful voltage checks will reveal the defective part, even without a second scope. Using a TV set is not very helpful here, although it is possible to use the vertical or horizontal sweep signal from the TV set to drive the horizontal amplifiers of the scope.

Probably the most bothersome defect in scopes is the lack of proper synchronization. Usually this is apparent first on internal locking. If no sync can be obtained in either internal, external, or line positions, then the sync tube is the most likely trouble spot. If sync is difficult or intermittent only on certain internal signals, then the trouble may be really hard to find. First, be sure that the amplitude of the vertical signal is sufficient and that it is not accompanied by noise spikes of equal height. In checking TV sync troubles, it occasionally happens that, in a noisy location, the noise pulses are as great as or greater than the desired sync pulses. While the TV set may have a noise-suppression circuit which permits its horizontal oscillator to sync correctly in such circumstances, the scope will tend to lock in on noise pulses, with the result that jitter and unstable sync appears. This does *not* usually mean that the scope is defective. If loss of sync occurs only on certain ranges of the scope sweep generator, then that circuit is at fault. If poor locking occurs on all internal sweep frequencies, the network coupling the vertical signal to the sweep generator or the sync selector switch and its wiring should be suspected.

In addition to the 13 symptoms listed in Table 1, there are some marginal-performance possibilities which can be determined by the methods already listed for the circuit involved. If, for example, the focus control does

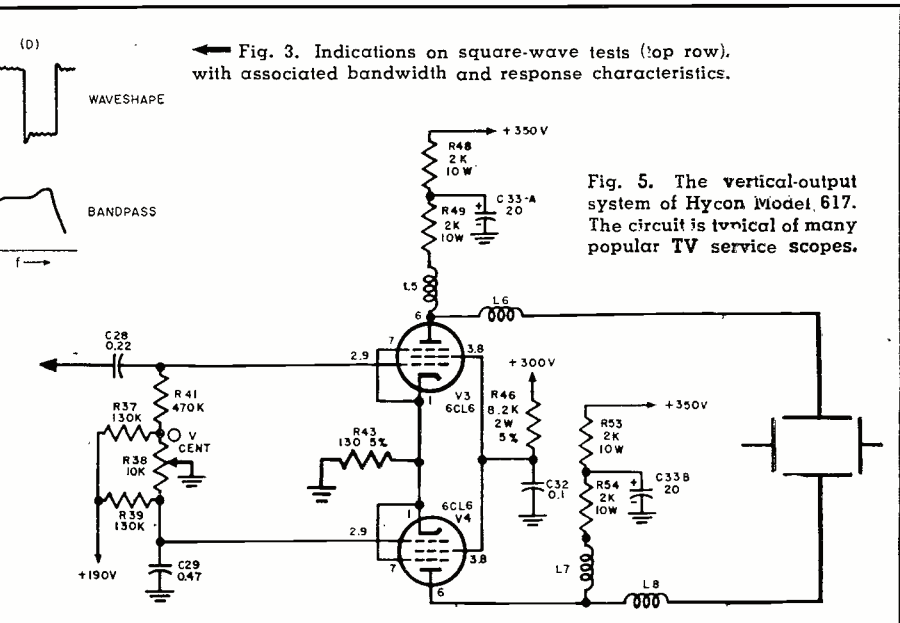
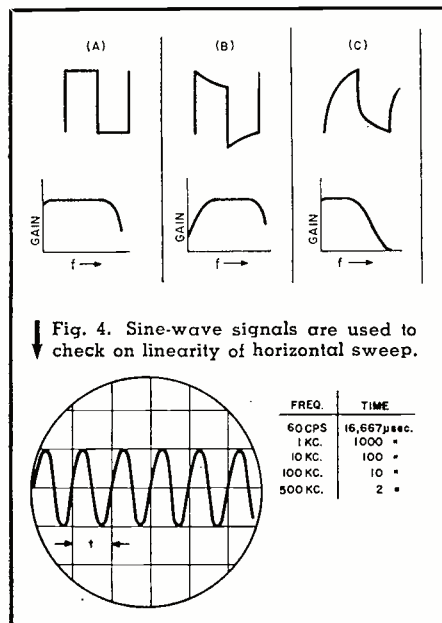

Fig. 3. Indications on square-wave tests (top row), with associated bandwidth and response characteristics.

Fig. 5. The vertical-output system of Hycon Model 617. The circuit is typical of many popular TV service scopes.

not provide quite the sharpest focus, the steps listed under Symptom 3 are indicated. Similarly if the vertical deflection is insufficient, the steps under 6 are suggested. In this connection, it is important to know just what kind of sensitivity, frequency response, sweep frequency, and other characteristics a particular instrument is supposed to have. There may be no point, for example, in troubleshooting a scope because it fails to display the output of a color sync circuit. That signal is a 3.58-mc. sine wave and, if the scope has a bandwidth of 500 kc. and a horizontal-sweep rate of 100 kc., it cannot display such a signal.

Maintenance

Since a scope has few parts, maintenance is largely confined to replacing weak or gassy tubes. Some scopes

use long shafts going from a point at the rear of the chassis to the front panel through shaft bearings. An occasional drop of oil is indicated, unless self-lubricating bearing are used. The frequency range switch and any other rotary switches in the scope should be cleaned with some contact cleaner and lubricated at least once a year. Cleaning of the scope screen behind the plastic grid, as well as the plastic grid itself, should be performed at regular intervals. Other points to check in any maintenance procedure are the various terminals, especially the vertical-input connections and its cables. Binding-post type terminals have a tendency to become loose and coaxial terminals often become worn and partly shorted by dirt.

Needless to say, particularly when the scope is moved around much, the

line cord should be replaced before it gets completely frayed.

Calibration

Calibration of a scope for the most important characteristics requires a knowledge of the manufacturer's specifications as concerns frequency response of the vertical and horizontal sections, sensitivity, sweep frequencies, and sweep linearity. Frequency response of the vertical amplifier can be checked by displaying a sine-wave signal of the highest frequency within the flat portion of the bandpass and using it to check sensitivity. The horizontal amplifier can be checked in the same manner except that, in this case, the length of the horizontal line serves as indication of the gain. In calibrating the RCA type WO-91A, for example, the bandwidth in the wide-band position is given as 4.5 mc. ± 1 db, and the sensitivity of the vertical amplifier as .15 volt peak-to-peak per inch. This means a 4.5-mc. signal of .053 volt r.m.s. should be 1 inch high.

To measure the input, it is only necessary to use a 4.5-mc. signal generator, connect a diode probe to it, and read the voltage at the voltmeter. If a voltage divider of two 100,000-ohm resistors is connected across the generator output, and the signal to the scope is taken off across one half of this divider, the meter diode probe can be connected across the other half of the divider, and the generator output is set so that the meter reads .15 volt d.c. The diode probe is a peak detector, meaning that the peak-to-peak signal at the generator output will be .3 volt, with the scope getting half.

In a similar manner we can calibrate the horizontal sensitivity and bandwidth. A method for checking sweep frequencies was given in an earlier paragraph, as was a method for checking the linearity of the horizontal scope sweep. Assuming that these checks show a need for adjustment, it may be necessary to remove the cover or else reach into the various adjustment points with a long alignment tool. Few scopes have any adjustment for high-frequency compensating networks, but some do have potentiometers for varying low-frequency response. When the sensitivity is substantially less than specified, aging of tubes is the most common reason. In some scopes, internal gain-adjustment potentiometers are provided to balance out the push-pull output stage. Almost all scopes have some adjustment for horizontal sweep linearity and this control should be set while a display like the one shown in Fig. 4 is observed. Perfect linearity is unlikely, but sweep should be uniform over at least 75% of its width.

Calibration of sweep frequency is usually accomplished by adjusting trimmer capacitors located in the sweep-generator stage. If really exact frequency calibration is desired, an accurate signal generator must be used against which the horizontal sweep is compared.

Table 1. Troubleshooting chart lists usual scope defects with their causes.

SYMPTOM	PROBABLE TROUBLE
1. Pilot doesn't light	Pilot light bulb defective A.C. power cable and plug Fuse Switch and wires Power transformer
2. No spot on CRT	Horizontal or vertical position control misadjusted High-voltage supply defective CRT filament open CRT socket loose Vertical amplifier plate resistor open Horizontal amplifier plate resistor open
3. No focus or intensity control action	CRT socket loose or defective High-voltage bleeder open Focus control defective Intensity control open CRT defective
4. No vertical positioning	Vertical amplifier tubes Vertical positioning control defective Low-voltage power supply Leads to deflection plates open Vertical amplifier circuitry defective
5. No horizontal positioning	Horizontal amplifier tubes Horizontal positioning control defective Low-voltage power supply Leads to deflection plates open Horizontal amplifier circuitry defective
6. No vertical deflection	Input cable and connector open or shorted Vertical amplifier tubes Low-voltage power supply Vertical attenuator switch open Vertical gain control defective Vertical amplifier circuitry defective
7. Poor vertical frequency response	Frequency compensating networks defective Coupling capacitors leaky Vertical amplifier tubes High-impedance probe defective
8. No horizontal sweep on some ranges	Range switch defective Capacitors on range switch shorted Horizontal sweep generator tubes
9. No horizontal sweep on any range	Horizontal sweep generator tubes Horizontal amplifier tubes Horizontal gain control defective Sync selector switch and wiring defective Low-voltage supply Horizontal sweep circuitry defective Horizontal amplifier circuitry defective
10. Horizontal sweep too narrow or non-linear	Horizontal amplifier tubes Horizontal amplifier circuitry defective Low-voltage supply Horizontal sweep generator circuitry defective Horizontal amplifier frequency compensation circuit
11. No sync on internal sync or 60 cps	Sync selector switch and wiring defective Sync amplitude control open or shorted Range switch defective Horizontal sweep generator tubes Sync injection circuit defective Low-voltage power supply
12. No sync on external sync	External sync terminal and wiring open or shorted Sync amplitude control defective External sync pulse shape or amplitude wrong
13. No retrace blanking	Blanking amplifier tube Blanking coupling circuit defective CRT socket loose

RC Filter Tone Controls

By H. ALAN SCHWAN

THE audiophile who builds his own equipment is inevitably faced with the problems of manual frequency response adjustment. Since the basement audio engineer rarely likes or feels at home with other people's tone control designs, outlining a simple control design procedure may be of interest.

It is generally agreed that a successful tone control must affect only the areas and quantities for which it is intended; *i.e.*, a treble control must have no noticeable effect on the low frequencies or on the apparent volume level. Further, the use of inductances in tone control circuits is pretty well precluded by their expense and susceptibility to hum. Hence, *RC* filters will be considered exclusively. Finally, it is desirable to be able to design one extreme of a given control independent of the other extreme, that is, the characteristic of the tone control at one extreme setting should be determined by the circuit at that particular end and should not be affected by the circuit at the other end.

With these considerations in mind the author has developed a simple design procedure for a generalized *RC* tone control based on the fundamental circuit of Fig. 2. This circuit was chosen because it allows accurate, independent design of the two end positions while offering smooth continuous control.

For frequency response correction in audio amplifiers, four basic types of tone control settings will satisfy virtually all of the practical requirements. These settings are: treble boost, treble cut, bass boost, and bass cut. Two independent controls and four filters are required to allow practical combinations of these settings.

RC filters, whether boost or cut types, must necessarily be attenuators. A filter which gives an apparent boost characteristic in its active area does so by reducing the amount of attenuation in that area. The maximum amount of boost available is equal to

Practical design information and examples of tone control circuits for the audiophile who builds his own equipment.

the nominal insertion loss of the filter. Thus, a treble boost filter must be designed so as to reduce the insertion loss of the filter at the higher frequencies. However, if the filter is to have no effect on the low frequencies, it must not begin its reduction of attenuation until some minimum frequency is reached. Similar criteria apply to the bass boost filter.

Treble Boost Filter: The basic treble boost filter is shown in Fig. 1A. As the source frequency is increased from zero, no significant change in output level is noticed until the reactance of the capacitor starts to decrease toward the value of R_1 . At such a frequency the capacitor begins the effective bypassing of R_1 , and the impedance in series with the source and

the load (R_2) starts to decrease. As the input frequency increases further, the output voltage rises toward the input voltage until a frequency is reached where the capacitor's reactance is small compared with the resistance of R_2 . At this point, the capacitor is a virtual short circuit and the output is effectively connected directly to the input. Here, the attenuation has dropped to a negligible value and a treble boost has taken place.

The designer of such a filter is interested in the rate of boost, the maximum amount of boost available, and the point where significant boosting starts. The rate of boost in an *RC* filter is fixed by the fundamental nature of *RC* circuits at some value

Fig. 1. Basic *RC* tone control filter networks with their appropriate equations.

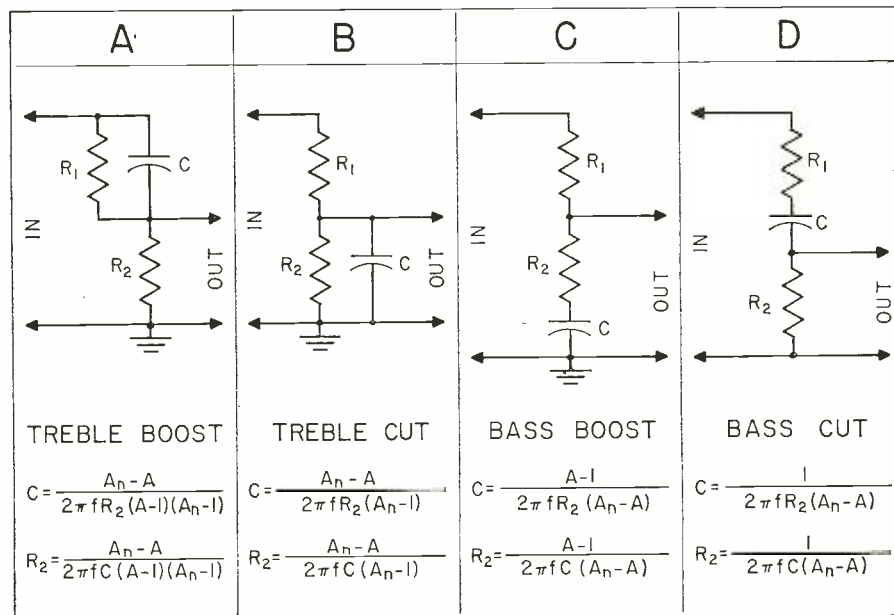

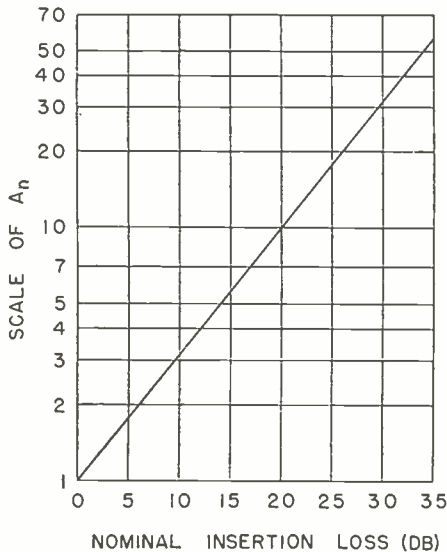

Table 1. Relation between nominal insertion ratio, A_n , and nominal insertion loss. Maximum boost desired is projected vertically to line, then horizontally to the vertical scale. This value of A_n is used in the equations.

less than six decibels per octave. However, the complete tone control circuit allows manual adjustment of the boost rate. The maximum amount of boost is equal to the nominal insertion loss of the filter where the nominal insertion loss is:

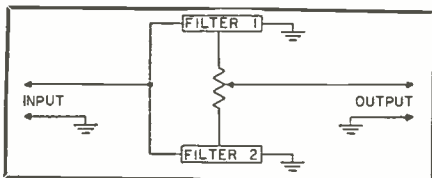
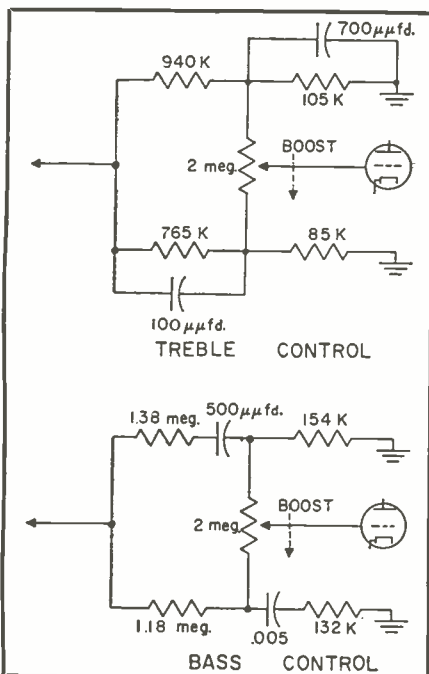

Fig. 2. Movement of pot wiper toward filter 2 causes the input-output relation to be modified more by filter 2 and less by filter 1. This is the basic tone control scheme.

Fig. 3. Treble and bass controls. Bass turnover is 500 cps, treble turnover is 1000 cps, and nominal insertion loss is 20 db.



$$\text{decibel loss} = 20 \log \frac{R_1 + R_2}{R_2} = 20 \log \frac{V_{in}}{V_{out}}$$

In practice, the amount of boost is chosen to suit the requirements of the tone control. Twenty decibels is usually assumed for this value and is generally adequate. If twenty decibels is assumed, then:

$$\frac{R_1 + R_2}{R_2} = 10, \text{ and } R_1 = 9R_2.$$

At this point it is necessary to investigate the source impedance. If the tone control is to be driven from the plate of a voltage amplifier, the control circuit should have a mid-frequency input impedance of around 500,000 ohms. This requires that $R_1 + R_2$ be near one megohm since the tube must drive two such filters in parallel. If the control is to be driven by a cathode follower, $R_1 + R_2$ should probably be in excess of 50,000 ohms. Assuming a plate loaded amplifier as a source, 0.1 megohm might be a good value to assume for R_2 as a start. (Thus R_1 plus R_2 equals one megohm.)

If we let A_n be the nominal insertion ratio of the filter and A be the ratio of input to output voltage at some frequency f , then the decibel boost at that frequency is the nominal insertion loss minus the attenuation at the frequency f :

$$\text{decibel boost} = 20 \log A_n - 20 \log A = 20 \log \frac{A_n}{A}$$

where:

$$A_n = \frac{R_1 + R_2}{R_2}$$

A consideration of the treble boost filter circuit shows that:

$$C = \frac{A_n - A}{2\pi f R_2 (A - 1) (A_n - 1)}$$

A determination of C can be made from this equation if a value of boost is assumed at some frequency. A convenient point to choose is the desired turnover point, the frequency at which significant boosting starts. The turnover point has a boost of three decibels and, for the treble boost circuit, should occur at around 1000 cps. Continuing with the previous assumptions in illustration, then:

$$C = \frac{10 - 7.07}{2\pi \times 1000 \times 100,000 (7.07 - 1) (10 - 1)} = 85.4 \mu\text{fd.}$$

It is preferable to use standard component values where possible, hence, the value of C is to be regarded as an approximation, and a more convenient value would probably be 100 $\mu\text{fd.}$ However, if the value chosen for R_2 is kept and the rather arbitrary value of C is used, the turnover frequency cannot be expected to come out to the assumed value. Since the input impedance is rarely critical, it is expedient to alter the value of R_2 to bring the turnover frequency back to the

assumed value. The final value of R_2 , then, is found for the treble boost filter by substituting the desired turnover frequency, the new value of C , and the value of A at the turnover frequency into the equation:

$$R_2 = \frac{A_n - A}{2\pi f C (A - 1) (A_n - 1)}$$

In the present example, R_2 equals 85,000 ohms. R_1 is now found from the initial consideration of maximum boost where $R_1 = (A_n - 1) R_2$. In the example, $R_1 = 9R_2 = 765,000$ ohms.

The purist will insist on using these values for R_1 and R_2 . However, a slight deviation in the interest of allowing the use of standard values will usually be satisfactory. (Changing R_2 from the ideal 85,000 ohms to the standard 82,000 ohms and R_1 from the ideal 765,000 ohms to the standard 750,000 ohms will change the turnover frequency from the assumed 1000 cycles to 1040 cycles. Such an alteration is almost always admissible.) However, care should be taken to change both resistors by roughly the same percentage in the same direction.

Treble Cut Filter: The circuit for the basic treble cut filter is shown in Fig. 1B. As the source frequency is increased from zero, no change in output is noticed until the reactance of C approaches the value of R_2 . At such a frequency, effective bypassing of R_2 begins and the output voltage starts to drop.

The determination of the values to be used in this filter follows essentially the same procedure as was just outlined for the treble boost circuit. Assuming that this filter is to be used at the end of the tone control opposite from the treble boost filter, it should have a nominal insertion loss equal to that of the boost circuit in order to insure a constant volume level over the entire range of the control. Values of f and A are determined as before, and an approximate value of R_2 decided upon. In the case of the treble cut filter, an approximate value of C is determined from the equation:

$$C = \frac{A_n - A}{2\pi f R_2 (A_n - 1)}$$

and a standard value of C is chosen as close as possible to that determined by the equation. Then the final value of R_2 is calculated from the equation:

$$R_2 = \frac{A_n - A}{2\pi f C (A_n - 1)}$$

and a close standard value chosen. R_1 is then found as before.

The Bass Filters: If a very high frequency is applied to the input of the circuit of Fig. 1C, capacitor C will act as a short circuit and the output will be attenuated by the nominal insertion loss of the filter. As the input frequency is reduced, the reactance of C will increase until it approaches the value of R_2 , at which time the output will begin to rise significantly. As the signal frequency is reduced toward zero, the capacitor

reactance will approach infinity so that with d.c. applied across the input no attenuation occurs. Thus a boost has been effected across the output in the region between d.c. and where X_c approaches R_2 . The operation of the bass cut filter is similar.

The same procedure is followed in designing the two bass filters except that the equations used are:

$$C = \frac{A-1}{2\pi f R_2 (A_n - A)}$$

$$R_2 = \frac{A-1}{2\pi f C (A_n - A)}$$

and:

$$C = \frac{1}{2\pi f R_2 (A_n - A)}$$

$$R_2 = \frac{1}{2\pi f C (A_n - A)}$$

for the boost and cut filters respectively.

The Tone Control

The potentiometer used as a tone control to link any pair of filters should be large compared to the value of R_2 for either filter, otherwise adequate isolation of the two filters will not be effected and interaction will occur between them. If the pot is ten times larger than either R_2 , adequate isolation should be accomplished. If it is twenty times as large, the isolation can be considered complete.

Care must be taken not to load the output of the control or significant changes in volume level will be experienced as the tone control setting is changed. An ideal situation in this respect is to drive an amplifier grid directly from the pot wiper, as indicated in Fig. 3, using only the control circuit for the d.c. grid return.

If two tone controls are to be included in an amplifier, probably the most reasonable choice would be a treble and a bass control, although this is not the only possibility. This choice requires a treble cut filter at one end of the treble control and a treble boost filter at the other. It further requires a bass cut filter at one end of the bass control and a bass boost filter at the other. In this kind of an arrangement both filters connected to a given control should be designed to have the same turnover frequency.

Very nice single control units can be built by employing a bass boost filter at one end of the control and a treble boost filter at the other. The two-control design is usually to be preferred, however. In any event, the filters associated with any given control should have the same value of nominal insertion loss.

Resumé of Design Procedure

In brief, the procedure for the design of the filters is as follows:

1. Decide which pair of filters is to be coupled to a given control.
2. Determine the maximum desired boost and calculate A_n from the equation:

$\text{decibel boost} = 20 \log A_n$, or determine A_n from Table 1.

3. Determine an approximate value of mid-frequency impedance, Z_i , by considering the load requirements of the driver. (The tone control constitutes the load.)

4. Compute an approximate value of R_2 from the relation: $R_2 = Z_i/A_n$.

5. Choose some point on the desired frequency response characteristic of the filter; i.e., determine a value of boost or cut at some specific frequency. (Usually the turnover point will be chosen, but this is not necessary.) From the value of boost or cut thus known and from A_n found in step 2, find A , either from the equation:

$$\begin{aligned} \text{decibel boost} &= 20 \log A_n/A \\ \text{decibel cut} &= 20 \log A/A_n \end{aligned}$$

or from Table 2.

6. Calculate a first value for C by substituting the values for A_n , A , f , and R_2 found in steps 2 through 5 into the appropriate filter equation as listed in Fig. 1.

7. Choose a standard capacitor value near that calculated in step 6.

8. Insert the values of A_n , A , and f found in steps 2 through 5 and the value of C found in step 7 into the appropriate equation for R_2 as listed in Fig. 1.

9. Calculate R_1 from the equation: $R_1 = (A_n - 1) R_2$.

10. It is usually acceptable to use standard values for R_1 and R_2 if they are close to those calculated in steps 8 and 9.

It is to be noted that if R_1 and R_2 are expressed in ohms, then C will be in farads. If R_1 and R_2 are given in megohms, then C will be in microfarads.

Practical Filters

A practical example of each of the four types of filters in a tone control application is illustrated in Fig. 3. The values shown result in the response characteristics plotted in Fig. 4. These response curves represent the extreme limits of the tone controls.

The criteria used in designing the

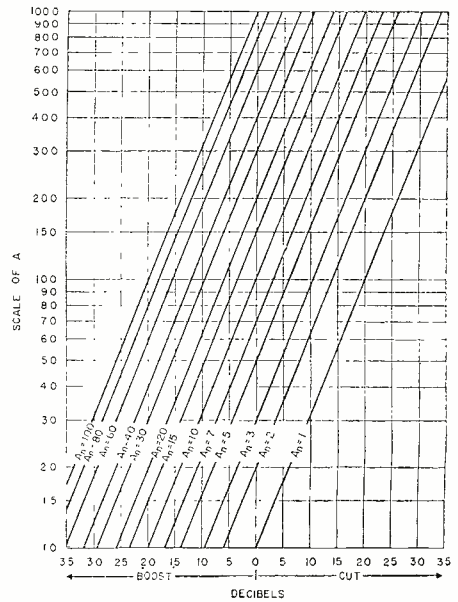

Table 2. Relation of input-output voltage ratio, A , of any RC filter with insertion ratio A_n and the decibel boost or cut. Project upward from the desired db value of boost or cut to the line representing value of A_n from Table 1. Then project horizontally to scale of A , and read the value of A .

filters illustrated were as follows:

1. Input impedance, roughly 500,000 ohms (individual filter input impedance, Z_i , roughly one megohm).
2. Bass crossover point at 500 cycles.
3. Treble crossover point at 1000 cycles.
4. 20 decibels maximum boost.

It is to be noted that the exact values of R_1 and R_2 , as calculated from procedure described previously were employed; i.e., standard values were not substituted. It is suggested that the values of the components shown be computed by the designer to serve as a check on the over-all design procedure.

The technique described herein has given good results and should be very useful to anyone interested in the problems of tone control or fixed frequency response correction. -30-

Fig. 4. Response characteristics of four filters shown in Fig. 3. This represents the response of the controls when set at their respective extreme positions.

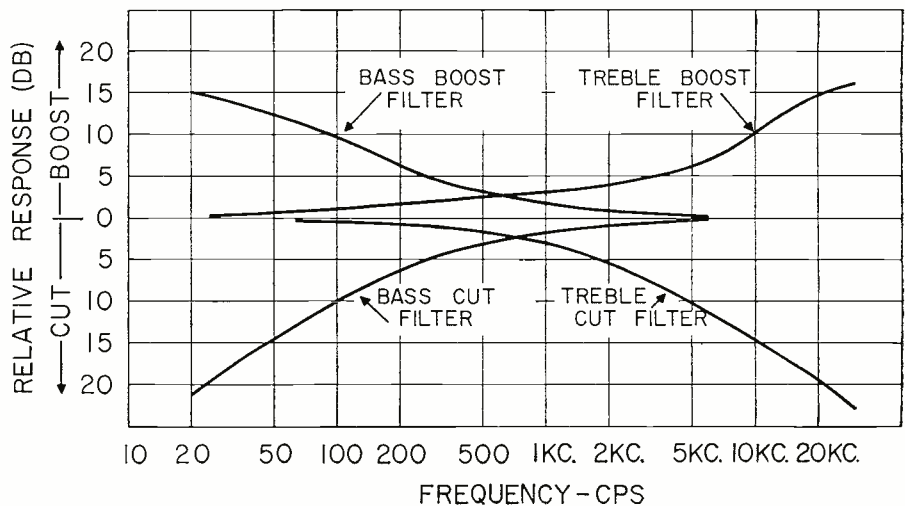

All About Audio and Hi-Fi

Speaker Mounting

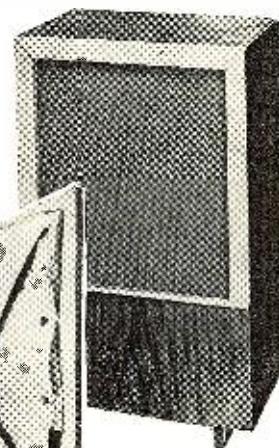
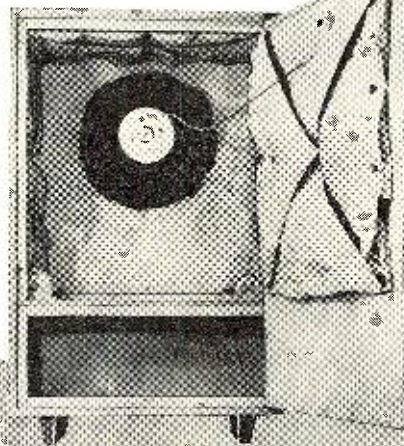

Fig. 41. Outside and inside views of cabinet described in article. The entire top section is lined with 1" padding.

By **G. A. BRIGGS**
Managing Director
Wharfedale Wireless Works Ltd.

Part 9. Concluding comments on cabinet construction along with characteristics of various cabinet types.

WE NOW come to the last—and most difficult to write—installment in this series of articles. In fact, if we had not already committed ourselves to deal with cabinets, baffles, etc., I think we should have put up the shutters at the end of Part 8. The subject is so vast, and so much has already been written about it, that it is difficult to know where to start; it is always much easier to write at length about a small problem than to deal briefly with a big one. At any cost, we must avoid a re-hash of what has gone before, but I think we might usefully begin by outlining our latest thoughts on the old, old questions that are so very important.

(1) The first thing to remember is that cabinets and horns are a necessary evil, used to avoid cancellation of sound waves from back and front of a cone. They don't improve the quality of sound and we should be much better off if we could do without them.

(2) Although it is possible to improve the performance of small enclosures by acoustic devices, it is almost impossible to make a small cabinet sound like a big one.

(3) With reflex enclosures, dodges like fitting pipes and diaphragms to vents make a difference to resonances, which are pushed around but not usually eliminated.

(4) Padding enclosures and hanging drapes in them gets rid of standing wave effects and often smooths the

response, but the speaker unit is still working in a cabinet which colors results.

(5) Folded horns are a useful device for obtaining large-scale results in a limited space, but a folded horn is not truly exponential and never equals a straight one.

(6) Flat baffles are better than is generally believed. They are free from cabinet resonance. Two speakers in parallel on one baffle give a 3 db gain at low frequencies and double the power handling capacity so that bass lift can be used in the amplifier, resulting in four times the low-frequency output of a single unit. The floor also improves bass by reflection, and walls can be harnessed in the same good cause. Baffles are efficient because the sound from both sides of cone is used, and I am now inclined to the belief that equal air loading front and back is a good thing.

(7) Directional effects are serious. It is only necessary to look at an orchestra to realize how omni-directional most instruments are; hence the virtue of omni-directional reproducers, especially in upper registers.

(8) Convenience in use is becoming more and more a necessity as the interest in hi-fi reaches the music lover as distinct from the sound enthusiast. Some compromise is always necessary and perfection is as far off as ever, so the foregoing drastic observations should not be taken too seriously.

Sighing for the moon does not bring it any nearer.

Cabinet Construction

Details are now given for the construction of reflex cabinets of two sizes. The fact that we deal with vented enclosures and not with corner horns does not mean that we have any prejudice against the latter; it simply means that we have done more work on reflex designs and therefore have more first-hand information available. Many people prefer horn loading; I could be happy with either if soundly conceived and constructed.

The cabinets described are fitted with an acoustic filter designed by my colleague, Mr. R. E. Cooke, and calculated to give bass without boom. The device is the subject of patent applications in this country and America and should therefore only be used privately in cabinets constructed at home. Although designed around Wharfedale 10" and 12" foam surround units, the cabinets can be used with other speakers provided the open baffle resonance does not exceed 45 cps.

The vent is tuned to resonate at about 40 cycles—low enough to avoid coloration and high enough to give body to the reproduction. The vent output will blow out a lighted match at the resonant frequency with 2 to 3 watts input to the speaker.

The acoustic filter is made of plywood and should form an airtight fit to the front, sides, and back so that the only air path from the upper compartment to the lower one is through the slits which permit the required transmission of low frequencies only. This also explains why the lower compart-

ment is not lined with absorbent material.

The design and dimensions for the 12" model are given in Fig. 45 and are self-explanatory.

The data for the 10" model is as follows:—

Cabinet in 3/4" plywood
Volume—2 cubic feet
Height—28" outside
Width—14" outside
Depth—12" outside
Vent—2" diameter circle

Acoustic filter in 3/8" plywood with four slits 1/16" wide and 8 1/4" long over-all. Position 17" from top, outside. Vent resonance 45 cps.

Suitable slits in the acoustic filter are easily made with a hand saw or better still, with a circular saw.

Photographs of a finished cabinet with inside and outside views are reproduced in Fig. 41.

Taking into account size, cost, and ease of construction, the reflex enclosure still pays better dividends in the bass than any other system.

The smaller unit can with advantage be used in the larger cabinet, but the process should not be reversed.

Adding a Tweeter

If it is desired to improve the high-frequency response, the simplest method is to mount a tweeter on a small baffle—preferably facing upwards—and stand it on top of the main cabinet, using the circuit of Fig. 42.

Baffles

Having paid baffles a few compliments, the least we can do is to give the reader a few hints on how to get the best out of such a system.

Two speakers in parallel are the obvious choice for 3 db gain at low frequencies. Sheet aluminum 1/4" thick, backed with fiber board or coated with a damping medium, makes a splendid baffle and gives a nice crisp tone to the reproduction. If plywood is used it should be sandfilled as shown in Fig. 43. The dimensions combine reasonable performance with convenient size.

For the bass end, a 10", 12", or 15" speaker could be used, but the resonance should be not higher than 40 cycles. It must be made clear that it is the availability of low resonance units which makes possible this new approach to the long-discarded open baffle.

In order to reduce middle and treble but maintain maximum bass, an inductance can be placed in series with this unit, as shown in Fig. 44. The tapped coil (used alone) described in Part 8 would make an ideal variable control here.

The second speaker could be an 8" or 10" unit, with resonance preferably below 50 cycles, but even above 50 cps is acceptable because parallel working makes the higher resonance virtually harmless. Here we have shown a slot in place of the usual circular opening, to reduce beaming and improve high-frequency dispersal. Useful dimensions are: 8" unit, slot 3" x 7"; and 10" unit, slot 3" x 8". The two speakers must be correctly phased. If they are

out-of-phase, you will have a 20 db loss at low frequency instead of a 3 db gain. Adding a tweeter with the circuit of Fig. 42 is simple and phasing at high frequencies is of no consequence in this case.

Even a single speaker can be used on a baffle with good results, but low cone resonance is essential. So much for baffles. At least they are free from boom.

Reflex vs Horn Loading

It is not our intention to hold a Beauty Contest and pick the winner here, nor do we propose to outline vital statistics; it is better to leave the choice to personal preference. But I do think that the response curves of Figs. 46 and 47 throw some light on the question of relative efficiency which was raised in the previous article.

Both curves were taken out of doors with the same 15" foam-surround unit, and with the cabinets placed in a corner formed by the walls of a building. The microphone distance was 4 feet on-axis in both tests.

The conclusions to be drawn from these tests are as follows:—

(1) The output below 100 cps is about the same in both cases.

(2) The main output from the horn is located between 100 and 400 cycles but, when comparing it with the reflex model, it should be remembered that this has considerable vent output with a peak around 200 cps as shown in Part 5.

(3) As usual, the working range of the horn is limited to 3 to 4 octaves, but the reflex design will easily extend to 7 octaves. Above 500 cycles, reflections play havoc with the output of the folded horn, but such effects are normally sidetracked by crossover networks.

So we are left with the 64,000 dollar question of how best to assess the efficiency of either system. If you take the horn performance between 100 and 300 cps, I will take the reflex output between 300 and 1000 cps and confound you, or I will take the next two octaves and knock you clean out of the ring. On the other hand, we can all take the region of 40 to 100 cycles and practically call it a draw.

The fact is that it is quite as logical to say that reflex loading is twice as efficient as horn loading because it covers twice as many octaves as to say

(Continued on page 120)

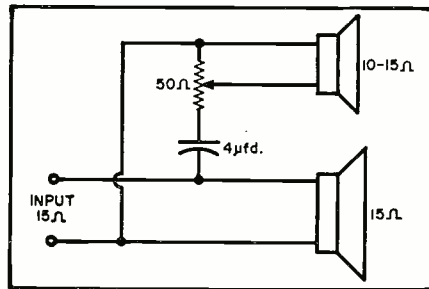

Fig. 42. Adding a 10-15 ohm tweeter to augment response above 3-5 kc. If the impedance of the main loudspeaker is 2-3 ohms, the tweeter should also be 2-3 ohms. The filter capacitor and volume control should then be 12 μfd. and 20 ohms respectively. For 8-ohm units, the capacitor that is employed should be about 6 μfd.

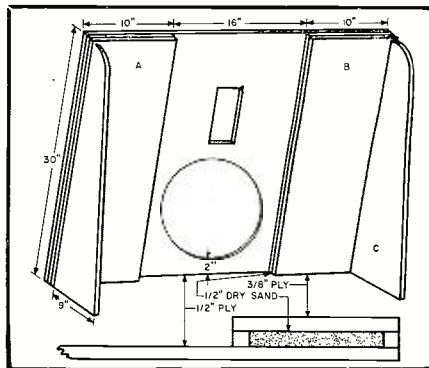

Fig. 43. Shown in this illustration is a back view of the simple flat baffle arrangement that is discussed in the accompanying text. The front sheet of plywood should be at least one-half inch thick. The two portions marked A and B are backed with three-eighths plywood which is spaced one-half inch for sand filling. This is shown in the detailed view. The side supports, marked C, may be constructed of one-half inch plywood. The dimensions shown are not critical.

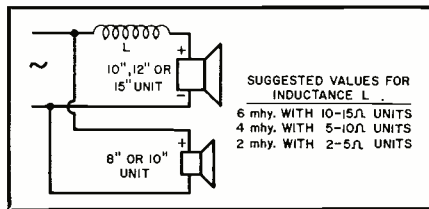

Fig. 44. Shown here is a useful circuit that may be employed to obtain good results with two loudspeakers mounted on an open baffle. The two speakers are connected together in-phase to avoid "hole" in the response.

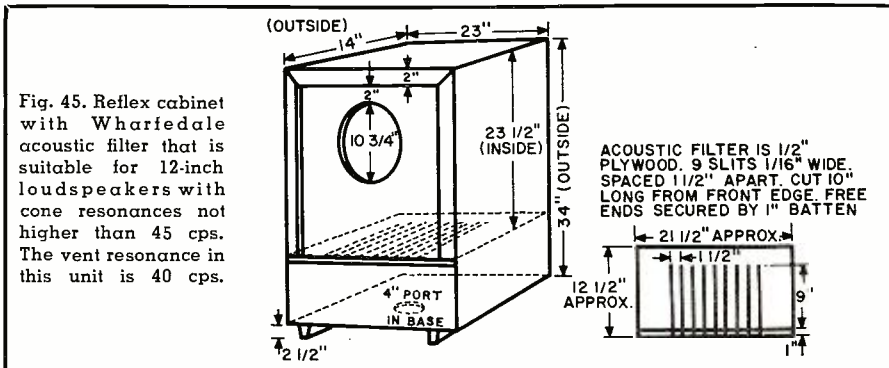
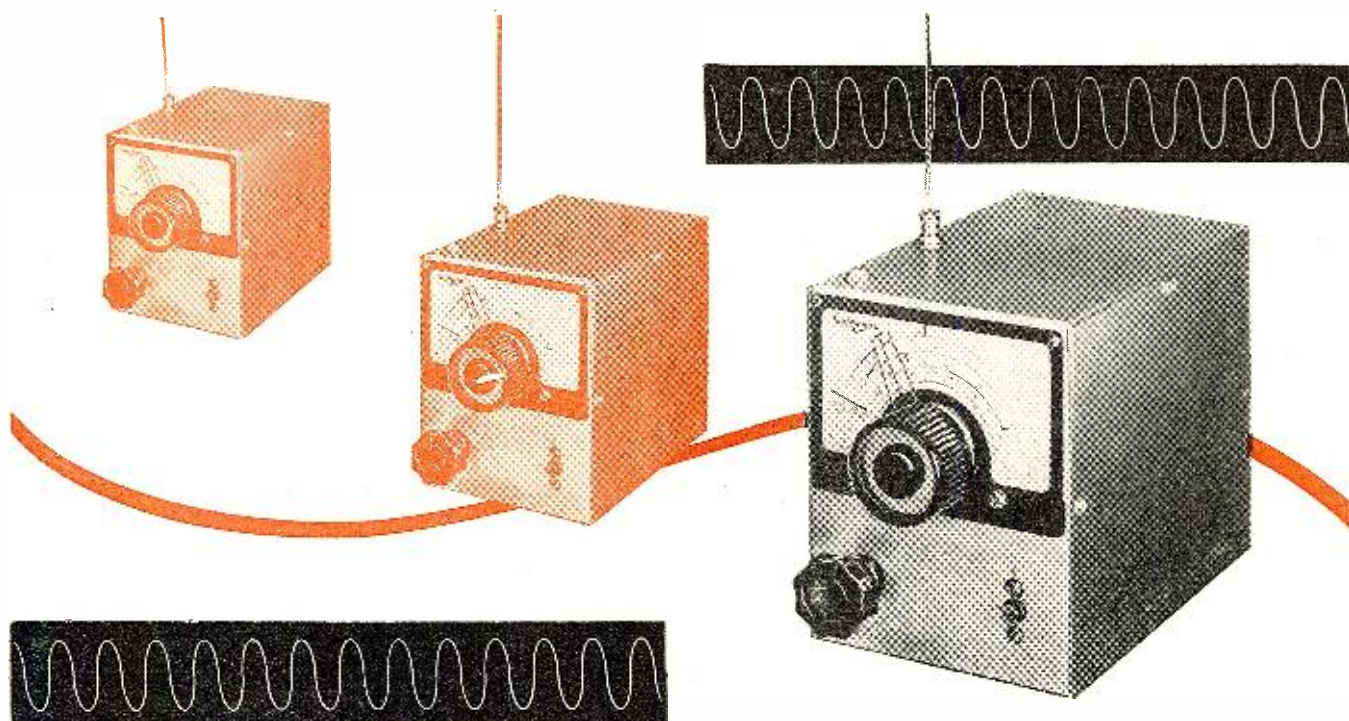

Fig. 45. Reflex cabinet with Wharfedale acoustic filter that is suitable for 12-inch loudspeakers with cone resonances not higher than 45 cps. The vent resonance in this unit is 40 cps.

Monitor Your Tone and Frequency



Over-all view of the monitor. A 12" length of wire from a coat hanger soldered to banana plug serves as pickup antenna.

By **LEON A. WORTMAN, W2LJU**

Simple two-tube c.w. monitor requires very little table space and is quite inexpensive to construct.

IT'S a very embarrassing experience. Your morale sinks to a very low ebb. You blush with shame. You hope your friends won't hear about it. You have violated a federal regulation! I'm talking about receiving a "green ticket" from an FCC monitor station. A "green ticket" is one of those, as the name indicates, green colored slips that the FCC listening posts use to notify hams when they have violated an FCC regulation; and the "green ticket" orders you to reply in affidavit form, "within three days," setting forth the exact causes for the violation and precisely what measures you have taken to remove them.

The notice may be for off-band operation, frequency changes caused by keying a transmitter (popularly or unpopularity known as "chirp"). It may be for key clicks, which are definitely spurious and superfluous radiations that cause unnecessary interference and annoyance to other radio communications; and, whether these spurious radiations occur inside or outside of the amateur band limits, they nevertheless constitute a violation of regulations.

An impure tone means an amplitude or a frequency modulated c.w. carrier. It can be ruled to be a modulated

signal which is on a frequency permitting only unmodulated radiotelegraphy. For instance, a transmitter operating on 7.15 mc. is within the "ham" band but an "impure tone" (possibly caused by an improperly filtered power supply) can be cited for utilizing type A4 and/or type A2 modulation in a band permitting only type A1 transmissions. Harmonic radiations are a violation and quite often they could fall outside the limits of a ham band which is in harmonic relation to the band of fundamental operation. Such an occurrence might cause serious interference to other services. Thus the violator is guilty of off-band operation and/or causing unnecessary interference to other stations.

Any one of these violations can be quite easily detected by the alert FCC monitor stations scattered throughout the United States and operating 24 hours a day. There is no legitimate defense against the charges. The regulations require that the transmissions be as "pure as the state of the art permits" and that suitable means of monitoring the frequency and the character of the transmitted signal shall be provided.

However, many hams neglect to

provide any monitoring facilities. Usually this is because of the estimated cost of the equipment and the table space required for the installation. The preference is to invest the money in "extra watts," a new chrome plated bug, or a new microphone. All these are nice to own and use and they might improve the station. But, holding an operator's license and a station call-sign are obligations that cannot be minimized, obligations to fellow hams, and obligations to a government that permits freer use of the ham bands than any other government does.

Here is a simple c.w. monitor that is compact in size, requiring very little table space, and inexpensive enough to construct and still permit those "extra watts" and accessories. To use an overworked phrase, "the unit can be built from the contents of almost any ham's junk box." All components are of standard manufacture, including the tuning coil. Once built, it should suffice for many years as a monitor. Once you develop the habit of using it, you'll wonder how you ever did without it.

The unit consists of an oscillator tunable over the 80, 40, 20, 15, and 10 meter bands, a signal mixer and audio amplifier, and a power supply. A 6BH6 is an excellent oscillator which drives the mixer-amplifier, a 12AT7 with its twin-triodes in parallel connection. A phone jack is provided

for earphone monitoring. An insulated banana jack on the top of the 4" x 5" x 3" metal box that houses the miniature monitor is connected directly to the grids of the 12AT7. A 12" length of wire from a coat hanger is soldered to a banana plug and serves as an antenna for picking up a small amount of r.f. voltage from the transmitter to be monitored.

The monitor operates on the heterodyne-detection principle. A radio-frequency signal is generated within the unit by the oscillator and is heterodyned or beat against another externally generated radio-frequency signal. When two signals are heterodyned there results, in addition to the two original signal frequencies, a signal that is the sum of the two frequencies and a signal that is the difference of the two frequencies. In this particular application we utilize the "difference" frequency. If the two original frequencies are separated by an audio frequency (approximately 16 to 20,000 cycles) they may be detected by a simple audio device. For example, assume the transmitter to be monitored is radiating on 7150 kilocycles. Tuning the monitor to 7151 kilocycles, a 1000 cycle tone will be heard in the earphones. The sum frequency, 14,301 kilocycles, and the two original frequencies of 7150 and 7151 kilocycles are removed by the small bypass capacitor (C_6) at the plates of the 12AT7. This capacitor is of a value selected to offer low reactance to the 7 and 14 megacycle radio frequencies and high reactance to audio frequencies. By listening to the quality and stability of the audio output of the monitor we can determine with suitable accuracy the character of the transmitter's signal as it might sound to a distant receiving station. Keying "chirps" are distinctly audible as are rough notes and modulated signals.

The frequency of the transmitter can be determined by directly calibrating the monitor against a calibrated receiver. The output of the monitor's oscillator is strong enough to be heard in the receiver with the

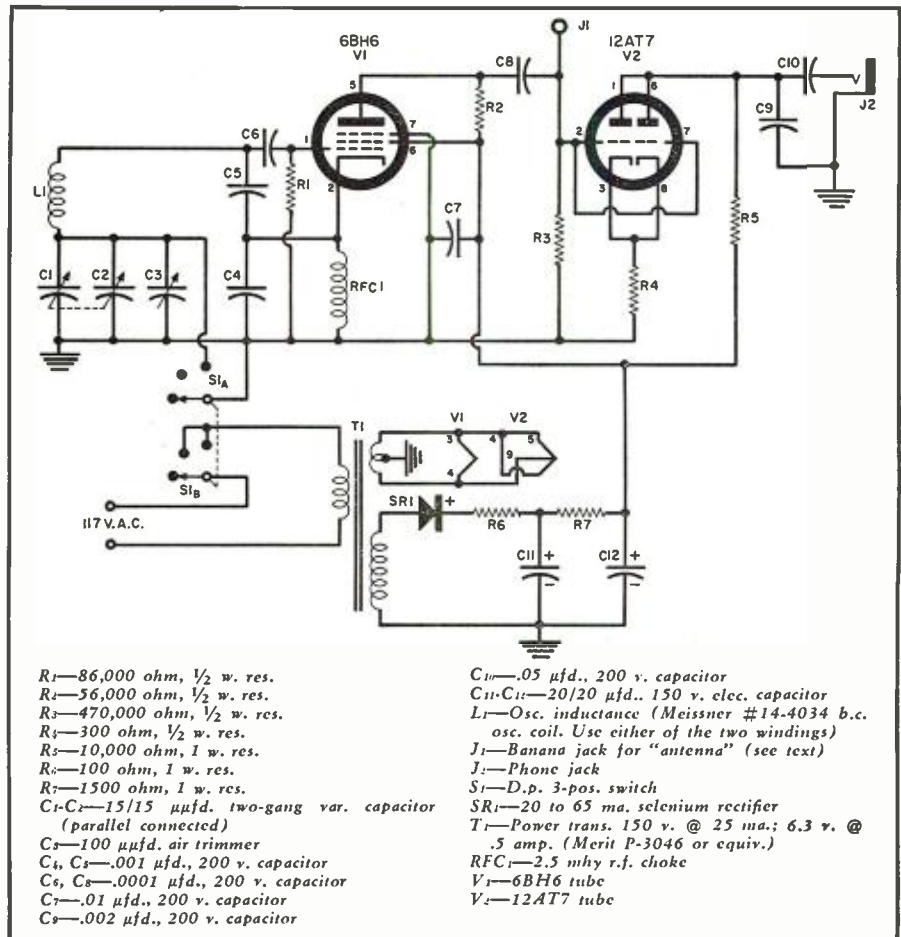

Schematic diagram of the unit is seen to consist of a 6BH6 tunable oscillator which is used to drive a 12AT7 mixer-amplifier with triode sections in parallel.

b.f.o. on. For setting the transmitter to a certain frequency when the monitor is not directly calibrated, zero beat the monitor with the receiver. Then zero beat the transmitter frequency to the monitor. The transmitter will then be simultaneously tuned to the same frequency as the receiver.

Tuning the monitor to one side of the transmitter carrier gives an audio tone on the monitor earphones. At W2LJU this side tone is used to monitor the keying of a "bug" as well as

the transmitter. Any breakdown or change in the signal is easily and immediately detected by listening to the tone as the rig is keyed. A 3-position switch is provided on the front panel for off-on-standby control. C_3 , an air-trimmer, is also front-panel mounted for convenience in adjusting calibration frequency.

Continuous use of a tone and frequency monitor is a good operating habit. Not only does the FCC require it, good operating necessitates it. —30—

Top view of tone and frequency monitor. Power transformer, main tuning and trimmer capacitors, and tubes may be seen.

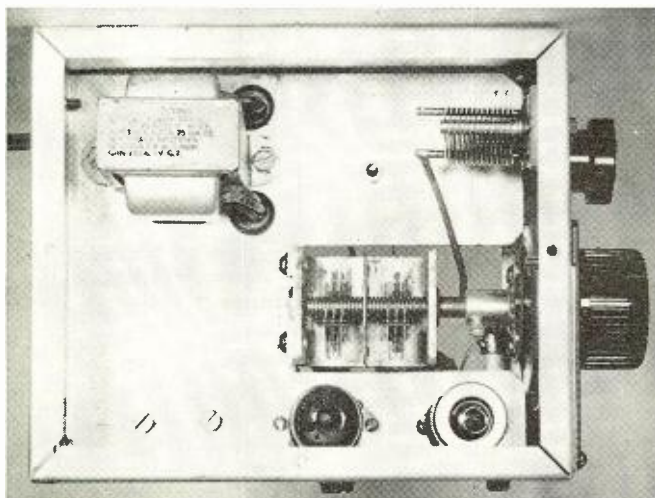

Bottom view of unit. Power supply components are mounted toward the rear while the oscillator coil is behind switch.

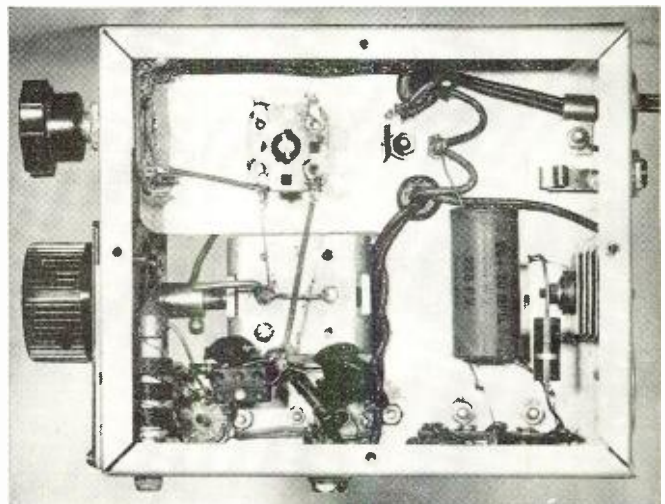

Twelve Volts - Heater and Plate

By HOWARD BURGESS

Here are three of the new 12-volt tubes that can be used to build portable gear.

Some ideas on using the new 12-volt tubes in simple, portable gear that works directly off the car battery.

ONE of the great accomplishments of the transistor has been its ability to show what can be done with very low power. This new appreciation of low-level power has even moved into the field of vacuum tubes and several manufacturers are offering tubes that require 12 volts or less on the plate. These include such tubes as the 12AC6 r.f. pentode, 12AE6 double diode triode, 12AD6 heptode converter, 12K5 space charge tetrode, and many others such as double triodes and special types.

After using the customary 200 to 300 volts on receivers and test equipment, one is amazed by the number of jobs that can be done well with very low values of plate supply. Superhet all-wave receivers, grid dip meters, v.h.f. converters, crystal calibrators, and many other pieces of equipment can be made to work with plate voltages as low as 6 volts in many cases.

With the coming of the 12-volt automotive systems and the 12- and 24-volt systems in use on aircraft and boats, those interested in portable and mobile operations will find these new tubes a great asset in simplifying equipment. The same voltage that is applied to the heater can be used on the plate circuits. This eliminates the need for expensive vibrator and dynamotor power supplies, not to mention the reduction in noise that accompanies such power sources. The fact that no cathode bias resistors or capacitors are required, no screen resistors are used, and one bypass capacitor can usually serve for all plate and screen circuits, contributes

to the utmost in circuit simplicity.

New tube types can be difficult to obtain in some rural areas and for this reason tests were run on some of the popular numbers using very low plate voltages. Surprising to say, all of the common types tried worked very well if certain basic rules of low-plate-voltage operation were followed.

Nearly all commercially available tubes have a certain amount of grid current leakage (sometimes called contact potential). In Fig. 1 this electron flow from the cathode to the grid, through R_g , and back to the cathode will develop a voltage drop across R_g and place a negative voltage on the grid. In the average tube this voltage may range from .2 volt to 1.5 volts depending upon the value of R_g and the grid structure of the tube. In high-

Fig. 1. Contact potential bias is common.

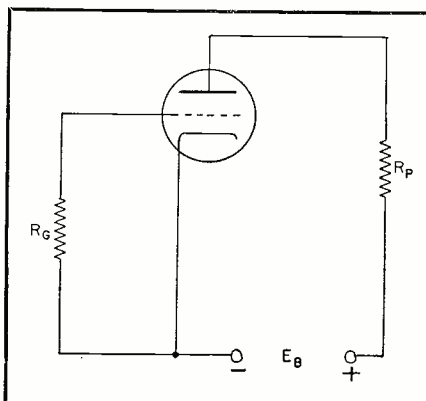

voltage applications this small grid voltage goes unnoticed but when only 12 volts is used for plate supply, this self-developed grid voltage can bias many tubes beyond cut-off. However this objectionable voltage can be turned into an advantage. When controlled it can be used as a source of useful grid bias. Generally speaking this leakage current becomes worse on tubes with high amplification factors.

When the new 12-volt tubes are used, good results will be obtained if the manufacturers' specifications are followed but if ordinary tubes are used, several rules of thumb can be followed in selecting tube types and in circuit design. These simple rules would include:

1. Select tube types with a low amplification factor and a high transconductance.
2. Except in special cases keep the grid circuit resistance as low as possible to reduce bias voltage.
3. When practical, the plate circuit resistance should be kept low to avoid excess loss in voltage. This applies mainly to high-resistance interstage transformers.

Very few tube manuals continue the curves down to the lower voltages. Shown in Figs. 3, 4, and 5 are several curves for some of the new 12-volt series and some of the older 12-volt tubes. As might be expected, the curves do some odd things in the very low voltage regions. Two tubes that proved to be very useful were the 12AW6 triode-connected and the 12BH7.

Nearly all of the well-known circuits operate quite well with the new tubes if a few changes are made. These changes are simple and consist of such things as removing any cathode biasing

Fig. 2. Simple equipment can be built for Novice who likes to "rough-it." Power is gotten from car cigarette lighter socket.

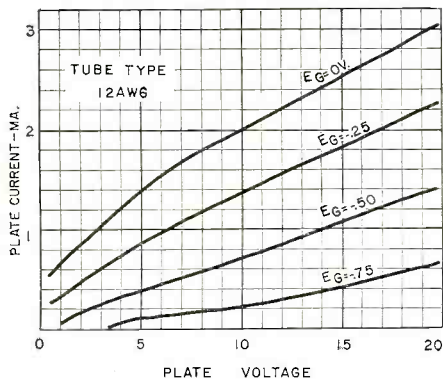

Fig. 3. Curves for triode-connected 12AW6.

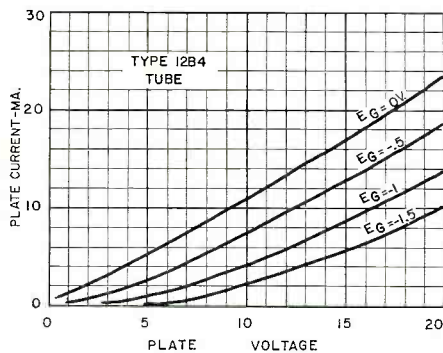

Fig. 4. Low voltage curves for 12B4 tube.

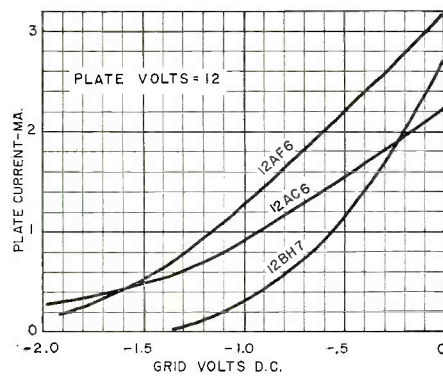

Fig. 5. Comparison of three useful tubes.

and placing full plate supply voltage on the screen. When required, insert a grid resistor such as the one used in the r.f. amplifier in the converter diagrammed in Fig. 7B.

Perhaps one of the most widely used single pieces of mobile gear is the high-frequency converter. Either fixed frequency for nets or the tunable kind have given very good results when used with a 12-volt plate supply. Fig. 7B is the circuit of one designed for a fixed net frequency. Tuned circuits L_1C_1 and L_2C_2 are tuned to the signal frequency. The frequency of the crystal is above or below the signal frequency by an amount equal to the i.f. frequency. The tuned circuit L_3C_3 is tuned to a frequency several hundred kilocycles higher than the crystal frequency and is not critical. Of special interest is the grid resistor of the 12AC6 r.f. amplifier. Do not be alarmed if all r.f. and i.f.

amplifiers resemble a grid leak detector. This is the method for obtaining grid bias.

Fig. 7C is almost identical to Fig. 7B except that a tunable oscillator is used in place of the crystal. The oscillator gave very good results with the coil tapped about one third of the way up from the bottom. This circuit gave excellent results as high as 35 megacycles with only nine volts of battery supply. An ordinary 12BE6 also gave very good results as a converter with this low voltage. A newcomer desiring to construct a converter such as this will no doubt need more information than we have room to give at this time. However, these circuits are just the old "standbys" simplified to use low-voltage techniques and any good handbook may be consulted for the mechanical construction details.

Another gadget (Fig. 7A) using the
(Continued on page 107)

Fig. 6. From left to right, a v.h.f. converter, a v.h.f. superhet, and a superregen detector plus audio. All use 12 v. on plates.

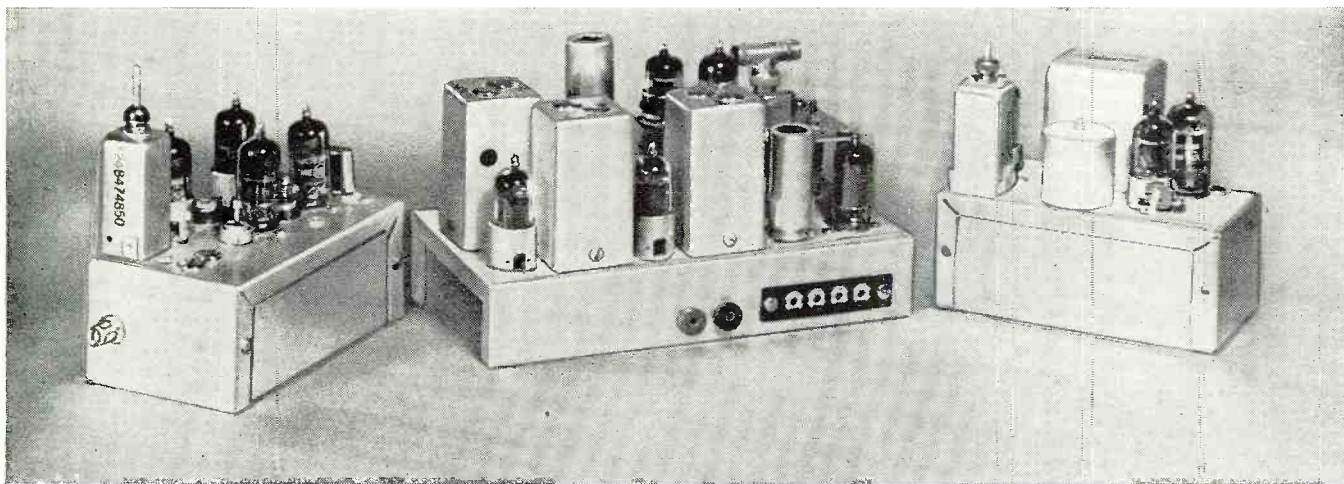

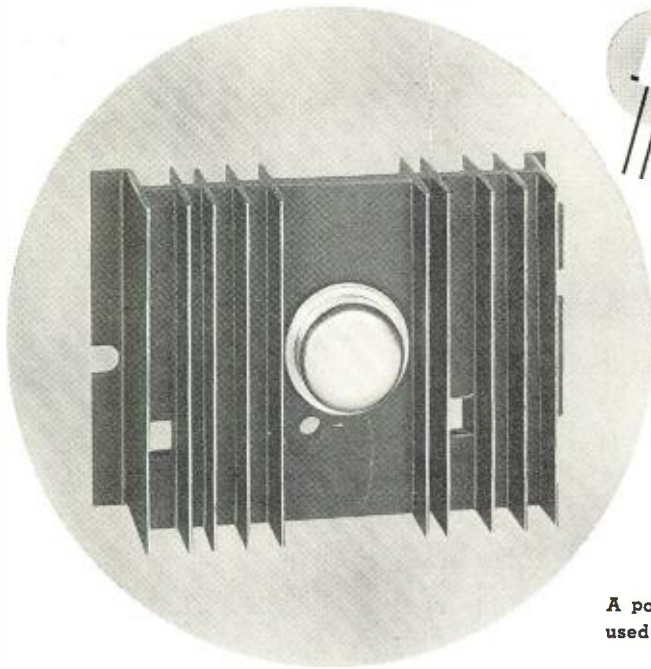

A power transistor mounted in a heat sink used in some Delco-built automobile sets.

Transistor Heat Sinks

By PAUL PENFIELD, JR.

Thermal resistance calculations and some practical suggestions for experimenters using power transistors.

THE major problem in operating power transistors is temperature. Germanium models should usually be kept below 90°C, and unless steps are taken to insure that the heat generated is removed to a heat sink, the transistor dissipation are sometimes Manufacturers' ratings on power transistor dissipation are sometimes given assuming an "infinite heat sink"—a mathematical entity which is not approximated by the usual chassis. It is important to calculate just how effective your heat sink really is and keep your power dissipation down.

This is really quite easy to do because of an analogy with electric circuits which makes it easy for radio people to understand.

All power dissipated in a transistor appears as heat. Although heat can be transmitted by at least three processes—conduction, convection, and radiation—only conduction is important now. Fig. 1 shows the path of heat flow from a power transistor—through the mounting, through the mica washer, to the chassis, which heats up. The chassis, in turn, gives the heat to the surrounding air. This cooling method is simple and widely used.

How hot the transistor *junction* gets (call this temperature T_j) depends on the power dissipation P (in watts), on the temperature T_a of the surrounding air, and on a property of the heat sink called the thermal resistance θ . In fact, $T_j = T_a + P\theta$ so the higher the dissipation, the further T_j is above T_a .

Since all work in this field is done in degrees centigrade, not Fahrenheit, convert to °C by the formula:

$$^{\circ}\text{C} = \frac{5}{9} (^{\circ}\text{F} - 32).$$

It is necessary now to call the transistor mounting base temperature T_b

and the chassis temperature at the transistor T_c , as indicated in Fig. 1. (Don't worry if you get scared by the math here. It will all be clear in a minute.) Now the same power P flows as heat through the mounting base, the mica washer, and the chassis. How much the mica hinders the flow of heat is expressed in its thermal resistance θ_w , equal to the ratio of the temperature difference across it ($T_b - T_c$) to the rate of heat flow through it, or

$$\theta_w = (T_b - T_c) / P.$$

In a similar way the thermal resistance of the transistor proper, θ_t , measures the difference in temperature between the collector junction and the mounting base bottom, or

$$(T_j - T_b) = \theta_t P.$$

And, finally, the difference in temperature between the surrounding air and the chassis is accounted for by the thermal resistance θ_c of the chassis heat sink.

Each of these three thermal resistances is characteristic of a different part of the set-up—one of the transistor, one of the mica washer, and one of the heat sink. Each is calculated in a different way, but all are necessary.

It is no accident that these θ quantities are called thermal resistances. They behave with heat flow and temperature the same way electrical resistances do with current and voltage. In fact, the thermal properties of Fig. 1 are the same as the electrical properties of Fig. 2, if we let R_t correspond to θ_t , R_w to θ_w , I to P , V_j to T_j , V_c to T_c , and so forth. This is seen by writing the equations for the electrical "analogue" and replacing each quantity by the one to which it corresponds. If you do that, you will come out with just the equations previously given.

While the thermal quantities and equations may be strange, the corresponding electrical ones (using Fig. 2) should be easy enough. If you got bogged down in the math thus far, go over it again, using the electrical analogue, and you'll see how logical it is.

For example, what we need in practical cases is the total thermal resistance θ relating the difference between T_j and T_a to the power P . The other three thermal resistances are helpful only in calculating this over-all value.

It is obvious from Fig. 2 that this over-all θ is equal to the sum of the other three smaller thermal resistances—an important fact which was not obvious a moment ago.

With other types of arrangement involving heat sinks in parallel and series, the corresponding resistances in parallel and series make a similar type of electrical diagram. Heat flow splits between two parallel paths the same way current does with parallel resistors. The combined thermal resistance is found from the well-known parallel resistance rule.

Complicated structures can be analyzed this way very easily.

Calculating Thermal Resistances

The fact that, in our case, the over-all θ is just the sum of the three smaller ones, is very important. Each of these thermal resistances is found in a different way.

The transistor thermal resistance θ_t is either specified by the manufacturer, or can be obtained from a graph such as Fig. 3, which the manufacturer supplies.

In Fig. 3, the maximum power dissipation is shown for every mounting base temperature T_b . This "de-rating curve" goes to zero at the maximum recommended junction temperature, marked T_m here. The difference in temperature between the points "A" and "B," where the allowed dissipation

is one watt, is numerically equal to θ_c .

As far as the mica washer goes, for the newer transistors with the oblong mounting base and leads coming out the bottom, the mica thermal resistance is about .31 °C/watt for each mil (.001 inch) of thickness. Thus a 3-mil washer would have a thermal resistance of 0.93 °C/watt.

A good number for the smaller-contact-area transistors is 0.5 °C/watt per mil thickness.

The thickness can be measured with a micrometer if one is available. Generally thicknesses run from 1.5 up to 4 or 5 mils.

A mica washer only needs to be used when the transistor case (usually the collector) cannot be electrically connected to the chassis. Otherwise, omit the washer and call its thermal resistance zero.

It is assumed good thermal contact is made between washer and transistor and between washer and chassis. Before mounting the transistor, be sure the chassis area is free from metal filings, burrs, and dirt, which not only make for bad thermal contact but may also punch through the mica. Even with the best surfaces, though, there will be air pockets tending to make a bad contact. To prevent these, coat the washer with something to drive out the air.

Ordinary water would be suitable if it didn't evaporate so quickly and wouldn't short the transistor to the chassis. For high reliability such as is required by the military, silicone grease (a *Dow-Corning* product) is used. But for ordinary use good non-evaporating lubricating oil, SAE #40, or preferably a thicker grease, will do. Test it before use to make sure it is non-conducting.

Power transistors should never be mounted "dry" if much power dissipation is expected.

Ordinary screwdriver tightening is sufficient to insure good contact if oil or grease is used.

The thermal resistance of the heat sink is found by Fig. 4. Use the appropriate line. For instance, if air is trapped on one side of the chassis and is not very free to move, that side does not help the process. The labels on Fig. 4 indicate on which sides the air is free. It is best (lowest thermal resistance) to use both surfaces. Where that is impossible, arrange it so the top horizontal surface is free and use the second line from the bottom in Fig. 4. The reason for the difference, of course, is that hot air rises away from the top horizontal surface, but tends to stay near the bottom surface, if that side is the free one.

Aluminum is the best material (besides copper and silver) to use for a heat sink and Fig. 4 was drawn for a heat sink. Steel is not as good as a heat sink.

While these curves were made for a circular disc of that area, they are not far off for rectangular chassis provided the longest dimension is under about 25 inches.

The sum of the three thermal resistances θ_c , θ_w , and θ_t gives the overall thermal resistance θ , the quantity of interest. Now we are able to find out how much power can be dissipated safely. For a given T_a (room temperature is 20-23°C) and maximum recommended junction temperature T_m (given by the manufacturer) the power dissipated should not exceed

$$P_m = (T_m - T_a) / \theta$$

It's as simple as that. The only hard part was in calculating the thermal resistance.

Think of the electric analogue of Fig. 2. Now the problem reduces to, "how much current can I send through the total resistance without the voltage drop exceeding the safe value?" Phrased this way, the answer is easy enough to find.

Other problems can be solved as well. "How big a fin, or chassis, do I need?" That depends on the power dissipation. Once that is determined, the value of θ_c necessary comes from working with Fig. 2 and the size of the fin needed is read from the values given in Fig. 4.

The only problem remaining is, what power is meant by P ? The original assumption was that of a steady dissipation. In practical cases, is P the peak power? the instantaneous power? the average power?

No harm can come if P is interpreted as the peak power and this is often done. Because the instantaneous power is never greater than this, and is normally lower, an automatic safety factor is provided. It is possible to improve this rating by considering the time constants of the thermal circuits, but improvement this way may not be worth while. In experimental circuits it is good to keep the instantaneous power *always below* the rating calculated for steady power.

However, this is somewhat wasteful, and if you want to get the most out of your transistor the next section tells how to do better.

Improving This Power Limit

If the power dissipation is varying as time goes on, as it will in practical cases, then there is an *average* of this dissipation and let's call it P_{av} .

For class A operation the difference between the average and the maximum power is not great, since with no signal the transistor dissipates the greatest amount of power. Since an audio amplifier, at least, should be able to operate safely with no signal, the no-signal power dissipation should be used throughout the calculation and the method of this section will not help.

For class B (or AB) operation, however, there is an advantage. The average power P_{av} will be greatest with full signal and will be very small with no signal. For ideal class B operation, the average power dissipation is about one quarter of the power input, the other three-quarters appearing as useful power output. However, in practical circuits the efficiency will probably

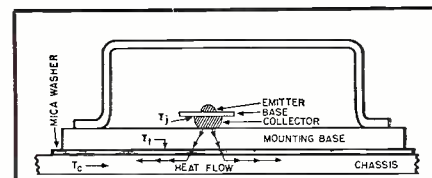

Fig. 1. Cross-section of power transistor showing heat flow. Mountings not shown.

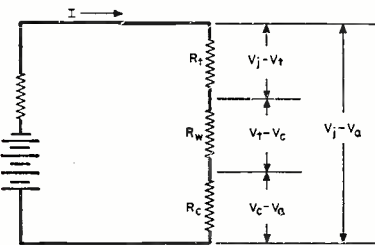

Fig. 2. This electrical analogue of heat flow problem has the same sort of equations.

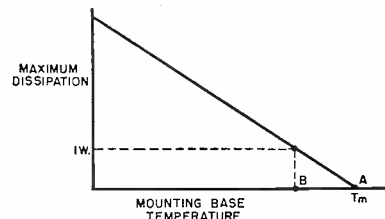

Fig. 3. Power derating curve of the type normally supplied by the manufacturer.

be less than 50%, meaning more power dissipation than output.

When computing the junction temperature, it is permissible to use the average power P_{av} in connection with the thermal resistance θ_c of the chassis, but we should use the peak power in connection with the other two thermal resistances.

The reason for this is very simple. The chassis, being composed of a large amount of metal with a high heat capacity and losing its heat by the relatively inefficient method of transferring it to the free air, has a large *thermal time constant*. That is, if you try to heat up a chassis, it takes several minutes before it reaches temperature. The transistor is trying to do just that—heat up the chassis. Because the chassis is so sluggish, it takes several minutes.

(Continued on page 142)

Fig. 4. Thermal resistance of a fin that has free air on one or on both sides of it.

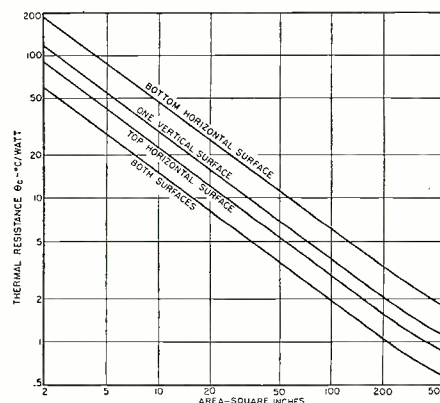

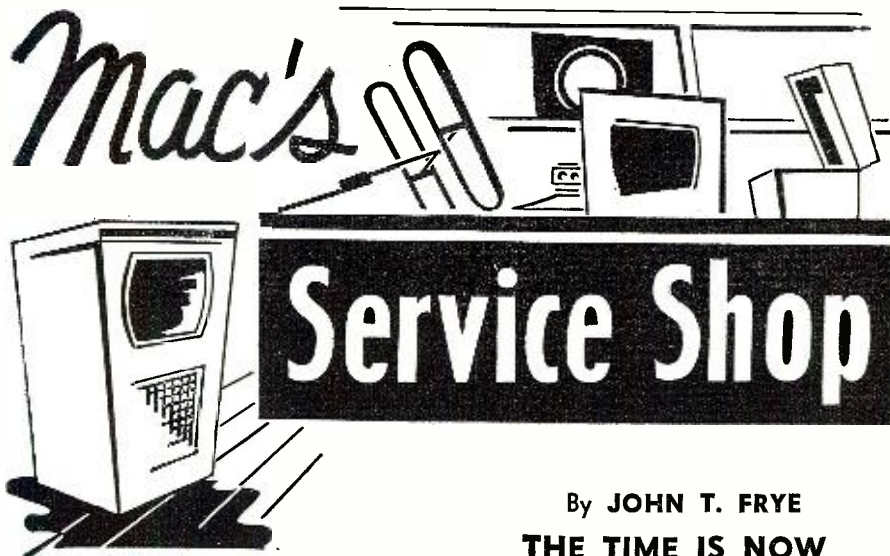

By JOHN T. FRYE
THE TIME IS NOW

A HA!" Barney exclaimed as he came sailing into the service shop out of a gusty March morning and found Mac, his employer, bent over a piece of test equipment on the bench; "new gadget, huh?"

"Yep," Mac answered as he plugged the cord of the instrument into a socket. "This is a replacement for our old battery eliminator. I bought it in kit form and put it together last night."

"What was the matter with the old one?"

"Nothing except that it's outmoded. As you know, we've been hooking a battery in series with the eliminator to work on twelve-volt sets but that arrangement leaves a lot to be desired. For some time I've been intending to buy a new eliminator that would handle both six- and twelve-volt radios, but I was holding out in the hope someone would build in the extra filtering needed in powering hybrid or all-transistor sets. In the past few months several manufacturers have come on the market with just such instruments; so I no longer had an excuse."

"I get you. Since the battery voltage furnished a hybrid or transistor receiver is equivalent to the plate voltage in a tube radio, it must be well filtered to prevent hum."

"Your little gray cells are working today!" Mac applauded. "As you can see, this eliminator has continuously variable output voltages of either 0-8 or 0-16 volts. Output voltage and current are monitored by the two meters. Notice there are two sets of binding posts, one on each end of the panel. Those on the left provide moderately filtered output, with about 2% ripple, for use in battery charging or with vibrator-type sets. You can take continuous currents of ten amperes at six volts or five amperes at twelve volts from them. The posts on the right furnish five amperes at either voltage with very low ripple."

"How is the ripple reduced?"

"By passing the moderately filtered output through an extra L-section filter consisting of a heavy choke and a

10,000 μ fd. capacitor. This brings the ripple down to less than .3%. I am not just taking the manufacturer's word for this; I measured it with the scope; but let me show you the difference."

As he said this, Mac connected a high-wattage, low-resistance resistor across the right-hand output terminals and adjusted the eliminator so that it was furnishing about four amperes of current to the resistor. Then he connected a large capacitor to one of the tip leads of a pair of earphones and touched the other earphone lead and the free end of the blocking capacitor to the two output terminals on the left side of the panel. A very noticeable low-pitched hum came from the phones. He transferred the connections to the right-hand terminals.

"Hey," Barney exclaimed as he pressed the muff-type earphones tightly against his head, "I can't hear the least trace of hum!"

"And you shouldn't," Mac said as he turned off the eliminator. "That ripple level must be very low if you are going to use the eliminator to power all-transistor sets as I expect to find in many cars next year. Of course, when the variable voltage feature is not needed, we can always cut the hum still more and provide very good voltage regulation by floating a battery across the output of the eliminator, but I don't think that will be needed. In a few cases in working with extremely high-gain transistor amplifiers we might want to cut the ripple to an absolute minimum. Such circuits would not require any appreciable current; so it would be very simple to use an outboard filter section consisting of a high-inductance, low-resistance choke and a whopping big capacitor of low voltage between the eliminator and the transistor circuit. About the only time you would need such extreme filtering would be in experimental work, but it's nice to know a simple addition to the eliminator will provide very nearly pure direct current."

"While we're talking about it, I want to mention a couple of other points to

watch in working on the new hybrid or all-transistor auto sets, in fact, for working on any set that employs power transistors in the output. With the auto sets, you must be very, very sure that the voltage applied to the set on the bench has the same polarity as that provided by the car battery. Reversed polarity will ruin the transistors almost immediately. After being used to working with interrupter-type vibrators in which the polarity of the connections makes no difference, you could overlook this very easily.

"Make sure, too, that the output transistors are working into a proper load at all times. Running a signal into them with the speaker disconnected is a fine way to ruin them. And you've got to be careful what you do with your test prods when you're working on one of these sets. They are as touchy in that respect as battery portables, but for a different reason. With the portables, you have to be careful that you do not accidentally short the high plate voltage across the fragile filaments and blow them. With the transistor sets, it's not the voltage as much as the almost unlimited current provided by the battery that you have to treat with respect. A test prod that accidentally grounds the base of an output transistor can ruin the transistor while you are batting your eyes. That's why you must *never* try to use the old circuit-disturbance type of troubleshooting in which you ground a tube grid and listen for a click in the speaker in working on transistor sets. Ground a base and the click you hear will probably be the last."

"I'd think that a battery-eliminator, being fused and providing only a limited amount of current, might provide some measure of insurance against that kind of damage."

"It does, but don't depend on it. A charged 10,000 μ fd. capacitor can put out a lot of current for a few milliseconds and a fuse takes an appreciable time to melt. Let's just say you'd be *less* likely to ruin a transistor when the set is being powered by an eliminator than you would when a battery was furnishing the current."

"Sounds to me as though we're getting pretty transistor-minded all at once."

"That we are and I think this is precisely the time we should. We have to keep in mind that the attitude of a practical service technician toward new electronic developments has to be considerably different from that of an experimenter or hobbyist. The latter start working with the new device as soon as they can get their hands on it, but the wise service technician knows that he cannot do this and still take care of his bread-and-butter job the way he should. He has just about all he can do to keep abreast of the new circuits that are constantly being thrown at him by radio, TV, and hi-fi manufacturers. When and if the new development proves itself and is incorporated in the equipment the tech-

(Continued on page 119)

**NEW
COMPLETE**

**DIRECT
VIEWING**





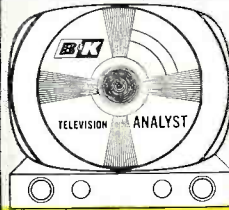
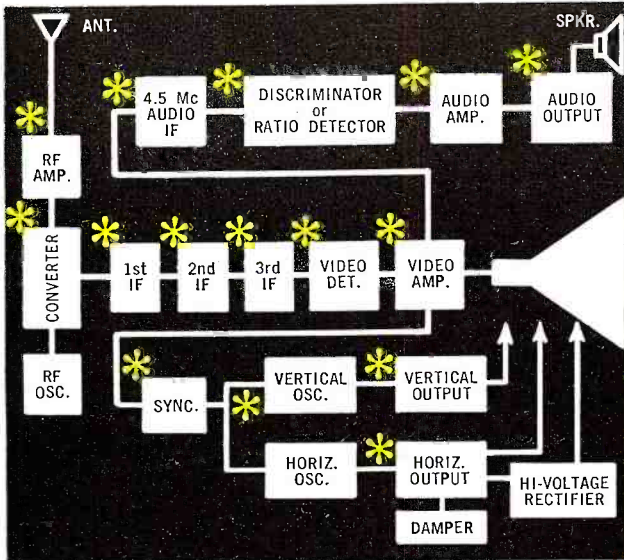

E E V S O N ANALYST

test each stage
SEPARATELY



← and watch the
result on the
TV set itself

UNIQUE NEW SIGNAL-INJECTION TECHNIQUE
Saves TV Trouble-Shooting Time and Work

-  **R.F.** Supplies complete r.f. and i.f. signals with video and audio modulation to quickly trouble-shoot each stage in each of the sections of the TV receiver. Enables you to check the r.f. sensitivity and AGC settings of TV receivers.
-  **VIDEO** Reproduces a complete test pattern on the screen of the TV picture tube and injects signals into each video stage of the TV receiver for fast, visual trouble-shooting and correction—anywhere, anytime. Makes it easy to check bandwidth, resolution, shading and contrast capabilities of the TV set.
-  **SYNC** Provides composite signal, sync positive and negative.
- SWEEP CIRCUIT DRIVING PULSES** Provides separate vertical and horizontal driving pulses for trouble-shooting deflection circuits.
- INTERMITTENTS** Test signal injection also aids in locating intermittent troubles.
-  **AUDIO** Provides a 4.5 mc sound channel, FM modulated with approximately 25 kc deviation. (This audio carrier is modulated either from a built-in 400 cycle tone generator, or from your own external audio source.) Injection of the 400 cycle tone signal simplifies trouble-shooting of the audio section.
-  **COLOR** Enables you to trouble-shoot and signal trace color circuits in color TV sets.
Generates white dot and crosshatch patterns on the TV screen for color TV convergence adjustments.
Generates full color rainbow pattern of orange, red, magenta, blue, cyan, green to test color sync circuits, check range of hue control, align color demodulators, etc.
-  **SET ADJUSTMENT** Enables you to check and adjust the vertical and horizontal linearity, size and aspect ratio of television receivers.



NEW
MODEL 1075

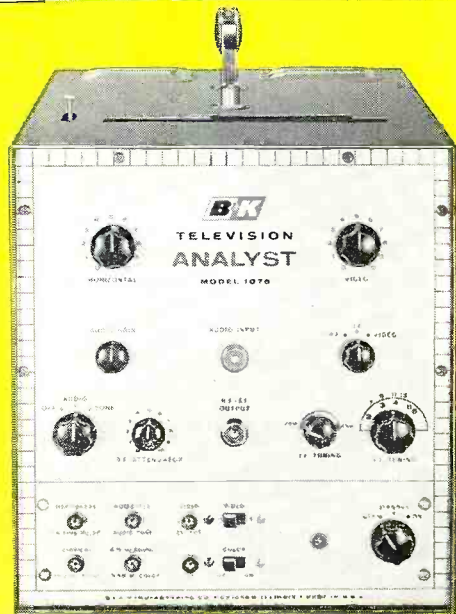

QUICK, DIRECT, COMPLETE TV TROUBLE-SHOOTING

Now, by point-to-point signal injection and test pattern reproduction, you can easily trouble-shoot and signal trace *any stage throughout the video, audio and sweep sections* of black & white and color TV receivers. With the remarkable new Model 1075 B&K TELEVISION ANALYST, you can quickly isolate and diagnose TV troubles (including intermittents). By use of the generated test pattern, you can *actually see* the condition directly on the picture tube of the television set itself. No external scope is needed. The TELEVISION ANALYST is practically a *complete TV service shop in one instrument!* Net, \$259⁹⁵



See your B&K Distributor or write for Bulletin 1075-N

B & K MANUFACTURING CO.
3726 N. Southport Ave. • Chicago 13, Illinois

Canada: Atlas Radio Corp., 50 Wingold, Toronto 10, Ont.

Export: Empire Exporters, 458 Broadway, New York 13, U.S.A.

DICK JURGENS and his band have played in virtually every state in the union, and just about every important hotel, night club, theater, and one-night stand, in the country, has echoed to the sounds of his music. He has done a number of radio shows, and made over five-hundred recordings with Columbia Records in seventeen years. He was head of the first all-marine entertainment unit during World War II, and toured the South Pacific for almost two years with this group. His own band was reorganized again after the war. Dick Jurgens was co-author of such hit tunes as: "One Dozen Roses", "Elmer's Tune", "Careless", "If I Knew Then", "A Million Dreams Ago", and his theme song, "Daydreams Come True at Night." He has come a long way in the world of music and entertainment since his first "big time" engagement at the St. Francis Hotel in San Francisco some years ago, and is now well known for his musical talents.

A lesser known side of Dick Jurgen's life, however, is his interest and ability in electronics—that had its beginnings in the late 20's, and has continued as his main hobby until the present time. Dick has built about twenty-five Heathkits, and considers electronics his serious hobby. He especially likes test equipment and high fidelity projects, and hopes some day to make a business of his electronics interests. We are quite proud to list Dick Jurgens among our "do-it-yourself" customers.

everybody's doing it!

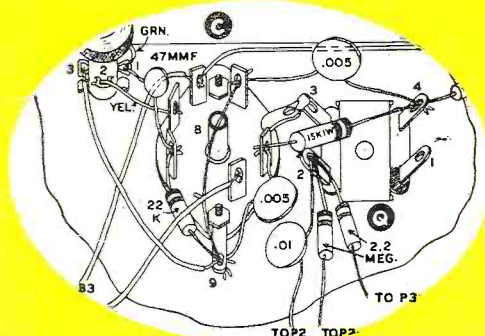
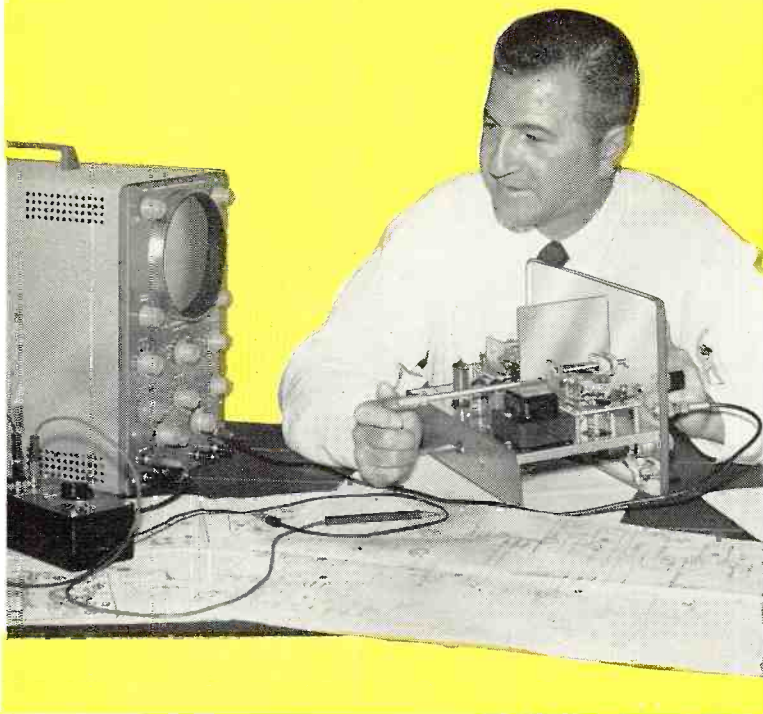

You'll get plenty of these detailed pictorial diagrams in your Heathkit construction manual to show where each and every wire and part is to be placed. Everything you do is spelled out in pictures so you can't go wrong.

That's what makes it such fun!

Heathkits[®]

By DAYSTROM

...fun to build
and a thrill to own!

and here's why...

1. You get higher quality at lower cost by dealing direct, and by doing your own assembly.
2. You receive personal, friendly, service (before and after sale) for complete satisfaction.
3. You benefit from the latest in engineering designs because of our concentration on kit-form equipment only.
4. You may depend on performance as advertised—backed by Heath's world-wide reputation for quality.
5. You can take a full year to pay with the HEATH EASY TIME PAYMENT PLAN.

- (✓) Connect a 22 K Ω resistor (red-red-orange) from socket C1 (NS) to ground lug C9 (NS). See Figure 8.
- (✓) Connect a .005 μ f disc capacitor from socket C4 (NS) to IF transformer Q4 (NS).
- () Bend socket lug C5 and IF transformer lug Q3 toward each other until they make contact and overlap slightly. Solder the connection securely. (1).
- () Install a .005 μ f capacitor from socket (NS) to ground lug C9 (NS). Dress the capacitor close to chassis, under the capacitor previously installed.

Read the step . . . perform the operation . . . and check it off—it's just that simple. These plain-worded, easy-to-follow, steps are combined with pictorial diagrams to take you through every phase of assembly. Let our experience be your teacher!

TIME PAYMENTS . . .

The Heath Time Payment Plan was designed for your convenience. Now, you can order the kits of your choice, and pay for them in small monthly installments. Write for full details.

HEATHKIT EXTRA PERFORMANCE 70-WATT AMPLIFIER KIT

For really high performance, with plenty of reserve power, the W-6M is a natural. The full 70-watts output will seldom, if ever, be required. However, this reserve insures distortion-less sound on power peaks. The W-6M will loaf along at normal listening levels and yet is always ready to extend itself when program material demands it, without the least amount of strain. The output circuit employs 6550 tubes with a special-design Peerless output transformer for maximum stability at all power levels. A quick-change plug selects 4, 8 and 16 ohms or 70-volt output and the correct feedback resistance. A variable damping control is also provided for optimum performance with any speaker system. Extremely good power supply regulation is possible through the use of a heavy-duty transformer along with silicon-diode rectifiers, which are noted for their very long life, and yet are smaller than a house fuse. Frequency response at 1 watt is ± 1 db from 5 cps to 80 kc with controlled hi-folloff above 100 kc. At 70 watts output harmonic distortion is below 2%, 20 to 20,000 cps and IM distortion below 1%, 60 and 6,000 cps. Hum and noise 88 db below full output. In addition to high performance, its fine appearance makes it a pleasure to display in your living room. Proper layout of chassis insures ease of assembly by eliminating those cramped and difficult places to get at. Clear instructions—and top-quality components. Get started now and make this amplifier the heart of your hi-fi system. Shipped express only. Shpg. Wt. 50 lbs.

MODEL W-6M

\$109⁹⁵

MODEL W-6: Consists of W-6M kit, plus WA-P2 preamplifier. Express only. Shpg. Wt. 59 lbs. \$129.70

HEATHKIT HIGH FIDELITY FM TUNER KIT

This tuner can bring you a rich store of FM programming, your least expensive source of high fidelity material. It covers the complete FM band from 88 to 108 mc. Stabilized, temperature-compensated oscillator assures negligible drift after initial warmup. Features broadbanded circuits for full fidelity, and better than 10 uv sensitivity for 20 db of quieting, to pull in stations with clarity and full volume. Employs a high gain, cascode RF amplifier, and has AGC. A ratio detector provides high-efficiency demodulation without sacrificing hi-fi performance. IF and ratio transformers are prealigned, as is the front end tuning unit. Special alignment equipment is not necessary. Edge-lighted glass dial for easy tuning. Here is FM for your home at a price you can afford. Shpg. Wt. 8 lbs.

MODEL FM-3A

\$25⁹⁵

(with cabinet)

HEATHKIT BROADBAND AM TUNER KIT

This AM tuner was designed especially for high fidelity applications. It incorporates a special detector using crystal diodes, and the IF circuits feature broad band-width, to insure low signal distortion. Audio response is ± 1 db from 20 cps to 9 kc, with 5 db of preemphasis at 10 kc to compensate for station rolloff. Sensitivity and selectivity are excellent, and tuner covers complete broadcast band from

550 to 1600 kc. Quiet performance is assured by 6 db signal-to-noise ratio at 2.5 UV. Prealigned RF and IF coils eliminate the need for special alignment equipment. Incorporates AVC, two outputs, two antenna inputs, and built-in power supply. Edge-lighted glass slide-rule dial for easy tuning. Your "best buy" in an AM tuner. Shpg. Wt. 8 lbs.

MODEL BC-1A

\$25⁹⁵

(with cabinet)

HEATHKIT MASTER CONTROL PREAMPLIFIER KIT

Designed for use with any of the Williamson-type amplifiers, the WA-P2 has five switch-selected inputs, each having its own level control to eliminate blasting or fading while switching through the various inputs, plus a tape recorder output. A hum control allows setting for minimum hum level. Frequency response is within $\pm 1\frac{1}{2}$ db from 15 to 35,000 cps. Equalization provided for LP, RIAA, AES, and early 78's. Separate bass and treble controls. Low impedance cathode follower output circuit. All components were specially selected for their high quality. Includes many features which will eventually be desired. Shpg. Wt. 7 lbs.

MODEL WA-P2

\$19⁷⁵

(with cabinet)

An amplifier you will be proud to own

70-WATT AMPLIFIER

AM-TUNER

SELECTS AND CONTROLS SOUND TO YOUR TASTE

PREAMPLIFIER



ADVANCED-DESIGN
25-WATT AMPLIFIER

*Top performance
in its
power class!*

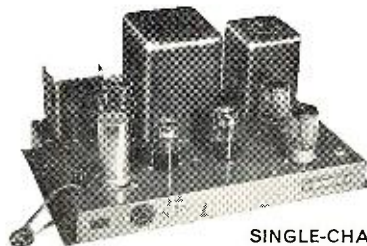

SINGLE-CHASSIS
20-WATT AMPLIFIER

*Hi-Fi equipment
for your listening
pleasure!*

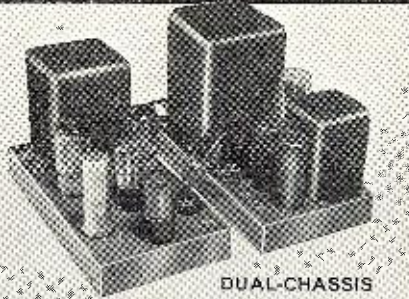

DUAL-CHASSIS
20-WATT AMPLIFIER



GENERAL-PURPOSE
20-WATT AMPLIFIER

HEATHKIT ADVANCED-DESIGN 25-WATT HIGH FIDELITY AMPLIFIER KIT

Designed especially to satisfy critical audio requirements, the W-5M incorporates the extra features needed to compliment the finest in program sources and speaker systems. Faithful sound reproduction is assured with a frequency response of ± 1 db from 5 to 160,000 cps at 1 watt, and harmonic distortion is less than 1% at 25 watts, with IM distortion less than 1% at 20 watts. Hum and noise are a full 99 db below rated output, assuring quiet, hum-free operation. Output taps are 4, 8 and 16 ohms. Exclusive Heathkit features include the "tweeter saver", and the "bas-bal" balancing circuit, requiring only a voltmeter for indication. Years of reliable service are guaranteed through the use of conservatively rated, high quality components. KT66 tubes and Peerless output transformer are typical. Shipped express only. Shpg. Wt. 31 lbs.

MODEL W-5: Consists of W-5M kit above plus model WA-P2 preamplifier. Express only. Shpg. Wt. 38 lbs. \$79.50

MODEL W-5M
\$59⁷⁵

HEATHKIT DUAL-CHASSIS 20-WATT HIGH FIDELITY AMPLIFIER KIT

The model W3-AM is a Williamson-type amplifier built on two separate chassis. The power supply is on one chassis, and the amplifier stages are on the other chassis. Using two separate chassis provides additional flexibility in installation. Features include the famous acrosound model TO-300 "ultralinear" output transformer and 5881 tubes for broad frequency response, low distortion, and low hum level. The result is exceptionally fine overall tone quality. Frequency response is ± 1 db from 6 cps to 150 kc at 1 watt. Harmonic distortion is less than 1% and IM distortion is less than 1.3% at 20 watts. Hum and noise are 88 db below 20 watts. Designed to match the speaker system of your choice, with taps for 4, 8 or 16 ohms impedance. A very popular high fidelity unit employing top quality components throughout. Shipped express only. Shpg. Wt. 29 lbs.

MODEL W-3A: Consists of W-3AM kit above plus model WA-P2 preamplifier. Express only. Shpg. Wt. 37 lbs. \$69.50

MODEL W-3AM
\$49⁷⁵

HEATHKIT SINGLE-CHASSIS 20-WATT HIGH FIDELITY AMPLIFIER KIT

The model W4-AM Williamson-type amplifier will amaze you with its outstanding performance. A true Williamson circuit, featuring extended frequency response, low distortion, and low hum levels, this amplifier can provide you with many hours of listening enjoyment with only a minimum investment compared to other units on the market. 5881 tubes and a special Chicago-standard output transformer are employed to give you full fidelity at minimum cost. Frequency response extending from 10 cps to 100 kc within ± 1 db at 1 watt assures you of full coverage of the audio range, and clean clear sound amplification takes place in circuits that hold harmonic distortion at 1.5% and IM distortion below 2.7% at full 20 watt output. Hum and noise are 95 db below full output. Taps on the output transformer are at 4, 8 or 16 ohms. Shipped express only. Shpg. Wt. 28 lbs.

MODEL W-4A: Consists of W-4AM kit above, plus model WA-P2 preamplifier. Express only. Shpg. Wt. 35 lbs. \$59.50.

MODEL W-4AM
\$39⁷⁵

Heathkits...

By DAYSTROM

*bring you the lasting satisfaction
of personal accomplishment*

HEATHKIT GENERAL-PURPOSE 20-WATT HIGH FIDELITY AMPLIFIER KIT

The model A-9C will provide you with high quality sound at low cost. Features a built-in preamplifier with four separate inputs, and individual volume, bass and treble controls. Frequency response covers 20 to 20,000 cps within ± 1 db. Total harmonic distortion is less than 1% at 3 db below rated output. Push-pull 6L6 tubes are used, with output transformer tapped at 4, 8, 16 and 500 ohms. A true hi-fi unit using high-quality components throughout, including heavy-duty "potted" transformers. Shpg. Wt. 23 lbs.

MODEL A-9C
\$35⁵⁰

**HEATHKIT "BASIC RANGE"
HI-FI SPEAKER SYSTEM KIT**

The extremely popular Heathkit model SS-1 Speaker System provides amazing high fidelity performance for its size. Features two high-quality Jensen speakers, an 8" mid-range woofer and compression-type tweeter with flared horn. Covers from 50 to 12,000 CPS within ± 5 db, in a special-design ducted-port, bass reflex enclosure. Impedance is 16 ohms. Cabinet measures 11½" H x 23" W x 11¼" D. Constructed of veneer-surfaced plywood, ½" thick, suitable for light or dark finish. All wood parts are precut and predrilled for easy, quick assembly. Shpg. Wt. 30 lbs.

MODEL SS-1
\$399.5

**HEATHKIT "RANGE EXTENDING"
HI-FI SPEAKER SYSTEM KIT**

Extends the range of the SS-1 to ± 5 db from 35 to 16,000 CPS. Uses 15" woofer and super-tweeter both by Jensen. Kit includes crossover circuit. Impedance is 16 ohms and power rating is 35 watts. Measures 29" H x 23" W x 17½" D. Constructed of veneer-surfaced plywood ¾" thick. Easy to build! Shpg. Wt. 80 lbs.

MODEL SS-1B
\$999.5

**HEATHKIT "LEGATO"
HIGH FIDELITY SPEAKER SYSTEM KIT**

The quality of the Legato, in terms of the engineering that went into the initial design, and in terms of the materials used in its construction, is matched in only the most expensive speaker systems available today. The listening experience it provides approaches the ultimate in esthetic satisfaction. Two 15" theater-type Altec Lansing speakers cover 25 to 500 CPS, and an Altec Lansing high-frequency driver with sectoral horn covers 500 to 20,000 CPS. A precise amount of phase shift in the crossover network brings the high frequency channel into phase with the low frequency channel to eliminate peaks or valleys at the crossover point, by equalizing the acoustical centers of the speakers. The enclosure is a modified infinite baffle type, especially designed for these speakers. Cabinet is constructed of veneer-surfaced plywood, ¾" thick, precut and predrilled for easy assembly. Frequency response 25 to 20,000 CPS. Power rating, 50 watts program material. Impedance is 16 ohms. Cabinet dimensions 41" L x 22¼" D x 34" H.

Choice of two beautiful cabinets. Model HH-1-C in imported white birch for light finishes, and HH-1-CM in African mahogany for dark finishes. Shpg. Wt. 195 lbs.

MODEL HH-1-C
MODEL HH-1-CM
\$325.00
EACH

Heathkits...

By DAYSTROM

*let you save up to ½
or more on all types
of electronic equipment.*

HEATHKIT SINE-SQUARE GENERATOR

The new AG-10 provides high quality, sine and square waves over a wide range, for countless applications. Some of these are; radio and TV repair work, checking scope performance, as a variable trigger source for telemetering and pulse work, and checking audio, video and hi-fi amplifier response. Frequency response is ± 1.5 db from 20 CPS to 1 MC on both sine and square waves, with less than .25% sine wave distortion, 20 to 20,000 CPS. Sine wave output impedance 600 ohms, square wave output impedance 50 ohms, (except on 10v ranges). Square wave rise time less than .15 usec. Five-position band switch—continuously variable tuning—shielded oscillator circuit—separate step and variable output attenuators in ranges of 10, 1, and .1 volts for both sine and square wave, with extra range of .01 volt on sine wave. Both sine and square wave can be used at the same time without affecting either wave form. Power supply uses silicon-diode rectifiers. Shpg. Wt. 12 lbs.

MODEL AG-10
\$499.5

HEATHKIT AUDIO ANALYZER KIT

The AA-1 is actually three instruments in one compact package. It combines the functions of an AC VTVM, an audio wattmeter, and an intermodulation analyzer. Input and output terminals are combined, and high and low frequency oscillators are built in. VTVM ranges are 0-.01, .03, .1, .3, 1, 3, 10, 30, 100 and 300 volts (RMS). Wattmeter ranges are .15 mw, 1.5 mw, 15 mw, 150 mw, 1.5 w, 15 w and 150 w. IM scales are 1%, 3%, 10%, 30% and 100%. Provides internal load resistors of 4, 8, 16 or 600 ohms. A tremendous dollar value. Shpg. Wt. 13 lbs.

MODEL AA-1
\$499.5

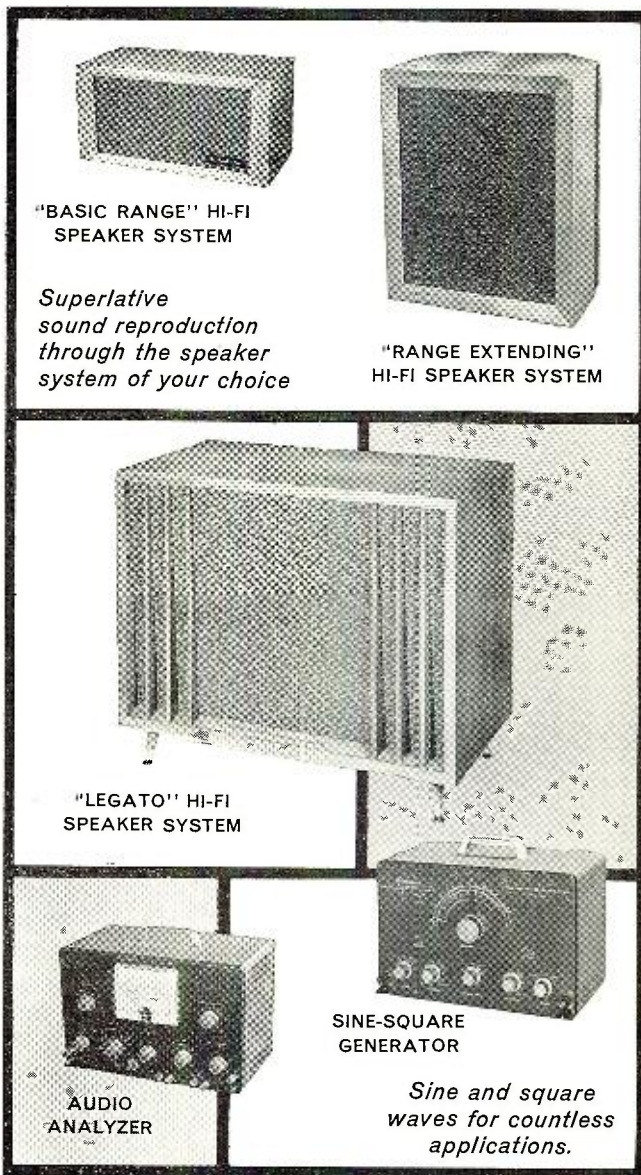

"BASIC RANGE" HI-FI
SPEAKER SYSTEM

*Superlative
sound reproduction
through the speaker
system of your choice*

"RANGE EXTENDING"
HI-FI SPEAKER SYSTEM

"LEGATO" HI-FI
SPEAKER SYSTEM

AUDIO
ANALYZER

SINE-SQUARE
GENERATOR

*Sine and square
waves for countless
applications.*

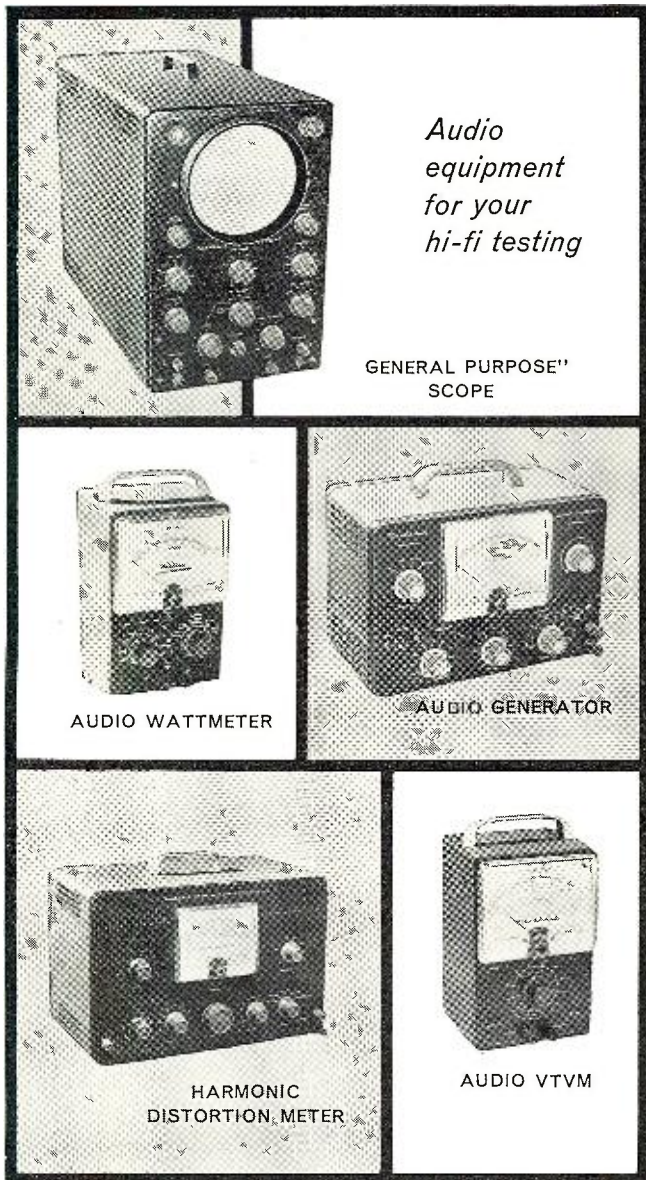

*Audio
equipment
for your
hi-fi testing*

**GENERAL PURPOSE"
SCOPE**

AUDIO WATTMETER

AUDIO GENERATOR

**HARMONIC
DISTORTION METER**

AUDIO VTVM

HEATHKIT "GENERAL PURPOSE" 5" OSCILLOSCOPE KIT

The model OM-2 Oscilloscope is especially popular with part-time service technicians, students, and high fidelity enthusiasts. It features good vertical frequency response ± 3 db from 4 cps to over 1.2 mc. A full five-inch crt, and sweep generator operation from 20 cps to over 150 kc. Stability is excellent and calibrated grid screen allows precise signal observation. Extra features include external or internal sweep and sync, 1-volt peak-to-peak calibrating reference, 3-position step-attenuated input, adjustable spot shape control, push-pull horizontal and vertical amplifiers, and modern etched-metal circuits. Easy to build and a pleasure to use. Ideal for use with other audio equipment for checking amplifiers. Shpg. Wt. 21 lbs.

MODEL OM-2

\$42⁵⁰

HEATHKIT AUDIO WATTMETER KIT

The AW-1 Audio Wattmeter can be used in any application where audio power output is to be measured. Non-inductive LOAD resistors are built in for 4, 8, 16 or 600 ohms impedance. Five power ranges cover 0-5 mw, 50 mw, 500 mw, 5 w, and 50 w full scale. Five switch-selected db ranges cover -10 db to +30 db. All indications are read directly on a large $4\frac{1}{2}$ " 200 microampere meter. Frequency response is

± 1 db from 10 cps to 250 kc. Precision type multiplier resistors used for high accuracy, and crystal diode bridge for wide-range frequency response. This meter is used in many recording studios and broadcast stations as a monitor as well as servicing. A fine meter to help supply the answers to your audio operating or power output problems. Shpg. Wt. 6 lbs.

MODEL AW-1

\$29⁵⁰

HEATHKIT AUDIO SIGNAL GENERATOR KIT

The model AG-9A is "made to order" for high fidelity applications, and provides quick and accurate selection of low-distortion signals throughout the audio range. Three rotary switches select two significant figures and a multiplier to determine audio frequency. Incorporates step-type and a continuously variable output attenuator. Output indicated on large $4\frac{1}{2}$ " panel meter, calibrated in volts and db. Attenuator system operates in 10 db steps, corresponding to meter calibration, in ranges of 0-.003, .01, .03, .1, .3, 1, 3, 10 and 10 volts RMS. "Load" switch permits use of built-in 600-ohm load, or external load of different impedance. Output and frequency indicators accurate to within $\pm 5\%$. Distortion less than .1 of 1% between 20 and 20,000 cps. Total range is 10 cps to 100 kc. Shpg. Wt. 8 lbs.

MODEL AG-9A

\$34⁵⁰

HEATHKIT HARMONIC DISTORTION METER KIT

All sounds consist of dominant tones plus harmonics (over-tones). These harmonics enrich the quality and brightness of the music. However, additional harmonics which originate in the audio equipment, represent distortion. Used with an audio signal generator, the HD-1 will accurately measure this harmonic distortion at any or all frequencies between 20 and 20,000 cps. Distortion is read directly on the panel meter in ranges of 0-1, 3, 10, 30 and 100% full scale. Voltage ranges of 0-1, 3, 10 and 30 volts are provided for the initial reference settings. Signal-to-noise ratio measurements are also permitted through the use of a separate meter scale calibrated in db. High quality components insure years of outstanding performance. Full instructions are provided. Shpg. Wt. 13 lbs.

MODEL HD-1

\$49⁵⁰

Heathkits...

By DAYSTROM

*are well known for
their high quality
and reliability.*

HEATHKIT AUDIO VTVM KIT

This new and improved AC Vacuum Tube Voltmeter is designed especially for audio measurements and low-level AC measurements in power supply filters, etc. Employs an entirely new circuit featuring a cascode amplifier with cathode-follower isolation between the input and the amplifier, and between the output stage and the preceding stages. It emphasizes stability, broad frequency response, and sensitivity. Frequency response is essentially flat from 10 cps to 200 kc. Input impedance is 1 megohm at 1000 cps. AC (RMS) voltage ranges are 0-.01, .03, .1, .3, 1, 3, 10, 30, 100 and 300 volts. Db ranges cover -52 db to +52 db. Features large $4\frac{1}{2}$ " 200 microampere meter, with increased damping in meter circuit for stability in low frequency tests. 1% precision resistors employed for maximum accuracy. Stable, reliable performance in all applications. Shpg. Wt. 5 lbs.

MODEL AV-3

\$29⁵⁰

HEATHKIT COLOR BAR AND DOT GENERATOR

The CD-1 combines the two basic color service instruments, a Color Bar Generator and White Dot Generator in one versatile portable unit, which has crystal-controlled accuracy and stability (no external sync lead required). Produces white dots, cross hatch, horizontal and vertical bars, 10 vertical color bars, and a new shading bar pattern for screen and background adjustments. Variable RF output on any channel from 2 to 6. Positive or negative video output, variable from 0 to 10 volts peak-to-peak. Crystal controlled sound carrier with off-on switch. Voltage regulated power supply using long-life silicon rectifiers.

Gain knowledge of a new and profitable field by constructing this kit. Shpg. Wt. 12 lbs.

MODEL CD-1

\$59⁹⁵

Heathkits...

By DAYSTROM

are guaranteed to meet or exceed advertised specifications

HEATHKIT TV ALIGNMENT GENERATOR KIT

This fine TV alignment generator offers stability and flexibility difficult to obtain even in instruments costing several times this low Heathkit price. It covers 3.6 mc to 220 mc in four bands. Sweep deviation is controllable from 0 to 42 mc. The all-electronic sweep circuit insures stability. Crystal marker and variable marker oscillators are built in. Crystal (included with kit) provides output at 4.5 mc and multiples thereof. Variable marker provides output from 19 to 60 mc on fundamentals and from 57 to 180 mc on harmonics. Effective two-way blanking to eliminate return trace. Phasing control. Kit is complete, including three output cables. Shpg. Wt. 16 lbs.

MODEL TS-4A

\$49⁵⁰

HEATHKIT "EXTRA DUTY" 5" OSCILLOSCOPE KIT

This fine oscilloscope compares favorably to other scopes costing twice its price. It contains the extra performance so necessary for monochrome and color-TV servicing. Features push-pull horizontal and vertical output amplifiers, a 5UPI CRT, built in peak-to-peak calibration source, a fully compensated 3-position step-type input attenuator, retrace blanking, phasing control, and provision for Z-axis modulation. Vertical amplifier frequency response is within +1.5 and -5 db from 3 CPS to 5 MC. Response at 3.58 MC down only 2.2 db. Sensitivity is 0.025 volts RMS/inch at 1 kc. Sweep generator covers 20 CPS to 500 kc in five steps, five times the usual sweep obtained in other scopes through the use of the patented Heath sweep circuit. Etched-metal circuit boards reduce assembly time and minimize errors in assembly, and more importantly, permit a level of circuit stability never before achieved in an oscilloscope of this type. Shpg. Wt. 21 lbs.

MODEL O-11

\$69⁵⁰

HEATHKIT ELECTRONIC SWITCH KIT

A valuable accessory for any oscilloscope owner. It allows simultaneous oscilloscope observation of two signals by producing both signals, alternately, at its output. Four switching rates. Provides gain for input signals. Frequency response ± 1 db, 0 to 100 kc. A sync output is provided to control and stabilize scope sweep. Ideal for observing input and output of amplifiers simultaneously. Shpg. Wt. 8 lbs.

MODEL S-3

\$21⁹⁵

HEATHKIT VOLTAGE CALIBRATOR KIT

This unit is an excellent companion for your oscilloscope. Used as a source of calibrating voltage, it produces near-perfect square wave signals of known amplitude. Precision 1% attenuator resistors insure accurate output amplitude, and multivibrator circuit guarantees good sharp square waves. Output frequency is approximately 1000 CPS. Fixed outputs selected by panel switches are; .03, 0.1, 0.3, 1.0, 3.0, 10, 30 and 100 volts peak-to-peak. Allows measurement of unknown signal amplitude by comparing it to the known output of the VC-3 on oscilloscope. Shpg. Wt. 4 lbs.

MODEL VC-3

\$12⁵⁰

Functional styling with clean uncluttered look

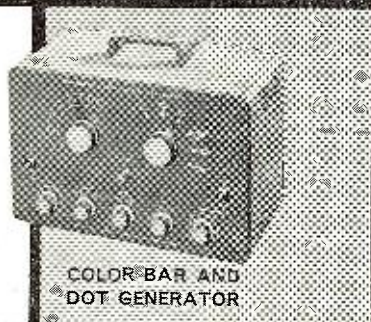

COLOR BAR AND DOT GENERATOR



"EXTRA DUTY" SCOPE

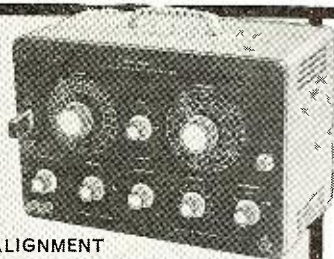

TV ALIGNMENT GENERATOR



ELECTRONIC SWITCH



VOLTAGE CALIBRATOR

HEATH COMPANY A Subsidiary of Daystrom, Inc. **BENTON HARBOR 15, MICH.**
March, 1958

HEATHKIT TUBE CHECKER KIT

Eliminate guesswork, and save time in servicing or experimenting. The TC-2 tests tubes for shorted elements, open elements, filament continuity, and operating quality on the basis of total emission. It tests all tube types encountered in radio and TV service work. Sockets are provided for 4, 5, 6 and 7-pin, octal, and loctal tubes, 7 and 9 pin miniature tubes, 5 pin hytron miniatures, and pilot lamps. Tube condition indicated on 4½" meter with multi-color "good-bad" scale. Illuminated roll chart with all test data built in. Switch selection of 14 different filament voltages from .75 to 117 volts. Color-coded cable harness allows neat professional wiring and simplifies construction. Very easy to build, even for a beginner. Shpg. Wt. 12 lbs.

MODEL TC-2

\$29.50

HEATHKIT HANDITESTER KIT

The small size and rugged construction of this tester makes it perfect for any portable application. The combination function-range switch simplifies operations. Measures AC or DC voltage at 0-10, 30, 300, 1000 and 5000 volts. Direct current ranges are 0-10 ma and 0-100 ma. Ohmmeter ranges are 0-3000 (30 ohm center scale) and 0-300,000 (3000 ohm center scale). Very popular with home experimenters, electricians, and appliance repairmen. Slips easily into your tool box, glove compartment, coat pocket, or desk drawer. Shpg. Wt. 3 lbs.

MODEL M-1

\$17.95

HEATHKIT PICTURE TUBE CHECKER KIT

The CC-1 can be taken with you on service calls so that you can clearly demonstrate the quality of a customer's picture tube in his own home. Tubes can be tested without removing them from the receiver or cartons if desired. Checks cathode emission, beam current, shorted elements, and leakage between elements in electromagnetic picture tube types. Self-contained power supply, and large 4½" meter. CRT condition indicated on "good-bad" scale. Relative condition of tubes fluorescent coating is shown in "shadowgraph" test. Permanent test cable with CRT socket and anode connector. No tubes to burn out, designed to last a lifetime. Luggage-type portable case. Shpg. Wt. 10 lbs.

MODEL CC-1

\$24.95

HEATHKIT ETCHED-CIRCUIT VTVM KIT

This multi-purpose VTVM is the world's largest selling instrument of its type—and is especially popular in laboratories, service shops, home workshops and schools. It employs a large 4½" panel meter, precision 1% resistors, etched metal circuit board, and many other "extras" to insure top quality and top performance. It's easy to build, and you may rely on its accuracy and dependability. The V7-A will measure AC (RMS) and DC voltages in ranges of 0-1.5, 5, 15, 50, 150, 500 and 1500. It measures peak-to-peak AC voltage in ranges of 0-4, 14, 40, 140, 400, 1400 and 4000. Resistance ranges provide multiplying factors of X 1, X 10, X 100, X 1000, X 10k, X 100k, and X 1 megohm. Center-scale resistance readings are 10, 100, 1000, 10k, 100k, 1 megohm and 10 megohms. A db scale is also provided. The precision and quality of this VTVM cannot be duplicated at this price. Shpg. Wt. 7-lbs.

MODEL V7-A

\$24.50

Heathkits...

By DAYSTROM

*let you fill your exact needs
from a wide variety
of instruments*

HEATHKIT 20,000 OHMS/VOLT VOM KIT

This fine instrument provides a total of 25 meter ranges on its two-color scale. It employs a 50 ua 4½" meter, and features 1% precision multiplier resistors. Requires no external power. Ideal for portable applications. Sensitivity is 20,000 ohms-per-volt DC and 5000 ohms-per-volt AC. Measuring ranges are 0-1.5, 5, 50, 150, 500, 1500 and 5000 volts, AC and DC. Measures direct current in ranges of 0-150 ua, 15 ma, 150 ma, 500 ma and 15 a. Resistance multipliers are X 1, X 100 and X 10,000, with center-scale readings of 15, 1500 and 150,000 ohms. Covers -10 db to +65 db. Easy to build and fun to use. Attractive bakelite case with plastic carrying handle. Shpg. Wt. 6 lbs.

MODEL MM-1

\$29.95

*High quality
test gear you
will be
proud to own*

ETCHED
CIRCUIT VTVM

*Priced low
to fit your
budget*

HANDITESTER

PICTURE TUBE
CHECKER

20,000
OHMS/VOLT VOM

HEATHKIT RF SIGNAL GENERATOR KIT

Even a beginner can build this prealigned signal generator, designed especially for use in service work. Produces RF signals from 160 kc to 110 mc on fundamentals in five bands. Covers 110 mc to 220 mc on calibrated harmonics. Low impedance RF output in excess of 100,000 microvolts, is controllable with a step-type and continuously variable attenuator. Selection of unmodulated RF, modulated RF, or audio at 400 CPS. Ideal for fast and easy alignment of radio receivers, and finds application in FM and TV work as well. Thousands of these units are in use in service shops all over the country. Easy to build and a real time saver, even for the part-time service technician or hobbyist. Shpg. Wt. 8 lbs.

MODEL 5G-8

\$19.50

HEATHKIT LABORATORY RF GENERATOR KIT

Tackle all kinds of laboratory alignment jobs with confidence by employing the LG-1. It features voltage-regulated B+, double shielding of oscillator circuits, copper-plated chassis, variable modulation level, metered output, and many other "extras" for critical alignment work. Generates RF signals from 100 kc to 30 mc on fundamentals in five bands. Meter reads RF output in microvolts or modulation level in percentage. RF output available up to 100,000 microvolts, controlled by a fixed-step and a variable attenuator. Provision for external modulation where necessary. Buy and use this high-quality RF signal generator that may be depended upon for stability and accuracy. Shpg. Wt. 16 lbs.

MODEL LG-1

\$48.95

HEATHKIT DIRECT-READING CAPACITY METER KIT

Here's a fast, simple capacity meter. A capacitor to be checked is merely connected to the terminals, the proper range selected, and the value read directly on the large 4½" panel meter calibrated in mmf and mfd. Ranges are 0 to 100 mmf, 1,000 mmf, .01 mfd, .1 mfd full scale. Not affected by hand capacity. Shpg. Wt. 7 lbs.

MODEL CM-1

\$29.50

Heathkits...

By DAYSTROM

*are educational
as well as functional*

HEATHKIT "IN-CIRCUIT" CAPACI-TESTER KIT

With the CT-1 it is no longer necessary to disconnect one capacitor lead to check the part, you can check most capacitors for "open" or "short" right in the circuit. Fast and easy—to save your valuable time in the service shop or lab. Detects open capacitors from about 50 mmf up, so long as the capacitor is not shunted by excessively low resistance value. Will detect shorted capacitors up to 20 mfd (not shunted by less than 10 ohms). (Does not detect leakage.) Employs 60 cycles and .19 megacycle test frequencies. Electron beam "eye" tube used as indicator. Compact, easy-to-build, and inexpensive. Test leads included. Shpg. Wt. 5 lbs.

MODEL CT-1

\$7.95

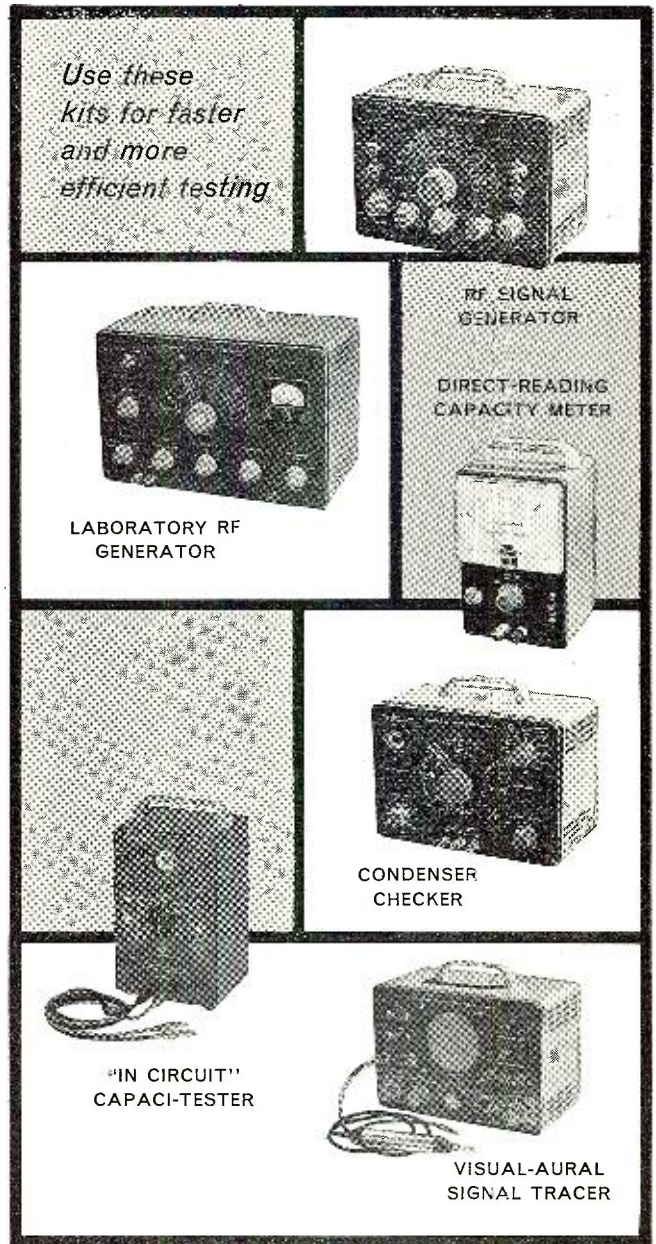

HEATHKIT CONDENSER CHECKER KIT

This handy instrument uses an electron beam "eye" tube as an indicator to measure capacity in ranges of .00001 to .005 mfd, .5 mfd, 50 mfd and 1000 mfd. Also measures resistance from 100 ohms to 5 megohms in two ranges. Checks paper, mica, ceramic and electrolytic capacitors. Selection of five polarizing voltages. Shpg. Wt. 7 lbs.

MODEL C-3

\$19.50

HEATHKIT VISUAL-AURAL SIGNAL TRACER KIT

Although designed originally for radio receiver work, the T-3 finds application in FM and TV servicing as well. Features high-gain channel with demodulator probe, and low-gain channel with audio probe. Traces signals in all sections of radio receivers and in many sections of FM and TV receivers. Built-in speaker and electron beam eye tube indicate relative gain, etc. Also features built-in noise locator circuit. Provision for patching speaker and/or output transformer to external set. Shpg. Wt. 9 lbs.

MODEL T-3

\$23.50

HEATH COMPANY A Subsidiary of Daystrom, Inc. BENTON HARBOR 15, MICH.
March, 1958

HEATHKIT IMPEDANCE BRIDGE KIT

The model IB-2A employs a Wheatstone Bridge, a Capacity Comparison Bridge, a Maxwell Bridge, and a Hay Bridge in one compact package. Measures resistance from 0.1 ohm to 10 megohms, capacitance from 100 mmf to 100 mfd, inductance from 0.1 mh to 100 h, dissipation factor (D) from 0.002 to 1, and storage factor (Q) from 0.1 to 1000. A 100-0-100 ua meter provides for null indications. The decade resistors employed are of 1% tolerance for maximum accuracy. Completely self-contained. Has built in power supply, 1000-cycle generator, and vacuum-tube detector. Special two-section CRL dial insures convenient operation. Instruction manual has entirely new schematic that clarifies circuit functions in various switch positions. A true laboratory instrument, that will provide you with many years of fine performance. Shpg. Wt. 12 lbs.

MODEL IB-2A

\$59⁵⁰

HEATHKIT "LOW RIPPLE" BATTERY ELIMINATOR KIT

This modern battery eliminator incorporates an extra low-ripple filter circuit so that it can be used to power all the newest transistor-type circuits requiring 0 to 12 volts DC,

and the new "hybrid" automobile radios using both transistors and vacuum tubes. Its DC output, at either 6 or 12 volts, contains less than .3% AC ripple. Separate output terminals are provided for low-ripple or normal filtering. Supplies up to 15 amps on 6 volt range or up to 7 amps on 12 volt range. Output is variable from 0 to 8 or 0 to 16 volts. Two meters constantly monitor output voltage and current. Will also double as a battery charger. Shpg. Wt. 23 lbs.

MODEL BE-5

\$39⁹⁵

HEATHKIT ISOLATION TRANSFORMER KIT

The model IT-1 is one of the handiest units for the service shop, home workshop or laboratory. Provides complete isolation from the power line. AC-DC sets may be plugged directly into the IT-1 without the chassis becoming "hot". Output voltage is variable from 90 volts to 130 volts allowing checks of equipment under adverse conditions such as low line voltage. Rated for 100 volt amperes continuously or 200 volt amperes intermittently. Panel meter monitors output voltage. Shpg. Wt. 9 lbs.

MODEL IT-1

\$16⁵⁰

Heathkits...

By DAYSTROM

*are designed with high-quality,
name-brand components to
insure long service life*

HEATHKIT "Q" METER KIT

At this price the laboratory facilities of a Q Meter may be had by the average service technician or home experimenter. The Q Meter permits measurement of inductance from 1 microhenry to 10 millihenry, "Q" on a scale calibrated up to 250 full scale, with multipliers of 1 or 2, and capacitance from 40 mmf to 450 mmf \pm 3 mmf. Built in oscillator permits testing components from 150 kc to 18 mc. Large 4 1/2" panel meter is featured. Very handy for checking peaking coils, chokes, etc. Use to determine values of unknown condensers, both variable and fixed, compile data for coil winding purposes, or measure RF resistance. Also checks distributed capacity and Q of coils. No special equipment is required for calibration. A special test coil is furnished, along with easy-to-follow instructions. Shpg. Wt. 14 lbs.

MODEL QM-1

\$44⁵⁰

HEATHKIT REGULATED POWER SUPPLY KIT

Here is a power supply that will provide DC plate voltage and AC filament voltage for all kinds of experimental circuits. The DC supply is regulated for stability, and yet the amount of DC output voltage available from the power supply can be controlled manually from 0 up to 500 volts. At 450 volts DC output, the power supply will provide up to 10 ma of current, and provide progressively higher current as the output voltage is lowered. Current rating is 130 ma at 200 volts output. In addition to furnishing B+ the power supply also provides 6.3 volts AC at up to 4 amperes for filaments. Both the B+ output and the filament output are isolated from ground. Ideal unit for use in laboratory, home workshop, ham shack, or service shop. A large 4 1/2" meter on the front panel reads output voltage or output current, selectable with a panel switch. Shpg. Wt. 17 lbs.

MODEL PS-3

\$35⁵⁰

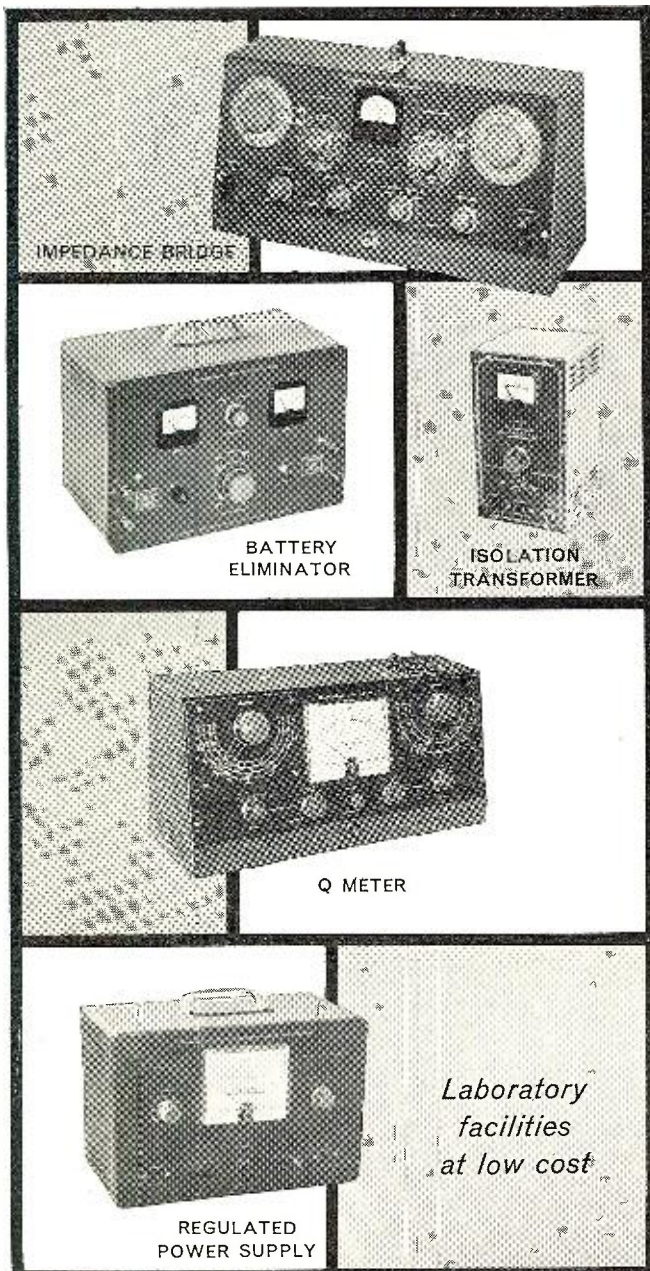



*Terrific values
in amateur
equipment!*

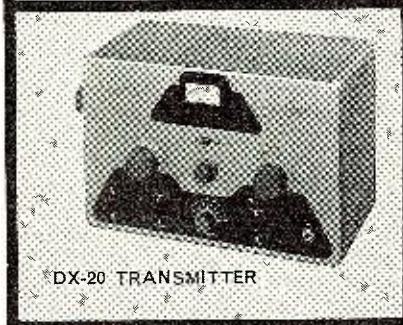

DX-20 TRANSMITTER



DX-40 TRANSMITTER

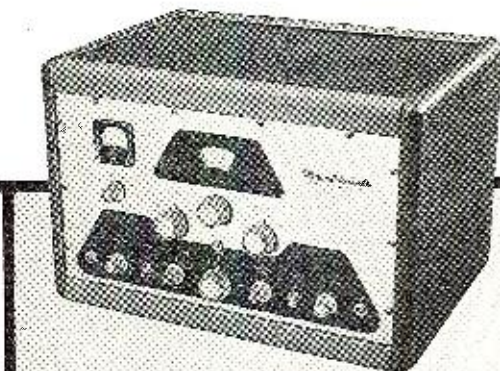

DX-100 TRANSMITTER

HEATHKIT DX-20 CW TRANSMITTER KIT

The Heathkit model DX-20 "straight-CW" transmitter features high efficiency at low cost. It uses a single 6DQ6A tube in the final amplifier stage for plate power input of 50 watts. A 6CL6 serves as crystal oscillator, with a 5U4GB rectifier. It is an ideal transmitter for the novice, as well as the advanced-class CW operator. Single-knob band switching is featured to cover 80, 40, 20, 15, 11 and 10 meters. Pi network output circuit matches various antenna impedances between 50 and 1000 ohms and reduces harmonic output. Top-quality parts are featured throughout, including "potted" transformers, etc., for long life. It has been given full "TVI" treatment. Access into the cabinet for crystal changing is provided by a removable metal pull-out plug on the left end of the cabinet. Very easy to build from the complete step-by-step instructions supplied, even if you have never built electronic equipment before. If you appreciate a good, clean signal on the CW bands, this is the transmitter for you! Shpg. Wt. 18 lbs.

MODEL DX-20

\$35⁹⁵

Heathkits...

By DAYSTROM

*are designed by
licensed ham-engineers,
especially for you*

HEATHKIT DX-40 PHONE AND CW TRANSMITTER KIT

A most remarkable power package for the price, the new DX-40 provides both phone and CW facilities for operation on 80, 40, 20, 15, 11 and 10 meters. A single 6146 tube is used in the final amplifier stage to provide full 75 watt plate power input on CW, or control carrier modulation peaks up to 60 watts for phone operation. Modulator and power supplies are built right in and single knob bandswitching is combined with a pi network output circuit for complete operating convenience. The tight fitting cabinet presents

a most attractive appearance, and is designed for complete shielding to minimize TVI. A 4-position switch provides convenient selection of three different crystals or a jack for external VFO. The crystals are reached through access door at rear of cabinet. You can build this rig yourself and be proud to show it off to your fellow hams. Shpg. Wt. 25 lbs.

MODEL DX-40

\$64⁹⁵

HEATHKIT DX-100 PHONE AND CW TRANSMITTER KIT

Listen to any ham band between 160 meters and 10 meters and note how many DX-100 transmitters you hear! The number of these fine rigs now on the air testifies to the enthusiasm with which it has been accepted by the amateur fraternity. No other transmitter in this power class combines high quality and real economy so effectively. The DX-100 features a built in VFO, modulator and power supplies, complete shielding to minimize TVI, and pi network output coupling to match impedances from approximately 50 to 600 ohms. Its RF output is in excess of 100 watts on phone and 120 watts on CW, for a clean strong signal on all the ham bands from 10 to 160 meters. Single-knob band switching and illuminated VFO dial and meter face add real operating convenience. RF output stage uses a pair of 6146 tubes in parallel, modulated by a pair of 1625's. High quality components are used throughout, such as "potted" transformers, silver-plated or solid coin silver switch terminals, aluminum heat-dissipating caps on the final tubes, copper plated chassis, etc. This transmitter was designed exclusively for easy step-by-step assembly. Shpg. Wt. 107 lbs.

MODEL DX-100

\$189⁵⁰

FUNCTIONAL DESIGN . . .

The transmitters described on this page were designed for the ham, by hams who know what features are desirable and needed. This assures you of the best possible performance and convenience, and adds much to your enjoyment in the ham shack.

Automatically turns off transmitter and gives visual signal

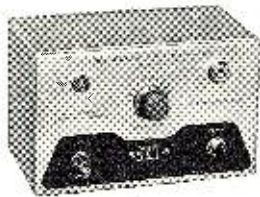

"AUTOMATIC"
CONELRAD ALARM



GRID DIP METER

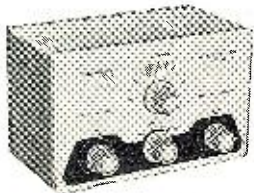

"Q" MULTIPLIER

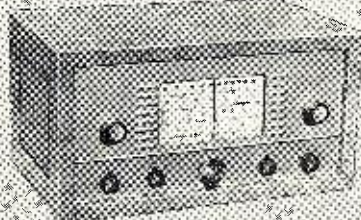

COMMUNICATIONS-TYPE
RECEIVER

*An ideal receiver
for the beginning
ham or short
wave listener*

HEATHKIT "AUTOMATIC" CONELRAD ALARM KIT

This conelrad alarm works with any radio receiver; AC-DC-transformer operated—or battery powered, so long as the receiver has AVC. Fully complies with FCC regulations for amateurs. When the monitored station goes off the air, the CA-1 automatically cuts the AC power to your transmitter, and lights a red indicator. A manual "reset" button reactivates the transmitter. Incorporates a heavy-duty six-ampere relay, a thyratron tube to activate the relay, and its own built-in power supply. A neon lamp shows that the alarm is working, by indicating the presence of B+ in the alarm circuit. Simple to install and connect. Your transmitter plugs into an AC receptacle on the CA-1, and a cable connects to the AVC circuit of a nearby receiver. A built-in sensitivity control allows adjustment to various AVC levels. Receiver volume control can be turned up or down, without affecting alarm operation. Build a Heathkit CA-1 in one evening and comply with FCC regulations now! Shpg. Wt. 4 lbs.

MODEL CA-1
\$13⁹⁵

HEATHKIT "Q" MULTIPLIER KIT

The Heathkit Q Multiplier functions with any AM receiver having an IF frequency between 450 and 460 KC, that is not "AC-DC" type. It derives its power from the receiver, and needs only 6.3 volts AC at 300 ma (or 12 VAC at 150 ma) and 150 to 250 volts DC at 2 ma. Simple to connect with cable and plugs supplied. Adds additional selectivity for separating signals, or will reject one signal and eliminate heterodyne. A tremendous help on crowded phone and CW bands. Effective Q of 4000 for sharp "peak" or "null". Tunes any signal within IF band, pass without changing the main receiver tuning dial. A convenient tuning knob on the front panel with vernier reduction between the tuning knob and the tuning capacitor gives added flexibility in operation. Uses a 12AX7 tube, and special high-Q shielded coils. Instructions for connecting to the receiver and operation are provided in the construction manual. A worthwhile addition to any communications, or broadcast receiver. It may also be used with a receiver which already has a crystal filter to obtain two simultaneous functions, such as peaking the desired signal with the crystal filter and nulling an adjacent signal with the Q Multiplier. Shpg. Wt. 3 lbs.

MODEL QF-1
\$9⁹⁵

HEATHKIT GRID DIP METER KIT

A grid dip meter is basically an RF oscillator for determining the frequency of other oscillators, or of tuned circuits. Extremely useful in locating parasitics, neutralizing, identifying harmonics, coil winding, etc. Features continuous frequency coverage from 2 mc to 250 mc, with a complete set of prewound coils, and a 500 ua panel meter. Front panel has a sensitivity control for the meter, and a phone jack for listening to the "zero-beat." Will also double as an absorption-type wave meter. Shpg. Wt. 4 lbs.

Low Frequency Coil Kit: Two extra plug-in coils to extend frequency coverage down to 350 kc. Shpg. Wt. 1 lb. No. 341-A. \$3.00

MODEL GD-1B
\$21⁹⁵

HEATHKIT ALL-BAND COMMUNICATIONS-TYPE RECEIVER KIT

This communications-receiver covers 550 kc to 30 mc in four bands, and provides good sensitivity, selectivity, and fine image rejection. Ham bands are clearly marked on an illuminated dial scale. Features a transformer-type power supply—electrical band spread—antenna trimmer—head-phone jack—automatic gain control and beat frequency oscillator. Accessory sockets are provided on the rear of the chassis for using the Heathkit model QF-1, Q Multiplier. Accessory socket is handy, also, for operating other devices that require plate and filament potentials. Will supply +250 VDC at 15 ma and 12.6 VAC at 300 ma. Ideal for the beginning ham or short wave listener. Shpg. Wt. 12 lbs.

Cabinet: Fabric covered cabinet with aluminum panel as shown. Part no. 91-15A. Shpg. Wt. 5 lbs. \$4.95.

MODEL AR-3
\$29⁹⁵
(Less cabinet)

Heathkits...

By DAYSTROM

*are outstanding in performance
and dollar value*

HEATHKIT REFLECTED POWER METER KIT

The Heathkit reflected power meter, model AM-2, makes an excellent instrument for checking the match of the antenna transmission system, by measuring the forward and reflected power or standing wave ratio. The AM-2 is designed to handle a peak power of well over 1 kilowatt of energy and may be left in the antenna system feed line at all times. Band coverage is 160 meters through 2 meters. Input and output impedances for 50 or 75 ohm lines. No external power required for operation. Meter indicates percentage forward and reflected power, and standing wave ratio from 1:1 to 6:1. Another application for the AM-2 is matching impedances between exciters or R.F. sources and grounded grid amplifiers. Power losses between transmitter output and antenna tuner may be very easily computed by inserting the AM-2 in the line connecting the two. No insertion loss is introduced into the feeder system, due to the fact that the AM-2 is a portion of coaxial line in series with the feeder system and no internal connections are actually made to the line. Complete circuit description and operation instructions are provided in the manual. Cabinet size is 7-3/8" x 4-1/16" x 4-5/8". Can be conveniently located at operating position. Shpg. Wt. 3 lbs.

MODEL AM-2

\$15⁹⁵

HEATHKIT VARIABLE FREQUENCY OSCILLATOR KIT

Enjoy the convenience and flexibility of VFO operation by obtaining the Heathkit model VF-1 Variable Frequency Oscillator. Covers 160-80-40-20-15-11 and 10 meters with three basic oscillator frequencies. Better than 10 volt average RF output on fundamentals. Plenty of output to drive most modern transmitters. It features voltage regulation for frequency stability. Dial is illuminated for easy reading. Vernier reduction is used between the main tuning knob and the tuning condenser. Requires a power source of only 250 volts DC at 15 to 20 milliamperes and 6.3 volts AC at 0.45 amperes. Extra features include copper-plated chassis, ceramic coil forms, extensive shielding, etc. High quality parts throughout. VFO operation allows you to move out from under interference and select a portion of the band you want to use without having to be tied down to only two or three frequencies through use of crystals. "Zero in" on the other fellow's signal and return his CQ on his own frequency! Crystals are not cheap, and it takes quite a number of them to give anything even approaching comprehensive coverage of all bands. Why hesitate? The model VF-1 with its low price and high quality will add more operating enjoyment to your ham activities. Shpg. Wt. 7 lbs.

MODEL VF-1

\$19⁵⁰

Heathkits...

By DAYSTROM

are the answer for your electronics hobby.

HEATHKIT BALUN COIL KIT

The Heathkit Balun Coil Kit model B-1 is a convenient transmitter accessory, which has the capability of matching unbalanced coax lines, used on most modern transmitters, to balance lines of either 75 or 300 ohms impedance. Design of the bifilar wound balun coils will enable transmitters with unbalanced output to operate into balanced transmission line, such as used with dipoles, folded dipoles, or any balanced antenna system. The balun coil set can be used with transmitters and receivers without adjustment over the frequency range of 80 through 10 meters, and will easily handle power inputs up to 250 watts. Cabinet size is 9" square by 5" deep and it may be located any distance from the transmitter or from the antenna. Completely enclosed for outdoor installation. Shpg. Wt. 4 lbs.

MODEL B-1

\$8⁹⁵

HEATHKIT 6 OR 12 VOLT VIBRATOR POWER SUPPLY KITS

These little power supply kits are ideal for all portable applications with 6 volt or 12 volt batteries, when you are operating electronic equipment away from power lines. By replacing the power supplies of receivers, small public address systems, or even miniature transmitters with these units, they can be used with conventional 6 or 12 volt batteries. Use in boats, automobiles, light aircraft, or any field application. Each unit provides 260 volts DC output at up to 60 milliamperes. More than one power supply of the same model may be connected in parallel for increased current capacity at the same output voltage. Everything is provided in the kit, including a vibrator transformer, a vibrator, 6X4 or 12X4 rectifier, and the necessary buffer capacitor, hash filter, and output filter capacitor. Shpg. Wt. 4 lbs.

6 VOLT
MODEL VP-1-6
12 VOLT
MODEL VP-1-12

\$7⁹⁵ Each

REFLECTED POWER METER

Insure your "on the air" performance with these fine accessories.

VARIABLE FREQUENCY OSCILLATOR

VIBRATOR POWER SUPPLY

BALUN COIL SET

**HEATHKIT ELECTRONIC
IGNITION ANALYZER KIT**

Previous electronic experience is not necessary to build this fine ignition analyzer. The construction manual supplied has complete step-by-step instructions plus large pictorial diagrams showing the exact placement and value of each component. All parts are clearly marked so that they are easily identified. The IA-1 is an ideal tool for engine mechanics, tune-up men, and auto hobbyists, since it traces the dynamic action of voltage in an ignition system on a cathode-ray tube screen. The wave form produced is affected by the condition of the coil, condenser, points, plugs, and ignition wiring, so it can be analyzed, and used as a "sign-post" to ignition system performance. This analyzer will detect inequality of spark intensity, a poor spark plug, defective plug wiring, breaker-point bounce, an open condenser, and allow setting of dwell-time percentage for the points. An important feature of this instrument is its ability to check dynamic performance, with the engine in operation (400 to 5000 RPM). It will show the complete engine cycle, or only one complete cylinder. Can be used on all types of internal combustion engines where breaker-points are accessible. Use it on automobiles, boats, aircraft engines, etc. Shpg. Wt. 18 lbs.

MODEL IA-1
\$59⁹⁵

**HEATHKIT PROFESSIONAL
RADIATION COUNTER KIT**

This Heathkit professional-type radiation counter is simple to build successfully, even if you have never built a kit before. Complete step-by-step instructions are combined with giant-size pictorial diagrams for easy assembly. By "building it yourself" you can have a modern-design, professional radiation counter priced far below comparable units. Provides high sensitivity with ranges from 0-100, 600, 6000 and 60,000 counts-per-minute, and 0-.02, .1, 1 and 10 miliroentgens-per-hour. Employs 900-volt bismuth tube in beta/gamma sensitive probe. Probe and 8-foot expandable cable included in kit price, as is a radiation sample for calibration. Use it in medical laboratories, or as a prospecting tool, and for civil defense to detect radioactive fallout, or other unknown radiation levels. Features a selectable time constant. Meter calibrated in CPM or mR/hour in addition to "beep" or "click" from panel-mounted speaker. Prebuilt "packaged" high voltage power supply with reserve capacity above 900 volt level at which it is regulated. Merely changing regulator tube type would allow use of scintillation probe if desired. Employs five tubes (plus a transistor) to insure stable and reliable operation. Kit price includes batteries. Shpg. Wt. 8 lbs.

MODEL RC-1
\$79⁹⁵



IGNITION
ANALYZER



*Kit includes everything
you need for
construction — even
batteries!*

RADIATION COUNTER

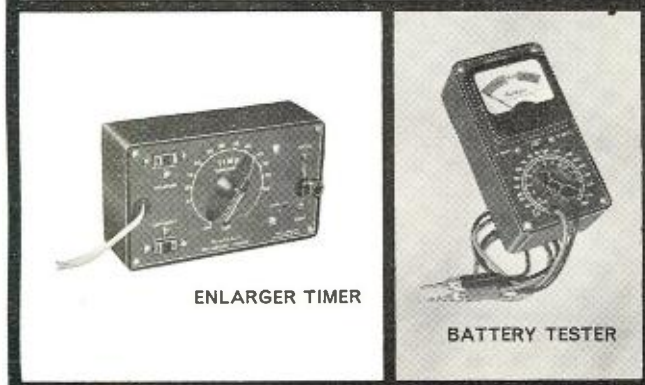

ENLARGER TIMER

BATTERY TESTER

Heathkits...

By DAYSTROM

*are supplied with comprehensive
instructions that eliminate costly
mistakes and save valuable time*

HEATHKIT ENLARGER TIMER KIT

The ET-1 is an easy-to-build electronic device to be used by amateur or professional photographers in timing enlarger operations. The calibrated dial on the timer covers 0 to 1 minute, calibrated in 5-second gradations. The continuously variable control allows setting of the "on" cycle of your enlarger, which is plugged into a receptacle on the front panel of the ET-1. A "safe light" can also be plugged in so that it is automatically turned "on" when the enlarger is turned "off." Handles up to 350 watts with built-in relay. All-electronic timing cycle insures maximum accuracy. Timer does not have to be reset after each cycle, merely flip lever switch to print, to repeat time cycle. A control is provided for initial calibration. Housed in a compact plastic case that will resist attack of photographic chemicals. A fine addition to any dark room. Shpg. Wt. 3 lbs.

MODEL ET-1
\$11⁵⁰

HEATHKIT BATTERY TESTER KIT

The BT-1 is a special battery testing device that actually "loads" the battery under test (draws current from it) while it is being tested. Weak batteries often test "good" with an ordinary voltmeter but the built-in load resistance of the BT-1 automatically draws enough current from the battery to reveal its true condition. Simple to operate with "good-weak-replace" scale. Tests all kinds of dry cell batteries within ranges of 0-15 volts and 0-180 volts. Slide switch provides for either 10 ma or 100 ma load, depending on whether you're testing an A or B battery. Not only determines when battery is completely exhausted, but makes it possible to anticipate failure by noting weak condition. Ideal for testing dry cell hearing aid, flashlight, portable radio, and model airplane batteries. Test batteries in a way your customers can understand and stimulate battery sales. Shpg. Wt. 2 lbs.

MODEL BT-1
\$8⁵⁰

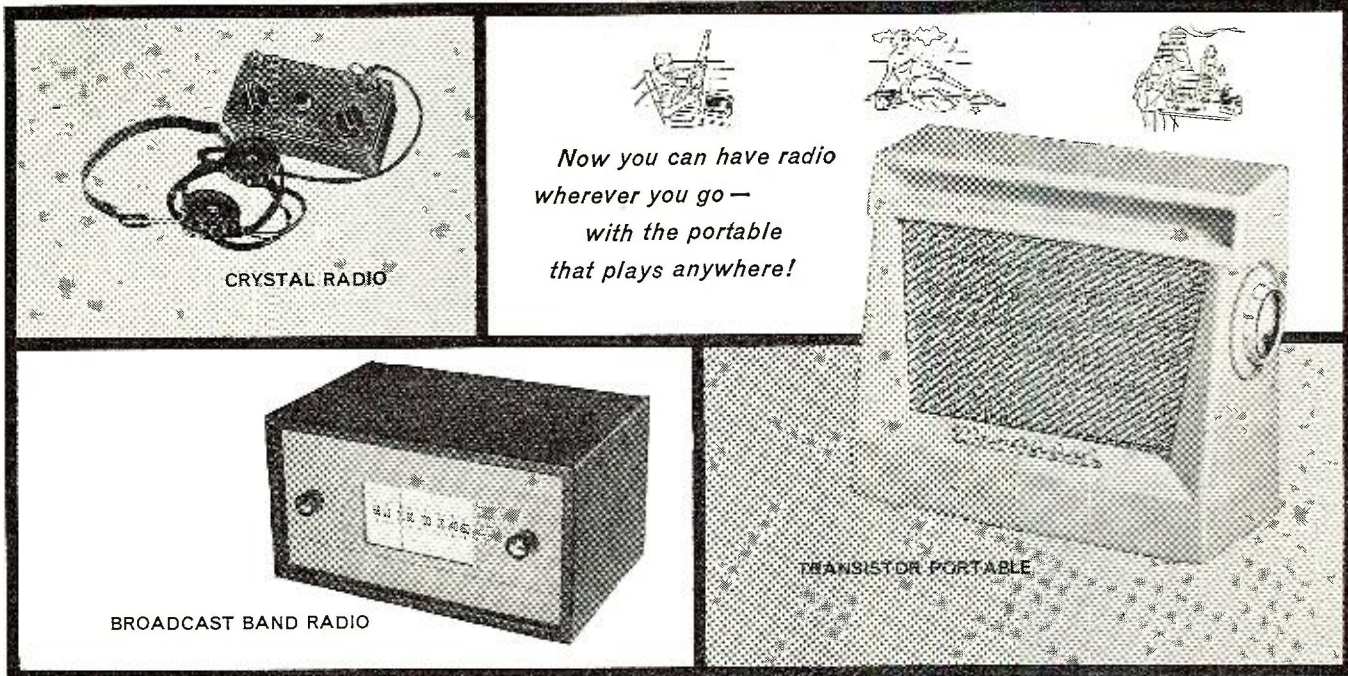

Now you can have radio
wherever you go —
with the portable
that plays anywhere!

CRYSTAL RADIO

BROADCAST BAND RADIO

TRANSISTOR PORTABLE

HEATHKIT CRYSTAL RADIO KIT

The Heathkit model CR-1 crystal radio is similar to the "crystal sets" of the early radio days except that it has been improved by the use of sealed germanium diodes and efficient "high-Q" coils. The sealed diodes eliminate the critical "cats whisker" adjustment, and the ferrite coils are much more efficient for greater signal strength. Housed in a compact plastic box, the CR-1 uses two tuned circuits, each with a variable tuning capacitor, to select the local station. It covers the broadcast band from 540 to 1600 kc. Requires no external power whatsoever. This receiver could prove valuable to emergency reception of civil defense signals should there be a power failure. The low kit price even includes headphones. Complete step-by-step instructions and large pictorial diagrams are supplied for easy assembly. The instruction manual also provides the builder with the basic fundamentals of signal reception so that he understands how the crystal receiver functions. An interesting and valuable "do-it-yourself" project for all ages. Shpg. Wt. 3 lbs.

MODEL CR-1
\$7⁹⁵

result of these efforts. Six name-brand (Texas Instrument) transistors were selected for extra good sensitivity and selectivity. A 4" by 6" PM speaker with heavy magnet was chosen to insure fine tone quality. The power supply was designed to use six standard size "D" flashlight cells because they are readily available, inexpensive, and because they afford extremely long battery life (between 500 and 1000 hours). Costs you no more to operate from batteries than what you pay for operating a small table-model radio from the power line. An unbreakable molded plastic was selected for cabinet material because of its durability and striking beauty. Circuit is compact and efficient, yet components are not excessively crowded. Transformers are prealigned so it is ready for service as soon as construction is completed. Has built in rod-type antenna for reception in all locations. Cabinet dimensions are 9" L x 8" H x 3 $\frac{3}{4}$ " D. Comes in holiday gray, with gold-anodized metal speaker grille. Compare this portable, feature by feature, to all others on the market, and you'll appreciate what a tremendous dollar value it represents! Shpg. Wt. 4 lbs.

MODEL XR-1
\$34⁹⁵
(Less batteries)
(With cabinet)

Heathkits...

By DAYSTROM

*are easy and fun to build,
and they let you learn
by "doing-it-yourself"*

HEATHKIT TRANSISTOR PORTABLE RADIO KIT

Heath engineers set out to develop a "universal" AM radio, suitable for use anywhere. Their objective was a portable that would be as much "at home" inside as it is outside, and would feature top quality components for high performance and long service life. The model XR-1 is the

HEATHKIT BROADCAST BAND RADIO KIT

This table-model broadcast radio is fun to build, and is a fine little receiver for your home. It covers the standard broadcast band from 550 to 1600 kc with good sensitivity and selectivity. The 5 $\frac{1}{2}$ " PM speaker provides surprisingly good tone quality. High-gain IF transformers, miniature tubes, and a rod-type built in antenna, assure good reception in all locations. The power supply is transformer operated, as opposed to many of the economy "AC-DC" types. It's easy to build from the step-by-step instructions, and the construction manual includes information on operational theory, for educational purposes. Your success is assured by completely detailed information which also explains resistor and capacitor color codes, soldering techniques, use of tools, etc. A signal generator is recommended for final alignment. Shpg. Wt. 10 lbs.

Cabinet: Fabric covered cabinet with aluminum panel as shown. Shpg. Wt. 5 lbs. Part no. 91-9A. \$4.95.

MODEL BR-2
\$18⁹⁵
(Less cabinet)

HEATH COMPANY A Subsidiary of Daystrom, Inc. **BENTON HARBOR 15, MICH.**

March, 1958

87

protects against possible explosion and fire from undetected fuel vapor

FUEL VAPOR DETECTOR



detects electrolysis currents which cause deterioration of underwater metal fittings on your boat

ELECTROLYSIS DETECTOR



indicates condition and charge of batteries for safe cruising

BATTERY CHARGE INDICATOR

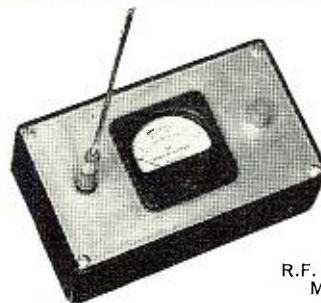

R.F. POWER METER

HEATHKIT FUEL VAPOR DETECTOR KIT

Protect your boat and its passengers against fire or explosion from undetected fuel vapor by building and using one of these fine units. The Heathkit Fuel Vapor Detector indicates the presence of fumes on a three-color "safe-dangerous" meter scale and immediately shows if it is safe to start the engine. A pilot light on the front panel shows when the detector is operating, and it can be left on continuously, or just used intermittently. A panel control enables initial calibration of the detector when installed. Features a hermetically-sealed meter with chrome bezel, and a chrome-plated brass panel. It is very simple to build and install, even by one not having previous experience. Models FD-1-6 (6 volts DC) and FD-1-12 (12 volts DC) operate from your boat batteries. The kit is complete in every detail, even to the inclusion of a spare detector unit. Shpg. Wt. 4 lbs.

6 volt
MODEL FD-1-6
12 volt
MODEL FD-1-12

\$35⁹⁵
EACH

HEATHKIT BATTERY CHARGE INDICATOR KIT

The Heathkit model CI-1 Marine Battery Charge Indicator has been designed especially for the boat owner, although it has found use in service stations, power stations, and radio stations where banks of batteries are kept in reserve for emergency power. It is intended to replace the hydrometer method of checking storage batteries, and to eliminate the necessity for working with acid in small, below-decks enclosures. Now it is possible to check as few as one, or as many as eight storage batteries, merely by turning the switch and watching the meter. A glance at the meter tells you instantly whether your batteries are sufficiently charged for safe cruising. Dimensions are 2-7/8" W x 5-11/16" H x 2" D. Operates on either 6 or 12 volt systems using lead-acid batteries, regardless of size. Simple installation can be accomplished by the boat owner in fifteen minutes. Shpg. Wt. 3 lbs.

MODEL CI-1
\$16⁹⁵

HEATHKIT ELECTROLYSIS DETECTOR KIT

The Heathkit model ED-1 Electrolysis Detector indicates the extent of electrolysis currents between the boat's common ground and underwater fittings, except on boats having metal hulls. These currents, undetected, could

cause gradual corrosion and deterioration of the propeller or other metal fittings below the water line. It is particularly helpful when installing electrical equipment of any kind, or to determine proper polarity when power is obtained from a shore supply. Easy to build, the model ED-1 consists of a hermetically-sealed, waterproof meter, special sensing plate, and sufficient wire to install, including the necessary hardware. Mounts on instrument panel where it can be easily seen. Requires no power for operation, and gives instant warning to guard your boat for a lifetime. Shpg. Wt. 2 lbs.

MODEL ED-1
\$9⁹⁵

HEATHKIT RF POWER METER KIT

The Heathkit RF Power Meter Kit is designed to sample the RF field in the vicinity of your transmitter, whether it be marine, mobile, or fixed. Output meter is merely placed in some location close to the transmitter, to pick up RF radiation from the antenna. Requires no batteries, electricity, nor direct connection to the transmitter. It provides you with a continuing indication of transmitter operation. You can easily detect if power is dropping off by comparing present meter readings with past ones. Operates with any transmitter having output frequencies between 100 kc and 250 mc, regardless of power. Sensitivity is 0.3 volts RMS full scale, and a special control on the panel allows for further adjustment of the sensitivity. Meter is a 200 ua unit, mounted on a chrome-plated brass panel. The entire PM-1 measures only 3 3/4" W x 6 1/4" L x 2" D. An easy way to put your mind at ease concerning transmitter operation. Shpg. Wt. 2 lbs.

MODEL PM-1
\$14⁹⁵

Heathkits...

By DAYSTROM

now offer you completely modern marine equipment with outstanding design features

**HEATHKIT TRANSISTOR
RADIO DIRECTION FINDER KIT**

The Heathkit Transistor Radio Direction Finder model DF-1 is a self-contained, self-powered, 6-transistor super heterodyne broadcast radio receiver incorporating a directional loop antenna, indicating meter, and integral speaker. It is designed to serve primarily as an aid to navigation when out of sight of familiar landmarks. It can be used not only aboard yachts, fishing craft, tugs, and other vessels which navigate either out of sight of land or at night, but also for the hunter, hiker, camper, fisherman, aviator, etc. It is powered by a 9-volt battery. (A spare battery is also included with the kit). The frequency range covers the broadcast band from 540 to 1600 kc. and will double as a portable radio. A directional high-Q ferrite antenna is incorporated which is rotated from the front panel to obtain a fix on a station and a 1 ma meter serves as the null and tuning indicator. The controls consist of: tuning, volume and power (on-off), sensitivity, heading indicator (compass rose) and bearing indicator (antenna index). Overall dimensions are 7½" W x 5⅝" H x 5⅜" D. Supplied with slip-in-place mounting brackets, which allow easy removal from ship bulkheads or other similar places. Shpg. Wt. 5 lbs.

MODEL DF-1
\$54⁹⁵

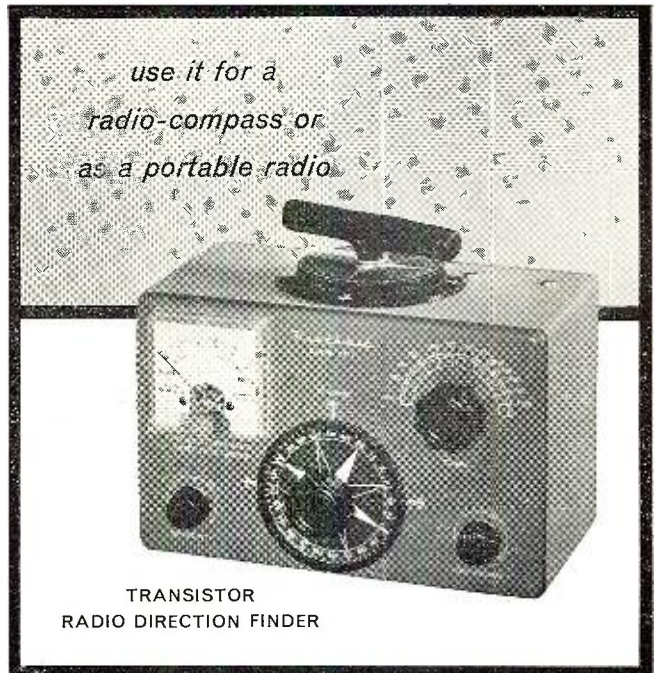

Heathkits...

By DAYSTROM

*are sold only by direct mail,
passing middleman
profits on to you*



Pioneer in
"do-it-yourself"
electronics

HOW CAN YOU MISS?

The Heath Company maintains a technical consultation service, should you experience some sort of difficulty in construction or operation. Although only a very small percentage of our customers ever have occasion to use this service (usually only beginners in electronics) it is still reassuring to know that technical help is available when needed. A service department is also available, should you wish a complete factory check of operation and alignment or repair. After you build your first Heathkit you'll realize how easy it is.

Free Catalog

Send for this
informative booklet
listing more than
100 "do-it-yourself" kits.

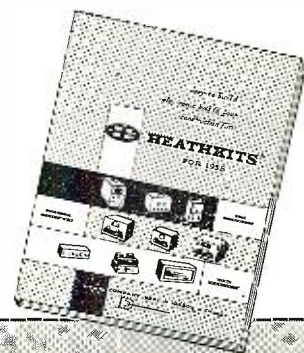

HEATH COMPANY

A Subsidiary of Daystrom, Inc.



BENTON HARBOR 15, MICH.

ORDER BLANK

NOTE: All prices subject to change without notice.
Enclosed find () check () money order for _____ Please ship C.O.D. () postage enclosed for _____ pounds.
On Express orders do not include transportation charges—they will be collected by the express agency at time of delivery.
ON PARCEL POST ORDERS include postage for weight shown. ORDERS FROM APO'S must include full remittance. All prices F.O.B. Benton Harbor, Mich.

Name _____
Address _____
City & Zone _____ State _____
(PLEASE PRINT)

- SHIP VIA**
 Parcel Post
 Express
 Freight
 Best Way

QUANTITY	ITEM	MODEL NO.	PRICE
		POSTAGE	
		TOTAL	

SEND FREE Heathkit Catalog

Certified

Record Revue

by Bert Whyte

AS 1957 passed into limbo, the almost universal and dominant subject of the record industry was the monogroove stereo disc. That the stereo disc should become such a matter of prominence is not surprising—after all, as the most aesthetically satisfactory means of musical reproduction, the stereo disc carries within itself the seeds of a great new industry.

What was a little surprising, however, was the rapid acceleration of interest and fast-moving developments in the stereo disc during the last few weeks of the year. Supposedly, the various types of stereo discs were under study and discussion by various industry groups, with the avowed purpose of determining which system was the best and most desirable. On the results of these studies an industry-wide meeting was to be held and the system of choice was to be voted as the universal standard for stereo disc recording. By the time you read this, that meeting may have taken place and the stereo disc standard may be a reality. If this has happened . . . it is much sooner than anyone anticipated.

A little background on this may be of interest to you. When the *Westrex* and *London* stereo discs were demonstrated at the October AES convention in New York, all the record companies who were members of the RIAA, resolved that there would be no repetition, with the stereo disc, of the disastrous situations imposed on company and public in the early days of the LP record. The internecine "speed war" of that period had the industry and the public in an uproar and before the "war" was ended, a great deal of money was lost and, along with it, a great deal of public good-will. So the idea of an industry-wide approach and a mature and intelligent handling of the stereo disc was greeted on all sides with approbation. Oh, there were cynical eyebrows raised . . . there were those who felt that the record industry was, to put it mildly, "highly competitive" and that the "dog-eat-dog" participants would make strange bedfellows indeed!

In spite of this, the industry kept its resolve and the stereo program got under way without any defections. Everything seemed to go along smoothly and then the first chinks in the armor began to appear. Rumors began to circulate that so-and-so was favoring the *Westrex* system or that such-and-such was "definitely" going to switch to the *London* system, etc., etc. Soon, some of the rumors began to have some foundation and the pressures began to build up and then the stereo "peace pact" was rudely shaken by a story which appeared in the show business weekly "Billboard." *Audio Fidelity Records*, a small independent record company well-known in hi-fi circles, announced that it was issuing the first stereo disc and that it would be cut in the *Westrex* system. In a later story in "Retailing Daily," this announcement was expanded to the point where the company was issuing 11 stereo discs in January 1958, all in the *Westrex* system. This was quickly followed by *Fairchild* announcing the availability of a stereo cartridge and arm to play *Westrex*-type stereo discs.

After some of the smoke cleared away, there were some modifications of the original stories concerning the discs, with phrases like

"misquote" being bandied about. *Audio Fidelity* contended that it had merely made the disc as an investigational tool for use by pickup manufacturers. Whatever the reason, it did indeed furnish a means of demonstrating stereo cartridges and *Fairchild* quickly took advantage of this fact. Not long afterwards, *Pickering & Co.* demonstrated its stereo cartridge which also espoused the *Westrex* cause. *Pickering* emphasized however, that the cartridge was *not* commercially available and that it intended to wait the outcome of the industry meeting on stereo standards and to abide by whatever standard was chosen. But still the snowball was rolling . . . it was purported that stereo cartridges were in the works at *Brush*, *Electro-Voice*, and *Webcor*, and, in all cases, they were to be utilized with the *Westrex* system.

Your reporter was very kindly invited to *Fairchild's* laboratory where I was fortunate enough to hear a stereo disc demonstration. The *Fairchild* stereo disc playback equipment is quite interesting. The arm used is the large studio turret head type which is found in many broadcasting stations. The cartridge is a novel design, utilizing two moving coils to pick up the "45-45" groove modulations of the *Westrex* system. Reduced to its most simple geometry, the *Westrex* system can be likened to two vertical channels. In the *Fairchild* cartridge there is a very clever "decoupling" or isolation circuit which is used to separate the left and right channels. With this design the claimed cross-modulation figures are on the order of minus 30 db and as I listened to the *Audio Fidelity* stereo disc and to some of the original *Westrex* material which was used at the AES convention, from audible evidence at least, this figure would seem realistic.

The *Audio Fidelity* disc turned out to be quite good. One side was the well-known "Dukes of Dixieland" and the other side was devoted to steam railroad sounds. The left-right separation was good although, as a whole, the directionality feature was overdone. Frequency and dynamic range seemed quite normal and I was again impressed by the very good signal-to-noise ratio of the stereo disc. The *Fairchild* stereo cartridge is at present quite a bit larger than its conventional 225 units and for this reason the large studio arm is used. Engineering on the stereo unit is continuing with a view towards reducing the size to normal limits but the present arm and cartridge works very well and it is actually available to those affluent people who can afford the rather breathtaking 250 dollar price tag. But, then, there are always those who want to be "fustest with the mostest."

Pickering & Co. was also kind enough to invite me to a stereo demonstration . . . in fact I attended two separate demonstrations. One, the first, was held at the *Pickering* laboratories and the other was at the Park Sheraton Hotel in New York in company with many worthy cohorts from the hi-fi press corps. Of the two, I was impressed most of all by the private demonstration, because *Pickering* had set up its stereo demonstration

in a room closely approximating normal living room dimensions and the room was treated with draperies and carpeting greatly aiding the stereo reproduction. The playback system may be of interest . . . each channel was a *Marantz* preamp feeding into a 60-watt *McIntosh* and this driving a large infinite baffle with 15" *Wharfedale* speaker for the woofer and crossing over at 400 cycles into the new model of *Pickering's* large electrostatic speaker. A standard *Garrard* transcription turntable was used to spin the disc and a conventional *Pickering* 190D arm was used for the *Pickering* stereo cartridge. The arm and cartridge was *Pickering's* real surprise . . . it was evident that the engineering and development was very well advanced. The cartridge was roughly the same size as a standard *Pickering* "Fluxvalve" and the arm a completely standard production unit. The cartridge itself employs the principle of two moving irons with, of course, a means of decoupling for minimum cross-modulation. The cartridge utilizes a one-half mil stylus and tracks at approximately two grams. *Pickering* advised me that tests had been conducted with the cartridge in a changer, in which a one mil stylus is used at a stylus force of 4 or 5 grams. The significant thing here, of course, is that *Pickering's* cartridge has already been reduced to dimensions sufficiently small for use in standard hi-fi equipment.

I listened once again to the *Audio Fidelity* disc and to some *Westrex* material. The resultant reproduction was absolutely first rate and, in fact, the *Westrex* material which quite frankly had sounded pretty poor and was very noisy at the AES convention, was excellent in this demonstration. The *Audio Fidelity* disc displayed all of the stereo virtues with the *Pickering* cartridge and since this was a brand new pressing, the signal-to-noise ratio was very good.

This business of signal-to-noise ratio on the stereo disc, is to me, one of the most attractive features of the whole process. You must remember that a stereo disc, in common with any disc, is cut from a master tape and in the whole recording process from the lacquer master to the production stamper, you've still only had a one-time duplication. Thus the hiss level of a high quality vinylite record in new condition is generally not too far removed from the hiss level of the master tape. In other words, given first-rate playback equipment and a good stereo disc, it is likely to have less hiss than a commercial stereo tape dub.

The *Pickering* demonstration at the Park Sheraton was very well attended and, although the acoustical environment was not as good as in *Pickering's* plant, the demonstration was quite impressive and well received. In fact, there were a number of comments from the audience that the stereo disc equipment and the resultant demonstration seemed to be of more than acceptable commercial quality and when would the playback equipment become available. This attitude is really the crux of this whole matter. As noted, *Pickering* says that it will await the outcome of the industry decision before going into production on any cartridge. Most other manufacturers say the same thing. Yet for all the laudable intentions of avoiding

The opinions expressed in this column are those of the reviewer and do not necessarily reflect the views or opinions of the editors or the publishers of this magazine.

make the most of your work...use a high precision **JBL LOUDSPEAKER!**

You will put many hours into learning the fundamentals, and then the fine points of high fidelity. You will spend your time and energy freely in building the very finest sound system you know how. Remember this when choosing your loudspeaker. Get a speaker of the highest precision—one that bears the symbol "JBL"—one that is worthy to demonstrate your own best efforts. JBL precision and advanced design are responsible for JBL efficiency—highest in the world. JBL efficiency gives you the smoothest, cleanest, most realistically lifelike sound you can get.

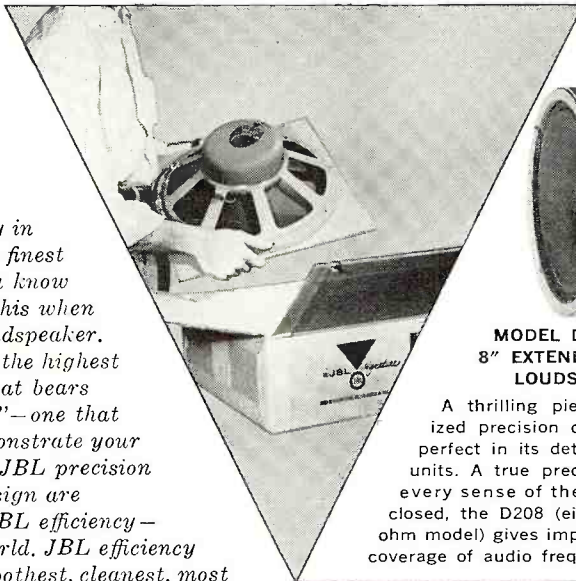

**MODEL D123
12" EXTENDED RANGE LOUDSPEAKER**

An outstanding value, the D123 at first glance is most unusual because of its shallow structure—only 3 3/8". More unusual is the crisp, clean bass it generates. Listening will develop great respect for the D123's smooth response, excellent handling of transients, and pleasingly lucid highs.

**MODEL D208/D216
8" EXTENDED RANGE LOUDSPEAKER**

A thrilling piece of miniaturized precision craftsmanship. As perfect in its details as larger JBL units. A true precision transducer in every sense of the term. Properly enclosed, the D208 (eight ohms, D216 is 16 ohm model) gives impressive, rich, full range coverage of audio frequency range.



MODEL 075 HIGH FREQUENCY UNIT

Exciting to behold, the precision-machined 075 embodies a new concept in high frequency reproduction. A ring, rather than a diaphragm, radiates sound energy into the annular throat of an aluminum exponentially tapered horn. Above 2500 cps, 075 sets a new standard for linear reproduction.

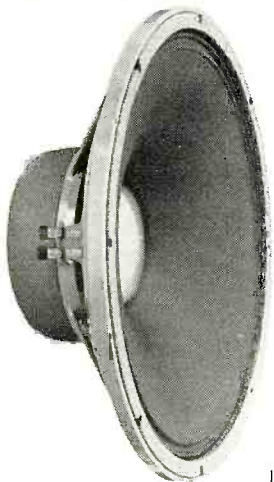

**MODEL D130 15"
EXTENDED RANGE LOUDSPEAKER**

The only speaker of its kind...only one made with a 4" voice coil...only single unit speaker to give you complete, true high fidelity coverage of the entire audio spectrum. Your basic speaker. Use alone at first, later add JBL high frequency unit and dividing network for supreme excellence of JBL 2-way system.



**MODEL 175DLH
HIGH FREQUENCY ASSEMBLY**

The finest of high precision drivers designed for 1200 cycle crossover is combined with a machined exponential horn and acoustical lens for optimum sound reproduction in the home. The lens, an exclusive JBL development, acoustically illuminates a 90° solid angle with equal intensity regardless of frequency.



Only a few of the many precision JBL products are shown on this page. Whatever your needs, you will find exactly the right system or unit for you in the complete, free JBL Signature catalog. Send for your free copy. A limited number of technical bulletins are also available. Please ask only for those in which you are vitally interested.

Please send me the following:

- Free Catalog of JBL Signature Products
- Name and address of Authorized JBL Signature Audio Specialist in my community

TECHNICAL BULLETINS ON:

- D130 D123 D208
- 175DLH 075

NAME _____

ADDRESS _____

CITY _____ ZONE _____ STATE _____

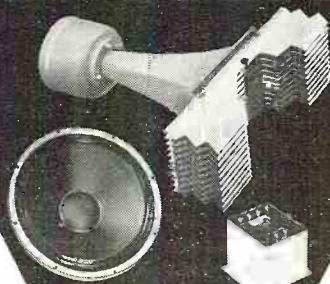

**MODEL 086 KIT OF
PROFESSIONAL COMPONENTS**

The finest speaker complement made. Designed for theaters, used in the Hartsfield, available for other applications to industry and the serious high fidelity enthusiast.

"JBL" means **JAMES B. LANSING SOUND, INC.** 3249 Casitas Avenue, Los Angeles 39, California

March, 1958

91



BOZAK

one line
one quality
loudspeakers

are designed and built
without compromise,
that they may produce

The Very Best in Sound



B-207a Two-Way
Speaker System



B-209
Mid-Range
Speaker



N-10102
Crossover Network

- 1 Mount them in a suitable infinite baffle;
- 2 Power them with the finest amplifier of 20 Watts or more;
- 3 Feed them with wide-range, low-distortion discs, tape or FM...

your Bozaks will make
no compromise
with natural sound.

Hear them
at your Franchised Bozak Dealer.

BOZAK

THE R. T. BOZAK SALES COMPANY
DARIEN - CONNECTICUT

Exports:

Electronics Manufacturers Export Company
Plainview, New York

industry strife, most seem to be paying little more than lip service to the idea. After all, developmental engineering costs money and it may be assumed that since virtually all the manufacturers working on a stereo cartridge have based their prototypes on the *Westrex* system, they are taking what amounts to a "calculated risk" that the *Westrex* system will indeed become the industry standard. Thus, as it stands now, there are some cautious souls who say that anything is possible, that there hasn't been sufficient time to properly evaluate the merits of the various stereo disc systems. They caution against rushing into a system which may look good on the surface but which may present unforeseen problems, such problems being thrust upon the hapless consumer. This reporter is all for precise and thorough investigation, but must frankly admit that I agree with many of the people at the *Pickering* demonstration, that what we heard was without any question "commercial." One thing is certain . . . the industry has a tremendous stake in the stereo disc. There are those who feel, and I think quite rightly, that the stereo disc will be the ticket to that magic land of the "mass hi-fi market." I think it is fairly safe to say that with the advent of the stereo disc, the hi-fi movement will enter its golden age and the real hi-fi boom will begin. Let me hasten to add that I believe all aspects of hi-fi will benefit therefrom, including stereo on tape.

Tape still has inherent advantages as a stereo medium over disc and in the improvements and modifications which are sure to come, the co-existence of tape and disc is reasonable to expect. It is also highly probable that the advent of the stereo disc will hasten research and development towards the ultimate goal of true three-channel stereo on tape. In summing up, unless some unforeseen problem crops up, the "ground swell" of the equipment manufacturers' development of *Westrex* type stereo cartridges, will exert pressure for an early decision on the stereo disc standard and I will be one very surprised guy if at the next New York Hi-Fi Show, there isn't a plentitude of stereo discs and cartridges for their playback!

(Unless otherwise indicated all discs reviewed are 12-inch, 33 $\frac{1}{3}$ rpm long play with RIAA playback equalization. Note: Prices quoted are those in effect when records were received and are subject to change.)

BARTOK
VIOLIN CONCERTO

Yehudi Menuhin, violinist, with Minneapolis Symphony Orchestra conducted by Antal Dorati. Mercury MG50140. Price \$3.98.

This is, without question, the outstanding violin concerto recording of the past few seasons. The score is sheer magnificence, a musical distillation of the genius that is Bartok. Menuhin displays an extraordinary affinity for the work, most sensitively attuned to its demands, and Dorati, dedicated pupil of Bartok, honors his mentor with a brilliant performance. I was fortunate enough to hear the concert performance of this work at Carnegie Hall, on the occasion of a special all-Bartok program for Hungarian Relief. Menuhin, Dorati, and the Minneapolis were tremendous and richly deserved the accolades the music critics lavished upon them in the morning papers.

But the critics missed the best performance! The same night about an hour after the concert, at approximately midnight, Menuhin once again took bow in hand, Dorati gave the downbeat and thus began the *Mercury* recording session that lasted into the wee small hours. I was invited to the session and as you can imagine, I accepted with alacrity. Now the most astonishing thing was that after having played this complex and exhausting work earlier in the eve-

new hi-fi cartridge



tropic powered

No humidity problems

requires no preamp,

however, when used with preamp performance exceeds expensive magnetic pickups.

- Response: flat from 30 to 24000 cps
- IM distortion negligible even at very high velocities because of extremely small moving mass.
- Output: .4 volts @ 1 sec/cm.
- Ronec exclusive Stylomatic* design permits quick and positive styli replacement with no tools whatsoever.
- No hum problems—no turntable pull.
- With 1 and 2.5 mil sapphire styli.
- Diamond styli available. *Trade Mark

See your nearest Ronec distributor or write to:

Ronec Acoustical Corp.
190 Earle Avenue • Lynbrook, N.Y.

RADIO AND TV
SERVICEMEN

Here's the perfect companion
to any tester!

Model GCT-8
**GRID
CIRCUIT
TUBE
TESTER**

(U.S. Pat. No. 2,784,372)



Quickly spots grid errors and leakage

Here's the perfect accessory for every serviceman! Checks critical "Control-Grid" condition of vacuum tubes faster, more accurately than any other tester! As many as eleven simultaneous checks—automatically! Stops guessing, substitution checking, and costly rechecks. Electron-eye tube indicates following faults at a glance: Control Grid Emission Excl., Grid-to-Cathode Shorts, Gaseous Condition, Cathode-to-Heater Shorts, Grid-to-Heater Shorts, Grid-to-Plate Shorts, Plate-to-Heater Shorts, Grid-to-Screen Shorts, Screen-to-Heater Shorts, Heater-to-Suppressor Shorts, Grid-to-Suppressor Shorts.

Truly portable—may be stored and carried anywhere. Complete, easy-to-assemble kit **\$19.95 net**

Wired and factory tested. **\$29.95 net**



Write today for free literature
MANUFACTURING CO.
5015 Penn Ave. So., Mpls., Minn.

ning, Menuhin, Dorati, and the orchestra were surpassing their previous effort. There was an almost palpable sense of rapport, a spirit, vigor, and assurance to the playing beyond the earlier conception. Menuhin's steel-fingered, but loving, perusal of the score was virtuosity in its fullest meaning. His technique was impeccable and, when the score permitted, an abundance of his lush rich tone.

The Bartok work is by no means as formidable as many people think. Of course, there is the usual dissonance and atonality and, in some sections, the scoring is very lean and perhaps even a little astringent. But there is also a considerable leaven of typical Bartok folk melodies and a lyric quality that is quite lovely. In the allegro sections we have the rhythmic propulsion that makes Bartok's music so exciting.

Soundwise, this is simply gorgeous. Menuhin's instrument is liquid gold, an undistorted sonic splendor. In the strange but felicitous acoustics of Carnegie Hall, the Minneapolis sound is superb. All is pristine, clean of line and transient, the violin/orchestral balance is nigh perfect, dynamic and frequency range is impressively wide. Recommended without reservation.

**PROKOFIEV
CINDERELLA (BALLET)**

Royal Philharmonic Orchestra conducted by Robert Irving. Angel 35529. Price \$4.98.

This recording fills a gap in the LP catalogue of Prokofiev repertoire. There was a recording of excerpts from the ballet on Columbia in the early days of LP but it has been deleted from the LP catalogue for some time. This present recording is handsomely mounted. Irving is an old ballet hand and he affords the work the kind of light-handed, strongly contrasting performance it needs. The playing he elicits from the Royal Philharmonic is really outstanding, both in solo work and in ensemble. The score is one of Prokofiev's most delightful, full of musical whimsy, racy and impudent, an ebullient and effervescent fantasy.

Hi-fi buffs will enjoy the work for its brilliant scoring, employing much brass and it abounds in percussion of all types. The sound, too, is some of the best we have had from Angel. Good clean string tone, brilliant brass and woodwind, and the percussion is notable for its accuracy and clean sharp impact. With the medium-close-up recording and the spacious acoustics, detail is sufficient to lend snap and sparkle and enhance the excellent over-all feeling of "presence." A delightfully "different" Prokofiev work, that I assure you will offer any music lover a full measure of enjoyment.

**FALLA
NIGHTS IN THE GARDENS OF
SPAIN**

Gonzalo Soriano, pianist.

**RODRIGO
CONCERTO FOR GUITAR AND
ORCHESTRA**

Narciso Yepes, guitarist. National Orchestra of Spain conducted by Ataúlfo Argenta. London LL1738. Price \$3.98.

Manuel de Falla's "Nights in the Gardens of Spain," has always seemed to me one of this composer's most brilliant and evocative works. In it he has truly caught the atmosphere of Spain . . . its color and rhythm, its mystery and passion. Because it is so representative, it requires a pianist sensitive to its values and capable of deep expression. This is the 8th recording of the work and I feel that at last we have a recording which comes close to satisfying all requirements. Soriano is not a "big" name among pianists and, in truth, in matters of technique and

March, 1958

**EASIEST ON YOUR RECORDS
... EASIEST ON YOUR EARS**



\$99.75 net

New 4-speed Thorens TD-124, with 11½ lb. table, has lowest wow, flutter and rumble of any 12" turntable with equal or less inertia

The most advanced turntable design plus precision Swiss craftsmanship make the new Thorens TD-124 a turntable that will give you years of rumble-free, wow-free performance.

A year, two years, from now you'll find the TD-124 is giving you the same top quality performance as the day you bought it.

And you'll be getting longer life, lower surface noise, from your records, too. That's because of the easy, fast starts you get with the Thorens Roto-Drive clutch. It lets you set the stylus down gently on a stationary record, and then start the turntable.

Check the TD-124's outstanding features, and you'll see it's small wonder that the new TD-124 is the hottest hi-fi turntable on the market today. At your Thorens hi-fi dealer's now.

B.2

OUTSTANDING FEATURES: Four speeds, each with $\pm 3\%$ speed adjustment. Built-in illuminated strobe disk for all speeds. Built-in level bubble and leveling screws. Precision 4-pole motor, extra-compliant belt-drive and idler system plus exclusive Thorens Roto-Drive principle, provide complete vibration isolation, absolutely constant speed. Provision for easily changing arms without

leaving unsightly permanent marks:—just replace low-cost arm mounting board, available for 12" or 16" arms in various finishes. Easy to mount, the TD-124 requires only 2¼" clearance below mounting board. Furnished with attached line cord, shielded cable and solder plate. 50/60 cycles, 100/250 volt operation. Simple adjustment; no extra parts.



ONE YEAR GUARANTEE. Now all Thorens units are covered by a 1-year guarantee—4 times as long as the usual 90-day electronic equipment guarantees! Ask your hi-fi dealer about this.

THORENS

SWISS MADE PRODUCTS
HI-FI COMPONENTS • LIGHTERS
SPRING-POWERED SHAVERS
MUSIC BOXES
NEW HYDE PARK, NEW YORK



**NEW RECORD CHANGER
ACHIEVES HIGH FIDELITY
TURNTABLE PERFORMANCE
GLASER-STEERS**

GS *Seventy Seven*

**offers fully automatic operation
and added record and stylus protection**

At last, the quality performance of a turntable has been combined with flawless record handling convenience. The result is — the new Glaser-Steers GS Seventy Seven. Wow and flutter are virtually non-existent. Rumble, for all practical purposes, has been eliminated, and automatic features such as the amazing 'SPEEDMINDER' mark the GS-77 as the most advanced record changer of our time.

'SPEEDMINDER' does your thinking — prevents you from using the wrong stylus with your records; selects the correct turntable speed . . . and intermixes and plays 33 and 45 rpm records automatically, without regard to size or sequence.

Another important GS-77 feature is that the turntable pauses during change cycles and doesn't resume motion until next record has come into play position and stylus is in lead-in groove. This eliminates record surface wear caused by grinding action of record dropping on moving disc — a common drawback in other changers.

Other GS-77 features include — CHANGE CYCLE — only 5 seconds — fastest in the field. MOTOR — 4-pole induction; dynamically balanced, hum shielded and shock suspended. ARM — acoustically isolated; has vernier adjustment for stylus pressure, and convenient finger lift for manual play, as well as indicator to facilitate location of stylus on groove; variation in stylus pressure between first and tenth record is less than 1 gram. MUTING SWITCH & R/C NETWORK — maintains silence except when record is being played. IDLER — automatically disengages in 'off' position to prevent flat spots. PRE-WIRED for easy installation, replaces most other changers.

The new GS-77 is absolutely jam-proof. A single knob controls all automatic and manual speed operations.

\$59.50 less cartridge and base
(base illustrated, \$9.60)

See and hear the new GS-77 at your local high fidelity dealer, or write for information.

GLASER-STEERS CORP.
20 Main Street, Belleville 9, N. J.

Please send me complete information on the GS-77.

NAME _____

ADDRESS _____

CITY _____ ZONE _____ STATE _____

RN-3

tone, there are other pianists in other versions of this work who surpass him on that score. But in this recording Soriano has the essential feel of the work, he responds most expressively to its demands. Most of all, there is an authenticity to his phrasing and dynamics missing from the competing editions. Here too we have the superb support of Argentina, whose star grows ever brighter with each new recording. He has the insight and understanding to cope with the rhythmic complexities of the score and the ability to develop and enhance its Spanish flavor.

Soundwise this is at the head of the class. The piano is slightly favored over the orchestra and is a lovely, clean-toned thing with sharp transients, no harshness or ringing evident. The orchestral sound is big with very clean strings, very fluent smooth woodwind, some rich mellow French horn, and all wrapped in a spacious acoustic frame. Wide frequency range and expressive dynamics help in maintaining the illusion of "presence."

The Rodrigo work is quite interesting and unusual . . . you don't hear concertos for guitar and orchestra very often! The work is on the light side, easily digested and quite entertaining.

For those looking for a slightly off-beat recording with both a different instrumental and musical content, this will be refreshing.

**VIVALDI
THE FOUR SEASONS**

I Solisti di Zagreb conducted by Antonio Janigro, Jan Tomasow, solo violinist. Vanguard-Bach Guild BG564. Price \$3.98.

There have been other recordings of this wondrous Vivaldi work and good ones too . . . there comes to mind the excellent I Musici version for *Epic* and the Giulini/*Angel* disc. Good as they are, they are but pale shadows when compared to the scintillant brilliance of this recording. I have been lavish in praise of the Solisti di Zagreb before . . . on this occasion words fail me. This is simply fabulous. This is transcendental playing . . . a group virtuosity that is hard to believe. Their balance, their phrasing, their tight-knit control is a unique experience.

Of course, no small credit should go to the *Vanguard* engineers. The sound is of the type that upon hearing it, you know at once that this is wide-range high-fidelity sound at its best. The strings are smooth as butter, and yet they have a nice sharp incisive bite when the score demands. Couple this with acoustics perfectly balanced for maximum liveness and you have not only the recording of choice, but one of the prize gems of the year.

**POPULAR PIANO MUSIC
OF RAVEL AND DEBUSSY**

Robert Casadesus, pianist. Columbia ML5213. Price \$3.98.

Don't let the title of this scare you away! This is a long way from the tasteless conglomeration the title may imply. Rather, this is a brief compendium of the extraordinary talents of Casadesus, applied to piano works of Debussy and Ravel with which his name has long been associated. I do not mean to stigmatize the word "popular," for although the works recorded herein have certainly been long-time favorites with many people, I feel that the title was ill-chosen and the record might be passed over by the casual observer. The program is neatly balanced . . . Ravel contributing such items as "Pavanne for a Dead Princess," "Fountains," "Habanera," "Ondine," and others . . . and Debussy represented by "The Sunken Cathedral," "Golliwog's Cakewalk," "Reflections in the Water," "Minstrels," and others.

In all of them, Casadesus displays his innate understanding of the music's meaning, his playing is sensitive, expressive yet re-

FOR A **brighter**
TV picture

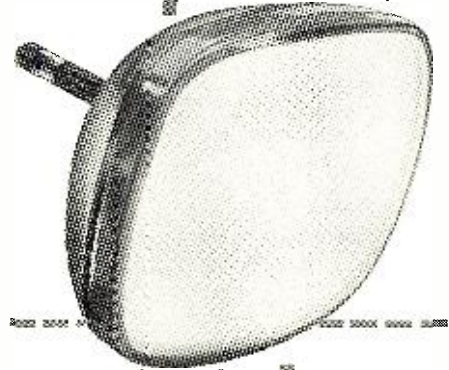

FOR A **brighter**
profit,
picture

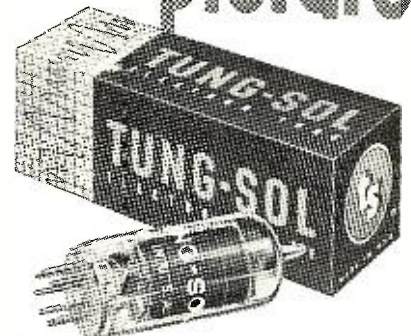

Keep your customers sold on you! Use the exact same tubes leading independent set makers specify. Tell your supplier you'd rather have Tung-Sol Tubes.

Tung-Sol Electric Inc., Newark 4, N. J.

TUNG-SO
MAGIC MIRROR ALUMINIZED
PICTURE TUBES
RECEIVING TUBES

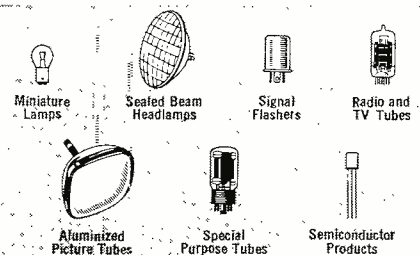

strained. His tone and temperament are ideally suited for the music's dimensions. The sound is pure delight, with a very luminous, almost transparent piano, clean-lined and free from wow or flutter in the slower sustained passages and holds. A delightful record for easy listening and every bit as "hi-fi" as its more spectacular brethren. Surely, on the strength of this recording, Casadesu inherits the mantle from the late, great Gieseking as the greatest living exponent of the piano music of Ravel and Debussy.

TCHAIKOVSKY

MANFRED (SYMPHONIC POEM)
State Symphony of the USSR conducted by Natan Rakhlin. Westminster YXN-18536. Price \$3.98.

This is the third recording on LP of this massive and moody work. Often referred to as Tchaikovsky's "7th symphony," it is surprising that it is so little known, since it has much of the style of writing and orchestral devices that have made this composer's symphonies so popular. Here we have a Russian performance that is heavy on the drama and a little ponderous at times, but is probably closer to the spirit of the work than any of the existing versions.

Soundwise, this is once again that which is becoming less and less a rarity . . . a good Russian tape. This is generally clean with excellent string tone, good bright brass, sharp weighty percussion. This is not as fine-grained a sound as the *Angel* recording, but it is quite acceptable and with the fine performance adds up to a good buy.

BEETHOVEN

SEPTET IN E FLAT (OP. 20)
Chamber Music Ensemble of the Berlin Philharmonic Orchestra. Decca DL9934. Price \$3.98.

Before you lovers of the massive symphonies quickly pass this over, try just a little listen to this recording. I think you will be pleasantly surprised to find that given a master like Beethoven, a work of this nature can make some very impressive sounds. The work is one of Beethoven's most ingratiating and few who call themselves music lovers can deny its blandishments. This has beauty of form, is melodious, has plenty of spark and drive. The instrumentalists are obviously top-notch men, as the playing here is nothing but exemplary. The sound is splendid, just the sort of thing that *Deutsche Grammophon* has long been famous for . . . the lovely over-all blend of good individual instrumental detail coupled with an acoustic perspective that enhances "liveness" and smooths out sonic contours. Of its type, a superb recording.

BEETHOVEN

FIVE CONCERTOS
Artur Schnabel, pianist, with Symphony of the Air conducted by Josef Krips. Victor LM6702. Price \$24.90. Five discs.

A monumental undertaking this recording and for the most part quite successful. Needless to say this album could take pages to review if one were to evaluate each concerto *versus* all the existing versions. I think a rather less ponderous idea is to take the concertos as a whole with the over-all impression afforded by the interpretations of one artist. On that basis, this effort of Rubenstein must be adjudged as the best to date. Performance-wise he is variable and is happier with the 4th and 5th concertos than with the first three. To all of them he brings the weight of his forceful personality, that almost brash assurance bolstered by his tremendous technique and characterized by his unflinching drive and spirit. His conception is fuller,

March, 1958

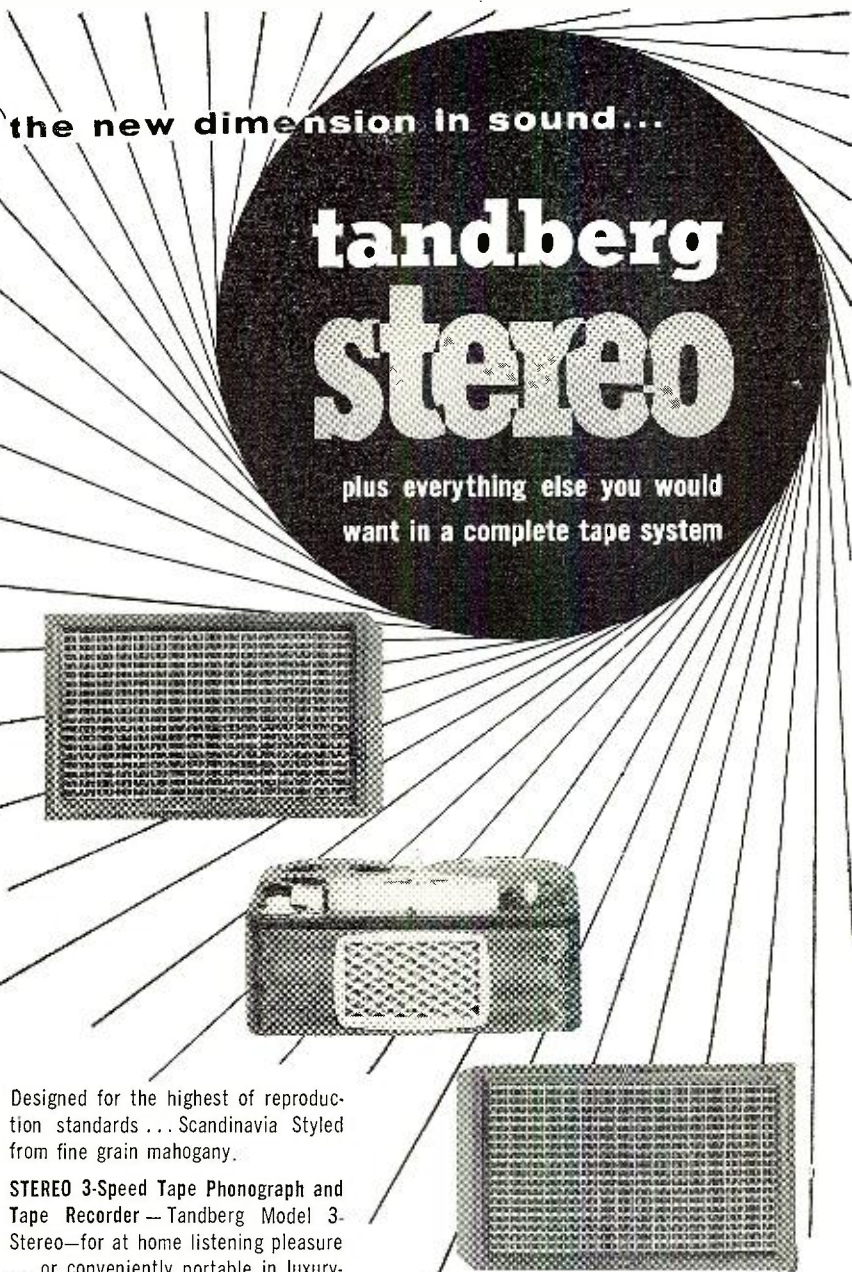

Designed for the highest of reproduction standards . . . Scandinavia Styled from fine grain mahogany.

STEREO 3-Speed Tape Phonograph and Tape Recorder—Tandberg Model 3-Stereo—for at home listening pleasure . . . or conveniently portable in luxury-styled luggage type carrying case for traveling enjoyment.

For the finest in sound reproduction, two extremely well-balanced power playback amplifiers are built-in with such efficiency of design that the distortion of each amplifier is under 1%. A specially manufactured in-line stereo head, unique in design and construction, provides a clarity of reproduction and a range of response heretofore unattainable.

The model 3-Stereo weighs 27 pounds, and is priced at **\$369.50**. Complete with microphone and carrying case.

Hear and See the Tandberg Stereo-Trio or write for full information to:

stereo-trio
a complete home music system—perfectly matched

The Tandberg stereo-trio including model 3-Stereo recorder/reproducer and two perfectly matched 266 speaker systems furniture styled by Scandinavian craftsman in the same fine grain mahogany as the model 3-Stereo cabinet. Comparable to the finest — at almost half the price. **\$469.95.**

3-Speed Versatility — Records half track . . . plays back half-track, full track and stereophonic tapes. Frequency response at 7 1/2 i.p.s. is within ±2 DB from 30 to 17,000 cycles (± DB from 50 to 10,000 cycles).



10 E. 52nd St.
 New York 22, N. Y.

AC-DC PROBE

2 METERS IN PROBE

1 meter measures Voltage 55, 110, 220, 440. Second meter indicates whether AC or DC, and if DC, polarity is at tip of probe.

PRICE.....\$5.50 ea.

REDMOND BLOWER

110V. 60 cyc. .3 Amp. 1600 Rpm. 3 3/4" Blower wheel—Outlet 2" Diameter. Suitable for cooling Transm. tubes, etc. \$7.95 ea. 2 for \$15.00

PLATE TRANSFORMER

Primary 110 V. 60 cy. 1 1/2 KW. Secondary 2350-0-2350 V. AC @ 680 mls full wave by using two transformers. Each—Size: 7"x7"x7". Weight 40 lbs. each with Porcelain Insulator. 2 for..... \$24.95
1 of above 2350 V. AC @ 340 MA 1/2 wvds. Each.....\$14.95

Plate Transformers

Primary 110V. 60 cy. Secondary 1450-0-1450 @ 500 Ma. \$14.95

FILAMENT TRANSFORMER

Primary 110 volt 60 cycle. Secondary 2 1/2 V. 10 amps 10,000 V. Insulation. Suitable for pair of 866 tubes. \$3.95

OIL CONDENSER SPECIALS BRAND NEW

2 MFD 600 VDC .50	2 MFD 2000 VDC 1.50
4 MFD 600 VDC .75	4 MFD 2000 VDC 3.50
6 MFD 600 VDC .85	6 MFD 2000 VDC 4.95
8 MFD 600 VDC .95	2 MFD 2500 VDC 2.50
10 MFD 600 VDC 1.10	4 MFD 2500 VDC 4.95
12 MFD 600 VDC 1.50	1 MFD 3000 VDC 1.85
1 MFD 1000 VDC .60	1 MFD 7500 VDC 6.95
2 MFD 1000 VDC .85	5 MFD 7500 VDC 2.95
4 MFD 1000 VDC 1.35	2 MFD 10,000 VDC 10.00
8 MFD 1000 VDC 1.95	VDC 39.95
10 MFD 1000 VDC 2.95	1 MFD 15,000 VDC 34.50
1 MFD 1200 VDC .45	1 MFD 25,000 VDC 69.50
1 MFD 1500 VDC .75	10 MFD 300 AC. 1.95
2 MFD 1500 VDC 1.10	8 MFD .680 AC. 2.35
8 MFD 1500 VDC 2.95	16 MFD 660 AC. 2.95
10 MFD 1500 VDC 3.50	
24 MFD 1500 VDC 6.95	
1 MFD 2000 VDC .85	

CHOKES—FULLY CASED

10 HENRY 80 Mil (unshielded) 90c
6 HENRY 150 Mil \$1.90
8 HENRY @ 200 Ma 1.95
10 HENRY @ 315 Ma 3.50
3 HENRY @ 630 Ma 5.95
8 HENRY 500 Mil 5.95
20 HENRY 500 Mil 9.95

SIGMA 5F RELAY

16,000 ohm in dual 8,000 ohm coils. (Can be paralleled) SPDT adjustable silver contacts. Adjustable armature tension. Operates at 500 microamperes or less. Ultimate in a sensitive relay. Ideal for precision control work \$3.95
Write for quantity prices.

RELAYS

Sealed Claire SPST. Norm. closed 3000 ohm coil 4 ma.	95c
Claire Telephone Type 11,300 ohm coil DPDT cont. 10 amp 125V. Sens. 4M.A.	\$3.95
Hermetically Sealed Relay Coil 110V AC 60 cy SPDT Contacts 5 Amps.	\$1.85
12 Volt DPDT DC Relay Each	\$1.35
Cramer Time Delay Relay, 220V 60 cy. 45 sec. adj. 2 pole DT ea.	\$6.95
G.E. Plug in Relay 5 prong 2000 ohm coil 4 mil. SPDT (Sigma 4F) ea.	\$2.50
G.E. Plug in Relay 5 prong 10,000 ohm coil 1 mil. SPDT ea.	\$2.50
Advance Relay 12V. DC DPST Each	\$1.25
Telephone type relay 12 V. DC @ 10 ma. triple pole single throw. Normally open.	\$1.25
Dynamotor Starting Relay, 12VDC 20 amp contacts ea.	\$1.50
G.E. Relay control, contains 8000 ohm relay, sensitivity 2 mls. 10 for \$9.25. ea.	\$1.10

PANEL METERS

G.E. WESTINGHOUSE. W.E. SIMPSON, etc.	
2" METERS	
0-50 Micro DC 5.95	0-5 Mil DC 3.95
0-25 Ma DC 2.95	0-50 Mil DC 3.95
0-200 Ma DC 2.95	0-25 Amp DC 3.95
0-300 Mil DC 2.95	50-0-50 Amp DC 4.50
0-500 Mil DC 2.95	0-500 Volts DC 4.50
1-0-1 Amps DC 2.95	0-1 KV DC 5.00
0-5 Amps DC 2.95	0-1.5 KV DC 5.50
0-25 Amps DC 2.95	0-7.5 V. AC 3.95
18-36 Volts DC 1.99	0-30 Amps RF with Ext. Thermocouple 12.95
0-50 Volts DC 2.95	
0-150 V. AC 3.49	
0-4 Amps RF 2.95	
3" METERS	
20-0-20 Micro 8.95	Running Time Meter 0-9,999.9 hrs. (Sc. 0-100) 6.95
0-50 Micro (Scale 0-100) 6.95	110 V 60 cy (removed from equip.) 9.95
0-100 Micro (Scale 0-3) 5.95	

MISCELLANEOUS SPECIALS

N.E. 51 NEON LAMPS, Box of 10. ea. \$1.00
Write for quantity prices
50 ohm 6 watt ea. 35c
HEINEMANN CIRCUIT BREAKER
AM12MT 110V. 60 cy 20 Amps ea. \$1.10

All merchandise sold on a 10 day money back guarantee basis

Min. Order \$3.00—25% with Order—F.O.B. New York

PEAK

ELECTRONICS COMPANY

66 W. Broadway, New York 7, N. Y., WO-2-5439

richer, and more "romantic" if one can use that term, than Kempff's complete edition on Decca, but does not quite have the depth nor understanding nor grandeur of conception that was peculiarly Schnabel's in his exposition of the five concertos.

Soundwise, this is generally good clean recording with, at times, the piano miked too distant for effectively sharp detail. However, the piano itself is never guilty of ringing, transients are clean, wow and flutter nowhere apparent. Krips, in general, furnishes a sympathetic accompaniment, although some of his tempi are questionable. The orchestral sound is scaled to be big if at times a little formless. Acoustics are a mite overly spacious, which also accounts for some loss of detail. Of course, in comparison to the other two complete editions, this sound is infinitely better . . . and in comparison with many individual Beethoven concerto recordings is equal to many and better than most.

GLIERE

SYMPHONY #3 (ILYA MOURO-METZ)

Houston Symphony Orchestra conducted by Leopold Stokowski. Capitol P8402. Price \$3.98.

This recording of Glier's long, but interesting, symphony based on prehistoric Russian folktales, is notable in several respects. It gives us the first opportunity to hear what Leopold Stokowski has accomplished with the Houston Symphony and it is the Maestro's first modern recording of this work with which he has always been closely identified. As a performance, there is no question of its

definiteness. Stokowski himself, helped Glier edit the original score into practicable concert length. The Maestro knows its every twist and turn, all its subtleties and nuances, the compass of dynamic expression. All his years of knowledge and experience with this score are effectively realized in this recording. As to the orchestral playing, this was quite a revelation. No, the Houston orchestra is not on the same plane with the Boston or Philadelphia outfits, but the playing as a whole was excellent.

I have heard the Houston Symphony in person on a number of occasions previous to the Maestro's engagement as permanent conductor. While a reasonably proficient group, the improvement noted in this recording is nothing short of astonishing and serves to highlight Stokowski's teaching ability.

In the matter of sound there is some spectacular material here. The work abounds in sections where full and elaborate use of brass and percussion make an almighty sound. Dr. Stokowski has explored the extremes of dynamics on this recording and I think it safe to say that no other Capitol recording has ever displayed such crashing fortissimos. However, I must again call attention to some of the odd balances favored by the Capitol engineers. The sound is still heavily weighted towards the top and middle at the expense of the bass. But, at least this time, the balance can be restored by judicious use of the bass tone control, something almost impossible with the earlier Capitol/Stokowski recordings. All things considered, despite its shortcomings, it is the recording of choice among the existing versions. —30—

TELEPHONE PICKUP AMPLIFIER KIT

LAFAYETTE RADIO is now marketing a 4-transistor, speaker-operated telephone pickup amplifier in kit form.

Telephone conversations are picked up inductively by means of the coil, amplified, and fed through a 3.2 ohm PM speaker which is housed in a sloping panel metal case.

The circuit features transformer coupling and class B push-pull output. As can be noted from the schematic below, the circuit requires few parts and is free from gimmicks. Argonne transistor transformers are used. The circuit is powered by a single 9-volt battery which fits into a special holder on the rear of the chassis, as can be seen from the photograph.

The pickup coil, which slips under the telephone instrument, is supplied assembled while the construction of the device itself is left to the buyer. Complete instructions accompany the kit.

Construction of the unit is quite simple and should pose no problems. —30—

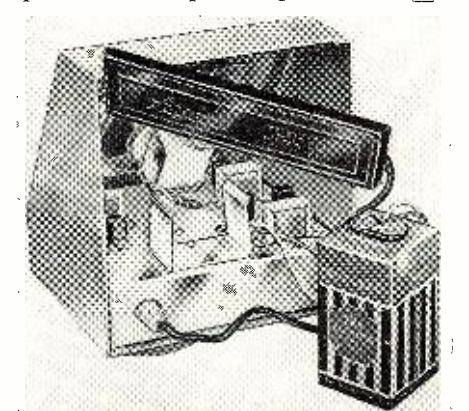

Over-all view of telephone pickup unit.

Complete schematic of pickup. Four inexpensive transistors are used in circuit.

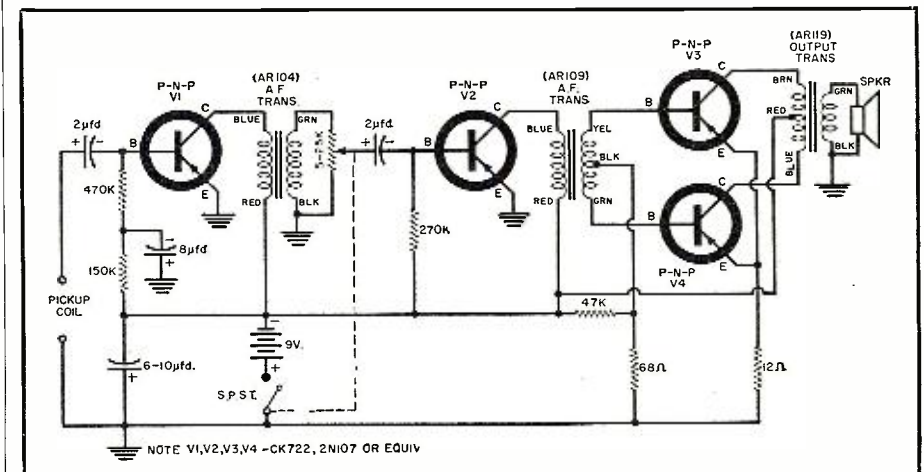

NOTE V1,V2,V3,V4 -CK722, 2N107 OR EQUIV

Use Delco Radio Service Parts!

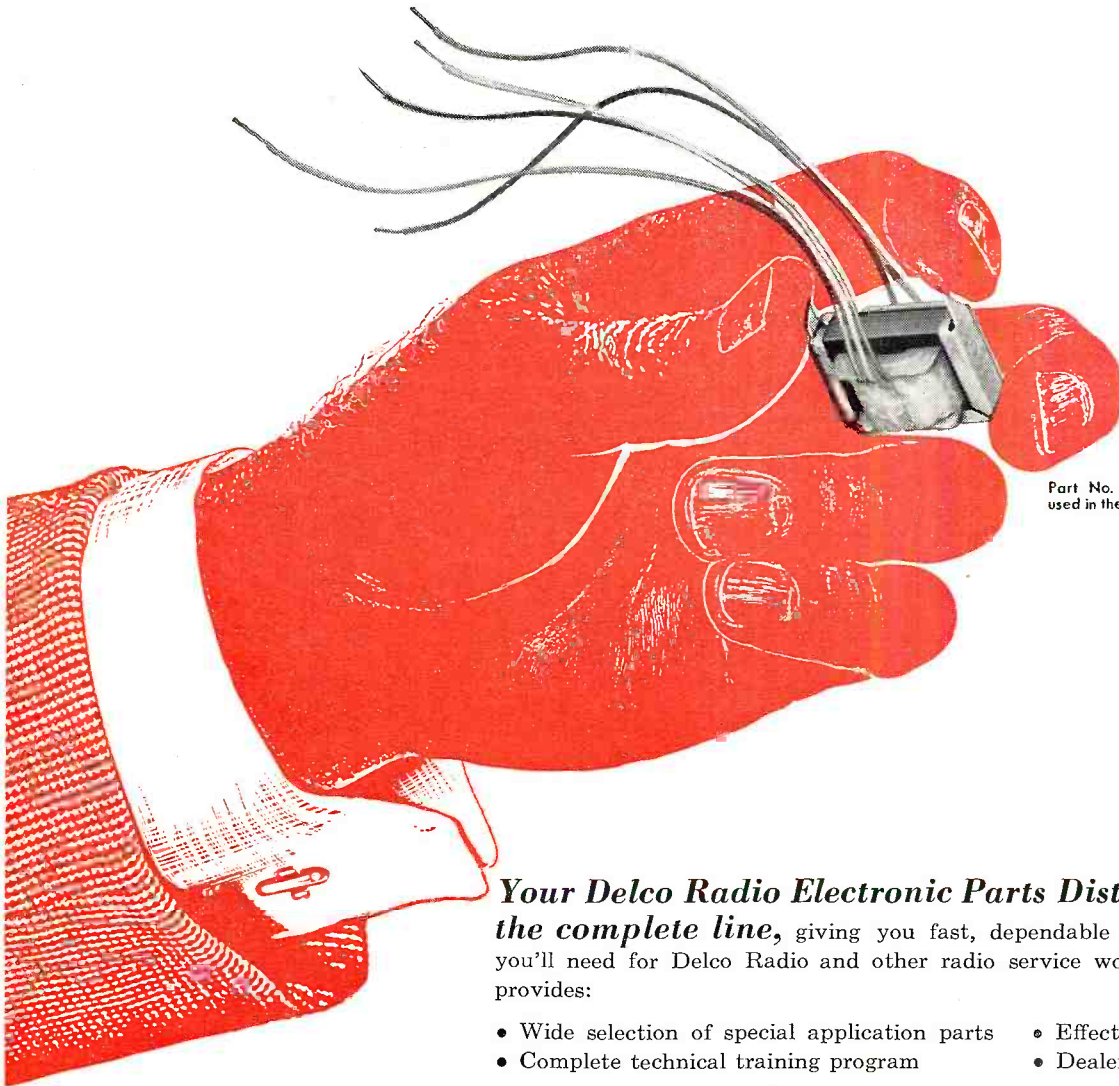

Part No. 7270804—output transformer used in the new Delco Portable Car Radio.

Your Delco Radio Electronic Parts Distributor carries the complete line, giving you fast, dependable service on the items you'll need for Delco Radio and other radio service work. Delco Radio also provides:

- Wide selection of special application parts
- Complete technical training program
- Effective warranty program
- Dealer identification signs

Get the facts today on this truly profitable dealer setup, and grow with General Motors!

Available everywhere through Electronic Distributors associated with ...



DELCO RADIO

DIVISION OF GENERAL MOTORS, KOKOMO, INDIANA

<p>SPEAKERS</p>	<p>TUNER PARTS</p>	<p>TUBES</p>	<p>IRON CORES</p>
<p>TRANSISTORS</p>	<p>COILS</p>	<p>RESISTORS</p>	<p>CAPACITORS</p>
	<p>VIBRATORS</p>	<p>CONTROLS</p>	

**2 YEARS
OF STUDY
can give you these
ADVANTAGES**

- Associate in Applied Science degree
- Preparation for a career as an engineering technician in

**ELECTRONICS
ELECTRICAL POWER
METALLURGY
COMPUTERS
AIR CONDITIONING**

- or you can continue without loss of credit to a 4-year Bachelor of Science degree in Mechanical or Electrical Engineering

at **MSOE**
in Milwaukee

**THE
ENGINEERING
TECHNICIAN**

FREE
folder answers your questions about the Engineering Technician, who he is, what he does, and how to become one.

SEND TODAY

**MILWAUKEE
SCHOOL OF ENGINEERING**

1025 N. Milwaukee St., Dept. RT-358
Milwaukee, Wisconsin

Please send free folder

- "The Engineering Technician;"
- Booklet "Your Career in Engineering." (please print)

I'm interested in.....
(name of course)

Name.....Age.....

Address.....

City.....Zone.....State.....

Eligible for vets. educational benefits
 yes no.

Discharge date.....

MS-94

The "Control Master"

(Continued from page 49)

next soldered inside the cabinet, near the rear, for mounting the crystal socket board.

A coat of enamel or other finish to match the transmitter may be desired. The pictured unit was given a coat of gray *General Cement* wrinkle varnish. With the finish dry, mount the rotary switch.

The crystal socket board was salvaged from a BC-604 transmitter and cut to fit the cabinet. If this item is not handy, eleven separate sockets may be mounted on a similar board.

Wiring is made easier by partially wiring the crystal board before assembly. Start the wiring, connecting one side of all sockets together, using a single length of bare wire. This becomes the common, grounded side of the crystals and the v.f.o. input socket. Next, attach a piece of wire to each remaining socket terminal, long enough to reach the switch terminals. Mount the socket board, using sheet-metal screws. Complete the wiring, connecting each wire to the switch terminals, making connections as short as possible. Connections should be made so that, viewing the crystals from the rear, there is a logical, top-to-bottom and left-to-right order of frequencies.

The dial assembly is a simple "sandwich" of four discs, each 3 1/8" in diameter, and clamped together with a 1/4" collar from a discarded volume control. The "finger hole" disc of 1/8" aluminum sheet, contains twelve equally spaced, 1/2" holes. Ten are for crystals, one for v.f.o., and one for the "off" position. The dial markings are typewritten on the white paper disc and protected with a transparent plastic disc. Incidentally, the "VFO" marking is covered with a small square of red Cellophane as a cautionary measure.

The dial clamping collar is positioned on the switch shaft next and a small hole drilled through both the collar shoulder and the shaft. A pin through this hole secures the collar solidly to the shaft. Now the dial may be stacked on the collar and clamped firmly with the original volume control nut. The ornamental center cap was taken from a surplus telephone, as was the finger

stop. Two small bolts fasten the stop to the cabinet panel.

The four rubber feet may now be added. These provide stability during dialing and protect furniture surfaces.

The output leads should be no longer than necessary for convenient operation, their length being limited chiefly by their mutual capacity and the activity of the crystals. A single, two-wire cable is *not* recommended. The output plug, *Lafayette Radio* number TS-102, is attached to one lead and a *Mueller* 30 clip to the ground lead. Since only one pin of the output plug is active, the plug may be marked so that the "hot" crystal plate always connects to the oscillator grid circuit.

Adjustment

The dial action may be too stiff for comfortable dialing. This is easily corrected by discarding *one* of the steel balls from the switch detent or otherwise reducing the detent tension until a gentle, but positive, operation results.

If the dial holes do not properly align with the finger-stop after dialing, proceed as follows: Loosen the center dial clamping nut, rotate the top disc and the paper disc, until the finger just comes to rest as the selected contact closes. Tighten the dial to retain this alignment.

Operation

Load the "Control Master" with crystals of good activity, arranged to correspond with the dial markings. Clip one lead to the transmitter chassis, plug the other lead into the transmitter crystal socket, and you are ready to operate.

Some eyebrows may be hoisted, at the relatively long crystal leads. However, during tests, satisfactory operation has resulted with leads up to six feet long! Also, several different crystal oscillator circuits were tested with equally good results.

When ten crystals whose frequencies are close together are used, eliminating any transmitter re-tuning, real "push-button" convenience is enjoyed. Ideal for "net" operation, v.f.o. calibration may be checked against a crystal frequency with a flick of the finger. In addition, this little gem "files" those loose crystals out of sight, yet they are always instantly available for the dialing!

-30-

The sandwich construction of the dial is illustrated in this photograph.

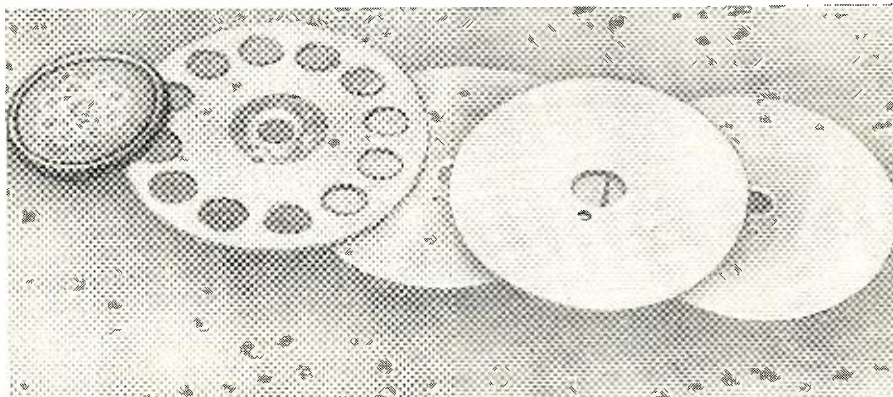

Build the Best— build ALLIED knight®-kits



the finest electronic equipment in money-saving kit form

LOWEST COST

ALLIED'S giant buying power passes biggest savings on to you—you do the easy assembly and your finished instrument equals the performance and appearance of equipment selling for several times the low KNIGHT-KIT cost. Your savings are BIG.

EASIEST TO BUILD

KNIGHT-KIT "Step-and-Check" instruction manuals with wall-sized picture diagrams are marvels of clarity—it's like having a good instructor at your side. No experience required—you can easily build any KNIGHT-KIT and get professional results.

LATEST DESIGN

Each ALLIED KNIGHT-KIT incorporates the very latest circuitry for top-quality performance. Tried and proved professional design and the use of premium quality parts throughout help insure your building success to bring you quality results.

COMPLETE KIT SELECTION:

- HI-FI
- HOBBY
- INSTRUMENT
- AMATEUR



MONEYBACK GUARANTEE. When properly assembled, KNIGHT-KITS fully meet published specifications or we refund your money in full.

EASY TERMS. If your KNIGHT-KIT order comes to \$45.00 or more, you can make your purchase on our attractive Easy Payment Plan.

High Fidelity Everyone Can Afford

- World's Finest Hi-Fi Kits
- Custom-Styled
- Easiest to Build Hi-Fi
- Money-Saving

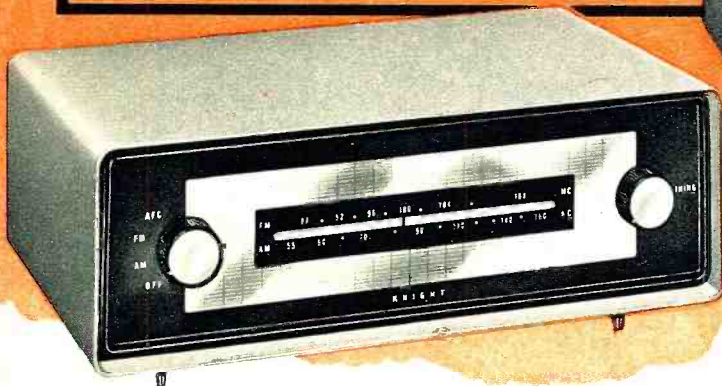

knight-kit High Fidelity FM-AM Tuner Kit

Model Y-787

\$49.95

Only \$4.99 down

- Latest Time-Saving Printed Circuit Design
- Flywheel Tuning
- Automatic Frequency Control
- 2.5 μ v FM Sensitivity
- True High Fidelity Response
- Beautiful Custom-Styled "Space Saver" Case

The best-looking, best-performing FM-AM tuner kit your money can buy! Carefully designed for quick, easy construction—a tuner you'll enjoy assembling and be proud to own, both for its amazing musical performance and outstanding beauty. Covers the full AM broadcast band and 88 to 108 mc FM. On FM, sensitivity is a remarkable 2.5 microvolts for 20 db of quieting; hum and noise, -60 db; IF bandwidth, 200 kc at 50% down on curve; response, \pm 0.5 db, 20-20,000 cps. On AM, sensitivity is 3 microvolts for 10 db signal-to-noise ratio; IF bandwidth, 8 kc at 50% down on curve; response, 20-8000 cps. Outstanding features include: Inertia Flywheel Tuning for effortless, accurate tuning; Automatic Frequency Control (plus AFC disabling) to "lock-in" FM stations; printed circuit board (with most of the kit wiring already done for you) assures time-saving, error-free assembly; pre-aligned RF and IF coils; tuned RF stage on FM; drift-compensated oscillator; neon glow tuning pointer; cathode follower output; two output jacks—one for recorder, one for amplifier; rotatable built-in ferrite antenna for AM. Includes beautiful French-gray case with chrome-finished tapered feet, 4 x 13 x 8". Ideal for use with 18, 20 or 30 watt KNIGHT-KIT amplifiers. Ready for easy assembly. Shpg. wt., 12 lbs.

Model Y-787. FM-AM Tuner Kit. Net only.....\$49.95



knight-kit 18-Watt Complete Hi-Fi Amplifier Kit

Model Y-786

\$39.95

Only \$3.99 down

- The Last Word in Custom Hi-Fi Styling
- Full 18 Watts with Superb Hi-Fi Specifications
- 8 Inputs for Every Desired Signal Source
- Printed Circuit Switch and Printed Circuit Boards
- Full Equalization for All Record Types

Here is a custom-styled, easy-to-build complete Hi-Fi amplifier at a price that defies comparison. Delivers full 18 watts output with wide-range, flat frequency response for true hi-fi reproduction. Features 8 inputs for every possible signal source, including NARTB equalized tape head input. At full 18 watts output, distortion is only 0.5%; uses new RCA 6973 hi-fi output tubes. Frequency response is \pm 1 db, 20-30,000 cps; tape head and magnetic cartridge sensitivity, 5 microvolts for 18 watts output; hum and noise level better than 60 db below 18 watts. Output taps for 4, 8 or 16 ohm speakers. Controls: Input and Record Equalization; Bass Boost and Attenuate; Treble Boost and Attenuate; Volume. Simplest assembly is made possible through the use of an exclusive printed circuit switch and two printed circuit boards—most of the kit wiring is already done for you. With custom-styled French-gray "space-saver" case on tapered feet finished in chrome, 4 x 13 x 8". Complete with case, tubes, all parts, and step-by-step instructions, for easy, error-free assembly. Shpg. wt., 15 lbs.

Model Y-786. 18-Watt Hi-Fi Amplifier Kit. Net only.....\$39.95

EASY TERMS TO FIT YOUR BUDGET. ALLIED KNIGHT-KITS may be purchased under our Easy Payment Plan. Your order need total only \$45.00 or more—only 10% down, small monthly payments thereafter. No red tape—fast handling assured.

Our 37th Year



© Registered Trade-Mark of Allied Radio Corporation

ORDER FROM ALLIED RADIO 100 N. WESTERN AVE. • CHICAGO 80, ILL.

www.americanradiohistory.com

Now you can have Custom-Styled Hi-Fi in **ALLIED**



knight-kit 30-Watt Complete Hi-Fi Amplifier Kit

Model Y-762

\$76⁹⁵

- Full Equalization, $\pm \frac{1}{2}$ db of Recommended Accuracy
- Printed Circuit Switches • Printed Circuit Boards
- 8 Inputs For Every Possible Signal Source
- Full 30 Watts Output • Custom-Styled Beauty

Only \$7.69 down

Comparable to the best in Hi-Fi—at far less cost! Deluxe features include: Linear-deluxe Williamson-type circuit for flawless response; equalization for all records within $\frac{1}{2}$ db of recommended accuracy; 2 exclusive new printed circuit switches in preamp section (no complex wiring to do); 3 printed circuit boards for time-saving, error-free assembly; separate, continuously variable Level and Loudness controls; use of premium 12AY7 tube for low noise and hum; DC on all filaments of preamp tubes; exclusive A-AB-B speaker selector switch (use speakers of mixed impedances without mismatch). 8 inputs: Tape Head direct; G.E. and Pickering cartridges; Ceramic cartridge; Microphone; Auxiliary; Tape Preamp; Tuner (with separate Level Set control). Power amplifier response, $\pm \frac{1}{2}$ db, 15-100,000 cps at full 30 watt level; distortion—harmonic, 0.55% at 30 watts—IM, 0.74% at 20 watts. Separate Bass and Treble controls; rumble filter switch; variable damping. Output, 8 and 16 ohms. With smart French-gray cabinet, 4 x 15 x 15". Ready for easy, money-saving assembly. Shpg. wt., 32 lbs.

Model Y-762. 30-Watt Hi-Fi Amplifier Kit. Net only **\$76.95**

knight-kit High Fidelity FM Tuner Kit

Model Y-751

\$38⁹⁵

- Authentic High Fidelity FM Response
- Flywheel Tuning • Automatic Frequency Control
- Printed Circuit • Pre-Adjusted Coils and IF's
- 4 Microvolt Sensitivity Guaranteed

Only \$3.89 down

Here is top value in creative engineering, impressive hi-fi performance and distinctive design—a tuner you'll be proud to build and own. Covers the full FM band, 88 to 108 mc. Features Automatic Frequency Control (with disabling feature) to "lock-in" stations and prevent drift; Inertia Flywheel Tuning for velvet-smooth, accurate station selection; pre-adjusted RF coils; pre-aligned IF's; cascode broad-band RF amplifier; drift-compensated oscillator; neon bulb pointer. All critical wiring is already done for you in the form of a printed circuit board—assembly is simple. Sensitivity is 4 microvolts for 20 db of quieting across entire band; output, 2 volts at 1000 microvolts input; IF bandwidth, 200 kc; response, 20-20,000 cps. with only 0.6% distortion. Output jacks for amplifier and tape recorder; cathode follower output. Ideal for use with the KNIGHT-KIT amplifiers, or any amplifier with phono-tuner switch. Features custom-styled case in French-gray, with tapered chrome-finished feet, 4 x 13 x 8". Includes all parts, tubes and step-by-step instructions for easy assembly. Shpg. wt., 12 lbs.

Model Y-751. Hi-Fi FM Tuner Kit. Net only **\$38.95**

knight-kit Deluxe 3-Way Speaker System Kit

Model Y-937

\$89⁵⁰

- Pre-Finished "Quik-Craft" Corner Enclosure
- Klipsch Designed and Licensed
- Famous Knight 12" 3-Way Speaker
- Easy to Assemble—Top Hi-Fi Quality
- Choice of Enclosure Finishes

Only \$8.95 down



3-Way Speaker



Deluxe quality high fidelity speaker system at a money-saving low price. Easy to assemble—all you need is a screwdriver. System includes KNIGHT "Quik-Craft" corner-type folded-horn enclosure kit, and the famous-value KNIGHT 3-Way 12-inch speaker. Just assemble the enclosure—no finishing required—all surfaces are finished in hand-rubbed Korina blonde, mahogany or walnut. The speaker is the new 3-way type: 12" woofer cone for bass (full $1\frac{3}{4}$ pound woofer magnet), conical radiator for mid-frequencies, built-in compression-type tweeter (with wired level control and calibrated dial) for highest frequencies. Unexcelled enclosure efficiency and superb speaker performance combine to cover the whole spectrum of audible sound for true hi-fi response from 35 to 15,000 cps, ± 3 db. Kit includes 12" 3-Way speaker, prefinished enclosure panels, grille cloth, hardware and instructions. Specify Korina blonde, mahogany or walnut when ordering. Shpg. wt., 44 lbs.

Model Y-937. 3-Way Speaker System Kit. Net only **\$89.50**

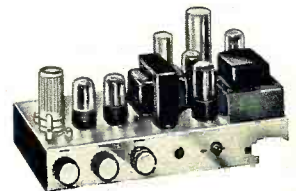

knight-kit 10-Watt Hi-Fi Amplifier Kit

Y-753

\$23⁵⁰

Low-cost, authentic hi-fi amplifier. Response, ± 1 db, 30-20,000 cps. Input for crystal phono or tuner; chrome-plated chassis is punched for preamp kit below, to permit use of magnetic phono. Only 0.5 volt drives amplifier to full output. Separate bass and treble controls. Only 1% harmonic distortion. Matches 8-ohm speaker. 7 x 13 x 6". With all parts, tubes and instructions. Shpg. wt., 13 lbs.

Model Y-753. Net only . . . **\$23.50**
Y-235. Preamp Kit \$ 3.10
Y-757. Metal Cover \$ 3.95

ALLIED RADIO

America's Pioneer in Electronic Kits



So Easy To Build
Anyone can build
KNIGHT-KIT HI-FI.
No experience re-
quired to get top
results!

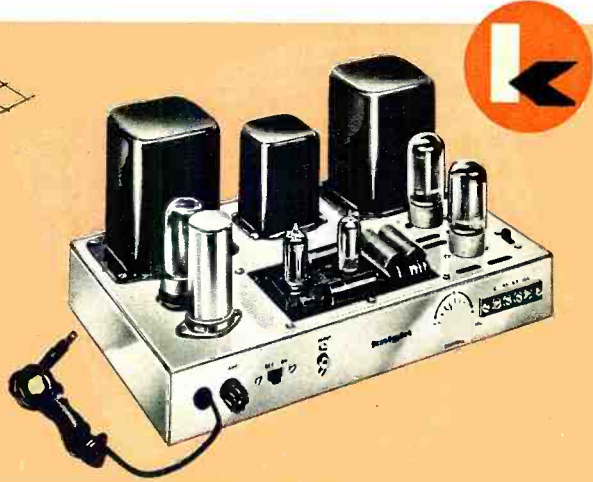

knight-kit High Fidelity Preamp Kit

Model Y-754
\$39.95

- Exclusive Printed Circuit Switches and Boards
- Equalization $\pm \frac{1}{2}$ db of Recommended Accuracy
- 8 Inputs Including Tape Head
- DC on All Tube Filaments
- Self-Powered
- Custom-Styled

Only \$3.99 down

Sensational Hi-Fi design at amazing low cost. Provides precise record equalization guaranteed within $\frac{1}{2}$ db of recommended accuracy!—more accurate than all but the most expensive factory-built preamps. Includes exclusive new KNIGHT-KIT printed circuit switches for easy, error-free assembly; 2 printed circuit boards eliminate all other wiring, except for power supply and control leads—so easy to build. Has built-in power supply; includes premium 12AY7 and ECC82 tubes. Frequency response, ± 0.5 db, 10-50,000 cps. Has 8 inputs: Tape Head; G.E. Phono; Pickering Phono; Ceramic; Microphone; Auxiliary; Tape Preamp; Tuner. Level adjustment for tuner input. Includes separate Bass and Treble controls; separate Level and Loudness controls; Rumble Filter switch; DC on all tube filaments; cathode follower output; 2 extra AC outlets. You get every advanced hi-fi feature in this easy-to-build preamplifier at the lowest possible cost. Includes beautiful custom-styled French-gray case, with tapered chrome-finished legs, 4 x 13 x 8". With all parts, tubes, step-by-step instructions; ready for easy assembly. Shpg. wt., 12½ lbs.

Model Y-754. Hi-Fi Preamp Kit. Net only.....\$39.95

knight-kit 25-Watt Hi-Fi Basic Amplifier Kit

Model Y-755
\$44.50

- Hi-Fi Response, ± 0.5 db, 10 to 120,000 cps
- Only 0.15% Distortion at 30 Watts Output
- Printed Circuit Wiring Board • Chrome-Plated Chassis
- Williamson-Type Circuit with Over 25 Watts Output

Only \$4.45 down

Here's superb Hi-Fi performance at less than half the cost of a comparable commercially-assembled unit. Williamson-type linear-deluxe circuit delivers over 25 watts of virtually undistorted reproduction. Ideal for use with the KNIGHT-KIT preamp at left. Includes printed circuit board for simplified, error-free assembly. Remarkable hi-fi response, ± 0.5 db, 10-120,000 cps at 20 watts. Harmonic distortion, 0.15% at 30 watts; IM, 0.4% at 20 watts. Hum level, 85 db below 25 watts output. Output impedances, 4, 8 and 16 ohms; output tubes, 2-5881. Includes balance control for precise matching of the output tubes; variable damping control for maximum performance with any speaker system—prevents low-frequency distortion from overdamping or underdamping. Very attractive black and chrome styling, 6¼ x 14 x 9". An outstanding engineering achievement in a basic hi-fi amplifier, delivering performance equal to the finest commercially assembled units. Includes all parts and tubes; with step-by-step instructions, ready for easy assembly. Shpg wt., 25 lbs.

Model Y-755. 25-Watt Amplifier Kit. Net only.....\$44.50
Y-759. Metal Cover for above; black finish. 5 lbs. Net.....\$4.25

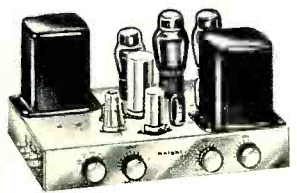

knight-kit 20-Watt Hi-Fi Amplifier Kit

Y-750
\$35.75

True hi-fi for less! Complete with full set of controls and built-in preamplifier. Response, ± 1 db, 20-20,000 cps; distortion 1% at 20 watts. Inputs for magnetic phono, microphone, crystal phono or recorder, and tuner. Compensation positions for 78 and LP records. Separate bass and treble controls. Output impedances, 4, 8, 16 and 500 ohms. Chrome-plated chassis. 7 x 13 x 8¾". Ready for easy assembly. Shpg. wt., 20 lbs.

Model Y-750. Net only...\$35.75
Y-758. Metal Cover.....\$4.15

knight-kit 2-Way Hi-Fi Speaker System Kit

Model Y-789
\$49.95

- Easy to Assemble—Pre-Finished Enclosure
- High Fidelity Response, 45 to 14,000 cps
- 12" Woofer and Horn-Type Tweeter
- A Wonderful Money-Saving Speaker Value

Only \$4.99 down

BIG SAVINGS—assemble your own quality KNIGHT-KIT 2-way speaker system—it's quick and easy! The cabinet is *pre-finished* in full-grained, high luster blonde or mahogany—you just assemble 7 pieces, mount the speaker components and enjoy rich, thrilling hi-fi sound—at incomparably low cost. Special Jensen-engineered baffle features "ducted port" construction to bring out the full beauty of bass notes, perfectly matching the Jensen woofer and compression tweeter; genuine L-pad control is rear-mounted to permit adjustment of tweeter for best tonal balance. Impedance, 16 ohms. The assembled unit delivers a frequency response of 45 to 14,000 cps. Enclosure measures 26 x 19 x 14". Beautifully styled to blend in any room. Kit includes Jensen 12" woofer, Jensen compression-type tweeter, pre-finished wood parts (with grille cloth installed), acoustic material, glue, hardware and step-by-step instructions. Absolutely no furniture finishing required. *Specify blonde or mahogany finish when ordering.* Shpg. wt., 33 lbs.

Model Y-789. 2-Way Speaker System Kit. Net only.....\$49.95



Fascinating

ALLIED **knight-kits**

FOR EXPERIMENTERS AND HOBBYISTS

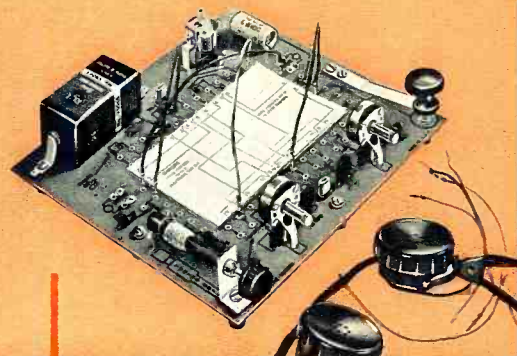
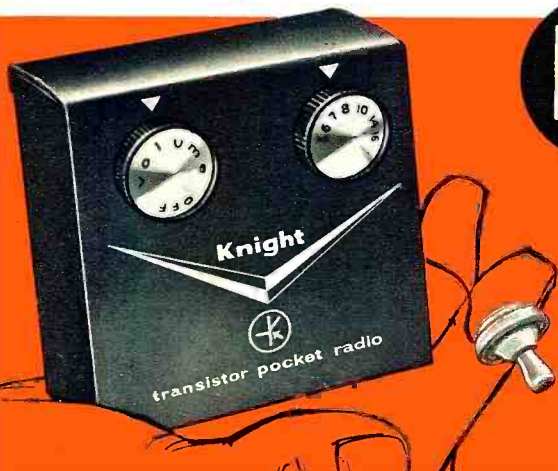

knight-kit 2-Transistor Pocket Radio Receiver Kit

Model Y-262
\$14.65

- Loud, Clear Local Reception
- Newest Printed Circuit Board
- Built-In Loop Antenna
- Complete Kit—Nothing Else To Buy

It's fun to build this pocket-size two-transistor radio—and you'll enjoy its crystal-clear local broadcast-band reception wherever you go! Fits in your pocket, or with its button-down flap, can be worn from your belt. Completely self-contained with built-in ferrite loopstick antenna—no external antenna needed. Extremely efficient reflex type 2-transistor circuit actually does the work of 3 transistors! Printed circuit board reduces building time to about one hour. Has air-dielectric variable capacitor for easy, accurate station tuning. Operates for months and months on long-life alkaline battery supplied. Sensitive miniature earpiece provides crystal-clear tone. Handsome tan carrying case, plastic-impregnated, is styled to resemble leather; only 4x3 $\frac{3}{4}$ x1 $\frac{1}{4}$ ". Kit includes all parts, transistors, earpiece, battery and case. Shpg. wt., 1 $\frac{1}{2}$ lbs.

Model Y-262. Net only **\$14.65**

knight-kit "Trans-Midge" Transistor Receiver Kit

Model Y-767
\$2.45

Tiny, cigarette-pack-size one-transistor radio kit—fascinating to build—so low-priced. This novel miniature receiver will provide endless listening

pleasure the moment assembly is completed. Covers the local AM broadcast band with exceptional sensitivity and selectivity. Special features include: Efficient, slug-tuned coil for excellent station separation; external knob for easy station tuning; low-drain transistor operating for months from single penlight cell supplied; hinged-back, red plastic case. Kit includes all parts, transistor, battery, compact case and easy-to-follow instructions for quick assembly. (External antenna and headphones required.) Shpg. wt., 8 oz.

Model Y-767. Net only **\$2.45**
J-149. 4000 Ohm Headphones. 1 lb. **\$2.15**
C-100. Antenna Kit. 1 $\frac{1}{2}$ lbs. **\$1.03**

knight-kit 10-Circuit Transistor Lab Kit

Model Y-299
\$15.75

Sensational experimenters' transistor kit—an electronic marvel! Perfect for experimenter, student or hobbyist.

Assemble basic parts once, then complete project after project (10 in all), by simply plugging leads into proper jacks on printed circuit board—no wiring changes needed. You learn how transistors operate by "plugging in" to make any one of the following circuits; AM radio for strong headphone reception; 2-stage audio amplifier; wireless broadcaster; code practice oscillator; electronic timer; electronic switch; electronic flasher; photoelectric relay; voice-operated relay; capacity-operated relay. Includes all parts, 2 transistors, battery, headphones, circuit leads, relay, photocell, special guide cards for each project, explanation of each circuit. 3 lbs.

Model Y-299. Net only **\$15.75**

knight-kit 5-Transistor Superhet Personal Portable Radio Kit

Model Y-766
\$29.95

- Styled to Equal the Finest
- Push-Pull Audio Drives 3 $\frac{1}{2}$ " Speaker
- Printed Circuit for Easy Building
- 200 Hour Battery Playing Life

Beautiful, easy-to-build transistorized personal portable with every ultra-modern design feature: 5 Texas Instrument Co. transistors; latest printed circuit chassis for easy, error-free assembly; bigger-than-average 3 $\frac{1}{2}$ " speaker; class B push-pull audio output; built-in high-gain ferrite loopstick antenna; plus phone jack output for private listening. Provides sensitive reception of the AM broadcast band with exceptional tone quality. Ultra-smart high-impact ivory plastic case has handsome gold trim with ebony accents; includes pull-out handle; only 7 $\frac{1}{2}$ x3 $\frac{3}{8}$ x1 $\frac{1}{4}$ ". With all parts, transistors, 9 volt transistor radio battery, carrying case and instructions anyone can easily follow. Shpg. wt., 2 lbs.

Model Y-766. Net only **\$29.95**

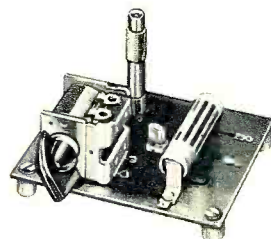

1-Transistor Radio Kit

\$3.95

Offers excellent AM local broadcast headphone reception. Printed circuit board for easy assembly. Operates from single penlight cell for months. Complete with all parts, transistor and penlight cell. (Antenna and headphones required.) Shpg. wt., 1 lb.

Model Y-765. Net only **\$3.95**

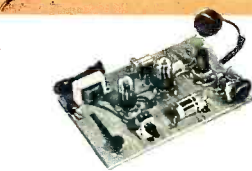

"10-In-One" Electronic Lab Kit

\$12.65

Famous experimenters' kit. Builds any of 10 fascinating projects, including broadcast receiver, wireless phono oscillator, code practice oscillator, signal tracer, relays, etc. Shpg. wt., 5 lbs.

Model Y-265. Net only **\$12.65**



"6-In-One" Electronic Lab Kit

\$8.45

A favorite with beginners. After basic wiring is completed, you make circuit changes without soldering. Builds any of six favorite projects, including radio, wireless broadcaster, etc. Shpg. wt., 3 lbs.

Model Y-770. Net only **\$8.45**



Crystal Set Hobby Kit

\$2.15

Entertaining, educational. Delivers clear headphone reception of local broadcast stations. With all parts, ready for easy assembly. (Antenna and headphones required.) Shpg. wt., 1 lb.

Model Y-261. Net only **\$2.15**



Wireless Broadcaster Kit

\$9.50

Play music or make announcements through your radio set—no connection to set required! Loads of fun—easy to build. Works up to 50 feet from set. Shpg. wt., 3 lbs.

Model Y-705. Net only **\$9.50**

ORDER FROM **ALLIED RADIO** 100 N. WESTERN AVE. • CHICAGO 80, ILL.



Interruption of light beam triggers relay, which in turn sounds chime or bell, turns on lights, etc.



knight-kit Photoelectric Relay Kit

Model Y-702 Advanced-design, ultra-sensitive photoelectric relay—build it yourself and save! Dozens of uses: for automatic control of lights, door announcer, burglar alarm, counting devices, etc. Provides dependable operation up to 250 feet with white light, up to 125 feet with "unseen" light (red filter) from Light Source Kit listed below. Selectable operation, with "trip" for burglar alarm to provide continuous ringing of alarm; and "auto" if relay is to operate each time beam is broken (for chimes, counting devices, turning on lights at darkness). Has SPST relay operated from thyatron; 6.3 v. terminals provide power for accessories. For 105-120 v. 50-60 cy. AC use. 6 lbs.

Model Y-702. Relay Kit. Net only. **\$13.50**
Model Y-703. Light Source Kit. With bulb and red filter. Shpg. wt., 3½ lbs. Net. **\$6.75**



knight-kit "Ocean Hopper" All-Wave Radio Kit

Model Y-740 This top-performing regenerative receiver puts a world of listening pleasure at your finger-tips. Tuning range (using coils listed below) is virtually world-wide; covers 155 kc to 35 mc. including every type of radio transmission: AM broadcast, marine, aircraft, distress channels, direction-finding, Amateur, frequency standard, foreign broadcast, and police. With hand-spread tuning. For use with headphones or 3-4 ohm PM speaker. Kit is supplied with standard broadcast band coil and all tubes and parts. (Less extra coils, headphones, speaker and cabinet.) Shpg. wt., 5 lbs.

Model Y-740. Net only. **\$11.95**
Y-746. Cabinet for above. 1½ lbs. Net **\$2.90**
 Extra coils available: Long Wave Coil (155-470 kc), Net 79c. Short Wave (1.65—4.1 mc; 2.9—7.3 mc; 7—17.5 mc and 15.5—35 mc), Each 65c.



knight-kit "Space-Spanner" Bandswitching World-Wide Radio Kit

Model Y-243 • Broadcast or Short Wave Reception
 • Sensitive Regenerative Circuit
 • Convenient Bandspread Tuning
 • Built-in Loudspeaker

Imagine the thrill of hearing overseas broadcasts on a precision receiver you've built yourself—and then, at the flip of a switch, being able to tune to your favorite local broadcast station! Bandswitch selects exciting short wave, including foreign broadcasts, amateur calls, aircraft, police and marine radio on the 6.5 to 17 mc range, as well as standard 540-1700 kc broadcasts. Features highly sensitive regenerative circuit. Includes built-in 4" PM speaker and beam-power tube for strong volume and clear tone. Headphone connectors are available for private listening; switch cuts out speaker. Controls: Bandspread, Main Tuning, Antenna Trimmer, Bandswitch, Regeneration, Volume. 7x10x6". Easy to build from step-by-step instruction manual. For 110-120 v., 50-60 cy. AC or DC. (Less cabinet.) Shpg. wt., 5 lbs.

Model Y-243. Net only. **\$15.95**
Y-247. Cabinet for above. Shpg. wt. 2 lbs. Net. **\$2.90**



"Ranger II" Superhet Receiver Kit

\$17.25 Popular Broadcast band receiver built and enjoyed by thousands. Features built-in antenna, automatic volume control, ball-bearing tuning condenser, PM dynamic speaker. Handsome plastic cabinet. Easy to assemble. AC or DC operation. Shpg. wt., 8 lbs.

Model Y-735. Net only. **\$17.25**

knight-kit 2-Way Intercom System Kit

Model Y-295 • Low Cost—Easy to Assemble
 • High Gain—Clear Tone
\$14.75 • Handsome Metal Cabinets
 • Includes 50-Foot Cable

Easy to build at lowest cost—ideal for home, office, shop or school. Consists of Master unit and Remote unit. Remote unit may be left "open" for answering calls from a distance, for "baby sitting", etc. Remote also may be set for "private" operation—cannot be "listened-in" on, but it can be called and can originate calls. Master unit includes high-gain 2-stage amplifier, combination volume control and on-off switch, plus pilot light. Each unit has 4" PM dynamic speaker. System responds to even a whisper. Handsome Antique white cabinets, each 4¾x6½x4¾". With all parts, tubes and 50-ft. cable (up to 200-ft. may be added). For 110-120 v., AC or DC. 8 lbs.

Model Y-295. Master and one Remote. Net only. **\$14.75**
Y-296. Extra Remote Station Kit. 3 lbs. **\$3.75**



Phono Amplifier Kit

\$9.45 Build it yourself—and save! Ideal for use in a portable phonograph—just add record player and 3-4 ohm speaker. 1½ watts output. Inverse feedback circuit. Easy to assemble. Shpg. wt., 3 lbs.

Model Y-790. Net only. **\$9.45**



Electronic Photoflash Kit

\$28.50 Ideal for color or black and white photography. 1/700th-of-a-second flash; 50 watt/second output. Synchronizes with any camera with X or O shutter. (Less battery.) Shpg. wt., 4 lbs.

Model Y-244. Net only. **\$28.50**



Code Practice Oscillator Kit

\$3.95 Ideal for beginners learning the code. Transistorized circuit. Operates for months from single penlight cell supplied. Clear, crisp 500 cycle tone. Jacks for headphones; screw terminals for key. 1 lb.

Model Y-239. Net only. **\$3.95**



Phono Oscillator Kit

\$5.85 "Broadcasts" recorded music through any standard radio set up to 50 feet away. No direct connection to set required. Easy to build—fun to use. Shpg. wt., 2 lbs.

Model Y-760. Net only. **\$5.85**



knight-kit Low-Cost Tube Tester Kit

- Model Y-143
\$29.75
- With 16 Filament Voltages
 - 600 Latest Tube Types Listed
 - Easy-to-Read 4½" Meter
 - Tests Series-String TV Tubes

Expertly designed for complete, up-to-date coverage of tube types. Tests *series-string TV tubes*; tests 4, 5, 6 and 7 pin large, regular and miniature types, octals, loctals, 9-pin miniatures and pilot lamps. Tests for open, short, leakage, heater continuity and performance (by amount of cathode emission). Big 4½" square meter has clear "GOOD-?-REPLACE" scale. With line-voltage indicator and line-adjust control. Choice of 16 filament voltages from 0.63 to 117 volts to check virtually all receiving tubes; blank socket for future type tubes. Universal-type selector switches permit selection of any combination of pin connections. Single-unit, pre-assembled 10-lever function switch simplifies and speeds assembly. Up-to-date illuminated roll chart lists over 600 tube types. Counter model case, 5 x 14 x 10". Easy to build. 14 lbs.

- Model Y-143. Net only **\$29.75**
 Y-142. Portable Case model. 15 lbs. Net **\$34.75**
 Y-141. Picture Tube Adapter. 1 lb. Net **\$ 4.25**

knight-kit RF Signal Generator Kit

- Model Y-145
\$19.75
- Build this wide-range, extremely stable RF signal generator—save two-thirds the cost of a comparable wired instrument! Large, semi-circular dial is clearly calibrated; range is covered in 5 separate bands for close accuracy in setting individual frequencies. Ideal for aligning RF and IF stages in radio and TV sets and for troubleshooting audio equipment. Delivers output on fundamentals from 160 kc all the way out to 112 mc; useful harmonics to 224 mc. Has built-in 400-cycle sine-wave audio oscillator for modulating RF; audio is also available externally. Features high-stability Colpitts circuit. Convenient jack for external modulation. Maximum audio output 10 volts; RF output over 0.1 volt on all ranges. Step and continuous-type attenuator controls. Supplied with precision-wound coils that require no adjustment. 7 x 10 x 5". Shpg. wt., 11 lbs.
- Model Y-145. Net only **\$19.75**

knight-kit 1000 Ohms/Volt VOM Kit

- Model Y-128
\$16.95
- Exceptional accuracy and versatility at amazing low cost. Ideal for service shop, lab or Amateur use. Large 4½", 400 microamp meter with separate scales for AC and DC voltage and current, decibels and resistance. Uses 1% precision resistors; has 3-position function switch and 12-position range switch. 38 ranges include: AC, DC and output volts, 0-1-5-10-50-500-5000 (1000 ohms/volt sensitivity); Resistance, 0-1000-100,000 ohms and 0-1 meg (center scale readings of 60, 150 and 1500 ohms); Current, AC or DC, 0-1-10-100 ma and 0-1 amp; Decibels, -20 to +69 in 6 ranges. Precision resistors are used as shunts and multipliers to assure exceptional accuracy of measurements. With all parts, battery, test leads and black bakelite case with convenient carrying handle, 6¾ x 5¼ x 3¾". A great value in an easy-to-build quality instrument. Shpg. wt., 2½ lbs.
- Model Y-128. Net only **\$16.95**

knight-kit Vacuum Tube Voltmeter Kit

- Model Y-125
\$24.95
- 200 µa Movement, 4½" Meter
 - Includes AC, Peak-to-Peak
 - Balanced-Bridge, Push-Pull Circuit
 - 1% Film-Type Resistors

Top buy in an extremely stable, highly accurate VTVM. Easy to assemble—entire chassis is printed circuit board. Perfect for radio-TV service work, lab and Amateur use. Features low-leakage type switches; 1% film-type precision resistors; balanced-bridge, push-pull circuit (switch to any range without readjusting zero set); zero center scale and direct-reading db scale; polarity reversing switch. Ranges: Input Resistance, 11 megs; DC and AC rms, 0-1.5-5-15-50-150-500-1500; AC Peak-to-Peak, 0-4-14-40-140-1400-4000; Response, 30 cycles to 3 mc; Ohms, 0-1000-10K-100K and 0-1-10-100-1000 megs; db, -10 to +5. Includes all parts, tubes, battery, test leads and portable case, 7¾ x 5¼ x 4-¾". Easy to assemble. Shpg. wt., 6 lbs.

- Model Y-125. Net only **\$24.95**
 Y-126. Hi Voltage Probe; extends DC to 50,000 v **\$ 4.75**
 Y-127. Hi-Frequency Probe; extends AC to 250 mc **\$ 3.45**



6V-12V Battery Eliminator Kit

- Model Y-129
\$32.95
- High current rating; continuously variable filtered output; delivers 15 amps at 6 volts, 10 amps at 12 volts. May be used as battery charger. Two meters provide simultaneous current and voltage readings. Shpg. wt., 18 lbs.
- Model Y-129. Net only **\$32.95**



Transistor Checker Kit

- Model Y-149
\$8.50
- Checks gain ratio of all types of transistors; checks germanium and silicon diodes; checks for continuity and shorts. A valuable instrument at very low cost. Easy to assemble. Shpg. wt., 2½ lbs.
- Model Y-149. Net only **\$8.50**

Flyback Checker Kit

- Model Y-118
\$19.50
- Checks condition of all types of horizontal output transformers and deflection yokes, as well as TV linearity and width coils. 4½" meter; widest range in its field. Shpg. wt., 6 lbs.
- Model Y-118. Net only **\$19.50**

Sweep Generator Kit

- Model Y-123
\$43.75
- Extreme linearity on a par with costly lab instruments; fundamentals to 250 mc; output flat within 1 db; electronic blanking. Easy, money-saving assembly. Shpg. wt., 16 lbs.
- Model Y-123. Net only **\$43.75**

Capacitor Checker Kit

- Model Y-119
\$12.50
- Tests capacitors while in the circuit! Has widest range—20 mmf to 2000 mfd. Exclusive circuit for cancelling lead capacity. "Magic Eye" indicator. Save 60% over factory-wired units. 5 lbs.
- Model Y-119. Net only **\$12.50**

**ADVANCED-DESIGN INSTRUMENTS FOR SERVICE, INDUSTRIAL AND RESEARCH USE
IN EASIEST-TO-BUILD, MONEY-SAVING KIT FORM**



knight-kit 20,000 Ohms/Volt VOM Kit

Model Y-140 Outstanding quality and performance at money-saving low price. Features 1% precision multipliers; $4\frac{1}{2}$ " meter accurate within 2% of full scale deflection; 50 microamp sensitivity for 20,000 ohms/volt input resistance on DC; front panel "Zero adjust"; single switch to select function and range. 32 ranges: AC, DC and output volts, 0-2.5-10-50-250-1000-5000; Resistance, 0-2000-200,000 ohms and 0-20 meg.; DC ma, 0-0.1-10-100; DC amps, 0-1-10; Decibels, -30 to +63 in six ranges. Moisture-resistant film-type resistors for extreme accuracy. Carefully engineered circuit design achieves high sensitivity and extremely versatile application. Kit includes all parts, battery, test leads and black bakelite case with highly legible white markings; size $6\frac{3}{4} \times 5\frac{1}{4} \times 3\frac{3}{4}$ ". Easy to assemble. Shpg. wt., 5 lbs.

Model Y-140. Net only \$29.50



knight-kit High-Gain Signal Tracer Kit

Model Y-135 A remarkable value in an easy-to-build instrument which permits visual and aural signal tracing of RF, IF, video and audio circuits. Has *highest gain in its price class*. Traces signal from antenna to speaker. Reproduces signal at plate or grid connection of any stage. Identifies and isolates "dead" stages. Features: usable gain of 91,000; "magic eye" with calibrated attenuators for signal presence indication and stage-by-stage gain measurements; built-in 4" PM speaker; combination 2-position probe, one for RF (6 mmf. input), the other for audio. Provides noise test; built-in watt-meter calibrated from 25 to 1000 watts; provision for external scope or VTVM. Binding posts provide output transformer and speaker substitution test, plus external 280 volts B+. With all parts, tubes and probe. $7 \times 10 \times 5\frac{1}{2}$ ". 12 lbs.

Model Y-135. Net only \$26.50



knight-kit 5" Wide-Band Oscilloscope Kit

- Model Y-144**
- 5 mc Width for Color TV
 - Horizontal Sweep to 600 kc
 - 25 mv/inch Sensitivity
 - Z-Axis Input
 - Printed Circuit Construction

Only \$6.90 down

Equals or betters the performance of commercially wired scopes costing far more. Two printed circuit boards and laced wiring harness assure wiring accuracy and cut assembly time. Ideal for lab use, color TV servicing and high frequency applications. Wide sweep range—15 to 600,000 cps. Vertical response, ± 3 db, 5 cps to 5 mc; only 1 db down at 3.58 mc color burst. High vertical sensitivity of .025 rms v/inch. Input capacity, 20 mmf. Outstanding features: cathode follower inputs; 2nd anode provides 1400 volts high-intensity trace; push-pull amplifiers; positive and negative locking; frequency-compensated attenuator; Z-axis input; one volt P-P calibrating voltage; astigmatism control; retrace blanking circuit; DC positioning control. Includes CRT. $14\frac{1}{2} \times 9\frac{1}{2} \times 16\frac{1}{2}$ ". 40 lbs.

Model Y-144. Net only \$69.00
Y-148. Demodulator Probe. Net \$ 3.45
Y-147. Low Capacity Probe. 12 mmf. Net \$ 3.45



Voltage Calibrator Kit

\$12.75 Permits use of any scope as precision peak-to-peak AC voltmeter. Puts a true square-wave voltage on scope screen. Selects any voltage between .01 and 100 volts; feeds external signal direct to scope for instant comparison. Shpg. wt., 5 lbs.

Model Y-136. Net only \$12.75

knight-kit 5" General-Purpose Scope Kit

- Model Y-146**
- Phantastron Linear Sweep
 - 25 mv/inch Sensitivity
 - Printed Circuit Board
 - Retrace Blanking Circuit

\$42.00

Only \$4.20 down

Feature for feature the world's best oscilloscope kit value. A stand-out in its class with all these fine features: *Printed Circuit* wiring board and laced harness for quick, error-free assembly. *Phantastron Sweep Circuit* for high linearity of sweep from 15 to 150,000 cps. *25 Millivolts Per Inch Sensitivity*—3 times that of similarly priced scope kits. *Calibration Voltage*—1 volt peak-to-peak square wave, fully regulated. *Vertical Amplifier*—frequency response ± 3 db, 3 cps to 1.5 mc (± 6 db to 2.5 mc). Includes: Directly coupled positioning controls; retrace blanking circuit; frequency-compensated vertical input attenuator; positive and negative internal sync; high 2nd-anode voltage for high-intensity trace; input capacity, 45 mmf. Kit includes CRT. $9\frac{1}{2} \times 13\frac{3}{4} \times 17\frac{3}{4}$ ". 26 lbs.

Model Y-146. Net only \$42.00



Resistance Substitution Box

\$5.95

Easily determines resistor values required in a circuit. Makes available 36 standard 1-watt resistance values in 2 ranges between 15 ohms and 10 megohms, with 10% accuracy. Slide switch selects range; 18-position switch for value selection. Shpg. wt., 2 lbs.

Model Y-139. Net only \$ 5.95



Audio Generator Kit

\$31.50 Excellent design; range, 20 cps to 1 mc; less than .25% distortion; 600 ohm output. Ideal for hi-fi testing; offers the flat response of a lab standard. Shpg. wt., 16 lbs.

Model Y-137. Net only \$31.50



R/C Tester Kit

\$19.50 Measures capacitance and resistance. Balanced-bridge circuit; indicates power factor; tests capacitors at rated voltage. Large, easy-to-read dial and "magic eye." Shpg. wt., 10 lbs.

Model Y-124. Net only \$19.50



Capacitance Substitution Box

\$5.95

Makes it easy to find capacitor values needed in a circuit. Provides 18 standard values from .0001 mfd to .22 mfd. $\pm 20\%$. All values are 600 volt, except .15 and .22, which are 400 volt. 18-position selector switch. Shpg. wt., 2 lbs.

Model Y-138. Net only \$ 5.95

EASY TERMS AVAILABLE

Take advantage of the most liberal Easy Pay plan in electronics. On Knight-Kit orders totaling \$45 or more—just 10% down, small monthly payments thereafter. Low carrying charges—no "red tape."



knigh -ki S FOR THE RADIO AMATEUR

knigh-kit All-Band Amateur Receiver Kit

Model Y-726

- Tunes 540 kc to 31 mc
- Built-In Q-Multiplier
- Constant Running HF Oscillator
- Worthy of the Advanced Ham Operator
- Printed Circuit Bandswitch
- Printed Circuit Board • 1.5 μ v Sensitivity

\$104⁵⁰
Only \$10.45 down

A sensational communications receiver value with all the selectivity, sensitivity and features of high-priced commercial units. Uses printed circuitry throughout, including the exclusive new KNIGHT-KIT printed circuit band-switch, for remarkably easy assembly. Covers 540 kc to 31 mc in 4 ranges; calibrated, electrical bandspread on 80-10 meter Ham bands; slug-tuned Hi-Q coils; continuous, VR tube-regulated B+ applied to HF oscillator lets you switch from standby to receive with no drift; built-in Q-multiplier peaks desired signal or nulls interference; delayed AVC; provision for crystal calibrator (below). Sensitivity, 1.5 microvolts for 10 db signal-to-noise ratio. Selectivity: variable from 300 cps to 4.5 kc at 6 db down. Exalted BFO injection. Controls: Main tuning, bandspread, band selector, Q-multiplier selectivity, Q-multiplier tune, null-off-peak, BFO pitch, RF gain, AF gain, BFO-MVC-AVC-ANL, off-stby-rec-cal, antenna trimmer, and phone jack. Cold-rolled $\frac{1}{16}$ " steel chassis. Handsome metal cabinet, 10 x 10 x 16 $\frac{1}{2}$ ". (Less phones, 8-ohm loudspeaker and S-meter.) 23 lbs.

Model Y-726. Amateur Receiver Kit. Net..... **\$104.50**
Y-727. S-Meter Kit for above. 1 lb. Net..... **\$9.50**



knigh-kit 50-Watt CW Transmitter Kit



Model Y-255
\$38⁹⁵
Only \$3.89 down

- Ideal for the Novice
- Pi Antenna Coupler
- Bandswitching—80 to 10 Meters

There's exceptional value in this very popular bandswitching transmitter kit. Compact and versatile, it's the perfect low-power rig for the beginning novice as well as the seasoned veteran. Has bandswitching coverage of 80, 40, 20, 15 and 10 meters. Rated at 50 watts—actually operates at up to 60 watts on 80 and 40 meters. Oscillator is efficient 6AG7; final is reliable 807. Crisp, clean, cathode keying of oscillator and final. Built-in pi coupler permits use with random length antennas. Has highly effective TVI suppression. Other features not usually found in transmitter kits at this low price include: Ceramic-insulated final tank capacitor; pre-assembled switches; pre-wound parasitic chokes; ceramic coil forms; coax connector; crystal and VFO socket on front panel; power take-off jack for accessory equipment. Meter reads either plate or grid current of final. Takes crystal or VFO without circuit changes. Cabinet interior and chassis are copper-finished. Size, 8 $\frac{1}{2}$ x 10 $\frac{1}{2}$ x 8 $\frac{1}{4}$ ". With tubes and all parts for easy assembly. (Less crystal and key.) Shpg. wt., 19 lbs.

Model Y-255. 50-Watt Transmitter Kit. Net only..... **\$38.95**

knigh-kit Self-Powered VFO Kit



Model Y-725
\$28⁵⁰
Only \$2.85 down

Complete with built-in power supply! Careful design and voltage regulation assure high stability. Excellent oscillator keying characteristics for fast break-in without clicks or chirps. Full TVI suppression. Has plenty of bandspread; separate calibrated scales for 80, 40, 20, 15, 11 and 10 meters; vernier drive mechanism. 2-chassis construction keeps heat from frequency determining circuits. Output cable plugs into crystal socket of transmitter. Output: 40v on 80, 20v on 40. With Spot-Off-Transmit switch for spot frequency tuning. Extra switch contacts for operating relays and other equipment. Attractive metal cabinet, 8 $\frac{3}{4}$ x 6 x 6". Ready for easy assembly. Shpg. wt., 8 lbs.

Model Y-725. VFO Kit. Net only..... **\$28.50**

knigh-kit 100 Kc Crystal Calibrator Kit

Model Y-256 Crystal frequency standard at very low cost. Gives marker every 100 kc up to 32 mc. A "must" for marking band edges. Mounting flanges for installation in or back of receiver cabinet. Size only 1 $\frac{1}{2}$ x3". Requires 6.3 v. at 0.15 amp and 150-300 v. DC at 3-6 ma. Trimmer for zero-beating with WWV; On-Off switch. Complete with tube, crystal, all parts and easy-to-follow instructions. Shpg. wt., 1 lb.

Model Y-256. 100 Kc Crystal Calibrator Kit. Net only..... **\$10.50**



Model Y-253
\$5⁸⁵

knigh-kit Amateur RF "Z" Bridge Kit

Measures standing wave ratio (SWR) and impedance-of antenna systems; ideal for adjusting antenna systems for optimum results. Measures impedances from 20 to 400 ohms up to 100 mc; SWR to 150 mc. Any VOM may be used for null indicator. With coax input and output connectors. Meters both input and bridge voltage. Calibrated dial gives direct impedance reading; includes 1% precision resistor for precise calibration adjustment. With all parts and handy plasticized SWR chart (less meter). 2 $\frac{1}{2}$ x 3 x 4 $\frac{1}{2}$ ". Shpg. wt., 1 $\frac{1}{2}$ lbs.

Model Y-253. "Z" Bridge Kit. Net only..... **\$5.85**

ORDER BLANK

ALLIED RADIO

100 N. WESTERN AVE., CHICAGO 80, ILL.

ALLIED RADIO, Dept. RE, 100 N. Western Ave., Chicago 80, Ill.

Ship me the following KNIGHT-KITS:

Quantity	Description	Model No.	Price

\$..... enclosed. (For parcel post, include postage—express is shipped collect).

My Down Payment in the amount of \$..... is enclosed. Send Time Payment form.

Name.....

Address.....

City..... Zone..... State.....

ALL PRICES NET F. O. B. CHICAGO



FREE 1958
404-PAGE
ALLIED
CATALOG

See the 1958 ALLIED 404-Page Catalog for complete listings of more than 50 KNIGHT-KITS, covering Hi-Fi, Hobby, Test Instrument and Amateur Kits. The 1958 ALLIED Catalog is your complete Buying Guide to the world's largest stocks of everything in Electronics.

Send FREE 404-Page 1958 ALLIED Catalog.

12 Volts—Heater and Plate

(Continued from page 69)

low-voltage approach which is very useful to the mobile operator is a portable grid dip meter. This meter can be clipped across any 12-volt battery and will then be ready for operation. The circuit is not as complicated as it appears at first glance and was used because of the high value of grid current which could be obtained with very low plate voltages. If a more sensitive meter movement is available, the cathode resistor is increased from 100 ohms to a value which will reduce the grid current to the desired amount. The mechanical layout is not critical.

Fig. 6 is a photo of three pieces of experimental gear designed to use low-voltage tubes. The small chassis at the left is a crystal-controlled v.h.f. converter designed to operate on the 144 mc. band. A 12AW6 is used as a conventional triode crystal oscillator. Another 12AW6 is used as a screen grid multiplier (x6). The r.f. amplifier uses a 12AW6 as a screen grid amplifier and

the mixer is the very conventional grid leak mixer. An i.f. frequency of 10.7 mc. was used. For the information of anyone attempting a unit such as this it is suggested that the multiplication of the crystal oscillator output be accomplished in two stages (2x3) rather than in one stage. This will deliver more oscillator power to the mixer.

The center chassis is a full superhet for use on the aircraft frequencies at 120 mc. and at the right is a superregenerative detector plus audio to be used as a second detector with v.h.f. converters.

In conclusion it might be suggested that this type of operation should be a natural for the experimenter or Novice who has access to a 12-volt auto system (Fig. 2). A simple receiver constructed along these lines can be used as portable or mobile without a complicated power supply and at the home location from a simple filament transformer-rectifier power supply. It is impossible to cover all the potential uses for this type of tube operation in one article but perhaps this quickie summary can help kick a few new home projects into the mill. —50—

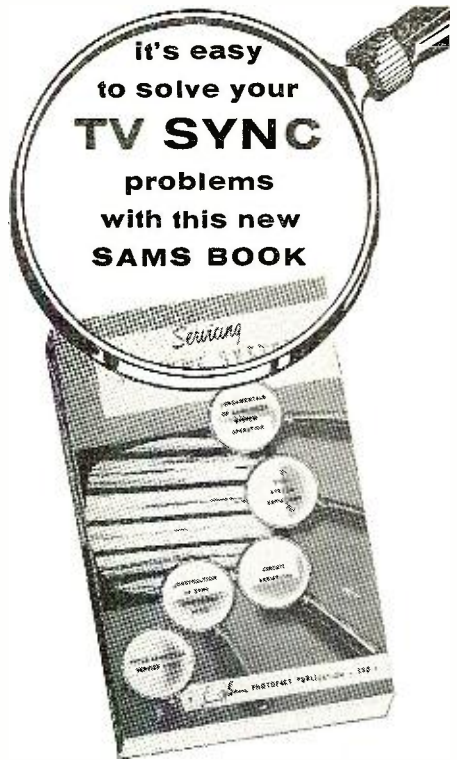

"Servicing TV Sync Systems"

by Jesse Dines

Valuable time-saving book for Service Technicians. Covers fully the theory of operation, circuit function and circuit variations of the 18 different types of sync systems used in TV receivers. Explains various types of sync separator, horizontal and vertical oscillator, and horizontal AFC circuits used in sync systems. Methods of analyzing and troubleshooting these circuits are supported by actual picture tube photos and waveforms illustrating types of sync troubles. Includes valuable data on oscillator coils, transformers and printed electronic circuits used in sync systems. Has chapter on practical servicing hints. This book will definitely help the technician to better understand and more easily service any type of sync system trouble. Written clearly and simply for quick and easy understanding. 320 pages; 221 illustrations, 5½ x 8½".

PRICE ONLY **\$3.95**

SEE THIS MONEY-EARNING BOOK AT YOUR ELECTRONIC PARTS DISTRIBUTOR OR MAIL COUPON TO HOWARD W. SAMS...

FREE TRIAL COUPON

Howard W. Sams & Co., Inc., Dept. 1-C8
2201 E. 46th Street
Indianapolis 5, Indiana

Send me Jesse Dines' book "Servicing TV Sync Systems" for 10 days FREE examination. In 10 days I will pay for the book, plus small delivery cost, or return postpaid.

We pay delivery costs if you remit with this coupon. Same return privilege.

Name.....

Address.....

City..... Zone..... State.....
(outside U.S.A. priced slightly higher)

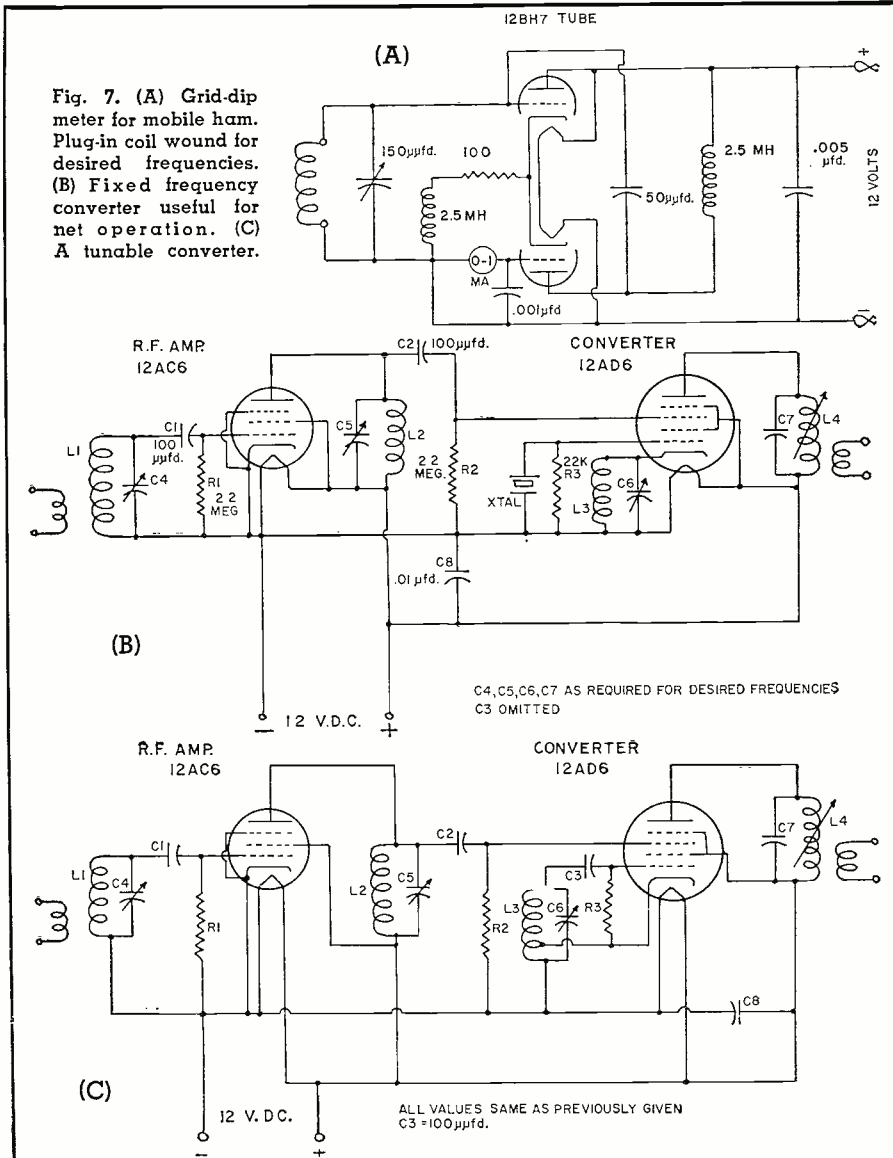

Fig. 7. (A) Grid-dip meter for mobile ham. Plug-in coil wound for desired frequencies. (B) Fixed frequency converter useful for net operation. (C) A tunable converter.



Marion McPartland makes her tape recordings on

irish
BRAND
ferro-sheen
recording
tape

That's not the reason
why you should use

irish
BRAND
ferro-sheen
recording
tape

Here's why you should use

irish
BRAND
ferro-sheen
recording
tape

It's the best engineered tape
in the world

...gives you better highs... better lows... better sound all around! Saves your tape recorder, too—because the **irish FERRO-SHEEN** process results in smoother tape...tape that can't sand down your magnetic heads or shed oxide powder into your machine. Price? Same as ordinary tape!



Available wherever quality tape is sold.
ORRadio Industries, Inc., Opelika, Alabama
Export: Morhan Exporting Corp., New York, N. Y.
Canada: Atlas Radio Corp., Ltd., Toronto, Ontario

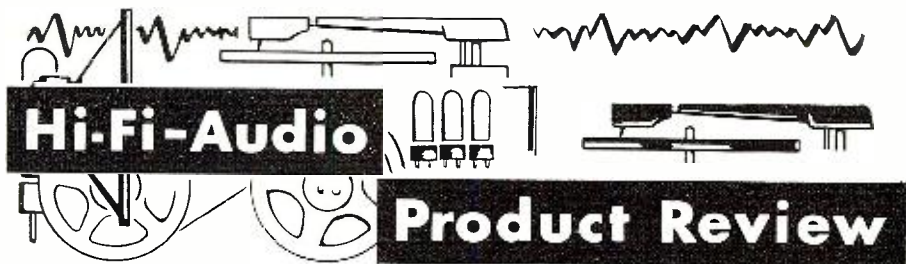

30-WATT AMPLIFIER

Allied Radio Corporation, 100 N. Western Ave., Chicago 80, Ill. has just released a new 30-watt amplifier in its "Knight" audio line.

The Model KN-530 can be used with a tape deck; tape recorder; record player equipped with magnetic, ceramic, or crystal cartridge; radio tuner; TV sound; etc. It features a 3-way speaker selector switch for playback through either of two speaker systems or through two speaker systems simultaneously, rumble and scratch filters

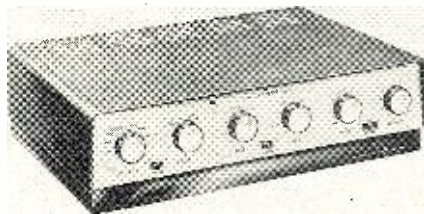

for suppression of turntable and record noises, loudness control, twelve combinations of record equalization and NARTB equalization to permit direct use with a tape head. Variable damping is also provided.

Frequency response is from 20 to 40,000 cps \pm 1/2 db at 30 watts. Harmonic distortion is 1/2% at mid-frequencies and does not exceed 1.5% from 30 to 20,000 cps, according to the company.

VARIABLE GAIN A.C. PREAMP

Burr-Brown Research Corporation, Box 6444, Tucson, Ariz., is now offering a transistorized variable gain a.c. preamplifier which is designed to be used as a preamp for microphones, magnetic pickups, search coils, strain gauge systems, gyro pick-off coils, and similar transducers.

The Model 110 may also be used to extend the sensitivity of oscilloscopes,

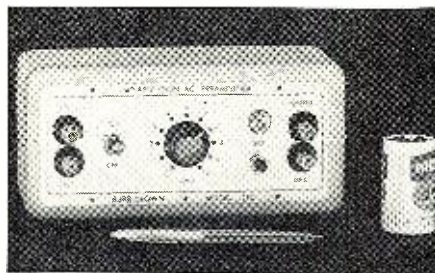

meters, and volume level indicators and is useful for noise measurements in audio, supersonic, and low-radio-frequency applications. The unit is completely transistorized and self-powered from ordinary "C" size flashlight cells. It features an input imped-

ance of over 1 megohm, continuously adjustable gain to 50 db, response from 10 to 500,000 cps, .5% maximum distortion, and 750 hour battery life.

The unit is housed in a deep-drawn aluminum case measuring 4"x8"x4". It can be supplied with either continuous or stepped gain control. A data sheet on the unit is available on request.

"FORTIFIED" RECORDING TAPE

ORRadio Industries, Inc., Shamrock Circle, Opelika, Ala. has added a "Fortified" double-play tape to its line of "Irish" magnetic recording tapes.

Designated as catalogue number 400, the new tape is made on Du Pont "Mylar" polyester base, especially reinforced for sinewy strength. This 60-gauge Mylar tape will withstand a pull of 3 pounds without distortion. A 7" reel, carrying 2400 feet, will record 2 hours at 3 3/4 ips single track or 4 hours on dual track.

KARLSON CONSOLE

Karlson Associates Inc., 1610 Neck Road, Brooklyn 29, N. Y. is now marketing the "18" console which is designed to accommodate 12", 15", or 18"

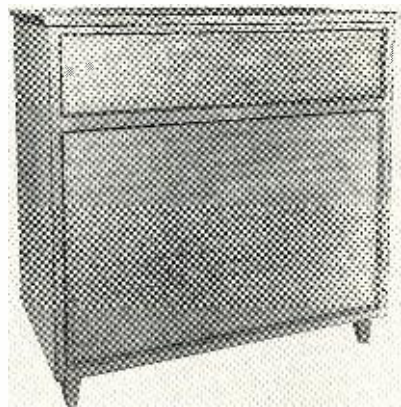

coaxial, triaxial, extended range speakers and woofers in addition to tuners and amplifiers, etc.

The console measures 42" high, 40 5/8" long, and 22" deep. It measures 37 1/2" high, without legs. It is available in blonde, walnut, and mahogany wood finishes or can be supplied unfinished on special order. The top panels are hinged.

The compartment interior size is 38" x 19 3/8" x 9 3/4". The unit is one of the enclosures covered by U.S. Patent No. 2,816,619 on which basic claims have been allowed.

A.F. TRANSISTORS

The Semiconductor Division of Radio Corporation of America, Somerville, N. J. is now offering two new "p-n-p"

germanium junction transistors which have been designed especially for class A audio-frequency driver service in compact, entertainment-type receivers.

The 2N405 and its flexible lead version, the 2N406, are said to have excellent stability throughout life. In a common-emitter type of circuit, these transistors have a typical small-signal current transfer ratio of 35 and a matched-impedance power gain of 43 db. These characteristics make them especially useful in low-power audio applications.

A technical bulletin on these two transistors is available on request.

FM "RANGE EXTENDER"

Jerrold Electronics Corporation, 23rd and Chestnut Sts., Philadelphia 3, Pa. has announced the availability of an

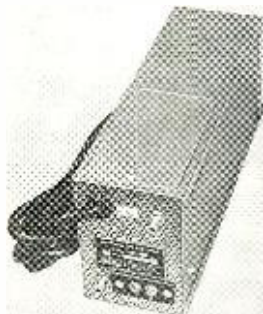

FM preamplifier which effectively extends the reception range of high-fidelity FM tuners.

Known as the "Range Extender," the new FM preamp is designed to be installed between the antenna and FM tuner. The unit is available in two models with option of either indoor or antenna mast mounting and 24-volt remote or 117-volt local operation. Both units are available with either 300 or 75 ohm input. Frequency response is flat ± 1 db across a 20 mc. bandwidth. The preamps, using only two tubes to achieve a minimum gain of 25 db and a maximum undistorted output of .5 volt r.m.s., composite signal, have input and output matched to a v.s.w.r. of less than 1.4.

TRANSISTORIZED AMPLIFIER

Video Instrument Company, Inc., 2340 Sawtelle Blvd., Los Angeles 64,



Calif. has introduced an all-transistorized audio power amplifier designed for use in home music systems.

The "Vico" Model 77 amplifier has a power output of 20 watts. The front panel is provided with bass, treble, input selection, and loudness controls. Hum and noise are more than 100 db below rated output. The amplifier is

March, 1958

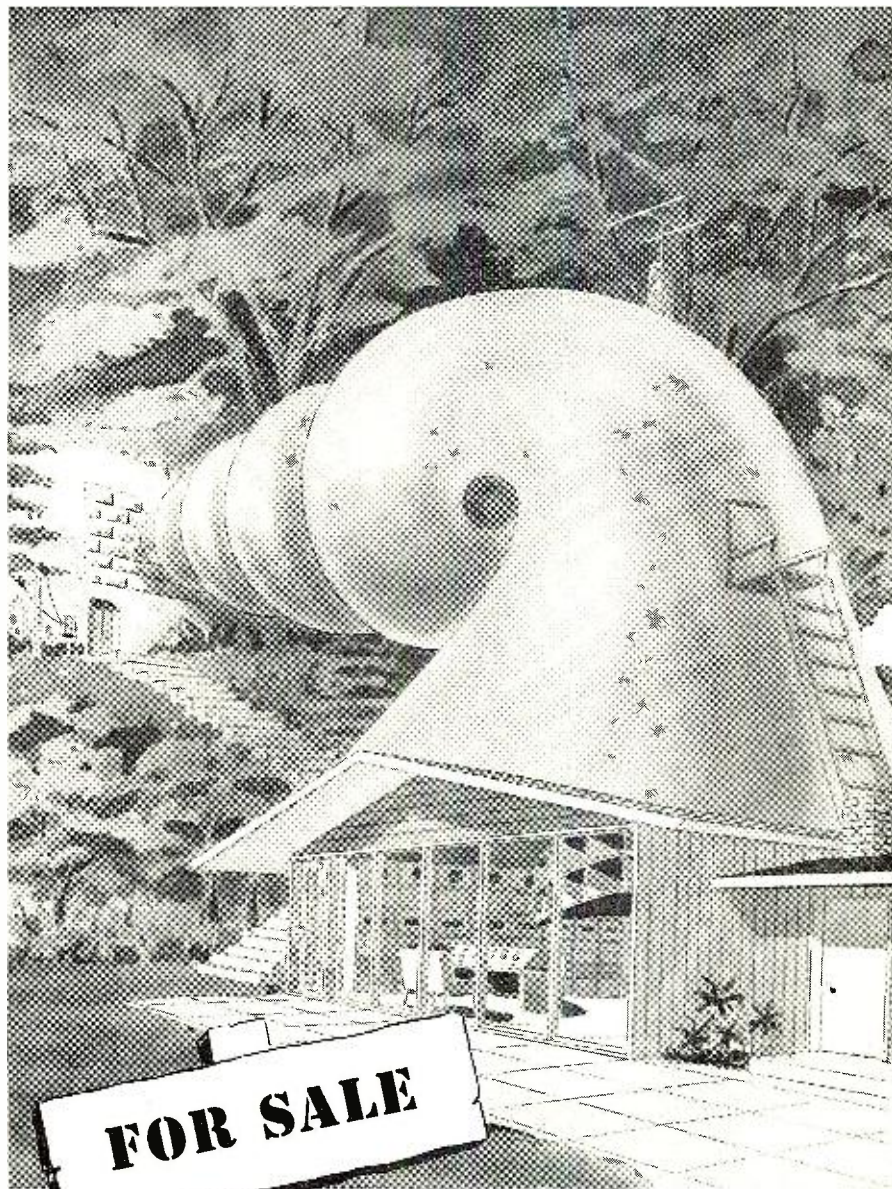

Practically new ranch house with 200-foot, poured-concrete, spirally curled, exponential bass horn; 12-foot multicellular midrange horn (24 cells); large inventory of assorted dynamic and electrostatic tweeters; three 2,000-watt water-cooled amplifiers; infinite-attenuation electronic crossover networks; master control-mixer-preamplifier console; two 1,500-lb. belt-driven turntables suspended in mercury bath; vacuum-sealed record-positioning chamber with servo-controlled record lifters and nuclear-reactor record deionizer; foam-rubber basement for acoustical feedback isolation; also complete blueprints for construction of identical house for stereo.

Will sacrifice; or trade for NORELCO speaker, which owner of house has discovered to be ideal for delightful hi-fi listening without electronic anxiety neuroses or showdowns with the loan company. For detailed and convincing confirmation of latter viewpoint, write to North American Philips Co., Inc., High Fidelity Products Division, 230 Duffy Avenue, Hicksville, Long Island, N. Y.

WANTED

NORELCO®
loudspeakers

a complete line of 5" to 12" high-fidelity speakers and acoustically engineered enclosures

THE VIKING BILLBOARD

Vol. 1

No. 2

Tape heads should be demagnetized at frequent intervals to avoid damage to recorded tapes and to insure minimum distortion in recording. This does not necessarily involve use of a bulk eraser or head demagnetizer. The heads on your Viking deck can be degaussed using a gun-type soldering iron. Hold the transformer case (not the tip) close to the heads. Energize the transformer, and slowly withdraw it to a distance of two feet or more before releasing the trigger. A bulk eraser, of course, works equally well. It is almost unnecessary to say that any valued tapes should be kept at a distance of at least two feet during this procedure.

Viking owners frequently ask whether they can use the phono input on a general purpose mixer-preamplifier for playback of recorded tapes . . . The equalization controls provided on such preamplifiers are usually adequate to provide for proper equalization. Usually, however, the phono input is shunted by a resistance of from twenty to fifty thousand ohms. When used as the input for a tape head, this shunting resistance should be removed.

A few instances have been reported where the capstan drive belt on a Viking deck had been replaced with a *somewhat similar belt* obtained from jobber replacement parts stocks. The belts in question were not Viking belts, were originally intended for another purpose, and resulted in a pronounced increase in flutter and wow.

The highly compliant belt used on the Viking 75 Series decks in combination with the heavy capstan flywheel, provides a unique filtering effect. The filtering out of interpole variations in motor speed is one of the largest factors responsible for the very low flutter and wow characteristic of the Viking deck.

You can expect five thousand hours of operation from this fragile appearing belt. If and when you do replace it, however, be sure you use the regular Viking belt. It was built for the job.

One of the best ways to check the performance of a tape recorder is to "AB" the recording performance against the original source. This is most easily accomplished using a record player, or AM-FM tuner as the source.

Viking "RM" models, or other recorders equipped with independent heads for recording and playback, can be set up for instantaneous "AB" comparison, selecting either the original program or the recorded track at the flip of a switch. This provides for the most practical evaluation of what we call "the R/P factor"; the degree to which a recorder will record and play back with absolute fidelity. Ask your Viking Dealer for an "RP" demonstration.



OF MINNEAPOLIS

9600 Aldrich Avenue South,
Minneapolis 20, Minnesota

designed for operation from a 117-volt a.c. source or a 12-volt battery. It may be operated directly from vehicle batteries without internal or external vibrators or other conversion devices.

Frequency response is said to be flat within $\pm \frac{1}{2}$ db from 20 to 30,000 cps. A data sheet giving complete specs is available on request.

STEREO CARTRIDGE

Fairchild Recording Equipment Co., 10-40 45th Ave., Long Island City 1, N. Y. has developed a stereo cartridge designed for playing stereo discs cut by the Westrex system.

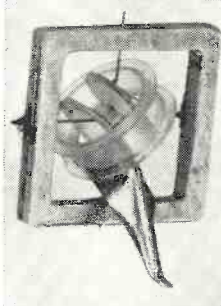

The heart of the single-stylus cartridge consists of two coil forms mounted in a frame at 45 degrees to the vertical axis of the record groove. Each coil form is at 90 degrees to the other with an aluminum stylus arm secured to both members. Two crossed wires provide a unique method of pivoting the pickup coil.

According to the company, the new cartridge will play any of the Westrex stereo recordings or can be used to play back standard vertical or standard lateral recordings, making it completely compatible for existing discs.

CROSSOVER NETWORK

Vidaire Electronics Manufacturing Corp., Baldwin, N. Y. is now marketing a crossover network, Model CN-5, for hi-fi system applications.



The unit is a high-pass filter network which permits the range of an amplifier system to be extended by the addition of a high-frequency speaker. The circuit is designed to be used with either 8 or 16 ohm speaker systems. The crossover frequency matches most hi-fi speakers and, according to the company, there is no network loss in the pass region.

A data sheet on this new crossover is available without charge on request.

FOUR NEW ALTEC SPEAKERS

Altec Lansing Corporation, 1515 S. Manchester Avenue, Anaheim, Calif. has added four new residential speaker systems to its 1958 line.

The cabinets, all of the phase-computed, base-reflex type, are of extremely heavy construction, braced and blocked so that no part of the enclosure can vibrate and absorb any speaker energy.

The "Laguna" has a guaranteed frequency response from 30 to 22,000 cps without peaks, false bass, treble rise, or other misleading frequency accentuations. It incorporates a matched

foundation for
the world's
finest high fidelity
systems

marantz

* Marantz components have achieved recognition as the finest high fidelity amplifying equipment available. Truly worth the difference.

* Marantz lives up to specifications by a wide margin whether you judge by your ears, by test equipment, by looking at the "innards" or, we hope, by all three. With Marantz you do get what you are paying for.

* Servicing problems are almost non-existent! 100% inspection and testing of every unit, coupled with superior construction techniques and rugged, conservatively rated component parts will ensure trouble-free operation. A full one-year warranty accompanies all Marantz Products.

* Most carefully engineered circuitry results in lowest distortion, lowest hum and noise, and highest listening pleasure.

Audio Console **\$153**
(Cabinet extra)

Power Amplifier **\$198**

Electronic Crossover **\$90**
(Cabinet extra)

Slightly higher
in West and
Deep South

write for literature

marantz company

25-14 Broadway,
Long Island City 6, N. Y.

pair of 15" speakers, a high-frequency driver mounted on a horn, and a 500 cps dividing network.

The "Capistrana" has one 15" bass speaker, a dividing network, and a driver with horn. Guaranteed range is 35 to 22,000 cps. The "Corona" system is a corner version of the "Capistrana" and incorporates the same components.

The final new model is the "Verde" which houses a duplex loudspeaker. Its 35 to 22,000 cps range is designed for hi-fi systems of moderate size.

NEW "WIGO" SPEAKERS

United Audio Products, 202-4 East 19th St., New York 3, N. Y. has announced the availability of two new speakers in the "Wigo" line.

The Model WD155 is a 16" super-woofer which will cover the range from 25 to 6000 cps with a 30 cps cone resonance. Impedance is 16 ohms and the woofer will handle 50 watts. The second unit is the Model ER85, an 8½" extended range speaker designed especially for applications requiring minimum size. Frequency response is 40 to 15,000 cps. Impedance is 16 ohms and the power rating 15 watts.

Complete specifications on either of these units is available from the manufacturer.

STEREO ADAPTER KIT

Shure Brothers, Inc., 222 Hartrey Ave., Evanston, Ill. has placed a do-it-yourself stereo adapter kit on the market for the benefit of those who own *Revere* and *Wollensak* tape recorders.

The kit consists of an in-line stereophonic magnetic tape head which replaces the standard monaural head. Two amplifiers and two speakers are needed to play stereo recordings. One set of leads from the new stereo tape head goes directly to the self-contained amplifier and speaker in the recorder. The other leads may be carried to any external amplifier and speaker system available to the user.

The new TK-41 magnetic head also contains an a.c. erase head and can be used for standard recording-playback of monaural tapes.

"HIFILITE" BAFFLE

Lowell Manufacturing Company, 3030 Laclede Station Road, St. Louis 17, Missouri, has introduced a combination all-weather light and baffle which has been especially designed for outdoor sound applications.

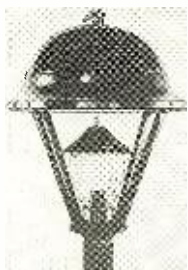

Although designed primarily for commercial use by country clubs, motels, resorts, and drive-in restaurants, the new unit can also be used by home owners. The baffle is constructed of heavy-gauge spun aluminum and the upper dome section of the baffle is lined with ¾" jute to make it waterproof. Atop the

New Transcription-Type Tone Arm Makes Collaro World's First True High Fidelity Changer

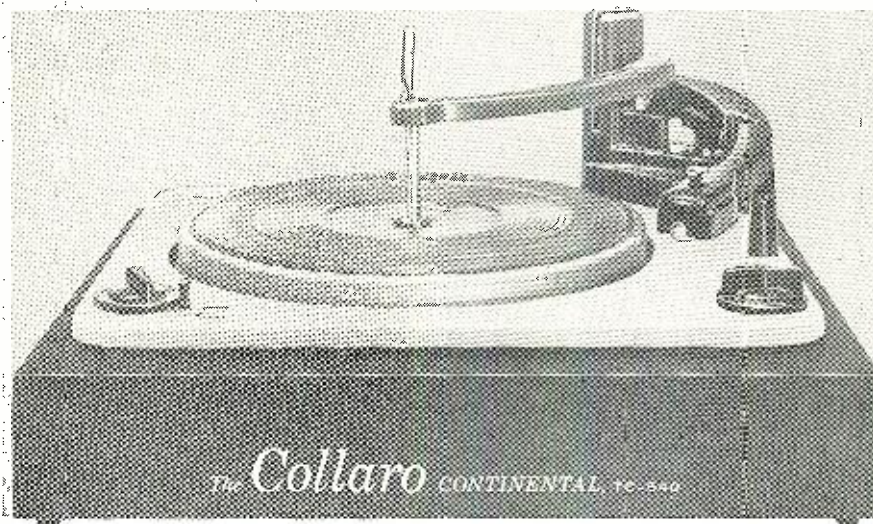

The Turntable That Changes Records

From Collaro Ltd., world's largest manufacturer of record playing equipment—comes the most significant development in years—the exclusive new transcription-type tone arm, which transforms the conventional record changer into a **TRANSCRIPTION CHANGER**, with features of the finest professional equipment.

The arm is a one-piece, spring-damped, counter-balanced unit which will take any standard high-fidelity cartridge. It is free of any audio spectrum resonances.

Stylus pressure between the first and last record in a stack remains virtually constant at less than a gram of difference, compared to 4 to 8 grams on conventional changers. Vertical and horizontal friction are reduced to the lowest possible level, insuring longer life for records and styli.

In its superb performance, the new Collaro Continental, Model TC-540, meets the rigid requirements for high fidelity equipment, offering professional quality at a record changer price. The Continental is \$46.50. Other Collaro changers are priced from \$37.50 up. (Prices slightly higher west of Mississippi.)



FREE: Colorful new catalog, containing guide on building record library plus complete Collaro line. Write to Dept. R-015

ROCKBAR CORPORATION
MAMARONECK, N. Y.

Rockbar is the American sales representative for Collaro Ltd. and other fine companies.

NOW...

stereophonic

HIGH FIDELITY components

by

Pilot

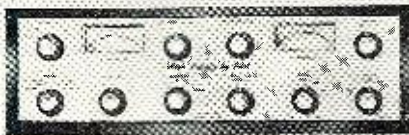

SP-215

Stereo Preamplifier

\$189.50

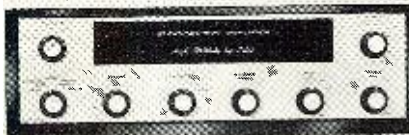

SM-244

Stereo Preamp and Amplifier

\$189.50

PRICES SLIGHTLY HIGHER IN WEST

For complete details, mail this coupon today.

Pilot Radio Corporation
37-06 36th St., L. I. C. 1, New York

Please send literature covering Pilot Stereo Components.

NAME _____

ADDRESS _____

CITY _____ ZONE _____ STATE _____

Manufacturer in electronics for over 39 years

dome is a gold-finished eagle. The lower baffle section is a modified version of the company's STL baffle and is supported on four steel tubes 1/2" in diameter. One of these support tubes is punched for concealment of the speaker leads. The baffle will handle 7" and 8" speakers.

STEREO AMP-TUNER

Madison Fielding Corp., 5 Lorimer St., Brooklyn 6, N. Y. has just released a matched stereophonic amplifier and tuner as the Series 320 and 333.

The amplifier is a 40-watt unit which contains two complete amplifiers, each with a fully integrated preamp section. In addition to the individual controls for each channel, the unit features a master volume control which

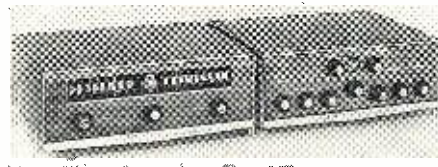

controls both levels simultaneously for stereo program levels. Another special feature is the novel "dual magic eye" configuration which, together with a calibrated scale, permits pre-program level settings and adjustment of outputs to meet special conditions.

The companion FM-AM multiplex tuner can be used for either AM or FM reception individually or both signals simultaneously.

Matching cabinets are available at a slight additional charge so that the companion units present a uniform appearance.

DYNAMIC PREAMP

Dynamic Electronics-New York, Inc. of Forest Hills, N. Y. has developed an inexpensive preamplifier unit which is intended to make possible the conversion of any amplifier or radiophograph to operate with a variable reluctance pickup or tape recorder.

Measuring 6"x3 1/4"x3 1/2" in a black and copper shielded cabinet, the unit has a frequency response from 11 to 25,000 cps ± 1.5 db, noise and hum level 60 db below 10 millivolts, and an over-all gain of 34 db.

The unit features a shielded cable with molded-on pin plug, a pilot light, phono input jack, "on-off" switch, and operation on a.c. from 110 to 117 volts. Power drawn is 15 watts.

MAGNECORD PT6-6 RETURNS

The *Magnecord Division of Midwestern Instruments, Inc.*, Tulsa, Oklahoma has announced the resumption of production on its PT6-6 series of tape recorders.

Housed in two separate cases for convenience in handling, the new PT6-6 is unchanged except for a front panel of stainless steel and an increase in panel size to 19" instead of the former 17" so that the units will fit standard relay racks in studios.

Specifications on this new professional recording equipment will be supplied by the manufacturer on request.

AUDIO CATALOGUES

CABINART ENCLOSURES

Cabinart, a division of *G & H Wood Products Co., Inc.*, 99 North 11th St., Brooklyn 11, N. Y. is now offering a multi-colored catalogue which describes its line of high-fidelity equipment cabinets and speaker enclosures suitable for virtually any type of home application or decor.

The line is pictured and described in some detail. Both finished and unfinished types have been included. Dimensional drawings provide complete information concerning the placement of individual components. Copies are available from local dealers or the manufacturer direct.

"SPLIT/KITS"

Transvision, Inc. of New Rochelle, N. Y. has issued a 20-page catalogue which describes its complete line of "Split/Kits."

Included in the line are hi-fi kits, hi-fi cabinets, as well as kits for assembling television receivers, electronic instruments, and electronic photo-flash units. Among the audio items listed and described in detail are 24- and 10-watt amplifier-preamps, a 4-watt amplifier, record changers, a 50-watt amplifier, AM/FM tuner, speaker enclosures for all speaker and room requirements, equipment cabinets, as well as complete "packaged" units assembled from quality components.

Write the manufacturer direct for a copy of the catalogue and full details on the "Split/Kit" plan.

KLIPSCHORN LINE

Klipsch and Associates of Hope, Ark. has issued a 16-page general catalogue and 4-page price list covering its line of "Klipschorn" speaker systems.

The publication describes the design principles involved and then pictures and describes the various models currently available in the line. The enclosures are shown in room settings and complete specifications are given as to finishes, dimensions, and performance.

Write the company direct for a copy of this catalogue or additional details on any unit in the firm's line.

UNIVERSITY "KWIKITS"

University Loudspeakers, Inc. 80 S. Kensico Ave., White Plains, N. Y. is now offering a handy illustrated folder which describes its line of folded-horn "Kwikits"—the do-it-yourself high-fidelity enclosure kits.

Full specifications and prices are included on the Model KEN-15, an enclosure for 12" and 15" speakers and multi-speaker systems, and also the Model KEN-12 for 12" units and systems. The folder graphically details the construction and design advancements incorporated in the line and explains

RADIO & TV NEWS

the advantages of assembling these kits.

AR-2 SPEAKER BROCHURE

Acoustic Research, Inc., 24 Thorn-dike St., Cambridge 41, Mass. has prepared a new four-page brochure on the AR-2 which it is offering without charge to interested persons.

The brochure includes a brief explanation of the patented acoustic suspension design, harmonic distortion and frequency response curves, and excerpts from press comments on the AR-2.

SPEAKER ENCLOSURE DATA

Able Wood Products Manufacturing Corp., 214 Franklin St., Brooklyn, N. Y. has available for distribution a colorful folder which describes its complete line of ten speaker enclosures.

The booklet pictures and describes a number of resonator, bass reflex, and infinite baffle type speaker housings as well as record changer and turntable enclosures. Most of the units are available either finished or unfinished.

Copies of this publication are available without charge on request. -50-

COOK RESUMES PRODUCTION

COOK LABORATORIES of Stamford, Conn., which was hit by a disastrous fire at its main plant in Glenbrook, Conn., has re-established its catalogue with a series of new disc releases and six representative numbers on stereo tape.

The three new discs are "Voices of the Sky" (1075) on modern aircraft; "From the Frontier of Space" (5021) which contains official recordings of radio signals from Sputniks I and II; and "King of Organs" (1150).

The stereo tape releases include "King of Organs" (1150S); Brahms' "First Symphony" (1060S); "Masterpieces of the Theater" (1064S); "Clambake on Bourbon Street" (1181S); "Speed the Parting Guest" (1041S); and "Jump-Up Carnival" (1072S).

Both tapes and discs in the re-established catalogue are being offered by direct mail to give dealers time to replenish their stocks. -50-

Molten silicon being pulled from crucible at Merck & Co., Inc. to form a single crystal, using high-frequency method of heating. Ultra-pure silicon is presently being used for the manufacture of transistors, signal diodes, and rectifiers.

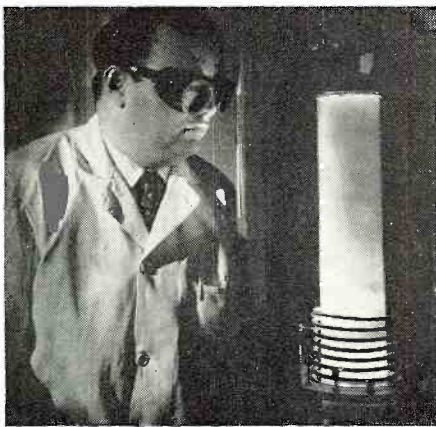

March, 1958

Garrard models change. Garrard ideals do not. Meaningful new features are added. Time-proven features are carefully retained. Gadgets, for the sake of gadgetry, are sternly rejected. The all-important fact to remember is that thirty-five years of experience in designing, testing, and building fine record players, guide us in offering you the present Garrard models.

Garrard

WORLD'S FINEST RECORD PLAYING EQUIPMENT

B. I. C. ENDORSED QUALITY

There's a Garrard for every high fidelity system

<p>Model 301 PROFESSIONAL TRANSCRIPTION TURNTABLE Each speed variable! Each unit with its own performance test report. \$89.00</p>	<p>Model RC98 4-SPEED SUPER AUTO-MANUAL CHANGER Continuous - or - variable control on all speeds. \$67.50</p>
<p>Model TPA/10 TRANSCRIPTION TONE ARM Professional performance, jewel-like construction and exceptional versatility. \$24.50</p>	<p>Model RC88 4-SPEED DELUXE AUTO-MANUAL CHANGER Exclusive pusher platform protects your records. \$54.50</p>
<p>Model T Mark II 4-SPEED MANUAL PLAYER A superior unit for quality budget systems. \$32.50</p>	<p>Model RC121 4-SPEED MIXER AUTO-MANUAL CHANGER Fine performance with economy and compactness. \$42.50</p>

For Information Write: GARRARD SALES CORPORATION, Dept. GC-48, PORT WASHINGTON, N. Y.

QUALITY + ECONOMY = With Perma-Film



Economical . . . A little does a lot

- Cleans, lubricates, restores all tuners, including water type
- Won't change or affect capacities, inductance or resistance
- Won't harm insulations or precious metals nor attack plastics
- Eliminates all noise, oxidation and dirt indefinitely
- Use for TV, radio and FM
- Non-toxic, non-inflammatory
- Insures trouble-free performance

6 oz. Aerosol Can, Net to Servicemen **\$3.25**

The Original, Dependable NO-NOISE TUNER-TONIC

Beware of Imitations

VOLUME CONTROL AND CONTACT RESTORER

With Perma-Film

- Cleans
- Lubricates
- Protects

NOT A CARBON TET SOLUTION



2 oz. Bottle, Net to Servicemen **\$1.00**



6 oz. Spray Can, Net to Servicemen **\$2.25**

Also available in 8 oz. bottles and quart cans At Your Nearest Distributor

ELECTRONIC CHEMICAL CORP. 813 COMMUNIPAW AVENUE JERSEY CITY 4, N. J.

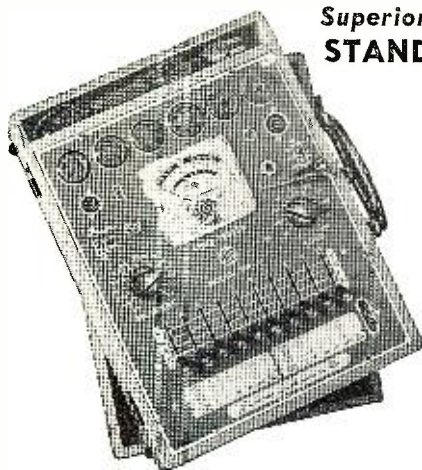

**Superior's New Model TW-11
STANDARD PROFESSIONAL**

UBE TES ER

- Tests all tubes, including 4, 5, 6, 7, Octal, Lockin, Hearing Aid, Thyatron, Miniatures, Sub-miniatures, Novals, Sub-minars, Proximity fuse types, etc.
- Uses the new self-cleaning Lever Action Switches for individual element testing. Because all elements are numbered according to pin-number in the RMA base numbering system, the user can instantly identify which element is under test. Tubes having tapped filaments and tubes with filaments terminating in more than one pin are truly tested with the Model TW-11 as any of the pins may be placed in the neutral position

- when necessary.
 - The Model TW-11 does not use any combination type sockets. Instead individual sockets are used for each type of tube. Thus it is impossible to damage a tube by inserting it in the wrong socket.
 - Free-moving built-in roll chart provides complete data for all tubes. All tube listings printed in large easy-to-read type.
- NOISE TEST:** Phono-jack on front panel for plugging in either phones or external amplifier will detect microphonic tubes or noise due to faulty elements and loose internal connections.

EXTRAORDINARY FEATURE

SEPARATE SCALE FOR LOW-CURRENT TUBES—Previously, on emission-type tube testers, it has been standard practice to use one scale for all tubes. As a result, the calibration for low-current types has been restricted to a small portion of the scale. The extra scale used here greatly simplifies testing of low-current types.

The Model TW-11 operates on 105-130 Volt 60 Cycles A.C. Comes housed in a beautiful hand-rubbed oak cabinet complete with portable cover.

\$4750
NET



**Superior's New
Model TD-55**

FOR TUBE TESTER

The Experimenter or Part-time Serviceman, who has delayed purchasing a higher priced Tube Tester. The Professional Serviceman, who needs an extra Tube Tester for outside calls. The busy TV Service Organization, which needs extra Tube Testers for its field men.

Speedy, yet efficient operation is accomplished by:

1. Simplification of all switching and controls.
2. Elimination of old style sockets used for testing obsolete tubes (26, 27, 57, 59, etc.) and providing sockets and circuits for efficiently testing the new Noval and Sub-Minar types.

You can't insert a tube in wrong socket

It is impossible to insert the tube in the wrong socket when using the new Model TD-55. Separate sockets are used, one for each type of tube base. If the tube fits in the socket it can be tested.

"Free-point" element switching system

The Model TD-55 incorporates a newly designed element selector switch system which reduces the possibility of obsolescence to an absolute minimum. Any pin may be used as a filament pin and the voltage applied between that pin and any other pin or even the "top-cap."

Checks for shorts and leakages between all elements

The Model TD-55 provides a super sensitive method of checking for shorts and leakages up to 5 Megohms between any and all of the terminals. Continuity between various sections is individually indicated. This is important, especially in the case of an element terminating at

more than one pin. In such cases the element or internal connection often completes a circuit.

Elemental switches are numbered in strict accordance with R.M.A. specification.

One of the most important improvements, we believe, is the fact that the 4 position fast-action snap switches are all numbered in exact accordance with the standard R.M.A. numbering system. Thus, if the element terminating in pin No. 7 of a tube is under test, button No. 7 is used for that test.

The Model TD-55 comes complete with operating instructions and charts. Housed in rugged steel cabinet. Use it on the bench — use it for field calls. A streamlined carrying case, included at no extra charge, accommodates the tester and book of instructions.

\$2695
NET

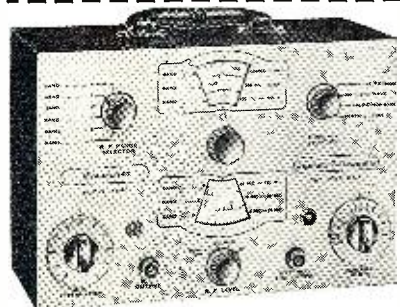

**Superior's New
Model TV-50**

GENOMETER

A versatile all-inclusive GENERATOR which provides ALL the outputs for servicing:
A. M. Radio • F. M. Radio • Amplifiers • Black and White TV • Color TV

7. Signal Generators in One!

- ✓ R.F. Signal Generator for A.M.
- ✓ R.F. Signal Generator for F.M.
- ✓ Audio Frequency Generator

- ✓ Bar Generator
- ✓ Cross Hatch Generator
- ✓ Color Dot Pattern Generator
- ✓ Marker Generator

R. F. SIGNAL GENERATOR: The Model TV-50 Genometer provides complete coverage for A.M. and F.M. alignment. Generates Radio Frequencies from 100 Kilocycles to 60 Megacycles on fundamentals and from 60 Megacycles to 180 Megacycles on powerful harmonics.

VARIABLE AUDIO FREQUENCY GENERATOR: In addition to a fixed 400 cycle sine-wave audio, the Model TV-50 Genometer provides a variable 300 cycle to 20,000 cycle peaked wave audio signal.

BAR GENERATOR: The Model TV 50 projects an actual Bar Pattern on any TV Receiver Screen. Pattern will consist of 4 to 16 horizontal bars or 7 to 20 vertical bars.

CROSS HATCH GENERATOR: The Model TV-50 Genometer will project a cross-hatch pattern on any TV picture tube. The pattern will consist of non-shifting horizontal and vertical lines interlaced to provide a stable cross-hatch effect.

MARKER GENERATOR: The Model TV-50 includes all the most frequently needed marker points. The following markers are provided: 189 Kc., 264.5 Kc., 456 Kc., 600 Kc., 1000 Kc., 1400 Kc., 1600 Kc., 2000 Kc., 2500 Kc., 3579 Kc., 4.5 Mc., 5 Mc., 10.7 Mc., (3579 Kc. is the color burst frequency.)

THE MODEL TV-50 comes absolutely complete with shielded leads and operating instructions.

\$4750
NET

DOT PATTERN GENERATOR (FOR COLOR TV): Although you will be able to use most of your regular standard equipment for servicing Color TV, the one addition which is a "must" is a Dot Pattern Generator. The Dot Pattern projected on any color TV Receiver tube by the Model TV-50 will enable you to adjust for proper color convergence.

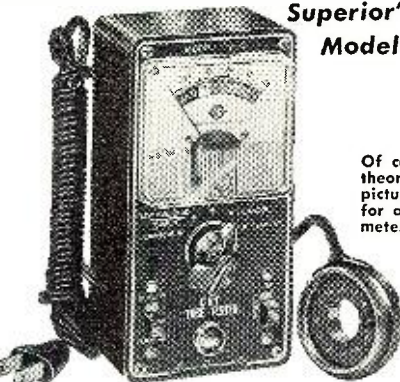

**Superior's New
Model TV-40**

PICTURE TUBE TESTER

NOT A GADGET—NOT A MAKE-SHIFT ADAPTER, BUT A WIRED PICTURE TUBE TESTER WITH A METER FOR MEASURING DEGREE OF EMISSION—AT ONLY \$15.85

Of course you can buy an adapter for about \$5—which theoretically will convert your standard tube tester into a picture-tube tester; or a neon type instrument which sells for a little more and is supposed to be "as good as" a metered instrument. Superior does not make nor do they

recommend use of C.R.T. adapters or neon gadgets because a Cathode Ray Tube is a very complex device, and to properly test it, you need an instrument designed exclusively to test C.R. Tubes and nothing else.

Tests ALL magnetically deflected tubes . . . in the set . . . out of the set . . . in the carton!!

- Tests all magnetically deflected picture tubes from 7 inch to 30 inch types.
- Tests for quality by the well established emission method. All readings on "Good-Bad" scale.
- Tests for inter-element shorts and leakages up to 5 megohms.
- Test for open elements.

EASY TO USE: Simply insert line cord into any 110 volt A.C. outlet, then attach tester socket to tube base (Ion trap need not be on tube). Throw switch up for quality test . . . read direct on Good-Bad scale. Throw switch down for leakage tests.

Model TV-40 C.R.T. Tube Tester comes absolutely complete—nothing else to buy. Housed in round cornered, molded bakelite case. Only

\$1585
NET

EXAMINE BEFORE YOU BUY!
USE APPROVAL FORM ON NEXT PAGE

25 WORDS

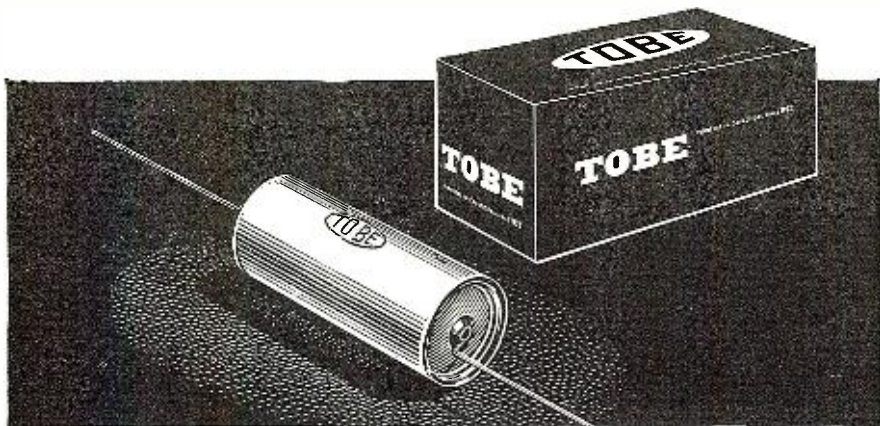

Tell Why You Like Tobe Service Capacitors

Your 25 words can win the Ford Ranch Wagon

And Here Are the TSC* Features to Help You Win • No standard materials can possibly enter the manufacture of TOBE SERVICE CAPACITORS, because *everything* is quality-checked beforehand • Highest grade dielectric materials prevent voltage breakdown in service • TSC's are designed for high-temperature operation — will not dry out or deteriorate in service • Copperweld leads soldered directly to foil insure you against opens • Moisture-tight seals guard against shorts • Pigtail leads will not pull out or break off • No danger of hot soldering iron opening internal connection or melting sealing compound • TSC's will maintain specified capacity over entire operating temperature range • TSC's receive 100% quality-control inspection prior to shipment • Continuous production-line testing automatically rejects "duds" • Maintenance of large inventories on complete line means faster delivery to your TOBE DISTRIBUTOR and you.

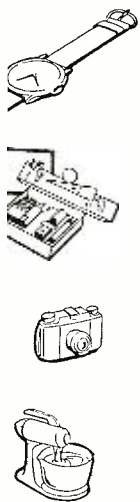

TOBE
RADIART
CAPACITORS

be Service Capacitors



Tobe Deutschmann Corporation, Dept. C
2900 Columbia Avenue, Indianapolis 5, Indiana

"I prefer Tobe Service Capacitors in my work because _____

NAME _____

ADDRESS _____

CITY _____ ZONE _____ STATE _____

I enclose a Tobe boxtop

Although the "Q" may be low enough in a particular circuit, that is not enough assurance by itself that bypass action is adequate. The center frequency of the series-resonant circuit should be in the center of the band to be bypassed, or nearly there. Otherwise the bypass action at extremes of the band (near sound and pix carrier, for example) may be different. Where necessary, the center frequency may be "adjusted" by moving the bypass capacitor to or away from the chassis. If this measure fails, the wire leads may be made longer or shorter. Be sure to do this ever so sparingly, observing the results after each change. Even paralleling one wire lead with another may be enough to lower the inductance and raise the frequency by a sufficient amount.

These hints should enable a service technician to handle the cases of trouble he may encounter with series-resonant bypassing. It is particularly advisable to have a few series-resonant bypass capacitors handy for cooling down hot radio sets not amenable to otherwise "kind" treatment. —30—

AMPLIFIER SWITCHING

By JAMES F. SUTHERLAND

WITH higher wattage hi-fi power amplifiers becoming more common, the ordinary methods of switching the system on and off with a switch incorporated in the volume control on the preamp panel may become inadequate.

Even with elaborate shielding, well filtered plate-voltage supplies, d.c.-powered heaters, and a good ground, hum can be a problem due to the fact that all of the input a.c. power must pass through the "on-off" switch which is usually located close to the high-gain stages of the preamp.

An ideal switching system would eliminate all sources of hum noise in the preamp. One "humless" method of switching the incoming line current to the hi-fi power amplifier from a remote preamp panel is shown in the diagram below.

Closing the relay coil circuit momentarily with S₁ causes the relay contacts to energize the main power transformer. Pushing S₁ a second time turns the system off since RL₁ alternately opens and closes its contacts with each successive pulse.

The total cost of parts for this system is approximately \$7.00. The small 24-volt transformer and ratchet relay can be mounted either under the power amplifier chassis or on a separate small chassis. —30—

Circuit for switching a high power hi-fi amplifier on or off without causing hum.

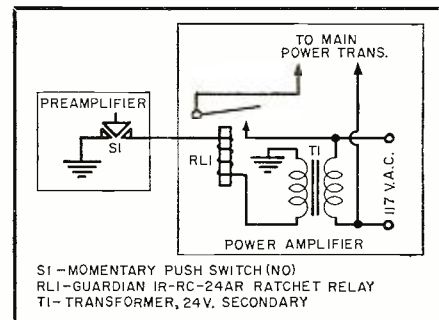

nician must service, then it is high time he becomes thoroughly familiar with its possibilities, its limitations, and its general behavior.

"As far as transistors are concerned, I believe that time is right now. We both, of course, have kept abreast of the theory and general development of transistor circuits through the fine magazine articles that have been published on the subject, and we have had no trouble taking care of the few transistor radios that have drifted into the shop so far; but from here on in we can expect to meet transistors more and more often. Now is the time to get any special equipment needed to service transistorized equipment, and now is the time to start getting all the practical experience we can with transistors. What's happened to your beagle instincts? Over there on the end of the bench is a new transistor-tester you haven't even noticed yet!"

"Well so it is! I have read, though, that transistors fail very seldom as long as they are not abused. In fact, it is said that in a tube set that won't work, the first thing you suspect is a bad tube; but in a transistor set, the transistors themselves are the last thing to test."

"That's probably true, but I expect to use the transistor tester in a lot of ways. For one thing, it is often necessary to use matched transistors and this tester will allow us to select such matched pairs. Also it will permit us to sort through our stock of transistors—pretty limited, I'll admit, at present—and select the best transistors for particular jobs. For example, we can sort out low-noise units for the front end of amplifier circuits, save the high-gain transistors for places where gain is important, and so on."

"The whole discussion makes pretty good sense," Barney admitted. "I was reading the other day where a Mr. Fancher of *General Electric* said that while transistors are used in only about 12% of new electronic equipment built this year, they will go into 80% of the equipment built in 1967. Looks like it's time we got on the bandwagon."

"Check! I'm also collecting all the transistor data I possibly can from the various manufacturers," Mac said as he waved at a new shelf on the wall. "Every one of them puts out some printed information on their products and various applications. These vary from simple characteristic leaflets to complete booklets on the theory of transistors, suggested circuits, etc. Every time I see something new is published I order it."

"I see some books on that shelf that are not concerned with transistors," Barney observed.

"That's right. I'm trying to select a bunch of books that will help us with the 'dogs.' Each book covers just a specialized portion of a circuit or piece

WIN THE FORD

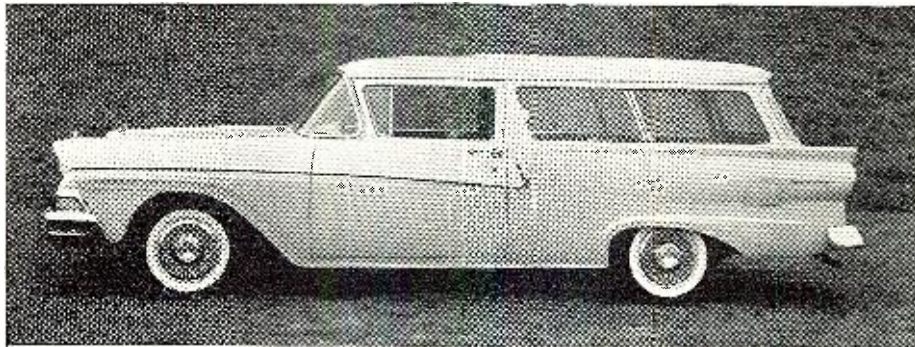

RANCH WAGON

Or one of 49 other valuable prizes



Here's all you do . . . In 25 words or less, tell us why you prefer TOBE SERVICE CAPACITORS.

Then, send your entry to us with the top from any TOBE capacitor carton, or the plastic box some TOBE capacitors are packed in.

That's all there is to it. Enter as many times as you wish, providing each entry is accompanied by a TOBE carton top or the plastic box. Use entry blank below. Additional entry blanks can be obtained from your TOBE DISTRIBUTOR.

Contest Closes May 30

Contest is open to all service-men over 21 years of age residing in the continental United States. Employees of the TOBE DEUTSCHMANN CORPORATION and their advertising agency are excluded. All entries become the property of TOBE DEUTSCHMANN CORPORATION. Decisions of the judges are final. In case of ties, duplicate prizes will be awarded. Contest closes May 30, 1958. Winners will be announced June 30th.

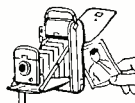

HERE'S YOUR
ENTRY BLANK



TOBE
RADIANT
CAPACITORS

Tobe Deutschmann Corporation, Dept. C
2900 Columbia Avenue, Indianapolis 5, Indiana

"I prefer Tobe Service Capacitors in my work because _____

NAME _____

ADDRESS _____

CITY _____ ZONE _____ STATE _____

I enclose a Tobe boxtop

QUALITY CUT QUARTZ FOR EVERY SERVICE

All crystals made from Grade "A" imported quartz—ground and etched to exact frequencies. Unconditionally guaranteed! Supplied in:

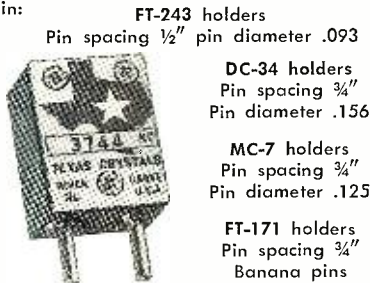

FT-243 holders

Pin spacing 1/2" pin diameter .093

DC-34 holders

Pin spacing 3/4"
Pin diameter .156

MC-7 holders

Pin spacing 3/4"
Pin diameter .125

FT-171 holders

Pin spacing 3/4"
Banana pins

MADE TO ORDER CRYSTALS

1001KC to 2500KC:

.01% Tolerance...\$1.75 .005% Tolerance...\$2.50

2501KC to 9000KC:

.01% Tolerance...\$1.50 .005% Tolerance...\$2.50
Specify holder wanted.

3500 KC hermetically sealed frequency marker crystal .005% tolerance fits octal tube socket . . . Special **\$1.00**

ANY AMATEUR BAND CRYSTAL
.05% Tolerance

NOVICE BAND CRYSTALS

80 meters 3701-3749KC
40 meters 7152-7198KC
15 meters 7034-7082KC

99c
each

6 METER TECHNICIAN BAND CRYSTALS

ASK YOUR LOCAL PARTS DISTRIBUTOR FOR TEXAS CRYSTALS . . . LOOK FOR YELLOW & RED DISPLAY BOARD.

SEALED OVERTONE CRYSTALS supplied in metal HC/6U holders—pin spacing .486, diameter .050.
10 to 30 MC .005 tolerance . . . \$3.85 ea.
30 to 54 MC .005 tolerance . . . \$4.10 ea.
55 to 75 MC .005 tolerance . . . \$4.25 ea.

STOCK OVERTONE CRYSTALS in FT-243 holders \$1.00. Frequencies listed in megacycles:

15.01	16.7	17.15	18.225
15.11	16.8	17.16	18.325
16.335	16.9	18.025	18.475
16.435	17.0	18.125	18.925

MARINE FREQUENCY CRYSTALS

All marine frequencies from 2000-3200KC
.005 tolerance . . . \$2.50
(Supplied in either FT-243, MC-7, or FT-171 holders.)

RADIO CONTROL CRYSTALS

27.255 MC sealed crystals (1/2" pin spacing . . . specify pin diameter .093 or .050) . . . \$2.50 ea.

Stock crystals in FT-243 holders from 5675KC to 8650KC in 25KC steps.50¢

FT-241 lattice crystals in all frequencies from 370KC to 540KC (All except 455KC and 500KC.)50¢
Matched pairs ±15 cycles \$2.50 per pair.

200KC Crystals . . . \$2.00 500KC Crystals . . . \$1.00
455KC Crystals . . . \$1.00

1000KC Frequency Standard Crystals . . . \$3.50
Dual Socket for FT-243 Crystals . . . \$.15
Ceramic socket HC/6U Crystals . . . \$.15

(Add 5¢ per crystal for postage and handling.)
WRITE FOR CATALOG AND QUANTITY PRICES.

Texas Crystals

The Biggest Buy in the U. S.

9538 W. GRAND AVENUE • RIVER GROVE, ILL.
ALL PHONES—GLADSTONE 3-3555

Terms: All items subject to prior sale and change of price without notice. All crystal orders MUST be accompanied by check, cash or M.O. WITH PAYMENT IN FULL. NO C.O.D.s. Postpaid shipments made in U.S. and possessions only. Add 3¢ per crystal for postage and handling charge.

of equipment. You'll find them on servicing sweep circuits, video circuits, a.g.c. systems, sync circuits, TV tuners, hi-fi systems, tape recorders, and record changers. When we get a real tough problem in the shop and know that the trouble must lie in a particular portion of the equipment, we need exhaustive information on the problem to make sure that we are not overlooking a possibility. That is where the books are well worth their cost. They provide a concentrated review of everything we should know about that particular circuitry or mechanism. I know from experience that leafing through one of these books can often spotlight a source of trouble I was completely overlooking. I intend to keep adding to that shelf. For example, I intend to get a book on color convergence procedures and another on industrial electronics as soon as I can."

"Good," Barney applauded. "I can see where reading through one of these books will be just like having someone say, 'Did you try this?' and 'Did you try that?' But where was your imagination when you built that shelf? Why didn't you build it in the shape of a dog house?"

All About Audio

(Continued from page 65)

that horn loading is much more efficient than other forms because it squirts out more concentrated sound. It is rather like taking a shower bath; the available jet of water must be nicely spread out for comfort.

It should be explained that these

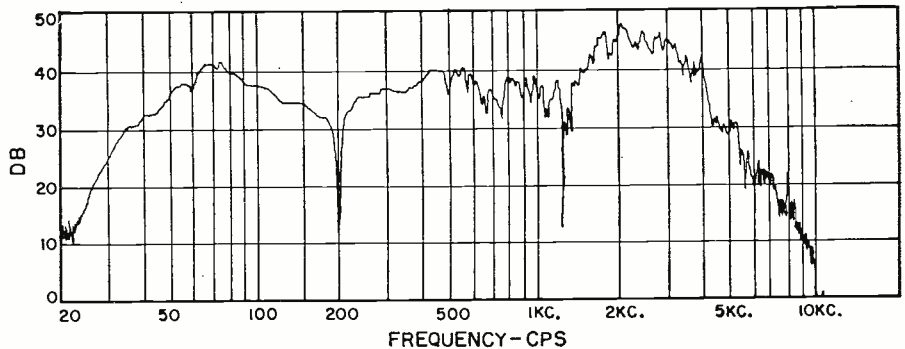

Fig. 46. Response curve of 15-inch loudspeaker unit in 9 cu. ft. corner reflex enclosure which has been constructed with sand-filled panels. The input level was 2 watts and the microphone distance was 4 ft. on axis, and 3 ft. above ground.

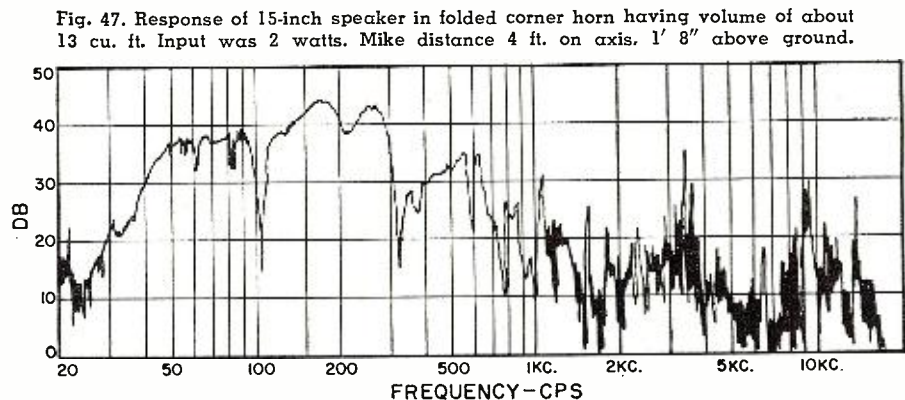

Fig. 47. Response of 15-inch speaker in folded corner horn having volume of about 13 cu. ft. Input was 2 watts. Mike distance 4 ft. on axis, 1' 8" above ground.

tests were made with a front-loading horn, the output from the back of the cone being purposely absorbed. Results would have been quite different with a back-loading horn, where the output from the front of the cone plays straight into the room. The axial response curve above 1000 cycles, for what it is worth, would then be similar to Fig. 46 but it would *not* be horn loading.

For ordinary listening, I would say that, by and large, horn loading gives more output than reflex cabinets, offset to some extent by directional effects when tests are extended to higher frequencies and shorter horns, where open baffles would be used in preference to reflex enclosures. The over-all difference is nothing like the off-quoted 40% efficiency for horns with less than 10% for other systems.

Using the models of Figs. 46 and 47 as the bass end of a 3-speaker system, I liked the reproduction from either and found it difficult to express a definite preference.

Conclusion

We now reach a conclusion with which we can all agree, for I mean only that we have come to the end of the series. Mr. Cooke joins me in saying that it has been a great pleasure writing for RADIO & TV NEWS and we hope to have succeeded in expressing our views without treading on too many American toes. As a matter of fact, we think very highly of much of the American hi-fi equipment and business would undoubtedly be more of a two-way traffic if the dollar and the pound were only at par. May the day soon come!

IT'S NEW! Send for this

FREE

booklet today!

see

what the

rapidly

expanding

field of

ELECTRONICS

offers

you

- BETTER JOB
- BETTER PAY
- PROMOTION
- GREATER SECURITY
- GREATER CONFIDENCE
- BETTER LIVING FOR YOU AND YOUR FAMILY

All these benefits can be yours if you act now! Take that first big step this minute—No obligation whatsoever! Please fill out the coupon completely.

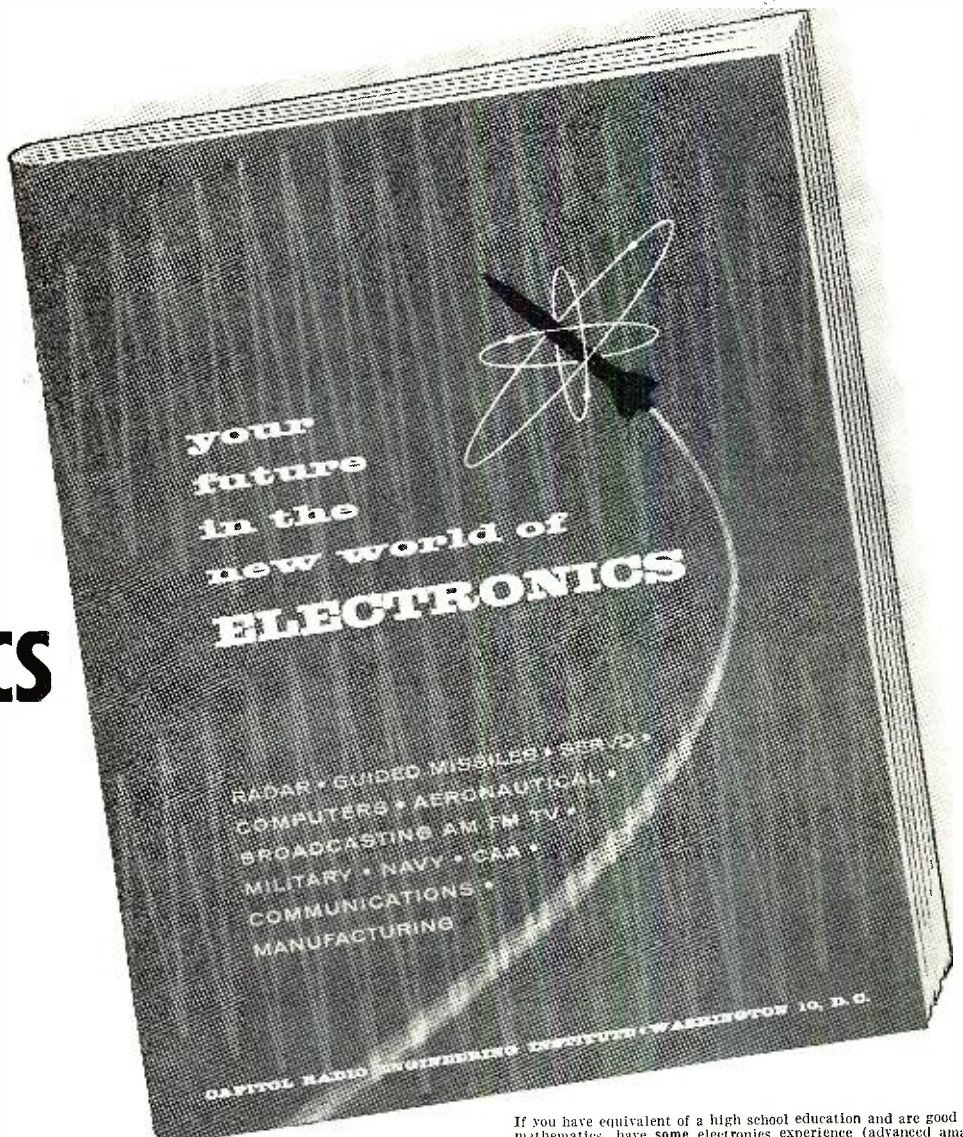

If you have equivalent of a high school education and are good at mathematics, have some electronics experience (advanced amateur, military or industrial)—you can qualify for CREI home study training. (Electronic experience is not required for admission to CREI Residence School.) Mail coupon today, or write Capitol Radio Engineering Institute, Dept. 113-Y, 3224 16th St. N.W. Washington 10, D. C.

TAKE A MINUTE TO MAIL THIS COUPON FOR FREE BOOKLET !

CAPITOL RADIO ENGINEERING INSTITUTE

ECPD Accredited Technical Institute Curricula—Founded 1927
Dept. 113-Y, 3224 16th St., N.W., Washington 10, D. C.

Please send me your course outline and FREE Illustrated Booklet "Your Future in the New World of Electronics" . . . describing opportunities and CREI home study courses in Practical Electronic Engineering Technology.

- CHECK FIELD OF GREATEST INTEREST
- Radar, Servo and Computer Engineering Technology
 - Electronic Engineering Technology
 - Broadcast (AM, FM, TV) Engineering Technology
 - Television Engineering Technology
 - Aeronautical Electronic Engineering Technology

Name Age

Street

City.....Zone..... State.....

CHECK: Home Study Residence School Korean Veteran

To help us answer your request intelligently, please give the following information:

EMPLOYED BY.....

TYPE OF PRESENT WORK.....

EDUCATION: YEARS HIGH SCHOOL.....

YEARS COLLEGE.....

ELECTRONICS EXPERIENCE.....

Basic Electronic Counting

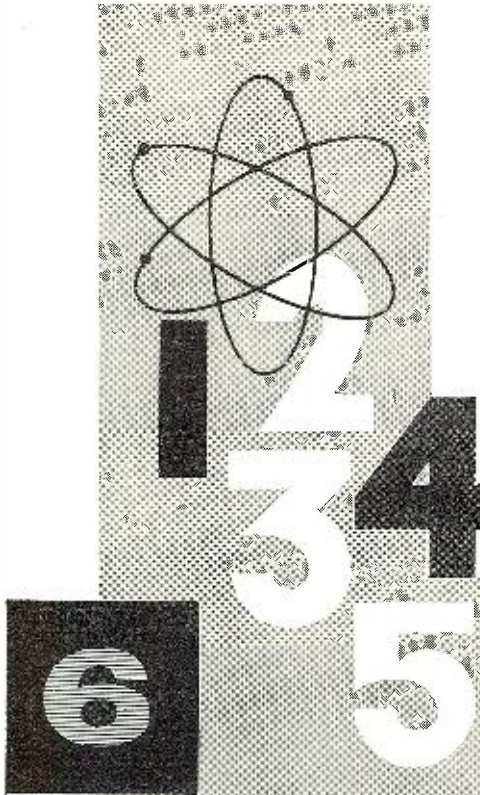

By **ED BUKSTEIN**

Northwestern Television & Electronics Institute

A technician's introduction to binary notation, an important digital technique in computer work.

AT ONE TIME, binary numbers were relegated to an obscure little corner in the basement of mathematics and were of concern only to a few cloistered mathematicians whose interest in such numbers was largely academic. Today, the binary numbering system is used extensively in computers, electronic counters, and automation equipment.

In the decimal numbering system, each digit of a number may have any of ten different values: 0, 1, 2, 3, 4, 5, 6, 7, 8, or 9. For example, 743,297 is a number expressed in the decimal system. In the binary numbering system, each digit of a number may have either of two values: 0 or 1. For example, 1101011110 is a number expressed in binary notation.

In the decimal system, the relative positions of the digits determine the value of a number. The right-hand digit represents "ones," the next digit

to the left represents "tens," the next digit represents "hundreds," the next "thousands," etc. The decimal number 4632 therefore means 4 thousands, 6 hundreds, 3 tens, and 2 ones. In binary notation, the relative positions of the digits also determine the value of a number. The right-hand digit represents "ones," the next digit to the left represents "twos," the next digit represents "fours," the next "eights," etc. The value of each position is double that of the position to the immediate right. The binary number 10111 therefore means sixteen and four and two and one. This system of positional values is illustrated in Fig. 2. The binary equivalents of several decimal numbers are given in Table 1, for illustration.

In any machine used for counting or computing, each digit of a number is represented by a circuit or component. Fig. 3 shows how a group of switches, for example, can be used to represent either decimal or binary numbers. When the numbers are to be expressed in decimal notation, each switch (or circuit) must be able to represent any of ten different conditions, as in Fig. 3A. When binary notation is used, however, each switch (or circuit) need be capable of representing only two different conditions, as in Fig. 3B. The resulting simplicity of the required circuitry is the reason for preference of binary notation in com-

puting and counting devices. Some computers are designed to work with decimal numbers, but even in these machines each digit of the decimal number is usually represented by its binary equivalent.

Manually operated switches like those shown in Fig. 3 are not often used in practice, because it is desirable to make the operation of the circuit as nearly automatic as possible. Relays and stepping switches are used only sparingly because they cannot operate at the speeds normally required. Each switch shown in Fig. 3 would therefore be replaced by an electronic circuit. A circuit to replace each ten-position switch shown in Fig. 3A would require ten tubes (with some refinements, the number of tubes could be reduced). Each binary switch of

Table 1. The binary equivalent of any decimal number is expressed as a series of "ones" and "zeros," as explained in text, with each "one" representing a given value according to its position. For illustration, several decimal numbers are given here with binary equivalents, showing derivation of the latter.

DECIMAL	BINARY	INTERPRETATION OF BINARY
5	101	1 + 4
7	111	1 + 2 + 4
12	1100	4 + 8
22	10110	2 + 4 + 16
35	100011	1 + 2 + 32
105	1101001	1 + 8 + 32 + 64

EDITOR'S NOTE: With the mushroom growth of computer technology, there has been a continuing demand for qualified personnel in this field on all levels. Unfortunately, of the meager sources of information in this area, most are quite specialized or on an advanced technical level. This article is a straightforward treatment of a system of counting, different from the one with which we are familiar, that has become a basic digital technique. It is used because it happens to suit those electronic circuits that can be adapted to counting. The basic counting circuit is also indicated. Are you interested in more articles of this type? Let us hear from you.

Fig. 3B however, could be replaced by a circuit using only one double triode. This circuit, the flip-flop, is shown in Fig. 1. This same circuit is sometimes referred to as a binary scaler, bi-stable multivibrator, or Eccles-Jordan circuit.

Like the two-position switch which it replaces, the flip-flop circuit has two conditions: off and on. When the left-hand triode is cut off and the right-hand triode is conducting, the circuit is said to be in the off or zero condition. When the circuit is in the opposite state—left-hand tube conducting and right-hand tube cut off—it is said to be in the on or one condition.

In many types of instruments, it is necessary to determine (without removing the instrument from its case) whether the flip-flop is in the zero condition or the one condition. For this purpose, a small neon indicator is mounted on the panel of the instrument and connected in the circuit as shown in Fig. 1. When the circuit is in the zero condition, the left-hand tube will be cut off and the neon lamp will be dark. However, when the circuit is in the one condition, the left-hand tube will be conducting and the neon lamp will glow.

In the flip-flop circuit shown in Fig. 1, each plate is coupled, through a resistor, to the opposite grid. It is for this reason that one tube will conduct when the other tube is cut off. If, for example, the left-hand tube is cut off,

its plate voltage will be high. This high voltage, applied through the coupling resistor to the grid of the right-hand tube, causes the right-hand tube to conduct. If a negative pulse is now applied to the input, the right-hand grid will be driven to cut-off and the plate voltage of this tube will rise. This increase of voltage, applied through the coupling resistor, will now cause the left-hand tube to conduct. The circuit therefore reverses its condition each time it receives an input pulse. If the circuit is in the zero condition at the start, it will switch to the one condition when an input pulse is applied. A second input pulse will switch it back to the zero condition, a third input pulse switches it to the one condition again, and so on.

The circuit is quite similar to the cathode-coupled multivibrator used as the vertical or horizontal oscillator in many television receivers. In such sets, however, components are chosen to provide time constants that will alternately cause each of the triode sections to cut off and conduct, even when no pulse is applied. Thus, a free-running oscillator is obtained whose frequency depends on the time constants chosen. In the flip-flop circuits used for counting, the triodes retain their condition of cut-off or conduction until they are signaled to change by an input pulse.

It is apparent that a group of circuits like the single one shown in Fig.

1 can be used to represent a binary number. For example, the binary number 1011 can be represented (stored) in a group of four flip-flops with the first, second, and fourth circuits in the one condition, and the third circuit in the zero condition. (The first circuit corresponds to the right-hand digit of the binary number.) In computer work, a group or bank of flip-flop stages is known as a register.

The bank of six flip-flop stages shown in Fig. 4 can be used to store any binary number from 000000 to 111111. The six neon lamps in these circuits can be used to indicate the decimal equivalent of the binary number stored. This is accomplished by assigning a value to each light. These values are often printed on the panel of the instrument as shown in Fig. 4. The lights, starting with the first circuit, are assigned values of 1, 2, 4, 8, 16, and 32. The decimal equivalent of the binary number stored in the flip-flops is determined by adding up the assigned values of the lights that are on. For example, if the binary number 110101 is to be stored in the flip-flops, an input pulse would be applied to the first, third, fifth, and sixth stages, assuming that all stages started in the zero condition. The lights in these stages will now be on and their assigned values (1, 4, 16, and 32) add up to 53, which is the decimal equivalent for binary number 110101. —50—

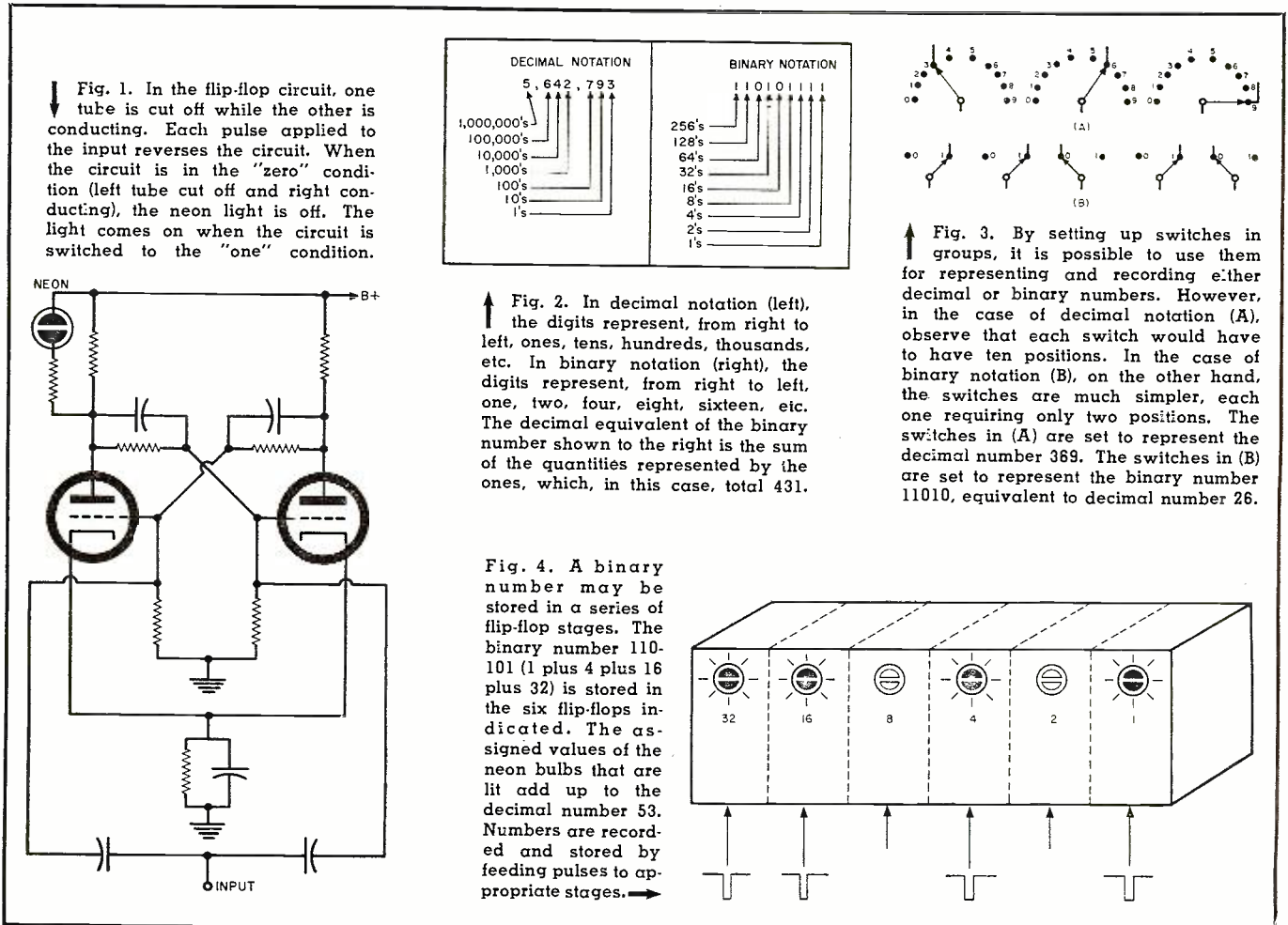



Brand New!

No matter what part of radio, electronic, communications or electrical work you plan to do, this is the most important training of all.

Complete training in **BASIC ELECTRICITY**

Your key to Success
in Radio-Electronics

Includes BASIC ELECTRONICS

... general and industrial ... even covers transistors and their uses.

BRINGS YOU THE COMPLETE "KNOW HOW" OF: Circuits & Currents; Controls; Electromagnetism; Capacitance; Inductances; Resistance; Phase Relations; Generators; Motors; Transformers; Rectifiers; Wiring; Illumination; Instruments & Measurements; Tubes; Amplifiers; Oscillators; Transistors; Industrial Electronics & Automation; X-Rays; Power Factor; Servos ... and dozens more.

All electrical equipment from industrial units to TV sets; from guided missile controls to hi-fi systems are based on the same fundamental electrical principles.

Learn these principles thoroughly ... and then everything else comes 10 times as easy!

You'll understand new circuits and new equipment in a jiffy. You'll have a firm grasp of ALL electrical-electronic matters that will amaze you. And you'll be far better fitted for interesting, good-paying jobs along almost any electrical line. Rufus Turner's new 396-page **BASIC ELECTRICITY** manual brings you the kind of practical training that can pay off in a dozen different ways!

From basic currents and circuits to electromagnetism ... from polyphase systems to oscilloscopes ... right down the line to transistors, tubes, sound reproduction and even telemetering, **BASIC ELECTRICITY** covers the entire field.

Training That Shows You How!

300 pictures make things doubly clear!

You get practical examples of reactance, phase relations, impedance ... even power factor. You see how and why to make measurements by various methods. "Set up" diagrams teach you to extend meter ranges or to measure speed, strain, thickness, etc. Essentials such as motors, generators, batteries, etc., are fully covered. Complicated controls are explained ... with no need for advanced mathematics to understand them.

Send coupon! You be the judge without risking a cent!

10-DAY FREE EXAMINATION

Dept. RN-38, RINEHART & CO., INC.
232 Madison Ave., New York 16, N. Y.

Send Turner's 396-page **BASIC ELECTRICITY** manual for 10-day **FREE EXAMINATION**. If book is satisfactory, I will then send you \$6.50 (plus postage) promptly in full payment. If not, I will return book within 10 days and owe nothing. (Save! Send \$6.50 with order and we pay postage. Same 10-day return privilege with money refunded.)

Name

Address

City, Zone, State.....

OUTSIDE U.S.A.—Price \$7.00 cash with order. Money back if you return book within 10 days.

Facts about Vertical Sweep

(Continued from page 53)

pedance is concerned. When this discharge circuit is opened, the oscillator takes off at a much higher speed, sometimes as high as 1500 cps. It is such an unusual effect that if the technician has never encountered it, it is worth while clipping the circuit open on a set on the bench, just to observe the resulting confusion and make it more easily recognizable in the future. No amount of description is as effective as actually seeing it.

Poor Noise Immunity

The .01- μ fd. capacitor connected to the junction of the integrator and the blocking transformer sometimes causes one of those faults which are so evasive that it isn't at all certain whether or not the trouble is really there at all. With this capacitor open, the set will often have better-than-normal lock when no electrical interference is present—but incoming pulses of noise easily cause the picture to jump or jitter vertically. Although this capacitor is a bypass device, it should not be replaced merely with one "at least as big" as the original. Experiment will show that, if the replacement is of too high a capacity, lock will not be satisfactory; whereas, if it is too small, noise immunity will be poor. If this unit is completely open, horizontal pulses may be picked up on the wiring between integrator and transformer. These will disrupt interlace.

Another capacitor which does a rather unobtrusive job is the bypass across the output winding of the vertical-output transformer. This component, too, is concerned with preventing pulses from the horizontal winding of the yoke being induced into the vertical winding, thus making interlace difficult or impossible.

Loss of Retrace Blanking

The .02- μ fd. capacitor and 33,000-ohm resistor connected to the "hot" side of the yoke in Fig. 3 convey a pulse to the grid of the picture tube. This pulse momentarily drives the tube into cut-off while vertical retrace is occurring. If the circuit goes open, blanking is accomplished only by the blanking pedestal of the signal waveform. Then, if the contrast is adjusted lower than normal, faint white lines appear diagonally across the picture, often described by a viewer as "like telephone lines curving down across the screen." Some older receivers do not have a retrace-blanking circuit at all and it is a worthwhile improvement to add when the set is on the bench.

Use of the Blanking Bar

No discussion of the vertical section is complete without a reference to the appearance of the vertical blanking bar, and the ways in which it can be used by the technician.

Fig. 6. shows the appearance of a

normal vertical-sync pulse in the blanking bar. Contrast has been reduced to make the pulse visible. Clean and regular shape of this sync pulse shows that a clean ghost-free signal is arriving at the antenna terminals and is being passed undistorted through the signal portions of the set right to the picture-tube input. If the set is in good shape in the sync section, the picture should lock positively and stay stable when the pulse looks like this. If, on the other hand, the sync pulse is unrecognizable due to smearing, ghosting, or white lines trailing the black, then, although the sync portion of the receiver may be in good condition, it may be impossible to lock the picture. It should be noted that trouble in the signal part of the set can obscure the pulse as displayed on the picture tube, even though a clean, sharp signal may be coming from the antenna.

It is well known that, in the absence of a test pattern, observation of the width of the blanking bar at different parts of the raster as the picture rolls will give a fair indication of linearity adjustment. Not so well known is the fact that, by advancing the contrast control until the blanking bar just obscures the sync pulse, the contrast can be correctly set up irrespective of whether or not the program material is of good contrast. The technician should remember that the blanking bar represents 100% black level. Knowledge of this fact will, for example, enable a technician to set up a receiver in a store window in full daylight, knowing his adjustment will be correct to show a perfect picture when the sun goes down. If it is known how to use the blanking bar to adjust contrast and brightness, it is not necessary to wait for a test pattern or for a well-transmitted program before attempting final adjustment when leaving a repaired receiver in the customer's hands. A little instruction to the viewer on this technique is not out of place, as it will help him avoid the common mistake of running his set with too much contrast, thus obscuring detail in the shadows of the picture.

Fig. 7 illustrates a case where the blanking bar shows contrast level to be correct, although there is nothing resembling black in the picture detail itself.

Another simple yet useful tip is that the blanking bar can be used as an easy-to-see indication that the picture is level, when setting up the yoke.

Complete absence of scan has not been covered here, as this is usually due to an obvious and straightforward type of failure, relatively easy to troubleshoot. It is, however, worthwhile to mention one fault which occurs sometimes when a minute break appears in the grid winding of a vertical blocking transformer, causing absence of scan when the set is cold. The set sometimes resumes normal operation when it is warm, due to expansion of the wire bringing the broken ends into physical contact. —50—

FREE

LAFAYETTE'S 1958 CATALOG

The Complete Catalog Featuring
"The Best Buys In The Business"

Send for Lafayette's 1958 Catalog—the most complete, up-to-the-minute electronic supply catalog crammed full of everything in electronics at our customary down-to-earth money-saving prices.

Depend on LAFAYETTE for all of your needs . . . complete stocks—immediate shipment—personal technical assistance—proven dependability.



FOR THE NEWEST AND FINEST IN

- Hi-Fi Components and Systems
- Exclusive Lafayette Transistor Kits
- Largest Supplies of Transistors and Miniature Components
- Tape Recorders and Stereophonic Equipment
- Public Address Components and Systems
- Radio and TV Tubes, Parts and Antennas
- Industrial Electronic Supplies and Equipment
- Binoculars, Telescopes and Microscopes
- Amateur Receivers and Transmitters

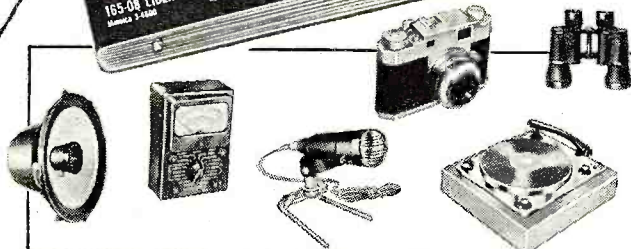

FEATURING

The most extensive line of Lafayette's own kits—providing the greatest value in easy-to-build kits at the lowest prices. In addition to hi-fi amplifier, pre-amplifier and stereo tuner kits, Lafayette makes available the largest selection of transistor kits anywhere.

LEADERS IN HI-FI

The most complete selection and largest stocks of hi-fi components and systems—available for immediate delivery at the lowest possible prices. Save even more on Lafayette endorsed "best-buy" complete systems.

CONTAINS HUNDREDS OF EXCLUSIVE LAFAYETTE ITEMS NOT AVAILABLE IN ANY OTHER CATALOG OR FROM ANY OTHER SOURCE — SEND FOR YOUR COPY NOW!

A "must" for the economy-minded hi-fi enthusiast, experimenter, hobbyist, engineer, technician, student, serviceman and dealer.

Ow
38th

Year



165-08 LIBERTY AVE. JAMAICA 33, N.Y.
Jamaica 3-4600 Open FRIDAY 'till 8:45 P.M.



The World's Greatest Electronics, Radio, T.V. and Hi-Fi Center

CUT OUT
AND MAIL
TODAY

send for the world's leading electronic,
radio, t.v., industrial, and hi-fi guide

FREE

LAFAYETTE RADIO, DEPT. RC
P. O. BOX 511, JAMAICA 31, N. Y.

Send FREE LAFAYETTE Catalog 305

Name

Address

City..... Zone..... State.....

Other locations

NEW YORK, N.Y. 100 6th Ave. REctor 2-8600 open THURSDAY 'till 8:45 P.M.	BOSTON, Mass. 110 Federal St. HUbbard 2-7850 open MONDAY 'till 8:45 P.M.	BRONX, N.Y. 542 E. Fordham Rd. FOrdham 7-8813 open THURSDAY 'till 8:45 P.M.	NEWARK, N.J. 24 Central Ave. MArket 2-1661 open WEDNESDAY 'till 8:45 P.M.	PLAINFIELD, N.J. 139 W. 2nd St. PLAINfield 6-4718 open THURSDAY 'till 8:45 P.M.
---	--	---	---	---

Exclusive Lafayette Money-Saving Values



MODEL PK-225

SPECIAL MONEY-SAVER COMBINATION

PK-225 Turntable, PK-90 12" Tone Arm, New GE VRII Series Triple-Play Cartridge Model 4G-052 with Genuine GE Diamond and Sapphire Styli. **SPECIAL!** Net 81.50

PROFESSIONAL TURNTABLE WITH HYSTERESIS-SYNCHRONOUS MOTOR

The Lafayette Model PK-225 is a true hysteresis-synchronous motor and is free from speed variations due to fluctuations in line voltage, load and temperature. It is the smoothest type known, completely free from "cogging" (the minute variations of speed which show up as waw and flutter)!

ONLY LAFAYETTE'S HYSTERESIS-SYNCHRONOUS MOTOR, in its price class, is made to extremely fine tolerances (on the order of .00001 inches)! Only Lafayette's motor has 16 cores; a high permeability rotor magnet, ball thrust bearings, oilite sleeve bearings plus felt oil reservoir, cooling fins as an integral part of the rotor and a hollow rotor core for maximum efficiency and minimum heat. Only Lafayette's motor can be oiled from above, without disassembly, through a unique oil feed system. Only Lafayette's motor has a self-aligning armature.

Here's THE turntable—the last word in professional high-fidelity performance! A fine precision instrument in every sense. Just look at some of these **OUTSTANDING FEATURES:- WOW AND FLUTTER:** Less than 0.2%. • **TURN-TABLE:** Heavy, diecast aluminum. Lathe-turned for perfect balance and concentricity. 12" diameter—weighs approx. 4 lbs. and provides amazingly constant speed; the extra-heavy rim acts just like a flywheel to prevent speed variations • **TRUE-HYSTERESIS-SYNCHRONOUS MOTOR:** For smooth, low-noise, wow- and flutter-free operation • **RUMBLE: AND NOISE:** 50db below average recorded level • **INTEGRATED SPEED CONTROL:** For all 3 speeds—78, 45 and 33 1/3 rpm • **2 OVERSIZE, HEAVY DUTY IDLERS:** Precision-ground; provide positive constant-speed rim drive • **SINGLE BALL THRUST BEARING:** Turntable rides smoothly over ball bearing floating on a thin film of oil • **FREE FLOATING, SHOCK-MOUNTED MOTOR** • **RUBBER CUSHION SHOCKMOUNTS** • **AUTOMATIC IDLER DISENGAGEMENT** • **CORK AND RUBBER MAT** • **STAINLESS STEEL PRECISION SPINDLE** • **POWER REQUIREMENTS:** For 105-130 volts, 60 cps AC; draws 16 V.A. • **ACCESSORIES SUPPLIED:** 45 RPM adapter, Strobe disc • **SIZE:** 2 1/8" above and 4" below motor board; 1 3/4" deep x 12 1/4" wide • **SHIPPING WEIGHT:** 16 lbs.

Deluxe Woodbase for PK-225 and 12" Tone Arm (Specify Finish). Shpg. wt., 13 lbs. Net 14.95
 Deluxe Woodbase for PK-225 and 16" Tone Arm (Specify Finish). Shpg. wt., 15 lbs. Net 15.95
LAFAYETTE MODEL PK-225 Net 64.50

VISCIOUS DAMPED TRANSCRIPTION TONE ARMS



PK-90—11.95

VISCIOUS DAMPED ARM

LICENSED UNDER CBS U. S. PATENT NO. 2676806



PK-17.95

VISCIOUS DAMPED ARM

LAFAYETTE MATCHED HIGH-FIDELITY PHONO SYSTEM

NOBODY BUT LAFAYETTE can bring you a phono system of this quality—and at this price. Indeed a Lafayette "best buy" system designed around the new Lafayette LA-69 20 watt amplifier. The performance of this phono system surpasses the most critical requirements of music lovers at a price below that of commercial phonographs. Twenty-four combinations of record equalization provide an almost endless variety of tone compensation to match varying recording characteristics. In addition to the LA-69 this system includes the famous Garrard RC-121 4-speed Record Changer featuring full automatic and manual positions and Simple-mix operation; the new improved VRII Variable Reluctance GE Triple Play Turnover Cartridge Model 4G-052 with genuine GE diamond and sapphire styli, and the celebrated Lafayette SK-58 12" Coaxial Hi-Fi Speaker. All units are supplied with plugs, jacks and prepared coded interconnecting cables for quick easy installation. For 110-125 volt, 60 cycle AC. Shpg. wt., 50 lbs.

HF-179—Complete Phono System.....Net 119.50

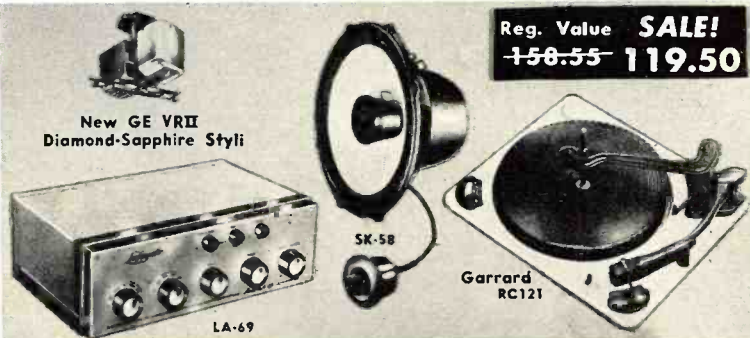

New GE VRII Diamond-Sapphire Styli

LA-69

SK-58

Garrard RC121

Reg. Value **SALE!**
~~158.55~~ 119.50

NEW 6 TRANSISTOR SUPERHET RECEIVER KIT

with LATEST NPN-PNP COMPLEMENTARY SYMMETRY CIRCUIT

- GE 2N188A AUDIO TRANSISTORS IN PUSH-PULL OUTPUT
- 100% SUBMINIATURIZED
- NEW 28 PAGE INSTRUCTION MANUAL

29.95
 Less Case and Battery

Newly revised Lafayette KT-119A 6 Transistor Superhet Kit uses latest GE NPN-PNP transistors in a complementary symmetry circuit to provide superior commercial quality with maximum sensitivity, selectivity and stability. Has matched set of 3 IF's, oscillator coil, hi-Q loop and efficient transformer coupling. Efficient 2" speaker and earphone jack for private listening. Complete with all parts, transistors, pre-punched chassis and new 28 page detailed instruction book. Size 8 1/2" x 3 1/2" x 1 1/2". Shpg. wt., 8 lbs.

KT-119A—Complete Kit-Less Case and Battery.....Net 29.95
 BATTERY—BURGESS 2N6.....Net 1.30
 MS-339A—Sturdy, attractive brown leather case with carrying strap for KT-119A Net 2.95
 MS-366—Sensitive matching earphone.....Net 1.29

3 TRANSISTOR SUPERHET POCKET RADIO KIT

- A TRUE POCKET SUPERHET RECEIVER
- NO EXTERNAL ANTENNA
- NO EXTERNAL GROUND

A remarkable sensitive, super-selective pocket superhet receiver with astonishing performance over the complete broadcast band. Uses 2 high-frequency and one audio transistor plus efficient diode detector and features 2 specially matched IF transformers for maximum power transfer. The components are housed in a professional looking beige plastic case. The receiver's appearance enhanced by attractive maroon and silver station dial. Sensitive built-in ferrite antenna eliminates need for external antenna. A designer's dream in a true pocket superhet receiver! Complete with all parts, transistors battery, case, dial and easy to follow step-by-step instructions. 4 3/8" x 2 5/8" x 1-1/16". Shpg. wt., 1 lb.

KT-116—Complete Kit, less earphone.....Net 16.95
 MS-260—Super Power Dynamic Earphone.....Net 3.95

Nationally Advertised

4-SPEED AUTOMATIC RECORD CHANGER

39.50 ~~59.50~~ Reg.

with NEW G.E. TURNOVER CARTRIDGE VRII and GENUINE G.E. DIAMOND SAPPHIRE STYLI

NOT A CLOSEOUT—NOT A DISCONTINUED Model, this is a nationally advertised, latest model record changer, with new GE VRII Series Triple Play Cartridge with G. E. Genuine diamond and sapphire styli and is priced so low that we DARE NOT mention the manufacturer's name. This fully automatic record changer has exclusive and deluxe features for the finest hi-fi systems, such as automatic intermix, muting switch, click filter and automatic shut-off after last record. Heavy duty 4-pole shaded pole motor with heavy rim-weighted turntable. 4 speeds, 78, 45, 33 1/3, 16-2/3 RPM. Negligible wow and flutter. We are so confident that you will be happy with this purchase, that if for any reason you do not feel you have received an exceptional value, we shall cheerfully refund your purchase price. Size 12 1/4" x 13 3/4", requiring 11/16" clearance above and 2-11/16" below motorboard. Shpg wt., 21 lbs.

PK-250 RECORD CHANGER (less woodbase) with NEW GE 4G-052 Diamond Sapphire Cartridge.....Net 39.50
 MAHOYAGAN OR BLONDE WOODBASE CUT TO FIT ABOVE
 PK-111—Specify Finish, Shpg. wt., 5 lbs. Net 3.95

Lafayette Radio 165-08 Liberty Ave. JAMAICA 33; N. Y.

NEW YORK, N.Y. 100 6th Ave. REctor 2-0600	BOSTON, Mass. 110 Federal St. HUBbard 2-7850	BRONX, N.Y. 542 E. Fordham Rd. FORDham 7-8813	NEWARK, N.J. 24 Central Ave. MARket 2-1661	PLAINFIELD, N.J. 139 W. 2nd St. PLAINfield 6-4718
---	--	---	--	---

INCLUDE POSTAGE WITH ORDER

New! YEARS AHEAD! Lafayette STEREO TUNER KIT

**THE MOST FLEXIBLE
TUNER EVER DESIGNED**

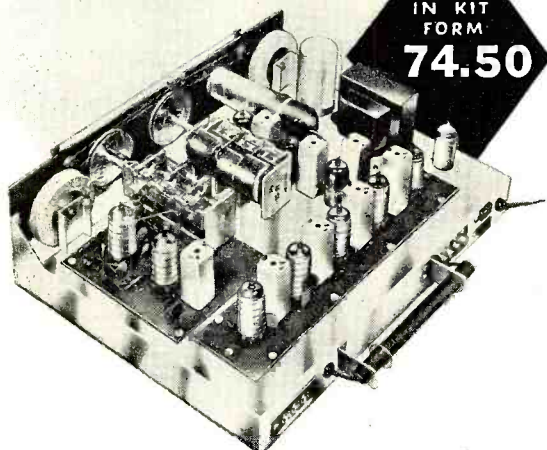

**KT-500
IN KIT
FORM
74.50**

Use it as a Binaural-Stereophonic FM-AM tuner
Use it as a Dual-Monaural FM-AM tuner
Use it as a straight Monaural FM or AM tuner

- 11 Tubes + Tuning Eye + Selenium Rectifier • 12 Tuned Circuits
- Dual Double-Tuned Transformer Coupled Limiters.
- Separately Tuned FM and AM Sections • Dual Cathode Follower Output
- Armstrong Circuit with FM/AFC and AFC Defeat

More than a year of research, planning and engineering went into the making of the Lafayette Stereo Tuner. Its unique flexibility permits the reception of binaural broadcasting (simultaneous transmission on both FM and AM), the independent operation of both the FM and AM sections at the same time, and the ordinary reception of either FM or AM. The AM and FM sections are separately tuned, each with a separate 3-gang tuning condenser, separate flywheel tuning and separate volume control for proper balancing when used for binaural programs. Simplified accurate knife-edge tuning is provided by magic eye which operates independently on FM and AM. Automatic frequency control "locks in" FM signal permanently. Aside from its unique flexibility, this is, above all else, a quality high-fidelity tuner incorporating features found exclusively in the highest priced tuners.

FM specifications include grounded-grid triode low noise front end with triode mixer, double-tuned dual limiters with Foster-Seeley discriminator, less than 1% harmonic distortion, frequency response 20-20,000 cps \pm 1/2 db, full 200 kc bandwidth and sensitivity of 2 microvolts for 30 db quieting with full limiting at one microvolt. AM specifications include 3 stages of AVC, 10 kc whistle filter, built-in ferrite loop antenna, less than 1% harmonic distortion, sensitivity of 5 microvolts, 8 kc bandwidth and frequency response 20-5000 cps \pm 3 db.

The 5 controls of the KT-500 are FM Volume, AM Volume, FM Tuning, AM Tuning and 5-position Function Selector Switch. Tastefully styled with gold-brass escutcheon having dark maroon background plus matching maroon knobs with gold inserts. The Lafayette Stereo Tuner was designed with the builder in mind. Two separate printed circuit boards make construction and wiring simple, even for such a complex unit. Complete kit includes all parts and metal cover, a step-by-step instruction manual, schematic and pictorial diagrams. Size is 13 3/4" W x 10 3/4" D x 4 1/2" H. Shpg. wt., 18 lbs.

The new Lafayette Model KT-500 Stereo FM-AM Tuner is a companion piece to the Models KT-300 Audio Control Center Kit and KT-400 70-watt Basic Amplifier Kit and the "Triumvirate" of these 3 units form the heart of a top quality stereo hi-fi system.

KT-500.....Net **74.50**

**LAFAYETTE MASTER
AUDIO CONTROL CENTER with
BINAURAL CHANNEL AND DUAL
VOLUME CONTROLS**

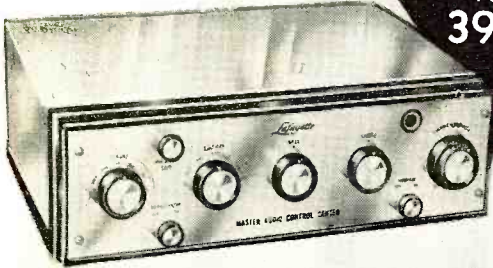

**KT-300
IN KIT
FORM
39.50**

- Self-Powered • DC On All Filaments • 24 Positions of Equalization
- Tape Head Input, High Impedance • Dual Cathode Follower Output Stages

This is not only the finest hi-fi preamp characterized by unmatched features, but it has been functionally designed to keep pace with the conversion of your present hi-fi system to binaural (Stereophonic) sound. Incorporates an extra channel and dual volume control for binaural reproduction. Features include DC on all tube filaments, negative feedback in every stage, dual cathode follower output stages and latest printed circuit construction. Less than 0.09% IM distortion and less than 0.07 harmonic distortion at 1V. Hum and noise level better than 80 db below 3V. Uniformly flat frequency response over entire audible spectrum. 7 inputs for every type of phono, tuner or tape. Tasteful styling, brilliantly executed. Size 12 3/4" x 9 1/2" x 3 3/4". Shpg. wt., 10 1/2 lbs.

KT-300—Lafayette Master Audio Control Kit Complete with cage and detailed assembly instructions. Net **39.50**

LT-30—Same as above completely wired and tested with cage and instruction manual. Net **59.50**

**DELUXE 70 WATT BASIC
AMPLIFIER**

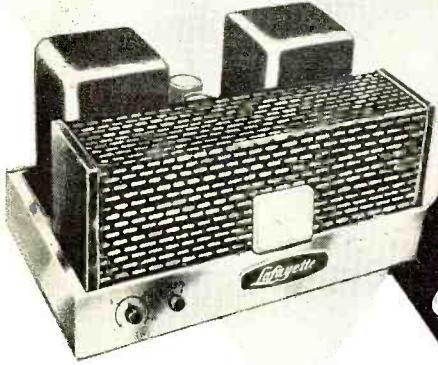

**KT-400
IN KIT
FORM
69.50**

- Conservatively Rated At 70 Watts • Inverse Feedback • Variable Damping
- Metered Balance And Bias Adjust Controls • Available In Kit and Wired Form

Here's ultra-stability in a 70 watt basic power amplifier employing highest quality components conservatively rated to insure performance and long life. Features matched pair KT 88's and wire range linear Chicago output transformer, variable damping control, meter for bias and balance and gold finish chassis. Frequency response 10-100,000 cps \pm 1db. Hum and noise 90 db below full output. IM distortion less than 1 1/2% at 70 watts, less than 0.3% below 30 watts. Harmonic distortion less than 2% at 70 watts from 20 to 20,000 cps \pm 1 db. Output impedance 4, 8 and 16 ohms. Handsome decorative cage perforated for proper ventilation. Size 14 1/2" x 10 x 7 3/4" including cage and knobs. Shpg. wt., 40 lbs.

KT-400—Lafayette 70 watt Deluxe Basic Amplifier Kit complete with cage and detailed assembly instructions. Net **69.50**

LA-70—Same as above completely wired and tested with cage and instruction manual. Net **94.50**

Lafayette Radio 165-08 Liberty Ave. JAMAICA 33, N. Y. 100 SIXTH AVE., NEW YORK, N. Y. NEWARK, N. J., 24 Central Ave. BRONX, N. Y., 542 E. Fordham Rd. BOSTON, MASS., 110 Federal St. PLAINFIELD, N. J., 139 West 2nd St.

What's

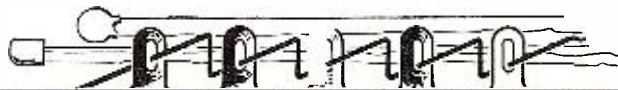

New in Radio

COLOR TV MICROSCOPE

D. P. Bushnell & Co., Inc., 412 Bushnell Bldg., Pasadena, Calif. is now offering a versatile microscope for color TV service applications.

Designed as a means of checking color convergence on the screen of a



color television tube, the new unit is extremely compact and only slightly larger than a pocket microscope. It has the comfortable working distance and rack and pinion focusing of a laboratory instrument, according to the manufacturer.

The extensible foot equalizes the effect of TV tube curvature and permits focusing to a depth of 70 mm. Interchangeable opaque and transparent bases allow the microscope to use either reflected or transmitted light.

The instrument weighs 5½ ounces, its closed height is 135 mm. and the height fully extended is 200 mm. A leather carrying case and one each opaque and transparent extensible bases are included in the modest price.

"SLIMMEST TV CABINET"

Sylvania Electric Products Inc., 1740 Broadway, New York 19, N. Y. has gone into production on a 21" television console with a cabinet depth of only 10 inches, the slimmest ever developed for the commercial market, according to the company.

Known as the "Sylouette," the slim cabinet was achieved by means of the firm's "floating picture" design which reduces cabinet depth by projecting the picture and its surrounding lighting mask out from the cabinet. Equipped with a "Silver Screen 85"

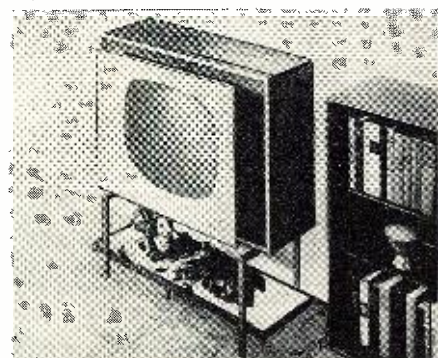

picture tube, the set provides 249 square inches of viewable area. It is powered by a custom S-110 chassis that is 70 per-cent automated, providing full fringe area performance.

The receiver which measures 36½" high, 34" wide, and 10" deep is being offered in mahogany, limed oak, and walnut finishes.

"VIKING THUNDERBOLT"

E. F. Johnson of Waseca, Minn. is now offering a new linear amplifier with over 2000 watts peak envelope power input.

The most powerful linear amplifier any amateur operator can use, the new "Viking Thunderbolt" is designed to insure a dominant signal on all popular amateur bands, 3.5 through 30 mc. When used with any of the firm's drivers, power increases range from 3.8 to as high as 25 times.

The amplifier is being offered in either kit (No. 240-353-1) or wired and tested (No. 240-353-2) form. A cata-

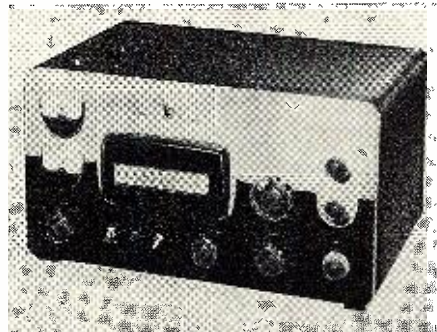

logue which includes complete specifications and a schematic of this new unit is available from the manufacturer on request.

GRID CIRCUIT TUBE TESTER

Seco Manufacturing Company, 5015 Penn Ave. So., Minneapolis, Minn. has just released the new Model GCT-8 grid circuit tube tester.

This compact instrument, which measures only 6½" x 2½" x 6½", has been designed to check the critical control grid condition of vacuum tubes and will provide as many as eleven simultaneous tests on a typical pentode such as the 6AU6. The presence of any or a combination of eleven faults will register as "bad" on the electron-eye indicators.

Write the company direct for full details on this new and patented unit.

FIELD STRENGTH METER

Blonder-Tongue Laboratories, Inc., 9-25 Alling St., Newark 2, N. J. is now offering a new v.h.f. field strength meter as the Model FSM-1.

This battery-operated unit tunes continuously through the frequency range from 54 to 216 mc. to supply accurate, direct voltage readings. The bands covered are v.h.f. television, FM,

aircraft, mobile, amateur, and other special services. A companion u.h.f. converter expands signal readings to the complete u.h.f. television range. Exact signal strengths can be read from 10 microvolts to 3 volts.

The meter includes a phone jack, front panel attenuator switches, pilot light, handle and carrying strap, db and percentage AM modulation scales,

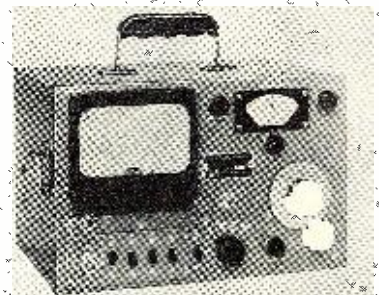

and a Model MB balun to handle 300-ohm inputs. The total weight, less batteries, is only 14 pounds.

The company will supply a data sheet, carrying full details, on request.

ZENITH TRANSISTOR PORTABLE

Zenith Radio Corporation, 6001 W. Dickens, Chicago 39, Ill. has recently introduced a transistorized version of its "Trans-Oceanic" portable which tunes eight wavebands to give reception of thousands of foreign stations on the international short-wave channels plus reception of ship-to-shore communications, Coast Guard weather broadcasts, and standard broadcast stations.

The set is housed in a chrome-plated cabinet trimmed in black leather. It weighs 13 pounds including batteries. The circuit features bandspread tuning, a time zone dial and world time zone map etched in metal, an

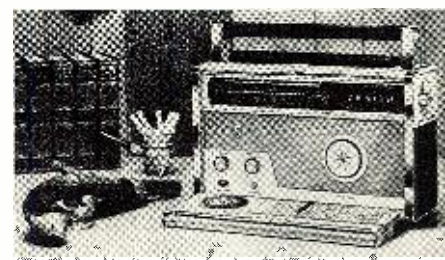

earphone connection for private listening, a phono jack, a dial light and separate volume and tone controls.

TRANSISTOR CHECKER

Service Instruments Corporation (Sencore) of 171 Official Road, Addison, Ill. has announced the availability of a new and improved transistor checker which also tests crystal diodes and selenium rectifiers.

The new model provides a more complete check on power transistors than did the firm's earlier unit, the Model TDC22. The addition of the selenium rectifier tests makes the new checker more versatile.

The TRC4 is the same size as the

older model. It will test for opens, shorts, current gain, and leakage on

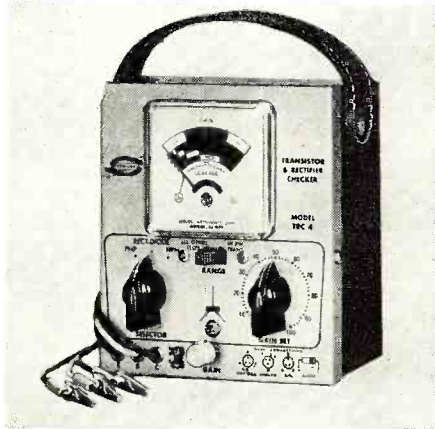

all transistors and forward-to-reverse currents on crystal diodes and rectifiers.

"CAPACITOR OF TOMORROW"

Good-All Electric Manufacturing Company, Ogallala, Neb. is now offering its 600-UE capacitor to the replacement market. Already widely accepted by original equipment manufacturers because of its good operating characteristics in humid climates, its low leakage, and high stability, the new capacitor uses a Mylar dielectric molded in epoxy resin.

The company engineers have developed a production technique which permits these two materials to be molded into a single piece, rugged,

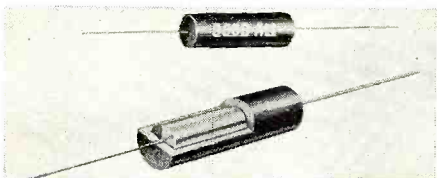

space-saving capacitor. The unit is competitively priced. Write to the distributor's division of the company for full details on this replacement line.

360° CHASSIS CRADLE

As an aid to TV technicians, electronic equipment manufacturers, and installers, General Cement Mfg. Co., 400 S. Wyman St., Rockford, Ill. has recently released a chassis cradle that rotates equipment 360 degrees to simplify repairs.

The cradle will handle any size chassis and hold it securely in place or rotate it 360 degrees for any angle of exposure. Speed clamps are provided which allow the chassis to be quickly mounted or removed.

CONTROL AND P-P SWITCH

The Distributor Division of P. R. Mallory & Co. Inc., Indianapolis 6, Ind. is now marketing a volume control which incorporates a new type of a.c. line switch with push-pull action. This switching action, being featured in many new TV set models, gives extra convenience to the set owner and added life to the control.

The line circuit closes when the control shaft is pulled out, opens when

Just 2 settings on the NEW CENTURY FAST-CHECK TUBE TESTER

Model FC-1

tests over 600 tube types completely, accurately... AND IN SECONDS!

handsome hand-rubbed oak carrying case

Dimensions: Width: 12 3/4" Height: 11 1/4" Depth: 4 3/8"

CANNOT BECOME OBSOLETE

Engineered to accommodate all future tube types... new tube listings furnished periodically.

SEE THE FC-1 BEFORE YOU BUY IT!

No money required with order to examine FC-1 for 10 days

EASY TO BUY IF YOU'RE SATISFIED!

Pay in small monthly payments at net cash prices, ...no financing charges

Model FC-1W factory wired \$58.50 Net

Model FC-1K semi-kit form \$48.50 Net

These extremely low prices are made possible only because YOU ARE BUYING DIRECT FROM THE MANUFACTURER.

WIDE RANGE OF OPERATION
 ✓ Checks quality of over 600 tube types (employing the time-proven dynamic cathode emission test)... This covers more than 99% of all TV and radio tubes in use today, including the newest series-string TV tubes, auto battery-type 12 plate-volt tubes, 024s, magic eye tubes and gas regulators ✓ Detects inter-element shorts and leakage up to 3 megohms ✓ Checks high gas content ✓ Checks for life expectancy.

OUTSTANDING FEATURES

IMPORTANT ▶ Checks each section of multi-purpose tubes. If one section is defective the tube will read "Bad" on the meter scale • 41 tube sockets accommodate all present and future tube types • Less than 10 seconds required to test any tube • Large D'Arsonval type meter is extremely sensitive, yet rugged... with two multi-color "Good-Bad" scales • Selection of 12 filament voltages • Line isolated • 7-pin and 9-pin straighteners mounted on panel • Large easy-to-read quick reference chart for over 600 tube types in use today • Line voltage compensation • Guaranteed for one full year. • Meter fully protected against accidental burn-out.

"You've really made tube testing a snap"... "I've almost got the cost of the FC-1 paid off with the extra money I've made, and it's only 2 weeks since I received it"... "It's easier to use than you said"... "I wouldn't ever want to be without it"... "I use it in the shop and take it along on every call!"

*Names on request

Model AD-1 PICTURE TUBE ADAPTER—Available only for the FC-1. Checks all picture tubes (including the new short-neck 110 degree RCA-type picture tubes) for cathode emission, shorts and life expectancy. Also rejuvenates and restores cathode emission of weak picture tubes.

Model AD-1 (factory wired only).....\$4.50

WHAT SERVICEMEN* are SAYING ABOUT THE FC-1

SEND COUPON TODAY — NO OBLIGATION TO BUY

CENTURY ELECTRONICS CO., INC. 111 Roosevelt Avenue Dept. 203, Mineola, N. Y.

Please rush the FAST-CHECK TUBE TESTER in form indicated for 10 day examination period. If not completely satisfied I will return the instrument within 10 days without further obligation. If fully satisfied I agree to pay the down payment within 10 days and the monthly installments as shown...no financing charges. Should I fail to make payment when due, the unpaid balance shall become due and payable at once.

- Model FC-1W (wired).....\$58.50 \$14.50 within 10 days. Balance \$11.00 monthly for 4 months.
- Model FC-1K (semi-kit).....\$48.50 \$12.50 within 10 days. Balance \$9.00 monthly for 4 months.
- Model AD-1 (wired only) PICTURE TUBE ADAPTER—(available only with FC-1 Fast-Check Tube Tester) \$4.50

Prices Net F.O.B. Mineola, N.Y.

Name.....

Address.....

City..... State.....

ABSOLUTELY NO RISK ON YOUR PART

NEVER BEFORE OFFERED!
A Terrific Buy From
HARVEY RADIO!

JENNINGS
VARIABLE VACUUM CAPACITOR

—Just what you've been looking for!



BRAND NEW! INDIVIDUALLY PACKED!

Ideal for remote or push-button control of your new 1 kilowatt DC input linear amplifier. The Jennings Model (UCSX) Variable Vacuum Capacitor with 24 volt motor drive is yours for a fraction of the original cost!

Look at these features—capacity range from 20 to 675 mmfd.; operation up to 10,000 volts, DC maximum current carrying capacity 45 amperes. The motor operates on 24-volt DC and is reversible. Mounted on it is an engage/disengage clutch and limit switches. A potentiometer is provided for remote indication of percentage of rotation with additional circuitry.

The entire unit is completely insulated to operate at its rated voltage on its own mountings, as shown in the illustration. For manual operation, simply remove the motor drive

Only an exclusive buy makes this low, low price possible. Original catalog price of capacitor alone \$200.20. Yours, at Harveys, **\$39⁵⁰** Net F.O.B. for only N. Y. City

Recommended Accessories:

- Barker & Williamson #850 A All band variable inductor **\$35.00**
- Barker & Williamson #3902 Counter Dial **\$14.55**
- Johnson #116-208 — **\$ 9.80**
- 4 Dial **\$ 9.80**
- With lock **\$11.10**

These are just a few of the recommended accessories for use with above.



HARVEY
 RADIO COMPANY, INC.

103 W. 43rd St., New York 36, N. Y. • JU 2-1500

the shaft is pushed in. Volume always remains at proper level because the set

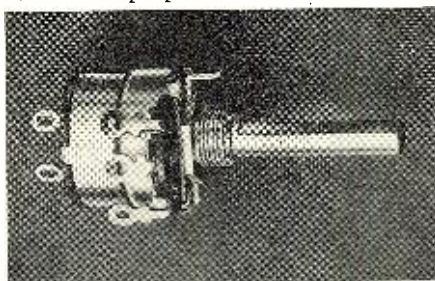

is turned on at the same volume at which it was turned off. Excessive wear on the low end of the element is thus eliminated.

This feature is available on single- and dual-controls in ratings to match original controls in popular radio and TV sets.

"TRANS-MIDGE" RADIO KIT

Allied Radio Corporation, 100 N. Western Ave., Chicago 80, Ill. has released a new, low-cost 1-transistor radio receiver in kit form.

Only slightly larger than a cigarette package, the "Trans-Midge" performs well over the standard broadcast band when used with headphones and an external antenna. The circuit uses a low-drain transistor, slug-tuned coil for high sensitivity and good separation of stations, external tuning knob, and impact-resistant plastic case.

According to the company, kit builders should be able to assemble this unit in a matter of hours. It comes complete with plastic case, all parts,

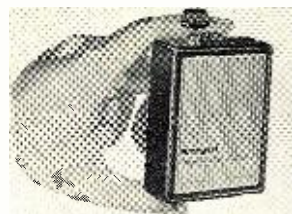

transistor, wire, solder, battery, and instructions. Write the company for details on Stock No. 83Y767.

HEADLIGHT DIMMER TUBE

The Industrial Tube Products Department of RCA's Electron Tube Division, Harrison, N. J. has designed a new short multiplier phototube of the nine-stage type especially for use in automobile headlight-dimming equipment.

The new phototube (RCA-7117) has instantaneous response to meet the critical timing of headlight-control service and is capable of providing stable performance over long periods, according to the company. The high luminous sensitivity of the 7117 allows use of an amplifier with relatively low-impedance input and fewer stages than would be required by a less sensitive tube.

Spectral response covers the approximate range from 3000 to 6200 angstroms, with maximum response at about 4000 angstroms. When operated with a supply voltage of 1000

volts d.c., the 7117 has a median luminous sensitivity of 35 amperes per lumen.

PLASTIC-FOAM TAPE

United Mineral & Chemical Corp., 16 Hudson St., New York 13, N. Y. is handling the U.S. distribution of a new polyurethane plastic-foam, self-adhesive tape which is being made by P. Beiersdorf Co. of West Germany.

The new tape has a number of applications in the electronic and electrical fields. It can be used for cushioning and dust exclusion on dial faces; the prevention of vibration, shock, and shifting of sensitive laboratory instruments; eliminate resonance

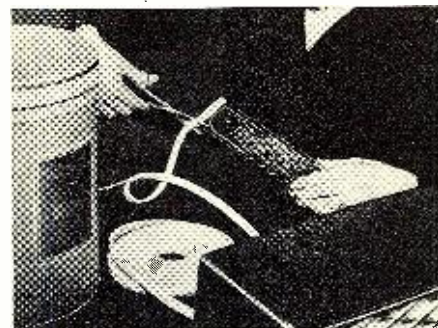

and vibration in electric motors and relays; as well as acting as a shock panel in front of a television picture tube; an absorber under a turntable to reduce rumble; or at the contact edge of a speaker to prevent rattle.

The product is available in a variety of widths, thicknesses, and colors. For recommendations on "Tesamoll" for specific applications, write the U.S. distributor direct, outlining the problem to be handled.

NEW SILICON RECTIFIER

The Rectifier Division of Audio Devices, Inc., 620 E. Dyer Road, Santa Ana, Calif. is now in production on the first silicon type rectifier in its line.

Designed to be used in radio, television, and electronic devices, the A750 is hermetically sealed, it will either screw into the chassis or plug into a holder, and is rated at 750 ma. at 400 volts.

This is the first of what is to be a complete line of silicon rectifiers which the company will offer. Contact L. E. Potter, sales manager of the firm, for full details and delivery data.

TRANSISTOR SOCKET

Grayhill, Inc., 561 Hillgrove Ave., La Grange, Ill. has designed and is marketing a new socket for use with the

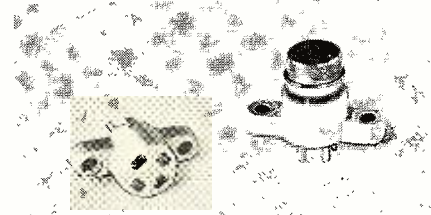

new 3- and 4-pin "Jetec 30" transistors. The socket body is molded from mica-filled phenolic per MIL-M-14. Type MFE.

The beryllium copper contacts are wrap-around style, silver plated and gold flashed for good contact and corrosion resistance. Contact numbers, molded into the rear of the socket, make identification easy. The key mark is molded into the top of the socket for line-up with the transistor case tab. Either rivets or No. 2 screws can be used for mounting.

PROTO WIRE STRIPPER

Proto Tool Company of Los Angeles has announced the availability of a new type of wire stripper which has been designed with the needs of the professional user in mind.

The No. 299 is only 5" long, features a thumb-operated gauge, and will strip all commonly used insulated wire from 14 to 24 gauge without nicking or cutting. Even the larger sizes of wire can be handled with ease. Specially hardened edges facilitate the cutting operation.

INDUSTRIAL "ENGINSCOPE"

Allen B. Du Mont Laboratories, Inc., 750 Bloomfield Ave., Clifton, N. J. has developed an oscilloscope engine analyzer for spark ignited industrial equipment.

Featuring multi-line presentation, cylinder-by-cylinder, the new "Industrial EnginScope" allows secondary signal information to be viewed. This multi-line presentation allows a mechanic to pinpoint troubles by cylinder comparison. Each cylinder operation, from the firing of the spark to the opening of the points, is shown on the instrument's television-like picture screen, one line below the other in the exact firing order of the engine. -30-

Sun	Mon	Tue	Wed	Thu	Fri	Sat
			1	2	3	4
						5
						12
						19
						26

CALENDAR of EVENTS

MARCH 16-21

Nuclear Engineering and Science Congress. Sponsored by IRE Professional Group on Nuclear Science and others. Palmer House, Chicago, Ill. Daniel I. Cooper, 7/8 Nucleonics, 330 W. 42nd St., New York City, program coordinator.

MARCH 24-27

1958 IRE National Convention. Sponsored by 27 IRE Professional Groups. Waldorf-Astoria Hotel and New York Coliseum, New York City. Exhibit will occupy all four floors at Coliseum with 850 exhibitors. A program of 275 papers will be presented in 55 sessions held at both convention sites. Additional details from E. K. Gannett, Institute of Radio Engineers, Inc., 1 East 78th Street, New York 21, New York.

MARCH 26-28

20th Anniversary Meeting of American Power Conference. Hotel Sherman, Chicago. Inquiries to R. A. Budenholzer, Mechanical Engr. Dept., IIT, 330 Federal St., Chicago 16, Ill.

BEST BUY IN HI-FI



20PG 20 Watt High Fidelity Amplifier

A deluxe amplifier with new styling and exceptional performance . . . the best buy in the medium priced field. The new 20PG has greater flexibility of controls, new advanced circuitry and the highest quality components. Features: Feedback throughout, separate turnover and roll-off record compensators, new loudness control, wide range bass and treble controls, rumble and scratch filters and six inputs including tape head. The 20PG is designed for the audiophile who wants all the features and flexibility of the finest amplifiers built and knows that 20 watts is all the power he can utilize in his home.

SPECIFICATIONS

Frequency response: ± 0.5 DB. 20 to 30,000 CPS. at 1 watt.
Power response: ± 1. DB. 20 to 20,000 CPS. at 20 watts.
Distortion: 1% harmonic and 2% intermodulation at 20 watts.
Feedback: 70 DB. plus throughout; 15 DB. around output transformer.
Outputs: 4, 8 and 16 ohms plus high impedance for tape recorder.
Sensitivity: Aux.; tuner; tape amp. channels—4 volts. Phono channel—.008 volts at 20 watt output.
Hum and Noise: 75 DB. below rated output on high level inputs.
Tubes: 3-12AX7, 2-6L6GB and 5U4GB.
Cabinet: In charcoal gray with brushed brass control plate.
 13"W x 5"H x 9"D. Weight 21 lbs.

Net Price\$89.50

15PG8 15 Watt High Fidelity Amplifier. The all new deluxe 15PG8 has less power but the same advanced circuitry, the highest quality components and greater flexibility of controls. Features feedback throughout, record compensators, new loudness control, wide range bass and treble controls, rumble and scratch filters, and six inputs including tape head. Frequency Response: ± 0.5 DB. 20 to 20,000 CPS. Distortion: 2% harmonic and 3% intermodulation at 15 watts. In charcoal gray and brass.

Net Price 69.50

10PG8 10 Watt High Fidelity Amplifier. Here is new styling with a full set of controls providing exceptional flexibility in a moderately priced amplifier. The simple efficient flat compact design features modern feedback circuitry, record compensator, loudness control, wide range bass and treble controls, rumble and scratch filters, and five inputs, including one for tape head. Frequency Response: ± 1 DB. 20 to 20,000 CPS. Distortion: 2% harmonic and 3% intermodulation at 10 watts.

Net Price 55.00

Ask your High Fidelity Dealer to demonstrate the New PG Series or write for complete details and where to buy.

Grommes Div. of Precision Electronics, Inc.
 Dept. R-3 9101 King Street, Franklin Park, Ill.

- Send details on "Little Genie" kits.
- Send Free Hi-Fi Equipment Brochure.

Name

Street

CityZoneState



● LAYER-BUILT ● COLOR-GUIDE
 Before you build another kit see this new method of Kit Assembly. Each kit is complete with all parts and Instruction Book.

PRESS COMMENT

"The Atlantic (John M. Conly)

"The AR-1W woofer gives the clearest bass response I ever have heard."

AUDIO (Edward Tarnall Conby)

"... the highs impressed me immediately as very lovely, smooth, unprepossessing, musical (for music) and unusually natural. No super-hi-fi screech and scratch. As to the lows... I was no end impressed, from the first time I ran my finger over a pickup stylus and got that hearty, wall-shaking thump that betokens real bottom bass to the time when I had played records and tapes on the speaker for some months on end."

*The Audio League Report**

"Speaker systems that will develop much less than 10% distortion at 30 cycles are few and far between. Our standard reference speaker system,† the best we've ever seen, has about 5% distortion at 30 cycles."

*Vol. 1 No. 9, Oct., 1955. Authorized quotation #30. For the complete technical and subjective reports on the AR-1 consult Vol. 1 No. 11, *The Audio League Report*, Pleasantville, New Y.

†The AR-1W

The Saturday Review (R. S. Lanier)

"... goes down into the low, low bass with exemplary smoothness and low distortion. It is startling to hear the fundamentals of low organ notes come out, pure and undistorted, from a box that is two feet long and about a foot high."

High Fidelity (Roy Allison)

"... a woofer that works exceptionally well because of its small size, not in spite of it... I have heard clean extended bass like this only from enclosures that were at least six or seven times its size."



Prices for Acoustic Research speaker systems, complete with cabinets, (AR-1 and AR-2) are \$89.00 to \$194.00. Literature is available from your local sound equipment dealer, or on request from: Dept. T

ACOUSTIC RESEARCH, INC.
24 Thorndike St., Cambridge 41, Mass.

Sound on Tape

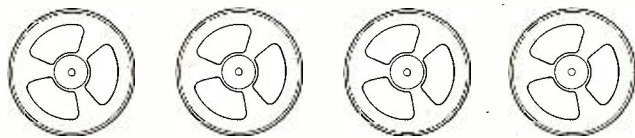

By BERT WHYTE

NO DOUBT many of you have become aware that a number of attempts have been made recently to reduce the cost of stereo tapes. There are many tapes available now at anywhere from \$4.95 to \$8.95. This would certainly seem like a step in the right direction. And yet, this new pricing trend has already had some unexpected opposition. The story goes something like this. As you all remember when stereo tapes first appeared, they were pegged at astronomical levels, as high as \$18.95. Early in the game, the companies manufacturing stereo tapes decided to sell them on a time basis. In other words, a tape costing say \$12.95 would have a playing time of perhaps 28 to 30 minutes, while the \$18.95 tape would play up to 46 minutes. Undismayed by these prices, the stereo market burgeoned rapidly but, as the market expanded, there was (and still is) a constant gripe about tape prices. The companies hit on the idea that by turning out some shorter tapes, they could get down in price where it is easier to extract 5 or 6 dollars from the customer, rather than the ten dollars and up for the longer works. This idea caught on rapidly and quite a few companies are following that practice today.

However, the picture has now come full cycle and many people are highly resentful about the shorter tapes. Why? Not because of the price itself, but because the tapes are of such short duration! Even though many of these shorter tapes are selling well today and probably will continue to sell for some time, it has been my experience that relative newcomers to the stereo field are the people who are buying them. After the first magic flush of stereo has worn a little and they are not just drunk with sound, it occurs to them, as it has occurred to the older stereo hands, that these short tapes are negating the advantages of tape. After all, most people are by now thoroughly used to the LP record and its up to 31 or so minutes of music *per side*. One of the really great advantages of tape and the development of the one mil and half mil long play tape in particular, is that entire symphonies can be played straight through without interruption. Maybe the modern American is just a lazy guy and perhaps it is also a reflection of general economic wellbeing, but in any case, while no one seems happy with stereo tape prices, they appear to be less concerned with price than they are with the bother and annoyance of tapes lasting but 10 or 12 minutes.

To a lot of average people stereo has been worth the trouble of investing in new equipment and learning to handle tape, which even the most rabid stereo fan will admit is more difficult than plopping a disc on a turntable. Now compound this handling problem with short tapes requiring attention every 10 or 12 minutes and you've got the makings of a most unhappy fella! I've had any number of people tell me that the stereo tape prices they still don't like, but they would much rather the stereo companies issue longer tapes even though it's going to cost them more money. I hardly need add that the real problem and one that could become very acute when the stereo disc begins to appear, is the whole basic price structure of stereo tape. With the price of tapes tied to the present methods of duplication and the high cost of basic raw stock, the recorded tape companies have a tough nut to crack. It is to be hoped that responsible people in the tape companies are cognizant of this problem and are bending every effort towards its solution.

This column is being written just after the new year and there has been a seasonal lull and let-up, so that the new releases of most companies have not as yet reached your reviewer. So I'll have to dig around a bit for material and there may be a few "oldies" among them. I should have plenty of interesting new material in time for next month. (Unless otherwise indicated, all tapes are on 7-inch reels, play at 7½ inches per second tape speed, and should be equalized to conform to the NARTB tape equalization curve.)

OFFENBACH MELODIES
Boston Pops Orchestra conducted by Arthur Fiedler. Victor BCS50. Price \$8.95

This should wake up your tired blood! This is one of the most gay, light-hearted, and thoroughly enjoyable stereo tapes in the catalogue. Offered here on this all-too-short tape, is the overture to "La Belle Helene" and an orchestral medley from "La Perichole." The music abounds with the typical Offenbachian zip and sparkle and it is particularly effective in stereo with much interplay and directionality. This sort of thing has been Fiedler's meat for years and with the superb backing of his Boston players, he gives a performance of unflagging verve and spirit.

This is one of the most close-up recordings of the Boston group Victor has issued in some time. This makes for

DYNAKIT

Amplifier Kits

A proven circuit of finest sound quality in a new deluxe 60 watt model and standard 50 watt model



Mark III 60 watts \$79.95*

4, 8, 16 ohm outputs net

The new Mark III includes all the sensational attributes of the popular Mark II plus these outstanding deluxe features

- ★ 60 watts at less than 1% distortion. Instantaneous peak power of 140 watts. IM less than .05 at average listening levels.
- ★ Choke filtering and low noise circuitry reduce hum and noise to 96 db below 60 watts.
- ★ New rugged KT-88 tubes and other heavy duty parts used conservatively.

Mark II 50 watts \$69.75*

8, 16 ohm outputs net

The Mark II is the best buy in high power high fidelity kits

- ★ Ease of assembly due to uniquely simple circuitry and printed circuit construction with factory-mounted parts.
- ★ Highest stability using patented stabilizing networks with minimum number of phase shifting stages. Suitable for all loudspeaker systems including electrostatic.
- ★ Dyna Biaset (patent pending) for simplified adjustment and complete freedom from effects of unbalanced components. No balancing adjustments required to meet published specifications.
- ★ Dynaco Super-Fidelity output transformer with patented para-coupled windings. This is the finest available transformer of its type for the most critical audio uses.

Available from leading Hi-Fi dealers everywhere. Descriptive brochure available on request.

* Slightly higher in West

DYNACO INC.

617 N. 41st Street • Philadelphia 4, Pa.
Export Division: 25 Warren St., New York 7, N. Y.

terrific instrumental detail and the strings fairly zing and the brass is bright and burly and the woodwinds chortle most realistically. As with much of Offenbach's music there is a good counterpoint of a low bass drum almost always in evidence. The sharp detail was leavened by considerable hall reverb which made for great liveness. There was good center fill and the music as a whole had a good forward projection. A real dilly of a tape!

SYMPHONIC SPECTACULAR Concert Hall EX-61. Price \$11.95.

This is an interesting tape as it affords the opportunity to compare the sound of three different orchestras in three different halls. First is heard Mozart's Overture to "The Abduction from the Seraglio" with Otto Ackerman conducting the Guerzenich Orchestra of Cologne. Then we have Berlioz's Overture to "Beatrice and Benedict" with Walter Goehr conducting the Netherlands Philharmonic, and finally we hear Wagner's Prelude to Act 1 of "Die Meistersinger" with Carl Bamberger conducting the Frankfurt Opera Orchestra. Each is quite well done in its particular fashion. The Mozart work has a rather big sound, fairly closely recorded with a hall of fine spacious acoustics. Good orchestral detail, with especially fine string tone. Directionality was adequate to the score—of center fill, it was somewhat lacking. All in all, a rather opulent sound of convincing realism.

The Berlioz piece is far different than the Mozart in recording. Here is medium-close mike pickup, giving reasonable detail, and with a less spacious, somewhat "drier" hall sound, the two blend together quite well. Here, too, is good string tone, rather mellow brass and woodwind. Directionality proved good but center fill was virtually nil. Somewhat subdued dynamics here, the over-all impression being that the sound is occasionally almost formless and it could have been improved with a closer mike perspective.

"Die Meistersinger" is a big florid work and it should be played by a big orchestra. Such is not the case here. The players blow lustily and produce a sound of laudable size, but it just doesn't have that great weight that spells Wagner. The mike is pretty close up here, the saving grace that gave a lot of instrumental detail and lent at least an illusion of weight. The hall reverb is spacious but a mite on the hard side. Generally good strings here and blustery brass, which shows fine direction. As I said, an interesting tape which has much to recommend from the musical standpoint as well.

THEY'RE PLAYING OUR SONG Billy Butterfield and his Orchestra. Victor BPS-77. Price \$8.95.

This tape has a really corny title and the music doesn't deserve such maltreatment. Actually this is a very tasty potpourri of big band music, featuring that wonderful trumpet man, Billy Butterfield. Billy and the boys

DYNAKIT

Preamplifier

An Outstanding Companion
Kit to the World Famous
Dynakit Amplifiers

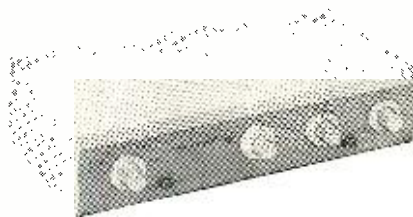

This handsome new control unit gives crystal clear, noise-free reproduction from any modern program source. Its unique all feedback design by David Hafler sets a new standard of preamplifier performance. The design of the Dynakit preamplifier is a synthesis of outstanding features which produce smoother, more natural sound. Compare these features with any other units regardless of price.

★ Unequaled performance

Actually less than .1% distortion under all normal operating conditions. Response ± 5 db 6 cps to over 60 kc. Distortion and response unaffected by settings of volume control. Superlative square wave performance, and complete damping on any pulse or transient test.

★ Easiest assembly

All critical parts supplied factory-mounted on XXXP printed circuit board. Eyeleted construction prevents damage to printed wiring. This type of construction cuts wiring time by 50% and eliminates errors of assembly. Open simplified layout offers complete accessibility to all parts.

★ Lowest noise

Integral dc heater supply plus low noise components and circuitry bring noise to less than 3 microvolt equivalent noise input on RIAA phono position. This is better than 70 db below level of 10 millivolt magnetic cartridge.

★ Finest parts

1% components in equalization circuits to insure accurate compensation of recording characteristics. Long life electrolytic capacitors and other premium grade components for long trouble-free service.

★ High flexibility

Six inputs with option of extra phono, tape head, or mike input. Four ac outlets. Controls include tape AB monitor switch, loudness with disabling switch, full range feedback tone controls. Takes power from Dynakit, Heathkit, or any amplifier with octal power socket.

★ Outstanding appearance

Choice of bone white or charcoal brown decorator colors to blend with any decor. Finished in indestructible vinyl coating with solid brass escutcheon.

★ Best Buy

Available from your Hi-Fi dealer at only \$34.95 net (slightly higher in the West), and yet the quality of performance and parts is unexcelled at any price.

Descriptive brochure available on request

Pat. Pending

DYNACO INC.

617 N. 41st St., Philadelphia 4, Pa.
Export Division: 25 Warren St., New York 7, N. Y.

Telematic

CUSTOM HIGH FIDELITY KITS

AM/FM TUNER

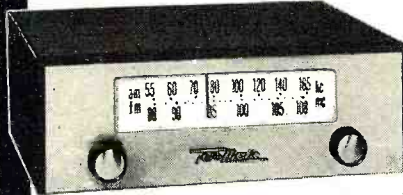

2 uv for 20 DB quieting, AFC plus Defeat, Full Frequency Response, 300 KC bandwidth.
Model KC-400

20-WATT INTEGRATED AMPLIFIER

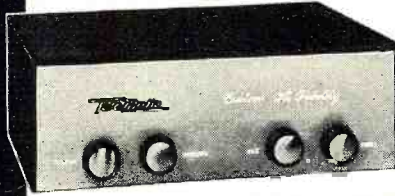

Power Response CONSTANT at 20 Watts, 1 ± DB Full Frequency Response, Infinite Equalization Bass Treble Controls; 3 Hi, 1 Low inputs.
Model KC-401

Exclusive! STEREOGRAPHIC KITS

AM/FM STEREOGRAPHIC TUNER WITH WIRED FM FRONT END

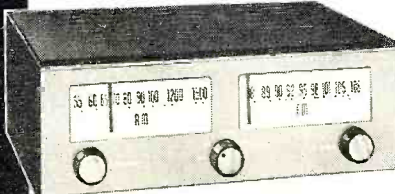

NEW DIMENSIONS IN SOUND—Each section used individually or together—0.9 uv for 20 DB quieting, 330 kc Bandwidth 3-gang variable AM tuning, 15 uv per meter loop sensitivity.
Model KB-402

40-WATT STEREOGRAPHIC AMPLIFIER

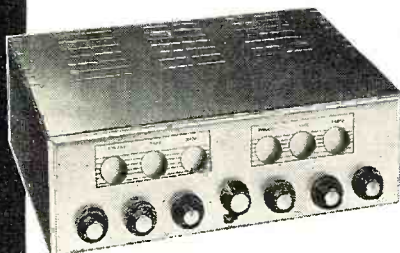

NEWEST DEVELOPMENT IN STEREOGRAPHIC SOUND FOR THREE DIMENSIONAL LIFE-LIKE REALISM! Twin 20-Watt Channels—Each with FULL PRE-AMP sections and Master Volume Control.
Model KB-403

For full details, see your local dealer or write

TELEMATIC INDUSTRIES, INC.

215 LEE AVENUE, BROOKLYN 6, N. Y.

sock out some highly arranged versions of such as "Goodbye Blues," "Time on My Hands," "Stormy Weather," and others. Very fine ensemble work here as well as notable rides by some of the stellar players in the orchestra. Interesting to hear this sort of stuff in stereo... it's obviously the type where multi-mikes are fed into a three-channel stereo recorder and then post-mixed for desired effects. Thus many of the effects that you hear are not normally present in the music, but are simply included for their "shock" or novelty effect. Here we have a vastly overdone acoustic spaciousness along with obviously contrived directionality. However phony it might be, it's all in good fun and the music is enormously effective.

AMERICA'S MOST DANCEABLE MUSIC

Griff Williams and his Orchestra. Mercury MDS2-7. Price \$12.95.

Griff Williams leads a so-called "society" orchestra and in 20 years he has played at most of the plushier hotels and country clubs around the country. The numbers on this popular tape include such as "The Lady is a Tramp", "What is there to Say", "Thou's Swell", "It Had to be You", "There's a Small Hotel", and many others. In matters of sound this can't be recommended too highly. If this type of dance music is your dish of tea, I can assure you that you will hear it with unsurpassed realism.

Directionality is very obvious and excellent center-channel fill helps to spread an orchestra across the end of your living room. All the instruments are highly detailed, very clean and bright and reverb has been judiciously added to make the sound almost palpably "live."

VIENNA

Chicago Symphony Orchestra conducted by Fritz Reiner. Victory ACS-63. Price \$6.95.

This is Fritz Reiner's contribution to the steadily mounting stream of stereo waltz recordings. This is another of those shortie tapes I have been talking about and actually contains but two numbers, Johann Strauss, Jr.'s "Morning Papers" and Josef Strauss' "Village Swallows." I do not know whether Vienna would quite approve of the massiveness of orchestration Reiner employs for these waltzes, but I can tell you that from a stereo standpoint, these are mighty effective.

I reiterate that Orchestra Hall in Chicago is one of the most superb halls in existence for stereo recording. The recording was closeup and highly detailed with excellent projection and, with those magnificent acoustics, the qualities of liveness are outstanding. The string sound is pure magnificence and the huge weighty brass must be heard to be appreciated and believed! Add a bass drum of noble proportions which whams away with great abandon and the wide frequency and dynamic range and these are waltzes for the stouthearted!



PROVEN:

Soldering tips
last 10 times
as long with

SAVBIT

A SPECIAL ALLOY
AVAILABLE ONLY
IN ERSIN

FIVE-CORE
SOLDER



This tip made only 7500 joints using ordinary solder.

This tip made only 1000 joints using ordinary solder.

This tip made more than 10,000 joints using SAVBIT.

Copper solder tips last 900% longer when you use economical SAVBIT!

Sold only through radio parts jobbers

MULTICORE SALES CORPORATION, PORT WASHINGTON, N. Y.

FREE! 360 pages of the Newest in

ELECTRONICS

HIGH FIDELITY • RADIO • TV



NEW CATALOG 1958

Offers you a fast, efficient, dependable way of selecting the finest components in the field at the lowest prices.

NEWARK

ELECTRIC COMPANY

Write Dept. R3

223 W. Madison St. • Chicago 6, Illinois
4736 W. Century Blvd. • Inglewood, Calif.

RADIO & TV NEWS

Antenna News

SPICO "VISCOUNT"

Spiraling Products Co., Inc., Henrietta St. and Duffy Ave., Hicksville, N. Y. recently introduced a new indoor television antenna which is being offered as the "Spico Viscount."

Combining new styling with patented electronic features, the company is

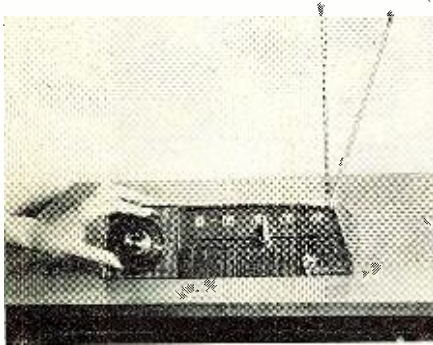

offering the unit in mahogany, ivory, or ebony finishes to match or contrast with any living room decor. Entire concealment of the "rabbit ears" is made possible by the telescoping of the dipoles into the cabinet of the unit. When extended during use, the dipoles are equal in length to standard antennas and may be oriented to any degree for the sharpest possible picture. Very light polished brass tubing used in their manufacture prevents the unit from becoming top-heavy when in use.

The circuit incorporates a "selectronic" tuner which permits the set owner to match the impedance or power of the antenna to his particular TV set. A 12-position phasing switch automatically provides a combination of circuits which, depending on location, delivers to each set the required circuit for maximum reception in the area. A fine tuner adjusts the capacity of the dipoles for maximum reception of a particular channel.

TWO-SET BOOSTER

Blonder-Tongue Laboratories, Inc., Newark, N. J., is now in production on its Model B-23 two-set booster. This

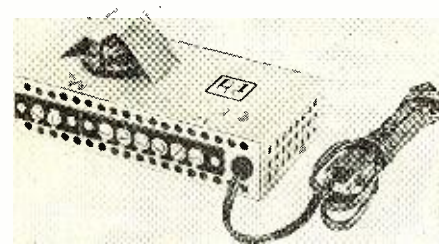

all-channel broadband amplifier is designed to improve reception on one, two, or three TV sets.

The Model B-23 permits operation of two or three TV receivers from one antenna. The unit amplifies signals

LISTEN TO JansZen*

HEAR THE SPEAKER WITHOUT A "VOICE"

The JansZen Electrostatic has no voice of its own. It does not add to the music . . . exaggerate the instruments . . . distort the sound. Instead, it reproduces music with a clarity that borders on the superb. The JansZen Electrostatic, combined with the new JansZen Dynamic . . . a widely acclaimed, low frequency counterpart . . . gives you a complete, high quality loudspeaker that produces the musical realism you've always wanted but could never obtain.

Listen to JansZen*. Write for literature and the name of your nearest dealer.

The Model 130 Electrostatic Tweeter . . . the most nearly perfect loudspeaker. \$184 in mahogany.



The Z-200 . . . a combination of the 130 Electrostatic and 250 Dynamic. The woofer and tweeter are so smoothly matched and blended that nearly perfect realism results. \$329 in mahogany.



Hear the Music, Not the Speaker

*Designed by Arthur A. Janszen

Products of **NESHAMINY ELECTRONIC CORP.**, Neshaminy, Pa.

Export Division: 25 Warren Street, N. Y. C. 7 • Cable Simonrice, N. Y.

COYNE
TELEVISION
RADIO-COLOR TV

Only from famous COYNE do you get this modern up-to-the minute TV Home Training. Easy to follow instructions—fully illustrated with 2150 photos and diagrams. Not an old Radio Course with Television tacked on. Includes UHF and COLOR TV. Personal guidance by Coyne Staff. *Practical Job Guides* to help you EARN MONEY QUICKLY IN A TV-RADIO SALES AND SERVICE BUSINESS—part time or full time. COSTS MUCH LESS—pay only for training—no costly "put together kits."

SEND COUPON FOR FREE BOOK

SEND COUPON BELOW for Free Book and full details including EASY PAYMENT PLAN. NO COST OR OBLIGATION—NO SALESMAN WILL CALL.



B. W. COOKE, JR. PRES. **COYNE** FOUNDED 1899
ELECTRICAL SCHOOL

A TECHNICAL TRADE INSTITUTE OPERATED NOT FOR PROFIT
500 S. Paulina Dept. 38-H6 Chicago 12, Illinois

COYNE ELECTRICAL SCHOOL
Television Home Training Div.
500 S. Paulina St., Chicago 12, Ill., Dept. 38-H6

Send FREE BOOK and details of your Television Home Training offer.

Name _____

Address _____

City _____ State _____

INFRARED SNIPERSCOPE TELESCOPE and PARTS

See in the dark—without being observed. War surplus Sniperscope M-2. Gov't cost about \$1200. Used for industrial plant security; research lab experiments; infrared photography; spectroscopy, etc. Instrument complete, ready to use. Includes Power Pack, infrared light source. Will operate from 6 V auto battery. Battery or transformer available.



Stock No. 85,053-DU . . . Shipping \$150.00 weight approx. 12 lbs. . . . f.o.b. Barrington, N. J.

Order by stock No.—Send check or M.O.—money-back guarantee!

Save still more money! Build your own Sniperscope! We will furnish instructions—parts, including: Power Packs, 1P25A image tubes, light units, filters, etc. For details—request FREE Catalog "DU."

SPECIAL! SPECIAL!

INFRARED 1P25A IMAGE TUBE

Stock No. 70,127-DU . . . \$9.95 pstd.

COLOR TV TUBESCOPE

Saves time, effort in alignment of color dot pattern.

Stock No. 50,139-DU . . . 22 power. \$24.50 pstd.

GET FREE CATALOG "DU"

America's No. 1 source of supply for experimenters, hobbyists. World's largest variety of Optical Items. Bargains galore. . . . War Surplus—Imported—Domestic! Microscopes, Telescopes, Satellitescopes, Color TV Tubescopes, Infrared sniperscopes and Parts, Prisms, Lenses, Reticles, Mirrors and dozens of other hard-to-get Optical Items.

WRITE FOR FREE CATALOG DU

EDMUND SCIENTIFIC CO.
BARRINGTON, NEW JERSEY

Get
Your First Class Commercial
F.C.C. LICENSE
in
12 Weeks!

F.C.C. License—the Key to Better Jobs

An FCC commercial (not amateur) license is your ticket to higher pay and more interesting employment. This license is Federal Government evidence of your qualifications in electronics. Employers are eager to hire licensed technicians.

Learn by Mail or in Resident Classes

Grantham School of Electronics specializes in preparing students to pass F.C.C. examinations. Correspondence training is conducted from Washington and Hollywood; resident DAY and EVENING classes are held in both cities. Either way, we train you quickly and well—NO previous training required. A beginner may qualify for his first class F.C.C. license in as little as 12 weeks.

Here's Proof! A few of our recent graduates, the class of license they got, and how long it took them:

Name	License	Weeks
James M. Farish, 926 Cardone Ave., Reno, Nev.	1st	12
Francis Krug, Station WNCC, Barnesboro, Pa.	1st	14
Steve Galvan, 1911 Brockwell, Monterey Park, Calif.	1st	13
Douglas Moore, 5102 Flambeau Rd., Madison, Wisc.	1st	11
Bernard Kirschner, 504 E. Fifth, New York, N. Y.	1st	12
Richard Meelan, 166 Jerome St., Brooklyn, N. Y.	1st	10
Charles Page, General Delivery, Yuma, Ariz.	1st	16
Edwin Harman, 6162 Bonner, North Hollywood, Calif.	1st	12

Grantham's Communications Electronics Course

offers you complete preparation for F.C.C. examinations required for a first class F.C.C. license. Even though it is planned primarily as preparation for F.C.C. examinations, it is not a "cram course" but prepares you by TEACHING you electronics.

OUR GUARANTEE FCC-TYPE EXAMS

If you should fail the FCC exam after finishing our course, we guarantee to give you additional training at NO ADDITIONAL COST. Read details in our free booklet.

FCC-type tests are used throughout the Grantham course. Constant practice with these FCC-type tests helps you prepare for the actual FCC examination.

TWO COMPLETE SCHOOLS: To better serve our many students throughout the entire country, Grantham School of Electronics maintains two complete schools—one in Hollywood, California and one in Washington, D. C. Both schools offer the same rapid courses in FCC license preparation, either home study or resident classes.

MAIL TO SCHOOL NEAREST YOU

(mail in envelope or paste on postal card)

Grantham Schools, Desk 86-C

1505 N. Western Ave. OR 821 - 19th Street N.W.
Hollywood 27, Calif. OR Washington 6, D. C.

Please send me your free booklet telling how I can get my commercial F.C.C. license quickly. I understand there is no obligation and no salesman will call.

Name

Address

City State

I am interested in: Home Study, Resident Classes

on one, two, or three sets, even when all sets are in operation at the same time. The circuit consists of a one-tube amplifier, 300-ohm input, and 300-ohm output to 1, 2, or 3 sets. Power requirements are 117 volts at 60 cycles. The device draws .12 amp. The booster is housed in a compact cabinet that measures 6¼"x3¾"x2½". It can be mounted out of sight or at the rear of one of the receivers. The device is designed for continuous operation.

"SUPER SHOWMAN"

Channel Master Corp. of Ellenville, N. Y., has begun the distribution of the "Super Showman" indoor TV antenna, a new and more powerful version of its "Showman."

The new antenna has two added design features to improve performance. A new disappearing dipole boosts low-band performance and a new parasitic reflector delivers extra high-band performance.

The 12-channel "Metro-Dyne" variable inductance tuning system for channel selectivity is also an important feature of this new antenna.

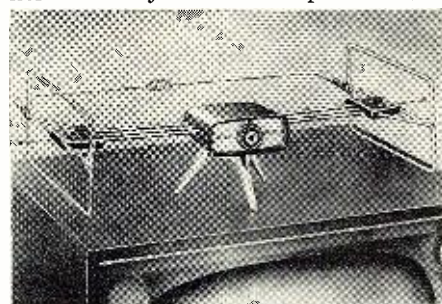

By turning the knob to the same channel as the TV set, the picture is locked in sharp focus.

The antenna is available in either mahogany and gold or blonde and gold finishes.

PARABOLIC FOR COMMUNICATIONS

Technical Appliance Corporation of Sherburne, N. Y., has developed a series of 19-foot parabolic antennas which has been expressly designed for communications work.

Available in various combinations of mounts and feed systems, all using the same parabolic reflector, the model

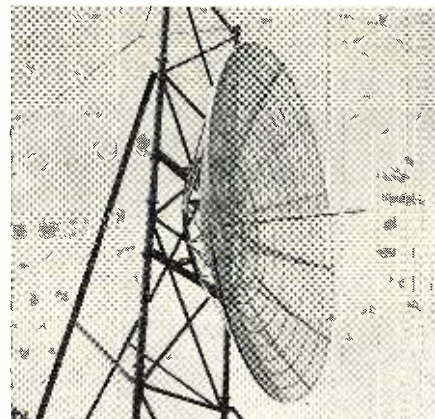

will operate over a wide range of frequencies, depending on the feed system selected.

The reflector is made up of four pie-shaped sections to facilitate easy transportation to the installation site. The individual sections are readily assembled and result in an extremely rugged structure. The base of the antenna is a circular ring truss 8 feet in diameter. Pre-formed radial members fan out from the ring truss to the tips of the reflector. Circumferential tubing is Heliarc-welded to the radial members. A rigid ring surrounds the entire structure.

Complete electrical and mechanical specifications on a full range of dishes are available from the manufacturer.

COMMUNICATION ANTENNA

Andrew Corporation, 363 E. 75th St., Chicago, Ill. is now offering a new "radome" antenna for 450-470 mc. communication applications.

The Types 212 and 213 are omnidirectional with a measured gain of 10 db over a half-wave dipole. The Type 213 is designed for systems using pressurized air dielectric cable. The connection is a 7/8" EIA flange. The power rating is 250 watts. The Type 212 may be used for systems with solid dielectric lines. The input connection is a Type N plug. Power rating is 200 watts. Air dielectric cables are recommended when cable length is greater than 35 feet.

A data sheet on these new antennas will be supplied on request. -30-

Harvey Radio Company, New York's largest electronic parts distributor, has just opened a new ham center at 103 W. 43rd St. Completely modern display facilities provide enough space for every known piece of ham gear. A feature of the Center will be a plastic package service for ham licenses. Special incapsulation equipment makes this possible. Any ham can avail himself of this service by dropping in.



ONE PRICE FOR EVERY TYPE OF TUBE

PROMPT SHIPMENT ON ALL ORDERS
DON'T PAY MORE FOR SET TESTED LONG LIFE
DEPENDABLE RADIO & TV TUBES
BUY VIDEO INDIVIDUALLY BOXED
ALL GUARANTEED FOR ONE YEAR
OR YOUR MONEY BACK

- Some Standard Brand—Others With Famous VIDEO Brand
- | | | | | |
|-------|--------|--------|---------|---------|
| 0A2 | 4B9T | 6BE6 | 6S8T | 12BH7 |
| 0A3 | 5AM8 | 6BF5 | 6SV1 | 12BY1 |
| 0A4 | 5AN8 | 6BG6G | 6T8 | 12C6U |
| 0B2 | 5AQ5 | 6BH6 | 6U4GT | 12SA1 |
| 0C3 | 5AT8 | 6BJ6 | 6U7G | 12SG7 |
| 0Z4 | 5AW4 | 6BK5 | 6U8 | 12SH7 |
| 1A7GT | 5AZ4 | 6BK7 | 6V3 | 12SJTGT |
| 1B3GT | 5J6 | 6BL7GT | 6V6GT | 12SK7 |
| 1C7G | 5T4 | 6BN6 | 6W4GT | 12SNTGT |
| 1F4 | 5T8 | 6BQ6GT | 6W6GT | 12SQ7 |
| 1H4 | 5U4G | 6BQ7 | 6X4 | 12V6GT |
| 1H5GT | 5U8 | 6BY5G | 6X5GT | 12X4 |
| 1J6GT | 5V4G | 6BZ7 | 6X8 | 14A1 |
| 1L4 | 5V6GT | 6C4 | 6Y6G | 14B6 |
| 1L6 | 5Y3 | 6CB6 | 7A5 | 14Q7 |
| 1LA6 | 5Y4G | 6CD6G | 7A7 | 19BG6G |
| 1LC5 | 6AB4 | 6CF6 | 7B5 | 19T8 |
| 1LH4 | 6ACT | 6CS6 | 7B7 | 24A |
| 1LN5 | 6AG5 | 6CU6GT | 7C5 | 25AV5GT |
| 1N5GT | 6AF4 | 6E5 | 7C6 | 25BQ6GT |
| 1S4 | 6AH4GT | 6H6GT | 7C7 | 25CD6G |
| 1S5 | 6AK5 | 6J4 | 7F1 | 25CU6 |
| 1T4 | 6AL5 | 6J5GT | 7F8 | 25L6GT |
| 1U4 | 6AM8 | 6J6 | 7N1 | 25W4GT |
| 1U5 | 6AN4 | 6K6GT | 7Q7 | 25Z6GT |
| 1V2 | 6N8 | 6L6 | 7Y4 | 35L6GT |
| 1X2 | 6AQ5 | 6NTGT | 7Z4 | 35W4 |
| 2A7 | 6AQTGT | 6S4 | 12A6 | 35Y4 |
| 2D21 | 6AS5 | 6STG | 12AHTGT | 35Z3 |
| 2X2 | 6ASTG | 6SAT | 12AT6 | 35X5GT |
| 3A4 | 6AT6 | 6SB7Y | 12AT7 | 50A5 |
| 3A5 | 6AU4GT | 6SCT | 12AU6 | 50B5 |
| 3AL5 | 6AU5GT | 6SF5 | 12AU7 | 50C5 |
| 3AU6 | 6AU6 | 6SFT | 12AV6 | 50L6GT |
| 3BC5 | 6BU5GT | 6SGT | 12AV7 | 80 |
| 3CB6 | 6AV6 | 6SH7 | 12AX4GT | 117NTGT |
| 3Q4 | 6AX4GT | 6SJ7GT | 12AX7 | 117PTGT |
| 3Q5GT | 6AK5GT | 6SK7GT | 12A21 | 117Z3 |
| 3S4 | 6BA6 | 6SL7GT | 12B4 | |
| 3V4 | 6BC5 | 6SN7GT | 12BA6 | |
| 4B2T | 6BC7 | 6SQ7 | 12BE6 | |

FREE RCA "CHEATER" CORD GIVEN WITH ANY TUBE ORDER OF \$7.00 OR MORE!!

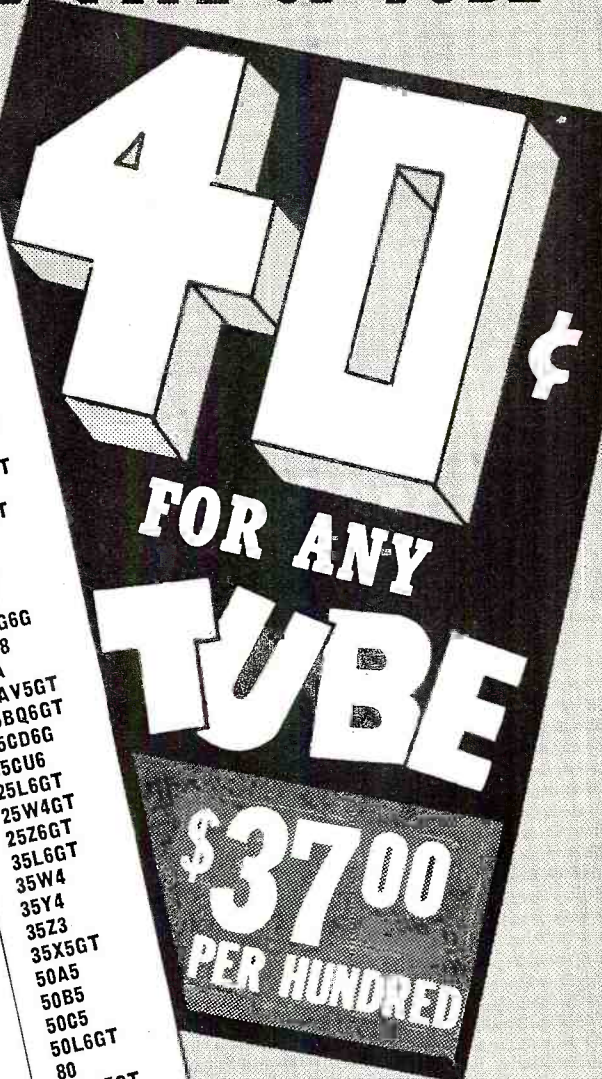

SEND for our **FREE** complete TUBE & PARTS LIST and order blank.

FREE BONUS ANTENNA GIVEN WITH ANY TV SET ORDER!!

We have OVER 1000 USED TV SETS
 At All Times In Our Huge Warehouse Buy one or more of these WORKING TVs to sell or use as your own second set! All Sets in GOOD WORKING condition!
 Your Choice—Console or Table Model

10" ...\$23.00	19" ...\$58.00
12" ...\$28.00	20" ...\$64.00
14" ...\$33.00	21" ...\$72.00
16" ...\$40.00	24" ...\$99.00
17" ...\$46.00	

When ordering TV's, state whether table model or console is desired. Also preference on make of set. All TV's sent railway express F.O.B. Newark. On any quantity WIRE or CALL today!

Brand New Factory Seconds! Electrically Perfect Factory Seconds! Used Tubes! New and Used Jan Surplus Tubes!

FREE POSTAGE in U.S.A. and Territories on orders over \$5.00. 25¢ handling charge on orders under \$5.00. 25% deposit required on C.O.D.'s. Please send approximate postage or freight on Canadian and foreign orders. Subject to prior sale.

VIDEO

ELECTRIC COMPANY
 79 CLINTON PL. NEWARK, N. J. Phone Humboldt 4-9848

RAD-TEL TUBE Co.

Transformer PRICE Spectacular!



All Power Transformers 117V
60C 5V Rect. & 6.3V Fil.

Part No.	H.V. Sec. All C.T.	Price	Lots of 3 DEDUCT 5%	Lots of 10 DEDUCT 10%	Lots may be assorted!
454	696	\$3.20			
488	440	\$2.20			
490	156 No C.T.	\$2.20			
508	686	\$4.20			
509	640	\$3.00			
451	700/412	\$3.20			
#451 has 2-5 V Sec. only					

E.M. SPEAKERS E.M.

Part No.	Dia.	Field	V.C.	Price
345	5"	600	3.2	79¢
330	5"	1300	3.2	79¢
331	5"x7"	600	3.2	89¢
346	6"	1700	3	98¢
343	6"x9"	1100	5.3	\$1.09
344	7"	1075	3	99¢
333	12"	700	10	\$1.99
332	12"	800	3.2	\$1.99
334	12"	1100	5.1	\$2.05

SPECIAL WITH THIS AD ASST. OF 3 DEDUCT 1/3

MARCH SPECIAL!

FILTER CHOKE
RAD-TEL ASSORTMENT

1 to 65 Henrys
300 to 10 MA. **\$3.00**
Our Asst. Of 6,

ALL RAD-TEL TUBES Guaranteed 1 Full Year!

Not Affil. With Any Other Tube
Mail Order Co.

Rad Tel TUBE CO.

Write Dept. RN-3 for
FREE Catalog of Tubes
& Parts. Subject to
prior sale. No C.O.D.'s,
please, on this sale.
Allow for Postage.

55 CHAMBERS STREET, NEWARK 5, N. J.

The "Mark III"



A wire cage over the tubes and a bottom plate are used to enclose the entire unit.

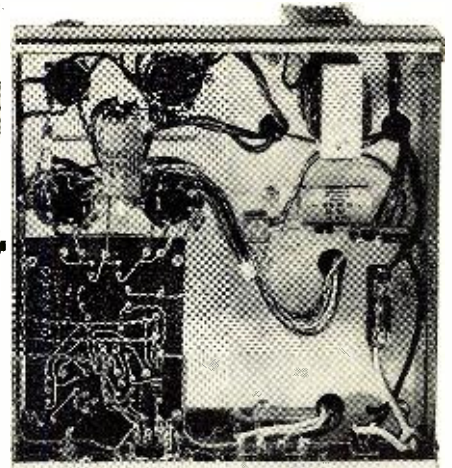

KT88 output tubes provide 60 watts of audio in this easy-to-build high-fidelity power amplifier.

LIKE almost everyone interested in high-fidelity, your editors always look forward to new items, components, or even circuits that will further improve the quality of sound reproduction. It hasn't been too long ago since the British-made KT88 output tube reached the American market. It has been received with so much enthusiasm that within a short period of time one will find many power amplifiers, produced in this country, equipped with this new tube.

It is actually the "big brother" to the KT66 which most audiophiles will remember achieved its greatest prominence in the Williamson amplifier.

One of the first such amplifiers that has come to our attention for a performance check is the "Mark III," manufactured by the *Dyna Company* and marketed in kit form. The circuit does not differ, to any great extent, from the original 50-watt "Mark II" design. It does, however, include refinements in that component toler-

While diagram shows simplicity of design, circuit provides real hi-fi performance.

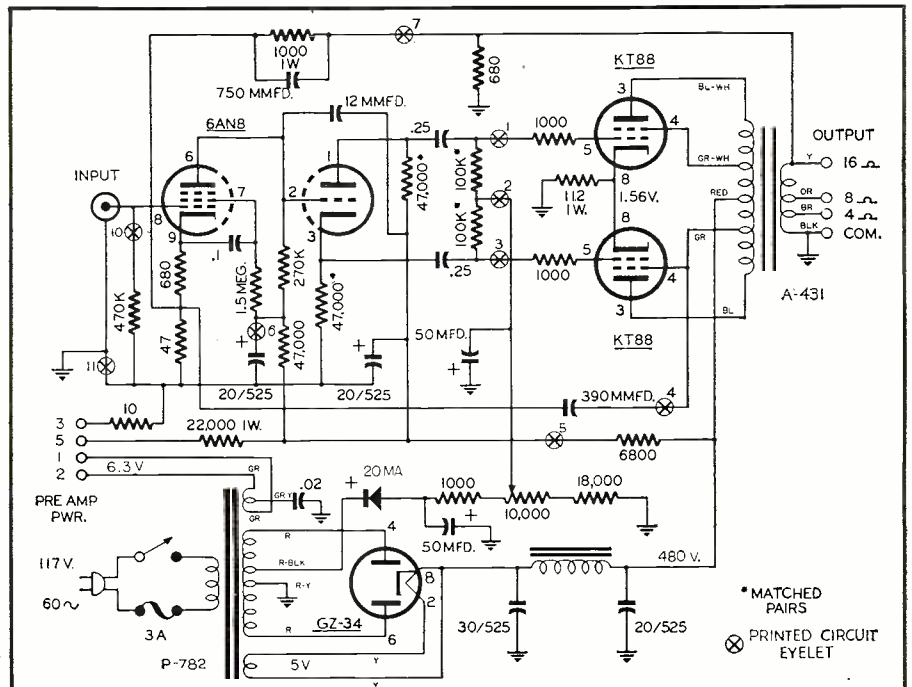

ances and circuit adjustments were given much more consideration, resulting in a power amplifier with extremely low distortion, even at 60 watts output. In addition, a 4-ohm output tap is provided for hi-fi loudspeakers with this value of impedance. Choke filtering is employed in this unit so that a lower hum level is produced than would be the case if simple resistance-capacitance filtering were used.

There are four tubes: a 6AN8, two KT88's, and a GZ-34 rectifier used in the design. The input stage, a pentode voltage amplifier, is directly coupled to a cathodyne phase inverter, driving the output tubes operating with fixed bias. The screens of these output tubes are operated from a 33% turns point on the output transformer, improving the regulation of this stage and making it comparatively uncritical to load impedance variations.

As to performance, listening tests showed extremely good quality, equal to that of better amplifiers on the market today. Yet, instead of going over the subjective performance of the unit, which would be merely personal opinion, let's review the actual performance report taken in our own laboratory:

Sensitivity: 1.55 volts r.m.s. input for maximum power output.

Hum and Noise: -78 db from 2 watts, open input circuit. -80 db from 2 watts, shorted input.

Frequency Response: 5 to 64,000 cps ± 1 db at 2 watts. 13 to 43,000 cps ± 1 db at 60 watts.

IM Distortion: With 60 and 6000 cycles (4:1 ratio) and equivalent sine-wave output of 2 watts, the intermodulation distortion is .048%. At maximum output of 60 watts under the same conditions, the IM distortion is .37%. These figures are extremely low, however, distortion does rise very sharply above 60 watts. Actually, at 62.7 watts, the IM distortion is 1%.

Harmonic Distortion: At 1000 cycles, 2 watts output, the harmonic distortion is .02% and gradually rises to 1% at 60 watts. At 20 cps, harmonic distortion of 2% occurs at an output of 54.5 watts. At the high frequency end (20,000 cps), this harmonic figure is obtained with an output of 51.5 watts.

According to the manufacturer, the amplifier does not exhibit any bounce or flutter when pulsed. It is extremely stable irrespective of loudspeaker load and with any reasonable length of leads for remote speaker operation.

There was one particular point worthy of comment. The original model constructed had somewhat higher IM distortion at 2 watts (.42%) than called for by the maker's specs. It was found that the two 47,000-ohm resistors in the phase splitter were not matched close enough and after adjustment the results, as quoted, were obtained. The manufacturer immediately tightened initial inspection so that this should not be a problem.

-50-

March, 1958



RCA THYRATRONS

for
industrial
duty



For top reliability in motor-, welding-, and other control equipment it pays to use RCA long-life Thyratrons. There are many types to meet industrial requirements. Available at your RCA Industrial Tube Distributor.



RADIO CORPORATION OF AMERICA
Electron Tube Division
Harrison, N. J.

For free booklet (PG101C) on RCA Thyratrons as well as other RCA Gas and Power Tubes for industry, write RCA Commercial Engineering, Sect. C-41-T, Harrison, N. J.



139

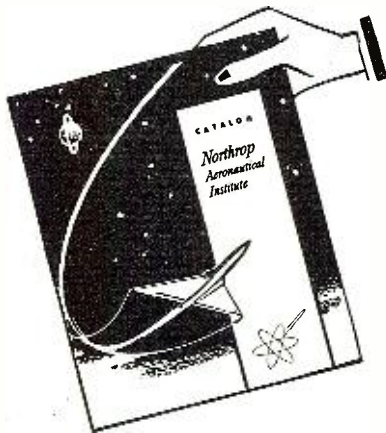

You can have this

ILLUSTRATED
FREE BOOK
32 page



Shows You — Tells You
about the wonderful career opportunities
in the world's fastest growing
interdependent industries:

- **AERONAUTICS**
- **ELECTRONICS**

Tells how you can take your place in a surprisingly short time, at Big Pay and with a Future Unlimited, alongside the hundreds of successful Northrop graduates. They are employed by many of the country's leading companies on such projects as:

Electronic Computer Planning,
Missile Flight Test Engineering,
Design of Servomechanisms,
Design of Rocket Powerplants,
Celestial Guidance Systems,
and many more.

It will cost you nothing but a postage stamp to find out about the wonderful future open to you, and about the great demand for Northrop Institute graduates.

APPROVED FOR VETERANS



Northrop
Aeronautical Institute
An Accredited Technical Institute
1185 W. Arbor Vitae Street
Inglewood 1, California

NORTHROP AERONAUTICAL INSTITUTE
1185 W. Arbor Vitae Street, Inglewood 1, Calif.
Please send me immediately the Northrop catalog, employment data, and schedule of class starting dates. I am interested in:

Electronic Engineering Technology
 Aeronautical Engineering Technology
 Aircraft Maintenance Engineering Technology
 Master Aircraft and Engine Mechanic
 Jet Engine Overhaul and Maintenance

Name..... Age.....
Address.....
City..... Zone..... State.....
Veterans: Check here for Special Veteran Training Information.

FEEDBACK

By PAUL W. KLIPSCH
Klipsch & Associates

MUCH has been written on the application of feedback to compensate for speaker impedance variation. The height appears to have been reached in claiming to have extended the range of a speaker. (Refer to the article "A New Look at Positive Current Feedback" by Zink and Sanford in the November, 1957 issue of RADIO & TV NEWS.)

Feedback in an amplifier, to obtain lower amplifier distortion, or to maintain a low internal amplifier impedance (nearly constant voltage with varying load impedance) or some condition between that and constant current; all these are good or useful, depending on the application. But to make a speaker go an octave lower by means of the altered internal impedance of an amplifier can be shown to be a fallacy.

In testing a speaker, a certain voltage is applied to its terminals. Since at the given frequency the speaker exhibits a certain impedance, a certain current flows. There results a certain sound output. Now at that frequency it makes no difference whether the internal impedance of the amplifier is high, low, or negative. It is the current in the voice coil that produces the force and its resultant motion. Assuming the amplifier to be free from distortion, it makes absolutely no difference whether the amplifier has zero impedance, has positive feedback, or even if its power rating is high or low as long as the power rating is adequate to produce the stipulated volts and amperes. Hence if a speaker is tested at its optimum input volt-ampere conditions, we can not improve the speaker response with an amplifier of some peculiar internal impedance characteristic.

Now, of course, the feedback may cause an altered frequency response; since the speaker impedance is a complicated function of frequency one could apply feedback of a type to raise the amplifier impedance, say, making it approach constant current instead of constant voltage, with resultant peaking of speaker output by compounding high efficiency with high power absorption at high impedance peaks. But as for making a speaker deliver undistorted acoustic power outside its operating range, this is an operation bootstrap. It's nice to wish for it, but wishful thinking doesn't make it so. Some have claimed to have obtained 20-cycle output from a Klipschorn; sure it can be done but at minute amounts of power; try to equalize that output up to "useful" levels and all one gets is distortion. This can be said of any speaker.

What the feedback proponents are accomplishing is simply an equalization which becomes a function of speaker impedance, for better or worse. Equalization has long been thought of as a means of extending speaker range, but invariably it increases distortion.

Furthermore it would be useless if a speaker did produce a fundamental tone at 20 cycles. Experiments with a stethoscope and pistonphone capable of 140 db pure sine wave pressures down to 2 cycles per second were studied aurally. Below about 35 cycles most listeners heard pulses rather than sine waves and no one tested so far heard fundamentals below about 28 cycles. This type of test is not extensive enough to state these results as being general, but they appear to be usual.

NEW!

FIRST ISSUE
NOW ON SALE



HiFi & Music Review is America's newest, most exciting high fidelity magazine. Features more than 20 pages of record and tape reviews, exclusive picture stories on musical personalities, informative articles on new hi-fi equipment and developments.

Buy your copy of HiFi & Music Review today!

On sale at all newsstands, leading hi-fi salons and record stores now—
ONLY 35c

**GET MORE WORK
OUT OF YOUR
OSCILLOSCOPE**

Learn to service
**ANY radio or TV
faster... with the
handiest instrument of all!**



Here, in a greatly enlarged edition, is THE book that really shows you how to use oscilloscopes!

Clearly as A-B-C, MODERN OSCILLOSCOPES AND THEIR USES tells you exactly when, where and how. You learn to locate either AM or FM radio or television troubles in a jiffy. Even tough realignment jobs are made easy. No involved mathematics! Every detail is clearly explained—from making connections to adjusting circuit components and setting the oscilloscope controls. And you learn to analyze patterns fast and RIGHT!

ENLARGED 2nd EDITION!

Includes Color TV 'Scope Data

Includes latest data on use of 'scopes in color TV, industrial electronics, teaching... even in atomic energy work. Over 400 pages and over 400 clear pictures. Dozens of pattern photos make things doubly clear... even for beginners!

PRACTICE 10 DAYS FREE!

Dept. RN-38, RINEHART & CO., Inc.
232 Madison Ave., New York 16, N. Y.
Send new 2nd edition of MODERN OSCILLOSCOPES AND THEIR USES for 10-day examination. If I like book, I will then send \$6.50 (plus postage) in full payment, or return book postpaid and owe you nothing.

Name.....
Address.....
City, Zone, State.....
Outside U.S.A.—Price \$7.00, cash with order only.
Money back if you return book in 10 days.

A Flyback Tester

(Continued from page 48)

normal length, as no boost voltage is being developed in the absence of a yoke.)

6. If r.f. is present, remove the test box. Disconnect everything except "B+" from the suspected flyback; re-connect the plate clip; and try for an arc from the rectifier plate cap. If no r.f. is present, there is a short circuit somewhere in the flyback. If r.f. does exist, the flyback is good (or there may be an open in the primary, which is easily checked).

7. Now re-connect the original flyback leads in the set *one at a time*. The connection which kills the r.f. is the one leading to the circuit which contains the fault.

This little gimmick is so quick and easy to use that you will find yourself *beginning* the search with the flyback instead of *finishing* it there!

It pays to know how a piece of test equipment operates; so, for those not fully familiar with transformer operation, some explanation of the principle of the device will be interesting. The flyback is a high-"Q" transformer. One shorted turn can lower the "Q" enough to kill r.f. Even a single loop of wire around the core, not connected to anything else, can do this. By connecting the test box, we use the horizontal-output tube as an r.f. generator, as in Fig. 3A. The r.f. voltage is increased by the step-up ratio of the autotransformer, but is smaller than normal because no boost voltage is generated. With other circuits disconnected from the suspect transformer, the top part should work just as the test box did, as long as no internal shorts exist in the windings. See Fig. 3B. The lower portion of the transformer winding goes along for the ride—it contributes nothing but it does no harm. If a short exists anywhere in the winding, the "Q" is lowered and r.f. is inhibited. If a defect in an associated circuit is improperly loading the transformer to prevent the development of r.f., this circuit will be localized when its connection to the transformer is made (Step 7) and r.f. is cut off.

Try this simple little gadget. After you have used it two or three times, you will begin to feel that it is indispensable. —30—

Fig. 3. (A) Connection of the test flyback. (B) Re-insertion of 3 connections of the suspect flyback before auxiliary connections are restored, one at a time.

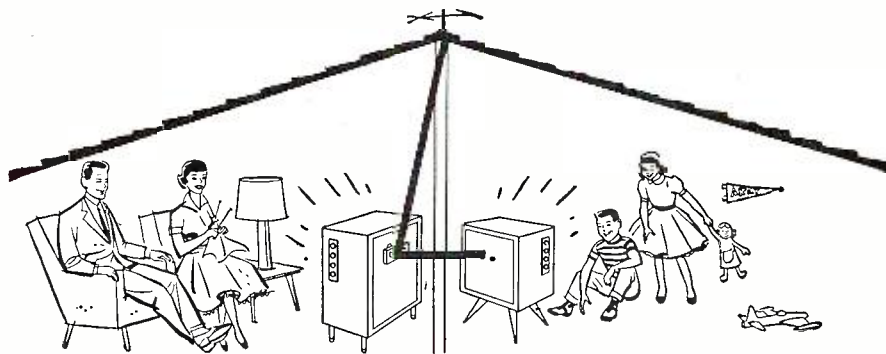
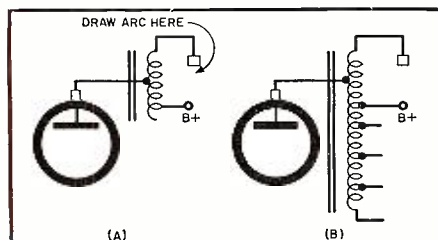

NOW!

sharper, clearer pictures on 1, 2 or 3 tv sets with 1 antenna

NEW  B-23

TWO-SET BOOSTER

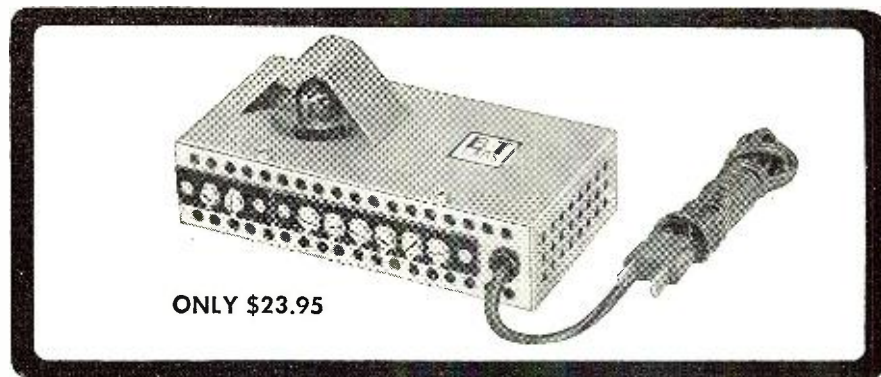

From B-T comes the most important step forward in better TV reception for 1958—a broadband TV amplifier that boosts signal strength on all VHF channels 2-13 and operates 1 or 2 or 3 TV sets with one antenna. No tuning is required.

combines two functions in one

A single B-23—

- **BOOSTS** signal strength on 1 or 2 or 3 TV sets—up to 6 db gain operating two TV sets from one antenna.
- **COUPLES** 2 or 3 TV sets—using the present antenna. Outperforms non-powered couplers in any reception area by more than 2 to 1.

check these B-23 features:

- Ideal for color—add a color TV set and keep present black-and-white set, use the same antenna—the result, sharper, clearer pictures on both sets.
- Low noise figure—designed to work with new VHF sets.
- Reduces interference.
- Easily installed at antenna terminals of set. Can be mounted out of sight at the rear of the receiver.
- Automatically amplifies channels 2-13.
- Ideal small TV system (motels, multiple dwellings, TV showrooms).

FOR OPERATING 3 TO 8 TV SETS, USE THE B-T LABS DA8-B—MORE THAN 10 DB GAIN ON ALL VHF CHANNELS.

The DA8-B Distribution Amplifier is a broadband, all-channel unit that requires no tuning, impedance matching devices, pre-amps or other special fittings. Ideal for all small TV systems including garden apartments, motels, TV showrooms serving more than 3 sets. Approved for color. only \$94.50.

The B-23, the DA8-B, and a host of other B-T quality engineered products to improve television reception, are available at electronic parts distributors.

For further information, use coupon.

 **B-LONDER-TONGUE LABS., INC.**
9 Alling Street, Newark 2, New Jersey

Please send me literature covering:

B-T B-23 B-T TV Accessories

Name _____

Address _____

City _____ Zone _____ State _____

RTN-3

REGULATED POWER SUPPLIES

... Like New Condition

A special purchase of a large quantity of Dressen-Barnes Regulated Power Supplies Offered at a real savings of \$ \$ \$ \$ \$.



- Model D3-500B Dual Regulated Supply
 - 2 0-300 VDC. 0-500 ma.
 - 2 Bias Voltage 300 VDC. fixed.**\$390.00**
- 2 6.3 VAC. @ 10 amps unreg.
- Model D5-300B Dual Reg. Supply
 - 2 0-500 VDC. 0-300 ma.
 - 2 Bias Voltage 300 VDC. fixed.**\$390.00**
- 2 6.3 VAC. @ 10 amps unreg.
- Model 5-300F Reg. Supply
 - 1 0-500 VDC. @ 0-300 ma.
 - 1 0-300 VDC. @ 0-150 ma.**\$240.00**
- 1 6.3 VAC. @ 10 amps unreg.
- Model 3-1.5 MB Reg. Supply
 - 1 0-300 VDC. @ 0-150 ma.
 - 1 0-150 VDC. @ 5 ma.**\$390.00**
- 1 6.3 VAC. @ 10 amps unreg.
- Model D50-.05B Dual Reg. Supply
 - 2 0-50 VDC.
 - @ 0-50 ma.**\$160.00**
- Model D1-100B Dual Reg. Supply
 - 2 0-100 VDC.
 - @ 0-100 ma.**\$270.00**
- Model 3-150B Reg. Supply
 - 1 0-300 VDC. @ 0-150 ma.
 - 1 0-150 neg. VDC. @ 5 ma.**\$120.00**
- 1 6.3 VAC. @ 6 amps unreg.
- Model D5-200C Dual Reg. Supply
 - 2 30-500 VDC. @ 0-200 ma.
 - 2 6.3 VAC. @ 10 amps unreg.**\$375.00**
- Model 4-200X Sub Chassis Mtg. Supply
 - 1 400 VDC. @ 0-200 ma.
 - 1 6.3 VAC. @ 6 amps unreg.**\$80.00**
- Model 3-150L Reg. Power Supply
 - 1 0-300 VDC. @ 0-150 ma.
 - 1 6.3 VAC. @ 6 amps unreg.**\$75.00**
- Model 1.5-150X Sub Chassis Mtg. Supply
 - 1 150 VDC. @ 0-150 ma.
 - 1 6.3 VAC. @ 6 amps unreg.**\$50.00**
- Model 28-5MX Sub Chassis Mtg. Supply
 - 1 28 VDC.
 - @ 0-5 amps unreg.**\$30.00**

Several other models in limited quantities

- APN4B Loran—New with mounts, plugs, and new PE-206 Inverter . . . **\$119.50 each**
- Kay Mega-Sweep Video Generator, Calif. Model—Excellent. . . **150.00 each**
- Electronic Research Assn. Model CC-200 Constant Current Generator. . . **150.00 each**
- LX1 Signal Generator Model 8-330 MC—Metal Case—Like New Hickok Universal Video Generator Model 650C—Like New. . . **150.00 each**
- Hewlett-Packard Test Oscillator Model 650A—Excellent. . . **250.00 each**
- Hewlett-Packard Audio Oscillator Model 205A—Excellent. . . **250.00 each**
- TS-175/U Frequency Meter 85-1000 mc.—Excellent. . . **300.00 each**
- Dumont Type 342R Cathode-Ray Oscillograph 50-400 cy.—Excellent. . . **450.00 each**
- Teletronic Lab. Model 101 Oscillograph—Excellent. . . **150.00 each**
- General Radio Vacuum Tube Fork 1000 cy. Type 723A with power supply—New Condition. . . **75.00 each**
- General Radio Oscillator 500 mc. Type 857A with power unit Type 857A-P1—Like New. . . **100.00 each**

PHOTOFLASH SPECIALS

- G. E. FT-524 Quartz Photoflash Tubes 3000 W. S.—New. . . **\$ 20.00 each**
- G. E. 80 mfd. @ 4000 V. Photoflash Capacitors 640 W. S.—New. . . **49.50 each**
- Sprague 100 mfd. @ 4000 V. Photoflash Capacitors 800 W. S.—New. . . **62.50 each**

F.O.B. Pasadena, California

PHOTOCON SALES

421 North Alhadena Drive
PASADENA, CALIFORNIA
SYcamore 2-4131 RYan 1-6751

Transistor Heat Sinks
(Continued from page 71)

It makes little difference if the power is applied steadily to the chassis or in jerks. The average power is the quantity that is important. The chassis will not get hotter than what would be expected from its average heat flow—averages over two or three minutes.

This means in practice that the chassis will in fact be somewhat cooler than predicted using the peak power dissipation. We can use this fact to advantage and push the transistor a little harder without danger of burn-out.

In many cases it is not easy to calculate the average power dissipation and this can be avoided by measuring the chassis temperature directly. This is most easily done with a thermocouple or thermistor.

It can also be measured with an ordinary thermometer provided care is taken to insure a good contact. Grease (such as is required for the mica washer) is helpful. Place a small heap of grease on the chassis near the transistor and lay the bulb of the thermometer in it making sure it is touching the chassis and surrounded by grease. Placing cotton or some other insulating material on top of the thermometer sometimes helps insure accuracy.

Whether the chassis temperature is measured or computed using the average power dissipation and the chassis thermal resistance by the formula: $T_c = T_a + \theta_c P_{av}$ it is now known. The junction temperature can be calculated now from the formula (remember the electrical analogue if you don't "see" this formula)

$$T_j = T_a + P(\theta_w + \theta_c)$$

The electrical analogue can be extended to include the thermal time constant of the chassis by merely adding a capacitor to the circuit. Fig. 5 shows the new circuit, with I again corresponding to P , R_c to θ_c , V_j to T_j , etc. The capacitor C is chosen to make the time constant CR_c just equal to the thermal time constant of the chassis.

Here the circuit is easy to analyze. If the current I is not steady, it has an average value. The voltage drop across R_c will be steady, because of the large value of the capacitor shunting it, and will be equal to the average current multiplied by R_c . The top voltage V_j is just this steady voltage V_c plus the two IR drops in the two re-

Fig. 5. C represents chassis heat capacity.

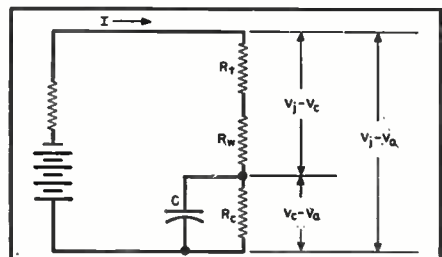

SPELLMAN HIGH VOLTAGE

STEP-UP COILS

FOR

EXPERIMENTERS • ENGINEERS
RESEARCH LABORATORIES

for construction of
RF type High Voltage
DC POWER SUPPLIES



Coils are furnished with schematic diagrams showing various circuits, regulated and unregulated, of DC power supplies from 5KV to 90KV.

35 KV COIL

- 5 KV \$ 7.00
- 10-15 KV 12.00
- 25 KV 36.00
- 35 KV 42.00
- 70 KV 75.00

Filament Transformers \$1.50

All prices are Net

SEND FOR COMPLETE CATALOG RT OF POWER SUPPLIES AND COILS

SPELLMAN TELEVISION CO., INC.
3029 WEBSTER AVENUE
N. Y. 67, N. Y.
Kingsbridge 7-0306

ENGINEERING Home Study Courses

Courses written by world authorities in all branches of engineering. Step-by-step instructions using methods proved successful by thousands of our graduates. One hour each day in your spare time will start you off to higher pay, security, prestige. Check the course you are interested in and we will send you a complete outline of the course with a booklet describing the Institute and our advanced methods of teaching. Send to:

CANADIAN INSTITUTE OF SCIENCE AND TECHNOLOGY LTD.
#674 Century Bldg.

- | | |
|------------------------------|-------------------|
| 412, 5th St. N. W. | Washington, D. C. |
| Civil Eng. | Electrical Eng. |
| Surveying | Radio |
| Archfrcture | Electronics |
| Forestry | Television |
| Mining | Aeronautical Eng. |
| Structural | Aircraft Engineer |
| Mechanical Eng. | Navigation |
| Industrial Eng. & Management | General Education |
| Refrigeration | Chemical |
| Heating | Mathematics |
| Drafting | Journalism |
| Plastics | Accounting |

Name
Address
City State

Canadians: Send to Canadian Institute of Science & Technology Limited, #674 Garden Bldg., 263 Adelaide St. West, Toronto, Ontario.

sistors R_w and R_t . This is just the result we found a minute ago, if we think back to the thermal situation.

A question that may be raised is, "Since the capacitor shunting R_c is due to the heat capacity of the chassis, and since the transistor mounting base must have some heat capacity itself, shouldn't there be a capacitor shunting R_t ?" Yes, there should be. Its value should make the upper time constant equal to the so-called "junction time constant," which for modern transistors is a few milliseconds.

However, relying on this capacitor to smooth out the junction temperature is risky, for even moderate audio frequencies last long enough so that the capacitor is not too effective.

The resistor representing the mica washer should also have a capacitor shunting it, but this value will be very small.

When making an experimental circuit, it is often wise to use a very large heat sink and keep the peak power dissipation below the limit calculated from the data here. However, when the circuit is built up in final form, such a large heat sink is often unnecessary. By using the fact that the chassis heat capacity smooths out the short-term fluctuations in chassis temperature, you can get by in practical cases with a somewhat smaller chassis, and still be safe.

To account for unexpected conditions it is wise to plan to stay below the power rating you compute. Leave as big a "safety factor," or "factor of ignorance" as you feel will account for unexpectedly high ambient temperatures, current and voltage surges, etc.

-30-

CRYSTAL CARTRIDGE TEST

By PAUL MITNAUL

HERE is a quick and simple way to test crystal cartridges and, at the same time, put to good use some of those dust-laden capacitor checkers which are to be found in many service shops.

Set the range switch of the checker to the 10-5000 μfd . scale. Next disconnect the leads from the crystal cartridge. It is not necessary to remove the cartridge from the tone arm unless the leads are soldered directly onto the cartridge as in the old type of record changers.

Next clip the test leads of the capacitor checker onto the terminals of the crystal and adjust the checker for a balanced condition as indicated by widest deflection angle of the eye or whatever other device is used to indicate a balanced circuit. In other words, go through the same procedure as for testing a paper capacitor.

Now the needle should be plucked gently with the finger. If the crystal is good, the eye's shadow will flicker violently due to the generated voltage and the change of capacitance in the crystal, causing the unbalance in the bridge circuit. On the other hand, if the crystal is defective, little or no variation will be noticed.

Crystal mikes may also be tested by this method by speaking into the mike or thumping with the finger and noting the resultant eye movement.

-30-

RADIO • TELEVISION • INDUSTRIAL ELECTRONICS

THIS professional TRAINING IS THE KIND THAT Really Pays Off!

... and it costs only a fraction of what you might expect to pay!

FIX ANY RADIO OR TV SET EVER MADE...easier...better...faster

Backed by the how-to-do-it methods so clearly explained in this one big 822-page book, you'll be prepared for fast, accurate service on any radio or television receiver ever made.

Radio & Television TROUBLESHOOTING AND REPAIR by Ghirardi & Johnson is far and away the world's most modern, easily understood guide. Step by step, it takes you through each service procedure... from locating troubles with less testing to repairing them promptly by fully-approved professional methods... the kind that enable you to handle tough jobs as slick as you now do the easy ones.

Best of all, the cost is only \$7.50 (or see money-saving combination offer in coupon).

COMPLETE SERVICE TRAINING

For beginners, this giant book is a complete training course. For

experienced servicemen it is the ideal way to develop better methods and to find fast answers to tough jobs.

Here are just a few of the subjects covered: Components and Their Troubles; Basic Troubleshooting Methods; "Static" and "Dynamic" Testing; Practical Troubleshooting Tips and Ideas; AC/DC, 3-way Portable and Battery Set Troubleshooting Problems; Servicing Communications Receivers; a Complete Guide to Television Service; AM, FM, and TV Realignment Made Easy; Resistor, Capacitor, Inductor and Transformer Problems; Servicing Tuning, Selector and Switching Mechanisms; Loudspeakers; Servicing Recorders and Record-playing Equipment... and dozens more! 417 illustrations. Read TROUBLESHOOTING AND REPAIR for 10 days AT OUR RISK!

LEARN BASIC CIRCUITS FULLY... and watch service "headaches" disappear

It's amazing how much easier and faster you can repair radios, television sets and even industrial electronic equipment when you know all about circuits and what makes each one "tick."

You locate troubles in a jiffy because you know what to look for and where to look.

You make repairs lots faster, better and more profitably!

Actually, there are only a comparatively few BASIC circuits in modern equipment. Radio & Television RECEIVER CIRCUITRY AND OPERATION by Ghirardi and Johnson gives you a complete understanding of these as well as their variations. It teaches you to recognize them... to understand their peculiarities and likely "troublespots"... and shows how to eliminate useless testing and guesswork in making repairs.

A COMPLETE GUIDE TO RADIO-TV CIRCUITS

Throughout, this 669-page book with its 417 clear illustrations gives you the kind of above-average professional training that fits you for the better, big pay jobs in either servicing or general electronics.

Covers all circuits in modern TV and radio receivers, amplifiers, phono-pickups, record players, etc.

Price only \$6.75... or see money-saving offer in coupon. Examine it 10 days at our risk!

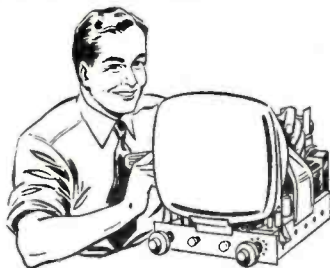

These books explain SERVICE PROCEDURES so you can really understand them!

Almost 1300 pages and over 800 pictures and diagrams in these two new books explain things so clearly it's next to impossible for you to go wrong.

MODERN RADIO AND TELEVISION SERVICING LIBRARY

receiver troubles

SAVE \$1.25

Make your training library complete! Get both big books for only \$13.00. (You save \$1.25)

MODERN RADIO AND TELEVISION SERVICING LIBRARY

receiver circuitry &

FREE EXAMINATION... easy terms

Dept. RN-38, RINEHART & CO., INC.
232 Madison Ave., New York 16, N. Y.

Send books indicated for FREE EXAMINATION. In 10 days, I will either remit price indicated plus postage or return books postpaid and owe you nothing.

Radio & TV TROUBLESHOOTING AND REPAIR (Price \$7.50) Radio & TV CIRCUITRY AND OPERATION (Price \$6.75)

COMBINATION OFFER... Both books only \$13.00 (Regular price separately \$14.25... you save \$1.25)

(Combination offer is payable at rate of \$4 (plus postage) after 10 days if you decide to keep books, and \$3 a month thereafter until \$13 has been paid.)

Name.....

Address.....

City, Zone, State.....

OUTSIDE U.S.A. ... \$8.00 for TROUBLESHOOTING & REPAIR; \$7.25 for CIRCUITRY & OPERATION; \$14.00 for both books.

Cash with order, but money refunded if you return books in 10 days.

Look for these
Tarzian
"Kit-Paks"
 AT YOUR
 DISTRIBUTORS



M-500

CONVERSION KITS FOR TELEVISION

At no extra cost, provide your customers with the best television picture their set can deliver. Replace weak selenium rectifiers with Tarzian silicon rectifiers. A complete kit, with instructions, is supplied. Constant output voltage maintains full size picture throughout the full life of the rectifier. Replaces all selenium rectifiers rated 200 to 500 ma and 130 volts.

M-150

REPLACEMENT KITS FOR RADIO

A low cost silicon rectifier that will fit into any small size receiver yet deliver enough power for the largest console sets. A variety of mounting methods is provided by adaptors included with the kit. The Tarzian M-150 replaces all seleniums rated 150 ma or less.

Why stock over 12 types of bulky selenium rectifiers when two types of silicon will handle almost all of your replacements. Buy them by the kit or by the carton.

Be sure to send for Service Notes #1 and #4 that completely describe Tarzian Silicon rectifier replacement use.

Sarkes Tarzian Rectifier Division
 DEPT. N-1
 415 N. COLLEGE AVE.
 BLOOMINGTON, IND.
 In Canada: 700 Weston Rd., Toronto 9, Tel. Rogers 2-7535
 Export: Ad Auriema, Inc., New York City



ASSOCIATION member: have you sent in yet, on behalf of your group, a filled-in copy of the coupon below? It takes only a few minutes of your time, and it can be pasted on a postal card. It will help your association in two ways: it will directly publicize your group's activities, and it will assist you indirectly by giving you a picture of how other groups function.

The editors of service-association house organs have been steadily increasing their use of copy that encourages association members to examine critically their own business-operating and customer-relations practices. While they continue to throw the white light of publicity on industry practices and developments that, in their opinions, are not in the best interests of the independent service industry, there is a noticeable acceptance of the fact that some of the bad publicity TV service has received has been due to the bad business practices and poor customer-relations efforts on the part of many full-time, legitimate service dealers.

In a recent issue of "The Raster," the official publication of the Electronic Service Council of the Ozarks,

"Why the slow pay on the part of the shop owner? Well, we can't give the answers, or at least not all of them, but we believe we can put our finger on a few weak spots. First and foremost, we believe that some shop owners do not have the proper attitude toward the paying of their accounts. They assume that the distributor is made of money and more able to wait than the shop owner. This just isn't so! The distributor is caught in a giant squeeze, especially the legitimate one, who must nearly always wait for his money, coupled with the fact that the shop owner in general is rather disloyal when he owes money to a distributor. Quite often, when a shop owner gets in debt to a distributor, he will spend his cash with someone who will give him a slightly larger discount. There is always some distributor who will come along and give a longer discount if you pay cash but beware when you need merchandise replaced or other services that only the legitimate distributor will render!

"If you are in debt to a distributor, you are morally obligated to spend your cash with that distributor, much

Service Editor
 RADIO & TV NEWS
 1 Park Avenue
 New York 16, New York

We want to tell you more about our association. Please send us your questionnaire.

Name of Association.....

Mailing Address

Name of President or Corresponding Sec'y.....

Editor Wayne Lemons covered an important but touchy subject in an editorial titled, "Why Can't Technicians Pay Their Bills?" "Maybe the question should be," wrote Editor Lemons, "Why won't technicians pay their bills?"

"One of the things we hear regularly from distributors, is the number of slow accounts in their files. It's no secret that a great number of shop owners do not discount their bills by paying their accounts on time. This is a rather sad situation, not only from the standpoint of the distributor who needs the money to pay bills of his own, but also to the shop owner who could save himself enough in just one year to take an expense-paid vacation.

more so than if your account is paid up!

"Another fault that many shop owners fall into is that of not paying themselves a salary and then living on that salary. They carry all their money in the pocket and dish it out to the first creditor, or to the wife for something new, or for one thing or another, forgetting completely their obligation to the parts distributor. Every shop owner should pay himself a salary and have at least a simple bookkeeping system that will tell him when he is losing money, either by not charging enough or by having too many charge accounts, or whatever the cause may be.

"Shop owners must learn to make money selling, rather than by trying

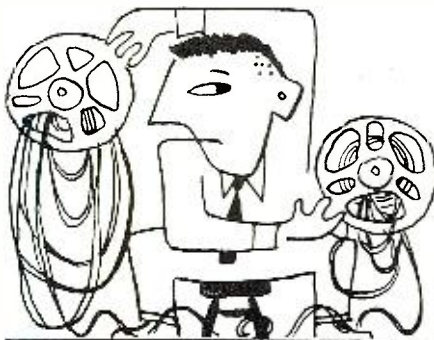

get the straight facts on current model TAPE RECORDERS

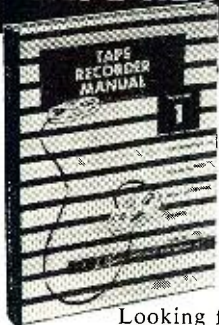

Howard W. Sams
**"TAPE
RECORDER
MANUAL"**
VOL. 1

Looking for unbiased facts about various makes of tape recorders? This is the book that shows you the "inside story"—no sales pitches—just down-to-earth descriptions and illustrations of all mechanical and electrical features and how they work.

Sams "Tape Recorder Manual", Vol. 1, covers tape recorders and players produced in 1956 and 1957 by the following manufacturers: Ampex, Bell-Sound, Columbia Records, Ekotape, Ellamac, Magnecord, Silvertone, V-M and Wilcox-Gay.

Presents complete authoritative data on each model: exclusive "exploded" views of all mechanical parts; details of each adjustment and control; complete operating instructions; photographs of all external and internal parts; complete wiring diagrams and replacement parts lists. Includes tips on how to avoid and cure troubles such as wow, flutter, failure to erase and others. Shows you how to disassemble and assemble each recorder and how to check for source of trouble. A valuable book for everyone interested in tape recorder design, operation and servicing. 148 pages; 8 1/2 x 11"; profusely illustrated.

PRICE
ONLY **\$295**

SEE THIS AUTHORITATIVE BOOK
AT YOUR SAMS DISTRIBUTOR OR
MAIL COUPON TO HOWARD W. SAMS

FREE TRIAL COUPON

Howard W. Sams & Co., Inc., Dept. 1-CC8
2201 E. 46th Street, Indianapolis 5, Ind.

Send me Sams "Tape Recorder Manual" Vol. 1, for 10 days FREE examination. In 10 days I will pay for the book, plus small delivery cost, or return postpaid. We pay delivery costs if you remit with this coupon, same return privilege.

Name

Address

City Zone State

(outside U.S.A. priced slightly higher)

to save a few pennies *buying* from distributors who would be glad to sell the serviceman down the river for a few dollars.

"Finally, let us say, we have a moral obligation to pay our bills and to pay them as promptly as possible. If we cannot pay our bills for one reason or another, then we should borrow the money and pay the distributor. By any stretch of imagination, we cannot construe that a parts distributor is also a finance company."

In a similar vein, Gilbert P. Clark, editor of the "New England Service News," recently covered the subject of service-dealer loyalty to fair-dealing parts jobbers in a guest editorial in "The Hoosier Test Probe."

Under the caption, "A Buck Is a Buck," Editor Clark opened his editorial with the quote of a remark familiar to all distributor salesmen, "I'd like to buy from you, but I get an extra 10 off on tubes from the 'We Sell to Anyone Supply Company.'"

"The legitimate parts distributors would like to know," Clark continued, "who is going to subsidize their businesses if they sell you at their cost and keep the doors closed to retail trade, part timer, and the hi-fi-do-it-yourself traffic. How is the jobber going to stay clean if you don't support him?"

"I figured it out," you might say, "I can save \$360.00 a year on tubes by taking the extra ten per-cent. After all, a buck is a buck."

"Let's stop and analyze that \$360.00 to see what you have really gained. But first, let's examine the source of income for a typical 'We Sell to Anyone' jobber: Industrial sales—50%; Service Dealers (You)—20%; Part-timers, etc.—30%.

"For the service-replacement market, you represent 40% of his business and *your* customers represent 60%. To this distributor, *your* business is less profitable than the over-the-counter trade in two respects. First of all, he gets top mark-up from this retail trade, and secondly, it is a cash sale; no billing, no waiting 60 to 90 days for payment, and no salesman's commission.

"Without any exaggeration, he makes *3 times* as much profit on your customers' business as he does on your business.

"Now let's get back to that \$360.00 that you *thought* you saved last year. Assume that the \$360.00 saving was on the purchase of about 300 tubes per month, or 3600 for the year. Your total profit from the sale of those tubes, including the \$360.00, was approximately \$4000.00. Had you paid the normal discount prices, your profit would have been about \$3600.00. But *wait!* For every four tubes you buy (from the We Sell to Anyone Jobbers) your customers buy six over the counter!

"Had you kept just one out of those six sales, you would be ahead by the amazing figure of 900 tube sales, or almost three times the profit you were

NEW! IMPROVED!

SENCORE TRC4 TRANSISTOR CHECKER

Another
Sencore
Time-
Saver

America's newest,
most popular test
instruments

NOW CHECKS:

★ Transistors

for opens, shorts,
leakage and cur-
rent gain. In-
cludes new
gain test on
power transistors.

★ Crystal Diodes

checks forward to reverse
current ratio on all
diodes.

★ Selenium Rectifiers

checks forward and re-
verse currents.

Controls are accurately
set for each transistor

by referring to replaceable set-up chart on rear.
Test leads or socket provides for fast hook-up.

See your parts distributor.



Mfg by **SERVICE
INSTRUMENTS CORP.**
171 OFFICIAL RD., ADDISON, ILL.

Cut out this ad now for further information

A... Always
B... Buy
C... Columbia

EXPORTERS—IMPORTERS

Complete installations shipped the world over!
Our goods meet or exceed mil. specs. Overseas
wrapping. **TELL US YOUR NEEDS TODAY!**

ARC-1-3 ARC-27 BC-312
ARC-5 ARC-13 BC-348
ARC-9 ARC-6 BC-610
ARC-12 ARC-7 BC-373

BC-683 RECEIVER

27-38.9 MC. 10 tubes. Continuous and
push-button tuning on 10 pre-set chan-
nels. Complete with 10 tubes, speaker
and switch circuit, R.F. gain like new. \$14.95
ACCESSORIES: 12 V. DYN. \$3.95. 24 V.
DYN. \$1.95.

BC-603 RECEIVER. Same as above except
freq. is 20-28.5 MC. Like new and new
cond. \$5.95

BC-659 TRANSCIEVER

Crystal control on 2 pre-selected chan-
nels. 5 to 10 W. input. Complete with
14 tubes, meter and speaker. New
orig. box \$12.95

BC-604 TRANSMITTER

30 W. input. 20-28 MC. Crystal con-
trolled. 10 pre-set channels. Power re-
quired 625 V. @ 225 MA and 12 VDC.
NEW. less tubes & imp. trans. \$3.00
SAME AS ABOVE, but complete. 3.95
Used cond. 3.95

BC-375-E TRANSMITTER

200 12,500 KC with proper tuning unit.
AM phone. 100 W. CW. Built-in VFO
and modulator. Complete with one 3000,
4500 KC tuning unit. Like new. \$29.95
NOTE: Tell us your needs for accessories for
above.

HEADSET ROUND-UP SPECIALS!

- 1) HI IMP. Cloth band and rubber cord. Com-
plete with phone plug. Mfg. by Telepho-
nic. New. \$2.95
- 2) HI FL. 600 ohm. binatural. dual-channel.
New. Covered head band. cloth cords.
phone plugs. \$10.95
- 3) HI FL. Single channel. 300 ohm imp.
wide freq. response. Mfg. by Permaduc.
New \$9.95

TUBES—Huge Clean 'Em Out Sale!

803 \$3.50	815 \$ 1.95
805 2.95	828B 5.95
80779	832A 4.95
807W 1.95	4-65A 12.50
810 7.50	4-125A 17.50
811 1.95	4X150A 17.50

All orders FOB Los Angeles. 25% deposit re-
quired. All items subject to prior sale. NOTE:
MINIMUM ORDER \$3.00 WRITE TO DEPT. R.



ELECTRONICS
2251 W. WASHINGTON BLVD.
LOS ANGELES 18, CALIFORNIA

RADIO & TV NEWS

so proud to cut from the 'hand that supplies you.'

"While we are being quite liberal with the specific application of these figures, the totals are the important consideration, and sadly, they are painfully accurate.

"Yes, no matter how you slice it, a buck is still a buck—but why slice it?"

In an article in the "Long Island Guild News" titled "Does Your Shop Pay for Itself?", Robert A. Larsen urges service dealers to add product sales to their service activities in order to survive. He pointed out that the cost of maintaining the shop in a business location is expensive. A large part of this expense he contends, can be recaptured through store sales of new products.

"Remember," Mr. Larsen concluded, "the television service business is one of the most competitive and least rewarding businesses today. If a shop is to succeed, the owner must use imagination and business acumen. Within the next few years many shops will go out of business, only the fittest will survive. If you use every means of making your shop a well run and profitable venture you will probably stay in business."

And A. N. Archie, editor of the "MTTTA News," is deeply perturbed over the wide range of tube filament voltages in the new series filament sets. In a recent editorial, he said:

"Is the independent service shop working for the TV manufacturers, the tube manufacturers, or trying to make a living for himself and his employees?"

"It seems that all of the new TV sets have a new line-up of tubes by each set manufacturer. We have been plagued by a rash of two, three, four, five, eight, nine, ten, seventeen, eighteen, and nineteen volt tubes at an average list price of \$3.50.

"All of these tubes are used in the series filament sets and require the independent service shop to invest quite a lot of money for tubes that cannot be sold for at least ninety days, at a profit, since the set manufacturer gives that guarantee. Why should we be required to invest this money, when all of these tubes are duplicates of older tubes, with different filament and current ratings only? Why can't the set manufacturers get together and at least use the same type tubes?"

"We have enough trouble with their printed circuits and their idea of trying to cram as many parts as possible into the smallest possible space without this extra investment.

"I may be wrong about this; what do you think?"

President Solomon Sagall of *Teleglobe Pay-TV* told an industry group that his company's system does not threaten independent service. The normally transmitted *Teleglobe* picture would be received conventionally on home sets. Available only through a direct-wire network, sound would be fed to a speaker that is independent of the set.

WE TRADE HIGHER!



THE
"DREAM"
RECEIVER



AT A
REALISTIC
PRICE

NC 300 \$399.00
Speaker 19.95



NC 109 \$199.95
Speaker 17.50



NC 188 \$159.95
Speaker 17.50

IT'S EASY TO DO BUSINESS WITH WALTER ASHE!

1. Just tell us what factory-built gear (made since 1945) you have to trade, and what new gear you wish to purchase. You'll get our top dollar quote by return mail.

2. When the deal is made, you ship your equipment to us by prepaid express or, if express is not available, by prepaid truck. We check it at once and, in most cases, your new gear is on its way to you within 24 hours after we receive your trade-in.

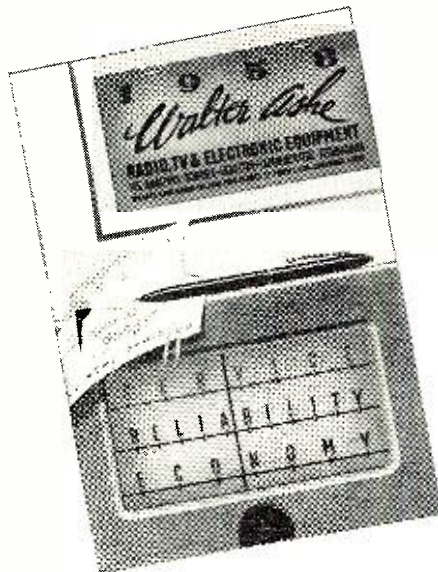

HEY! LOOK!
HOW ABOUT THIS?

SEND FOR OUR
BIG FREE 1958
CATALOG

144 PAGES
THE
"TREASURE CHEST"
OF VALUES

WRITE FOR FULL DETAILS ABOUT OUR TIME PAYMENT PLAN

All prices f. o. b. St. Louis



WALTER ASHE RADIO COMPANY
1125 Pine Street, St. Louis, Mo.

OUR 36TH YEAR

Rush "Surprise" Trade-In Offer on my.....
for.....
(show make and model number of new equipment desired)

Send new FREE 1958 Walter Ashe catalog. RN-3-58

Name.....
Address.....
City..... Zone..... State.....

STAN-BURN

CATHODE RAY TUBE SPECIALS

ONE YEAR GUARANTEE

G.E.	Type	STAN-BURN	G.E.	Type	STAN-BURN
\$15.80	10BP4	\$10.00	\$24.75	17LP4	\$18.00
19.10	12LP4A	13.95	37.00	19AP4A	24.00
20.35	13GP4	15.00	22.75	20CP4B*	15.95
20.35	13UP4	15.00	33.60	20CP4B*	21.95
20.75	14CP4	13.75	36.00	21AP4	25.00
33.75	15DP4	14.50	29.75	21CP4A	20.15
33.75	16AP4	18.50	34.85	21EP4B*	23.25
32.20	16DP4A	15.25	30.90	21FP4	21.15
33.75	16GP4	18.75	28.35	21MP4	26.25
23.50	16HP4	18.75	29.75	21YP4	22.00
28.40	16KP4*	18.75	34.85	21YP4A*	25.00
31.50	16LP4A	16.25	28.30	21ZP4	24.00
31.50	16WP4	16.25	33.60	21ZP4B*	24.00
23.50	17BP4	15.75	100.00	24AP1	56.00
28.40	17BP4B*	18.75			
30.75	17CP4	20.50	48.40	24CP4	(6 mos. guar.)
33.90	17GP4	21.50	50.00	24DP4A*	39.00

*ALUMINIZED—INQUIRE FOR ANY TUBE TYPE NOT LISTED. STAN-BURN CRT TUBES ARE A LICENSED PRODUCT OF THE GENERAL ELECTRIC CO. MANUFACTURED BY LINCOLN. All orders 6 or more STAN-BURN CRT are subject to additional 10% discount. PRICES SUBJECT TO CHANGE WITHOUT NOTICE.

WHY PAY MORE? HI-FI COMPONENTS • KITS • RECORD PLAYERS • TAPE RECORDERS • TUNERS • AMPLIFIERS • SPEAKERS • ELECTRONIC PARTS & TUBES • Etc.

Top brand nationally adv. merchandise in this and other Radio & TV mags. is yours at low, low cost. Send us your list. Give Mfr's name and Model No. of item. Write for '58 catalogs to Dept. RTV-3 today.

NOW YOU CAN HAVE QUALITY HIGH FIDELITY AT THE LOW STAN-BURN PRICE

Here is top value combined with superb HI-FI performance. The new STAN-BURN MARK VIII High Fidelity Phone System featuring the DeWald 12 watt amplifier with a frequency response of 30-20,000 cps and distortion less than 1/2% at full rated output. Included also in this excellent system is the Collaro 4 speed record changer supplied complete with the new GE VR11 series magnetic variable reluctance cartridge with dual sapphire stylus, a bass reflex speaker cabinet finished in either blonde or mahogany with luxurious grille cloth to match. Cabinet measures 20" wide x 16" deep x 23" high, footed base included. Completing the system is the new STAN-BURN ELECTRONIC 12" coaxial speaker to give you live performance realism right in your own living room.

F.O.B.—N.Y. **\$97.49**

above with AM/FM tuner add \$47.50
above with Diamond LP needle add \$8.00
Tuner only \$47.50—Amplifier only \$32.50

HI-FI DIAMOND NEEDLES—1 Yr. Guar.
Diamond needles reduce record wear and needle noise thus retaining full frequency response and tonal qualities of your records for a longer period of time.
SINGLE DIAMOND needle.....\$7.95
DIAMOND SAPP dual needle.....8.95
Shipment PPD. (specify cartridge make)

RECORD CHANGERS

COLLARO RC-456 4 speed changer...\$33.81
GARRARD RC-88 4 speed changer...\$34.41
GARRARD RC-98 4 speed changer...\$66.15
FREE wood mounting base, record wiping cloth and 45 RPM spindle with all orders for Collaro and Garrard changers, with this ad.
VM 4 SPEED HI-FI CHANGER—Model 1210 with Ronette or Astatic flip-over cartridge.....\$22.95
MONARCH Model UABU 4 SPEED AUTO. INTERMIX CHANGER less crystal cartridge.....\$19.95
RONETTE (phono fluid) cartridge flip-over type.....\$2.98
SONOTONE cartridge, flip-over.....\$2.98
45 RPM SPINDLE for V.M. or Monarch...\$1.98
WOOD MOUNTING BASE for V.M. or Monarch.....\$3.95
MOUNTING BOARD unfinished for V.M. or Monarch.....\$1.50
NEW GENERAL ELECTRIC HI-FI VARIABLE RELUCTANCE CARTRIDGE. Replaces discontinued RPX050 type. Full range reproduction 20-20,000 cycles. Four gram tracking force for minimum record and stylus wear.
4G050—Dual Sapphire needles.....\$8.77
4G052—Diamond, Sapphire needles...\$18.99

KITS! We stock the following manufacturers complete line of kits—see Advertisers Index for reference pages.
EICO QUALITY CABINART
DYNA BOGEN ELECTRO-VOICE
ARKAY GROMMES TECHMASTER
All domestic orders will be shipped prepaid. Send us your list. Order by Mfr. and Model No. of item.

\$20 WORTH OF ELECTRONIC PARTS IN GRAB-BAG consisting of: Porcelain sockets, coils, speaker, trans resis. cond. ONLY.....\$1.98 (Plus 50¢ postage)

YOU NAME IT—WE HAVE IT

Complete line of T.V. & Radio receiving tubes, coils, trans., controls, antennas & accessories—No Minimum Order—DEALER DISCOUNTS! Thousands of satisfied HI-FI enthusiasts and dealers will vouch that STAN-BURN GIVES THE BEST DEAL POSSIBLE!

EXPORT INQUIRIES AND OFFERS INVITED
Terms: 20% with order. Balance C.O.D. All prices F.O.B. NEW YORK Warehouse.
Write for our latest price list and HI-FI Catalog RTV-3. All Prices Subject to Change Without Notice.

STAN-BURN RADIO and ELECTRONICS CO.
558 CONEY ISLAND AVE. • B'KLYN 18, N. Y.

Within the Industry

(Continued from page 30)

Co. . . . *Filteros, Inc.* has promoted **MALCOLM A. PELTON** applications engineer . . . *International Business Machines Corp.* elected **PAUL L. DAVIES** to its board of directors . . . **R. T. SILBERMAN** has been appointed president of *Cohu Electronics, Inc.'s Kin Tel Division* . . . The appointment of **JOSEPH A. GENTILE** as manager of marketing administration for *Motorola Inc.'s semiconductor division* has been announced . . . **JAMES P. DAVIS** and **WALTER W. BULLOCK** have been elected vice-presidents of *RCA Victor record division* . . . **JAMES F. TOOLE** has been named treasurer and **CHARLES ONDRICK** controller of *Sperry Rand Corp.* . . . **WILLIAM J. LEHNER** is now manager, automation engineering, for the radio and TV division of *Sylvania Electric Products Inc.* . . . **STUART R. HENNIES** has been named manager of applications engineering for *Granger Associates* . . . *Polytechnic Institute of Brooklyn* announces the election of **DOCTOR ERNST WEBER** as the Institute's sixth president . . . **A. C. "BUD" KNUDSEN** has been appointed to the post of product line manager, controls, *Beckman/Systems Div.* . . . **WALTER W. FINKE** has been elected a vice-president of *Minneapolis-Honeywell Regulator Co.* . . . The appointment of **CARL N. REIFSTECK** as manager, general quality control, *RCA Victor television division*, has been made known . . . **NATHANIEL M. MARSHALL** has been appointed to the new post of associate director for sales of the industrial products division at *General Precision Laboratory Inc.* . . . **WILLIAM MELANSON** is now vice-president of *Cambridge Thermionic Corp.* . . . **RUSSELL W. McFALL** has been named a vice-president of *Litton Industries* . . . **HENRY F. FRAILEY** has been appointed operations manager for power and special purpose tubes, *Westinghouse Electric Corp.* . . . **PATRICK E. HAGGERTY**, executive vice-president of *Texas Instruments Inc.*, has been notified by the board of directors of the Institute of Radio Engineers of his election as a Fellow of the Institute . . . **THOMAS M. MERRICK**, former general manager of *Adleta Company*, passed away recently . . . **HARRY F. RANDOLPH**, manager, receiving tube operations, *RCA electron tube division*, died recently of a heart attack . . . **BASIL M. GOLDSMITH**, material control manager of the industrial tube division of *Allen B. Du Mont Laboratories, Inc.*, died suddenly at the age of 49.

ELECTRONIC INDUSTRIES ASSOCIATION has come to the defense of the nation's radio and television service technicians against charges of unethical practices which appeared in articles written for two nationally circulated magazines. The association stated that the "vast majority of these people are sound, ethical businessmen and are technically competent."

EIA said it deplored the type of publicity which places emphasis on the "comparatively rare but more sensational examples of unethical practice," instead of "praising the less newsworthy but vast majority of competent, honest service."

According to the association, the two publications carried rare and sensational stories about unethical servicing practices but eliminated reference to the "work which service associations and industry have done and are doing to help improve the competency, ethics, and business practices of servicemen."

HAROLD W. ARLIDGE has been appointed manager of the audio and Recordata division of *American Electronics, Inc.*



Prior to joining the firm, Mr. Arlidge was executive vice-president and general manager of *G & M Equipment Co.*, directing the company's sales, contacts, and organization of its representatives and distributorships throughout the United States.

From 1951 to 1954 Mr. Arlidge was associated with *Advance Electric & Relay Co.* as general manager in charge of manufacturing, sales, and finance.

In his present capacity he is responsible for coordination of the division's products and sales, extension and growth of its product line, and general supervision of the plant.

NATIONAL ELECTRONIC DISTRIBUTORS ASSOCIATION'S board of directors voted unanimously to change the method of electing its executive committee.

Acting on a proposal from the Ways and Means Committee, the board approved "the more democratic way" of choosing the group. The new method divides the nation into six districts of no more than six NEDA chapters each. At the May Parts Show in Chicago, directors of chapters in each of the six districts will select one of their number for the executive committee.

FRED SPEAKS has been named to the new post of assistant director of marketing for research and development, *Eitel - McCullough, Inc.*

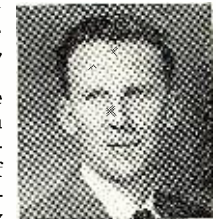

He joined the firm in 1954 and in 1957 was named assistant director of research and development. In his new capacity he will be responsible for the sale of research and development services and new products developed in the laboratory.

Prior to joining the organization he was employed as a civilian production specialist on electronic components and systems with the San Francisco District Office of the U.S. Air Force. Be-

fore this he served on classified research and development at the Livermore, California, laboratory of the Atomic Energy Commission.

NATIONAL SCIENCE FOUNDATION has announced that it will accept proposals from universities and colleges interested in sponsoring In-Service Insti-

tutes for secondary school teachers of science and mathematics during the academic year 1958-59.

The institutes will offer work in science and mathematics with the sessions held outside of regular school hours so that teachers may attend and still continue their full-time teaching assignments. A typical institute might meet

two hours each week for thirty weeks.

Additional details on setting up such a course and how to obtain NSF grants to implement the program are available from Division of Scientific Personnel and Education, National Science Foundation, Washington 25, D. C.

Universities and colleges are invited to write promptly.

-50-

**POLICE • CD • FIRE • CAP
Communication Equipment
20 TO 50 — 150 TO 172 MC**



**30-50 MC
FM RECEIVER**

**NEW:
\$29.95**

**USED:
\$24.95**

Converted Gov't. Surplus. 15 MC Spread. Specify Freq. Spread. Receiver illustrated at left, described below, prices at right. FM Receiver, continuous tuning & 10 preset channels, speaker, stuech, 10 tubes.

BC-603: 20-27.9 MC—Used \$14.95. New \$19.95
BC-683: 27.9 to 38.9 MC—Used \$24.95
12 V Dynamotor f/above Rec.—Used \$2.95—New 6.95
115 V 60 cycle Power Supply f/above Rec.—New 17.95

BC-604 FM TRANS.—20-27.9 MC—U: \$14.95—N: \$19.95
BC-924 FM TRANS.—27-38.9 MC—U: 14.95—N: 19.95

BC-620 FM TRANS.—REC.—20-27.9 MC—U: 14.95
BC-659 FM TRANS.—REC.—27-38.9 MC—U: 14.95
POW. SUP. 6 or 12 VDC f/BC-620-659 U: \$9.95—N: 12.95

**30-40 MC
FM RECEIVER \$34.95**

Link Model FM RIUF—6 VDC Crystal Control preset, 10 Tubes. 2/6H6, 1/6V6, 2/6AC7, 2/6S17, 1/6K6, 1/6C8, 2/6K8. Size: 13" L x 7 1/2" H x 8 1/2" W. NEW—Complete with Tubes and Power Supply.

**1-208 FM
SIGNAL GENERATOR \$59.50**

1-208 FM SIGNAL GENERATOR—Standard of Voltage Frequency and Frequency Deviation for the test alignment, calibration, sensitivity measurements of FM Receivers. Frequency Range 1.9 to 4.5 MC & 19 to 45 MC. Frequency Deviation can be adjusted 0 to 5 KC for 1.9 to 4.5 MC and 0 to 50 KC each side for the 19 to 45 MC Ranti. Stability .03 percent through use of crystal calibrator. Modulation Freq.: 150-400, 1000, 2500, & 5000 CPS. With Output Meter & Speaker; 115 Volt 60 cycle or 12 VDC input—Used.

TRANSMITTER-RECEIVER

150-172 MC FM



Fixed Frequency Crystal Control; less Crystal. Both units on a common chassis. Transmitter 30 Watt—Separate 6 VDC Power Supply—Complete with Cables, Control Unit, Microphone, & Antenna. Used—Checked Raytheon #21TR11A—\$59.50

POWER SUPPLIES

TYPE No.:	VOLTAGE:	USED WITH:	NEW:	USED:
PE-110	115 V—60 cye.	BC-669	\$49.50	
PE-117	6 or 12 VDC	BC-659	12.95	\$ 9.95
PE-97	6 or 12 VDC	BC-620	12.95	9.95
RA-20	115 V—60 cye.	BC-342/312	14.95	12.95
PS-274	115 V—60 cye.	Rec. 274/ARC-5	18.95	
PS-3050	115 V—60 cye.	BC-603/683	17.95	
PS-1206	115 V—60 cye.	BC-1206	18.95	

TRANSFORMERS and CHOKES

1080 VCT/190 MA—6.3/1.2; 6.3/3.6; 5V/4.	\$4.95
600 VCT/100 MA—6.3/5A; 5/3A	3.95
240 VCT/35 MA—24/9A; 6.3/6; 6.3/3.	1.75
1500 VCT/260 MA—6.3/3A; 6.3/6; 5V/4.5A	7.95
700 VCT/500 MA—6.3/4.5A; 5V/3A	3.95
1890 VCT/12.6 MA—Tapped 2.5V/2A	3.95
1100 VCT/80 MA—7.5 VCT/3.25A	3.95
560 VCT/70 MA—6.3V/2.1A; 5V/3A	2.95
16 Volt 35 Amp. \$14.95; 9 Volt CT 35 Amp.	5.95
5V/2 Amp 3 Windings; 5V/6A	2.95

TRANSFORMERS FOR SURPLUS EQUIPMENT:

1200 VCT/200 MA—12.5/2A; 12.5/2A; 5V/3A—H-108	\$8.95
500 VCT/50 MA—24V/1A; 6.3V/1A—H-109	4.95
500 VCT/80 MA—24V/2A; 5V/3A—H-110	4.95
12.6/2 Amp. \$1.95; 24V/1 Amp.	1.95
Dual Winding—12V/4 Amp or 24V/2 Amp.	5.95
CHOKES 12.5 HY/100 MA	1.95
CHOKES 10 HY/250 MA	4.95
CHOKES 8 HY/150 MA 200 ohm Open Frame	1.25
CHOKES 5 HY/150 MA—85 ohm	1.50

**PANORAMIC \$34.95
ADAPTER:**

NAVY MODEL RDP—115/230 Volt 60 cycle; for viewing of Radio Signals on 3" R Tube 5 MC above and below the receiver frequency simultaneously; 30 MC input, 10 MC max. sweepwidth, Size: 18" L x 10" H x 17" W. Used—Complete with tubes.

RADAR OSCILLOSCOPE

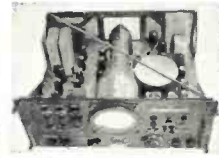

Control Indicator with 25 Tubes, consisting of 12/6SN7, 5/6SL7, 7/6V6, & 1/5CPI. All Controls on front panel, such as horizontal, vertical, sweep, intensity, centering, input and output circuits, etc. Voltage required: 2400 VDC 300 VDC & 6.3 V. Size: 24" L x 20" D x 10 1/2" H. Complete with tubes and circuit diagram—NEW: \$14.95

**SCR - 522
REC. - TRANS. \$29.95**

100-156 MC Crystal Control, 4 channel AM Voice, Preset Freq., 18 Tubes. Complete with Tubes, Schematic, and Conversion to 2 Meters. Used.

RECEIVER Chassis Only. \$14.95
Less Shifters— 7.95
TRANSMITTER Chassis Only, Less Shifters— \$18.95
Less Tubes— 7.95

6 VDC DYNAMOTORS:

640 VDC—260 MA—Reconditioned by G.E.—\$12.95
420 VDC—260 MA—Reconditioned by G.E.—9.95

12 VDC DYNAMOTORS:

	NEW:	USED:
625 VDC—225 MA	DM-35	\$11.95
540 VDC—450 MA	DA-12	\$14.95
425 VDC—163 MA	WE-377	12.95
225 VDC—100 MA	D-402	5.95
220 VDC—80 MA	DM-34	2.95
275 VDC—150 MA	DM-64	8.95
230 VDC—90 MA	PE-133	4.95
150 VDC—100 MA	DM-310X	2.95
250 VDC—60 MA	DM-32-12V	4.95
250 VDC—50 MA	DM-25	4.95

Send us your Specifications and requirements for other type Dynamotors—Inverters—Generators!

Gasoline Engine GENERATOR

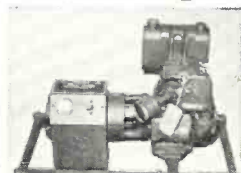

1000 Volts DC 350 MA & 14 VDC 25 Amp gasoline engine Generator. Engine 2.5 HP 4 cyle, Generator output 1000 VDC 350 MA & 14 VDC 25 Amp. Control Box has starting switch, ammeter, circuit breakers, reversing switch, etc. Can be used for transmitter standby and low voltage can be used for charging battery. Gov't. reconditioned, like new with spare parts and tools. Shipping Wt. 30 lbs. F.O.B. Ky. \$79.50
No. PE-49

**SCR - 625 MINE
DETECTOR \$29.95**

• For Prospectors, Miners, Oil Companies, Plumbers, etc. An ideal portable unit for locating all types of buried metal objects up to 24" or more, depending on size and ground condition. Detection by means of a tone. Packed in a chest. Operating weight approx. 15 lbs. Shipping wt. approx. 40 lbs. Complete w/batteries.

RANGE FILTER	SIDE BAND	PHONE PATCH
FL-8 U: \$1.50 Navy Type	Loading Coil C-114—\$1.95	TRANS. FORMER C-161—\$1.95

SCHEMATICS and MANUALS

Surplus Conversion Manual #1 or 2. \$2.50
Surplus Conversion Manual—Command Sets. \$1.50
TECHNICAL MANUALS—BC-603/604, BC-659, BC-745, BC-223, BC-312, Mark II. Each: 3.00
SCHEMATICS—BC-348, BC-224, BC-375, BC-603, BC-229/429, BC-230/430, Mark II. Each: 1.00

SEND FOR FREE CATALOG

SATELLITE RECEIVER \$4.95



Receive Radio Signals being transmitted by the U. S. Satellite—on approx. 108 MC. This Receiver is AM and Crystal Control on Six preset frequencies in the 108.3 to 110.3 MC range. Provides audio and band pass filter output of 90 and 150 cycles for aircraft instrument landing for which it was originally used. Complete with Ten Tubes: 1/2AH7, 2/12SG7, 2/12SR7, 1/12SQ7, 3/717, 1/12A6.

Crystals and Schematic. Voltage required: 12 or 24 VDC & 220 VDC 80 MA. Size: 13 3/4" x 5" x 7". Also can be converted to FM Receiver 80 to 108 MC. Price—Used—Less Tubes & Crystals—\$ 4.95
NEW—Complete with Tubes and Crystals—12.95
Control Box—N: \$2.00. Cross Point Indicators—U: 2.00
Plugs for Receiver, Indicator, or Control Box—Ea.: 1.00

**100 WATT
TRANSMITTER \$24.95**

Voice CW—Freq. 200-500 KC. 1500-12500 KC by use of plug in Tuning Units. Used 1/10y & 4/VT-4C Tubes. Size: 23" L x 21" H x 8" W. Complete with Tubes, less tuning units.
BC-191 Transmitter—12 Volt: Used \$24.95—New \$34.95
BC-375 Transmitter—24 Volt: Used \$29.95

TUNING UNITS For BC-375 & BC-191:

TU-5	1.5 MC to 3 MC	NEW	USED
TU-6	3 to 4.5 MC	\$5.95	\$4.95
TU-7	4.5 to 6.2 MC		3.95
TU-8	6.2 to 7.7 MC	3.95	2.95
TU-9	7.7 to 10 MC	3.95	2.95
TU-10	10 to 12.5 MC	3.95	2.95
BC-306	Antenna Tuner	3.95	2.95
CABLES PL-64-GI or PL-59	Each End	3.05	2.75

ANTENNA MATCHER—Variable inductance Tuner with calibrated venter lock Dial, 100 Watt Capacity. Size: 7 1/2" x 3 1/2"—Used—\$ 9.95
UNIT with 0-8 RF Meter and Panel—Used—\$12.95

HANDSETS & MICROPHONES:



HANDESET with Retractable Cord—Butterfly Sw., PL-68 & PL-55
Plugs H-22/U—New: \$4.95
TS-9 HANDESET—Push to talk Sw. No Plugs. Used: \$2.95—New: 4.95
TS-13 HANDESET—Push to talk Sw. w/PL-68 & PL-55. Used: \$3.95; New: 5.95

FREE \$1.50 Value Rubber covered HANDESET HANGER—FREE of charge with purchase of any Handset!

F-1 BUTTON CARBON MIC.—High Gain—For desk, car, hand use. Complete—New: \$1.95
RS-38 CARBON MIC. with PL-68 Plug—Used: 2.95
T-17 MICROPHONE—New: \$3.95—Used: 3.95
HS-23 HEADSET—2000 ohm, Rubber Cushion—Used: 2.95
HS-30 HEADSET—Hearing Aid Type—250 ohm—1.95

**BC - 1206 \$2.95
RECEIVER**

BC-1206 CM BEACON RECEIVER—200 to 400 KC; 5 Tubes. 135 KC IF; Operates from 24 VDC—Less Tubes, Used: \$2.95. With Tubes—New: \$9.95—Used: \$5.95
For 12 Volt operation, use PM DYNAMOTOR—12 VDC input; output 24 VDC. Size: 2 1/2" x 4" x 7". Dyn. only—\$4.95
AC POWER SUPPLY—To operate BC-1206 from 110 V 60 cycle. Complete with Speaker, in attractive cabinet—\$18.95

**AIR COMMUNICATIONS \$18.95
MONITORING RECEIVER**

115 Volt 60 cycle Receiver for Airport monitoring. Frequency Range: 200-500 KC Five Tube, fixed tuned TRF Circuit by use of four Plug-in coils. Unit fits standard 19" Rack Panel, 3 1/2" deep. Complete with Tubes: 2/6SK7, 6S17, 6V6, & 5Y3GT and Four Plug-in Coils to cover the Freq. Range. Also Instruction Book. New.

**EE - 8 FIELD \$14.95
TELEPHONE**

Ideal for private telephone system for two or more phones, up to 17 miles. Hand ringer, generator with handset, carrying case. Uses 2 flashlight batt. Used, Checked.
WIRE—Weatherproof Twisted Pair: 500 Ft. \$4.75—135 Ft. \$1.00—2500 Ft. \$19.95. Per Foot at 1 1/2¢.
COMBAT WIRE—Rubber covered W-130. \$.01 per Ft.

Address Dept. RN • \$5.00 Order Minimum, & 25% Deposit on C.O.D.'s • Prices are F.O.B. Lima, Ohio

FAIR RADIO SALES

132 SOUTH MAIN ST.
LIMA, OHIO



GIANT SALE!

OF LEKTRON'S FOUR MOST POPULAR POLY-PAK® KITS

CERAMIC CONDENSERS 200
100 for \$1 for \$1.01

PRECISION RESISTORS 80
40 for \$1 for \$1.01

DISC CONDENSERS 60
30 for \$1 for \$1.01

GERMANIUM DIODES 12
6 for \$1 for \$1.01

LEKTRON YOUR CHOICE OF ANY POLY-PAK®

LISTED BELOW FREE WITH EVERY \$10 ORDER! (ONE-CENT-SALE KITS NOT INCLUDED IN THIS OFFER)

- 40 HI-Q CONDENSERS. Finest porcelain types. Reg. \$8. **\$1**
- 2 MIKE TRANSFORMERS. 200 ohms to hi-impedance grid. Encased. 6 leads. Wt. 1 lb. Reg. \$5. **\$1**
- EMERSON PERMEABILITY TUNER. Covers 840 to 1500 kc for transistors. Reg. \$5. **\$1**
- "FLEA-POWER" MINI MOTOR. Permanent magnet. 1 1/2" to 3 VDC to operate. 3,000 rpm. Wt. 1 oz. **\$1**
- HI IMPEDANCE PICKUP. Magnetic. Arm, cartridge, stand. Reg. \$1. **\$1**
- 000-999 COUNTER by Vee-der Root. Reset type; for tape, coil winding. Reg. \$6. **\$1**
- 20 MINI NEON BULBS. Type NE-2 with axial leads. Hundreds of uses! **\$1**
- 10 TO 60 MINUTE TIMER. For photo, shop use. Sounds alarm at end of cycle. Wt. 2 lbs. **\$1**
- CRYSTAL MIKE. Postage stamp size! Crisp! 100 to 8,000 cps. Reg. \$5. **\$1**
- 6 TRANSISTOR SOCKET with mount-ing plate. **\$1**
- 6 RAYTHEON CL-705 DIODES. Silicon. 1-N34. W/leads. Reg. \$5. **\$1**
- 6 POPULAR DIODES. Crystal and silicon. Some worth \$10. **\$1**
- 60 COILS & CHOKES. RF. IF ANT., large variety; incl. slug-tuned. Wt. 2 lbs. Reg. \$15. **\$1**
- 3 LBS. HARDWARE. Approx. 2000 pcs. asstd. screws, brackets, etc. Reg. \$8. **\$1**
- 40 MOLDED CONDENSERS. Black Beauties, porcelain, etc. 0001 mf to 1000V. Oils incl. **\$1**
- 40 PRINTED CIRCUIT PARTS. Diodes; carbon, precision resistors; chokes; molded, ceramic cond.; boards. Reg. \$15. **\$1**
- 150 RESISTORS! 1/2, 1 W. 40 values; 5 ohms to 10 meg. 3%, too. Reg. \$15. **\$1**
- 2 TRANSISTOR TRANSFORMERS. CTC "couner" type. Interstage: 1 x 3/4 x 3/4" imp. ratios unknown. Color coded leads. Reg. \$10. **\$1**
- WORLD'S SMALLEST RADIO KIT. 2 1/2 x 1 3/4 x 3/4" w/permeability tuner, diode, all parts, directions. Reg. \$3.50. **\$1**
- SEVEN 25-FT. ROLLS WIRE. Asstd. colors, stranding, insulation. ±18 to 24. Wt. 2 lbs. Reg. \$1. **\$1**
- 80 INSULATED RESISTORS! Many 1 & 5%. 1/2 to 1 W. 10 ohms to 10 meg. 30 values. Reg. \$16. **\$1**
- SUB-MINI SOLE-Change elec. energy to mechanical. 12 VDC @ 300 ma actuates plunger. Wt. 2 oz. Reg. \$5. **\$1**
- 60 TUBULAR CONDENSERS. Paper, molded, oil. 0002 to 1000V. Wt. 2 lbs. **\$1**
- 40 TUBE SOCKETS. 4 to 14 prong. Bakelite, ceramic, mica. Shielded types. 100. Wt. 2 lbs. **\$1**
- 40 SUB-MINI RESISTORS. Only 1/4" long. 20 values; 13 ohms to 10 meg. Color-coded. **\$1**
- 4 OUTPUT TRANSFORMERS. 50L6, 35L6, 6V6, 50B4 to 3/4 ohm v.c. Wt. 1 lb. Reg. \$1. **\$1**
- 8-PC. NUTDRIVER SET. Plastic handle, 3/16, 7/32, 1/4, 5/16, 11/32, 3/8, 7/16" steel socket wrenches in plastic case. Wt. 1 lb. Reg. \$3. **\$1**
- 15-PC. TWIST DRILL SET. 1/16 thru 1/4" x 64ths; in graduated plastic holders. Reg. \$4. **\$1**
- 100 RADIO PARTS. Surprise asstmt. Reg. value over \$15. Wt. 3 lbs. **\$1**
- 60 TERMINAL STRIPS, BOARDS. Wide variety; soldering, binding, etc. Wt. 1 lb. **\$1**
- 50 PLUGS & RECEPTACLES. Audio power, chassis, panel & split types. Wt. 2 lbs. **\$1**
- 70 MICA CONDENSERS. Clear plastic. 30 values; .00001 to .01 mf. To 1000 V. Wt. 1 lb. **\$1**
- 40 POWER RESISTORS. WW, candohm, vitreous, sand-coated. 15 values; 1/2 to 50 W. 35 to 10000 ohms. Wt. 2 lbs. **\$1**
- 15 VOLUME CONTROLS. Single & dual to 1 meg. Wt. 1 lb. **\$1**
- 10 "POLY" BOXES. Clear plastic, hinged, w/snap locks. Asstd. sizes. Reg. \$2.50. **\$1**
- 60 ASSORTED KNOBS. Bakelite, plastic, including set-screw types. Wt. 2 lbs. Reg. \$9. **\$1**
- 10 ELECTROLYTICS. Asstd. can. tubular types to 500 mf. Wt. 3 lbs. **\$1**
- 20 ROTARY SWITCHES. Assorted. Wt. 3 lbs. **\$1**
- 3 VARI-LOOPSTICKS. Adjustable. For transistor circuits. 560-1500 kc. **\$1**
- 6 FERRI-LOOPSTICK CORES. Asstd. flat & tubular, 5 to 7" long. Hi-Q. Wt. 1 1/2 lbs. **\$1**
- EST VARIABLES. Scoop! 10-365. 1 1/2" sq. w/1" shafts. **\$1**
- MINI-METER. 1 1/2" round. 0-6 amps, AC. Chrome face. **\$1**
- 75-PC. RESISTOR SPEC. All types, asstd. Power, carbon, transistor, precision. 30 values. Worth \$15. Wt. 1 lb. **\$1**

Check items wanted. Return entire ad w/check or M.O. including sufficient postage; excess returned. C.O.D. orders, 25% down. Rated, net 30 days. Print name, address, amount money enclosed, in margin. (Canada postage: 45¢ 1st lb., 28¢ each addl.)

EXPORT ORDERS INVITED

HOW TO ORDER

LEKTRON

133 EVERETT AVE., CHELSEA 50, MASS.

150

Communication Radio Service (Continued from page 47)

ment, however, the signal must be fed to the receiver input. To prevent interference and consequent difficulty in aligning the receiver, a shielded room may be needed. If you plan to do much work of this type you should build such a room. It is easy to do if you use 2" x 4" lumber as the framing and then spread fine-mesh screen over the entire surface, including the bottom. A 7' x 9' compartment is generally large enough. Incidentally, be sure to use filters in the power leads going to the "shielded room."

Most common meters used in service shops are entirely satisfactory for use as output indicators and, in many cases, the receiver "S" meter will give all the indications needed. If a separate indicator is used, it can be connected in any one of the three ways shown in Fig. 2. The method shown in Fig. 2A is best since it allows the audio gain control to be turned down during alignment.

I.F. Crystal Filters

Two adjustments of each trimmer are required in aligning an i.f. amplifier using a crystal filter: the first with the crystal switched out of the circuit and the second with the crystal filter adjusted for maximum selectivity. In the second group of steps, the signal generator is adjusted to the crystal frequency which may be slightly different from the frequency specified for the i.f. adjustments.

First, let's clear up a misconception that exists among some technicians. The crystal in the filter circuit is not removed and connected in a simple oscillator with the signal from that oscillator used to align the i.f. strip. In the first place, the oscillator action might be erratic, or the crystal might be damaged. Second, the crystal frequency would be subject to change when the crystal was not connected in the receiver circuit. Therefore, do not remove the crystal from the receiver during alignment.

Assuming that the i.f. stages are completely out of alignment, which is always the correct starting point, adjust the signal generator to the i.f. value specified in the service information. Connect the signal-generator output to the point specified. Turn the a.v.c. off, the b.f.o. off, and the r.f. gain all the way up. The setting of the audio gain control does not matter unless you are using the audio signal as an output indication. If you are, turn this control all the way up. Adjust the individual i.f. trimmers for peak output. Go through the peak in each case and then come back to be sure you have absolute maximum.

After the i.f. trimmers are set to approximately the right frequencies, set the selectivity control to the sharpest crystal position. Set the phasing control to "0"—the point

Special price paid for R.C. 286 Antenna

SELLING

Receivers, Transmitters, Radar, Special Purpose Tubes, Relays, Meters, Switches, Connectors, Rectifiers, Transformers, Motors & Generators, Wiring Cable, Instruments and All Electronic Components.

WILL BUY ALL

New or Used

- Leach Relay #5059-R
- #5058
- #5055
- #5053-SM
- #5053

Price Bros. Relay #10
Relay #5586
#5587

Antenna Switching Relay
Box # CBY 23049
BG-AN-198
BC -408

Tubes #53A
VT-127A VT-227A
35T VT-327A
WL-530 15E

Highest prices paid for most all types of aircraft sparkplugs, magnetos and magneto breaker points.

Wholesale Only

RADIO & ELECTRONIC SURPLUS

14000 BRUSH STREET
Detroit 3, Mich. TO 9-3403

installing TV antennas? for the right accessories to do the best job

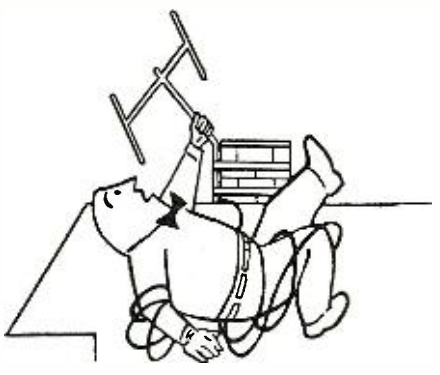

you'll find it faster in the MASTER

new 1958 edition—world's largest electronic catalog only \$3.50 at your local parts distributor—now Free! Write for Panel Lamp Chart.

THE RADIO-ELECTRONIC MASTER
60 MADISON AVE., HEMPSTEAD, N. Y.

where it has no effect. Vary the signal-generator frequency slightly to each side of the original point. At some frequency, there will be a sharp peak in the response. This is the crystal frequency. Re-set the signal generator to that frequency, and peak all the i.f. trimmers.

The procedure just described is given only to acquaint you with the over-all method. In servicing a particular receiver, always follow the specific procedure given in the service information.

"Q" Multiplier Alignment

The "Q" multiplier is a tunable device that can be aligned to match the receiver i.f. Basically, the procedure involves adjusting the frequency-sensitive control of the multiplier so that the response frequency matches the i.f. when the frequency control is set to the center position. To do this, it may be necessary to remove and reposition the knob or adjust a tuned circuit in the "Q" multiplier. Remember that some of these circuits, particularly the "outboard" type, have two tuning adjustments. Check the alignment instructions. After the unit has been aligned, check each function by comparing the operation with the service notes.

Oscillator, Mixer, and R.F.

Bandswitching in communication receivers can be done in either of two ways: by disconnecting one set of coils and substituting another or by connecting additional coils in series to obtain successively lower frequencies. Also, a combination of the two methods can be used. With separate coils for each range, the order of alignment is unimportant in most cases; with series-connected coils, the highest band must be aligned first, the next highest second, and so on. Even though this is the basic rule, you should always follow the instructions in the service information *exactly*. Otherwise, you may align one band perfectly, and then "de-align" it in the next step. Perhaps the only exception to this rule is found in aligning receivers for hams who want maximum sensitivity on the ham bands rather than at some arbitrary point near the high end of the dial.

Servicing communication receivers can become an important part of the work done in a service shop. It is sometimes difficult to get these sets repaired simply because many service technicians will not touch them. If you are interested in building up your business in this field, study the schematics of the older receivers and also the schematics of the newer ones as they are published. If there is a ham club in your area, attend a few of the meetings and make it known that you service the sets. Many wholesalers who handle parts for hams have a "swap-and-shop" bulletin board for the convenience of their ham customers. A small advertisement or announcement placed there should help. —30—

FLASH!! TELEMARINE NOW IN NEW 6-FLOOR BLDG. IN MANHATTAN!

SPECIALIZING IN COMMUNICATION BARGAINS

50 WATT, 6 CHANNEL RADIOTELEPHONE FOR BOATS OR FIXED STATIONS

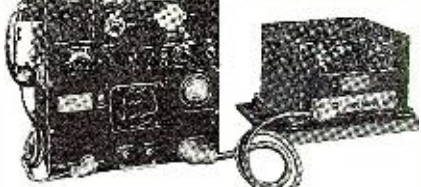

THE RADIOTELEPHONE BARGAIN all the Pleasure and Fishing Boats are talking about! This Transmitter-Receiver (BC-669, part of SCR-543) is beautifully and ruggedly built. Provides 6 fixed channels of crystal-controlled transmission and reception, in addition to manual tuning. When desired for receipt of 1600 to 4500 KC. The BC-669 FCC currently accepted 2-3 mc marine band. With recommended 12 V. DC (or 24 V. DC dynamotor power supply for above). Has 2 Dynamotors, one for transmitter (340 V. at 450 ma.) and one for receiver. Produces 50/60 watts output. All wired and tested. **EACH \$99.50**

50 W. RADIOTELEPHONE (BC-669 A, B, or C). USED-EXCELLENT, as described above. Shpg. wt. **\$99.50**
185 lbs. EACH
SAME AS ABOVE, NEW, UNUSED. EACH \$139.50
12 V. DC POWER SUPPLY for above. Has 2 Dynamotors, one for transmitter (340 V. at 450 ma.) and one for receiver. Produces 50/60 watts output. All wired and tested. **EACH \$89.50**
COMPLETE 12 V. DC POWER SUPPLY KIT. Assemble and wire yourself. All material and diagram. **\$45.00**
PE-110, A, B, or C POWER SUPPLY for 110 V. 60 cycles AC operation. LIKE NEW condition. **\$89.50**
EACH
HANDSET FOR ABOVE with appropriate plug connector. **\$14.50**

FM TRANSCEIVER 29-40 MC

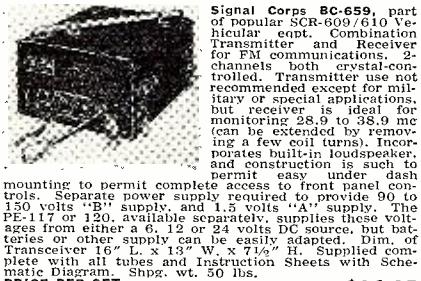

Signal Corps BC-659, part of popular SCR-609/610 Vehicular ept. Combination Transmitter and Receiver for FM communications. 2 channels, both crystal-controlled. Transmitter use not recommended except for military or special applications, but receiver is ideal for monitoring 28, 30, 35, 39 mc (can be extended by removing a few coil turns). Incorporates built-in dash mounting to permit complete access to front panel controls. Separate power supply required to provide 90 to 150 volts "B" supply, and 1.5 volts "A" supply. The PE-117 or 150, available separately, handles these voltages from either a 6, 12 or 24 volts DC source, but batteries or other supply can be easily adapted. Dim. of Transceiver 16" L. x 13" W. x 8" H. Supply complete with all tubes and Instruction Sheet with Schematic Diagram. Shpg. wt. 50 lbs. **PER SET, BRAND NEW, UNUSED. \$24.95**
Price, PE-120 Power Supply for above. \$25.00
Used-Good

30-40 MC DELUXE FM RECEIVER FOR MOBILE POLICE & FIRE CALLS



This FM receiver, the R-237 part of an AN/VRC-2 Ept., is a single channel-crystal controlled receiver covering 30-40 mc. Used by police, and fire dept. frequencies. It is of superior design and construction with all of the best features such as built-in dash mounting, a version superhet (455 KC and 4.3 mc. I.F.'s) with both oscillator crystal-controlled, noise squelch, double limiter stages, loud-speaker output, and an exceptionally clean. Dimensions with tubes and power supply which is designed for 6 V. DC operation. All units are practically like-new condition and exceptionally clean. Dimensions with removable cover, illustrated, 11 1/2" x 10" x 17". Separate loud-speaker, or phones (if desired) required. Supplied with tubes and schematic diagram, but less crystals, loud speaker, etc. Net wt. 41 lbs. Shpg. wt. 65 lbs. **PRICE, EACH, Not tested at this low price. \$29.95**

NEW, WALKY-TALKY (BC-611) CHASSIS

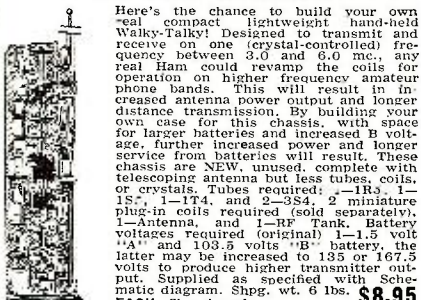

Here's the chance to build your own compact lightweight hand-held Walky-Talky! Designed to transmit and receive on crystal-controlled frequency between 3.0 and 3.0 mc, your real Ham could revamp the coils for operation on higher frequency amateur phone bands. This will result in increased antenna power output and longer distance transmission. By building your own case for this chassis will allow for larger batteries and increased B voltage, further increased power and longer service from batteries with result. These chassis are NEW, unused, complete with telescoping antenna but less tubes, coils, or crystals. Tubes required: 1B5, 1B5, 1-174, and 2-3S4. 2 miniature plug-in coils required (sold separately). 1-Antenna, 1-RF Tank, 1-Battery, voltages required (original) - 1.5 volt "A" and 103.5 volts "B" battery, the latter may be increased to 135 or 167.5 volts to produce higher transmitter output. Supplied as specified with Schematic diagram. Shpg. wt. 6 lbs. **\$8.95**
EACH-Chassis only. \$1.25
PAIR OF COILS, for above, Ant. & RF Tank. \$1.25
See "LIMITED QUANTITY BARGAINS" for major accessory items for BC-611 to assemble a complete original unit.

LIMITED QUANTITY BARGAINS

BC-791 CODE RECORDER. Consists of Amplifier and Recorder of code signals on paper tape, with ink writing stylus. Similar to McElroy Model RRD-900. For operation on 110V. AC, with tape puller. Housed in oak case, all NEW Units. Shpg. wt. 40 lbs. **EACH \$14.95**
6 or 12V. DC VIBRATOR POWER SUPPLY. Type PE-104, operates from either voltage and supplies completely filtered voltages as follows: 1.5, -4.5 (Biss) and 90 volts DC. Uses synch. vibrator, no tubes. Ideal for mobile pack transceivers, etc. Dim. 7" x 4 3/4" x 6 3/4". **NEW UNITS. Shpg. wt. 12 lbs. EACH \$9.95**
12V. DC, 1/2 HP DC MOTOR. Make electric car or tractor for kiddies. Rated at 1/2 HP at 1725 rpm, but with built on reducing gear assembly actually develops more power at final speed of 43 rpm. 7" heavy brass worm gear available separately for 2 1/2 rpm. **NEW material MOTOR, EACH \$19.95**
WORM GEAR, 7" for 2 1/2 rpm. \$2.75

2-CHANNEL FM TRANSCEIVER, 30-39 MC. The BC-1335 is an 18 miniature tube FM transmitter-receiver with final output of 1.5 watts. Range, under average conditions, to 10 miles, when used mobile or fixed station. Incorporates vibrator-type power supply which operates from either 6 or 12 V. DC. Both channels crystal-controlled. See Feb. '58 ad in this magazine for full details. Shpg. wt. **EACH, used-excellent, with all tubes, not tested. \$34.95**

15-60 KC. 6-BAND RECEIVER. Navy Model R-34, for ship and shore communications. Receives CW, IOW, and phone signals. Employs 7 modern tubes in TRF circuit with controlled regeneration, and audio limiter stage with automatic gain control. Operates from 110 to 115 V. 60 cycles AC. USED-Excellent Condition, but not tested. Shpg. wt. 110 lbs. **\$29.95**

BC-683 MOBILE RECEIVER. Ideal for car or truck installation for monitoring Police, Fire calls, etc. Operates from 12 V. DC, but easily converted to 110 V. AC operation using an RA-20 AC power pack. Tuning Range 27.0 to 30.0 mc, with ten push-button channels for selection of any 10 preset frequencies in this range. Incorporates loudspeaker, squelch circuit, double limiter stages, and telephone jacks, etc. Complete with 45W motor, schematic diagram. Shpg. wt. 65 lbs. **\$24.95**
PRICE, EACH, used-excellent, not tested. \$39.50
LAB MODEL FM SIGNAL GENERATOR, the I-208 is a precision instrument worth \$39.50. Used in mobile service shop, or for production testing and alignment on mobile FM receivers. Freq. range, in 2 bands, 1.9 to 4.5 mc (I.F. alignment) and 19.0 to 45 mc. Incorporates such fine features as Calibrated Microvoltage-transducer, Adjustable Sweep, RF vacuum Tube Voltmeter, Crystal Calibrator (1 mc and harmonics), etc., etc. See Feb. '58 ad for illustration and full details. Operates from either 12 V. DC (internal dynamotor) or portable field work. Complete with 60 cycles for lab. use. Complete with tubes, crystal and instruction data. Shpg. wt. 175 lbs. **\$69.95**
PRICE, EACH, used-excellent, not tested. \$139.50
MOBILE FM RECEIVER BC-923. A 4-channel mobile unit well known to many hams, photographers, fire and police "buffs," for stability and excellent performance. Covers 27.0 to approx. 39.3 mc (calibrated to 38.9), but can be extended by removing a few turns from Ant., RF, and Osc. coils. Employs permeability tuning for low-drift and hi-train. Operates from 12 V. DC source. Dim. 11 1/2" H x 6 3/4" W x 12 1/4" D. Shpg. wt. 60 lbs., Complete with tubes and dynamotor. **PRICE, EACH, used-excellent, not tested. \$32.50**

ACCESSORIES FOR BC-611 HAND-HELD WALKY-TALKY

CAST ALUMINUM HOUSING case for Above Walky-Talky. Includes battery compartment, Push-to-Talk Switch with rubber weatherproof cover, top and bottom covers. All items separate for home assembly. **\$17.75**
PRICE, EACH
MICROPHONE & RECEIVER ELEMENTS, with matching transformer and bakelite covering caps. **\$5.50**
TEST UNIT I-135 Contains Microphone and Receiver elements, Volt-Milliammeter, and RF Pierce Oscillator circuit to thoroughly test above Walky-Talky. Parts can be used to help complete unit. Used-Excellent. Shpg. wt. 35 lbs. **PRICE, EACH \$17.95**

PUSH-TO-TALK SWITCH, and Pacerum assembly for actuating trans-receive slide-switch on chassis. Also includes special rubber cover for weatherproofing switch. Shipped Postpaid (add 10c if insurance desired). **\$1.95**
PER SET.

MALLOY 12V. DC VIBRAPACKS. Model 12B900C. Dim: 6"00" x 4"00" x 4"00". 45W. Supplied with vibrator but less Raytheon BH Rectifier Tube (required). Like New Condition. Shpg. wt. 17 lbs. **EACH \$6.95**
TCS-5 (to 9) TRANSMITTER. All tubes, schematic diagram. Excellent, but not tested. **\$29.95**
Shpg. wt. 60 lbs.
TCS-5 (to 14) RECEIVER, complete with tubes and schematic diagram. Excellent cond. Not tested. Shpg. wt. 50 lbs. **EACH \$34.50**

LORAN RECEIVING EQPT., APN-4, AT LOWEST PRICE EVER!!!

We made a "buy" on this popular model APN-4 Loran unit, used on Fishing and Pleasure boats and Aircraft for navigation purposes. All are used but in Very Clean condition, complete with tubes and crystals. Each set consists of an R9/APN-4 Receiver and an ID-6/APN-4 Indicator. Originally sold in surplus for \$100.00 or more per set, it would be wise to buy an indicator for "Spare" while available at this real low price! Sorry, no accessories or inverter (80 to 115 V. AC, 400 to 2400 cycles, required) available at this time. Inverters for this equip. are available from many surplus houses. **PRICE PER SET, each consisting of one Indicator and one Receiver, as above. Over 50 modern type tubes in eqpt. Not Tested. \$25.50**
Excellent-Used. Shpg. wt. 80 lbs.

All Above Material Subject to Prior Sale. 25% Minimum Deposit with All C.O.D.'s. Min. Order —\$5.00. All Prices F.O.B. Our Address.

—TELEMARINE—
COMMUNICATIONS CO., INC.
140 WEST B'WAY, NEW YORK 13, N. Y.
PHONE: COrTand 7-5444
Cable Address: Telemarine N. Y.



STOP!
Demand the finest in Electronic Test Equipment—EMC, of course. You get the most quality per measurement dollar!

NEW! EMC Model 301 Speedi Tube Tester

Checks tubes in seconds. Checks shorts, leakages, and quality. Over 375 tubes, including OZ4, now listed. New listings available. Checks and rejuvenates Picture Tubes with Model PTA (Picture Tube Adaptor), at only \$4.50. Model 301P (illustrated),



with 4½" meter & oak Carrying case\$47.50
Kit 33.20
Model 302C, (with 7½" meter) 62.90
Kit 47.90

NEW! EMC Model 108 Handi Tester

The only appliance and auto battery tester in its price class to use a D'Arsonval, instead of an iron vane type meter. Gives exclusive advantages of maximum accuracy and scale length, and minimum battery replacement cost . . . at no added charge. Complete with test leads and instruction manual.



Wired\$15.95 Kit 12.95

NEW! EMC Model 905-6A Battery Eliminator, Charger, and Vibrator Checker

A MUST for auto radio service. Features continuously variable voltage output—in either 6 or 12 volt operation. Checks all 6 or 12 volt vibrators.



Wired\$67.90 Kit 44.90

NEW! EMC Model 601, Wide Band Oscilloscope for Color & Monochrome TV

Features full 5 mc band with push-pull vertical amplifier with sensitivity .02 volts per inch, retrace blanking amplifier for clearer pictures, and multivibrator sweep from 15 cycles to over 75 kilocycles. Wired and tested\$117.90

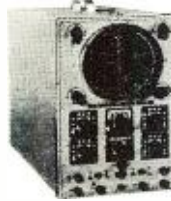

NEW! EMC Model 206P Dynamic Mutual Conductance Tube Tester

The lowest priced mutual conductance tube checker on market. Checks tubes for microhmo value and gas content. Completely flexible switching. Your best buy in a quality tube tester. (Hand rubbed Carrying Case)\$83.50



Yes, tell me more, send me—FREE— a detailed catalog of the complete EMC line. RN-3

NAME _____
STREET _____
CITY _____ STATE _____

EMC Electronic Measurements Corp.
625 B'way • New York 12, N. Y.
Ex. Dept. 370 B'way, N. Y. 13

Service Notes

KAYE-HALBERT SOUND TUNING

When receivers using chassis 253 are picking up weak signals, it may be found that sound tuning is quite critical. This sharp characteristic is due to the fact that the sound i.f. circuits operate at high gain on weak signals, with some regeneration occurring. An easy remedy for this condition is to cut down the regeneration by reducing gain in the audio i.f. strip slightly. This is accomplished simply by detuning the 1st i.f. transformer somewhat, just enough to eliminate the sharpness in tuning.

RASTER RINGING, MAJESTIC

If excessive ringing should develop along the side of the raster due to insufficient damping in chassis 99 through 103 and 105, check balancing capacitor C₁₁, across one winding of the horizontal-deflection coils. If the value of this unit is 75 μfd., replace it with a unit whose value is 39 μfd., 1500 volts. If a capacitor having the latter value is not readily available, add another 75-μfd. unit in series with the one already in the circuit.

CATHODE-HEATER SHORT IN CRT

A great many Stromberg-Carlson receivers in the Model 24, 119 series have had picture tubes replaced because of the development of cathode-to-heater shorts. Since there is a potential between cathode and heater in the earlier chassis of these series, the nuisance and expense of this replacement is deemed necessary in the field to restore a satisfactory picture. However, the cathode and heater circuits in these receivers may be modified so that normal operation will continue in

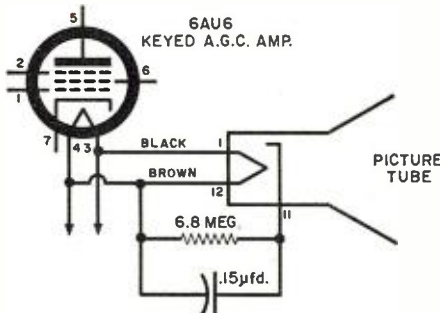
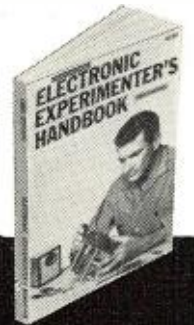

Fig. 1.

the presence of a heater-cathode short. As shown in Fig. 1, the modification involves deliberately tying the cathode to the heater externally. The black and brown picture-tube heater leads are disconnected from their present ground and filament-voltage points and reconnected to the heater terminals (3 and



60
NEW PROJECTS FOR "DO-IT-YOURSELFERS"
in the NEW EDITION of the
ELECTRONIC EXPERIMENTER'S HANDBOOK

ADVANCE NOTICE: This new 1958 Edition of the *Electronic Experimenter's Handbook* will go on sale March 27. If you like to build useful, profitable electronic devices, reserve your copy of the new *Handbook* now.

60 Devices . . . Nearly 200 pages . . . a Practical "File" of Electronics Ideas and Information

FOR YOUR HI-FI. Presence control. Hi-fi crossover. Filter. Electrostatic speaker system. Mixer equalizer. Spare amplifier. \$5 coax. 3-way speaker system. Junior hi-fi. Crossover with brilliance.

RECEIVERS. Shirt pocket transistor superhet. Vokar receiver. Superegen unit. Miniature VHF ear. Junkbox BC receiver. Etched circuit two-tuber.

FOR YOUR HOME. Invisible light door opener. Electronic brain to control house lights. DC supply for AC/DC motors. Power transistor for pocket radios. Light-operated relay. Transistorized intercom. Radio intercom. Electronic Christmas bells.

FOR YOUR DARKROOM. Audio photometer. Transistor slave flash unit. "Varistrobe." Light distributor. Darkroom timer. Enlarger exposure meter.

FOR YOUR HAM SHACK. Simple shortwave receiver. VHF explorer's receiver. 70-watt transmitter. Double your Heathkit AT-1 output. Code practice set. Antenna tuner. Transistor 10-meter receiver.

FOR YOUR WORKSHOP. Economy tube tester. Heat-controlled solder stand. Economy signal generator. Simple oscilloscope calibrator. \$14 signal tracer. Transistor checker. Capaci meter. Low-cost multi-tester. Transistorized signal tracer.

FOR THE KIDS. IQ tester. Electronic worm digger. Model spaceship. Game computer. Transistorized phonograph amplifier.

SPECIAL PROJECTS. Solar battery experiments. Electronic anemometer. Picture tube rejuvenator. Detectorscope. Simplified etched circuits. Geiger gun. Frost sentinel. Vibrato for an electric guitar.

COMING SOON— Only \$1
Reserve Your Copy Today at Your Newsstand or Radio Parts Store
ZIFF-DAVIS PUBLISHING CO.,
64 East Lake St., Chicago 1, Ill.

4) of the keyed-a.g.c. tube, a 6AU6. Effectively, this means that heater voltage is being taken from the separate F_2 winding on the power transformer. The cathode and suppressor grid of the 6AU6 (pins 7 and 2) are disconnected from the heater. Effectively this means severing the connection between pins 2 and 3 on the 6AU6 socket. The parallel combination of a 6.8-megohm resistor and a .15- μ fd. capacitor is then inserted, as shown, between the cathode of the CRT (pin 11) and the heater (pin 12).

ZENITH SOUND IMPROVEMENT

In fringe areas, the sound output of receivers in the following chassis series may tend to be noisy: 20H, 20J, 21J, 22H, 23H, and 24H. This will occur because, in the interests of good fidelity, only a moderate degree of high-frequency de-emphasis has been designed into the 6BN6 detector circuit. The circuit will tolerate additional roll-off quite well, if necessary. In areas where the sound tends to be noisy, therefore, the value of the .001- μ fd. capacitor from plate to ground of the 6BN6 can be increased

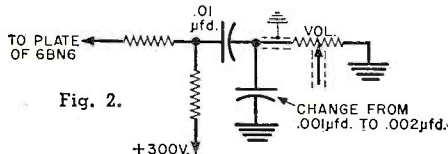

to .002 μ fd. (Fig. 2), either by removing the present unit and replacing with a new one of the recommended value, or simply by shunting another .001- μ fd. unit across the existing one.

Other measures for improving fringe-area sound include touch-up adjustment or instrument check of the sound take-off coil, the buzz control, the grid coil of the 6BN6, and the quadrature coil. All of these adjustments may be performed without removal of the chassis from its cabinet.

If the recommended change has been made and some improvement is still desired although all sound-channel adjustments and alignment are correct, deliberate detuning of the co-channel i.f. sound trap may be helpful. If the slug is turned farther into the trap, the resonant frequency will be lowered, permitting the sound-carrier level to rise. However, if this trap is detuned too far, 4.5-mc. grain interference may become evident, especially on the stronger channels. The best procedure is to detune the trap *slightly* while the set is tuned to the weakest channel to the point where sound improvement is noted. Then the receiver should be accurately tuned to the strongest channels to determine whether grain is beginning to appear in the picture. If no grain is evident, and if further improvement in the sound is desired, it is then possible to return to the weakest channel and to detune to obtain the best sound output possible on the weakest channels short of deteriorating the picture quality on strong channels.

-30-

YOU NEED THIS...

FREE GIANT ALL NEW 1958 BA CATALOG

A COMPLETE BUYING GUIDE FOR EVERYTHING IN

RADIO • TV ELECTRONICS

BA 1958

ANNUAL CATALOG 581

SINCE 1927

172 KING-SIZED PAGES

EVERYTHING IN RADIO TV AND ELECTRONICS

100'S OF NEW ITEMS LISTED HERE FOR 1st TIME

21 PAGES OF BARGAINS NOT IN ANY OTHER CATALOG

Guarantee

We guarantee everything in our Catalog to be of the quality and value represented. We conform exactly to the illustration and description. To perform at the manner and give the service intended for such apparatus.

RUSH COUPON TODAY!

INDEX PAGE 170

BURSTEIN-APPLEBEE

**BURSTEIN-APPLEBEE CO. Dept. M,
1012-14 McGee St., Kansas City 6, Mo.**

Send Free 1958 B-A Catalog No. 581.

NAME _____

ADDRESS _____

CITY _____ STATE _____

Castle Television Tuner Service

Aligned to Original Standards
Oscillator Tracking Assured by
Crystal Controlled Generators

IMPORTANT

Price includes WORN parts only.

F.O.B. CHICAGO or TORONTO.

DOES NOT include tubes needed; nor parts missing or damaged by abuse and negligent handling.

152 MAIN ST., TORONTO 13, ONT.,

CANADA

OXford 4-5637

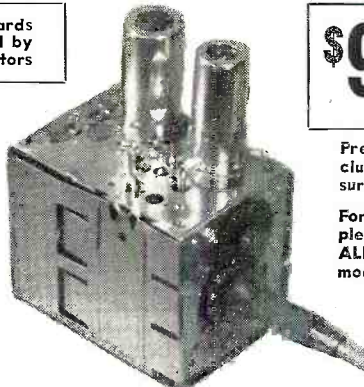

\$9.95 Dealer Net

EACH TUNER (VHF or UHF)

90 DAYS WARRANTY

Prepaid remittances must include return postage and insurance.

Forward defective tuner complete with GOOD tubes and ALL parts. Quote make and model.

1723 LUNT AVE., CHICAGO 26, ILL.

U.S.A.

AMBassador 2-7505

APN4B LORAN

Consisting of ID6B and R9B, complete with tubes, BRAND NEW in original cartons **\$48.50**

AN/APR-4 UHF receiver 28-4000 Mc. precision receiver utilizing 5 tuning units with direct reading dials in Mc. Receiver has a wide and narrow band width 30 Mc. I.F. strip which may be selected at will. 110 V AC. 60-2600 cycle.

Brand New **\$89.50**
Tuning units for above Exc. **\$59.50**
TN 16/38-95 Mc. Exc. **\$69.50**
TN17/74-320 Mc. Exc. **\$69.50**
TN 18/300-1000 Mc. Exc. **\$79.50**

BC-659 FM Receiver-transmitter, xtal controlled, two channels, freq. range 27-38.9, 9 Mc. 13 tubes, built-in speaker, dual meter for testing filament and plate circuits. **\$6.95**

BC 620—Same as above except less speaker and 20 to 27 Mc. **\$6.95**

BC 633. Ten Channel Push-button or continuous tuning FM RECEIVER 27 to 39 Mc complete w/tubes, speaker, squelch circuit, 12 volt power supply. Exc. **\$22.95**

BC 603. Same as above except 20 to 27 Mc. **\$14.95**

BC 604—10 Channel, 30 Watt Crystal Controlled 20 to 27 Mc Transmitter. Complete with tubes. Ship. **\$3.95**

F.O.B. Chicago or Sacramento, Calif.

ATR-11 4 Channel Crystal Controlled Transceiver 2.5 Mc to 6.7 Mc, complete with tubes, Exc. **\$29.95**

12 Volt dynamotor for above, with dual output 220 V, 125 MA, and 450 V 230 MA, complete with filter and 12 V starting relay, Exc. **\$14.95**
Both units **\$40.00**

J-38 HIGH SPEED HAND TELEGRAPH KEY, with on off switch, adjustable spring tension and contact spacing, mounted on Bakelite base. **\$1.69**

DM-65 HIGH VOLTAGE HIGH CURRENT 12 Volt DC input dynamotor, 440 volt 400 MA output, complete with base and Jones Plug. Brand New **\$19.95**
Used Exc. **\$14.95**

Bendix 100 Watt Transmitter

Easily converted to 10-20-40-80 Meters. Has four separate output tanks. One 4 position selector which changes the ECO IPA and output tank simultaneously. Uses 2—807, 4—12Sk7. Complete w/tubes. **\$22.95**

MP-28 modulation and Power supply for the TA-12 transmitter. Complete with 4 tubes. Dynamotor has 20 output of 540 V. DC @ 450 ma. Input at 28 V. DC. With dynamotor. **\$14.95**

3 GM-X Band Airborne Search Radar

Brand new RECEIVER and TRANSMITTER complete with Parabolic Antenna; amplifiers, indicators, control box, tube, less junc. box.

Tube complement consists of:
2 ea.—723AB 30 ea.—6J6 1 ea.—725A
2 ea.—1B22 9 ea.—6V6GT 3 ea.—807
4 ea.—3B24 11 ea.—6AK5 1 ea.—VR105
2 ea.—3FP7 4 ea.—6SL7GT 4 ea.—VR150
3 ea.—5U4 2 ea.—7248
(govt. acquis. cost over \$4000.00). Ship. wt. 431 lbs. w/operating instructions. **\$69.50**
YOUR SPECIAL PRICE. F.O.B. Penna. warehouse.

I-208 A standard of voltage freq. and freq. deviation for the testing, alignment, calibration and sensitivity measurement of FM receivers. Freq. range 1.9 to 4.5 Mc. and 19 to 45 Mc. Operates from either 12 VDC or 110 VAC. Govt. acq. cost. \$1800.00. Exc. **\$59.50**

LM FREQUENCY METER

Heterodyne, crystal calibrated, modulated less calibration book 125KC to **\$24.95**
20,000KC—Exc. ea.

HS-30 HEADSETS

Low Impedance hearing aid size, w/headband, rubber insert and Y cord. Like New. Only **\$1.29**
10 for. **\$9.95**

MODULATOR . . . with tubes . . . 2 ea. 813; 1 ea. 6D4. Exc. 807; 1 ea. 5R4; 2 ea. 6AG7; 1 ea. 6D4. Exc. Ship. wt. 60 lbs. **\$14.95**

WRITE FOR NEW BULLETIN

25% Deposit required with orders

R W ELECTRONICS

2430 So. Michigan Ave., Chicago 16, Ill.
Dept. N, PHONE: CALumet 5-1281-2-3

Satellite Signals

(Continued from page 38)

play is normally only exceeded in length by the long calibration and identification channel C1.

The second type of solar Lyman-alpha radiation signal transmitted represents an orbital peak or maximum value (channel F). Marked increases in solar Lyman-alpha radiation are expected to take place during periods of solar flares. Solar flares take place infrequently and at random and are of relatively short duration. While possible, it is quite unlikely that a solar flare will take place as the satellite is passing over a primary recording station. While leaving much to be desired, correlation between visually observed solar flares and orbital peak values of Lyman-alpha signals will permit collection of valuable data. Two magnetic memory units will be used in storing and transmitting peak orbital values of these signals. One memory unit will be storing information on the current orbit while the second memory unit is transmitting the peak value stored during the immediately preceding orbit. Once each orbit, on transition from darkness to daylight, a light-sensitive device is used to interchange the function of the two memory units. The unit which has been transmitting has its previous memory cancelled and begins to store data during the next orbit. Simultaneously the unit which has been storing information starts to transmit its stored data. Since the technique used permits the transmitted signal to change only once each complete orbit, adequate utilization of this data is expected from official recording stations. Two calibration curves are shown for peak Lyman-alpha data in Fig. 5. Different frequency ranges are used for readout of the two memory units. This permits individual calibration as well as a check on proper functioning.

Opportunity does exist for amateur observers to make a major contribution to the solar Lyman-alpha radiation experiment. Valuable indeed would be a properly prepared amateur recording showing instantaneous values of Lyman-alpha radiation during the progress of a solar flare. Recordings of interest would be any showing an electrometer current in excess of 200 microamperes. By use of the calibration curve for channel A of Fig. 5, this can be translated into a telemetry signal frequency. Thus, it can be seen that recordings of value would be those in which the frequency in any Lyman-alpha burst momentarily drops below 10 kc.

Precise measurement of these signals requires elaborate equipment. Amateur observers can make reasonably accurate determinations from simple listening tests. A little practice will permit rather easy identification of the Lyman-alpha signal burst channel. This information is distinguished

as the first and longest of the often repeated rhythmical alternation between channels A and B. It should be pointed out that recordings played back at reduced speed will have the desired signal frequencies correspondingly reduced. Thus a tape played back at one half of the recording speed would be of interest if the Lyman-alpha burst frequency dropped below 5 kc. It is suggested that a comparison test tape be prepared for ease in identifying valuable signals. An audio oscillator would be used to record a 10 kc. signal at the same tape speed planned for recording satellite signals. This tape would then be played back at the same speed used for listening tests. This procedure provides automatic compensation for changes in tape speeds.

Solar Aspect: A silicon solar cell located on the satellite equator will provide information on the orientation of the satellite with respect to the sun. This data is required by the Lyman-alpha experimenters for detector sensitivity calibration. It will also provide accurate information on satellite spin and spin damping. This signal is presented six times each telemetry frame on channel B. Calibration is shown in Fig. 5.

Surface Erosion Experiments: Erosion of the surface of the satellite will be studied by means of small erosion gages attached to the outer shell. These gages consist of small glass plates on which a thin-film metallic resistor has been deposited. The telemetry system will detect the wearing away of this metallic film by monitoring changes in resistance during this process. Reference to Fig. 5 shows two types of gages are used for different sensitivity ranges. Thus a polar erosion gage providing information on channel A1 consists of a very thin film having an initial resistance of 20,000 ohms. Thicker films on gages represented by channels E1 and F1 provide an initial resistance of 2000 ohms. Resistance of all gages will increase as erosion takes place. At anticipated erosion rates, ample information is expected from primary receiving stations. Thus the resistance values are expected to undergo only minute changes during intervals between official observations. Properly spaced amateur recordings could provide vital information in the event of early complete breaks in the metallic film. Amateur recordings could, under these circumstances, provide the only source of information to distinguish between an abnormally high but uniform erosion or collision with a single particle(s) of sufficient size to result in destruction of gages on first impact.

Cadmium Sulphide Meteor Detector: Another type of detector for meteoritic collision experiments uses a cadmium-sulphide cell covered by an opaque layer. The cadmium sulphide is photoresistive in that its electrical resistance decreases when exposed to light. This cell is initially protected from sunlight by the opaque cover. As

meteorites puncture the protective layer, sunlight will be permitted to reach the sensitive element. When the satellite is in sunlight, the resistance change will reflect the amount of the opaque layer removed. The photore-sistive element is of a selected type having a long time constant. Thus the resistance changes will take place only slowly so as to minimize effect of satellite spin. This information is displayed on telemetry channel F2. No calibration for this channel is given in Fig. 5. This channel will initially be at its high resistance value presenting a burst spacing of about 11 milliseconds. As the opaque layer is punctured this interval will become progressively shorter during the sunlit portion of each orbit.

Amateur recordings could provide much valuable information for this experiment. Adequate coverage could provide accurate timing of collisions detected. Such recordings could also permit the distinction between single collisions with large particles and multiple collisions with small particles removing the same area of cell cover material.

Skin-Puncture Experiment: This experiment is designed to detect collision with particles of sufficient collision energy to puncture the outer shell. Two pressure-tight zones are incorporated into the satellite outer shell. Prior to launching, these two zones are initially pressurized to significantly different pressures. A single differ-

ential pressure measurement made between the two zones can indicate the puncture of either or both zones. With both zones intact, the differential pressure gage would indicate the initial value. When either zone becomes punctured its internal pressure will equalize with the near perfect vacuum of the satellite environment. Thus with either one of the two zones punctured, the differential pressure measurement will display the pressure of the zone remaining intact. When both zones become punctured, the differential pressure will be zero since both zones will be evacuated to ambient atmospheric conditions. Amateur recordings could assist in more precisely determining the time at which punctures occurred. If both zones were punctured in an interval between primary recordings, amateur observations would be the only potential source of information to permit determining whether separate punctures occurred or if a single particle punctured both zones. This data is presented on telemetry channel B1.

Meteoritic Collision Experiment: Sensitive microphones attached to the outer shell of the satellite are used to detect collision with small particles in space. Magnetic memory units in the satellite are used to store and continuously transmit information on the cumulative number of such counts detected. Three channels of the telemetry system serve to provide counting

(Continued on page 156)

SURPLUS BUYS!

ELECTRONIC SWITCH—TS43B/U. Used cond. \$14.95
HALLICRAFTER RECEIVER—R100/U.R.R. .5-20MC. 3 bands. 115VACDC. Clean. . . . \$34.95
HAMMARLUND RECEIVER—BC779 (Super-Pro Aircraft version). Used cond. Not checked. As is. No major components broken or stripped. \$65.00
HAMMARLUND SUPER-PRO Power Supply—RA-84. Input 115VAC—60CPS. Used. Fair cond. \$14.95
POWER SUPPLY—RA-2B. Input 115V—60CPS. Output 1150 to 1420VDC—450Mils. Cabinet 19 x 15 x 12. Wt. 150 lbs. Brand new w/spare 86A's. Reduced. . . . \$59.95
FILAMENT TRANSFORMER—2.5V-10 amps. 10KV insulation. As used in BC610. New. . . . \$3.95
RECEIVER—TBS. Self contained. 115V-60 Cy. P.S. 12 tubes. 60-80 Mc. 26X9X17. Exc. op. cond. 6 meters. Lim. Quant. . . . \$19.95
SEXTANT—Aircraft bubble type. Designed for aerial navigation. Records angular altitude for a heavenly body with reference to a bubble artificial horizon. Contains spare 2X telescope for use on faint stars. Battery case, marker discs, etc. Housed in instrument carry case. 9X9X5. No instructions. Used—good cond. . . . \$12.95
PORTABLE AUDIO AMPLIFIER—111F. Used with 625 mine detector. Compl. w/tubes, schem. cable. L. N. 12 x 4 x 4. 9 lbs. . . . \$3.95
TORSIONAL RELAY—Wallace & Tiernan Frequency selective. For use in applications where radio waves are control medium. . . . \$3.95
TRIPLET MICROAMMETER—0-500 u/a Dc. 2 1/2" rd. bakelite case, white scale. ea. \$3.45
G. E. METER—2 1/2" rd. 0-500 mils. New \$2.95
METER: 0-1 Mil (3KV scale) 3 1/2" rd. Marion—new. . . . \$3.95
FREQUENCY METER—T45/APM-3. 115V. 60-80 cps. input. 9300-9450MC. Can be used as a CW or Pulsed Signal Generator. Brand new. With Tech. manual. . . . \$79.95
FREQ. METER—Weston 814 (4 1/2" Rd) 100-125V. 380-420CPS (40 Div) . . . \$14.95
MIN. CARBON BUTTON MIKE—C-1 (ANB-MC1) w/plug. Br. new. 6 for \$5.00. . . ea. \$1.00
PANORAMIC ADAPTER—RDP—5" screen—115/230V 55/65 cy. w/all tubes. . . . \$49.95
DUAL RECEIVER RACK (ARC-5) Br. new \$1.95
Carbon Deposit 1% RESISTOR—Kit. . . \$1.00
ISOLATION & FILAMENT XFORMERS—115V to 115V +6.3V—small. . . \$1.00
COLLINS 20 Watt MODULATION XFORMER 3 for \$5.00—each. . . \$1.95
SCOPE, SIGNAL GENERATOR & POW. SUPPLY (115V 60CPS) all in one unit—w/tubes, meter, schem., L.N. 60 lbs. . . \$19.95
COLLINS CARB. MIKE XFORM. 3 for \$2.00
RADIO SOUND TRANSMITTER—T69F/AM2—390-410MC—w/2 tubes. ant. New. . . \$1.95
RETRACTABLE PHONE CORD—latest type—3 cond.—Automatic elec. . . \$1.00
REX RADIO SUPPLY CO.
 88 Cortlandt Street New York 7, N. Y.

Just Out

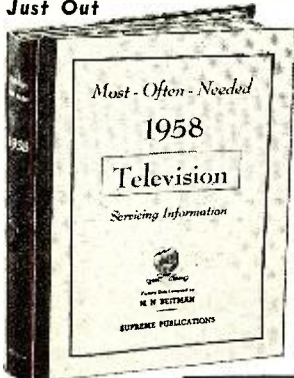

New SUPREME 1958 TV Manual

AMAZING BARGAIN

The new 1958 TV manual is the scoop of the year. Covers all important sets of every make in one giant volume. Your price for this mammoth manual is only \$3. This super-value defies all competition. Other annual volumes at only \$3 each. Factory service material simplifies repairs. Includes all data needed for quicker TV servicing. Practically tells you how to find each fault and make the repair. More pages, more diagrams, more service data per dollar of cost.

TELEVISION SERVICING COURSE

Let this new course help you in TV servicing. Amazing bargain, complete, only \$3, full price for all lessons. Giant in size, mammoth in scope, topics just like a \$200.00 correspondence course. Lessons on picture faults, circuits, adjustments, short-cuts, UHF, alignment facts, hints, antenna problems, trouble-shooting, test equipment, picture analysis. Special, only \$3



Companion RADIO COURSE, Introduction to TV

Here is your complete radio training in 21 easy-to-follow lessons. Covers fundamentals, fault finding, use of test equipment. Everything in radio, introduction to TV. Self-test questions. New edition. Special, only \$2.50

17 RADIO VOLUMES

RADIO DIAGRAMS

Supreme is your best source for all needed RADIO diagrams and service data. Covers everything from the most recent 1957 radios to pre-war old-timers; home radios, auto sets, combinations, changers. HI-FI, FM, and portables. Sensational values. Only \$2 for most volumes. Every manual has extra large schematics, all needed alignment facts, parts lists, voltage values, trimmers, dial stringing, and helpful hints. Volumes are large in size, 8 1/2 x 11 inches, about 190 pages. See coupon at right for a complete list of these radio manuals.



Supreme Publications
 Sold by All Leading Parts Jobbers

COVERS ALL POPULAR SETS

Here is your service data for faster, easier TV repairs. Lowest priced. Best by comparison. **Supreme TV** manuals have all needed service material on every popular TV set. Helpful, practical, factory-prepared data that will really make TV servicing and adjustment easy for you. Benefit and save with these amazing values in service manuals. Only \$3 per large volume. The choice of wise servicemen.



SIMPLIFIES TV REPAIRS

These giant TV manuals have complete circuits, needed alignment facts, curves, service hints, all factory production changes, voltage charts, waveforms, and double-page schematics. Here are your authentic service instructions to help you do expert work quicker; and priced at only \$3 per large yearly manual. Repair **any TV model** ever made by having in your shop all 13 volumes as listed in coupon. Your special price for all, only \$36. Or try the new 1958 TV manual to see what an amazing bargain you get for \$3. Send no-risk trial coupon today.

The repair of any television set is really simple with **Supreme TV** service manuals. Every set is covered in a practical manner that will simplify trouble-shooting and repair. This is the help you need to find toughest faults in a jiffy. Each \$3 TV volume covers a whole year of service material. New **Television Servicing Course** will aid you in learning TV. Be wise, buy **Supreme Manuals** only once each year instead of spending dollars every week.

NO-RISK TRIAL ORDER COUPON

SUPREME PUBLICATIONS, 1760 Balsam Rd., Highland Park, ILL.

Rush today TV manuals checked below and Radio manuals at left. Satisfaction guaranteed.

New 1958 Television Servicing Manual, only. . . \$3.
 Additional 1957 TV, \$3. Early 1957 TV, \$3.
 1956 Television Manual, \$3. Early 1955 TV, \$3.
 Additional 1955 TV, \$3. 1954 TV Manual, \$3.
 1953 Television Manual, \$3. 1952 TV, \$3.
 1951 TV, \$3. 1950 TV, \$3. 1949 TV, \$3.
 1948 TV, \$3. 1957-58 RCA Victor TV, \$1.50
 New Television Servicing Course, complete. . . \$3.

I am enclosing \$ Send postpaid.
 Send C.O.D. I am enclosing \$ deposit.

Name: _____
 Address: _____

Transistorized 6-Watt Hi-Fi

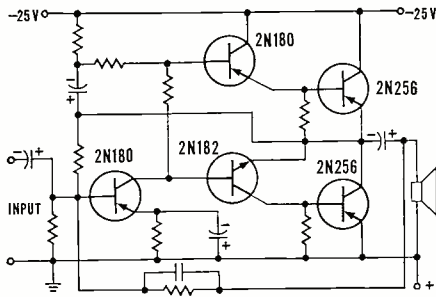

New experimental all-transistor hi-fi amplifier delivers 6 watts with: ± 1.5 db response from 30-15,000 cps, less than 1% harmonic and 2.5% intermodulation distortion, noise level 74 db down. Simple circuit features: pre-driver, driver, and final amplifier using low-cost CBS 2N256 power transistors . . . negative feedback . . . complementary-symmetry driver . . . direct coupling . . . economical power supply.

CBS alloy-junction germanium power transistors 2N255 (6-volt) and 2N256 (12-volt) are useful also in many other economical amplifiers . . . fixed or mobile . . . with up to 10 watts output Class B push-pull. Second Edition of CBS Power Transistor Applications, Bulletin PA-16, helps put them to work. Free, it gives complete data and circuits. Pick it up with your 2N255 and 2N256 transistors at your CBS Tube distributor's — today.



CBS-HYTRON

Semiconductor Operations, Lowell, Mass.
A Division of
Columbia Broadcasting System, Inc.

156

data in the form of three decimal digits. Consider, for example, the telemetry channel C which provides units-count data. As can be seen from Fig. 5, the frequency in this burst increases from about 5 kc. to 12.5 kc. in discrete intervals. One such frequency change is made for each input count up to nine. Upon arrival of the tenth count, channel C returns to 5 kc. ("zero" units count) while the frequency in channel D makes the appropriate increase to indicate the tens count; i.e., the number of times the unit count has returned to zero. Similarly, channel E frequency will present hundreds digit information by advancing one "count" for each reset of the tens digit counter. This can be seen to be similar to the operation of the mileage indicator of an automobile speedometer. The units counter advances one digit for each mile traveled. For each ten miles the units digit returns from nine to zero while one count is added to the tens digit. The nature of these signals can be further illustrated by reference to Fig. 6. The two oscillograms show similar portions of two successive telemetry frames. Both display the final portion of the units count and the complete tens count burst. The signals shown were extracted from records made during a rocket flight in which satellite instrumentation equipment was being test flown. The brief interruption of the tens burst is the equipment "dead time" which occurs whenever a count is being received. This interruption is many times shorter than the shortest burst spacing and would not be confused by a practiced observer. The upper trace thus shows a time interval including an actual collision of the rocket in flight with a meteoritic particle. The unit count burst in this upper trace is at its highest (12.5 kc.) frequency representing a count of "nine," while the tens count starts at a slightly lower (12 kc.) frequency representing a count of "eight," thus indicating a cumulative count of 89. The hundreds count is not shown but is unimportant in this illustrative discussion. Following this collision the frequency of the tens count burst has increased to 12.5 kc. representing a count of "nine" in the tens digit. The bottom oscillo-

graphic trace shows indeed that the units count has returned to its low (5 kc.) frequency to indicate a "zero" units count while the tens count remains unchanged at its "nine" count for a cumulative count of 90.

No really satisfactory estimates are available as to the number of such collisions to expect from a satellite in orbit around the earth. Counts of a few hundred or less per orbit can be studied by means of the difference in cumulative count between recording periods. The information transmitted presents total counts only up to 999 before returning to 000 to begin a new sequence. Therefore, high counting rates extending into thousands of counts per orbit cannot be studied in this way. Such large counting rates would be studied by change in total count over shorter time intervals, such as the signal reception interval for a single receiving station or occasional satellite transits which provide less than full orbit intervals between recordings.

Many potential contributions could be made by amateur observers in the study of collision between the satellite and micrometeorites. For example, in a single orbit, a series of amateur records from properly distributed geographical locations could establish whether particles are distributed at random or clustered in clouds. Amateur recordings would also be of great value in the event of unanticipated high counting rates. Ample data could also provide clues as to the possible origin of such particles. Study of micrometeorites by means of satellites is a new field with most meager background information upon which to base estimates and plan experimental techniques. The subject is expected to be much better understood after the present satellite experiment has been completed. Extensive useable records from a single successful satellite would provide a sound basis for an exhaustive scientific study and analysis.

Skin-Temperature Experiments: Measurements of the temperature of the outer shell of the satellite are made at two points. One temperature sensing element is located near one satellite pole; i.e., near the spin axis. The second sensing element is located near the equator of the satellite; i.e.,

Fig. 6. This is a portion of the telemetry record obtained from a rocket flight. The record shows the collision of the rocket with a micrometeorite.

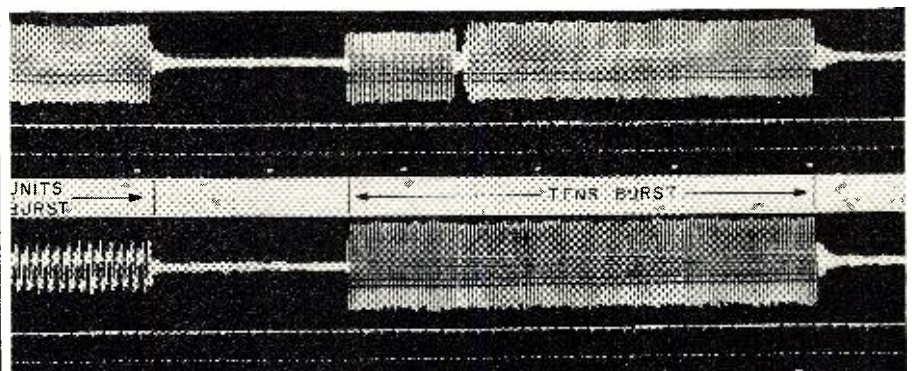

RADIO & TV NEWS

the plane perpendicular to the spin axis passing through the center of the sphere. Data on these two measurements are transmitted as burst spacings on channels D2 and E2 respectively.

Virtually all heat transfer to and from the satellite in orbit will take place by the process of radiation. Ambient atmosphere at satellite altitudes is so rarefied as to make negligible any aerodynamic heating or heat transfer to or from this atmosphere. The satellite will be heated by radiant energy received primarily from the sun and the earth. Some heating will also be derived from power dissipation of internal instrumentation equipment. The satellite will be cooled by radiating energy into space. Satellite temperatures can be controlled to a certain extent by means of coatings applied to the outer surface. These coatings permit selective control of the ability of the satellite to radiate heat into space and its ability to absorb radiant energy. Thus a satellite which was an efficient radiator and a poor absorber would tend to run cold and *vice versa*. Precise temperature control is not possible since coatings are applied prior to launching on the basis of assumed values of many factors which affect the satellite temperature. For example, heating of the satellite due to radiation from the sun will depend upon the length of time the satellite remains in sunlight in each orbit. Variations in orbit can cause a variation of nearly two to one in the absolute time per orbit which the satellite remains in sunlight. As one further example, the energy radiated by the earth will undergo radical changes with the amount of cloud cover. In spite of the many unpredictable factors, it is expected that mean orbital temperatures of the outer shell will lie between 0° C and 60° C (32° F and 140° F) under most unfavorable conditions. Outer shell temperatures during any orbit will vary from ±5° C to ±15° C from the orbital mean value as the satellite heats up when in sunlight and cools when in the earth's shadow.

Ample information on temperatures are expected from primary recording stations for any satellites of a normal active life. Recordings made by amateur observers would be of great value in the event of unexpected temperature extremes which could result in early equipment or battery failures.

Instrumentation-Compartment Temperature: Airborne electronic equipment is located in an internal instrumentation compartment. This inner compartment will be thermally isolated from the outer shell so that heat exchange will be a very slow interchange by radiation. This tends to isolate the internal equipment from orbital temperature variations. The instrument compartment temperature will thus remain relatively stable at a value a very few degrees above the mean orbital temperature of the outer shell.



Write for the latest Oxford catalog

OXFORD Components, Inc.
 Subsidiary of Oxford Electric Corp.
 556 West Monroe, Chicago 6, Ill.
 Export: Robert Alberts, New York City
 In Canada: Atlas Radio Corp., Ltd., Toronto

MAKE SURE IT FITS!

OXFORD SPEAKERS

When you order a speaker (for replacement or original installation), demand units that meet your most exacting needs.

Each OXFORD SPEAKER is "tailor-designed" to actually "fit the application."

The next time you specify speakers, make certain they fit the job by selecting OXFORD... unsurpassed quality for over thirty years.

<p>RADIO & TV SPEAKERS</p>  <p>OXFORD Speakers are used by more original set manufacturers — find out why!</p>	<p>OUTDOOR SPEAKERS</p>  <p>For rugged, steady performance under any conditions, OXFORD Weather-proof speakers will meet the need.</p>
<p>DUAL CONE HI-FI SPEAKERS</p>  <p>Oxford's newest development to provide maximum performance. For Hi-Fi and rear deck applications.</p>	<p>PORTABLE RADIO SPEAKERS</p>  <p>More Oxford speakers are used in portable sets than ever before... there must be reasons!</p>

30 Watt Hi-Fi Super Lin Kit
 AMP-PREAMP with TRANSISTORIZED FRONT END
 FREQUENCY RESPONSE: — 1 db 10-40,000 cps.
 TUBES: uses (1) 6AU6, (1) 12A7, (1) 12AU7, (2) EL34's, (1) 5Y4-GB.
 SHIPPING WEIGHT 26 lbs. PL-30
 Sale Price... **\$42.00** F.O.B. N.Y.
 Send for Free Catalogue
CUTICK ELECTRONICS HI-FI RADIO T.V. PARTS
 171 Washington St., WOrth 2-5866, New York 7, N.Y.



BARGAIN HUNTING? TV SERVICEMEN!
 Write for SENSATIONAL CATALOG
HENSHAW RADIO SUPPLY
 3619 TROOST KANSAS CITY, MO.



GET INTO ELECTRONICS



V.T.I. training leads to success as technicians, field engineers, specialists in communications, guided missiles, computers, radar and automation. Basic and advanced courses in theory and laboratory. Assoc. degree in electronics in 29 mos. B.S. in electronic engineering obtainable. ECED accredited. C.I. approved. Graduates in all branches of electronics with major companies. Start Sept., Feb. Dorms, campus. H.S. grad or equivalent. Catalog.

VALPARAISO TECHNICAL INSTITUTE
 Dept. RD Valparaiso, Indiana

Amazing New Handbook Takes The "Headache" Out of TV Trouble Shooting

Pin Point TV TROUBLES IN 10 MINUTES



SAVES TIME... ELIMINATES GUESSWORK!
 Now, a simple, practical way to accurately spot the cause of trouble in any TV set, FAST! Quick, easy-to-understand tests tell you in which of 5 TV set sections to find the cause of trouble. Fool-proof Check Charts help you locate the exact trouble spot at once, from as many as 700 possibilities. Book fits easily into your tool kit for handy on-the-job use. Over 300 spiral bound fast reference pages with 50 time-saving Check Charts; dozens of easy to understand diagrams and tests; explanations of circuits and designs. The hours and aggravation this amazing handbook can save you on a single servicing job more than pay its low price!

USE IT ON 7 DAYS FREE TRIAL!
 Send no money, just the coupon. We'll rush your copy on FREE TRIAL. After 7 days, send only \$3.95 plus postage or return the book and owe nothing. Act NOW!

MAIL COUPON NOW!

Educational Book Publishing Div.
 COYNE ELECTRICAL SCHOOL, Dept. 38-RT
 500 S. Paulina St., Chicago 12, Ill.

Rush TV handbook for 7 days FREE TRIAL per offer.

Name Age

Address

City Zone State

Check here if \$3.95 enclosed. We pay postage. 7-day money-back guarantee.



America's
most complete
line of

**MOBILE
COMMUNICATIONS
EQUIPMENT**

MODEL M-2

List
\$19.40
Complete

Here it is! An antenna with a bumper mount that will fit any bumper—simple to adjust—can be attached without any need for drilling holes. It will set tighter than any antenna you've seen. Comes complete with spring and 96" stainless steel whip.

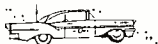

Dump your problems in our lap
with a phone call



Rely on our know-how as original equipment manufacturers. Remember, the a/s line is not only big, but it's versatile and flexible. **WHATEVER YOUR REQUIREMENTS, a/s has 'em or can make 'em fast!**

**FASTEST SHIPPING POLICY
IN THE INDUSTRY**

1. Long distance 'phone order maximum 12 hour delivery
2. Telegram 24 hour delivery
3. Air Mail Letter 48 hour service

the
antenna  **specialists**
company
12435 EUCLID AVENUE • CLEVELAND 6, OHIO
5Wectbriar 1-7878

It can be seen that many potential contributions are possible from recordings of satellite scientific signals prepared by amateur observers. The necessary equipment is available to many now and could be prepared by others by inexpensive modification of present equipment. Preferable tapes would be made on "stereophonic" tape recorders with the satellite signal on one track and a reliable time base on the second track. Suitable time base would be obtained from a stable oscillator or recording of signals from WWV including a time announcement.

To be useable, any tapes must be accompanied by certain basic information as follows:

- (1) Name and address of the observer if tapes and their interpretation are to be returned.
- (2) Make and type of recorder on which tapes were prepared.
- (3) Tape speed in inches per second at which recording was made.
- (4) Number of channels and signals recorded on each.
- (5) Date on which recording was made.
- (6) Exact time at which recording was made including a.m. or p.m., time zone (or Greenwich time), and whether daylight or standard time.
- (7) Exact location at which recording was made, preferably including latitude and longitude.
- (8) Any special scientific data the record may be believed to contain.

All correspondence relative to programs for receiving satellite signals or available tapes should be addressed to U. S. Naval Research Laboratory, Washington 25, D. C., Attention: Code 4105. Recorded tapes should not be mailed without further instructions.

Any tapes prepared early in the life of a satellite should be carefully preserved until the fate of the satellite and its scientific experiments have been determined. Such recordings could be of great value.

When the one millionth Bogen amplifier rolled off the production line in Paramus, N. J. Lester H. Bogen, president of David Bogen Company, Inc. was on hand to receive it and congratulations from Irving Olson, president of Olson Radio Warehouse, Inc. (left) and Mortimer Sumberg, district sales manager for the audio firm, which is now celebrating its 25th anniversary.



21 High Speed DRILLS \$250



**BRAND NEW! U.S.A. TOP GRADE!
FULL RANGE FROM 1/16" thru 1/4"
Less Than 12c Each**

Here's the greatest drill value we have ever offered! Precision crafted HIGH SPEED STEEL DRILLS made right here in the U. S. A., unconditionally guaranteed to easily, cleanly and speedily drill through the hardest steels or any tough metals and, of course, plastics, aluminum, wood, etc. These are not cheap carbon drills that dull after a short time, but top quality, full jobber-length shank drills with keen cutting edges that will give you perfect performance every time! Imagine! You get 21 drills—of all most-used sizes from needle-sized 1/16" thru 1/4"—ideal for industry and home—for use with portable or fixed electric drills. If you can buy these for less than \$10.00 at any store, keep one of the drills for your trouble and return the rest for a full refund!

ONLY 75c EACH

for the FINEST QUALITY Imported
PRECISION PLIERS

FOR JEWELERS, OPTICAL WORKERS, HOBBYISTS, CRAFTSMEN OF ALL KINDS! These superb European imports are of deep-forged, heat-treated high quality tool steel, fabricated to most exacting specifications. All-over ground and polished to smooth hard surfaces. Smooth working joints with just the right tension. Jaws meet perfectly to safely and securely hold even the most delicate objects in the hard-to-reach corners and angles. Each plier is 4" long and a veritable gem of precision and strength.

75c each all 7 for \$5.00

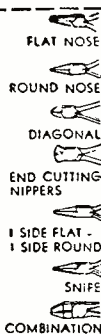

**Surgical Steel—Hand Ground—Set of 12
CARVING KNIVES**



The sharpest, keenest ground, surgical steel blades we have ever seen—sharp enough to split a human hair in two! 12 different shapes and edges can do every job of wood carving, model making, linoleum cutting, sculpting and whitening imaginable. Each knife has long hardwood handle for easy gripping . . . heavy duty blade is firmly attached by means of a brass ferrule to insure long continued use. Each surgical steel blade precision hand-ground to easily and quickly notch and cut any shape you wish. A sensational all-purpose set, well worth \$5.95.—ppd. **\$2.00**

Money Back Guarantee. Send Check or M. O. If C. O. D., fees extra.

SCOTT-MITCHELL HOUSE, Inc.
611 Broadway, Dept. R-3, New York 12, N. Y.

INFRARED SNOOPERSCOPIES!

**OPTICS • LAMPS
TUBES • PARTS** **Army Model M-2**

Former "Top-Secret" Infra-Red Viewers For Seeing In Total Darkness—Undetected, Now Available For Civilian Applications!

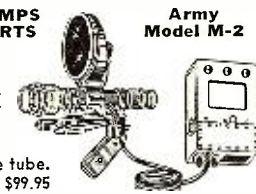

Bell & Howell—
uses IP25-A Image tube.
Priced from \$50 to \$99.95

IMAGE TUBE POWER SUPPLY
—SNOOPERSCOPE PART #1450-A
Power-pack for IP25-IP25-A tubes "will also supply CV-147 tubes! Input 6 volts d.c. at only 0.33 ampere. Output 4.250 volts d.c. and additional focusing voltages. Operates from single 6-volt dry cell lantern battery. Each unit Gov't cost \$92.00. NEW CONDITION. Complete, ready to use, only \$7.95 ppd.

INFRARED LIGHT SOURCE
SNOOPERSCOPE PART #1364-A
Input 6-volts, 5 amperes. 53" double glass filter. Projects a powerful beam of invisible radiation (free of all visible light) illuminates for infra-red viewing or photography up to distance of 400 feet. STK. #L-5459. BRAND NEW, only \$5.95 ppd.

TERMS: Cash With Order. Merchandise Guaranteed. Write today for FREE CATALOG. Contains detailed description, price list, and wide uses of units. Also large selection of other infra-red parts available at our amazing low prices.

McNEAL Electric & Equipment Co.
4736 Olive St., Dept. R-3, St. Louis 8, Mo.

2 WAY PORTABLE RADIO SET

Sends—Receives up to 10 miles as shown
or hundreds of miles with outside antennal 50 and 40 meter amateur radio bands (over) also (aircraft) and broadcast radio bands (8 to 3 mc.). POWERED WITH SELF-CONTAINED PORTABLE RADIO BATTERIES. NO AC PLUGS NEEDED! Take it with you everywhere you go—Keep in contact with home, friends, Has 5 watt crystal controlled transmitter—Sensitive Regenerative Receiver—Send-receive switch. Wt. only 3 lbs. Size, only 6"x4"x4" TESTED—PROVEN—SATISFIED—PRACTICAL—Full information given on quick easy to get license.

SEND ONLY \$3.00 (bill, ck. mo) and \$1.95 COD postage on arrival or send \$4.95 for "over-aid" delivery. Complete kit includes all parts, tube, coils, plastoid cabinet, easy instructions. 66 of battery—COMPLETELY WIRED AND TESTED POSTPAID \$10.95. A regular \$49.95 value—Order now before price goes up, GUARANTEED—AVAILABLE ONLY FROM:
WESTERN RADIO Dept. BNT-3 KEARNEY, NEBR.

Five Months of IGY Disclose Space Secrets

First summary report shows new data on the ionosphere.

A SUMMARY of the first five months of the U. S. International Geophysical Year (IGY) program was released by the American Association for the Advancement of Science. By Hugh Odishaw, Executive Director of the US-IGY Committee, the report describes a wide range of early scientific results of this 18-month, international research program of our earth and its environment. The findings cover each of the dozen fields in which IGY programs are being conducted and reflect the work of hundreds of scientists and many institutions. They demonstrate also the construction participation of many other nations.

The results range from the recovery of living organisms from record ocean depths to the reception of radio signals sent curving two or three earth radii out into space to test whether a sparse medium actually fills the void between earth and sun. Probing into the upper atmosphere with the aid of rockets have corroborated the belief that radio "blackouts" are caused by an "extra" layer of ionized particles which occurs during solar flares in the upper atmosphere 10 to 12 miles below the lowest portions of the ionosphere. Another rocket experiment has established that this layer is caused by the sun's x-ray emissions.

Observatories located on Pacific islands have confirmed the probable existence of an "electro-jet," a narrow equatorial electric current which circles the earth in the high atmosphere. This is one of three hypothesized currents of perhaps several hundred thousand amperes circling the earth. The others girdle the North and South magnetic poles.

The Northern and Southern lights occur simultaneously and with some symmetry, according to preliminary findings by British scientists. These have since been supported by polar radio data obtained in the U. S. program.

University of Chicago specialists have pinpointed a "cosmic ray equator" by systematically flying and sailing instruments around the world. Since this line departs considerably from the geometric equator, the conclusion is that there are important magnetic fields in space which deflect incoming cosmic rays.

-30-

Twice The FM... At Half The Price...



Compare*

\$47⁵⁰

Introductory Sale!

\$5 Down, \$5 Monthly

REALISTIC® HI-FI FM TUNER

* COMPARE	Net Price	Microvolt Sensitivity	Frequency Response	Selectivity
Realistic FM Tuner with Cage	\$47.50	3 uv for 30 db Quieting	20-20,000 cyc./sec.	180 KC IF Bandwidth
Brand "A" FM Tuner with Cage	\$89.50	3 uv for 20 db Quieting	20-20,000 cyc./sec.	Not Given by Manu.
Brand "B" FM Tuner with Cage	\$99.50	5 uv for 30 db Quieting	20-20,000 cyc./sec.	Not Given by Manu.
Brand "C" FM Tuner with Cage	\$99.95	5 uv for 30 db Quieting	20-20,000 cyc./sec.	200 KC IF Bandwidth

REALISTIC FACTS

The basic function of any high fidelity FM tuner is to faithfully reproduce the transmitted signal (frequency response), at reasonable distances from the station (microvolt sensitivity), without noise or interference from other stations (quieting and selectivity). The new Realistic FM Tuner more than meets all of these requirements... while doing away with all of the pseudo-high fidelity gimmicks which only add to the cost without improving the quality. Functionally designed 6-tube (2-duals!) Armstrong — tuned RF circuit with AFC. Handsome Gold, Maroon and White faceplate and cage. 9 1/2" W x 4 3/4" H x 6 1/8" D., ship. wt. 9 1/2 lbs.

Radio Shack Corporation
167 Washington St., Boston 3, Mass.

Please send me:

___ Realistic FM Tuner @ \$47.50 #36R888-2
___ FREE 64-page Hi-Fi Buying Guide #59RN

My Name _____
Street _____
Town _____ Zone _____ State _____

RADIO SHACK CORP.

* Mail Orders: 167 WASHINGTON ST., BOSTON 3, MASS.
Stores: BOSTON, and 230 CROWN ST., NEW HAVEN, CONN.

TAPE RECORDERS

HI FI COMPONENTS
Tapes—Accessories
UNUSUAL VALUES
Send for Free Catalog

DRESSNER
69-02 RA-174 St.
Flushing 65, N. Y.

MERITAPE
Low Cost, High
Quality Re-
cording Tape—
in boxes or
cans.

**MOVE SENDING
RECEIVING SPEED**

Be a "key" man. Learn how to send and receive messages in International Morse code. Communicate with operators around the globe. Learn at home quickly through famous Candler System. Used by best operators. Qualify for Amateur or Commercial License. Write for FREE BOOK.
CANDLER SYSTEM CO.
Dept. 2-C, Box 928, Denver 1, Colo., U.S.A.

MOVING?

Make sure you notify our Subscription Department about any change of address. Be certain to include your postal zone number with both old and new addresses. Allow four weeks' time for processing.

RADIO & TV NEWS
Subscription Department
64 East Lake Street
Chicago 1, Illinois

RADIO ELECTRONIC SURPLUS

INFRA RED SNOOPERSCOPE

High quality now at surplus prices. Eastman Kodak Infra-Red SNOOPERSCOPE Receiver, Type B, 7" long with 5" SCHMIDT ultra-high-speed. Objective Lens (approx. f/0.5). Elaborate optical system, many coated lenses. Uses 2 penlight batteries. Govt. cost approx. \$300. Factory-new. Shipping wt. 9 lbs.



Price \$19.95
Waterproof Snooperscope Carrying Case, extra. Shipping weight 3 lbs. Price \$3.00

Dual purpose U.S.N. Floodlight throws strong beam of invisible infra-red rays. With infra-red lens, spare sealed beam lamp, batteries. Shipping weight 23 lbs. Price \$14.95

WALKIE TALKIES



Complete Walkie Talkie assemblies as shown, less tubes & case. Crystal controlled, and covers 3500kc to 6000 kc. Brand new. \$9.95 each 2 for \$17.95

AN/CRC-7 VHF TRANSCEIVER



With voice or transmit tone, used with air-sea rescue work. Crystal controlled. 140.58 mc. \$15.00 each (less battery)

44 POSITION STEPPING SWITCH

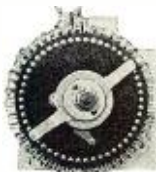

With automatic reset. 24 volt A.C. Dimensions 1/4" x 4 1/4" x 3" deep. Mfgd. by Wico.

\$3.00 each

Five for \$12.50 postpaid

BC 659 FM TRANSCEIVER

27-39 mc. Used, good condition. \$6.95
With tubes. Manuals.....each \$1.00

BC603 FM RECEIVERS

20 - 27 mc. Used, good condition. \$6.95
With tubes. Manuals.....each \$1.00

All items F.O.B. Pasadena. No C.O.D.'s. Remit full amount with order.

C & H SALES CO.

2176 E. Colorado St. - Pasadena 8, Calif.

college grads get ahead faster!

... have higher incomes ... advance more rapidly. Grasp your chance for a better life. Share rewards awaiting college men. Important firms visit campus regularly to employ Tri-State College graduates. Start any quarter. Approved for Vets.

Bachelor of Science degree in 27 months

Complete Radio Engineering courses (TV, UHF, FM, Electronics). Also Mechanical, Civil, Electrical, Chemical, Aeronautical Engineering. In 36-months a B.S. in Business Administration (General Business, Accounting, Motor Transport Management). Superior students faster. More professional class hours. Small classes. Enrollment limited. Beautiful campus. Well-equipped labs. Prep courses. Enter Mar., June, Sept., Jan. Earnest capable students (whose time and budget require accelerated courses and modest costs) are invited to write Jean McCarthy, Dir. Adm., for Catalog and book "Your Career in Engineering and Commerce."



TRI-STATE COLLEGE

1638 College Ave. Angola, Indiana

FM Receiver Conversion for U.S. Satellite Signals

By C. B. HOUSE

U. S. Naval Research Laboratory

An inexpensive FM tuner kit can be adapted to permit monitoring of the 108 mc. amplitude-modulated signals.

IT CAN BE a comparatively easy matter to listen to the telemetered signals from the Lyman-alpha earth satellite on your own FM receiver. The signal which will be transmitted is an amplitude-modulated carrier of 108 mc. frequency, so a method of detecting carrier amplitude variations must be incorporated into the receiver.

If you already own an FM radio or tuner with a ratio detector, it is a simple matter to convert it to an AM detector for the small cost of one resistor and a d.p.d.t. switch. If you do not already own an FM receiver, there are several inexpensive kits on the market which can very easily be converted for satellite listening.

Even though it may be inexpensive, the modern tuner has a great deal of gain. This could be surmised from the practice of manufacturers of quoting figures for quieting with a signal strength of only a few microvolts. A limitation of this type of receiver at small signals is its wide passband which will not cut out the atmospheric or thermal noise as well as the special receivers designed for receiving this signal. On the other hand, noises are

of a much smaller amplitude at the higher frequencies than at the lower broadcast and amateur frequencies. According to calculations, the received signal strength during the closer satellite transits should be large enough to overcome this ambient noise level in most tuners. Naturally a high-gain antenna will improve the reception and extend the range.

The tuner chosen for conversion was one of the most inexpensive of the nationally advertised tuner kits. Others in this same category would probably give equivalent performance and follow the same general principles for conversion. The original tuner circuit incorporating the changes is shown in Fig. 1. The conversion to AM output essentially consists of inserting a 68,000-ohm resistor in series with the rectified output and taking the audio-frequency amplitude variations from the high end of this resistor. The double-pole, double-throw switch enables the detector to be returned to normal FM operation when desired.

The ratio detector is inherently easy to convert from FM to AM detection because the rectifier diodes are in

Fig. 1. Simple modification involving one resistor and a d.p.d.t. switch.

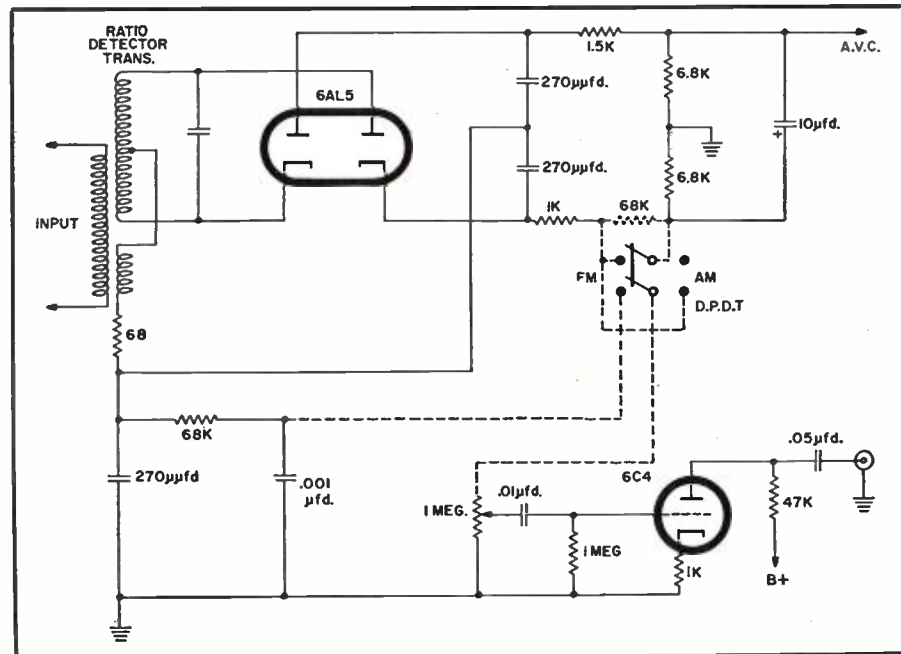

series across the output of the ratio detector transformer secondary and the amplitude variations are normally summed across the two load resistors in parallel with a large capacity. By inserting the 68,000-ohm resistor in series with the rectified output and taking the audio signals from the high end, four aims have been accomplished simultaneously: (1) Most of the signal amplitude variations now appear between the high end of this resistor and ground; (2) the large capacitor is effectively disconnected so that audio-frequency voltages are not filtered out; (3) the a.v.c. is effectively disconnected since the percentage of amplitude variations appearing across the top 6800-ohm resistor is small; and (4) the "Q" of the transformer secondary is increased.

The output from the detector is applied directly to the audio gain potentiometer to eliminate the degeneration of the higher audio frequencies caused by the de-emphasis circuit built into FM receivers. The elimination of this de-emphasis circuit is of considerable importance since the 75 μ sec. time-constant filter causes an attenuation of 17 db at 15 kc. and there will probably be frequency components near this value in the telemetered signal. After conversion of this tuner, recognizable signals were produced with an AM carrier input of a fraction of a microvolt.

The conversion described was made with the ratio detector since this was

used in the tuner purchased. However, the general principles should be applicable to discriminator detectors if one rectifying diode is disconnected and the limiter action disabled.

After conversion of this receiver, the audio enthusiast who possesses a tape recorder will be able to record the telemetered signal from the satellite and compare the changes in tones and burst durations arising from variations in the measured data between successive satellite passages. Also, conditions might arise where events of scientific importance occur when out of range of the regular receiving stations and the recorded information on this event might be of interest to the participating scientists.

Editor's Note: For complete information on the nature of the telemetered signals that are to be transmitted by the U. S. artificial earth satellite, we refer our readers to the article "Receiving U. S. Satellite Signals" by Whitney Matthews which appears in this issue. The article also gives specific information as to how our readers may assist in the scientific program by making their own recordings and observations.

It is presently expected that a number of scientific satellites will be launched in the near future. Therefore from time to time we will be publishing information describing some other methods that may be used to receive the signals that are due to be transmitted.

if surplus electronics can meet your needs,
get it from our new location, 7035 Laurel
Canyon, No. Hollywood, Cal.—the largest,
most extensively stocked electronics warehouse in the world! Send for free
Catalog 116. It is loaded with bargains!

ARROW SALES, INC.
Box 3007-RN No. Hollywood, Calif.

**SCHEMATICS—CONVERSIONS
FOR SURPLUS GEAR**

NEW LIST! MANY ADDITIONS!
Send stamped, self addressed envelope for
List D. Add 25c for chart explaining AN
nomenclature. **DO IT TODAY!**
R. E. BOX 1220
GOODHEART BEVERLY HILLS, CAL.

a TERRIFIC BARGAIN in a

**SOLA CONSTANT-
VOLTAGE
TRANSFORMER**
Ends fluctuating line
voltage!
Big Discount Off ...



the factory price at a 1-input 2,000 VA unit! And here's another bonus! This Air Circs 2,000 VA overstock, Sol-a Cat. No. 30768, has 4 inputs! 90-125 V., 190-250 V., 60 cy. or 50 cy. Isolated secondary is constant 115.0 V. \pm 1% from no-load to full-load of 1.4 amp. So, if you choose, use it as a 220:115 V. step-down. And slash \$97.50 off the factory 1-input price!
Brand new in original wood box.
4 cu. ft. Ship. wt. 254 lbs.
F.O.B. Pasco, Wash., Only. **\$147.50**
THE M. R. COMPANY
P. O. Box 1220-A Beverly Hills, Calif.

FEATURING FAMOUS FACTORY

TUBES

- INDIVIDUALLY BOXED!
- GUARANTEED ONE YEAR!
- FACTORY BOXED
- FACTORY IRREGULARS
- NEW JAN SURPLUS
- EQUIPMENT TUBES

**ALWAYS 1000
TYPES IN STOCK**

EXPORT ORDERS INVITED MANUFACTURERS ORDERS INVITED

**We Are Not Selling Price—
We Sell Only Quality**

Used Tubes, Electrically Perfect Factory Seconds, Brand New Factory Seconds and New and Used Jan Surplus Tubes.

**REMEMBER—You Buy Quality When
You Buy Standard. Quality Never
Shouts—It Always Whispers.**

**Below Is A Partial List—Send For
FREE Complete List and Order Form**

QZ4	42	5AT8	79	6BK7	75	7A4	46	12J5	39
1A7GT	42	5J7	74	6C17GT	57	7A6	44	12SA7	47
183GT	66	5T8	79	6BN6	57	7A7	44	12S67	54
1CSGT	40	5U4G	48	6BQ6GT	79	7A7	44	12SQ7	47
1C7G	25	5V4G	57	6BY5G	57	7AU7	69	12SK7	47
1D5GP	42	5V6GT	49	6BZ7	75	7B4	43	12SL7GT	59
1H4G	48	5X8	44	6C4	36	7B5	36	12SN7GT	44
1J6GT	46	5Y3	38	6CB6	50	7B6	41	12SQ7	39
1L4	45	5Y4G	42	6CD6G	117	7B7	42	12V6GT	44
1L4	44	5Z3	44	6CUG	75	7C4	40	12W6	59
1LA4	55	6A7	56	6D6	47	7C4	40	12X4	36
1LA6	46	6A8	46	6E5	43	7C5	41	14A7	44
1L54	58	6A9	44	6F5	36	7C6	42	14B6	44
1LC5	48	6AC7	66	6F6	37	7C7	44	14C7	44
1LC6	46	6AF4	75	6H6	37	7E5	44	197B	69
1LD5	56	6AG5	49	6J4	59	7E6	44	19B6G6	117
1LE3	56	6AG7	68	6J5	38	7E7	48	25BQ6GT	84
1LH4	63	6AH4G2	69	6J6	48	7F7	58	25CA5	79
1LN5	46	6AH6	70	6K6GT	38	7F8	65	25CD6	129
1NSGT	49	6AK5	63	6K7	53	7G7	74	25C6	99
1R5	50	6ALS	41	6L6	67	7N7	57	25C6U	99
1S5	45	6AM8	79	6M7	59	7O7	58	25L6GT	46
1T4	50	6AN8	79	6O7	79	7X7	64	25W4GT	42
1U4	46	6AQS	45	6S4	39	7Y4	34	25Z6	36
1V2	45	6AS7G	225	6SBGT	70	7Z4	39	27	27
1X2	66	6AT6	38	6SB7Y	75	12A6	40	35B5	49
2A7	49	6AT8	79	6SC7	47	12A85	59	35C5	47
2A7	49	6AU4GT	79	6SC7	49	12A85	59	35L6GT	46
2D21	95	6AUSGT	60	6SH7	42	12AT6	40	35W4	38
3A4	50	6AUG	42	6SJ7	42	12AT7	65	35Y4	38
3A5	50	6AUS	79	6SK7	49	12AUG	42	35Z7	40
3AL5	52	6AV5GT	64	6SL7GT	56	12AU7	58	35Z5GT	38
3AU6	52	6AV6	38	6SN7GT	56	12AV6	41	39/44	25
3B26	57	6AW8	89	6SQ7	40	12AV7	66	50A5	47
3BC5	57	6AX4GT	65	6SS7	40	12AX4GT	64	50B5	47
3BN6	57	6AX5GT	56	6T4	85	12AX7	62	50C5	47
3CB6	57	6BA6	46	6T4	67	12A27	62	50L6GT	44
3Q4	55	6BC5	49	6U5	54	12B4	67	50L6GT	44
3Q5GT	56	6BCE	89	6U8	79	12B6G	45	80	80
3S4	54	6BDSGT	52	6V3	79	12B7	59	84/624	45
3V4	55	6BE6	45	6V6GT	45	12BE6	45	117GT	125
4B07	75	6BF5	39	6W4GT	39	12BH7	59	117N7GT	125
4E27	75	6BGG	117	6WG	52	12CGT	52	117P7GT	125
5AM8	79	6BH6	50	6X4	38	12CA5	59	117Z3	36
5AN8	79	6BJ6	46	6X5	38	12CUG	79	117Z6GT	61
5A95	49	6BK5	67	6X8	74	12DQ6	79		

Bonus TV sets are shipped complete with cabinet and picture tube F.O.B. our warehouse. With slight adjustments and minimum labor they can be restored like new.

Receiving Tubes Sent Parcel Post
FREE! TWO SET COUPLER WITH EVERY TUBE ORDER OF
\$8.50 OR MORE!

FREE POSTAGE! On All Orders Shipped in U. S. A., Territories and A.P.O.'s.
Send 25c for handling on orders under \$5.00. Please send approx. postage on
Canadian and foreign orders. Excess will be refunded.

STANDARD LINE
ELECTRIC COMPANY

432 HARRISON AVENUE, HARRISON, N. J. Phone: HUmboldt 4-4997

POWER SUPPLY KIT BARGAIN

Primary 115V, 60 Cy. Sec. 400-0-400V. @ 200 Ma., 6.3V @ 5 Amp., 5V @ 4 Amp. Std. Mounting, plus 6 Hy, 200 Ma. choke and Two 8 Mfd. Oil Condensers. . . ea. **\$7.25**

STEPPING RELAY

Resettable type. 3 deck 10 position with additional 1A and 1B contact at reset position. Stepping coil 48 VDC. **\$995** ea. 10 for **\$9.50**

OIL CONDENSER BARGAINS

1 Mfd 600 VDC	.25	2 Mfd 2000 VDC	\$1.50
2 Mfd 600 VDC	.45	3 Mfd 2000 VDC	2.75
4 Mfd 600 VDC	.75	15 Mfd 1500 VDC	3.95
8 Mfd 600 VDC	.95	12 Mfd 2500 VDC	4.95
10 Mfd 600 VDC	1.15	6 Mfd 3500 VDC	5.75
25 Mfd 600 VDC	3.40	6 Mfd 2500 VDC	5.25
20 Mfd 600 VDC	2.75	8 Mfd 2500 VDC	5.75
1 Mfd 1000 VDC	.60	2 Mfd 5000 VDC	3.75
2 Mfd 1000 VDC	.75	1 Mfd 3000 VDC	1.85
4 Mfd 1000 VDC	1.25	15 Mfd 2500 VDC	4.95
10 Mfd 1000 VDC	1.75	8 Mfd 3000 VDC	5.75
4 Mfd 1500 VDC	1.75	4 Mfd 4000 VDC	12.75
10 Mfd 1500 VDC	3.75	1 Mfd 5000 VDC	3.25

PANEL METERS

2" METERS		3" METERS	
0-1 Amp	\$2.95	0-100 Micro	\$5.95
0-5 Amp RF	3.95	0-1 Ma DC	4.95
0-10 Ma DC	3.95	0-5 Ma	3.95
0-15 Ma DC	3.95	0-25 Ma DC	3.95
0-100 Ma RF	3.95	0-25 Ma DC	3.95
0-500 Ma	3.95	0-200 Ma DC	3.95
0-120 Ma RF with external Thermo-couple	3.95	0-150 VDC	3.95
0-150 V. AC	3.95	200-0-200 V. DC	3.95
0-300 VAC	3.95	40-0-40 Micro	4.95
-10-0-10	3.95	0-2 Amps DC	3.95
0-15 DC KV 3" with shunt	3.95	0-4 Amps DC	3.95
0-312 KV with shunt	5.95	0-2 Amps RF	4.95
2" Dual scale w/high and low/switch	0-150V DC	0-15 Amps RF	8.95
0-72 V. DC	3.95		
0-500 Ma 4" Fan type	\$5.95		

115 V. 60 CYCLES SELSYNS

High torque BRAND NEW in original wrappings. Made for Bendix Aviation. 2 for \$10.50. Each **\$5.95**

RELAYS

110 V. A.C.—3 pole heavy duty duncro relay, 30 amp. contacts. each **\$4.39**

HEINEMANN CIRCUIT BREAKERS
1 amp., 3 amp., 20 amp. 117 V. 60. **98c**
cyc. A.C.

0-200 MICROAMMETER
2", Mounted in Rubber case with cable. Ea. **\$2.95**

FILAMENT TRANSFORMER
6.3V 10 Amp 115V-60cy Primary— **\$2.19**
Each

G. E. RELAY CONTROL

(Ideal for Model Controls, Etc.)
Contains a sigma midget 8,000 ohm, relay (trips at less than 2 MA), high impedance choke, 91-metal strip, neon lamp and 25 parts. The sensitive relay alone is worth much more than the total low price of. **\$1.10** Each 10 for **\$9.25**

AUTO TRANSFORMER
750 Watt—110/220 V. 60 Cycle. ea. **\$5.95**

ANTENNA RELAY
12 Volt DC, DPDT plus exp. MPST 10 amp contact. Low loss ins. ea. **\$1.39**

BIG BARGAINS IN LITTLE TYPE

Kit of 10 ASSorted SWITCHES	\$1.49
Kit of 10 ARS-TID WAFER SWITCHES	1.49
Kit of 25 WIRE WOUND RES. 5 to 50 watts	1.25
Kit of 10 TRANSMITTING MICAS	1.00
500 MMF CERAMIC CONDENSERS	10 for 1.50
15 WEG 1% METER MULTIPLIER	1 for 1.49
1 MFD 400VDC OIL COND.	10 for 1.95
LINE CORD 8 Ft. w/Molded Plug J518/2/3	for 1.00

Min. Order \$3.00—25% with order F.O.B. New York—10 DAY GUAR. PRICE OF MDSE. ONLY

ADVANCE ELECTRONICS

6 WEST BROADWAY, NEW YORK 7, N. Y.
Phone REctor 2-0270

ENGINEERING DEGREES



E.E. OPTION ELECTRONICS
Earned through Home Study Residence classes also available
(Operating as a College of Engineering only at Present)
5719J Santa Monica Blvd.
Hollywood 38, California

TOPS in the FIELD!

ELEMENTS OF MAGNETIC TAPE RECORDING
by N. M. Haynes—Published by Prentice-Hall, Inc. The book that brings you up-to-date on tape recording. Complete history, theory, design. 392 Pages, 265 Illustrations, 5 1/4" x 9". Only \$7.95 at better book stores or get your autographed copy directly from author. Remit with order please. Book mailed same day. Order from:



AMPLIFIER CORP. of AMERICA 398 Broadway, New York 13, N. Y.

Upgrading the Amplifier

(Continued from page 51)

of changing the plate resistors in two triode stages to a substantially higher value inasmuch as triodes operate in more linear fashion as the plate load resistor is increased. At the same time, the cathode resistors had to be increased to maintain proper grid bias. As a means of keeping noise down, Allen-Bradley 1-watt resistors were employed, although on the basis of heat dissipation 1/2-watt ones would have been more than enough.

Upon checking frequency response of the control unit, it was found that the high end had been adversely affected somewhat, being about 4 db down at 15,000 cps at mid-setting of the volume control, which is the position where the greatest treble losses, due to circuit capacitance, take place. The deterioration resulted from increasing the plate load resistor in the output stage, with a consequent increase in output impedance and greater loss of high frequencies due to cable and other capacitance. (The control unit was built before the days when it became *de rigueur* to employ cathode followers in the output stage.) However, the situation was quickly corrected by using a .02 μfd. instead of a .01 μfd. cathode bypass capacitor at V₁ in Fig. 2. This maintained response flat within 1 db to 15,000 cps.

The final step was to coordinate the input signal level to the control unit and the input signal to the power amplifier. Both units have input level-set controls and the problem of coordinating them is as follows. If the level control of the power amplifier is set high, this has the advantage of requiring less signal from the control unit, which means less distortion produced in the latter. The disadvantage, however, is greater amplification by the power amplifier of noise and hum generated within the control unit. To the extent that the input level set of the power amplifier is turned down to reduce noise and hum from the control unit, the input level of the control unit must be turned up in order to provide adequate drive to the former. The higher the input level setting of the control unit, the more the distortion generated therein.

First the gain control of the control amplifier was rotated to about three-quarters position to represent the maximum volume likely to be used; thus a reasonable volume reserve was maintained for special occasions. The input level-set of the power amplifier was backed down slightly so that the noise and hum heard through the speaker was imperceptible except within a couple feet or so. (Any listening done within a few feet would hardly be with the gain control at an advanced position.) Then the input level-sets of the control amplifier for each source (phono, FM, TV, tape) were adjusted so that, when typical program material

MYSTERY PACKAGE

20 Pounds of ELECTRONIC PARTS
Worth \$40.00
OUR PRICE ONLY
\$3.95
It's Another THRILLING HERSCHEL SURPRISE. 20 pounds of BRAND NEW assorted Govt. Surplus. Perfect gift for Xmas, etc.

SCR-625 Army MINE DETECTOR

For Prospectors, Miners, Oil Companies, Plumbers, etc. An ideal portable unit for locating all types of buried metal objects up to 24" or more, depending on size and ground condition. Detection by means of tone. Packed in a chest. Operating weight approx. 15 lb. Shipping wt. approx. 60 lbs.
OUR PRICE ONLY **\$39.95**

IF Transformer
3 for \$1.00
30 MC. In square aluminum can. Silver slug tenna.

BK 22 RELAY
Containing 22K for meter, 2 Amp. 115V. 60 Hz. 5/8" x 1 1/2" x 1 1/2".
\$2.95

AUDIO CHOKE
60-1ML 4500 OHMS. 15,000 turns of #40 W.G. Steel. 1 1/2" x 1 1/2" x 1 1/2". Ideal for radio control, phono, head, etc.
95¢

BRAND NEW U.S. AIR FORCE B-29 BOMBSIGHT

Cost U.S. Govt. \$25,000.00
YOU PAY **29.50**



INCLUDES:
22H x 13W x 17D STEEL STORAGE CASE with KEY LOCK
• Contains Over 100 • Gyroscopes
• Precision Bearings • Motors • Gears
• Ground Optic Lenses • Switches • Relays
AND THOUSANDS OF OTHER USEFUL PARTS.
SHIPPED ANYWHERE IN U.S.A. FREE!

TERMS: Cash with order or 25% DOWN—BALANCE C.O.D.
ALL PRICES NET F.O.B. DETROIT MINIMUM ORDER \$2.00

HERSHEL RADIO CO.

5245 GRAND RIVER Detroit 8, Michigan
Phone TYler 8-9400

Say you saw it in RADIO & TV NEWS

ORDER by MAIL and SAVE! TV PICTURE TUBES

10BP4	\$ 7.95	17BP4	\$10.95	21AMP4	\$19.95
12LP4	8.95	17CP4	17.00	21ATP4	20.95
14B/CP4	9.95	17GP4	17.60	21AUP4	20.95
16DP4	14.95	17HP4	13.60	21EP4	14.95
16EP4	15.90	17LP4	13.60	21FP4	15.95
16GP4	15.90	17QP4	11.95	21WP4	17.30
16KP4	10.95	17TP4	19.30	21YP4	15.95
16LP4	10.95	19AP4	19.30	21ZP4	14.95
16RP4	10.95	20CP4	13.90	24CP4	23.95
16WP4	15.20	20HP4	17.95	24DP4	26.95
16TP4	10.95	21AP4	22.10	27EP4	39.95
17AVP4	15.20	21ALP4	20.95	27RP4	39.95

27"—6 month guarantee—all others 1 year. Aluminized Tubes \$5.00 more than above prices. These prices are determined to include the return of an acceptable similar tube under vacuum.

ALL PRICES FOB CHICAGO, ILLINOIS. Deposit required. When old tube is not returned, refund at time of return. 25% deposit required on COD shipments. Old tubes must be returned prepaid. We ship anywhere.

WRITE FOR COMPLETE LIST.

— PICTURE TUBE OUTLET —
3032 MILWAUKEE AVE.
CHICAGO 18, ILLINOIS
Dickens 2-2048

GET STARTED IN HI-FI

With Low Cost Compact HI-FI Amplifier Here's superb quality performance at down to earth prices within reach of all. All new components with Amperex tube complement. Complete deluxe pre-assembled HI-QUALITY "clean" 15 watt amplifier kit, fully guaranteed, only \$24.95.
ESSCO-NEW YORK 58 Walker St. N.Y.C. 13, N.Y.

was fed in, the maximum level ordinarily desired was obtained at three-quarter setting of the gain control.

This procedure made it impossible to hear any noise or hum at moderate gain control positions and of course at advanced positions the signal would drown out the increase in noise and hum (chiefly noise). It may be added that the control amplifier is mounted so as to make the level-sets readily accessible for adjustment in the event a very weak signal source is used. In fact, the control amplifier is sufficiently sensitive so that, with input level set full on, a dynamic microphone can be accommodated by any one of the high-level input channels.

The final results can only be determined by ear and it is not too easy to be sure, especially when the equipment was not really poor to begin with. However, particularly when good program material is available, such as a first-rate tape recording or, better yet, live FM, it seems that the reproduction has gained ease and clarity and that listening fatigue has been set back another notch. Whereas the 50-watt comparison amplifier had a definite edge before the changes, afterward the Williamson seemed at least as clean. It was not feasible, with the efficient speaker system used, to introduce levels into the listening room where the superior power capacity of the 50-watt made a difference, as it would of course under outdoor, auditorium, or other large-area conditions at realistic levels of reproduction.

-30-

LOW-LEVEL AUDIO DISTORTION

By JAMES A. McROBERTS

PERFORMANCE of the DeWald Model K-701 was satisfactory during loud music and speech passages but was distorted on low levels of sound.

This effect was due to the nonlinearity of the transistor characteristic curves at low input levels. This necessitates emitter bias in addition to base bias to correct.

The 12-ohm resistor in the circuit, see partial schematic below, accomplishes this. The 12 ohms was insufficient in this particular application so a 2.7-ohm resistor was added in series to increase the emitter-to-ground resistance and emitter bias. This corrected the trouble.

-30-

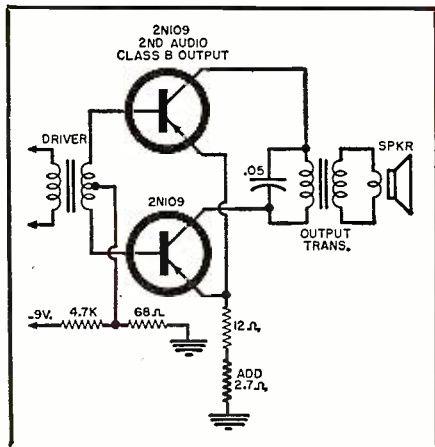

March, 1958

HERE'S HOW TO HAVE A HIGH AND STEADY Income...

Wherever you go, look for the fixed and mobile antennas of commercial and public-safety 2-way radios. These equipments must have periodic, competent maintenance—which means regular income to qualified servicemen. Much of this work is done by independent shops on a term-contract basis.

To learn about rates . . . typical contracts . . . and take-home pay . . . send for free booklet "HOW TO MAKE MONEY IN MOBILE-RADIO MAINTENANCE."

MAIL COUPON TODAY!

LAMPKIN LABORATORIES, INC.
MFM Division, Bradenton, Florida

At no obligation, please send me free booklet, technical data on Lampkin meters, and time-payment plan details.

Name _____
Address _____
City _____ State _____

Your present test equipment and those two Lampkin meters—plus 2nd class commercial license—are sufficient to get started.

Lampkin 105-B Frequency Meter.
Range 0.1 to 175 MC
and up. Price
\$220.00 net.



Lampkin 205-A FM Modulation Meter.
Range 25 to 500 MC.
Price \$240.00 net.



TIME PAYMENT PLAN AVAILABLE

LAMPKIN LABORATORIES, INC.
MFM Division
BRADENTON, FLORIDA

ROUND, SQUARE, KEY and "D" OPENINGS QUICKLY MADE with Greenlee Radio Chassis Punches

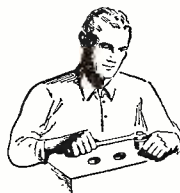

Save hours of hard, tedious work . . . cut accurate holes in chassis for sockets, plugs, controls, meters, panel lights, etc. with GREENLEE Punches. In 1-1/2 minutes or less make a smooth hole in metal, bakelite or hard rubber. Easy to operate . . . simply turn with ordinary wrench. Wide range of sizes. Write for details. Greenlee Tool Co., 1883 Columbia Avenue, Rockford, Ill.



LEARN

Television
RADIO-COLOR-TV
Electricity
ELECTRONICS
IN THE GREAT SHOPS OF COYNE

TRAIN QUICKLY! OLDEST, BEST EQUIPPED SCHOOL of ITS KIND in U.S.

Veterans and Non-Veterans—Get practical training in top opportunity fields. Prepare now for a better job and a real future. Advanced education or previous experience not needed. Employment service to graduates.

Enroll NOW—Pay Later

Finance Plan and Easy Payment Plan. Also Part Time Employment help for students. Training in Refrigeration and Electric Appliances can be included.

FREE BOOK Clip coupon for Big Free Illustrated Book. No obligation and No Salesman Will Call. Act NOW.

B. W. COOKE, Jr., President

COYNE Electrical School
500 S. Paulina St., Chicago 12, Ill. Dept. 38-6C
Established 1899
Dept. 38-6C

B. W. COOKE, Jr., Pres.
COYNE Electrical School
500 S. Paulina St., Chicago 12, Ill. Dept. 38-6C

Send FREE BOOK and full details on:
 TELEVISION-RADIO
 ELECTRICITY-ELECTRONICS

NAME _____
ADDRESS _____
CITY _____ STATE _____

BUILD 16 RADIO

CIRCUITS AT HOME WITH THE NEW DELUXE 1958 PROGRESSIVE RADIO "EDU-KIT"

Reg. U. Pat. Off.



A Practical Home Radio Course ONLY \$22.95

FREE: Set of Tools, Soldering Iron, Tester, Membership in Radio-TV Club; Consultation Service, TV, Radio, Hi-Fi, Quiz-Books, FCC Amateur License Training, Valuable Discount Card, Certificate of Merit.

The "Edu-Kit" offers you an outstanding PRACTICAL HOME RADIO COURSE at a rock-bottom price. You will learn radio theory, construction and servicing. You will learn to build radios, solder and wire in a professional manner, trouble-shoot radios. You will build 16 Receiver, Transmitter, Code Oscillator, Signal Tracer and Signal Injector circuits, and learn how to operate them. You will receive an excellent background for TV. In brief, you will receive a basic education in Electronics and Radio, worth many times the small price you pay.

You will receive all parts, tools and instructions necessary to build 16 different radio and electronic circuits, each guaranteed to operate. Our kits contain tubes, tube sockets, variable, electrolytic and paper dielectric condensers, resistors, tie strips, coils, hard-wire, tubing, punched metal chassis, Instruction Manuals, etc. You also receive a useful set of tools, a professional electric soldering iron, and a self-powered dynamic Radio and Electronics Tester. The "Edu-Kit" also includes Code Instructions and the Progressive Code Oscillator. You will also receive lessons for servicing with the Progressive Signal Tracer and the Progressive Signal Injector, TV, Radio, Hi-Fi and Quiz Books, FCC Amateur License Training. These sets operate on your regular AC or DC house current.

All parts, components, etc. of the "Edu-Kit" are 100% unconditionally guaranteed, brand new, carefully selected, tested and matched. Everything is yours to keep. The complete price of this practical home radio and electronics course is only \$22.95. Sold only by Progressive "Edu-Kits."

You will learn to trouble-shoot and service radios, using the professional Signal Tracer, the unique Signal Injector, and the dynamic Radio and Electronics Tester. Our Consultation Service will help you with any technical problems.

J. Stasaitis, of 25 Poplar Pl., Waterbury, Conn., writes: "I have repaired several sets for my friends and made money. The 'Edu-Kit' paid for itself. I was ready to spend \$240 for a Course, but I found your ad and technical problems."

PROGRESSIVE "EDU-KITS" INC.

497 UNION AVE., DEPT. 75-E, BROOKLYN 11, N. Y.

UNCONDITIONAL MONEY-BACK GUARANTEE

- I enclose full payment of \$22.95 for "Edu-Kit" sent postpaid.
- I will pay postman \$22.95 plus postage for "Edu-Kit" sent COD.
- Rush me FREE literature concerning "Edu-Kit."

NAME _____
ADDRESS _____

Verado Trav-Electric MOBILE POWER CONVERTERS

Give You **110 A.C. HOUSE CURRENT ANYWHERE** You Drive or Cruise

LIST
For 6 and 12 Volt Car Batteries — Capacities: 15 to 200 Watts **\$12.95 UP**

NO INSTALLATION
Just plug into cigar lighter on dash of car, truck, or boat—*and* away we go

- OPERATE PORTABLE TV, PORTABLE TV
 - SMALL DO-IT-YOURSELF
 - TOOLS WHEREVER NEEDED
- One of the great conveniences of our electronic age

101 USES

ALL ELECTRIC SHAVERS DO-IT-YOURSELF HOBBY TOOLS
See Your Electronic Parts Dealer or Jobber

Verado COMPANY
DESIGNERS & MFRS. OF ELECTRONIC EQUIPMENT SINCE 1927
1058 RAYMOND AVE., ST. PAUL 14, MINNESOTA
IN CANADA: ATLAS RADIO CORPORATION LTD. - ONTARIO



Sales Aids

TV TUBES
"hi-fi" DYNAMIC
HIGH FIDELITY FOR LESS

GARGANTUAN "NIPPER"

The newest addition to the Albany, N. Y. skyline is a four-ton, 25½-foot high statue of "Nipper," the RCA Victor dog trademark which stands atop



the new four-story warehouse-office of R.T.A. Distributors, Inc., the RCA distributor in the area.

Built by W. L. Stenagaard & Associates, Inc. of Chicago, the statue is reputed to be the largest of its kind in the world. It has a skeleton of steel joists, angle irons, and steel rods covered with wire mesh. The "skin" consists of several layers of glass fiber composition covered with a coating of pigmented resin. The dog can be seen for a distance of five miles and an airline warning light on the right ear serves as a guide for pilots.

SARKES TARZIAN "KIT-PAKS"

The Rectifier Division of Sarkes Tarzian, Inc., Bloomington, Ind. is merchandising two of its most popular silicon rectifiers in eye-catching "Kit-Paks."

Twenty M-500 conversion kits for television or twenty M-150 replacement kits (for radio) are packed in a three-color display carton which is easily



spotted on the jobber's shelf. The individual clear plastic kits have been completely redesigned for better product visibility and compactness.

Electrical ratings are plainly shown on the display cartons and complete installation data and ratings are included in each kit. Service technicians who have been using these two silicon rectifier types as replacements in tele-

BE QUALITY WISE... BUY QUAL-KITS!



HI-FI AMP. KIT
Complete 6 tube-10 watt amplifier. Push-pull beam power output, built-in pre-amp. 5 position selector switch, 3 position record equalization, LP, RIAA, Eur. Response ½ db. 20-20,000 cps. Output 10 watts at less than 2% 1M. Low noise level and harmonic distortion. **\$28.50**

Every kit complete with 28 page fully illustrated instruction and assembly manual. Cover and legs optional.



HI-FI AM-FM TUNER KIT
Advanced 7 tube circuit plus Rectifier for full sensitivity and selectivity. Distortion less than 1%. Sensitivity is 5 uv for 30 db quieting on FM, 25 uv AM. Armstrong FM Circuit with limiter. Foster-Seeley Discriminator. 20-20,000 cps response. Full AFC control — no drift. Easy assembly. **\$28.95**

Add 10% Fed. Tax Write for FREE catalog and name of nearest dealer carrying these remarkable units.

QUALITY-ELECTRONICS

319 Church St. Dept. T-3, New York 13, N. Y.

MINIATURE TRANSFORMER
can be used as MIKE Transformer
TRANSISTOR Transformer
S.S.B. Transformer

98¢ EA. • 3 FOR \$275
100 FOR \$750.00 GOVT. COST \$14.00 EACH

250-2500 CPS

GOVT. SURPLUS
JAN PORTABLE BATTERY TUBE
1U4 Mfg. by R.C.A.
TUNG-SOL, SYLVANIA

EACH ONE IND. BOXED BRAND NEW

3 FOR \$100 • SEALED BOX OF 200 \$50.00

DEALERS INQUIRIES INVITED

RADIO RECEIVER
FREQ. 2 to 6 MC
2 BANDS. 3.2 OHMS OUTPUT IMPED.
12 OR 24 VDC. 7 3/8 x 12 1/2 x 14 5/16

OUR PRICE \$2995 EA. • GOVT. COST \$42700

TERMS: 25% DEPOSIT WITH ORDER, BALANCE C.O.D., ALL MERCHANDISE GUARANTEED F.O.B. BUFFALO, N.Y.

SPARKS RADIO SUPPLY
194 GENESEE ST., BUFFALO 3, N. Y.

TAPE RECORDERS
WHOLESALE PRICES
HI-FI COMPONENTS
NATIONAL BRANDS
WRITE FOR FREE CATALOGUE

CARSTON 215-RD E. 88 ST.
NEW YORK 28, N. Y.

ENGINEERING B.S. DEGREE IN 27 MONTHS

Prepare for unlimited opportunities of the Electronic Age! Earn your B.S. DEGREE IN 27 MONTHS in Aeronautical, Chemical, Civil, Electrical or Mechanical Engineering; in 36 MONTHS in Mathematics, Chemistry, Physics. Intensive, specialized courses. Comprehensive training in electronics, television, advanced radio theory and design, math, nuclear physics and electronic engineering. Engineering Science preparatory courses. Low rate. Graduates in demand. Spacious campus; 20 bldgs., dorms, gym, playing field. Earn part of your expenses in Fort Wayne while studying. G.I. approved. Enter March, June, Sept., Dec. Catalog.

INDIANA TECHNICAL COLLEGE

938 E. Washington Blvd., Fort Wayne 2, Indiana
Please send me free information on B.S. ENGINEERING DEGREE IN 27 MONTHS as checked.

Electronics Chemical Aeronautical
 Civil Mechanical Electrical

B.S. DEGREE IN 36 MO. IN Math. Chem. Physics

Name _____
Address _____

vision sets, radios, and electronic equipment will find it practical to buy them by the carton.

* * *

ATR'S "SILENT SALESMEN"

American Television & Radio Company, 300 E. 4th St., St. Paul 1, Minn. is now offering two unique "Silent Salesmen" racks which have been especially designed to display the firm's battery chargers and inverters to best advantage.

The racks, which are made of heavy-gauge steel wire, stand 5-feet, 6-inches high and take up no more than 4 square feet of floor space. They are light and portable and when empty can be folded and moved from one location to another with ease. The top of the racks have suitable product identification to tie in with whichever of the firm's products is being featured.

* * *

PACKAGING FOR AUTOMATION

International Resistance Co., 401 N. Broad St., Philadelphia 8, Pa. has developed a new method of packaging its fixed composition resistors to facilitate automatic assembly operations in manufacturing plants.

A flexible strip holds the resistors

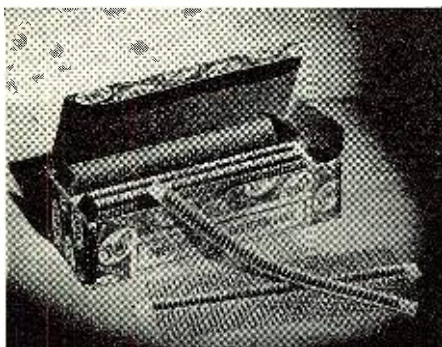

securely in place, equally spaced, and at right angles to the strip. A cutting machine can be used to trim leads on the strip without displacement of the units. Leads cannot be bent when withdrawing the strips from their box nor can the units be accidentally dislodged by twisting, inversion, flexing, etc.

At the present the "Grid Strip" packaging is being used for Type BTS 1/2-watt fixed composition resistors. Other value units may be offered to manufacturers at a later date.

* * *

NEW RAY-O-VAC PACKAGING

Ray-O-Vac Company, Madison 10, Wisc. has adopted a new integrated product and packaging design program for its entire line of lighting type batteries.

The company's trademark with red cloud, yellow background, and blue upswung panel has been simplified for a cleaner, fresher, "straight line" design with more merchandising appeal.

To complement the new trademark design, the company has adopted a complete color packaging design for the line. This includes a new retail display carton, dealer unit pack, and an outer standard shipper.

-30-



LEO I. MEYERSON
W8GFQ

Leo says: **Buy Your New Heavyweight Champ**
from **World Radio Laboratories!**

"The World's Largest Distributor of Amateur Radio Equipment"

hallicrafters'

SX-101

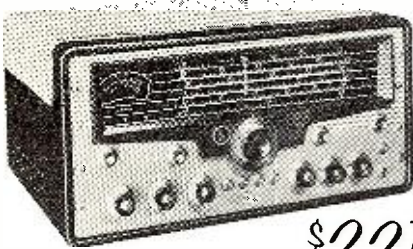

\$39.50 Down **\$2270** per mo.

Rugged is the word for the SX-101 receiver — and it's all amateur! Heaviest chassis in the industry. Full gear drive. Complete coverage of 7 bands: 160; 80, 40, 20, 15, 11 — 10 meters. Special 10 mc. pos. for WWV. Tee-notch filter. S-meter functions with A.V.C. off. Selectable side band Model SX-101 — \$395.00 amateur net.

New, Improved WRL Transmitters

- Globe Chief 90A Kit \$59.95; \$5.00 per mo.
- Globe Scout 680A \$119.95; \$9.90 per mo.
- Globe Champion 300A \$495.00;
\$28.47 per mo.
- Globe King 500C \$795.00; \$45.72 per mo.

Other Hallicrafters In Stock

- SX-99 \$149.95; \$12.94 per mo.
- SX-100 \$295.00; \$16.97 per mo.
- HT-32 \$675.00; \$38.82 per mo.
- HT-33 \$775.00; \$44.57 per mo.

Only **10%** Down

Dear Leo: Please send your latest catalog . . . and more information on Hallicrafters, WRL Transmitters!



NAME: _____
ADDRESS: _____
CITY & STATE: _____ RTV/3

BUILDING A HI-FI SYSTEM?

Send Us Your List Of Components For A Package Quotation

WE WON'T BE UNDERSOLD!

All merchandise is brand new, factory fresh & guaranteed. 20% deposit is required. Balance COD.

AIREX RADIO CORPORATION

64 Cortlandt St., N. Y. 7, CO 7-2137

PARTIAL LIST OF BRANDS IN STOCK

- Altec Lansing
- Electrovoice
- Jensen
- University
- AR • GE • VM
- Janszen
- Wharfedale
- Viking
- Concertone
- Bell • Lee
- Crown Prince
- Harman—Kardon
- Eico • Pilot
- Sherwood
- Acrosound
- Fisher
- Bogen
- Dynakit
- H. H. Scott
- Pentron
- Ampro
- Revere
- Wollensack
- Garrard
- Miracord
- Webster
- Collaro
- Thorens
- Rek-O-Kut
- Norelco
- Fairchild
- Pickering

Full Line of Cabinets



FIX OLD RADIOS IN A JIFFY!

Fix 'em good as new . . . without lost time or needless testing

Often it takes more time than it's worth to fix old radios . . . but NOT when you own this 3 1/2 pound, 744-page GIBRARDI RADIO TROUBLESHOOTER'S HANDBOOK! The only service guide of its kind still in print! Gives common trouble symptoms and remedies for over 4,800 old-time receiver models made by 202 manufacturers prior to 1942—also auto radios. Even beginners can use it to repair old sets that might otherwise be thrown away because service data is lacking or because testing takes too long.

CUTS SERVICE TIME IN HALF

This famous Handbook more than pays for itself the first time you use it. Covers 85% of the things that are apt to go wrong. Shows exactly where the trouble is likely to be. Explains step by step how to fix it without lost time or useless testing. Gives full service details on old sets made by Airline, Apex, Arvin, Atwater Kent, Belmont, Bosch, Brunswick, Clarion, Crosley, Emerson, Fada, G-E, Kolster, Majestic, Motorola, Philco, Pilot, RCA, Silvertone, Sparton, Stromberg and dozens more. Includes hundreds of pages of old tube, transformer and other component data.

10 DAY FREE EXAMINATION

Dept. RN-38, RINEHART & CO., Inc. 232 Madison Avenue, New York 16, N. Y.

Send RADIO TROUBLESHOOTER'S HANDBOOK for 10-day examination. If I decide to keep book, I will then send \$6.95 plus postage. Otherwise, I will return book promptly and owe you nothing. (SAVE! Send \$6.95 with order and we pay postage. Same 10-day return privilege with money refunded.)

Name _____
Address _____
City, Zone, State, _____
OUTSIDE U.S.A.—Price \$7.45 cash with order only. Money back if you return book in 10 days.

Save time — Step up efficiency in ELECTRONICS DESIGN

Here's a wealth of technical help for efficiently handling electronics design problems—help that gives you answers already worked out by the country's top electronics men!—help that can save you hours of research and experimentation!

You'll find electronics mathematics and theory in concise form—design practices for hundreds of pieces of electronics equipment—and even the results of advanced electronic experiments. Radio, television, facsimile, sound, and scores of other phases of electronics are covered—and it's all condensed, classified, and indexed for quick, easy use.

ELECTRONICS DESIGN LIBRARY

Edited by Markus and Zeluff, *Electronics Magazine*
4 vols., 2151 pp., 9 x 12, 3534 illustrations

Contains 1083 articles culled from recent issues of *Electronics*—the cream of information essential to design of electronics equipment.

Special price
saves you \$6.00

Regular catalogue price of books totals \$39.00; under this offer, price is only \$33.00, on easy terms.

The 4 big volumes are: *Electronics for Engineers*, *Handbook of Industrial Electronic Circuits*, *Electronics Manual for Radio Engineers*, and *Electronics for Communication Engineers*.

EASY TERMS!

10 DAYS' FREE EXAMINATION

McGraw-Hill Book Co., Inc., Dept. RTN-3
330 West 42nd Street, New York 36, N. Y.

Send me for 10 days' examination the ELECTRONICS DESIGN LIBRARY. In 10 days I will remit \$8.00, plus few cents delivery, then \$5.00 a month until \$33.00 is paid. If not satisfied, I will return books postpaid. (We pay delivery if you remit with this coupon; same return privilege.)

(PRINT)

Name

Address

City Zone State

Company

Position

For price and terms outside U.S. write McGraw-Hill Int'l., N.Y.C. RTN-3

New Isotronic Training Method

LEARN TV REPAIR IN ONE SHORT WEEK!

Now, after 5 year's research—a streamlined training system that *obsoletes all others!* In just 7 days you may earn \$150 weekly, without paying up to \$250 for training, studying long months! Developed by electronic scientists in cooperation with major TV mfr's., the new Isotronic method is the most practical ever devised! For conclusive proof, write for details and FREE SAMPLE LESSON. Use it on your own set or a friend's—repair it—convince yourself you can make big money immediately in your own TV business! Hurry—Free Lesson supply limited. Write: Electronic Engineering Co., Dept. B-763, 1038 So. La Brea, Los Angeles 19, Calif.

ELECTRONICS

PREPARE FOR A GOOD JOB!
BROADCAST ENGINEER
RADIO SERVICING AUTOMATION

TELEVISION SERVICING
BLACK & WHITE—COLOR

APPROVED FOR VETERANS AND SURVIVORS
OF VETERANS
BUILDING AIR CONDITIONED
SEND FOR FREE LITERATURE

BALTIMORE TECHNICAL INSTITUTE
1425 EUTAW PLACE, BALTIMORE 17, MD.

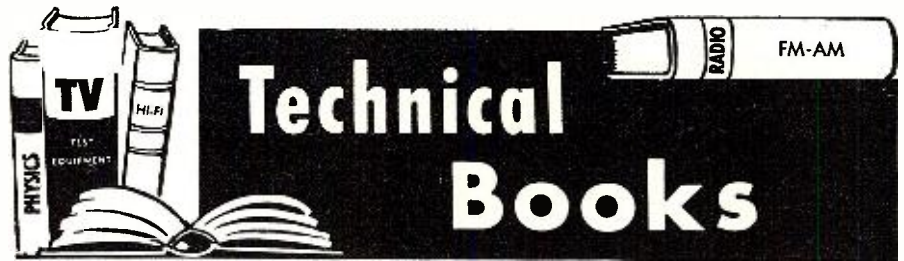

"ELEMENTS OF TAPE RECORDER CIRCUITS" by Herman Birstein & Henry C. Pollak. Published by *Gernsback Library, Inc.*, New York. 216 pages. Price \$2.90. Soft cover.

This is not an operator's manual for home tape recorders but rather an analysis of the circuitry that goes into such devices and a handbook of features and components which make up tape recorders suitable for home use. The audiophile with some electronic background as well as the service technician will find this manual helpful. Of special value and importance is the fairly extensive treatment of the subject of equalization requirements and circuits. The care with which this section particularly was prepared along with the amount of useful material included make this portion alone worth the entire price of the book.

The text is divided into ten chapters dealing with the elements of a tape recorder, characteristics of a quality unit, head characteristics, tape characteristics, bias current, equalization requirements, equalization circuits, oscillators, record-level indicators, and how to minimize noise and hum.

The text material is amplified by the lavish use of line drawings, graphs, schematics, and photographs of commercial units. A working knowledge of simple algebra would be helpful but is not entirely necessary for understanding of the text material.

* * *

"INDUSTRIAL ELECTRONICS HANDBOOK" by R. Kretzmann. Published by *Philosophical Library*, New York. 296 pages. Price \$12.00. Second Edition.

This is a basic reference text written especially for design engineers, maintenance technicians, and engineering students. In this second edition, the material included in the earlier volume has been revised, amplified, and brought up-to-date.

The first half of the volume is devoted to a thorough discussion of the principles and properties of the various classes of electronic tubes, together with typical applications and circuits. The balance of the volume is divided into separate chapters dealing with the main types of application, *i. e.*, electronic relays, counting circuits, timers, industrial rectifiers, dimmers, speed and temperature controls, resistance welding controls, motor controls, inductive and capacitive heating, and special purpose devices.

Data on some of the *Philips* industrial tubes, a subject matter index, and a bibliography complete the text. A working knowledge of math at the col-

lege level is prerequisite to an understanding of this text.

* * *

"SOUND" by Dr. Alexander Efron. Published by *John F. Rider Publisher, Inc.*, New York. 69 pages. Price \$1.25.

This volume is another in the "Basic Science Series" being issued by *Rider* for the benefit of students, the study-at-home group, and those interested in elementary data on scientific subjects.

Written by the chairman of the physics department of one of New York City's largest high schools, this volume covers hearing, speech, and music, with a full discussion of the wave nature of sound. The physics of sound, including such topics as sources of sound energy, the ear, perception of pitch, loudness, quality, standing waves, interference, and resonance, are also covered.

The text material is lavishly illustrated by line drawings, photographs, graphs, and charts.

* * *

"TECHNIQUES OF MAGNETIC RECORDING" by Joel Tall. Published by *The Macmillan Company*, New York. 453 pages. Price \$7.95.

This book is for those in any field where magnetic recording is or can be used to advantage. The author outlines and suggests many uses for this versatile equipment, devoting whole chapters to specialized applications requiring unusual techniques.

The entire volume is divided into twenty chapters which cover the historical and modern development of magnetic recording, theory, recording media, drive mechanisms, erasing, fundamentals of recording, recording sound in nature (written by Dr. Peter P. Kellogg of Cornell University), maintenance of tape recorders, spurious printing, editing, re-recording and copying techniques, radio broadcasting practice, motion picture and television techniques, information recording, magnetic recording in the medical field, magnetic recording in education; home uses and telephone recording; entertainment, advertising, and warning methods; legal uses and their limitations, and communication applications.

* * *

"HOW TO READ SCHEMATIC DIAGRAMS" by David Mark. Published by *John F. Rider Publisher, Inc.*, New York. 145 pages. Price \$3.50.

From the number of requests received by this magazine for pictorial wiring diagrams on equipment whose schematics have appeared in articles, it is a safe guess that there are a number of persons interested in electronics who haven't mastered the technique of

BOGEN

* The Ultimate in High Fidelity!

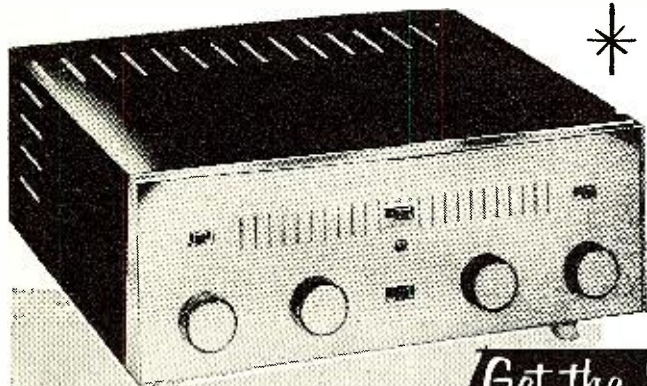

BOGEN DB-115
15 WATT AMPLIFIER
\$79⁹⁵ less enclosure
Stock No. AM-42
See below for Enclosure prices.

Designed to meet the needs of critical audiophiles who want a versatile 15-watt amplifier with extremely low distortion. Delivers full power at less than 1/2% distortion; frequency response 15 to 30,000 cycles. Equipped with built-in preamp and equalized inputs for tuner, tape recorder, television and all phonos with magnetic, ceramic or crystal cartridges.

Equipped with separate bass and treble controls, 3-position record equalizer, 3-position loudness contour selector, separate "hiss" and "rumble" filters and volume control. Has built-in 3-position Speaker Selection Switch for selecting either or both of two Speakers with automatic impedance match. Shown with mahogany finished metal enclosure but amplifier is sold less enclosure. Size 11 3/4" x 10 1/4" x 4 1/4". Operates on 115 volt 60 cy. AC. Shipping weight 16 lb.

Get the Smart, Trim Package... Save \$53³⁸

OLSON

... has combined the fine Bogen DB-115 amplifier, the University UXC-122 Diffaxial speaker in the University enclosure, the famous New Collaro RC-440 4-speed Automatic Changer and the Fairchild Micradjust 225A diamond cartridge. You save \$53.38 by ordering from Olson. Every unit is brand new, latest 1958 merchandise and comes to you in original factory sealed cartons.

Individual components may be ordered separately. Every unit is fully guaranteed by the manufacturer and Olson.

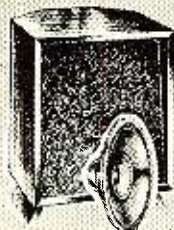

UNIVERSITY UXC-122

Diffaxial Speaker System

Employs the famous "Folded-Horn" design. Engineered by University to deliver maximum fidelity and realism. Constructed of heavy 3/4" wood and braced internally. For corner or wall use. Beautiful hand rubbed mahogany finish.

The University Speaker employed is the approved 12" Diffaxial with the Diffuscone high-frequency element, 1000 cycle crossover. Mid-range and treble notes are extended. Low frequencies are reproduced by a woofer diaphragm. Superb reproduction across entire audio range. 25 watts output. Magnet is full pound Alnico V. 8-16 ohms. Size 21" high, 15-1/2" wide, 12-1/2" deep. Shipping weight 31 lbs.

\$74.97

Stock No. S-308

FAIRCHILD 225A MICRADJUST CARTRIDGE



Perfect for Collaro changer but designed for all changers. Professional moving coil type. Miniature only 1-1/8" x 3/4" x 7/16". Response 20—20,000 cps. Output 5 millivolts. Equipped with genuine hand polished 1 mil diamond stylus for LP records.

\$37.50

Stock No. XC-65

SPECIAL—Collaro RC-440 Changer with Fairchild 225A diamond cartridge. Regular \$78.17 Value. \$62.00

for both
Olson's Stock No. RP-124



COLLARO RC-440

4 Speed Automatic Changer

The famous "Made-in-England" Coronation series 4-speed record changer featuring fully automatic intermixing of 7", 10" and 12" records. Pick-up arm equipped with plug-in head and takes all standard cartridges. Motor shaft polished to .000006" precision. Automatic muting switch during change cycle. 4 pole shaded pole motor. Heavy rim-weighted turntable, removable rubber turntable mat, reject lever, automatic shut-off after last record. Plays all 16-2/3, 33-1/3, 45 and 78 RPM discs. Handsome Maroon and Gold finish; Size 12 x 13-1/2; requires 5" above and 2-3/4" below mounting board. Operates on 110-120 volts AC, 60 cycle. Shipping weight 15 lbs.

\$40.67

Stock No. RP-110

Less Base and Cartridge—See below

rubber turntable mat, reject lever, automatic shut-off after last record. Plays all 16-2/3, 33-1/3, 45 and 78 RPM discs. Handsome Maroon and Gold finish; Size 12 x 13-1/2; requires 5" above and 2-3/4" below mounting board. Operates on 110-120 volts AC, 60 cycle. Shipping weight 15 lbs.

- Bogen DB115 Amp.
- University Speaker and Enclosure
- Collaro Changer w/Diamond Cart.

OLSON PRICE ONLY

\$179¹

Order Stock No. A5-320

Send For FREE Olson Catalog

Thousands of terrific bargains in Hi-Fi, TV, Electronics. Great values in Nationally advertised brands for the Ham, Equipment builder, Engineer, Tinkerer, Serviceman and Hobbyist. SAVE MONEY! Send for your free copy today.

See and Hear... Every unit shown, plus the complete Bogen line is available at any one of our seven stores listed below. Come in soon and thrill to the tone of Bogen's new Amplifiers. Hear Tonal quality that defies description.

AKRON—73 E. Mill St.

CHICAGO—4101 Milwaukee Ave.

PITTSBURGH—5918 Penn Ave.

CHICAGO—123 N. Western Ave.

MILWAUKEE—423 W. Michigan

CLEVELAND—2020 Euclid Ave.

BUFFALO—711 Main Street

BOGEN R-260 AM-FM TUNER



Stock No. AM-43

\$89⁹⁵

less enclosure

See right for enclosure prices.

Companion tuner to Bogen DB-115. Matches in appearance. Can also be used on any other type of amplifier. The Bogen R-260 Tuner features sensitivity and selectivity never before possible. Easy to tune. Stations pop in loud and clear. Just spin the flywheel driven knob and the lighted dial pointer fits across the calibrated panel.

Equipped with built-in antennas for both AM and FM band, however, outdoor antenna can be employed. Other features include Automatic Frequency Control and Automatic Volume Control which prevent overloading on strong signals and boosting on weak signals. Has 7 tubes plus rectifier.

Shown above with mahogany finished metal enclosure but Tuner is sold less enclosure. Size 11 3/4" x 10 1/4" x 4 1/8". Operates on 115 volts AC, 60 cycles. Shipping weight 12 lbs.

ACCESSORIES FOR YOUR HI-FI SYSTEM

AMPLIFIER ENCLOSURE

Mahogany finished, fits both Bogen DB-115 amplifier and R-260 tuner. Olson's Stock No. CA-38..... **\$7.00**

CHANGER BASE FOR COLLARO

Olson's Stock No. CA-59..... **\$4.07**

45 RPM SPINDLE ADAPTER

To Play 45 RPM Discs. Olson's Stock No. RP-109... **\$3.23**

RECORD STATIC CLEANER CLOTH

Silicon treated, protects records. Olson's Stock No. RP-51. **\$1.00**
Each 39¢—3 for.....

POLY SLEEVES FOR 12" RECORDS

Heavy plastic, Round Bottoms. Protects records. Olson's Stock No. RP-104. **88¢**
3 pkgs. for \$2.50—pkg. of 12....

RECORD CHANGER COVER

Heavy transparent plastic. Fits all changers. Olson's Stock No. RP-28... **\$1.29**

IT'S EASY TO ORDER FROM OLSON'S

MAIL ORDERS TO AKRON, OHIO

How to order: Order directly from this ad. For convenience, use this order blank. Fill in columns below with quantity desired, stock number, description, and price. You may send remittance with order (include enough for postage or parcel post shipment), or if you prefer SEND NO MONEY. Olson will ship C.O.D. and you may pay mail or expressman for merchandise and postage.

MONEY BACK GUARANTEE: Everything you order from Olson is guaranteed as advertised. If you are not more than satisfied, you may return merchandise for cash refund.

Quan.	Stock Number	DESCRIPTION	Price Each	TOTAL
<i>1 Free Olson Catalog—</i>				
			T-38	Total
				Add Postage
				TOTAL AMOUNT
NAME _____		CITY _____		STATE _____
ADDRESS _____		ZONE _____		

Olson Radio Warehouse

T-38 FORGE ST.
AKRON 8, OHIO

HQ for the 5 TOP QUALITY brands of

UBES

AT SENSIBLE PRICES!

- Individually Boxed • First Quality Only
- WRITE FOR LATEST TUBE CATALOG FREE!
- We stock over 1000 types including Diodes, Transistors, transmitting and Special Purpose types.

2-COLOR TUBE CARTONS

Keeps your tube stock neat. New safety partition prevents tube breakage. Distinctively lithographed in glossy red and black. The most distinctive tube carton available today. Minimum quantity: 100 of any one size. Write for case lot prices. Packed 1000 to case. F.O.B. N. Y. C.

SIZE For Tube Per 1000
 Miniature . . . 6AU6, etc. . . \$1.00
 GT . . . 6SN7, etc. . . 1.25
 Large GT . . . 123, etc. . . 1.50
 Large G . . . 5U4G, etc. . . 2.00

WHITE GLOSSY BOXES

Completely blank. No printing or color. Otherwise same as above. Same high quality, same low prices. Specify "WHITE" when ordering. When color is not stated, 2 color cartons will be shipped.



Equipment and Component Specials

- Sub-Min. Multi-Matching Xfmr—22K CT to 5200 ohms CT and/or 600 ohms CT. Used as phasing xfmr in SSB phone-patch or low level use. Size 1 1/2"x7/8" sq. Herm. sealed response: 250 to 2500 CPS @ \$1.35 ea. 10 for \$10.00.
- GE R.F. Ammeter—0-4 Amps. R.F. with built-in thermocouple—2" round, \$3.95.
- Zealco Nite Eye—Turns lights, etc., on at nite, off at dawn—complete, ready to plug-in—Model 611—\$10.50.
- Deluxe 866A Filament Xfmr—New, boxed. Pri:115-tapped 50/60 cycles—2.5 volts @ 10 amps. 12,000 volts test. Compact—Herm. sealed—\$3.95.
- Hallcraft 4" Square "S" Meter—Calibrated in "S" units and microvolts—New—\$4.95.
- 1 1/2" Meters—Brand new. Modern Square shape . . . 0-1 ma. \$3.95—0-100 microamps \$4.95.
- RCA or Hytron Jan Boxed 837 tubes @ \$1.25 each—10 for \$10.00. 807—\$1.00—807-W—\$1.25.
- National Company Power Xfmr—Brand new, exact replacement for NC-240, NC-101-X, etc.—\$5.95.
- IE-19-A Test Equipment, \$49.75. • MD-7 Modulator—\$9.95.
- General Radio Model 1021AU Signal General. 250 to 920 mcs. — w/G.R. power supply. New, \$495.00.
- VFO Precision Variable Capacitor—15 to 115 mmf. Double spaced, \$3.95. 3 for \$9.00.
- Shallcross Kilovoltmeter—0-5, 10, and 20 Kv. Model 760. Brand new, \$37.50. 2 for \$70.00.
- Collins Deluxe Filter Choke—6 hy. @ 400 ma. 70 ohms D.C. — 10 KV. Insul. — 8"x5 1/2"x6" with porcelain terminals hermetically sealed—Brand new; comm'l appearance, \$8.50 ea.; 3 for \$21.00.

Write for New 1958 Barry's Green Sheet
 • New Items • Low, Low Prices on Equipment, Transformers, Tubes, Ham Gear, Lab Supplies • 30 Pages Chock-Full of Real Buys • Unique Values in Industrial Electronics.

- Prop-Pitch Motor—55 lbs. uncrated. New or like new, \$28.00 each. F.O.B. N.Y.C. Via express or truck.
- 28 volt — 10 amp Xfmr — Pri:115 vac/60 — \$4.50.
- Tool-Kit—23 piece imported tool kit @ \$8.50.
- Glas-Line — Non-Metallic Guy Line @ \$2.89 per 100 ft.
- Crystal Microphone—electro-voice model 915 — jobber boxed, \$4.95. • Eldico Hi-Pass Printed-c'kt TV filter @ 75¢.
- GE Binary Scaler—Model 45N1BI w/5963 tube, \$5.00.
- Bud 77" Panel Space Relay Racks. Standard 19" amateur width—17" deep. Deluxe grey-crackle finish—louvered side panels—top and bottom—back door with double lock—brand new in original wrappings—complete with hardware — shipped knocked-down — F.O.B. N. Y. area. An excellent buy at \$35.00. (Qty. users write for prices.)
- T-126/ARC 5—100 to 146 Mc. Xfmr w/tubes. New/like new, \$13.95.
- T-23/ARC 5—100 to 156 Mc. Xfmr w/tubes. New/like new, \$14.95.
- BC 457A (4-5.3 Mcs.). Excellent \$4.95. New \$5.95.
- BC 458A (5.3-7 Mcs.). Excellent \$4.95. New \$5.95.

TERMS: 25% deposit with order, balance C.O.D. All merchandise guaranteed for cost of merchandise only. F.O.B. N.Y.C.
 Subject to price variation and stock depletion
 We are near Prince St./BMT Station
 Spring St./IRT Station

BARRY ELECTRONICS CORP.

512 Broadway, Dept. RN, N.Y. 12, N.Y.
 Phone: WAlker 5-7000

working from schematics. This group should find this book of special interest. No prior experience with electricity or electronics is required of the user.

The text material explains the basic theory back of the subject, symbolism, technical notations, and organization of schematics in pictorial diagrammatic form. Standard EIA (formerly RET-MA) and industry accepted symbols are used throughout and these, along with a generous helping of sample schematics and pictorials, help the student to visualize the circuitry.

Those handicapped in their construction projects by a lack of familiarity in working with schematics should welcome the availability of this handy "guide book."

* * *

"AUDIO AMPLIFIERS AND ASSOCIATED EQUIPMENT" by Sams Staff. Published by *Howard W. Sams & Co., Inc.*, Indianapolis, Ind. 226 pages. Price \$3.95. Vol. 9 (AA-9).

The ninth volume in this publisher's series on audio amplifiers presents complete photo coverage, standard notation schematics, parts lists, voltage and resistance values, and servicing information on fifteen amplifiers, three preamps, twelve tuners, and five custom radios which were released during 1956.

The amplifiers of *Brociner, Bogen, Fairchild, Fisher, Grommes, Harmon Kardon, McIntosh, Pederson, Pilot, and Rauland* and the tuners made by *Altec, Browning, Bogen, Grommes, Harmon Kardon, Newcomb, Pederson, Pilot, Rauland, and H. H. Scott* are covered. A cumulative index covering the first eight volumes in this series is also included for convenience in locating information on any amplifier model.

* * *

"MOST-OFTEN-NEEDED 1958 TELEVISION SERVICING INFORMATION" compiled by M. N. Beitman. Published by *Supreme Publications*, Highland Park, Ill. 192 pages. Price \$3.00. Soft cover. (Vol. TV-14.)

The newest volume in this publisher's series of servicing information handbooks covers television receivers made or distributed by *Admiral, Emerson, General Electric, Hotpoint, Motorola, Montgomery Ward, Packard-Bell, Philco, RCA, Westinghouse, and Zenith*.

As with the previous volumes, in each instance information on alignment, waveshapes, circuit diagrams, chassis views, voltage charts, and factory changes is given for the individual receiver. An index by make, model, or chassis number is also included. —30—

PHOTO CREDITS

Page	Credit
35, 36, 37, 38, 156	U.S. Naval Research Laboratory
46	Hickok Electrical Instrument Co.
54, 55	Official U.S. Army Photos
96	Lafayette Radio
113	Merck & Co., Inc.
136	Harvey Radio Company
138	Dyna Company
158	David Bogen Co., Inc.

ELECTRIC BRAIN KIT

Can you think faster than this machine?

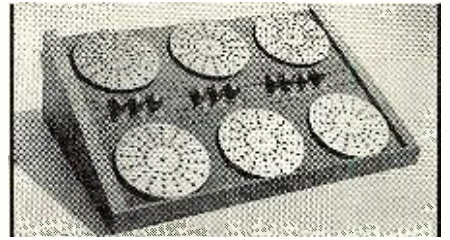

Control Panel of GENIAC set up to do a problem in check valve research

Be careful before you answer. GENIAC® the first electrical brain construction kit is equipped to play tic-tac-toe, cipher and encipher codes, convert from binary to decimal, reason (in syllogisms) as well as add, subtract, multiply and divide. Specific problems in a variety of fields—actuarial, policy claim settlement, physics, etc., can be set up and solved with the components. Connections are solderless and are completely explained with templates in the manual. This covers 33 circuits and shows how new ones can be designed.

You will find building and using GENIACS® a wonderful experience; one kit user wrote us: "this kit has opened up a new world of thinking to me." You actually see how computing, problem solving, and game play (Tic-tac-toe, nim, etc.) can be analyzed with Boolean Algebra and the algebraic solutions transformed directly into circuit diagrams. You create from over 400 specially designed and manufactured components a machine that solves problems faster than you can express them.

Schools and colleges, teachers of science or math, engineering, philosophy or psychology will find these excellent demonstrators of circuitry, solutions in symbolic logic, theory of numbers, cybernetics, and automation.

SEND for your GENIAC kit now. Only \$19.95 with over four hundred components and parts; fully illustrated manual and wiring diagrams. We guarantee that if you do not want to keep GENIAC after one week you can return it for full refund. Add \$1 west of the Miss. \$21.95 outside U.S.A.

Dept. RT-38, Oliver Garfield Co., Inc.
 126 Lexington Ave., N. Y. 16, N. Y.

STEREOPHONIC TAPE HEAD CONVERT MONAURAL RECORDERS TO STEREO



The model TLD-S is easily compensated to provide flat response from 30 to over 10,000 cycles. Unique construction assures precise gap alignment, negligible tape oxide accumulation, and 50 db crosstalk rejection. High quality—ideal for new equipment. Write for information and circuits. Net price \$19.50.

THE NORTRONICS COMPANY
 1017 South 6th St. Minneapolis 4, Minn.

MOVING?

BE SURE RADIO & TV NEWS FOLLOWS YOU. PLEASE SEND YOUR CHANGE OF ADDRESS TO

RADIO & TV NEWS
 Circulation Department

64 E. LAKE ST. CHICAGO 1, ILL.



Genuine OAK WOOD Antique TELEPHONES!

As is \$9.00 complete. Tested working order \$12.00. Shipments FOB Simpson, Pa. Write for free list.

Telephone Engineering Co.
 Dept. RT3 Simpson, Pa.

RADIO & TV NEWS

GET YOUR COMMERCIAL TICKET EASIER WITH ...

Kaufman's RADIO OPERATOR'S LICENSE Q AND A MANUAL

now available 6th EDITION up to the minute

The BEST book for FCC License Preparation Covers elements 1 thru 8.

The only book with complete discussion of answers to every technical question in the FCC Study Guide. Makes it very easy to answer multiple choice questions. Used by leading schools and industry. Only \$6.60 at jobbers, bookstores or direct from:

JOHN F. RIDER PUBLISHER, INC.
116 West 14th Street, New York 11, N. Y.



EASY TO LEARN CODE

It is easy to learn or increase speed with an Instructograph Code Teacher. Affords the quickest and most practical method yet developed. For beginners or advanced students. Available tapes from beginner's alphabet to typical messages on all subjects. Speed range 5 to 40 WPM. Always ready—no QRM.

ENDORSED BY THOUSANDS!

The Instructograph Code Teacher literally takes the place of an operator-instructor and enables anyone to learn and master code without further assistance. Thousands of successful operators have "acquired the code" with the Instructograph System. Write today for convenient rental and purchase plans.

INSTRUCTOGRAPH COMPANY
4711 SHERIDAN ROAD, CHICAGO 40, ILLINOIS



NEW!—HI-FI MUSIC MINDER ...

automatically shuts off entire hi-fi system after last record has played and turntable stops.

Completely electrical. Simply plug in record changer and hi-fi equipment—the MUSIC MINDER does the rest.

Available at all leading hi-fi shops and parts distributors.

Another first by the leader in quality hi-fi components.

\$7²⁰ NET

CBC C.B.C. ELECTRONICS CO., INC.
2401 NORTH HOWARD ST.
PHILADELPHIA 33, PENNA.



CLASSIFIED

RATE: 50¢ per word. Minimum 10 words. May Issue closes March 10th. Send order and remittance to: RADIO & TV NEWS, 366 Madison Ave., N. Y. C. 17, N. Y.

RADIO ENGINEERING

ELECTRONICS! Associate degree—29 months. Technicians, field engineers, specialists in communications, missiles, computers, radar, automation. Start September, February. Valparaiso Technical Institute, Dept. N, Valparaiso, Indiana.

FOR SALE

FOR Sale—used Kay Electric Megapix \$275.00; Megapipper (4 pips) \$45.00; Megasweep \$115.00. Also used Television Projects monoscope with monitor \$200.00. Tru-Way Radio & TV School, 224 Academy St., Wilkes-Barre, Pa.

COMBINATION VHF R. F. Wattmeter and Field Strength Meter Ideal for tuning mobiles. \$39.95. Write for descriptive Pamphlet. Vacri Co., Connersville, Indiana.

DON'T Be A Sninow, Buy Like a Pro. Factory Sealed, Lowest Prices.—Example: Bogen DB130 99.95, Scott 99D 89.95. Flash: 1800' Mylar Tape. Dozen Lots. Terms 25% deposit with order. Balance C.O.D. F.O.B. N.Y.C. Phips, Box 62 Canal St. Station, N. Y. 13, N. Y.

GOVERNMENT Sells—Surplus Electronics; Walkie-Talkies; Transceivers; Test Equipment; Oscilloscopes; Radar; Voltmeters; Misc.—Fraction of Army costs—Buy direct now from U. S. Government—"Depot List & Procedure" \$1.00—Brody, Box 8-RT, Sunnyside 4, New York.

RADIO & TV Tubes at manufacturers prices. Guaranteed—Send for free price list. Edison Electronic Tube Co., Menlo Park, N. J.

DIAGRAMS—Radios, Amplifiers, Changers, \$1.00 Each. Television service Data \$2.00. Unknown Models, Give Tube Layout And Part Numbers. Cable Electronics Corp., 851 10th Ave., New York, N. Y. (Formerly Kramer's Radio Service).

DIAGRAMS for repairing radios \$1.00. Television \$2.00. Give make, model. Diagram Service, Box 672-RN, Hartford 1, Conn.

TUBES—TV, Radio, Transmitting And Industrial Types At Sensibly Low Prices. New, Guaranteed, 1st Quality, Top Name Brands Only. Write For Free Catalog or Call WALKER 5-7000, Barry Electronics Corp., 512 Broadway, New York 12N, N. Y.

3x.2mf 4000vDCw \$2.15 2x.5mf 600vDCw 8.40 knob-dial 2 inch \$.10 2x6.3v @ 1A 7.5v @ 21A 2x5v @ 7A 115/60 cycle pri. \$7.45 send for list. Cooper Electrical Co. Park Ridge, N. J.

TELEVISION Sets \$11.95. Plus shipping. Jones TV, 147 High, Pottstown, Pa.

WANTED

CASH Paid! Sell your surplus electronic tubes. Want unused, clean transmitting, special purpose, receiving, TV types, magnetrons, Klystrons, broadcast, etc. Also want military & commercial lab test and communications gear. We swap too, for tubes or choice equipment. Send specific details in first letter. For a fair deal write, wire or telephone: Barry, 512 Broadway, New York 12, N. Y. WALKER 5-7000.

LABORATORY Quality Equipment and Military Surplus Electronics bought, sold. Engineering Associates, 432 Patterson Road, Dayton 9, Ohio.

CYLINDER and old disc phonographs. Edison, Conqueror, Idelia, and Oratorio models. Berliner Gramophones and Zono-o-phones, Columbia cylinder Graphophones, and coin-operated cylinder phonos. Want old catalogues and literature on early phonos prior to 1919. Will pay cash or trade late hi-fi components. Box 50 % Radio & TV News, 366 Madison Ave., New York 17, N. Y.

WANTED: Receiver R5/ARN-7, MN-62A Transceivers, RT18/ARC-1, AN/ARC-3, BC-788C, I-152C, Collins, Bendix equipment, Test Sets, Dynamotors, Inverters. We pay highest prices. Advise quantity, condition, price first letter. Aircraft Radio Industries, Inc., 70 East 45th St., N. Y. 17, telephone LExington 2-6254.

HIGH FIDELITY

WORLD famous high-fi speaker manufacturer has available additional outlets for part or full time custom installers and servicemen. Classified Box No. 364 % Radio & TV News, 366 Madison Ave., New York 17, N. Y.

PRICES? Try ours! Everything in Hi-Fi. Factory sealed components. Write right now. Audion, 61-62 Booth St., Rego Park 74, N. Y.

DISGUSTED Of "HI" HI-FI Prices? Unusual Discounts On Your High Fidelity Requirements. Write. Key Electronics, 120 Liberty St., New York 6, N. Y. BVergreen 4-6071.

we are

GROWING...

and you can grow with us.

A small ad in these classified columns delivers your sales message to more than a quarter million readers.

WRITE NOW TO

Martin Lincoln
Classified Advertising Manager
Ziff-Davis Publishing Company
366 Madison Avenue
New York 17, New York

FOR FURTHER DETAILS AND RATES

TAPE & TAPE RECORDERS

TAPE Recorders, hi-fi components, tapes. Unusual Values. Free catalog. Dressner, 69-02 R, 174 St., Flushing 65, N. Y.

RECORDERS, HiFi, Tapes, Free Wholesale Catalog. Carston 215-R E. 88 St., N. Y. C. 28.

WHOLESALE Catalog 10¢. Recorders! Tapes! Typewriters! Radios! Towers, #155, Philadelphia 5.

HI-FI Recording Tape, Mylar 2400' \$2.99, 6/\$2.89. Acetate 1800' \$1.89, 12/\$1.79. 1200' 6/\$1.29. Postage 20¢ per tape. Guaranteed. Catalogue. Broadcast Box 231R, Wallingford, Conn.

BUSINESS OPPORTUNITIES

HIGH Paying Jobs, Opportunities, foreign, U.S.A. All trades. Companies pay fare. For information Write Dept. 59L National Employment Information, 1020 Broad, Newark, New Jersey.

WELL established TV sales and service business, excellent opportunity for right party. Home and store optional. Midwest location. Retiring. Classified Box 565 % Radio & TV News, 366 Madison Ave., New York 17, N. Y.

\$200 TO \$300 weekly! Most TV failures due to tubes. Cash in on this tremendous market! Operate from home. No electronic knowledge needed. Information free. Electronic Enterprises, Box 279-RN, Lexington, Ky.

WANTED A-1 Sales Reps. For Real Hot Line Imported Miniature Electronic Components Just Being Introduced. Several Key Areas Still Open. Submit Full Particulars. Intercontinental Industries, Inc., 555 W. Adams St., Chicago 6, Ill.

CORRESPONDENCE COURSES

USED Correspondence Courses and Books sold and rented. Money back guarantee. Catalog free. (Courses bought.) Lee Mountain, Pisgah, Ala.

INSTRUCTION

ENGINEERING Degrees, EE Option Electronics earned by home study. Residence classes also available. Pacific International University (operating as a college of engineering only at present), 5719-C Santa Monica Boulevard, Hollywood 38, California.

MISCELLANEOUS

ENGRAVING: Panels, name-plates, Barber & Howard Co., East Ave., Westerly, R. I.

INVENTORS—Experimenters—Small Manufacturers. We produce prototype parts of metal, plastic, ceramic or wood. Send your specifications to us for our estimates. Norway Eng. & Mfg. Co., P.O. Box 1500, Waterford, Wis.

the mighty nine plus two!

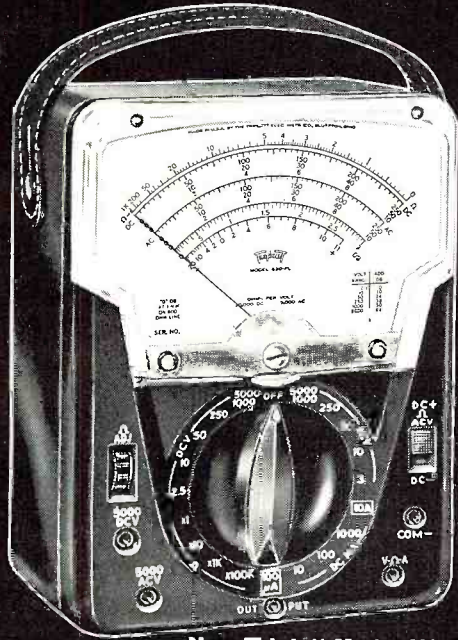

New Triplet Model 630-PL

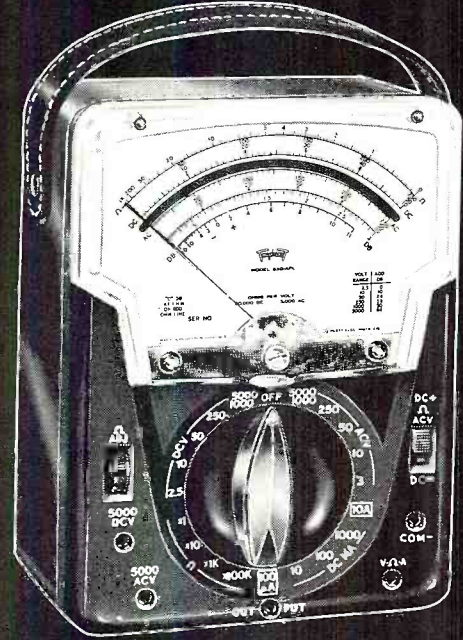

New Triplet Model 630-APL

TWO NEW VOLT-OHM-MILLIAMMETERS

Now the Triplet Mighty Nine Has Expanded to A Line of 11 VOMs Tailored to Meet Your Preference, Purse or Purpose. Only Triplet Offers So Complete A Variety.

With the new 630-PL and 630-APL you get these important new features:

- Voltage scales for those who want ranges reading by 10's (2.5-10-50-250-1000-5000).
- Instant-vision, wider spread scales; streamlined case, handsome modern design.

- D.C. Polarity Reversing Switch.
- 5 to 500,000 Cycles per second frequency response in A.C. measurements.
- 5000 ohms per volt sensitivity in A.C. ranges; 20,000 ohms per volt D.C.

Both new testers — with the popular continued Models 630 and 630-A—offer these proved Triplet advantages:

- One switch will select any range; minimizes chance of incorrect settings and burnouts.

- Reads from .1 ohm (4.4 ohm center scale) to 100 megohms; four ranges.

- Molded circuit panel for instant component replacement.

- Models 630-APL and 630-A feature 1/2% resistors for greater accuracy; long mirrored scales to eliminate parallax in reading.

- Banana-type leads for low contact resistance at jacks.

how do you want it?

X 3s or X 10s

Triplet Models 630 and 630-A read volts 0-3-12-60-300-1200-6000; or Triplet New Models 630-PL and 630-APL reading 2.5-10-50-250-1000-5000.

Choose your preference in range reading.

MODEL 630-PL... Dealer Net \$44.50

MODEL 630-APL... Dealer Net \$54.50

MODEL 630... Dealer Net \$44.50

MODEL 630-A... Dealer Net \$54.50

Only Triplet offers 11 VOM's—a line complete enough to give you exactly what you want.

TRIPLET

Triplet Electrical Instrument Co.
Bluffton, Ohio

53 Years of Experience



Triplet Model 630



Burton Browne Advertising

Triplet Model 630-A

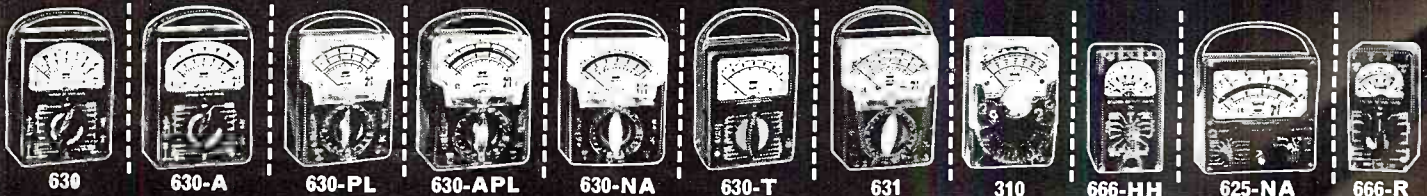

Let
Weather
Never
Bothers
A
MALLORY
"GEM"

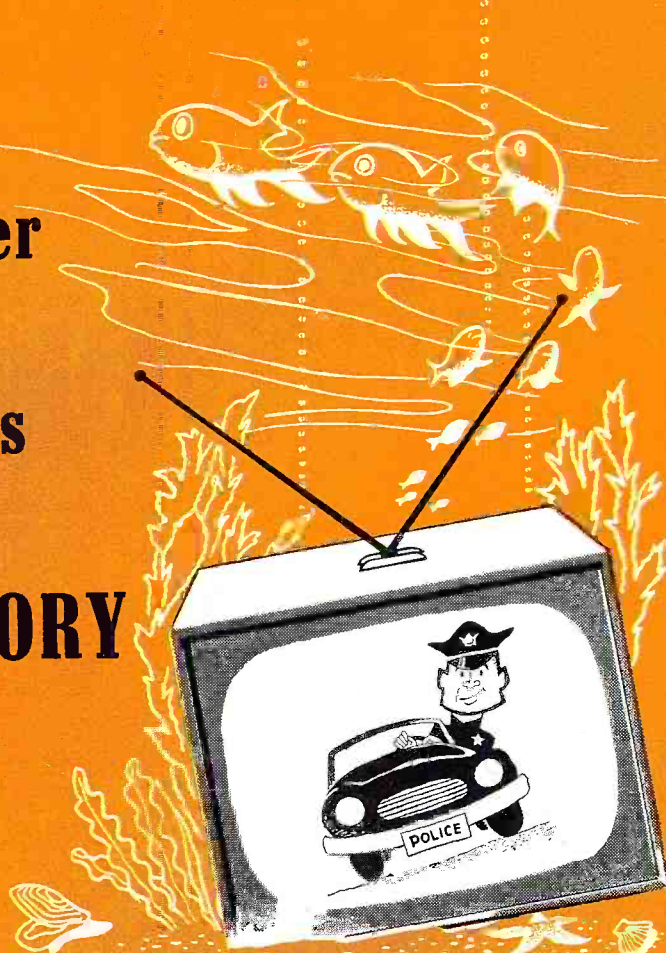

Run-of-the-mill radio and television equipment may never be called upon for such extreme service as under-water operation . . . but if it were, you could be sure that Mallory Gem capacitors would continue to deliver excellent performance.

Mallory "Gems" are tightly sealed in a mica filled bakelite case with epoxy resin that adheres both to case and wires . . . they withstand moisture and exposure without change of capacity or internal resistance. And, they're conservatively rated to assure complete reliability under the most severe conditions.

They're your best bet for outstanding service in any application—for by-pass, buffer, filter nets, or coupling circuits. Get Mallory "Gems" in all popular capacities and voltage ratings—from your Mallory Distributor.



P. R. MALLORY & CO. Inc., INDIANAPOLIS 6, INDIANA

- Capacitors
- Vibrators
- Resistors
- Power Supplies
- Mercury and Zinc-Carbon Batteries
- Controls
- Switches
- Rectifiers
- Filters