

HOW TO TEST YOUR FM TUNER

RADIO & TV NEWS

World's Leading Electronics Magazine

NOVEMBER

1957

35 CENTS

A
TELEPHONE
OPERATED
SWITCH

(See Page 51)

TELEMETRY
IN FLIGHT TESTING

SINGLE-SIDEBAND
RECEIVING ADAPTER

WHY LOW-EFFICIENCY
SPEAKER SYSTEMS?

TV REMOTE CONTROLS
FOR THE TECHNICIAN

INTERFERENCE-FREE
AM RECEPTION

SERVICE TECHNIQUES FOR
STANDARD COIL TUNERS

COAX LINE R. F. MONITOR

HEART RECORDING →
(See Page 65)

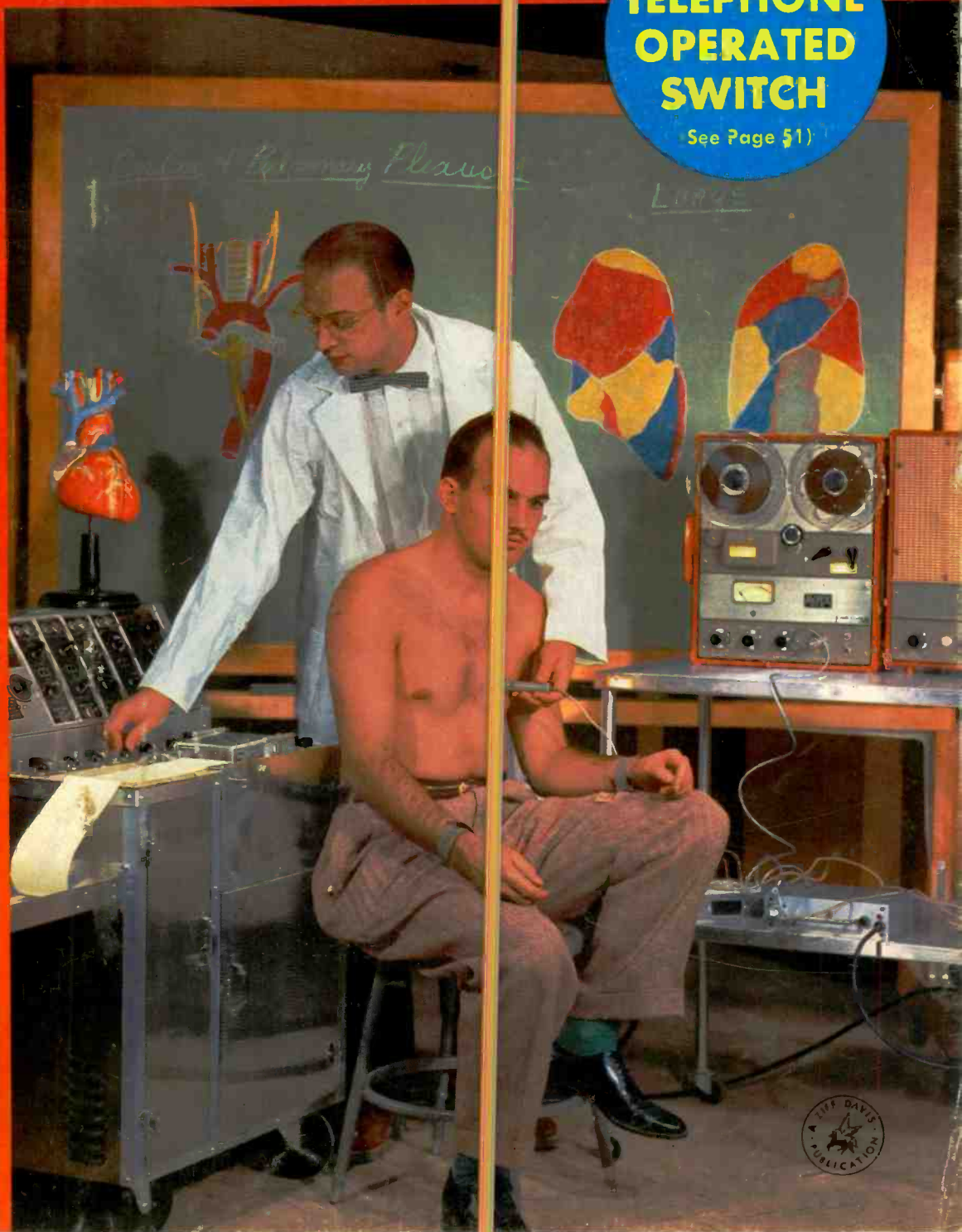

A wonderful offer
from the
**RAYTHEON RECEIVING
TUBE DISTRIBUTORS**
who sponsor the
**RAYTHEON BONDED
DEALER PROGRAM**



at no added cost

GROUP LIFE INSURANCE

(Administered and Underwritten by New England Mutual Life Insurance Co.)

for ^{Registered*} Raytheon Bonded Electronic Technicians
who by preference use Raytheon Receiving Tubes

Now, Registered Bonded Dealers can gain personal security for themselves and their families — automatically increase their life insurance coverage, through their regular purchases of Raytheon Receiving Tubes. The amount of coverage is determined by the quantity of Receiving Tubes the dealer buys.

The New England Mutual Life Insurance Company has created a Group Life Insurance Plan for Raytheon Bonded Electronic Technicians — a plan offered exclusively by Raytheon Distributors who sponsor the Bonded Dealer Program. Any such Distributor who meets the necessary requirements for

setting up a Group Life Insurance Plan for Bonded Dealers may give them this valuable protection without the necessity of a physical examination. Check with your Raytheon Sponsoring Distributor and see if he has it available to you.

If you're not at present a Raytheon Bonded Dealer, better see your Sponsoring Distributor as to whether you can qualify. You'll find being a Raytheon Bonded Dealer a real asset to you. You'll find using Raytheon quality receiving tubes is a big help, too.

**Only Registered Raytheon Bonded Dealers who own their businesses and have the necessary shop facilities and equipment to qualify for Bonding, are eligible for Group Insurance under this plan.*



RAYTHEON MANUFACTURING COMPANY

Receiving and Cathode Ray Tube Operations

NEWTON 58, MASS. CHICAGO, ILL. ATLANTA 6, GA. LOS ANGELES 7, CALIF.
55 Chapel Street 9501 Grand Ave. (Franklin Park) 1150 Zonolite Rd. N.E. 2419 So. Grand Ave.

Raytheon makes all these } Receiving and Picture Tubes, Reliable Subminiature and Miniature Tubes, Semiconductor Diodes and Transistors, Nucleonic Tubes, Microwave Tubes.



Excellence in Electronics

Why Guess? There's a Quick, Sure Way to Find TV Set Troubles

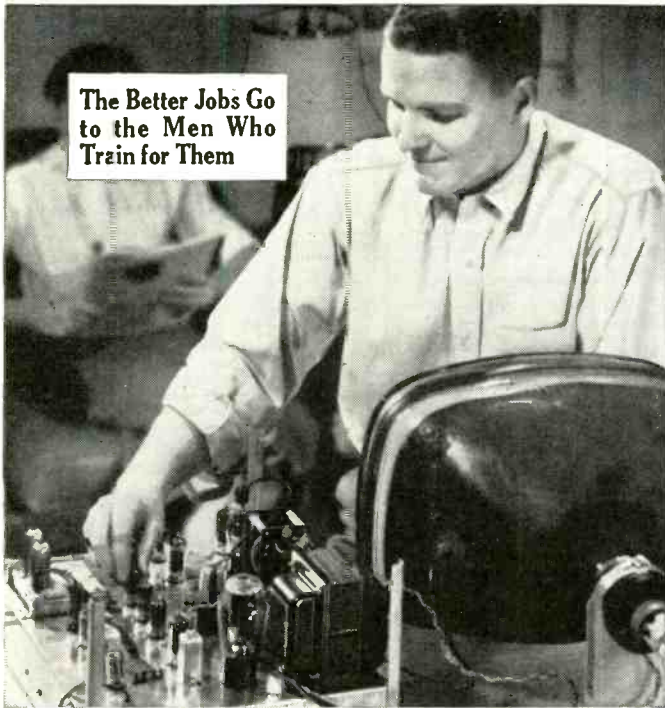

The Better Jobs Go to the Men Who Train for Them

PUT YOURSELF IN THIS PICTURE, experimenting at home with equipment we furnish, getting set to go places in TV servicing. Speed in servicing TV sets means stepped up earnings, greater security for you.

Acquire Superior Skills at Home in Spare Time

Professional TV Servicing pays good money to men with specialized knowledge and training. The exciting, expanding TV industry offers more than just good jobs. It offers success, a career, prestige to men qualified through training.

Be one of these experienced TV Servicemen. N.R.I.'s course is 100% learn-by-doing. You train at home in your spare time. We supply all the equipment plus comprehensive manuals covering a thoroughly planned program of practice. You learn how experts diagnose TV receiver defects quickly. And you learn how to fix them.

NRI HAS HELPED THESE MEN



"I have a much better outlook on the future thanks to your TV Servicing Course. I can find my way around in a TV Chassis as easy as I can my own home." C. DORITY, Silver Springs, Md.

"Since taking your Professional TV Servicing I have serviced about 95% of common TV complaints. I can fix one in minutes when it used to take hours." JAMES D. McINGVALE, Lake Cormorant, Miss.



"It takes the kind of experience you offer to really learn TV. You learn more and remember more than by just reading books." E. RAVITSKY, Northumberland, Pa.

NRI ALL-PRACTICE COURSE Shows How top TV servicemen fix ANY MAKE or model

Learn-by-Doing. NRI Sends You 17" Picture Tube, All Other Tubes, Components to Build TV Receiver; Professional Type 5" Scope, Signal Generator. Training Low in Cost... Easy Monthly Terms.

Many fellows "go around in circles" trying to isolate TV receiver defects. Don't guess. Take this training now. If you want to go places in TV servicing you will act quickly to find out how you can advance with better practical knowledge. Find out today what N.R.I. offers you. Mail the coupon. Get this important book, "How to Reach the Top in TV Servicing" FREE.

Get Color-TV Textbooks Early

The day you enroll, N.R.I. sends you special Color-TV textbooks to speed your knowledge of this fast-growing phase of TV. Many full color pictures and diagrams help you to recognize Color-TV defects and show you how to correct them quickly, easily, properly.

Remember, with this course you keep right on working, keep right on earning at your job while you learn through actual practice at home. Here, condensed into a

few months of training at home is everything that TV servicemen learn in months, even years. You get practice installing channel selector strips in modern UHF-VHF receivers. You get practice isolating complaints from scope patterns, eliminating interference, use germanium crystals to rectify the TV picture signal, many other professional methods.

OLDEST and LARGEST Home Study TV-Radio School

N.R.I.'s Professional All-Practice Television Servicing Course is not for beginners. It is for men with some knowledge of TV and Radio fundamentals but who need intensive, practical training with TV circuits and professional servicing techniques to be self reliant, confident, expert TV servicemen. Get this book FREE and judge for yourself how N.R.I.'s course will further your ambition. Address National Radio Institute, Dept. 7MET, Washington 16, D. C.

MAIL THIS NOW



NATIONAL RADIO INSTITUTE
Dept. 7MET, Washington 16, D. C.

Mail me Sample Lesson and 64-Page Catalog FREE. (No Salesman will call.)

Name.....Age.....

Address.....

City.....Zone.....State.....

ACCREDITED MEMBER, NATIONAL HOME STUDY COUNCIL

RADIO & TV NEWS is published monthly by Ziff-Davis Publishing Company, William B. Ziff, Chairman of the Board (1946-1953), at 64 E. Lake St., Chicago 1, Ill. Entered as second-class matter July 21, 1948, at the Post Office, Chicago, Ill., under the act of March 3, 1879. Authorized by Post Office Department, Ottawa, Canada, as second-class matter. SUBSCRIPTION RATES: one year U. S. and possessions, and Canada \$4.00; Pan American Union Countries \$4.50; all other foreign countries \$5.00.

RADIO & TV NEWS

Reg. U. S. Pat. Off.

First in radio-television-audio-electronics

Average Net Paid Circulation 258,790

Radio & Television News • Radio News • Television News Trademarks Reg. U. S. Pat. Off.

CONTENTS

NOVEMBER, 1957

VOL. 58 ■ NO. 5

Publisher

OLIVER READ, D. Sc., WIETI

Editor

WM. A. STOCKLIN, B. S.

Technical Editor

MILTON S. SNITZER

Service Editor

SIDNEY C. SILVER

Associate Editor

P. B. HOEFER

West Coast Editor

EDWARD A. ALTSHULER

Assistant Editor

J. JUSTER

Television Consultant

WALTER H. BUCHSBAUM

Art Editor

HERBERT ASCHER

Art and Drafting Dept.

**J. A. GOLANEK
JAMES A. ROTH
MILTON WHELPLEY**

Advertising Director

JOHN A. RONAN, JR.

Advertising Manager

MURRAY GOLDMAN

Midwest Adv. Manager

JIM WEAKLEY

Western Adv. Manager

JOHN E. PAYNE



ZIFF-DAVIS PUBLISHING COMPANY

William Ziff, President; H. J. Morganroth, Vice-President; Michael H. Froelich, Vice-President; Michael Michaelson, Vice-President and Circulation Director; George Carney, Secretary-Treasurer; Albert Gruen, Art Director.

Executive Office: 366 Madison Ave.
New York 17, N. Y. MU 7-8080
Editorial Office: 1 Park Ave.
New York 16, N. Y. MU 5-6367



Member
Audit Bureau of
Circulations

MEMBER
INSTITUTE OF



BRANCH OFFICES: Midwestern Office, 64 E. Lake St., Chicago 1, Ill., John A. Ronan, Jr., manager; Western Office, Room 412, 215 W. 7th St., Los Angeles 14, Calif., John E. Payne, manager.

EDITORIAL—INDUSTRY NEWS

For the Record.....	W. Stocklin	8
Spot Radio News.....	Washington Correspondent	16
New Television Station Grants.....		16
Telemetry in Flight Testing (Part 1).....	Charles M. Downs	37
Heart Recording.....		65
Britain's National Radio Show.....		127
First Over-Horizon TV Bridge.....		128
Calendar of Events.....		197

HIGH FIDELITY AND AUDIO

Testing FM Tuners at Home.....	Julian D. Hirsch	40
Why Low-Efficiency Speaker Systems?.....	Edgar Villichur	44
A New Look at Positive Current Feedback.....	H. D. Zink & L. R. Sanford	56
Tape Recorder Quiz.....	Herman Burstein	62
Hi-Fi—Audio Product Review.....		94
Certified Record Revue.....	Bert Whyte	99
Sound on Tape.....	Bert Whyte	142
In Defense of the Split-Load Phase Inverter.....	Daniel P. Peters	182

SERVICING

Television-Radio

Service Techniques for Standard Coil Tuners.....	Charles Garrett	46
Practical Color TV for the Technician (Part 4).....	Ken Kleidon	48
Electronic Service in Northern Mexico.....	Ronald L. Ives	50
Interference-Free AM Reception.....	Frank H. Tooker	54
TV Remote Control for the Technician.....	Walter H. Buchsbaum	58
Toying with TV Design.....	Bob Eldridge	62
Are You Losing Money?.....	William Leonard	70
Mac's Service Shop.....	John T. Frye	75
Antenna News.....		123
Service Industry News.....		170
Service Notes.....		193

Test Equipment

Use Your Scope Daily.....	Kenneth Bramham	55
A New Transistorized Voltmeter.....	Herbert Malamud	66
New Tube Tester Data.....		168

AMATEUR

Coax Line R.F. Monitor.....	Robert F. Lewis, W8MQU	43
Single-Sideband Receiving Adapter.....	Harry D. Hooton, W6TYH	71

ELECTRONIC CONSTRUCTION

Do It by Telephone—with a Phone Operated Switch.....	Tracy Diers	51
Build the "Transactivator".....	Frank H. Tooker	68
Photosensitive Meter Adapter.....	Gene Briendine, W4ATE	138
A Transistorized D.C. Voltage Multiplier.....	Paul S. Lederer	152
FM and TV Sound Tuner.....	Bruce A. Morrissette	162

DEPARTMENTS

Within the Industry.....	30	What's New in Radio.....	176
Technical Books.....	148	Manufacturers' Literature.....	187
Sales Aids.....	196		

Copyright © 1957 by Ziff-Davis Publishing Company. All rights reserved.

SUBSCRIPTION SERVICE. All communications concerning subscriptions should be addressed to Circulation Dept., 64 E. Lake St., Chicago 1, Ill. Subscribers should allow at least four weeks for change of address. Include your old address as well as new—enclosing, if possible, an address label from a recent issue of this magazine.

CONTRIBUTIONS: Contributors are advised to retain a copy of their manuscripts and illustrations. Contributions should be mailed to the New York Editorial Office and must be accompanied by return postage. Contributions will be handled with reasonable care, but this magazine assumes no responsibility for their safety. Any copy accepted is subject to whatever adaptations and revisions are necessary to meet the requirements of this publication. Payment covers all author's, contributor's, and contestant's rights, title, and interest in and to the material accepted and will be made at our current rates upon acceptance. All photos and drawings will be considered as part of the material purchased.

**LET DeVRY TECH PREPARE YOU IN
SPARE TIME AT HOME AS AN**

ELECTRONICS TECHNICIAN



**NO PREVIOUS TECHNICAL EXPERIENCE
OR ADVANCED EDUCATION NEEDED!**

Laborers and bookkeepers, store clerks, shop men, farmers, salesmen — men of nearly every calling — have taken the DeVry Tech program and today have good jobs or service shops of their own in Electronics. You don't have to quit your present job. If you are 17 to 55, see how you may get yourself ready for a future in the fast-growing Electronics field.

Whether you prepare at home or in our well-equipped Chicago or Toronto Laboratories, you get sound, basic training in both principles and practice. At home, you use educational movies. You build actual circuits and test equipment. You read simple directions, follow clear illustrations. When you finish, you are prepared to step into a good job in an excitingly different field. You may even start a service shop of your own. Mail coupon for free facts today.

Live-Wire Employment Service



Puts you in touch with job opportunities—or helps you toward a better position in the plant where you are now employed.

Draft Age?

We have valuable information for every man of draft age; so if you are subject to military service, be sure to check the coupon.

A SAMPLE LESSON

See for yourself how DeVry Tech trains you for real opportunities in Electronics. We'll also give you a free copy of an interesting booklet, "Electronics and YOU."

FREE



"One of North America's Foremost Electronics Training Centers"



Accredited Member
of National
Home Study Council

DEVRY TECHNICAL INSTITUTE

CHICAGO 41, ILLINOIS

FORMERLY

DEFOREST'S TRAINING, INC.



**AN INDEX
to a
BETTER JOB,
A BRIGHTER
FUTURE**

Electronics

Radar

Guided
Missiles

Television

Micro-Waves

Communications

Radio

Industrial
Electronics

Computers

Automation
Electronics

Remote Control
Systems

Broadcasting

Your Own
Service Shop

MAIL TODAY FOR FREE FACTS

DeVry Technical Institute

4141 Belmont Ave., Chicago 41, Ill., Dept. RN-11-N

Please give me a FREE Sample Lesson and your booklet, "Electronics and YOU."

NAME _____ AGE _____

STREET _____ Please print _____ APT. _____

CITY _____ ZONE _____ STATE _____

Check here if subject to military training.

#1090

DeVry Tech's Canadian Training Center is located at
626 Roselawn Avenue, Toronto 12, Ontario

Why you need every feature of these

NEW UNIVERSITY FOLDED-HORN ENCLOSURE KwiKits

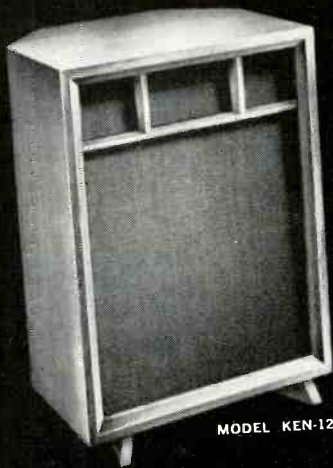

MODEL KEN-12

Because... in performance, mechanical design, construction and ease of assembly, these new KwiKits are unquestionably the very finest enclosure kits—at any price!

KEN-12 For 12" speakers & systems
15½" D x 21½" W x 29½" H **\$44.75**
USER NET

KEN-15 For 12"/15" speakers & systems
18½" D x 29" W x 35¼" H **\$59.50**
USER NET
Adapter for mounting 12" speakers in KEN-15 \$1.50 User Net

ROOM-BALANCED PERFORMANCE

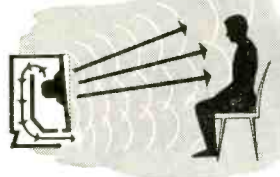

KwiKit acoustic design and tilted baffle combine direct speaker radiation and compensated rear horn loading in a way that blends bass, middle and treble ranges perfectly... for uniform response throughout the listening areas of a room.

HEAVIER CONSTRUCTION

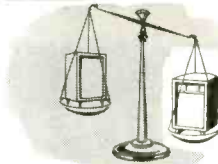

Heavy ¾" first grade, fully cured lumber for top, bottom, sides and back... not flimsy ½" wood commonly used in "kits." Bigger, sturdier—as much as 30% heavier than others in the same price class. Eliminates spurious resonances so detrimental to achieving richer, cleaner bass reproduction.

PRECISION MECHANICAL DESIGN



Exterior and interior elements, even the cleats, fit snugly with close tolerance "rabbeted" grooves. Gluing and screwing of each piece results in reliably air-tight, permanent joints. No nails used. No pencil markings necessary. Mitering and plenty of glue blocks and bracing for truly rigid construction.

PLACE ANYWHERE IN ROOM

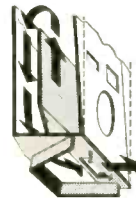

Underside view shows how advanced design, self-contained folded horn extends to the front of the cabinet, projecting low frequencies out into the room... not back into a corner, splashed against the walls. Small slot in base is resistively controlled vent which equalizes woofer diaphragm excursions in compression chamber. KwiKits are therefore independent of room furnishings, shape or placement and can be used against a flat wall, in a corner... even up in the air!

FOOLPROOF ASSEMBLY



All pieces are pre-cut and pre-drilled... engineered to go together quickly. All you need is a screwdriver! Baffle board is pre-cut... blank plugs and adapters supplied for easy installation of additional components as your system expands.

Your KwiKit includes all required hardware, plastic wood, glue, sandpaper, Tufflex insulation, easy-to-follow instructions and... special attention is given to packaging of KwiKits to insure safe, intact delivery to your door.

PROFESSIONAL RESULTS



There's no end of decorative treatment you can give your KwiKit enclosure. Genuine Korina veneer is same as used in fine furniture, and provides a beautiful finish. Decorative front moldings have been designed to complement and enhance your present decor. Exquisite, textured grille fabric is equally at home in settings of any period and is acoustically correct to prevent high frequency attenuation.

KWIKITS...THE PERFECT COMPLEMENT FOR P.S.E.*

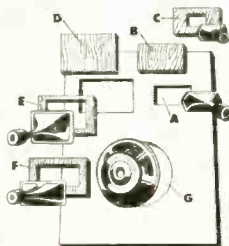

- A—Hole cut out for HF-206.
- B—Blank plug supplied when tweeter isn't used.
- C—Adapter supplied cut out for UXT-5.
- D—Blank plug supplied.
- E—Adapter supplied cut out for 4409.
- F—Adapter supplied cut out for H-600 horn.
- G—Takes 312, UXC-123, Diffusicone-12, UXC-122, Diffaxials, 6200, 6201 wide-range speakers and C-12W woofer.

MODEL KEN-12

takes any 12" wide-range or woofer cone speaker and any tweeter or mid-range speakers.

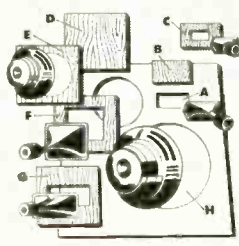

- A—Hole cut out for HF-206.
- B—Blank plug supplied when tweeter isn't used.
- C—Adapter supplied cut out for UXT-5.
- D—Blank plug supplied.
- E—Adapter supplied cut out for C-8W or Diffusicone-8.
- F—Adapter supplied cut out for 4409.
- G—Adapter supplied cut out for H-600 horn.
- H—Takes 315-C, 6303, Diffusicone-15 Diffaxials, and C-15W, C-63W woofers.

MODEL KEN-15

takes any 15" wide-range or woofer cone speaker and any tweeter or mid-range speakers.

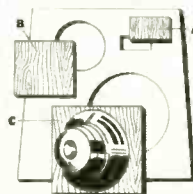

- A and B—Blank plugs supplied.
- C—Takes 312, UXC-123, Diffusicone-12, UXC-122 Diffaxials, 6200, 6201 wide-range speakers and C-12W woofer.

MODEL KEN-15

takes any 12" wide-range or woofer cone speaker when 12" adapter board (optional) is used.

* University's Progressive Speaker Expansion Plan

REMEMBER... if you like to build your own and save money too, the KwiKit is made to order for you... SEE YOUR DEALER TODAY!

UNIVERSITY LOUDSPEAKERS, INC. 80 SOUTH KENSICO AVENUE, WHITE PLAINS, N. Y.



University sounds better



RADIO & TV NEWS

Mr. Service Dealer...

PHILCO brings you extra picture tube business and extra dollars this Fall with a hard-selling, nation-wide advertising campaign. See your **PHILCO DISTRIBUTOR**. Cash in on this sales-making opportunity.



MARILYN VAN DERBUR, MISS AMERICA 1958

PHILCO Star Bright ²⁰/₂₀

ALUMINIZED PICTURE TUBES

Philco picture tubes give the sharpest, brightest picture on any make or model television receiver. Your old set will seem like new with a Philco Star Bright 20/20 picture tube.

**NATIONWIDE CAMPAIGN IN
TV GUIDE AND LOCAL NEWSPAPERS
TO RUN OVER YOUR NAME AND
BRING CUSTOMERS INTO YOUR STORE**

To back you up this Fall Selling Season Philco is running a tremendous advertising campaign in the magazine read by over 5,000,000 tele-viewing enthusiasts . . . TV Guide. In addition, in local newspapers the story of Philco superiority is being told to millions of additional prospects all over America.

DOUBLE SELLING ADVANTAGES
Only replacement picture tube for any set doubly protected by written bond and warranty.

See your **PHILCO DISTRIBUTOR**. CASH IN ON THIS SALES-MAKING OPPORTUNITY

PHILCO
Accessory Division

WORLD'S LARGEST DISTRIBUTOR OF

- Service Parts • Accessories • Universal Components • Power Packed Batteries • Long Life Tubes • Heavy Duty Rotors
- Star Bright 20/20 Picture Tubes • Long Distance Antennas

PHILCO ACCESSORY DIVISION
"A" STREET AND ALLEGHENY AVENUE
PHILADELPHIA 34, PENNSYLVANIA

Please send me further information on Philco's Star Bright 20/20 Aluminized Picture Tubes.

Name _____
Address _____
City _____ Zone _____ State _____

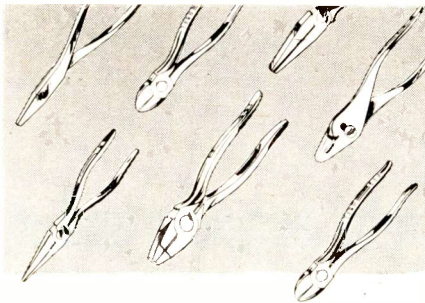

skilled hands
reach for...

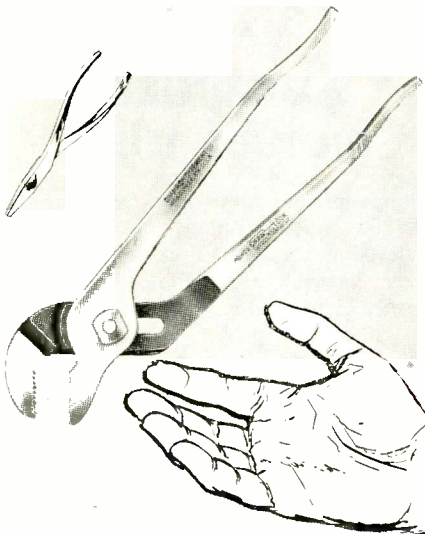

• Skilled mechanics... thousands of them every year... reach for and buy Channellock pliers. Why? Ask them. They'll tell you they like the positive gripping power... the rugged strength... the precision balance... the all 'round handy "feel" of these quality pliers. And you will too!

CHAMPION DEPARTMENT TOOL COMPANY
MEADVILLE, PENNSYLVANIA

ASK YOUR TOOL SUPPLIER
FOR *Genuine*
CHANNELLOCK PLIERS

For the **RECORD.**

"PAY-AS-YOU-SEE" TELEVISION

PERIODICALLY over the past ten years, the subject of "pay-see" TV has made the headlines. On September 18th, the FCC requested present or proposed TV station owners to file formal requests for permission to conduct trial subscription TV on a limited basis for a period of three years but stressed that such applications won't be acted upon prior to March 1st of next year.

Whether or not the final decision will be in favor of one of the proposed methods is problematical. At the moment, most of the Commissioners are in favor of such experiments while other FCC members are questioning the validity of any results that might be obtained. This latter group feels that tests made in localized areas might not be indicative of national acceptance at a later date.

To test the validity of any of the systems and to determine public acceptance or non-acceptance would involve experiments in a majority of the key areas throughout the country. The cost of such a series of tests more or less precludes such an experiment.

Although the FCC gave its blessing to such experiments, before actual licenses could be issued the Commission would have to resolve its present impasse with Congress—no small matter as things stand now. Congress has indicated that, as far as it is concerned, "pay-as-you-see" television is doomed. Most congressmen have indicated that they would vote against any legislation granting free use of the airwaves to profit-making corporations whose revenue derives from the "sale" of the public's air to the public.

As in the past, there is still a controversy as to whether the FCC has complete jurisdiction over such decisions or whether Congress has the final word. With both sides claiming this right, the matter may soon face a showdown. Irrespective of which argument prevails, "pay-as-you-see" television involving the transmission of signals through the air seems to have a hard road ahead of it.

There is, however, an alternative method of transmission—one not subject to control by either the FCC or Congress at the present time—that offers some possibilities of success. This is closed-circuit (wired) TV. This is "pay-as-you-see" television in a different form and at the present time is undergoing tests in Bartlesville, Oklahoma under the aegis of *Video Independent Theaters, Inc.* and dubbed "Telemovie System." Installed by *Jer-*

rold Electronics Corporation of Philadelphia as the first of its "Cable Theatres," the new set-up is a closed-circuit coaxial system whereby residents of the Oklahoma oil center can receive first-run movies in their own living rooms. The initial offering was the recently released *Warner Brothers' "Pajama Game."*

Subscribers pay a flat monthly fee of \$9.50 and approximately 500 of the estimated 8000 television homes in Bartlesville have signed up for the first month's service. The operators estimate that at least a fourth of the TV homes, or 2000 subscribers, will be required before the system pays off.

Another planned installation which has made many headlines is in connection with the N. Y. Giant baseball club moving to San Francisco. A part of the agreement was that San Francisco will be wired for "pay-as-you-see" TV. Permission has already been granted by the local council for such an installation. Whether or not San Francisco will eventually have "pay-as-you-see" TV is hard to say at the moment. Many involved in the final decision feel that the cost of installation far exceeds the potential revenue that would make it a profitable enterprise.

All-in-all, wired TV seems to have some potential of success. With the exception of local regulations there are no Federal restrictions or controls that would cause bottlenecks or confusion at the present time. This is only a temporary situation. It is hard to believe that the FCC or Congress will continue to give it a free hand once it gets rolling. As long as it is a public service and comes under the heading of communications, transmissions, etc., the FCC claims it has the legal authority to put restricting rulings on all phases of the operation of any of these systems. If there is any doubt that the FCC does not have this control, rest assured Congress will give it to them.

Whether or not "pay-as-you-see" TV will benefit the public as a whole remains to be seen. If it means that movies, plays, major sporting events, etc. that would not *otherwise be available* to viewers could be screened in the home, such systems would have a good chance of succeeding. If, however, such a service would result in the withdrawal of the better free TV programs from the air and their transfer to the closed-circuit lines, then the "fat would be in the fire." Another point—will the public pay \$9.50 a month? It will be an interesting experiment to watch! . . . W. S.

FREE!

ALLIED'S 1958 CATALOG

404 value-packed PAGES

the only COMPLETE catalog for everything in electronics

Get ALLIED'S 1958 Catalog—it's complete, up-to-date—404 pages packed with the world's largest selection of quality electronic equipment at lowest, money-saving prices. Get every buying advantage at ALLIED: fastest shipment, expert personal help, lowest prices, guaranteed satisfaction...

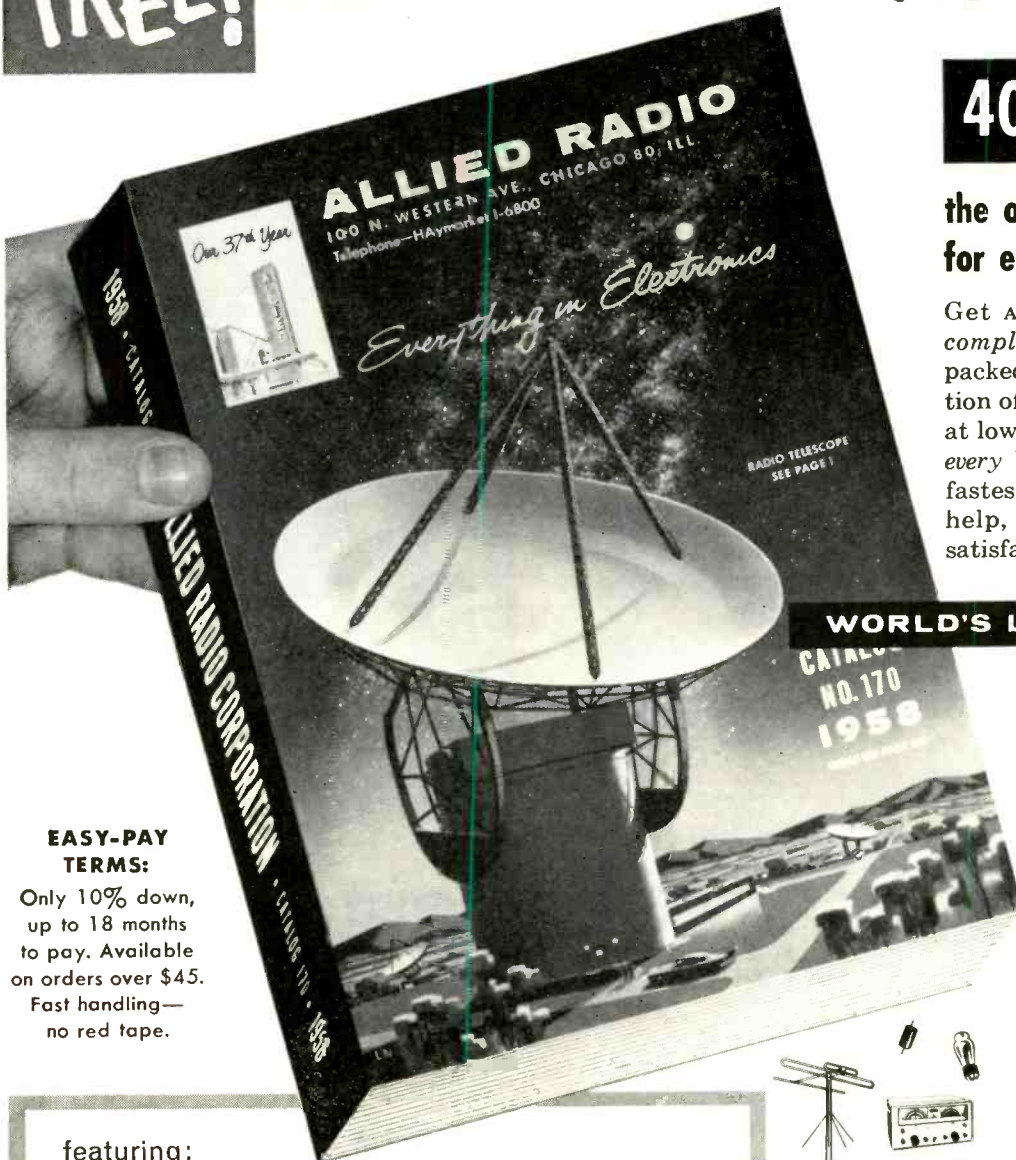

WORLD'S LARGEST STOCKS

- Latest Hi-Fi Systems and Components
- Money-Saving, Build-Your-Own KNIGHT-KITS
- Recorders and Supplies
- Public Address Systems and Accessories
- TV Tubes, Antennas and Accessories
- Amateur Receivers, Transmitters, Station Gear
- Test & Lab Instruments
- Specialized Industrial Electronic Equipment
- Huge Listings of Parts, Tubes, Transistors, Tools, Books

EASY-PAY TERMS:

Only 10% down, up to 18 months to pay. Available on orders over \$45. Fast handling—no red tape.

featuring:

ALLIED'S money-saving knight-kits:

Finest electronic equipment in money-saving kit form. Over 50 quality kits available—Hi-Fi amplifier, tuner and speaker kits, Hobby kits, Test Instruments, Ham kits (see our KNIGHT-KIT values elsewhere in this publication). ALLIED KNIGHT-KITS are easiest to build and they SAVE YOU MORE.

EVERYTHING IN HI-FI

World's largest selection of quality Hi-Fi components and complete music systems—available for immediate shipment from stock. Save on exclusive ALLIED-Recommended complete systems. Own the best in Hi-Fi for less!



send for the leading electronic supply guide

FREE!

ALLIED RADIO CORP., Dept. 1-17
100 N. Western Ave., Chicago 80, Ill.

Send FREE 404-Page 1958 ALLIED Catalog

Name _____

Address _____

City _____ Zone _____ State _____



Our 37th Year

ALLIED RADIO

World's Largest Electronic Supply House

November, 1957

Sylvania TV Damper Tubes



...New design plus



New heater-cathode design helps Sylvania damper types pass this dynamic arc test with flying colors. Dynamic tests such as this have now been instituted by Sylvania on all important types in every critical TV function. It's Sylvania's way of helping you overcome problems which often make the difference between profit and loss and a happy or unhappy customer.



new dynamic tests produce high E.L.A.*

Sylvania damper tubes scored an **Earned Life Average* of 99.54% in a recent test of types in the 6AX4GT family. This means greater service reliability for you with an absolute minimum of trouble resulting from arcing, heater-cathode shorts and heater burnouts. It's the result of a new heater-cathode design introduced by Sylvania to meet your service needs.

Earned Life Average is an established method for evaluating tube life performance; for the service industry it serves as an index of protection against call-backs. These tests

were performed in TV sets which simulated field service conditions where high line voltages are encountered.

109 Sylvania damper tubes performed for a total of 132,890 hours out of a possible 133,500 hours for an *Earned Life Average* of 99.54%.

To Sylvania this is satisfying evidence that the service industry has been provided with extra protection against the most common damper tube troubles. We think you'll agree too, that in the long run you'll profit more with Sylvania.



SYLVANIA

SYLVANIA ELECTRIC PRODUCTS INC.
1740 Broadway, New York 19, N. Y.
In Canada: Sylvania Electric (Canada) Ltd.
University Tower Bldg., Montreal

LIGHTING • RADIO • ELECTRONICS • TELEVISION • METALS & CHEMICALS

portable . . . or permanent



BOGEN FLEX-PAK[®]

MAKES EVERY PA JOB AN EASY ONE

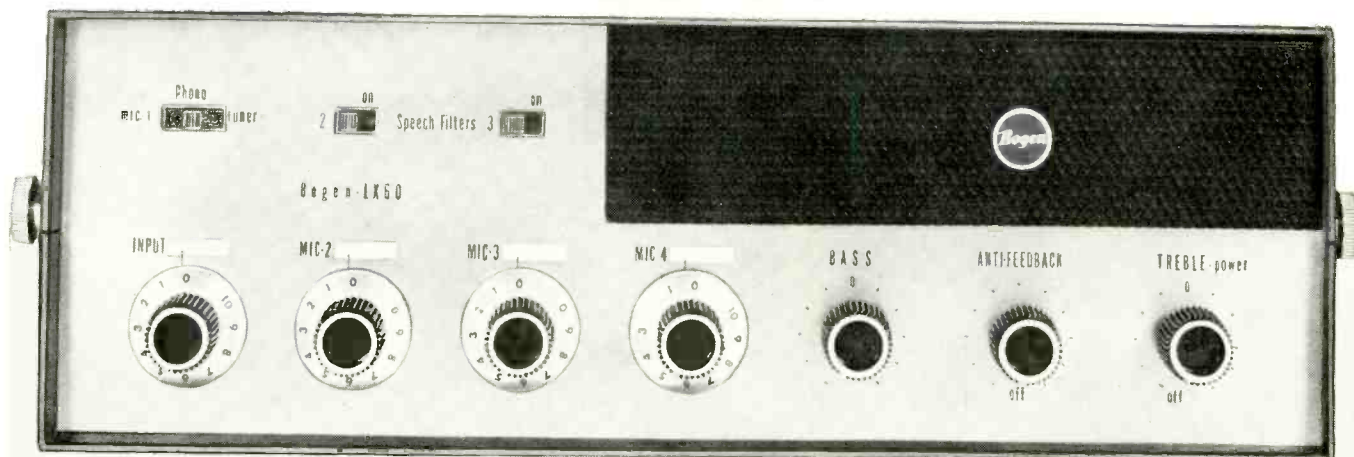

pre-engineered to serve 90% of your sound installations



Deluxe LX30 30-Watt Amplifier

4 Microphone Inputs (panel switch converts one microphone channel for phono or tuner); Built-In Remote Gain-Control Circuit; Exclusive Anti-Feedback Control; Speech Filters; Separate Bass and Treble Tone Controls.

H. 5 $\frac{3}{8}$ " W. 16 $\frac{1}{4}$ " D. 13" Wgt.: 25 lbs.



Superb L330 30-Watt Amplifier

3 Microphone Inputs (panel switch converts one microphone channel for phono or tuner); Speech Filters; Separate Bass and Treble Tone Controls.

H. 5 $\frac{3}{8}$ " W. 14 $\frac{1}{4}$ " D. 13" Wgt.: 24 lbs.

BOGEN'S FLEX-PAK LINE has the flexibility you need to meet virtually every PA installation problem. Flex-Pak units are light, compact, portable, and can be used separately or grouped together. The amplifiers are available in every popular price range and power output . . . 13 models in all. That's why, with Flex-Pak, you can tailor the sound system to fit the job, with none of the fuss and bother of custom installations.

And remember—you can look to Bogen for *all* your sound equipment needs . . . speakers, microphones, turntables, tuners, and accessories. See your Bogen distributor today.

EASY SERVICE . . . EASY INSTALLATION



Loosen 4 thumbscrews and the lid's off for fast, easy servicing.



Folds back when not in use in easy-sliding wall-mount bracket.

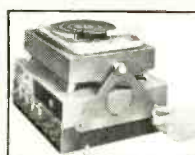

4 thumbscrews attach accessory record player mount.

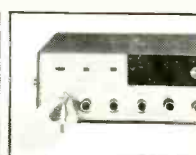

Easily erased write-in's on gain controls mark level settings.

Bogen EVERYTHING IN SOUND

A Division of Unitronics Corporation

David Bogen Company, Paramus, N. J., Dept. S-12
Gentlemen: Please send me descriptive catalog on your BOGEN FLEX-PAK Public Address Equipment and 24-page, illustrated brochure, "What You Should Know About Sound Systems."

NAME _____
 FIRM _____
 CITY _____ ZONE _____ STATE _____
 Check one dealer distributor sound specialist

MAIL COUPON TODAY

Electronics Boom Seen

Need For Television Technicians To Rise

Industry Warned About Shortage Of Trained Men

TV SALES SET NEW RECORD

Sylvania Head Expects Huge Electronic Gains

Transistor Radios Developed

RCA HEAD PREDICTS SALES BOOM FOR COLOR TV SETS

VETERANS - - NON-VETERANS

Get Into The Field That's Making Headlines



L. C. Lane, B.S., M.A.
President, Radio-Television Training Association,
Executive Director, Pierce School of Radio & Television

All over the nation the Television-Radio-Electronics industry is making News — News that means opportunity for YOU. You can cash in on the headlines. **I WILL TRAIN YOU AT HOME FOR A TOP-PAY JOB IN TELEVISION**

I will prepare you for a spot in America's fastest-growing industry. You can become a trained technician in your spare time without giving up your present job or social life. No experience needed.

LEARN BY DOING

As part of your training I give you the equipment you need to set up your own home laboratory and prepare for a top-pay job or set up your own business. You build and keep a TELEVISION RECEIVER designed and engineered to take any size picture tube up to 21-inch. (10-inch tube furnished. Slight extra cost for larger sizes.) . . . also a Super-Het Radio Receiver, AF-RF Signal Generator, Combination Voltmeter-Ammeter-Ohmmeter, C-W Telephone Transmitter, Public Address System, AC-DC Power Supply. Everything supplied, including all tubes.

Combination Voltmeter-Ammeter-Ohmmeter



C-W Telephone Transmitter

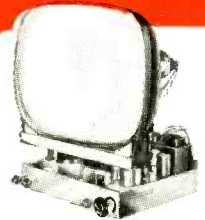

Public Address System

Super-Het Radio Receiver



AF-RF Signal Generator

STUDY NEWEST DEVELOPMENTS

My training covers all the latest developments in the fast-growing Television-Radio-Electronics industry. You learn about FM — RADAR — COLOR TV — TRANSISTORS — PRINTED CIRCUITS, etc.

CHOOSE FROM FOUR COMPLETE COURSES covering all phases of Radio, FM and TV

1. Radio, FM and Television Technician Course—no previous experience needed.
2. FM-TV Technician Course—previous training or experience in radio required.
3. TV Studio Technician Course—advanced course for trained men.
4. Color TV Technician Course—Includes latest color TV circuits.

EXTRA TRAINING IN NEW YORK CITY AT NO EXTRA COST!

After you finish your home study training in Course 1 or 2 you can have two weeks, 50 hours, of intensive Lab work on modern electronic equipment at our associate resident school, Pierce School of Radio & Television. THIS EXTRA TRAINING IS YOURS AT NO EXTRA COST WHATSOEVER!

FCC COACHING COURSE

Important for BETTER-PAY JOBS requiring FCC License! You get this training AT NO EXTRA COST! Top TV jobs go to FCC-licensed technicians.

VETERANS

My School fully approved to train Veterans under new Korean G. I. Bill. Don't lose your school benefits by waiting too long. Write discharge date on coupon.

FREE HOW TO MAKE MONEY IN TV

FREE SAMPLE LESSON

I'll send you my new 40-page book, "How to Make Money in Television-Radio-Electronics," a Free sample lesson, and other literature showing how and where you can get a top-pay job in Television.

MAIL THIS COUPON TODAY!

Mr. Leonard C. Lane, President

RTTA

Dept. RT-11D, 52 East 19th Street, New York 3, N.Y.

Dear Mr. Lane: Send me your NEW FREE BOOK, FREE SAMPLE LESSON, and FREE aids that will show me how I can make TOP MONEY IN TELEVISION. I understand I am under no obligation.

(PLEASE PRINT PLAINLY)

Name _____ Age _____

Address _____

City _____ Zone _____ State _____

- Color TV Tech. Course
- Radio-FM-TV Technician Course
- FM-TV Technician Course
- TV Studio Technician Course

VETERANS!
Write discharge date

Radio-Television Training Association

52 EAST 19th STREET • NEW YORK 3, N. Y.

Licensed by the State of New York • Approved for Veteran Training

NO OBLIGATION!

YOUR INSTALLATION VOLUME CAN BE GREATER!

If you're *not* a Channel Master Dealer you are probably not getting your share of the *really profitable* antenna installation business. Hundreds of dealers have doubled and even tripled their antenna sales *in less than one year* when they

switched to Channel Master and featured the famous T-W antenna. In fact, far more T-W antennas are bought than any other fringe area antenna. There must be good reasons for this. Below are listed but a few of them.

How much installation business are you losing every week? ... because you don't feature the CHANNEL MASTER® T-W

Put these extra selling advantages to work for you!

Superior PERFORMANCE! Outperforms any all-channel antenna ever made! Revolutionary "Traveling Wave" design delivers highest front-to-back ratios (better than 10:1) — top gain over the entire VHF range.

Stronger CONSTRUCTION! Super-strong in every detail of construction: Twin-Boom— the only antenna with 2 full length crossarms; 2 Super-Nests — the most powerful grip that ever held an antenna to the mast; Line-Lok — absorbs all transmission line tension; 7/16" dia. elements.

Bigger NATIONAL ADVERTISING! More than 75,000,000 advertising messages in America's leading national magazines. Now saturation coverage with big-space ads blanketing 173 prime outdoor antenna markets.

LIVE LEADS galore! Tens of thousands have already responded to Channel Master's Free "Antenna Check-Up Kit" offer — repeated in new national ads. Based on experience, 50% — and more — of these leads are converted into actual sales.

Local CO-OP ADVERTISING! The most liberal advertising allowance in the industry — so you can run your own local promotions. Channel Master dealers have the widest array of mats, radio and TV spots, and display materials.

Promoting ANTENNA REPLACEMENTS! Channel Master's national advertising hammers home the theme of antenna obsolescence — opening new markets for you!

Call your Channel Master distributor now!

© Reg. U.S. Pat. Office and Canada

7-element
model no. 350
5-element
model no. 351
3-element
model no. 352

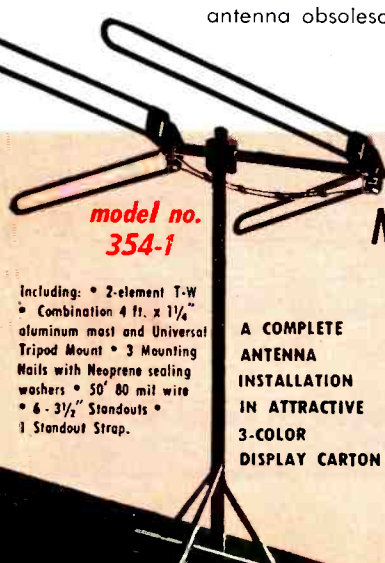
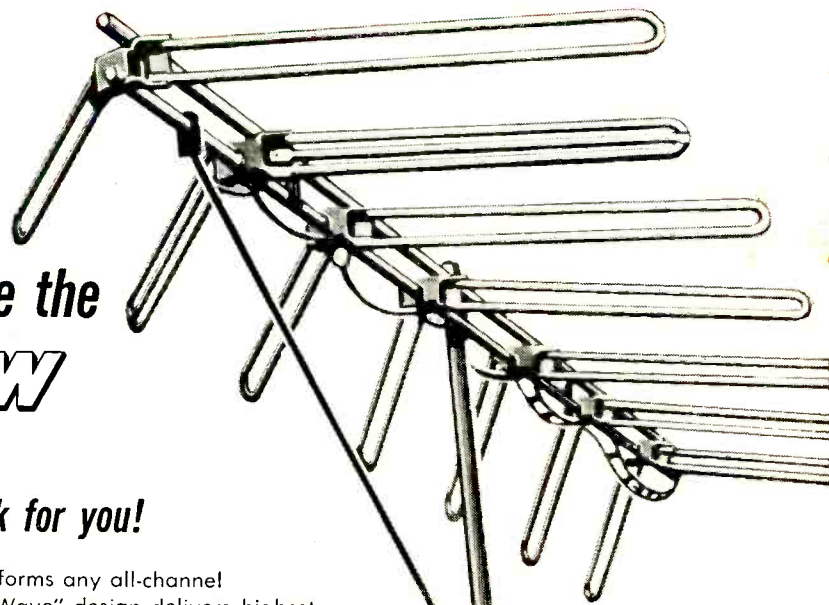

**model no.
354-1**

Including: • 2-element T-W
• Combination 4 ft. x 1 1/4" aluminum mast and Universal Tripod Mount • 3 Mounting Nails with Neoprene sealing washers • 50' 80 mil wire • 6 - 3 1/2" Standouts • 1 Standout Strap.

A COMPLETE ANTENNA INSTALLATION IN ATTRACTIVE 3-COLOR DISPLAY CARTON

NEW "INSTALL-IT-YOURSELF" ANTENNA KIT featuring new 2 ELEMENT T-W ANTENNA

Designed for top performance in suburban and metropolitan areas. Powerful "Traveling Wave" principle provides the 2-element T-W with better all around performance than a stacked conical.

Promotionally Priced at \$29⁹⁵ list



CHANNEL MASTER CORP.

ELLENVILLE, N. Y. copyright 1977 Channel Master Corp. WORLD'S LARGEST MANUFACTURER OF TV ANTENNAS AND ACCESSORIES

New Transcription-Type Tone Arm Makes *Collaro* World's First True High Fidelity Changer



The Turntable That Changes Records

From Collaro, Ltd., world's largest manufacturer of record playing equipment—comes the most significant development in the field in years—the new transcription-type tone arm.

This arm, exclusive with Collaro, literally changes the conventional record changer into a brand new instrument—a TRANSCRIPTION CHANGER—with features of the finest professional equipment.

The arm is a one-piece, spring-damped, counter-balanced unit which will take any standard high fidelity cartridge. It is free of any audio spectrum resonances. It permits the last record to be played with the same low stylus pressure as the first. Between the top and bottom of a stack of records there is a difference of less than a gram in tracking pressure as compared with 4 to 8 grams on conventional changers. Vertical and horizontal friction are reduced to the lowest possible level. These qualities, found only in the Collaro Transcription Changer, insure better performance and longer life for records and styli.

In its superb performance, the new Collaro Continental, Model TC-540, meets the rigid requirements for high fidelity

equipment. Here, for the first time in a changer is professional quality at a record changer price. The Continental is \$46.50. Other Collaro changers are priced from \$37.50 up. (Prices slightly higher west of the Mississippi.)

In addition to the new tone arm, the Collaro Continental features include: 4 speeds, manual switch for turntable operation; wow and flutter specifications—0.25% RMS at 33 $\frac{1}{3}$ RPM—superior to any changer in the world; automatic intermix; automatic shut-off after last record; heavy duty 4-pole, shaded pole induction motor; heavy rim-weighted balanced turntable; muting switch and pop-click filter for elimination of extraneous noises; jam proof machinery; pre-wiring for easy installation; attractive two-tone color scheme to fit any decor; tropicalization to operate under adverse weather and humidity conditions; easy mounting on pre-cut board or base; custom testing at the factory for wow, flutter, stylus pressure and correct set down position.

FREE: Colorful new catalog describes complete Collaro line. Includes helpful guide on building record collection.



WRITE TO
ROCKBAR CORPORATION

Dept. R-011

650 Halstead, Mamaroneck, N.Y.

Rockbar is the American sales agent for Collaro and other fine companies.



KLEIN

THE THRILL THAT
ONLY GOOD TOOLS
CAN GIVE



The radio ham, serviceman or designer knows that the most important tools in his kit are Klein Pliers—long nose, oblique cutters, side cutters.

The quality of the work you do depends in no small measure on the quality of the tools you use. Your reputation as a craftsman is protected when your pliers carry the Klein trademark.



100 years of service to linemen, electricians and industry is back of this new Pocket Tool Guide No. 100. A copy will be sent to you upon request, without obligation.



Mathias **KLEIN** & Sons
Established 1857 Chicago, U.S.A.
7200 McCORMICK ROAD • CHICAGO 45, ILLINOIS

Spot Radio News

* Presenting latest information on the Radio Industry.

By RADIO & TV NEWS
WASHINGTON EDITOR

SCORES OF VITAL radio and TV bills were left in the till when Congress adjourned some weeks ago.

Shelved until the New Year was the controversial \$7.00 excise tax credit measure that would be applied on TV sets which receive all of the channels.

Also tabled was Senator Mundt's bill which would make Inauguration Day a national holiday so . . . "that the whole nation could turn out every four years to see the Presidential inauguration ceremonies . . ." on TV.

Several bills prohibiting broadcasts of racing and lottery information were also put aside.

Representative O'Hara's bill prohibiting the use of any but Standard Time throughout the country was also put in mothballs; also Congressman Hale's proposal to exempt hotels from having to pay royalties for radio and TV programs and phonograph records received in rooms was neatly tied up and packed away.

Other bills that were not finalized were Senator Thurmond's pay-see TV item prohibiting charges for viewing TV in homes, and Senator Magnuson's request for an appropriation of up to a million dollars for each state for educational TV.

FOR MANY YEARS the only accurate method of evaluating a pilot's performance was to have an instructor watch his actions from a second seat in the plane. The Air Research and

Development Command has developed an observation method—a telemetry system—which now allows personnel on the ground to view the action in airborne single-seat jet interceptor aircraft; in essence, the new approach allows one to "look over the pilot's shoulder."

In this application of telemetry the picture on the pilot's radar scope is radioed to the ground. This is accomplished by a series of high-frequency radio signals. The signals received on the ground reproduce what is seen on the pilot's radar scope; thus both the pilot and ground personnel have essentially the same picture.

ARDC scientists have found that their new telemetry system duplicates, with extreme accuracy and fidelity, the actual radar scope picture.

Installation of the newly developed telemetry system in interceptor aircraft will result in better training for all-weather interceptor pilots. By means of telemetry, the pilot's instructor will be able, through voice communication, to instruct the student from the ground. In addition, the ground reproduction of the pilot's radar scope face will aid the instructor in measuring the student pilot's performance, thereby providing a medium for improving the training of all-weather interceptor pilots.

For details on the use of telemetry in the design and flight-testing of aircraft, see the feature story on page 37.

NEW TELEVISION STATION GRANTS

An additional listing of new construction permits and changes that have been made in station call letters. List continued next month.

STATE	CITY	CALL	CHANNEL	FREQUENCY	POWER*
Mississippi	Biloxi	—	13	210-216	3
"	Gulfport	—	56	722-728	21.47
Nebraska	Hay Spring	—	4	66-72	100
"	North Platte	—	2	54-60	2.8
South Carolina	Charleston	—	4	66-72	58
Texas	Amarillo	—	7	174-180	46
"	Monahans	—	9	186-192	27.5
Washington	Kennewick	—	25	536-542	8.22

* ERP = (effective radiated power, kw.)

this
Christmas
gift
is yours...

when you buy **SOUNDCRAFT TAPE**

fill your home with

♪ SOUNDS OF CHRISTMAS ♪

a high fidelity recording on your
own reel of Soundcraft Tape!

Adeste Fideles
Silent Night
Rudolph the Red
Nosed Reindeer
Noel
Jingle Bells
God Rest Ye
Merry Gentlemen

performed by
The Street Singer
Caroleers, orchestra and
chorus under the
direction of world famous
arranger-composer
Dewey Bergman.

The Spirit of Christmas
Captured in Sound! —
the best-loved of
traditional Christmas
melodies...joyous...
nostalgic...reverent...
as much a part of the
holiday season as
decorations on the tree!

A collector's item...
not for sale at any price
...this 15-minute
high fidelity recording
is yours FREE, except
for postage and
handling, when you buy
any 7" reel of
Soundcraft Tape. See
your Soundcraft dealer
now, or write us for
his name...he will tell
you how you can get
"SOUNDS OF CHRISTMAS"
recorded on your tape.
Not only the
"SOUNDS OF CHRISTMAS"
but the sounds of all
the year sound better
on Soundcraft Tape!



REEVES

SOUNDCRAFT

CORP.

10 E. 52nd St., New York 22
West Coast—338 N. LaBrea,
Los Angeles 36, Calif.

NOW! A TRUE COAXIAL SPEAKER SYSTEM: ONLY \$79.50

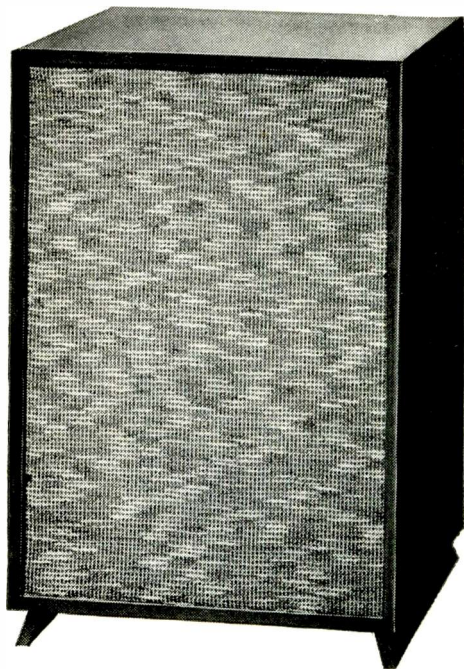

The Sonotone "110" Loudspeaker System

Only system in this price range to give you all these big-cabinet features:



True 2-speaker coaxial... 2 separate drivers... inductor-capacitor dividing network... full frequency range.

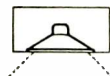

Speakers radiate *directly* for wide dispersion, true "presence"... cabinet can be placed *anywhere* in room.



"Rectilinear" vent enables startlingly vivid low-frequency performance equal to many larger-cabinet systems.



Hand-rubbed cabinet in choice of 3 fine finishes... ideal size for most homes (and for true 2-system stereo).

Interested? Wait till you *hear* it! Ask your dealer to demonstrate the "110." Send in the coupon below for full details!

Cabinet: 30" x 14" x 20"—Available in mahogany, blond or walnut hand-rubbed finish on birch. Shipped with CA-12 installed. Shipping weight: Approx. 50 lbs.

Price: **\$79.50**

Slightly higher in the West

Speaker: CA-12 12-inch coaxial
Power handling capacity 10 watts
Frequency range 40-14,000 cycles
Resonant frequency 50 cycles
Crossover frequency 2000 cycles
Impedance 50 ohms
Flux density 12,000 gauss

SONOTONE® CORPORATION

Electronic Applications Division
Dept. LN-117
Elmsford, N. Y.

Sirs: Please send me full details on the "110" loudspeaker system.

Name _____

Address _____

City _____ Zone _____ State _____

PAY-SEE TV was soundly scored by the American Veterans of World War II during their recent annual convention in Boston.

In a strongly worded resolution on toll-TV, representatives of AMVETS asked the FCC to return the issue to Congress and, in addition, requested that Congress table all legislation which would change the fundamental system of broadcasting in this country.

According to Dominick L. Strada, national commander of AMVETS, pay-TV could . . . "black out many of the free programs now seen by veterans at hospitals. We have no enforceable or legal assurances from the promoters of pay television that the free shows they now see could be continued without charge."

Continuing, the spokesman for the veterans said that . . . "Once pay TV is initiated, the major advertisers who now pay for the free TV entertainment given the American public will withdraw their support . . . since they will be unable to successfully advertise their products to large number of people in the better evening hours. . . ."

Without advertising revenue, the resolution said, public service shows, news, programs of the Armed Forces, government, veteran, and public affairs meetings would disappear.

A PLANE FOR FLIGHT CHECKING airways aids in Spain is now being equipped by the CAA in Washington.

The plane, a C-47 which the Spanish government bought in this country, will be equipped with about \$100,000 worth of electronic and recording equipment for its work in the "Protection of Flight" section of the Spanish Ministry of Air. The project is being financed by the International Cooperation Administration as part of U. S. aid to Spain.

Equipment being installed is similar to that used in standard CAA flight check planes, with additional equipment necessitated by the facilities in use abroad.

THREE SPECIAL CONSOLES to calibrate radio-frequency voltmeters for science and industry have been developed by the Bureau of Standards experts and installed in the calibration center in Boulder, Colorado.

With these new voltmeters, it will be possible to calibrate for any practical voltage level starting with .2 volt at discrete frequencies of 30, 100, 300, and 1000 kc. and 5, 10, 30, 100, 300, 400, 500, and 700 mc.

Salient feature of the system is the application of the AT voltmeter, the most stable radio-frequency voltage reference standard known to date (See "Stable Radio-Frequency Voltmeters" in the *NBS Technical News Bulletin* for February, 1956). This voltmeter can reproduce calibration data to ± 1 per-cent or better over a period of one year or longer. To make good use of such a standard, sources of error in

(Continued on page 120)

IT'S NEW! Send for this

FREE

booklet today!

see
 what the
 rapidly
 expanding
 field of
ELECTRONICS

offers
you

- BETTER JOB
- BETTER PAY
- PROMOTION
- GREATER SECURITY
- GREATER CONFIDENCE
- BETTER LIVING FOR YOU AND YOUR FAMILY

All these benefits can be yours if you act now! Take that first big step this minute —No obligation whatsoever!

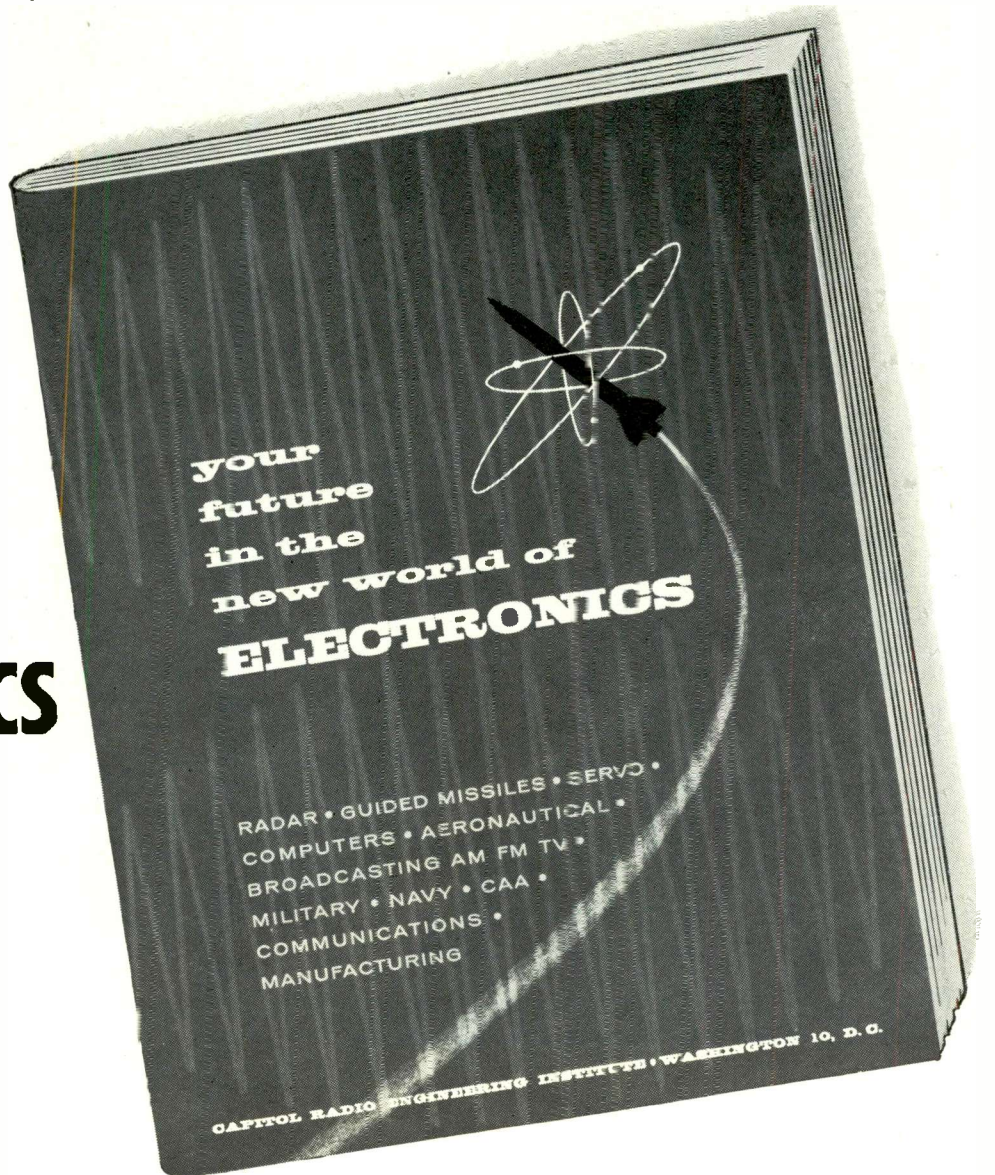

TAKE A MINUTE TO MAIL THIS COUPON FOR FREE BOOKLET !

CAPITOL RADIO ENGINEERING INSTITUTE
 Accredited Technical Institute Curricula Founded 1927
 Dept. 1111-D, 3224—16th St., N. W., Washington 10, D. C.

Please send me your course outline and FREE illustrated Booklet "Your Future in the New World of Electronics" . . . describing opportunities and CREI home study course in Practical Electronics Engineering.

CHECK FIELD OF GREATEST INTEREST } Electronic Engineering Technology
 Broadcast (AM, FM, TV) Engineering Technology
 Television Engineering Technology
 Aeronautical Electronic Engineering Technology

Name Age

Street

City.....Zone..... State.....

CHECK: Home Study Residence School Korean Veteran

To help us answer your request intelligently, please give the following information:

EMPLOYED BY.....

TYPE OF PRESENT WORK.....

SCHOOL BACKGROUND.....

ELECTRONICS EXPERIENCE.....

IN WHAT BRANCH OF ELECTRONICS ARE YOU MOST INTERESTED?



99.75 net

NEW 12" PRECISION TURNTABLE

OUTSTANDING FEATURES

Four speeds, each with +3% speed adjustment. Built-in illuminated strobe disk for all speeds. Built-in level bubble and leveling screws. Precision 4-pole motor, extra-compliant belt-drive and idler system plus exclusive Thorens Roto-Drive principle, provide complete vibration isolation, absolutely constant speed. Provision for easily changing arms without leaving unsightly permanent marks—just replace low-cost arm mounting board, available for 12" or 16" arms in various finishes. Easy to mount, the TD-124 requires only 2 3/4" clearance below mounting board. Furnished with attached line cord, shielded cable and solder plate.

Gyro-like Roto-Drive gives new Thorens TD-124 absolute speed uniformity. Heavier than 16-inch turntables, yet it starts, stops in less than 2/3 turn!

How to get the heaviest possible turntable for smooth, absolutely quiet operation without sacrificing fast starts and stops.

That's the problem Thorens engineers faced when they set out to build the best four-speed, 12-inch, hi-fi turntable money can buy. You'll be amazed at the simplicity of their solution.

The new TD-124 really has two turntables in one: (1) a heavy 10-lb. rim-concentrated, cast-iron flywheel (outweighs 16" aluminum turntables) (2) a light aluminum cover, or turntable proper. An exclusive, Thorens-originated clutch couples or decouples the light aluminum table to the heavy flywheel for instant starts and stops. What's more, the Thorens double turntable system gives you the weight of a cast-iron table (3 times as heavy as aluminum) without danger of attracting any pickup magnet. And with this unique construction, your pickup gets magnetic shielding from motor or transformer hum fields by the iron turntable.

Ask your hi-fi dealer to show you the Thorens TD-124. Better yet, arrange to hear one of those critical, slow piano records on the TD-124. If you don't know who your dealer is, write Thorens Company, Dept. R117, New Hyde Park, N. Y. 79.



THORENS

SWISS MADE PRODUCTS

HI-FI COMPONENTS · LIGHTERS · SPRING-POWERED SHAVERS · MUSIC BOXES

RADIO & TV NEWS

Prepare for a Good Paying Job—Or Your Own Business

Learn PRACTICAL RADIO-TV
with **25 BIG KITS**

of equipment I send you while
you train with me . . . for valuable
shop bench experience . . .

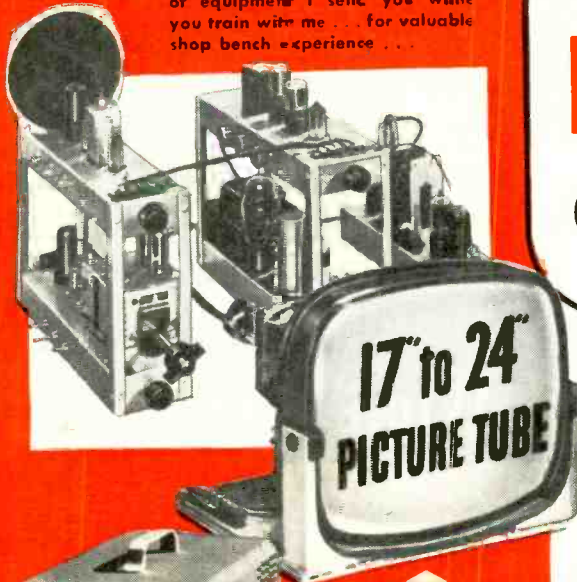

This is the new Sprayberry Training
Television receiver, built and tested
in sections for greatest instruction
value.

I now offer this fine modern oscil-
loscope to help you learn practical
Television servicing.

You will build this powerful short
wave and broadcast superhet radio
receiver for valuable shop instruc-
tion practice.

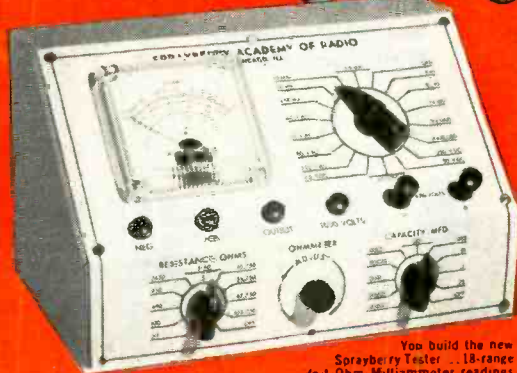
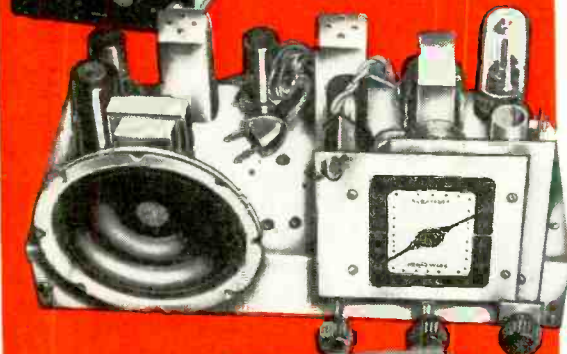

You build the new
Sprayberry Tester . . . 18-range
10-1-Ohm-Milliammeter readings
plus output meter and condenser
and resistor substitution selector.

Average cost per lesson
ONLY \$3.42
Including Kits and Equipment

"I Will Train You at Home in RADIO-TELEVISION

On Liberal No Obligation Plan!"

**New Equipment! New Lessons! Enlarged
Course! The true facts are yours in my
big new catalog . . . YOURS FREE . . .**

JUST MAIL COUPON!

I can train and prepare you in as little as 10 months to step into the big opportunity Radio-Television service field. Train *without* signing a binding contract . . . without obligating yourself to pay any regular monthly amounts. You train entirely at home in spare hours . . . you train as fast or as slowly as you wish. You'll have your choice of **THREE SPRAYBERRY TRAINING PLANS** . . . planned for both beginners as well as the more experienced man. Get the true facts about the finest most modern Radio-Training available today . . . just mail the coupon for my big new 56 page fact-filled catalog plus sample lesson—both **FREE**.



Frank L. Sprayberry
Educational Director

Train the Practical Way—with Actual Radio-Television Equipment

My students do better because I train both the mind and the hands. Sprayberry Training is offered in 25 individual training units, each includes a practice giving kit of parts and equipment . . . all yours to keep. You will gain priceless practical experience building the specially engineered Sprayberry Television Training Receiver, Two-Band Radio Set, Signal Generator, Audio Tester and the new Sprayberry 18 range Multi-Tester, plus other test units. You will have a complete set of Radio-TV test equipment to start your own shop. My lessons are regularly revised and every important new development is covered. My students are completely trained Radio-Television Service Technicians.

NEWEST DEVELOPMENTS

Your training covers U H F, Color Television, F M, Oscilloscope Servicing, High Fidelity Sound and Transistors.

See for Yourself... Make Your Own Decision ... Mail Coupon Today!

The coupon below brings you my big new catalog plus an actual sample Sprayberry Lesson. I invite you to read the facts . . . to see that I actually illustrate every item I include in my training. With the facts in your hands, you will be able to decide. *No salesman will call on you.* The coupon places you under no obligation. Mail it now, today, and get ready for your place in Radio-Television.

SPRAYBERRY ACADEMY OF RADIO-TELEVISION
1512 Jarvis Avenue, Dept. 25-U, Chicago 26, Illinois

Mail This Coupon For Free Facts and Sample Lesson

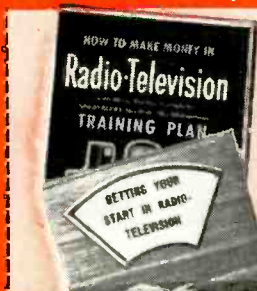

SPRAYBERRY ACADEMY OF RADIO-TELEVISION
1512 Jarvis Ave., Dept. 25-U, Chicago 26, Ill.

Please rush all information on your **ALL-NEW Radio-Television Training Plan**. I understand this does not obligate me and that no salesman will call upon me. Include New Catalog and Sample Lesson **FREE**.

Name _____ Age _____

Address _____

City _____ Zone _____ State _____



what's so different about Wigo speakers?

plenty.....

to this 12" extended range Wigo (\$59.50) ...

you can add cone tweeter array (\$20.00) — or buy the complete two-way system initially (\$79.50)

Prices slightly higher West of Rockies

25 to 18,000 cps.

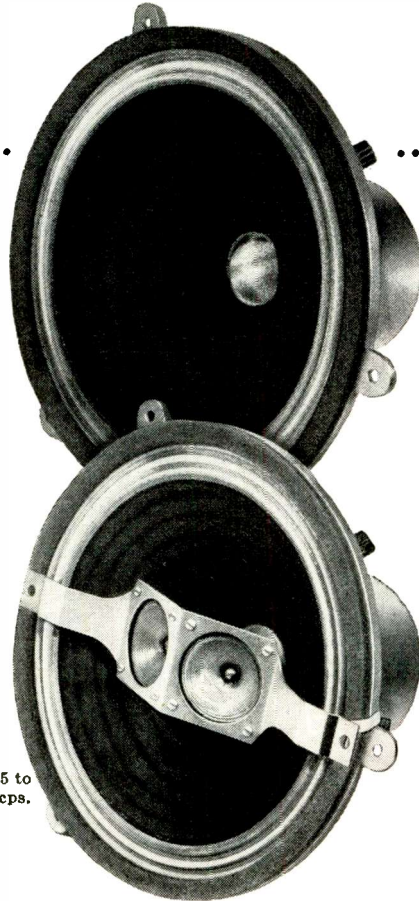

....their exclusive

**"CLIMATE-PROOF-
CONSTANT RESPONSE**

voice coil and cone suspension" assures you of constantly fine sound quality ... whether you're in Maine or Florida! Cast aluminum frame and hyperbolic cone design mark the Wigo as a *premium quality* speaker. All this ... plus the fact that the Wigo way is a wonderful way for your hi-fi system to grow up! It lets you enjoy the best quality *now* ... and all the quality you'd ever want *in the future!* It's worth listening to a Wigo! Write for catalog.

expand further with other Wigo additions ... 8" mid-range Wigo



16" super-woofer



wonderful **WIGO** speakers

United Audio Products (Div. of United Optical Mfg. Corp.), 202 East 19th Street, New York 3, N. Y.

RCA offers you the
 finest training
 at home in
Radio-TV
 electronics,
TV servicing,
Color TV



**SEND FOR THIS FREE
 BOOK NOW!**

Pay-as-you-learn. You need pay for only one study group at a time. Practical work with very first lesson. All text material and equipment is yours to keep. Courses for the beginner and advanced student.



RCA INSTITUTES, INC.
 A SERVICE OF RADIO CORPORATION of AMERICA
 350 WEST FOURTH STREET, NEW YORK 14, N.Y.
 in Canada—RCA Victor Company, Ltd.,
 5001 Cote de Liesse Rd., Montreal 9, Que.

RCA Institutes, Inc., Home Study Dept. N-117
 350 West Fourth Street, New York 14, N. Y.
 Without obligation, send me FREE 52 page CATALOG on Home Study Courses in Radio, Television and Color TV. No Salesman will call.

Name.....
 Please Print

Address.....

City..... Zone..... State.....

KOREAN VETS! Enter discharge date.....

To save time, paste coupon on postcard

what
could
be
more
exciting



to a
high
fidelity
enthusiast?



new
GLASER-STEERS **GS** *Seventy Seven**

the fully automatic record changer with turntable quality performance

At last — what every audiophile has been waiting for — the convenience of a fully automatic record changer with the performance quality of a transcription turntable.

The new GS-77 provides a quality of performance unsurpassed by turntables up to double the price. Flutter and wow are virtually non-existent. Rumble has, for all practical purposes, been eliminated. And as for automatic conveniences — it is, without doubt, the most advanced record changer of our time.

There is more originality in the GS-77 than in all other changers combined! See for yourself.

'SPEEDMINDER'*...the amazing GS-77 feature that automatically selects correct turntable speed, and gives you record and stylus protection no other changer can equal.

You simply set the indicator to **'SPEEDMINDER'** and automation takes over . . .

- with the standard groove stylus in play position, the changer automatically plays at 78 rpm.
- with the microgroove stylus in position, the changer automatically intermixes and plays 33 and 45 rpm records without regard to speed, size, or sequence.

TURNTABLE PAUSES during change cycles and doesn't resume motion until next record has come into play position and stylus is in lead-in groove. Eliminates record surface wear caused by grinding action of record dropping on moving disc—a common draw-back in other changers. And the change cycle lasts only 5 seconds — fastest in the field.

* Trademark

† Patents Pending

Every feature† spells—Greater Convenience and Better Performance — The ARM is shock suspended and damped, effecting complete acoustical isolation from deck plate and motor and practically eliminating resonance. An accessible vernier control adjusts stylus pressure to match any cartridge requirements. Once adjusted, the variation of stylus pressure between the first and tenth record on the table does not exceed 1 gram. Transcription arm convenience includes: finger lift for manual play, as well as indicator to facilitate location of stylus in groove. The MOTOR is 4-pole induction, dynamically balanced, hum shielded and shock mounted — all to assure accurate, constant speed, and smooth operation.

The IDLER and other rotating parts are precisely centered and mounted on low friction bearings. Idler automatically disengages in 'off' position. Prevents flat spots and wow. MUTING SWITCH and R/C filter network squelch all annoying sounds.

The GS-77 is absolutely jam-proof — built for years of trouble-free performance. A single knob controls all automatic and manual operations. The changer is pre-wired for easy installation, and is dimensioned to replace most changers.

less cartridge and base — **ONLY \$59⁵⁰**

Styling of the new GS-77 is gracefully simple — enhanced by its ebony and brushed gold finish and oyster white turntable mat. For a thrilling experience — see it — hear it at your high fidelity dealer. Descriptive literature available on request. Dept. RTN-11.

GLASER-STEERS CORP. 20 Main Street, Belleville 9, N. J.
In Canada: Glaser-Steers of Canada, Ltd., Trenton, Ontario.
Export Div.: M. Simons & Son, Co., Inc., New York 7, N. Y.

Cast your ballot for a successful future!

256 I. C. S. COURSES



Whether you stand at a machine or sit at a desk . . . whether you're making \$75 a week or \$75 hundred a year . . . whether your interest is Power Plants or Paper Pulp, Advertising or Electronics . . . chances are I. C. S. has exactly the course you need to get ahead.

I. C. S. is not only the oldest and largest correspondence school. It also offers the most courses. 256 in all. Each one success-proved by graduates who rose to top technical and administrative positions. Chief engineers. Superintendents. Foremen. Managers. Executive assistants.

I. C. S. Courses cover bedrock facts and theory plus practical, on-the-job applications. No skimping. Texts

are prepared by leading business and industrial authorities working with I. C. S. editors and educators. They are constantly being reviewed and revised in line with current developments.

As an I. C. S. student, you study in your spare time, set your own pace. No time lost getting to class or waiting for slower students to catch up. If you wish, I. C. S. will make progress reports to your employer. You win recognition as a "comer," one who is ready to move ahead. Thousands of students report pay increases and promotions within a few months of enrollment. All graduates win the coveted, approved I. C. S. diploma.

3 FREE BOOKS! Check the subject that interests you in the coupon below. I. C. S. will rush you (1) a special book outlining your opportunities in this field, (2) the 32-page gold mine of career tips, "How to Succeed," (3) a sample I. C. S. lesson (Math.) demonstrating the famous "I. C. S. Method." "X" MARKS OPPORTUNITY.



For Real Job Security—Get an I. C. S. Diploma! I. C. S., Scranton 15, Penna.

Accredited Member,
National Home Study Council

INTERNATIONAL CORRESPONDENCE SCHOOLS



BOX 23147K, SCRANTON 15, PENNA.

Without cost or obligation, send me "HOW TO SUCCEED" and the opportunity booklet about the field BEFORE which I have marked X (plus sample lesson):

ARCHITECTURE and BUILDING CONSTRUCTION

- Air Conditioning
- Architecture
- Arch. Drawing and Designing
- Building Contractor
- Building Estimator
- Carpentry and Millwork
- Carpenter Foreman
- Heating
- Interior Decoration
- Painting Contractor
- Plumbing
- Reading Arch. Blueprints

ART

- Commercial Art
- Magazine & Book Illus.
- Show Card and Sign Lettering
- Sketching and Painting

AUTOMOTIVE

- Automobiles
- Auto Body Rebuilding and Refinishing
- Auto Engine Tuneup
- Auto Technician

AVIATION

- Aero-Engineering Technology
- Aircraft & Engine Mechanic

BUSINESS

- Accounting
- Advertising
- Business Administration
- Business Management
- Cost Accounting
- Creative Salesmanship
- Managing a Small Business
- Professional Secretary
- Public Accounting
- Purchasing Agent
- Salesmanship
- Salesmanship and Management
- Traffic Management

CHEMICAL

- Analytical Chemistry
- Chemical Engineering
- Chem. Lab. Technician
- Elements of Nuclear Energy
- General Chemistry
- Natural Gas Prod. and Trans.
- Petroleum Prod. and Engr.
- Professional Engineer (Chem)
- Pulp and Paper Making

CIVIL ENGINEERING

- Civil Engineering
- Construction Engineering
- Highway Engineering
- Professional Engineer (Civil)
- Reading Struc. Blueprints
- Structural Engineering
- Surveying and Mapping

DRAFTING

- Aircraft Drafting
- Architectural Drafting
- Drafting Machine Design
- Electrical Drafting
- Mechanical Drafting
- Sheet Metal Drafting
- Structural Drafting

ELECTRICAL

- Electrical Engineering
- Elec. Engr. Technician
- Elec. Light and Power
- Practical Electrician
- Practical Lineman
- Professional Engineer (Elec)

HIGH SCHOOL

- High School Diploma

- Good English
- High School Mathematics
- Short Story Writing

LEADERSHIP

- Industrial Foremanship
- Industrial Supervision
- Personnel-Labor Relations
- Supervision

MECHANICAL and SHOP

- Diesel Engines
- Gas-Elec. Welding
- Industrial Engineering
- Industrial Instrumentation
- Industrial Metallurgy
- Industrial Safety
- Machine Design
- Machine Shop Practice
- Mechanical Engineering
- Professional Engineer (Mech)
- Quality Control
- Reading Shop Blueprints
- Refrigeration and Air Conditioning
- Tool Design
- Tool Making

RADIO, TELEVISION

- General Electronics Tech.

- Industrial Electronics
- Practical Radio-TV Eng'r'g
- Practical Telephony
- Radio-TV Servicing

RAILROAD

- Car Inspector and Air Brake
- Diesel Electrician
- Diesel Engr. and Fireman
- Diesel Locomotive

STEAM and DIESEL POWER

- Combustion Engineering
- Power Plant Engineer
- Stationary Diesel Engr.
- Stationary Fireman

TEXTILE

- Carding and Spinning
- Cotton Manufacture
- Cotton Warping and Weaving
- Loom Fixing Technician
- Textile Designing
- Textile Finishing & Dyeing
- Throwing
- Warping and Weaving
- Worsted Manufacturing

Name _____ Age _____ Home Address _____
 City _____ Zone _____ State _____ Working Hours _____ A.M. to P.M. _____
 Occupation _____

Canadian residents send coupon to International Correspondence Schools, Canadian, Ltd., Montreal, Canada. . . . Special tuition rates to members of the U. S. Armed Forces.

"CHECKUP"

at RCA

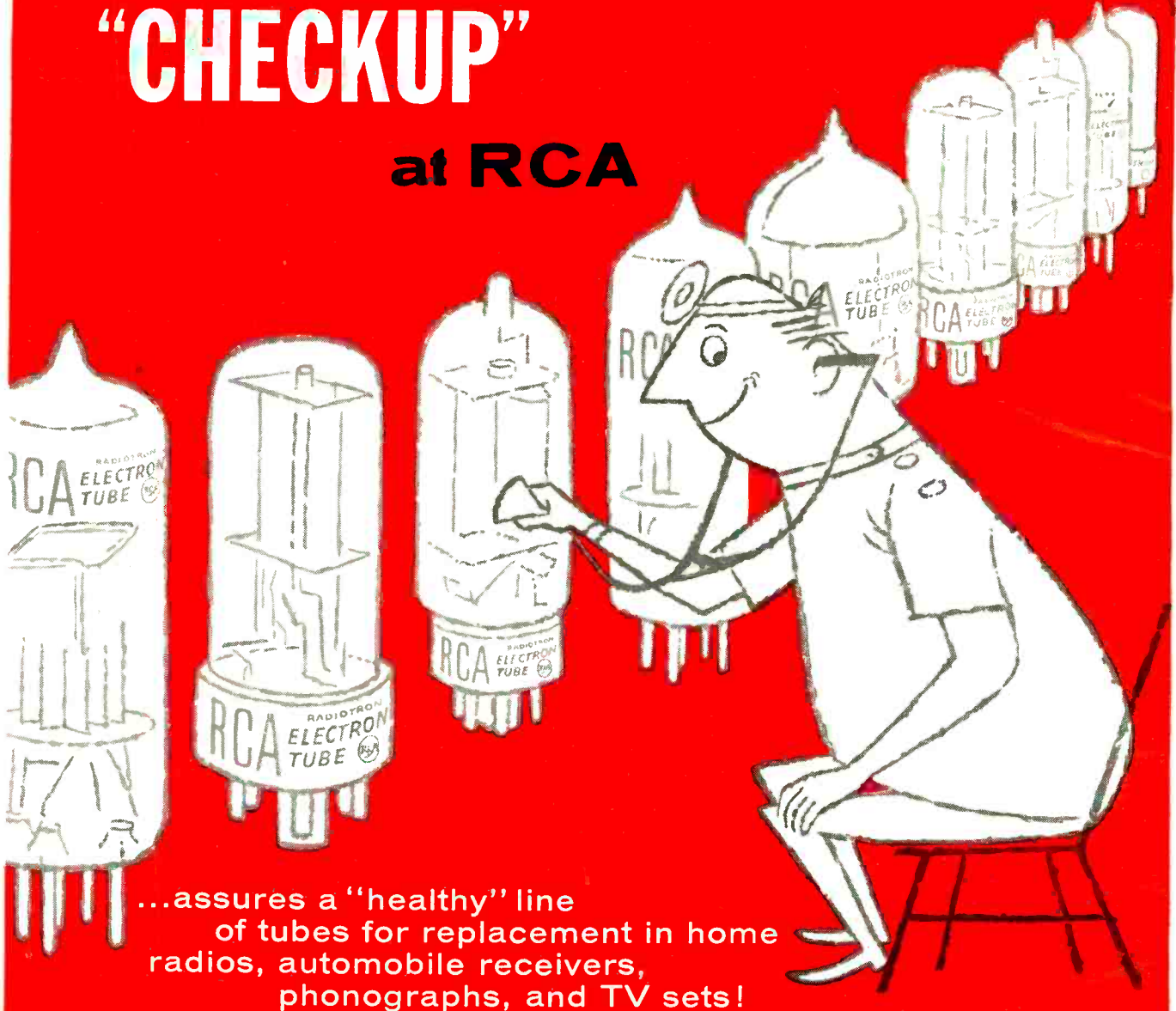

...assures a "healthy" line of tubes for replacement in home radios, automobile receivers, phonographs, and TV sets!

Fast service, efficient service—without time-taking callbacks due to early hour tube failures—are the vitamins, minerals, proteins and plasma of the healthy service business. "Out-of-the-carton" and "right-into-the-set" is the service dealer's dream. And RCA's rigid program of production-line testing and warehouse sampling converts it to reality.

Tests for shorts, heater-cathode leakage, and transconductance help weed-out the weaklings—assure superior-quality tubes. And where low noise and low microphonics are essential to top performance, certain tubes undergo visual and acoustic tests. Before RCA tubes are put into the famous red-and-black RCA carton they are tested all over again at the warehouse for "solid" shorts "flicker" shorts, and continuity. Add to this RCA's quality monitor: microscopic inspection of welds, seals, stems, and electrodes of all popular-types and new-type receiving tubes used in black-and-white and color-TV sets, and automobile receivers...and you have powerful reasons why RCA tubes are preferred by manufacturers of electronic equipment and by you who service it. So, never ask your distributor for "tubes" alone. Always specify: RCA TUBES!

Your "Profit Builders" Catalog

...now available from your RCA TUBE DISTRIBUTOR... lists and describes the many promotional, business, service, and technical aids RCA offers to service dealers. Get your copy and start building more profits right away.



RECEIVING TUBES
RADIO CORPORATION OF AMERICA

Electron Tube Division • Harrison, N. J.

Learn TELEVISION-RADIO

Servicing or Communications
by Practicing at Home
in Spare Time

WITHOUT EXTRA CHARGE you get special NRI kits developed to give actual experience with TV-Radio equipment. You build, test experiment with receiver or broadcasting circuits. All equipment yours to keep.



NRI Has Trained Thousands for Successful Careers in TV-Radio

Have the High Pay, Prestige, Good Future of a Skilled TV-Radio Technician

People look up to and depend on the Technician, more than ever before. Offices, plants, homes everywhere are obliged to buy his knowledge and services. His opportunities are great and are increasing. Become a TV-Radio Technician. At home, and in your spare time, you can learn to do this interesting, satisfying work—qualify for important pay. To ambitious men everywhere here in the fast growing Television-Radio field is rich promise of fascinating jobs, satisfaction and prestige as well as increasing personal prosperity.

Increased Opportunities in Growing Field

A steady stream of new Electronic products is increasing the job and promotion opportunities for Television-Radio Technicians. Right now, a solid, proven field of opportunity for good pay is servicing the tens of millions of Television and Radio sets now in use. The hundreds of TV and Radio Stations on the air offer interesting jobs for Operators and Technicians.

More Money Soon—Make \$10 to \$15 a Week Extra Fixing Sets in Spare Time

NRI students find it easy and profitable to start fixing sets for friends and neighbors a few months after enrolling. Picking up \$10, \$15 and more a week gives substantial extra spending money. Many who start in spare time soon build full time TV-Radio sales and service businesses.

Act Now—See What NRI Can Do for You

NRI has devoted over 40 years to developing simplified practical training methods. You train at home. Get practical experience, learn-by-doing. Address: NATIONAL RADIO INSTITUTE, Washington 16, D. C.



Studio Engr., Station KATV
 "I am now Studio Engineer at Television Station KATV. Before enrolling for the NRI Course, I was held back by limitation of a sixth grade education." **BILLY SANCHEZ, Pine Bluff, Ark.**

Has All the Work He Can Do
 "Since finishing NRI Course I have repaired more than 2,000 TV and Radio sets a year. NRI training certainly proved to be a good foundation." **H. R. GORDON, Milledgeville, Ga.**

Has Good Part Time Business
 "Quite early in my training I started servicing sets. Now have completely equipped shop. My NRI training is the backbone of my progress." **E. A. BREDA, Tacoma, Wash.**

The Tested Way To Better Pay **See Other Side** 
CUT OUT AND MAIL CARD NOW

SAMPLE LESSON AND CATALOG BOTH FREE

NO STAMP NEEDED!
WE PAY POSTAGE

This card entitles you to Actual Lesson on Servicing, shows how you learn Television-Radio at home. You'll also receive 64-Page Catalog.

NATIONAL RADIO INSTITUTE, Dept. A B Washington 16, D. C.

Please mail me the FREE sample lesson and 64-Page Catalog. (No Salesman will call.)

Name..... Age.....

Address.....

City..... Zone..... State.....

ACCREDITED MEMBER, NATIONAL HOME STUDY COUNCIL



**Technical "KNOW-HOW" Can Give You Interesting, Important Work
LEARN-BY-DOING with Kits NRI Sends at No Extra Charge**



YOU BUILD AC-DC Superhet Receiver

NRI Servicing Course includes all needed parts. By introducing defects you get actual servicing experience practicing with this modern receiver. Learn-by-doing.

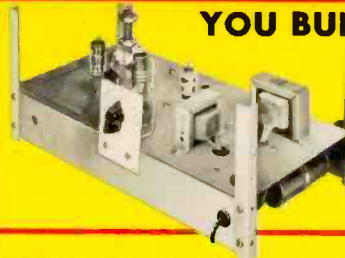

YOU BUILD Signal Generator

You build this Signal Generator. Learn how to compensate high frequency amplifiers, practice aligning typical I.F. amplifiers in receiver circuits. Make tests, conduct experiments.

YOU BUILD Broadcasting Transmitter

As part of NRI Communications Course you build this low power Transmitter, learn commercial broadcasting operators' methods, procedures. Train for your FCC Commercial Operator's License.



YOU BUILD Vacuum Tube Voltmeter

Use it to earn extra cash fixing neighbors' sets; bring to life theory you learn from NRI's easy-to-understand texts.



For Higher Pay, Better Jobs Be a Television-Radio Technician



Servicing Needs More Trained Men

Portable TV, Hi-Fi, Transistor Radios, Color TV are making new demands for trained Technicians. Good opportunities for spare time earnings or a business of your own.



J. E. Smith, Founder

Train at Home the NRI Way Famous for Over 40 Years

NRI is America's oldest and largest home study Television-Radio school. The more than 40 years' experience training men for success, the outstanding record and reputation of this school—benefits you in many ways. NRI methods are tested, proven. Successful graduates are everywhere, from coast to coast, in small towns and big cities. You train in your own home, keep your present job while learning. Many successful NRI men did not finish high school. Let us send you an actual lesson, judge for yourself how easy it is to learn.

Broadcasting Offers Satisfying Careers

4000 TV and Radio stations offer interesting positions. Govt. Radio, Aviation, Police, Two-Way Communications are growing fields. Trained Radio-TV Operators have a bright future.



No Experience Necessary—NRI Sends Many Kits for Practical Experience

You don't have to know anything about electricity or Radio to understand and succeed with NRI Courses. Clearly written, well-illustrated NRI lessons teach TV-Radio-Electronic principles. You get NRI kits for actual experience. All equipment is yours to keep. You learn-by-doing. Mailing the postage-free card may be one of the most important acts of your life. Do it now. Reasonable tuition. Low monthly payments available. Address: NATIONAL RADIO INSTITUTE, Washington 16, D. C.

NRI Graduates Do Important Work



Now Quality Control Chief
"Had no other training in Radio before enrolling, obtained job working on TV amplifiers before finishing course. Now Quality Control Chief." T. R. FAVALORO, Norwich, N. Y.

NRI Course Easy to Understand
"I opened my own shop before receiving my diploma. I have had to hire extra help. I am independent in my own business." D. P. CRESSEY, Stockton, Cal.

Works on Color-TV
"NRI changed my whole life. If I had not taken the course, probably would still be a fireman, struggling along. Now Control Supervisor at WRCA-TV." J. F. MELINE, New York, N. Y.

FIRST CLASS
Permit No. 20-R
(Sec. 34.9, P. L. & R.)
Washington, D.C.

BUSINESS REPLY CARD

No Postage Stamp Necessary if Mailed in the United States

POSTAGE WILL BE PAID BY

NATIONAL RADIO INSTITUTE

Washington 16, D. C.

**SAMPLE LESSON
64-page CATALOG
both FREE**

**See Other Side
for more
information on
the Tested Way
to Better Pay**

Practical CBS Transistor Home-Study Course

Learn all about transistors by using them



PREPARE NOW FOR THE FUTURE!

Let's face it. Transistors are here . . . now! Advancement opportunities are waiting for those who know all about their basic fundamentals. Are *you* ready?

This new, profusely illustrated Transistor Home-Study Course, a CBS first, was written to make it easy for you to learn by using transistors. Service-dealers . . . technicians . . . and engineers find this residence-course-at-home both fast and fascinating. What you learn you remember because you do it yourself . . . by making several practical transistor devices which you can keep and use. Course was written for CBS by A. C. W. Saunders, a well-known educator and author.

Check the table of contents. Then read how easy it is for you to start your Transistor Course today.

CBS Transistor Course Includes

- Ten intensive lessons (with 3-ring binder) . . . up-to-date, complete
- Simplified basic theory . . . how transistors work
- Practical experiments and servicing techniques for: Amplifiers . . . applications in all fundamental circuits
Oscillators . . . a-f, r-f, relaxation, multivibrator, special TV
Rectifiers . . . diode and transistor rectifiers and detectors
Practical commercial applications . . . immediate and future
- With free correction and consulting service . . . and up-to-date supplements for certified graduates

HOW TO GET IT

Call your CBS Tube distributor. He'll tell you how to get the CBS Transistor Home-Study Course, PA-175. See him, or write us . . . today!



CBS - HYTRON, Danvers, Mass.
A Division of
Columbia Broadcasting System, Inc.



In high fidelity

are
you
sure
you
have
the best?

The principles of servo-mechanisms have been widely used for years . . . in automation, for example, to check the output and correct errors before they can even begin. For years, too, audio engineers have known that servo techniques could be applied to sound systems. Yet nowhere has this principle been engineered into speaker systems where it could correct distortion where it *must* be corrected — in the output sound. Many companies knew the advantages. None built a servo-speaker system which you could buy.

Not until Integrand.

The Integrand is a new speaker-amplifier system. Totally new. There is much to tell: about its Servo-Speaker operation . . . its original speaker design . . . its transformerless, direct coupled amplifiers . . . its transistor crossovers and amplifiers . . . stereo . . . and about the 2,000-hour unconditional guarantee. In short, the whole story of

INTEGRAND[®]
SERVO SPEAKER AMPLIFIER SYSTEM

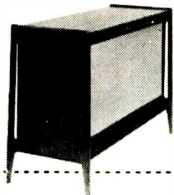

*you'll want all
the details. Clip
and mail this
coupon . . . now!*

To: **BRAND PRODUCTS, INC.**
Westbury, N. Y.

Please send me the full story about the Integrand.

NAME

ADDRESS

CITY..... ZONE ... STATE

XII

Within the Industry

ARTHUR F. BALDENSPERGER, JR., has been appointed to the newly created position of management development coordinator, sales, for *CBS-Hytron*, a division of *Columbia Broadcasting System, Inc.*



According to the company, this move was made necessary by the expansion of the department. Mr. Baldensperger's background is said to amply qualify him to coordinate the sales training and management development activities of the firm's replacement, original equipment, and internal sales activities.

He is an alumnus of Dartmouth and New York State University and was formerly associated with *Sylvania Electric Products*.

* * *

DR. IRVING LANGMUIR, world famous scientist, died at Falmouth, Mass. recently at the age of 76.

The Nobel-prize winning scientist, often regarded as one of the scientific geniuses of modern times, was on the staff of the *General Electric* research laboratory from 1909 until his retirement in 1950.

During his long career with the firm, his researches were estimated to have saved the American public nearly one billion dollars per year in electric light bills, helped establish modern radio and television broadcasting, helped safeguard the lives of soldiers in battle, and, more recently, provided man with a key to possible control of the weather.

For his accomplishments, Dr. Langmuir received the world's top-ranking scientific awards, including the Nobel Prize in chemistry, granted to him in 1932.

* * *

REGINALD G. SCHULER has been named general engineering manager of *Brush Electronics Company*, a division of *Clevite Corporation*.



For the past two years he has served as director of engineering of the *Badger Meter Manufacturing Company*. Previously, he was for seven years research director of the *Victor Adding Machine Company* and before that was chief of the research department of the *Teletype Corporation*.

A recipient of B.S. and E.E. degrees from Armour Institute of Technology,

Mr. Schuler is a member of the Institute of Radio Engineers, the Western Society of Engineers, and the Physics Club of Chicago.

In his new post, he will be fully responsible for the direction of the company's product engineering program.

* * *

INDUSTRO TRANSISTOR CORPORATION

announces the completion of its initial transistor manufacturing facility located at 87-31 Britton Avenue, Elmhurst, N. Y. . . . **REK-O-KUT COMPANY, INC.**, is now located at 38-19 108th Street, Corona, N. Y. . . . The carrier-microwave department of **WESTINGHOUSE ELECTRIC CORPORATION** has expanded its facilities in Halethorpe, Md., by constructing a new, modern office building adjacent to the manufacturing plant . . . **MINNEAPOLIS-HONEYWELL REGULATOR COMPANY** has announced the leasing of a new \$300,000.00 plant in Fall River, Mass., for production of a new line of electronic industrial controls. The new plant is to be a manufacturing unit of the industrial division . . . **STACKPOLE CARBON COMPANY** has opened a large scale magnet production facility in a new 37,000 square foot plant in Kane, Pennsylvania . . . **JFD ELECTRONICS CORP.** is presently fabricating its own aluminum tubing in a new 10,000 square foot mill . . . **ELECTRONIC ENGINEERING COMPANY OF CALIFORNIA** has purchased 530,000 square feet of land in Santa Ana, Calif., for the expansion of its own facilities and for the construction of a new plant for its subsidiary, **THE ENGINEERED ELECTRONICS COMPANY** . . . An acre and a half is being added to the main plant of **DUKANE CORPORATION** . . . **MAGNECORD DIVISION OF MIDWESTERN INSTRUMENTS, INC.** is being moved from Chicago to Tulsa, Okla. . . . The components division of **INTERNATIONAL TELEPHONE AND TELEGRAPH CORP.** is launching a new manufacturing operation in Palo Alto, Calif. The new plant is at 815 South San Antonio Road and contains approximately 8000 square feet of manufacturing space with a two-story office structure attached.

* * *

SALES MANAGERS' CLUB, Eastern Group, has been incorporated as Producers of Associated Components for Electronics, Inc., with a membership composed of electronic parts and equipment manufacturers located east of the Mississippi River.

The new organization continues as co-sponsor of the annual Electronic Parts Distributors' Show in Chicago. Its offices are located at 261 Broad-

RADIO & TV NEWS

**GREATEST
ADVANCE IN
SHOP-METHOD
HOME TRAINING**

EARN MORE MONEY...GET INTO TELEVISION ELECTRONICS-RADIO

Learn ALL 8 PHASES in ONE MODERN HOME-STUDY COURSE
At Home - In Spare Time

YOU GET ALL THIS NEWEST PRACTICAL EQUIPMENT

- Parts to build a modern TV set, including all tubes plus a large screen Picture Tube
- Parts to build a powerful Superhet Receiver, standard broadcast and short wave
- Parts to conduct many experiments and build Continuity Checker, RF Oscillator, TV Circuits, Audio Oscillator, TRF Receiver, Signal Generator
- A Valuable Professional Multitester

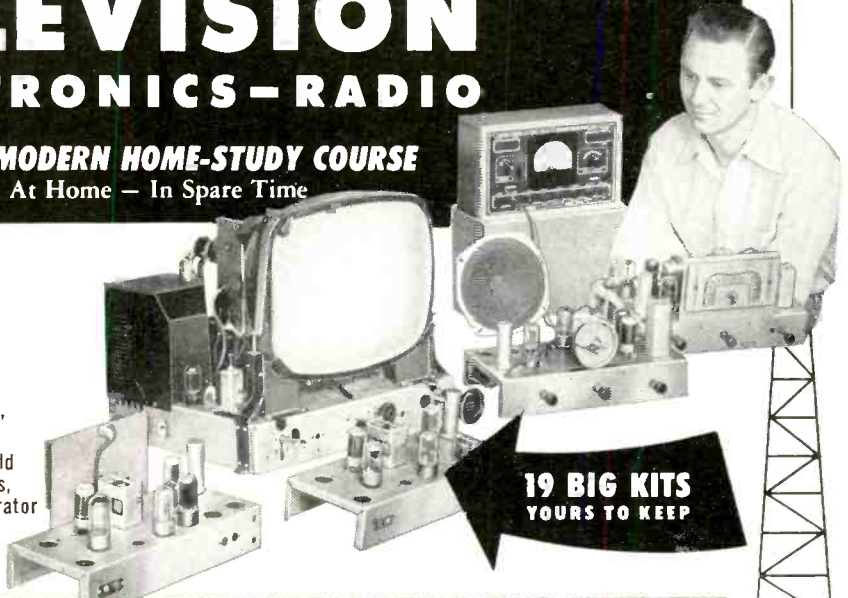

**19 BIG KITS
YOURS TO KEEP**

YOUR NATIONAL SCHOOLS TELERAMA COURSE COVERS ALL 8 PHASES

- | | |
|------------------------------------|--------------------------------|
| 1. TELEVISION, INCLUDING COLOR TV | 5. PREPARATION FOR FCC LICENSE |
| 2. RADIO, FM AND AM | 6. AUTOMATION |
| 3. INDUSTRIAL ELECTRONICS | 7. RADAR AND MICRO WAVES |
| 4. SOUND RECORDING AND HI FIDELITY | 8. COMMUNICATIONS |

YOU ARE NEEDED IN THE TELEVISION-ELECTRONICS-RADIO INDUSTRY!
You can build a secure future for yourself if you get into Electronics NOW! Today's shortage of trained technicians creates tremendous opportunities. National Schools Shop-Method trained technicians are in constant and growing demand for high-pay jobs in Broadcasting and Communications, Electronic Research, Servicing and Repair, and many other branches.

Let National Schools, a Resident Technical School for over 50 years train you for today's unlimited opportunities in electronics! Our Shop Method trains you to be a MASTER-TECHNICIAN. Completely up to date, developed by experienced instructors and engineers, your Telerama Course will teach you all phases of the industry quickly, clearly and correctly. You can master the most modern projects, such as Color TV, printed circuits - even prepare for FCC License without taking a special

course. You can handle sales, servicing, manufacturing, or make good money in your own business. SEND FOR FACTS TODAY!

EARN AS YOU LEARN. Many of our students earn their entire tuition and more in Spare Time jobs we show them how to do while learning.

YOU GET EVERYTHING YOU NEED - Clear, profusely illustrated lessons, shop-tested manuals, modern circuit diagrams, practical job projects - all the valuable equipment shown above

- many other materials and services - consultation privilege with our qualified staff, and Graduate Employment Service. **EVERYTHING YOU NEED** for outstanding success in Electronics.

RESIDENT TRAINING AT LOS ANGELES

If you wish to take your training in our Resident School at Los Angeles, the world's TV capital, start NOW in our big, modern Shops, Labs and Radio-TV Studios. Here you work with latest Electronic equipment—professionally installed—finest, most complete facilities offered by any school. Expert, friendly instructors. Personal attention. Graduate Employment Service. Help in finding home near school—and part time job while you learn. Check box in coupon for full information.



FREE! Fully illustrated "Career" Book in TV-Radio-Electronics. PLUS actual sample lesson—yours at no cost, no obligation. CLIP COUPON NOW... MAIL IT TODAY!



MEMBER



APPROVED FOR G. I. TRAINING NATIONAL SCHOOLS

4000 S. FIGUEROA ST., LOS ANGELES 37, CALIF.

NATIONAL SCHOOLS

TECHNICAL TRADE TRAINING SINCE 1905
LOS ANGELES 37, CALIFORNIA

GET FAST SERVICE - MAIL NOW TO

NATIONAL SCHOOLS, DEPT. RH-117
4000 S. FIGUEROA ST.
LOS ANGELES 37, CALIF.

Rush free TV-Radio "Opportunity" Book and sample lesson. No salesman will call.

NAME _____ AGE _____

ADDRESS _____

CITY _____ ZONE _____ STATE _____

Check if interested ONLY in Resident School training at Los Angeles. VETERANS. Give date of Discharge _____



Ericofon®

If you handle communications equipment, PX's, PAX's, intercom systems, the Ericofon is for you!

The completely new North Ericofon represents the first real advance in telephone design in over 50 years!

A masterful departure from stereotyped design that puts the whole phone, receiver, transmitter, and dial all in one, yet remains as light as the ordinary telephone handset alone!

The "dial comes to you" feature makes dialing from any angle, any position simple and easy.

The Ericofon is available in six decorator colors.

For the Ericofon, exclusive with North, and other North telephone and communication equipment and components, write —

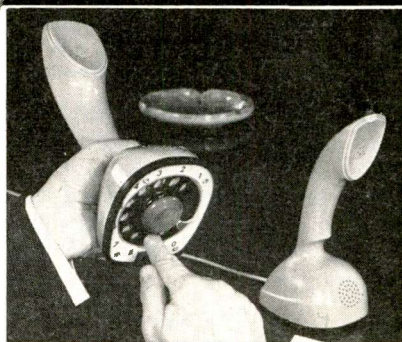

telephone of tomorrow — here today

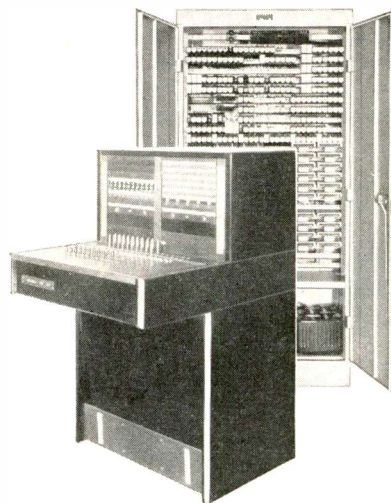

INDUSTRIAL DIVISION

NORTH ELECTRIC COMPANY

257 SOUTH MARKET STREET • GALION, OHIO

Available world-wide through L. M. Ericsson Sales offices.



way, New York City, with David Susser, executive vice-president, in charge of coordinating administrative and committee activities.

Sidney Harman, *Harman-Kardon, Inc.*, is president of the association. Other officers are: Leonard Carduner, *British Industries Corp.*, first vice-president; Edward Rothenstein, *Arco Electronics, Inc.*, second vice-president; and W. Walter Jablon, *Mark Simpson Manufacturing Co.*, secretary-treasurer.

The board of directors includes: Sam Baraf, *United Transformer Corp.*; Robert Ferree, *International Resistance Corp.*; Charles Golenpaul, *Aerovox Corp.*; Edward Finkel, *JFD Manufacturing Co.*; Joseph Kerner, *Blonder-Tongue Labs., Inc.*; Jerome Kirschbaum, *Precision Apparatus Co.*; Howard B. Saltzman, *Alpha Wire Corp.*; and George Silber, *Rek-O-Kut.*

The new organization's purposes are to promote the interests of manufacturers of parts and equipment for the electronic and allied industries; to foster trade in the manufactured products of these industries; to disseminate all useful information concerning the industry; and to promote better business relationships, more efficient operations, and better service for distributors, suppliers, and ultimate consumers of the electronics and allied industries.

Meetings of the membership have been scheduled for the fourth Wednesday of each month and will feature prominent speakers on specific ideas of prime interest to the organization.

In addition to the officers and directors, fourteen standing committees will develop the activities of the organization.

* * *

RICHARD DEUTSCH has been appointed chief sales engineer of *Channel Master Corp.*

In this capacity he will be in charge of the company's sales and field engineering department, which conducts dealer and distributor meetings and new product seminars throughout the country. The department is also responsible for answering the large volume of technical correspondence resulting from consumer and trade advertising.

Mr. Deutsch joined the firm's mechanical engineering department in 1953. Two years later he transferred to the sales department as a sales engineer.

* * *

RIXON ELECTRONICS, INC., Silver Spring, Maryland, has become an independent company, with James L. Hollis as the new president. It was formerly a subsidiary of **PAGE COMMUNICATIONS ENGINEERS, INC.**, Washington, D. C. . . . **VITRO CORPORATION OF AMERICA** has concluded negotiations to acquire all the business and facilities
(Continued on page 113)



HOW TO PASS Your FCC Commercial LICENSE EXAMS*

Get Your FCC License in a Hurry!

We Guarantee*

to train you
until you receive

Your FCC License

* See Free Catalog for complete details

**Cleveland Institute training results in success
with commercial FCC examinations
... easily ... and quickly**

Here's Proof:

Name and Address	License	Time
Prentice Harrison, Lewes, Delaware	1st	27 weeks
John H. Johnson, Boise City, Okla.	1st	20 weeks
Herbert W. Clay, Phoenix, Ariz.	2nd	22 weeks
William F. Masterson, Key West, Fla.	2nd	24 weeks
Thomas J. Bingham, Finley, N. Dak.	2nd	9 weeks

(Names and addresses of trainees in your area sent on request)
Cleveland Institute training results in job offers like these:

Radio Operators & Technicians

American Airlines has openings for radio operators and radio mechanics. Operators start at \$334.53 per month. Radio mechanic's salary up to \$1.99 per hour. Periodic increases with opportunity for advancement. Many company benefits.

Electronic Technicians

Convair Electronics Department: Radio and Radar Mechanics, Electronics Technicians, and Junior Engineers are wanted for a special program on fire control development and installation. Beginning rate: \$365 and up.

And our trainees get good jobs

Salary Increased

"I recently secured a position as Test Engineer with Melnar, Inc. A substantial salary increase was involved. My Cleveland Institute training played a major role in qualifying me for this position."

Boyd Daugherty
105 Goodwin Ct., Apt. C
Falls Church, Va.



Eastern Airlines

In a year and a half, he received his first class FCC License. He is continuing his training with Cleveland Institute. His goal is much higher than his present position with Eastern Airlines, so he is adding technical "know-how" to his practical experience.



Bob Thompson
2935 Ironwood Drive
Nashville 14, Tennessee
CLEVELAND INSTITUTE OF RADIO ELECTRONICS
Desk RN-11, 4900 Euclid Bldg., Cleveland 3, Ohio

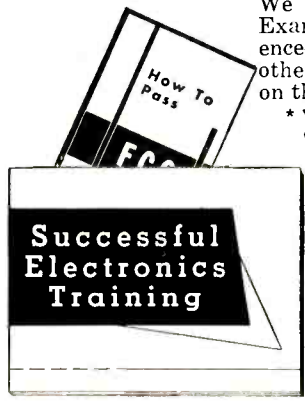

We can train you to pass your License Exams if you've had any practical experience—amateur, military, radio servicing, or other. Our proven plan can help put you on the road to success.

* Your FCC ticket will be recognized by employers as proof of your technical ability.

Mail Coupon Now

and get
**both
FREE**

Accredited by the National Home Study Council

Cleveland Institute of Radio Electronics

Desk RN-11, 4900 Euclid Bldg., Cleveland 3, Ohio



Please send Free Booklets prepared to help me get ahead in Electronics. I have had training or experience in Electronics as indicated below:

- | | |
|---|---|
| <input type="checkbox"/> Military | <input type="checkbox"/> Broadcasting |
| <input type="checkbox"/> Radio-TV Servicing | <input type="checkbox"/> Home Experimenting |
| <input type="checkbox"/> Manufacturing | <input type="checkbox"/> Telephone Company |
| <input type="checkbox"/> Amateur Radio | <input type="checkbox"/> Other _____ |

In what kind of work are you now engaged? _____

In what branch of Electronics are you interested? _____

Name _____ Age _____

Address _____

City _____ Zone _____ State _____

Special Tuition Rates to Members of Armed Forces **RN-11**

ALTEC®

SPEAKER COMPONENTS

*designed for the most natural...
most faithful sound reproduction*



ALTEC LANSING speaker components exemplify the ALTEC tradition to give the most faithful reproduction of sound obtainable through the most natural means.

ALL of these ALTEC high frequency horns are of the sectoral, exponential type which provides a clear, mathematically calculated flow path to direct the sound waves into the proper distribution pattern without interfering with their natural propagation in the air. These sectoral horns provide efficient distribution control at all frequencies, unlike diffusion and other types which have wide distribution at the lower frequencies and become extremely directional and inefficient in the higher ranges.

These sectoral horns and their associated driving elements represent the only true method for obtaining high efficiency, full dynamic range, smooth frequency response and wide, regular distribution of high frequency sounds.

Have the pleasure of listening to a two-way speaker system of ALTEC LANSING speaker components at your dealer's. If your ear is in tune, you'll take ALTEC home.

HORN 511B

This new ALTEC high frequency horn is the finest available for home use. When used with the ALTEC 802D high frequency driver the 511B gives amazingly smooth response throughout the range from 500 to 22,000 cycles, one-half octave above the range of the human ear. The ALTEC 803 bass speaker, either singled or paired, is recommended as a bass component for use with this horn. The 500D dividing network is needed to complete this system.



PRICE: \$36.00

811B HORN

This superb ALTEC horn is identical in design concept and quality with the 511B but is smaller and has a frequency range from 800 to 22,000 cycles. The 811B with the 802D driver can be used with the ALTEC 803A bass speaker or with the 415A Biflex to extend this wide range speaker to a full 22,000 cycle system.



PRICE: \$27.00

HIGH FREQUENCY DRIVER 802D

Designed specifically for use with the 511B and 811B horns for smooth 500 to 22,000 cycle high frequency reproduction.

Power: 30 watts; Range: 500-22,000 cycles; Impedance: 16 ohms; Magnet Weight: 1.3 lbs



PRICE: \$57.00

3000B HIGH FREQUENCY SPEAKER AND NETWORK

This newly developed high frequency speaker and horn used with the 3000B network is the ideal unit to extend the range of the ALTEC 412A and 415A Biflexes or of any efficient 12" or 15" cone speaker to a full 22,000 cycles. The dividing network separates high and low frequencies at 3000 cycles, crossing over at a smooth 12 db per octave curve.

Speaker—Power: 20 watts; Impedance: 8 ohms; Range: 3,000-22,000 cycles

PRICE: \$39.00

Network—Impedance: 8 ohms; HF Attenuation: 10 db continuously variable; Crossover: 3000 cycles

PRICE: \$21.00



500D

DIVIDING NETWORK

For use with the 802D h.f. driver and 511B horn. Has smooth 12 db per octave slope and detented high frequency shelving control designed for external mounting with 4 steps of 1½ decibels each for precise adjustment to individual rooms.

Impedance: 16 ohms; HF attenuation: 6 db, 1½ db steps; Crossover: 500 cycles

PRICE: \$54.00

803A

BASS SPEAKER

The 803A is used as the bass component in many of ALTEC's larger theatre speaker systems. Since it is intended for use with the 802D high frequency driver and either the 511B or 811B horn its efficient frequency range is limited to 30-1600 cycles. This 1600 cycle upper range assures a smooth crossover at any frequency up to 800 cycles. As a result the 803A has a bass performance far superior to that of loudspeakers designed to operate over a wider frequency spectrum.

Power: 30 watts; Impedance: 16 ohms; Range: 30-1600 cycles; Magnet Weight: 2.4 lbs

PRICE: \$60.00



800E

DIVIDING NETWORK

Has the same characteristics as the 500D but with 800 cycle crossover for use with the 811B horn and 802D h.f. driver.

Impedance: 16 ohms; HF Attenuation: 6 db, 1½ db steps; Crossover: 800 cycles

PRICE: \$42.00



ALTEC®

LANSING CORPORATION

ALTEC LANSING CORPORATION

1515 S. Manchester Avenue, Anaheim, Calif.

161 Sixth Avenue, New York 13, N.Y.

Write for free catalogue Dept. TM11

Ad #12-11

NEW! 12-WATT Williamson-type HIGH FIDELITY INTEGRATED AMPLIFIER HF12 with Pre-amplifier, Equalizer & Control Section
KIT \$34⁹⁵ WIRED \$57⁹⁵



Compact, beautifully packaged & styled. Provides complete "front-end" facilities and true high fidelity performance. Direct tape head & magnetic phono inputs with NARTB (tape) & RIAA (phono) feedback equalizations. 6-tube circuit, dual triode for variable turnover bass & treble feedback-type tone controls. Output Power: 12 w cont., 25 w pk. IM Dist. (60 & 6000 cps @ 4:1): 1.5% @ 2 w; 0.55% @ 6 w; 0.3% @ 4 w. Freq. Resp.: 1 w; ± 0.5 db 12 cps - 59 kc 12 w; ± 0.5 db 25 cps - 20 kc. Harmonic Dist.: 20 cps: 2% @ 4.2 w; $\frac{1}{2}$ % @ 2.5 w; 30 cps: 2% @ 1 w; $\frac{1}{2}$ % @ 6.5 w; 40 cps: 1% @ 12 w; $\frac{1}{2}$ % @ 9.3 w; 2000 cps: $\frac{1}{2}$ % @ 12 w; 10 kc: 1% @ 10 w; $\frac{1}{2}$ % @ 6 w. Transient Resp.: excellent square wave reproduction (4 usec rise-time); negligible ringing, rapid settling on 10 kc square wave. Inverse Feedback: 20 db. Stability Margin: 12 db. Damping Factor: above 8, 20 cps - 15 kc. Speaker Connections: 4, 8, 16 ohms. Tone Control Range: ± 10 db. ± 13 db; @ 50 cps, ± 16 db. Tubes: 2-ECC85, 12AX7, 1-ECC82/12AU7, 2-EL84, 1-EZ81. Size: HWD: 3 $\frac{3}{4}$ " x 12" x 6 $\frac{1}{4}$ ". 13 lbs. Mounts in and out of cabinet.

NEW! 50-WATT Ultra-Linear HIGH FIDELITY POWER AMPLIFIER
HF50 KIT \$57⁹⁵ WIRED \$87⁹⁵



Like the HF60 shown below, the HF50 features virtually absolute stability, flawless transient response under either resistive or reactive (speaker) load, & no bounce or flutter under pulsed conditions. Extremely high quality output transformer with extensively interleaved windings, 4, 8, & 16 ohm speaker connections, grain-oriented steel, & fully potted in seamless steel case. Otherwise identical to HF60. Output Power: 50 w cont., 100 w pk. IM Distortion (60 & 6000 cps @ 4:1): below 1% at 50 w; 0.5% @ 45 w. Harmonic Dist.: below 0.5% between 20 cps & 20 kc within 1 db of rated power. Freq. Resp. at 1 w: ± 0.5 db 6 cps - 60 kc; ± 0.1 db 15 cps - 30 kc at any level from 1 mw to rated power; no peaking or raggedness outside audio range. All other specs identical to HF60 below. Matching Cover E-2 \$4.50.

NEW! 50-WATT Ultra-Linear HIGH-FIDELITY INTEGRATED POWER AMPLIFIER HF52 with Pre-amplifier, Equalizer & Control Section
KIT \$69⁹⁵ WIRED \$109⁹⁵



Combines a power amplifier section essentially identical to the HF50 power amplifier with a preamp-equalizer control section similar to HF20 below. Provision for use with electronic crossover network & additional amplifier(s). See HF50 for response & distortion specs; HF60 for square wave response, rise-time, inverse feedback, stability margin, damping factor, speaker connections; HF20 for preamplifier, equalizer & control section description. Hum & noise 60 db below rated output on magnetic phono input (8 mv input for rated output), & 75 db below rated output on high level inputs (0.6 v input for rated output). Matching Cover E-1 \$4.50.

The specs are the proof...
7 NEW BEST BUYS by



NEW HIGH FIDELITY PREAMPLIFIER
#HF61A KIT \$24⁹⁵, WIRED \$37⁹⁵
With Power Supply: #HF61 KIT \$29⁹⁵, WIRED \$44⁹⁵

Will not add distortion or detract from the side-band or transient response of the finest power amplifiers at any control settings. High quality feedback circuitry throughout plus the most complete control & switching facilities. Heavy-gauge solid brushed brass panel, concentric controls, one-piece brown enamel steel cabinet for lasting attractive appearance. Feedback-type sharp cut-off (12 db/octave) scratch & rumble filters. Low-distortion feedback equalization: 5 most common recording curves for LPs & 78s including RIAA. Low-distortion feedback tone controls: provide large boost or cut in bass or treble with mid-freqs & volume unaffected. Centralab printed-circuit Sensi-Comp control loudness control with concentric level control. 4 hi-level switched inputs (tuner, tv, tape, aux.) & 3 low-level inputs (separate front panel low-level input selector permits concurrent use of changer & turntable). Proper pick-up loading & attenuation provided for all quartz cartridges. Hum bal. control. DC superimposed on filament supply. 4 convenience outlets. Extremely flat wideband freq. resp: ± 1 db 8-100,000 cps; ± 0.3 db 12-50,000 cps. Extremely sensitive. Negligible hum, noise, harmonic or IM distortion. Size: 4-7/8" x 12-5/13" x 4-7/8". 8 lbs.



NEW 60-WATT Ultra-Linear HIGH FIDELITY POWER AMPLIFIER #HF60 with ACRO TO-330 OUTPUT TRANSFORMER
KIT \$72⁹⁵ WIRED \$99⁹⁵

Superlative performance, obtained through finest components & circuitry. EF86 low-noise voltage amplifier direct-coupled to 6SN7GTB cathode coupled phase inverter driving a pair of Ultra-Linear connected push-pull EL34 output tubes operated with fixed bias. Rated power output: 60 w (130 w peak). IM Distortion (60 & 6000 cps @ 4:1): less than 1% at 60 w; less than 0.5% at 50 w. Harmonic Distortion: less than 0.5% at any freq. between 20 cps & 20 kc within 1 db of 60 w. Sinusoidal Freq. Resp.: at 1 w: ± 0.5 db 5 cps - 100 kc; ± 0.1 db 15 cps to 35 kc at any level from 1 mw to rated power; no peaking or raggedness outside audio range. Square Wave Resp.: excellent from 20 cps to 25 kc, 3 usec rise-time. Sensitivity: 0.55 v for 60 w. Damping Factor: 17. Inverse Feedback: 21 db. Stability Margin: 16 db. Hum: 90 db below rated output. ACRO TO-330 Output Transformer (fully potted). Speaker Taps: 4, 8, 16 ohms. GZ34 extra-rugged rectifier (indirectly-heated cathode eliminates high starting voltage on electrolytics & delays B+ until amplifier tubes warm up). Input level control. Panel mount fuse holder. Both bias and DC - balance adjustments. Std octal socket provided for pre-amplifier power take-off. Size: 7" x 14" x 8". 30 lbs. Matching cover Model E-2 \$4.50.



NEW COMPLETE with Pre-amplifier, Equalizer & Control Section 20-WATT Ultra-Linear Williamson-Type HIGH FIDELITY AMPLIFIER #HF-20
KIT \$49⁹⁵ WIRED \$79⁹⁵

A low-cost, complete-facility amplifier of the highest quality that sets a new standard of performance at the price, kit or wired. Rated Power Output: 20 w (34 w peak). IM Distortion (60 & 6000 cps/4:1) at rated power: 1.3%. Max. Harmonic Distortion between 20 & 20,000 cps at 1 db under rated power: approx. 1%. Mid-band Harmonic Distortion at rated power: 0.3%. Power Response (20 w): ± 0.5 db 20-20,000 cps; ± 1.5 db 10-40,000 cps. Freq. Resp. ($\frac{1}{4}$ w): ± 0.5 db 13-35,000 cps; ± 1.5 db 7-50,000 cps. 5 feedback equalizations for LPs & 78s. Low-distortion feedback tone controls: large boosts or cuts in bass or treble with mid-freqs & volume unaffected. Loudness control & separate level set control on front panel. Low Z output to tape recorder. 4 hi-level switched inputs: tuner, tv, tape, aux; 2 low-level inputs for proper loading with all cartridges. Hum bal. control. DC superimposed on filament supply. Extremely fine output transformer: interleaved windings, tight coupling, careful balancing, grain-oriented steel. 8 $\frac{1}{2}$ " x 15" x 10". 24 lbs. Matching cover Model E-1, \$4.50.

NEW COMPLETE with FACTORY-BUILT CABINET - 2-WAY HI-FI SPEAKER SYSTEM #HFS1 \$39⁹⁵

See the "BEST BUYS" NOW IN STOCK at your nearest distributor. Fill out coupon on other side for FREE CATALOG.

Prices 5% higher on West Coast.



Genuine 2-way book-shelf size speaker system. Jensen heavy duty 8" woofer (6.8 oz. magnet) & matching Jensen compression-driver exponential horn tweeter with level control. Smooth clean bass & crisp extended highs free of coloration or artificial brilliance. Factory-built tuned bass reflex birch hardwood cabinet (not a kit) constructed to high quality standards. Neutral acoustical grille cloth framed by a smooth-sanded solid birch molding. Freq. Resp. measured 2 ft. away on principal axis in anechoic chamber with 1 watt input - Woofer: ± 4 db 80-1800 cps; Tweeter: ± 2 db 2800-10,000 cps; Crossover Region: 1800-2800 cps, shift in level over this region depends on tweeter level control setting. Power-handling capacity: 25 watts. Size: 23" x 11" x 9". 25 lbs. Wiring Time: 15 min.



33-00 Northern Blvd., L. I. C., N.Y.

Turn page for other EICO ad.

the specs prove it . .
your BEST BUY is

EICO®

for COLOR & Monochrome TV servicing

FREE CATALOG

shows you HOW TO SAVE 50%
on 50 models of top quality
professional test equipment.
MAIL COUPON NOW!



NEW!
TV-FM SWEEP
GENERATOR &
MARKER #368

KIT \$69⁹⁵ WIRED \$119⁹⁵

Entirely electronic sweep circuit (no mechanical devices) with accurately-biased inductor for excellent linearity. Extremely flat RF output; new AGC circuit automatically adjusts osc. for max. output on each band with min. ampl. variations. Exceptional tuning accuracy: edge-lit hairlines eliminate parallax. Sweep Osc. Range 3-216 mc in 5 fund. bands. Variable Marker Range 2-75 mc in 3 fund. bands; 60-225 mc on harmonic band. 4.5 mc Xtal Marker Osc., xtal supplied. Ext. Marker provision. Sweep Width 0-3 mc lowest max. deviation to 0-30 mc highest max. dev. 2-way blanking. Narrow range phasing. Attenuators; Marker Size, RF Fine, RF Coarse (4-step decade). Cables: output, 'scope horiz., 'scope vertical. Deep-etched satin aluminum panel; rugged grey wrinkle steel cabinet.

**NEW! RF
SIGNAL GENERATOR
#324**

KIT \$26⁹⁵ WIRED \$39⁹⁵

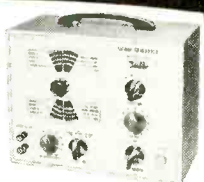

150 kc to 435 mc with ONE generator! Better value than generators selling at 2 or 3 times its cost! Ideal for IF-RF alignment, signal tracing & trouble-shooting of TV, FM, AM sets; marker gen.; 400 cps audio testing; lab. work. 6 fund. ranges: 150-400 kc, 400-1200 kc, 1.2-3.5 mc, 3.5-11 mc, 11-37 mc, 37-145 mc; 1 harmonic band 111-435 mc. Freq. accurate to ±1.5%; 6:1 vernier tuning & excellent spread at most important alignment freqs. Etched tuning dial, plexiglass windows, edge-lit hairlines. Colpitts RF osc. directly plate-modulated by K-follower for improved mod. Variable depth of int. mod. 0-50% by 400 cps Colpitts osc. Variable gain ext. amplifier: only 3.0 v needed for 30% mod. Turret-mounted coils slug-tuned for max. accuracy. Fine & Coarse (3-step) RF attenuators. RF output 100,000 uv; AF sine wave output to 10 v. 50-ohm output Z. 5-way jack-top binding posts for AF in/out; coaxial connector & shielded cable for RF out. 12AU7, 12AV7, selenium rectifier; xmfr-operated. Deep-etched satin aluminum panel; rugged grey wrinkle steel cabinet.

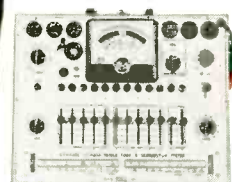

**NEW! DYNAMIC
CONDUCTANCE
TUBE & TRANSISTOR
TESTER #666**
KIT \$69⁹⁵ WIRED \$109⁹⁵

COMPLETE with steel cover and handle.

SPEED, ease, unexcelled accuracy & thoroughness. Tests all receiving tubes (and picture tubes with adapter). Composite indication of Gm, Gp & peak emission. Simultaneous sel of any 1 of 4 combinations of 3 plate voltages, 3 screen voltages, 3 ranges of continuously variable grid voltage (with 5% accurate pot). New series-string voltages: for 600, 450, 300 ma types. Sensitive 200 ua meter. 5 ranges meter sensitivity (1% shunts & 5% pot). 10 SIX-position lever switches: freepoint connection of each tube pin. 10 pushbuttons: rapid insert of any tube element in leakage test circuit & speedy sel. of individual sections of multi-section tubes in merit tests. Direct-reading of inter-element leakage in ohms. New gear-driven rollchart. Checks n-p-n & p-n-p transistors: separate meter readings of collector leakage current & Beta using internal dc power supply. Deep-etched satin aluminum panel; rugged grey wrinkle steel cabinet. CRA Adapter \$4.50

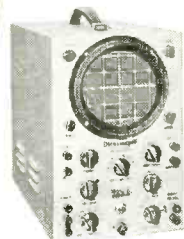

NEW!
**COLOR
and Monochrome
DC to 5 MC LAB & TV
5" OSCILLOSCOPE
#460**

KIT \$79⁹⁵ WIRED \$129⁵⁰

• Features DC Amplifiers!

Flat from DC-4.5 mc, usable to 10 mc. VERT. AMPL.: sens. 25 rms mv/in; input Z 3 megs; direct-coupled & push-pull thruout; K-follower coupling bet. stages; 4-step freq-compensated attenuator up to 1000:1. SWEEP: perfectly linear 10 cps-100 kc (ext. cap. for range to 1 cps); pre-set TV V&H positions; auto. sync. ampl. & lim. PLUS: direct or cap. coupling; bal. or unbal. inputs; edge-lit engraved lucite graph screen; dimmer; filter; bezel fits std photo equip. High intensity trace CRT. 0.06 usec rise time. Push-pull hor. ampl. flat to 400 kc, sens. 0.6 rms mv/in. Built-in volt. calib. Z-axis mod. Sawtooth & 60 cps outputs. Astig. control. Retrace blanking. Phasing control.

**NEW! PEAK-to-PEAK
VTVM #232 & UNI-
PROBE (pat. pend.)**

KIT \$29⁹⁵ WIRED \$49⁹⁵



Half-turn of probe tip selects DC or AC-Ohms.

Uni-Probe - exclusive with EICO - only 1 probe performs all functions!

Latest circuitry, high sensitivity & precision, wide ranges & versatility. Calibration without removing from cabinet. New balanced bridge circuit. High Z input for negligible loading. 4 1/2" meter, can't burn-out circuit, 7 non-skip ranges on every function. 4 functions: +DC Volts, -DC Volts, AC Volts, Ohms. Uniform 3 to 1 scale ratio for extreme wide-range accuracy. Zero center. One zero-adj. for all functions & ranges. 1% precision ceramic multiplier resistors. Measure directly peak-to-peak voltage of complex & sine waves: 0.4, 1, 4, 2, 14, 40, 140, 420. DC/RMS sine volts: 0-1.5, 5, 15, 50, 150, 500, 1500 (up to 30,000 v with HVP probe & 250 mc with PRF probe). Ohms: 0.2 ohms to 1000 megs. 12AU7, 6AL5, selenium rectifier; xmfr-operated. Deep-etched satin aluminum panel, rugged grey wrinkle steel cabinet.



5" PUSH-PULL
OSCILLOSCOPE
#425
KIT \$44.95
Wired \$79.95

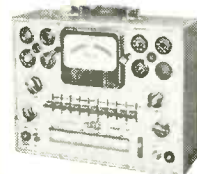

7" PUSH-PULL
OSCILLOSCOPE
#470
KIT \$79.95
Wired \$129.50

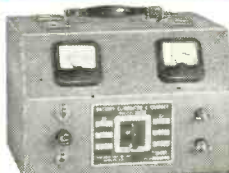

TUBE TESTER
#625
KIT \$34.95
Wired \$49.95
• tests 600 mil series string type tubes
• illuminated roll-chart

Pix Tube Test Adapter\$4.50

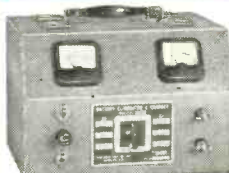

Sep. volt-meter & ammeter
KIT \$29.95
Wired \$38.95

6V & 12V BATTERY ELIMINATOR & CHARGER #1050



Sep. hi-gain RF & lo-gain audio inputs. Special noise locator. Calibrated wattmeter.
KIT \$24.95
Wired \$39.95

DELUXE MULTI-SIGNAL TRACER #147



20,000 Ohms/Volt
MULTIMETER #565
KIT 24.95
Wired \$29.95



1000 Ohms/Volt
MULTIMETER
#536
KIT \$12.90
Wired \$14.90



Reads 0.5 ohms -500 megs, 10 mmdf-5000 mfd, power factor.

KIT \$19.95
Wired \$29.95

R-C BRIDGE & R-C-L COMPARATOR #950B



VTVM PROBES	KIT	Wired
Peak-to-Peak	\$4.95	\$6.95
RF	\$3.75	\$4.95
High Voltage Probe-1		\$6.95
High Voltage Probe-2		\$4.95

SCOPE PROBES	KIT	Wired
Demodulator	\$3.75	\$5.75
Direct	\$2.75	\$3.95
Low Capacity	\$3.75	\$5.75

TURN PAGE
FOR MORE
EICO VALUES

EICO®

Send for
FREE CATALOG
now

EICO, 33-00 Northern Blvd., R-11
L.I.C. 1, N.Y.

Show me HOW TO SAVE 50% on Test Equipment and Hi-Fi. Send me FREE Catalog and name of neighborhood distributor.

Name.....
Address.....
City..... Zone..... State.....

Prices 5% higher on West Coast.

L.I.C. 1, N.Y.

Telemetry in Flight Testing

By

CHARLES M. DOWNS

Engineering Dept.
Convair (San Diego)

The Convair F-102A all-weather supersonic jet interceptor. Telemetry played an important part in the exhaustive flight testing of this aircraft at Edwards Air Force Base before the F-102A's became operational with Air Defense Command squadrons.

IN THE past few years a new application of electronics has "come of age." Telemetry (meaning to measure from a distance or to transmit a measurement) which has been used for the last ten years in missiles and rockets is now extensively used in flight testing military and commercial aircraft. With the advent of supersonic aircraft there was a need for a measuring system that would operate automatically with accuracy and precision without distracting the pilot of the aircraft in any way. Various airborne recording devices had the accuracy required but took up too much space, were too heavy, or were too restricted in the type of data they could record.

As an example, one type of recording oscillograph used as an airborne recorder weighs 70 pounds, records 26 functions and has a frequency range of from d.c. to about 500 cycles. With additional equipment (linear amplifiers) the frequency range is extended to 3000 cycles. A telemetry system weighing half as much can record many more functions with a response on some subcarrier bands (see Table 1) of from d.c. to speech frequencies. Safety functions such as temperature, pressure, and acceleration can be instantly and continuously monitored on the ground during flight. If safe limits are exceeded, the pilot can be notified for corrective action.

When an aircraft crashes into the ground at 500 miles per hour, there is little left from which to determine the cause of the crash. Lives have been saved because records, safe on the ground, revealed the cause of system or structural failure in telemetered aircraft. Data from airborne recorders would have been lost.

Since recording oscillographs are an

Part 1 of a two-part series on principles and applications of telemetry as used in developmental aircraft testing.

important part of the receiving station, it should be pointed out that telemetry has not replaced the oscillograph as a flight test recorder; it has only moved the oscillograph down on the ground where its full capabilities can be utilized.

An oscillograph uses small mirrors mounted in galvanometer movements to reflect beams of light onto a moving strip of photosensitive paper. Thus the waveform of the current fed to the coil of the galvanometer is photographed as a continuous graph. Paper speed is variable from about 0.5 to 100 inches per second. One of the factors which limits the upper frequency response of an airborne oscillograph is paper speed. Due to the short supply of paper that can be carried aloft, the speed must be kept low if more than a few minutes of flight are to be recorded. This problem is overcome when the recorder is located in the ground station. Telemetered data stored on magnetic tape can be played back as many times as desired and oscillograph records may be made at any paper speed. Here it should be pointed out that oscillograph records are usually employed to determine which parts of the flight should be selected for further data reduction.

Theory of Operation

The theory of operation of an FM/PM telemetry system should be easily understood by anyone familiar with audio circuits. Several audio oscillators, operating at different frequencies, are frequency modulated by their associated pickups. The frequency-modulated audio signals are used to

phase modulate a radio transmitter operating in the range of 215 to 235 megacycles. The r.f. signal is, in turn, picked up by a receiving station where the audio output of a receiver is passed through bandpass filters which separate the subcarrier oscillators (the audio oscillators in the aircraft) from the complex audio signal. The output of each bandpass filter is then fed into an audio discriminator which produces a varying d.c. voltage corresponding to the frequency shift of the subcarrier oscillator. The current in the discriminator output signal is the electrical equivalent of the original modulating signal obtained from the pickup in the aircraft. The discriminator output is then fed into electro-mechanical recorders such as recording oscillographs and pen recorders. Tape recorders, at the same time, record the audio output of the receivers so that in case of failure of one of the discriminators or electro-mechanical recorders, the data will not be lost. The tape playback can be fed directly into automatic data reduction computers if additional data reduction is required.

Airborne Components

Let us now consider various components of a system and their functions. Pickups and subcarrier oscillators (SCO's) fall into three basic types: voltage-, resistance-, and inductance-controlled. Of these three, the voltage-controlled oscillator is probably the most widely used. A diagram of a simple voltage-controlled system is shown in Fig. 1. Excitation voltage (in this case d.c.) is applied across a precision

BAND	CENTER FREQUENCY (cps)	LOWER LIMIT (cps)	UPPER LIMIT (cps)	FREQUENCY RESPONSE (cps)
1	400	370	430	6.0
2	560	518	602	8.4
3	730	675	785	11
4	960	888	1032	14
5	1300	1200	1389	20
6	1700	1572	1828	25
7	2300	2127	2473	35
8	3000	2775	3225	45
9	3900	3607	4193	59
10	5400	4995	5805	81
11	7350	6799	7901	110
12	10,500	9712	11,288	160
13	14,500	13,412	15,588	220
14	22,000	20,350	23,650	330
15	30,000	27,750	32,250	450
16	40,000	37,000	43,000	600
17	52,500	48,560	56,440	790
18	70,000	64,750	75,250	1050

Wide-band ($\pm 15\%$ of center frequency) operation may be used on 22 kc. through 70 kc. if adjacent bands are omitted.

Table 1. The various subcarrier bands that are employed in telemetering systems.

potentiometer. The shaft of the potentiometer is linked to an angular motion such as the rudder of an aircraft. The signal voltage from the arm of the pot is fed through shielded wire to the SCO. In one type of voltage-controlled SCO the input signal is fed to a reactance modulator combined with a Hartley oscillator. In another type, a free-running multivibrator is frequency modulated by using the signal voltage to bias the grid of one half of the oscillator. The frequency stability of either of these types under steady-state input conditions is excellent.

The frequency deviation of a voltage-controlled SCO is an inverse function of signal polarity shift. In other words, when the signal is made more positive, the output frequency decreases. Two voltage ranges are generally used: 0 to 5 volts and ± 2.5 volts. Since very sharp bandpass filters (down 60 db a few cycles past the bandpass limit) are used in the receiving station, SCO bandwidth limits and therefore input voltage limits must be carefully observed. Band limits (deviation limits) are determined as follows. There are 18 SCO frequencies established by the Department of Defense's Research and Development Board (RDB) now in use. (See Table 1.) Each SCO is allowed to deviate 7.5% of its center frequency each side of center frequency. As an example, given a 2.3 kc. SCO with a voltage range of 0 to 5 volts, the output frequency at 2.5 volts would be 2300 cps or f_c . At 5 volts the frequency would be 2127 cps or f_l . With 0 volt applied, the frequency would become 2473 cps or f_h . To provide a "fudge factor" and to reduce noise, many systems are operated at 80% bandwidth. Bandwidth now becomes 80% of 7.5% of f_c .

Special 15% units are available which are used when wide-band operation is desired.

So far, we have considered only a d.c. modulating signal. Although a.c. can be used to modulate voltage-controlled oscillators, another factor must be considered: that of the highest a.c. frequency that can be applied. Nat-

urally, it would be impossible to impress 2000-cycle modulation on a 2300-cycle SCO. Generally, it may be said that up to and including the 14.5 kc. band, maximum modulating frequency should not be more than 1.5% of f_c . Above 14.5 kc., 3% is the maximum. These limits are conservative and can be exceeded but a point will be reached where severe intermodulation will occur. It should be remembered, however, that it is the instantaneous value of an a.c. modulating signal and not the frequency of the signal that causes the SCO to deviate.

Voltage-controlled oscillators are used to measure control surface positions, gas and liquid pressures, vibration, acceleration, or any function which can be made to produce varying d.c. or a.c. voltage. A 70 kc. voltage-controlled SCO can be modulated by the pilot's microphone to provide one-way communication from the aircraft to ground. This can be used to record the pilot's comments which, for security reasons, cannot be transmitted over the aircraft's normal communications system.

The second basic type of SCO is the resistance-controlled oscillator which changes frequency when a resistance change occurs in one or more arms of an a.c.-excited Wheatstone bridge. A basic resistance-controlled oscillator system is shown in Fig. 2. Bridge unbalance causes phase shift to occur in a phase-sensitive amplifier-oscillator loop. Sensitivity is determined by the number of active arms. Strain-sensitive bridges, precision potentiometers, and other variable resistance transducers are employed with resistance-controlled oscillators.

A troublesome drawback is present in resistance-controlled systems. The shunt capacitance of the shield wire used between the pickup and oscillator causes the response curve of the oscillator to become slightly parabolic. (See Fig. 3.) This can be reduced, however, by shunting the bridge at the SCO with another capacitance to balance the unwanted capacitance of the shielded wire.

The third widely used type of SCO is the inductance-controlled oscillator. Mechanical motion is transferred to a Mumetal slug which is suspended in the field of a coil. The slug is oil- or air-damped, depending on the frequency response desired. The coil comprises the inductance of a Hartley LC oscillator. Thus the frequency of the oscillator is modulated by the mechanical motion. The pickup is not usually mounted more than a few feet from the oscillator because the shunt capacitance of the shielded wire can lower the frequency of the oscillator to a point where it is out of the particular band being used, or can actually prevent the SCO from oscillating. This is overcome by mounting the pickup near the oscillator and running tubing (in the case of a pressure measurement) from the oscillator-pickup location to the measurement point. In the case of an acceleration measurement, the accelerometer can be mounted with the oscillator at the point where acceleration is to be measured.

Many special types of pickups are on the market which are designed to do a specific job such as the measurement of airspeed, altitude, fuel flow, and fuel quantity. Some of these contain their own SCO's while others convert hard-to-measure functions into easily handled voltage, inductance, or resistance changes.

The Radio Transmitter

After the audio output of the SCO's in a system (most systems use from ten to twelve SCO's) have been mixed through voltage dividers into a common audio bus, the combined or "complex audio" signal is applied to the modulator input of a crystal-controlled, phase-modulated transmitter.

For those unfamiliar with the main difference between a phase-modulation and a frequency-modulation system, it might be well to point it out. The end result in either case is the same; the frequency of the transmitter becomes a function of the modulation impressed on that transmitter. However, that result is achieved by different methods. An FM transmitter is actually amplitude modulated. That is, the frequency change of the transmitter is a function of the amplitude of the modulating signal. A signal of 10,000 cps would cause the same frequency shift as a signal of 1000 cps if their amplitudes were equal. The rate at which the frequency of the transmitter is varying, however, is dependent on the frequency of the modulating signal that is used.

In a phase-modulated transmitter, the amount of frequency deviation of the transmitter is a function of both amplitude and frequency of the modulating signal. Given a modulator with flat frequency response, and a ten SCO system with equal levels for all ten SCO's, the deviation of the transmitter caused by each SCO would be proportional to the frequency of the SCO. However, the frequency response of the modulator tube and circuit is

far from flat. The modulator tends to attenuate the level of the higher frequency SCO's. The result of these two opposing response curves (the increasing deviation of the transmitter with an increase in modulation frequency, and the attenuation of the higher frequency SCO's by the modulator tube) is a decrease in deviation response with an increase in frequency. It is therefore necessary to pre-emphasize the higher frequency SCO's in order to obtain the correct modulation index for a given transmitter.

The transmitter is a compact frequency multiplier with about 2.5 watts output. When used to telemeter vehicles or objects which are fairly close to the receiving station (1 to 3 miles) the power output of the transmitter alone is enough to deliver satisfactory signal strength; but when used in missiles and aircraft, additional power amplifiers are required. Telemetry power amplifiers usually contain 1 or 2 tubes (4X150A and 832B are commonly used types) and produce from 15 to 100 watts output, depending on tube type and plate supply voltage.

Antenna Systems

Antenna systems are more of a problem than usual when mounted on supersonic aircraft. In addition to exhibiting a satisfactory radiation pattern, the antenna must produce a minimum of drag and turbulence. For this reason flush antennas such as notch exciters, slot antennas, and quarter-wave dipoles imbedded in non-metallic material are used extensively. The air-speed measuring system on flight test aircraft usually consists of a short tapered tube, an inch or two in diameter, extending from the center of the nose of the aircraft. If insulated, the air-speed boom can serve as a quarter wave "spike" antenna. Blade antennas, in the form of an airfoil, can be mounted on the bottom of the aircraft where maximum r.f. propagation is effected. A quarter wavelength at the frequencies in use is about 9 to 11 inches which facilitates compact antenna design.

One system uses one antenna mounted in each wingtip to prevent signal dropout during rolls and sharp banks. Duplexers are in use which permit two transmitters of different frequencies to be loaded into a single antenna; three duplexers may be used to load four transmitters into one antenna system.

Design Considerations

Telemetry systems are manufactured in "building block" form. Due to the individual requirements of any one flight research program, it would be hard to build a "package deal" to be installed in all types of aircraft. Therefore, it is up to the engineers and technicians working with the equipment to use their ingenuity in selecting the components for their system. With these things in mind, a few design considerations will be discussed here.

Every system has its drawbacks and telemetry is no exception. Possibly the

greatest problem encountered in a measurement system is noise. Types of noise existent in a telemetering system can be placed in two general classes: intermodulation and random or transient noise. Intermodulation can be caused by applying a complex wave to a non-linear impedance. Appearing as beats between the component frequencies of the complex signal, it produces frequencies which are not present in the original complex wave. Beat frequencies are always present in a complex audio bus (the combined output of the several subcarriers in a telemetering system) but the levels of the beats are down 30 db or so in relation to the subcarriers. If two subcarrier levels are allowed to increase to a high enough level, the beat between them will attain a high enough level to seriously affect the other subcarriers in the system. Intermodulation can be reduced or eliminated by the use of impedance matching devices, extra isolation, and carefully balanced subcarrier levels.

Random and transient noise should, if possible, be eliminated at its source. Relays switching reactive loads can produce a transient which can be picked up fifty feet away. A large capacitor or neon lamp placed across the contacts of the relay can suppress much of the noise. Ground loops can be avoided by grounding the shielding at one point only and as close to the SCO as possible. Noise which amplitude modulates the SCO envelope is reduced by the limiters in the receiving station radio receivers. However, noise which frequency modulates the SCO must be eliminated at its source if the frequency response of the SCO is to be utilized. In the case of a d.c. or low-frequency a.c. measurement, the recording device can be damped so that

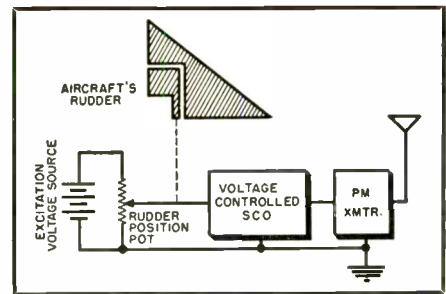

Fig. 1. Block diagram of a simple voltage controlled subcarrier oscillator system.

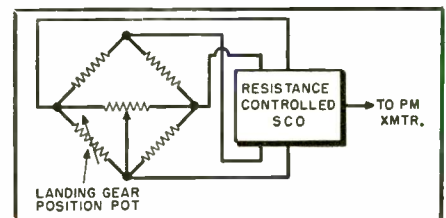

Fig. 2. Resistance controlled SCO system.

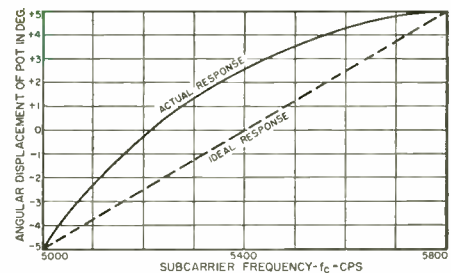
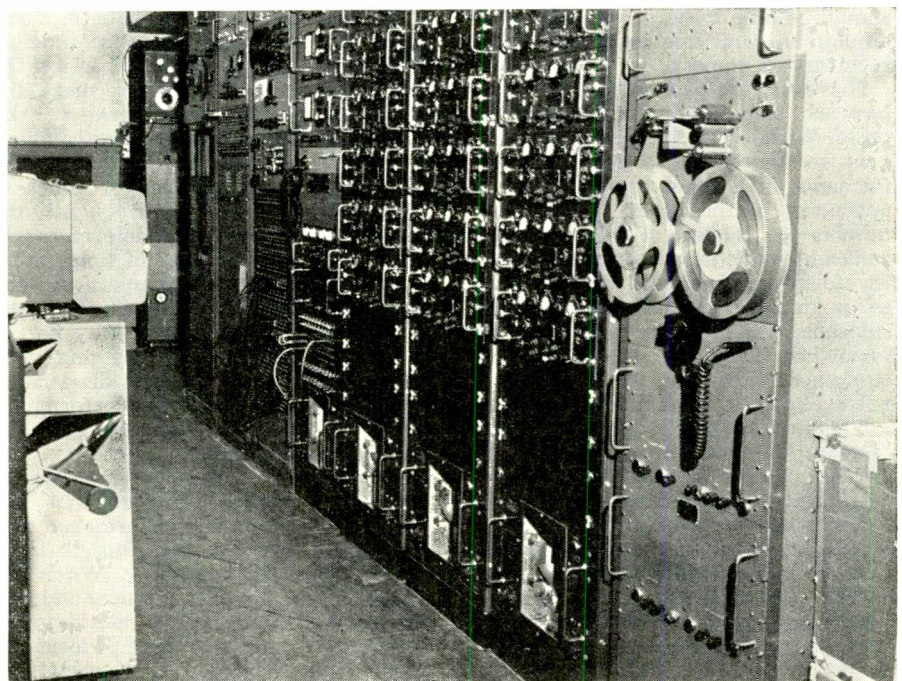

Fig. 3. Resistance controlled SCO response.

its upper frequency limit falls below the noise frequency. Low-pass filters in the discriminator output circuit are also useful in noise reduction but again the high-frequency response of the subcarrier is limited.

(Concluded next month)

Convair's receiving station at Edwards AFB flight test facility. In right foreground is playback unit for airborne tape. The next three racks contain subcarrier discriminators. Left racks contain receivers, test gear, and patch boards.



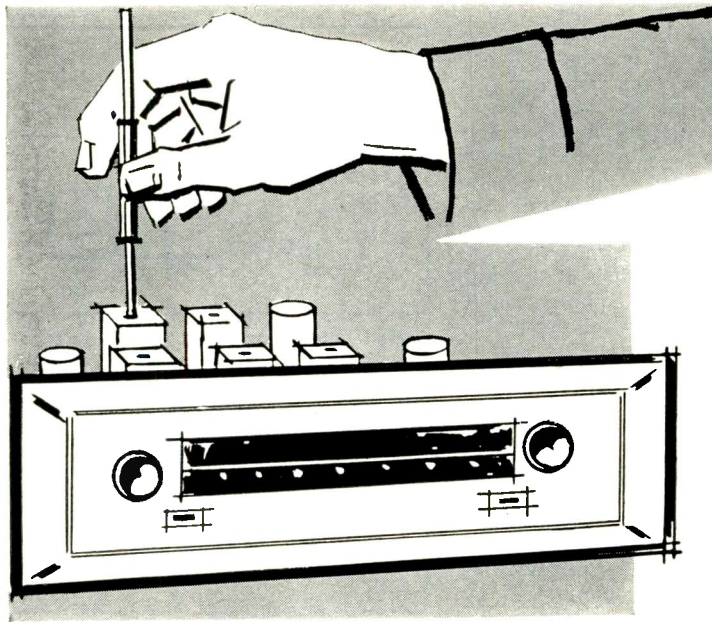

Testing FM Tuners at Home

By **JULIAN D. HIRSCH**
Audio Consultant

*Check and maintain your tuner's performance
without the use of elaborate test equipment.*

FM TUNER performance specifications may describe the tuner in terms of its quieting sensitivity, bandwidth, frequency stability, and distortion. Accurate determination of these performance factors requires considerable expensive laboratory equipment and is usually beyond the scope of the audiophile or radio technician.

The alignment and adjustment of an FM tuner may be performed with relatively inexpensive service instruments such as a signal generator, audio analyzer, v.t.v.m., and oscilloscope. Many users of FM tuners have one or more of these test instruments available and should be able to perform much of the adjustment and maintenance on their receivers at home.

However, the vast majority of users have no test equipment at their disposal. Without at least a v.t.v.m., it is next to impossible to check the performance of a tuner or to align it for optimum performance. However, a number of modern FM tuners have sufficient built-in metering, either in the form of signal and tuning meters or as "magic eye" tubes, so that considerable maintenance may be performed on them without additional test equipment. The eye, in effect, constitutes a built-in vacuum-tube voltmeter.

This article will describe some of the tests and procedures which may be followed at home in order to check and maintain the performance of an FM tuner without recourse to expensive laboratory-type test equipment. For some of these tests, one or two simple service instruments will be required. These may be purchased ready built, may be constructed from kits, or may be borrowed from a friend who is for-

tunate enough to have them available.

Sensitivity Measurement

The sensitivity of an FM tuner is normally expressed as "X microvolts for 30 db quieting." This is defined as the minimum signal for which a 30 db increase in output is obtained when modulation percentage is changed from zero to 30%. Most tuners are advertised as having a sensitivity ranging from 1 to 10 microvolts. In most cases the actual sensitivity is not of great interest to the user. He merely wants to be able to receive his local FM stations with low background noise and distortion-free audio reproduction. The quieting sensitivity of an FM tuner is dependent, among other things, on the alignment of the i.f. transformers, the tracking and alignment of the r.f. and converter stages, and the transconductance of the tubes used in the r.f. and i.f. stages. It is normal for tubes to deteriorate with use and frequently the adjustment of the i.f. transformers will change with the passage of time, under conditions of variable temperature and humidity. These deteriorations usually occur very gradually and may not be noticed in day-to-day listening. The usual result is an eventual dissatisfaction with the receiver's performance without being able to pinpoint the source of the trouble.

Fortunately, it is very simple to determine whether a receiver has lost some of its original performance if a system of periodic checking is instituted from the beginning. When the tuner is first put into service, and if it seems to be operating satisfactorily, the signal strengths of several local stations should be noted. If the tuner has

a signal strength meter, as many do, this may be used as a direct indicator of signal strength. If only a zero-center tuning meter, or no meter at all, is provided, it will be necessary to measure the limiter grid bias with a v.t.v.m. See Fig. 1. On tuners employing limiting followed by a Foster-Seeley discriminator, the limiter grid circuit is easily identified. If the receiver uses more than one stage of limiting, the measurement should be made at the grid of the first limiter.

If a ratio detector is used, without limiting, the output voltage of the detector is usually used for a.g.c. and may be used as a measure of signal strength. See Fig. 2 for a typical circuit employing a ratio detector. In either case a negative voltage will be read, whose magnitude increases with signal strength. This voltage is indicative both of the signal strength and the gain of the preceding r.f. and i.f. stages. If strong local stations are selected as reference signals, it may be expected that their strengths will not vary greatly with time. Sometimes one station may vary widely in strength due to transmitter or antenna difficulties or changes. However, using several check signals will permit easy detection of such an occurrence.

Assuming that the signal strengths of the check stations remain constant, any reduction in meter reading at a subsequent time indicates a deterioration in performance of the tuner. Since some meter circuits are sensitive to line voltage changes, it is a good idea to check line voltage if there is a sudden drop in meter readings. The loss of performance may be easily separated into that due to weak tubes and that due to mis-alignment. The alignment may be checked without use of additional instruments, using a strong local station as a test signal. Disable the a.f.c., either by switching it off or by grounding the

a.f.c. line. See Fig. 3. Tune in the station for maximum meter reading at the limiter or ratio detector. Using an insulated aligning tool, carefully adjust the top and bottom alignment screws on each i.f. transformer, starting from the one preceding the limiter and working toward the mixer stage. Only very slight adjustments should be made, to avoid seriously mis-aligning the tuner. If the alignment is correct, the meter reading will decrease in each case. Return the transformer for the original maximum reading before proceeding to the next stage. If one or more transformers are found to give substantially higher meter readings when their settings are changed, it may be assumed that they were improperly aligned.

If this procedure does not result in an increased meter reading, it is probable that one or more of the tubes is weak. It is a good idea to have a spare for each type of tube used in the tuner, which may be substituted in the receiver until the defective tube is found. If the receiver has been in use a long time, it is likely that several weak tubes will be found.

This method of aligning an FM tuner, while not as good as the usual methods employing instruments, is likely to be quite satisfactory in most cases. If a service type signal generator is available, a more precise alignment may be accomplished. Fig. 4A shows the setup for the i.f. alignment of an FM tuner. The signal generator, set at 10.7 mc., is fed to the mixer grid. The i.f. transformers are peaked as described previously. Fig. 4B shows an alternate method which may be used when a signal generator covering the 88-108 mc. FM band is available. In this case, the signal is fed directly into the antenna terminals of the receiver through a resistance network which provides the proper driving impedance. The receiver in this case must be tuned to the generator frequency, which should be set at a point where no station is being received.

The alignment of the r.f. and mixer stages may be adjusted when the signal is introduced in this manner, but the details of this adjustment will vary somewhat with the particular receiver involved. Such r.f. alignment is not recommended for the relatively non-technical audiophile except for adjustment of the oscillator trimmer to calibrate the dial. Fortunately, the r.f. stages of an FM set are relatively broad and usually there is little loss of sensitivity from mis-alignment of these stages.

Detector Alignment

It is fairly common to find that the detector of an FM tuner is not aligned precisely on the center of the i.f. pass-band. This frequently causes distortion or high background noise level. If the receiver is equipped with a zero-center tuning meter or "magic eye" tube the alignment of the detector may be easily checked. The zero reading of the meter or the corresponding appearance of the eye tube should occur at the same fre-

quency for which the limiter or detector output meter reads a maximum. If it is necessary to detune from this maximum in order to center the tuning indicator, the detector is not properly aligned. The simplest way to correct this condition is to carefully tune the receiver for maximum voltage at the limiter grid (or maximum signal strength meter indication) and adjust the secondary tuning of the discriminator transformer for zero d.c. volts at the discriminator output or a center reading on a zero-center tuning meter or eye tube. The easiest way to adjust the primary tuning of the discriminator transformer is to listen to a station or a modulated FM signal generator, properly tuned in, and adjust the primary tuning of the transformer for maximum audio output.

The alignment techniques just described are, of course, crude by comparison to the usual methods employing sweep signal generators and oscilloscopes. However, they are capable of giving, for all practical purposes, the same order of performance and have the advantage that they may be applied without technical training or elaborate equipment.

In general, final alignment of a ratio detector requires the use of a sweep generator and oscilloscope. A v.t.v.m. can be used for approximate alignment of a ratio detector by observing the variation of d.c. voltage at the detector output (measured at the point marked "X" in Fig. 2) as the receiver is tuned through a signal. The voltage should swing equally far on both sides of the center reading. This assumes that the i.f. stages are properly aligned and that the center frequency corresponds to the maximum meter reading on the a.g.c. line. If the voltage swings on both sides of center are unequal, adjust the secondary of the ratio detector transformer for symmetry. The primary is adjusted for maximum output, as with the discriminator.

H.F. Oscillator Alignment

After extended periods of use, or sometimes even when new, the dial calibration of an FM receiver will be found to be in error, either at one end of the dial or possibly at all points. Assuming that no mechanical slippage of the dial pointer has occurred, the cause of this calibration error is an incorrect adjustment of the oscillator tracking. The usual procedure for alignment of a tuner requires that the inductance of the oscillator coil be adjusted at the low-frequency end of the tuning range and the small trimmer capacitor shunting the tuning capacitor be adjusted at the upper end of the range. It is sometimes a risky business for a novice to start squeezing or stretching coil turns on the local oscillator tuning coil and thus is not recommended unless the calibration error is great. In this case, it is a job best performed by a competent service technician.

A minor calibration error in the middle or upper end of the band can be easily corrected by setting the dial to

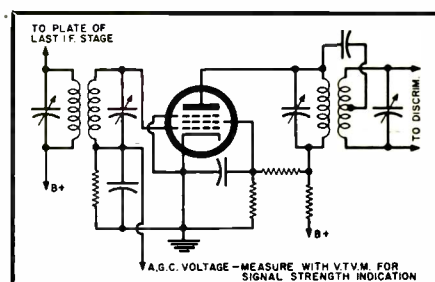

Fig. 1. Typical tuner limiter circuit.

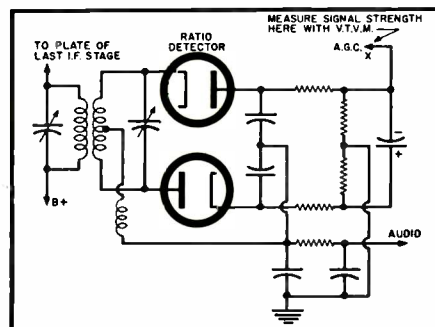

Fig. 2. Typical ratio detector circuit.

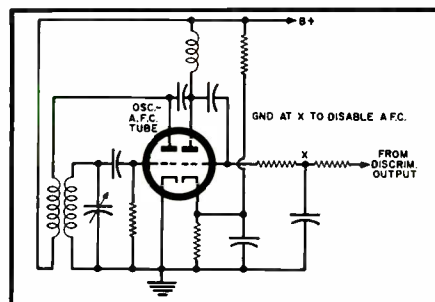

Fig. 3. Common oscillator-a.f.c. circuit.

the known frequency of a local station and carefully adjusting the oscillator trimmer capacitor until the station is tuned in correctly. Consult the schematic and instruction manual for the particular receiver to determine the location of this capacitor. In the absence of other information, the oscillator trimmer may be easily located since signals will be strongly detuned when the hand is brought near it.

Frequency Stability

Few things are more annoying than having to re-tune an FM receiver every

Fig. 4. I.f. and front end alignment setups.

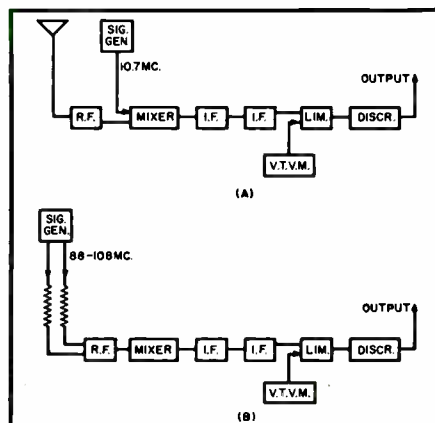

15 minutes or half hour due to a continuous frequency drift in the local oscillator. Many older sets suffered from this fault but it is fortunately uncommon in the more modern receivers.

The incorporation of automatic frequency control (a.f.c.) in most receivers has helped the situation considerably, but a.f.c. can only mask the effects of drift and is, in itself, no guarantee of long-term stability. The correct solution is temperature stabilization of the oscillator, which renders a.f.c. unnecessary or, at best, a convenience in tuning.

If a receiver has excessive drift during warm-up, there is little that can be done about it by the user on a relatively non-technical level. Establishing the existence of drift is simple, however. With a.f.c. switched off, turn on the receiver and tune in a strong station as soon as it warms up. Use the receiver's tuning meter or an external v.t.v.m. as a tuning indicator. In many receivers there will be some drift in the first ten minutes of operation, but this should not cause high distortion or signal loss. After ten minutes, re-tune the set, if necessary, and continue to observe the tuning indicator. Any appreciable drift after this point is definitely undesirable.

Another form of drift which has received less publicity than warm-up drift is that due to line voltage variation. In many locations, line voltage fluctuations are considerable during the evening hours and many tuners exhibit rather large drifts with changes in line voltage. Actual measurement of this effect requires equipment beyond the scope of the ordinary user, but its detection is simple. Supply power to the tuner through a length of inexpensive rubber-covered wire having a cube tap at one end, such as is frequently used as an extension cord. When the set has fully stabilized temperature-wise, tune in a station carefully. Plug an electric iron, broiler, or other high wattage appliance into the same cube tap supplying the tuner. This will usually drop the line voltage from 5 to 10 volts. Most tuners will show a noticeable drift under these conditions. The important thing to note is whether the station is detuned to the point of distortion or requires retuning to make the signal

useable. Of course, this test, as with all drift measurements, should be done with a.f.c. disabled.

Distortion

Distortion may be introduced in an FM tuner in two ways. Audio distortion occurs in the audio stages following the detector. Most tuners have little or no audio amplification and the signal levels are such that audio distortion is usually not significant. Most audible distortion comes from the detection process. Mis-alignment is a common cause of distortion. Assuming the receiver is properly aligned, the most likely causes of distortion are insufficient bandwidth in the detector or in the i.f. amplifier.

A fully modulated FM signal deviates 75 kc. each side of its center frequency. The discriminator must be linear over at least a 150 kc. bandwidth to give distortionless output from such a signal. Also, the i.f. bandwidth must be at least 150 kc. or the outermost components of the FM transmitted spectrum will be reduced in amplitude by the time they reach the detector. Discriminator performance is based on the signal having a constant amplitude and loss or reduction of the frequencies at the edges of the transmitted band will cause distortion exactly the same as inadequate discriminator bandwidth.

The effects of i.f. or detector bandwidth limitations cannot be measured without expensive test equipment, but they can easily be detected at home. If the receiver is well designed, a signal strong enough to "quiet" the receiver to a 30 db signal-to-noise ratio will sound clean and undistorted even though some background noise may be audible. If the receiver has insufficient i.f. bandwidth, a weak signal will sound distorted. If no weak signals are available, replace the antenna with a short wire to reduce the strength of a local station. If distortion becomes audible while the signal-to-noise ratio is still good, this is an indication of too much i.f. selectivity.

The reason for this can be seen in Fig. 5. The i.f. selectivity curve in Fig. 5A is typical of those found in low-priced FM tuners. A weak signal, not modulated very heavily, will be received without distortion, but as the

frequency deviation becomes larger, the signal falls below the limiting level and distorts. A signal must be strong enough so that its outermost components limit fully if distortion is to be avoided. This condition is shown by the upper curve in Fig. 5A.

Fig. 5B shows the i.f. response of the more expensive FM tuners. The "flat top" means that any signal strong enough to reach the limiting level will be received with little distortion.

If the discriminator bandwidth is too narrow, loud passages will sound distorted on strong stations as well as weak ones. On most receivers, the discriminator bandwidth is at least as great as the i.f. bandwidth so this is not too great a problem. If the discriminator and i.f. both have 150 kc. bandwidth, tuning is critical and a slight drift will cause distortion. Many better tuners now employ wide-band discriminators, several megacycles wide, which make tuning fairly non-critical.

Hum

Hum in an FM tuner can be introduced by frequency modulation of the local oscillator, usually by heater-cathode leakage in the oscillator tube or in the discriminator stage, for the same reason. If the receiver has an audio section, it may arise here as well.

A quick check is to remove the discriminator tube. If hum persists, it is in the audio section; if it disappears it is due to the earlier stages. The next step is to remove the limiter stage, or stages. Any hum remaining probably arises in the discriminator stage. If it disappears, the local oscillator is the most likely cause. Local oscillator hum only appears when a station is tuned in and is not present in the absence of a signal. The receiver hiss may mask hum when no station is received, but an oscilloscope across the audio output will disclose its presence.

It is worth remembering that many FM stations have appreciable amounts of hum in their audio systems. This will be indistinguishable from hum modulation of the receiver local oscillator. If hum is heard on some stations but not on others, the receiver is probably not to blame. If it is present on all stations, it is most likely the fault of the receiver.

The only practical treatment of hum arising from heater-cathode leakage in a receiver tube is replacement of the tube. Many receivers now use germanium diodes in the discriminator stage, which eliminates that possible source of trouble.

It is possible for the user of an FM tuner to make simple home checks of its performance, which will permit him to detect deterioration in its operation without the use of elaborate test instruments. Many simple tests and alignment procedures can be performed with no instruments other than the tuning indicators usually supplied with FM tuners. Practically all other service and test functions can be performed with simple, inexpensive equipment.

Fig. 5. Effect of bandwidth on distortion with (A) peaked and (B) flat-topped curves.

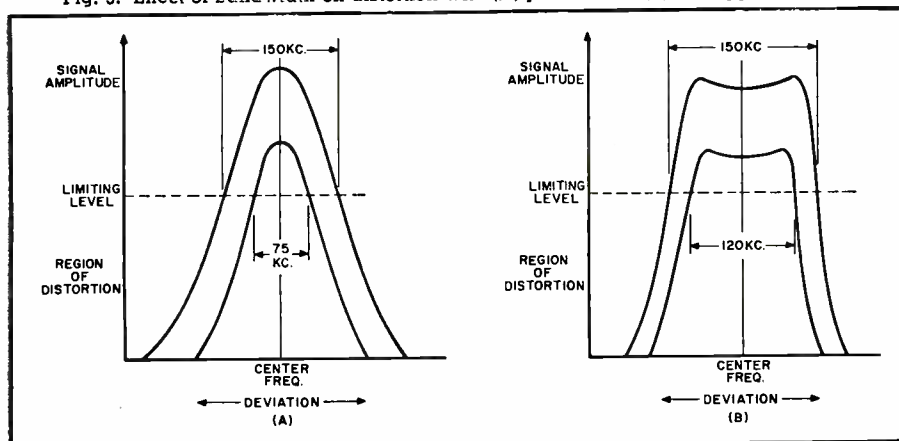

Coax Line R.F. Monitor

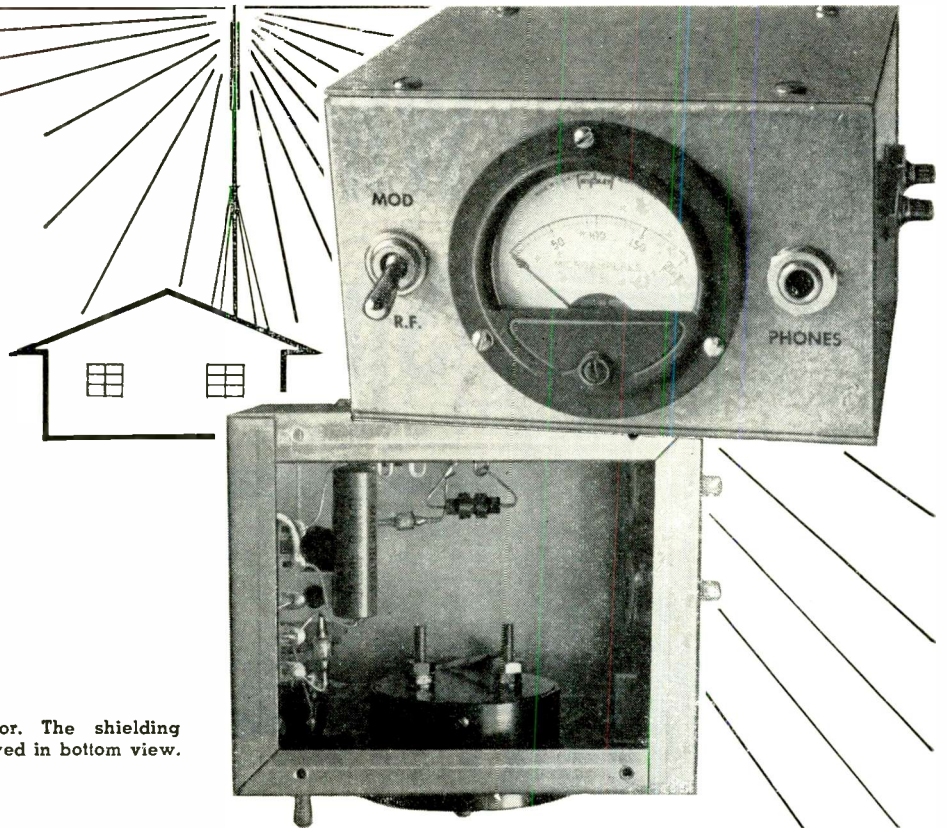

Views of r.f. monitor. The shielding cover has been removed in bottom view.

By **ROBERT F. LEWIS, W8MQU**

MOST amateur radio operators, these days, are fairly well supplied with instruments for measuring the various operating characteristics of their equipment. Practically any ham can determine, with reasonable accuracy, his operating frequency or final amplifier power input. Very few stations, on the other hand, have any facilities at all for determining the quantity or quality of r.f. output into the transmission line or antenna system.

In an attempt to help fill this gap, an r.f. output meter was developed which provides for the monitoring of: (1) relative carrier output power; (2) amplitude modulation percentage; and (3) aural monitoring of modulation. In view of the almost universal use of coaxial output circuits the instrument was designed to be inserted into a coaxial line without upsetting the characteristics of the line.

The circuit of the monitor is very simple. No external power source is required and the total cash outlay for component parts should not exceed ten or fifteen dollars, depending on the cost of the microammeter.

Briefly the monitor functions as follows: Resistors R_1 and R_2 form a voltage divider network across the coaxial line. That portion of the r.f. line voltage which appears between the junction of the two resistors and ground is rectified by CR_1 , a 1N34 germanium diode. The rectified current passes through an r.f. filter composed of RFC_1 and C_1 , through calibrating resistors R_3 and R_4 , and then through M_1 (when S_1 is in the "R.F." position). The audio component of the signal passes through C_3 and T_1 and is recti-

Output meter for ham shack measures relative power, modulation percentage, and monitors the modulation.

fied by CR_2 . The rectified current is indicated on M_1 when S_1 is in the "MOD." position. Thus it is possible to read either the relative r.f. carrier level or modulation percentage of a signal by merely throwing S_1 to one position or the other. Output for aural monitoring is available at J_3 . Interstage transformer T_1 is connected in a stepdown arrangement to provide a better match between the low-impedance load and the high-impedance primary circuit.

The resistance values of R_1 and R_2 are not given in the parts list as they must be determined for each individual

case. The total network resistance (R_1 plus R_2) should be roughly one-hundred times the nominal line impedance, that is, between 5000 and 7500 ohms. It can be readily seen at this point that the monitor will draw a very insignificant amount of power from the transmission line, probably not more than one per-cent. The ratio of R_1 to R_2 should be chosen so that between 5 and 10 volts of unmodulated r.f. will appear across R_2 . Much more than this may damage the germanium diode, CR_1 , especially with amplitude modulation. The total power-dissipation rating of R_1 plus R_2 should be one per-cent, or more, of the expected transmitter power output. Both resistors should be of the non-inductive carbon type.

All other component values remain as indicated in the parts list irrespective of transmitter power rating. It should be noted, however, that calibrating resistors R_3 and R_4 were chosen for use with a 0-200 microampere meter. In the event that a meter of different range is used, it would be advisable to change the values of R_3 and R_4 . Thus if M_1 were to have a range of 0-100 microamperes, then the values of R_3 and R_4 should be doubled. The use of a meter of greater than 1 milliamperere range is not recommended.

The construction of the instrument can assume many variations. However, several points should be observed. First, the unit should be built in a
(Continued on page 108)

Schematic and parts list of r.f. monitor.

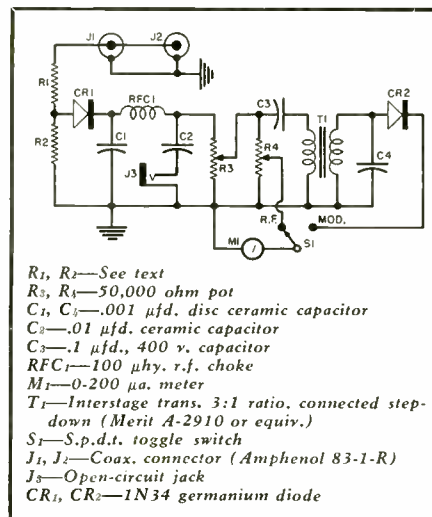

Why Low-Efficiency Speaker Systems?

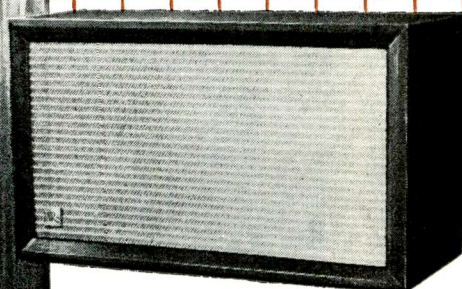
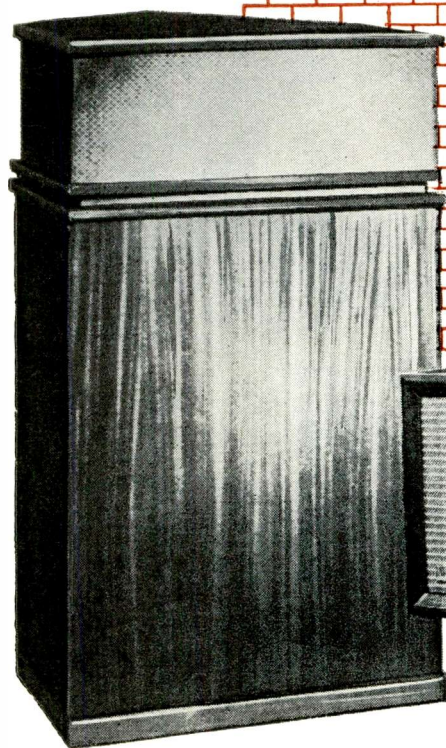

Two extremes in speaker system design—the Klipschorn, considered as having the highest over-all efficiency, and the Acoustic Research AR-1, which is rated as having the lowest over-all output efficiency.

By **EDGAR VILLCHUR**
Acoustic Research, Inc.

A leading proponent of the low-efficiency loudspeaker system discusses its characteristics and gives his reasons for the use of this type of system.

THERE has been a lot of recent interest in loudspeaker efficiency, particularly with regard to its side effects. It has been claimed, for example, that high efficiency is a necessary earmark of good transient response, or that only low-efficiency speakers are capable of musical quality. Neither claim is accurate, and some of the "old wives' tales" about this particular subject need clearing up.

First, let us examine the factors that actually determine the electro-acoustic efficiency—the relationship between acoustic power output and electrical power input—of a speaker. These are: (1) strength of the magnetic field, (2) amount of copper or other material in the gap, (3) mass and friction of the moving system, and (4) nature of the coupling between the voice-coil and the air which it drives.

These factors are not constant at all frequencies. Mid-range efficiency may be quite different from efficiency at the frequency extremes; for example, the speaker which has the lowest over-all efficiency of any on the high-fidelity market is rated¹ as one of the most efficient, if not *the* most efficient, in the frequency range below 30 cycles. Apparently it is necessary to dig a little deeper.

Strength of Magnetic Field

For a given magnetic structure, the size and strength of the magnet can

be taken as an index of the magnetic flux in the gap. Yet a "replacement" type speaker, with an *Alnico V* magnet of 6.8 oz., may have much higher mid-range efficiency than a quality speaker whose magnet, made of the same material, weighs five times as much. The amount of magnetic flux is thus only a relative figure, without absolute significance unless all of the other factors are held constant.

Amount of Copper in Gap

One of the reasons why the strength of the magnetic field is not an absolute index of efficiency is that the relative amount of working copper (or other conducting material) in the gap may vary from speaker to speaker.

If we design the voice-coil with a view to keeping bass harmonic distortion as low as possible, we must allow the winding to overhang the gap, so that even with large excursions the entire length of the gap is filled with copper. Unless the voice-coil is longer than the gap, each large excursion will remove some of the turns from the controlling field, and reduce the force generated by the signal; with voice-coil "overhang" the same number of turns is always immersed in the field, as shown in Fig. 1A. Here is a case where we must choose between efficiency on the one hand and reduced bass distortion on the other.

Fig. 2 is a comparison of performance, with regard to distortion, be-

tween a standard low-efficiency AR-1 speaker system (one-inch long voice-coil suspended in a half-inch long gap) and a non-production model of the same speaker, whose voice-coil length was purposely made the same as that of the gap. In the improperly designed, higher efficiency model *all* of the copper works to drive the speaker at mid-range frequencies, while in the standard model half of the signal voltage appears across non-active sections of the voice-coil. Ignoring fringing of the magnetic field, the sacrifice in mid-range efficiency would be by a factor of four, since power varies as the square of the voltage.

Mass and Friction

It is easy to understand intuitively that the heavier the vibrating cone and voice-coil and the greater the friction that must be overcome, the more electrical power will be required to set the speaker into motion at a given sound level. It might seem that the speaker designer should simply try for as light and frictionless a moving system as possible.

But here again there are complicating factors. When we go to light cones we must accept more violent cone flexure or "breakup," a phenomenon directly associated with harmonic distortion and with dips and peaks in the frequency response curve. Furthermore it is often desirable to deliberately introduce friction into the

speaker's moving system, in the form of a viscous damping substance at the cone rim suspensions. This suppresses edge reflections and the attendant standing waves set up in the cone.

An additional element in avoiding too light a cone has to do with over-damping, which will be considered in more detail a little later.

Speaker-Air Coupling

The factors that have been discussed so far involve the speaker mechanism itself, exclusive of its enclosure. These factors indicate the reasons that, at the present state of the art, *all* loudspeakers in themselves are grossly inefficient. Probably the best that can be hoped for, from a loudspeaker in a simple baffle, is a general efficiency on the order of 10%. A more typical figure is 5%, and current low-efficiency units boast efficiencies of one or two per-cent. At best, we must throw away 90 per-cent of our amplifier power before we convert it into sound; at worst, 99% or more.

This should not be a surprising situation to those familiar with the electronic field. It is an accepted fact in circuit design, for example, that narrow-band, resonant circuits can be designed with high gain, while wide-band circuits must limp along with low gain. A TV amplifier stage, with 4 megacycle bandpass, is not expected to provide the gain of a comparable audio stage. The analogy is not exact, but it will serve. If a loudspeaker had only to reproduce a narrow band of frequencies, we would not have to spend so much electrical power on it.

We now come to the most important single element that influences speaker efficiency, and the crux of the problem. The type of coupling between the speaker and the air (once the cone area is fixed), as determined by the speaker enclosure, not only has a direct and important bearing on the efficiency figure, but also influences the kind of design that can be used in the speaker mechanism itself. It tells the speaker designer whether he should be building a speaker whose mid-range efficiency (before enclosure) is in the one to three per-cent category, or in the seven to ten per-cent bracket. The enclosure thus counts twice with regard to efficiency.

In spite of the many apparent varieties of speaker enclosures available on the market, there are only three basic types: the direct-radiator (infinite baffle, acoustic suspension, etc.), the resonant (bass-reflex, acoustical labyrinth, etc.) type, and the horn. The resonant enclosure and the horn have one characteristic in common: the cone is coupled to an increased volume of air at low frequencies, compared to that which it would engage directly, and a given bass sound level is associated with smaller cone excursions. This means (1) voice-coil overhang requirements are reduced, and (2) the problem of over-damping,

which would attenuate the bass in the region of speaker resonance, is likewise reduced, due to compensation of the enclosure. Both of these results enable the speaker designer to work for maximum mid-range efficiency. And since horn loading also increases the efficiency directly, it is possible to end up with a transducer whose conversion losses are relatively small. Horn efficiencies as high as 50% have been claimed.

If we were to take a speaker mechanism designed for maximum over-all efficiency and mount it as a direct-radiator, we would be likely to get very disappointing results. The speaker would not be capable, either electrically or mechanically, of undergoing the large excursions required in the bass, and it would also be over-damped. The bass range would be attenuated and harmonic distortion at low frequencies would be high.

On the other hand, a speaker designed for use as a direct-radiator would have the necessary overhang of voice-coil winding, and freedom from over-damping, and would fall in the low-efficiency range. The direct-radiator baffling system counts twice here, too, this time against efficiency; once in directing the speaker designer to choose features that must sap efficiency, and again in giving up any aid in coupling the cone to the air, other than that of direct contact. One may wonder, then, why anyone would deliberately choose a direct-radiator over a horn or resonant system, with the former's inherent sacrifice in electro-acoustic efficiency.

The author believes that each of the design approaches just referred to are valid, and that successful results can be achieved with any of them. Since the author's own experience has yielded the most success with the low-efficiency, direct-radiator approach, its case will be outlined here.

The benefits sought by such an approach, in return for the sacrifice of

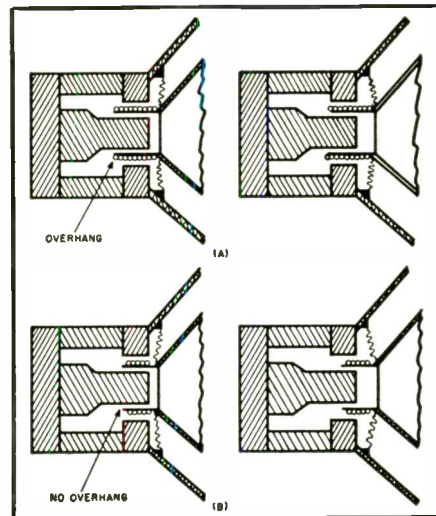

Fig. 1. A large voice-coil overhang keeps the number of turns in the gap constant, even on large cone excursions, but it results in a loss of efficiency.

efficiency, are decreased bass harmonic distortion (in spite of the increased voice-coil travel), better uniformity of frequency response (and the attendant improvement in transient response), and a more extended range of frequency response at the bass end.

A speaker is a resonant mechanical device, whether we like it or not, and much of the effort of the designer must be directed toward taming this resonance. The use of a horn, bass-reflex, or resonant-column enclosure adds greatly to the problem. Acoustical resonances, which produce response peaks and dips, and boomy, hollow sound, are very nasty and difficult to deal with, usually far more difficult than the primary resonance of the speaker itself. It is not theoretically impossible to tame acoustical resonance—bass-reflex ports can be damped, horns can be made with large enough mouth diameters to discourage

(Continued on page 140)

Fig. 2. (A) Acoustic output at 30 cycles, 39 watts to rated impedance, of a standard AR-1 speaker having a 1/2-inch voice-coil overhang. Output of the amplifier was adjusted for 1/2-inch cone excursions. (B) Acoustic output, at the same input frequency, of a special speaker system, identical to the AR-1 except for lack of voice-coil overhang. Only 23 watts were required for the same peak sound level at the microphone. (The actual 30-cycle level is less than that represented by the height of the waveform, because of the harmonic content.) A DuMont type 302 Polaroid oscilloscope camera and a type 401 oscilloscope were used for waveforms.

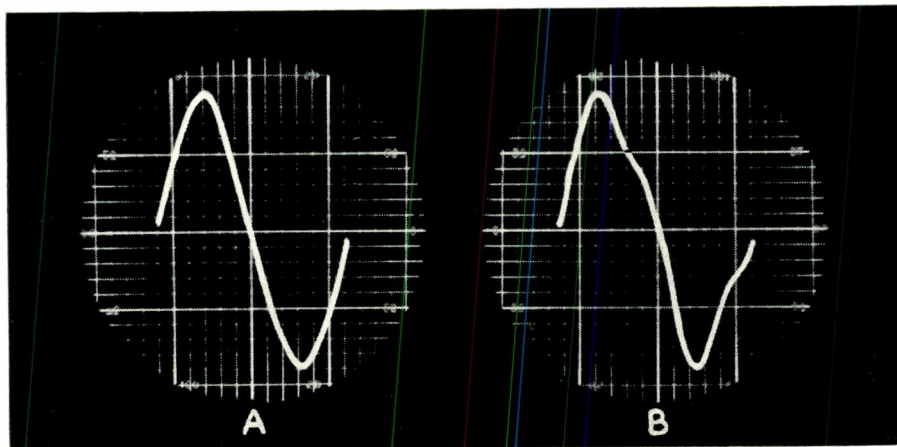

Service Techniques for Standard Coil Tuners

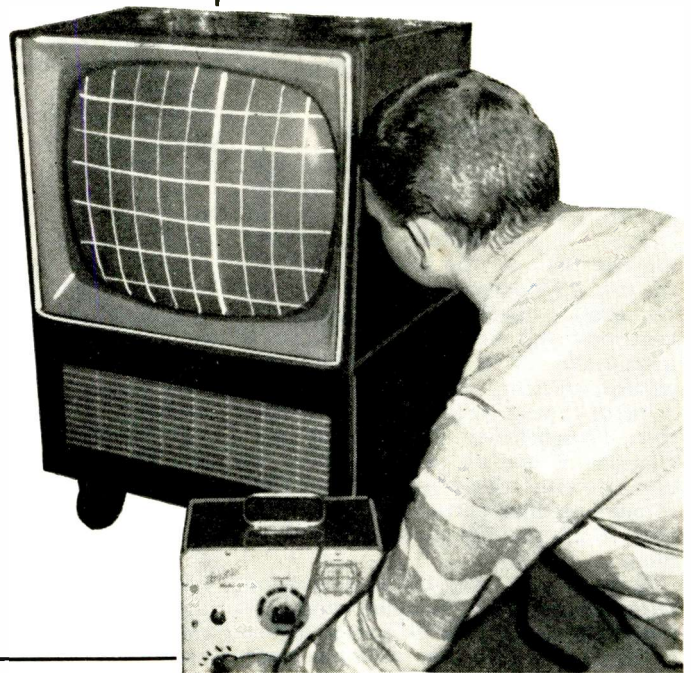

Fig. 1. A technician uses a pattern generator to check tuner sensitivity.

By CHARLES GARRETT

Procedures for handling electrical and mechanical difficulties on these widely employed front ends.

THE STANDARD COIL tuner is standard equipment in many of the more popular television receivers, both past and present models. Although it is not a difficult tuner to service, several special techniques, aids, and tools can speed up needed repairs, make its servicing more convenient, and help to insure maximum performance from each unit.

The basic mechanical design of this type of channel selector can be seen in Fig. 2. Each channel has an individual strip on which are mounted an antenna coil and r.f. coil for that channel. Also, in line with each antenna-r.f. strip, is another strip for that channel on which are mounted the mixer and oscillator coils for the channel. Each set of strips is designed and tuned for just one channel to obtain maximum gain and bandpass. Some later models have each channel's coils integrated into one extra-long strip instead of two strips. The contact points on the strips for the channel being viewed touch finger-springs which connect each strip's coils to the tubes and other circuitry in the tuner. All these channel strips are mounted on a drum or turret which rotates to select the various channels individually and independently.

All channel strips, other than those for the channel being viewed, are disconnected and could be removed without having any appreciable effect on the reception of that channel. This

permits an interesting technique to be employed in the servicing of these tuners. Also, since any adjustment made on one channel's r.f. or oscillator strips has no effect on any other channel, this simplifies oscillator adjustments.

Cleaning and Maintenance

The most common servicing need of *Standard Coil* tuners is for the removal of tarnish that forms on the channel-strip contacts and on the finger-springs. Most technicians are familiar with the symptoms: fluctuating and intermittent performance of the channel selector. To the set owner it acts as if the detent fails to click in correctly or that, as he is likely to put it into words, "something is loose or shorted."

Tarnish on contacts can easily be removed without removing the drum from its tuner housing simply by applying a commercial tuner-contact cleaner fluid to a clean cloth and wiping each strip's contacts (Fig. 2) as the drum is rotated. Files, sandpaper, and emery cloth should not be used for this purpose as they can easily wear through the relatively soft finish on the contacts. It is not necessary to remove the drum, either, with the resultant difficulties often encountered in re-installing it, in order to clean the finger-springs or to check and adjust their tension.

Instead of removing the drum or

turret, remove two or three adjacent sets of channel strips and rotate the drum so that the resultant empty spaces are under the finger-springs, as shown in Fig. 3. This gives the technician a clear view and sufficient working area to clean and adjust the finger-springs. A pencil with its eraser dipped into contact cleaner is a convenient tool for this purpose. Before re-installing the strips on the drum, check the tension of the finger-springs. Their tension is correct when they rub firmly against the plastic of the channel strips as the drum is rotated. Proper tension keeps the strip contacts clean for a longer time.

Repair Techniques

Although the *Standard Coil* tuner is not a difficult one to service, it does offer some obstacles, especially to voltage and component testing while it is assembled and in operation. Even with its side panel removed, many of the tube-socket terminals cannot be reached with test prods and many components are inaccessible unless the drum is removed. But, with the drum removed, the tuner cannot operate and therefore cannot be thoroughly tested under operating conditions.

Adapter test sockets are sometimes suggested as a partial solution to this difficulty by allowing socket voltages to be measured from the top of the tuner chassis with the tubes functioning. The technician will, however, have to take into account the fact that the inherent capacitance and inductance in these test sockets has considerable effect on the tuner's performance as well as on the tube-socket voltages—

particularly those in the oscillator and mixer circuits.

There is a more accurate way to test socket voltages and, at the same time, gain access to the circuitry on the underside of the tuner chassis. Remove most or all of the channel strips with the exception of the one channel being used. In this way (see Fig. 4) access to the tube sockets and circuit components is obtained.

Mechanical Repairs

The plastic cam on the rear of the fine-tuning shaft can develop slippage, thus making the fine-tuning control inoperative. The set owner usually brings about this condition by forcing the fine-tuning knob to turn the shaft farther than it is intended to go (usually due to an incorrectly set individual-channel oscillator adjustment) and by rough handling in general. No repair or replacement is generally called for unless the plastic cam refuses to rotate when the shaft is rotated.

When fine tuning is inoperative for this reason, remove and inspect the fine-tuning shaft and its attached cam, as shown in Fig. 5. Inspect the area around the flange that the shaft forms about the hole in the cam. Look for signs of chipping of the plastic. Where the flange is only loose or the chipping is moderate, reseating the flange should correct the slippage. Place the shaft upright on a hard surface with the plastic cam uppermost. Then gently indent the flange into the cam with a small steel chisel or a screwdriver, as shown in Fig. 5. This will correct slippage if the cam or flange, or both, are not too badly worn.

Many cases of intermittent tuner operation can be traced to one or more of the topside tuning screws (Fig. 6) having worked loose. When the washer-like conical nuts that hold these trimmer-capacitor assemblies in place become loose, they provide a poor ground for these screws. Actually, each screw is one terminal of its trimmer capacitor. These trimmers and conical nuts should be inspected for this condition when an elusive intermittent condition exists; if one is found to be loose, the conical nut should be turned down tight, then soldered in place to the tuner chassis.

Alignment and Sensitivity

Seldom is it necessary to completely re-align a *Standard Coil* tuner unless

the adjustments were tampered with or unless extensive parts replacements were made in the signal-handling circuits. In either case, the set manufacturer's alignment data—data that may vary for his particular set or model or for the various models of *Standard Coil* tuners that are encountered—should be closely followed.

Most technicians are quite familiar with the individual-channel oscillator adjustment. It simply involves, in most cases, removing the channel-selector and fine-tuning knobs; inserting a non-metallic alignment tool or one with a non-metallic tip into the hole provided for it in the front of the tuner; and adjusting the powdered-iron tuning core in and out for the best picture and sound on the channel being received. These individual-channel adjustments have no effect on any other channel.

The problem sometimes encountered in this procedure is the loss of the tuning core caused by its accidentally being turned too far so that it slides to the rear of the coil form and disables that channel. Normally removal of the chassis of the disabled channel strip would be required to reposition the core. However, with the various tools now on the market, designed for retrieving these tuning cores from the front of the cabinet, dismantling a receiver is no longer necessary.

Receiver sensitivity, or its ability to produce a usable, snow-free picture from a relatively weak signal, is dependent on the tuner. Snow or background and shot-effect noise can be overcome by a TV signal of sufficient strength to cause the receiver's a.g.c. action to reduce the gain of the r.f. tube—a source of most background and shot-effect noise. This is of course true for all brands and types of tuners. The picture will be snow-free as long as the antenna is delivering a sufficient amount of signal and this signal is properly handled and amplified by the tuner.

Consequently, a defect in the antenna system or in the receiver's tuner can reduce this signal and produce receiver snow. In borderline and fringe areas and in some difficult locations, a certain amount of picture snow is commonplace. In these locations, the technician cannot assume receiver snow to be an indication of a defect. However, if either tuner or antenna system is defective, doubt can exist as to which. The readings of a field-

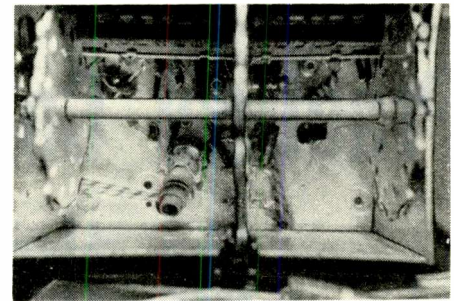

Fig. 4. All strips removed except one pair in use, for access to circuitry.

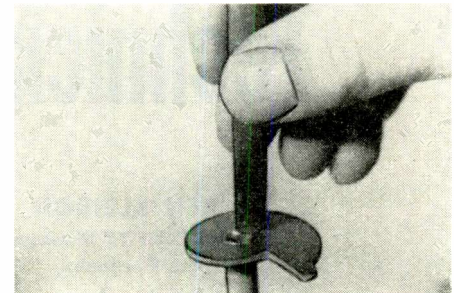

Fig. 5. Procedure for re-seating a plastic fine-tuning cam on its shaft.

strength meter are of little value in these cases, since there is usually no way of telling what the "normal" signal is for that particular location. The use of a portable linearity or cross-hatch generator with r.f. output can be of assistance.

The idea is to use the r.f. output of this generator to test, by comparative r.f. attenuator settings obtained from normal receivers, the minimum perceptibility or sensitivity level and the snow-free level of the receiver under test. The technician can then judge whether the snow (or excessive snow) is caused by a defect in the set or in the antenna system.

Comparative attenuator settings are obtained from two normally operating TV sets, one with a pentode tuner using r.f. tubes such as the 6AG5, 6BC5, or 6CB6, the other with a cascode tuner using a 6BK7, 6BQ7, 6BZ7, 6BS8 or the like. First connect the pattern generator to the antenna terminals of a set with a pentode tuner; tune the generator to the frequency of the channel being used; and adjust the generator output attenuator until the cross-hatch pattern on the screen is barely perceptible, as shown in Fig. 7. Mark or record the setting for a pentode tuner on the generator
(Continued on page 192)

Fig. 2. A cloth moistened with contact cleaner fluid is used to remove tarnish.

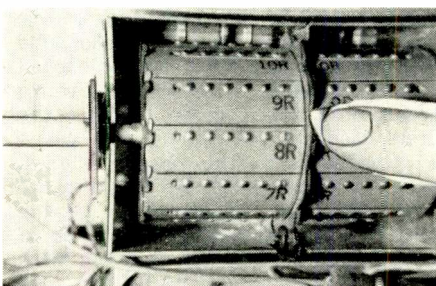

Fig. 3. Tuner drum with three sets of strips removed to expose finger springs.

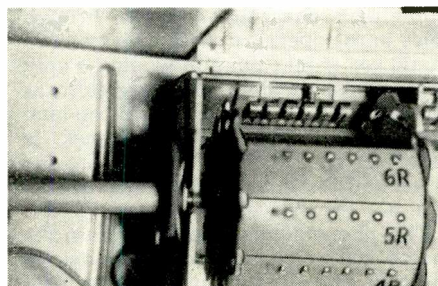
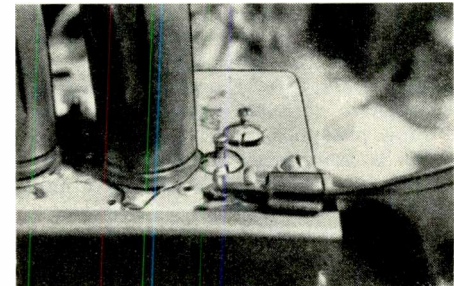
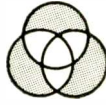

Fig. 6. The conical nut on the trimmer screw at the right has worked loose.



Practical Color TV for the Technician



By **KEN KLEIDON**
National Color TV Manager
Hycon Electronics

Part 4. The three-gun color picture tube and how it handles signals to make many colors of three.

THE PICTURE tube in a color receiver performs the final act in the reproduction of the televised scene as it converts the electrical signal impulses into the necessary color and light variations. As presently used, these tubes are of the three-gun type. While other types are still mentioned as possible, no commercial receiver manufactured to this date has used any but a three-gun tube and no set has been announced specifically for future production that uses any other. Thus, any understanding of color reception must include a study of this device.

In many ways, it is easier to look upon this tube as three separate ones built into a single envelope. Each gun has its own cathode, control grid, screen grid, and focus electrode. In fact, it may even be said that each gun has its own phosphor screen (although this screen has been broken up into dots of phosphor that appear side by side with dots of other phosphors).

Each of the three separate picture tubes integrated into a color CRT can independently function as would a monochrome picture tube. We could, for example, hook up a color picture tube so that only its red gun was in use. It would then produce a monochrome picture entirely in shades of red. The only difference between any of these three guns and any other is the color of the phosphor each is intended to activate. Each of the guns is designed to activate either red, green, or blue phosphors, and each of these colors is considered a primary color. That is, by various combinations of any two or all three of these primaries, white and all other colors can be produced.

Since there is only a single faceplate

in the single tube envelope on which all three screens can be placed, the screens are broken up in an interesting manner. Minute dots of red, green, and blue phosphors are scattered all over the faceplate to fill its surface, but they are not put down in a random manner. They are precisely deposited in a repetitive, triangular relationship, as illustrated to the right in Fig. 2.

Inside the color CRT is the aperture mask, an element not found in conventional monochrome picture tubes. It is located between the neck of the tube and the faceplate, but much nearer to the latter. In fact, looking at this mask from the neck end of the tube, we would say that it covers the entire faceplate, whose contour and shape it follows.

The aperture mask, or shadow mask, is full of minute, regularly spaced holes, and there is one hole in the mask for each group of three phosphor dots on the faceplate. The three separate guns are mounted roughly parallel in the neck of the tube, and all aimed so that their beams converge in the plane of the aperture mask. In this way, as shown in Fig. 2, they will pass through the holes in the mask together, then separate so that each goes on to strike its own phosphor dot. In fact, if we could get inside each of the aimed electron guns separately and sight through holes in the aperture mask, the view we would see from each gun would be only of the phosphor dots belonging to it, as shown in Fig. 3. The view from the blue gun through the aperture mask is shown at (A), with the views from the green and red guns being shown at (B) and (C) respectively.

This phenomenon helps to explain the reason for using an aperture mask in the first place. Since it would be diffi-

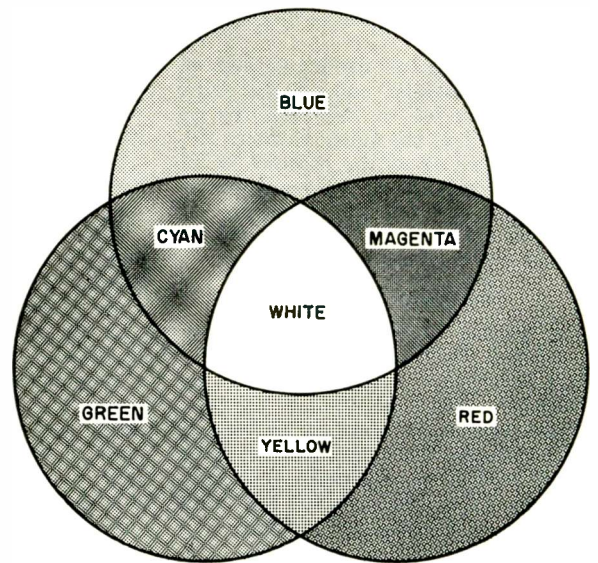

Fig. 1. The color combinations that result when the lights from a red, a green, and a blue lamp are thrown on a screen so that their beams overlap.

cult to design a gun in which all the emitted electrons would be accurately aimed only at those phosphor dots of the right color, the mask acts as a control device. Only those electrons that are being propelled in the proper direction will get through the openings and activate phosphors. Any that are off target, that is, heading for a phosphor dot of the wrong color—will be blocked by the mask. Thus the mask is said to maintain color purity.

Once we have our three colors carefully separated, we go about mixing or adding them under controlled conditions to achieve desired results. The concept of color *addition* and the color combinations that result from it seem strange to many people, since most of us are used to blending colors by the mixing of pigments, which is a form of color *subtraction* and produces results that are quite different.

To begin with, physicists have established the fact that white light is actually a combination of lights of all colors mixed in a given proportion. This can be demonstrated by shining a white light on one face of a glass prism and permitting the light that leaves through another face of the prism to be projected on a flat, clear surface. The resulting light appears, not as white, but as a rainbow. Conversely, we can take colored lights and mix them in appropriate proportions to produce white light.

To illustrate this latter principle, which is used in the three-gun picture tube, we can use three matched slide projectors (or any other three matched sources of white light), a viewing screen, and three color filters. The filters used are red, green, and blue—to correspond to the shades of red, green, and blue phosphors found in the color CRT and considered to be the primary colors for television. Each of the projectors or lamps is fitted with one of the three transparent filters. The

circular spots of light are then projected onto the viewing screen.

If the colored lights are projected to different points of the screen, we will see separate spots of red, green, and blue light. If the lamps are positioned so that they tend to converge and all three overlap, as in Fig. 1, we can see the results of the addition of colored lights. In the center, where all three colors overlap, we will see white light. If the filters are properly matched and light output of the three projectors or lamps is properly balanced, a pure white can be seen; if not, balancing out the line voltage fed to each of the lamps may achieve this condition. Where only blue and green overlap, cyan, a blue-green shade, will be seen. Where only blue and red overlap, magenta, a purplish shade, will be visible. Where red and green overlap, yellow will appear.

A great number of other colors can be produced by individually varying the brightness of each of these three primaries. This may be done by varying the line voltage input to each lamp. For example, the yellow wedge of light is shown to result from the addition of red and green. If brightness of the green lamp is reduced, the yellow segment begins to appear orange. Since we can infinitely vary the combinations of brightness settings for the three lamps, we can produce infinite color combinations. The three guns of the color picture tube function like the three projectors.

Actually, the phosphors excited by the three guns never overlap and blend together. Since the phosphor dots are so fine and so closely spaced, however, the human eye cannot resolve them except at the closest distance, and they appear to blend together. Their separate character can be confirmed by placing a magnifying glass in front of the screen of a color TV receiver to view the dots. Where yellow is seen on the screen from viewing distance, individually excited red and green dots can be seen under magnification; where magenta appears, individual red and blue dots will be revealed.

Three new types of adjustment arise with reference to the color CRT using three guns; they pertain to purity, convergence, and balance. These are important because they are performed at the time of installation of the color receiver and in many cases after the need for servicing the set has arisen.

Fig. 2. Beams from the three guns must converge in passing through the openings in the aperture mask.

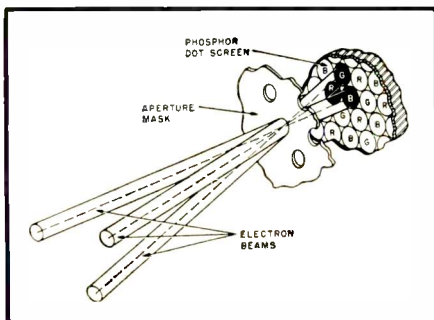

Purity adjustments involve positioning the deflection yoke, adjustment of a purity magnet which is located on the neck of the picture tube, and adjustment of field equalizing magnets located around the perimeter of the face of the picture tube. The goal in manipulating all or any of these is to ensure that the electron beam of any of the three electron guns will strike phosphor dots only of its own color over the entire surface of the screen. The components typically associated with the picture tube are shown in Fig. 4.

Convergence adjustments are necessary because the electron beam does not always travel over the same distance from the point where it leaves its gun to the point where it strikes the screen. This is true because the screen of the tube does not follow a conspicuously curved shape that is made to correspond with the arc through which the three electron beams swing. Fig. 5, for example, shows the limits of deflection through which the three beams are swung in broken lines. Also shown in broken lines is the arc described by these beams.

Since this arc does not correspond to the shape of the somewhat flatter aperture mask and phosphor dot screen, the point at which the three beams converge in going through the apertures of the mask will not always be the same during deflection. At the center of the screen, they must converge at a point nearer to the guns than they converge at the outer edges of the screen.

Although there is no intention to delineate the convergence adjustment procedures here in detail, it is worth pointing out that signals for varying the beam length, derived from and in step with the deflection circuits, are fed to special convergence coils around the neck of the tube to vary the converging point of the three beams as they scan to match the distance to the aperture mask at any given moment.

It will obviously be an unreasonable production requirement to expect that all three guns of the picture tube be entirely identical in all respects, although the degree to which they approach this condition is important. Since some variation among these guns is inevitable, each electron gun is provided with balancing adjustments to facilitate the matter of matching all three to each other externally. These consist of individual screen and brightness controls for each gun. With these, the light output from each phosphor can be balanced against the output of the other two guns so that they all exist together in the proper proportion to produce white or other colors, as determined by incoming signal. This balancing arrangement is not too unlike the procedure, mentioned earlier, of adjusting line voltage input to the three projection lamps.

This greatly simplified explanation of some of the things that happen in the color picture tube will be of most value to the service technician if he remembers that he is fundamentally dealing with three monochrome picture tubes

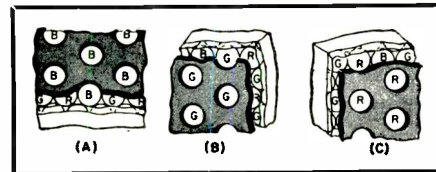

Fig. 3. Views through the aperture mask from (A) the blue, (B) the green, and (C) the red guns of the color CRT.

that have been placed in the same envelope. It may even happen, in fact, that he will have to deal with defectiveness in one of these three entities that does not directly involve the other. It will then help to remember that he can "turn off" any one or two of these three, for example, to isolate defects involving one gun or one of the channels associated with it.

This separate nature of the three guns, of course, comes into play only when the picture tube is being considered analytically—that is, from the point of view of troubleshooting or adjustment—and the technician is quite likely to be lulled away from this character of the CRT because the nature of his job is more often to manipulate these three tubes so that they act as one!

(To be continued)

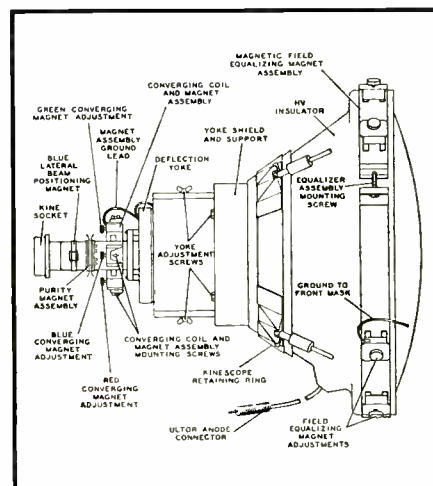

Fig. 4. A mounted tri-gun color CRT with some of its associated components.

Fig. 5. Paths of beams from the three guns must converge at the shadow mask.

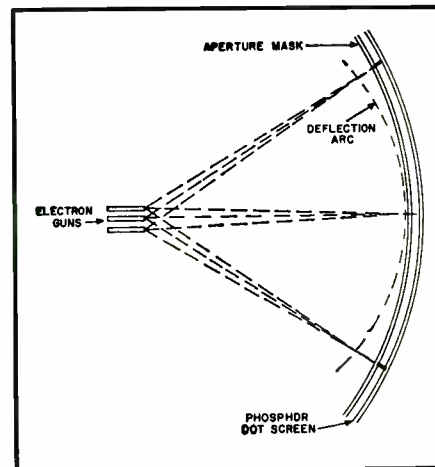



Fig. 1. A radio shop in Guaymas, Mexico, advertises quick service on transmitters, receivers, and phonographs.

By

RONALD L. IVES

Repair rather than replacement and other notable shifts in emphasis arise from economic factors.

THE use of radio equipment has expanded enormously in northern Mexico during the past two decades to the point where almost every community, no matter how small or how isolated, has a radio link with some central administrative point. In addition, every resident of Mexico who has a relatively simple and inexpensive receiver is able to receive at least one program in Spanish. In many areas, programs are also available in the local Indian dialects. Over the greater part of Mexico, a multiplicity of broadcast programs is available.

Plans are now underway to extend the Mexican television network so that the republic will have complete video coverage. Radio, radar, and sonar equipment is becoming standard on Mexican vessels and the extensive Mexican airline system has adequate radio communications gear which operates very effectively.

Broadcast programs in Mexico are much like those in the United States and range in quality from the superla-

tively presented operas and symphonies from Mexico City to commercial programs which originate from the local stations. Singing commercials are as prevalent in Mexico as in the United States—many of them advertising familiar U. S. products with the same jingles and tunes used here.

With this great expansion of radio communication, both point-to-point and broadcast, has come an enormous increase in the work load of the radio service technicians who commonly repair not only broadcast receivers but local communication and shipboard equipment as well as complicated appliances. Radio servicing in Mexico is a profession, as it is in the United States, which provides an excellent income for the competent man. Shortages of skilled technicians in Mexico are quite serious and are complicated by the parallel demand for such personnel in the United States. An ambitious Mexican is likely to learn English at night school and then migrate to the United States where

he has a good chance at higher wages.

The training program for technicians is at present inadequate although there are excellent technical schools in such urban centers as Mexico City and Monterrey. Some technicians learn radio by working for established servicemen. An appreciable number are largely self-taught, using rather good Spanish instruction books, most of them published in Argentina. Quite a few successful proprietors gained their technical knowledge by serving in the U. S. armed forces during World War II and in the Korean conflict.

Radio shops in Mexico look much like those in the United States, as can be seen from Fig. 1. Equipment in the better shops is quite adequate for the type of work handled. An inspection of test equipment in several shops disclosed that it was in good working order despite obvious long-time use. Adequate hand tools were found in most shops, although many of the tools had a slightly unfamiliar appearance since they were made in Germany, Sweden, Switzerland, or Japan. Mexico's growing small-tools industry cannot as yet fill all of its domestic needs.

Because labor is cheap relative to parts, most of which must be imported, radio servicing in Mexico involves much more actual *repairing* and much less *parts changing* than is customary north of the border. Coils, power transformers, and even i.f. transformers are often rewound; open wirewound resistors are skillfully patched, and bent plates of damaged variable capacitors are laboriously straightened. For the same economic reasons, receivers are repaired and patched up long after they would have reached the "throw-away" point in the United States.

There is an extensive Mexican market in second-hand receivers, both "as is" and skillfully rebuilt, and, in many communities, second-hand but usable components, stripped from hopelessly worn-out receivers, find a

(Continued on page 153)

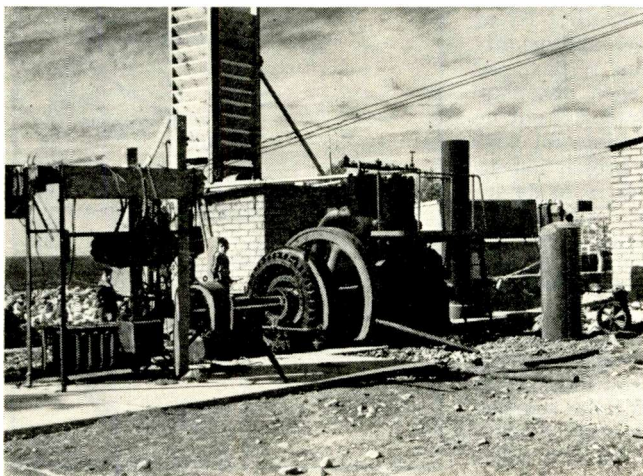

Fig. 2. Typical of others of its kind, this small-town generating plant supplies all of the power used locally. At the time the photograph was taken, the plant was shut down for repairs. This is not an infrequent occurrence.

Do it by Telephone

with a Phone Operated Switch

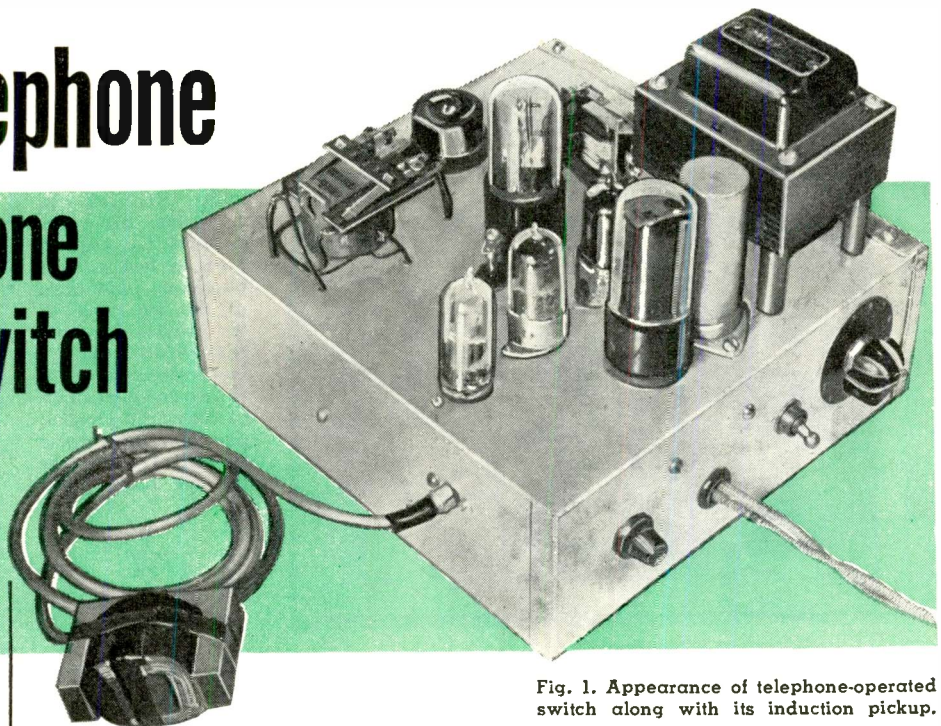

Fig. 1. Appearance of telephone-operated switch along with its induction pickup.

By **TRACY DIERS**

Staff Engineer, WNYE, New York, N. Y.

Use your phone to operate your electrical appliances from a distance. No connection to instrument required.

ALL of us, at one time or another, have been placed in a situation in which we wished we had the ability to turn some electrical device on or off when miles away from home. Perhaps it was some simple desire such as wanting to turn the air conditioner on before returning home or maybe that car battery was on charge and it became necessary to shut it off after a certain length of time. While it is true that automatic timers will turn things on or off they don't have the intelligence to allow for a change that may occur later, either in the mind of the owner or in surrounding conditions.

Take the case of that air conditioner you are planning for next summer. You may decide to go to the show on a warm evening, perhaps in town or at some distance from home. Connecting the air conditioner to a timer will cause it to go on even if the weather has cooled down while you were enjoying the show and perhaps you may have met some friends and decided to stay out longer. The result is that the air conditioner will be running possibly several hours and wasting power. The long arm of electronics makes it possible to reach into your home many miles away and turn on the air conditioner when you decide it's time to turn it on. Then when you return, cool, dry air will greet you with a minimum of wasted power.

The only requirement you need to perform this miracle is a telephone in your home. The fact that you have those two wires entering your home makes it possible to enjoy easier living.

The possibilities are limited only by the fact that you must be able to reach your number by *dial system* since a

manual system involves a telephone operator. This limitation will be explained shortly.

Circuit Description

The device, Fig. 1, about to be described needs no electrical connections to the telephone lines. An inductive pickup coil is placed close to your telephone and this coil is activated by the magnetic field which is produced when the telephone bell rings.

The dialing code is simple, all you do is dial your number and let the bell ring *once only*. When the bell rings, the telephone is surrounded by a magnetic field which is picked up by the inductive pickup coil and fed to V_1 , a 12AT7 audio amplifier. (See Fig. 3.) This is designed to amplify very low frequencies such as the alternating current which rings the telephone bell.

The amplified a.c. voltage is passed through C_1 to the 12AX7 tube (V_2) which is hooked up as a diode rectifier. This gives a d.c. voltage which is applied to capacitors C_6 and C_7 . Notice that C_7 will have a slower rate of charge than C_6 because of the circuit arrangement. When the telephone bell rings once, C_6 immediately charges but C_7 takes only a partial charge. This charge on C_6 is negative and is present on the control grid of V_{3B} . The plate current of V_{3B} is cut off and the armature of relay RL_1 then opens and this applies the line voltage to the thermal delay relay RL_2 . However RL_2 will not close for ten seconds at the end of

which time it completes the circuit to the power relay, RL_3 which closes and turns the equipment on or off.

Now about this time someone always asks the question, "What happens if someone should call me on the telephone?" This is how the device can separate calls and determine when it should act and when it should do nothing. Should someone else call your number the first bell will start the cycle of operations but anyone trying to get you will naturally let the bell ring more than once. The instant a second bell comes through the device will reject the call in this way:

Remember capacitor C_7 in the description of operations given previously? It had received a partial charge as a result of that first bell. The second and third bells will charge it still further *but* the charge it receives is of opposite polarity to the charge on C_6 . Thus it overpowers the negative charge which C_6 has put on the control grid of V_{3B} and now plate current flows again, RL_1 pulls its armature in and RL_2 no longer receives current. Since this happens in less than ten seconds, RL_2 never closes and thus the final power relay never closes. After a period of two minutes the circuits are ready to start all over again.

Construction

There are no problems in construction. See Fig. 2. Any layout may be used but try to keep wires carrying a.c. away from the grid leads of V_{3B} .

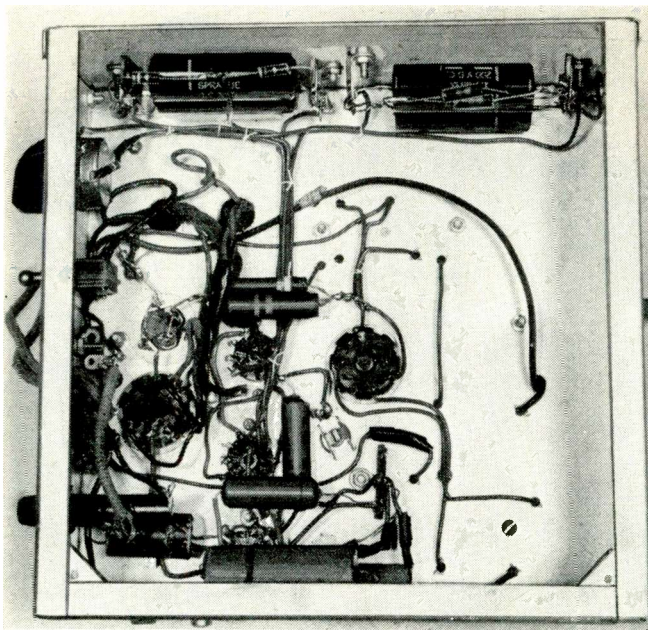

★
 Fig. 2. There are no unusual difficulties in wiring the unit. Be sure that capacitors C_6 and C_7 , shown here as two pair of paralleled 1- μ fd. units at the top edge of the chassis, are well insulated from the metal chassis to avoid leakage-to-ground problems. Any logical parts placement would be satisfactory for the unit shown here.
 ★

Use good quality components, especially for capacitors C_6 and C_7 . If these are inferior, they will leak charge on humid days. They should be of the plastic-sealed type and designed for 600 volts. Use a large chassis for ease in wiring and good ventilation since the finished job may run for days at a time.

The pickup coil is made out of a

modified high inductance choke. Any choke having an inductance of 100 henrys or over will work well. The choke used in this unit is 120 hy., 5 ma. and is made by UTC under the number R22. Another suitable choke would be the Thordarson 20C50. A mike-to-grid transformer is also suitable. Use only the secondary connections. Whichever coil you use it will

be necessary to open the core. Most chokes or transformers are made in such manner that one side of the laminations can be taken off thus leaving the coil surrounded by the pole pieces. See Fig. 4. This treatment will increase the voltage pickup capabilities of the coil.

Preliminary Tests

After you have finished preparation of the pickup coil, you may proceed with the first test on the main unit. Plug in all tubes and turn the power on. In a few seconds RL_1 should pull its armature in. With your v.t.v.m. take readings at the tube sockets. These readings should come close to the ones shown in the diagram of Fig. 3. If the project passes its d.c. voltage test, then you may proceed with the adjustment and installation tests. The first step is to find the best spot on your telephone to position the pickup.

Fig. 5 shows the best spot for one type of telephone; this may vary in other types of phones. Also there still are a few real "oldies" in various parts of the country and Canada. These ancient phones have the bell ringing coils in a metal box attached to the wall. The box acts as a fairly good shield, hence pick up of the triggering signal is difficult from the outside.

To locate the best spot, proceed this way: Remove the thermal delay relay,

Fig. 3. Complete schematic diagram and parts listing for the phone-operated switch.

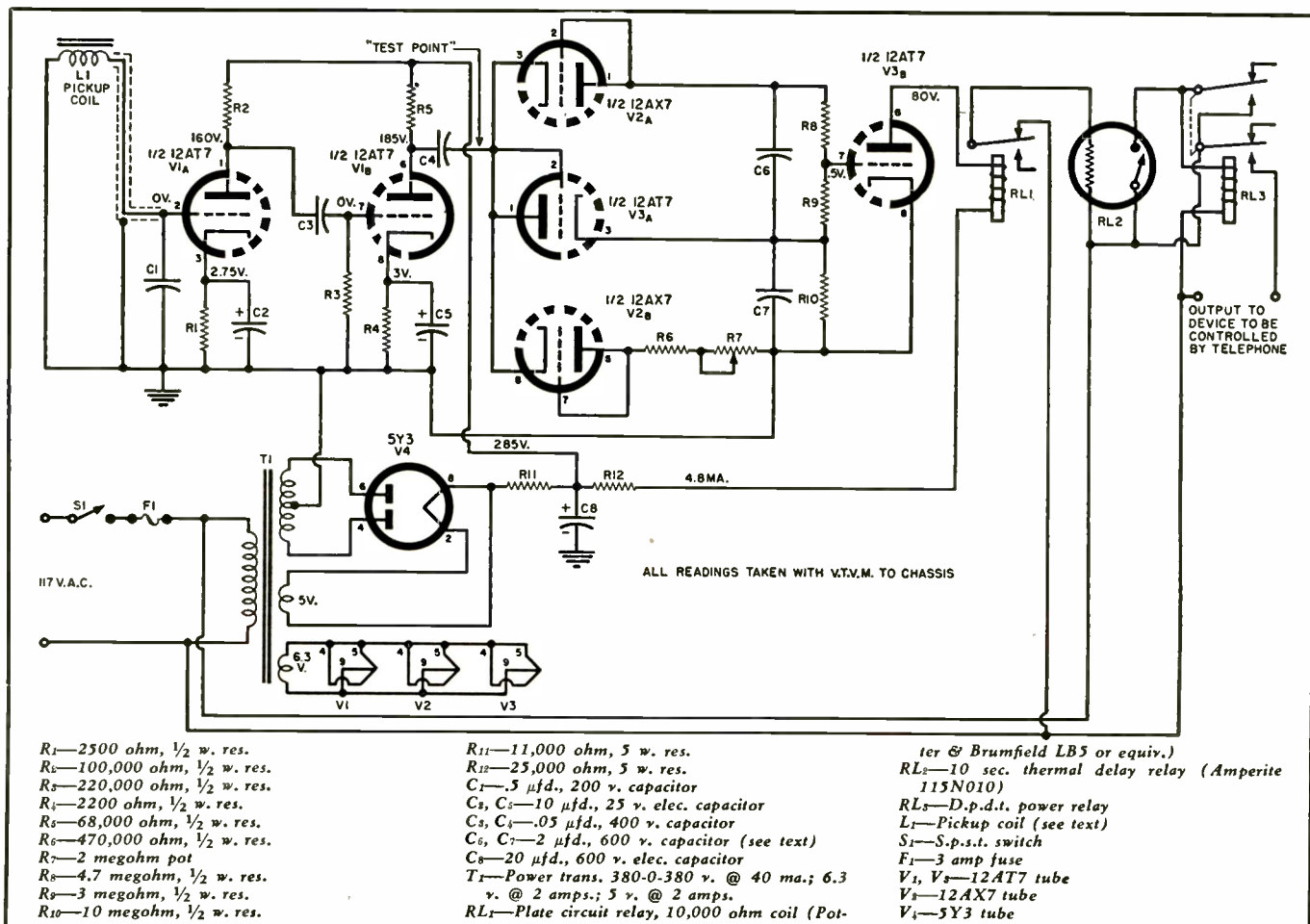

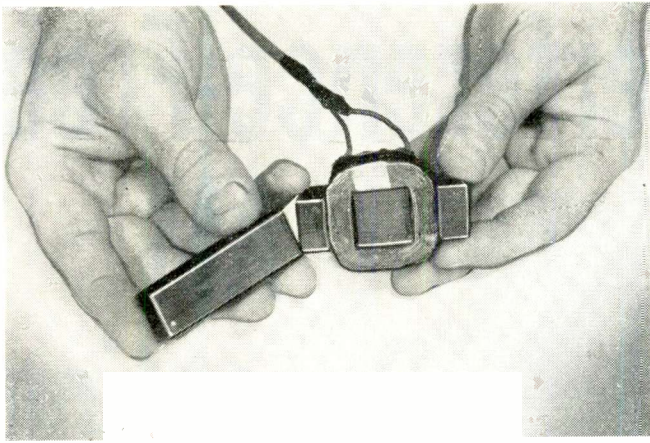

Fig. 4. In order to increase the pickup sensitivity of the choke it is necessary to take one side of the core off as shown. Most laminated cores will come apart quite easily.



Fig. 5. In recent model telephones the pickup choke will work well in the area shown here or on the side. For telephones with metal housing the best spot is under the phone.

V_2 , and V_3 . Set your v.t.v.m. for a.c. readings and connect it to the "test point" and chassis. Now have a friend call you on the telephone. While the bell is ringing move the pickup coil around until you find a spot which will produce 100 to 120 volts at the test point. The amplifier must develop this voltage, if it doesn't, test the audio amplifier separately as described later. When you are receiving the proper voltage at the test point, you may proceed with the adjustment of the unit.

Place V_2 and V_3 in their sockets and put the pickup coil on the phone. Your associate should now telephone you allowing your bell to ring only once. Almost instantly the armature of RL_1 should open and should stay open for 13 to 18 seconds. Then it should suddenly pull in as plate current once again flows in V_{3b} . If the armature of RL_1 stays open too long then change the setting of the pot, R_7 . Less resistance will decrease the time between opening and closing. If the relay armature pulls in too soon then advance the pot to increase resistance. Allow at least a minute between tests because capacitors C_6 and C_7 must reach discharge.

Also, and this is very important, do not dial an outgoing call while your pickup coil is on the phone since the dial pulses will cause capacitors C_6 and C_7 to start charging. Remove the pickup coil to a distance at least two feet from the phone when dialing or lifting the receiver during this test period.

The best method is to have your associate dial your number about once every two minutes, allowing the bell to ring only once. After four or five trials you will arrive at the proper setting for R_7 . When RL_1 armature opens instantly with one bell and stays open for 13 to 18 seconds, then pulls in; you are ready for the final test.

Now have your associate dial your number and let the bell ring twice. The first bell should open the relay armature and the second bell should pull it in almost immediately. If the second bell does not cause rapid pull-in of the armature then turn R_7 in the

direction of lower resistance. A change of at least 20,000 or 30,000 ohms is necessary.

If your unit is working satisfactorily it will meet the test in which one bell opens the armature of RL_1 and the second bell closes it.

Now put the thermal relay tube in its socket. While the RL_1 armature is in its "pull-in" position the thermal relay will not function.

Final Testing

Your unit is ready now for its final test. As soon as the first bell rings, the RL_1 armature will fall out. Immediately the thermal delay relay starts to heat up and tick off the seconds. If no second bell comes along, RL_2 completes its timing process of ten seconds and finally it closes—then the power relay RL_3 snaps shut and stays closed thus turning on whatever device is plugged into the output terminals.

However if the bell rings more than once, RL_1 will pull its armature in and thus remove heater current from RL_2 . Because of this, RL_3 won't close.

When you leave home put the pickup coil on the phone and turn on the power to the unit. Plug in whatever must be turned on. Be sure that the power relay you are using can handle the required wattage.

When you are ready to call on the unit to perform, simply go to a dial telephone and dial your number, let the bell ring once and hang up. As you know, bell ringing is automatic and your call may come through on the end of a ringing cycle. This is a rare occurrence. To be absolutely certain that your device will function, especially if it is important, let the bell ring once, hang up and do it again two minutes later. If you should hear a busy signal when you call be sure you allow at least two minutes before placing your call. The bell ringing sound you hear when you dial is not necessarily *your* bell which is ringing—it is a sound provided by the central exchange but you may use it as a guide to timing anyhow. In other words, act as though it were your bell, it will still work. In practically all

(Continued on page 122)

Fig. 6. The solder gun or any a.c. power transformer may be employed in place of the telephone bell for initial adjustments and operation check of the unit.

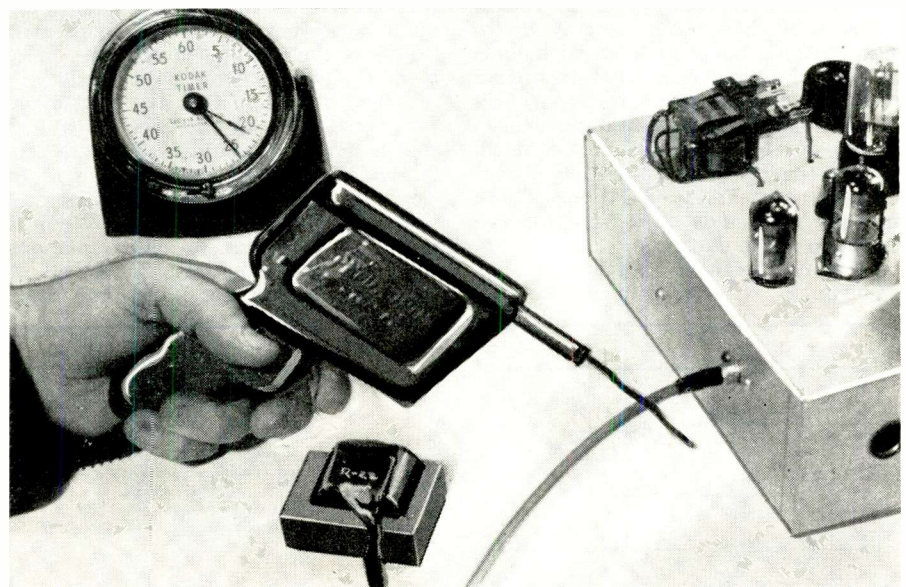

Interference-Free AM Reception

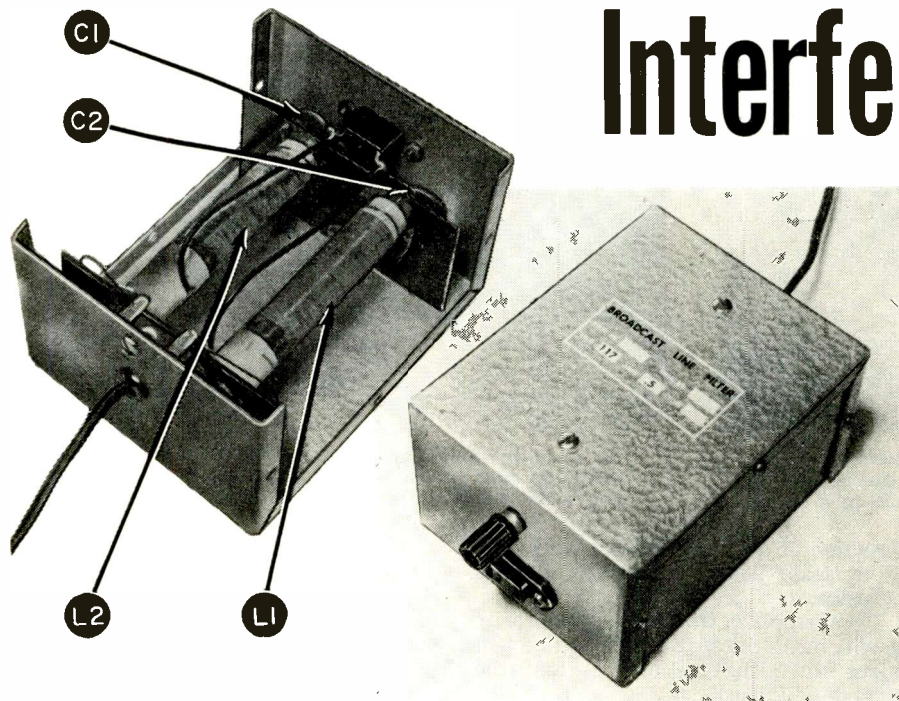

Fig. 1. An effective interference filter broadly tuned in the broadcast band.

By
FRANK H. TOOKER

Howls and other noises caused by TV sets and other appliances often ruin broadcast-band listening. Remedial steps include an effective tuned filter.

IN THESE DAYS of television sets and a host of household appliances in almost every human abode, enjoyable listening from an ordinary AM broadcast-band receiver often becomes well-nigh impossible—especially when the broadcast station is forty to sixty miles away and the devices in question are within twenty to forty feet.

Where several TV sets are operating and are relatively near the broadcast receiver (twenty to forty feet), the yowling and snarling set up in the broadcast receiver by the TV sets' sweep circuits is sufficient to smother all reception on the low-frequency portion of the AM band and to create considerable havoc all the way up to the high end. Some makes and models of TV sets are worse offenders than others, and some sets are apparently in need of new parts and/or adjustments—for quite a few can be heard at distances that are obviously in infringement of FCC regulations. There must be thousands of these scattered throughout the country.

Possibly the best solution to this problem is strictly enforced federal

regulations to put an end to all forms of interference—not just from poor TV receivers, irrespective of age, but from all other serious interference creators: vacuum cleaners, electric razors, hand power drills, and a host of others. We are also in need of popularly priced broadcast-band receivers that are better able to reject the interference—for it has been the author's experience that, by far, the greater part of the noise due to TV sets and household appliances at distances of twenty feet or more comes in *via* the power line. In the meantime—while waiting for regulations and better receivers—considerable improvement can often be effected in present broadcast sets even though they may be of the most basic a.c.-d.c. variety.

It has been said that the best place to get rid of interference is at its source. To this could well be added, "provided someone calls upon you to clean up the interference for him and is willing to pay for the job." When it comes right down to cases, persons who are interested in getting rid of interference that doesn't bother them

directly are quite rare. Most householders who own offending appliances are reluctant, to put it mildly, about paying to "improve reception on my neighbor's radio." Yet the easiest thing in the world is to "clean up" a particular interference-plagued home, only to find that most of the havoc was—and still is—coming from next door, or across the street or from both of these points at the same time!

Even where neighbors tend to be cooperative about having their equipment worked on to reduce their role as offenders, there may be too many of them to deal with practically, one at a time, on an individual basis. While this is theoretically the best procedure, a single solution is to be preferred to many separate solutions.

The a.c.-d.c. type of broadcast receiver does an excellent job of picking up unwanted signal from the power lines. It takes a pretty good line filter to make these sets behave. If one isn't careful, it's easy to spend more on a filter than would be necessary for the power transformer the set might have had in the first place. Merely connecting a capacitor, even a very large one, across the power line usually has little or no beneficial effect, principally because, while one side of the line may be grounded for 60-cycle a.c., both sides are almost invariably several hundred ohms above ground at radio frequencies. Thus, maximum rejection of interference can be obtained only when both sides of the line are filtered and bypassed to a local ground with a good, low-impedance connection.

The filter shown in Fig. 1 and in the schematic of Fig. 2 has been designed to be particularly effective at broadcast frequencies. Its excellent rejection characteristics are due to the fact that the two coils, L_1 and L_2 , are made to

(Continued on page 158)

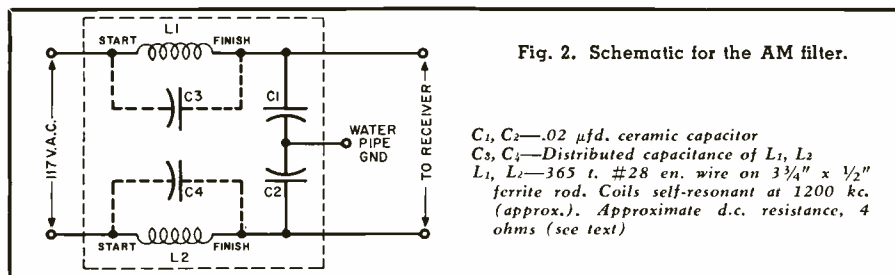

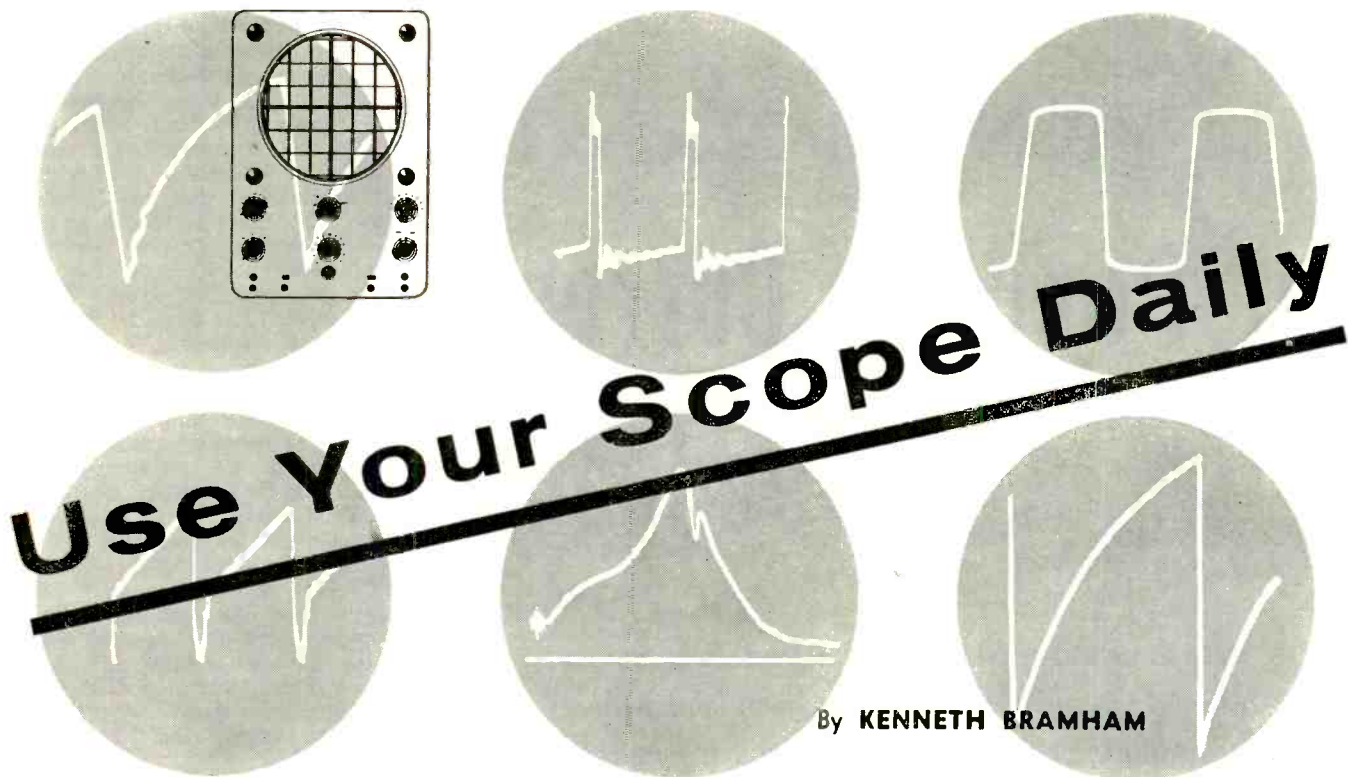

THE OSCILLOSCOPE, now a normal part of the radio-TV service shop, represents a sizable investment, often being the most expensive piece of equipment on the bench. Nevertheless, how many technicians get full value for this investment? Often the attitude is, "I don't use it very often, but I just cannot be without it." A more profitable attitude would be, "I have to have a scope and I am going to get every possible use from it."

A scope which gathers dust waiting for an alignment job or a tough sync fault is better discarded completely. When it eventually has to be used, more time will be wasted by the technician who is not familiar with it than can be saved by its use. Many of the results produced will be unreliable or misleading and the outcome may be an unsatisfactory job.

The only reliable combination of technician and equipment is the one of constant use. This does not mean that every set going through the shop must be completely aligned merely to keep the technician in practice; it does mean that there are other uses for a scope which will improve bench efficiency while making the instrument as familiar to the technician as his v.t.v.m. and cutters.

There are cases where a scope is allowed to go into disuse simply because it is not adequate for the job. In this case the solution is to replace it or modify it until it is adequate.

Perhaps the most useful way in which a scope can be kept in constant use is to develop a checking routine for all completed bench jobs. This will not only familiarize the operator with the equipment but also with the test points in the circuits on which he works. There will, eventually, be less

Familiarity breeds efficiency. Try these regular applications to keep your scope technique sharp.

need to consult a schematic; finding a test point will become automatic. Waveforms displayed on the scope will become more familiar until the question of whether or not a pattern is correct can be answered automatically. This is perhaps the biggest problem in TV bench service and only solid familiarity with correct waveforms will make an incorrect shape obvious. Routine checking of completed sets will also reveal minor defects which may have been overlooked, bringing about an improvement in service quality and a lower percentage of "re-peats."

"Synchroguide" waveforms should head any routine check-list. Horizontal sync may seem perfect under shop conditions, but checking and adjusting the "Synchroguide" phasing

coil will ensure that it is still good when returned to the less favorable conditions in the customer's home. The "Synchroguide" test point and correct waveform is shown in Fig. 1. Adjustment of the phasing coil should place the sine wave about 10% down from the peak. An adjustment which is too high will result in a "Christmas-tree" or "mode-hopping" effect on the screen. Unstable sync and poor noise immunity will result from too low an adjustment.

(EDITOR'S NOTE: *The bulk of existing service literature on pulse-width or "Synchroguide" circuit adjustment recommends equal amplitude for the rounded sine-wave portion and the pulse peak. The author is one of a growing group which has found that better long-term stability is obtained from the adjustment he recommends. This view is reflected in the manufacturers' service data on some of the newer sets using this circuit.*)

"B" supplies may be checked with the scope for incorrect filtering. While the scope oscillator is still set for the horizontal sweep frequency (after the "Synchroguide" check), the probe should be applied to the final filter capacitor of the power supply. If this capacitor is functioning normally, no waveform will be noted. An open capacitor or one of low value may not show as 60-cycle interference or "pull" in the raster, but may cause 15,750-cycle feedback through "B+," which may show up as a sync or a.g.c. fault. The test point for this check is shown

(Continued on page 186)

Fig. 1. Test point for a pulse-width oscillator is at junction of the three coils.

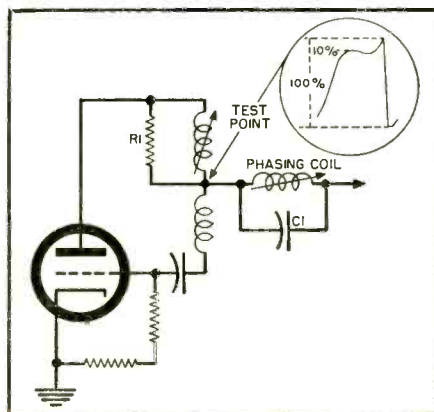

A New Look at Positive Current Feedback

By
H. D. ZINK
and
L. R. SANFORD

Tests show that positive current feedback improves hi-fi systems which already have good loudspeakers providing the correct feedback circuit is employed.

THE use of current feedback to provide improved bass response in a high-fidelity speaker system has caused a lot of discussion pro and con. It has been argued that it cannot greatly improve speaker damping because the mechanical parts of the speaker are not coupled closely enough to the electrical parts.¹ It has also been argued that it might help on an inadequate speaker system but that it was worse than useless on a truly high-fidelity speaker.² On the other side, curves have been presented which give dramatic proof of the improved damping obtained with a particular kind of current feedback,³ but few details are given about the speaker system used and, therefore, no adequate conclusions can be drawn. This difference of opinion is understandable since the most desirable mode of loudspeaker operation for the best listening is not agreed upon even by experts in the field. The only way an individual can determine for himself the merits of such feedback is by the use of his ears.

Listening tests in commercial demonstration rooms are not necessarily conclusive for two reasons; (1) many of the current feedback circuits are so arranged that a common ground between the amplifier input and a speaker lead destroys the feedback network and common grounds are frequently used in demonstration rooms, (2) many amplifiers provide only for negative current feedback which can only decrease the damping on a speaker and thereby accentuate its undesirable characteristics. Therefore, opinions formed by a brief listening test in a demonstration room may not be valid about current feedback.

The question in the minds of the

authors was whether positive current feedback (that which *increases* speaker damping) could add anything to a truly high-fidelity system which already had good speakers. The results of tests showed the answer to be conclusively *yes*, if the correct kind of feedback circuit were used. However, the feedback configuration most suitable was different from those heretofore used and for best results different speaker enclosures required somewhat different configurations.

What is actually accomplished with current feedback can be best understood by forgetting the ideas of damping, negative impedance, etc. for the moment and concentrating only on the frequency response. Anyone who has heard an audio oscillator through any speaker system has probably observed that while the response may be poor below a certain frequency, frequencies much lower than this can usually be reproduced if the power to the speaker at these frequencies is increased relative to the higher frequencies. Often, when this is done, appreciable harmonic distortion is present and the speaker cone rattles. Usually for music system use, if the bass output from the speaker is increased by conventional bass-boosting techniques, then such distortions are objectionable. In the optimum use of positive current feedback these objections to low-frequency boosting are overcome by using a rising bass characteristic as part of the feedback network. This compensates for the loss of low-frequency acoustic output without the harmful effect noted, since the positive current feedback keeps the speaker cone under control and, thereby, significantly reduces the distortion which would otherwise result.

In some cases, the frequency below which no acoustic output at all is obtained is actually lowered.

The term, positive current feedback, is disturbing to some because, as is well known, positive feedback increases the distortion of an amplifier to which it is applied. This is true in this application also, but it must be noted that the net feedback applied to the amplifier is never positive but simply less negative in the region where the positive current feedback is effective. See Fig. 1. The slight increase in distortion, which results from the decrease in the amount of negative feedback applied in the bass region, is more than offset by the decrease in speaker distortion in the same region. In the high-frequency region, where amplifier distortion is more disturbing, no positive feedback is applied and the amplifier characteristics remain unchanged. The important point to note is that positive current feedback applied to the amplifier is effectively negative feedback as far as the speaker cone is concerned. This point is not obvious, so the following experiment will be described to suggest why this is actually the case.

Arrange a speaker, battery, multi-range ammeter, and a switch as shown in Fig. 2. With the switch on the "A" contacts so that the battery is out of the circuit, push the speaker cone in the minus direction and note the direction of the current generated by the movement of the voice coil through the speaker field. Assume this current flows in the direction of the arrow *I*. Now connect the battery through the "B" contacts so that the current which it causes to flow is also in the direction of the arrow, and note the direction in which the speaker cone moves. It is found that the speaker cone moves in the plus direction, that is, in the opposite direction from which it was moved in the first case. The current which acts on the speaker results in a plus motion of the cone whereas a *minus* motion of the cone produces the *same* direction of current when the cone reacts on the circuit. This means that when the cone oscillates after a driving signal has ceased, the current generated by the erroneous motion can be fed back through the amplifier to produce a driving current which will be in the same direction as the error current and that this current will drive the cone in the opposite direction. The net effect will be that the cone moves very little after the original driving force ceases. It can thus be seen that in order for the forces on the cone to cancel out (negative feedback) the error signal must be fed back without a change of phase (positive feedback).

When these facts are realized, the correct application of positive current feedback to any speaker system then becomes merely a matter of cut and try until the right boost characteristic is found. Since no electrical measurements can indicate the total effect,

the final results must be reached by listening tests. The correct results are achieved when the speaker has a deeper bass than it has ever reproduced before without any trace of boominess. A very good test is when low-level, low-frequency bass notes, such as the light tap of a tympani, bass drum, or soft organ pedal, are clearly evident without being boomy or muffled. An excellent demonstration of the effect of positive current feedback was given when the low-frequency response of a *Klipschorn* was extended from 27 cps to below 20 cps with a clean fundamental response. The difference in reproduction of a complex 16 cps organ tone before and after was quite impressive and easily noticed even by the untrained ear.

The block diagram of the current feedback network used by the authors is shown in Fig. 3A. The essential difference between this circuit and similar ones used on commercial amplifiers is that no provision is made for negative current feedback, and an LC circuit is used in the frequency discriminating section of the feedback network instead of a single capacitor. It is necessary to use an LC circuit because the single capacitor gives too much bass boost in a region where no boost is needed when used with some speaker systems (especially the *Klipschorn* and "Rebel" series). This results in an unpleasant over-accentuated bass sound and is probably the reason some have rejected the use of current feedback with high-quality speakers.

The 25-ohm potentiometer shunted across the 1-ohm resistor provides a means of varying the feedback from zero to full positive. Its use, except for comparison purposes, is questionable since usually full positive feedback is the most desirable condition. It could be omitted with no harmful effects in which case the 240-ohm resistor is tied to the ungrounded end of the 1-ohm resistor.

The amount of feedback and therefore the degree of bass boost may be varied in several ways aside from the use of the potentiometer. The principal way is by changing the value of the 1-ohm resistor. It will be noted that a dividing network is formed between the speaker impedance and the current feedback resistor, such that if the speaker is high impedance (16 ohms) less feedback voltage will be developed across the resistor than if the speaker impedance is low (4 ohms). That is, for a given resistor more bass boost would be obtained when feeding a 4-ohm speaker than when feeding a 16-ohm speaker. The 1-ohm resistor has been found satisfactory when used with a speaker system having a net impedance of 4 ohms and, therefore, in some instances a 4-ohm resistor might be desirable for a 16-ohm speaker system.

The amount of feedback and, therefore, the amount of boost can also be changed by changing the "Q" of the circuit elements used in the feedback network. The values called for usually

require electrolytic capacitors and if these units are leaky or are used singly instead of in series pairs back-to-back, then less feedback will be obtained than would be expected. If the inductor used is variable, its "Q" will vary as it is tuned and this will also change the feedback. It should be noted that since the resistance in series with the speaker absorbs power it represents a loss in peak output, therefore, it is desirable to keep it as small as possible while still obtaining the required feedback voltage. Since high "Q" elements in the feedback network represent more voltage feedback than do low "Q" ones, they are to be preferred unless they give a boost characteristic that rises too sharply. This is an unlikely occurrence. It should be noted that the characteristics of the network, when not connected in the feedback loop, are not a good indication of the over-all amplifier response when the network is in the loop since a "Q" multiplication effect is obtained and the amplifier response is sharper than the network response.

To determine the constants of the LC network shown in Fig. 3A, procure an audio oscillator or frequency test record whose range is slightly lower than the lowest range of interest and listen to the performance of the speaker system using a conventional negative feedback amplifier. Note: (1) the frequency at which the bass response just begins to roll off and (2) the frequency at which no more acoustic output is obtained irrespective of how much power is used to drive the speaker. An LC network having a low-pass or bandpass filter configuration is then designed so that the upper turnover frequency occurs slightly above the frequency at which the response starts to roll off and the peak response occurs slightly below the frequency at which no output is normally heard. (The hypothetical termination resistance necessary for calculating the filter sections can be assumed to be about 600 ohms since it has been found experimentally that this value gives networks that are satisfactory.) This network will serve as a starting point and by varying the parameters while listening to the system using an audio oscillator or tone record the best sounding arrangement can be determined. For those not technically able to perform such calculations, the networks to be discussed will give moderately good results on any speaker system and will serve as a starting point for more experimentation. It is

Fig. 1. Effect of positive current feedback on the frequency response of amplifier.

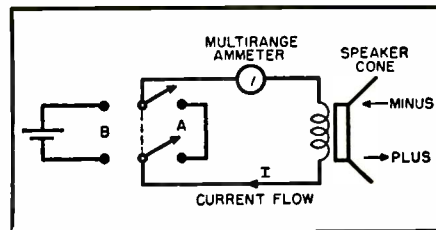
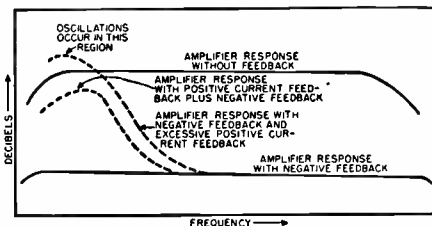

Fig. 2. Experimental setup that is used to determine how positive feedback works.

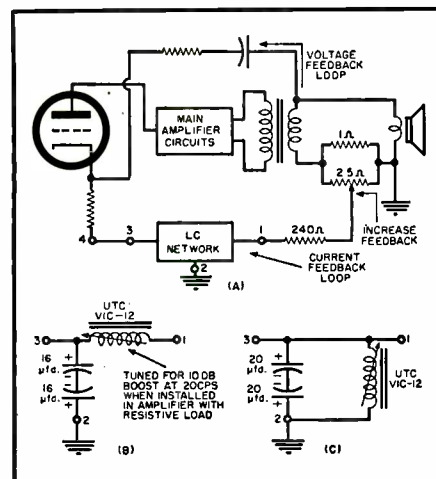

Fig. 3. (A) Location of positive current feedback network. (B) shows Klipschorn network. (C) shows Rebel 4 LC network.

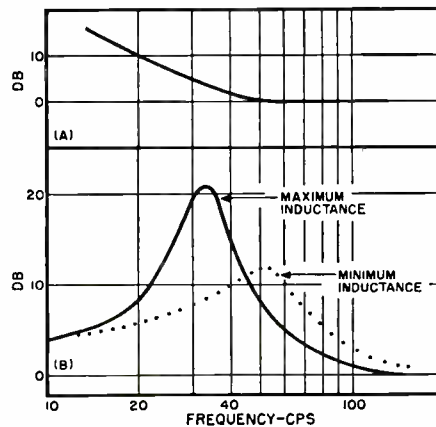

Fig. 4. (A) Amplifier response with networks shown in Fig. 3B and (B) Fig. 3C.

not advisable to use music for the first tests since low-frequency tones occur rather infrequently and are of rather short duration so it is difficult to notice the effect of circuit changes.

The specific LC circuit configuration used with a *Klipschorn* is shown in Fig. 3B. This type of enclosure normally falls off below 27 cps so the feedback network is designed to become effective in this region and to provide 10 db of boost at 20 cps as measured across a resistive load. The response curve of the amplifier, when this circuit is used, is shown in Fig. 4A. It must be remembered that this curve was taken with a 16-ohm resistive load substituted for the speaker and does not necessarily represent the actual boost curve obtained with the speaker connected. In this case, suf-

(Continued on page 137)

TV Remote Controls for the Technician

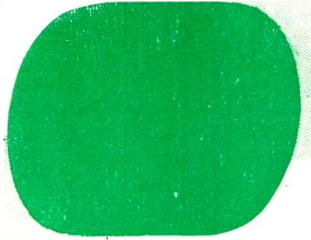

By
WALTER H. BUCHSBAUM
Television Consultant
RADIO & TV NEWS

Wired or wireless, partial or complete, hand-held or chairside—they all need occasional service.

IN THE PAST few years, the trend towards remote controls for TV receivers has increased steadily. Almost all manufacturers now offer some kind of remote-control feature either as part of the set or as an extra accessory. Many older receivers have been modified for remote control as well and, by now, the service technician has occasion to work on such a control.

Basically there are three different types of remote control units. One, like the *Zenith* "Space Command" or the *Hoffman* "Beamrider," uses no wires between the control and the receiver. The second variety, cable-connected, controls the receiver by means of relays and a tuning motor while the third type contains a separate remote tuner, i.f. strip, audio section and various controls as well.

The complexity of the various systems depends largely on how many

functions are controlled remotely. It is interesting to note that, with few exceptions, all current TV models have some provision for remote control and, in the majority of sets, this is done by cable-connected units of the motor-relay type.

Frequent Trouble Spots

Every service technician has had instances where the only thing wrong with a TV set was the lack of a.c. power, frequently because the plug was out of its receptacle or the line cord broken. Similarly, a great many service calls where the complaint is that only the remote control operation is defective will be due to such simple defects. The cable itself, as well as the connectors should be checked carefully first. Almost all sets have a switch at the rear for selecting remote-control operation. Forgetting to turn that switch or accidental change to the "direct" setting will naturally cause apparent failure of the remote control.

Troubleshooting of the ultrasonic "Space Command" system is somewhat different from the wired systems and was described in more detail in the October 1956 issue of this publication. Basically the most likely troubles in the *Zenith* system are found in the section which makes up the ultrasonic receiver, frequency discriminator, and control circuitry. The remote unit is a tuning-fork type of ultrasonic generator containing no tubes. Unless mechanical troubles occur, this part rarely needs servicing. In the *Hoffman* "Beamrider" the most likely defect is



Fig. 1. RCA's hand-held "Magic Brain."

a weak transmitter battery or defective tubes in either transmitter or receiver.

Having examined the condition of the cable and connectors, a few ohmmeter tests are usually sufficient to spot the defective part. Those remote units which contain a separate tuner, i.f., and audio circuits are, of course, subject to difficulties just like these sections in the receiver, but the most likely defects in any remote-control unit are open or shorted leads in the cable or connectors. The second most likely trouble spot is the switch or potentiometer which does the remote tuning. A poor contact or broken lead at either end can upset the control action. Fortunately the location of this type of defect is indicated by the malfunction of a particular section. If, for instance, the tuner never tunes to Channel 6 on remote, the corresponding contact, wire, or connector is probably defective. If all controls work except the volume control, the defect obviously is in the connections to that control. When the on-off switch does not work on remote and the connections have been checked, the fault might be in a relay, where used, which either may not be actuated or else may have defective contacts. Such defects are not too difficult to find and repair.

Simple Remote Controls

From the servicing point of view, the simplest controls are those having only a switch for tuning channels, possibly also a remote off-on volume and fine-tuning control. These are not much different from the now popular "automatic" tuning systems which use *Microswitches* to actuate the tuner motor or stepping solenoid. A few words might be said here about the different systems of rotating the tuner

Fig. 2. The Packard-Bell separate control box houses an auxiliary loudspeaker.

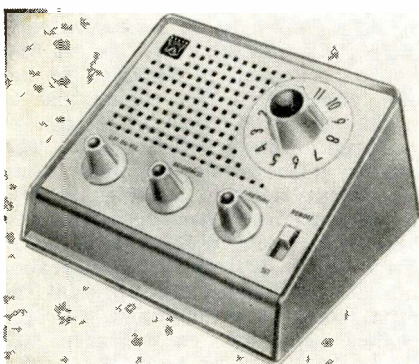

shaft. Some motor units drive the shaft of the tuner through a gear train and operate by starting and stopping the motor either through a relay, detent switch, or selector switch arrangement. The latter circuit is used in the *RCA* remote-tuning unit shown in the photograph of Fig. 1 and the schematic of Fig. 4. Wafer switches corresponding to those used in the remote selector are mounted on the tuner shaft in the set and so connected that the motor keeps going until the rotation of the shaft turns the switch to the point that the current to the motor is shut off.

A much simpler system is used by *Emerson*, and this is shown in the circuit of Fig. 5. Channel selection is accomplished by a single switch which powers the tuning motor through the motor relay. As the tuner shaft turns, it actuates a detent switch which interrupts the motor relay power and thus stops the motor. This means that the viewer presses the channel selector button once for each tuner step, while in the *RCA* system the desired channel is selected directly and the motor continues to operate until that channel is reached. *Packard-Bell* and some other manufacturers offer both types of tuning, one as a standard remote feature and the other as optional full remote control.

Although the *Philco* "Top Touch Tuning" and its remote control are also of the single-step type, the method for moving the tuner shaft is different. A rotary solenoid is used here to actuate a spring-loaded lever which

turns the tuner shaft. Anyone familiar with telephone central selector switches or the *Automatic Electric Company's* Model 44 automatic step switch, will recognize the *Philco* system as very similar. The top tuning feature consists of a *Microswitch* in parallel with a similar switch at the remote control. Fig. 6 shows the circuit of the *Philco* system without showing the motor itself.

More Complex Systems

The *Packard-Bell* unit shown in the photograph of Fig. 2 contains not merely channel tuning, on-off, and volume controls but also has its own remote loudspeaker. The circuit diagram of Fig. 7 shows how this unit is connected and also indicates how fine tuning is accomplished. As in most units, this is done by varying the voltage on the local oscillator tube and thus changing its frequency to a small degree.

A variation of this system is found in later *Emerson* models, where a separate crystal diode is connected across the oscillator plate circuit and the current through that diode is varied remotely to control frequency. The *RCA* circuit uses a neon tube (see Fig. 4) and current variation through it. These methods have less effect on oscillator output and therefore less effect on receiver sensitivity in weak signal areas.

The *RCA* "Magic Brain" system is designed primarily for installation on all receivers using the KCS-96 and 97 chassis but can be adapted for use



Fig. 3. This Hoffman control unit, a wireless type, is a transmitter that activates a receiver at the TV set.

with any receiver back to the KCS-66. From the circuit of Fig. 4, it appears that three separate assemblies make up the "Magic Brain" kit. One, shown in Fig. 1, is the remote-control head, which contains the channel selector, fine tuning, volume, and contrast controls. The second unit comprises the tuning motor mounted on a master bracket which mounts directly to the tuner chassis. A shaft coupling for the tuning shaft contains the required selector switches, all wired. The third chassis contains a 24-volt transformer and three relays. *RCA* also furnishes

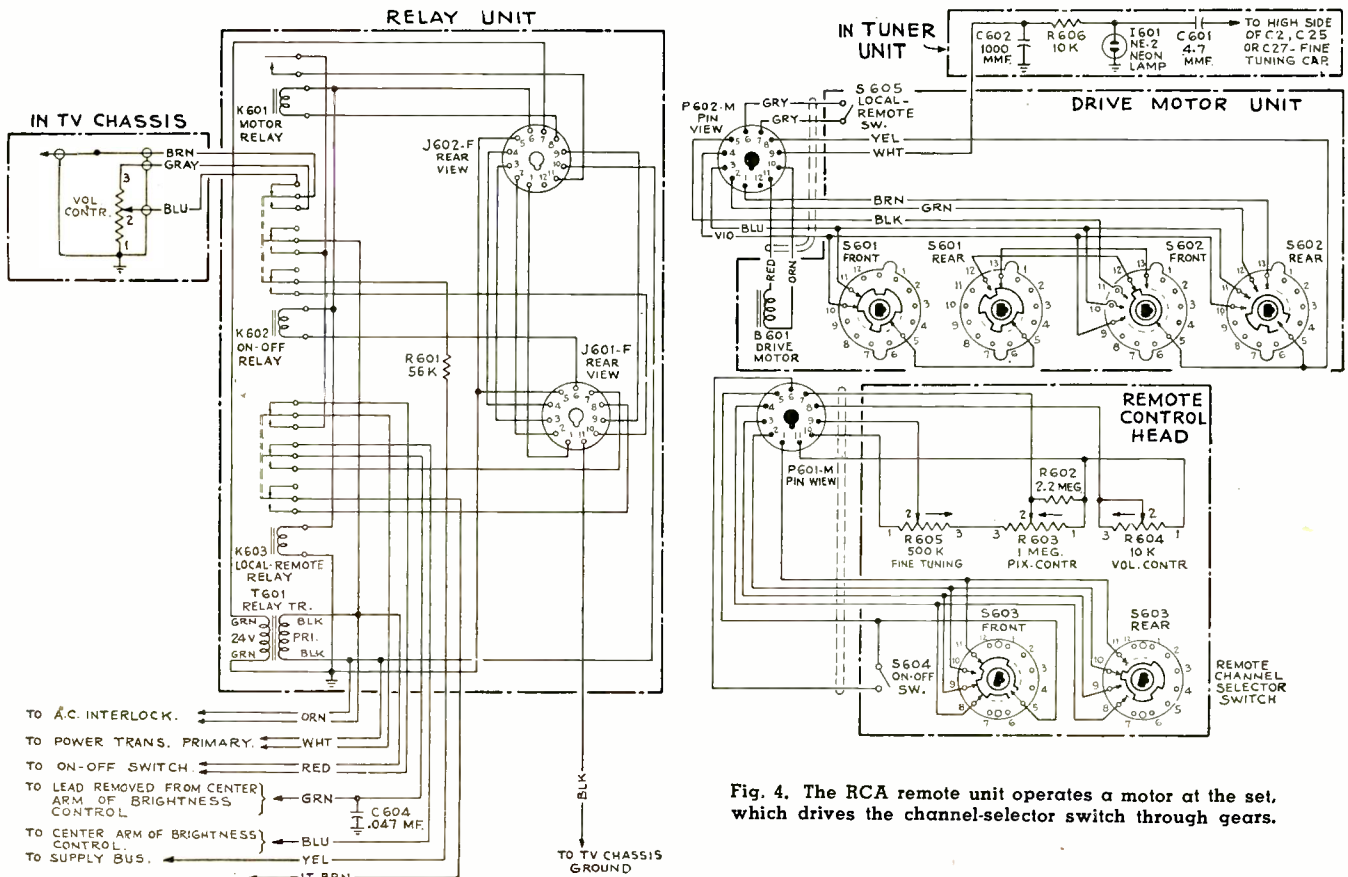

Fig. 4. The RCA remote unit operates a motor at the set, which drives the channel-selector switch through gears.

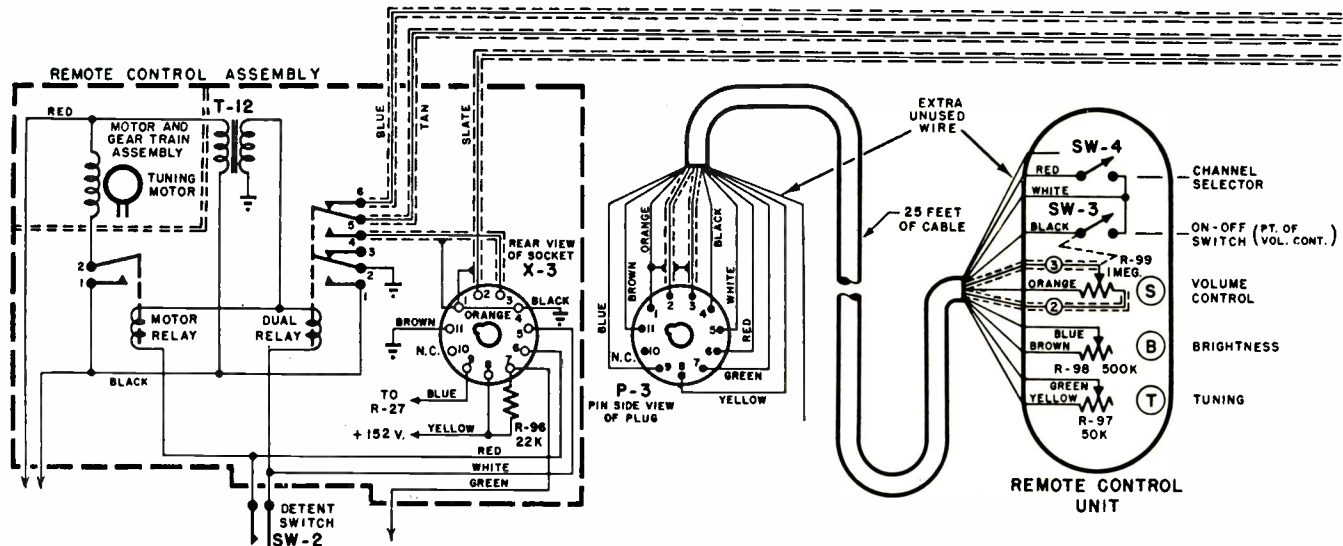

Fig. 5. The tuning motor, through its relay, moves one channel at a time in this Emerson remote station selector.

brackets, resistors, hardware and a neon lamp together with detailed instructions for connection to any of the previously mentioned RCA chassis. In most installations some wiring changes must be made, making this job a suitable one only for the experienced service technician.

As mentioned in the beginning, the Zenith "Space Command" unit makes use of an ultrasonic tuning-fork generator, the sound of which is received by a microphone at the set, amplified, and passed through filters. This permits the use of different frequencies for different command functions, but also requires a number of relays and control circuits.

Another wireless remote-control unit is the Hoffman Electronics Co. "Beam-riders" system which, however, only switches channels. As shown in the photograph of Fig. 3, it is a small, self-contained unit. Its circuit, shown in Fig. 8, consists of a single-stage, crystal-controlled oscillator operating at 26.25 mc. To select a station, the "on" switch on the transmitter is depressed, actuating the quick-heating battery-type tube and transmitting a c.w. signal. The companion receiver

has two tubes (four sections), and is a superregenerative type with a biased control tube operating a relay. Since this system is intended for use with Hoffman's "Dyna Touch" TV receivers, the relay simply shorts out the Microswitch which otherwise actuates the tuning motor.

In troubleshooting the Hoffman unit, primary emphasis will have to be placed on the life of the battery and tube in the transmitter. Since the batteries are used only intermittently, they should last a reasonably long time. Nonetheless, their failure will be a thing to watch for. Another thing to look out for is the dislocation or mistuning of the receiver antenna. This latter is usually located at the rear of the TV set, and will be adjusted at the initial installation. Moving the set or overzealous dusting and cleaning in back of the set often results in either outright damage or some dislocation, causing the over-all sensitivity to drop. Otherwise the receiver may require troubleshooting just as any superregenerative set would. The transmitter is best checked through the receiver.

Somewhat more elaborate is the

Motorola system which is used in conjunction with chassis TS-539. The major components of this system, shown in Fig. 10, are a small, transistorized transmitter operating at 2.6 mc. and a three-tube remote receiver and control circuit. The receiver is a two-stage TRF circuit with a crystal-diode detector, a.v.c., and a relay-control stage. This remote system connects directly to the automatic tuning circuit which, as mentioned previously in connection with the Philco system, is Microswitch controlled. Motorola has an additional feature: by adjustment of indexing rods and tabs, the tuner is set up so that unused channels are skipped. This means that a cam-driven Microswitch is shunted across the tuning switch to actuate the motor while the shaft skips unused channels. An a.c. shaded-pole motor drives a system of reduction gears which turn the tuner shaft as well as the associated cams, switches, etc. During the tuning operation, a set of cam-driven contacts also shorts out the sound and picture to avoid blasting.

Another remote-control system is the type in which a portion of the receiver is separated and mounted in a small unit, suitable for chairside operation. Typical of this is the Tech Master "Duo Master" shown in Fig. 9. It is similar in many respects to the "Fleetwood" Model 800 made by Conrac, Inc. Both units contain a TV tuner, i.f. section, sound detector, and sound-output stage driving a local speaker. Each has a self-contained power supply. To drive the TV set, the detected video signal is passed through a cathode follower and then fed to the remote picture-tube chassis by coaxial cable. Provision is also made to furnish sound to a remote speaker. The Tech Master system also has an audio jack for simultaneous tape recording or hi-fi connection. The troubleshooting of these units should not present any difficulties, since most circuits are identical to those found in conventional TV sets. The cathode followers are rather simple and require

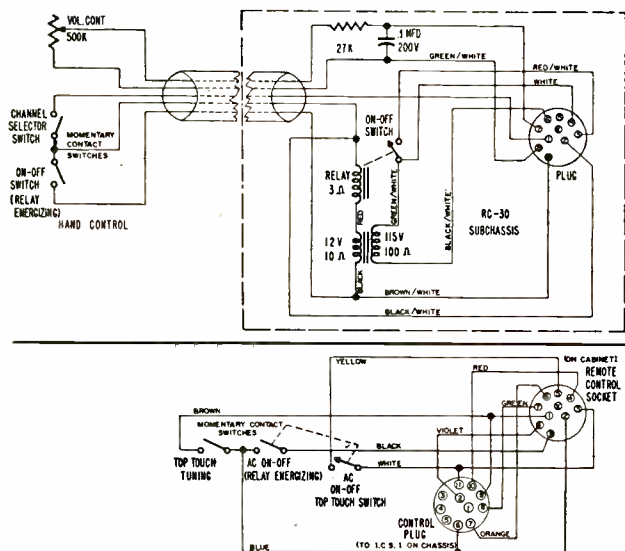

Fig. 6. How the remote unit (top) connects to the main receiver circuit (bottom) in the system used by Philco. Remote operation is tied in with "Top Touch Tuning" featured by Philco.

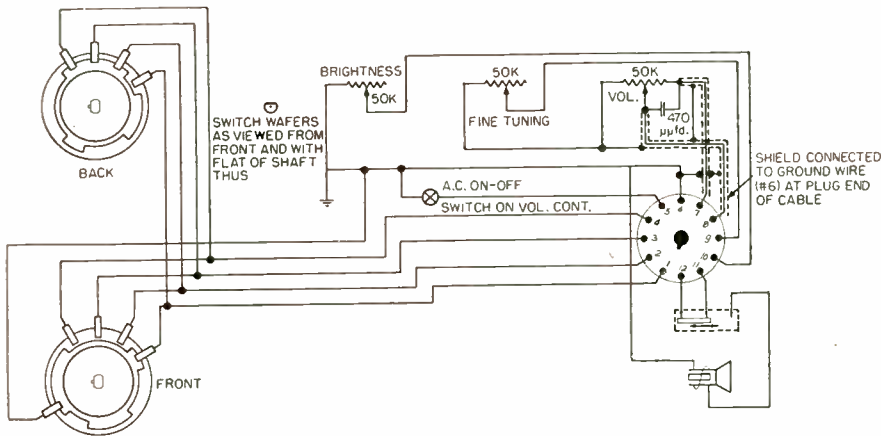

Fig. 7. The Packard-Bell remote unit contains its own integral loudspeaker, as well as a fine-tuning control that varies the oscillator plate voltage.

no alignment or adjustment; the cable connections are as subject to defects as those of other remote-control units.

Special Components

Most of the circuits used in remote controls are not too complex electronically and can be traced out by resistance or voltage measurements. What makes servicing of remote control units different from regular TV receiver work is the defects which occur in the electro-mechanical components, such as the switches, relays, and motors.

While most readers are familiar with rotary selector switches, they may not have really looked at the construction of a typical wafer. Double-sided wafer switches especially can contain hard-to-find defects. A typical problem is to replace a defective switch wafer with an exact duplicate. Unless all connections are checked for proper function in several positions of the shaft, it is possible to reverse the orientation of the switch. Bent finger springs, loose rotor blades, and cracked wafers are other troubles to look for.

Relays are often considered a field in themselves, their design and application requiring considerable mechanical and electrical knowledge. The types of relays used in remote-control units are not too complex but, in order to function properly, they must be adjusted with care. Basically these relays operate by applying the magnetic force generated by the current in the relay coil to overcome the spring tension which keeps the armature from the pole piece. If the spring is too tight, then the current will not have sufficient force to pull or to hold the armature against the pole.

It may happen that the current can attract the armature but, after the first impact, the latter bounces off and the spring pulls it away again. Chattering can also be caused by insufficient current or insufficient magnetic force due, occasionally, to a shorted turn in the relay coil. When the spring is too loose, residual magnetism may, after a while, prevent the relay from opening after the current is removed.

The contacts of a relay are even

more subject to trouble than the armature and relay coil. Arcing can take place if the contacts do not close tightly or do not open sufficiently wide. Arcing could destroy the contact points in time, but usually this defect becomes apparent as a failure to actuate the motor fully or failure to stop completely. Arcing and relay chatter are usually audible, and the technician can thus locate this type of defect without trouble.

To repair relay contacts, a small ignition file or a double piece of emery cloth is inserted between the points to clean off the pitted area. Contacts are mounted on springs; these springs can usually be bent slightly to adjust the contact spacing. On some relays, the contact springs are backed up by a more solid steel leaf which can be bent to regulate the maximum travel of the spring. Relay adjustment, which can be quite tricky, requires more patience than electronic knowledge.

The motors used to turn the tuner shaft in most TV sets are simple, single-phase, a.c. motors. They are mass produced and have hardly any adjustable or replaceable parts. If a motor fails, the most likely reason is a broken lead or mechanical failure in the gear train. Defective connections can be found with the ohmmeter and mechanical failure in the gear train becomes apparent when the gears are manipulated by hand. Lubrication data and any possible adjustments of the motor drive mechanism are included in the manufacturer's service

data and these should be followed.

One of the effects that motor tuning has on the wearing characteristics of TV tuners is that contacts will tend to become corroded somewhat sooner than on manually operated sets. The reason is that most motor-turned tuner shafts always turn in the same direction. If the tuner is set for Channel 7 and Channel 5 is desired, it will have to turn through Channels 8, 9, 10 etc., while in manual operation it would be turned only through Channel 6. This means not only more frequent contact actuation but also that the contacts are always wiped in one direction and some of the self-cleaning action is lost. However, the remainder of the tuner, especially the shaft bearings, will wear well since the motor action is more uniform than in manual tuning.

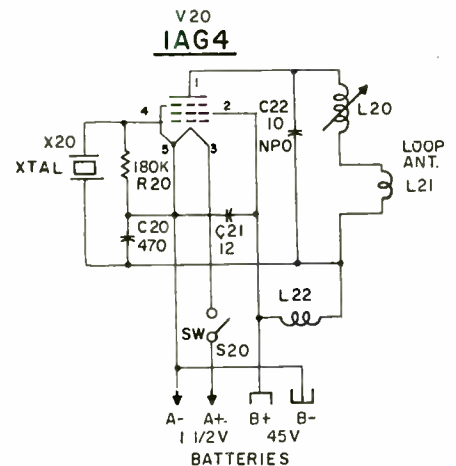

Fig. 8. Heart of the Hoffman system is this single-stage, battery-operated oscillator, controlled by a crystal.

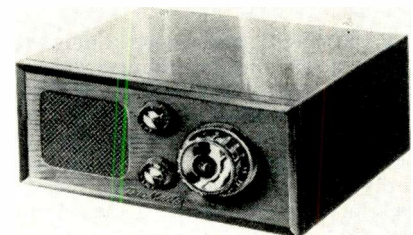
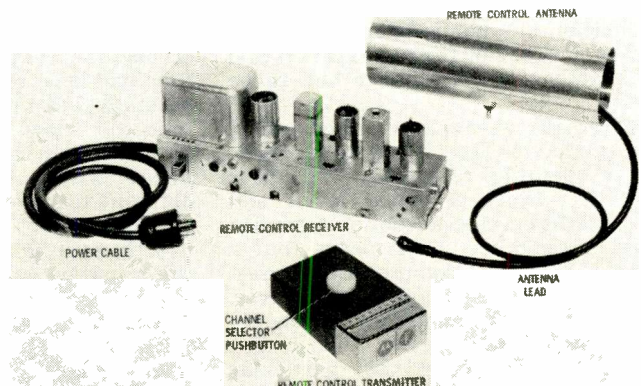
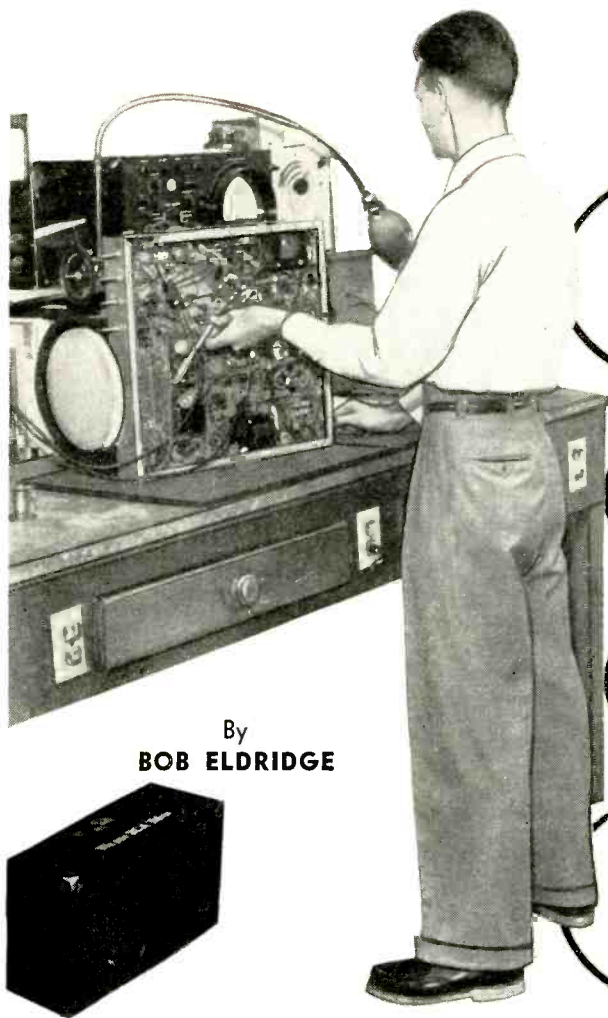

Fig. 9. A good portion of the receiver signal circuits is included in the remote-control box of the TechMaster unit.

★
Fig. 10. The major components of the Motorola remote-control system. Included is a transistorized transmitter unit.





By
BOB ELDRIDGE

Toying with TV Design

It's all right to make circuit changes if you know what you're doing and why the changes are needed.

FEW THINGS are more likely to throw a TV design engineer into a fit than the practice of meddling with his brain-child, on the part of the service technician, in an effort to improve performance. So, before we commit ourselves along just those lines, let's begin with a word of caution.

We are dead against indiscriminate changes in component values or other circuit modifications in a TV receiver if they can be avoided. When such changes are finally made, there should be full awareness on the part of the technician of what is happening in the set as a result of the modification and of exactly why the change had to be made.

After all, when a new set comes off the production line, it has to be capable of operating reasonably well under a wide variety of signal levels and other differences in reception from one locale to another. This means that a certain degree of compromise is present in the design of any receiver. Furthermore, accumulated errors in component values—even though the individual deviations of particular components may be well within toler-

ance—sometimes add up to a total deviation that results in performance that is less than acceptable. In such cases, as long as we use knowledge and discretion, it is possible to "custom-tailor" certain constants in a set so that an otherwise unhappy customer is satisfied.

Incorrect A.G.C. Balance

To illustrate the desirability of being able to "customize" a chassis for a particular purpose, let us take as an example an actual case which arose recently. The set had been in use for about nine months when a tube failure occurred in the sync section. After the tube had been replaced the set worked normally, but the customer complained that the snow level behind the two strongest signals was now higher than before. Two subsequent callbacks by different technicians failed to convince the owner that the set was operating exactly as it had before. (We all know this situation only too well, of course!)

It so happens that this make of set had rather high i.f. gain with very efficient gated a.g.c., and a slight noise level is usually visible in the background of the strongest signal. The

customer, not having noticed it before, was sure it had never been there until the unfortunate technician replaced the sync clipper. Changing the value of one resistor, to put a little more bias on the i.f. strip and a little less on the tuner, did the trick perfectly (and incidentally left the customer not only happy but triumphant: "You see, young man, there *was* something wrong.").

A simplified diagram of the a.g.c. line is shown in Fig. 1. Before you read farther, have a look at this diagram. Which resistor would you have changed to alter the balance of the two bias lines?

Let us examine briefly the operation of the circuit shown. Each time the a.g.c. tube conducts, current flows through the series resistor network, R_1 , R_2 , and R_3 , which form a voltage divider. We can consider point A as being the source of our common negative bias for both tuner and i.f. strip. With a strong signal being received, the voltage at this point will be on the order of 30 or 40 volts negative. The i.f. bias is taken from the junction of R_2 and R_3 , and, the ratio of these two resistors being 10:1, the actual bias applied to the grids of the first and second i.f. tubes will be about one eleventh of that present at point A.

The tuner bias is taken off through R_4 and an opposing positive voltage, derived from a source of "B+" through R_5 is also applied to the a.g.c. input line to the tuner. The value of R_4 is such that the net result of the two bucking voltages is a negative value for a normal signal. The a.g.c. input to the tuner is clamped to ground by a diode, to insure that the r.f. amplifier bias can never go positive. (Positive bias would result in excessive conduction in the r.f. amplifier, with resultant damage to the tube). If the bias goes momentarily positive, the diode conducts, short-circuiting the line to ground and restoring the voltage to zero. When the voltage is negative, the diode is, of course, inoperative.

So much for the operation of the circuit. There is one thing more to consider. If, by some means, we reduce the bias on the tuner, this will automatically produce an *increase* in bias on the i.f. tubes. This is because, by increasing the gain of the tuner, we pass a stronger signal through to the video amplifier. The a.g.c. tube responds by conducting more heavily and thereby increases the over-all bias produced at point A (Fig. 1). Conversely, by increasing the bias on the i.f. tubes only, a.g.c. action will produce less bias than was available before at the tuner.

To return to our problem of the set with slight snow behind a strong signal, increasing R_3 to 39,000 ohms achieved the desired balance of gain between i.f. and tuner. Note that lowering the value of R_2 would have the same effect, because it is the *ratio* between the two arms of the divider that we have to change.

An attempt could also have been made to handle the problem directly at the tuner line: a reduction in value of R_1 would have provided more positive bucking voltage, which would have reduced negative bias to the r.f. amplifier where it is taken off between R_1 and R_2 . However, as Fig. 2 shows, R_1 and R_2 also form a voltage divider with a potential difference of 175 volts across them in the original circuit, if we disregard the relationship to ground momentarily. Reducing resistance in the divider would have reduced the potential difference across the entire divider, with the result that the negative 35 volts from which i.f. a.g.c. voltage is derived would also have been reduced. This would have made the entire receiver more sensitive. Since plenty of signal was available from the antenna to which the set in question was connected, it was decided that this would not be advisable. The deterioration in over-all a.g.c. action might have resulted in annoying overload conditions on some strong signals.

Leaving aside for the moment our pretensions to redesigning the TV set on the bench, it is obvious that the technician who knows just which values affect which function in a circuit such as the one just discussed, is better able to service a set in which one of the components has changed in value due to normal aging or failure. Every tube jockey soon learns that a snowy picture probably means lack of gain in the front end, but it is not so obvious that *excessive* gain in the i.f. stages could be pushing up the tuner bias and causing the lowered tuner output.

Poor A.G.C. Compensation

In a multi-channel area with one or more very powerful local signals it sometimes happens that a set will over-compensate in the a.g.c. circuit, causing washed out contrast on the stronger signals. Of course, the opposite effect sometimes occurs, with too much contrast on the stronger signals. Fig. 3, a typical keyed a.g.c. stage shows the component to play with to correct either of these effects. R_1 , shown in the diagram as 180,000 ohms, is a useful regulating device to set the keying level of the a.g.c. tube; that is to say, the signal level at which it will begin to conduct, and, at the other end of the grid curve, the signal level above which further increase ceases to create greater conduction. Notice, however, that the grid-cathode bias on the tube is more or less established by the voltage drop across R_2 in the plate circuit of the video amplifier. It is important that this resistor be checked before attempting any changes in grid-cathode relationships in the a.g.c. stage. In passing, it should also be noted that, if it is desired to achieve more gain in the video amplifier at the expense of some bandwidth, R_2 should be raised slightly, rather than R_1 lest a.g.c. action be upset.

Rather than rely on visual observa-

tion of the picture in estimating whether or not the a.g.c. is fully effective, it is a better idea to hook the scope probe to the output of the video detector or grid of the video amplifier. The signal-waveform display at this point should remain at a reasonably constant level irrespective of the channel being received. This method enables a reliable check to be made, and reduces the chance of being fooled by unusually low contrast due to low modulation level (as when films are used) on an otherwise strong carrier. If a v.t.v.m. is used instead of a scope, bear in mind that d.c. across the diode load is dependent on average signal information level, so the character of the picture must be taken into account when comparing the voltage developed on different channels.

Stacked "B+" Systems

Fig. 4 is a simplified schematic of a typical set using the cathode of the audio output tube as a source of "B+" for several stages of the receiver. When we consider that, in this particular case, the 140-volt line feeds not only the i.f. strip but also the mixer, audio i.f., screen of the video amplifier, and both sync stages, it is obvious that, if the 140-volt line is low, it will have a serious effect on the performance of the whole set.

In this method of operation, the self-bias resistor of the audio output tube is effectively made up of the resistance of all these other stages in parallel. Each separate stage passes relatively little plate current, so a change in the operation of one of them will not have much effect on the voltage produced at the audio-output cathode.

However, if we leave the resistance in the cathode path of this tube constant, we can conveniently change the plate-current flow by varying the grid-cathode bias, so this is the obvious way to regulate the 140-volt line to the correct level. We must, of course, stay within the bias limits of the audio tube itself in respect to its function

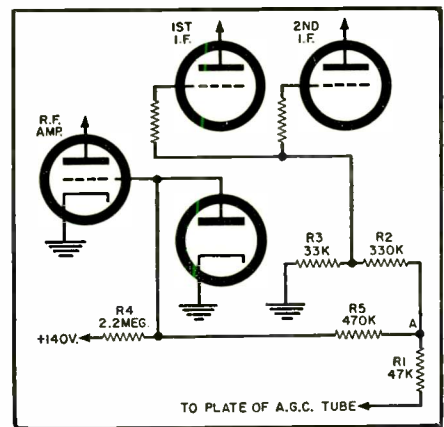

Fig. 1. Voltage dividers and bucking voltages often establish the delicate balance between r.f. and i.f. a.g.c.

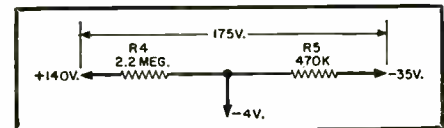

Fig. 2. Detail of part of a.g.c. divider shows total potential difference.

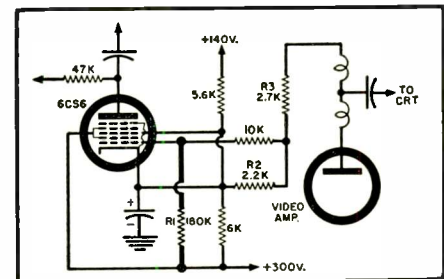
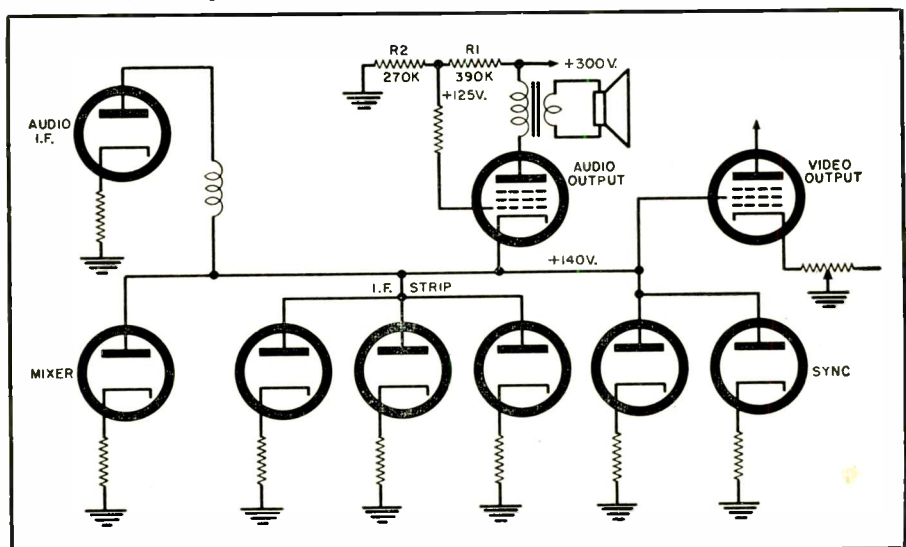

Fig. 3. The keying level in this typical keyed a.g.c. stage is set by R_1 .

as an amplifier. The cathode being elevated above ground, the grid must have a somewhat similar potential. Referring again to Fig. 4, we see that R_1 and R_2 form a potential divider which is used to establish the bias. Changing the value of either arm of

(Continued on page 126)

Fig. 4. A representative circuit using a "stacked B+" supply, wherein low "B+" voltages are derived from the cathode of the audio output amplifier.



Tape Recorder Quiz

By HERMAN BURSTEIN

How many of these answers do you know relating to tape recording principles and practices?

THE role of the tape recorder in high-fidelity systems is one of fast-growing importance, particularly since the machines available at moderate prices are steadily improving. The individual who wants maximum performance from his unit must approach it with at least a basic technical understanding. The following "true-or-false quiz" is designed to check and possibly augment your knowledge of tape recorder operation and practices.

1. *The NARTB standard provides a specific equalization characteristic for playback of tapes.*

TRUE. This standard characteristic is in the nature of a playback bass-boost curve. After the stipulated playback characteristic is provided, NARTB then states that record equalization should be adjusted to effect relatively flat record-playback frequency response, that is, within NARTB limits. It should further be pointed out that NARTB playback equalization requires treble boost to be incorporated to the extent that playback head losses cause treble response to fall below NARTB requirements. The amount of such playback head losses can be estimated on the basis of nominal gap width or can be found by playing a standard test tape.

2. *A record head with a very narrow gap provides better high-frequency response than one with a relatively wide gap.*

FALSE. Within a relatively wide practical range, the gap width of the record head is unimportant. When a.c. bias is used, as is almost always the case today, recording takes place at the trailing edge of the gap, and the requirement here is that the gap edge be as linear and sharply defined as possible.

3. *A playback head with a very narrow gap provides better high-frequency response than one with a relatively wide gap.*

TRUE. In playback, when the width of the gap becomes more than half of the recorded wavelength, very severe losses begin to take place. High frequencies are represented on the tape by short recorded wavelengths, so that high-frequency response is inversely related to gap width. For high-fidelity performance at 7.5 ips, a gap of .00025" or less is required, although at 15 ips equally good results can be had with a .0005" gap.

4. *A low-impedance head is desirable for record and a high-impedance one for playback.*

TRUE. A low impedance winding minimizes the amount of voltage that must be developed by the record amplifier and by the oscillator in order to drive the required audio and bias currents through the record head. On the other hand, a high impedance winding is desirable for the playback head in order to generate as much playback signal as is practical and thereby maximize the signal-to-noise ratio. Here is one of the reasons that a machine with separate record and playback heads can yield better results than one which utilizes the same head for record and playback.

5. *If a constant amount of signal is to be recorded on the tape at all audio frequencies then a constant amount of voltage must be applied to the record head at these frequencies.*

FALSE, on two counts:
a. Since the record head is an inductive device, its impedance rises with frequency, so that for a given applied voltage the current through the head declines. What is required is *constant current* through the head in order to

apply equal magnetic flux at all frequencies to the tape.

b. Even though constant magnetic flux is *applied* to the tape, this does not result in equal amounts of flux recorded on the tape. This is so because, due to bias current and the phenomenon of self-demagnetization, there are very substantial losses in the amount of recorded flux at high frequencies—as much as roughly 35 db at 15,000 cycles when recording at a speed of 7.5 ips.

6. *Some tape recorders, particularly professional ones, operating at 7.5 ips record a flat signal on the tape.*

FALSE. This would be a difficult attainment in the present state of the art. A professional tape recorder, which ordinarily uses NARTB equalization or a close equivalent, permits the recorded signal (flux) to be 3 db down at 3180 cycles and to decline thereafter at a rate approaching 6 db-per-octave. This is so because of the heavy record losses described in the answer to statement 5, which cannot be fully compensated by practicable amounts of record treble boost. Other tape recorders permit the decline in recorded signal to commence at frequencies lower than 3180 cycles. This decline is compensated in playback inasmuch as the playback head, being an inductive device, has an output that tends to rise at the rate of 6 db-per-octave over most of the audio range. It should be added that even in the case of 15 ips tape recorders it is not feasible to record a flat signal on the tape, although this is done by some 30 ips machines.

7. *Harmonic distortion of 3% at average levels is acceptable in tape recording, and for this reason the rated signal-to-noise ratio of a number of high-quality machines is based upon an output level corresponding to 3%.*

FALSE. 3% harmonic distortion is acceptable only on *peaks*, which are characteristically of short duration and therefore much less offensive to the ear (when they contain this much

distortion) than if they were sustained. The signal-to-noise ratio of a tape recorder is based upon *peak* output level. The amount of IM distortion corresponding to 3% harmonic distortion is quite large, on the order of 10 to 20%. At average signal levels this much IM would of course be incompatible with high-fidelity requirements.

8. *Azimuth alignment is a more critical process in the case of full-track heads than half-track ones.*

TRUE. A given degree of misalignment produces considerably greater high-frequency losses in the case of a full-track head.

9. *Optimum bias current maximizes high-frequency response.*

FALSE. Although high-frequency response can be greatly extended by keeping bias current relatively low, this practice results in appreciable distortion. Optimum bias is that which produces the most satisfactory combination of low distortion and wide frequency range. Since lower distortion can also be had by reducing the record level, optimum bias implicitly takes into consideration the requirements with respect to signal-to-noise ratio.

10. *Distortion continues to decrease as bias current is increased.*

FALSE. In the practical operating range, an increase in bias current ordinarily results in less distortion. However, a minimum point is reached beyond which a rise in bias serves to increase distortion. When recording at 7.5 ips, it is rather unlikely that excessive bias would be used because before then the high-frequency response would have been reduced to an inordinate degree. On the other hand, when recording at 15 ips, it is possible for bias to be beyond the point of minimum distortion and at the same time allow adequate treble response.

11. *Distortion and frequency response characteristics may vary significantly from one kind of tape to another.*

TRUE. There may be as much as 6 db or more difference in response at 15,000 cycles for the same bias current. For a given output level, there may be an appreciable difference in minimum distortion obtained by varying the bias.

12. *If a tape is recorded half-track on a machine that moves the tape from left to right, this tape can be played back successfully on another machine with right-to-left motion.*

TRUE. The conventional arrangement is that recording takes place on the upper half (track) of the tape for left-to-right motion, and on the lower half for right-to-left. Thus if the upper track were recorded on a left-to-right machine, when the tape is reversed on a right-to-left transport this recorded track becomes the lower one and is therefore the one which is played back.

-30-

COVER STORY

Heart Recording

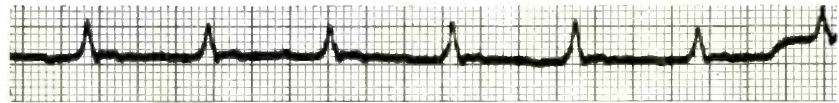
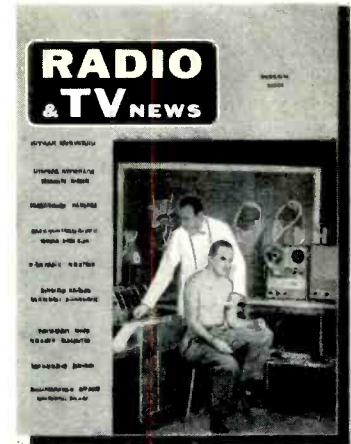

New hope for cardiacs is offered with the development of special and highly sensitive electronic diagnostic tools.

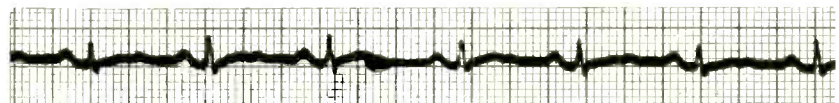

WITHIN recent years considerable progress has been made in the application of acoustic methods to medical problems. This month's cover photograph shows the Altec Lansing 21MA contact medical microphone and M-16 microphone system being used in conjunction with an Ampex 600 tape recorder for the instruction of medical students.

Using this equipment, heart sounds can now be recorded so that an accurate, permanent record of the sound is available for teaching, diagnostic, and prognostic interpretation. About four years ago a public health grant was made available which resulted in the building up of a tape library which included normal heart sounds, heart action under the effects of drugs, hearts with various heart diseases and congenital abnormalities, and sounds resulting from wounds which penetrated the heart or circulatory system. The use of these tapes in medical schools is so effective that medical students are advanced two years ahead of classes not using this technique.

Another advantage of heart recording is that it permits filing of the tape for future reference so that the sounds can be directly compared with those of earlier examinations. This method allows no uncertainty as to memory or depreciation of hearing on the part of the physician.

Still another feature is the ability of a physician to record heart abnormalities and have them evaluated by a specialist at a later date. Today there are several types of heart diseases which can be greatly benefited or cured by skilled intervention. By this simple expedient of recording the heart sounds, the patient can benefit from the diagnosis of specialists throughout the country.

The reason why these recordings can be made today results from improved microphones which reproduce heart sounds more faithfully than had been possible with the

conventional acoustic stethoscope. The acoustical stethoscope consists, in general, of a fiber or metallic diaphragm clamped on its edge and mounted in a small enclosure. The tone of each heart sound depends on the diameter and thickness of the diaphragm, the material of which it is made, the size of the cavity back of the diaphragm, and the loss in the rubber tubing leading up to the ear. Usually these diaphragms are resonant at 200 cps.

As contrasted to this, a small condenser microphone, such as the Altec 21MA, uses a diaphragm having a natural resonance far higher than any heart sound and its output is a more exact reproduction of the chest sound. Electrical amplification without distortion permits the recording and reproduction through headphones or loudspeakers.

Basically, heart sounds extend from a very low frequency, such as 1 cps, up to 1000 cps. The sounds from 1 to 100 cps may be classified as "ballisto" sound or having to do with the stopping and starting of the column of blood in the circulatory system. The frequency range of 100 to 1000 cps is thought to be the range of sound produced by the motion of the blood through the valves in the heart. It is these frequencies which are considered most important for clinical stethoscope diagnosis. The condenser microphone faithfully reproduces these many variations in pitch and character so they can be accurately identified.

There is a growing tendency to use the microphone in the operating room to continuously monitor the patient's heart sounds so that the anesthetist will know at all times how the patient is responding, rather than use the intermittent method with an acoustical stethoscope. The microphone can also be used to run a rate recorder so that in the recovery room, one nurse can tell at a glance the condition of each patient. (Photo by Peter J. Samerjan)

A NEW

TRANSISTORIZED

Voltmeter



Fig. 1. Internal and external views of the completed transistor voltmeter.

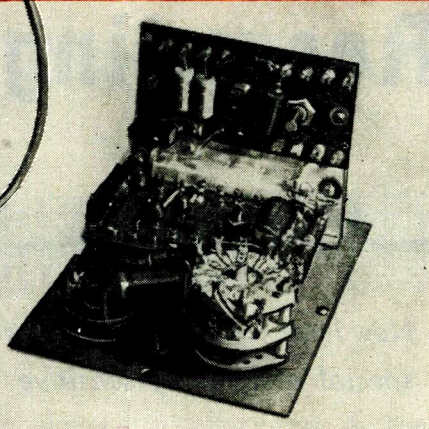

By

HERBERT MALAMUD

A reliable and relatively inexpensive unit with 100,000 ohms-per-volt sensitivity is realized.

TRANSISTORS had scarcely become commercially available when they were put to use to increase the sensitivity of conventional current-drawing meters. Some of the techniques involved and a suggested design for a practical transistorized voltmeter will be presented here. Before considering the finalized meter, however, it will be helpful to review briefly some traditional meter circuits out of which it developed.

A standard voltmeter consists of a meter movement plus a choice of multiplying resistors to be placed in series with it to increase the value of the voltage necessary to drive the rated current through the meter for full-scale deflection. Fig. 3 shows a repre-

sentative arrangement of this type. If the resistance of the meter movement is R and the current I is required to drive the meter to full-scale deflection, then the four voltage ranges for the switch positions shown will be IR , $10IR$, $100IR$, and $1000IR$.

A typical movement of high quality may have a full-scale current rating (I) of 100 microamperes and a resistance (R) of 5000 ohms. Then, in a circuit configuration like that of Fig. 3, it would have ranges of 0.5 volt, 5 volts, 50 volts, and 500 volts.

A vacuum-tube voltmeter is a voltage-driven device. A voltage to be measured is applied to a tube grid, where it draws a current so small that it is negligible for most purposes. The meter itself loads down the output of the tube, and draws the current necessary for its deflection without affecting the circuit being measured. A system of this type, diagrammed in Fig. 2, presents the same load to the circuit being measured, irrespective of the voltage scale in use. Typical values in common use have R about 1000 ohms, with scales ranging from perhaps 1 volt to 5000 volts full scale. (For simplicity, voltage scales are shown in steps of 10, al-

though practical meters usually employ one or more intermediate values to make it easier to keep readings somewhere near the middle of the scale.)

The transistor, a current-sensitive and current-amplifying device, can be used to increase the sensitivity of a meter movement. Its acceptance in this application can be attributed to the fact that a relatively inexpensive 200-microampere meter can be used, with transistors, to make a voltmeter of about 100,000 ohms-per-volt sensitivity. A comparable 10-microampere meter movement would cost several times as much as the common 200-microampere unit that could be used with transistors, and it would be much more fragile.

The circuit commonly used, shown in Fig. 4, is essentially a bridge, where the emitter-collector circuit of the transistor is one arm, balanced by the zero-set potentiometer. When an input current is supplied through the base-emitter circuit, the collector current changes. From the point of view of the meter, it is as though the impedance of one arm of the bridge changed. This unbalance permits the meter to draw current and give a reading.

There is good reason for using a bridge: the current through the collector circuit of the transistor is *not* zero when the base current is zero. The collector current, of course, must not be allowed through the meter, and it may be balanced out in the bridge circuit.

The major drawback to transistor voltmeters of this type is the fact that this zero-signal collector current (I_{co}) is not constant, but varies with temperature. A typical variation may be as much as 50% change in I_{co} for a temperature change from 20° to 40° centigrade. A less serious problem is the fact that current amplification itself depends on temperature—less serious because the change in amplification is on

Fig. 2. Typical vacuum-tube voltmeter circuit, showing meter loading plates of tubes while constant high impedance at the grid loads circuit under test.

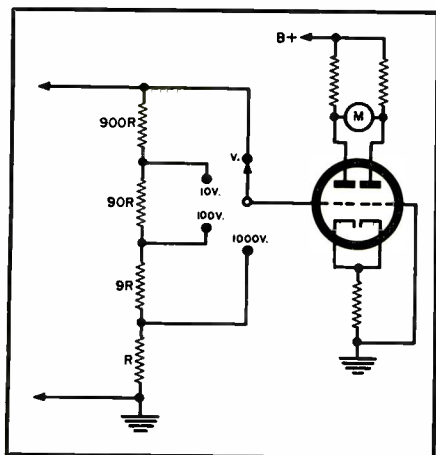
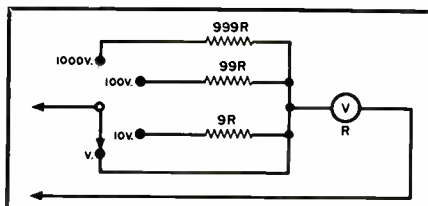

Fig. 3. A basic voltmeter circuit, using series multiplier resistors.



the order of 5% for the temperature change noted. Note that 20° centigrade is 68° Fahrenheit and 40° centigrade is 104° Fahrenheit. Considering that voltmeters are usually used indoors, this range thus roughly encompasses the variation to be expected in practice from winter to summer weather.

Unless something is done to compensate for it, this instability of the transistor's characteristics can make a meter using it hopelessly unreliable for any sort of accuracy. Since, in effect, it might be said that the transistor's resistance is varying with temperature, one approach tried is that of using a temperature-dependent resistor whose characteristic is roughly inverse to that of the transistor. However, another approach occurred to the author: Why not balance out the erratic behavior of one transistor with another matched transistor? If the two were of the same type, then the zero-signal collector current (I_{c0}) should vary in step for both and, if they were balanced in a bridge with a meter, the latter should keep its zero setting.

To avoid the need for two power supplies (since each transistor should be supplied with exactly the same voltage), a bit of juggling of the bridge was needed. The circuit evolved is shown in Fig. 5.

The experimental meter built according to this circuit kept its zero well, over a period of months, with no adjustment. However, small improvements were still considered possible. For one thing, the transistor characteristics are not best in the region at and near the zero base-signal point. For another, the second transistor was wasted as far as its amplification properties were concerned, as it was used exclusively to balance out zero signal.

The next step was to take advantage of its amplification properties by feeding in the signal between the two transistor bases. This seemed to mean that one of the transistors would have its

base made negative, while the other was made positive. However, this was avoided by biasing both bases with a positive current greater than the maximum signal to be applied and letting the signal simply increase one and reduce the other base current. This, of course, requires a second battery, but it was judged to be worthwhile in this application, shown in Fig. 6. The bridge now balances out not only I_{c0} but also collector current due to the bias signal. The second or bias battery has one other purpose. By supplying current through a resistor whose value is much greater than that of the base circuit, it acts to stabilize the transistor circuit somewhat as does a self-biased tube circuit.

The final circuit built is shown in Fig. 7. Provision has been made for an a.c. as well as d.c. voltmeter which should be flat in response down to about 10 cycles. By using precision resistors for R_5 and R_6 , a balancing potentiometer in the collector circuit is avoided.

If this potentiometer is desired, use a value of 1000 ohms, put it between R_5 and R_6 , and set it to zero the meter reading with points A and B shorted by a jumper. This potentiometer can then be more or less permanently fixed by a drop of cement or shellac where the shaft enters its body. It should not require frequent adjustment.

We use two capacitors at C_1 and C_2 to avoid the need for a 1- μ f., 1000-volt unit, which would be quite bulky and expensive compared to an extra set of switch positions on S_1 . The high value is needed on the low-voltage scale, since the scale resistor is only 100,000 ohms. The resistor for the 1000-volt scale is 100 megohms, and a .001- μ f., 1600-volt TV high-voltage capacitor is satisfactory. The 100-megohm resistor is either a high-voltage high-value unit especially made not to break down, or it can be assembled by putting four 22-megohm

(Continued on page 174)

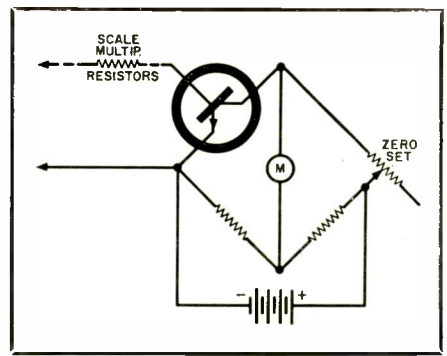

Fig. 4. Emitter-collector circuit of the transistor is one arm of a bridge circuit across which is meter movement.

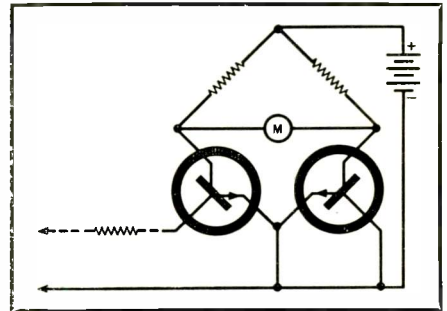

Fig. 5. With two transistors in this configuration, the instability of one cancels the instability of the other.

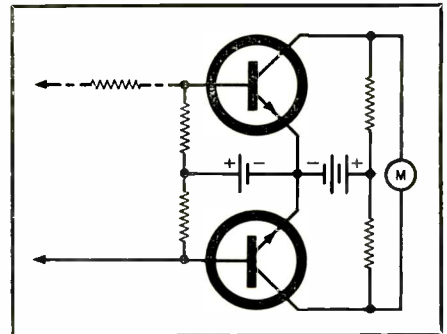
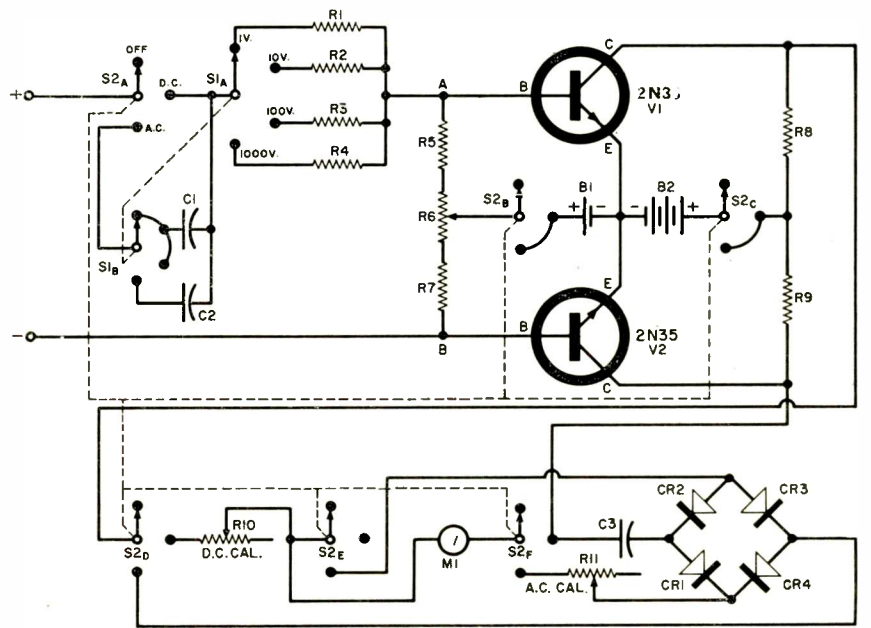

Fig. 6. Final evolution of the bridge.

Fig. 7. Complete schematic of the transistorized 100,000-ohm-per-volt meter.

- R_1 —100,000 ohm, $\frac{1}{2}$ w. res. $\pm 1\%$
- R_2 —1 megohm, $\frac{1}{2}$ w. res. $\pm 1\%$
- R_3 —10 megohm, $\frac{1}{2}$ w. res. $\pm 1\%$
- R_4 —100 megohm, $\frac{1}{2}$ w. res. (see text)
- R_5, R_7 —39,000 ohm, 1 w. res.
- R_6 —50,000 ohm wirewound pot
- R_8, R_9 —2000 ohm, $\frac{1}{2}$ w. res. $\pm 1\%$
- R_{10}, R_{11} —20,000 ohm wirewound pot
- C_1 —1 μ f., 200 v. capacitor
- C_2 —.001 μ f., 1600 v. capacitor
- C_3 —2 μ f., 200 v. capacitor
- S_1 —D.p. 4-pos. switch
- S_2 —6-pole, 3-pos. switch
- M_1 —100 μ a. meter
- CR_1, CR_2, CR_3, CR_4 —Bridge composed of four 1N34 rectifiers (meter rectifier may be substituted)
- B_1, B_2 —Mallory RM-1-R mercury cell (see text)
- V_1, V_2 —"n-p-n" junction transistor (Sylvania 2N35)





Build the "Transactivator"

← Over-all view of the transistor activator.

By FRANK H. TOOKER

An a.c.-operated transistor supply made for 24-hour-a-day use, switches to built-in battery during power failure.

HERE is a transistor activator (power supply) that is just about everything you have always wanted a transistor power source to be. Let's take a look at its features:

First of all, as the photos and the schematic diagram indicate, it is extremely simple and compact. It uses only a handful of miniature parts. Second, although it is fundamentally a.c.-operated, it keeps right on delivering current even though the plug is pulled out of the socket or a power line failure occurs! Third, there is less than $\frac{1}{4}$ of 1 per-cent ripple in its output (with new cells at B_1), yet it uses only a single half-wave rectifier, one electrolytic capacitor, and no iron-core filter choke. Fourth, it is voltage regulated. The output voltage is at all times very nearly equal to the battery voltage. Fifth, current drawn from the battery as a result of portable or power-line-failure operation is automatically replaced, insofar as is possible, by rejuvenation while the unit is operating on a.c.

The "Transactivator" is conservatively rated at 2.9 volts ($\pm 4\%$) and up to 10 milliamperes d.c. output.

How It Works

Most of the interesting and desirable features of this little power source are obtained through the functioning of the transistor, V_1 , which is connected in the manner of an emitter follower (analogous to a cathode follower in a vacuum-tube setup). Because

of this connection, the voltage across the output terminals tends to be a replica of the voltage across the battery, B_1 , in the base circuit, i.e., 3 volts d.c., and largely free from hum ripple. Thus, the transistor functions as a voltage regulator and as an electronic filter circuit.

When the "Transactivator" is operating from the a.c. line, all of the d.c. output is obtained from the a.c. source via the rectifier, CR_1 , and electrolytic capacitor C_1 . Most of the output current flows through the collector circuit of V_1 . Only a small fraction flows through resistor R_2 to the output via the base. If the a.c. source is interrupted, however (as during a power-line failure), the transistor itself automatically switches over and draws all of the output current via the base, i.e., from the battery. Since the transition from a.c. to battery is performed entirely within the transistor and, additionally, is involved with the discharge of capacitor C_1 , switching occurs smoothly—without sudden current interruptions or surges. Thus, there are no switching transients. Even at the full rated output of 10 milliamperes, the only evidence that the a.c. circuit has been broken is a very slight lowering of the output current due to the base-to-emitter voltage drop in V_1 .

When the a.c. connection is restored, the transistor automatically switches the output back to the rectifier and filter capacitor source of d.c. Since this operation is involved with the

charging of C_1 , switching in this direction also occurs smoothly.

The value of resistor R_2 has been chosen to make the current flowing through it greater than that needed to supply the fraction of the output demanded by V_1 's base circuit. The excess current flows in a reverse direction through the battery and tends to rejuvenate the battery, thereby effectively prolonging its useful life. At 10 milliamperes d.c. output from the "Transactivator" the reactivating current through the battery is in the vicinity of 2 milliamperes. At 1 milliampere output the reactivating current is about $3\frac{1}{2}$ milliamperes. Larger reactivating currents are not recommended, for two reasons: (1) larger currents may harm the battery instead of tending to reverse the chemical processes, and (2) decreasing the value of R_2 increases the percentage of hum ripple across the output terminals. With the specified value of R_2 , and with two good dry cells at B_1 , the measured ripple was below $\frac{1}{4}$ of 1 per-cent at 10 milliamperes d.c. output.

Switch S_1 is a d.p.d.t. component. One section (S_{1A}) breaks the primary circuit of the miniature step-down transformer, T_1 , while the second section (S_{1B}) opens the battery circuit and grounds the base of V_1 to prevent the output voltage from rising to the value across C_1 when the unit is switched off. Simultaneously, R_2 becomes a bleeder to discharge C_1 . The latter switching operation also prevents the discharge of the battery through the electrolytic capacitor and the back resistance of the rectifier at times when the "Transactivator" is not in use. Actually, the current flow here is small—on the or-

der of microamperes—but it could help to discharge the battery if the “Transactivator” is kept out of operation for long periods of time. When continuous operation is anticipated, S_1 may be eliminated, if desired. A small neon lamp is connected as a pilot light to indicate when the a.c. power is on.

Construction

The assembly of the author’s “Transactivator” is shown in the photos. Layout is not at all critical, so any reasonable construction is permissible. This particular setup is intended for use on the experimental bench. Thus, it is assembled as a separate unit. However, in many cases, it will be found expedient to construct the unit as part of the equipment it is to operate.

In the construction used by the author a small interlocking metal box chassis was employed. Holes were first drilled in the front panel for the “on-off” slide switch, the neon indicator bulb, and the two output terminals. A rubber grommet was used in the indicator bulb hole to protect the bulb. Insulating washers were used for the output terminals to prevent them from being short-circuited to the metal panel. Holes were also drilled in the sides of the box for the passage of the line cord, which was protected by means of a grommet, and for the terminal strip, battery clips, and for the transformer.

After mounting the slide switch and terminals, the clips for the two penlite cells were mounted, as was the terminal strip for the wiring, and the small transistor audio input transformer that was used as a power transformer.

Both the 2N188A transistor and the 1N91 germanium junction rectifier are mounted by means of their own leads. Spaghetti should be used to prevent short-circuiting of the leads. Be sure not to use excessive heat from the soldering iron and do not apply the iron too close to the transistor itself otherwise the unit may be damaged. It is a good idea to hold the lead with a pair of long nose pliers while soldering so that the pliers are between the iron and the transistor. In this way, the pliers act as a heat absorber and prevent damage.

After the remaining components have been soldered into place, the transformer connections made, and the batteries put into their clips, the unit is ready to be plugged into the a.c. line and tried out.

Applications

A supply of this type finds wide application wherever low-power transistors are used and reliable operation up to 24 hours a day is called for—such as in fire alarms, burglar alarms, rain alarms, remote amplifiers, repeaters and indicators, data-taking and recording machines, etc. It could conceivably be built in as part of a small transistor radio receiver. In this case, the receiver would operate from the battery in portable use, and would switch

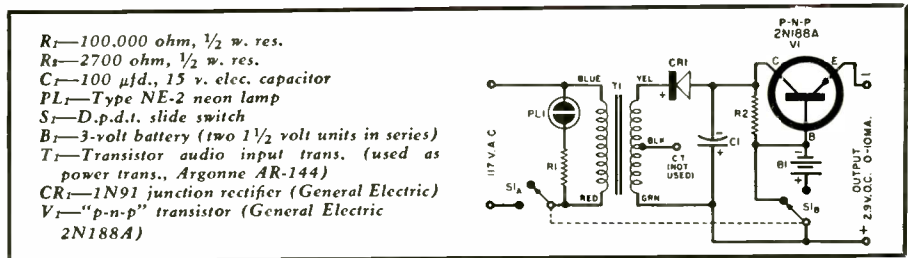

Fig. 1. Complete schematic diagram and parts list for the transistor circuit “activator”. The single transistor operates as a voltage regulator and filter.

automatically to a.c. operation when the power cord was plugged into an outlet. In such a relatively hum-sensitive application as this, additional filtering might possibly be needed in the bus to low level stages in some receiver circuits. Such filtering is almost always desirable anyway, however, even for 100% battery operation (to prevent objectionable regeneration or motorboating) so using the “Transactivator” circuit would add little or nothing to the cost in this area of the receiver.

Although rejuvenation prolongs the life of a dry-cell battery, sometimes to a surprising degree, it does not guarantee that the battery will last forever. Thus, a check on the condition of the battery should be made occasionally. Either one of the two following methods is suggested. One method is a check on the voltage across the output terminals of the “Transactivator” when the unit is operating on battery and delivering power to its usual load. An abnormal decrease in output voltage indicates deterioration of the battery. This is undoubtedly the most reliable method. However, a second method—especially when the “Transactivator” is being used to power a sensitive amplifier—is a check on the hum ripple in the output when the unit is operating on a.c. and delivering its normal amount of current. An in-

crease in ripple indicates an increase in the internal resistance of the battery which, in turn, indicates a need for battery replacement. Always interrupt the a.c. circuit before removing or replacing the battery, since without the cells in place and determining the voltage reference level, the output voltage may rise as high as the maximum across C_1 .

An unusual increase in d.c. output voltage when the unit is operating on a.c. may also indicate a worn-out battery, or it may mean that the rejuvenating current is too high. When the “Transactivator” is to be in continuous use, 24 hours a day, every day, such as in powering a fire alarm—and a.c. power failures are rare, so battery operation is infrequently needed—it may be desirable to increase the value of R_2 to reduce the reactivating current to one milliamper or less. Reactivating current should be checked only when the supply is delivering current to its usual load.

Although transients are absent when switching occurs in the transistor, a momentary pulse does appear across the output terminals when S_1 is switched off. When the “Transactivator” is used to power a device containing voltage-sensitive transistors, make sure that device also contains an RC filter to absorb the pulse before S_1 is operated.

—30—

Photo of the “Transactivator” with the cover removed. Note the transistor mounted between the power transformer and the two penlite cells to the left.

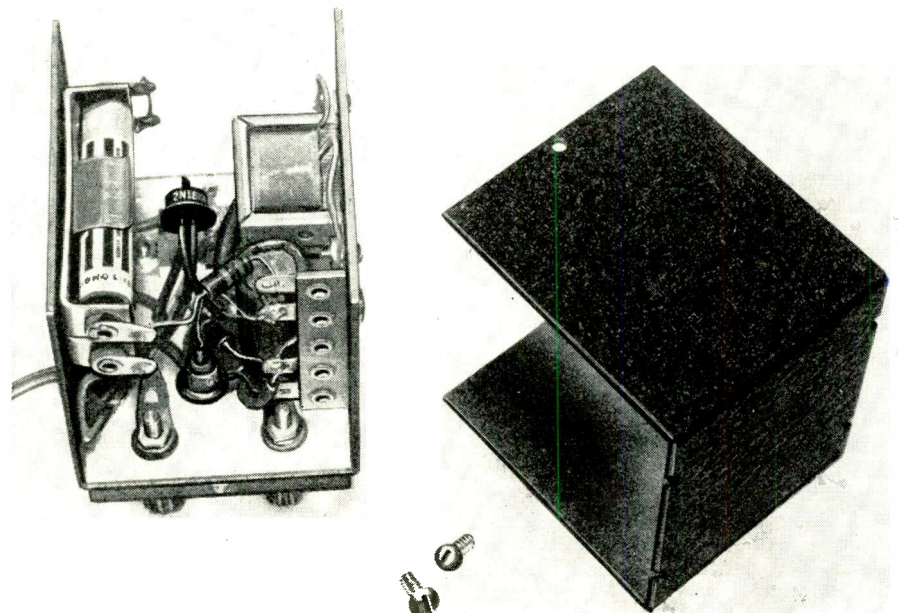



Are You Losing Money?

By WILLIAM LEONARD

Unrealistic charges, subnormal income eat away the basic assets of thousands of service businesses.

SEVERAL years ago a bright, shining new service shop was opened in a medium-sized midwestern city by a hopeful service technician. He had handled home radio and TV service as a part-time activity for several years. Now he had cut his ties with a regular job and embarked on a long-planned career as a full-time service business operator.

Today this shop looks drab and uninviting. The paint is dull, weather-beaten, and forlorn. The windows, which once framed attractive displays, are cluttered with a motley array of promotional pieces that look as if they were thrown in place. The owner is weary and worried because he is constantly hard-pressed for money to pay his bills.

What happened to blight this dream of economic independence in a self-owned business? Why did this service shop deteriorate while the market rose steadily for the services it had to sell?

There is no simple, easy answer to the question of why promising service businesses slowly wither and die. Many things are involved. The personality and aggressiveness of the owner are very important; also his ingenuity and adaptability—his willingness to change to meet the needs of the times.

There is a definite pattern, however, that is woven into the history of most service businesses that fail. That pattern is the tendency to sell service for less money than it costs to give it. In the case mentioned at the beginning of this article, that man thought he could build a business by selling service calls at a dollar per call less than the average charged by successful shops operating in a similar way.

The most important factor in the management of an electronic service business is the constant recognition that the major product it handles is the sale of *time*. If the *time* of the owner and employee cannot be sold at a profit, the business will finally fail. It may, for a time, continue to operate by burying some of the service charges in padded tube and parts bills. But, sooner or later, devices like the self-service tube testers move in to take a big slice of the lucrative tube business away from service shops. The dealers are left with the tough job of getting an adequate return for their time on the tougher service jobs.

How much do you get for a service call?

The most recent survey of the costs of operating a service business indicates that it *costs* \$5.14 to put a competent technician at the front door of a home prepared to give normal service to a TV set and up to 30 minutes of his time. This is a national average. It will vary fifty cents up or down depending on local conditions in different parts of the country. It is, however, an actual cost figure. The charge to the set owner should be ten percent more to provide the business with the income necessary to show a gross operating profit. This means that set owners should be paying about \$5.75 for TV service calls that require up to thirty minutes to complete.

It should be pointed out that the national average of \$5.14 per service call reflects the cost of operating in an efficient service business that pays its technicians competitive wages and normal fringe benefits. It is also based on the business having a suffi-

ent volume of work to keep its technicians fully occupied in making field calls eight hours per day.

For many years the curse of the independent service industry has been the advertising of service at three dollars (or less) per call, while the known cost of operating was rising steadily from about four dollars and thirty-five cents per call to the current average above five dollars. Despite the fact that all other costs have been spiraling upward, price advertisers have stuck to the three dollar ceiling. Since no dealer can beat the factor of basic costs in the sale of *time*, it would appear that there has been a steady rise in the padding of parts bills or else the TV service industry has attracted thousands of philanthropists who are devoting their lives to giving the public service on its finest entertainment medium at less than cost.

Consumer studies have consistently shown that bait advertisers eventually fold up because of customer dissatisfaction *if* the majority of their competitors maintain normal prices and provide honest service. It is unfortunate, however, that a large number of misguided service dealers try to meet fire with fire by participating in the bait advertising racket. The end result is that the entire service market in the area is depressed while consumer dissatisfaction expands to include the entire independent service industry.

In every market, service dealers say bitterly, "I am not making a decent living from my present charges but I can't raise mine because my competitors won't raise theirs." If a dealer is not making a decent living on the basis of his present charges he is losing money operating his business. Certainly he is not able to lay aside any reserves to repaint his store or to replace the equipment that is deteriorating. This applies to any competitor in the same market who uses the same scale of service charges. The end result is that all businesses engaged in this blind battle of price are headed for the rocks of financial trouble.

Economists say that the spiral of living costs will continue to climb in the months ahead. A recent business forecast stated:

"The price you'll pay will be pushed up by higher material and freight costs, as well as higher wages. At wholesale, the stability of recent months will give way to increases averaging as much as 2% by year-end; from 3% to 6% for steel products; 2% to 4% for fuels; 5% to 8% for electrical appliances.

"Consumer prices, after a summer decline because of seasonal food dips, will jump 1.5% to 2% this fall. Cars, apparel, and services all will cost more."

Everything the service dealer uses in his business costs more than it did two or three years ago. His own living

(Continued on page 185)

Single-Sideband Receiving Adapter

By

HARRY D. HOOTON
W6TYH

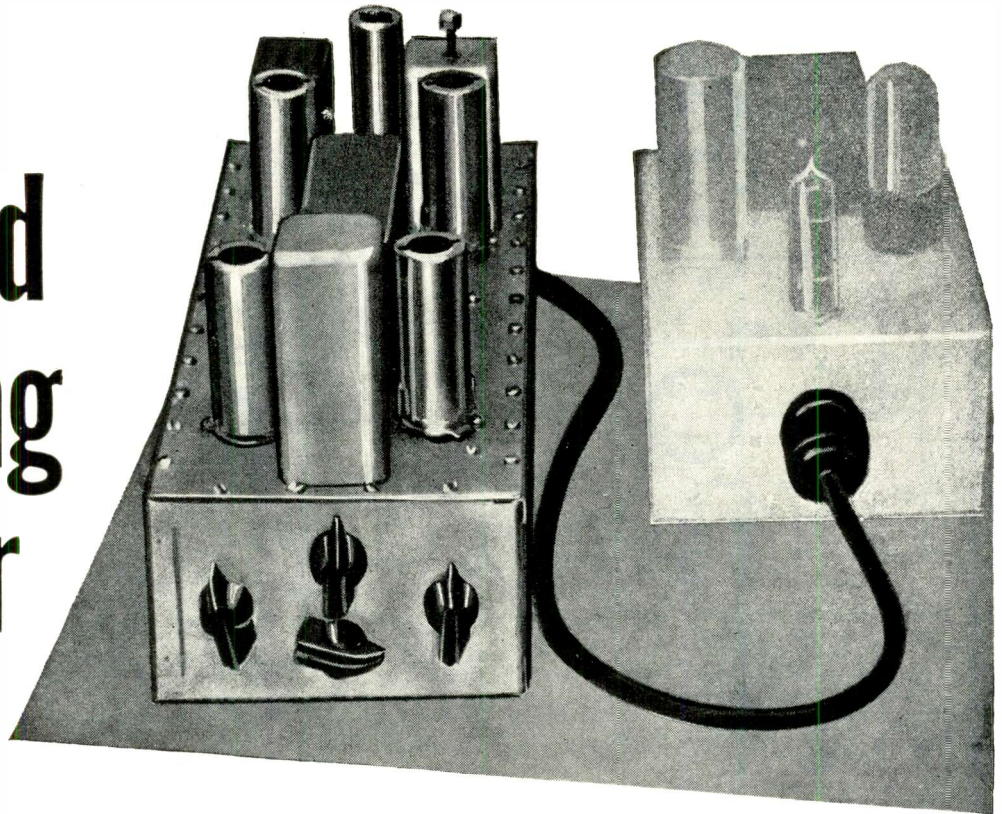

Single-sideband adapter, shown at left, with power supply recommended by author.

Easy-to-build unit allows SSB reception on standard 450 kc. i.f. ham receiver without receiver changes.

MORE and more amateurs are becoming interested in single-sideband transmission and reception. It is only necessary to examine the circuitry of some of the very latest communications receivers and transmitters to realize that great strides have been made in single-sideband techniques within the past few years. It is quite likely that during the next few years, most amateur voice transmissions will be carried out on single-sideband.

Unfortunately, for many amateurs, good commercial communications receivers, designed with the emphasis on single-sideband reception, are both complex and expensive. Some amateurs have attempted to revamp the circuits of their regular communications receivers in order to improve their performance on single-sideband. The results, in many cases, have been disappointing and the resale or trade-in value of the set has been considerably reduced.

The single-sideband adapter unit described here solves the single-sideband reception problem for the ham who already owns a good quality standard AM receiver having an intermediate frequency in the vicinity of 450 kc. The adapter unit will permit reception of single-sideband signals, on a standard receiver, with a clean-cut quality comparable to that of the best communications receiver on the market; no modifications of the receiver, either electrical or physical, are necessary. Either single-sideband or regular AM reception may be selected merely by

throwing a switch. The unit is easy to build since there are no tricky adjustments or alignment involved. The reception of regular AM and c.w. signals will be improved because the effective bandwidth required is cut in half. This narrow bandpass also reduces noise. The intelligibility of weak DX signals is increased over regular AM reception. Best of all, the adapter can be built for \$75.00 or less.

As shown in Fig. 1, the adapter unit uses five tubes. A type 6BA7 is used as a mixer to convert the receiver i.f. signal from around 450 kc. to 50 kc. where it can be filtered to remove one sideband. The oscillator tube, for the converter stage, is one-half of a 12AU7 which is controlled by either a 400 kc. or 500 kc. crystal, selectable from the front. The nominal 50 kc. output signal from the 6BA7 plate, which contains the transmitted carrier and two sidebands (assuming a regular AM signal), is applied to the input terminals of a toroidal sideband filter which passes the band of frequencies from 47 to 50 kc. but sharply attenuates the frequencies higher than 50 kc. The characteristic response of the filter, which is the heart of the adapter design, is shown in Fig. 2.

The receiver is normally tuned so that the AM carrier, or suppressed single-sideband carrier, is placed at the 50 kc. position, as indicated, approxi-

mately 20 db "down" on the high-frequency or steep side of the curve. The relative position of a double sideband (regular AM) signal is shown by the dotted line in Fig. 3. The solid line indicates the portion of the signal which is passed by the filter. It will be noticed that the "upper" or high-frequency sideband is sharply attenuated to 70 db or more and, for all practical purposes, is virtually removed. The output of the filter, with an applied AM signal, then consists of a reduced carrier and the spectrum of sideband frequencies which lie between 50 and 47 kc. In single-sideband terminology, the filter passes only the "lower sideband" and a reduced amplitude carrier and suppresses the "upper sideband." The bandpass of a filter is usually specified as the width of a band of frequencies passed between two points on the characteristic curve 6 db below the peak or maximum amplitude. The filter shown here has a bandpass of 3000 cycles or 3 kc. between the 6 db points. This figure has become more or less a standard for voice communications.

It must be remembered that the filter itself passes only the lower sideband. In order to select either an upper or a lower sideband, as desired, we must be able to "invert" or change the polarity or position of the two sidebands in the mixer plate circuit so that the desired sideband always appears to the

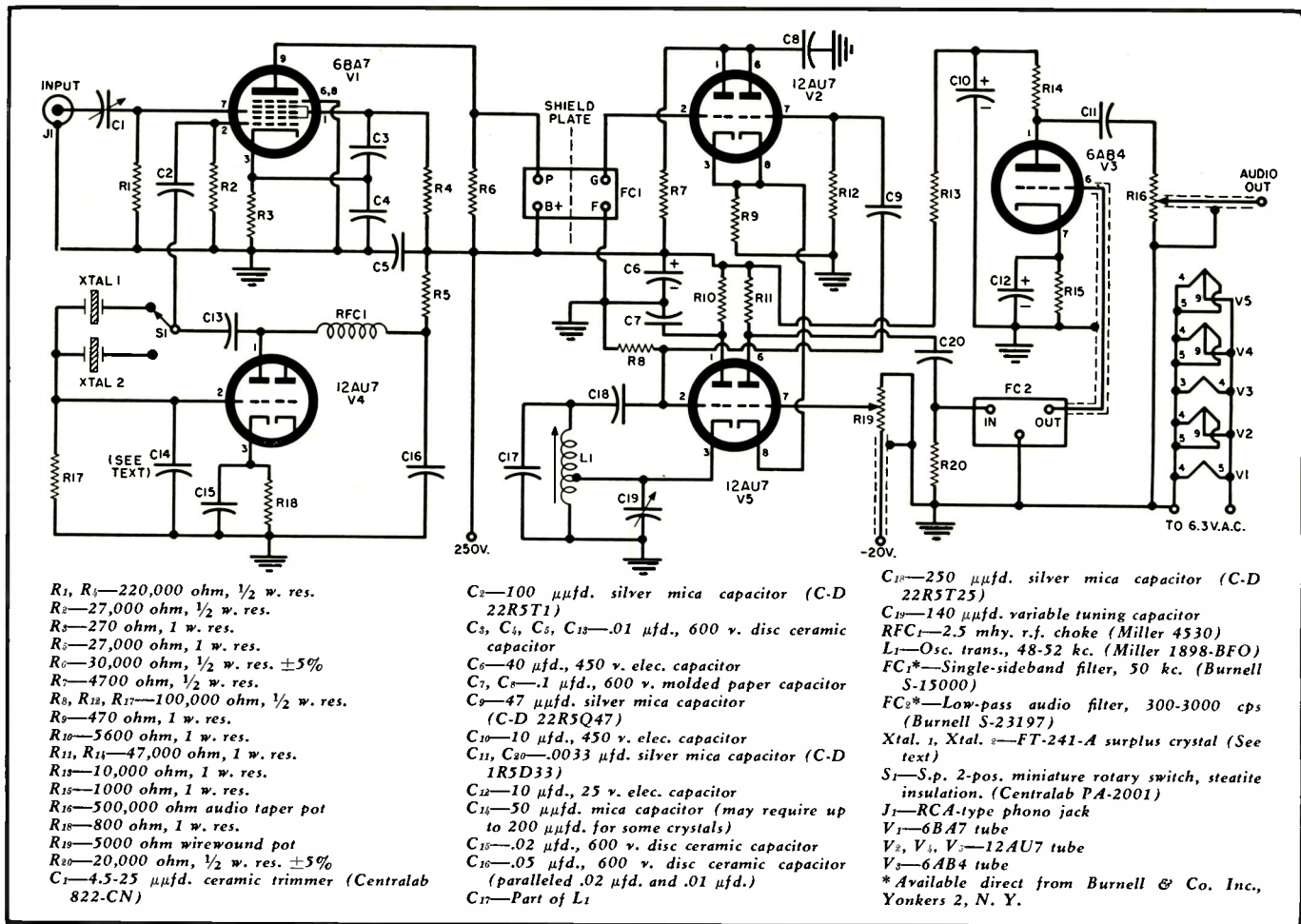

Fig. 1. Complete schematic diagram and parts list for the single-sideband adapter.

filter as a lower sideband. Fortunately, it is a characteristic of mixer-oscillator circuits that the relative positions of the two sidebands in the frequency spectrum are reversed when the oscillator frequency is changed above or below the signal frequency by an amount equal to the intermediate frequency. Thus, in this unit, the "signal" frequency is 450 kc. which is taken from the receiver i.f. circuit, and the two oscillator frequencies required for sideband inversion will be equal to 450 kc. plus 50 kc. and 450 kc. minus 50 kc. or 500 kc. and 400 kc. respectively.

The oscillator frequencies must be capable of being maintained exactly plus and minus 50 kc. with respect to the i.f. carrier position; otherwise, the carrier will not fall at exactly 50 kc. on the filter curve and the full benefits of sideband selection will not be realized. It is for this reason that the oscillator is crystal controlled. To select sidebands, it is only necessary to select either of the two crystal frequencies. The crystals used are surplus type FT-241-A units which can be purchased at low cost in most radio surplus stores or may be ordered by mail from the advertisers in this magazine. A listing of the proper crystal frequencies and channel numbers for several popular intermediate frequencies is given in Table 1.

The signal from the filter, which now consists of a carrier and one sideband,

is applied to a "product" or "exalted carrier" demodulator. This type of demodulator does not "detect" or rectify the signal, in order to recover the audio intelligence, in the usual sense; the product demodulator is really a form of converter, where the 47-50 kc. signal is mixed with a 50 kc. oscillator, the "difference" frequency, in this case, being the original audio or modulation frequencies. The 50 kc. oscillator signal voltage amplitude is approximately 100 times that of the signal from the filter output and is therefore generally called an "exalted" carrier. The actual signal and oscillator voltage values at the demodulator are approximately 0.1 and 10 volts respectively.

The output from the demodulator is applied to the input of a low-pass audio filter, which limits the audio response to the frequencies between 300 and 3000 cycles. The low-pass filter serves the dual purpose of limiting the audio range in order to "clean up" the signal and also prevents the high amplitude 50 kc. "exalted" or "synthetic" carrier voltage from appearing at the input of the audio amplifier which would cause overloading and distortion.

The demodulator circuit uses two type 12AU7 tubes. Three of the triodes are used as cathode followers. The first is used as a cathode follower for the 47-50 kc. signal voltage; the second is used as a cathode follower for the 50 kc. injected carrier, and the third is

used as the mixer for the oscillator and signal voltages. The fourth triode is used as the 50 kc. oscillator.

The first three triodes work into a common 470-ohm cathode resistor; the mixing process occurs in the third triode, which has its grid grounded for the signal voltages but contains an audio load resistor in its plate circuit. The bias on the mixer and the signal cathode follower is adjustable by means of a 5000-ohm potentiometer in the grid circuit of the third triode. This control, which is on the front panel, is ordinarily adjusted, with the 50 kc. oscillator turned off, to a point just below where AM signals are heard. This point should be marked for future reference. When the oscillator is turned on, the audio will be heard and the output will be proportional to the "product" of the applied signal and oscillator voltages. The signal-to-oscillator voltage ratio will be approximately correct when the bias control is adjusted as described. However, it may be desirable to vary this adjustment slightly under actual operating conditions in order to minimize distortion on over-modulated AM signals, interference from adjacent strong AM carriers, etc.

An audio preamplifier stage, using a 6AB4 triode, is included in the adapter circuit. In order to prevent overloading the first audio amplifier stage in the receiver, an adjustable audio level control is provided on the front of the

adapter unit. Either the level control or the regular receiver volume control may be used to control the audio gain.

It is important that the audio leads from the 12AU7 detector plate to the input of the low-pass filter, the lead from the filter output to the 6AB4 grid, and the leads from the 6AB4 plate to the level control and output jack be shielded and kept away from wires carrying 60-cycle a.c., such as the heater leads. The audio level at the 6AB4 grid is very low and any a.c. introduced into this circuit may appear in the output with a hum level equal to that of the audio signal. The audio lead from the adapter unit to the receiver must be shielded to prevent hum pickup and should not be over two or three feet in length. The input and output connections are made at the rear of the chassis by means of RCA-type phono jacks and plugs.

The arrangement of the various parts on the chassis is important and it is recommended that the layout shown in the photographs be followed closely. The two FT-241-A crystal sockets are mounted near the front so that the leads from the sockets to the crystal switch will be short. When in use, the crystals are normally covered by the aluminum shield can. The tube at the left front is the 12AU7 crystal-controlled oscillator. The crystal selector switch is controlled by the pointer knob at the left; the knob at the right is the frequency adjustment control for the 50 kc. oscillator. The knob at the top center is the bias adjustment control and the knob at the bottom center is the audio level control.

The 6BA7 mixer is at the right front of the chassis. The 50 kc. *Burnell* S-15000 single-sideband filter is mounted lengthwise on the chassis just behind the oscillator and mixer tubes. The two tubes at the rear of the 50 kc. filter are the 12AU7's used for the demodulator and 50 kc. oscillator. One triode section of the 12AU7 at the right is used as the oscillator; the shield can mounted just behind it contains the 50 kc. oscillator coil. The *Burnell* S-23197 low-pass audio filter is mounted at the left rear of the chassis and the 6AB4 audio preamplifier is mounted at the extreme rear and center.

The phono jack at the left, on the rear panel, is the 450 kc. i.f. input from the receiver; the jack at the right is the audio output from the adapter unit.

The center shield terminals of the five tube sockets are connected together with #12 tinned bus wire which is grounded to the chassis plate through the two long brass 6/32 machine screws shown in the bottom view. The shield plate between the input and output terminals of the filter is necessary in order to prevent undesired stray signal coupling which would destroy the bandpass characteristics. One terminal of each tube heater is connected to the common ground bus; the other common heater lead should be kept short and direct and as far from the audio leads as possible. The audio lead shielding is

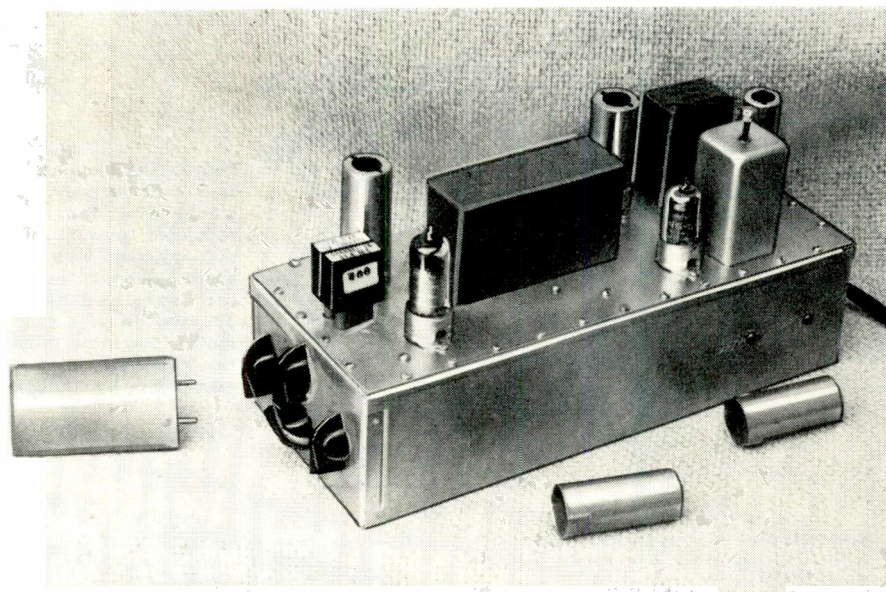

Over-all view of unit with crystals shield and two of the tube shields removed. Output and input phono jacks (not visible in photo) are on right end of chassis.

RECEIVER I.F.	SIDE BAND #1	SIDE BAND #2
450 kc.	400 kc. (21.6 mc.)	500 kc. (27.0 mc.)
455 kc.	405 kc. (21.9 mc.)	505 kc. (27.3 mc.)
460 kc.	410 kc. (22.1 mc.)	510 kc. (27.5 mc.)
465 kc.	415 kc. (22.4 mc.)	515 kc. (27.8 mc.)
470 kc.	420 kc. (22.7 mc.)	520 kc. (28.0 mc.)

Note: Data applies to "two digit" crystals only. To obtain fundamental frequency, divide frequency (in mc.) by 54. The "three digit" crystals (channel number contains three figures) frequency (in mc.) must be divided by 72 to obtain the fundamental frequency. All crystals are FT-241-A type.

Table 1. Relationship between the sideband, crystal, and receiver i.f. frequencies.

connected to the common ground bus rather than the metal plate.

The leads to the crystal sockets must be kept short. All bypass capacitors should have the shortest possible leads between the terminal to which they are connected and the common ground bus. A long capacitor lead may couple sufficient 50 kc. signal energy around the filter to distort its characteristics. In general, keep away from "beautiful" wiring arrangements and use the shortest possible point-to-point connections.

The construction job will be easier

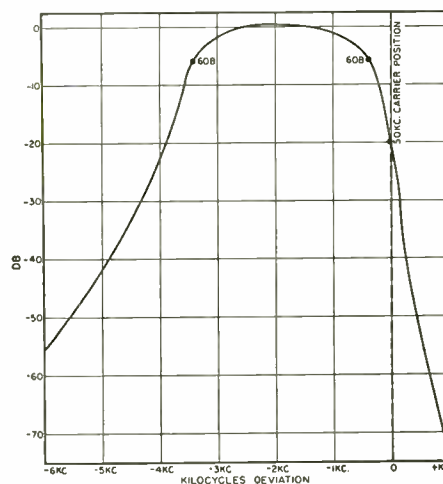
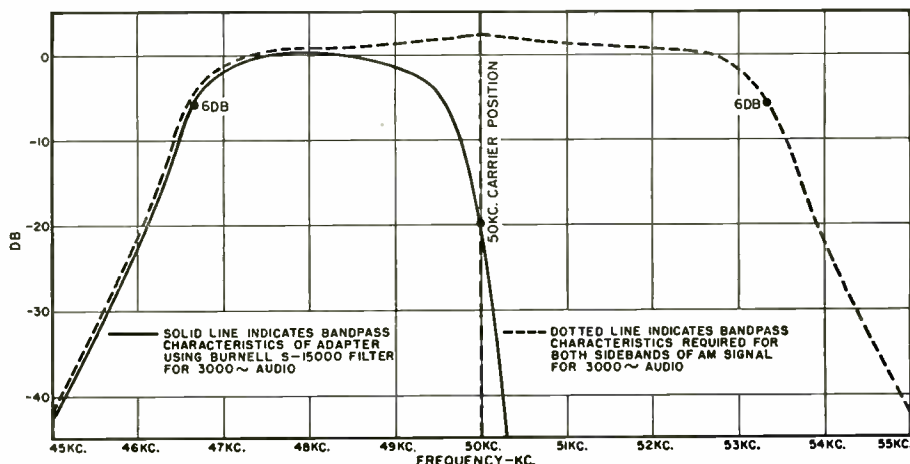
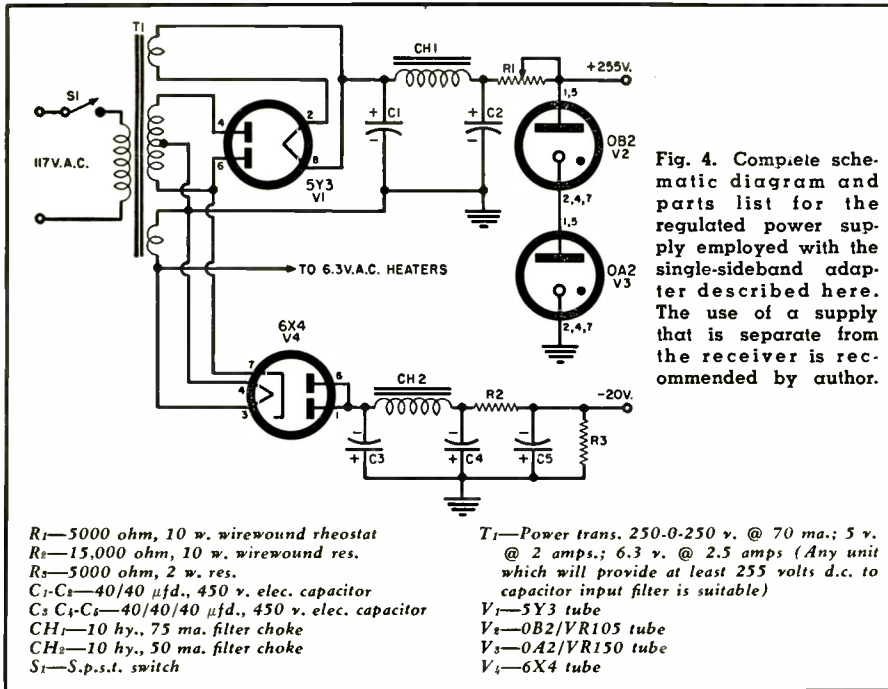

Fig. 2. Characteristics of the Burnell S-15000 single-sideband filter employed.

if the top plate is removed from the rails during the wiring process. After the wiring on the top plate is completed, it is placed in position on the side and end rails and secured by the screws provided. The potentiometers,

Fig. 3. Bandpass characteristics of adapter with S-15000 filter for 3000 cps audio compared with bandpass requirements for both sidebands of the AM signal.





the crystal switch, the variable tuning capacitor and the output and input jacks are wired into the circuit. The unit is now ready for operation.

The use of a power supply separate from that of the receiver is recommended. The small power unit shown in Fig. 4 supplies 255 volts at 50 ma. for the plates and screens, a bias voltage of -20 volts and the necessary 6.3 and 5.0 volt a.c. for the heaters. The voltage regulation shown on the schematic is not incorporated in the power unit shown in the photographs; however, it is desirable since it will eliminate adjustments of the 50 kc. oscillator frequency during changes of line voltage. The -20 volt supply must be well filtered and precautions taken to insure that a.c. is not coupled into the lead; this lead is shielded all the way up to the bias control potentiometer.

In this discussion we have referred to an i.f. signal of 450 kc. and oscillator frequencies of 400 and 500 kc. Many

communications receivers use an i.f. of 455, 460, or 465 kc. In order to select the proper crystal frequencies, merely add and subtract 50 kc. from the intermediate frequency of your particular receiver. The i.f. is given in the instruction or service manual, usually on the schematic. It can be obtained by writing to the manufacturer or by reference to the appropriate service manuals which are carried by most radio parts stores. The FT-241-A crystals are marked in "channel" numbers. The 400 and 500 kc. units shown are marked "channel 16, 21.6 mc." and "channel 70, 27.0 mc." respectively. These crystals are known among hams as the "two digit" series, since the channel numbers consist of two digits. The two-digit crystals have a fundamental frequency equal to the *frequency marking in megacycles divided by 54*. Crystals with three digits in the channel number have a fundamental equal to the megacycle designation divided by 72. The two digit

crystals are employed in this adapter.

The easiest way to select the proper crystals for your particular application is to add and subtract 50 kc. from the i.f. to obtain the two fundamental frequencies. Then multiply each fundamental frequency (in megacycles) by 54 and the crystal frequency marking in megacycles will be obtained. Now, select a *two-digit* crystal with the proper megacycle marking and it will be correct. As an example, suppose the receiver i.f. is 455 kc. The fundamental frequencies of the crystals will be 455 - 50 or 405 kc., for one crystal, and 455 + 50 or 505 kc. for the other crystal. Converting kilocycles to megacycles, 405 kc. is equal to .405 mc. and 505 kc. is equal to .505 mc. To arrive at the crystal marked frequency, we multiply .405 x 54 and obtain 21.87 mc. (this crystal will be marked 21.9 mc.); the other crystal marking is determined by multiplying .505 x 54 which gives 27.27 mc. or, possibly an actual designation of 27.3 mc. The slight error at the fundamental is negligible and causes no noticeable effects when switching from one sideband to the other.

The i.f. signal should be taken from the receiver through a low-capacitance cable such as the shielded lead used between an automobile antenna and the receiver. *Do not use coaxial line*, such as RG-59/U, since the capacitance-per-foot value is too high and will result in both signal loss and detuning effects.

A small 10 μ f. coupling capacitor should be soldered directly on the plate terminal of the last i.f. tube socket in the receiver. When connected in this manner, the capacitance of the shielded lead will be in series with 10 μ f. across the primary winding of the i.f. transformer and the detuning effect will be negligible. The i.f. trimmer, however, should be repeaked after the connection is made. The easiest way to take the i.f. signal from the receiver and return the audio to it, is to install a phono jack for each circuit at the rear of the cabinet. If auto antenna cable is used to transfer the i.f. signal, the auto radio connectors will be more suitable than the phono jacks since these cables come complete with fittings. The audio cable may be any type of good quality shielded wire.

If the receiver does not already have a "radio-phonograph" switch, this would be a desirable feature since the type of reception may be changed from single-sideband to AM by merely throwing a single switch. Frequently, signals which are unreadable on AM, due to interference and other causes, may be copied on the adapter without difficulty.

Best results will be obtained with the adapter-receiver combination if a definite operating procedure is established. Practice on an AM signal, preferably a local broadcast station, until you become familiar with the tuning characteristics. When receiving AM, tune the receiver so that the carrier falls in the center of the receiver i.f. bandpass

(Continued on page 118)

Bottom view of the single-sideband adapter showing the clean-cut construction. Control knobs are to the right; output, input, and power connections are to left.

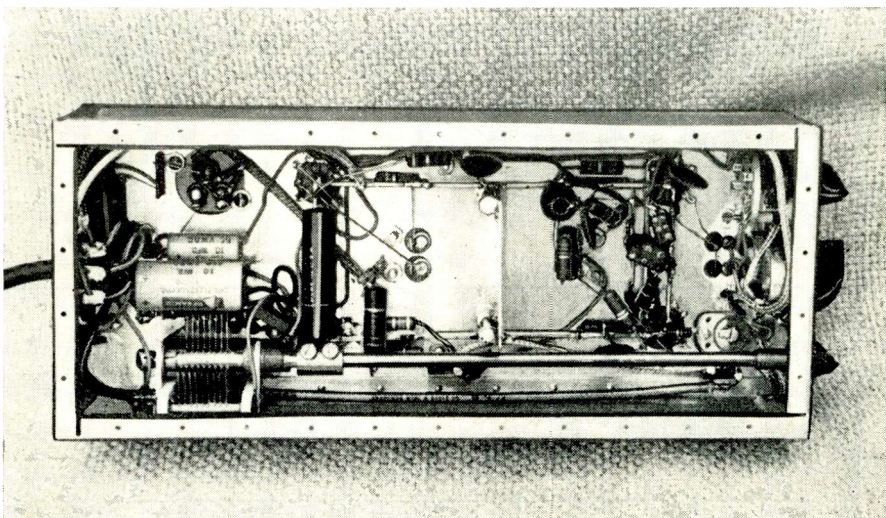

MAC was watching Barney put a small a.c.-d.c. receiver back in the cabinet. As the youth wrapped the line cord up in a neat little hank, Mac reached over and pulled lightly on the cardboard back. The loosely fitting Trimounts came out of their sockets and the back fell off.

"You intend to let it go out like that?" Mac asked quizzically.

"Sure, why not? The spring has gone out of those Trimounts and they will not hold much, but what's the difference? If we would take that back off and throw it clear away the set would operate cooler."

Mac closed his eyes as he said slowly, "Of course we never know exactly the circumstances under which a set such as this will be used in the customer's home, but I always try to think of a picture such as this: I see a little child standing barefoot on a damp basement floor running his chubby little hands over the set trying to get his fingers into where the music is coming from. Now do you see why it's important the back be held securely in place?"

"Yeah, I guess I do," Barney said with a flushed face as he squirted Duco cement into each of the Trimount sockets and pushed the spread Trimounts firmly into place. "This cardboard back, in such a case, would be all that would prevent the child's getting a severe burn or maybe even a bad shock."

"Right. The old days when the console radio was enthroned in the living room and was only approached with awe, respect, and caution are gone. Radio and TV sets are being carried around these days as they never were before and they are being used in every conceivable place from the garret to the side of the swimming pool. In view of all the handling sets get these days, it might be a good idea if we reviewed our service practices aimed at protecting the customer from possible injury or even death from his electronic equipment that we service. We've talked a lot about protecting ourselves from injury; now let's think about what we should do to make sure our customers don't get hurt.

"We know by the papers that occasionally someone is killed by a radio or TV set. I remember one case in which a radio toppled from a shelf into a bathtub and electrocuted the occupant. These occurrences are very, very rare considering the number of radio and TV sets in daily use under all kinds of circumstances; and this fact is a fine tribute to the safety precautions of the manufacturers.

"However, no matter how carefully sets are designed and tested at the factory, things can happen out in the field through age or abuse that may render them deadly. That is where we come in. If we are constantly on the alert to detect any potentially dangerous condition and remedy it, we can make sure the safety measures built into the equipment stay on guard for its entire life."

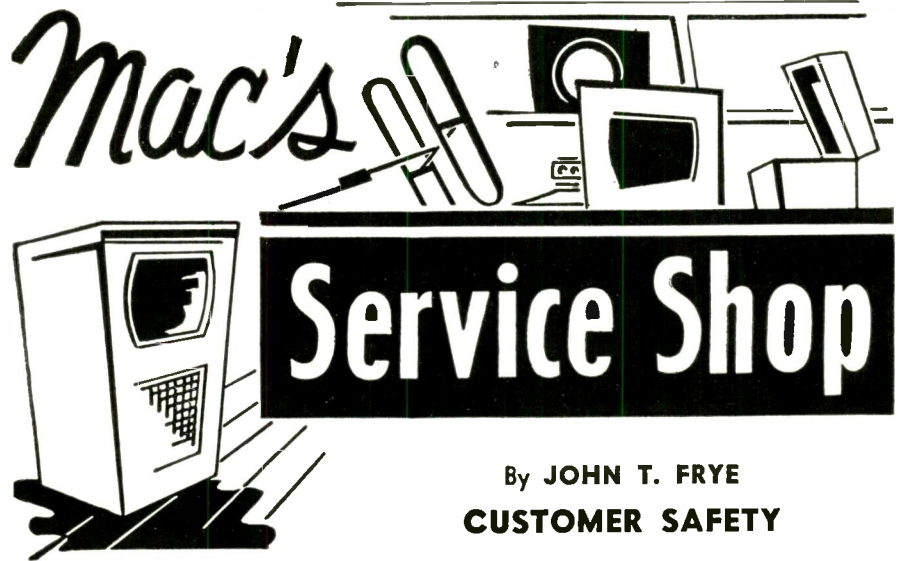

By JOHN T. FRYE
CUSTOMER SAFETY

"You got any specific examples in mind?"

"Lots of them. Take, for example, the line cord, probably the most abused part of a radio or TV set. Let's inspect the insulation on every one of these cords as carefully as though we were depending on that insulation to restrain a couple of live cobras, for the analogy is not too far fetched. If the insulation shows any sign of deteriorating, such as hardening, cracking, or flaking, replace it. Do not depend on the customer's asking that the cord be replaced, for this will seldom happen. It is astonishing how people will continue to use an electrical appliance with a cord from which great chunks of insulation have disappeared.

"Be sure and examine with special care the points where the line cord enters the wall plug and where it passes through the chassis. These are the points of greatest normal wear and a breakdown at either place could easily lead to serious shock or maybe cause a fire."

"How about those a.c.-d.c. sets we get in to repair that are in badly broken cabinets or have no cabinets at all?"

"Either repair the cabinet so that it is safe or get a new cabinet. If the customer does not want to go to this expense after you have explained to him how dangerous such an unprotected chassis can be, refuse to service the set. We do not want to be a party to a possible tragedy for a few dollars."

"OK, but some of the wise boys are going to get pretty huffy about that."

"Let them. Usually our customers are always right, but we don't want any of them dead right."

"Once in a great while," Barney observed, "we come across a set in which the capacitor from one side of the line to the chassis is shorted out. When this happens, touching the chassis and the ground simultaneously could kill you. I wonder if it wouldn't be a good idea to make a routine check for resistance between both sides of the line

cord and the chassis on every set before it leaves the shop. That way we'd catch these rare but potentially deadly cases."

"A fine idea!" Mac applauded. "When that capacitor does short-circuit, it usually means the heads of the bolts holding the chassis in the cabinet and those holding the antenna in place on the back of the chassis are, for all practical purposes, connected to one side of the line. If the wall plug is inserted one way, this means these exposed points carry the full line voltage with respect to the ground."

"With one of these sets a person will always feel a light shock when touching the chassis and ground even though the capacitor is perfectly all right," Barney pointed out. "A small amount of a.c. current passes through the capacitor and through the resistor, usually around a quarter of a megohm, that shunts it."

"That's right, and this fools a lot of people who use such equipment in basement playrooms or other places where the feet are in contact with the ground or cement floors. Quite often they want us to do something that will prevent their feeling this tingle. About all we can do is insulate exposed metal surfaces carrying this small current with tape or plastic spray, or suggest the floor around the apparatus be carpeted with rubber matting. Of course reversing the plug in the wall socket will often get rid of the condition, but this is not always the case.

"Before leaving the subject, though, I want to make one important point: never, under any circumstances, dismiss a customer's complaint that he has received a shock from his equipment as being caused by a condition of this harmless nature. Investigate. Make sure nothing is wrong. Fail to do so and you may be sorry all your life."

"Will do," Barney said as he nodded his head vigorously. "Let me ask you another. Now and then when I am working on a TV set in a customer's home and employ a cheater cord so I

(Continued on page 116)

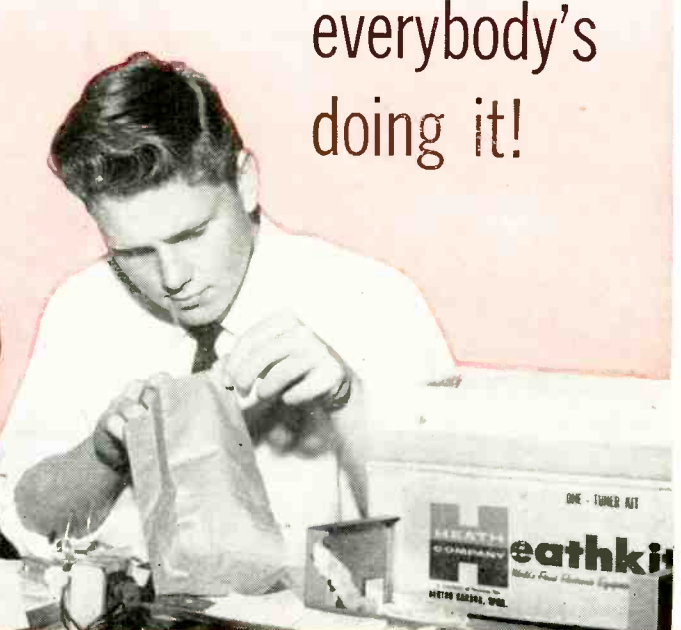

everybody's
doing it!

Motion picture and TV personality, Jackie Coogan, looks on with unbelieving interest as his 14-year-old son, Anthony, prepares to assemble his latest Heathkit, a hi-fi FM tuner. The Coogans have found out about the fun and savings of building their own electronic equipment the Heathkit way . . . so why don't you?

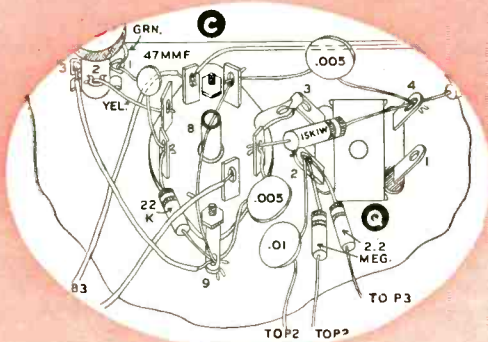

You'll get plenty of these detailed pictorial diagrams in your Heathkit construction manual to show where each and every wire and part is to be placed. Everything you do is spelled out in pictures so you can't go wrong. That's what makes it such fun!

Heathkits[®]

BY DAYSTROM

... fun to build
and a thrill to own!

and here's why...

1. You get higher quality at lower cost by dealing direct, and by doing your own assembly.
2. You receive personal, friendly, service (before and after sale) for complete satisfaction.
3. You benefit from the latest in engineering designs because of our concentration on kit-form equipment only.
4. You may depend on performance as advertised—backed by Heath's world-wide reputation for quality.
5. You can take a full year to pay with the HEATH EASY TIME PAYMENT PLAN.

- (✓) Connect a 22 K Ω resistor (red-red-orange) from socket C1 (NS) to ground lug C9 (NS). See Figure 8.
- (✓) Connect a .005 μ f disc capacitor from socket C4 (NS) to IF transformer Q4 (NS).
- () Bend socket lug C5 and IF transformer lug Q3 toward each other until they make contact and overlap slightly. Solder the connection securely. (1).
- () Install a .005 μ f capacitor from socket (NS) to ground lug C9 (NS). Dress the acitor close to chassis, under the "capacitor previously installed".

Read the step . . . perform the operation . . . and check it off—it's just that simple. These plainly-worded, easy-to-follow, steps are combined with pictorial diagrams to take you through every phase of assembly. Let our experience be your teacher!

TIME PAYMENTS . . .

The Heath Time Payment Plan was designed for your convenience. Now, you can order the kits of your choice, and pay for them in small monthly installments. Write for full details.

HEATHKIT EXTRA PERFORMANCE 70-WATT AMPLIFIER KIT

For really high performance, with plenty of reserve power, the W-6M is a natural. The full 70-watts output will seldom, if ever, be required. However, this reserve insures distortion-less sound on power peaks. The W-6M will loaf along at normal listening levels and yet is always ready to extend itself when program material demands it, without the least amount of strain. The output circuit employs 6550 tubes with a special-design Peerless output transformer for maximum stability at all power levels. A quick-change plug selects 4, 8 and 16 ohms or 70-volt output and the correct feedback resistance. A variable damping control is also provided for optimum performance with any speaker system. Extremely good power supply regulation is possible through the use of a heavy-duty transformer along with silicon-diode rectifiers, which are noted for their very long life, and yet are smaller than a house fuse. Frequency response at 1 watt is ± 1 db from 5 cps to 80 kc with controlled hf rolloff above 100 kc. At 70 watts output harmonic distortion is below 2%, 20 to 20,000 cps and IM distortion below 1%, 60 and 6,000 cps. Hum and noise 88 db below full output. In addition to high performance, its fine appearance makes it a pleasure to display in your living room. Proper layout of chassis insures ease of assembly by eliminating those cramped and difficult places to get at. Clear instructions—and top-quality components. Get started now and make this amplifier the heart of your hi-fi system. Shipped express only. Shpg. Wt. 50 lbs.

MODEL W-6: Consists of W-6M kit, plus WA-P2 preamplifier. Express only. Shpg. Wt. 59 lbs. \$129.70

MODEL W-6M

\$109⁹⁵

HEATHKIT HIGH FIDELITY FM TUNER KIT

This tuner can bring you a rich store of FM programming, your least expensive source of high fidelity material. It covers the complete FM band from 88 to 108 mc. Stabilized, temperature-compensated oscillator assures negligible drift after initial warmup. Features broadbanded circuits for full fidelity, and better than 10 uv sensitivity for 20 db of quieting, to pull in stations with clarity and full volume. Employs a high gain, cascode RF amplifier, and has AGC. A ratio detector provides high-efficiency demodulation without sacrificing hi-fi performance. IF and ratio transformers are prealigned, as is the front end tuning unit. Special alignment equipment is not necessary. Edge-lighted glass dial for easy tuning. Here is FM for your home at a price you can afford. Shpg. Wt. 8 lbs.

MODEL FM-3A

\$25⁹⁵

(with cabinet)

HEATHKIT BROADBAND AM TUNER KIT

This AM tuner was designed especially for high fidelity applications. It incorporates a special detector using crystal diodes, and the IF circuits feature broad band-width, to insure low signal distortion. Audio response is ± 1 db from 20 cps to 9 kc, with 5 db of preemphasis at 10 kc to compensate for station rolloff. Sensitivity and selectivity are excellent, and tuner covers complete broadcast band from

550 to 1600 kc. Quiet performance is assured by 6 db signal-to-noise ratio at 2.5 UV. Prealigned RF and IF coils eliminate the need for special alignment equipment. Incorporates AVC, two outputs, two antenna inputs, and built-in power supply. Edge-lighted glass slide-rule dial for easy tuning. Your "best buy" in an AM tuner. Shpg. Wt. 8 lbs.

MODEL BC-1A

\$25⁹⁵

(with cabinet)

HEATHKIT MASTER CONTROL PREAMPLIFIER KIT

Designed for use with any of the Williamson-type amplifiers, the WA-P2 has five switch-selected inputs, each having its own level control to eliminate blasting or fading while switching through the various inputs, plus a tape recorder output. A hum control allows setting for minimum hum level. Frequency response is within $\pm 1\frac{1}{2}$ db from 15 to 35,000 cps. Equalization provided for LP, RIAA, AES, and early 78's. Separate bass and treble controls. Low impedance cathode follower output circuit. All components were specially selected for their high quality. Includes many features which will eventually be desired. Shpg. Wt. 7 lbs.

MODEL WA-P2

\$19⁷⁵

(with cabinet)

*An amplifier
you will be
proud to own*

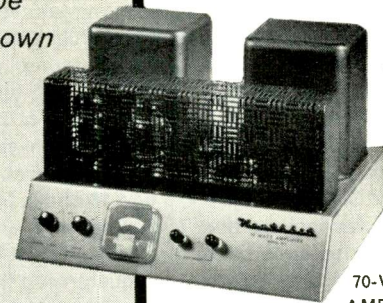

**70-WATT
AMPLIFIER**

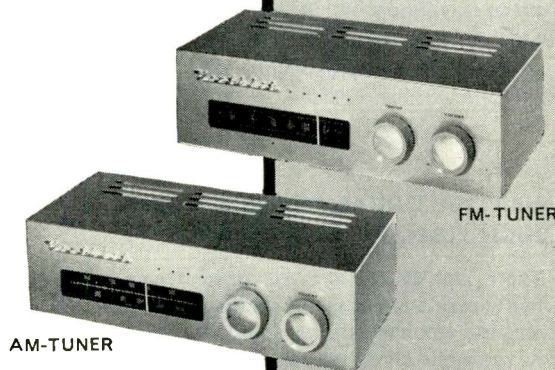

AM-TUNER

FM-TUNER

*Selects and
controls sound
to your taste*

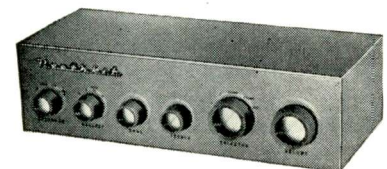

PREAMPLIFIER



ADVANCED-DESIGN
25-WATT AMPLIFIER

*Top performance
in its
power class!*



SINGLE-CHASSIS
20-WATT AMPLIFIER

*Hi-Fi equipment
for your listening
pleasure!*

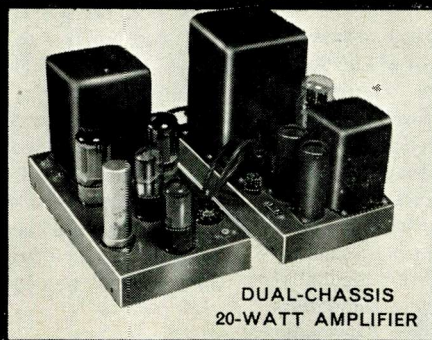

DUAL-CHASSIS
20-WATT AMPLIFIER

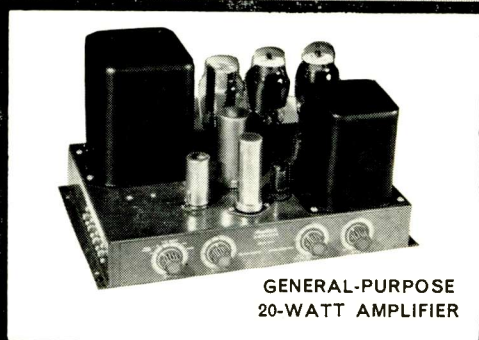

GENERAL-PURPOSE
20-WATT AMPLIFIER

HEATHKIT ADVANCED-DESIGN 25-WATT HIGH FIDELITY AMPLIFIER KIT

Designed especially to satisfy critical audio requirements, the W-5M incorporates the extra features needed to compliment the finest in program sources and speaker systems. Faithful sound reproduction is assured with a frequency response of ± 1 db from 5 to 160,000 cps at 1 watt, and harmonic distortion is less than 1% at 25 watts, with IM distortion less than 1% at 20 watts. Hum and noise are a full 99 db below rated output, assuring quiet, hum-free operation. Output taps are 4, 8 and 16 ohms. Exclusive Heathkit features include the "tweeter saver", and the "bas-bal" balancing circuit, requiring only a voltmeter for indication. Years of reliable service are guaranteed through the use of conservatively rated, high quality components. KT66 tubes and Peerless output transformer are typical. Shipped express only. Shpg. Wt. 31 lbs.

MODEL W-5: Consists of W-5M kit above plus model WA-P2 preamplifier. Express only. Shpg. Wt. 38 lbs. \$79.50

MODEL W-5M

\$59⁷⁵

HEATHKIT DUAL-CHASSIS 20-WATT HIGH FIDELITY AMPLIFIER KIT

The model W3-AM is a Williamson-type amplifier built on two separate chassis. The power supply is on one chassis, and the amplifier stages are on the other chassis. Using two separate chassis provides additional flexibility in installation. Features include the famous acrosound model TO-300 "ultralinear" output transformer and 5881 tubes for broad frequency response, low distortion, and low hum level. The result is exceptionally fine overall tone quality. Frequency response is ± 1 db from 6 cps to 150 kc at 1 watt. Harmonic distortion is less than 1% and IM distortion is less than 1.3% at 20 watts. Hum and noise are 88 db below 20 watts. Designed to match the speaker system of your choice, with taps for 4, 8 or 16 ohms impedance. A very popular high fidelity unit employing top quality components throughout. Shipped express only. Shpg. Wt. 29 lbs.

MODEL W-3A: Consists of W-3AM kit above plus model WA-P2 preamplifier. Express only. Shpg. Wt. 37 lbs. \$69.50

MODEL W-3AM

\$49⁷⁵

HEATHKIT SINGLE-CHASSIS 20-WATT HIGH FIDELITY AMPLIFIER KIT

The model W4-AM Williamson-type amplifier will amaze you with its outstanding performance. A true Williamson circuit, featuring extended frequency response, low distortion, and low hum levels, this amplifier can provide you with many hours of listening enjoyment with only a minimum investment compared to other units on the market. 5881 tubes and a special Chicago-standard output transformer are employed to give you full fidelity at minimum cost. Frequency response extending from 10 cps to 100 kc within ± 1 db at 1 watt assures you of full coverage of the audio range, and clean clear sound amplification takes place in circuits that hold harmonic distortion at 1.5% and IM distortion below 2.7% at full 20 watt output. Hum and noise are 95 db below full output. Taps on the output transformer are at 4, 8 or 16 ohms. Shipped express only. Shpg. Wt. 28 lbs.

MODEL W-4A: Consists of W-4AM kit above, plus model WA-P2 preamplifier. Express only. Shpg. Wt. 35 lbs. \$59.50.

MODEL W-4AM

\$39⁷⁵

Heathkits...

BY DAYSTROM

*bring you the lasting satisfaction
of personal accomplishment*

HEATHKIT GENERAL-PURPOSE 20-WATT HIGH FIDELITY AMPLIFIER KIT

The model A-9C will provide you with high quality sound at low cost. Features a built-in preamplifier with four separate inputs, and individual volume, bass and treble controls. Frequency response covers 20 to 20,000 cps within ± 1 db. Total harmonic distortion is less than 1% at 3 db below rated output. Push-pull 6L6 tubes are used, with output transformer tapped at 4, 8, 16 and 500 ohms. A true hi-fi unit using high-quality components throughout, including heavy-duty "potted" transformers. Shpg. Wt. 23 lbs.

MODEL A-9C

\$35⁵⁰

**HEATHKIT "BASIC RANGE"
HI-FI SPEAKER SYSTEM KIT**

The extremely popular Heathkit model SS-1 Speaker System provides amazing high fidelity performance for its size. Features two high-quality Jensen speakers, an 8" mid-range woofer and compression-type tweeter with flared horn. Covers from 50 to 12,000 CPS within ± 5 db, in a special-design ducted-port, bass reflex enclosure. Impedance is 16 ohms. Cabinet measures 11½" H x 23" W x 11¾" D. Constructed of veneer-surfaced plywood, ½" thick, suitable for light or dark finish. All wood parts are precut and predrilled for easy, quick assembly. Shpg. Wt. 30 lbs.

MODEL SS-1
\$39⁹⁵

**HEATHKIT "RANGE EXTENDING"
HI-FI SPEAKER SYSTEM KIT**

Extends the range of the SS-1 to ± 5 db from 35 to 16,000 CPS. Uses 15" woofer and super-tweeter both by Jensen. Kit includes crossover circuit. Impedance is 16 ohms and power rating is 35 watts. Measures 29" H x 23" W x 17½" D. Constructed of veneer-surfaced plywood ¾" thick. Easy to build! Shpg. Wt. 80 lbs.

MODEL SS-1B
\$99⁹⁵

**HEATHKIT "LEGATO"
HIGH FIDELITY SPEAKER SYSTEM KIT**

The quality of the Legato, in terms of the engineering that went into the initial design, and in terms of the materials used in its construction, is matched in only the most expensive speaker systems available today. The listening experience it provides approaches the ultimate in esthetic satisfaction. Two 15" theater-type Altec Lansing speakers cover 25 to 500 CPS, and an Altec Lansing high-frequency driver with sectoral horn covers 500 to 20,000 CPS. A precise amount of phase shift in the crossover network brings the high frequency channel into phase with the low frequency channel to eliminate peaks or valleys at the crossover point, by equalizing the acoustical centers of the speakers. The enclosure is a modified infinite baffle type, especially designed for these speakers. Cabinet is constructed of veneer-surfaced plywood, ¾" thick, precut and predrilled for easy assembly. Frequency response 25 to 20,000 CPS. Power rating, 50 watts program material. Impedance is 16 ohms. Cabinet dimensions 41" L x 22¼" D x 34" H.

Choice of two beautiful cabinets. Model HH-1-C in imported white birch for light finishes, and HH-1-CM in African mahogany for dark finishes. Shpg. Wt. 195 lbs.

MODEL HH-1-C
MODEL HH-1-CM
\$325⁰⁰
EACH

Heathkits...

By DAYSTROM

*let you save up to ½
or more on all types
of electronic equipment.*

HEATHKIT SINE-SQUARE GENERATOR

The new AG-10 provides high quality, sine and square waves over a wide range, for countless applications. Some of these are; radio and TV repair work, checking scope performance, as a variable trigger source for telemetering and pulse work, and checking audio, video and hi-fi amplifier response. Frequency response is ± 1.5 db from 20 CPS to 1 MC on both sine and square waves, with less than .25% sine wave distortion, 20 to 20,000 CPS. Sine wave output impedance 600 ohms, square wave output impedance 50 ohms, (except on 10v ranges). Square wave rise time less than .15 usec. Five-position band switch—continuously variable tuning—shielded oscillator circuit—separate step and variable output attenuators in ranges of 10, 1, and .1 volts for both sine and square wave, with extra range of .01 volt on sine wave. Both sine and square wave can be used at the same time without affecting either wave form. Power supply uses silicon-diode rectifiers. Shpg. Wt. 12 lbs.

MODEL AG-10
\$49⁹⁵

HEATHKIT AUDIO ANALYZER KIT

The AA-1 is actually three instruments in one compact package. It combines the functions of an AC VTVM, an audio wattmeter, and an intermodulation analyzer. Input and output terminals are combined, and high and low frequency oscillators are built in. VTVM ranges are 0-.01, .03, .1, .3, 1, 3, 10, 30, 100 and 300 volts (RMS). Wattmeter ranges are .15 mw, 1.5 mw, 15 mw, 150 mw, 1.5 w, 15 w and 150 w. IM scales are 1%, 3%, 10%, 30% and 100%. Provides internal load resistors of 4, 8, 16 or 600 ohms. A tremendous dollar value. Shpg. Wt. 13 lbs.

MODEL AA-1
\$49⁹⁵

"BASIC RANGE" HI-FI SPEAKER SYSTEM

Superlative sound reproduction through the speaker system of your choice

"RANGE EXTENDING" HI-FI SPEAKER SYSTEM

"LEGATO" HI-FI SPEAKER SYSTEM

AUDIO ANALYZER

SINE-SQUARE GENERATOR

Sine and square waves for countless applications.



Audio equipment for your hi-fi testing

GENERAL PURPOSE" SCOPE

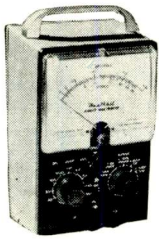

AUDIO WATTMETER

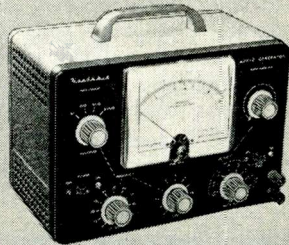

AUDIO GENERATOR



HARMONIC DISTORTION METER

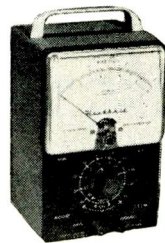

AUDIO VTVM

HEATHKIT "GENERAL PURPOSE" 5" OSCILLOSCOPE KIT

The model OM-2 Oscilloscope is especially popular with part-time service technicians, students, and high fidelity enthusiasts. It features good vertical frequency response ± 3 db from 4 cps to over 1.2 mc. A full five-inch crt. and sweep generator operation from 20 cps to over 150 kc. Stability is excellent and calibrated grid screen allows precise signal observation. Extra features include external or internal sweep and sync, 1-volt peak-to-peak calibrating reference, 3-position step-attenuated input, adjustable spot shape control, push-pull horizontal and vertical amplifiers, and modern etched-metal circuits. Easy to build and a pleasure to use. Ideal for use with other audio equipment for checking amplifiers. Shpg. Wt. 21 lbs.

MODEL OM-2
\$42⁵⁰

HEATHKIT AUDIO WATTMETER KIT

The AW-1 Audio Wattmeter can be used in any application where audio power output is to be measured. Non-inductive LOAD resistors are built in for 4, 8, 16 or 600 ohms impedance. Five power ranges cover 0.5 mw, 50 mw, 500 mw, 5 w, and 50 w full scale. Five switch-selected db ranges cover -10 db to +30 db. All indications are read directly on a large 4½" 200 microampere meter. Frequency response is

± 1 db from 10 cps to 250 kc. Precision type multiplier resistors used for high accuracy, and crystal diode bridge for wide-range frequency response. This meter is used in many recording studios and broadcast stations as a monitor as well as servicing. A fine meter to help supply the answers to your audio operating or power output problems. Shpg. Wt. 6 lbs.

MODEL AW-1
\$29⁵⁰

HEATHKIT AUDIO SIGNAL GENERATOR KIT

The model AG-9A is "made to order" for high fidelity applications, and provides quick and accurate selection of low-distortion signals throughout the audio range. Three rotary switches select two significant figures and a multiplier to determine audio frequency. Incorporates step-type and a continuously variable output attenuator. Output indicated on large 4½" panel meter, calibrated in volts and db. Attenuator system operates in 10 db steps, corresponding to meter calibration, in ranges of 0-.003, .01, .03, .1, .3, 1, 3 and 10 volts RMS. "Load" switch permits use of built-in 600-ohm load, or external load of different impedance. Output and frequency indicators accurate to within $\pm 5\%$. Distortion less than .1 of 1% between 20 and 20,000 cps. Total range is 10 cps to 100 kc. Shpg. Wt. 8 lbs.

MODEL AG-9A
\$34⁵⁰

HEATHKIT HARMONIC DISTORTION METER KIT

All sounds consist of dominant tones plus harmonics (over-tones). These harmonics enrich the quality and brightness of the music. However, additional harmonics which originate in the audio equipment, represent distortion. Used with an audio signal generator, the HD-1 will accurately measure this harmonic distortion at any or all frequencies between 20 and 20,000 cps. Distortion is read directly on the panel meter in ranges of 0-1, 3, 10, 30 and 100% full scale. Voltage ranges of 0-1, 3, 10 and 30 volts are provided for the initial reference settings. Signal-to-noise ratio measurements are also permitted through the use of a separate meter scale calibrated in db. High quality components insure years of outstanding performance. Full instructions are provided. Shpg. Wt. 13 lbs.

MODEL HD-1
\$49⁵⁰

Heathkits...

By DAYSTROM

are well known for their high quality and reliability.

HEATHKIT AUDIO VTVM KIT

This new and improved AC Vacuum Tube Voltmeter is designed especially for audio measurements and low-level AC measurements in power supply filters, etc. Employs an entirely new circuit featuring a cascode amplifier with cathode-follower isolation between the input and the amplifier, and between the output stage and the preceding stages. It emphasizes stability, broad frequency response, and sensitivity. Frequency response is essentially flat from 10 cps to 200 kc. Input impedance is 1 megohm at 1000 cps. AC (RMS) voltage ranges are 0-.01, .03, .1, .3, 1, 3, 10, 30, 100 and 300 volts. Db ranges cover -52 db to +52 db. Features large 4½" 200 microampere meter, with increased damping in meter circuit for stability in low frequency tests. 1% precision resistors employed for maximum accuracy. Stable, reliable performance in all applications. Shpg. Wt. 5 lbs.

MODEL AV-3
\$29⁵⁰

RADIO & TV NEWS

HEATHKIT COLOR BAR AND DOT GENERATOR

The CD-1 combines the two basic color service instruments, a Color Bar Generator and White Dot Generator in one versatile portable unit, which has crystal-controlled accuracy and stability (no external sync lead required). Produces white-dots, cross hatch, horizontal and vertical bars, 10 vertical color bars, and a new shading bar pattern for screen and background adjustments. Variable RF output on any channel from 2 to 6. Positive or negative video output, variable from 0 to 10 volts peak-to-peak. Crystal controlled sound carrier with off-on switch. Voltage regulated power supply using long-life silicon rectifiers. Gain knowledge of a new and profitable field by constructing this kit. Shpg. Wt. 12 lbs.

MODEL CD-1
\$59⁹⁵

HEATHKIT "EXTRA DUTY" 5" OSCILLOSCOPE KIT

This fine oscilloscope compares favorably to other scopes costing twice its price. It contains the extra performance so necessary for monochrome and color-TV servicing. Features push-pull horizontal and vertical output amplifiers, a 5UPI CRT, built in peak-to-peak calibration source, a fully compensated 3-position step-type input attenuator, retrace blanking, phasing control, and provision for Z-axis modulation. Vertical amplifier frequency response is within +1.5 and -5 db from 3 CPS to 5 MC. Response at 3.58 MC down only 2.2 db. Sensitivity is 0.025 volts RMS/inch at 1 kc. Sweep generator covers 20 CPS to 500 kc in five steps, five times the usual sweep obtained in other scopes through the use of the patented Heath sweep circuit. Etched-metal circuit boards reduce assembly time and minimize errors in assembly, and more importantly, permit a level of circuit stability never before achieved in an oscilloscope of this type. Shpg. Wt. 21 lbs.

MODEL O-11
\$69⁵⁰

Heathkits...

By DAYSTROM

are guaranteed to meet or exceed advertised specifications

HEATHKIT ELECTRONIC SWITCH KIT

A valuable accessory for any oscilloscope owner. It allows simultaneous oscilloscope observation of two signals by producing both signals, alternately, at its output. Four switching rates. Provides gain for input signals. Frequency response ± 1 db, 0 to 100 kc. A sync output is provided to control and stabilize scope sweep. Ideal for observing input and output of amplifiers simultaneously. Shpg. Wt. 8 lbs.

MODEL S-3
\$21⁹⁵

HEATHKIT TV ALIGNMENT GENERATOR KIT

This fine TV alignment generator offers stability and flexibility difficult to obtain even in instruments costing several times this low Heathkit price. It covers 3.6 mc to 220 mc in four bands. Sweep deviation is controllable from 0 to 42 mc. The all-electronic sweep circuit insures stability. Crystal marker and variable marker oscillators are built in. Crystal (included with kit) provides output at 4.5 mc and multiples thereof. Variable marker provides output from 19 to 60 mc on fundamentals and from 57 to 180 mc on harmonics. Effective two-way blanking to eliminate return trace. Phasing control. Kit is complete, including three output cables. Shpg. Wt. 16 lbs.

MODEL TS-4A
\$49⁵⁰

HEATHKIT VOLTAGE CALIBRATOR KIT

This unit is an excellent companion for your oscilloscope. Used as a source of calibrating voltage, it produces near-perfect square wave signals of known amplitude. Precision 1% attenuator resistors insure accurate output amplitude, and multivibrator circuit guarantees good sharp square waves. Output frequency is approximately 1000 CPS. Fixed outputs selected by panel switches are; .03, 0.1, 0.3, 1.0, 3.0, 10, 30 and 100 volts peak-to-peak. Allows measurement of unknown signal amplitude by comparing it to the known output of the VC-3 on oscilloscope. Shpg. Wt. 4 lbs.

MODEL VC-3
\$12⁵⁰

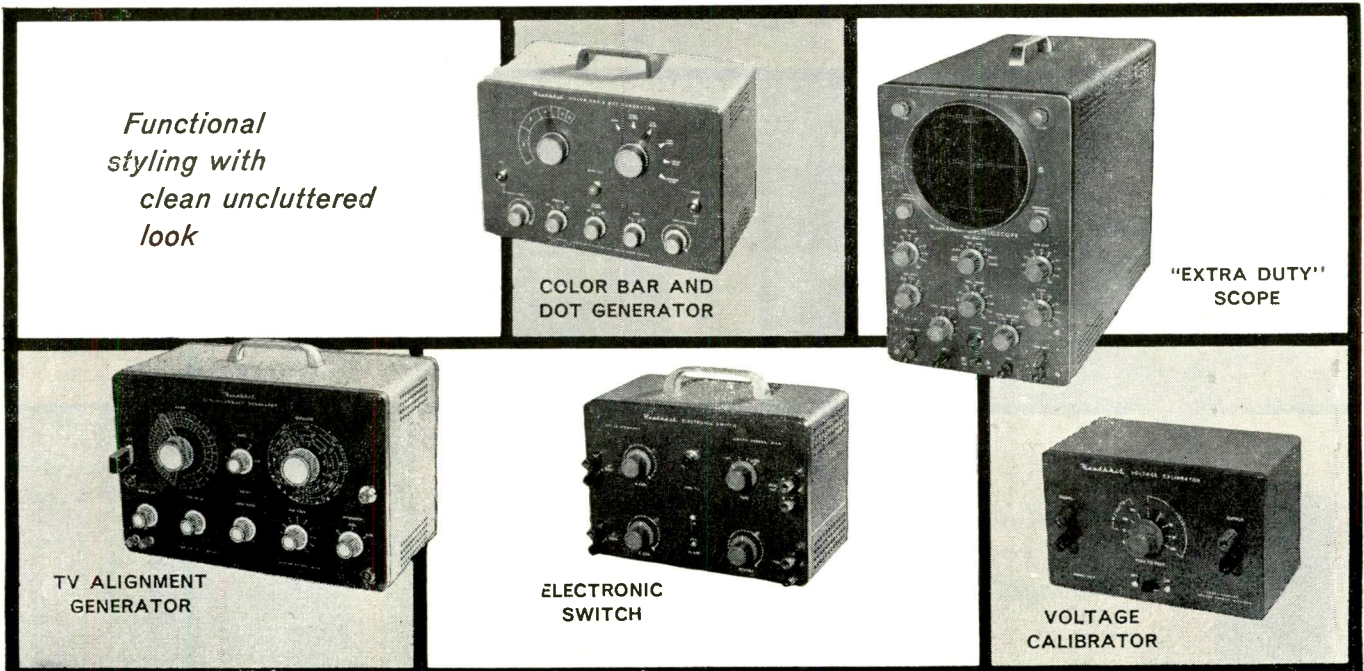

Functional styling with clean uncluttered look



COLOR BAR AND DOT GENERATOR

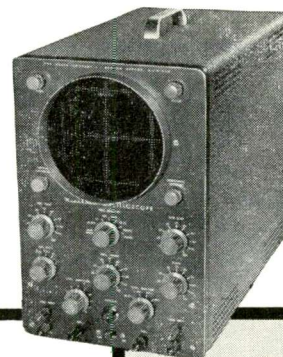

"EXTRA DUTY" SCOPE

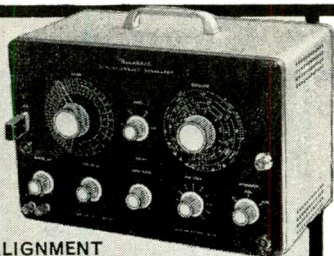

TV ALIGNMENT GENERATOR



ELECTRONIC SWITCH



VOLTAGE CALIBRATOR

HEATHKIT TUBE CHECKER KIT

Eliminate guesswork, and save time in servicing or experimenting. The TC-2 tests tubes for shorted elements, open elements, filament continuity, and operating quality on the basis of total emission. It tests all tube types encountered in radio and TV service work. Sockets are provided for 4, 5, 6 and 7-pin, octal, and loctal tubes, 7 and 9 pin miniature tubes, 5 pin hytron miniatures, and pilot lamps. Tube condition indicated on 4½" meter with multi-color "good-bad" scale. Illuminated roll chart with all test data built in. Switch selection of 14 different filament voltages from .75 to 117 volts. Color-coded cable harness allows neat professional wiring and simplifies construction. Very easy to build, even for a beginner. Shpg. Wt. 12 lbs.

MODEL TC-2
\$29.50

HEATHKIT HANDITESTER KIT

The small size and rugged construction of this tester makes it perfect for any portable application. The combination function-range switch simplifies operations. Measures AC or DC voltage at 0-10, 30, 300, 1000 and 5000 volts. Direct current ranges are 0-10 ma and 0-100 ma. Ohmmeter ranges are 0-3000 (30 ohm center scale) and 0-300,000 (3000 ohm center scale). Very popular with home experimenters, electricians, and appliance repairmen. Slips easily into your tool box, glove compartment, coat pocket, or desk drawer. Shpg. Wt. 3 lbs.

MODEL M-1
\$14.50

HEATHKIT PICTURE TUBE CHECKER KIT

The CC-1 can be taken with you on service calls so that you can clearly demonstrate the quality of a customer's picture tube in his own home. Tubes can be tested without removing them from the receiver or cartons if desired. Checks cathode emission, beam current, shorted elements, and leakage between elements in electromagnetic picture tube types. Self-contained power supply, and large 4½" meter. CRT condition indicated on "good-bad" scale. Relative condition of tubes fluorescent coating is shown in "shadow-graph" test. Permanent test cable with CRT socket and anode connector. No tubes to burn out, designed to last a lifetime. Luggage-type portable case. Shpg. Wt. 10 lbs.

MODEL CC-1
\$22.50

HEATHKIT ETCHED-CIRCUIT VTVM KIT

This multi-purpose VTVM is the world's largest selling instrument of its type—and is especially popular in laboratories, service shops, home workshops and schools. It employs a large 4½" panel meter, precision 1% resistors, etched metal circuit board, and many other "extras" to insure top quality and top performance. It's easy to build, and you may rely on its accuracy and dependability. The V7-A will measure AC (RMS) and DC voltages in ranges of 0-1.5, 5, 15, 50, 150, 500 and 1500. It measures peak-to-peak AC voltage in ranges of 0-4, 14, 40, 140, 400, 1400 and 4000. Resistance ranges provide multiplying factors of X 1, X 10, X 100, X 1000, X 10k, X 100k, and X 1 megohm. Center-scale resistance readings are 10, 100, 1000, 10k, 100k, 1 megohm and 10 megohms. A db scale is also provided. The precision and quality of this VTVM cannot be duplicated at this price. Shpg. Wt. 7-lbs.

MODEL V7-A
\$24.50

Heathkits...

By DAYSTROM

*let you fill your exact needs
from a wide variety
of instruments*

HEATHKIT 20,000 OHMS/VOLT VOM KIT

This fine instrument provides a total of 25 meter ranges on its two-color scale. It employs a 50 ua 4½" meter, and features 1% precision multiplier resistors. Requires no external power. Ideal for portable applications. Sensitivity is 20,000 ohms-per-volt DC and 5000 ohms-per-volt AC. Measuring ranges are 0-1.5, 5, 50, 150, 500, 1500 and 5000 volts, AC and DC. Measures direct current in ranges of 0-150 ua, 15 ma, 150 ma, 500 ma and 15 a. Resistance multipliers are X 1, X 100 and X 10,000, with center-scale readings of 15, 1500 and 150,000 ohms. Covers -10 db to +65 db. Easy to build and fun to use. Attractive bakelite case with plastic carrying handle. Shpg. Wt. 6 lbs.

MODEL MM-1
\$29.50

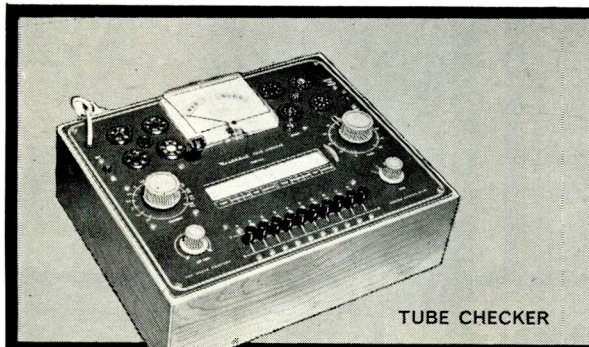

TUBE CHECKER

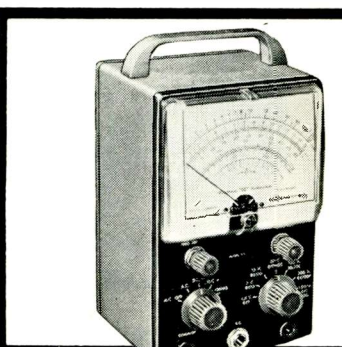

ETCHED
CIRCUIT VTVM

*High quality
test gear you
will be
proud to own*



HANDITESTER

*Priced low
to fit your
budget*



PICTURE TUBE
CHECKER



20,000
OHMS/VOLT VOM

HEATHKIT RF SIGNAL GENERATOR KIT

Even a beginner can build this prealigned signal generator, designed especially for use in service work. Produces RF signals from 160 kc to 110 mc on fundamentals in five bands. Covers 110 mc to 220 mc on calibrated harmonics. Low impedance RF output in excess of 100,000 microvolts, is controllable with a step-type and continuously variable attenuator. Selection of unmodulated RF, modulated RF, or audio at 400 CPS. Ideal for fast and easy alignment of radio receivers, and finds application in FM and TV work as well. Thousands of these units are in use in service shops all over the country. Easy to build and a real time saver, even for the part-time service technician or hobbyist. Shpg. Wt. 8 lbs.

MODEL SG-8

\$19⁵⁰

HEATHKIT LABORATORY RF GENERATOR KIT

Tackle all kinds of laboratory alignment jobs with confidence by employing the LG-1. It features voltage-regulated B+, double shielding of oscillator circuits, copper-plated chassis, variable modulation level, metered output, and many other "extras" for critical alignment work. Generates RF signals from 100 kc to 30 mc on fundamentals in five bands. Meter reads RF output in microvolts or modulation level in percentage. RF output available up to 100,000 microvolts, controlled by a fixed-step and a variable attenuator. Provision for external modulation where necessary. Buy and use this high-quality RF signal generator that may be depended upon for stability and accuracy. Shpg. Wt. 16 lbs.

MODEL LG-1

\$48⁹⁵

HEATHKIT DIRECT-READING CAPACITY METER KIT

Here's a fast, simple capacity meter. A capacitor to be checked is merely connected to the terminals, the proper range selected, and the value read directly on the large 4½" panel meter calibrated in mmf and mfd. Ranges are 0 to 100 mmf, 1,000 mmf, .01 mfd, .1 mfd full scale. Not affected by hand capacity. Shpg. Wt. 7 lbs.

MODEL CM-1

\$29⁵⁰

Heathkits...

By DAYSTROM

*are educational
as well as functional*

HEATHKIT "IN-CIRCUIT" CAPACI-TESTER KIT

With the CT-1 it is no longer necessary to disconnect one capacitor lead to check the part, you can check most capacitors for "open" or "short" right in the circuit. Fast and easy—to save your valuable time in the service shop or lab. Detects open capacitors from about 50 mmf up, so long as the capacitor is not shunted by excessively low resistance value. Will detect shorted capacitors up to 20 mfd (not shunted by less than 10 ohms). (Does not detect leakage.) Employs 60-cycles and 19 megacycle test frequencies. Electron beam "eye" tube used as indicator. Compact, easy-to-build, and inexpensive. Test leads included. Shpg. Wt. 5 lbs.

MODEL CT-1

\$7⁹⁵

Use these kits for faster and more efficient testing

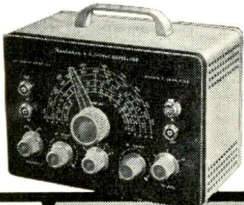



LABORATORY RF GENERATOR

RF SIGNAL GENERATOR



DIRECT-READING CAPACITY METER



"IN CIRCUIT" CAPACI-TESTER



CONDENSER CHECKER



VISUAL-AURAL SIGNAL TRACER

HEATHKIT CONDENSER CHECKER KIT

This handy instrument uses an electron beam "eye" tube as an indicator to measure capacity in ranges of .00001 to .005 mfd, .5 mfd, 50 mfd and 1000 mfd. Also measures resistance from 100 ohms to 5 megohms in two ranges. Checks paper, mica, ceramic and electrolytic capacitors. Selection of five polarizing voltages. Shpg. Wt. 7 lbs.

MODEL C-3

\$19⁵⁰

HEATHKIT VISUAL-AURAL SIGNAL TRACER KIT

Although designed originally for radio receiver work, the T-3 finds application in FM and TV servicing as well. Features high-gain channel with demodulator probe, and low-gain channel with audio probe. Traces signals in all sections of radio receivers and in many sections of FM and TV receivers. Built-in speaker and electron beam eye tube indicate relative gain, etc. Also features built-in noise locator circuit. Provision for patching speaker and/or output transformer to external set. Shpg. Wt. 9 lbs.

MODEL T-3

\$23⁵⁰

HEATHKIT IMPEDANCE BRIDGE KIT

The model IB-2A employs a Wheatstone Bridge, a Capacity Comparison Bridge, a Maxwell Bridge, and a Hay Bridge in one compact package. Measures resistance from 0.1 ohm to 10 megohms, capacitance from 100 mmf to 100 mfd, inductance from 0.1 mh to 100 h, dissipation factor (D) from 0.002 to 1, and storage factor (Q) from 0.1 to 1000. A 100-0-100 ua meter provides for null indications. The decade resistors employed are of 1% tolerance for maximum accuracy. Completely self-contained. Has built in power supply, 1000-cycle generator, and vacuum-tube detector. Special two-section CRL dial insures convenient operation. Instruction manual has entirely new schematic that clarifies circuit functions in various switch positions. A true laboratory instrument, that will provide you with many years of fine performance. Shpg. Wt. 12 lbs.

MODEL IB-2A

\$59⁵⁰

HEATHKIT "LOW RIPPLE" BATTERY ELIMINATOR KIT

This modern battery eliminator incorporates an extra low-ripple filter circuit so that it can be used to power all the newest transistor-type circuits requiring 0 to 12 volts DC,

and the new "hybrid" automobile radios using both transistors and vacuum tubes. Its DC output, at either 6 or 12 volts, contains less than .3% AC ripple. Separate output terminals are provided for low-ripple or normal filtering. Supplies up to 15 amps on 6 volt range or up to 7 amps on 12 volt range. Output is variable from 0 to 8 or 0 to 16 volts. Two meters constantly monitor output voltage and current. Will also double as a battery charger. Shpg. Wt. 23 lbs.

MODEL BE-5

\$39⁹⁵

HEATHKIT ISOLATION TRANSFORMER KIT

The model IT-1 is one of the handiest units for the service shop, home workshop or laboratory. Provides complete isolation from the power line. AC-DC sets may be plugged directly into the IT-1 without the chassis becoming "hot". Output voltage is variable from 90 volts to 130 volts allowing checks of equipment under adverse conditions such as low line voltage. Rated for 100 volt amperes continuously or 200 volt amperes intermittently. Panel meter monitors output voltage. Shpg. Wt. 9 lbs.

MODEL IT-1

\$16⁵⁰

Heathkits...

By DAYSTROM

*are designed with high-quality,
name-brand components to
insure long service life*

HEATHKIT "Q" METER KIT

At this price the laboratory facilities of a Q Meter may be had by the average service technician or home experimenter. The Q Meter permits measurement of inductance from 1 microhenry to 10 millihenry, "Q" on a scale calibrated up to 250 full scale, with multipliers of 1 or 2, and capacitance from 40 mmf to 450 mmf \pm 3 mmf. Built in oscillator permits testing components from 150 kc to 18 mc. Large 4½" panel meter is featured. Very handy for checking peaking coils, chokes, etc. Use to determine values of unknown condensers, both variable and fixed, compile data for coil winding purposes, or measure RF resistance. Also checks distributed capacity and Q of coils. No special equipment is required for calibration. A special test coil is furnished, along with easy-to-follow instructions. Shpg. Wt. 14 lbs.

MODEL QM-1

\$44⁵⁰

HEATHKIT REGULATED POWER SUPPLY KIT

Here is a power supply that will provide DC plate voltage and AC filament voltage for all kinds of experimental circuits. The DC supply is regulated for stability, and yet the amount of DC output voltage available from the power supply can be controlled manually from 0 up to 500 volts. At 450 volts DC output, the power supply will provide up to 10 ma of current, and provide progressively higher current as the output voltage is lowered. Current rating is 130 ma at 200 volts output. In addition to furnishing B+ the power supply also provides 6.3 volts AC at up to 4 amperes for filaments. Both the B+ output and the filament output are isolated from ground. Ideal unit for use in laboratory, home workshop, ham shack, or service shop. A large 4½" meter on the front panel reads output voltage or output current, selectable with a panel switch. Shpg. Wt. 17 lbs.

MODEL PS-3

\$35⁵⁰

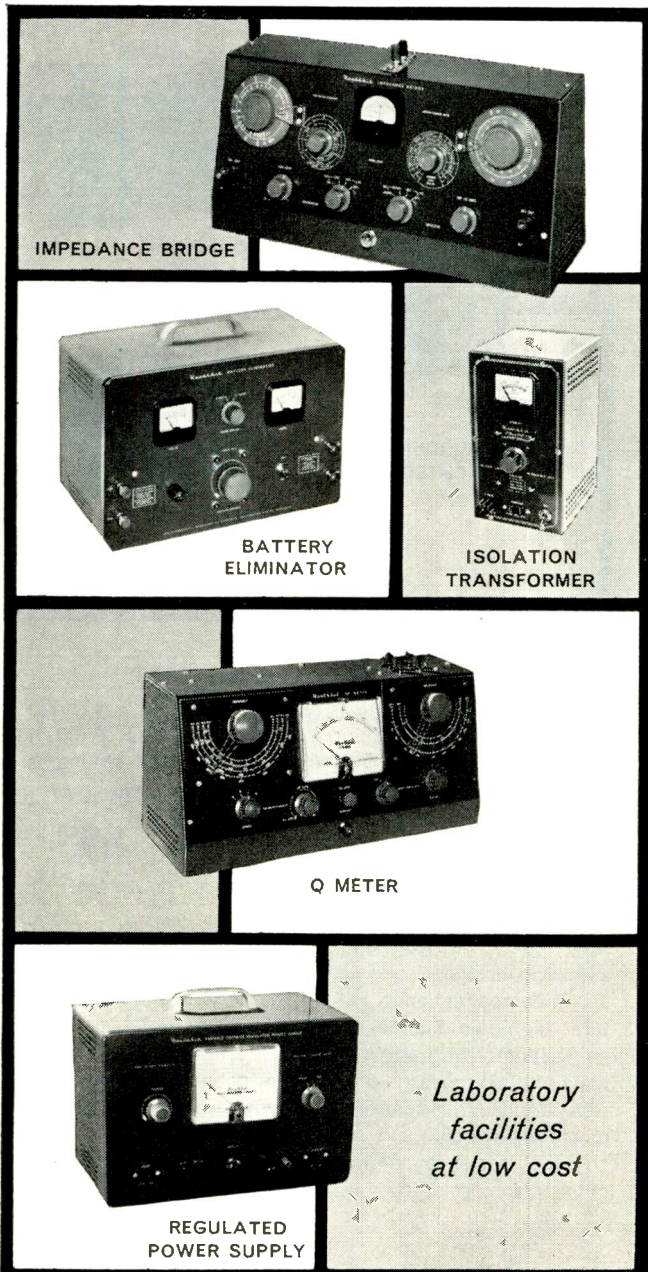

IMPEDANCE BRIDGE

BATTERY ELIMINATOR

ISOLATION TRANSFORMER

Q METER

REGULATED POWER SUPPLY

Laboratory facilities at low cost



*Terrific values
in amateur
equipment!*



DX-20 TRANSMITTER



DX-35 TRANSMITTER



DX-100 TRANSMITTER

HEATHKIT DX-20 CW TRANSMITTER KIT

The Heathkit model DX-20 "straight-CW" transmitter features high efficiency at low cost. It uses a single 6DQ6A tube in the final amplifier stage for plate power input of 50 watts. A 6CL6 serves as crystal oscillator, with a 5U4GB rectifier. It is an ideal transmitter for the novice, as well as the advanced-class CW operator. Single-knob band switching is featured to cover 80, 40, 20, 15, 11 and 10 meters. Pi network output circuit matches various antenna impedances between 50 and 1000 ohms and reduces harmonic output. Top-quality parts are featured throughout, including "potted" transformers, etc., for long life. It has been given full "TVI" treatment. Access into the cabinet for crystal changing is provided by a removable metal pull-out plug on the left end of the cabinet. Very easy to build from the complete step-by-step instructions supplied, even if you have never built electronic equipment before. If you appreciate a good, clean signal on the CW bands, this is the transmitter for you! Shpg. Wt. 18 lbs.

MODEL DX-20
\$35⁹⁵

Heathkits...

By DAYSTROM

*are designed by
licensed ham-engineers,
especially for you*

HEATHKIT DX-35 PHONE AND CW TRANSMITTER KIT

The DX-35 transmitter can be thought of as the "little brother" of the DX-100. It features both phone and CW operation on 80, 40, 20, 15, 11 and 10 meters. A single 6146 tube is used in the final amplifier stage to provide full 65 watt plate power input on CW, or controlled carrier modulation peaks up to 50 watts for phone operation. Modulator and power supplies are built right in and single knob band switching is combined with a pi network output circuit for complete operating convenience. The tight fitting cabinet

presents a most attractive appearance, and is designed for complete shielding to minimize TVI. Back panel control provides convenient switch selection of three different crystals, reached through access door at rear of cabinet. A most remarkable power package for the price. Complete step-by-step instructions with pictorial diagrams to assure your success in assembly. Shpg. Wt. 24 lbs.

MODEL DX-35
\$56⁹⁵

HEATHKIT DX-100 PHONE AND CW TRANSMITTER KIT

Listen to any ham band between 160 meters and 10 meters and note how many DX-100 transmitters you hear! The number of these fine rigs now on the air testifies to the enthusiasm with which it has been accepted by the amateur fraternity. No other transmitter in this power class combines high quality and real economy so effectively. The DX-100 features a built in VFO, modulator and power supplies, complete shielding to minimize TVI, and pi network output coupling to match impedances from approximately 50 to 600 ohms. Its RF output is in excess of 100 watts on phone and 120 watts on CW, for a clean strong signal on all the ham bands from 10 to 160 meters. Single-knob band switching and illuminated VFO dial and meter face add real operating convenience. RF output stage uses a pair of 6146 tubes in parallel, modulated by a pair of 1625's. High quality components are used throughout, such as "potted" transformers, silver-plated or solid coin silver switch terminals, aluminum heat-dissipating caps on the final tubes, copper plated chassis, etc. This transmitter was designed exclusively for easy step-by-step assembly. Shpg. Wt. 107 lbs.

MODEL DX-100
\$189⁵⁰

FUNCTIONAL DESIGN . . .

The transmitters described on this page were designed for the ham, by hams who know what features are desirable and needed. This assures you of the best possible performance and convenience, and adds much to your enjoyment in the ham shack.

Automatically turns off transmitter and gives visual signal



"AUTOMATIC" CONELRAD ALARM



GRID DIP METER

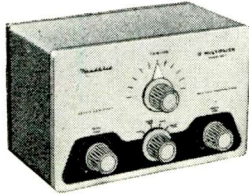

"Q" MULTIPLIER

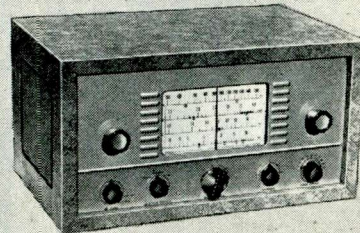

COMMUNICATIONS-TYPE RECEIVER

An ideal receiver for the beginning ham or short wave listener

HEATHKIT "AUTOMATIC" CONELRAD ALARM KIT

This conelrad alarm works with any radio receiver; AC-DC-transformer operated—or battery powered, so long as the receiver has AVC. Fully complies with FCC regulations for amateurs. When the monitored station goes off the air, the CA-1 automatically cuts the AC power to your transmitter, and lights a red indicator. A manual "reset" button reactivates the transmitter. Incorporates a heavy-duty six-ampere relay, a thyratron tube to activate the relay, and its own built-in power supply. A neon lamp shows that the alarm is working, by indicating the presence of B+ in the alarm circuit. Simple to install and connect. Your transmitter plugs into an AC receptacle on the CA-1, and a cable connects to the AVC circuit of a nearby receiver. A built-in sensitivity control allows adjustment to various AVC levels. Receiver volume control can be turned up or down, without affecting alarm operation. Build a Heathkit CA-1 in one evening and comply with FCC regulations now! Shpg. Wt. 4 lbs.

MODEL CA-1
\$13⁹⁵

HEATHKIT "Q" MULTIPLIER KIT

The Heathkit Q Multiplier functions with any AM receiver having an IF frequency between 450 and 460 KC, that is not "AC-DC" type. It derives its power from the receiver, and needs only 6.3 volts AC at 300 ma (or 12 VAC at 150 ma) and 150 to 250 volts DC at 2 ma. Simple to connect with cable and plugs supplied. Adds additional selectivity for separating signals, or will reject one signal and eliminate heterodyne. A tremendous help on crowded phone and CW bands. Effective Q of 4000 for sharp "peak" or "null". Tunes any signal within IF band, pass without changing the main receiver tuning dial. A convenient tuning knob on the front panel with vernier reduction between the tuning knob and the tuning capacitor gives added flexibility in operation. Uses a 12AX7 tube, and special high-Q shielded coils. Instructions for connecting to the receiver and operation are provided in the construction manual. A worthwhile addition to any communications, or broadcast receiver. It may also be used with a receiver which already has a crystal filter to obtain two simultaneous functions, such as peaking the desired signal with the crystal filter and nulling an adjacent signal with the Q Multiplier. Shpg. Wt. 3 lbs.

MODEL QF-1
\$9⁹⁵

HEATHKIT GRID DIP METER KIT

A grid dip meter is basically an RF oscillator for determining the frequency of other oscillators, or of tuned circuits. Extremely useful in locating parasitics, neutralizing, identifying harmonics, coil winding, etc. Features continuous frequency coverage from 2 mc to 250 mc, with a complete set of prewound coils, and a 500 ua panel meter. Front panel has a sensitivity control for the meter, and a phone jack for listening to the "zero-beat." Will also double as an absorption-type wave meter. Shpg. Wt. 4 lbs.

Low Frequency Coil Kit: Two extra plug-in coils to extend frequency coverage down to 350 kc. Shpg. Wt. 1 lb. No. 341-A. \$3.00

MODEL GD-18
\$19⁹⁵

HEATHKIT ALL-BAND COMMUNICATIONS-TYPE RECEIVER KIT

This communications-receiver covers 550 kc to 30 mc in four bands, and provides good sensitivity, selectivity, and fine image rejection. Ham bands are clearly marked on an illuminated dial scale. Features a transformer-type power supply—electrical band spread—antenna trimmer—head-phone jack—automatic gain control and beat frequency oscillator. Accessory sockets are provided on the rear of the chassis for using the Heathkit model QF-1, Q Multiplier. Accessory socket is handy, also, for operating other devices that require plate and filament potentials. Will supply +250 VDC at 15 ma and 12.6 VAC at 300 ma. Ideal for the beginning ham or short wave listener. Shpg. Wt. 12 lbs.

Cabinet: Fabric covered cabinet with aluminum panel as shown. Part no. 91-15A. Shpg. Wt. 5 lbs. \$4.95.

MODEL AR-3
\$29⁹⁵
(Less cabinet)

Heathkits...

By DAYSTROM

are outstanding in performance and dollar value

HEATHKIT REFLECTED POWER METER KIT

The Heathkit reflected power meter, model AM-2, makes an excellent instrument for checking the match of the antenna transmission system, by measuring the forward and reflected power or standing wave ratio. The AM-2 is designed to handle a peak power of well over 1 kilowatt of energy and may be left in the antenna system feed line at all times. Band coverage is 160 meters through 2 meters. Input and output impedances for 50 or 75 ohm lines. No external power required for operation. Meter indicates percentage forward and reflected power, and standing wave ratio from 1:1 to 6:1. Another application for the AM-2 is matching impedances between exciters or R.F. sources and grounded grid amplifiers. Power losses between transmitter output and antenna tuner may be very easily computed by inserting the AM-2 in the line connecting the two. No insertion loss is introduced into the feeder system, due to the fact that the AM-2 is a portion of coaxial line in series with the feeder system and no internal connections are actually made to the line. Complete circuit description and operation instructions are provided in the manual. Cabinet size is 7-3/8" x 4-1/16" x 4-5/8". Can be conveniently located at operating position. Shpg. Wt. 3 lbs.

MODEL AM-2

\$15⁹⁵

HEATHKIT VARIABLE FREQUENCY OSCILLATOR KIT

Enjoy the convenience and flexibility of VFO operation by obtaining the Heathkit model VF-1 Variable Frequency Oscillator. Covers 160-80-40-20-15-11 and 10 meters with three basic oscillator frequencies. Better than 10 volt average RF output on fundamentals. Plenty of output to drive most modern transmitters. It features voltage regulation for frequency stability. Dial is illuminated for easy reading. Vernier reduction is used between the main tuning knob and the tuning condenser. Requires a power source of only 250 volts DC at 15 to 20 milliamperes and 6.3 volts AC at 0.45 amperes. Extra features include copper-plated chassis, ceramic coil forms, extensive shielding, etc. High quality parts throughout. VFO operation allows you to move out from under interference and select a portion of the band you want to use without having to be tied down to only two or three frequencies through use of crystals. "Zero in" on the other fellow's signal and return his CQ on his own frequency! Crystals are not cheap, and it takes quite a number of them to give anything even approaching comprehensive coverage of all bands. Why hesitate? The model VF-1 with its low price and high quality will add more operating enjoyment to your ham activities. Shpg. Wt. 7 lbs.

MODEL VF-1

\$19⁵⁰

Heathkits...

By DAYSTROM

are the answer for your electronics hobby.

HEATHKIT BALUN COIL KIT

The Heathkit Balun Coil Kit model B-1 is a convenient transmitter accessory, which has the capability of matching unbalanced coax lines, used on most modern transmitters, to balance lines of either 75 or 300 ohms impedance. Design of the bifilar wound balun coils will enable transmitters with unbalanced output to operate into balanced transmission line, such as used with dipoles, folded dipoles, or any balanced antenna system. The balun coil set can be used with transmitters and receivers without adjustment over the frequency range of 80 through 10 meters and will easily handle power inputs up to 250 watts. Cabinet size is 9" square by 5" deep and it may be located any distance from the transmitter or from the antenna. Completely enclosed for outdoor installation. Shpg. Wt. 4 lbs.

MODEL B-1

\$8⁹⁵

HEATHKIT 6 OR 12 VOLT VIBRATOR POWER SUPPLY KITS

These little power supply kits are ideal for all portable applications with 6 volt or 12 volt batteries, when you are operating electronic equipment away from power lines. By replacing the power supplies of receivers, small public address systems, or even miniature transmitters with these units, they can be used with conventional 6 or 12 volt batteries. Use in boats, automobiles, light aircraft, or any field application. Each unit provides 260 volts DC output at up to 60 milliamperes. More than one power supply of the same model may be connected in parallel for increased current capacity at the same output voltage. Everything is provided in the kit, including a vibrator transformer, a vibrator, 6X4 or 12X4 rectifier, and the necessary buffer capacitor, hash filter, and output filter capacitor. Shpg. Wt. 4 lbs.

6 VOLT
MODEL VP-1-6
12 VOLT
MODEL VP-1-12

\$7⁹⁵ Each

REFLECTED POWER METER

Insure your "on the air" performance with these fine accessories.

VARIABLE FREQUENCY OSCILLATOR

VIBRATOR POWER SUPPLY

BALUN COIL SET

HEATHKIT ELECTRONIC IGNITION ANALYZER KIT

Previous electronic experience is not necessary to build this fine ignition analyzer. The construction manual supplied has complete step-by-step instructions plus large pictorial diagrams showing the exact placement and value of each component. All parts are clearly marked so that they are easily identified. The IA-1 is an ideal tool for engine mechanics, tune-up men, and auto hobbyists, since it traces the dynamic action of voltage in an ignition system on a cathode-ray tube screen. The wave form produced is affected by the condition of the coil, condenser, points, plugs, and ignition wiring, so it can be analyzed, and used as a "sign-post" to ignition system performance. This analyzer will detect inequality of spark intensity, a poor spark plug, defective plug wiring, breaker-point bounce, an open condenser, and allow setting of dwell-time percentage for the points. An important feature of this instrument is its ability to check dynamic performance, with the engine in operation (400 to 5000 RPM). It will show the complete engine cycle, or only one complete cylinder. Can be used on all types of internal combustion engines where breaker-points are accessible. Use it on automobiles, boats, aircraft engines, etc. Shpg. Wt. 18 lbs.

MODEL IA-1
\$59⁹⁵

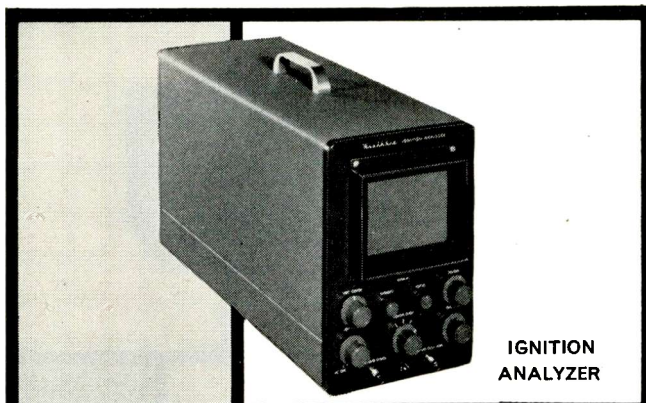

IGNITION
ANALYZER

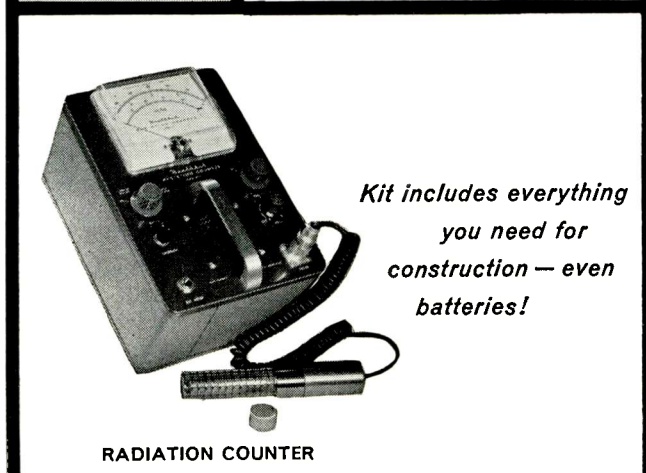

*Kit includes everything
you need for
construction — even
batteries!*

RADIATION COUNTER

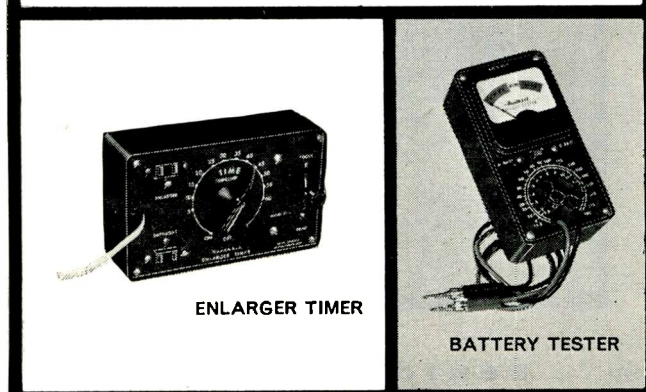

ENLARGER TIMER

BATTERY TESTER

HEATHKIT PROFESSIONAL RADIATION COUNTER KIT

This Heathkit professional-type radiation counter is simple to build successfully, even if you have never built a kit before. Complete step-by-step instructions are combined with giant-size pictorial diagrams for easy assembly. By "building it yourself" you can have a modern-design, professional radiation counter priced far below comparable units. Provides high sensitivity with ranges from 0-100, 600, 6000 and 60,000 counts-per-minute, and 0-.02, .1, 1 and 10 miliroentgens-per-hour. Employs 900-volt bismuth tube in beta/gamma sensitive probe. Probe and 8-foot expandable cable included in kit price, as is a radiation sample for calibration. Use it in medical laboratories, or as a prospecting tool, and for civil defense to detect radioactive fallout, or other unknown radiation levels. Features a selectable time constant. Meter calibrated in CPM or mR/hour in addition to "beep" or "click" from panel-mounted speaker. Prebuilt "packaged" high voltage power supply with reserve capacity above 900 volt level at which it is regulated. Merely changing regulator tube type would allow use of scintillation probe if desired. Employs five tubes (plus a transistor) to insure stable and reliable operation. Kit price includes batteries. Shpg. Wt. 8 lbs.

MODEL RC-1
\$79⁹⁵

Heathkits...

By DAYSTROM

*are supplied with comprehensive
instructions that eliminate costly
mistakes and save valuable time*

HEATHKIT ENLARGER TIMER KIT

The ET-1 is an easy-to-build electronic device to be used by amateur or professional photographers in timing enlarger operations. The calibrated dial on the timer covers 0 to 1 minute, calibrated in 5-second gradations. The continuously variable control allows setting of the "on" cycle of your enlarger, which is plugged into a receptacle on the front panel of the ET-1. A "safe light" can also be plugged in so that it is automatically turned "on" when the enlarger is turned "off." Handles up to 350 watts with built-in relay. All-electronic timing cycle insures maximum accuracy. Timer does not have to be reset after each cycle, merely flip lever switch to print, to repeat time cycle. A control is provided for initial calibration. Housed in a compact plastic case that will resist attack of photographic chemicals. A fine addition to any dark room. Shpg. Wt. 3 lbs.

MODEL ET-1
\$77⁵⁰

HEATHKIT BATTERY TESTER KIT

The BT-1 is a special battery testing device that actually "loads" the battery under test (draws current from it) while it is being tested. Weak batteries often test "good" with an ordinary voltmeter but the built-in load resistance of the BT-1 automatically draws enough current from the battery to reveal its true condition. Simple to operate with "good-weak-replace" scale. Tests all kinds of dry cell batteries within ranges of 0-15 volts and 0-180 volts. Slide switch provides for either 10 ma or 100 ma load, depending on whether you're testing an A or B battery. Not only determines when battery is completely exhausted, but makes it possible to anticipate failure by noting weak condition. Ideal for testing dry cell hearing aid, flashlight, portable radio, and model airplane batteries. Test batteries in a way your customers can understand and stimulate battery sales. Shpg. Wt. 2 lbs.

MODEL BT-1
\$8⁵⁰



CRYSTAL RADIO



Now you can have radio
wherever you go —
with the portable
that plays anywhere!



BROADCAST BAND RADIO

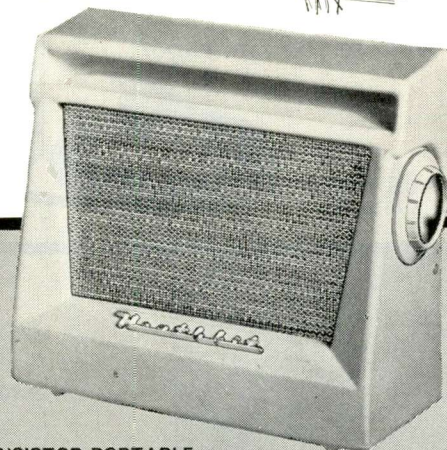

TRANSISTOR PORTABLE

HEATHKIT CRYSTAL RADIO KIT

The Heathkit model CR-1 crystal radio is similar to the "crystal sets" of the early radio days except that it has been improved by the use of sealed germanium diodes and efficient "high-Q" coils. The sealed diodes eliminate the critical "cats whisker" adjustment, and the ferrite coils are much more efficient for greater signal strength. Housed in a compact plastic box, the CR-1 uses two tuned circuits, each with a variable tuning capacitor, to select the local station. It covers the broadcast band from 540 to 1600 kc. Requires no external power whatsoever. This receiver could prove valuable to emergency reception of civil defense signals should there be a power failure. The low kit price even includes headphones. Complete step-by-step instructions and large pictorial diagrams are supplied for easy assembly. The instruction manual also provides the builder with the basic fundamentals of signal reception so that he understands how the crystal receiver functions. An interesting and valuable "do-it-yourself" project for all ages. Shpg. Wt. 3 lbs.

MODEL CR-1
\$7⁹⁵

result of these efforts. Six name-brand (Texas Instrument) transistors were selected for extra good sensitivity and selectivity. A 4" by 6" PM speaker with heavy magnet was chosen to insure fine tone quality. The power supply was designed to use six standard size "D" flashlight cells because they are readily available, inexpensive, and because they afford extremely long battery life (between 500 and 1000 hours). Costs you no more to operate from batteries than what you pay for operating a small table-model radio from the power line. An unbreakable molded plastic was selected for cabinet material because of its durability and striking beauty. Circuit is compact and efficient, yet components are not excessively crowded. Transformers are prealigned so it is ready for service as soon as construction is completed. Has built in rod-type antenna for reception in all locations. Cabinet dimensions are 9" L x 8" H x 3³/₄" D. Comes in holiday gray, with gold-anodized metal speaker grille. Compare this portable, feature by feature, to all others on the market, and you'll appreciate what a tremendous dollar value it represents! Shpg. Wt. 4 lbs.

MODEL XR-1

\$34⁹⁵

(Less batteries)
(With cabinet)

Heathkits...

BY DAYSTROM

*are easy and fun to build,
and they let you learn
by "doing-it-yourself"*

HEATHKIT TRANSISTOR PORTABLE RADIO KIT

Heath engineers set out to develop a "universal" AM radio, suitable for use anywhere. Their objective was a portable that would be as much "at home" inside as it is outside, and would feature top quality components for high performance and long service life. The model XR-1 is the

HEATHKIT BROADCAST BAND RADIO KIT

This table-model broadcast radio is fun to build, and is a fine little receiver for your home. It covers the standard broadcast band from 550 to 1600 kc with good sensitivity and selectivity. The 5¹/₂" PM speaker provides surprisingly good tone quality. High-gain IF transformers, miniature tubes, and a rod-type built in antenna, assure good reception in all locations. The power supply is transformer operated, as opposed to many of the economy "AC-DC" types. It's easy to build from the step-by-step instructions, and the construction manual includes information on operational theory, for educational purposes. Your success is assured by completely detailed information which also explains resistor and capacitor color codes, soldering techniques, use of tools, etc. A signal generator is recommended for final alignment. Shpg. Wt. 10 lbs.

MODEL BR-2

\$18⁹⁵

(Less cabinet)

Cabinet: Fabric covered cabinet with aluminum panel as shown. Shpg. Wt. 5 lbs. Part no. 91-9A. \$4.95.

protects against possible explosion and fire from undetected fuel vapor

FUEL VAPOR DETECTOR



detects electrolysis currents which cause deterioration of underwater metal fittings on your boat

ELECTROLYSIS DETECTOR



indicates condition and charge of batteries for safe cruising

BATTERY CHARGE INDICATOR

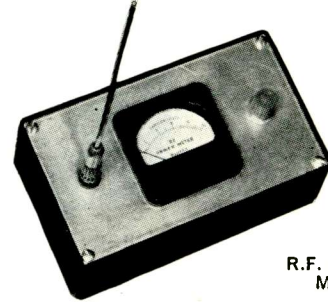
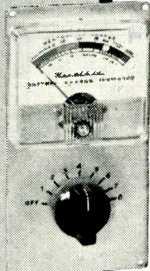

R.F. POWER METER

HEATHKIT FUEL VAPOR DETECTOR KIT

Protect your boat and its passengers against fire or explosion from undetected fuel vapor by building and using one of these fine units. The Heathkit Fuel Vapor Detector indicates the presence of fumes on a three-color "safe-dangerous" meter scale and immediately shows if it is safe to start the engine. A pilot light on the front panel shows when the detector is operating, and it can be left on continuously, or just used intermittently. A panel control enables initial calibration of the detector when installed. Features a hermetically-sealed meter with chrome bezel, and a chrome-plated brass panel. It is very simple to build and install, even by one not having previous experience. Models FD-1-6 (6 volts DC) and FD-1-12 (12 volts DC) operate from your boat batteries. The kit is complete in every detail, even to the inclusion of a spare detector unit. Shpg. Wt. 4 lbs.

6 volt
MODEL FD-1-6
12 volt
MODEL FD-1-12
\$35⁹⁵
EACH

HEATHKIT BATTERY CHARGE INDICATOR KIT

The Heathkit model CI-1 Marine Battery Charge Indicator has been designed especially for the boat owner, although it has found use in service stations, power stations, and radio stations where banks of batteries are kept in reserve for emergency power. It is intended to replace the hydrometer method of checking storage batteries, and to eliminate the necessity for working with acid in small, below-decks enclosures. Now it is possible to check as few as one, or as many as eight storage batteries, merely by turning the switch and watching the meter. A glance at the meter tells you instantly whether your batteries are sufficiently charged for safe cruising. Dimensions are 2-7/8" W x 5-11/16" H x 2" D. Operates on either 6 or 12 volt systems using lead-acid batteries, regardless of size. Simple installation can be accomplished by the boat owner in fifteen minutes. Shpg. Wt. 3 lbs.

MODEL CI-1
\$16⁹⁵

HEATHKIT ELECTROLYSIS DETECTOR KIT

The Heathkit model ED-1 Electrolysis Detector indicates the extent of electrolysis currents between the boat's common ground and underwater fittings, except on boats having metal hulls. These currents, undetected, could

cause gradual corrosion and deterioration of the propeller or other metal fittings below the water line. It is particularly helpful when installing electrical equipment of any kind, or to determine proper polarity when power is obtained from a shore supply. Easy-to-build, the model ED-1 consists of a hermetically-sealed, waterproof meter, special sensing plate, and sufficient wire to install, including the necessary hardware. Mounts on instrument panel where it can be easily seen. Requires no power for operation, and gives instant warning to guard your boat for a lifetime. Shpg. Wt. 2 lbs.

MODEL ED-1
\$9⁹⁵

HEATHKIT RF POWER METER KIT

The Heathkit RF Power Meter Kit is designed to sample the RF field in the vicinity of your transmitter, whether it be marine, mobile, or fixed. Output meter is merely placed in some location close to the transmitter, to pick up RF radiation from the antenna. Requires no batteries, electricity, nor direct connection to the transmitter. It provides you with a continuing indication of transmitter operation. You can easily detect if power is dropping off by comparing present meter readings with past ones. Operates with any transmitter having output frequencies between 100 kc and 250 mc, regardless of power. Sensitivity is 0.3 volts RMS full scale, and a special control on the panel allows for further adjustment of the sensitivity. Meter is a 200 ua unit, mounted on a chrome-plated brass panel. The entire PM-1 measures only 3 1/4" W x 6 1/4" L x 2" D. An easy way to put your mind at ease concerning transmitter operation. Shpg. Wt. 2 lbs.

MODEL PM-1
\$14⁹⁵

Heathkits...

By DAYSTROM

now offer you completely modern marine equipment with outstanding design features

**HEATHKIT TRANSISTOR
RADIO DIRECTION FINDER KIT**

The Heathkit Transistor Radio Direction Finder model DF-1 is a self-contained, self-powered, 6-transistor super heterodyne broadcast radio receiver incorporating a directional loop antenna, indicating meter, and integral speaker. It is designed to serve primarily as an aid to navigation when out of sight of familiar landmarks. It can be used not only aboard yachts, fishing craft, tugs, and other vessels which navigate either out of sight of land or at night, but also for the hunter, hiker, camper, fisherman, aviator, etc. It is powered by a 9-volt battery. (A spare battery is also included with the kit). The frequency range covers the broadcast band from 540 to 1600 kc and will double as a portable radio. A directional high-Q ferrite antenna is incorporated which is rotated from the front panel to obtain a fix on a station and a 1 ma meter serves as the null and tuning indicator. The controls consist of: tuning, volume and power (on-off), sensitivity, heading indicator (compass rose) and bearing indicator (antenna index). Overall dimensions are 7½" W x 5⅞" H x 5⅞" D. Supplied with slip-in-place mounting brackets, which allow easy removal from ship bulkheads or other similar places. Shpg. Wt. 5 lbs.

MODEL DF-1

\$49⁹⁵

(Available after
November 15)

*use it for a
radio-compass or
as a portable radio*



TRANSISTOR
RADIO DIRECTION FINDER

Heathkits...

By DAYSTROM

*are sold only by direct mail,
passing middleman
profits on to you*



Pioneer in
"do-it-yourself"
electronics

HOW CAN YOU MISS?

The Heath Company maintains a technical consultation service, should you experience some sort of difficulty in construction or operation. Although only a very small percentage of our customers ever have occasion to use this service (usually only beginners in electronics) it is still reassuring to know that technical help is available when needed. A service department is also available, should you wish a complete factory check of operation and alignment or repair. After you build your first Heathkit you'll realize how easy it is.

Free Catalog

Send for this
informative booklet
listing more than
100 "do-it-yourself" kits.

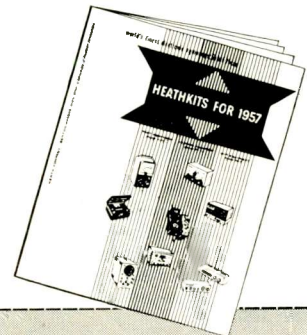

HEATH COMPANY A Subsidiary of Daystrom, Inc. **BENTON HARBOR 15, MICH.**

ORDER BLANK

NOTE: All prices subject to change without notice.

Enclosed find () check () money order for _____
Please ship C.O.D. () postage enclosed for _____ pounds.

On Express orders do not include transportation charges—they will be collected by the express agency at time of delivery.

ON PARCEL POST ORDERS include postage for weight shown. ORDERS FROM APO'S must include full remittance. All prices F.O.B. Benton Harbor, Mich.

Name _____

Address _____

City & Zone _____ State _____

(PLEASE PRINT)

SHIP VIA

- Parcel Post
- Express
- Freight
- Best Way

QUANTITY	ITEM	MODEL NO.	PRICE
		POSTAGE	
		TOTAL	

SEND FREE Heathkit Catalog

for
LOWEST

hum...noise...
microphonics...

in a low- μ
dual triode...



the

Amperex

ECC82 A PLUG-IN
REPLACEMENT FOR THE 12AU7

MICROPHONICS:

Negligible in amplifiers requiring an input voltage of at least 100 mv for an output of 5 watts. No special precautions against microphonics necessary even though the tube is mounted in the near vicinity of a loudspeaker with 5% acoustical efficiency.

HUM AND NOISE LEVEL:

Better than -60 db relative to 100 mv when the grid circuit impedance is no greater than 0.3 megohms (at 60 cps), the center tap of the heater is grounded and the cathode resistor is by-passed by a capacitor of at least 100 mfd.

OTHER Amperex TUBES FOR HIGH-FIDELITY AUDIO APPLICATIONS:

- EL84/6BP5 9-pin power pentode; 17 W PP
- 6CA7/EL34 High-power pentode; 100 W PP
- EF86/6267 Low-noise high- μ pentode
- ECC81/12AT7 Low-noise medium- μ dual triode
- ECC83/12AX7 Low-noise high- μ dual triode
- GZ34 Cathode-type rectifier; 250 ma.
- EZ80/6V4 9-pin rectifier; cathode; 90 ma.
- EZ81/6CA4 9-pin rectifier; cathode; 150 ma.

At All Leading Electronic
Parts Distributors

Amperex
ELECTRONIC CORP.
230 Duffy Ave., Hicksville, Long Island, N.Y.

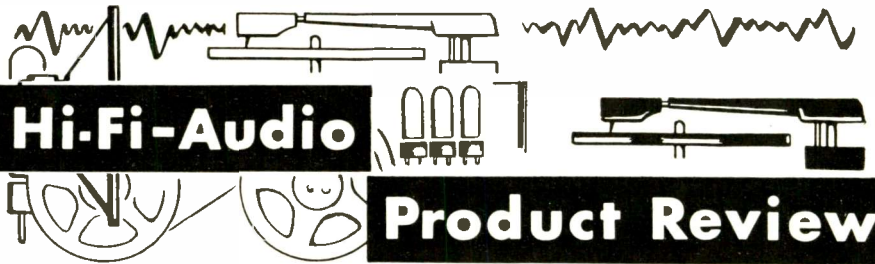

STEREO-BINAURAL KITS
Arkay, 120 Cedar Street, New York, N. Y. has recently introduced a new stereo-binaural component line which is being offered in kit or wired form. The line consists of the SA-25 25-watt stereo preamp-amplifier, the SP-6 dual-channel stereo preamp, and

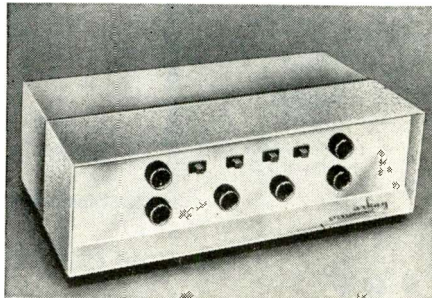

the ST-11 stereo AM-FM tuner. The SA-25 features a dual-channel preamp which drives its own 25-watt linear Williamson amplifier in conjunction with any existing amplifier.

The SP-6 dual preamp has the same features as the Model SA-25, less the amplifier. The controls of both models include equalization for all records, tuner, NARTB tape heads, and auxiliary equipment. A two-position lo-cut and hi-fi filter enables the user to filter out undesirable frequencies at either end of the band. Frequency response of both models is 20-20,000 cps.

The ST-11 tuner offers the listener a choice of monaural or stereo operation. Plans are underway to offer a hi-fi stereo tape recorder in the near future.

BATTERY-OPERATED RECORDER

Electronic Applications, 50 East 35th St., New York, N. Y. is handling the U. S. distribution of a new Swiss-built battery-operated portable tape recorder, the "Nagra II CI."

The unit, which measures 12" x 6" x 4 3/4", is designed to record at standards conforming to broadcast and disc



specifications. Frequency response is guaranteed to be within ± 2 db from 50 to 10,000 cps. Signal-to-noise is better than 55 db on recording and better than 50 db on playback, both referred

to total distortion under 3% over-all. At 7.5 ips, the unit will provide 15 minutes playing time on 5" reels and 22 minutes on 5" long-play tape.

The recorder is powered by two 67.5 volt and two 1.5 volt batteries. A spring motor powers the mechanism. A built-in speaker permits playback and monitoring operations.

Write the U. S. distributor for full specifications and prices.

TRIAD AUDIO TRANSFORMERS

Triad Transformer Corporation, 4055 Redwood Ave., Venice, Calif. has added four new units to its line of transformers for audio applications.

Two of the new units are output transformers, one is a line-to-grid input transformer, and the other a voice-coil-to-grid input type.

Complete specifications on these four units plus details on other transformers in the company's line are included in the firm's new general catalogue, TR-57, which is available from distributors or the manufacturer direct.

VARIABLE RELUCTANCE UNITS

The hi-fi component department of General Electric Company, Auburn, N. Y. has announced the availability

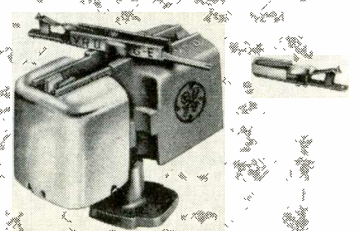

of a new line of seven moderately priced magnetic reluctance cartridges to be known as the "VR-II" series.

Providing a frequency response from 20 through 20,000 cps at a tracking pressure of four grams, these new cartridges have 33% less tracking pressure and 40% greater compliance than the company's RPX-type units.

The new units have a narrower body with a 27% weight reduction and a 10% lighter stylus. They also incorporate a new electrostatic shield. The shield is designed to eliminate electrostatic hum from such external electrical fields as fluorescent light fixtures and pops during playback from the buildup of electrostatic charges on the record.

The cartridges are being offered in four single-stylus types and three dual-stylus types, all with G-E "Clip-In-Tip" stylus assemblies. The styli

build with
the best...

JBL signature loudspeakers!

The careful work you do in building your high fidelity sound system will be shown off to best advantage if you use precision-made JBL SIGNATURE Loudspeakers. These are the most efficient units to be found anywhere, made with the most exacting care, meticulous attention to detail. Remember, it takes no more effort on your part to build with the best.

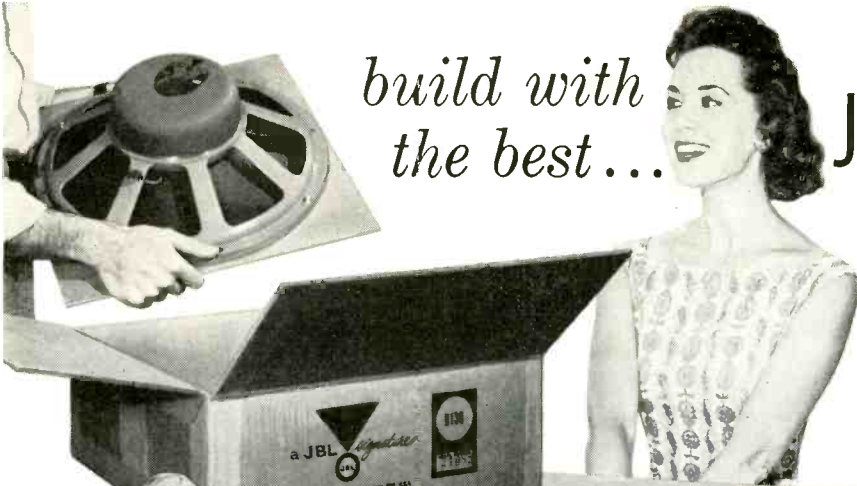

MODEL D130
15" Extended
Range
Loudspeaker

The only 15" extended range speaker made with a 4" voice coil is the world-famous JBL Signature D130. The large voice coil stiffens the cone for crisp, clean bass; smooth, extended highs. Your basic speaker, the D130 works alone at first, later becomes a low frequency driver when you add a JBL Signature high frequency unit and dividing network to achieve the ultimate excellence of a JBL Signature two-way system.



MODEL D208
8" Extended Range
Loudspeaker

A precision transducer in every sense of the word, the famed JBL Signature 8" D208 is made with the same care and precision as the larger units in the James B. Lansing Sound, Inc. line. If space and cost are major considerations, the D208, properly enclosed, provides the most lastingly satisfactory sound you can get. It is widely used in top quality systems where extension speakers are desired for areas other than the main listening room.



MODEL D123
12" Extended
Range
Loudspeaker

With outstanding "presence" and clean response throughout the entire audio spectrum, the D123 features an unusual shallow construction. Only 3 3/8" deep, it is designed to mount flush with the wall, between studding, in any standard wall or partition. Frequently, the D123 is used in multiples in "infinite baffle" wall installations. In this case the JBL Signature 075 is a logical high frequency unit to add when you advance to a two-way system.



MODEL 075
High
Frequency Unit

Another exclusive for James B. Lansing Sound, Inc., is the ring radiator in the JBL Signature 075 high frequency unit. A ring, rather than a diaphragm, radiates into the annular throat of an exponential horn. The result is high frequency reproduction of unmatched smoothness and clarity, absolutely free of resonances and strident peaks. The horn is beautifully machined from aluminum, the entire unit a gratifying, solid piece of fine craftsmanship. Designed for crossover at 2500 cycles with the JBL Signature N2500 Network.



MODEL 175DLH High Frequency Assembly

The acoustical lens is only available on JBL Signature high frequency units. The 14 element lens on the 175DLH disperses sound within the listening area over a 90° solid angle, smoothly, with equal intensity regardless of frequency. The acoustical lens is the greatest contribution to life-like high frequency reproduction in 20 years, and it was developed for use with high fidelity equipment by James B. Lansing Sound, Inc. In addition to the lens the 175DLH consists of a high precision driver with complex phasing plug and a machined aluminum exponential horn. Designed for crossover at 1200 cycles with the JBL Signature N1200 Network.

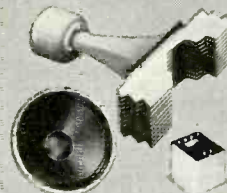

**JBL Signature
Two-way
Systems Are
Available
As Kits**

D86 KIT This two-way system is made up of units which have been acclaimed by impartial authorities as the finest available anywhere today. Included in the kit are the 150-4C Low Frequency Driver, N500H Network, 375 High Frequency Driver, 537-509 Horn-Lens Assembly. These are the same units—including the serpentine acoustical lens—which are used in The Hartsfield... units designed originally for installation in the most modern theaters in the world.

There are many more kits and loudspeakers in the JBL Signature line. Whatever your needs, you will find exactly the right unit or system in the complete JBL Signature catalog. Send for your free copy. A limited number of technical bulletins are also available. Please ask only for those in which you are vitally interested.

JBL means

James B. Lansing Sound, Inc.

JAMES B. LANSING SOUND, INC., 2439 Fletcher Dr. • Los Angeles 39, Calif.
Please send me the following:

- Free Catalog of JBL Signature Products Name and address of Authorized JBL Signature Audio Specialist in my community

TECHNICAL BULLETINS ON:

- D130 D123 D208 175DLH 075 375 150-4C

Name _____

Address _____

City _____ Zone _____ State _____



NOW... there's a GARRARD

**Auto-Manual
Record Changer
for every
hi-fi system**



World's Finest
**RECORD PLAYING EQUIPMENT
from Manual Players to
Professional Transcription
Turntables**

**RC 88
Deluxe Changer**
\$54.50
net

Full manual and automatic positions. True-turret drive... uses no belts. 4-pole "Induction Surge" motor. Fool-proof Garrard Pusher Platform.

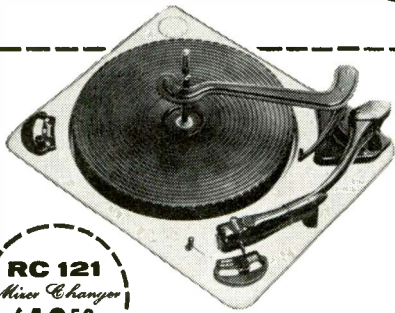

**RC 121
Mixer Changer**
\$42.50
net

Garrard's most compact, economical changer - fits any cabinet. Simpli-Mix Operation permits stacking all record sizes together. 4-pole motor. Manual position.



**RC 98
Super Changer**
\$67.50
net

All RC 88 features, including full manual position and true-turret drive, PLUS continuous + or - variable speed control on all speeds.

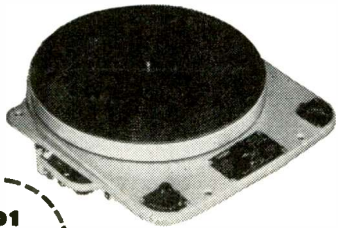

**301
Turntable**
\$89.00
net

Supreme in its class. Individual card gives performance measurements for each unit. Dynamically balanced cast aluminum turntable. Heavy-duty 4-pole shaded motor.



**New
Model T
Manual Player**
\$32.50
net

This is the answer for a quality budget system. Incorporates all record playing features of the Garrard automatic changers. 4-pole motor; automatic stop.

MAIL THIS COUPON TODAY

All Garrard and other B.I.C. components are illustrated and described fully in the B.I.C. High Fidelity Plan Book, a useful guide in planning any hi-fi system.
A quality-endorsed product of the B.I.C. Group



British Industries Corporation Dept. GS-47
Port Washington, N. Y.
Please send B.I.C. High Fidelity Plan Book.
Name _____
Address _____
City _____ Zone _____ State _____

FREE

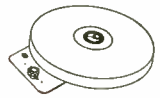

With your purchase of the REK-O-KUT L-34 Rondine Jr. Turntable (\$59.95) and matching Rek-O-Kut 120-tone arm (\$26.95)—you will receive free the new VR11 General Electric Diamond and Sapphire 4G052 Cartridge. (Replaces RPX052A.) All units brand new in factory sealed cartons W/MFGR's full warranty.

Order Now! The L-34, 120 and 4G052... only \$86.90
Full payment or 25% dep. Bal. C.O.D. Shipments F.O.B., N.Y.C.

KEY electronics company
120 Liberty St., N. Y. 6, N. Y.

BARGAIN HUNTING? TV SERVICEMEN!
Write for SENSATIONAL CATALOG
HENSHAW RADIO SUPPLY
3619 TROOST KANSAS CITY, MO.

TAPE RECORDERS
WHOLESALE PRICES
HI-FI COMPONENTS
NATIONAL BRANDS
WRITE FOR FREE CATALOGUE
CARSTON 215-RD E. 88 ST.
NEW YORK 28, N. Y.

are diamond or sapphire, with some sapphires synthetic.

60-WATT AMPLIFIER

MusiCraft, 48 E. Oak Street, Chicago 11, Ill. is currently offering a basic power amplifier, the Model M-60, rated at 60 watts.

Frequency response of the new unit is $\pm .5$ db from 20 to 20,000 cps and

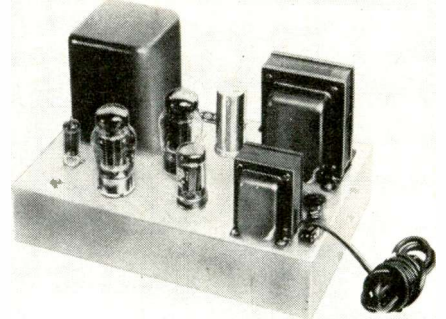

± 1 db from 7 to 70,000 cps. The amplifier will handle 120 watt peaks. IM distortion is less than 1% at 60 watts measured with 60 and 7000 cps 4:1. Hum and noise level is 85 db below 60 watts output. There is a choice of damping factors of 15 or 30, selectable by means of a switch.

The unit comes completely assembled and tested. It is housed in a chrome plated chassis measuring 9" x 14" x 8".

The output transformer is fully potted and varnish impregnated for moisture protection. Grain oriented laminations are used.

A data sheet on this special amplifier will be forwarded on request.

STEREOPHONIC RECORDER

The Audio Electronics Division of Superscope, Inc., 780 Gower Street, Hollywood 38, Calif. is now offering a new stereo and monaural tape unit which records and plays back in both modes.

Known as the "Sterecorder," the new unit is housed in two carrying

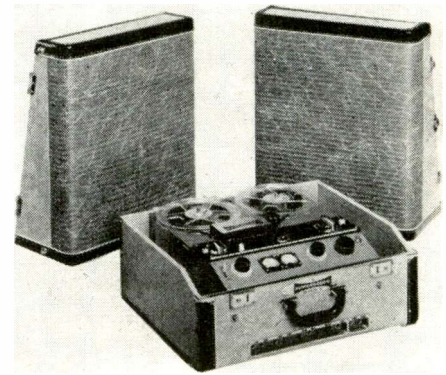

cases. Available with the recording and playback unit are two separately enclosed James B. Lansing "Signature" twelve-inch speakers and two high-impedance dynamic microphones.

Although designed for professional use, the unit is simple to operate and practical for home or office applications. It features a hysteresis synchronous motor, two vu meters, cueing and editing facilities, and two self-

DYNAKIT

Preamplifier

An Outstanding Companion
Kit to the World Famous
Dynakit Amplifiers

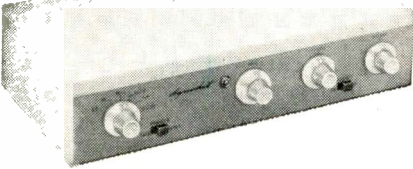

This handsome new control unit gives crystal clear, noise-free reproduction from any modern program source. Its unique all feedback design by David Hafler sets a new standard of pre-amplifier performance. The design of the Dynakit preamplifier is a synthesis of outstanding features which produce smoother, more natural sound. Compare these features with any other units regardless of price.

★ **Unequaled performance**

Actually less than .1% distortion under all normal operating conditions. Response ± 5 db 6 cps to over 60 kc. Distortion and response unaffected by settings of volume control. Superlative square wave performance, and complete damping on any pulse or transient test.

★ **Easiest assembly**

All critical parts supplied factory-mounted on XXXP printed circuit board. Eyeleted construction prevents damage to printed wiring. This type of construction cuts wiring time by 50% and eliminates errors of assembly. Open simplified layout offers complete accessibility to all parts.

★ **Lowest noise**

Integral dc heater supply plus low noise components and circuitry bring noise to less than 3 microvolt equivalent noise input on RIAA phono position. This is better than 70 db below level of 10 millivolt magnetic cartridge.

★ **Finest parts**

1% components in equalization circuits to insure accurate compensation of recording characteristics. Long life electrolytic capacitors and other premium grade components for long trouble-free service.

★ **High Flexibility**

Six inputs with option of extra phono, tape head, or mike input. Four ac outlets. Controls include tape AB monitor switch, loudness with disabling switch, full range feedback tone controls. Takes power from Dynakit, Heathkit, or any amplifier with octal power socket.

★ **Outstanding appearance**

Choice of bone white or charcoal brown decorator colors to blend with any decor. Finished in indestructible vinyl coating with solid brass escutcheon.

★ **Best Buy**

Available from your Hi-Fi dealer at only \$34.95 net (slightly higher in the West), and yet the quality of performance and parts is unexcelled at any price.

Descriptive brochure available on request

Pat. Pending

DYNA COMPANY

617 N. 41st St., Philadelphia, Pa.

Export Division: 25 Warren St., New York 7, N. Y.

contained independent channels of pre-amplification and power amplification to insure precision recording and reproduction.

COLLARO CHANGERS FOR 1958

The Rockbar Corporation, 650 Halstead Ave., Mamaroneck, N. Y., U. S. sales representative for Collaro, Ltd., has announced three new record changers for 1958, two of which incorporate a new transcription-type tone arm.

The tone arm feature is included in the Model TC-540 ("Continental") and Model TC-340 ("Conquest"). The third model, RC-440 ("Coronation") uses a standard plug-in arm and universal head shell which will accept all standard hi-fi cartridges.

The transcription-type tone arm is a one-piece, spring-damped, counter-balanced unit which will accept any standard high-fidelity cartridge. It is completely free from audio spectrum resonances.

All of the units incorporate four speeds and have four-pole shaded-pole



induction motors. All have manual switches and feature automatic shut-off after the last record is played.

LIGHTWEIGHT RECORDER

Telectronic Corporation, 35-16 37th St., Long Island City, N. Y. is now offering a new two-speed tape recorder with simple push-button speed change control that is easy to operate and compact and light enough for wide-range portability.

The Model 1960 measures 7 $\frac{1}{4}$ " x 11" x 11 $\frac{1}{2}$ " and weighs less than 15 pounds. It is housed in a two-tone, luggage-type carrying case. At the 3.75 ips speed it will provide up to two hours of recording time. The 7.5 ips speed is designed for applications

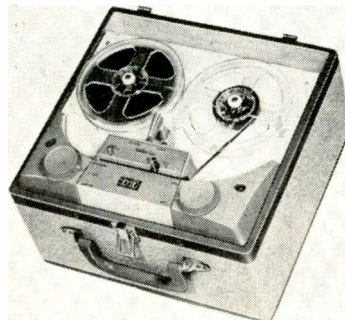

where greater fidelity is required. A single control for record and play makes the unit simple to operate. The

DYNAKIT

Amplifier Kits

A proven circuit of finest sound quality in a new deluxe 60 watt model and standard 50 watt model



Mark III 60 watts \$79⁹⁵*
4, 8, 16 ohm outputs

The new Mark III includes all the sensational attributes of the popular Mark II plus these outstanding deluxe features

★ 60 watts at less than 1% distortion. Instantaneous peak power of 140 watts. IM less than .05 at average listening levels.

★ Choke filtering and low noise circuitry reduce hum and noise to 96 db below 60 watts.

★ New rugged KT-88 tubes and other heavy duty parts used conservatively.

Mark II 50 watts \$69⁷⁵*
8, 16 ohm outputs

The Mark II is the best buy in high power high fidelity kits

★ Ease of assembly due to uniquely simple circuitry and printed circuit construction with factory-mounted parts.

★ Highest stability using patented stabilizing networks with minimum number of phase shifting stages. Suitable for all loudspeaker systems including electrostatic.

★ Dyna Biaset (patent pending) for simplified adjustment and complete freedom from effects of unbalanced components. No balancing adjustments required to meet published specifications.

★ Dynaco Super-Fidelity output transformer with patented para-coupled windings. This is the finest available transformer of its type for the most critical audio uses.

Available from leading Hi-Fi dealers everywhere. Descriptive brochure available on request.

* Slightly higher in West

DYNA COMPANY

617 N. 41st Street • Philadelphia, Pa.

Export Division: 25 Warren St., New York 7, N. Y.

FULL FIDELITY MUSIC ENJOYMENT

TWIN-CONES IN A SINGLE

F.R.S. SPEAKER
COVER THE
AUDIBLE RANGE

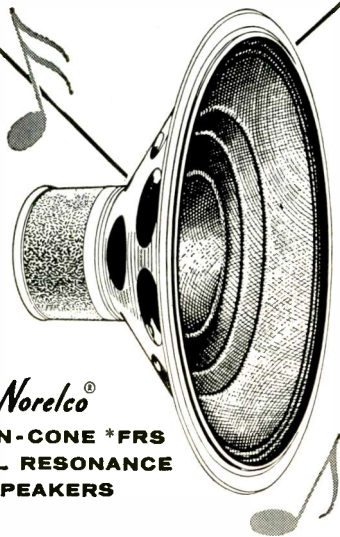

Norelco®
TWIN-CONE *FRS
*FULL RESONANCE
SPEAKERS

In a single speaker, Norelco has created an unusually efficient sound radiator. These twin-cone speakers incorporate a small cone for reproducing high frequencies and a large cone for lower frequencies. Both cones operate in conjunction from a single voice coil—producing balanced sensitivity and uniform sound for all ranges. Arrangement of both cones reflect and diffuse the sound while moving in phase to provide even sound distribution.

A deep air gap within a homogeneous magnetic field provides unusually large movement of the voice coil resulting in distortion-free reproduction over the entire frequency range. Impedance does not diminish with higher frequencies and volume is practically constant throughout the whole audible range.

Send today for your catalog on Norelco *FRS Twin-Cone Speakers. It contains specification data, sound distribution curves, frequency characteristics on these speakers as well as the new Norelco Speaker Enclosures.

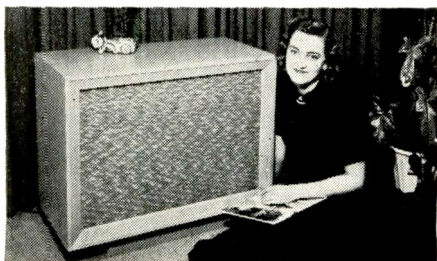

Send to Dept. G11 for more details

NORTH AMERICAN PHILIPS CO., INC.
High Fidelity Products Division
230 Duffy Ave. Hicksville, L. I., N. Y.

"on-off" knob serves as the volume control and for setting the proper recording level.

The recorder comes complete with a microphone, 1-hour reel of tape, and take-up reel. A patch cord for direct recording is available as an accessory.

POWER TETRODE TRANSISTOR

Minneapolis-Honeywell Regulator
Company's Semiconductor Products

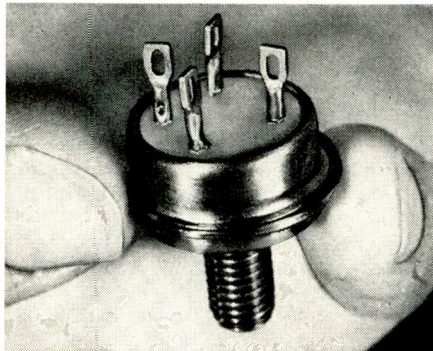

Division has unveiled a new power tetrode transistor which has been especially designed for applications in the audio field.

According to the company, the use of this new component in high-fidelity amplifiers will reduce the amount of circuitry required and lessen the chance of thermal runaway because of the inherent stability of the device. This new tetrode is designed to operate on a 28-volt system and can carry up to 10 amperes.

Limited quantities are currently available. Inquiries regarding deliveries and for information on specifications should be addressed to R. O. Anderson, transistor sales manager, in care of the division at 2753 Fourth Ave., S., Minneapolis 8, Minn.

"DYNAKIT" PREAMPLIFIER

Dyna Company, 617 North 41st St., Philadelphia 4, Pa. has incorporated several novel features in its new "Dynakit" preamplifier which has just been put on the market.

The unit which measures only 6" x 12" x 2½" includes a printed circuit board on which all components are premounted at the factory and dip-soldered, a built-in voltage-doubler

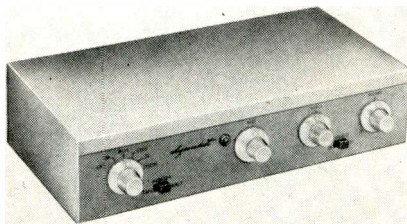

rectifier to supply d.c. for the filament circuits, a unitized switch assembly which contains 1% components for accurate record compensation, and similar unique features.

Utilizing a new type of all-feedback tone control with a true flat center setting plus wide control range of ± 20 db at 30 cps and ± 15 db at 15 kc., the tone control network in flat posi-

tion offers no distortion on square waves over the range from 20 to 20,000 cps. Frequency response is $\pm .5$ db, 60 to 60,000 cps, at any setting of the volume control.

Six inputs are furnished with one being an option of extra phono, tape head, or microphone. An A-B monitor switch will be of special interest to tape recordists.

The kit is offered in a choice of two colors. A solid brass escutcheon is furnished and an optional escutcheon can be obtained to simplify cabinet mounting of the unit. A complete brochure with performance and design information is available on request.

TAPE REPEATER

Soundcraft Inc., 3456 E. Jefferson Ave., Detroit 7, Mich. is now offering its new "Soundpac" tape repeater which utilizes the "Fidelipac" continuous-loop tape cartridge.

The new unit is designed to permit the user to record directly into the fully-enclosed endless-play tape cartridge. It is intended for p.a. merchandising, point-of-sale promotions, background music applications, educational

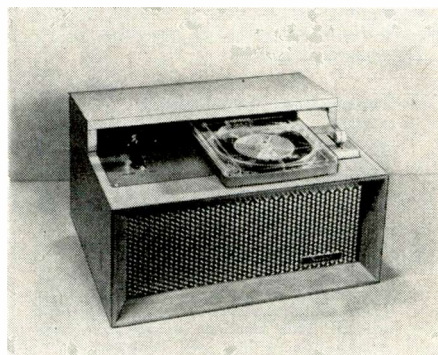

work, and home use. Tape cartridges may be as short as a few seconds and as long as two hours. Blank and various pre-recorded tapes are now available.

Three models of the new "Soundpac" are available. For full details write the manufacturer direct.

UNFINISHED HI-FI CABINETS

To meet the needs of audiophiles who want distinctive enclosures for their equipment yet prefer to finish them in custom colors, Salmanson & Co., Inc., 1107 Broadway, New York 10, N. Y. has introduced three functional hi-fi cabinets for the do-it-yourself crowd.

Designed to house a record player, audio gear, and as many as 200 LP records in a sliding door cabinet, the units are of kiln-dried ponderosa pine. Panels are supplied to contain the record player and front-end audio components if desired. Optionally, the record storage compartment may be used to house a speaker system.

The units are shipped assembled, sanded smooth, ready for painting, staining, or varnishing. The three models now in the line include an "economy" version (No. 3001) which measures 16" x 35" x 24¼"; the "lift-top" model (No. 3002) which

measures 16" x 35" x 24 $\frac{3}{4}$ " (both models have optional 5 $\frac{1}{4}$ " legs); and the "deluxe" unit which sits on a solid base and measures 16" x 35" x 30". It is catalogued as the No. 3003.

A data sheet giving full specs on all models is available on request.

PHONO JACKS AND PLUGS

Switchcraft, Inc., 1328 N. Halsted St., Chicago 22, Ill. is now offering a new line of phono plugs and extension

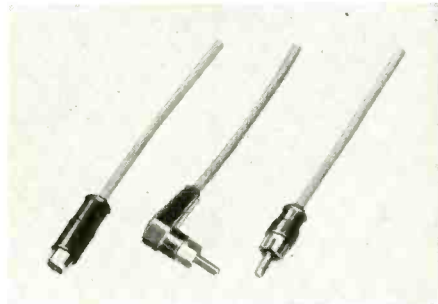

jacks (with shielded handle) molded to cable. The plugs are available in both straight and right-angle types.

The new line will be available in standard cable assemblies of the type used in high-fidelity and audio equipment for interconnecting amplifiers, microphones, etc.

Full details on prices, specifications, and delivery are available from the manufacturer.

SYSTEMS FOR ELECTROSTATICS

KLH Research and Development Corporation, 30 Cross St., Cambridge 39, Mass. is now in production on three new loudspeaker systems covering the low and mid-frequency range and designed for use with the Janszen electrostatic tweeter.

Designated as Models One, Two, and Three, the new units feature low-frequency distortion through use of the acoustic suspension principle and an unusual degree of freedom from mid-range irregularities through use of specially designed and manufactured speaker cones.

NEW AMPEX STEREO UNITS

Ampex Audio Inc., 1020 Kifer Road, Sunnyvale, Calif. will have a full line of stereo units for the home on the



market this fall, including consoles, portables, and table models.

November, 1957

clear,
natural
sound
from

EKTACOM

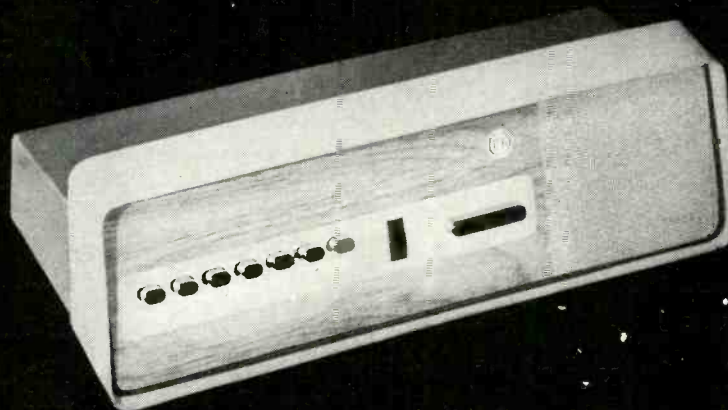

A multi-station inter-communication system using special high fidelity techniques for extremely low distortion and high speaker damping. You get the clear, natural sound of voices. The printed wiring, heavy duty all metal construction, and instrument-type components make the Ektacom system outstanding.

Send for illustrated brochure



FISHER BERKELEY CORPORATION

4224 Holden Street Emeryville 8, California

EARN TOP SALARIES! BUILD AN EXCITING FUTURE! READ:

YOUR CAREER IN ELECTRONICS

A NEW
ZIFF-DAVIS
PUBLICATION

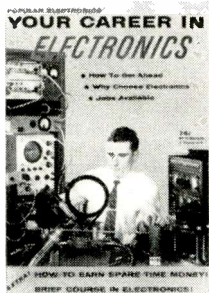

This fact-filled volume prepared by the combined staffs of RADIO & TV NEWS and POPULAR ELECTRONICS is written for men who have a stake in the fastest-growing industry in the world—electronics! If you're eager and ready to move in to a more advanced, higher-paying electronics specialty or want to begin an electronics career, don't miss this informative 132-page publication.

IT TELLS YOU

- what job opportunities are available in electronics
- how to prepare for a job in electronics
- how to get a job in electronics

CONTENTS

ELECTRONS, SLIDE RULES AND YOU— Careers in Electronics . . . Am I Too Old to Learn Electronics . . . Women in Electronics . . . What About Tech Writing? . . . Electronics Stands Guard

CAREERS IN PROGRESS—I am an Atomic Engineer . . . I Ride the Satellites and Rockets . . . I Make Electronic Brains . . . Thank Me for Safe Air Travel . . . We Make Color TV . . . We're Looking for Tomorrow

SURVEY OF THE JOB MARKET—Personnel requirements of the largest electronic manufacturing firms—number of technicians, engineers needed, kind of background required, salaries offered, training given and opportunities for advancement.

COURSES, CREDITS AND DEGREES— Training for a Career . . . Home Study . . . College Training . . . Resident Schools

ELECTRONICS IS A PROFITABLE HOBBY— Spare Time TV Servicing . . . Use Your Hi-Fi Know-How . . . Build Gadgets for Money . . . Kits For Sale . . . Profit From P.A. Rentals

BASIC ELECTRONICS—A brief course in the fundamentals of electronics. It gives the beginner a knowledge of terminology and some familiarity with the electronics field.

Buy a Copy of
**YOUR CAREER IN
ELECTRONICS**
ON SALE NOW AT ALL
NEWSSTANDS—only 75c



In the console versions the cabinets contain matched amplifier-speaker systems, a Fisher AM-FM tuner, a Garrard 4-speed record changer, tape recorder-stereo reproducer, and microphone for recording off-the-air or from other sound sources.

The portable and table models are housed in three separate cases, one containing the tape mechanism and the other two the amplifier-speaker systems. Both wood and luggage-type cases are offered in these models.

For full details on this new line, including information on the styles and cabinet finishes, write the manufacturer direct.

TUBES FOR FM TUNERS

The Electron Tube Division of Radio Corporation of America, Harrison, N. J. has introduced two new general-purpose high-mu twin triodes designed to be used as r.f. amplifiers and combined oscillator-mixers in FM tuners.

Designated as the 6DT8 and 12DT8, the triodes are identical except for their heater voltage and current. The two units of each type are effectively isolated from each other by an internal shield having a separate base-pin terminal. This shielding arrangement enables the designer to achieve substantial reduction of antenna radiation thus providing stable performance in high-frequency applications.

The two cathodes in each type have separate base-pin terminals to provide the equipment designer with greater flexibility in circuit connections.

KLIPSCH STEREO TAPES

Klipsch and Associates, Hope, Ark. has announced the release of the 7000-series of recorded tapes for 7.5 ips operation.

This new series are stacked-head stereo, 1200 feet on 7" reels, recorded at 7.5 ips. The first three releases at this new speed (prior recordings were at 15 ips) include an organ recital by John Eargle featuring a variety of classical works played on two Aeolian-Skinner pipe organs (one in Kilgore and the other in Longview, Texas); popular favorites played on the four-

manual Wurlitzer at the Palace in Dallas by Weldon Flanagan; and The Joe Holland Quartet in a series of modern jazz numbers.

AUDIO CATALOGUES

PILOT BOOKLET

Pilot Radio Corporation, Long Island City 1, N. Y. has published a 16-page booklet written for the audio consumer.

Entitled "High Fidelity in the Home—A New Approach by Pilot," the brochure contains a glossary of high-fidelity terms, describes the history and development of high-fidelity, and illustrates representative equipment.

Copies are available at no charge from the company direct or through its authorized dealers.

STEREOPHONIC SOUND

Ampex Audio Inc., 1020 Kifer Road, Sunnyvale, Calif. has recently published a 16-page, full color booklet which explains the nature of stereophonic sound and tells how it can be enjoyed in the home.

An illustrated article explains, in easily understood language, what is meant by stereo sound and how the firm's line of home music systems enables the music lover to enjoy such reproduction. The various models in the company's stereo line are shown by means of color photographs.

LAFAYETTE FLYERS

Lafayette Radio, 165-08 Liberty Ave., Jamaica 33, N. Y. is now offering copies of three 4-page flyers covering various items of equipment of interest to audiophiles.

Publication ST-70 covers a full line of speakers, enclosures, and complete systems; leaflet ST-62 pictures and describes various tone arms, audio systems for custom installation, and turntables. The third publication lists special offerings in speakers and changers, describes the firm's 70-watt amplifier and master audio control center, as well as miscellaneous audio components.

Write the company for any or all of these bulletins. —30—

Aerial view of RCA Victor's new radio and "Victrola" plant in Cambridge, Ohio. This 355,000 square-foot factory is said to be the world's largest facility for the production of "packaged high-fidelity units." The plant employs nearly 2000 persons and is capable of turning out 6000 instruments from its fifteen assembly lines during an eight-hour shift. The plant was dedicated September 11th.

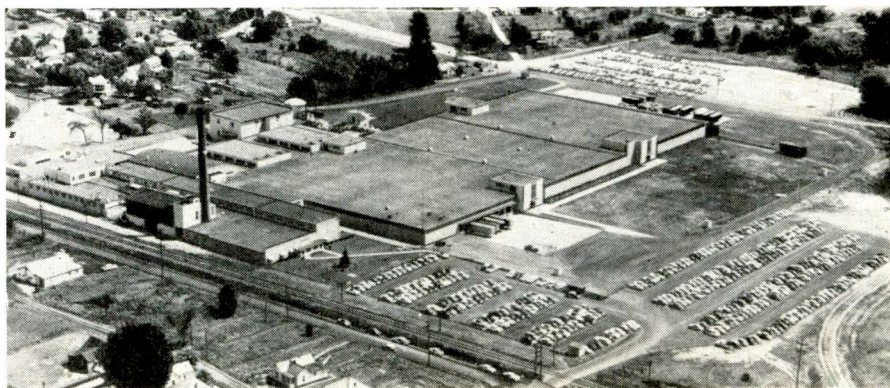

Certified
RECORD REVUE

By **BERT WHYTE**

THIS issue is produced before the new season's Hi-Fi Shows so I can't give you any report on them until a later issue. So not having much to say, I'll get on with the reviews and try to catch up on the flood of new material. Oh, I almost forgot to warn you that, contrary to some opinions, LP record prices are not due for any further reductions and, in fact, there is much talk of a price rise, because of increased costs, etc. Several labels have slyly pegged some records as "special!" merchandise and have already upped the tariff one dollar over the existing \$3.98 base. Thus it might behoove you to latch on to some of the records you've been planning to buy, "sometime," before you find your buying power sadly diminished. Don't say you haven't been warned!

IBERT

SUITE ELIZABETHAINE
 Vienna Symphony Orchestra conducted by Henry Swoboda.

DIVERTISSEMENT
CAPRICCIO

Winterthur Symphony Orchestra conducted by Henry Swoboda. Westminster XWN18520. RIAA curve. Price \$3.98.

This record was an early *Westminster* success which has now been re-mastered using the new RIAA equalization. The advances in cutting and pressing techniques have made a notable improvement in a record which, in its original issue, was much admired for its clean, crisp, well-balanced sound. The delightfully satirical "Divertissement" is the most familiar Ibert work on this disc and Swoboda affords it a light-handed, most engaging performance. The "Suite" and the "Capriccio" are not of the same level of inspiration which sired the "Divertissement," but are nonetheless interesting examples of the Ibert style.

HOROWITZ IN RECITAL

Vladimir Horowitz, pianist. Victor LM1957. RIAA curve. Price \$3.98.

This is a rather odd collection of piano works ranging from a Haydn Sonata and a Brahms Intermezzo, to a Chopin Polonaise and Mazurka, the Schumann Variations on a Theme by Clara Wieck, a pair of Scriabin Sonatas and winding up with s'help me . . . the Horowitz piano transcription of Sousa's "Stars and Stripes Forever!" Melange it might be, but shining through it all is the artistry of Horowitz.

Here he gives a generous display of his prodigious technique and although quite awed by such *bravura* virtuosity, one is puzzled why this great pianist is so poorly served on records. His disc output is small and very circumscribed as to repertoire. One might add that the recorded sound is not all that it might be. On this disc, *Victor* fails to identify where the recitals were recorded, and mentions only that the Scriabin Sonatas were especially recorded for this album. This fact is audibly noticeable since the Scriabin works sound far cleaner and brighter than the other

The opinions expressed in this column are those of the reviewer and do not necessarily reflect the views or opinions of the editors or the publishers of this magazine.

November, 1957

the
 sum
 of
 all
 its
 parts...

s i l e n c e



REK-O-KUT Rondine Turntable

REK-O-KUT HIGH-FIDELITY TURNTABLES — TURNTABLE ARMS

Dept. 123 38-19 108th ST., CORONA 68, N. Y.

Custom-crafted motors feature wear-resistant bearings, electronically-balanced rotors.

Motor pulley machined with motor in operation—insures permanently smooth power transmission.

Special neoprene tire on idler wheel provides rumble-free traction and durability.

Motors and drives checked under operating conditions — insuring lifelong unerring performance.

Self-lubricating Spiral-Grooved turntable shaft, exclusive with Rek-O-Kut, provides oil-cushioned spin on chrome-steel ball bearing.

Cast aluminum turntable with resonant-inhibiting properties . . . machined to aircraft tolerances.

Prices from \$59.95

Write for
 Catalog and
 FREE STROBE DISC

REK14

KOPELOVE SURPLUS BARGAINS FOR NOVEMBER



TS-16/APN Test Set—Used for alignment and calibration of ARN-1, APN-1 and other radio altimeters. Has 28-volt vibrator supply, audio generator, many valuable parts. Complete with all cables and sturdy wood case.

Now only..... **\$7.95**

BC-906D Frequency Meter—144-225 mc. Battery operated. Complete with case. Only..... **\$6.95**

RBH-2 Receiver—Tunes 300 kc to 16 mc. Built-in power supply for 115v. 50-60 c. Made by National. Good condition. Only..... **\$7.50**

R98/APN4 Radio Receiver. Used, good condition. Only..... **\$3.95**

I-196B Signal Generator—Now only..... **\$3.95**

TS-3/AP Wave-Meter, Watt-Meter—Cavity tuned 2400 to 3400 mc. New condition. A real buy..... **\$29.95**

TS-3A/AP Wave-Meter, Watt-Meter—Only..... **\$69.95**

RD-7/APA 23 Recorder—Used for frequency monitoring. Time signal, etc. Requires 80-115 vac. 60 cycles and 28 vdc. New, with book..... **\$25.00**

TS 170-ARN-5 Test Oscillator—330 mc. range. For Glide Slope receivers or other UHF applications. New, \$14.95. Used, good condition..... **\$9.95**

H-22A/U Handset—with hangar and two extra mic covers..... **\$5.25**

RT-7/APN-1 Altimeter Transceiver—This terrific value includes all 14 tubes, 27-volt dynamotor and famous wobblulator unit. Like new..... **\$4.95**

APR-4 Laboratory Receiver—40 to 3300 mc. Less tuning units..... **\$65.00**

Minimum order \$3.00. All items shipped f.o.b. our warehouse. On C.O.D.'s include 25% with order. Ohio residents add 3% Sales Tax. All items subject to prior sale.

KOPELOVE ELECTRONICS COMPANY

Dept. RN-1157, 1919 East First Street, Dayton 3, Ohio

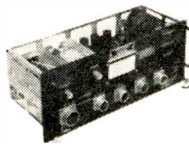

AMPEX STEREO

SIGNATURE OF PERFECTION IN SOUND



takes you

BEYOND THE HI-FI BARRIER!

Add Ampex Stereo to your system, and you've pierced the last barrier that stands between you and the long-sought goal of actually experiencing the complete realism of the original performance. Hear it once, and you'll never be satisfied with anything less.

Ampex is most-wanted because it is best-engineered. You can install this precision tape-deck in the secure knowledge that it is not only the finest equipment available today, but years from now will still be outperforming everything in the field.

In addition to the Ampex Model A124-U recorder-stereophonic reproducer shown here, there are portables, modular units, and consoles complete with their own AM-FM tuners and record changers.

AMPEX

CREATORS OF THE VIDEOTAPE TELEVISION RECORDER; MAKERS OF AMERICA'S BEST-ENGINEERED, MOST-WANTED AUDIO EQUIPMENT

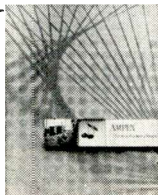

AMPEX AUDIO INC.

1044 KIFER ROAD, SUNNYVALE, CALIFORNIA

Please rush free Ampex Stereophonic Sound brochure to:

NAME _____

ADDRESS _____

CITY _____

pieces. The piano sound is generally fair in quality, with the saving grace that virtually no wow or flutter could be detected. With so few Horowitz recordings in circulation, any new disc of his is welcome, but one rather wistfully wishes for new Horowitz recordings alive with the top quality sound of which *Victor* is capable.

SYMPHONIC DANCES

Hollywood Bowl Symphony Orchestra conducted by Felix Slatkin. Capitol P8369. RIAA curve. Price \$3.98.

This is a fine record for the hi-fi beginner who wants some spectacular music to "show off" the capabilities of his hi-fi system. A collection of reliable old chestnuts like the "Sabre Dance" of Khachaturian, the "Galop" from Kabalevsky's "The Comedians," the "Sailor's Dance" from Gliere's ballet, "The Red Poppy," and the "Bacchanale" from Saint-Saens' opera, "Sampson and Delilah," are performed by Slatkin and his men with great verve and spirit. These agile orchestral capers are a natural for hi-fi treatment and *Capitol's* engineers have not spared the decibels. This is fairly close-up, highly detailed recording, with enough reverb to lend "liveness." Wide in frequency and dynamic range and with very low distortion, even in the inner grooves, this recording is certain to find favor with those people who like their classical music on the "light" side but liberally spiced with brass and percussion.

ELGAR

WAND OF YOUTH SUITES #1 AND #2

London Philharmonic Orchestra conducted by Edward van Beinum. London LL1587. RIAA curve. Price \$3.98.

Here is some of Elgar's most charming and spritely music, affectionately performed by the London Philharmonic. This is the first LP recording to offer both suites and is definitely to be preferred to the old *MGM* disc which coupled the first suite with less compatible music. Van Beinum may not be the ideal choice of conductor for these scores, but he acquits himself very well and is always thorough and musicianly in his readings. The sound on this disc is most unusual coming from *London*. Generally it is quite clean and bright, but in a few sections there is distortion in the strings and somewhat "crackly" surfaces. Maybe I got a bum review copy, but it might be prudent to check your copy before you buy.

LISZT

PIANO CONCERTO #1 IN E FLAT HUNGARIAN FANTASIA

Gyorgy Cziffra, pianist, with Paris Conservatoire Orchestra conducted by Pierre Dervaux. Angel 35436. RIAA curve. Price \$3.98, standard pack.

This is piano-playing in the grand romantic tradition and no less romantic is the story behind the pianist, Gyorgy Cziffra. He was a child prodigy in Budapest and at the age of eight was studying under the redoubtable Ernst von Dohnanyi. Cziffra began his professional career when he was twelve, and concertized extensively in Europe until the outbreak of World War Two. After serving in the Army for three years, he was demobilized and went back to his piano and further studies. Life was difficult in post-war Hungary and Cziffra tried to flee the country but was caught and imprisoned. After many difficulties, he managed to resume his career, but it was not until 1955 that he was allowed to give a few concerts outside Hungary . . . and at all times he was under the strictest supervision. The November 1956 uprising in Hungary finally afforded Cziffra a chance to escape his bondage and he escaped across the border into Austria. Helpful friends in Vien-

na arranged for a concert and it was a tremendous success.

On December 2, 1956 he played the Liszt "Piano Concerto #1" in Paris and the critics and public went wild, comparing his playing to that of Horowitz and other greats. So extravagant was their praise that critics in this country adopted a very skeptical attitude. I wondered if the Viennese and the Parisiennes had not been caught up in a wave of sentiment and sympathy for Cziffra, because of the nature of circumstances surrounding his background.

A listen to this recording confirmed one thing . . . here was indeed a pianist with a formidable talent, a veritable giant at least as far as Lisztian repertoire was concerned. This man has technique to burn . . . his phrasing and dynamics are things at which to marvel, his tone is very rich, broad, and meaty. He can match delicacy of touch and subtleties of fingering with the best. His attacks and ritards are micrometrically precise. Above all, in his sweeping thundering perorations, he never loses sight of the musical essentials of the score. Yet for all this fabulous pianism, this is by no means the best Liszt "Concerto #1" on records. The accompaniment afforded Cziffra by Dervaux and the Paris Conservatoire Orchestra is merely competent and there is the bare minimum of rapport between pianist and orchestra.

I find the "Hungarian Fantasia" an even greater revelation of Cziffra's extraordinary pianistic prowess. *Angel* has tried to maintain this illusion of greatness around Cziffra by giving him exceptional engineering. This is one of the most close-up *Angel* recordings I can remember—very sharply detailed, clean and free from wow and flutter. Orchestral/piano balance is good, slightly in favor of the piano.

In summation, there is, no doubt, a certain glamour and romance surrounding Cziffra which in all honesty must in some degree color opinions regarding his pianism. But putting this aside as best one can, he still stands revealed as one of the most exceptional talents to come out of Europe in recent years and he certainly will bear watching.

ARNOLD HOMAGE TO THE QUEEN

Philharmonia Orchestra conducted by Robert Irving. Victor LM2037. RIAA curve. Price \$3.98.

The clever Malcolm Arnold wrote this work as an "Homage to the Queen," on the occasion of Elizabeth the Second's coronation. Essentially the work is a ballet in which the elements, Earth, Water, Fire, and Air do "homage to the Queen." As with most of Arnold's work, the scoring and orchestration is extremely colorful with much reliance on brass and percussion. There are those who have dismissed this work as "trite," but while this is admittedly not "earthshaking," it has interesting writing and much that lends itself to spectacular hi-fi sound. This there is in plenty and all of it quite clean and free from distortion.

MOZART SERENADE FOR WIND INSTRUMENTS #10 IN B FLAT MAJOR

Berlin Philharmonic Orchestra conducted by Fritz Lehmann. Decca DL9918. RIAA curve. Price \$3.98.

The fourth recording of this delectable "Serenade" and, everything considered, the best. Lehmann conducts this music with authority and elicits a noteworthy performance from his superb musicians. The sound is just about right for this type of music . . . the darker sound of the four horns, two bassoons, and double bass splendidly balanced with the lighter tones of the paired oboes, clarinets, and basset-horns. The recording is not ultra-

EXCITINGLY NEW COMPONENTS FROM H. H. SCOTT

Get the facts! 11 brand new H. H. Scott components. NEW styling . . . NEW features . . . a completely NEW line for '58.

Want all the facts on the most exciting hi fi line of the year? Then write for H. H. Scott's new free catalog.

Get all the technical data on Scott's brand new Model 300 AM-FM tuner. Get technical specs on our completely redesigned 210F amplifier.

Read all about the new features we've added to our famous '99' complete amplifier.



H. H. Scott, 111 Powdermill Road, Maynard, Massachusetts
Export Dept.: Telesco International Corp.
36 West 40th Street, New York City

Rush me your new catalog R-11 and complete technical specifications on H. H. Scott components for '58.

NAME
ADDRESS
CITY STATE



PILOT

and only

PILOT

offers you peak performance
in high fidelity at low cost

AMPLIFIERS

Pilot-engineered Williamson-type circuits employing specially wound output transformers to insure absolute stability and lowest distortion. Power specifications are conservatively rated, and amplifiers are designed for continuous operation at full output.



AA-920

Rated output with less than 1% distortion: 20 watts (40 watts peak); frequency response: 20 to 20,000 cycles, ± 1 db. Has built-in preamp and audio control with hum-free DC on tube heaters; tape head and phono inputs with separate equalization; 3-position rumble and scratch filters; bass and treble controls; loudness-contour and volume controls; plus tape recorder output. Housed in handsome enclosure finished in brushed brass and burgundy.

Dimensions: 4 $\frac{3}{4}$ "h x 13 $\frac{1}{4}$ "w x 9"d.

\$99.50 Complete



AA-903B

Rated output with less than 1% distortion: 14 watts (28 watts peak); frequency response at rated output: 20 to 20,000 cycles, ± 1 db. Has built-in preamp and audio control with hum-free DC on tube heaters; tape head and phono inputs with separate equalization; 2-position rumble and scratch filters; bass and treble controls; loudness-contour and volume controls; plus tape recorder output. Housed in handsome enclosure finished in brushed brass and burgundy.

Dimensions: 4 $\frac{3}{4}$ "h x 13 $\frac{1}{4}$ "w x 9"d.

\$79.95 Complete



AA-410A

Basic amplifier—rated output with less than 1% distortion: 20 watts (40 watts peak); frequency response: 20 to 20,000 cycles, ± 0.5 db; 6L6GB output tubes. Chassis and cover cage finished in brushed brass.

Dimensions: 4" x 12 $\frac{3}{4}$ " x 6" high.

\$59.50 Complete

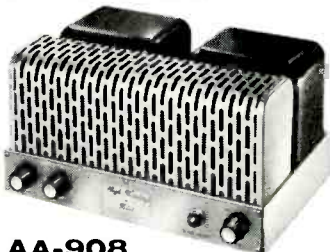

AA-908

Basic amplifier—rated output with less than 1% distortion: 40 watts (80 watts peak); frequency response: 20 to 20,000 cycles, ± 0.1 db; 6CA7 output tubes; provision for selecting optimum damping factor. Chassis and cover cage finished in brushed brass.

Dimensions: 12 $\frac{1}{4}$ " x 8 $\frac{1}{4}$ " x 6 $\frac{1}{2}$ " high.

\$125.00 Complete

Make your own performance tests of these amplifiers at your Pilot dealer.

For complete specifications, write to Dept. DX-11

Prices slightly higher west of Rockies.

close-up, but is finely detailed nonetheless. The acoustical perspective was somewhat larger than that for which the music was originally written, but this should be considered as "recording license." The little extra reverb adds needed "liveness" and affords a mellow richness to the sound. If you are one of those music lovers to which Mozart has always been a little inaccessible, I urge you to listen to this lovely music. This is light-handed music, full of rollicking good humor, and very easy on the ear.

VIENNESE NIGHT AT THE PROMS
Halle Orchestra conducted by Sir John Barbirolli. Mercury MG50124. RIAA curve. Price \$3.98.

Waltzes and champagne are supposed to go together but in this recording Sir John has changed the tittle to 100 proof dynamite. The names are certainly familiar . . . "Gypsy Baron Overture," "Die Fledermaus Overture," "Blue Danube," etc. and while the baronet conducts them with great clan and evokes memories of bockwurst and gemütlichkeit, there is another side to this coin and when it flips . . . wow! In other words these waltzes have life to them. They are gay and effervescent, giddy panoplies of purple sound. The high-voltage recording has as much to do with this as Sir John. Here we have the rich sonorities of massed strings, the mellow lift of the woodwind, the bright brilliant summons of the brass, the authoritative majesty and imposing weight of the percussion. Dynamics are ultra-wide, recording super-detailed and the whole is enrobed in spacious acoustics in emulation of baronial halls and castle ballrooms. In other words one of the doggondest waltz recordings ever made and if you can't make time with your gal on this one, you just ain't hep, Jack!

SCHUMANN
MARCH #2, OP. 76
WALSZENEN
FANTASIESTUCKE

Sviatoslav Richter, pianist. Decca DL-9921. RIAA curve. Price \$3.98.

Here is yet another European pianist, Russian Sviatoslav Richter, relatively unknown in this country, whose press raves have preceded his recordings to this country. The press was literally ecstatic about Richter's fabulous pianism and frankly I approached this recording with a good deal of skepticism. My fears were certainly unfounded as this fellow is indeed one of the most remarkable I have ever heard. His playing is in the most pure and classical mold, combining exquisite technique with superb musicianship. His perusal of these Schumann scores is very warm and personal, deeply expressive, yet he never cloys, never oversentimentalizes.

The recording is one of the best to come from Decca. Piano tone is big, broad, very sonorous, transients crisp and clean, no wow or flutter. Close-up mike technique was used, but judiciously as no hammer action was discernible. Acoustics were slightly dry and this made for a sound of extreme clarity. All-in-all an auspicious disc debut by a really outstanding artist who has heightened our appreciation of these pleasant Schumann scores.

SHISHAKOV
CONCERTO FOR BALALAIKA AND
ORCHESTRA OF FOLK INSTRUMENTS

CHAIKIN
CONCERTO FOR ACCORDION
Westminster XWN18464. RIAA curve.
Price \$3.98.

Unfamiliar names to say the least! This is a Russian-derived recording and the names of the various orchestras and performers is a mile long, so forgive me if I don't use up

space listing them. These concertos are for instruments rarely, if ever, employed in this country. Surprisingly, both turn out to be quite fascinating. The balalaika is a kissin' cousin of the guitar and as utilized in this concerto it is not difficult to follow the music. Despite the fact that both composers are contemporaries resident in Russia, their concertos reflect little modernism in construction and are more romantic in inclination than anything else.

Soundwise this is the first Russian material I can honestly begin to compare with our domestic product. Most Russian tapes imported for transfer to disc have been absolute sonic horrors. Here we have high level sound, with generally clean strings, good bright brass, smooth woodwind, and sharp weighty percussion. The balance between accordion and balalaika and the orchestra is exemplary and both instruments are vividly reproduced with their characteristic timbres. Frequency and dynamic range is as wide as that common to our domestic recordings. Recording was close-up, highly detailed, and the spacious acoustics allowed commendable "liveness" Off-beat, but highly listenable and interesting music, with no apologies for sound quality necessary. Two other short works fill out this worthwhile disc.

RIMSKY-KORSAKOV

TALE OF THE TSAR SALTAN SUITE
MAY NIGHT OVERTURE
RUSSIAN EASTER FESTIVAL
L'Orchestre de la Suisse Romande conducted by Ernest Ansermet. London LL1635. RIAA curve. Price \$3.98.

As you can imagine, the combination of this exotically-scored music, Ansermet, and London's superb sound makes for a highly exciting recording. This is really one for the hi-fi buffs . . . it's loaded with sharp sparkling brass, high and low percussion, lush woodwinds and more often than not, they're all playing *mezzo-forte* or better. This is the fourth version of the "Tsar Saltan Suite" to appear on LP and although the Dobrowen reading on *Angel* had much to recommend, this tops it both in performance and sound. This is the first time on LP you can get to hear a part of Rimsky's opera "May Night." Heretofore only the complete opera was available. The "Russian Easter" gets its 8th recording on LP and tops all competition as to performance, although the Paray and Stokowski versions come close. Soundwise it's a dead heat between this and the *Mercury* edition. Dynamic range here is exceptional, all orchestral elements are reproduced with extreme clarity and London once again essays a highly detailed big-hall sound with spacious acoustics. With the colorful program, the authoritative performances, and the splendor of the sound, this is a sure sales winner for London.

DVORAK

SYMPHONY #5 IN E MINOR
Vienna Philharmonic Orchestra conducted by Rafael Kubelik. London LL1607. RIAA curve. Price \$3.98.

You've heard the well-known phrase, "Nobody but Nobody Undersells Gimbels." Well with Dvorak's 5th symphony, nobody but Kubelik outdoes Kubelik. Six years have passed since Kubelik's memorable recording of this work with the Chicago Symphony. As one of the very earliest *Mercury* "Olympian Series" recordings this was the sonic wonder of its day and most critics were unanimous in their praise of performance and sound. But time does march on and now Kubelik is in London's camp and at the helm of the great Vienna Philharmonic.

I dug out the old recording and had a fine time comparing various sections as regards both performance and sound. I was amazed

PILOT and only PILOT

offers you peak performance
in high fidelity at low cost

3-in-1 COMPONENT UNITS

Pilot engineering and ingenuity at its best! Tuner, amplifier and preamp-audio-control built onto a single chassis for greatest convenience in assembling a high fidelity system. Only the speaker, and record player or tape recorder need be connected.



HF-42

Includes FM-AM Tuner with tuned RF stage and dual cascade limiter-discriminator FM circuit for maximum sensitivity - perfect quieting even with fringe signals; precise BEACON tuning indicator; AFC with disabling switch; 10 KC filter for AM; built-in FM and AM antennas; flywheel tuning.

Preamp-Audio Control with hum-free DC on tube heaters; tape head and phono inputs with separate equalization; bass and treble controls; loudness-contour and volume controls; tape recorder output.

Power Amplifier with less than 1% distortion at 20 watts rated output (40 watts peak); frequency response: 20 to 20,000 cycles, ± 1 db; built in rumble filter. Housed in handsome enclosure finished in brushed brass and burgundy.

Dimensions: 4 $\frac{1}{4}$ "h x 13 $\frac{1}{4}$ "w x 12 $\frac{1}{4}$ "d.

\$209.50 Complete

HF-30

Includes FM-AM Tuner with tuned RF stage for high sensitivity - perfect quieting even with fringe signals; precise BEACON tuning indicator; AFC with disabling switch; 10 KC filter for AM; built-in FM and AM antennas; flywheel tuning.

Preamp-Audio Control with phono and auxiliary inputs; bass and treble controls, loudness-contour and volume controls, tape recorder output.

Power Amplifier with less than 1% distortion at 12 watts rated output (24 watts peak); and frequency response: 20 to 20,000 cycles, ± 1 db; selector switch for independent or simultaneous operation of two speaker systems. Housed in handsome enclosure finished in brushed brass and burgundy.

Dimensions: 4 $\frac{1}{4}$ "h x 14 $\frac{1}{4}$ "w x 10 $\frac{1}{4}$ "d.

\$169.50 Complete



Make your own performance test of these component units at your Pilot dealer.

For complete specifications, write to Dept. DV-11

Prices slightly higher west of Rockies.

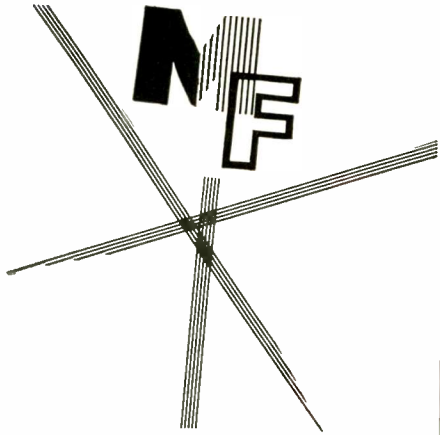

madison fielding FM TUNER SERIES 230



\$89.95

ULTRA-SENSITIVE PERFORMANCE WIDENS THE HORIZONS

0.9 microvolts for 20 db quieting makes possible a range of more than 150 miles.

EXCLUSIVE "DYNAMIC MICRO-BEAM TUNING SYSTEM"

ensures perfect "center of channel" visual tuning.

SPECIFICATIONS

SENSITIVITY:

Full limiting on 0.75 microvolt signal;
0.9 microvolts for 20 db quieting;
1.8 microvolts for 30 db quieting.

FREQUENCY RESPONSE:

Uniform within 1 db, 20 to 20,000 cycles.

INPUTS:

300 Ohm, balanced.

STABILITY:

No Drift—completely stable after 1 minute.

RADIATION:

Completely shielded; radiation far below F.C.C. requirements!

OUTPUT:

Cathode Follower stage output gives 3 volts for 100% modulated signal. Output lead may be up to 200 feet.



For complete catalog
see your local dealer or write

MADISON FIELDING CORPORATION
Creators of Distinctive Audio Instruments
861 Madison Street, Brooklyn 21, New York

that in the course of six years, Kubelik had changed his performance so slightly. In matters of tempi he is a hair faster in this new recording. As far as phrasing and dynamics and other forms of expression it was literally a carbon copy. On this new disc he gives the same powerful, spirited reading, displays the same humanity and warmth which characterized his earlier effort. Soundwise, the *London* has the edge but it is surprising how well the old recording stood up to the advance and progress in recording techniques. In the *London* the tympani are more sharply delineated and are cleaner, the strings of the Vienna orchestra are more full and rich-sounding than their Chicago counterparts. The brass is fairly equal in weight and brightness in the two discs, but acoustically the older disc has the advantage of Chicago's Orchestra Hall which is renowned for its brass sound. The woodwind were brighter and more articulate in the new recording. On over-all sound, the *London* is more extended in frequency response while the older recording still has a slight edge in dynamic range. Recording in each case was quite close-up affording superb inner detail in the orchestras, acoustic perspective broad in each case to allow maximum "presence." In the final impression, the *London* is undeniably the modern-sounding recording and breathtaking in its realism. Couple that with Kubelik's near definitive performance and this is obviously the recording of choice.

HI-FI WITH THE GRENADIER GUARDS

Band of the Grenadier Guards conducted by Major F. J. Harris. *London* LL1623. RIAA curve. Price \$3.98.

This is a darby of a band record. The Grenadier Guards are a first-rate, high-precision outfit, that plays with great vigor. They play six selections on this disc ranging from the "Grand March" from Verdi's "Aida," Suppe's "Light Cavalry Overture," to other less familiar and more "British" works. The sound is terrific on this disc, with the band displaying that huge brazen weightiness that seems to characterize British Service bands. The trombones and tubas give forth with powerful low frequency "oompah-oomphs," the trumpets are crisp and bright, the percussion very big, productive of some laudable "whumps" and clangorous clashing. Frequency was notably wide as were the dynamics. Needless to say, if you want to really appreciate the disc, play loud!

RIMSKY-KORSAKOV PIANO CONCERTO IN C SHARP MINOR

FRANCK
SYMPHONIC VARIATIONS
Philharmonic Symphony Orchestra of London conducted by Arthur Rodzinski.
SCRIABIN

PIANO CONCERTO, OP. 20
Paul Badura-Skoda, pianist, with Vienna Symphony Orchestra conducted by Henry Swoboda. Westminster XWN-18521. RIAA curve. Price \$3.98.

This record contains that which is old and new. In the early years of LP, Westminster gained considerable approbation when it issued the Rimsky-Korsakov and Scriabin piano concertos performed by Paul Badura-Skoda. These recordings were considered prime examples in the art of recording piano sound. Now on this disc, we have the original Scriabin performance, remastered and refurbished and the Rimsky-Korsakov is given the benefit of a brand new recording with Rodzinski conducting. In addition, because of modern cutting methods which allow more time on a disc, we have the bonus of a performance of Franck's "Symphonic Variations." The result is an outstandingly good

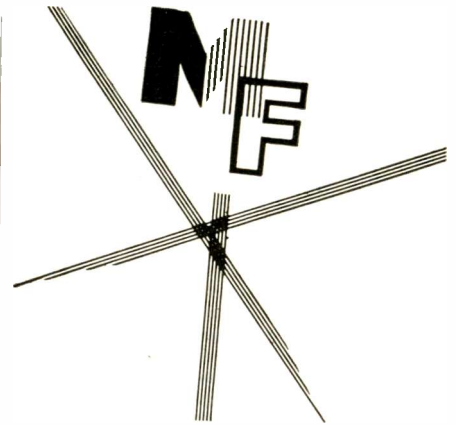

madison fielding introduces The NEW 20-Watt INTEGRATED AMPLIFIER SERIES 220

Featuring

'All-Transistor Pre-Amp Section'

NO HUM!
NO NOISE!
NO MICROPHONICS!



\$94.50

SPECIFICATIONS

POWER OUTPUT:

Constant at 20 Watts, within 1 db, 20 to 20,000 cycles.

FREQUENCY RESPONSE:

Uniform within 1/2 db, 20 to 20,000 cycles.
Uniform within 2 db, 10 to 75,000 cycles.

DISTORTION:

Less than 0.1% at 1 Watt.
Less than 1% at 20 Watts.

INPUTS:

Four High Impedance (500 K); One low-level for magnetic cartridges, tape-head playbacks, or microphone.

OUTPUTS:

4, 8, and 16 Ohms, low-level tape-recording jack.

CONTROLS:

Equalization-Selector (RIAA, LP, AES, 78, NARTB standard for tape-head playback, variable phono equalization facilities, and 3 high-level positions). Bass and Treble tone controls, with 20 db boost or attenuation at 20 and 20,000 cycles. Three Position Loudness Contour Control. Three Position Rumble Filter with sharp low frequency attenuation at 40 and 80 cycles.



For complete catalog
see your local dealer or write

MADISON FIELDING CORPORATION
Creators of Distinctive Audio Instruments
861 Madison Street, Brooklyn 21, New York

recording with sonic virtues on the same high plane as the original.

It is a tribute to *Westminster's* skill that the Scriabin concerto sounds as good as it does when compared to the newer Rimsky-Korsakov. The Rimsky is broader acoustically and has the edge in dynamics and frequency response, but the difference is amazingly little. Badura-Skoda has changed his interpretation of the Rimsky very little in the intervening years. His fingering seems more assured and confident, his tone is fuller, pedal work more accurate. Except for the somewhat faster tempi and the more precise phrasing, it is almost a mirror image. In the Franck "Variations," Badura-Skoda gives a fairly eclectic reading, somewhat more free-flowing and rhapsodic than most, but lacking the degree of warmth and expression afforded by Gieseking or Casadesu. Piano tone throughout the disc is rich and full, free from transient distortion and blameless of wow or flutter. Rodzinski's accompaniment is quite estimable and the orchestral sound a crisp clean complement to the piano.

MENOTTI

THE UNICORN, THE GORGON AND THE MANTICORE

A Madrigal Fable for Chorus, Ten Dancers, and Nine Instruments. Conducted by Thomas Schippers. Walter Baker, chorus master. Angel 35437. RIAA curve. Price \$3.48, standard package.

This is versatile Gian-Carlo Menotti's latest work and an entirely new departure for him. Here he looks backward in musical time to the form of the madrigal which flourished everywhere in Europe during the 15th century. If you remember the repetition and counterpoint of "Three Blind Mice" . . . that's the same sort of thing that makes a madrigal. Menotti has written a madrigal fable, charming and delightful in its blend of whimsy and wisdom and with more than a few philosophical overtones. The work was performed by the New York City Ballet in January of this year, to great critical acclaim. Menotti's music is a perfect complement to his brilliant text, having a definite rhythmic beat setting the mood for the repetitions of the chorus.

There are twelve madrigals in the setting of the story and some of these are separated by brief instrumental interludes, while some others are accompanied by the music. The scoring is very interesting utilizing a flute, oboe, clarinet, bassoon, trumpet, violincello, bass, harp, and percussion. Madrigal singing imposes a severe task on any chorus and it is a credit to the chorus master, Walter Baker, the way the chorus handles the difficult phrasing and manages to keep everything reasonably articulate. Schippers has very little trouble in getting what he wants from his top-notch instrumentalists. The sound is wonderful throughout the score, the chorus clean-lined and pure of tone, the orchestra alive with crisp detail. Although this work has large visual elements in it, this does not unduly detract from its aural enjoyment. Not everyone may like this sort of recording, but if you have a craving for the unusual and the beautiful, this will certainly meet your requirements.

That clears up some of the tremendous backlog of records which, surprisingly, accumulated during the so-called "slow" summer months. Now that the fall cutting and pressing season is again in full swing, with orchestras and artists back from the music festivals both at home and abroad, records should be arriving in succulent batches. When it comes to anticipating the new fall crop of discs, your reviewer becomes a starry eyed fan just like most of his readers!

See you next month with news of the newest of new at the Audio Fairs and lots of reviews of the recent discs.

Look . . . only the
Fluxvalve
has 100%
IQF*

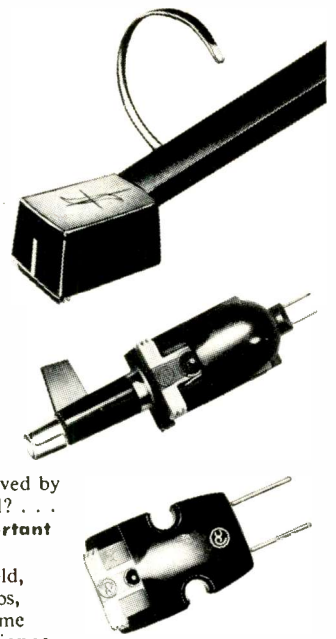

Choice of the *best* phonograph pickup can *only* be resolved by comparison! What is the yardstick? . . . How can you tell? . . . What do you look for? . . . the answer is 100% **Important Quality Features!**

PICKERING has had long experience in the cartridge field, supplying the finest quality products for recording studios, broadcast stations, wired music services, and high fidelity home music systems. As a result of this extensive experience, PICKERING has developed the **FLUXVALVE** . . . the *one* cartridge which incorporates *all* of the **Important Quality Features** . . . so necessary for high fidelity reproduction from records.

Before you choose a cartridge . . .
LISTEN AND COMPARE . . . demand 100% IQF*!

Feature	FLUXVALVE	Cartridge A	Cartridge B	Cartridge C
Frequency Response. Flat 20-20,000 cps ± 2 db (see curves on right)	YES 20 Points	NO 0 Points	NO 0 Points	NO 0 Points
Low Tracking Force. 2.4 grams	YES 20 Points	NO 0 Points	YES 20 Points	NO 0 Points
High Output, No Transformer Required	YES 10 Points	NO 0 Points	NO 0 Points	YES 10 Points
Replaceable Stylus	YES 10 Points	NO 0 Points	NO 0 Points	YES 10 Points
1/2 Mil Stylus	YES 15 Points	NO 0 Points	NO 0 Points	NO 0 Points
One Cartridge For LP's and 78's	YES 5 Points	NO 0 Points	NO 0 Points	YES 5 Points
Anti-Hum Design	YES 10 Points	YES 10 Points	YES 10 Points	YES 10 Points
Hermetically Sealed	YES 10 Points	NO 0 Points	NO 0 Points	NO 0 Points
TOTAL POINT VALUE	100%	10%	30%	35%

THE FLUXVALVE . . . chosen time and again as the *top* cartridge solely on the basis of *listening quality* . . . by panels of qualified experts . . . tests which have proven that it is *actually* less costly to own a **FLUXVALVE**.

The **FLUXVALVE** preserves the quality and prolongs the life of your record since there is complete absence of resonances throughout the audio range.

It may interest you to know that the **FLUXVALVE**, because of its ability to make *precise* and *reproducible* record measurements, is used for calibrating recording channels and record masters.

Make the IQF* test today . . . listen to your favorite record reproduced with a **FLUXVALVE** . . . the *gentle* pickup.



IMPORTANT QUALITY FEATURES
—so necessary for high fidelity reproduction from records.

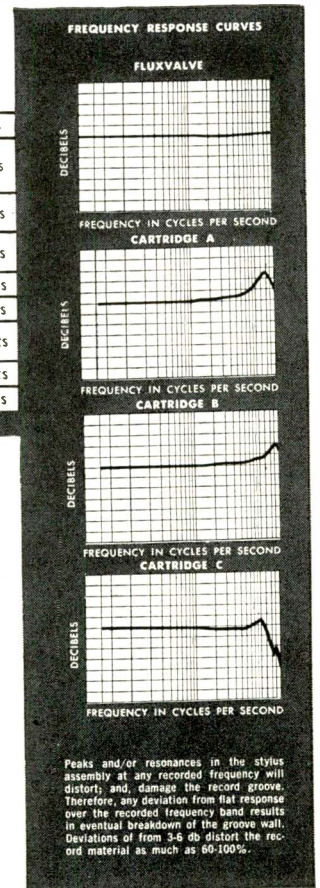

Series 194D UNIPOISE Pickup Arm with **FLUXVALVE** Cartridge.

Model 194D with 1 mil diamond "T-Guard" stylus \$59.85
Model 194D with 2.7 mil diamond "T-Guard" stylus 59.85
Model 194 5D with 1/2 mil diamond "T-Guard" stylus 65.85

SERIES 3500 "T-Guard" STYLUS

S-3510	1 mil Sapphire	6.00	370-15	1 mil Sapphire	17.85
S-3527	2.7 mil Sapphire	6.00	370-25	2.7 mil Sapphire	17.85
D-3510	1 mil Diamond	18.00	370-10	1 mil Diamond	29.85
D-3527	2.7 mil Diamond	18.00	370-20	2.7 mil Diamond	29.85
D-3505	1/2 mil Diamond	24.00	370-50	1/2 mil Diamond	35.85

SERIES 370 SINGLE FLUXVALVE

350-00	1 mil Diamond	17.85
350-500	1/2 mil Diamond	17.85
350-05	1 mil Diamond/2.7 mil Sapphire	29.85
350-00	1 mil Diamond/2.7 mil Diamond	29.85
350-050	1 mil Diamond/1/2 mil Diamond	35.85

SERIES 350 TWIN FLUXVALVE

350-00	1 mil Diamond	36.00
350-500	1/2 mil Diamond	42.00
350-05	1 mil Diamond/2.7 mil Sapphire	42.00
350-00	1 mil Diamond/2.7 mil Diamond	54.00
350-050	1 mil Diamond/1/2 mil Diamond	60.00

For those who can **hear** the difference FINE QUALITY HIGH FIDELITY PRODUCTS BY



PICKERING & COMPANY, INC., Oceanside, N. Y.

The Exciting **NEW** Anniversary Series by **FISHER**

IT IS APPROPRIATE that Avery Fisher, pioneer maker of high fidelity instruments, should mark his twentieth year of engineering leadership with the introduction of the new, FISHER Anniversary Series. In this group of outstanding instruments will be found two FM-AM tuners and the very latest of FISHER audio amplifiers.

Nothing we can say here, no photographic illustration we reproduce, could possibly convey the giant step forward represented by these new models. They will serve to establish even more firmly the leadership that Fisher equipment has held these two decades. Be sure to visit your high fidelity dealer soon, to see the Anniversary Series — and best of all, compare their performance to any competitive equipment — *regardless of price*. You are in for the most pleasant surprise of your hi-fi life!

Write today for complete specifications.



FISHER RADIO Corporation

21-23 44th Drive • Long Island City 1, N. Y.



THE FISHER

Model 90-R • FM-AM TUNER

■ Combining engineering excellence and dazzling performance, THE FISHER 90-R is truly representative of the renowned FISHER tradition for quality. Providing both maximum sensitivity and maximum signal-to-noise ratio, **without compromise**, the 90-R may even bring in FM stations before you have connected the FM antenna! Incorporating the celebrated FISHER Gold Cascode RF amplifier, and companion circuitry, the 90-R has a rated sensitivity as low as 1 microvolt—with AM sensitivity better than 3 microvolts at full output. The exclusive, new **Microbeam Tuning Indicator** provides ease of tuning **never before possible**—and is more accurate on weak signals than a meter or conventional tuning eye. Still another FISHER exclusive, the new, three-position **Push-Button FM Muting and AM Bandwidth Selector** effectively eliminates both interstation noise and annoying on-station side-response distortion. The most advanced FM-AM tuner in the world today, THE FISHER 90-R is a superb, professional instrument.



■ Outstanding specifications of the 90-R include: ■ 1 microvolt FM sensitivity for 20 db of quieting; 1.6 microvolts for 30 db of quieting, using 72-ohm antenna. ■ FM sensitivity 2 microvolts for 20 db of quieting; 3.2 microvolts for 30 db of quieting, using 300-ohm antenna. ■ 12 tuned circuits, including 3 variable. ■ Gold Cascode RF Amplifier stage. ■ Entire front end features silver-plated shielding against undesirable noise, interference and radiation. ■ Special antenna input circuit on FM and AM accommodates five different kinds of antenna connections. ■ Four IF amplifier stages provide maximum bandwidth while maintaining maximum selectivity. ■ Dual Dynamic Limiters for instantaneous limiting of random and impulse-type noise. ■ Wide Band Ratio Detector. ■ High capture ratio eliminates co-channel interference. ■ Uniform frequency response from 20 to 20,000 cycles within 1 db. ■ Delayed AGC for constant audio output. ■ FM Dipole antenna included. ■ Antenna input accommodates 300-ohm or 72-ohm external antenna. ■ Separate AM front end with 9 tuned circuits, including 3 variable. ■ AM sensitivity better than 3 microvolts for full rated output. ■ Special antenna input designed for maximum signal-to-noise ratio. ■ Convenient antenna terminal and switch permits choice of ferrite loop or external antenna. ■ Tuned RF amplifier stage has constant bandwidth over tuning range for optimum fidelity-to-selectivity ratios. ■ Two IF amplifier stages featuring three-position push-button controlled adjustable bandwidth. ■ IF bandwidth 18 Kc in Broad, 11.5 Kc in Medium, and 6 Kc in Sharp positions. ■ AM Detector circuit incorporates separate diode and operates without distortion even on high-modulation broadcast signals. ■ Special Bridged-T circuit design of 10-Kc sharp cut-off filter assures complete suppression of undesirable adjacent-channel interference, or heterodyne "whistle." ■ Two low-impedance, high-level outputs, one for amplifier and one for recording. ■ Hum and Noise Level: 77 db below signal for 2 volts output. ■ Die-cast, three-dimensional brushed-brass escutcheon. ■ Large, brilliantly illuminated dial with logging scale. ■ Pin-point indicator lights for FM muting or AM bandwidth. ■ Smooth, fly-wheel tuning. ■ 12 tubes including Microbeam Tuning Indicator, plus 6 crystal diodes. ■ Size: 15½" wide x 10½" deep x 7" high. ■ Shipping Weight: 21 pounds.

Chassis, **\$199.50**

Mahogany or Blonde Cabinet, \$19.95

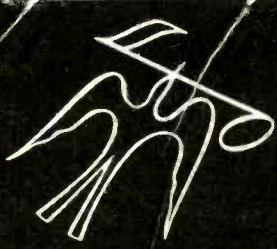

THE FISHER

Model 90-T • FM-AM TUNER

■ If any FM-AM tuner possibly can offer more in performance and engineering than the 90-R, it is the equally new, FISHER Model 90-T. Here is the identical, extreme-sensitivity FM-AM tuner as the 90-R—with the Gold Cascade RF amplifier, Microbeam Tuning and Push-Button FM Muting—AM Bandwidth Control—plus an audio control center incorporating stimulating new concepts in design and engineering. A new FISHER feature, the Presence Control, creates the concert-hall effect of emphasizing and bringing forward from the orchestra, instrumental and solo passages. A three-position, sharp cut-off Rumble Filter eliminates low-frequency noise with minimum possible loss of frequency response. A similar, three-position, sharp cut-off Noise Filter suppresses noise, interference and other annoying high-frequency effects such as static, record scratch and high-frequency distortion. The additional tuner specifications of the FISHER 90-T FM-AM tuner are identical to the new FISHER 90-R.

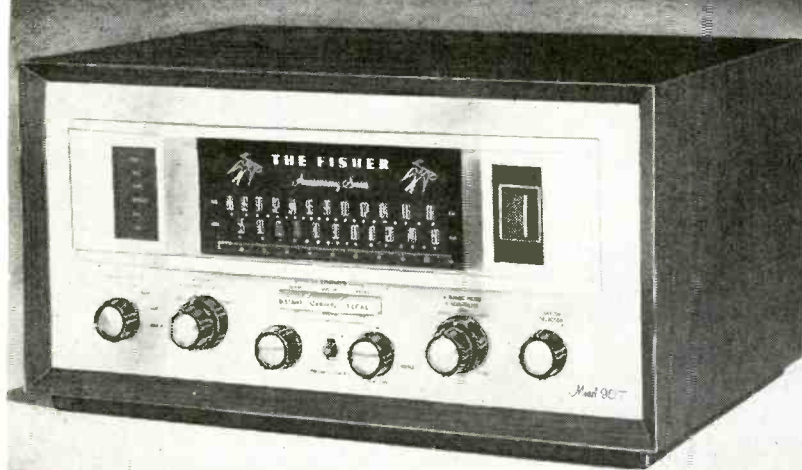

■ The four input jacks of the control center can accommodate a low-level magnetic phonograph cartridge and a tape playback head, plus a stereo channel, TV sound, a ceramic, crystal or FM cartridge, tape recorder or other high level signal source. ■ Two output jacks provide a low-impedance connection for use with an amplifier or separate signal for recording. ■ Less than 0.1% distortion for 3 volts output, with uniform frequency response from 25 to 40,000 cycles, within 1 db. ■ Hum and noise level better than 80 db below signal for 2 volts output. ■ High-gain, two-stage preamplifier for low-level phonograph cartridges and tape playback head. ■ Three-positions of equalization for all makes of recordings, plus standard NARTB tape equalization. ■ Individual bass and treble controls for complete, personal tonal adjustment. ■ Master Volume Control eliminates need for separate volume controls on associated equipment. ■ Four-position Loudness Contour Control accurately compensates for the natural loss in hearing sensitivity at low listening levels. ■ Die-cast, three-dimensional brushed-brass escutcheon. ■ Large, brilliantly illuminated dial with logging scale. ■ Pin-point channel indicator lights. ■ Smooth, fly-wheel tuning. ■ 15 tubes including Microbeam Tuning Indicator, plus 6 crystal diodes. ■ Size: 15½" wide x 10½" deep x 7" high. ■ Shipping Weight: 23 pounds.

Chassis, **\$239.50**

Mahogany or Blonde Cabinet, \$19.95

THE FISHER

Model 125-AX Audio Amplifier

■ 125 Watts! THE FISHER Model 125-AX sets new standards for power amplifiers—from the standpoint of design, performance and reliability. Its exceptionally high power output and significantly low distortion provide the ideal combination for quality reproduction, with ample reserve power for every requirement of the music connoisseur or professional user. The 125-AX is ideal for use with the most critical recording and laboratory instruments, in addition to the newest, low-efficiency and cone-type speaker systems.

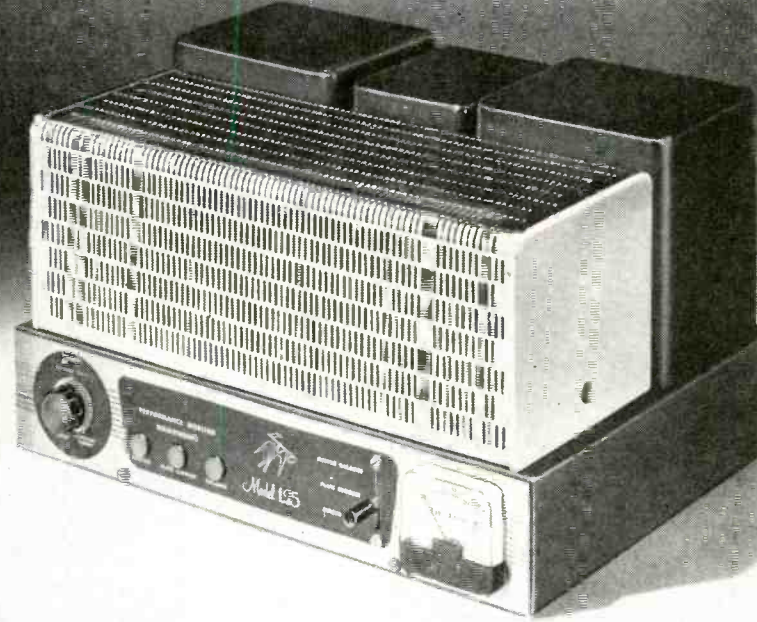

■ Outstanding specifications of the new FISHER Model 125-AX audio amplifier include: ■ 125 watts with normal program material. ■ 90 watts continuous sine wave duty. ■ Harmonic distortion less than 0.6% at 125 watts; less than 0.5% harmonic distortion at 90 watts. ■ Two separate power supplies, assuring optimum amplifier operation. ■ Unique, illuminated FISHER Performance Monitor meter indicates correct adjustment of output tube bias, screen voltage and output balance—and shows average power in watts. ■ Less than 1% IM distortion at 90 watts; less than 2% IM distortion at 125 watts (measured 60/3000 cycles at 4:1). ■ Frequency response within 0.25 db, 20 to 20,000 cycles. ■ Hum and noise better than 92 db below full-output. ■ 4, 8 and 16-ohm speaker output impedances, plus 70.7-volt output at 90 watts. ■ Power socket supplies all necessary voltages for operation of unpowered, external components. ■ Exclusive FISHER Z-Matic, a variable damping factor control with three times the range of ordinary controls of this type, assures a perfect impedance match between the amplifier and speaker system. ■ Total of eight controls: Input Level, Speaker Impedance Switch, Meter Switch, Bias, Screen Voltage, Output Balance, Driver Balance, Z-Matic. ■ Tube Complement: Total of 12, including 2 neon regulators—1-12AU7, 1-12AX7, 4-EL34 (6CA7), 1-6Y6, 1-6AU6, 2-5R4GY, 2-NE16. ■ Size: 14" wide x 11½" deep x 8¾" high. ■ Shipping Weight: 55 pounds.

Model 125-AX, **\$229.50**

Model 125-A, with 8 and 16-ohm outputs only, \$219.50

this.....

makes
this

when you buy
the fabulous

AUDAX TONEARM KIT

A screwdriver... 15 minutes of your time... and the fabulous Audax tonearm kit — that's all you need to own your own compass-pivot Audax Professional Tonearm at a big saving! You'll find accurate assembly of this exclusive kit a very simple affair — with assurance that the final result will be as fine as factory-assembled units! Use any cartridge with your Audax arm. Thrill to the wonderful new difference it makes in your high fidelity system! See your dealer right now!

12" Tonearm Kit \$14.55 16" Tonearm Kit \$17.55 RA5

AUDAX • Div. of Rek-O-Kut Co., Inc., Dept. RTN 38-19 108 St., Corona 68, N. Y.

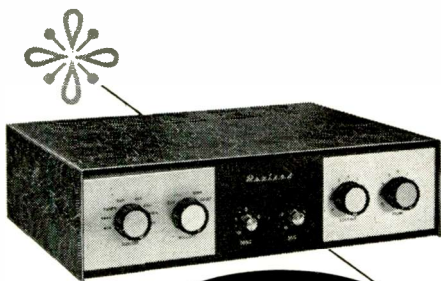

Rauland

Golden Series HI-FI



The "GOLDEN CREST" 20-Watt Amplifier... with continuously variable contour control for Fletcher-Munson correction...

one of a complete line of advanced design high fidelity tuners, amplifiers and components...

hear these quality RAULAND units at your Hi-Fi dealer or write for details...

RAULAND-BORG CORPORATION

3515 W. Addison St., Dept. T, Chicago 18, Ill.

Now, from

TELEFUNKEN

makers of the world's best professional microphones...

NEW DYNAMIC MICROPHONES

...for lifelike reproduction of both speech and music.



Because of its above average frequency response, this moving coil Telefunken microphone maintains fidelity of performance even in close-up talking. Distortions, often disturbing at low and high frequencies, do not occur with this microphone.

Impedance: 200 ohms. It is also available in 50 ohms impedance on special order. \$49.00

ACCESSORY: Mounting equipped with swivel head with 3/8" + 27 stand thread for mounting on floor, desk or boom. \$16.00

WRITE FOR COMPLETE ILLUSTRATED CATALOG OF OTHER TELEFUNKEN DYNAMIC MICROPHONES, PRICED FROM \$43.00 TO \$93.50.

Exclusive U.S. Importers
AMERICAN ELITE, INC.
Dept. R1, 7 Park Ave., New York 16, N. Y.

Coax Line R.F. Monitor

(Continued from page 43)

metal enclosure. The two coaxial connectors should be mounted close together and their center studs connected by a heavy wire. Resistors R_1 and R_2 should be soldered directly from the coaxial circuit to the nearest available ground point, preferably to one of the coaxial connector mounting screws. The resistors should be spaced away from other metal parts in order to prevent stray capacities which might upset the characteristic impedance of the line.

Inspection of the photographs will show the mechanical arrangement of the author's monitor. The case is a standard 3"x4"x5" aluminum box. On the front panel are mounted the microammeter, S_1 and J_3 . Calibrating resistors R_3 and R_4 are mounted on the right side of the box, while transformer T_1 is atop the chassis on the left. The following components are mounted on a terminal strip at the back of the case: R_1 , R_2 , CR_1 , RFC_1 , and C_1 . Care should be taken in the soldering of the crystal diodes to prevent damage from excessive heat. This can be accomplished by holding the leads with long-nose pliers while soldering.

Accurate calibration of the monitor for observation of modulation percentage requires the use of another modulation indicator of known accuracy or an oscilloscope capable of showing the trapezoidal or wave-envelope modulation pattern. With the instrument connected in position in the coaxial line, but before applying power, turn both R_3 and R_4 to zero (arm at ground end). Throw switch S_1 to the "MOD." position. Turn on the transmitter and adjust for 100 percent sine-wave modulation, using an audio oscillator or some other steady signal source. Turn up R_3 until the reading on the meter comes up to a point arbitrarily picked for 100 percent modulation. Now throw S_1 to the "R.F." position and increase R_4 until the indication is the same as that obtained in the "MOD." position. From this point, the setting of R_4 should be left unchanged. Any future adjustment necessary to bring the r.f. reading to the reference point should be done with R_3 . Due to the nature of speech waveforms, 100 percent voice modulation indications will occur at 60 to 70 percent of the sine-wave reading. Thus, if an audio oscillator gives a reading of 100 on the meter for full modulation, then average speech readings should be around 60 or 70.

This little instrument will work with transmitters of any power and on any frequency. It really comes into its own in v.h.f. applications where other types of indicators frequently fall down. Perhaps one of the best features is that the monitor will permit compliance with FCC regulations regarding the checking of modulation percentage.

-50-

RADIO & TV NEWS

Electro-Voice®

**BUILDS
"TEMPLES OF TONE"
IN YOUR HOME**



Patrician 600, Mahogany, Net \$819.00

These are the Tasks Performed by Specialized Driver Units in the Famous PATRICIAN

Very High Section. This octave adds the final touch to the illusion of musical reality. Its upper harmonics, tingling and effervescent, impart delightful brilliance to music. The range above 3,500 cps, extending well beyond the range of hearing, is reproduced by the E-V Model T350 Super-Sonax very-high-frequency driver. Through the Model T350, the remaining octaves of the upper audible register are completely accomplished with no measurable distortion.

Treble Section. At usual listening levels the ear is most sensitive in this portion of the audible spectrum. Augmenting the power in these octaves enhances the magical illusion of "presence." You are there. From 600 to 3,500 cps or the next 2½ octaves, the Electro-Voice Model T25A treble driver exhausts into a 600-cycle Model 6HD diffraction horn. This diffraction horn is of the latest design and employs the principles of optical diffraction to disperse high frequencies uniformly. Thus the important "presence" range is assured of complete and proper transmission by this specialized driving unit. Other frequencies, not a part of this range, are completely excluded from this driver.

Mid-Bass Section. Because the ear is fairly sensitive in this range, almost all reproducers handle it with facility. A separate horn employed as an indirect radiator with its two complimentary Model 828HF driver units takes over for only the next 1½ octave range to 600 cps. Because no metal horn presently developed satisfactorily reproduces down to 200 cps, the horn load for the intermediate bass drivers is fabricated of wood and phenolic tubes. These are a part of the overall interior assembly.

Low-Bass Section. Only the finest high-fidelity systems reproduce these lowest tones, down to the threshold of feeling in the first octave. Except for the organ, most serious music is written for the second octave and above. The Patrician IV utilizes an 18-in., low-frequency driver, Model 18WK. When the Patrician is placed in a corner, the entire room becomes a part of the bass horn, allowing the large wave lengths of the second and the upper part of the first audible octave to be formed properly.

Crossover Network. To allocate the various portions of the spectral energy to the respective driver units, the Model X2635 crossover network divides the amplifier power into four separate portions, and eliminates upper harmonic and intermodulation distortion from one driver in the region covered by the next.

Octaves
and Frequencies

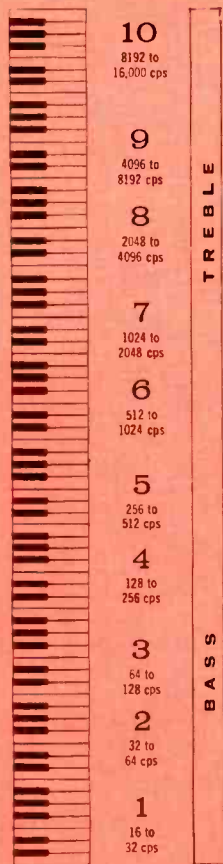

TREBLE

BASS



Model T350
VHF Driver



Model T25A
HF Driver with
Model 6HD Horn

Model 828HF
Drivers with
A8419 Horns

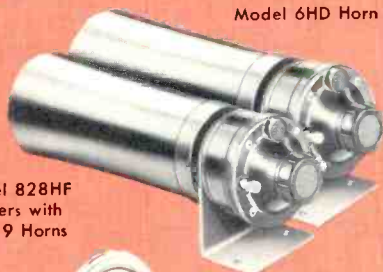

Model 18WK
LF Driver

This is the famous Electro-Voice Patrician 600 speaker system. Model 115 Interior Horn Assembly, Net \$190.00 Components Model 103E System, Net \$431.00



...These Important Points will help you to choose easily the

a



Model T2BW,
Net \$35.00



Model T5W,
Net \$89.00

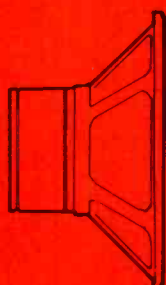

Model 18W,
Net \$120.00

a Which LOUDSPEAKER DIAMETER should you select?

The diameter of the loudspeaker governs the bass response range which can be achieved in simple enclosures of a certain size. Choice of the diameter therefore depends upon the size of the cavity in the enclosure. *Electro-Voice* offers a wide selection of enclosures to fit various size speakers. Smaller diameter drivers will deliver extended bass range in cavities of smaller volume. However, the additional cone area of a large 15-inch unit allows about 2 db more efficiency (almost twice the acoustic output) when used in a proper size cabinet. This increase is quite noticeable to the ear. Some 15-inch drivers employ heavier magnet structures and provide greater efficiency in smaller enclosures without further bass extension, but in a larger enclosure of proper acoustic size, the large diameter loudspeaker will give both greater power-handling capacity and lower range bass response, with less distortion. Indirect Radiator Corner Horns are designed around *Electro-Voice* speakers or drivers of specific diameters, and changing from the designed size to another will degrade both range response and efficiency. In infinite baffles, or in very large cavities, the 15-inch and 18-inch diameters deliver the most extended bass range.

b

later you can add



Model SP12,
Net \$66.00



Model T35,
Net \$35.00

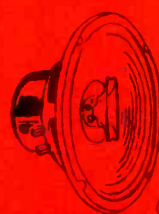

Model 15TRX,
Net \$149.00



Model 8HD,
Net \$18.00



Model T25A Driver,
Net \$58.00



b COAXIAL versus INTEGRATED 3-WAY DRIVERS

Should you purchase a narrower-range coaxial unit with large magnet, or a wider-range integrated 3-way unit with lighter magnet when the prices are comparable? This question can be answered only by you, bearing these points in mind: Choose integrated 3-way units if you have established their price as your ultimate expenditure. While distortion is slightly greater with lighter magnets, the wider range offered presents the best value. The *Electro-Voice* Model 15TRX is an excellent integrated 3-way speaker with a 5 3/4 lb. magnet. There is little distortion with this speaker. Choose the coaxial unit with large magnet when you wish later to add, in step with the budget, mid-range and very-high-frequency components eventuating in an *Electro-Voice* deluxe system of highest quality.

c

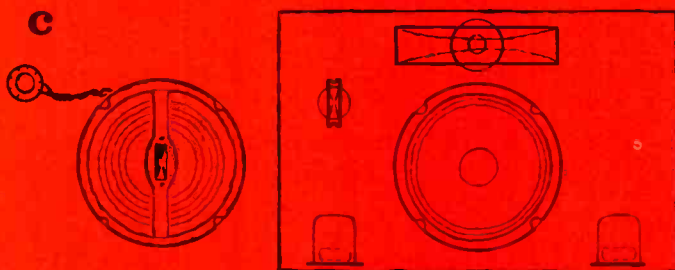

c Choosing between INTEGRATED and SEPARATE 3-WAY SYSTEMS

In integrated, or unitary 3-way driver systems, the crossover point from bass to treble is dictated by the space available within the cone apex. This means a higher crossover frequency is necessary than that achieved with separate multi-way combinations. Integrated speakers make their appeal to the common desire for a compact assembly, although actual speaker space is dictated by the cavity or housing required for extension of the bass range. This volume is the same for both integrated and separate multi-way systems with bass cones of the same diameter. In separate multi-way systems, there is no compromise on treble component size or crossover point. The higher frequencies are dispersed more efficiently and with less distortion. The cost is greater but well worth it if the budget allows.

d



Model X6,
Net \$39.00



Model 8HD,
Net \$22.00

Model T25A Driver with Model 8HD Horn,
Net \$58.00



Model X8,
Net \$32.00



Model 8HD,
Net \$18.00

Model 10A,
Net \$42.50



Model T35,
Net \$35.00



Model T350,
Net \$60.00

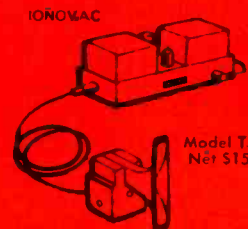

Model T3500,
Net \$150.00

d How to select CROSSOVER NETWORKS and the HIGHER-FREQUENCY HORNS

The size of the mid-bass, treble and very-high-frequency horns determines the crossover point or frequency at which the transition from the lower driver to the higher one should take place. All *Electro-Voice* high-frequency driver specifications list the recommended lowest crossover point. You may cross over higher but never lower than this frequency or irregular response will result. The larger the higher-frequency horn, the lower can be the crossover point employed. The lowest possible crossover from the cone-type driver should be chosen because this will reduce system intermodulation distortion. But the size of the treble horn sometimes enters the picture. For instance, the *Electro-Voice* 6HD 600-cycle horn is too deep to fit in the *Aristocrat* enclosure. The smaller, lower cost 800 cps Model 8HD horn fits perfectly and calls appropriately for the Model X8 800 cps crossover. The *Electro-Voice* Model T35 is recommended as a very-high-frequency driver at a moderate price while the Model T35B gives VHF reproduction for multi-way systems with medium efficiency. The *Electro-Voice* Model T3500 Ionovac offers the ultimate for those who desire the very finest in smooth, extended high-frequency reproduction. Its notably smooth high response reaches well into the ultrasonic range. A glowing violet "cloud" of ionized air replaces the speaker diaphragm in this radical new approach to reproduction of the higher octaves. It must be remembered that the efficiency of any speaker depends upon the magnet weight and *Electro-Voice* has a great variety for every purpose to choose from.

Speaker Equipment best suited to your musical taste and budget

e

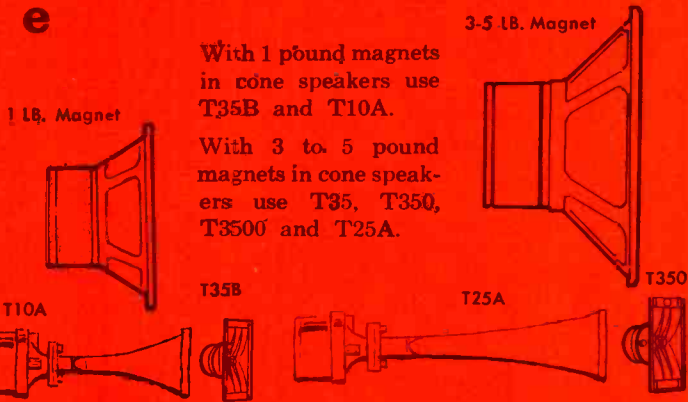

With 1 pound magnets in cone speakers use T35B and T10A.

With 3 to 5 pound magnets in cone speakers use T35, T350, T3500 and T25A.

e The meaning of RETMA SENSITIVITY RATINGS and how you should use them in choosing MULTI-WAY COMPONENTS

The Radio Electronic and Television Manufacturers Association has established a method of rating the acoustic output of a driver for a given power input. The higher this rating, the more efficient is the driver. Granting good design, the larger magnet structures will deliver the greatest efficiency with the least distortion. A high RETMA sensitivity rating, therefore, is one of the hallmarks of excellence. *Electro-Voice* is proud of its high RETMA ratings. Make certain that the *sensitivity ratings of the mid- and high-frequency units are comparable*, otherwise musical imbalance between one portion of the reproduced spectrum and the other will result. The E-V Model AT37 Level Control will offset this discrepancy when very-high-efficiency drivers are employed.

f

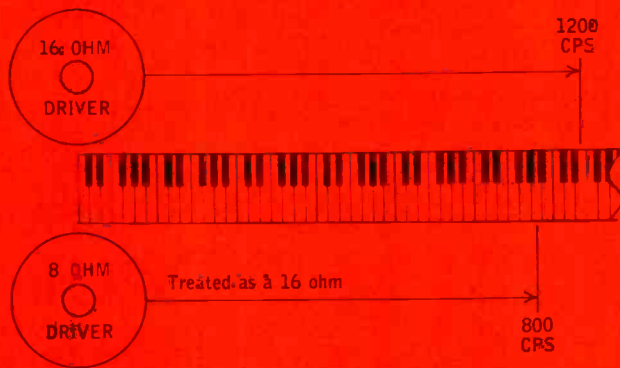

f Here is the significance of IMPEDANCE RATINGS and what they mean to you

There has been a tacit acceptance among most high-fidelity manufacturers of the 16-ohm impedance as the standard for high-fidelity systems. This makes economic sense, for an 8-ohm impedance would require double the value of condenser and therefore more than double the final cost of the crossover network. Higher impedances are not used commonly, for the speaker manufacturers find difficulty in avoiding voice coil losses due to winding with finer wire. An 8-ohm bass unit can be used properly by treating it as a 16-ohm unit and keeping the crossover point below 800 cps. This will sacrifice some efficiency in the upper register but will actually cause an increase of efficiency below 100 cps.

g

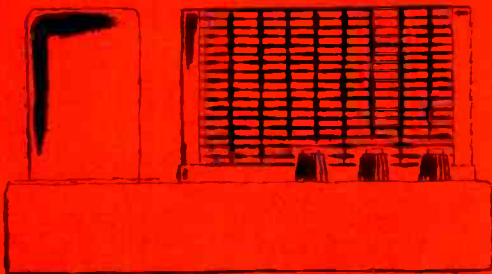

g What the ELECTRO-VOICE CRITICAL DAMPING FACTOR RATING means in enhancing speaker performance

Every *Electro-Voice* cone speaker specifies a certain CRITICAL DAMPING FACTOR to which the amplifier should be adjusted to insure an optimum distortion-free bass response and flatness of frequency response. Most, but not all, quality amplifiers have a variable damping control. The recommended setting for the particular speaker and the type of enclosure in which it is employed should be used to achieve the utmost in musical enjoyment.

h

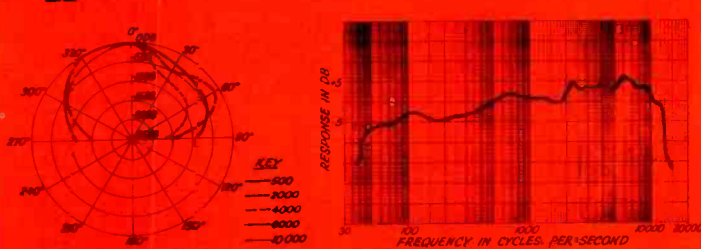

What do FREQUENCY RESPONSE CURVES mean in the selection of loudspeakers and components?

Curves are very important provided that the viewer is instructed in the interpretation of them. It is vital that the manner in which the curves are run be stated and that the environment of the loudspeaker under test be recognized and evaluated. A frequency response curve alone, even with complete corollary data mentioned, gives no hint as to how the speaker will sound in a living room unless *polar curves* are included. Polar curves show *distribution of energy* throughout the listening area and the response and polar curves form an excellent measure of quality when judged with each other.

Electro-Voice®

Here Is The Story of Electro-Voice Superiority!

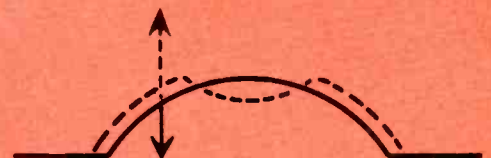
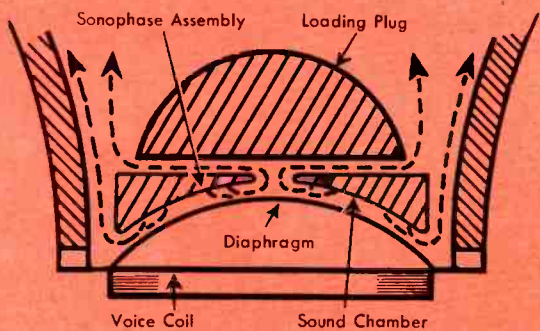

Action of diaphragm at higher frequencies. Dotted line shows departure from piston action.

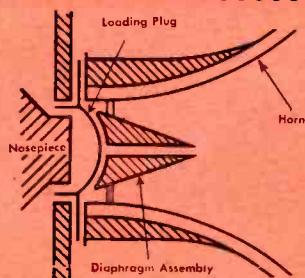

Avedon Throat Design

The unique throat design illustrated here overcomes a problem common in conventional high-frequency drivers. This is diaphragm deformation at high-frequencies occurring at frequencies above 5-kilocycles. Piston action is destroyed, the phase is shifted and the result is destructive interference. Electro-Voice UHF Drivers solve the diaphragm deformation problem with a longer sound path from the center of the diaphragm. This restores proper phase relationship. This is especially important above 12-kilocycles where sound must be taken from the center of the diaphragm and from the outer edge simultaneously. The first diagram shows E-V's Avedon construction. Diagram 2 shows what happens in a conventional high-frequency driver. There is excellent response up to 4- or 5-kc. But beyond this, destructive interference results from the diaphragm's inability to act as a piston. Diagram 3 shows the conventional high-frequency driver. Increasingly higher frequencies cause the phase to shift due to central diaphragm deformation.

The Hoodwin Diffraction Horn

This is the Electro-Voice development which is used in all E-V horns to disperse sound *equally* in all lateral directions from a single point source. This is especially important in stereophonic reproduction to preserve the undistorted depth and width of the original sound. Diffraction horns insure balanced levels throughout the room from both right and left speakers.

These Great Electro-Voice Speaker Features Assure Quality Reproduction

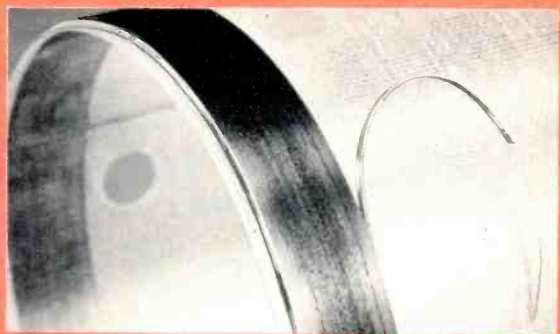

1



2



3

Heaviest Magnetic Circuits

Lowest distortion and greatest range. The heaviest, most powerful magnetic structures in their price class.

Hidden Parts are Precision Ground

Perfect assembly. E-V internal parts have watch-jewel accuracy.

Specialized Adhesives and Plastics

To achieve the lightest but most rigid moving mechanism possible, recent advances in thermosetting adhesive compounds are used in *Electro-Voice* drivers and loudspeakers.

High Pressure Die-Cast Frame Assemblies

Lifetime durability. Rigid frame or basket assemblies of E-V cone-type speakers or drivers are designed to support the magnet weight and prevent any bending of the precision magnet structure.

1 Voice Coils of Edgewise-wound Ribbon

Electro-Voice utilizes edgewise-wound pure aluminum ribbon voice coils in all full-range reproducers. This provides 18% more efficiency. Even under hard driving, this greater structural rigidity gives greater power-handling capacity and assures finer reproduction.

2 Moisture-Resistant Cones and Suspension Spiders

E-V speakers deliver sustained quality response because both high- and low-frequency driver cones are specially treated to prevent moisture-absorption even in regions of high humidity.

3 Tough One-Piece Molded Cones

Heavy, compliant, ribbed one-piece molded bass-driver cones lower displeasing transient and harmonic distortion. Used in E-V speakers, a naturalness of response for greater listening pleasure is the result.

NO FINER CHOICE THAN—

Electro-Voice

ELECTRO-VOICE, INC., BUCHANAN, MICHIGAN

Within the Industry
(Continued from page 32)

of **NEMS-CLARKE, INC.**, Silver Spring, Md. The latter will become an operating division of the parent organization . . . A change in the corporate name of the hermetic seal division of the **PHILIPS CONTROL CORPORATION**, Joliet, Ill., has been announced. The new name is **PHILTROL SEALS, INCORPORATED**, changed from **SUPERIOR HERMETIC SEALS COMPANY**. . . Jerome J. Kahn, former president of **STANDARD TRANSFORMER CORPORATION**, has acquired a majority interest in the **ADORN COMPANY**. He announces that the corporate name will be changed to **ADORN PLASTIC SPECIALISTS, INC.** . . . **VICLAD INDUSTRIES, INC.**, has acquired the **ALDEN WIRE CORPORATION** . . . **THE NARDA CORPORATION** has changed its name to **THE NARDA MICROWAVE CORPORATION** . . . **LING ELECTRONICS, INC.** announces the acquisition of **AMERICAN MICROWAVE CORPORATION**. The company will operate as a subsidiary of the parent firm . . . **PHILIPS CONTROL CORPORATION**, a subsidiary of **ALLIED PAPER CORPORATION**, announces that it has entered the sub-miniature electrical relay field by purchasing the assets and business of **DELTRONIC CORPORATION**, a subsidiary of **SIGNAL OIL AND GAS COMPANY** . . . **EL SIN ELECTRONICS CORP.** has become a subsidiary of **GENERAL TRANSISTOR CORPORATION**. Also announced was the appointment of Norman Jacobson as president of the firm . . . **NORBUTE CORPORATION** has purchased the assets of **KURMAN ELECTRIC CO. INC.**, which becomes a division of the parent firm.

* * *

MATTHEW JAMES LEONARD has been appointed vice-president, customer relations, for *Hycon Mfg. Company*.

Before joining the firm, he was with *Hughes Aircraft Company*. Prior to that association, he was vice-president and director of *MESA*, a consulting group headquartered in Dayton, Ohio.



Mr. Leonard has also been employed by the *Chrysler Corporation*, in a variety of capacities, between 1940 and 1951. In the company's Airtemp division, he was manager of the engineering department and subsequently director of heating and residential cooling sales.

* * *

L. J. COLLINS has been named general sales manager, sales department, of *RCA Victor* and "*Victrola*" division. **A. R. BAGGS** is now manager, merchandising, and **R. E. CONLEY** has been given increased responsibilities in his capacity as manager, advertising and sales promotion . . . **JEROME G. McCORMICK** has been appointed assistant general credit manager at *Allen B. Du Mont*

November, 1957

NEW PHAOSTRON EXPANDED SCALE AC Voltmeter

Available now from distributors in 90V to 130V Range, AC Rectifier Type in all custom styles and sizes.

3 1/2" or 4 1/2" rectangular meter

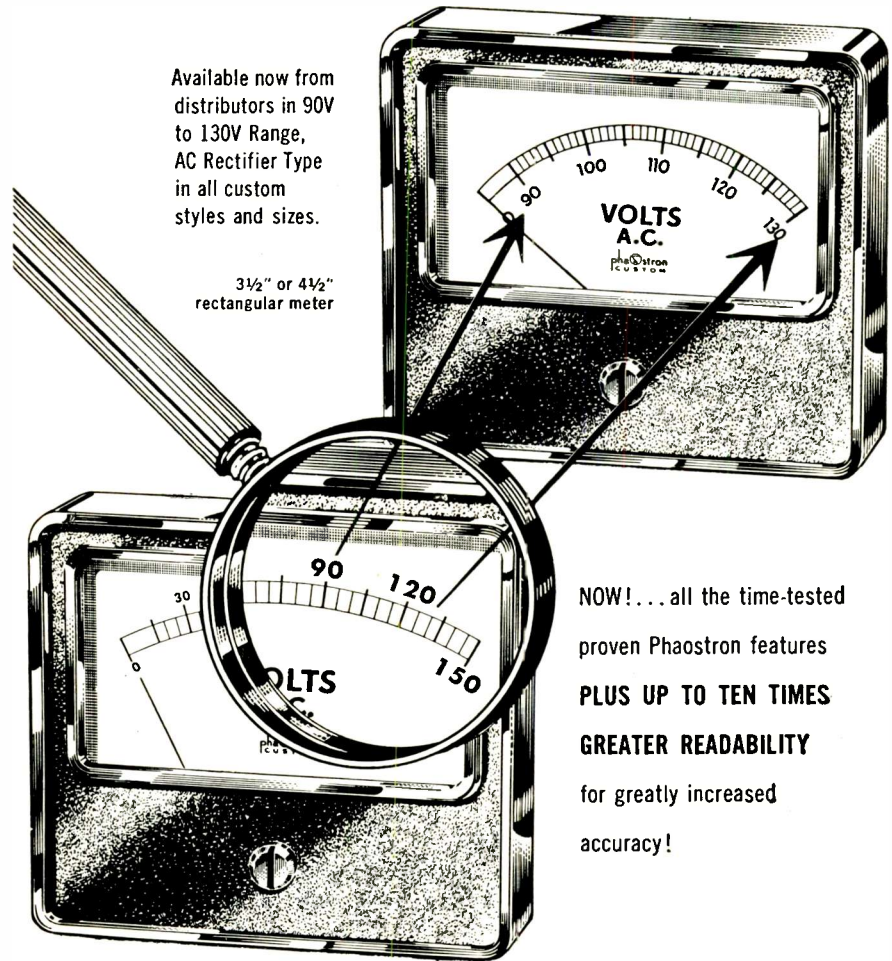

NOW! . . . all the time-tested proven Phaostron features PLUS UP TO TEN TIMES GREATER READABILITY for greatly increased accuracy!

2 1/2" or 3 1/2" square meter

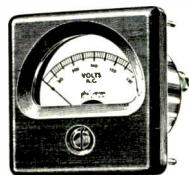

6" rectangular meter

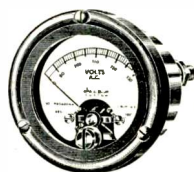
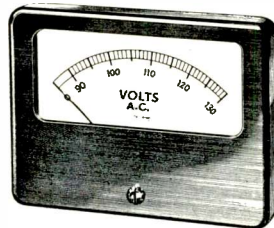

2 1/2" or 3 1/2" round meter

All meters available with illuminated dial on special order.

Phaostron has squeezed down that under 90V portion of the scale, where you don't need it, and expanded the section where you need it most—between 90 and 130V. Precisely calibrated 1 volt scale increments provide greater reading accuracy. Wide frequency range—linearity—true rms reading and Phaostron craftsman construction.

Phaostron Custom Panel Meters, with expanded scale, 90V to 130V AC rms, are available in nine types at your Parts Distributor. For special requirements for AC or DC expanded scale meters, write to Product Development Dept. for practical recommendations.

PHAOSTRON

PHAOSTRON INSTRUMENT & ELECTRONIC CO., 151 PASADENA AVE., SOUTH PASADENA, CALIF.

NEW AUTOMATION PUNCHED CARD TV TUBE TESTER PROVED! IN OVER 1 MILLION TUBE TESTS!



Fastest, most complete
portable dynamic
mutual conductance tester!

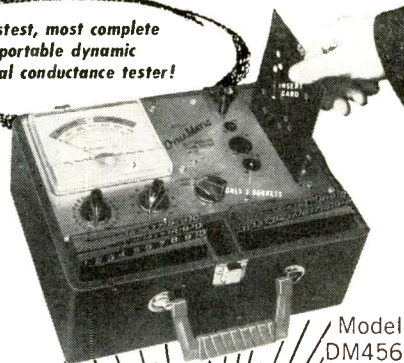

Model
DM456

the original

Dealer Net
149⁹⁵

Prices slightly higher
west of the Rockies

Speed-test complete set of
tubes in minutes with the
new DynaMatic Tube Tester

- So simple to use—a customer can operate it!
- LIGHTEST and SMALLEST Gm tester available. Take it on ALL house calls.
- Perforated plastic cards set up socket pin connections and test voltages.
- Permits full-complement tube testing.
- DynaMatic is a dynamic mutual conductance tester—NOT an emission checker.
- Accurately measures mutual conductance in micromhos on 2 ranges, 0-6000, 0-18000.
- Also checks battery tubes.
- Needs only 58 Cards for complete testing.



IMMEDIATE DELIVERY!

136-10 31st Road, Flushing 54, N. Y.

CANADA: WHITE RADIO LTD., 41 WEST AVE.
NORTH, HAMILTON, ONTARIO

EXPORT: ROBURN AGENCIES, 431 GREENWICH ST.
NEW YORK 13, N. Y.

EASY TO LEARN CODE

It is easy to learn or increase speed with an Instructograph Code Teacher. Affords the quickest and most practical method yet developed. For beginners or advanced students. Available tapes from beginner's alphabet to typical messages on all subjects. Speed range 5 to 40 WPM. Always ready—no QRM.



ENDORSED BY THOUSANDS!

The Instructograph Code Teacher literally takes the place of an operator-instructor and enables anyone to learn and master code without further assistance. Thousands of successful operators have "acquired the code" with the Instructograph System. Write today for convenient rental and purchase plans.

INSTRUCTOGRAPH COMPANY

4711 SHERIDAN ROAD, CHICAGO 40, ILLINOIS

BARGAIN HUNTING? **TV SERVICEMEN!**
Write for SENSATIONAL CATALOG
HENSHAW RADIO SUPPLY
3619 TROOST KANSAS CITY, MO.

\$

TV SERVICEMEN!
MAKE \$50—\$100 EXTRA PER WEEK
Install Surgistors on all calls
See your distributor or write:
WUERTH TUBE-SAVER CORP.
9125 Livernois Ave., Detroit 4, Mich.

\$

Labs., Inc. . . . **O. R. (BOB) COBLENTZ** has been named to the new position of manager of marketing for the radio division of *Hoffman Electronics Corp.* . . . Promotion of two executives of *General Precision Laboratory Inc.* has been announced by the parent organization, *General Precision Equipment Corporation.* **DR. RAYMOND L. GARMAN** has been elected chairman of the board and **JAMES W. MURRAY** is now president and chief executive officer . . . **EUGENE A. TRACEY** has been appointed vice-president in charge of sales of *Emerson Radio and Phonograph Corp.* . . . *Sylvania Electric Products Inc.* announces the appointment of **DAVID G. COWDEN** as manager of special-purpose-tube operations for the firm's television picture tube division . . . **ALBERT COUMONT** and **KENNETH PRICE** have been named regional sales supervisors for the *Sprague Products Co.* . . . **KENNETH M. MILLER** has resumed his position as manager of engineering of *Lear, Inc.*'s "LearCal" division.

* * *

LEONARD T. DONNELLY is the new manager of component sales at *Allen B. Du Mont Laboratories, Inc.*



In this newly established post Mr. Donnelly will be responsible for all aspects of a program for the sale of electronic components manufactured by the company's government division.

Prior to joining the firm, he was associated with *W. L. Maxson Corp.* For a number of years he served as assistant to the administrative manager of *Van Reekum Paper, Inc.* and was also office manager for the *Sperry Gyroscope Co.* in Los Angeles. He attended Cornell and Columbia Universities.

* * *

B. W. SAUTER has been appointed general manager of the *Westinghouse* electronic tube division located at Elmira, N. Y. . . . **W. HARRISON FAULKNER, JR.** has been promoted to the position of general manager, engineering and development, of *Tracerlab, Inc.* . . . **DR. THOMAS H. JOHNSON** has been appointed manager of the *Raytheon Manufacturing Company's* research division . . . *Howard W. Sams & Co., Inc.*, has announced two new appointments. **JACK W. MERRITT** has been appointed sales manager of the newly formed electronic distributor division, and **WALTON G. WILSON** has been named sales manager of the industrial service division . . . **ROBERT L. FEISTEL** has been named general sales manager of *Budelman Radio Corp.* . . . *Ronette Sales Corp.* has appointed **GARY COHN** assistant sales manager . . . **ROBERT M. VANBRUNDT** has been appointed advertising manager of the hearing aid division of *Zenith Radio Corp.* . . . **ROBERT L. JOHNSTON**, Colonel USAF retired, is now assistant to the president at *Advance Industries, Inc.* . . . The appointment of **RICHARD D. KENNEDY** to the

newly established post of advertising and sales promotion manager of the *General Electric* receiving tube department has been announced . . . *Trans Electronics, Inc.*, announces that **WILLIAM J. MILLER** has joined the organization as an officer of the corporation and general manager of its plant . . . **ERIC M. FARR** has been named manager of manufacturing services for the *Westinghouse* radio-television division . . . *Fairchild Recording Equipment Co.* has appointed **REIN NARMA** as manager of the firm's production and engineering divisions . . . **GORDON P. FELTS**, president and chief engineer of *Microdot, Inc.*, has reached 65 and announces his retirement from the firm. **CLAYTON TRIGGS** will take over as president and **JERRY PARKS** is the new chief engineer.

-30-

WRL CODE OSCILLATOR

ANOTHER compact, self-contained transistorized unit of interest to radio amateurs has made its appearance on the market. World Radio Laboratories, Inc. of Council Bluffs, Ia. is now offering a printed circuit code oscillator kit, the Model CPO-3.

Designed to provide an audio tone of 1000 cps, the circuit is conventional with the transistor functioning in the same way as would a tube in this application. Because the transistor power requirements are small, however, the entire unit can be powered by two 1.5 volt penlite cells.

The need for a minimum number of components makes it possible to house the code oscillator in a cabinet which measures a mere 1 3/8" x 2 1/8" x 4". The use of a printed wiring board simplifies the assembly and reduces the number of tools required in putting the kit together.

The instruction manual which accompanies the kit is remarkably complete and, in addition to providing details for assembling this particular unit, includes information on the correct way to solder, the color code, the Morse Code, and other data of interest to the hobbyist and home constructor. The kit, less headphones and key, is priced at \$4.95.

-30-

Schematic of WRL's code oscillator unit.

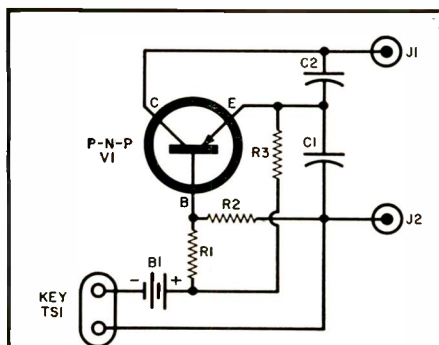

R_1 —2200 ohm, 1/2 w. res.
 R_2 —1500 ohm, 1/2 w. res.
 R_3 —22,000 ohm, 1/2 w. res.
 C_1, C_2 —.01 μ f. disc ceramic capacitor
 B_1 —3 volt battery (two 1.5 volt penlite cells)
 J_1, J_2 —Tip jack
 TS_1 —Terminal strip for key
 Headphones—2000-ohm headphones (Trim "Rex" or equiv.)
 Key—Practice key (Johnson 114-300 or equiv.)
 V_1 —"p-n-p" transistor (Raytheon CK722 or equiv.)

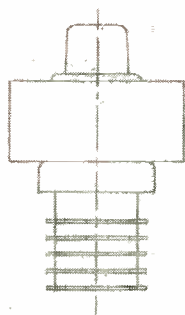

New ceramic tubes assure longer life—greater dependability

Ultra-compact new HT-33 kilowatt amplifier first to employ extra-safe, extra-long-life ceramic power tube



Performance and dependability were key words in the Hallicrafters laboratories when the HT-33 was on the drawing boards. That's why our engineers insisted on new, costlier ceramic power tubes. Result: another Hallicrafters first that means consistently higher performance over a longer life.

Here's what ceramic tubes mean to you: 100 watts greater plate dissipation. Greater overload safety. Unbelievable ruggedness (they'll withstand repeated 11 milli-second shocks of 50g) and reliability. *Advanced design, too.* Notice the clean lines, the compactness of the HT-33—just 12 3/8 inches high, for trim table-top application. See it, and compare these and other features, at your supplier's today.

MORE FACTS ABOUT THE HT-33

- Six amateur bands: 80, 40, 20, 15, 11-10 meters
- Simplified tuning: greater

power transfer and higher harmonic attenuation.

- Low drive requirement: 8 watts P.E.P. will drive to full KW
- New type Neon Indicator light for fuse overload.
- Quieter operation: higher performance allows low speed blower.

Available with convenient terms from your Radio Parts Distributor

NEW
 FROM
hallicrafters
 CHICAGO 24, ILLINOIS

WHERE THE BEST IDEAS IN COMMUNICATIONS ARE BORN

Export Sales: International Operations
 Raytheon Manufacturing Co.
 Waltham, Massachusetts

MORE ACTIVE! EFFECTIVE!



THE BEST FOR TV-RADIO WORK . . . EVERYTHING ELECTRICAL—Kester "Resin-Five" Core Solder is better and faster than any solder ever developed. It has an activated flux-core that does a perfect job on all metals including zinc and nickel-plate. The flux residue is absolutely non-corrosive and non-conductive.

Available in all practical Tin-Lead Alloys; 40/60, 50/50 and 60/40 in diameters of $\frac{3}{32}$ ", $\frac{1}{16}$ ", $\frac{3}{64}$ ", $\frac{1}{32}$ " and others.

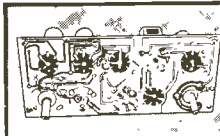

Printed Circuit Soldering
On Copper-etched boards use 60% Tin - 40% Lead Alloy . . . for those that are Silver-surfaced use 3% Silver-61½% Tin-35½% Lead

KESTER SOLDER COMPANY

4235 Wrightwood Avenue, Chicago 39, Illinois • Newark 5, New Jersey, Brantford, Canada

Mac's Service Shop (Continued from page 75)

can keep the set turned on while I work on it, the customer wants to buy a cheater cord from me so that he can do the same thing. So far, I've never had an extra one along; but I wonder what you think of selling these cords."

"Refuse to sell any untrained person such a cord and explain that you're doing it for his own protection. Mention the thousands of volts used on the kinescope and tell him it is extremely important that a person working on a set know where he can safely put his fingers and the spots from which he must shy away. Give a graphic description of what happens when a picture tube implodes and explain how easy it is to cause such an implosion by scratching or striking the comparatively thin glass neck of the tube. Of course if he is persistent, he can buy a cheater cord somewhere else, but let's not be guilty of selling him a method of cheating a safety device that has been installed for his protection."

Mac paused a minute while a shamefaced grin spread over his wrinkled face.

"I may as well confess something. Long ago I learned that people quite often pay little attention to what you say, especially when they don't want to hear it; so I've worked out a system to put across my safety story in a more graphic manner. When the customer seems the sort who might tinker with his set, I really put on a show for his benefit.

"Just before I remove the back, I don my safety glasses and heavy gloves. Everyone is herded over into a far corner of the room where they will not be hurt by flying shards of glass in case the picture tube implodes. When the back is off I work as slowly and cautiously as a person disarming a dud bomb. I'll even admit to pulling loose the high voltage lead and permitting it to do a little arcing just for the sake of that nasty hissing sound. When I am all through, I carefully replace the back, replace all the screws, and then give a very loud sigh of relief as I strip off my gloves and remove the safety goggles."

"Man," Barney said with a giggle, "you ought to get an Oscar for a performance like that."

"Yeah, and the funny thing is that I am only doing what every technician should do to protect himself. Well, I'll admit that wearing gloves all the time is laying it on a little thick, but after all I feel I should be allowed some artistic license, especially when the object is the commendable one of keeping a foolhardy customer from injuring himself!"

"Maybe your performance isn't as hammy as it sounded when you first mentioned it, now that I come to think about it!"

-30-

Another Sencore Time-Saver

the ALL NEW SENCORE Align-O-Pak TV BIAS SUPPLY

For **BLACK and WHITE and COLOR**

Just Dial any DC Voltage from 0 to 18 volts positive or negative—For AGC trouble shooting and alignment—Do away with messy bias batteries.

Completely isolated. Recommended by TV manufacturers. Wire wound control for calibration accuracy. For AGC trouble shooting, connect to AGC buss and vary voltage from 0 to 18 volts negative. If picture stabilizes at any voltage, AGC is defective. Complete with test leads. **MODEL BE3**

\$785
Dealer Net
Leather Carrying Case... \$2.95

Mfg by **SENCORE**

SERVICE INSTRUMENTS CORP.
171 OFFICIAL RD. ADDISON, ILL.

POPULAR SENCORE PRODUCTS

- Transistor Tester
- Leakage Checker
- Filament Tester
- Handy "38"
- Vibra-Dapter

RAD-TEL

What \$1 Buys!

\$1

Interstage Transformer 6J5 to PP6L6 No. 541 \$1 ea.

Chimney Mount—standard type —Complete No. 556 \$1 ea.

Phono Motor 60 cycle 105/125V VAC. RIM drive 2 pole universally used type.

List \$15.00 78 RPM No. 338 \$1 ea.

List \$16.00 33 RPM No. 341 \$1 ea.

Hook-up wire 5-50 foot rolls No. 562 \$1 ea.

Remote Motor Mounts on Famous type tuner 28 VAC No. 538 \$1 ea.

FREE!!

WITH THIS AD AND ORDER OF ANY ITEM FREE EXACT WEIGHT SCALE CO. WEIGHT INDICATOR—CALIBRATED 0-8 oz.—PENCIL SIZE—MANY USES: STYLUS, PRESSURE GAUGE, MAIL ETC.

Send for New Transformer List! No C.O.D.'s, please. Allow for postage. Subject to prior sale. No handling charge with this ad.

Send for PARTS and TUBE CATALOG

Rad Tel TUBE CO.

Not Affl. With Any Other Tube Mail Order Co.

55 Chambers St. Newark 5, N. J.

Use Delco Radio Service Parts!

2N278—Highest power transistor used in auto radios.

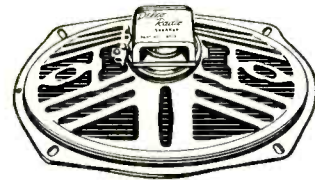

SPEAKERS



IRON CORES



RESISTORS



CAPACITORS



CONTROLS



TUBES



COILS



VIBRATORS

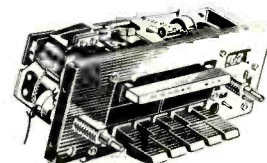

TUNER PARTS

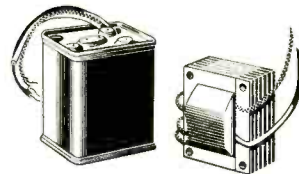

TRANSFORMERS

Your Delco Radio Electronic Parts Distributor carries the complete line, giving you fast, dependable service on the items you'll need for Delco Radio—and other radio—service work. Delco Radio also provides:

- Wide selection of special application parts
- Complete technical training program
- Effective warranty program
- Dealer identification signs

Get the facts today on this truly profitable dealer setup, and grow with General Motors!

Available everywhere through Electronic Distributors associated with . . .



DELCO RADIO

DIVISION OF GENERAL MOTORS, KOKOMO, INDIANA

New LOW Prices for CBS Power Transistors



2N255
\$1.35

2N256
\$1.50



Stepped-up sales and production made them possible. The savings go to you. Your net prices for the CBS 2N255 and 2N256 are cut in half!

Now radio amateurs and experimenters can build a variety of economical transistorized equipment, fixed or mobile, capable of real power output:

- Ten-watt mobile modulator
- Mobile power inverters
- Six-watt hi-fi amplifier
- Code practice oscillator
- Compact mobile p-a system
- Portable phono amplifier
- Sensitive relay circuit
- D-c voltage multiplier
- Regulated power supply



Write for Bulletin PA-16, CBS Power Transistor Applications, giving complete details. Or pick it up along with your low-cost 2N255 and 2N256 transistors at your CBS Tube distributor's.

CBS-HYTRON

Semiconductor Operations, Lowell, Mass.
A Division of
Columbia Broadcasting System, Inc.

Single-Sideband Adapter

(Continued from page 74)

with the crystal filter off. This will normally be at peak S-meter reading if the receiver i.f. circuits are in proper alignment. Now, switch the audio amplifier to the output of the adapter and turn up the bias and audio level controls until the AM signal is heard with the 50 kc. oscillator off. Adjust the bias control just below the point where the AM signal can be heard with a high level audio setting. Mark the bias control setting for future reference. Turn on the 50 kc. oscillator. Adjust the oscillator tuning capacitor for about one-half maximum capacitance. Leave the capacitor at this adjustment and turn the slug adjustment screw of the oscillator transformer for zero beat with the transmitted carrier.

Rotate the tuning dial back and forth across the signal *very slowly*. There should be a loud whistle on one side of center and a weaker one on the other. Turn out the oscillator transformer slug until the weak whistle is just barely perceptible when tuning across the signal (the loud one probably will be much stronger). Retune the dial for maximum S-meter indication and "zero beat" (absence of a whistle). The incoming carrier is now placed at the 50 kc. point on the filter response and the audio is *one sideband* of the AM signal.

To select the other sideband, simply switch to the other crystal position. The Miller 1898-BFO transformer tunes from 48 to 52 kc. The frequency is increased when the slug screw is turned counterclockwise and decreased when it is turned clockwise. Once the slug is adjusted, the lock nut should be tightened; any further adjustments of the oscillator frequency can be made with the front panel control. This control is purposely made to tune very broadly; it changes the oscillator frequency only about 700 cycles from one extreme to the other, making the tuning of both AM and single-sideband signals relatively easy.

A single-sideband signal is tuned for maximum "kick" of the receiver S-meter; leave the dial at this setting. Rotate the adapter oscillator control knob until the speech is crisp and clean without distortion. If the voice frequencies appear to be "inverted," try the other position of the sideband selector switch and clear up the speech with the oscillator control. It may be necessary to change positions of the crystal switch when listening to different stations. Ordinarily, one sideband is transmitted on 75 meters and the other is used on 20 meters; however, this is no hard and fast rule, since some stations may suppress one sideband and others may suppress the other.

All AM signals will be received through the adapter as single-sideband transmissions. The carrier, however, is not completely suppressed, as in SSB, but will be reduced in amplitude by about 20 db. When tuning from the

BEWARE OF IMITATIONS

There Is Only One
Original, Dependable
NO-NOISE
TUNER-TONIC
with PERMA-FILM

Cleans, lubricates, restores all tuners, including wafer type. Won't change or affect capacities, inductance or resistance. Won't harm insulations or precious metals, nor attack plastics. Eliminates all noise, oxidation and dirt indefinitely. For television, radio and FM.

Non-toxic. 6 oz. Aerosol Can. Non-inflammatory. Net to servicemen. 3.25



Extra economical because a small amount does the job!

Volume Control and Contact Restorer with Perma-Film



2 oz. bottle. Net to servicemen. \$1.00

Cleans, lubricates, protects. NOT A CARBON-TET SOLUTION. Still available in the new 6 oz. spray can. Net to servicemen. \$2.25

"NO NOISE"

Also available in 8 oz. bottles and quart cans. At Your Nearest Distributor.

ELECTRONIC CHEMICAL CORP.

813 Communipaw Avenue Jersey City 4, N. J.

FREE! 360 pages of the
Newest in

ELECTRONICS
HIGH FIDELITY • RADIO • TV

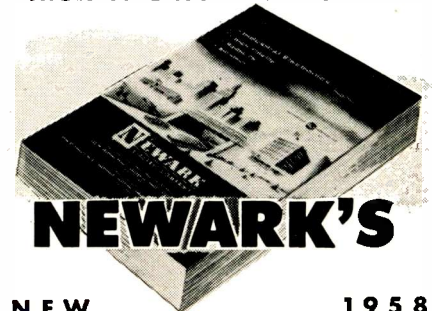

NEW CATALOG 1958

Offers you a fast, efficient, dependable way of selecting the finest components in the field at the lowest prices.

NEWARK
ELECTRIC COMPANY

Write Dept. R11

223 W. Madison St. • Chicago 6, Illinois
4736 W. Century Blvd. • Inglewood, Calif.

center of an AM signal, assuming the receiver i.f. bandpass is symmetrical, it will be found that the signal cuts off abruptly when the dial is turned in one direction and cuts off more gradually when turned in the other direction. If the crystal switch is placed in the other position, this tuning characteristic will be reversed. This is normal and, when the carrier abruptly drops out, it is being placed "down" on the sharp (high-frequency) side of the filter characteristic and is highly attenuated. The slow drop out means, of course, that the signal is being placed on the gradual (low-frequency) slope of the filter response where the attenuation is not so rapid. Normally, the receiver will be tuned so that the signal is almost at the point where AM becomes "garbled" and "sounds like single-sideband."

The 50 kc. oscillator, when adjusted to exactly 50 kc. and the receiver is properly tuned to place the 50 kc. incoming carrier at the correct point on the filter response, will usually give clean, crisp demodulation of an AM signal; however, if the oscillator is left in this position, there will be a "tweet" on one side of the signal when tuning. If this is objectionable, the oscillator may be turned off or detuned to about 52 kc. In this case, the bias control may be advanced to the point where best reception is obtained. Reception of AM signals, however, where the station's carrier is not exalted, in a narrow filter such as the *Burnell S-15000*, sometimes produces second-harmonic distortion when demodulated by a linear detector. This is due to some inherent angle modulation with one sideband plus carrier detection and is particularly noticeable when the percentage of modulation at the station is high. The use of the carrier oscillator will generally give better performance on all signals.

The sideband unit is useful for eliminating QRM which may be present on one sideband and not on the other. In many cases interference may be eliminated simply by selecting the other position of the crystal switch. In extreme cases, select the sideband with the least interference or place the interfering signal on the steep side of the filter characteristic. Rock the tuning dial slightly and the unwanted signal will "drop over the cliff." The crystal filter in the receiver is used in the usual manner for "notching" out interfering carriers, etc. but, in general, should be turned off during initial tuning.

The use of the product demodulator and exalted carrier will also reduce interference considerably since only signals which combine with the injected carrier will produce audio; in a diode or other type of envelope detector, two strong signals will beat against each other and produce an audible interference (the stronger of the two usually eliminates the weaker one). In the product demodulator, cross modulation does not occur and the interference, if present, sounds like "monkey chatter" which is less objectionable than howls and whistles.

-30-

PRECISION

...manufacturers of fine
electronic test instruments
for over 25 years...

INTRODUCES

P A C O

quality test
instruments
in kit form

For the first time—
a line of test instrument kits
engineered and produced under
the auspices of a major test
equipment manufacturer... and
conveniently available directly
from your own local
electronic parts distributor.

PRECISION's
25 years of experience
is your assurance of PACO's
superior quality, styling,
performance and value.

COMING SOON...

Model G-30 — RF Signal Generator

Model Z-80 — Audio-RF Signal Tracer

Model M-40 — High Sensitivity V-O-M



Model V-70
VACUUM TUBE VOLTMETER KIT
wide-range • peak to peak.
Net Price: \$31.50



Model B-10; BATTERY ELIMINATOR KIT
• less than 0.3% ripple output.
• no external filter adaptors required.
Net Price: \$41.95

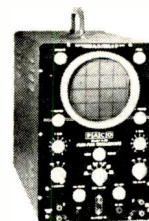

Model S-50
5" CATHODE RAY OSCILLOSCOPE KIT
push-pull vertical and
horizontal amplifiers.
Net Price: \$47.50



Model C-20
RESISTANCE — CAPACITY-RATIO
BRIDGE KIT
10 mmfd to 2000 mfd
½ ohm to 200 megohms.
Net Price: \$20.95

Available and on display at leading
electronic parts distributors.
Write for descriptive bulletin.



Model T-60; TUBE CHECKER KIT
full free-point lever selector system.
Net Price: \$36.75
Matching, hinged, removable cover.
Net Price: \$3.95

P A C O

ELECTRONICS CO., INC.
70-31 84th Street, Glendale 27, L. I., N. Y.

A DIVISION OF **PRECISION** Apparatus Company, Inc.

Export: 458 Broadway, New York 13, New York
Canada: Atlas Radio Corp., Ltd., 50 Wingold Ave., Toronto 10, Ont.

Learn Transistors!

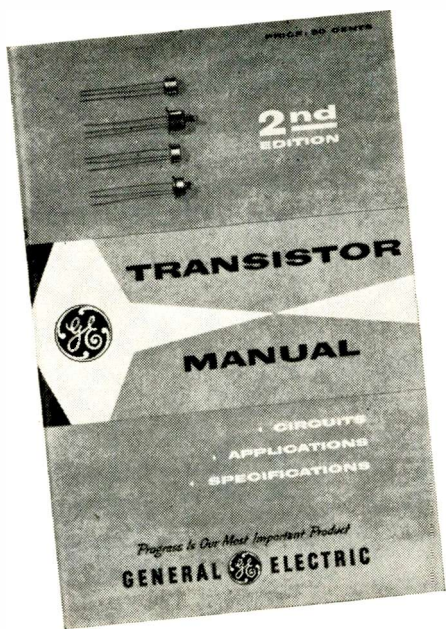

Now Ready! New Enlarged Edition of the Authoritative, Best-Selling G-E TRANSISTOR MANUAL

More than 100,000 hams, hobbyists, technicians, universities and engineers now have copies of the first edition of this invaluable manual. Now the twice-as-large, twice as useful second edition is ready for you. The CIRCUIT DIAGRAM section has been almost doubled . . . the APPLICATIONS section has been tripled . . . and specifications are given on more than 15 new G-E transistor types, including silicon types.

Learn the 8 things you want to know about transistors

1. Basic Semiconductor Theory
2. Transistor Applications
3. Specifications of G-E Transistor Types
4. Circuit Diagrams
5. Transistor Construction Techniques
6. Parameter Symbols
7. Registered RETMA Transistor Types
8. Transistor Radio Cross Reference Chart

This valuable manual of 112 fact-packed pages can be yours by return mail—send the coupon today with only 50¢. Or obtain at your G-E Tube Distributor. Not sold in bookstores. General Electric Company, Semiconductor Products Department, Electronics Park, Syracuse, New York.

General Electric Company
Semiconductor Products Department, Section 558107
Electronics Park, Syracuse, New York

Please rush me the new enlarged edition of your TRANSISTOR MANUAL. I enclose 50¢.

Name _____

Address _____

City _____ Zone _____ State _____

GENERAL ELECTRIC

Spot Radio News (Continued from page 18)

the auxiliary components must be kept to a minimum.

The operation of the system is as follows: Seven fixed-type AT voltmeters, calibrated for levels of .2 to several hundred volts, are mounted on the underside of a special metallic ground plate that permits rapid connection of an "unknown" voltmeter on the top side of this plate. The input planes of the "unknown" and of the AT voltmeter are located very close together across the terminals of a coaxial cable imbedded in the plate. The cable furnishes radio-frequency voltages to the two voltmeters thus connected in parallel with essentially no connecting leads. This has been found to eliminate errors normally introduced by standing waves.

The radio-frequency voltages originate in constant-temperature, crystal-controlled oscillators. These voltages are amplified and filtered to reduce all harmonics at least 60 db below the fundamental and are fed *via* proper matching networks to the voltmeters. Overload circuits and relays protect the thermo-elements of the AT voltmeters from accidental overload. An automatic amplitude stabilizing circuit keeps the radio-frequency voltage, applied to the voltmeters, constant to .1 per-cent over a period of one hour or longer. Errors caused by voltage drifts during observations are thus made negligibly small. The radio-frequency voltage levels are shown on a common panel indicator and are translated into voltage values by the use of line charts obtained when the AT voltmeters are calibrated in terms of NBS primary standards.

IN-FLIGHT REFUELING of Air Force planes anywhere in the world has now become a routine operation largely because of an airborne high-powered radar beacon—a homing beacon.

Developed by the Air Research and Development Command, the beacon makes it possible for fuel-hungry airplanes to rendezvous with flying tankers day or night or in any kind of weather. Its long range enables squadrons of planes to pinpoint the exact location of scheduled tanker planes from hundreds of miles away.

In air-to-air operations, the beacon is installed in a designated rendezvous aircraft. Other aircraft wishing to "home" on the beacon from hundreds of miles away use interrogating radar to send out pulses of a specific type to trigger the beacon. In response to the proper interrogation signal, the beacon transmits a coded reply. The operator of the interrogating radar is thereby able to identify the beacon-equipped aircraft, as well as to determine its exact range and bearing.

PROCEDURES TO BE FOLLOWED by civil and military government aviation agencies and users of airspace in the event of an air-defense emergency were announced recently by William B. Davis, acting administrator of civil aeronautics in the Department of Commerce.

Known as SCATER (plan for the Security of Air Traffic and Electromagnetic Radiation during an air defense emergency) and based on a plan approved in 1952, the program has now been enlarged to include rules for the security control of air traffic, which will become effective immediately upon the declaration of an air-defense emergency.

The purpose of SCATER is to establish responsibilities, procedures, and general instructions for the security control of civil and non-tactical military traffic, air navigation radio aids, and aeronautical communications during an emergency.

THE FCC ANNUAL report on TV broadcasting income for the 1956 period, recently released, reveals that the total revenues from television during the calendar year of '56 were \$896.9 million or 20.4 per-cent above 1955. The industry's broadcast profits (before Federal income tax) amounted to \$189.6 million, or 26.2 per-cent above 1955.

The total revenues of 95 pre-freeze v.h.f. stations, \$260.7 million, were 13.3 per-cent higher than in 1955. Profits for

this group, \$89.7 million, were also up about 10 per-cent from the preceding year.

The total revenues of the 364 post-freeze stations amounted to \$193.9 million in 1956. This represented 21.6 per-cent of the entire industry revenues. In 1955, post-freeze stations accounted for about 19 per-cent of the entire industry business.

ARDC has let an \$80,000 contract to *Consolidated Electrodynamics* for additional magnetic-tape recorder-reproducer equipment. This equipment is similar to the instrumentation previously supplied to ARDC'S Air Force Missile Test Center, Patrick Air Force Base, Florida, for the testing of intercontinental ballistic missiles (ICBM).

Consolidated's equipment, placed at 100 strategic points on islands and aboard ships along the 5000-mile test range at the Missile Test Center's Cape Canaveral launch site, records telemetered data from the missiles, such as temperatures, pressures, and thrust, and plays it back for analysis and interpretation.

THE LONG-DEBATED low-high band issue for the Albany-Schenectady-Troy-Vail Mills, New York area, has finally been officially resolved. Channels 6 and 10 remain here and Channel 13 shifts from Utica-Rome, New York to this zone, too.

Channel 2 will replace Channel 13 (WKTV) in Utica-Rome and WTRI (Albany) has been authorized to operate on Channel 13 instead of its present Channel 35. Also WCDA in Albany has received permission to operate on Channel 10 in Vail Mills; this station formerly operated on Channel 41.

Other assignments made by the Commission during the past few weeks appear in the table on page 16 of this issue.

AT LONG LAST, the *father* of the radar idea in this country, Colonel William R. Blair, has been awarded a patent for his discovery.

The plan for the bounce-signal method of transmission-reception was conceived by the Colonel prior to 1930, but because of the secrecy surrounding radar during World War II, the patent application was shelved and delayed until 1945.

Today the government uses the Blair patent under a special free-license arrangement. But the patent grant does pave the way for the Colonel to reap some gain from industry agencies who are now using radar for commercial applications.

The nation and industry are deeply indebted to Colonel Blair for his remarkable development, which played so vital a role during the war period and today is of such significant help not only to our civil and military aircraft, but to the marine world, providing solid safety in travel in the air and on the sea.

AS WE GO TO PRESS the FCC has just issued report No. 18 directing preparation of a document looking forward to the acceptance and consideration of applications from present or proposed TV stations requesting authorization to conduct trial subscription TV operations on a limited basis for a period of three years subject to the furnishing of pertinent detailed information and controlled conditions to be set forth in the very near future.

Applications *will not be acted upon* prior to March 1st, 1958. According to the report, the FCC points out that this action does not constitute a commitment that any applications will be granted nor does the action constitute adoption of a final order.

At the special meeting held September 18th, Commissioner Hyde voted "no" on the approval of the notice, Commissioner Bartley dissented, and Commissioner Ford abstained. Thus the report was passed by a margin of four to three which demonstrates a lack of unanimity regarding the Pay-See-TV question.

Proponents of the various systems, although not overjoyed by the tentative nature of the report, feel that at last the dam has been broken and that they can at least see a chance of displaying their subscription-television wares publicly. . . . L. W.

This is KRAEUTER'S

LITTLE NIPPER

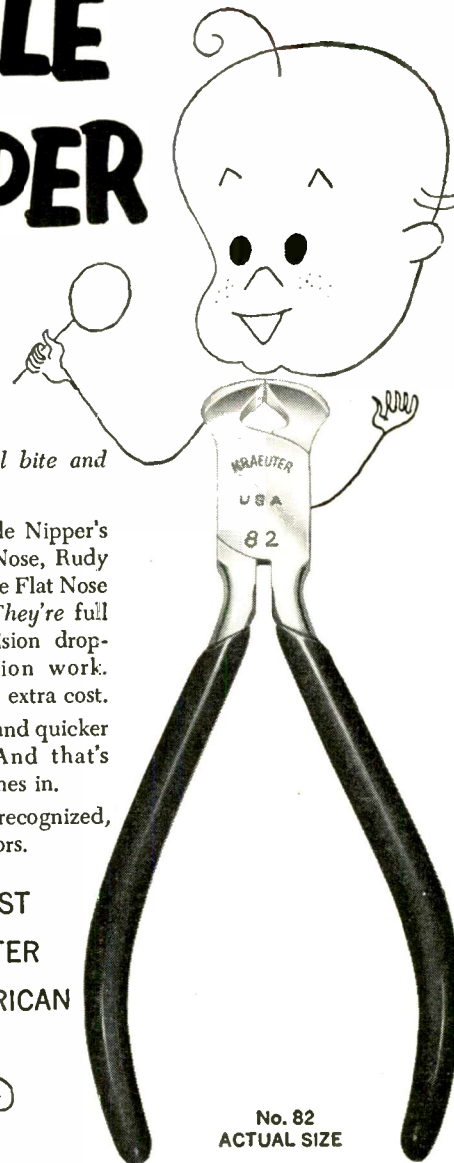

Only 4½" — but *all bite and precision.*

And below are Little Nipper's pals—Larry Long Nose, Rudy Round Nose, Frankie Flat Nose and Slick Cutter. *They're* full of fight, too. Precision drop-forged for precision work. Cushion grips at no extra cost. The job goes easier and quicker with fine tools. And that's where Kraeuter comes in.

Sold *only* through recognized, legitimate distributors.

BUY THE FINEST
BUY KRAEUTER
BUY AMERICAN

No. 82
ACTUAL SIZE

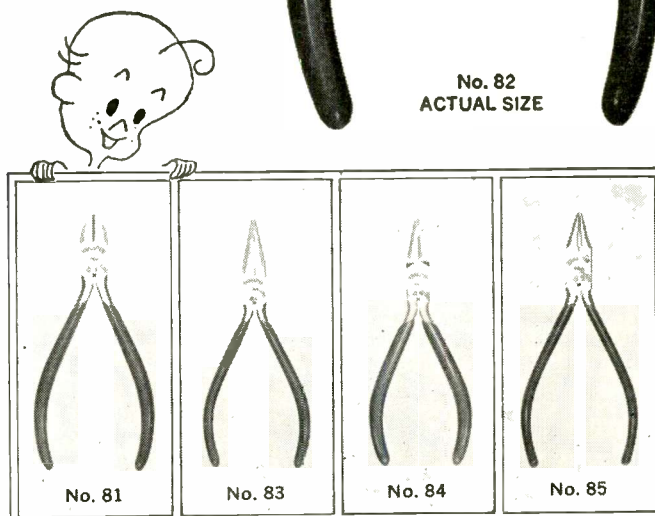

AS MODERN AS TOMORROW

kraeuter & co., inc

FOR 100 YEARS THE FINEST IN HAND TOOLS 1860-1960 • NEWARK, N. J.



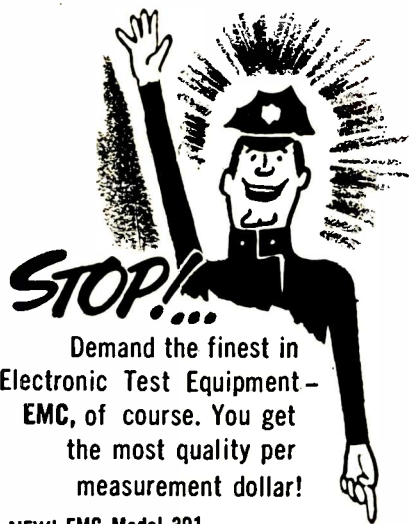

STOP!
Demand the finest in Electronic Test Equipment—EMC, of course. You get the most quality per measurement dollar!

NEW! EMC Model 301 Speedi Tube Tester

Checks tubes in seconds. Checks shorts, leakages, and quality. Over 375 tubes, including OZ4, now listed. New listings available. Checks and rejuvenates Picture Tubes with Model PTA (Picture Tube Adaptor), at only \$4.50. Model 301P (illustrated),

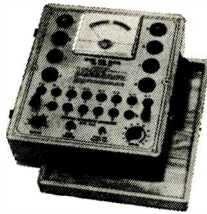

- with 4 1/2" meter & oak Carrying case \$47.50
- Kit 33.20
- Model 302C, (with 7 1/2" meter) 62.90
- Kit 47.90



NEW! EMC Model 108 Handi Tester

The only appliance and auto battery tester in its price class to use a D'Arsonval, instead of an iron vane type meter. Gives exclusive advantages of maximum accuracy and scale length, and minimum battery replacement cost . . . at no added charge. Complete with test leads and instruction manual.

- Wired \$15.95
- Kit 12.95

NEW! EMC Model 905-6A Battery Eliminator, Charger, and Vibrator Checker

A MUST for auto radio service. Features continuously variable voltage output—in either 6 or 12 volt operation. Checks all 6 or 12 volt vibrators.

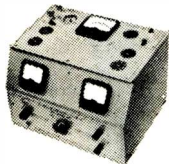

- Wired \$67.90
- Kit 44.90

NEW! EMC Model 601, Wide Band Oscilloscope for Color & Monochrome TV

Features full 5 mc band with push-pull vertical amplifier with sensitivity .02 volts per inch, retrace blanking amplifier for clearer pictures, and multivibrator sweep from 15 cycles to over 75 Kilocycles. Wired and tested\$117.90

NEW! EMC Model 206P Dynamic Mutual Conductance Tube Tester

The lowest priced mutual conductance tube checker on market. Checks tubes for microhm value and gas content. Completely flexible switching. Your best buy in a quality tube tester. (Hand rubbed Carrying Case)\$83.50

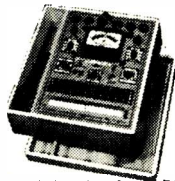

Yes, tell me more, send me—FREE—RN-11 a detailed catalog of the complete EMC line.

NAME _____

STREET _____

CITY _____ STATE _____

EMC Electronic Measurements Corp.
625 B'way • New York 12, N. Y.
Ex. Dept. 370 B'way, N. Y. 13

Do It by Telephone
(Continued from page 53)

parts of the country the bell duration is approximately 1 1/2 seconds followed by a 3 or 4 second pause. Other systems will work but you will have to do some further experimenting and it may be necessary to use a thermal delay relay with a different time delay.

Lastly, here is some test data which may help you to troubleshoot the unit. If you do not receive 100 to 120 volts a.c. at the "test point" when probing the telephone for the best spot, test the audio amplifier in this way:

Unplug the pickup coil and remove V₂ and V₃. Connect your audio signal generator to the input of the amplifier. Adjust it for 24-cycle, .1 volt output. At V_{1B} control grid you should get an a.c. signal of 3 volts and at the test point you should read 75 volts.

If you have any difficulty adjusting R₇ by means of telephone bells then you may use your solder gun (Fig. 6) as a signal source for rough adjustment. Remove V₂ and V₃ and connect your v.t.v.m. to the "test point." Place your solder gun near the pickup coil, pull the trigger, and move it around until you read 120 volts at the "test point." Don't change this distance! (A power transformer may also be used. Just connect it to the a.c. line and your pickup coil will react to the a.c. field being radiated.) This testing procedure is being performed at 60 cycles but the results will still be applicable to 24 cycles.

When the test voltage reads 120 volts replace V₂ and V₃. Use a clock with a large sweep second hand for timing as shown in Fig. 6. Pull the trigger on your solder gun (or turn on the power transformer) for a period of 1 1/2 to 2 seconds. This is the first bell. RL₁ should release its armature. Adjust R₇ for the proper timing. When RL₁ is performing properly on one pulse then try it with two pulses but separate them by an interval of about 4 seconds which is the time the bells would be separated. Once you get it working in this manner then you can plug in RL₂ and try it on the telephone.

After your unit has been properly adjusted you will find that it is very dependable. However there is always the rare possibility that someone may dial your number by mistake and then quickly hang up after letting the bell ring once only. You can prevent this from happening by adding a stepping relay to the system. This could take the place of RL₂. When a stepping relay is energized it won't pull its armature in until the proper number of pulses reach it. Another gimmick you can add is a latching relay which will make it possible to not only turn on the equipment but will also turn it off when you desire. With a little imagination and a good relay catalogue you will discover many possible refinements.

OUR BEST VALUE OF THE YEAR!
2 1/2 AMP. Rugged Duty 1/4" THOR SPEEDRILL
with Geared Chuck and Key
AC-DC 2400 RPM
BRAND NEW! OUR PRICE . . . \$14.95
If your work calls for a "rugged" drill with POWER to SPARE, insist on a 2 1/2 Amp. job . . . and make pp. & hdls. sure it's THOR! No finer drill made! Solid steel, heat-treated helical gears; thrust taken on hardened steel ball and plate; gears permanently packed and sealed in LIFETIME grease! Switch, trigger and lock assembly simplifies locking and releasing trigger. You'll be wise to buy 2 at this price. Supplies limited!

ONLY 75c EACH for the FINEST QUALITY Imported **PRECISION PLIERS**

FOR JEWELERS, OPTICAL WORKERS, HOBBYISTS, CRAFTSMEN OF ALL KINDS! These superb European instruments are of deep-forged, heat-treated, high quality tool steel, fabricated to most exacting specifications. All-over ground and polished to smooth hard surfaces. Smooth working joints with just the right tension. Jaws meet perfectly to safely and securely hold even the most delicate objects in the hard-to-reach corners and angles. Each plier is 4" long and a veritable gem of precision and strength.

75c each all 7 for \$5.00

6 Swiss Precision Screwdrivers
Perfect for jewelers, watchmakers, hobbyists, etc. **SIX DIFFERENT SIZES:**
No. 3 No. 6
No. 4 No. 8
No. 5 No. 10
Knurled body grip assures easy handling. Finest steel and craftsmanship. A hard-to-beat value from Switzerland. **\$1.25** ppd.
Money Back Guarantee. Send Check or M. O. If C. O. D., fees extra.

SCOTT-MITCHELL HOUSE, Inc.
611 Broadway, Dept. M-485, New York 12, N. Y.

TV TELLS HOW TO ANSWER RADIO T.V. QUESTIONS SERVICE LIBRARY

HERE IS LATE INFORMATION IN A HANDY FORM FOR RADIO AND TELEVISION REPAIRMEN, SERVICEMEN AND STUDENTS

AUDELS TV RADIO SERVICE LIBRARY—Over 1500 Pages, 1085 Illustrations & Diagrams, 1001 Important Facts & Figures on Modern TV, Radio, Electronic Devices at your fingers' ends. Highly Endorsed.

INCLUDES TRANSISTORS and Transistor Circuits Rectifiers, Record Changers, P. A. Systems, Tape Recorders, Phonograph Pick-ups, F.M., Auto Radio; Radio Compass. Short Wave, Radar, etc.

ASK TO SEE IT! IT WILL PAY TO KNOW—
The Basic Principles—Construction—Installation—Operation—Repairs—Trouble Shooting. Shows How to get Sharp, Clear TV Pictures. Install Aerials—How to Test, Explains Color Systems. Methods of Conversion. Terms, etc. Includes Ultra High Frequency—Valuable for Q & C K Ready Reference and Home Study.

\$8 COMPLETE 2 VOLUMES
Get this Information for Yourself 7 DAY TEST—PAY ONLY \$2.00.

MAIL ORDER
AUDEL, Publishers, 49 W. 23 St., New York 10, N. Y.
Mail AUDELS T. V. RADIO SERVICE LIBRARY (2 Volumes) \$8 on 7 days free trial. If O. K. I will remit \$2 in 7 days and \$2 monthly until \$8, plus shipping charge, is paid. Otherwise I will return them.

Name _____
Address _____
Occupation _____
Employed by _____
 SAVE SHIPPING CHARGES! Enclose Full Payment With Coupon and We Pay Shipping Charges.

Antenna News

"COLOR 'CEPTOR" FOR 1958

Winegard Company, 3000 Scotten Blvd., Burlington, Ia., has made three new improvements in its "Color 'Cep- tor" antenna line (Models CL-4 and CL-4X).

The new units feature "TDM" insulators which are said to be virtually unbreakable. They are black in color to contrast with the gold anodizing of the antenna. In place of the dye formerly used in the anodizing process, the company is now using a gold color pigment which is claimed to be more impervious to sunlight than the dye.

To add extra strength and longer life to the reflector elements, the company is now making these of a new aluminum alloy of higher tensile strength. In addition, 16-inch aluminum dowels have been inserted in the center of each reflector. These improvements are being supplied on all new models at no increase in price.

TRIO "COLOR ROYAL"

Trio Manufacturing Company of Griggsville, Ill., has developed a new all-channel color antenna which is being marketed as the "Color Royal."

Specifically designed for color reception, the new antenna features the company's "Magni-Chrome" element system and "Trio-stop" reflectors in addition to the firm's new extended wing dipole. The "Magni-Chrome" ele-

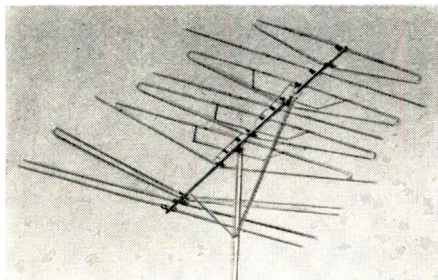

ment system consists of an extended wing dipole accurately coupled with a precision "V'ed" dipole. This combination is designed to magnify the chromatic characteristics of the incoming color signal.

According to the company, the flat frequency response of the antenna over the entire v.h.f. band gives true color intensity and high contrast in black-and-white. Write the manufacturer for further details and prices.

HIGH-GAIN BEAM

Technical Appliance Corporation of Sherburne, N. Y., has added a high-gain beam to its TACO antenna line for radio amateurs.

Available in four models for working the 1 1/4, 2, or 6 meter amateur bands, all of the units are based on the company's design for FM and TV antennas.

The Case of The Serviceman WHO SAVED A MARRIAGE!



Smith wanted to watch the fights; Mrs. Smith insisted on "This Is Your Wife". Fights they got, since a second set was within their means but there was only one antenna and no multi-set coupler they tried had worked satisfactorily.

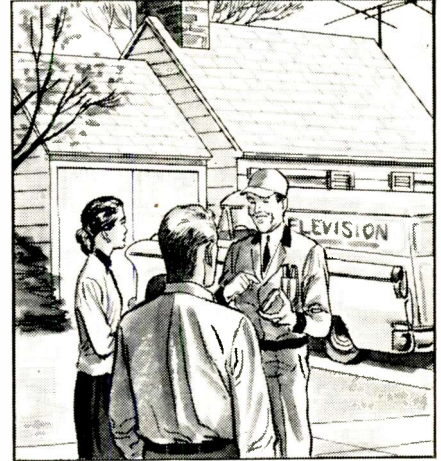

"You won't need another antenna with this 'NEW' Jerrold Multi-set COUPLER", said the TV Serviceman. "Its special design allows for equal distribution of the signal with exceptionally low loss and without smearing or ghosting"

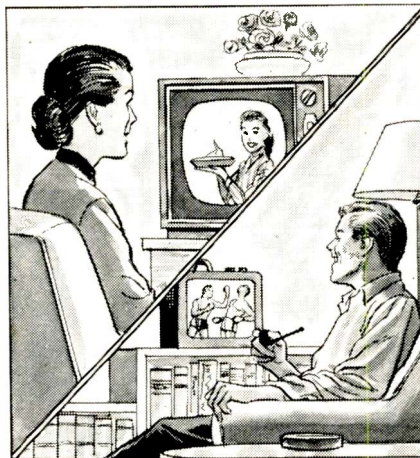

The Jerrold multi-set coupler took only minutes to install... now, both the Smiths watch their favorite TV shows.

UNIVERSAL MOUNTING

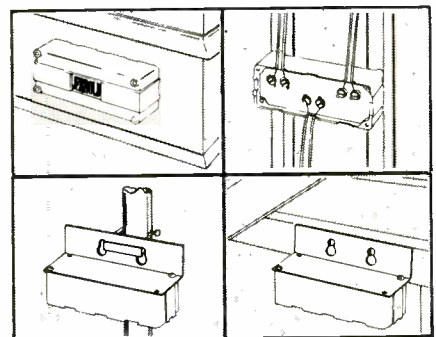

- On the baseboard. Connectors completely concealed.
- In the attic or basement with terminals exposed for ease of servicing.
- Outdoors, on the antenna mast or on the side of the house.

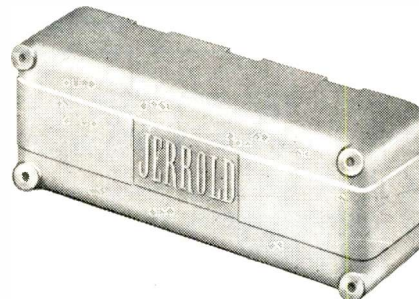

New! JERROLD LOW LOSS COUPLERS

Available in 3 models

- M-2—for strong signal areas . . list \$3.50
- MF-2—for fringe areas list 4.50
- MF-4—up to 4 sets—all areas . list 5.75

Engineered for V.H.F., U.H.F., Color reception. See your Jerrold Distributor or write for complete information to Dept. P.D. #18

JERROLD ELECTRONICS CORPORATION

Main Office: 23rd & Chestnut Streets, Philadelphia 3, Pa.

Export Representative: C.B.S. International, New York 22, N.Y.

LOOK TO JERROLD FOR AIDS TO BETTER TELEVIEWING

ASSEMBLE YOUR OWN WALKIE-TALKIE RADIOPHONES



for as little as
\$6.98
plus accessories

Specifications: Tunes 144-148 mc. 1 to 5 mile range (depending on terrain) with 18 inch antenna and much more with directional beam antenna. Variable frequency transceiver circuit. High level amplitude modulation. Silver plated tank circuit and many other exclusive features assure maximum efficiency and long battery life. Fully portable — no external connections ever needed. Meets FCC requirements for general class amateur license. No minimum age requirement.

The following components are all you need to assemble a complete walkie-talkie as illustrated:

Factory wired and tested transceiver chassis complete with VHF dual tube.....	\$6.98
High output carbon mike.....	1.49
Miniature mike transformer.....	.98
Powerful alnico magnet headphone.....	1.25
Strong 16 gauge aluminum case (7" x 5" x 3") with all holes punched, battery compartment, battery switch plus all hardware and fittings including 18" antenna.....	3.98
Case finished in gray hammertone if desired.....	.75

Both models use standard batteries available at your local radio store. All components guaranteed for one year against defects in manufacture.

HOW TO ORDER DIRECT FROM FACTORY:

Check each item desired and add 5% of total for postage and insurance. Orders not paid in full will be sent C.O.D. for the balance due. All C.O.D. orders must include \$2.00 deposit.

MAIL TO:

All orders immediately acknowledged.



for as little as
\$14.98
plus accessories

Specifications: Tunes 50 to 54 mc. 1 to 5 mile range (depending on terrain) with 24" antenna and much more with directional beam antenna. Crystal controlled transmitter and variable frequency receiver with R.F. stage. Silver plated coils, highest quality components and exclusive design assure maximum efficiency and long battery life. Fully portable—no external connections ever needed. Meets FCC requirements for technician and general class amateur license as well as civil defense and other special services. Available also on neighboring frequencies at slight extra cost.

The following components are all you need to assemble a complete walkie-talkie as illustrated:

Factory wired and tested transmitter-receiver chassis complete with all tubes...\$14.98

Very active quartz transmitting crystal ground to .01% of your desired frequency and hermetically sealed..... 3.98

Western Electric communication type telephone handset with push-to-talk switch and standard cord..... 6.98

Coiled spring cord if desired..... 1.00

Handset input transformer..... .98

Handset output transformer..... .98

Strong 16 gauge aluminum case (8" x 5" x 3") with all holes punched, battery compartment, battery switch, telephone handset cradle plus all hardware and fittings including 24" antenna and loading coil... 4.98

Case finished in gray hammertone if desired..... .75

Adjustable shoulder strap (not shown) if desired..... .50

SPRINGFIELD ENTERPRISES

Manufacturing Division
Box 54-R11, Springfield Gardens 13, N. Y.

ONLY **\$18.75**

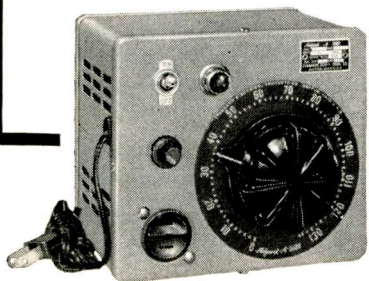

Adjust-A-Volt

PA-3 VARIABLE TRANSFORMER

The highly efficient new Adjust-A-Volt PA-3 is a modern, deluxe variable autotransformer designed for servicemen, model shops, laboratories or other applications where variable A.C. voltage is needed. Max. load rating 0.4 KVA. Max. output current 3.0 A. Delivery from stock of your jobber

STANDARD

ELECTRICAL PRODUCTS CO.
2240 E. THIRD ST. • DAYTON, OHIO

PICBOOST DUZ-ALL GIVES YEARS MORE LIFE TO WORN-OUT PICTURE TUBES

Smooth, variable control—exclusive with CBC—lets you increase picture tube brightness exactly as needed. Can be re-adjusted as time goes on to stretch picture tube life for years.

- No soldering . . . just plug in and turn knob for brightest picture.
- Works with all TV sets . . . series or parallel.
- Isolation feature automatically corrects heater-to-cathode shorts.



\$4.90 list

Available at all leading parts distributors.



C.B.C. ELECTRONICS CO., INC.
2601 NORTH HOWARD ST.
PHILADELPHIA 33, PENNA.

Say you saw it in
RADIO & TV NEWS

GET YOUR COMMERCIAL TICKET EASIER WITH . . .

Kaufman's
**RADIO OPERATOR'S LICENSE
Q AND A MANUAL**

The BEST book for
FCC License Preparation
Covers elements 1 thru 8.

The only book with complete discussion
of answers to every technical question in
the FCC Study Guide. Makes it very easy
to answer multiple choice questions.
Used by leading schools and industry.
Only \$6.60 at jobbers, bookstores
or direct from:

JOHN F. RIDER PUBLISHER, INC.
116 West 14th Street, New York 11, N. Y.

These antennas are assembled in the exclusive "Auto-Lock" and "Spring-Lock" design whereby the antenna is ready for installation in less than a minute.

The Model 5A6M is a five-element, 6-meter beam which provides 8 db gain; the Model 10A6M is a ten-element, 6-meter unit which provides a gain of 11 db; the Model 10A2M is designed for 2-meter operation and consists of 10 elements providing 11 db gain; and the Model 10A1¼M is for 1¼ meters and uses ten elements to give a gain of 11 db.

Complete information on any or all of these new beams is available from the manufacturer.

MULTI-SET COUPLERS

Jerrold Electronics Corporation, 23rd and Chestnut Streets, Philadelphia 3, Pa., has announced the availability of a series of multi-set couplers which are engineered specifically for either fringe or strong-signal-area applications.

Three models are presently available in the new series: a two-set coupler for



strong signal areas; two-set couplers for fringe areas; and four-set couplers for either area. The latter two models feature exceptionally low loss as well as a.c. isolation between receiver and antenna. All models are engineered for v.h.f. or u.h.f. reception as well as undistorted passage of color signals.

Universal mounting permits installation of these couplers indoors or outdoors. All couplers are housed in attractive, high-impact polystyrene cases. Electronic parts distributors are handling these units.

CHANNEL MASTER "MATCHMAKER"

Channel Master Corp. of Ellenville, N. Y., has recently introduced the "Matchmaker," a new type of two-set coupler based on the "Diplexer" principle.

The new coupler divides the signal power equally and simultaneously to both receivers; holds insertion loss to the absolute minimum 3 db, which occurs when half the available signal power goes to each receiver; prevents signals of both sets from interacting with each other; maintains a perfect 300-ohm impedance match at the receiver's terminals and at the antenna terminals; and prevents any impedance variation at one receiver from affecting the signal at the second set when they are tuned to different channels.

The manufacturer will supply additional details on this new coupler upon written request.

Make **MORE** Money **FASTER** with **B&K**

LABORATORY-ACCURATE

DYNA-QUIK

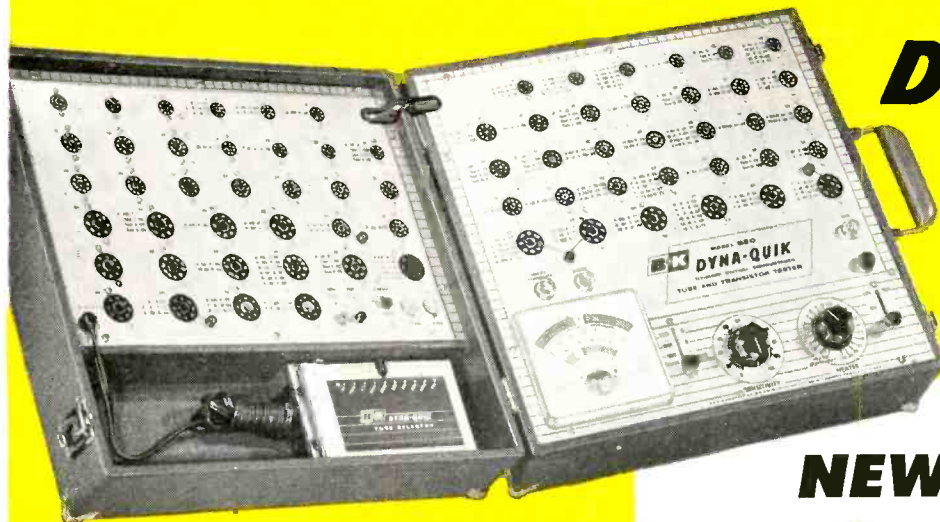

NEW Model 650

Today's Fastest, Most Complete, Portable
**DYNAMIC MUTUAL CONDUCTANCE
 TUBE & TRANSISTOR TESTER**

Offers **New Features—More Features!** Checks over **99%** of the tubes most widely used in television receivers, plus popular home and portable radio tubes. **Tests over 500 tube types. Lists over 125 tube types**, with settings, on socket panels for maximum operating speed. Complete listing in **fast telephone-index type selector**. Includes 16 spare sockets and sufficient filament voltages for future new tube types. Phosphor bronze socket contacts. **Tests each section of multiple tubes separately for Gm—Shorts—Grid Emission—Gas Content—and Life.** Gives instantaneous **Heater Continuity** check. Shows tube condition on "Good-Bad" scale and in micromhos. Special bridge assures automatic line compensation. Simple to operate. **No multiple switching—No roll chart.** Includes pin straighteners. **Transistor Tester** checks junction, point contact and barrier transistors, germanium and silicon diodes, selenium and silicon rectifiers. **\$16995**
 Net,

CUT TESTING TIME IN HALF—DOUBLE TUBE SALES

Measures *true dynamic mutual conductance* with laboratory accuracy under actual operating conditions *right in the home*. Makes complete tube test in seconds. Quickly detects weak or in-operative tubes. Shows customer the true condition and life expectancy of the tubes and *sells more tubes right on the spot*. *Cuts servicing time, saves costly call-backs, wins customer confidence, and brings more profit.* One extra tube sale on each of 5 calls a day pays for the Dyna-Quik in a few weeks.

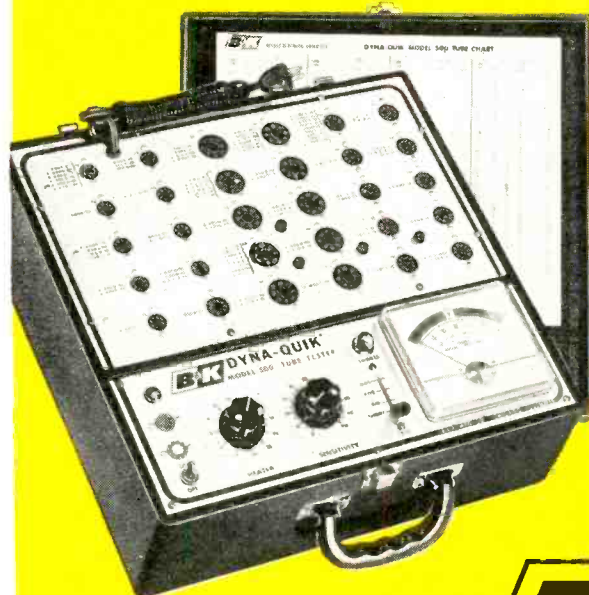

FAMOUS Model 500

World's Fastest Selling Portable

DYNAMIC MUTUAL CONDUCTANCE TUBE TESTER

This is the B&K quick-check tube tester that has revolutionized TV set servicing! Servicemen* say: "Best tube tester I've ever owned for speed and dependability." "Wonderful instrument. Makes money!" "Paid for itself several times. Really indispensable!" "Have two...one for the shop and one for house calls!" "Adds income and saves unprofitable call-backs!" That is why thousands of the Model 500 are now in profitable use all over the nation. Tests tubes for **Shorts, Grid Emission, Gas Content, Leakage, and Dynamic Mutual Conductance—in a matter of seconds.** **Life Test** detects tubes with short life expectancy. Shows tube condition on "Good-Bad" scale and in micromhos. **One switch tests everything.** No multiple switching—No roll chart. Special bridge maintains automatic line compensation. 7-pin and 9-pin straighteners. **\$10995**
 Net,

See your B&K Distributor,
 or write for Bulletin 500-650-N



B & K MANUFACTURING CO.
 3726 N. Southport Ave. • Chicago 13, Illinois
 Canada: Atlas Radio Corp. 50 Wingold, Toronto 10, Ont.
 Export: Empire Exporters, 439 Broadway, New York 13, N. Y.

*Names on request

Kits for Christmas! GENIAC COMPUTER KIT

You can construct over 50 different circuits and 40 different machines that compute, reason, solve puzzles and demonstrate a wide variety of basic computer circuits with the GENIAC electric brain construction kit. Thousands of schools, colleges, industrial firms and private individuals have bought GENIACS since we first brought them on the market.

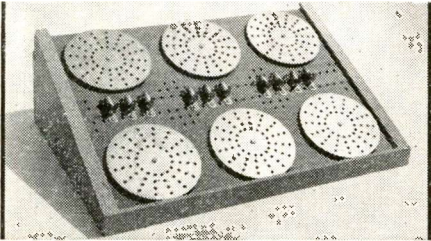

GENIAC set up to do a problem in check valve research

We have recently added a circuit for composing music, which gives us special pleasure because it was designed by a 16 year old boy who learned about computers from his GENIAC. Dozens of other youngsters have created their own designs for computing circuits, used GENIACS in their school projects and established a solid foundation of information on computers with GENIACS.

Each kit comes complete with Beginners Manual, Study Guide, instructions for building all the machines and circuits, rack (exclusive with our GENIAC), parts tray, and our complete question answering service. When you buy a GENIAC you are buying a first course in computer operation.

Each kit comes with a one week money back guarantee if you are not satisfied.

Price of Kit complete with parts tray, rack, all components, manuals and texts **\$19.95** (postpaid in U. S., add 80¢ west of Mississippi). (**\$2.00 outside United States.**)

SCIENCE KITS, Dept. RT-117

Oliver Garfield Company

126 Lexington Avenue, New York 16, N. Y.

OPTICAL BARGAINS

INFRARED SNIPERSCOPE TELESCOPE and PARTS



See in the dark—without being observed. War surplus Sniperscope M-2. Gov't cost about \$1200. Used for industrial plant security; research lab experiments; infrared photography; spectroscopy, etc. Instrument complete, ready to use. Includes Power Pack, infrared light source. Will operate from 6 V auto battery. Battery or transformer available.

Stock No. 85,053-DU . . . Shipping **\$150.00**
weight approx. 12 lbs.

f.o.b. Barrington, N. J.

Save still more money! Build your own Sniperscope! We will furnish instructions—parts, including: Power Packs, 1P25A image tubes, light units, filters, etc. For details—request FREE Bulletin A-26-DU.

GET FREE CATALOG DU

America's No. 1 source of supply for experimenters, hobbyists. World's largest variety of Optical Items. Bargains galore. . . . War Surplus—Imported—Domestic! Microscopes, Telescopes, Satellites, Color TV Tubes, Infrared sniperscopes and Parts, Prisms, Lenses, Reticles, Mirrors and dozens of other hard-to-get Optical Items.



WRITE FOR FREE CATALOG DU

EDMUND SCIENTIFIC CO.
BARRINGTON, NEW JERSEY

Toying with TV Design (Continued from page 63)

the divider will change the relative voltage applied to the grid, and, by changing the plate-current flow, will achieve the desired control over the voltage appearing at the cathode.

A better method of deriving grid bias voltage is shown in Fig. 5, where the grid voltage is seen to be taken from the cathode itself, through a potential divider to ground. The advantage of this method is that the grid voltage is bound to be negative with respect to the cathode whatever hap-

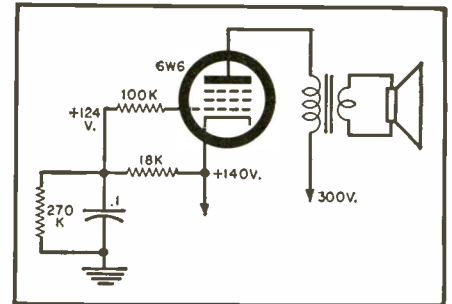

Fig. 5. Deriving the grid voltage from the cathode is an improved method for a circuit like that shown in Fig. 4.

pens in the circuit (unless, of course, the lower arm of the divider goes completely open, in which case zero bias is established).

Horizontal Drive Control

These days, sets are often not equipped with a variable horizontal drive control. A perusal of the schematics of other sets, which are so provided, will reveal many methods of drive adjustment. Fig. 6 shows a very easy and uncomplicated method. The decoupling resistor, R_1 , also serves as a voltage dropping device, and variation in the value of this resistor is a very convenient method of reducing or increasing the output of the oscillator without changing the linearity of the waveform to any appreciable extent.

While the points discussed here for adjusting constants to achieve satisfactory performance cover a wide range of problems that occur in this area, the technician will often encounter cases in which he is on his own. He must remember to proceed with caution and exact knowledge of what he is doing.

-50-

Fig. 6. In sets without a horizontal drive control, adjust the value of R_1 .

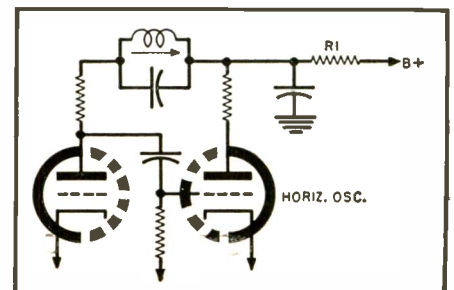

MONEY-MAKING METERS

That's what hundreds of Mobile-Radio Engineers call their Lampkin Test Equipment!



LAMPKIN 105-B MICROMETER FREQUENCY METER. Measures all nearby crystal-controlled transmitters, 0.1 to 500 mc. No additional crystals or coils needed. Price \$220.00 net.



LAMPKIN 205-A FM MODULATION METER. Measures peak FM swing ± 12.5 kc. or ± 25 kc. on transmitters from 25 to 500 mc. in one band. Price \$240.00 net.

Wouldn't you like a *guaranteed* income in this competition-free field? To learn more, ask for free booklet, "How To Make Money in Mobile-Radio Maintenance."

MAIL COUPON
TODAY!

Easy monthly payment plan available!

LAMPKIN LABORATORIES, INC.
MFM Division
BRADENTON, FLORIDA

LAMPKIN LABORATORIES, INC.
MFM Division, Bradenton, Florida

At no obligation to me, please send

Free booklet Data on Lampkin meters.

Name _____

Address _____

City _____ State _____

Britain's National Radio Show

Report on trends and prices
in one of Great Britain's
most active industries.

GREAT Britain's National Radio Show, at Earls Court, London, this year has an air about it of a young man with the key to the door, his pocket full of money and raring to go. The young man is backed by a record export business which is expected to reach £45,000,000 (\$126,000,000) this year. Business is good, but manufacturers are out to make it even better. Prices of TV sets are lower than last year owing to technical achievements; there is an increasing drive for the European market as evidenced by the many continental style cabinets.

The 17-inch set, still the most popular size, now costs an average of £76, 10s (\$214) with tax, just over £13 less than last year. It is strongly challenged by the 21-inch set which has dropped £50 in a year to an average £99 (\$278).

Introduction of the 90-degree "wide-angle" picture tube has reduced the front-to-back size of sets by 3 or 4 inches. Many manufacturers are adding FM radio reception to their TV sets at a small extra cost. Elaborate combinations, including TV, radio, phonograph, tape recorder, and cocktail cabinet were also shown. Small portables, with 9-inch picture tubes, were also in evidence. Printed wiring is used extensively in these sets.

Radio-phonographs have been strongly influenced by continental ideas. Long, low models have appeared with lids that can be used as magazine tables. They allow ample storage space for records and room for several loudspeakers. Prices range from \$140 to about \$230.

Radio sets are still in great demand and are becoming smaller and more attractive each year. The smallest shown measures 3¼" x 5¾" x 1", uses transistors, and is powered by flashlight batteries. An even smaller one has caught on to the current do-it-yourself craze and is the size of a pack of cigarettes. For about \$17 it can be built by the enthusiast and, with an earplug, offers private listening. Transistor battery sets are still quite a bit more expensive than the small 4-tube receivers.

All-in-all there is plenty of evidence of the vitality of the industry, and the fact that the U. S. is Britain's best customer gives British manufacturers some cause for satisfaction.

MORE TV SIGNAL GAIN AT LOWER COST FOR ALL VHF INSTALLATIONS...



**Automatic Broadband
VHF BOOSTERS and AMPLIFIERS**

Whether you need signal amplifiers for a 2000-set master TV system or a booster for a single TV receiver, there's a B-T unit that's designed for the job.

Most TV technicians and installers will say 'amen.' They have learned that they can rely on products bearing the B-T Labs symbol. Rigorous factory quality control of construction, gain and match assures dependable and uniform performance of each product that goes out into the field.

And for positive proof of superior engineering . . .

Exclusive patents: $\left. \begin{array}{l} 2,710,314 \\ 2,710,315 \\ 2,609,466 \end{array} \right\}$ covering automatic broadband circuits and relays have been granted to Blonder-Tongue.

Check to see which one of these units will clear up your specific signal gain problem.

	<p>VHF AMPLIFIER Model MLA</p> <p>Powerful all-channel VHF cascode amplifier with more than 37 db gain. Has variable gain controls for equalizing high and low bands. Output on each band: 1.25 volts RMS, flat to within 2 db. Self-powered. Matched input. 75-ohm coax fittings at input and output. When used with MAGC maintains constant output level.</p> <p style="text-align: right;">\$124.50 list</p>
	<p>COMMERCIAL ANTENSIFIER Model CA-1</p> <p>A popular broad band VHF amplifier for antenna and line applications. Gain: 26 db on low band and 24 db on high band. Low noise circuit. Matched 75 ohm and 300 ohm input. Gain control. Self-powered, \$84.50 list</p>
	<p>ANTENNA BOOSTER Model AB with Remote Control</p> <p>More than 25 db gain. Most popular broadband antenna amplifier in weatherproof housing with mast-mounting bracket. Remote control power supply located near set. Furnishes either 24 or 110 volts to amplifier, as desired. Single line carries power 'up' and signal 'down.' 'On-off' is automatic with TV set. \$99.50 list</p>
	<p>HOME BOOSTER Model HA-3</p> <p>Provides more than 16 db gain. Automatic 'on-off' operated by TV set. No tuning. Features low-noise, push-pull, broadband circuits. Self-powered. \$44.50 list</p>

This Typical Response Curve means superior performance — greater gain with lower noise, flatter response, minimum maintenance requirements, and lower initial cost.

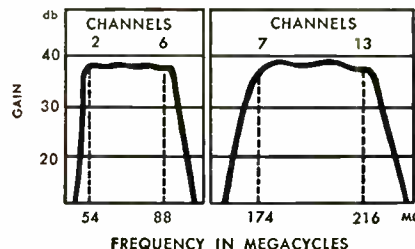

Dept. RTN-11

BLONDER-TONGUE LABS., INC.
9-25 Alling Street, Newark 2, N. J.

Industrial TV Cameras • TV Systems • VHF and UHF Amplifiers and Converters • TV Accessories

for ENGINEERED
exact
replacements
look to

STANCOR

Stancor exact replacement transformers are engineered—not copied. With manufacturers' original prints used as a basis for physical exactness, the circuit and operating requirements are carefully analyzed by the Stancor engineering staff. Where necessary, heavier wire, more insulation, protective coatings, corona rings, or heavier shielding are used to assure you of "better-than-new" performance. Even where the original may have been easily overloaded—it won't happen again with the Stancor replacement.

Chicago Standard has the largest engineering staff of any replacement transformer manufacturer—your assurance of a carefully and correctly designed transformer.

A free copy of the latest Stancor catalog and TV Guide is available at your distributor or direct from Stancor.

CHICAGO STANDARD TRANSFORMER CORPORATION

3505 ADDISON STREET CHICAGO 18, ILLINOIS

Export Sales: Roburn Agencies, Inc., 431 Greenwich St., New York 13, N.Y.

ENGINEERING

Prepare for unlimited opportunities of the Electronic Age! Earn your B.S. DEGREE IN 27 MONTHS in Aeronautical, Chemical, Civil, Electrical or Mechanical Engineering; in 36 MONTHS in Mathematics, Chemistry, Physics, Intensive, specialized courses. Comprehensive training in electronics, television, advanced radio theory and design, math, nuclear physics and electronic engineering. Engineering Science preparatory courses. Low rate. Graduates in demand. Spacious campus: 20 bldgs., dorms, gym, playing field. Earn part of your expenses in Fort Wayne while studying. G.I. approved. Enter Dec., March, June, Sept. Catalog.

**B.S. DEGREE
IN 27 MONTHS**



INDIANA TECHNICAL COLLEGE

9117 E. Washington Blvd., Fort Wayne 2, Indiana
Please send me free information on B.S. ENGINEERING DEGREE IN 27 MONTHS as checked.

Electronics Chemical Aeronautical
 Civil Mechanical Electrical
B.S. DEGREE IN 36 MO. IN Math. Chem. Physics

Name
Address

ZYTRON "QUALITY BRAND"

RADIO & TV RECEIVING

TUBES

The Ideal Source of Supply for the Independent Service Dealer.



All Tubes Brand New, Individually Boxed, very Low Priced! Send TODAY for Catalog.

ZYTRON TUBE CORPORATION

220 West 42nd Street - New York 36, N. Y.



One of four 60-foot "big screen" Blaw-Knox antennas used in new microwave scatter link.

First Over-Horizon TV Bridge

New 185-mile TV-telephone link set up between Florida and Cuba employs scatter.

SCIENTISTS and engineers at Federal Telecommunication Laboratories have developed the world's first microwave radio system capable of carrying television and more than 100 telephone channels for a distance of almost 200 miles. Over-the-horizon microwave equipment, employing scatter techniques, provides an electronic bridge between Florida City, Florida and Guanabo, Cuba—a distance of 185 miles. High-power transmitters and high-gain antennas are used in the new link. The system differs from others constructed or under construction in that it incorporates a frequency band broad enough to accommodate television and more than 100 telephone conversations at the same time. The conventional "O/H" system is narrow-band and is capable of carrying only a limited number of voice or telegraph channels. Overland links from the O/H terminals to the main offices in Miami and Havana were installed by the American Telephone and Telegraph Co.

In order to achieve the utmost in system reliability, broadband transmitters and receivers are used in a suitable dual and quadruple diversity system. The equipment, which is basically FM, operates in the 692-880 mc. band. A transmitter power level of 10 kw. is used.

Besides this Florida-Cuba link, International Telephone and Telegraph Corp. is installing five major O/H links. One joins the 240-miles-apart Mediterranean islands of Sardinia and Minorca, providing direct telephone service between Spain and Italy. —30—

Build the Best— build ALLIED knight®-kits



the finest electronic equipment in money-saving kit form

LOWEST COST

ALLIED'S giant buying power passes biggest savings on to you—you do the easy assembly and your finished instrument equals the performance and appearance of equipment selling for several times the low KNIGHT-KIT cost. Your savings are BIG.

EASIEST TO BUILD

KNIGHT-KIT "Step-and-Check" instruction manuals with wall-sized picture diagrams are marvels of clarity—it's like having a good instructor at your side. No experience required—you can easily build any KNIGHT-KIT and get professional results.

LATEST DESIGN

Each ALLIED KNIGHT-KIT incorporates the very latest circuitry for top-quality performance. Tried and proved professional design and the use of premium quality parts throughout help insure your building success to bring you quality results.

COMPLETE KIT SELECTION:

- HI-FI
- HOBBY
- INSTRUMENT
- AMATEUR



MONEYBACK GUARANTEE. When properly assembled, KNIGHT-KITS fully meet published specifications or we refund your money in full.

EASY TERMS. If your KNIGHT-KIT order comes to \$45.00 or more, you can make your purchase on our attractive Easy Payment Plan.

High Fidelity Everyone Can Afford

- World's Finest Hi-Fi Kits
- Custom-Styled
- Easiest to Build Hi-Fi
- Money-Saving



knight-kit High Fidelity FM-AM Tuner Kit

Model Y-787

\$49.95

Only \$4.99 down

- Latest Time-Saving Printed Circuit Design
- Flywheel Tuning
- Automatic Frequency Control
- 2.5 μ v FM Sensitivity
- True High Fidelity Response
- Beautiful Custom-Styled "Space Saver" Case

The best-looking, best-performing FM-AM tuner kit your money can buy! Carefully designed for quick, easy construction—a tuner you'll enjoy assembling and be proud to own, both for its amazing musical performance and outstanding beauty. Covers the full AM broadcast band and 88 to 108 mc FM. On FM, *sensitivity is a remarkable 2.5 microvolts for 20 db of quieting*; hum and noise, -60 db; IF bandwidth, 200 kc at 50% down on curve; response, \pm 0.5 db, 20-20,000 cps. On AM, *sensitivity is 3 microvolts for 10 db signal-to-noise ratio*; IF bandwidth, 8 kc at 50% down on curve; response, 20-8000 cps. Outstanding features include: Inertia Flywheel Tuning for effortless, accurate tuning; Automatic Frequency Control (plus AFC disabling) to "lock-in" FM stations; printed circuit board (with most of the kit wiring already done for you) assures time-saving, error-free assembly; pre-aligned RF and IF coils; tuned RF stage on FM; drift-compensated oscillator; neon glow tuning pointer; cathode follower output; two output jacks—one for recorder, one for amplifier; rotatable built-in ferrite antenna for AM. Includes beautiful French-gray case with chrome-finished tapered feet, 4 x 13 x 8". Ideal for use with 18, 20 or 30 watt KNIGHT-KIT amplifiers. Ready for easy assembly. Shpg. wt., 12 lbs.

Model Y-787. FM-AM Tuner Kit. Net only..... **\$49.95**



knight-kit 18-Watt Complete Hi-Fi Amplifier Kit

Model Y-786

\$39.95

Only \$3.99 down

- The Last Word in Custom Hi-Fi Styling
- Full 18 Watts with Superb Hi-Fi Specifications
- 8 Inputs for Every Desired Signal Source
- Printed Circuit Switch and Printed Circuit Boards
- Full Equalization for All Record Types

Here is a custom-styled, easy-to-build complete Hi-Fi amplifier at a price that defies comparison. Delivers full 18 watts output with wide-range, flat frequency response for true hi-fi reproduction. Features 8 inputs for every possible signal source, including NARTB equalized tape head input. At full 18 watts output, distortion is only 0.5%; uses new RCA 6973 hi-fi output tubes. Frequency response is \pm 1 db, 20-30,000 cps; tape head and magnetic cartridge sensitivity, 5 microvolts for 18 watts output; hum and noise level better than 60 db below 18 watts. Output taps for 4, 8 or 16 ohm speakers. Controls: Input and Record Equalization; Bass Boost and Attenuate; Treble Boost and Attenuate; Volume. Simplest assembly is made possible through the use of an exclusive printed circuit switch and two printed circuit boards—most of the kit wiring is already done for you. With custom-styled French-gray "space-saver" case on tapered feet finished in chrome, 4 x 13 x 8". Complete with case, tubes, all parts, and step-by-step instructions, for easy, error-free assembly. Shpg. wt., 15 lbs.

Model Y-786. 18-Watt Hi-Fi Amplifier Kit. Net only..... **\$39.95**

EASY TERMS TO FIT YOUR BUDGET.

ALLIED KNIGHT-KITS may be purchased under our Easy Payment Plan. Your order need total only \$45.00 or more—only 10% down, small monthly payments thereafter. No red tape—fast handling assured.

Our 37th Year



® Registered Trade-Mark of Allied Radio Corporation

ORDER FROM **ALLIED RADIO** 100 N. WESTERN AVE. • CHICAGO 80, ILL.

Now you can have Custom-Styled Hi-Fi in **ALLIED**



knight-kit 30-Watt Complete Hi-Fi Amplifier Kit

Model Y-762

\$76⁹⁵

- Full Equalization, $\pm 1/2$ db of Recommended Accuracy
- Printed Circuit Switches • Printed Circuit Boards
- 8 Inputs For Every Possible Signal Source
- Full 30 Watts Output • Custom-Styled Beauty

Only \$7.69 down

Comparable to the best in Hi-Fi—at far less cost! Deluxe features include: Linear-deluxe Williamson-type circuit for flawless response; equalization for all records within $1/2$ db of recommended accuracy; 2 exclusive new printed circuit switches in preamp section (no complex wiring to do); 3 printed circuit boards for time-saving, error-free assembly; separate, continuously variable Level and Loudness controls; use of premium 12AY7 tube for low noise and hum; DC on all filaments of preamp tubes; exclusive A-AB-B speaker selector switch (use speakers of mixed impedances without mismatch). 8 inputs: Tape Head direct; G.E. and Pickering cartridges; Ceramic cartridge; Microphone; Auxiliary; Tape Preamp; Tuner (with separate Level Set control). Power amplifier response, $\pm 1/2$ db, 15-100,000 cps at full 30 watt level; distortion—harmonic, 0.55% at 30 watts—IM, 0.74% at 20 watts. Separate Bass and Treble controls; rumble filter switch; variable damping. Output, 8 and 16 ohms. With smart French-gray cabinet, 4 x 15 x 15". Ready for easy, money-saving assembly. Shpg. wt., 32 lbs.

Model Y-762. 30-Watt Hi-Fi Amplifier Kit. Net only..... **\$76.95**

knight-kit High Fidelity FM Tuner Kit

Model Y-751

\$38⁹⁵

- Authentic High Fidelity FM Response
- Flywheel Tuning • Automatic Frequency Control
- Printed Circuit • Pre-Adjusted Coils and IF's
- 4 Microvolt Sensitivity Guaranteed

Only \$3.89 down

Here is top value in creative engineering, impressive hi-fi performance and distinctive design—a tuner you'll be proud to build and own. Covers the full FM band, 88 to 108 mc. Features Automatic Frequency Control (with disabling feature) to "lock-in" stations and prevent drift; Inertia Flywheel Tuning for velvet-smooth, accurate station selection; pre-adjusted RF coils; pre-aligned IF's; cascode broad-band RF amplifier; drift-compensated oscillator; neon bulb pointer. All critical wiring is already done for you in the form of a printed circuit board—assembly is simple. Sensitivity is 4 microvolts for 20 db of quieting across entire band; output, 2 volts at 1000 microvolts input; IF bandwidth, 200 kc; response, 20-20,000 cps. with only 0.6% distortion. Output jacks for amplifier and tape recorder; cathode follower output. Ideal for use with the KNIGHT-KIT amplifiers, or any amplifier with phono-tuner switch. Features custom-styled case in French-gray, with tapered chrome-finished feet, 4 x 13 x 8". Includes all parts, tubes and step-by-step instructions for easy assembly. Shpg. wt., 12 lbs.

Model Y-751. Hi-Fi FM Tuner Kit. Net only..... **\$38.95**

knight-kit Deluxe 3-Way Speaker System Kit

Model Y-937

\$89⁵⁰

Only \$8.95 down

- Pre-Finished "Quik-Craft" Corner Enclosure
- Klipsch Designed and Licensed
- Famous Knight 12" 3-Way Speaker
- Easy to Assemble—Top Hi-Fi Quality
- Choice of Enclosure Finishes

Deluxe quality high fidelity speaker system at a money-saving low price. Easy to assemble—all you need is a screwdriver. System includes KNIGHT "Quik-Craft" corner-type folded-horn enclosure kit, and the famous-value KNIGHT 3-Way 12-inch speaker. Just assemble the enclosure—no finishing required—all surfaces are finished in hand-rubbed Korina blonde, mahogany or walnut. The speaker is the new 3-way type: 12" woofer cone for bass (full $1 3/4$ pound woofer magnet), conical radiator for mid-frequencies, built-in compression-type tweeter (with wired level control and calibrated dial) for highest frequencies. Unexcelled enclosure efficiency and superb speaker performance combine to cover the whole spectrum of audible sound for true hi-fi response from 35 to 15,000 cps, ± 3 db. Kit includes 12" 3-Way speaker, prefinished enclosure panels, grille cloth, hardware and instructions. Specify Korina blonde, mahogany or walnut when ordering. Shpg. wt., 44 lbs.

Model Y-937. 3-Way Speaker System Kit. Net only..... **\$89.50**



3-Way Speaker

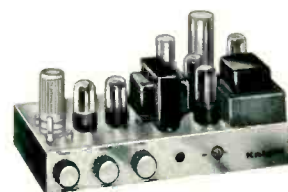

knight-kit 10-Watt Hi-Fi Amplifier Kit

Y-753

\$23⁵⁰

Low-cost, authentic hi-fi amplifier. Response, ± 1 db, 30-20,000 cps. Input for crystal phono or tuner; chrome-plated chassis is punched for preamp kit below, to permit use of magnetic phono. Only 0.5 volt drives amplifier to full output. Separate bass and treble controls. Only 1% harmonic distortion. Matches 8-ohm speaker. 7 x 13 x 6". With all parts, tubes and instructions. Shpg. wt., 13 lbs.

Model Y-753. Net only... **\$23.50**
Y-235. Preamp Kit... **\$ 3.10**
Y-757. Metal Cover... **\$ 3.95**

ALLIED RADIO

America's Pioneer in Electronic Kits

knight-kits

THE VERY FINEST MUSICAL QUALITY—SO EASY TO BUILD
MONEY-SAVING HI-FI EVERYONE CAN AFFORD

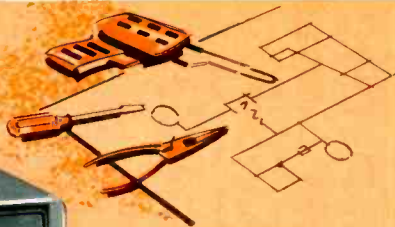

So Easy To Build
Anyone can build
KNIGHT-KIT HI-FI.
No experience re-
quired to get top
results!



knight-kit High Fidelity Preamp Kit

Model Y-754

\$39⁹⁵

Only \$3.99 down

- Exclusive Printed Circuit Switches and Boards
- Equalization $\pm \frac{1}{2}$ db of Recommended Accuracy
- 8 Inputs Including Tape Head
- DC on All Tube Filaments
- Self-Powered
- Custom-Styled

Sensational Hi-Fi design at amazing low cost. Provides precise record equalization guaranteed within $\frac{1}{2}$ db of recommended accuracy!—more accurate than all but the most expensive factory-built preamps. Includes exclusive new KNIGHT-KIT printed circuit switches for easy, error-free assembly; 2 printed circuit boards eliminate all other wiring, except for power supply and control leads—so easy to build. Has built-in power supply; includes premium 12AY7 and ECC82 tubes. Frequency response, ± 0.5 db, 10-50,000 cps. Has 8 inputs: Tape Head; G.E. Phono; Pickering Phono; Ceramic; Microphone; Auxiliary; Tape Preamp; Tuner. Level adjustment for tuner input. Includes separate Bass and Treble controls; separate Level and Loudness controls; Rumble Filter switch; DC on all tube filaments; cathode follower output; 2 extra AC outlets. You get every advanced hi-fi feature in this easy-to-build preamplifier at the lowest possible cost. Includes beautiful custom-styled French-gray case, with tapered chrome-finished legs, 4 x 13 x 8". With all parts, tubes, step-by-step instructions; ready for easy assembly. Shpg. wt., 12 $\frac{1}{2}$ lbs.

Model Y-754. Hi-Fi Preamp Kit. Net only... **\$39.95**

knight-kit 25-Watt Hi-Fi Basic Amplifier Kit

Model Y-755

\$44⁵⁰

Only \$4.45 down

- Hi-Fi Response, ± 0.5 db, 10 to 120,000 cps
- Only 0.15% Distortion at 30 Watts Output
- Printed Circuit Wiring Board
- Williamson-Type Circuit with Over 25 Watts Output

Here's superb Hi-Fi performance at less than half the cost of a comparable commercially-assembled unit. Williamson-type linear-deluxe circuit delivers over 25 watts of virtually undistorted reproduction. Ideal for use with the KNIGHT-KIT preamp at left. Includes printed circuit board for simplified, error-free assembly. Remarkable hi-fi response, ± 0.5 db, 10-120 000 cps at 20 watts. Harmonic distortion, 0.15% at 30 watts; IM, 0.4% at 20 watts. Hum level, 85 db below 25 watts output. Output impedances, 4, 8 and 16 ohms; output tubes, 2-5881. Includes balance control for precise matching of the output tubes; variable damping control for maximum performance with any speaker system—prevents low-frequency distortion from overdamping or underdamping. Very attractive black and chrome styling, 6 $\frac{1}{4}$ x 14 x 9". An outstanding engineering achievement in a basic hi-fi amplifier, delivering performance equal to the finest commercially assembled units. Includes all parts and tubes; with step-by-step instructions, ready for easy assembly. Shpg. wt., 25 lbs.

Model Y-755. 25-Watt Amplifier Kit. Net only... **\$44.50**
Y-759. Metal Cover for above; black finish. 5 lbs. Net... **\$4.25**

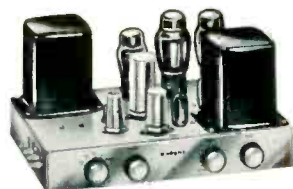

knight-kit 20-Watt Hi-Fi Amplifier Kit

Y-750

\$35⁷⁵

\$3.57 down

True hi-fi for less! Complete with full set of controls and built-in preamplifier. Response, ± 1 db, 20-20,000 cps; distortion 1% at 20 watts. Inputs for magnetic phono, microphone, crystal phono or recorder, and tuner. Compensation positions for 78 and LP records. Separate bass and treble controls. Output impedances, 4, 8, 16 and 500 ohms. Chrome-plated chassis. 7 x 13 x 8 $\frac{3}{4}$ ". Ready for easy assembly. Shpg. wt., 20 lbs.

Model Y-750. Net only... **\$35.75**

Y-758. Metal Cover... **\$4.15**

knight-kit 2-Way Hi-Fi Speaker System Kit

Model Y-789

\$49⁹⁵

Only \$4.99 down

- Easy to Assemble—Pre-Finished Enclosure
- High Fidelity Response, 45 to 14,000 cps
- 12" Woofer and Horn-Type Tweeter
- A Wonderful Money-Saving Speaker Value

BIG SAVINGS—assemble your own quality KNIGHT-KIT 2-way speaker system—it's quick and easy! The cabinet is *pre-finished* in full-grained, high luster blonde or mahogany—you just assemble 7 pieces, mount the speaker components and enjoy rich, thrilling hi-fi sound—at incomparably low cost. Special Jensen-engineered baffle features "ducted port" construction to bring out the full beauty of bass notes, perfectly matching the Jensen woofer and compression tweeter; genuine L-pad control is rear-mounted to permit adjustment of tweeter for best tonal balance. Impedance, 16 ohms. The assembled unit delivers a frequency response of 45 to 14,000 cps. Enclosure measures 26 x 19 x 14". Beautifully styled to blend in any room. Kit includes Jensen 12" woofer, Jensen compression-type tweeter, pre-finished wood parts (with grille cloth installed), acoustic material, glue, hardware and step-by-step instructions. Absolutely no furniture finishing required. *Specify blonde or mahogany finish when ordering.* Shpg. wt., 33 lbs.

Model Y-789. 2-Way Speaker System Kit.

Net only... **\$49.95**



knight-kit HI-FI IS AVAILABLE ON EASY TERMS TO FIT YOUR BUDGET

Fascinating

ALLIED **knight-kits**

FOR EXPERIMENTERS AND HOBBYISTS

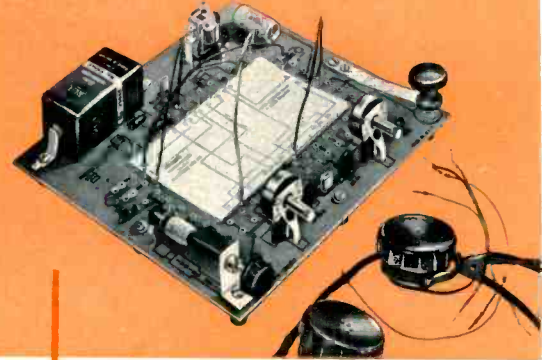

knight-kit 2-Transistor Pocket Radio Receiver Kit

Model Y-262 • Loud, Clear Local Reception
 • Newest Printed Circuit Board
 • Built-In Loop Antenna
 • Complete Kit—Nothing Else To Buy

\$14.65

It's fun to build this pocket-size two-transistor radio—and you'll enjoy its crystal-clear local broadcast-band reception wherever you go! Fits in your pocket, or with its but-on-down flap, can be worn from your belt. Completely self-contained with built-in ferrite loopstick antenna—no external antenna needed. Extremely efficient reflex type 2-transistor circuit actually does the work of 3 transistors! Printed circuit board reduces building time to about one hour. Has air-dielectric variable capacitor for easy, accurate station tuning. Operates for months and months on long-life alkaline battery supplied. Sensitive miniature earpiece provides crystal-clear tone. Handsome tan carrying case, plastic-impregnated, is styled to resemble leather; only 4x3 3/4 x 1 3/4". Kit includes all parts, transistors, earpiece, battery and case. Shpg. wt., 1 1/2 lbs.

Model Y-262. Net only \$14.65

knight-kit "Trans-Midge" Transistor Receiver Kit

Model Y-767 Tiny, cigarette-pack-size one-transistor radio kit—fascinating to build—so low-priced. This novel miniature receiver will provide endless listening

pleasure the moment assembly is completed. Covers the local AM broadcast band with exceptional sensitivity and selectivity. Special features include: Efficient, slug-tuned coil for excellent station separation; external knob for easy station tuning; low-drain transistor operating for months from single penlight cell supplied; hinged-back, red plastic case. Kit includes all parts, transistor, battery, compact case and easy-to-follow instructions for quick assembly. (External antenna and headphones required.) Shpg. wt., 8 oz.

Model Y-767. Net only \$2.45
 J-149. 4000 Ohm Headphones. 1 lb. \$2.15
 C-100. Antenna Kit. 1 1/2 lbs. \$1.03

knight-kit 10-Circuit Transistor Lab Kit

Model Y-299 Sensational experimenters' transistor kit—an electronic marvel! Perfect for experimenter, student or hobbyist.

\$15.75

Assemble basic parts once, then complete project after project (10 in all), by simply plugging leads into proper jacks on printed circuit board—no wiring changes needed. You learn how transistors operate by "plugging in" to make any one of the following circuits; AM radio for strong headphone reception; 2-stage audio amplifier; wireless broadcaster; code practice oscillator; electronic timer; electronic switch; electronic flasher; photoelectronic relay; voice-operated relay; capacity-operated relay. Includes all parts, 2 transistors, battery, headphones, circuit leads, relay, photocell, special guide cards for each project, explanation of each circuit. 3 lbs.

Model Y-299. Net only \$15.75

knight-kit 5-Transistor Superhet Personal Portable Radio Kit

Model Y-766 • Styled to Equal the Finest
 • Push-Pull Audio Drives 3 1/2" Speaker
 • Printed Circuit for Easy Building
 • 200 Hour Battery Playing Life

\$29.95

Beautiful, easy-to-build transistorized personal portable with every ultra-modern design feature: 5 Texas Instrument Co. transistors; latest printed circuit chassis for easy, error-free assembly; bigger-than-average 3 1/2" speaker; class B push-pull audio output; built-in high-gain ferrite loopstick antenna; plus phone jack output for private listening. Provides sensitive reception of the AM broadcast band with exceptional tone quality. Ultra-smart high-impact ivory plastic case has handsome gold trim with ebony accents; includes pull-out handle; only 7 1/2 x 3 3/4 x 1 3/4". With all parts, transistors, 9 volt transistor radio battery, carrying case and instructions anyone can easily follow. Shpg. wt., 2 lbs.

Model Y-766. Net only \$29.95

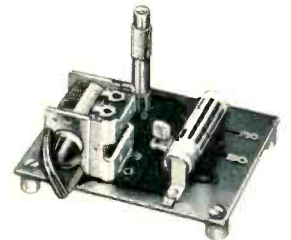

1-Transistor Radio Kit

Model Y-765 Offers excellent AM local broadcast headphone reception. Printed circuit board for easy assembly. Operates from single penlight cell for months. Complete with all parts, transistor and penlight cell. (Antenna and headphones required.) Shpg. wt., 1 lb.

Model Y-765. Net only \$3.95

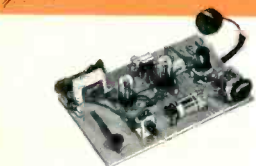

"10-In-One" Electronic Lab Kit

Model Y-265 Famous experimenters' kit. Builds any of 10 fascinating projects, including broadcast receiver, wireless phono oscillator, code practice oscillator, signal tracer, relays, etc. Shpg. wt., 5 lbs.

Model Y-265. Net only \$12.65

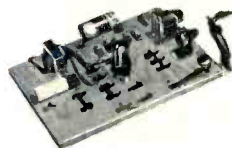

"6-In-One" Electronic Lab Kit

Model Y-770 A favorite with beginners. After basic wiring is completed, you make circuit changes without soldering. Builds any of six favorite projects, including radio, wireless broadcaster, etc. Shpg. wt., 3 lbs.

Model Y-770. Net only \$8.45

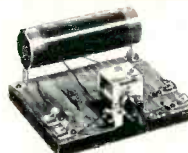

Crystal Set Hobby Kit

Model Y-261 Entertaining, educational. Delivers clear headphone reception of local broadcast stations. With all parts, ready for easy assembly. (Antenna and headphones required.) Shpg. wt., 1 lb.

Model Y-261. Net only \$2.15

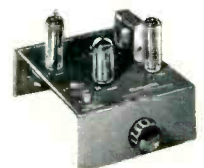

Wireless Broadcaster Kit

Model Y-705 Play music or make announcements through your radio set—no connection to set required! Loads of fun—easy to build. Works up to 50 feet from set. Shpg. wt., 3 lbs.

Model Y-705. Net only \$9.50

FUN TO BUILD . . . INSTRUCTIVE . . . LATEST CIRCUITS FOR TOP PERFORMANCE

WIDEST CHOICE OF QUALITY HOBBYIST KITS



Interruption of light beam triggers relay, which in turn sounds chime or bell, turns on lights, etc.



knight-kit Photoelectronic Relay Kit

Model Y-702 Advanced-design, ultra-sensitive photoelectronic relay—build it yourself and save! Dozens of uses: for automatic control of lights, door announcer, burglar alarm, counting devices, etc. Provides dependable operation up to 250 feet with white light, up to 125 feet with "unseen" light (red filter) from Light Source Kit listed below. Selectable operation, with "trip" for burglar alarm to provide continuous ringing of alarm; and "auto" if relay is to operate each time beam is broken (for chimes, counting devices, turning on lights at darkness). Has SPST relay operated from thyatron; 6.3 v. terminals provide power for accessories. For 105-120 v. 50-60 cy. AC use. 6 lbs.

Model Y-702. Relay Kit. Net only **\$13.50**

Model Y-703. Light Source Kit. With bulb and red filter. Shpg. wt., 3½ lbs. Net. **\$6.75**



knight-kit "Ocean Hopper" All-Wave Radio Kit

Model Y-740 This top-performing regenerative receiver puts a world of listening pleasure at your finger-tips. Tuning range (using coils listed below) is virtually world-wide; covers 155 kc to 35 mc. including every type of radio transmission: AM broadcast, marine, aircraft, distress channels, direction-finding, Amateur, frequency standard, foreign broadcast, and police. With band-spread tuning. For use with headphones or 3-4 ohm PM speaker. Kit is supplied with standard broadcast band coil and all tubes and parts. (Less extra coils, headphones, speaker and cabinet.) Shpg. wt., 5 lbs.

Model Y-740. Net only **\$11.95**

Y-746. Cabinet for above. 1½ lbs. Net **\$2.90**
Extra coils available: Long Wave Coil (155-470 kc), Net 79c. Short Wave (1.65—4.1 mc; 2.9—7.3 mc; 7—17.5 mc and 15.5—35 mc), Each 65c.



knight-kit "Space-Spanner" Bandswitching World-Wide Radio Kit

Model Y-243 • Broadcast or Short Wave Reception
• Sensitive Regenerative Circuit
• Convenient Bandspread Tuning
• Built-In Loudspeaker

Imagine the thrill of hearing overseas broadcasts on a precision receiver you've built yourself—and then, at the flip of a switch, being able to tune to your favorite local broadcast station! Bandswitch selects exciting short wave, including foreign broadcasts, amateur calls, aircraft, police and marine radio on the 6.5 to 17 mc range, as well as standard 540-1700 kc broadcasts. Features highly sensitive regenerative circuit. Includes built-in 4" PM speaker and beam-power tube for strong volume and clear tone. Headphone connectors are available for private listening; switch cuts out speaker. Controls: Bandspread, Main Tuning, Antenna Trimmer, Bandswitch, Regeneration, Volume. 7x10x6". Easy to build from step-by-step instruction manual. For 110-120 v., 50-60 cy. AC or DC. (Less cabinet.) Shpg. wt., 5 lbs.

Model Y-243. Net only **\$15.95**

Y-247. Cabinet for above. Shpg. wt. 2 lbs. Net. **\$2.90**



"Ranger II" Superhet Receiver Kit

\$17.25 Popular Broadcast band receiver built and enjoyed by thousands. Features built-in antenna, automatic volume control, ball-bearing tuning condenser, PM dynamic speaker. Handsome plastic cabinet. Easy to assemble. AC or DC operation. Shpg. wt., 8 lbs.

Model Y-735. Net only **\$17.25**

knight-kit 2-Way Intercom System Kit

Model Y-295 • Low Cost—Easy to Assemble
• High Gain—Clear Tone
• Handsome Metal Cabinets
• Includes 50-Foot Cable

Easy to build at lowest cost—ideal for home, office, shop or school. Consists of Master unit and Remote unit. Remote unit may be left "open" for answering calls from a distance, for "baby sitting", etc. Remote also may be set for "private" operation—cannot be "listened-in" on, but it can be called and can originate calls. Master unit includes high-gain 2-stage amplifier, combination volume control and on-off switch, plus pilot light. Each unit has 4" PM dynamic speaker. System responds to even a whisper. Handsome Antique white cabinets, each 4¾x6½x4¾". With all parts, tubes and 50-ft. cable (up to 200-ft. may be added). For 110-120 v., AC or DC. 8 lbs.

Model Y-295. Master and one Remote. Net only **\$14.75**

Y-296. Extra Remote Station Kit. 3 lbs. **\$3.75**



Phono Amplifier Kit

\$9.45 Build it yourself—and save! Ideal for use in a portable phonograph—just add record player and 3-4 ohm speaker. 1½ watt output. Inverse feedback circuit. Easy to assemble. Shpg. wt., 3 lbs.

Model Y-790. Net only **\$9.45**



Electronic Photoflash Kit

\$28.50 Ideal for color or black and white photography. 1/700th-of-a-second flash; 50 watt/second output. Synchronizes with any camera with X or O shutter. (Less battery.) Shpg. wt., 4 lbs.

Model Y-244. Net only **\$28.50**



Code Practice Oscillator Kit

\$3.95 Ideal for beginners learning the code. Transistorized circuit. Operates for months from single penlight cell supplied. Clear, crisp 500 cycle tone. Jacks for headphones; screw terminals for key. 1 lb.

Model Y-239. Net only **\$3.95**



Phono Oscillator Kit

\$5.85 "Broadcasts" recorded music through any standard radio set up to 50 feet away. No direct connection to set required. Easy to build—fun to use. Shpg. wt., 2 lbs.

Model Y-760. Net only **\$5.85**



knight-kit Low-Cost Tube Tester Kit

Model Y-143

- With 16 Filament Voltages
- 600 Latest Tube Types Listed
- Easy-to-Read 4½" Meter
- Tests Series-String TV Tubes

\$29⁷⁵

Expertly designed for complete, up-to-date coverage of tube types. Tests *series-string TV tubes*; tests 4, 5, 6 and 7 pin large, regular and miniature types, octals, loetals, 9-pin miniatures and pilot lamps. Tests for open, short, leakage, heater continuity and performance (by amount of cathode emission). Big 4½" square meter has clear "GOOD-?-REPLACE" scale. With line-voltage indicator and line-adjust control. Choice of 16 filament voltages from 0.63 to 117 volts to check virtually all receiving tubes; blank socket for future type tubes. Universal-type selector switches permit selector of any combination of pin connections. Single-urit, pre-assembled 10-lever function switch simplifies and speeds assembly. Up-to-date illuminated roll chart lists over 600 tube types. Counter model case, 5 x 14 x 10". Easy to build. 14 lbs.

- Model Y-143. Net only **\$29.75**
 Y-142. Portable Case model. 15 lbs. Net. **\$34.75**
 Y-141. Picture Tube Adapter. 1 lb. Net. **\$ 4.25**

knight-kit RF Signal Generator Kit

Model Y-145

\$19⁷⁵

Build this wide-range, extremely stable RF signal generator—save two-thirds the cost of a comparable wired instrument! Large, semi-circular dial is clearly calibrated; range is covered in 5 separate bands for close accuracy in setting individual frequencies. Ideal for aligning RF and IF stages in radio and TV sets and for troubleshooting audio equipment. Delivers output on fundamentals from 160 kc all the way out to 112 mc; useful harmonics to 224 mc. Has built-in 400-cycle sine-wave audio oscillator for modulating RF; audio is also available externally. Features high-stability Colpitts circuit. Convenient jack for external modulation. Maximum audio output 10 volts; RF output over 0.1 volt on all ranges. Step and continuous-type attenuator controls. Supplied with precision-wound coils that require no adjustment. 7 x 10 x 5". Shpg. wt., 11 lbs.

Model Y-145. Net only **\$19.75**

knight-kit 1000 Ohms/Volt VOM Kit

Model Y-128

\$16⁹⁵

Exceptional accuracy and versatility at amazing low cost. Ideal for service shop, lab or Amateur use. Large 4½", 400 microamp meter with separate scales for AC and DC voltage and current, decibels and resistance. Uses 1% precision resistors; has 3-position function switch and 12-position range switch. 38 ranges include: AC, DC and output volts, 0-1-5-10-50-500-5000 (1000 ohms/volt sensitivity); Resistance, 0-1000-100,000 ohms and 0-1 meg (center scale readings of 60, 150 and 1500 ohms); Current, AC or DC, 0-1-10-100 ma and 0-1 amp; Decibels, -20 to +69 in 6 ranges. Precision resistors are used as shunts and multipliers to assure exceptional accuracy of measurements. With all parts, battery, test leads and black bakelite case with convenient carrying handle, 6¾ x 5¼ x 3¾". A great value in an easy-to-build quality instrument. Shpg. wt., 2½ lbs.

Model Y-128. Net only **\$16.95**

knight-kit Vacuum Tube Voltmeter Kit

Model Y-125

\$24⁹⁵

- 200 µa Movement, 4½" Meter
- Includes AC, Peak-to-Peak
- Balanced-Bridge, Push-Pull Circuit
- 1% Film-Type Resistors

Top buy in an extremely stable, highly accurate VTVM. Easy to assemble—entire chassis is printed circuit board. Perfect for radio-TV service work, lab and Amateur use. Features low-leakage type switches; 1% film-type precision resistors; balanced-bridge, push-pull circuit (switch to any range without readjusting zero set); zero center scale and direct-reading db scale; polarity reversing switch. Ranges: Input Resistance, 11 megs; DC and AC rms, 0-1.5-5-15-50-150-500-1500; AC Peak-to-Peak, 0-4-14-40-140-1400-4000; Response, 30 cycles to 3 mc; Ohms, 0-1000-10K-100K and 0-1-10-100-1000 megs; db, -10 to +5. Includes all parts, tubes, battery, test leads and portable case, 7¾ x 5¼ x 4-¾". Easy to assemble. Shpg. wt., 6 lbs.

- Model Y-125. Net only **\$24.95**
 Y-126. Hi Voltage Probe; extends DC to 50,000 v. **\$ 4.75**
 Y-127. Hi-Frequency Probe; extends AC to 250 mc. **\$ 3.45**



6V-12V Battery Eliminator Kit

\$32⁹⁵

High current rating; continuously variable filtered output; delivers 15 amps at 6 volts, 10 amps at 12 volts. May be used as battery charger. Two meters provide simultaneous current and voltage readings. Shpg. wt., 18 lbs.

Model Y-129. Net only **\$32.95**



Transistor Checker Kit

\$8⁵⁰

Checks gain ratio of all types of transistors; checks germanium and silicon diodes; checks for continuity and shorts. A valuable instrument at very low cost. Easy to assemble. Shpg. wt., 2½ lbs.

Model Y-149. Net only **\$8.50**



Flyback Checker Kit

\$19⁵⁰

Checks condition of all types of horizontal output transformers and deflection yokes, as well as TV linearity and width coils. 4½" meter; widest range in its field. Shpg. wt., 6 lbs.

Model Y-118. Net only **\$19.50**



Sweep Generator Kit

\$43⁷⁵

Extreme linearity on a par with costly lab instruments; fundamentals to 250 mc; output flat within 1 db; electronic blanking. Easy, money-saving assembly. Shpg. wt., 16 lbs.

Model Y-123. Net only **\$43.75**



Capacitor Checker Kit

\$12⁵⁰

Tests capacitors while in the circuit! Has widest range—20 mmf to 2000 mfd. Exclusive circuit for cancelling lead capacity. "Magic Eye" indicator. Save 60% over factory-wired units. 5 lbs.

Model Y-119. Net only **\$12.50**

**ADVANCED-DESIGN INSTRUMENTS FOR SERVICE, INDUSTRIAL AND RESEARCH USE
IN EASIEST-TO-BUILD, MONEY-SAVING KIT FORM**



knight-kit 20,000 Ohms/Volt VOM Kit

Model Y-140 Outstanding quality and performance at money-saving low price. Features 1% precision multipliers; $4\frac{1}{2}$ " meter accurate within 2% of full scale deflection; 50 microamp sensitivity for 20,000 ohms/volt input resistance on DC; front panel "Zero adjust"; single switch to select function and range. 32 ranges: AC, DC and output volts, 0-2.5-10-50-250-1000-5000; Resistance, 0-2000-200,000 ohms and 0-20 meg.; DC ma, 0-0.1-10-100; DC amps, 0-1-10; Decibels, -30 to +63 in six ranges. Moisture-resistant film-type resistors for extreme accuracy. Carefully engineered circuit design achieves high sensitivity and extremely versatile application. Kit includes all parts, battery, test leads and black bakelite case with highly legible white markings; size $6\frac{3}{4}$ x $5\frac{1}{4}$ x $3\frac{3}{4}$ ". Easy to assemble. Shpg. wt., 5 lbs.

Model Y-140. Net only \$29.50



knight-kit High-Gain Signal Tracer Kit

Model Y-135 A remarkable value in an easy-to-build instrument which permits visual and aural signal tracing of RF, IF, video and audio circuits. Has highest gain in its price class. Traces signal from antenna to speaker. Reproduces signal at plate or grid connection of any stage. Identifies and isolates "dead" stages. Features: usable gain of 91,000; "magic eye" with calibrated attenuators for signal presence indication and stage-by-stage gain measurements; built-in 4" PM speaker; combination 2-position probe, one for RF (6 mmf. input), the other for audio. Provides noise test; built-in watt-meter calibrated from 25 to 1000 watts; provision for external scope or VTVM. Binding posts provide output transformer and speaker substitution test, plus external 280 volts B+. With all parts, tubes and probe. 7x10x5". 12 lbs.

Model Y-135. Net only \$26.50



knight-kit 5" Wide-Band Oscilloscope Kit

Model Y-144

- 5 mc Width for Color TV
- Horizontal Sweep to 600 kc
- 25 mv/inch Sensitivity
- Z-Axis Input
- Printed Circuit Construction

Only \$6.90 down

Equals or betters the performance of commercially wired scopes costing far more. Two printed circuit boards and laced wiring harness assure wiring accuracy and cut assembly time. Ideal for lab use, color TV servicing and high frequency applications. Wide sweep range—15 to 600,000 cps. Vertical response, ± 3 db, 5 cps to 5 mc; only 1 db down at 3.58 mc color burst. High vertical sensitivity of .025 rms v/inch. Input capacity, 20 mmf. Outstanding features: cathode follower inputs; 2nd anode provides 1400 volts high-intensity trace; push-pull amplifiers; positive and negative locking; frequency-compensated attenuator; Z-axis input; one volt P-P calibrating voltage astigmatism control; retrace blanking circuit; DC positioning control. Includes CRT. $14\frac{1}{2}$ x $9\frac{1}{2}$ x $16\frac{1}{2}$ ". 40 lbs.

Model Y-144. Net only \$69.00

Y-148. Demodulator Probe. Net \$ 3.45

Y-147. Low Capacity Probe. 12 mmf. Net \$ 3.45



Voltage Calibrator Kit

\$12.75 Permits use of any scope as precision peak-to-peak AC voltmeter. Puts a true square-wave voltage on scope screen. Selects any voltage between .01 and 100 volts; feeds external signal direct to scope for instant comparison. Shpg. wt., 5 lbs.

Model Y-136. Net only \$12.75

knight-kit 5" General-Purpose Scope Kit

Model Y-146

- Phantastron Linear Sweep
- 25 mv/inch Sensitivity
- Printed Circuit Board
- Retrace Blanking Circuit

\$42.00

Only \$4.20 down

Feature for feature the world's best oscilloscope kit value. A stand-out in its class with all these fine features: *Printed Circuit* wiring board and laced harness for quick, error-free assembly. *Phantastron Sweep Circuit* for high linearity of sweep from 15 to 150,000 cps. *25 Millivolts Per Inch Sensitivity*—3 times that of similarly priced scope kits. *Calibration Voltage*—1 volt peak-to-peak square wave, fully regulated. *Vertical Amplifier*—frequency response ± 3 db, 3 cps to 1.5 mc (± 6 db to 2.5 mc). Includes: Directly coupled positioning controls; retrace blanking circuit; frequency-compensated vertical input attenuator; positive and negative internal sync; high 2nd-anode voltage for high-intensity trace; input capacity, 45 mmf. Kit includes CRT. $9\frac{1}{2}$ x $13\frac{3}{4}$ x $17\frac{3}{4}$ ". 26 lbs.

Model Y-146. Net only \$42.00



Resistance Substitution Box

\$5.95

Easily determines resistor values required in a circuit. Makes available 36 standard 1-watt resistance values in 2 ranges between 15 ohms and 10 megohms, with 10% accuracy. Slide switch selects range; 18-position switch for value selection. Shpg. wt., 2 lbs.

Model Y-139. Net only \$ 5.95



Capacitance Substitution Box

\$5.95

Makes it easy to find capacitor values needed in a circuit. Provides 18 standard values from .0001 mfd to .22 mfd, $\pm 20\%$. All values are 600 volt, except .15 and .22, which are 400 volt. 18-position selector switch. Shpg. wt., 2 lbs.

Model Y-138. Net only \$ 5.95



Audio Generator Kit

\$31.50

Excellent design; range, 20 cps to 1 mc; less than .25% distortion; 600 ohm output. Ideal for hi-fi testing; offers the flat response of a lab standard. Shpg. wt., 16 lbs.

Model Y-137. Net only \$31.50



R/C Tester Kit

\$19.50

Measures capacitance and resistance. Balanced-bridge circuit; indicates power factor; tests capacitors at rated voltage. Large, easy-to-read dial and "magic eye." Shpg. wt., 10 lbs.

Model Y-124. Net only \$19.50

EASY TERMS AVAILABLE

Take advantage of the most liberal Easy Pay plan in electronics. On Knight-Kit orders totaling \$45 or more—just 10% down, small monthly payments thereafter. Low carrying charges—no "red tape."

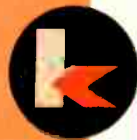

knight-kits FOR THE RADIO AMATEUR

knight-kit 50-Watt CW Transmitter Kit



Model Y-255

\$38.95

Only \$3.89 down

- Ideal for the Novice
- Pi Antenna Coupler
- Bandswitching—80 to 10 Meters

There's exceptional value in this very popular bandswitching transmitter kit. Compact and versatile, it's the perfect low-power rig for the beginning novice as well as the seasoned veteran. Has bandswitching coverage of 80, 40, 20,

15 and 10 meters. Rated at 50 watts—actually operates at up to 60 watts on 80 and 40 meters. Oscillator is efficient 6AG7; final is reliable 807. Crisp, clean, cathode keying of oscillator and final. Built-in pi coupler permits use with random length antennas. Has highly effective TVI suppression. Other features not usually found in transmitter kits at this low price include: Ceramic-insulated final tank capacitor; pre-assembled switches; pre-wound parasitic chokes; ceramic coil forms; coax connector; crystal and VFO socket on front panel; power take-off jack for accessory equipment. Meter reads either plate or grid current of final. Takes crystal or VFO without circuit changes. Cabinet interior and chassis are copper-finished. Size, 8½ x 10½ x 8¼". With tubes and all parts for easy assembly. (Less crystal and key.) Shpg. wt., 19 lbs.

Model Y-255. 50-Watt Transmitter Kit. Net only **\$38.95**

knight-kit All-Band Amateur Receiver Kit

Model Y-726

\$104.50

Only \$10.45 down

- Tunes 540 kc to 31 mc
- Built-In Q-Multiplier
- Constant Running HF Oscillator
- Worthy of the Advanced Ham Operator
- Printed Circuit Bandswitch
- Printed Circuit Board • 1.5 μv Sensitivity

A sensational communications receiver value with all the selectivity, sensitivity and features of high-priced commercial units. Uses printed circuitry throughout, including the exclusive new KNIGHT-KIT printed circuit band-switch, for remarkably easy assembly. Covers 540 kc to 31 mc in 4 ranges; calibrated, electrical bandspread on 80-10 meter Ham bands; slug-tuned Hi-Q coils; continuous, VR tube-regulated B+ applied to HF oscillator lets you switch from standby to receive with no drift; built-in Q-multiplier peaks desired signal or nulls interference; delayed AVC; provision for crystal calibrator (below). Sensitivity, 1.5 microvolts for 10 db signal-to-noise ratio. Selectivity: variable from 300 cps to 4.5 kc at 6 db down. Exalted BFO injection. Controls: Main tuning, bandspread, band selector, Q-multiplier selectivity, Q-multiplier tune, null-off-peak, BFO pitch, RF gain, AF gain, BFO-MVC-AVC-ANL, off-stby-rec-cal, antenna trimmer, and phone jack. Cold-rolled ¼" steel chassis. Handsome metal cabinet, 10 x 10 x 16½". (Less phones, 8-ohm loudspeaker and S-meter.) 23 lbs.

Model Y-726. Amateur Receiver Kit. Net **\$104.50**
 Y-727. S-Meter Kit for above. 1 lb. Net **\$9.50**

knight-kit Self-Powered VFO Kit



Model Y-725

\$28.50

Only \$2.85 down

Complete with built-in power supply! Careful design and voltage regulation assure high stability. Excellent oscillator keying characteristics for fast break-in without clicks or chirps. Full TVI suppression. Has plenty of bandspread; separate calibrated scales for 80, 40, 20, 15, 11 and 10 meters; vernier drive mechanism. 2-chassis construction keeps heat from frequency determining circuits. Output cable plugs into crystal socket of transmitter. Output: 40v on 80, 20v on 40. With Spot-Off-Transmit switch for spot frequency tuning. Extra switch contacts for operating relays and other equipment. Attractive metal cabinet, 8¾ x 6 x 6". Ready for easy assembly. Shpg. wt., 8 lbs.

Model Y-725. VFO Kit. Net only **\$28.50**

knight-kit 100 Kc Crystal Calibrator Kit

Model Y-256

\$10.50

Crystal frequency standard at very low cost. Gives marker every 100 kc up to 32 mc. A "must" for marking band edges. Mounting flanges for installation in or back of receiver cabinet. Size only 1½ x 1½ x 3". Requires 6.3 v. at 0.15 amp and 150-300 v. DC at 3-6 ma. Trimmer for zero-beating with WWV; On-Off switch. Complete with tube, crystal, all parts and easy-to-follow instructions. Shpg. wt., 1 lb.

Model Y-256. 100 Kc Crystal Calibrator Kit. Net only **\$10.50**



knight-kit Amateur RF "Z" Bridge Kit



Model Y-253

\$5.85

Measures standing wave ratio (SWR) and impedance-of-antenna systems; ideal for adjusting antenna systems for optimum results. Measures impedances from 20 to 400 ohms up to 100 mc; SWR to 150 mc. Any VOM may be used for null indicator. With coax input and output connectors. Meters both input and bridge voltage. Calibrated dial gives direct impedance reading; includes 1% precision resistor for precise calibration adjustment. With all parts and handy plasticized SWR chart (less meter). 2½ x 3 x 4½". Shpg. wt., 1½ lbs.

Model Y-253. "Z" Bridge Kit. Net only **\$5.85**

ORDER BLANK

ALLIED RADIO

100 N. WESTERN AVE., CHICAGO 80, ILL.

ALLIED RADIO, Dept. RE, 100 N. Western Ave., Chicago 80, Ill.

Ship me the following KNIGHT-KITS:

Quantity	Description	Model No.	Price

\$..... enclosed. (For parcel post, include postage—express is shipped collect).

My Down Payment in the amount of \$..... is enclosed. Send Time Payment form.

Name.....

Address.....

City..... Zone..... State.....

ALL PRICES NET F. O. B. CHICAGO



FREE 1958
404-PAGE
ALLIED
CATALOG

See the 1958 ALLIED 404-Page Catalog for complete listings of more than 50 KNIGHT-KITS, covering Hi-Fi, Hobby, Test Instrument and Amateur Kits. The 1958 ALLIED Catalog is your complete Buying Guide to the world's largest stocks of everything in Electronics.

Send FREE 404-Page 1958 ALLIED Catalog.

Positive Current Feedback (Continued from page 57)

ficient feedback is obtained from a 1-ohm resistor even though the speaker is 16 ohms. Listening tests with an audio oscillator indicate that this amplifier-speaker system appears to be acoustically flat to below 20 cps.

Fig. 3C shows the network found best for use with the Klipsch "Rebel 4" enclosure. In the specific case considered here a G-E A1-400 speaker is used in the "Rebel 4," but the same circuit is also used on a "Rebel 4" with a much cheaper speaker and gives excellent results. The configuration is different from that used with the Klipschorn because more boost is required and it was found that a network that gave a steadily rising bass characteristic, such as used with the Klipschorn, caused the amplifier to motorboat when the feedback was increased to the correct point. This was because, when enough positive feedback was provided in the required region, all of the negative feedback was cancelled out at some lower frequency and the net amplifier feedback became positive in this region and caused the oscillation (see Fig. 1). This condition is avoided with the configuration shown since it is arranged to peak at the lowest usable frequency and then fall off below this point so that the amplifier has almost full negative feedback in the critical motorboating frequency range. This configuration also largely eliminates thumps that occur when tuning through FM stations. Curves obtainable with this configuration are shown in Fig. 4B and it must be noted that these curves also were taken with a resistive load in place of the speaker. The solid curve was found most suitable in this case and the low-frequency response of the "Rebel 4" enclosure with the G-E A1-400 speaker was extended from 40 cps to slightly below 30 cps. It seemed as if several slight peaks in the response were also eliminated.

An attempt has been made to explain positive current feedback from a different viewpoint than is normally used and it is hoped that this article will clear up some of the controversy surrounding the subject. Three high-fidelity systems have been in use for almost one year with the networks described and at no time have any unpleasant results been observed nor has any listening fatigue been felt. Using these circuits on the Klipschorn and "Rebel" series enclosures gives a life-like bass that is only equalled by the most elaborate systems that are available.

REFERENCES

1. Crowhurst, N. H.: "What's All This About Damping," *Audio*, September, 1955
2. Klipsch, Paul: "Variable Damping," *Radio-Electronics*, October, 1956
3. Wilkins, Charles A.: "Variable Damping Factor Control," *Audio*, September, 1954

—30—

FAIRCHILD DESIGN

We're often asked—"How will the use of the Fairchild Arm in conjunction with the Fairchild Cartridge increase the performance of my high fidelity system?" Since the 280A Arm is the housing best designed for this famed cartridge, the results will be immediately apparent to the critical listener.

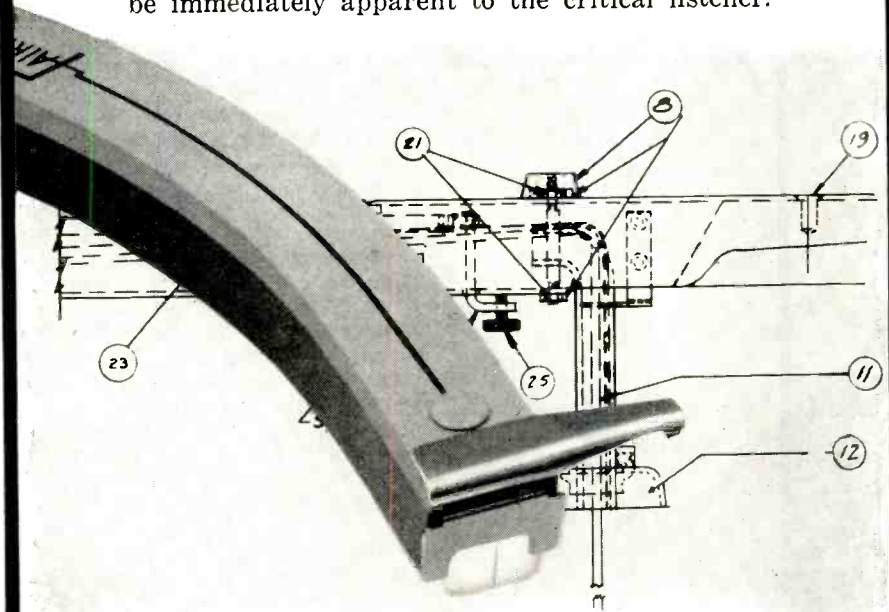

- It will reduce the fundamental resonance which is determined by the mass of the arm and the compliance of the cartridge.
- It will result in excellent tracking of the most heavily recorded passages.
- It will minimize side thrust and hence reduce distortion.
- It will allow complete freedom of motion without vibration or erratic performance.
- It will reduce tracking error to a minimum.
- It will provide unusual features of convenience and ease in handling.
- Most important, it will assure superb sound.

There is no question that a speaker housing is almost as important as the speaker itself. Similarly, the housing for the cartridge is equally important but often overlooked. The Model 280A Arm, the result of much experimentation and fundamental research³ can properly be classified as professional in performance, yet is modestly priced at only \$33.95.

**Journal of the Audio Engineering Society*,
Volume 2, Number 3, July, 1954.

Find out what to look for in a transcription arm.
Write Department "S" for free illustrated booklet
"HOW GOOD IS YOUR ARM."

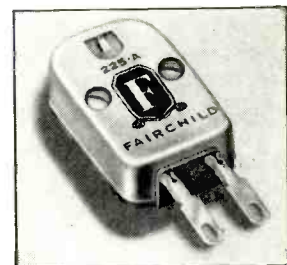

FAIRCHILD
RECORDING EQUIPMENT COMPANY
10-40 45th Avenue, Long Island City 1, New York

SHURE

presents the
dramatic new

Commando

a rugged controlled magnetic microphone
that provides unusual versatility
and excellent performance . . .
for Public Address and Home Recording

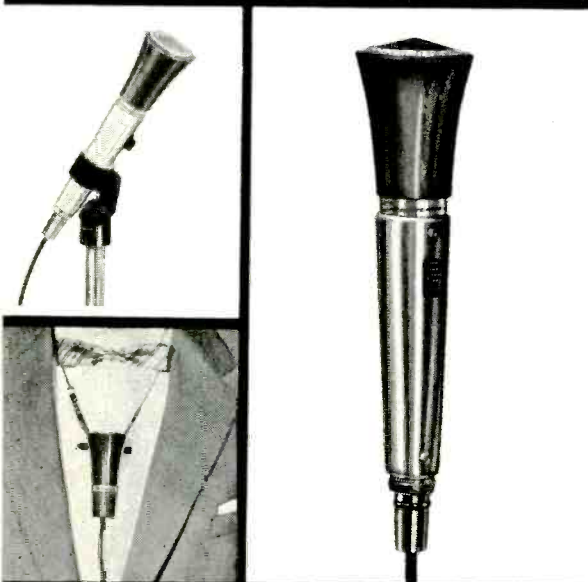

This striking, streamlined unit gives you fine voice and music reproduction in a multiplicity of public address and home recording applications. Whether you use it indoors or out, in the hand or on a desk or floor stand, you'll be delighted by its fine response, high output and beauty of design. The Commando offers you such important features as dual impedance, on-off switch, and cable connector.

The Commando is sturdy and rugged. Of patented controlled magnetic construction, it is unaffected by extremes of temperature and humidity; and it can be depended on to maintain its high level of quality through tough, sustained usage, year after year.

The Commando is available in three models:

DELUXE Model "430"

A dual-impedance unit with A25 swivel adapter, on-off switch, cable connector LIST PRICE \$38.50

LAVALIER Model "420"

A dual-impedance unit with lavalier cord and clip assembly LIST PRICE \$30.00

STANDARD Model "415"

A high impedance unit with A25 swivel adapter LIST PRICE \$27.50

SHURE

The Mark of Quality

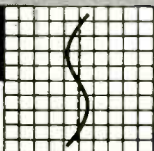

IN ELECTRONICS SINCE 1925

SHURE BROTHERS INC., 222 HARTREY AVE., EVANSTON, ILL.

Photosensitive Meter Adapter

By GENE BRIZENDINE, W4ATE

Profitable Products

Details on a simple adapter which can be used with any v.o.m. to provide monitoring of photosensitivity.

IN experimental or production work involving the measurement of light values, an easy-reading lightmeter is invaluable. The simple adapter described here provides this function inexpensively and conveniently. One application is the constant monitoring of the reflective qualities of a continuous manufacturing process, such as cloth dyeing, paint mixing, or lamp testing. Other uses suggest themselves in photography, where it is desirable to read the meter from across the room, as lighting adjustments are made.

A "sun battery," manufactured by International Rectifier Corporation, (IRC part number B-2M), is used to convert the measured light to corresponding current values. This tiny unit has been measured to produce 3 milliamperes, in direct sunlight! The adapter has provision for conveniently plugging the cell's output into the v.o.m. jacks. See Fig. 4.

When used in conjunction with the 100-microampere range of the popular Simpson Model 260 v.o.m., low values of light may be measured. High values are read by simply switching to a higher current range. Ample scale space is available, should calibration of the higher range be desired.

The light-proof compartment for the light cell consists of a plastic box, used to package *Walco* parts. To render the case light-tight, masking tape is first applied temporarily across the *inside* of one end. A half-teaspoon of flat black paint is now poured into the box. All surfaces are coated, by tilting the box, to "flow" the paint

over all inside areas. The excess paint may be poured onto the inside surface of the sliding lid, to complete the "black-out" of the enclosure.

When the paint dries, a permanent, glossy appearance results. Now the masking tape may be removed to provide the light "window."

Four holes are drilled, first the $\frac{3}{4}$ " size, to clear the meter's "function" switch knob, next two smaller holes for the cell output phone plugs. Lastly, a hole is drilled for the cell's mounting bracket. The box is next reduced in depth by cutting $\frac{1}{8}$ " from the top edges.

The output phone tips are shortened, so as not to obstruct light reaching the cell. Parts arrangement is shown in Figs. 1 and 2. The large ends of the plugs are cut off, leaving about $\frac{1}{8}$ " of the threads. The clamping collar is likewise shortened to about $\frac{1}{16}$ " thickness. Both of these operations may be easily done, by chucking the plug parts in a drill and "turning," using a small file for cutting.

The adapter scale is next cut from a sheet of $\frac{1}{8}$ " clear plastic, leaving the protective paper on both sides, until after attaching the cell box.

After mounting all parts in the box, the cover may be cemented in place, using *Duco* household cement.

To attach the scale to the box, first plug the box into the meter pin jacks. Coat the surfaces to be joined with cement and position the scale against the box and in alignment over the meter scale. Secure the parts in this position with rubber bands until thor-

Fig. 1. Bottom view of the compact adapter showing the arrangement of the output pins which plug into two mating jacks.

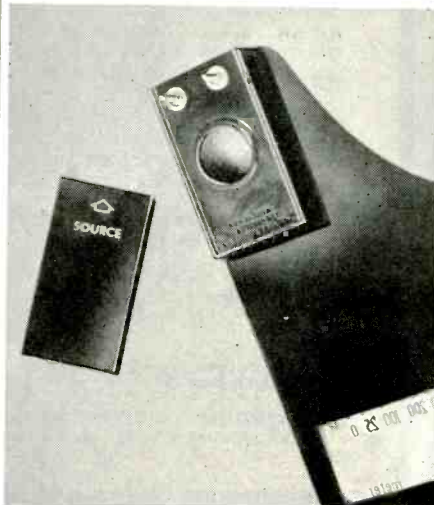
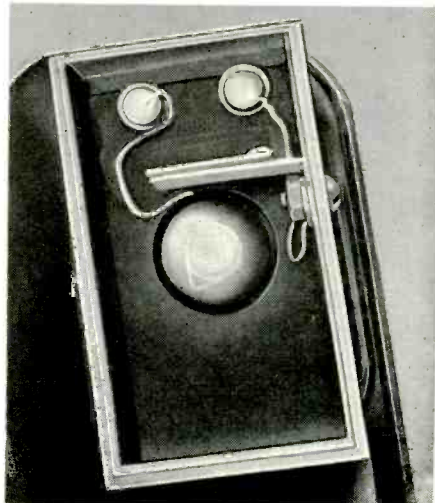

Fig. 2. Close-up view of unit showing interior parts arrangement in light-proof compartment. Switch knob comes through case.



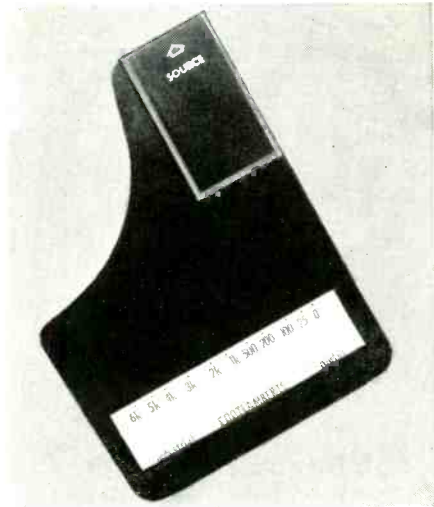

Fig. 3. The completed light meter adapter. The arrow, permanently etched on the case, points toward light source being monitored.

oughly dry. Now peel away the protective paper and apply a strip of masking tape of the correct size to form the scale "window," while the back side of the sheet is coated with black paint.

After the paint has thoroughly hardened, the masking tape may be removed.

A strip of masking tape is applied temporarily along the edge of the scale "window," to receive pencilled calibration points. An exposure meter is used as the calibrating standard. It is placed on the adapter, and aimed in exactly the same direction as the adapter cell. The meter used here was a G-E DW-68; however, other types are also suitable. Any means may be used to supply different light values for calibration. One system is to position a photoflood lamp at various distances from the setup, while pencilling in the corresponding points from the exposure meter readings.

Final scale markings are transferred to the adapter "window," using the decals now popular with electronic equipment constructors.

-30-

Fig. 4. Over-all view of adapter plugged into a Simpson Model 260 v.o.m. and in actual operation. Note the meter reading.



ARKAY

It's NEW!

ARKAY FM-8
Professional
Standard
FM TUNER

Engineered for precise FM reception Arkay "Miracle Ear Sensitivity" provides 1.9 uv for 20 db quieting. Freq. Response 20-20,000 cps. Outstanding features include 3 tuned RF stages, dual limiters, Armstrong FM Foster Seeley discriminator, variable AFC Silent tuning system, tuning meter, cathode follower, high-level & Binaural FM (multiplex) outputs, 0-100 log scale for station pinpointing, self-contained AC power supply plus many other extras.



AM-5

ARKAY AM-5 AM TUNER. Most sensitive AM tuner. "Miracle Ear" 2 uv for 20 db s/n Wide & Narrow Band 3 gang tuning cond. 10Kc whistle filter.
KIT \$39.95
WIRED \$59.95



ARKAY MODEL FL-30 HI-FI AMP PRE-AMP

An engineering masterpiece TRANSISTORIZED front end assures finest in Hi-Fi sound, record equalization for more than 30 records. Freq. response: 1/2 db. 10-40,000 cps. @ 30 watts, 50 watt peak inputs for magnetic pickup, tuner, tape &



ARKAY HFT-7 AM-FM Tuner. AFC. Sensitive. KIT \$32.00
WIRED \$49.95

2 aux. Complete with step-by-step plans, handsome black cabinet & rose gold panel.
KIT \$49.95
WIRED \$74.95

At Last! "LIVING SOUND" STEREO
AT Sensible Prices
by ARKAY



SA-25

At last the economical audiophile can enjoy "living sound"!
MODEL SA-25 - Just attach your present amp to this dual channel pre-amp & 25 watt amp.
KIT \$59.95
WIRED \$89.95



ST-11

MODEL ST-11 - Binaural stereo tuner highly sensitive AM & FM reception.
KIT \$47.95
WIRED \$69.95

Prices 5% higher west of Mississippi FREE! At your dealer or write for complete catalogues of Stereo & Monaural HI-FI, Radio & TV, Kits & Wired.

See and Hear

the Fabulous

ARKAY
STEREO HI-FI

KITS AND PREWIRED



Arkay FL-10-12 watt amp pre-amp - easy construction, only \$28.95

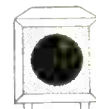

Arkay B12-Booster System Kit (7x17) 15 5/16" \$12.95. Mod B-126 with Coax. cable and Bal. \$25.00



Arkay FL-5-5 watt amp pre-amp. Base control. True HI-FI performance \$12.25



Arkay A-12-12-Amp pre-amp 12 watts 5 inputs, for budget-minded. \$22.95



Arkay 4421 TR Kit 25w. Kit group \$19.50



Arkay TR-6 All-trans con. 225 mill watts, superb! \$31 simple Cassi \$32.50



Arkay TR-5-5 Trans Personal Port High impact case, best for port. list \$31.45

arkay 120 CEDAR STREET NEW YORK 6

NEED QUALITY? INSTALL ANOTHER DERO PRODUCT

AVAILABLE AT YOUR LOCAL DISTRIBUTOR

DeRO
ELECTRONICS

134 NASSAU ROAD
ROOSEVELT, L. I., N. Y.

2-SET COUPLER

MATCHED TRANSFORMERS
for PEAK PERFORMANCE
on 2 TV SETS
from 1 ANTENNA



WRITE for Catalog



Guy Lombardo makes his tape recordings on

irish
BRAND
ferro-sheen
recording
tape

That's not the reason why you should use

irish
BRAND
ferro-sheen
recording
tape

Here's why you should use

irish
BRAND
ferro-sheen
recording
tape:

It's the best-engineered tape in the world ...

...gives you better highs...better lows... better sound all around! Saves your tape recorder, too—because the **irish FERRO-SHEEN** process results in smoother tape ...tape that can't sand down your magnetic heads or shed oxide powder into your machine. Price? Same as ordinary tape!



Available wherever quality tape is sold.
ORRadio Industries, Inc., Opelika, Alabama
Export: Morhan Exporting Corp., New York, N. Y.
Canada: Atlas Radio Corp., Ltd., Toronto, Ontario

Low-Efficiency Speakers

(Continued from page 45)

sound reflections, etc.—but the task is a difficult and sometimes delicate one, possibly requiring critical adjustments.

For the properly designed direct-radiator system, the absence of acoustical resonance and the fact that the designer does not have to contend with an enclosure bass cut-off frequency (determined rigorously by horn theory) simplifies the task of working towards uniform, non-boomy response. The fact that the enclosure does not "let go" below a given frequency also provides an opportunity to keep harmonic distortion at a minimum and to keep up relative bass efficiency, so that the absolute value of efficiency at very low frequencies may actually exceed that of the other systems. It is the author's opinion that of current speaker systems, the ones with the least bass distortion and most extended, uniform bass response are the direct-radiators.

Speaker Damping

The electrical damping of the speaker "motor" is a straightforward case of electro-magnetic damping, fully investigated and described in the literature, yet there is a great amount of general misunderstanding and legend about this subject.

If one were to take a typical unmounted, unconnected speaker, and gently work the cone back and forth, one would find the moving system springy but otherwise relatively free. If, however, the speaker terminals were connected together (the short representing the low internal resistance of a driving amplifier) the speaker, particularly if it had a heavy magnet, would act as though the voice-coil were being retarded by some viscous fluid. This would be due to the fact that the back e.m.f. generated by the coil in the magnetic field was forcing current to flow through the circuit (the d.c. resistance of the voice-coil itself in series with the external shorting wire).

The effect of this damping resistance—equivalent to mechanical friction—is to control speaker response in the region of resonance. Fig. 3 shows the theoretical response curves, as plotted by Beranek,² for different degrees of speaker damping, and Fig. 4 shows a set of actual measured response curves when the damping resistance is varied by changing the amplifier damping factor, for a direct-radiator speaker system.

The middle curves of Figs. 3 and 4 represent optimum damping, under which condition the steady-state response curve is the most uniform, and transient response is without hang-over. The top, peaked curve represents an underdamped condition, with accentuated bass at the resonant fre-

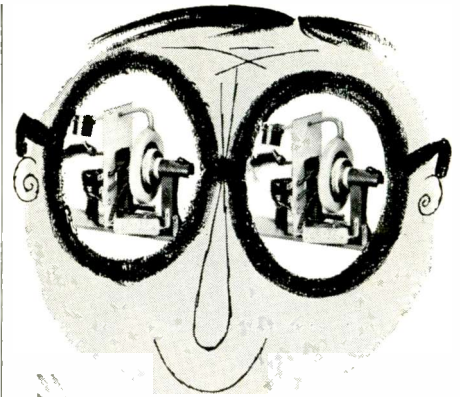

Seeing Double?

SURE... THEY LOOK ALIKE BECAUSE

THEY ARE EXACTLY ALIKE

Each Merit product of the same type is exactly the same as another—both in construction and appearance.

COMPARE IT WITH
MERIT

Take a Merit product off the shelf. Compare it with any other similar product on the market. You'll find Merit is superior!



COMPARE IT WITH
MERIT

MERIT COIL & TRANSFORMER CORP.
4427 N. CLARK ST., CHICAGO 40, ILLINOIS

BE QUALITY WISE... BUY QUAL-KITS!



HI-FI AMP. KIT
Complete 6 tube-10 watt amplifier. Push-pull beam power output, built-in pre-amp, 5 position selector switch, 3 position record equalization, LP, RIAA, Eur. Response 1/2 db. 20-20,000 cps. Output 10 watts at less than 2% THD. Low noise level and harmonic distortion. **\$28.50**

Every kit complete with 28 page fully illustrated instruction and assembly manual. Cover and legs optional.



HI-FI AM-FM TUNER KIT
Advanced 7 tube circuit plus Rectifier for full sensitivity and selectivity. Distortion less than 1%. Sensitivity is 5 uv for 30 db quieting on FM, 25 uv AM. Armstrong FM Circuit with limiter. Foster-Seeley Discriminator. 20-20,000 cps response. Full AFC control—no drift. Easy assembly. **\$28.95**

Add 100¢ Fed. Tax Write for FREE catalog and name of nearest dealer carrying these remarkable units.

QUALITY-ELECTRONICS

319 Church St. Dept. T-11 New York 13, N. Y.



Be a "key" man. Learn how to send and receive messages in International Morse code. Communicate with operators around the globe. Learn at home quickly through famous Candler System. Used by best operators. Qualify for Amateur or Commercial License. Write for FREE BOOK.

CANDLER SYSTEM CO.,
Dept. 2-M, Box 928, Denver 1, Colo., U.S.A.

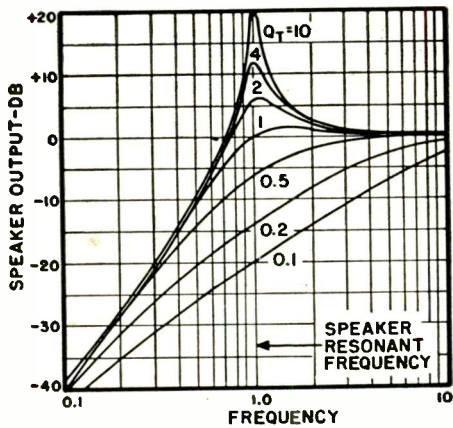

Fig. 3. Speaker response curves in the region of resonance for different values of total mechanical "Q" (Q_T). A condition of high "Q" is obtained with a small degree of damping (low amplifier damping factor), while low "Q" is obtained with a large degree of damping (high amplifier damping factor). Curves after Beranek, see reference.

quency and hangover on transients. The bottom curve, representing an overdamped condition, keeps transients clean but introduces bass attenuation. We want the electro-magnetic system of the speaker and amplifier to be as "tight" as that associated with the middle curves, but neither tighter nor looser.

Increasing the flux of a speaker's magnetic structure, other factors remaining constant, raises both efficiency and the degree of damping. The danger of magnetic overdamping therefore places a limit on efficiency for direct-radiators.

With the continuing advances in electronic circuitry and components, there has been a tendency to place more and more of the burden of high-fidelity reproduction on the electronic circuit. Low-output pickups (pickups with low mechanico-electric efficiency) and low-efficiency speakers are part of this picture. In testing and listening to such components and in comparing them with other, higher efficiency units, it is important that the necessary adjustments in electronic circuitry be provided; more preamplifier gain must be supplied for low-output pickups, and more amplifier output power for low-efficiency speakers.

REFERENCES

1. *Audio League Report, Volume 1, No. 11, January 1956, page 1*
2. Beranek, Leo L.: "Acoustics," McGraw-Hill Book Company, New York, 1954

-30-

Fig. 4. Acoustic response curves of the AR-1 system, radiating into a solid angle of 180° , in the region of resonance (as recorded on an automatic level recorder, and corrected to calibration curves of the measuring equipment), for three values of amplifier damping factor shown in diagram.

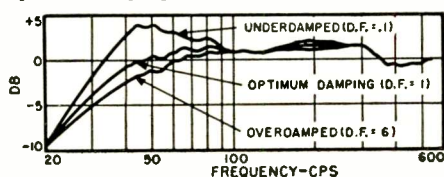

the
finest...
from
every
point
of
view...

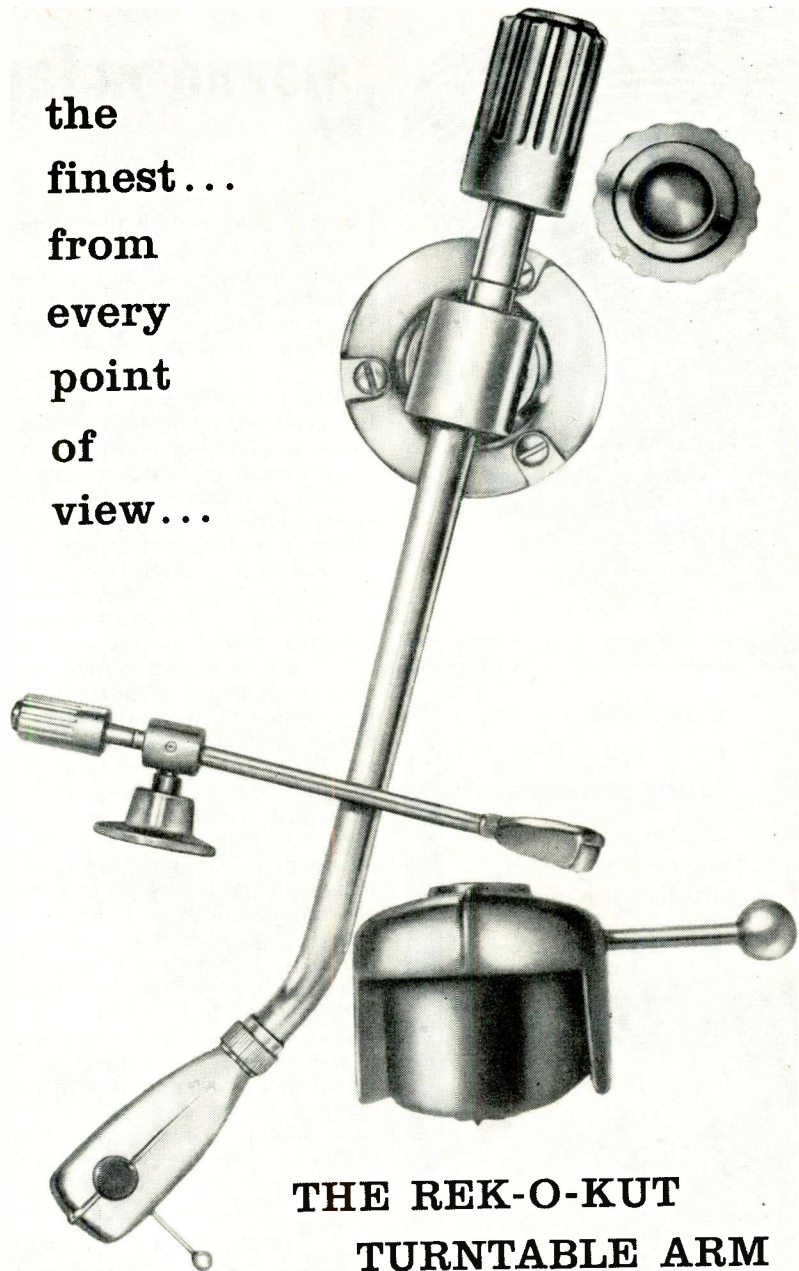

THE REK-O-KUT TURNTABLE ARM

Most superbly styled of all arms — this is also the *one* turntable arm that offers best compliance, lowest resonance, optimum tracking... to give you better sound! That is why it is the *one* arm invariably sold with every turntable — *outselling all other turntable arms combined!* Write for catalog and free Strobe disc. \$26.95 12" Arm, \$29.95 16" Arm.

EXCLUSIVE FEATURES! • Patented sealed Versa-Twin bearing pivot provides superior horizontal compliance. • For free vertical motion, arm pivots are mounted in chrome steel ball-bearing races. • Micrometer gram weight adjustment gives correct stylus pressure without need for stylus gauge. • Has easy arm-height adjustment. Takes all popular cartridges.



REK-O-KUT

HIGH FIDELITY TURNTABLES—TURNTABLE ARMS
38-19 108th St., Corona 68, N.Y.

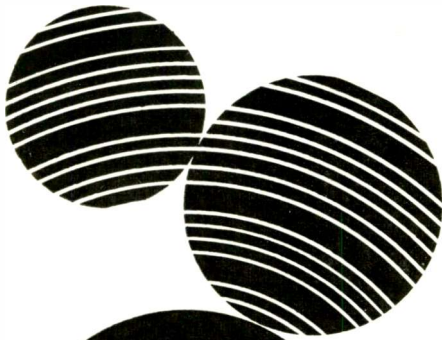

BOZAK

one line
one quality
loudspeakers

are designed and built
without compromise,
that they may produce

The Very Best in Sound

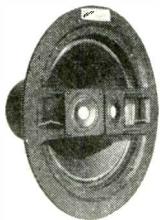

B-207a Two-Way
Speaker System



B-209
Mid-Range
Speaker

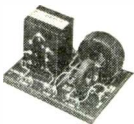

N-10102
Crossover Network

- 1 Mount them in a suitable infinite baffle;
- 2 Power them with the finest amplifier of 20 Watts or more;
- 3 Feed them with wide-range, low-distortion discs, tape or FM...

your Bozaks will make
no compromise
with natural sound.

Hear them
at your Franchised Bozak Dealer.

BOZAK

THE R. T. BOZAK SALES COMPANY
DARIEN - CONNECTICUT

Exports:
Electronics Manufacturers Export Company
Plainview, New York

Sound on Tape

By BERT WHYTE

IN THE midst of all this furious program of tape releases from the major companies, it might be a good time to call your attention to a practice which has cropped up in certain quarters. Because of the boom in stereo tape, there are a number of unscrupulous companies who are busily turning out "phony" stereo tapes. These small fly-by-night operators get some monaural tapes, doctor them in any of several ways and then sell them as stereo tapes at fancy stereo prices. In some cases the operators are so crude they merely turn out a full track tape. Others are more clever and will use "panning potentiometers" to increase or decrease the levels of each "channel" thus affording a certain amount of bogus directionality to the tape. Some trick phasing may be employed and other stunts to accomplish the job of turning monaural tape into so-called stereo. With so many inexpensive stereo playback machines coming into the hands of the public, these phony tapes are going to cause some unhappy experiences. Many people who are not technically trained will have difficulty perceiving the trickery... the only thing they'll think is that stereo isn't what it's cracked up to be and they will lose interest in tape and hi-fi in general. No doubt these fakers will eventually be rooted out. In the meantime it would seem prudent to make sure the tape you buy comes from a reliable dealer. He has a reputation to maintain and he is not going to offer merchandise he knows is spurious.

HANDEL WATER MUSIC (COMPLETE)

Frankfurt Opera Orchestra conducted by Carl Bamberger. Concert Hall CHT/BN14 stacked stereo. 7" reel, 7 1/2 ips. NARTB tape curve. Price \$11.95.

The gay and spritely "Water Music" of Handel turns out to be an ideal vehicle for stereo. There is much interplay between various sections of the orchestra, which is easily followed in this highly directional recording. Bamberger turns in a performance which ranks with the best available on disc. His tempi never drag and, in general, his reading is full-blown and vigorous. The bright scoring with the high flying trumpets and soaring french horns is quite infectious. This is fairly close-up recording which abounds in sparkling detail. The acoustics are very broad and open, giving great solidity and "presence" to the orchestra.

GRIEG
SYMPHONIC DANCES
Pro Musica Symphony of Vienna con-

HI-FI ACCESSORIES BY

Dynamic
ELECTRONICS

FOR BETTER RESULTS

RECORD COMPENSATOR

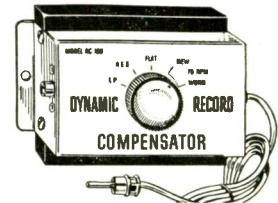

Finest precision accessory to obtain maximum quality from all types of recordings—European—Domestic LP's, old and new 78's, etc. To be used with all types of reluctance cartridges.

- Shielded Lead & Molded Pin Plug.
- Pin Jack & Rotary Switch.

Model RC 180 List \$950

THERE IS A DYNAMIC ACCESSORY FOR ALMOST EVERY NEED... SOLD ON A MONEY BACK GUARANTEE!

At leading distributors everywhere. Full Line Catalog on Request!

Manufactured By...
DYNAMIC ELECTRONICS-NEW YORK, INC.
Forest Hills, Long Island, N. Y.

CATALOG OF
Professional Quality Kits
"DIRECT FROM FACTORY"

FREE TRANSVISION
SPLIT-KITS

- TV KITS
- INSTRUMENT KITS
- HI-FI KITS, SPEAKERS
- HI-FI CABINETS (Largest Selection)
- Electronic PHOTOFLASH Kits

PAY AS YOU WIRE with Transvision "SPLIT-KITS." A few dollars gets you started. Each Kit is split into a few packages. You can order one at a time as you wire.

Also
RECORDS
RCA CBS
All Labels

at BIGGEST
DISCOUNT!

TRANSVISION, INC., New Rochelle, N. Y.
Rush FREE Catalog of KITS, HI-FI Equipment,
Cabinets, Records, etc

Name _____
Address _____
City _____ State _____

ducted by Edouard Van Remoortel. Phonotapes S-706 stacked stereo. 7" reel, 7½ ips. NARTB tape curve. Price \$11.95.

Another of the initial stereo offerings of *Phonotape* and an extremely interesting tape. This represents Grieg's most ambitious effort in orchestration and it is fortunate we can hear it in stereo. This has always seemed to me to be a rather turgid, thick textured score requiring a light hand on the orchestral reins. Van Remoortel takes this approach and affords us a reading which can be ranked as the most illuminating to be found in any recording. The rather ponderous effects found in some sections of the dances respond very well to stereo in terms of increased clarity and an "openness" of sound that removes some of the excessive weight.

This is excellent stereo recording, moderately close-miked. Nice concert hall "bloom" without excessive reverb which allows for plenteous detail. Overall sound is very clean, with smooth strings, bright punchy brass, sharp and accurate percussion. Directionality was good, "hole-in-the-middle" effect was minimal, and tape hiss was pleasingly low.

BUXTEHUDE ORGAN MUSIC

Alf Linder, organist, playing instrument at Varfrukyrka at Skanninge, Sweden. Sonotape SWB8022 stacked stereo. 7" reel, 7½ ips. NARTB tape curve. Price \$11.95.

Sonotape has been widely praised for its superb Bach recordings performed by Carl Weinrich on this Swedish organ. Now we have the first recording of what is eventually to be a complete survey of the organ works of Buxtehude. As with the Bach, this organ is ideally suited for the music of Buxtehude. The crisp baroque voicing in the organ makes for maximum articulation and clarity of detail in the scoring. Alf Linder is a professor at the Royal Academy of Sweden and is generally considered to be one of the most authoritative interpreters of the music of Buxtehude in Europe. On this tape he performs the "Prelude and Fugue in C Major," the "Tocatta in D Minor," a chorale fantasia, and chorale prelude.

Almost from the opening bars, Linder's reputation is confirmed. Here is solid, well grounded technique. The pedal is firm and assured, the manual work a marvel of dexterity. His choice of registration is precise, conservative, and highly effective. For all his authority Linder is no stuffy pedant. It is obvious he enjoys the works he is playing and his enthusiasm and musicianship are immediately apparent to the listener.

The sound here is as distinguished as the earlier Bach recording. The stereo embraces the listener and brings one almost literally to the Varfrukyrka. Here we have rich resonant fullness combined with an infinitude of detail. Many inner voicings and tiny little embellishments are revealed in

**NOW—
Get it from
your Parts
Jobber!**

**Admiral—
rated by servicemen
as the most foolproof
and trouble-free of
all changers!**

**Admiral—
built into more
phonos and combinations
than any other
changer in the world!**

Admiral® 4-Speed Record Changer



Beige and Coral
with Golden trim
(Base Optional)

- **PLAYS ALL FOUR SPEEDS—** 33⅓, 45, and 78 plus "talking book" 16⅓ r.p.m. Has neutral position. Changes 12 to 14 records; intermixes those of same speed. Automatic 2-way shut-off after last record. Returns tone arm to rest, stops turntable motor completely. NOTE: Can be wired to shut-off radio or amplifier chassis.

- **RUBBER TURNTABLE MAT**
- **FEATHERWEIGHT TONE ARM—** new resonance-free design. Less than ⅓ oz. pressure. Positive tracking . . . no "skip" or "jump" on loud passages.

- **DIAMOND LP STYLUS—** separate LP diamond and 78 r.p.m. sapphire needles for finest sound reproduction, long record life.

- **ATTACHED 40" SHIELDED AMPLIFIER CABLE—** eliminates pickup of unwanted noise. Cable has phono tip plug for quick easy connection into standard input phono-tip jack.

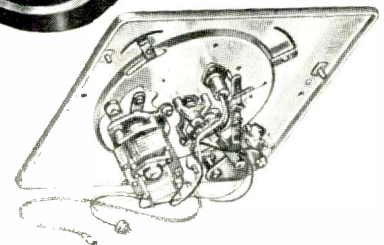

HEAVY DUTY MOTOR— powerful 4-pole constant speed shaded pole induction type motor. Operates without hum, rumble or "wows" (as little as 0.1590). Maintains even speed even if line voltage varies. Six foot line cord attached.

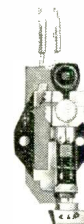

CERAMIC PICK-UP CARTRIDGE—twin lever hi-fi cartridge changes with flick of the finger from LP to 78 r.p.m. needle. Impervious to heat and humidity. High lateral compliance minimizes wear, eliminates hum and distortion. Smooth even response (± 3db) over the full high-fidelity frequency range (30-15,000 c.p.s.).

Write for Illustrated Specification Sheet.

Admiral®

**SPECIAL PRODUCTS DIVISION
3800 West Cortland Street
Chicago 47, Illinois**

TeleMatic

CUSTOM HIGH FIDELITY KITS

AM/FM TUNER

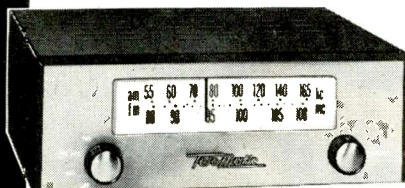

2 uv for 20 DB quieting, AFC plus Defeat, Full Frequency Response, 300 KC bandwidth.
 Model KC-400 Less Cage \$34.95 (FED. EX. TAX INC.)
 Wired and Tested 59.95

20-WATT INTEGRATED AMPLIFIER



Power Response CONSTANT at 20 Watts, 1 ± DB Full Frequency Response, Infinite Equalization Bass Treble Controls; 3 Hi, 1 Low inputs.
 Model KC-401 Less Cage \$46.00
 Wired and Tested 64.95

Exclusive! STEREO PHONIC KITS

AM/FM STEREO PHONIC TUNER WITH WIRED FM FRONT END

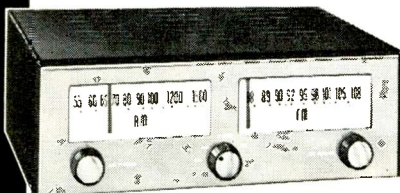

NEW DIMENSIONS IN SOUND—Each section used individually or together—0.9 uv for 20 DB quieting, 330 kc Bandwidth 3-gang variable AM tuning, 15 uv per meter loop sensitivity.
 Model KB-402 Less Cage \$69.95 (FED. EX. TAX INC.)
 Wired and Tested 99.50

40-WATT STEREO PHONIC AMPLIFIER



NEWEST DEVELOPMENT IN STEREO PHONIC SOUND FOR THREE DIMENSIONAL LIFE-LIKE REALISM!
 Twin 20-Watt Channels—Each with FULL PRE-AMP sections and Master Volume Control.
 Model KB-403 Less Cage \$ 82.50
 Wired and Tested 109.50

For full details, see your local dealer or write

TELEMATIC INDUSTRIES, INC.
 16 HOWARD AVENUE, BROOKLYN 21, N. Y.

the probing light of stereo and, at the same time, one is conscious of the vaulted airy spaciousness of the acoustics. Linder tailors his tempi to the reverb characteristics and, as a result, there is no annoying "slapback" or fusion of notes and phrases. This gives an almost palpable clarity to the pipes and you can hear their typical "breathiness" "reediness," and nasality. The pedal is solid and substantial and gives forth some quite low frequencies. However it does not explore the real "sub-basement" of the instrument such as was heard in the Bach "Passacaglia and Fugue in C Minor" (*Sonotape SWB8001*).

Frequency range was quite wide, dynamics equal to the demands of the score. I could not detect any distortions . . . transient, overload, or otherwise, and as a final bonus the tape hiss was very low and unobtrusive. Organ enthusiasts won't want to miss this one!

GRIEG

PIANO CONCERTO IN A MINOR
 Artur Rubenstein, pianist, with RCA Victor Symphony Orchestra conducted by Alfred Wallenstein. Victor DCS-47 stacked stereo. 7" reel, 7½ ips. NARTB tape curve. Price \$12.95.

One thing is certain about this tape. It will sell and sell and sell! And why shouldn't it? Combine one of the most popular piano concertos ever written, with a great and popular pianist, Rubenstein, and then record it with the bright glory of stereophonic sound and how can you miss? Rubenstein gives one of his great *bravura* performances of the work. He always displays tremendous vitality in his reading, yet everything is smooth and under control. His dynamic expression is fabulous, ranging from tiny, precise, *piu-ossissimo* caresses of the keys to huge thunderous *fortes*.

This was a pretty fair disc recording and while I was prepared for the improvement in quality stereo always seems to afford, I was astonished by the degree of difference between this tape and the disc. This is another of the close-up type of piano concerto recordings the *Victor* engineers seem to favor for stereo. The piano is made to sound very big and resonant, positioned just left of center. Then the orchestral accompaniment comes in with maximum instrumental definition. The engineers judiciously add hall reverb and *voila!* . . . we have that indefinable spacious, yet highly detailed sound we call stereo.

Over-all quality was very good with wide frequency and dynamic range. In spite of Rubenstein's thundering, the piano transients remained very clean, with no detectable ringing. Wow and flutter were absent, and signal-to-noise ratio was excellent. If you're having trouble trying to con the wife into a stereo rig, get her to a hi-fi shoppe and play this tape!

RIMSKY-KORSAKOV

SCHEHERAZADE

Vienna State Opera Orchestra conducted

by Mario Rossi. Miriam Solovieff, solo violinist. Vanguard VRT4001 stacked stereo. 7" reel, 7½ ips. NARTB tape curve. Price \$14.95.

Vanguard, that enterprising small company, has joined the stereo fray with an impressive first release. It includes the Haydn Symphonies Nos. 99, 100, 101, 104, in the superb Mogens Woldike interpretations; four jazz tapes, and this magnificent recording of "Scheherazade." Probably many of you have already heard this tape as *Vanguard* was demonstrating it at last year's New York Hi-Fi Show. This is one of the most outstanding stereo tapes yet produced. Rossi's interpretation, while not of definitive character, has been widely admired for its honest, straightforward musicianship. Also deserving of mention was the splendid playing of the orchestra. In matters of sound this is sheer unadulterated beauty. The string tone is lush, smooth, and butter-rich. Woodwind have a mellow fluency, whose tonal purity is not plagued by any excesses of vibrato. Brass is very big and open with great brilliance and weight. Percussion was exceptional for its crisp delineation. The vaunted *Vanguard* tympani were speaking in robust tones with great impact.

Vanguard's approach to stereo recording is one of extreme naturalness. They have struck a fine balance between overbright, over-detailed sound and the too distant, too reverberant formless type of pickup. This "Scheherazade" is a very impressive recording based on those principles. It is spacious and open and yet is not niggardly with detail and instrumental separation. Frequency and dynamic range were very wide, transient and other types of distortion were not audible. Directionality was well maintained in this tape and there was a gratifying amount of instrumental "fill" between the channels.

"Scheherazade" may indeed be an old warhorse, but when it can be heard with the gorgeous stereo quality on this tape, it becomes fresh, new, and an enjoyable musical experience. —30—

ENGINEERS WANTED!

The United States Civil Service Commission has announced the availability of a number of interesting engineering jobs both here and abroad for which applications are now being accepted.

Full details, including instructions on where to send applications, etc. are included in Civil Service Announcement No. 112B. Information on examinations and application forms are available at most post offices and from the Commission at Washington 25, D. C.

The engineering positions to be filled are in various fields of work and pay from \$4480 to \$11,610 a year. To qualify for these positions, applicants must show appropriate education or experience in engineering. A written test for certain positions is required of applicants who do not meet the requirements for a degree in engineering. Applications will be accepted from students who expect to complete the required study within nine months. —30—

RCA McGEE SCOOP! UP TO 75% OFF

RADIATION COUNTERS TO

NEW—GENUINE RCA

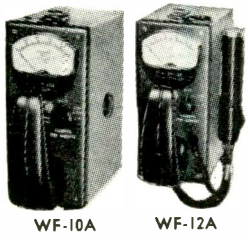

Reg. \$119.50 **\$29⁹⁵**
Model WF-10A ..
Reg. \$149.50 **\$34⁹⁵**
Model WF-12A ..
3 RANGES
0-100—1000—10,000 COUNTS

MODEL WF-10A Regular \$119.50 McGEE'S \$29⁹⁵
PRICE

RCA Model WF-10A, Radiation Geiger counter for amateur and professional use. Explore for Uranium or check for atomic fall-out radiation. Complete with test sample. Simple to use, weighs only 5 lbs. In aluminum case, 7 3/4" x 8 1/2" x 3 1/2". Indicates presence of radioactivity in 3 ways, by meter, neon light and headphones. Requires 2—67 1/2 volt Burgess XX45 "B" batteries and 3 #2 flashlight cells. Battery kit, \$5.29 extra. 3 sensitivity ranges, 0-100, 0-1000 and 0-10,000 counts per minute. A terrific value from McGee. RCA Model WF-10A with tubes and headphones, less batteries, \$29.95. Battery kit, \$5.29 extra.

MODEL WF-12A Regular \$149.50 McGEE'S \$34⁹⁵
PRICE

RCA Model WF-12A, Radiation Geiger counter. Similar to WF-10A, except has an external probe. Priced with tubes and headphones at \$34.95, less batteries. Kit of 2—XX45 Burgess "B," plus 3 #2 flashlight cells, \$5.29 extra.

Reg. \$154.50 **\$37⁹⁵**
Model WF-11A ..
Reg. \$186.00 **\$39⁹⁵**
Model WF-14A ..
3 RANGES
0-200—2000—20,000 COUNTS

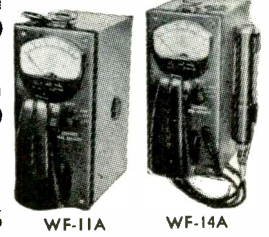

MODEL WF-11A Regular \$154.50 McGEE'S \$37⁹⁵
PRICE

RCA Model WF-11A, Radiation Geiger counter. Explore for Uranium or check for atomic fall-out. Uses extra sensitive Bismuth tube. Test sample included. Simple to use, weighs only 5 lbs. Weatherproof case 7 3/4" x 8 1/2" x 3 1/2". Indicates presence of radioactivity 3 ways, by meter, neon light and headphones. Requires 2 Burgess XX45 "B" batteries and 3 #2 flashlight cells. Battery kit \$5.29 extra. 3 sensitivity ranges, 0-200, 0-2000, 0-20,000 counts per minute. A terrific value from McGee. RCA Model WF-11A, Sale price, \$37.95 with tubes and headphones. Battery kit, \$5.29 extra.

MODEL WF-14A Regular \$186.00 McGEE'S \$39⁹⁵
PRICE

RCA Model WF-14A, similar to Model WF-11A, except has an external probe. Priced complete with extra sensitive Bismuth tube, other tubes and headphones, \$37.95 less batteries. Battery kit, \$5.29 extra.

Model WF-15A
RCA REG. \$475⁰⁰ SALE PRICE \$99⁵⁰
COMPLETE WITH 10 BISMUTH TUBES

RCA Model WF-15A, Radiation Geiger counter for schools, labs, professionals, etc. A super sensitive Geiger counter with 10 Geiger counter tubes. Three counting ranges, 0-1000, 0-10,000 and 0-100,000 counts per minute. Special features include background control, battery test. Weighs only 8 lbs. Price includes all tubes, headphone and leather carrying case. Measures 11" x 4 7/8" x 7 1/2". Requires 2 Burgess XX45, 67 1/2 volt "B" batteries, plus 3 #2 flashlight cells and 1 pen cell. RCA Model No. WF-15A, with test sample, McGee's Sale price, \$99.50, less batteries. Battery kit, \$5.37 extra.

Model WF-16A
RCA REG. \$750⁰⁰ SALE PRICE \$149⁵⁰
COMPLETE WITH 10 BISMUTH TUBES

RCA Model WF-16A is the most sensitive of all, having 10 super sensitive Bismuth tubes. Measures up to 200,000 counts per minute in 3 ranges; 0-2000, 0-20,000 and 0-200,000 CPM. 2 step switch permits fast or slow meter indication. A professional Geiger counter that was priced at \$750.00. Now offered by McGee for only \$149.50, that was priced at \$750.00. Now offered by McGee for only \$149.50. Weighs 8 lbs. 11" x 4 7/8" x 7 1/2". Requires 2—XX45 Burgess 67 1/2 volt "B," plus 3 #2, 1 1/2 volt flashlight cells and 1 pen cell. A terrific value for \$149.50, with tubes and headphone, less batteries, Battery kit, \$5.37 extra.

NEW 1958 MODEL SLIM LINE HI-FI AMPLIFIER \$34.95

SLIM LINE SL-20
16 WATTS \$34⁹⁵
PUSH PULL EL-84
RESPONSE 15 CPS TO 22,000 CPS
ORDER WITH A SPEAKER AND SAVE

★ WITH CU-14Y 12" COAX \$44.95 ★ WITH B-125X SPEAKER \$51.95
★ WITH P15-CR 15" COAX \$49.95 ★ WITH B-347 SPEAKER 69.95
WITH NORELCO 12" 9762-M \$69.00

New, 1958 model Imperial Slim-Line 16 watt high fidelity amplifier (20 watts peak), with built-in pre-amplifier. Full range audio response from 15 to 22,000 cps. Dual tone controls; full 18 db bass and full 15 db treble boost. Input for radio tuner, tape recorder and phono. Input compensation for the new 1958 model 4 gram General Electric variable reluctance cartridge as well as the famous G.E. RPX-050, RPX-052 and crystal phono cartridges. 3 position selector switch selects inputs and record compensation. Compensation for AES and RIAA phono records. A factory built amplifier at less than kit prices. Output impedance matches 8 or 16 ohm high fidelity PM speakers. Price includes tubes: 2—12AX7, 1—12AU7, 2—EL-84 and 5Y3GT. Modern multi-color leatherette covered wood cabinet at no added cost; matches blond or mahogany finish speaker systems. Size: 5 1/4" tall, 11 1/4" wide, 8" front to back. Ship wt. 15 lbs. Model SL-20 Imperial, List price \$69.50. McGee's Sale price, \$34.95.

SLIM LINE SL-10
12 WATTS \$24⁹⁵
PUSH PULL 6V6
RESPONSE 20 CPS TO 17,500 CPS
ORDER WITH A SPEAKER AND SAVE

★ WITH CU-14Y 12" COAX \$34.95 ★ WITH B-125X SPEAKER \$41.95
★ WITH P15-CR 15" COAX \$44.95 ★ WITH B-347 SPEAKER 59.95
WITH NORELCO 12" 9762-05 \$49.95

New, 1958 model Imperial Slim-Line, 12 watt high fidelity amplifier (16 watt peak), with built-in pre-amplifier. Full range audio response from 20 to 17,500 cps. Dual tone controls; full 12 db bass boost and full 15 db treble boost. Input for radio tuner or tape recorder and phono. Input compensation for the new 1958 model 4 gram General Electric variable reluctance cartridge as well as RPX-050, RPX-052 and crystal phono cartridges. Compensation for AES and RIAA phono records. A factory built amplifier at a price you might pay for a kit that actually includes less material. Output impedance matches any 8 ohm high fidelity PM speaker. Price includes tubes: 2—12AX7, 2—6V6GT and 5Y3GT. Modern multi-color leatherette covered wood cabinet, matches blond or mahogany finish speaker systems. Size: 5 1/4" tall, 11 1/4" wide and 8" front to back. Ship, wt. 12 lbs. Model SL-10 Imperial, List price, \$49.50. McGee's Sale Price, \$24.95.

COMPLETE 1958 MODELS HI-FI SPEAKER SYSTEMS IN BAFFLES

"HOLLYWOOD STYLING"
AT PRICES YOU MIGHT PAY FOR AN ENCLOSURE ALONE

MODEL H-4H, 4 SPEAKER SYSTEM IN BAFFLE **\$39⁹⁵**
MODEL Z-4Z SYSTEM **\$49⁹⁵**

New, 1958 Hollywood 4-speaker systems are designed to give realistic reproduction from your Hi-Fi amplifier or FM-AM radio. Juke box full bass with variable brilliance control. Genuine LC crossover network built-in. Ideal for use with our Slim-Line 12 and 20 watt high fidelity amplifiers, as well as our Espey and Malticrafters chassis. Small in size to be attractive, yet large enough to baffle properly. Fully enclosed and acoustically lined. Take \$3.00 discount if you order with any amplifier or the Espey chassis. Specify mahogany, walnut or blond when ordering, otherwise we will ship mahogany.

MODEL H-4H SYSTEM \$39.95
Model H-4H Hollywood 4 speaker high fidelity speaker system. 20 watts, response 20 to 17,500 cps. Choice of Mahogany or Walnut or Blond finish enclosure. Features a 12" General Electric 6.8 oz. Alnico V magnet, aluminum voice coil woofer, plus 6" mid-range and 2.5" tweeters. Built-in variable brilliance LC crossover network. Model H-4H, Ship, wt. 55 lbs. Price, \$39.95.
Either of above systems can be ordered in larger baffle shown at right for \$5.00 extra.

MODEL Z-4Z SYSTEM \$49.95
Model Z-4Z, Hollywood 4 speaker high fidelity speaker system. 25 watts, response from 18 to 17,500 cps. Choice of Mahogany or Walnut or Blond finish enclosure. Features a 15", 2 1/2 oz. Alnico V Utah heavy duty woofer, plus 6" mid-range and 2.5" tweeters. Built-in variable brilliance, LC crossover network. Model Z-4Z, Ship, wt. 57 lbs. Sale price, \$49.95.

IMPERIAL 80 SPEAKER **\$69⁹⁵**
IMPERIAL 90 SPEAKER **\$89⁹⁵**
FULL 10 CU. FT.

Choice of Blond, Mahogany or Walnut, speaker enclosure used with the 2 Imperial systems described below. Size 39" high, 24" wide and 23 1/2" deep. Over 10 cu. ft. of volume in this fully enclosed speaker cabinet. Beautiful finish with matching grill cloth covering entire front. Speakers are mounted on a heavy plywood baffle. Enclosure is lined with an acoustical material. Speakers and crossover network are wired up, ready to connect to 8 ohm output. Mahogany shipped if no color is specified.

IMPERIAL 80 \$69.95
25 watts response, 18 to 20,000 cps. A complete speaker system in the above described enclosure, ready to connect to your Hi-Fi amplifier. Built-in L-C, 3 way crossover network. Speakers included are an 15", 2 1/2 oz. Utah woofer, 8" 6.8 oz. mid-range and horn type Pioneer PT-3 tweeter, 8 ohms impedance. Stock No. Imperial 80, speaker system. Ship, wt. 80 lbs., Sale price, \$69.95.

IMPERIAL 90 \$89.95
Imperial 90, 30 watt speaker system with 5 speakers. Response, 18 to 20,000 cps. A complete speaker system in the above enclosure, ready to connect to the 8 ohm output of your high fidelity amplifier. Includes the 21 oz. Utah 15" woofer, two of the 8" 6.8 oz. mid-range speakers and two of the PT-3 Pioneer horn type tweeters. Built-in L-C type, 3 way crossover network. Imperial 90, speaker system. Ship, wt. 90 lbs., Sale price, \$89.95.

McGEE RADIO COMPANY TELEPHONE VICTOR 2-5092
SEND 25% OR FULL REMITTANCE WITH ORDER. 1903 MCGEE ST., KANSAS CITY, MISSOURI
BAL. SENT C.O.D.

22 TUBE ESPEY FM-AM HI-FI TUNER-AMPLIFIER SALE PRICE \$99.95

A REGULAR \$199.50 NET VALUE COMBINATION FOR \$99.95



FM/AM TUNER
ESPEY 14-TUBE MODEL 700G

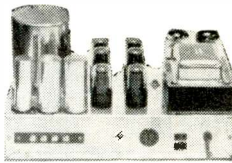

ESPEY 24 WATT
MODEL 501G AMPLIFIER

MODEL 700G
FM-AM TUNER
AND
MODEL 501G
AMPLIFIER

SPECIAL
SALE PRICE
BOTH FOR
\$99.95

ATTRACTIVE LEATHERETTE
TUNER CABINET \$7.95 EXTRA

ESPEY DEAL-1A
Espey 700G-501G tuner with 24 watt amplifier plus VM-956 GE 3 speed VM on metal base—1 Mil Diamond Stylus
Needle \$10.00 extra. Net **\$124.95**

ESPEY DEAL-2
Espey 700G-501G tuner with 24 watt amplifier plus new 456 Collaro changer equipped with a GE RPX-052A cartridge. Net **\$144.95**

ESPEY DEAL-3
Espey 700G-501G tuner with 24 watt amplifier plus Garrard RC-98 equipped with a GE RPX-052A cartridge. Net **\$174.95**

SPEAKERS RECOMMENDED
Order any of the following speakers with your Espey tuner and amplifier:
12" coaxial PM, CU-14Y—\$10.00 extra
15" coaxial PM, P15-CR—\$20.00 extra
Imperial VI system—\$15.00
Imperial V system—\$25.00
Norelco 9762-12" regularly \$59.50 at \$30.00 extra.
EV84-15W system—\$150.00 extra.

McGee offers you both the regular \$119.50, 14 tube Deluxe FM-AM tuner and the regular \$79.50, 8 tube audio amplifier for the special sale price of only \$99.95. The Model 700G Espey tuner has its own built in power supply. Performance features are: Sensitivity 3mv on AM, 5 mv on FM for 30 db quieting. AM selectivity 10kc at 6 db. FM 240 kc at 6db. Audio response flat from 20 cps to 20,000 cps, with less than 1/4 percent distortion with one volt audio output. Chassis is 14" long, 8 1/2" high and 10" deep. Features a one-piece molded, gold color plastic front which makes a custom installation both extremely attractive and easy at the same time. Full tuned RF stages. On FM with defeating switch for LP, AES or European records. Separate bass and treble tone controls with 23db boost. Chassis is equipped with AC outlet jacks, auxiliary input jacks for tape recorder, etc. Has built-in ferrite loop antenna for AM broadcast band and 300 ohm input for FM band. This fine quality FM-AM tuner is second to none. It has all in it a most desirable feature when the tuner is used in conjunction with a good audio amplifier, such as the 501G which was designed with no tone control or preamplifier circuits.

The Model 501G, 8 tube ultra-linear high fidelity, 24 watt audio amplifier is made to match the 700G tuner. This amplifier features less than 1/2 percent distortion with high fidelity response from 10 cps. to 20,000 cps. Hum level so low it can be detected by electrical inflections. Has an 8 pound potted case output transformer with specially made grain-oriented iron core. Output impedance taps of 4, 8 and 16 ohms. This output transformer alone is a \$20.00 value.

Buy both the 700G FM-AM tuner and the matching 501G amplifier for only \$99.95. Tuner shipping weight 20 lbs. Amplifier shipping wt. 22 lbs. See the special deals of the 700G-501G tuner-amplifier combination with record changer and GE cartridges for extra money saving values. Also, special discount on speakers and speaker systems when ordered with your Espey tuner and amplifier.

11-TUBE FM-AM HALLICRAFTERS

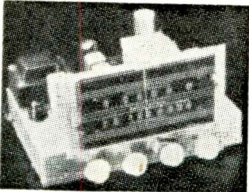

HALLICRAFTERS S-78A

REGULAR \$89.50 VALUE!
SALE PRICE **\$49.95**
WITH MONARCH 4-SPEED RECORD CHANGER, 12" COAX. SPEAKER
\$132.40 VALUE ALL FOR **\$86.95**

Now, buy a complete FM-AM chassis with push-pull audio built-in, at less than you would pay for a tuner without audio amplification. We offer you this nationally known Hallicrafters S-78A, 11 tube FM-AM radio chassis complete with escutcheon plate and a 11 tube power transformer operated or mounted in your recreation room wall. Features on FM, push-pull 6K6 audio gives up to 12 watts peak output with response to 15,000 cps. Use with a good Hi-Fi PM speaker or speaker system. Output matches 3, 2 or 8 ohms. Full bass boost tone control. Chassis size is 7 3/4" x 12 1/2" long and 11 front to back. Input for record changer with crystal cartridge. (Self powered pre-amplifier for AM chassis. Ship. wt. 22 lbs. Sale price, \$49.95.) Model S-78A, 11 tube FM-AM chassis with our CU-14Y, 12" coaxial PM speaker, both for \$59.95. S-78A chassis with our P15-CR, 15" coaxial PM speaker, both for \$69.95. S-78A with CU-14Y and UA8-H, 4 speed Monarch record changer with flip-over crystal cartridge, all for \$86.95. S-78A with CU-14Y and RC-88, 4 speed Garrard record changer with flip-over crystal cartridge, all for \$115.95.

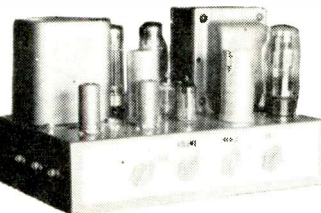

NEW 1958 MODEL—HOLLYWOOD "35"

35-WATTS RESPONSE **\$39.95**
15 TO 22500 CPS

- PUSH PULL EL-34
- BUILT IN PRE-AMPLIFIER
- TUNER INPUT
- 4 CONTROLS

McGee's new, 1958 "Hollywood 35." A full range, complete audio amplifier with the finest tone quality at any listening level you wish, from 1 watt to 35 watts. Full 20 db Built-in circuitry for new 46052A G.E. phono cartridge or regular crystal cartridge. Frankly, this is all the amplifier there is, there ain't no more. 7 tubes in all. A factory built amp at a price you might pay for a kit. Ship. wt. 22 lbs. Stock No. IMP-35. List price \$89.50. McGee's Sale price, \$39.95. Take 10% off if you order with other Hi-Fi equipment. Output impedance 4, 8 and 16 ohms for any speaker system.

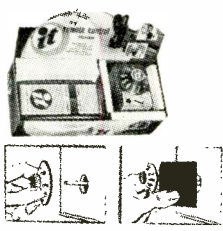

ALLIANCE "IT"
T.V. TUNER
REMOTE CONTROL
REG. \$19.50 LIST



McGee Special Purchase Sale!
Alliance "IT" remote tuner for your TV set. A small battery operated motor turns your tuner clockwise or counter-clockwise. Attractive bakelite case fits palm of your hand. Made to sell at over \$14.00 dealers net. McGee offers them for \$4.94, 3 for \$12.50 with flashlight batteries. Also adaptable to many other uses. Add 40c per unit for packing and postage.

McGEE'S SALE PRICE **\$4.94**
3 for \$12.50



McGee's Famous
12 AND 15 INCH COAXIAL P.M.
HIGH FIDELITY SPEAKERS
\$12.95 \$23.95
12-Inch Model CU-14Y
15-Inch Model P15-CR

Model CU-14Y, 12" high fidelity coaxial PM speaker. Response from 30 to 17,500 cps. Full 6.8 oz. Alnico V magnet in the 12" woofer. Special coaxially suspended dual tweeter. Built-in crossover network. Only two wires to connect to your radio or amplifier. Matches 3, 2 to 8 ohm output transformer. This speaker with many cheap speakers that are offered. This is a fine quality speaker. Stock No. CU-14Y. Sale price \$12.95 each, two for \$25.00.
Model P15-CR, 15" high fidelity coaxial PM speaker. Response down to 20 cps, and up to 17,500 cps. Full 21 1/2 oz. Alnico V magnet in the 15" woofer. Specially made coaxially suspended 5" high frequency tweeter. Built-in crossover network. Only two wires to connect. Matches 3, 2 to 8 ohm output transformer. A regular \$62.50 list price. Model P15-CR. McGee's Sale Price, \$23.95.
McGee's new 15" Junior coaxial PM speaker. 15" woofer has 6.8 oz. Alnico V magnet. 5" coaxially suspended tweeter with crossover. Only two wires to connect to any 8 ohm radio or amplifier. Frequency response from 40 to 15,000 cps. Model No. M15-CR, 15" Junior coax PM speaker. Sale price, \$16.95.

VM HI-FI CHANGER. SALE PRICE \$29.95 LESS BASE WITH GE



VM-936HF \$32.95
COLLARO 456 - \$34.50
MONARCH UA8 \$27.95

\$45.90 LESS GE RPX-052A
4 Speed Monarch
SALE PRICE **\$27.95**
with 222 Ronette Ceramic Cart.
Diamond 1 Mil Stylus \$10.00 Extra

New offering of VM Hi-Fidelity, 3 speed record changer with or without metal base. A large special purchase makes this low sale price possible. Reg. net on VM-935 less Hi-Fi Series changers are equipped with two plug-in tone arm heads which will hold constant speed, hum free operation with a VR cartridge. Plays all 3 speeds and all 3 sizes. Will inter-mix 10" and 12" records of same speed. Shuts off after last record RPM spindle. Chassis size 13 1/2 x 13 1/4 x 8 1/2" high, 4 1/2" above plate. Ship. wt. 12 lbs., with base 18 lbs.
VM-935HF, 3 speed Hi-Fi changer, less cartridge and base, only \$29.95.
VM-935HF-GE with G.E. RPX-050A VR cartridge, \$35.90.
VM-935HF-GE with "Golden Treasure" RPX-052A VR cartridge; 1 mil diamond and 3 mil sapphire styli, only \$45.90.
VM-936HF, 3 speed Hi-Fi changer with metal base, less cartridge, Sale price, \$32.95.
VM-936HF-GE with G.E. RPX-050A VR cartridge, \$38.90.
VM-936HF-GE with G.E. RPX-052A "Golden Treasure" cartridge; 1 mil diamond, 3 mil sapphire styli, only \$48.90.

4-SPEED COLLARO Latest 1957 model RC-456, Collaro 4 speed record changer. Plays all 4 speeds, 16, 33, 45 and 78 RPM both automatic and manually. Inter-mixes records of the same speed and shuts off after last record. Fast 6 second change cycle. Automatic disengagement of idler wheels eliminates flat spots that cause wow and flutter. Base size: 13 1/2" wide, 12" deep, 4 1/2" above motor bridge. Sale price, \$34.50. RC-456 Collaro 4 speed automatic record changer, less cartridge and 1 mil diamond stylus. Sale price, \$46.95. Large 45 RPM spindle, \$3.30 extra.

New Model UA8, Monarch 4 speed imported High Fidelity record changer. Features a high fidelity 4 pole motor, 8" turntable with molded rubber pallet. Counter-balanced 3 sizes. Inter-mixes 10" and 12" records of the same speed and shuts off after last record. Base size, 10 7/8" x 12 3/4". Ship. wt. 15 lbs. Large spindle for 45 RPM records, \$1.88 extra.

Model UA8-H with 222 Ronette Hi-Fi flipover ceramic cartridge, \$27.95.
Model UA8-HD, same as above but with 1 mil diamond stylus, \$37.95.
Model UA8-U with Goldring variable reluctance cartridge, \$29.95.
Model UA8-UD, same as above but with 1 mil diamond stylus, \$39.95.

4-SPEED WEBCOR New, 4 speed Model 152, Webcor "Magic-Mind" automatic record changer. Complete with G.E. RPX-050A variable reluctance cartridge. Plays all 4 speeds: 16, 33, 45 and 78 RPM automatically, 7", 10" and 12" LP records can be inter-mixed. Magic-Mind feature will switch speeds automatically between 33 and 45 RPM depending on the size of the record. Has heavy 4 pole motor and 8" turntable with rubber pad. Shuts off after last record plays and has neutral position to prevent flat spots on drive wheels that cause wow and flutter. Base size, 13 3/8" x 12". Ship. wt. 13 lbs. Sale price, \$31.95. Large 45 RPM spindle, \$2.94 extra.

3-SPEED VM VM-956GE, 3 speed automatic record changer with G.E. RPX-050A 33, 45 and 78 RPM and all 3 size records. Will inter-mix 10" and 12" records of the same speed. Shuts off after last record. Has heavy 4 pole motor. Base size, 13-3/16" x 13 1/4" deep, 7 3/4" high. Ship. wt. 15 lbs. Sale price, \$29.95. Large 45 RPM spindle \$1.88 extra.

14 TUBE ESPEY HI-FI CUSTOM FM-AM CHASSIS \$69⁹⁵

- ★ PUSH-PULL 6V6 OUTPUT
- ★ TWIN CONE CONTROLS
- ★ INPUTS FOR CRYSTAL OR V.R. PHONO, TAPE OR TV
- ★ WILLIAMSON TYPE CIRCUIT
- ★ ULTRA-LINEAR RESPONSE

MODEL HF-250C. A FULL HIGH FIDELITY AUDIO AMPLIFIER AND FM-AM TUNER—ALL ON ONE CHASSIS
REGULAR \$119.50 VALUE

SALE PRICE **\$69⁹⁵** LESS SPEAKER AND CABINET



LEATHERETTE COVERED CABINET \$7.85 EXTRA

Espey Model HF-250C, 14 tube FM-AM chassis with push-pull 6V6, 10 watt audio. A true Hi-Fidelity receiver built by a nationally famous maker of fine custom chassis. Ultra-linear output used in Williamson type circuit gives frequency response of 10 to 22,000 cps. Output taps of 4, 8, and 16 ohms. Separate RF stages for FM and AM assure high sensitivity. Temperature compensated FM front end for minimum drift. Separate bass and treble tone controls. Pre-amp for all types of magnetic cartridges. 2nd input for crystal phono, tape recorder or TV. 3 position equalizer for accurate reproduction of all records. Built-in antennas for both FM and AM. Response plus or minus 1 db from 10 to 22,000 cps. Harmonic distortion less than 1% and noise ratio. Off-on-volume and equalizer are combined on a concentric control. Has 2 AC outlets on rear of chassis. Beautiful edge lighted flywheel inertia slide rule dial. Size: 7 3/4" x 13 1/2" x 10" deep. Ship. wt. 24 lbs. (not including). Model HF-250C Sale price, \$69.95. Espey chassis with our PLS-OR, 15" coaxial PM speaker, both for \$89.95. Espey chassis with \$99.95 list, model 9762M, 12" Phillips speaker, both for \$104.95.

Beautiful modern tone tan leatherette covered cabinet to house the HF-250C Espey chassis for custom installations. Also will fit the 500G Espey tuner shown on the opposite page. High quality, sturdy wood cabinet expertly covered with modern tan leatherette material. Size, 15" long, 8 1/2" high and 10 3/4" deep. Stock No. LEC-50. Custom leatherette covered cabinet. Ship. wt. 7 lbs. Order with your Espey chassis for only \$7.95 extra.

SAVE ON NORELCO SPEAKERS AT MCGEE

LATEST IMPORTED 8" AND 12" HI-FI PM'S

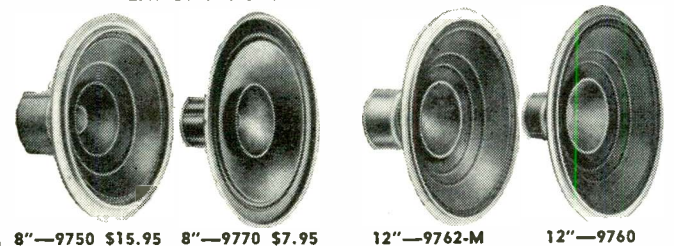

8"—9750 \$15.95 8"—9770 \$7.95 12"—9762-M 12"—9760

The choice of Hi-Fi PM speakers, imported from Holland. Made by the internationally famous Philips company. Twin cones are operated by the same super high efficiency Alnico magnet. The small center cone extends the audio range and loudness above 10,000 cps. Better and more natural sound reproduction. Extra number of gauss means more bass efficiency.

World Famous Hi-Fi Imported From Holland

12" Model 9762-M	reg. \$59.97	Sale Price \$39.95
12" Model 9760	reg. \$32.97	Sale Price \$19.95
8" Model 9750	reg. \$22.17	Sale Price \$15.95
8" Model 9770	reg. \$9.90	Sale Price \$7.95

NORELCO Model 9762-12" wide range Hi-Fi PM speaker, res. 35 to 18,000 cps at 30-watts. Voice coil imp. 8 ohms—new Alnico VI magnet gives 11,000 gauss. Regular \$59.97 net, on sale at McGEE for only \$39.95.
NORELCO Model 9760-12" wide range Hi-Fi PM speaker, res. 35 to 18,000 cps at 30-watts. Voice coil imp. 8 ohms—new Alnico VI magnet gives 8,000 gauss. Regular \$32.97 net, on sale at McGEE for only \$19.95.
NORELCO Model 9750-8" wide range Hi-Fi PM speaker, res. 50 to 20,000 cps at 10-watts. Voice coil 6 ohms—New Alnico VI magnet gives 13,500 gauss. Regular \$22.17 net, on sale at McGEE for only \$15.95.
NORELCO Model 9770-8" wide range Hi-Fi PM speaker, res. 75 to 19,000 cps. New Alnico VI magnet gives 11,000 gauss. Reg. \$9.90 net, on sale at McGEE for only \$7.95; or 2 for \$15.00.

FAMOUS 12" NORELCO PM SPEAKER

MODEL 9762-05	McGEE	\$29⁹⁵
REGULAR NET WAS \$59.97	SCOOP PRICE	

McGee Scoop. Genuine Norelco 9762-05 extended range high fidelity 12" PM speaker, 11,000 gauss. Heavy V magnet. Rated 20 to 20 watt. Response 35 to 18,000 cps. Regular \$60.00 net value. Has extended range bakelite dispersion feature built-in center of core to extend high frequency range. Never before have we had such a terrific value on this genuine Norelco 12" speaker. Made in Holland. Stock No. 9762-05. McGee's sale price, \$29.95.

1958 MODEL ON BAFFLE BOARDS

Speaker Systems	SALE PRICE
\$18⁹⁵	

Model B-125-X, high fidelity 15-watt, 5-way speaker system, mounted on an 18" square baffle board. Has 12" High Efficiency woofer, 2-4x6" mid-range speakers, plus a 4" high-range and 3" tweeter; all with Alnico V magnets. Built-in LC crossover network with variable brilliance control. Ship. wt. 11 lbs. Stock No. B-125-X, 5-way, 15-watt Hi-Fi speaker system. AUDIOPHILE VALUE \$30.00. SALE PRICE, \$18.95.

Model B-347, high fidelity 30-watt, SALE PRICE \$39⁹⁵

Model B-347, high fidelity 30-watt, 5-way speaker system, mounted on a 30" x 24" baffle board. Has 15" UTAM 21 1/2" woofer, 2-new high fidelity extending range 4x6" speakers, plus 2-5" tweeters; all with Alnico V magnets. Built-in LC crossover network with variable brilliance and presence controls. Ship. wt. 22 lbs. Stock No. B-347, 5-way, 30-watt Hi-Fi speaker system. AUDIOPHILE VALUE \$59.95. SALE PRICE, \$39.95.

Mount these Hi-Fi speaker systems in your own cabinet or use for custom installation. Ideal for use with any radio or amplifier. Completely wired, with only 2 wires to connect to any 8-ohm output. (Take 10% discount if ordered with any radio or amplifier listed hereon.) Grill cloth, 75c extra.

12" COAXIAL PM SPEAKER RESPONSE 25-17,000 CPS \$9⁹⁵

Model 12X3Y, new 1957 12" Coaxial PM Speaker, has high efficiency 12" woofer with Alnico V magnet and coaxially suspended 3 1/2" Alnico V tweeter. Built-in crossover with variable brilliance control on an 18" lead for remote control of the tweeter volume. 10-watts, response 25 to 17,000 cps. Ship. wt. 7 lbs. Stock No. 12X3Y, 12" coaxial PM Speaker. Sale Price \$9.95.

NEW TYPE "T" STANDARD COIL SINGLE STRIP TV TUNERS

PENTODE **\$9⁹⁵** CASCODE **\$12⁹⁵**
TUNERS TUNERS

2 FOR \$19.00 2 FOR \$25.00



New, "T" type, single strip Standard Coil Cascode tuner. Available for 21 mc and 41 mc, for either series or parallel filaments with various shaft lengths. This is the latest single strip, 12 position, 12 channel VHF tuner with 3/4" shaft having 3/8" concentric fine tuning knob. You can replace all of the older model 2 strip tuners with these. Ship. wt. 3 lbs. Your choice of tuner with 1 1/4", 2 1/2" or 3 1/2" shaft length. Sale price, \$12.95 each, 2 for \$25.00.
Tuners with 4", 4 1/2", 5", 6 1/2", 7", 8 1/4" or 10 1/2" shaft lengths. Sale price, \$13.95 each, 2 for \$27.00.
No. TCA-050, 2 tube 21 mc Cascode tuner with parallel filaments. Replaces 2000, 2200, 2300, 4200 series and others. Complete with 6BQ7 or 6BZ7 and 6J6 tubes.
No. TO-050, 2 tube 41 mc Cascode tuner with parallel filaments. Replaces TV-3000, 4400, 6000, 6500, 8000 and 8500 series. Complete with 6BZ7 or 6AT8 and 6J6 tubes.
TDS-050, 2 tube 41 mc Cascode tuner with series filaments. Complete with 4BQ7 and 5R8 tubes.
No. TDC-050, 2 tube 41 mc Cascode tuner with series filaments. Complete with 4BQ7 and 5R8 tubes.
No. TCS-050, 2 tube 21 mc Cascode tuner with series filaments. Complete with 4BQ7 and 5J6 tubes.

New, "T" type, single strip Standard Coil Pentode tuners. Available for 21 mc and 41 mc, for either series or parallel filaments. These are the latest single strip type tuners. 12 position, 12 channel VHF with regular 1 1/4" shaft having 3/8" concentric fine tuning. Your choice of tuner with 1 1/4", 2 1/2" or 3 1/2" shaft length. Sale price \$9.95 each, 2 for \$19.00.
Tuners with 4", 4 1/2", 5", 6 1/2", 7", 8 1/4" or 10 1/2" shaft lengths. Sale price, \$10.95 each, 2 for \$21.00.
No. TPA-050, 2 tube 21 mc Pentode tuner with parallel filaments. Complete with 6BC5 and 6J6 tubes. Replaces TV-100, TV-200, TV-300, TV-1200, TV-1300 and TV-1500.
No. TAS-050, 2 tube 21 mc Pentode tuner with series filaments. Complete with 3BC5 and 5J6 tubes.
No. TBS-050, 2 tube 41 mc Pentode tuner with parallel filaments. Complete with 6BC5 and 6AT8 tubes.
No. TBS-050, 2 tube 41 mc Pentode tuner with series filaments. Complete with 3BC5 and 5AT8 tubes.

Set of matched knobs for above Standard Coil tuners. Molded mahogany bakelite with 90° TAA-050 and metal inserts. Stock No. SCK-2 pair of knobs for channel selector and fine tuning, 59c.
Set of matching mahogany bakelite knobs for volume and contrast, Stock No. VCK-2, 59c per pair.

TWO-TUBE SARKES-TARZIAN TV TUNER WITH TUBES

21 MC PENTODE OR 41 MC CASCODE	SALE PRICE	2 FOR
\$7⁹⁵		\$14.95

No. TT-3A, 2 tube 21 mc Sarkes-Tarzian Pentode TV tuner. 12 position, 12 channel VHF complete with 6J6 and 6BC5 tubes. This popular tuner used in Arvin, Air King, Arlington, Crosley, Firestone, True-tone, Hallicoyne, Westinghouse and others. Specify shaft length, 2 1/2", 2 3/4" or 2 7/8". Ship. wt. 2 lbs. Sale price, \$7.95 ea., 2 for \$14.95. Available with longer shaft 3 1/4" to 9" long at \$1.00 extra. SCK-2, set of matching knobs for selector and fine tuning, 59c.

No. TT-2C, 2 tube 41 mc Sarkes-Tarzian Cascode TV tuner. 12 position, 12 channel VHF switch type. Complete with 6BZ7 or 6BQ7 and 6J6 tubes. This popular tuner used in many makes of TV sets; including Arvin E25702, E4012B, Silvertone E40352 and Westinghouse V11485. Available with shaft 3 1/4", 4", 4 1/4", 4 3/4" and 4 1/2" long. Ship. wt. 2 lbs. Sale price, \$7.95 each, 2 for \$14.95. For 9" shaft, add \$1.00. SCK-2, set of matching selector and fine tuning knobs, 59c.

No. ST-4B, 2 tube 41 mc Sarkes-Tarzian Pentode tuner. 12 position, 12 channel VHF complete with 6AK5 or 6BC5 and 6J6 tubes. Used in Westinghouse models V-9B86, V-10750, V-10805 and V-11385-1. Shaft lengths 3 1/4" and 3 3/4". Ship. wt. 2 lbs. Sale price, \$5.95 2 for \$10.95. SCK-2, set of matching selector and fine tuning knobs, 59c.

No. TT-1A, 2 tube 41 mc Sarkes-Tarzian Cascode TV tuner. 16 position switch type for 12 channel VHF and 4 positions for UHF converter (UHF converter not furnished). Complete with tubes, 6BZ7 and 6X8. Has 3 1/4" shaft for Westinghouse V-11333-1, etc. Sale price, \$5.95 each, 2 for \$10.95.

No. TT-5D, 2 tube 41 mc Sarkes-Tarzian Cascode TV tuner. 14 position switch type for 12 channel VHF and 2 positions for UHF converter (UHF converter not furnished). Complete with tubes, 6BZ7 and 6G8 and channel selector knob. For Westinghouse \$10.95. Available 9 1/4" shaft at \$1.00 extra.

No. TT-6A, 2 tube 41 mc Sarkes-Tarzian Pentode TV tuner. 16 position switch type for 12 channel VHF and 4 positions for UHF converter. (UHF converter not furnished). Complete with tubes, 6CB6 and 6X8. For Westinghouse model V-10880-2, also Arvin. Shaft length 3 3/4". Sale price, \$5.95 each, 2 for \$10.95.

GOLDRING V. R. CARTRIDGE WITH 2 SAPPHIRE STYLII \$5.95 WITH 1 MIL DIAMOND, 3 MIL SAPH. \$13.95

McGee offers the internationally famous Goldring variable reluctance phono cartridge, made in England and sold throughout the world to those who want the finest and most accurate music reproduction from 33 1/3, 45 and 78 RPM high fidelity phono records. (Input gain and compensation similar to G.E. v.r. cartridge required.) Furnished as standard equipment with sapphire 1 and 3 mil styli. A regular \$9.90 net item on sale at McGee for \$5.95. For \$13.95 with a diamond 1 mil styli. These are the latest production, individually cartoned turn-over cartridge with mounting bracket. Fits tone arms on most changers. Made for and bearing the famous Wilcox-Gay Recordia name. No. 546 Goldring V.R. (Wilcox-Gay) cartridge, Net \$5.95. No. DS46-95, Goldring V.R. (Wilcox-Gay) cartridge with diamond 1 mil styli, \$13.95. 1 mil diamond styli for Goldring V.R. cartridge, purchased separately, \$9.95.

McGEE RADIO COMPANY PRICES F.O.B. KANSAS CITY TELEPHONE VICTOR 2-5092
SEND 25% DOWN REMITTANCE WITH ORDER. 1903 MCGEE ST., KANSAS CITY, MISSOURI
BAL. SENT C.O.D.

FANTABULOUS

**IMPORTED BRITISH FM TUNER
FOR UNEXCELLED RECEPTION
DYNAMIC "V" BEAM TUNING INDICATOR**

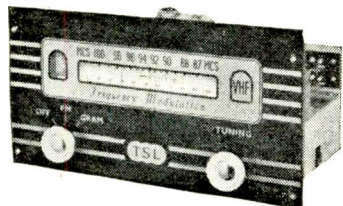

**Compare Our Specifications With Other Tuners
Costing Up To Twice Our Price. Reception to
150 Miles. Factory Wired and Tested.**

Sensitivity: .9 microvolt for 20 db quieting; 1.8 μ v for 30 db. Frequency response 20-20,000 cps \pm 1/2 db. Inputs: 300 OHM balanced. IF band width 200 KC. Stability: only 20 KC. Stable after 1 minute. 6 Mullard high gain, low noise tubes; 10 tuned circuits. Front end completely shielded in a solid casting. Better than FCC requirements. Frequency range: 88 to 108 MC with 0-100 logging scale. Grounded grid RF amplifier & reflex converter completely sealed—eliminates microphonics. Output level control: styroflex & ceramic condensers used throughout with carbon deposited resistors. "V" beam tuning indicator. Illuminated, unbreakable precision-calibrated dial assembly. Phono input connection: set is off when phono is on. 1 year warranty on all part defects. Tubes carry standard 90 day, 110/125V AC; 50-60 cycles; 30 watts. 10 1/2" wide; 5 3/4" high; 6 1/2" deep. 12 lbs.

**AIREX'S LOW
INTRODUCTORY PRICE \$44.95**

Wood cabinet (Mahogany or Blende) **\$8.95**

TSL Concert Soundcorner

Now you can add a true Hi-Fidelity 2-way speaker system to your present amplifier at new low cost without sacrificing floor space. These units are ideal for use in Stereo systems where 2 separate speakers are desired on the same wall. Excellent for extending your present loud-speaker system, or can be used to replace your present speaker in your radio or phonograph. Hangs on the wall and uses the sides of the wall as part of the enclosure.

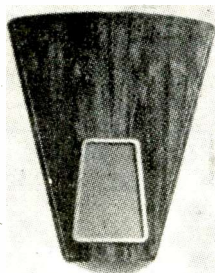

CARLTON

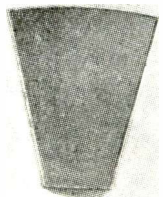

WALDORF

Uses Lorenz LP215 bass speaker, Lorenz LPH165 tweeter unit and associated crossover network. Units are mounted on a beautifully finished multiple ply bonded hardwood in mirror polished walnut. Carlton model has gold frame with neutral color grill cloth to blend in with any wall color and is washable. Every unit is fully guaranteed to give you the finest in listening pleasure. Specifications: Size: 27" high, 24" wide at top and 11 1/2" at the bottom. Frequency range 35 to above 17,000 cps. Power rating 15 watts. Impedance 8 ohms. No inter-modulation distortion. Comes complete ready to use. A product of British craftsmanship.

**AIREX'S LOW
INTRODUCTORY PRICE \$44.50**
either model

If you are building a Hi-Fi System, SEND US YOUR LIST OF COMPONENTS. We will give you a PACKAGE QUOTATION ON THEM.

All merchandise is brand new, factory fresh & guaranteed. Mail & phone orders filled on receipt of certified check or MO of 20% of items as a deposit. Balance C.O.D. F.O.B. N.Y. Prices & specifications subject to change without notice.

AIREX RADIO CORP.
64-R Cortlandt St., N. Y. 7, CO 7-2137



Technical Books

"BASIC MATHEMATICS FOR RADIO AND ELECTRONICS" by F. M. Colebrook & J. W. Head. Published by *Philosophical Library*, New York. 352 pages. Price \$6.00.

This is a new and expanded edition of the late Mr. Colebrook's earlier volume which appeared under the title "Basic Mathematics for Radio Students." The first seven chapters of this new edition are basically the same with two additional chapters covering the more advanced branches of mathematics contributed by J. W. Head, mathematical consultant to the BBC.

Primarily written for those interested in radio and electronic engineering who find their hobby or career blocked by insufficient mathematical background, the presentation makes for surprisingly "good reading" considering the subject matter. Mr. Colebrook's style is informal and he is lavish in his use of familiar analogies.

The nine chapters in the book cover elementary algebra; indices and logarithms; equations and complex numbers; continuity, limits, and series; geometry and trigonometry; differential and integral calculus; the application of mathematical ideas to radio; Heaviside's technique for dealing with more difficult electrical problems; and miscellaneous techniques. Problems and answers are included for students who use this volume as a home-study text.

"TV AND RADIO TUBE SUBSTITUTION GUIDE" by H. G. Cisin. Published by *Harry G. Cisin*, Amagansett, N. Y. 22 pages. Price 50 cents. Paper bound.

This is the 1957 edition which has been revised to include a number of the newer tubes, wherever substitutes are available. It also contains a chart of the 600 ma. series-string tubes with controlled warm-up time, gives classification for each tube, application data, and substitutes that can be made without socket or wiring changes. The TV picture tube section covers substitutions rather than conversions.

"THE PRESENTATION OF TECHNICAL INFORMATION" by Reginald O. Kapp. Published by *The Macmillan Co.*, New York. 147 pages. Price \$1.95.

Here is a succinctly written book on the presentation of scientific or "functional" information that should be "must" reading for anyone who wants to write a technical report, a factual article, or a scientific book or paper. This pithy little work is based on

four public lectures given by a former professor of electrical engineering and present dean of the faculty of engineering at University College, London. It tells how to reach the minds of readers by using psychology and style in writing.

A large number of "how-to-do-it" and "how-not-to-do-it" examples of technical writing, together with many rules for good writing add immeasurably to the value of this book.

"SERVOSYSTEMS LABORATORY MANUAL" by *Servo Corp.* Staff. Published by *Servo Corporation of America*, 2020 Jericho Turnpike, New Hyde Park, N. Y. 32 pages. Price \$2.00. Paper bound.

This manual has been prepared for use in both industry and schools and consists of basic material for an introductory laboratory course in servomechanisms, feedback control systems, etc.

Seven integrated, class-tested experiments are included in this volume each of which builds on what the student has learned in the earlier experiments. The experiments call for the breadboarding of a basic servo-system which is used throughout the course. Practical applications of principles are stressed and theoretical material is kept to a minimum.

The manual is well illustrated with diagrams and photographs. When used in conjunction with any standard servo text, it should provide a worthwhile coverage of the field.

"SEMICONDUCTORS — THEIR THEORY AND PRACTICE" by G. Goudet & C. Meuleau, translated from the French by G. King. Published by *Essential Books Inc.*, Fair Lawn, N. J. 310 pages. Price \$18.90.

This is a fundamental work for engineers, graduate students, and research workers since it covers the subject from both the theoretical and practical viewpoints.

In the first section of the book the theory of the complex phenomena of current flow in solids is analyzed along with an explanation of the latest theories regarding them. The second and third parts of this volume cover the basic problems encountered in making semiconductor diodes, transistors, photoelectric cells, and similar elements and adapting them to practical industrial circuits.

The treatment throughout is highly mathematical so a thorough grounding in the subject is prerequisite for even the most casual understanding of this work.

"TRANSISTOR MANUAL" by Semiconductor Dept. Staff. Published by *General Electric Co.*, Syracuse, N. Y. 112 pages. Price 50 cents. Paper bound.

This is a second edition of a book first published in January 1957. This book has been expanded to include almost twice as much material as the earlier volume.

WE TRADE HIGHER!

Howdoody...

This picture shows me, Jack S., spendin' a quiet evenin' in my own cozy little well-upholstered apartment after a hard day at the office as evaluator of trade-ins at Walter Ashe Radio Co. They immigrated me here from the Ozarks and I don't get to fraternize with the natives none.

The Boss says he's afraid they'll spoil my natural big-hearted stupidity and imbue (whatever that is) me with something he calls the profit motive. He says if I ever get the trade-in dept. out of the red he'll trade ME IN.....on an imbecile!.....or less!! I think he's red-herringing me though; I called the F.B.I. and they don't even have a file on a soul in the place!

So just write and tell me what old obsolete gear you want to trade in and I'll whip out my crazy mixed-up marking chalk and whomp up a price for it so high you'll swear I'm as buggy as an August Picnic. I shouldn't have said "Obsolete Gear". It can't be older than 1945. I found that out last week when I took in a gross of TV Kits, brand new, in original factory cartons with pre-bored scannin-discs!

Write your lonesome fren,

Jack S.



IT'S EASY TO DO BUSINESS WITH WALTER ASHE!

1. Just tell us what factory-built gear (made since 1945) you have to trade, and what new gear you wish to purchase. You'll get our top dollar quote by return mail.

2. When the deal is made, you ship your equipment to us by prepaid express or, if express is not available, by prepaid truck. We check it at once and, in most cases, your new gear is on its way to you within 24 hours after we receive your trade-in.

3. We will ship your new gear to you via express in most instances. Where express is not available, or not practical, we will ship by truck.

LOOK! FOUR BRAND NEW MODELS!

GON SET

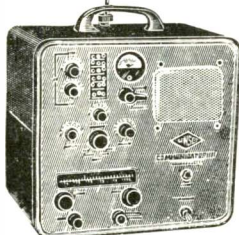

COMMUNICATOR III
2 or 6 Meters.....\$269.50

JOHNSON

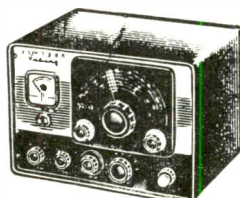

NAVIGATOR KIT \$100.00
Wired & Tested.....150.00

JOHNSON

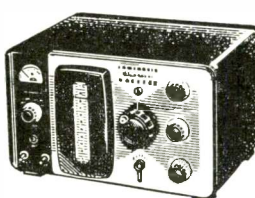

COURIER KIT.... \$235.00
Wired & Tested.....295.00

JOHNSON

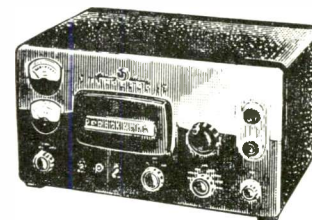

THUNDERBOLT KIT \$450.00
Wired & Tested..... 525.00

DO YOU HAVE OUR 1958 CATALOG? ITS FREE!

WRITE FOR FULL DETAILS ABOUT OUR TIME PAYMENT PLAN

All prices f. o. b. St. Louis . Phone CHestnut 1-1125



WALTER ASHE RADIO COMPANY
 1125 Pine Street, St. Louis, Mo.

Rush "Surprise" Trade-In Offer on my.....
 for.....
 (show make and model of new equipment desired)

Send new FREE Walter Ashe catalog.

Name.....
 Address.....
 City..... Zone..... State.....

OUR 36TH YEAR
 RN-11-57

HARVEY
has it...

THE LATEST FROM
DYNAKIT



Dynakit Mark III

A new 60 watt amplifier that meets the same high standards set by Dyna's 50 watt unit. Power achieved at less than 1% IM distortion, with a frequency response better than ± 5 db from 6 cps to over 60 kc. Response at any level up to 60 watts is ± 1 db over a range in excess of 20 cps to 20 kc. Pre-wired printed circuit assembly with parts mounted insures correct, trouble free construction in less than three hours. Extra premium KT-88 (or 6550) tubes—supplied in matched pairs—output impedances 4, 8 and 16 ohms. It's a value buy any way you look at it—as a kit—only **\$79.95. Wired and tested \$99.95**

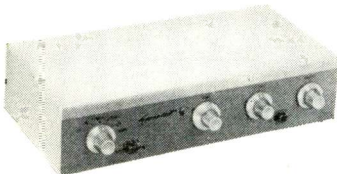

Dynakit Pre-Amplifier

Here's a low noise high gain pre-amplifier kit with full control facilities and six inputs for high and low level magnetic phono, radio, TV, tape, plus option of tape head, mike, or extra phono position. Unusual design provides for pre-assembled printed circuit board to reduce wiring time to less than three hours. May be powered from any amplifier. Unique, patent pending, feedback circuitry maintains lowest distortion and complete consistency of performance. Equalization available for RIAA, LP and 78 rpm records. An unbeatable buy at the low price of.....**\$34.95.** Complete with all parts and cabinet.

**MAIL ORDERS SHIPPED
SAME DAY AS RECEIVED**

Include with payment an allowance for shipping charges. Prices subject to change without notice.



ESTABLISHED 1927

**HARVEY RADIO
CO., INC.**

103 W. 43rd St., N. Y. 36, N. Y. • JU 2-1500

This manual, like its earlier counterpart, contains basic information on transistors and their use in electronic circuits. It has been written for electronic design engineers, service technicians, and hobbyists working with transistors. Included is material on basic semiconductor theory, construction techniques, explanations of transistor specification symbols now in common use, and specifications with outline drawings of all transistors registered with EIA (formerly RETMA).

The booklet includes circuit diagrams for 29 different pieces of equipment ranging from a simple transistorized code-practice oscillator to a sun-cell triggered relay and a completely transistorized high-fidelity amplifier system. A helpful handbook for the experimentally minded.

* * *

"BASIC MATHEMATICS FOR ELECTRICITY, RADIO, AND TELEVISION" by Bertrand B. Singer. Published by McGraw-Hill Book Company, Inc., New York. 508 pages. Price \$7.50.

Ambitious technicians, exceptional students, and do-it-yourselfers often ask your editors for a book which would enable them to study math on their own or brush up on rusty techniques as an aid to advancement in electronics.

This book should suit these readers to a "T." It is designed specifically as a self-study text and concentrates on the mathematical procedures involved in the electronic field. Even the problems and examples used to illustrate a point are directly related to the field. A study of the chapter headings might prove misleading if one didn't realize the plan behind the presentation. Such subjects as an introduction to electricity, simple electrical circuits, series and parallel circuits, resistance of wire, etc. might indicate that this is a basic text on

radio theory rather than a mathematical approach to circuitry.

Examples are given in each chapter with the problems worked out. At the end of the discussion are test questions, a summary of the chapter, and problems for the student to solve.

* * *

"TRANSISTOR CIRCUITS" by Rufus P. Turner. Published by Gernsback Library, Inc., New York. 156 pages. Price \$2.75. Soft cover.

The author of this volume was one of the "pioneer" engineers in the field of the application of transistors to "build-it-yourself" equipment. As early as 1950 he was designing and writing about equipment using the then-new transistor.

This book is the tangible evidence of the author's many years of work designing and building practical transistor circuits. Some 150 practical and usable circuits are described in detail, with schematics and parts lists to permit duplication.

The volume is divided into eleven chapters and covers audio amplifiers, r.f. and i.f. amplifiers, d.c. amplifiers, oscillators, power supplies, radio receivers, triggers and switches, control devices, test instruments, amateur equipment, and miscellaneous experimental devices.

* * *

"HOW TO MAKE A TRANSISTORIZED PORTABLE RADIO" by Sylvania Staff. Published by Sylvania Electric Products Inc., New York. 30 pages. Price 25 cents. Paper bound.

This little book for the hobbyist includes not only instructions for building a transistorized receiver but contains some twenty additional practical applications for r.f. transistors.

Chapters covering amplifiers, oscillators, receivers, ham radios, test instruments, and miscellaneous devices include complete construction details and parts lists.

-30-

**"CUSTOM" ANTENNAS FOR
PROBLEM AREAS**

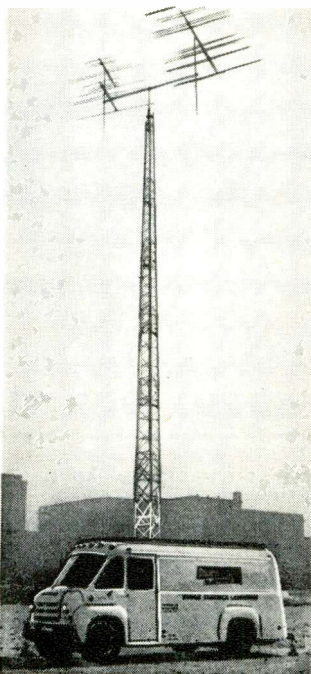

TV viewers and technicians in urban locations probably never give a second thought to the fact that there are vast areas in the U. S. where the job of getting a usable picture on the TV screen involves work, magic, and luck.

The Finney Company of Bedford, O. is well aware of this problem and is taking concrete steps to help out jobbers in communities where standard broadband antennas just haven't been able to deliver the signal. They have developed and are operating a mobile research laboratory which travels to the area involved. There the lab conducts extensive field tests, the results of which are relayed to the company's engineering staff which tackles the problem from a design standpoint and comes up with a "customized" antenna.

The equipment, which is at the disposal of dealers and distributors without charge, consists of a panel truck housing a wide variety of specialized test and measuring equipment, a sixty-foot telescopic tower, and twin antenna circuits.

Service technicians faced with a really "tough one" are invited to contact their nearest Finco antenna distributor so that a visit of the mobile antenna laboratory can be arranged. To locate the name and address of your nearest Finco distributor, write the company at 34 W. Interstate St., Bedford, Ohio.

-30-

how long would it take you to solve this service problem?

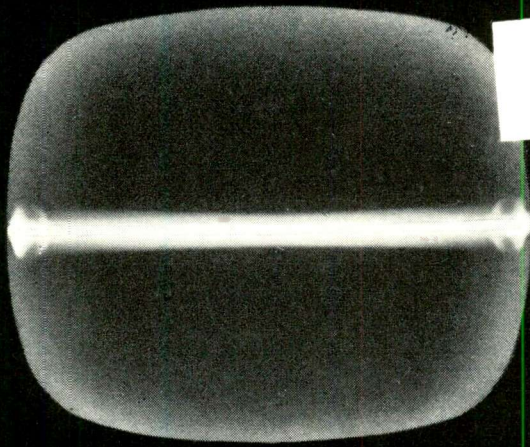

(Based on an actual case history taken from the Howard W. Sams book "TV Servicing Guide")

SYMPTOM:
Loss of Vertical Sweep

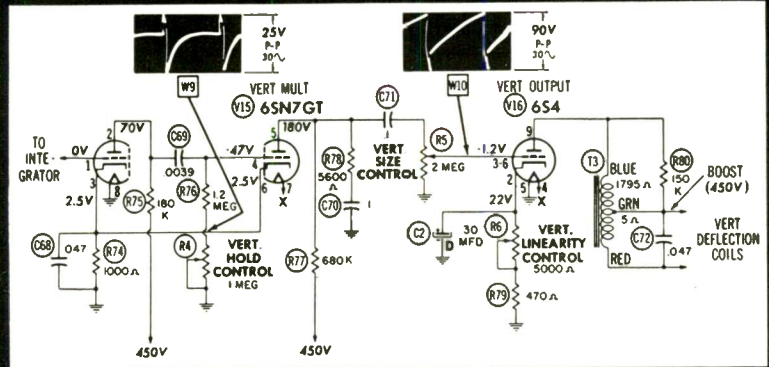

PHOTOFACT helps you lick problems like this in just minutes for only *2½¢ per model!

Let's take a look at this problem: This trouble symptom is present when there is no driving signal to the vertical deflection coils and when the horizontal scanning is normal. Look for the following possible causes:

1. Defective multivibrator or output tubes
2. Open coupling capacitors C71 or C69
3. Open linearity control R6 or cathode resistor R79
4. Open size control R5
5. Open output transformer T3

With the applicable PHOTOFACT Folder at your fingertips, you trouble-shoot and solve this problem in just minutes. Here's how:

Using the Tube Placement chart (you'll find it in every PHOTOFACT TV Folder) you can quickly locate and check

the multivibrator and output tubes.

Tubes okay?—then: Check waveform at grid of vertical output tube (W10). Wave shapes and peak-to-peak values appear right on the PHOTOFACT Standard Notation schematic. Waveform correct?—then: Check for open R6, or R79 or for faulty components in the output plate circuit. The DC resistance of the vertical output transformer and the lead colors are also shown right on the schematic.

Waveform incorrect?—then: Check voltages at the pins of the multivibrator tube. They're right on the exclusive Standard Notation schematic.

Whatever the trouble, you'll locate it faster and easier with a PHOTOFACT Folder by your side. Be sure to use the complete Replacement Parts List to select the proper replacement for the repair.

Use the servicing method you prefer—checking of waveform, voltage or resistance—you'll find all the information you need at your finger-tips in PHOTOFACT.

For only *2½¢ per model, PHOTOFACT helps you solve your service problems in just minutes—helps you service more sets and earn more daily!

*Based on the average number of models covered in a single set of PHOTOFACT Folders.

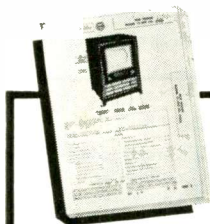

MONEY BACK GUARANTEE!

Got a tough repair? Try this—at Howard W. Sams' own risk: see your Parts Distributor and buy the proper PHOTOFACT Folder Set covering the receiver. Then use it on the actual repair. If PHOTOFACT doesn't save you time, doesn't make the job easier and more profitable for you, Howard W. Sams wants you to return the complete Folder Set direct to him and he'll refund your purchase price promptly. **GET THE PROOF FOR YOURSELF—TRY PHOTOFACT NOW!**

FREE



FOR SERVICE TECHNICIANS ONLY

Fill out and mail coupon today for Free subscription to the Sams Photofact Index—your up-to-date guide to virtually any receiver model ever to come into your shop. Send coupon now.

HOWARD W. SAMS & CO., INC.

Howard W. Sams & Co., Inc.
2203 E. 46th St. Indianapolis 5, Ind.

Put me on your mailing list to receive the Sams Photofact Index and Supplements. My (letterhead) (business card) is attached.

I'm a Service Technician: full time; part time

My Distributor is: _____

Shop Name _____

Attn: _____

Address: _____

City _____ Zone _____ State _____

PROTECT ALL ELECTRONIC TUBES

WITH



Electronic Tube PROTECTOR

Designed To Protect All Electronic Tubes in TV or Hi-Fi Sets, Amplifiers, and Similar Electronic Equipment. Will Double or Triple Tube Life Including Picture Tubes.



ATR Electronic Tube Protector Wall Model 250

List Price \$495—DEALER NET PRICE \$330

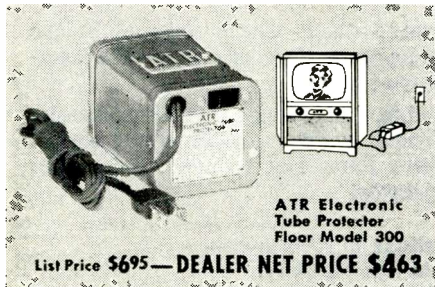

ATR Electronic Tube Protector Floor Model 300

List Price \$695—DEALER NET PRICE \$463

ATR Electronic Tube Protectors will double or triple the life of all electronic tubes including picture tube in TV or Hi-Fi Sets, Amplifiers, Electronic Organs, and other similar electronic equipment. The ATR Electronic Tube Protector utilizes a thermal cushion-action principle which also protects all other components by eliminating initial damaging surge currents. The ATR Electronic Tube Protector can be used with any electronic equipment having input wattage of 100 to 300 watts.

SEE YOUR JOBBER OR WRITE FACTORY

✓ NEW MODELS ✓ NEW DESIGNS ✓ NEW LITERATURE
"A" Battery Eliminators, DC-AC Inverters, Auto Radio Vibrators



AMERICAN TELEVISION & RADIO CO.
Quality Products Since 1931
SAINT PAUL 1, MINNESOTA, U. S. A.

A Transistorized D.C. Voltage Multiplier

By PAUL S. LEDERER

Simple d.c. supply for radio-control and mobile gear uses transistor and rectifier; works off car battery.

THE popularity of various radio-controlled models underlines the ever-present problem of power for such R/C equipment, especially the transmitter. FCC regulations limit the d.c. plate supply power fed to the transmitter to 5 watts. In most cases one to two watts seem quite sufficient for proper operation.

Some people use high-voltage batteries to supply the power but in view of the cost of such components, this is not an economical procedure. A better way is to use the d.c. voltage of the car battery and step it up to the amplitude required. One method for doing this involves the use of a vibrator. Another way is to use the circuit to be described.

The use of a transistor inverter is not a new idea. A "Transistorized Kilovolt" was described recently¹ and commercial transistorized d.c. voltage multipliers are on the market. Two manufacturers of transistors, CBS-Hytron and Clevite, in their data sheets on power transistors show suggested circuits. The latter requires a special transformer, while a modification of the former did not deliver enough voltage and power when tested.

The circuit finally built to operate from the 6-volt storage battery of an automobile uses one power transistor

(a CBS-Hytron 2N256) and a vibrator power transformer (rated at 300 volts, 100 ma. d.c.) obtainable as stock number TM-3011 from *Herbach & Rademan*, Philadelphia. The rest of the components are standard.

The transistor in the primary of the transformer operates as a non-sinusoidal oscillator powered by 6 volts d.c. The voltage is stepped up in the secondary and rectified by a 6X5 full-wave rectifier and filtered by an RC filter. Two similar transistors may be used to operate with a 6-volt d.c. supply: CBS-Hytron 2N255 or 2N256. The transistors are identical except for this: the 2N255 has a maximum collector-to-base voltage rating of -15 volts while the 2N256 is rated at -30 volts. In view of the only slightly higher cost of the 2N256, the latter was chosen for its greater possible use in future experimental circuits. A vacuum-tube rectifier was chosen for three reasons: it was on hand; due to the non-sinusoidal waveshape of oscillation, sharp high-voltage spikes are generated and there was concern about their effect on selenium rectifiers; and it was felt that the added drain on a 6-volt automobile storage battery imposed by the heater of the 6X5 (about 3.8 watts) was negligible.

Two other features of the circuit re-

D.C. OUTPUT (volts)	D.C. OUTPUT (ma.)	A.C. RIPPLE (volts, r.m.s.)	D.C. INPUT (amps.)
195	11.0	0.035	1.68
175	16.6	0.024	1.91
150	16.8	0.028	1.82
125	14.6	0.030	1.63
100	15.2	0.028	1.60
75	17.3	0.022	1.61
50	18.6	0.010	1.61

Table 1. Operating characteristics of transistorized d.c. voltage multiplier.

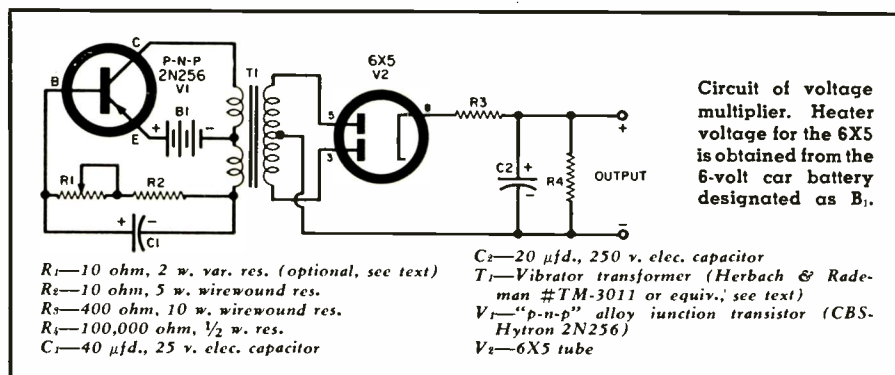

quire comment. The 10-ohm variable resistor (R_1) shown in the base circuit can be used to reduce the power output if desired. The data given in Table 1 was taken with this unit out of the circuit and it may therefore be omitted in the construction.

The large electrolytic capacitor bypassing the base bias resistor assures good operation of the circuit by providing large feedback voltage from the transformer. The circuit was tested with variable resistors as the load. The d.c. output voltage and current were measured, as were a.c. ripple at the output and the input current supplied by the 6-volt battery.

The frequency of the a.c. ripple varied from about 5000 cps at 195 volts d.c. output to about 1000 cps at 50 volts d.c. output. The d.c. power output at 175 volts d.c. is 2.9 watts. With a corresponding input power of 11.5 watts and about .5 watt lost in the filter resistor and bleeder, the circuit efficiency is 29%.

In order to permit the transistor to dissipate the input power without overheating, the transistor was mounted on a vertical aluminum plate $\frac{1}{16}$ " thick and measuring 3" x 5". After a half hour operation with a power input of 10 watts, the transistor was just barely warm to the touch.

REFERENCE

1. Queen, I.: "Transistorized Kilovolt," *Radio-Electronics*, Feb. 1957. —30—

ZENITH U.H.F. PROBLEM

By GARY CASSIDY

CHANGING the 6AF4 u.h.f. oscillator can be quite a problem in such Zenith chassis as the "Super K," used in the 19M21U and other models. The tube is located in a recess where it is difficult to withdraw by ordinary servicing methods.

In one effective withdrawal technique, the tube is permitted to warm up for a while. Then a strip of thin plastic tape is placed loosely but carefully over the top of the tube and pressed firmly against its sides, as shown in part (A) of the diagram. The tube is then permitted to cool for a while to achieve good adhesion. Then it can be rocked and pulled out.

Future difficulty can be avoided by running a cloth ribbon over the prongs of the replacement, and up over the top, as shown in (B). This makes a convenient handle for "next time." —30—

Removing hard-to-get-at u.h.f. oscillator.

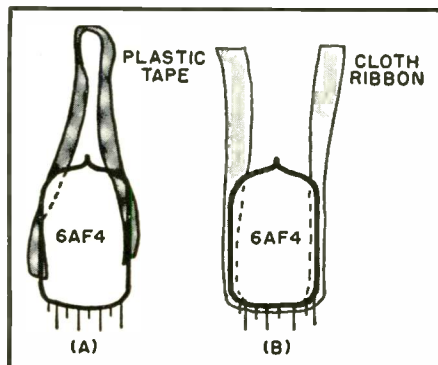

Ward's New Complete Disappearing

AUTO ANTENNA

MODEL DCF-3C

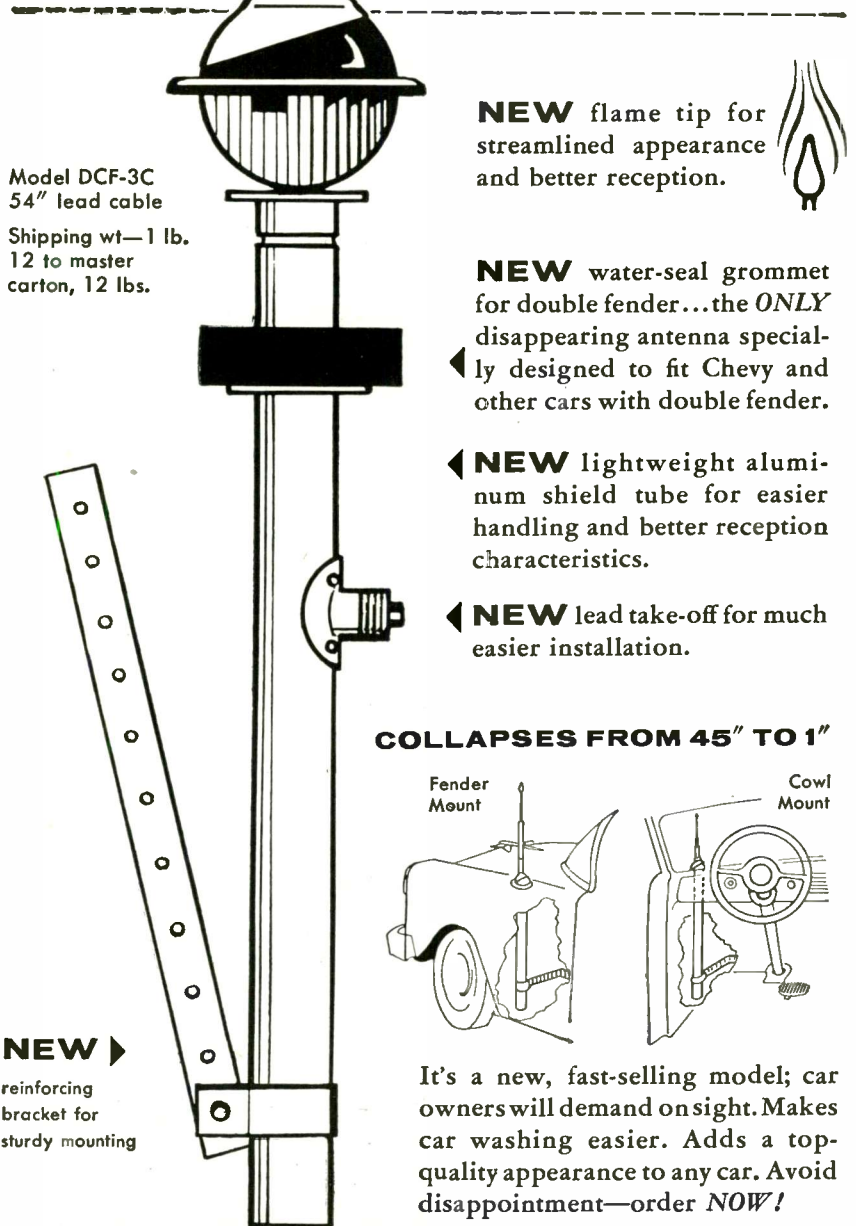

Model DCF-3C
54" lead cable

Shipping wt—1 lb.
12 to master carton, 12 lbs.

NEW flame tip for streamlined appearance and better reception.



NEW water-seal grommet for double fender... the **ONLY** disappearing antenna specially designed to fit Chevy and other cars with double fender.

NEW lightweight aluminum shield tube for easier handling and better reception characteristics.

NEW lead take-off for much easier installation.

COLLAPSES FROM 45" TO 1"

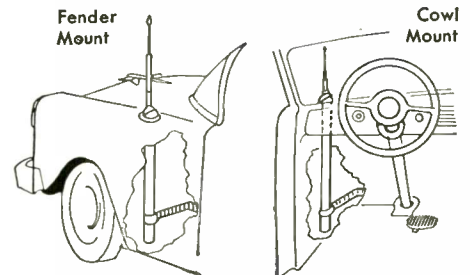

It's a new, fast-selling model; car owners will demand on sight. Makes car washing easier. Adds a top-quality appearance to any car. Avoid disappointment—order **NOW!**

NEW reinforcing bracket for sturdy mounting

Ward PRODUCTS CORP.

DIV. OF THE GABRIEL COMPANY

1148 EUCLID AVE. • CLEVELAND 15, OHIO

IN CANADA, ATLAS RADIO CORPORATION • 50 WINGOLD AVE • TORONTO, ONTARIO

How far can you go in Electronics without a Degree?

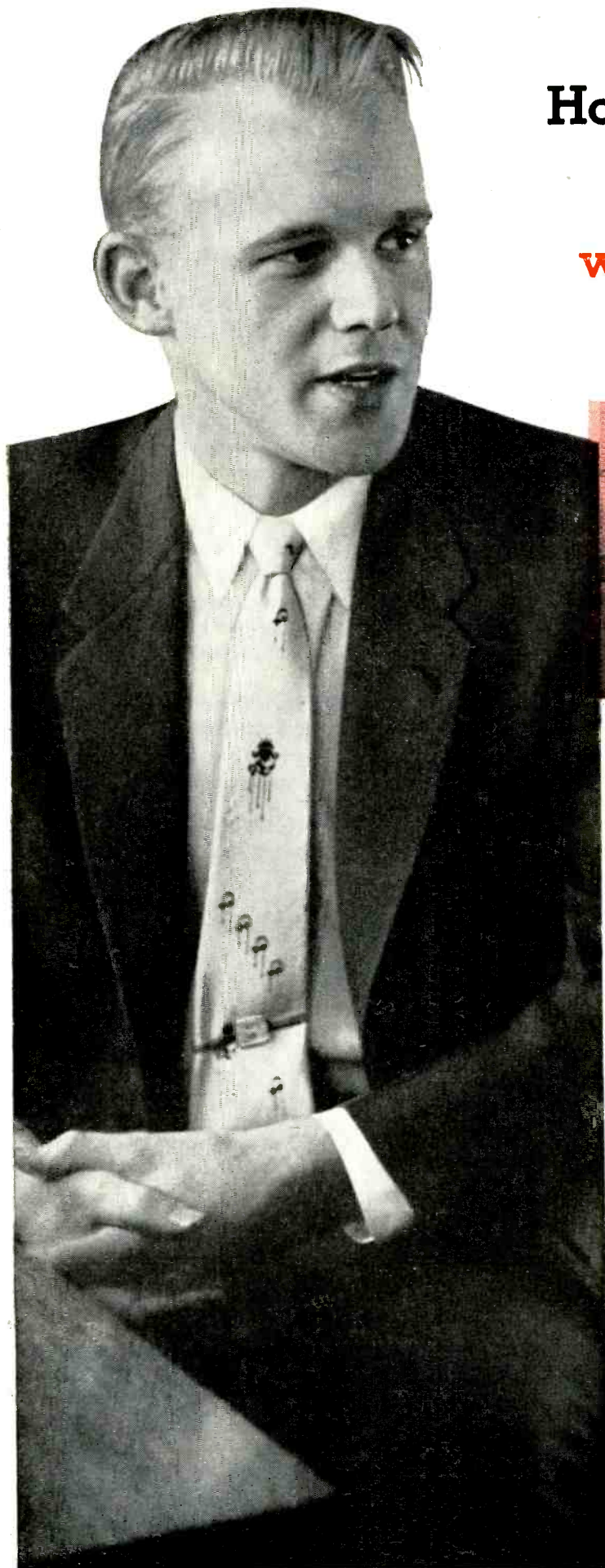

Bernie Roth examines ribbon from printer during Field Engineering Laboratory period.

Without a formal degree, 25-year-old Bernie Roth is already established as a Computer Systems Field Engineer—handling a key responsibility with IBM. Bernie is part of a team maintaining an entire electronic digital computer system. In this assignment, he must stay abreast of all the most advanced electronic concepts—developing his professional know-how every day. “That’s what’s different about IBM,” Bernie says. “The graduate engineer has an advantage anywhere—but here at IBM, the technician also can grow into managerial positions. IBM is one of the few organizations I know of that is willing to invest time and money in training the technical man—and then gauges his future ability strictly on performance.”

IBM instituted its program for specialized technical training many years ago. The theory behind this built-in educational system asked the question: Why should the capable man be denied the opportunity simply because he lacks a formal degree? The wisdom and foresight of IBM’s decision are reflected in the story of Bernie Roth—in the misgivings of his past—in the certainty of his future.

(Advertisement)

The Navy steers Bernie on the right course

When Bernie graduated from Flemington, N.J., High School in 1950, he received a general diploma—mathematics and science made up a small part of his curriculum. Enlisting in the Navy in 1951, Bernie proved his aptitude for technical work and was assigned to the electronics preparatory school in Jacksonville, Fla. Later, he attended the Class A Aviation Electronics School in Memphis, Tenn. . . . probably the most important phase of his naval training because it was in



Here, he scans the schematic of computer circuits.

Memphis that he became convinced that a technical career was "Right up my alley." But an event that occurred during a furlough in the spring of 1955 put a brand-new light on Bernie's future.

Reports for training

Bernie smiled when he mentioned that his mother had a tendency to clip want ads. "It was just pot-luck that one of the ads she spotted was for IBM Kingston and Project SAGE." Soon afterwards, Bernie hopped a bus to Newark for an interview with the IBM representative. He took the required number of tests—talked over his hopes and ambitions, and "That's about all there was to it." In July, Bernie notified IBM that he was definitely available, and supplied the necessary references. Meanwhile, he made a study of IBM's history, its policies, its growth, and its future—all of which impressed him favorably. One day in September, Bernie received instructions to report to Kingston to begin training as a Computer Units Field Engineer.

The material he studied at Kingston

"The Kingston program is a real experience, and quite an eye-opener in

electronic techniques. First of all, I studied basic circuitry. Then, I actually learned a new way to think—the ability to comprehend the whole from the assorted parts. The student must know how to form logic blocks, and in time, he should be able to design his own circuits. All of this proved especially helpful once I got into the field. Later on, I studied the various input-output devices which are used as auxiliary units to the central computer. Finally, I analyzed the methods that supply the power for this electronic giant. Millions of



Bernie checks a unit in one of the operating consoles.

watts are needed—a phenomenal amount. In general, I'd say that you couldn't find a better training ground for understanding the uses of electronic as well as electromechanical equipment."

Promoted to Computer Systems Field Engineer

Early this year, following additional training and on-the-job experience, Bernie became a Computer Systems Field Engineer and was assigned to Santa Monica, Calif. "I'm responsible for performance and evaluation of the system as a whole. I direct and conduct reliability testing and maintenance of computer equipment. The many Project SAGE outposts—picket ships, reconnaissance planes, Texas towers—flash their signals to input devices which, in turn, correlate and compile data for the main computer. After processing, data is available either through displayscopes, fast photographic devices, or printed data. The SAGE computer, incidentally, is the world's largest computer. It's built and tested at Kingston, then disassembled and shipped to directional control sites. My work is always different, never routine, and that's very important to me."

How does the future look to Bernie?

A happy and prosperous future is in the offing for Bernie Roth. Now a Computer Systems Field Engineer, he's confident that in a short time he will qualify as a Group Supervisor, and the next step up the ladder would be Group Manager. "The real satisfaction in working with IBM," Bernie says, "is the opportunity to learn and understand more and more about electronic techniques. IBM is quick to recognize and reward improved ability through greater knowledge."



An outdoor man, Bernie takes full advantage of available hunting facilities.

What about you?

Since Bernie Roth joined IBM Military Products and the Project SAGE program, opportunities are more promising than ever. IBM will invest thousands of dollars in the right men to insure the program's success.

If you have 2 years' education and/or experience gained through technical schooling or military service, you can become a member of this important, permanent, expanding project as a Computer Units Field Engineer. You'll receive 20 weeks' training at Kingston, N. Y., with full pay, plus living allowance, before assignment to a permanent location of your choice.

WRITE TODAY to:

**Mr. N. H. Heyer, Room 4311
Military Products Division
IBM Corp., Kingston, N. Y.**

You'll receive a prompt reply. Personal interviews arranged in all areas of the United States, if your resumé of experience and education indicates you have the qualifications.



DATA PROCESSING • ELECTRIC TYPEWRITERS
MILITARY PRODUCTS • TIME EQUIPMENT
SPECIAL ENGINEERING PRODUCTS • SUPPLIES

'SCOPES ARE "GOLD MINES"

... When you learn to use them **RIGHT** ... on all kinds of service jobs!

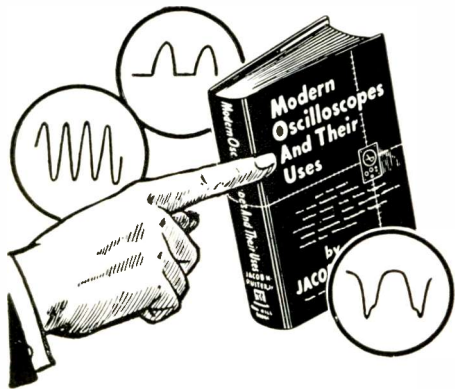

**THIS GREAT BOOK
TELLS ALL YOU NEED TO
KNOW ABOUT THEM!**

Big 2nd Edition

Contains Latest
Data and More
Than 30 Extra
Pictures.

Includes use of
'scopes in color
TV ... black and
white TV ... Radio
... Industrial Elec-
tronics ... Teach-
ing ... even in
atomic energy work!

Here's the "secret" of servicing any radio or Television set ever built ... easier, better and faster!

In plain language, MODERN OSCILLOSCOPES AND THEIR USES brings you the data on 'scopes that you really need. It teaches you when, where and exactly how to use oscilloscopes on all types of jobs.

You learn how to handle tough jobs easier and faster than you may have thought possible. Every detail is clearly explained—from making connections to adjusting components and setting the controls.

WORK EASIER—BETTER—FASTER

Equally important, you learn how to analyze oscilloscope patterns accurately and in less time. Almost 400 illustrations including dozens of pattern photos make every step perfectly clear.

This famous book—now in its revised 2nd Edition—is more widely used than any other of its type. That's because it gets right down to "brass tacks" in a way you can hardly fail to understand. No complicated mathematics. No involved theoretical discussions. You learn *exactly* how to use your oscilloscope on all types of AM, FM and television service (including color TV). You learn each step of the work fully—from locating troubles fast to handling tough realignment jobs.

PRACTICE 10 DAYS FREE!

Dept. RN-117, RINEHART & CO., INC.
232 Madison Ave., New York 16, N. Y.

Send 2nd Edition of MODERN OSCILLOSCOPES for 10-day FREE EXAMINATION. I will then remit \$6.50 (plus postage) promptly in full payment or return book and owe you nothing. (SAVE! Send \$6.50 with order and we pay postage. Same 10-day return privilege with money refunded.)

Name

Address

City, Zone, State.....

OUTSIDE U.S.A.—Price \$7.00, cash with order. Money back if you return book in 10 days.

Service in Northern Mexico

(Continued from page 50)

ready sale. Good, used vacuum tubes, tested in the presence of the customer, are offered for sale in some of the larger Mexican cities.

In the larger metropolitan centers, such as Mexico City, Vera Cruz, Monterrey, and Hermosillo, to mention a few, electrical power and distribution are adequate and a.c.-operated radio equipment is standard. In the smaller communities and in areas where the local distribution system has been outgrown, low line voltage, intermittent service, and variable frequency are common problems. Some of these difficulties are overcome by the extensive use of variable-voltage transformers and subsidiary filters. Generating equipment in many of the small communities is "umpteenth-hand," having been traded "downstream" as it became inadequate in the larger communities. The service given by these relics is rather good, all things considered. One such local power supply, "not operating for the day," is shown in Fig. 2.

Where even locally generated power is unavailable, battery-operated receivers are used despite the relatively high cost of batteries in Mexico and their short life in arid or tropical environments. Where a battery pack for the radio costs more than a week's pay, it becomes a domestic tragedy if little José leaves the set on after listening to the latest episode in the adventures of *Superhombre* and runs the battery down.

Television reception in most parts of Mexico is theoretically impossible because of the remoteness of the stations. Actually, by use of lofty antenna towers, boosters, and a lot of skillful adjustment of the receivers, many communities receive TV programs quite consistently from stations up to 250 miles away. Occasional pictures from Mexico City have been received as far away as Sonoita, Sonora, a small oasis town just south of the Arizona-

Sonora border. A typical antenna installation for "beyond the fringe" reception is shown in Fig. 3.

Complicating the task of the technician in most parts of Mexico is the great diversity of equipment he is expected to service. Although about half of the receivers in use in northern Mexico were manufactured in the United States, many of them are aging fugitives from the museum. Many receivers of German, Argentine, and Japanese manufacture are also in use and many of them give excellent service despite the unavailability of exact replacement parts. Ingenious substitutions keep most of them operating even after failure of most of the original parts.

Because interest in and the use of radio equipment has grown faster in Mexico than the domestic technical publishing industry, radio terminology is strangely mixed. Hispanicized English technical terms are quite common, examples being: *amplificacion de push-pull*, which should be self-explanatory; *batteria*, for battery (even though there is a perfectly good Spanish term, *pila*, for the same item); and loudspeaker, even though the Spanish terms *hablador* and *altoparlante* are widely approved and understood.

There is a considerable interest, in the major urban centers, in *alta fidelidad*, which we call "hi-fi" and discussions in the local radio shops currently deal with "*amplificacion de alta fidelidad con tubos KT66 en push-pull, con realimentacion negativo*." Away from these centers, high fidelity is usually confused with power output and the *fidelidad* is regarded as highest when smoke comes out of the back of the juke box!

Despite numerous problems and difficulties which include all the troubles we have in the United States plus serious shortages of domestically produced equipment, components, tools, and data books and an unfavorable foreign exchange situation, the service technician in northern Mexico seems to be performing very well indeed his primary function of "keeping them playing."

-30-

Fig. 3. An antenna installation at Sonoita, Sonora, Mexico. Rather good reception is the rule here although the nearest TV stations are about 200 miles away and all power is generated locally by a diesel plant of small size.



ONE PRICE FOR EVERY TYPE OF TUBE

Apology to Readers of Radio & TV News

Due to the tremendous response to our wonderful values in tubes, our huge staff at Video Electric Co. was unable to adhere to our Same Day Shipment policy. For this reason, some orders were delayed a number of days. We at Video wish to offer our profound apologies for any inconvenience caused our customers. We are attempting to remedy the situation at once.

PROMPT SHIPMENT ON ALL ORDERS

DON'T PAY MORE FOR SET TESTED LONG LIFE DEPENDABLE RADIO & TV TUBES • BUY VIDEO INDIVIDUALLY BOXED • ALL GUARANTEED FOR ONE YEAR OR YOUR MONEY BACK

Some Standard Brand—Others With Famous VIDEO Brand

- | | | | | |
|-------|--------|--------|---------|---------|
| QA2 | 4B97 | 6BE6 | 6SS7 | 12BH7 |
| QA3 | 5AM8 | 6BF5 | 6SV7 | 12BY7 |
| QA4 | 5AN8 | 6BG6G | 6T8 | 12CU6 |
| OB2 | 5AQ5 | 6BH6 | 6U4GT | 12SA7 |
| OC3 | 5AT8 | 6BJ6 | 6U7G | 12SG7 |
| OZ4 | 5AW4 | 6BK5 | 6U8 | 12SH7 |
| 1A7GT | 5AZ4 | 6BK7 | 6V3 | 12SJ7GT |
| 1B3GT | 5J6 | 6BL7GT | 6V6GT | 12SK7 |
| 1C7G | 5T4 | 6BN6 | 6W4GT | 12SN7GT |
| 1F4 | 5T8 | 6BQ6GT | 6W6GT | 12SQ7 |
| 1H4 | 5U4G | 6BQ7 | 6X4 | 12V6GT |
| 1H5GT | 5U8 | 6BY5G | 6X8 | 12X4 |
| 1J6GT | 5V4G | 6BZ7 | 6Y6G | 14A7 |
| 1L4 | 5V6GT | 6C4 | 7A5 | 14B6 |
| 1L6 | 5Y3 | 6CB6 | 7A7 | 14Q7 |
| 1LA6 | 5Y4G | 6CD6G | 7B5 | 19BG6G |
| 1LC5 | 6AB4 | 6CF6 | 7B7 | 19T8 |
| 1LH4 | 6AC7 | 6CS6 | 7C5 | 24A |
| 1LN5 | 6AG5 | 6CU6GT | 7C6 | 25AV5GT |
| 1N5GT | 6AF4 | 6E5 | 7C7 | 25BQ6GT |
| 1S4 | 6AH4GT | 6H6GT | 7F1 | 25CD6G |
| 1S5 | 6AK5 | 6J4 | 7F7 | 25CU6 |
| 1T4 | 6AL5 | 6J5GT | 7F8 | 25L6GT |
| 1U4 | 6AM8 | 6J6 | 7N1 | 25W4GT |
| 1U5 | 6AN4 | 6K6GT | 7Q1 | 25Z6GT |
| 1V2 | 6N8 | 6L6 | 7Y4 | 35L6GT |
| 1X2 | 6AQ5 | 6NTGT | 7Z4 | 35W4 |
| 2A7 | 6AQTGT | 6S4 | 12A6 | 35Y4 |
| 2D21 | 6AS5 | 6S7G | 12AHTGT | 35Z3 |
| 2X2 | 6ASTG | 6SA7 | 12AT6 | 35X5GT |
| 3A4 | 6AT6 | 6SB7Y | 12AT7 | 50A5 |
| 3A5 | 6AU4GT | 6SCT | 12AU6 | 50B5 |
| 3AL5 | 6AU5GT | 6SF5 | 12AU7 | 50C5 |
| 3AU6 | 6AU6 | 6SFT | 12AV6 | 50L6GT |
| 3BC5 | 6BU5GT | 6SH7 | 12AX4GT | 80 |
| 3CB6 | 6AV6 | 6SJTGT | 12AX7 | 117N7GT |
| 3Q4 | 6AX4GT | 6SK7GT | 12AZ7 | 117PTGT |
| 3Q5GT | 6AK5GT | 6SL7GT | 12B4 | 117Z3 |
| 3S4 | 6BA6 | 6SN7GT | 12BA6 | |
| 3V4 | 6BC5 | 6SQ7 | 12BE6 | |
| 4B27 | 6BC7 | | | |

FREE RCA "CHEATER" CORD GIVEN WITH ANY TUBE ORDER OF \$7.00 OR MORE!!

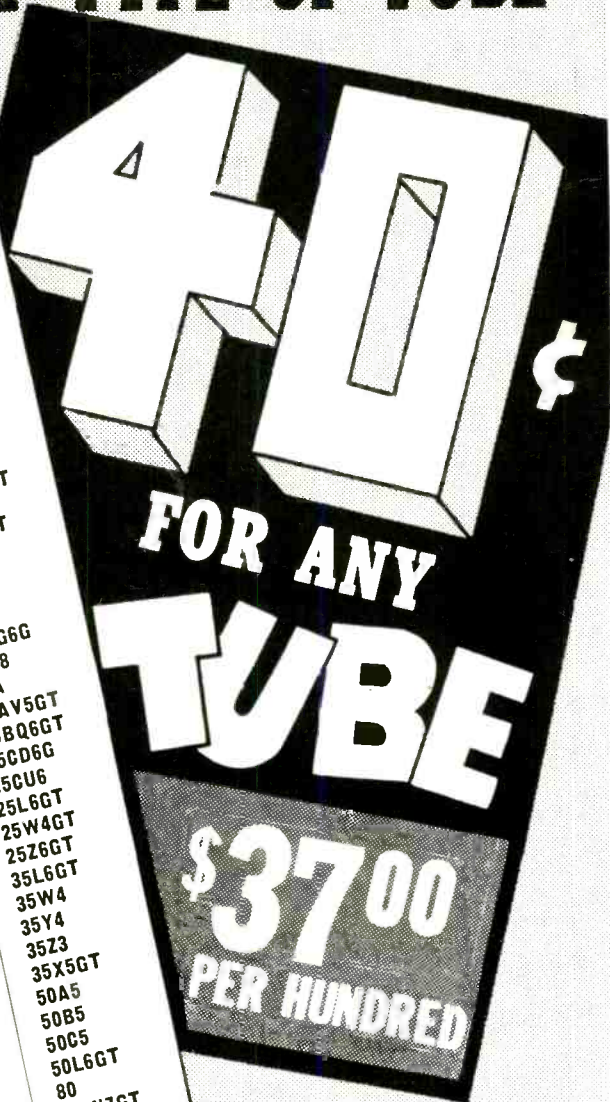

We have OVER 1000 USED TV SETS

At All Times In Our Huge Warehouse Buy one or more of these WORKING TVs to sell or use as your own second set! All Sets in GOOD WORKING condition!

Your Choice—Console or Table Model

10" ... \$23.00	19" ... \$58.00
12" ... \$28.00	20" ... \$64.00
14" ... \$33.00	21" ... \$72.00
16" ... \$40.00	24" ... \$99.00
17" ... \$46.00	

When ordering TV's, state whether table model or console is desired. Also preference on make of set. All TV's sent railway express F.O.B. Newark. On any quantity WIRE or CALL today!

SEND for our **FREE** complete TUBE & PARTS LIST and order blank.

FREE BONUS ANTENNA GIVEN WITH ANY TV SET ORDER!!

Brand New Factory Seconds! Electrically Perfect Factory Seconds! Used Tubes! New and Used Jan Surplus Tubes!

FREE POSTAGE in U.S.A. and Territories on orders over \$5.00. 25¢ handling charge on orders under \$5.00. 25% deposit required on C.O.D.'s. Please send approximate postage or freight on Canadian and foreign orders. Subject to prior sale.

VIDEO

ELECTRIC COMPANY
79 CLINTON PL. NEWARK, N. J. Phone Humboldt 4-9848



CHRISTMAS COMES EARLY AT LEKTRON!

DOUBLE VALUE FOR YOUR MONEY IN OUR

CHRISTMAS SHOP FROM OUR DAILY 12-PAGE
1958 FLYER of BARGAINS!
Models • Workshop • Gifts • Electronics • Housewares • Optics • Cameras • Hi-Fi!
FREE! WRITE TODAY!

5 & 10 SALE!

FREE! \$5 WORTH OF RADIO PARTS WITH ANY \$5 to \$9 ORDER!

FREE! \$10 WORTH OF RADIO PARTS WITH ANY \$10 ORDER plus YOUR CHOICE OF ANY \$1 ITEM FREE WITH EVERY \$10 ORDER!

FAMOUS DOLLARBUYS! SOLD AND GUARANTEED ONLY BY LEKTRON

- 60 TRANSFORMERS. COILS. REG. \$15. IF. ant., slug-tuned coils, chokes, 25 types. Wt. 3 lbs. \$1
- 3 LBS. HARDWARE. REG. \$8. Approx. 2000 pcs. Ass'd. screws, washers, nuts, etc. \$1
- 40 HI-Q CONDENSERS. REG. \$8. Ceramic, tubular cases. Assorted \$1
- 2 TRANSISTOR TRANSFORMERS. REG. \$10. UTC "uncer" type. Inter-stage, 1 x 3/4 x 3/4". Imp. ratios unknown. Color-coded leads. \$1
- WORLD'S SMALLEST RADIO KIT. REG. \$3.50. 2 1/2" x 1 3/4" x 3/4". w/ permeability tuner, diode, all parts, directions. \$1
- 30 ASSORTED BULBS. REG. \$3. Min. screw & bayonet to 6V. Wt. 1/4 lb. \$1
- EMERSON TUNER. REG. \$5. HI-Q, permeability tuned ANT & OSC coils w/ radders on 2 x 4" plate; variable tuning mech. 500 to 1600 Kcs. \$1
- SURPRISE KITSCOOP! REG. \$15. Wide assort. resistors, condensers, term. strips. Approx. 150 pcs. \$1
- 175 FT. HOOKUP WIRE. \$4.75. In 25-ft. rolls. Ass'd. colors, standing insulation. \$18 to 24" \$1
- "Postage Stamp" CRYSTAL MIKE. 3". Crisp, clear to 8,000 cps. \$1
- 60 RESISTORS. REG. \$16. Insulated. Many 1% & 5%; 1/2 to 2 W. 10 ohms to 10 megs. \$1
- SUB-MINI PNP TRANSISTOR. 1/2 pencil eraser size, used in "name" portables. W/spec sheets. \$5 value! \$1
- 2 SUB-MINI SOLENOIDS. REG. \$5. 1 x 3/4 x 3/4". Change elec. energy mech. 12 VDC @ 300 ma actuates plunger. Wt. 2 oz. \$1
- TEN 3-SEC. TIMING MECHANISMS. REG. \$3 each! Multi-gearred for all kinds of gadgets. Wt. 2 lbs. \$1
- 2 SUB-MINI I.F. TRANSFORMERS. 1/2" sq. double-ended, tuned ferrite cores. 5 terms. Transistor printed circuit hobby-type. \$1
- 60 CUBULAR CONDENSERS. REG. \$12. .0002 to .1 mf., to 2000 V. Oils incl. Wt. 2 lbs. \$1
- 30 TUBE SOCKETS. REG. \$8. Transistor printed circuit. 4-14 prong, mini standard types. Some mica filled. Wt. \$1
- 1 TRANSISTOR SOCKET. REG. \$3. Mica-filled. For sub-mini tubes, too. \$1
- 40 MOLDED CONDENSERS. REG. \$8. Black beauties, porcelain, etc. Oils, too. To .1 mf. to 1000 V. Wt. 1 lb. \$1
- 40 TRANSISTOR RESISTORS. REG. \$8. Only 1/4" long. 20 values: 15 ohms to 10 megs. Col. or-coded. \$1
- 4 OUTPUT TRANSFORMERS. REG. \$6. 50L6, 35L6, 6V6, 50B4 to 3-4 ohm v.c. Wt. 1 lb. \$1
- 8-PC. NUTDRIVER SET. \$3 value. Plastic handle, 3/16, 7/32, 1/2, 5/16, 3/8, 7/8" steel sockets w/ 1/8" steel socket wrenches in plas. case. Wt. 1 lb. \$1

- SIX DIODES. REG. \$15. Ass'd. sizes, crystal & silicon. \$1
- 40 PRECISION RESISTORS. REG. \$18. Carbonfilm, Wilkors, etc. 1/2 to 1 W. ass'd. Wt. 1/2 lb. \$1
- 100 RADIO PARTS. REG. value over \$15! Surprise assort. Wt. \$1
- 60 TERMINAL STRIPS, POSTS. Wide variety solder lug, binding. Wt. 1 lb. \$1
- 30 DISC CONDENSERS. REG. \$8. Transistor & printed circuit types. \$1
- 50 PLUGS & RECEPTACLES. Audio, power, chassis, panel & spkr. types. Wt. 2 lbs. \$1
- 60 MICA CONDENSERS. REG. \$5. Silver, 5/72 inch, 30 values; .0001 to .01 mf. To 1000 V. Wt. 1 lb. \$1
- R/C CONTROL SCOOP! Chassis incl. 4000-ohm mini control relay. 115 to 6.3-1.5A fil. xfmr., resistors, cond., pot., sockets, etc. Wt. 2 lbs. \$1
- 30 POWER RESISTORS. REG. \$8. WW, candohm, sand-canted, vitreous. 15 values: 5 to 50 W. 35 to 11000 ohms. Wt. 2 lbs. \$1
- 15 VOLUME CONTROLS. REG. \$10. Singlers, duals to 1 meg. Wt. 1 lb. \$1
- 20 PRINTED CIRCUITS. REG. \$10. Ass'd. top makes, for transistor, radio, hobby circuitry. \$1
- 10 "POLY" BOXES. REG. \$2.50. Ass'd. sizes, clear plastic hinged, w/ snap locks. \$1
- 125 RESISTORS. REG. \$15. 1/4, 1W, 40 values; 5 ohms to 10 M. 1/2, 1/4, 1W, 40 values. 5% to 10% \$1
- 10 IF TRANSFORMERS. REG. \$15. Metal can, ass'd. freqs. for radio, TV hobby use. Wt. 3 lbs. \$1
- 60 STANDARD KNOBS. REG. \$9. Bakelite & plastic, ass'd. colors. Set-screw types, too. Wt. 2 lbs. \$1
- 10 ELECTROLYTICS. REG. \$14. Ass'd. can, tubular types to 500 mf. Wt. 3 lbs. \$1
- 15 ROTARY SWITCHES. REG. \$10. Ceramic & bakelite; 1, 2, 3-gangs. Std. shafts. Wt. 3 lbs. \$1
- 30 PRINTED CIRCUIT PARTS, BOARDS. REG. \$17. Exclusive! Wide variety of useful parts, boards. Wt. 1 lb. \$1
- 100 CERAMIC CONDENSERS. REG. \$15. Ass'd. types, color-coded. Discs, too. \$1
- 15 ADJUSTABLE FERRITE COILS. REG. \$12. Ass'd. types, sizes, freqs. Wt. 1 lb. \$1
- 5 FERRITE LOOPSTICK COILS. REG. \$12. Carbofilm, precision-type, 25 values: 1/2 to 1 W. 50 ohms to 1 meg. Wt. 1 lb. \$1
- FLEA-POWER MOTOR. 1.5 to 3VDC. Needs only pen-lite cell. To 8000 rpm. \$1
- HOBBY TRANSFORMER, power. REG. \$8. 115 VAC @ 60 c. Supplies 300 VDC @ 60 ma. w/ multi fl. taps. Encased, leads. \$1

PRE-CHRISTMAS SPECIALS!

- HEARING AID PHONE SALE! All complete with cord.
 - Crystal \$1.39
 - 2,000 ohm \$1.89
 - 5,000 ohm \$1.89
- TRANSISTOR ADD-A-STAGE. Makes any crystal set into transistor radio, easily, quickly. All parts, instructions. \$1.99
- TRANSISTOR PORTABLE RADIO KIT with speaker.
 - No experience necessary! Famous make, with powerful HI-Q ferrite antenna, diode det., 2 transistor amp., stages, 4" spkr, 7 1/2 x 5 x 2 1/2" styrene case. For broadcast band. Instructions, diagrams, pictorials, all parts. \$12.94
 - 9V Battery, 69c extra.
- SUPER-SENSITIVE RELAY. REG. \$15
 - 100 to 500 micro-amps or 1/2 VDC. SPDT cont. Makes nifty transistor amplified photo-electric relay. (plans incl.) Hundreds of uses! \$2.98
 - 3-TUBE AC-DC AMPLIFIER. Reg. \$5. Fully wired; sep. vol., tone controls. Lowest price ever! \$2.99
 - TUBES. \$1.91 extra.
 - 12" HI-FI PM SPEAKER. 50 to 10,000 cps, hvy Alnico magnet. 3.2 ohm v.c. \$3.99
 - SUB-MINI TRANSFORMERS. Choice of three, .20K to 1K; .10K to 2K c.t.; .500 c.t. to 3.2 K ohms. Color-coded leads. EACH \$1.49

- ORDER NOW FOR DELIVERY IN TIME FOR CHRISTMAS!
- POCKET MULTI-TESTER. \$13 value! 3 1/2 x 2 x 1 1/2" bakelite case, 100 ohms/V. Zero adj. 0.1/1.5/150/1000 AC & DC V; 0.1/50 ma; 0/100,000 ohms. W/test leads, in orig. pack. \$6.99
- 100-200-300-power MICROSCOPE. w/slides. \$17.50 value. Top quality w/precision ground achromatic lenses \$3.99
- HI-FI TWEETER. Metal cased, cone. Freq. resp.—3,000 to 16,000 cps. Two types: 8 ohm or 16 ohm. Max. rating, 20 W. 2 1/2" x 2 1/2" w/flat surface mg. bracket. Elsewhere, \$3.99 to \$12.

HOW TO ORDER

Check items wanted. Return entire ad w/check or M.O. including sufficient postage; excess returned. C.O.D. orders, 25% down. Rated, net 30 days. Print name, address, amount money enclosed in margin. (Canada postage, 45c 1st lb., 28c ea, add'l lb.)

EXPORT ORDERS INVITED

LEKTRON

133 EVERETT AVE. CHELSEA 50, MASS.

college grads get ahead faster!

... have higher incomes ... advance more rapidly. Grasp your chance for a better life. Share rewards awaiting college men. Important firms visit campus regularly to employ Tri-State College graduates. Start any quarter. Approved for Vets.

Bach. Sc. degree in 27 months

Complete Radio Eng. courses (TV, UHF, FM, Electronics). Also Mech., Civil, Elec., Chem., Aero., Eng. 36-months in Bus. Adm. (Gen. Bus., Acctg., Motor Transport Mgt.). Superior students faster. More professional class hours. Small classes. Entrance limited to 1550. Beautiful campus. Well-equipped labs. Prep courses. Enter Jan., March, June, Sept. Earnest capable students (whose time and budget require accelerated courses and modest costs) are invited to write Jean McCarthy, Dir. Adm. for Catalog and "Your Career in Engineering and Commerce."

TRI-STATE COLLEGE
16117 College Avenue, Angola, Indiana

HAM WANTED

top money for his gear so he sold it to us!

WE URGENTLY NEED:

ART-13 BC-348 BC-224 APN-9

What else do you have?

J. J. CANDEE CO. Dept. RN
4002 W. Burbank Blvd., Burbank, Calif.
Phone Victoria 9-2411

Interference-Free AM (Continued from page 54)

be broadly self-resonant in the broadcast band. Thus, these coils behave like relatively wide-band wave traps, permitting maximum rejection at and for a few hundred kilocycles around the resonant frequency. Below resonance the coils, plus capacitors C₁ and C₂, perform as simple L-section filters. In the unit shown, resonance in L₁ and L₂ has been adjusted to approximately 1200 kc., since this particular adjustment appears to provide optimum rejection over the whole broadcast band.

L₁ and L₂ are identical. Each consists of 365 turns of No. 28 enameled wire wound in two sections—200 turns closewound on the inside section and 165 turns similarly wound on the outside section—on a 3 3/4" length of 1/2" diameter ferrite rod. Insulate the rod with a couple of layers of plastic tape and wind on the 200-turn section. Place a couple of layers of plastic tape over the turns, then wind the 165-turn section back over the first. See Fig. 3 for details. This method of winding may be poor practice in making tuned-circuit coils for the signal section of a receiver, but it provides just about the right amount of inductance and distributed capacitance for a good line-filter coil. Finish off the coils with a heavy coating of polystyrene coil dope.

The ends of the ferrite rods fit snugly in holes drilled in the two Bakelite end plates, and two small L-brackets mount the assembly in the 3" x 4" x 5" aluminum box. Note that in this case, as well as the inner connections of C₁ and C₂, are grounded. The unit should not be operated without this ground connection. If it is, the two capacitors work as a voltage divider to make the box "hot" to a.c., as well as impair the filter's performance.

The ferrite rod for the coils is available in 7 1/2" lengths from Lafayette Radio (Cat. No. MS-333). A single length is cut in half to supply the two pieces for the filter. The material is very brittle and close to glass in hardness. It's almost impossible to cut it with a hacksaw. The best method is to score the rod with a coarse, three-cornered file about 1/32" deep along a line drawn around its center, and then to rap it sharply against the bench. The rod will snap cleanly along the scored line, just as though it actually were glass.

This filter has been designed primarily for use at the broadcast re-

Fig. 3. Filter coil winding detail.

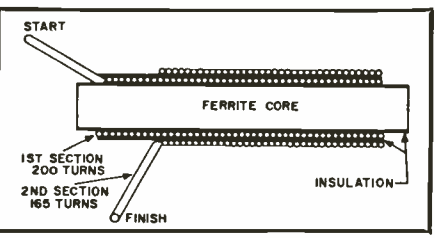

ceiver. The No. 28 wire in the coils will pass up to 50 watts of power without becoming more than hand warm. Thus, it's quite adequate for an a.c.-d.c. set. To put it to work, run the ground wire *via* the shortest possible route to the nearest cold-water pipe. With the filter connected, broadcast stations which previously could not be heard above the noise should come in with the hash pushed considerably into the background.

Additionally, some a.c.-d.c. receivers have provision for the connection of an external antenna: attaching a 5- to 10-foot length of wire here will sometimes attenuate the noise even more—because the pickup of signal on such a wire is often much greater than the pickup of interference. In some cases in the author's experience, broadcast stations which were unintelligible due to interference have been brought up to a level that's absolutely clean and clear through the use of the filter, this length of antenna wire, and just a little side tuning of the receiver!

Side tuning refers to tuning the receiver slightly to one side or the other of the actual frequency of the received signal to get out the last vestige of squeal. The short length of antenna wire doesn't work well in every case, but where it does work the result is so good that it's always worth a try. In any event, be sure to dress this lead well away from any power-line wiring. In cases where adding the antenna wire makes the noise *worse*, it is prob-

able that the interference is being picked up by direct radiation. Because of this, the filter may not be too effective either.

Broadcast receivers having power transformers can often be made to reject a considerable amount of interference simply by running a wire from the ground terminal or the chassis to the nearest cold-water pipe. Before connecting the ground lead, check the receiver to see if it has a bypass capacitor between one side of the power line and the chassis. If the set has such a capacitor, try the ground lead with the capacitor both connected and disconnected. Reverse the power-line plug in each instance. Because such a capacitor often sets up a ground loop through the chassis when a direct ground is connected to the receiver, better performance is nearly always obtained with the capacitor removed.

The filter described in this article will usually not be as effective with receivers having power transformers as it is with a.c.-d.c. sets. In fact, a receiver having a good electrostatic shield between the primary and secondary windings of the transformer; and no capacitor between power line and chassis, may receive no further benefits at all from the filter, if the chassis is well grounded.

Try these suggestions the next time you run up against a severe case of broadcast-band interference. You'll be surprised at how often you can turn the trick with one of them. —30—

ENGINEERING Home Study Courses

Courses written by world authorities in all branches of engineering. Step-by-step instructions using methods proved successful by thousands of our graduates. One hour each day in your spare time will start you off to higher pay, security, prestige. Check the course you are interested in and we will send you a complete outline of the course with a booklet describing the Institute and our advanced methods of teaching. Send to:

CANADIAN INSTITUTE OF SCIENCE AND TECHNOLOGY LTD.

#674 Century Bldg.
412, 5th St. N. W. Washington, D. C.
Civil Eng. Electrical Eng.
Surveying Radio
Architectural Electronics
Forestry Television
Mining Aeronautical Eng.
Structural Aircraft Engineer
Mechanical Eng. Navigation
Industrial Eng. & Management General Education
Refrigeration Chemical
Heating Mathematics
Drafting Journalism
Plastics Accounting

Name.....

Address.....

City..... State.....

Canadians: Send to Canadian Institute of Science & Technology Limited, #674 Garden Bldg., 263 Adelaide St. West, Toronto, Ontario.

below manufacturer's cost! fully guaranteed

60 WATT AMPLIFIER

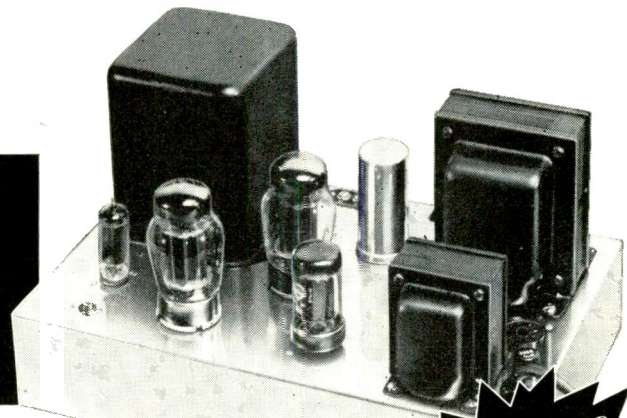

MusiCraft capitalized on a once-in-a-lifetime opportunity. Because this sale is limited, act fast. Look at the price . . . Check and compare the specifications . . . Complete satisfaction is assured or your money back.

SPECIFICATIONS

- IM Distortion . . . Less than 1% @ 60W.
- Harmonic Distortion . . . Less than 1% 20 cps. to 20,000 cps.
- Frequency Response . . . ±0.5DB, 20 cps. to 20,000 cps. . . ±1DB, 7 to 70,000 cps.
- Sensitivity . . . 1.5 volts rms. for 60 watts.
- Damping Factor . . . choice of 15 or 30 by a switch.
- Hum and Noise Level . . . 85DB below 60W.
- Hum Nullifier Control which compensates for aging or replaced tubes.

FEATURES

- Chrome plated chassis
- Choke filtered power supply
- Octal socket for preamplifier power connection (wired for Heathkit, Dyna-kit and other preamplifiers)
- Fuse receptacle on chassis
- Heavy duty power cord
- Biased filament supply
- Tubes: 2-6550, GZ34, 6BA8A
- Completely assembled, wired, and tested
- Dimensions—9" x 14" x 8" high. Shpg. Wt., 31 lbs.



IN FACTORY SEALED
CARTONS

manufactured
to sell for

\$169⁹⁵

NOW
\$74⁹⁵

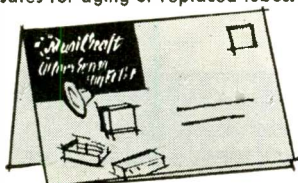

Mail Orders Filled Promptly
For more high fidelity bargains
write for MusiCraft's brochure.

MusiCraft 48 East Oak St., Chicago 11, Ill., DElaware 7-4150

Exclusive Lafayette Money-Saving Values

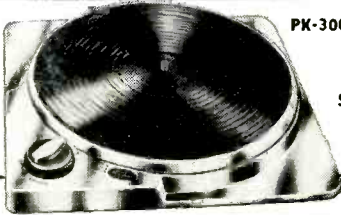

PK-300

**ILLUMINATED
BUILT-IN
STROBOSCOPE &
VIEWER**

LATEST IMPROVED MODEL PK-300 PROFESSIONAL TRANSCRIPTION TURNTABLE

New 3-speed instrument with built-in stroboscope and viewer for exact speed determination, and magnetic brake for instantaneous speed variation. Precision engineered to meet professional standards for wow, rumble and flutter content. Heavy 12" cast aluminum rim-driven turntable. Variable speed control permits adjustment of each speed within $\pm 7\%$ using efficient frictionless magnetic brake. Heavy-duty constant speed 4-pole induction motor freely suspended and isolated by shock-mountings to eliminate vibration transference. R-C filter network suppresses "pop" in speaker. Truly a delight for the connoisseur. Size: $13\frac{1}{2} \times 14$ " and requires $2\frac{3}{4}$ " clearance above and $3\frac{3}{4}$ " below motorboard. For 110-130V and 60/50 cycle AC. Power consumption 12 watts. Handsome hammertone gray finish. Shpg. wt., 20 lbs.

PK-300 Net **49.50**

**COMBINATION
DEAL**

**PK-300 TURNTABLE
PK-90 TONE ARM
G.E. CARTRIDGE
with GENUINE
DIAMOND & SAPPHIRE
STYLI Model 4G-052**

72.50

PK-90



LICENSED UNDER CBS
U. S. PATENT NO. 2676806

PK-90 VISCOUS-DAMPED TONE ARM

This transcription arm assures dependable and stable operation, utilizing the "floating action" principle of "viscous-damping." The arm is supported at a single point by a pivot and jewel bearing having negligible friction. Damping is accomplished by a silicone fluid occupying the gap between a ball and socket. This damping control permits high compliance and negligible tracking error, and prevents damage to either record or stylus should the tone arm be accidentally dropped. Low frequency resonance, skidding and groove-jumping are likewise minimized. The tone arm accepts all records up to 16" and accommodates virtually all hi-fi cartridges by means of precisely engineered adapters which simplify installation and provide proper stylus pressure.

This tone arm is a quality companion to the PK-300 with matching finish. Shpg. wt., $2\frac{1}{2}$ lbs.
PK-90—12" Transcription Tone Arm Net **11.95**

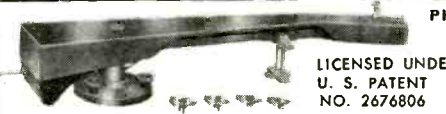

PK-170

LICENSED UNDER CBS
U. S. PATENT
NO. 2676806

16" VISCOUS DAMPED TRANSCRIPTION TONE ARM

A 16" viscous damped arm at an unbelievable low price. An exclusive sealed unit eliminates possibility of silicone leakage. Features single point pivot mounting, precision pickup arm adjustment controls, and plug-in adapters for all popular cartridges. Shpg. wt., $3\frac{1}{2}$ lbs.

PK-170—16" Transcription Tone Arm Net **17.95**

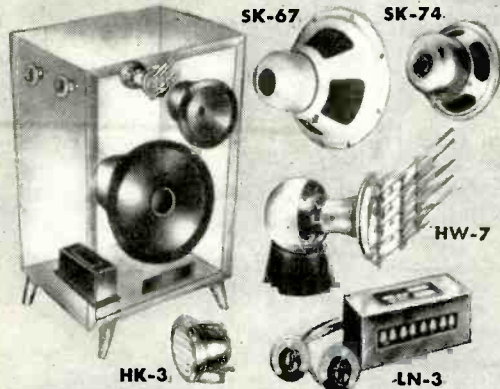

SK-67

SK-74

HW-7

HK-3

LN-3

3 WAY SYSTEM WITH 15" WOOFER . . . 8" MID-RANGE SPEAKER . . . HORN TWEETER . . . CROSSOVER NETWORK

• 15-INCH WOOFER WITH 31.5 OZ. MAGNETIC (SK-67) • 8-INCH MID-RANGE SPEAKER (SK-74) • NEW HIGH FREQUENCY ACOUSTICAL LENS TWEETER (HW-7) • 3-WAY CROSSOVER NETWORK (LN-3)

Lafayette presents this outstanding 3-way speaker system designed for the high fidelity enthusiast who desires performance formerly possible in multi-speaker systems costing many times this price. You won't believe your ears when you hear the superb reproduction throughout the entire audio spectrum. The SK-67 15" woofer provides phenomenal bass response, the SK-74 8" speaker delivers full bodied, mid-range frequencies, and the HW-7 high frequency acoustical lens tweeter faithfully reproduces the highest audible frequencies. Crossover points at 350 and 5000 cycles are provided by the LN-3 3-way inductance-capacitance network with continuously variable presence and brilliance controls that adjust tone balance to personal taste. Shpg. wt., 25 lbs.

SY-93. Complete System as listed above Net **55.50**

2 WAY SPEAKER SYSTEM 40-16,000 CYCLES

• 25 WATT WOOFER • CROSSOVER NETWORK • IMPORTED HI-FI TWEETER • LEVEL BRILLIANCE CONTROL

This 2-way speaker system is another excellent buy for the moderate purse. It is basically the same as the SY-85 system described at the top of the page, but incorporates the deluxe SK-68 speaker with 21.5 oz. Alnico V magnet. This results in more efficient reproduction and extension of the lower register. Complete system includes the SK-68 12" 25 watt woofer, HK-3 cone type tweeter and LN-2 crossover network with level-brilliance control. Range of system 35-16,000 cycles. Shpg. wt., 13 lbs.

SY-87—Complete System Net **27.50**



6 TRANSISTOR SUPERHET RECEIVER KIT

- 100% SUBMINIATURIZED
- SENSITIVE, SELECTIVE, STABLE
- PUSH-PULL OUTPUT
- PLENTY OF POWER
- AN INCOMPARABLE VALUE

The Lafayette KT-119 6 Transistor Superhet Transistor Kit provides superior commercial quality with maximum sensitivity, selectivity and stability. The circuit features 6 selected transistors and crystal diode, a specially matched set of 3 IP's. Oscillator coil, high Q loop, and audio transformer coupling. Has efficient 2 1/2" speaker and earphone jack for private listening. Complete with all parts, transistors, pre-punched chassis and easy to follow step-by-step instructions. $6\frac{1}{2} \times 3\frac{1}{2} \times 1\frac{1}{2}$ ". Shpg. wt., 3 lbs.

KT-119—Complete Kit—Less Case & Battery Net **29.95**

BATTERY RCA VS300 Net **1.23** BURGESS P6 Net **.77**

MS-339—Sturdy, attractive brown leather case with carrying strap for KT-119. Shpg. wt., 1 lb. Net **2.95**

MS-366—Sensitive matching earphone Net **1.29**



3 TRANSISTOR SUPERHET POCKET RADIO KIT

- A TRUE POCKET SUPERHET RECEIVER
- NO EXTERNAL ANTENNA
- NO EXTERNAL GROUND

A remarkable sensitive, super-selective pocket superhet receiver with astonishing performance over the complete broadcast band. Uses 2 high-frequency and one audio transistor plus efficient diode detector and features 2 specially matched IP transformers for maximum power transfer. The components are housed in a professional looking beige plastic case. The receiver's appearance enhanced by attractive maroon and silver station dial. Sensitive built-in ferrite antenna eliminates need for external antenna. A designer's dream in a true pocket superhet receiver! Complete with all parts, transistors battery, case, dial and easy to follow step-by-step instructions. $4\frac{1}{2} \times 2\frac{1}{2} \times 1\frac{1}{16}$ ". Shpg. wt., 1 lb.

KT-116—Complete Kit, less earphone Net **16.95**

MS-260—Super Power Dynamic Earphone Net **3.95**

NEW POCKET AC-DC VOM MULTITESTER

2,000 ohm per volt sensitivity on both DC and AC

160 ua 3" METER 1% PRECISION RESISTORS

SILVER CONTACT SELECTOR SWITCH

FULL SCALE RANGES

D.C. Volts: 0-10; 0-50; 0-500; 0-1000 Volts—A.C. Volts: 0-10; 0-50; 0-500; 0-1000 volts—D.C. Current: 500 ua and 500 ma—Resistance: 0-10K; 0-1 Meg—Decibels: -20 to +22; +20 to 36 db (0 db -0.775 V)—Capacity: 250 mfd. to 2 mfd—0.05 mfd to 1 mfd—Output Ranges: 0-10; 0-50; 0-500; 0-1000 volts.

Best Buy in America! A very accurate and sensitive VOM. This Multitester is a complete instrument (not a kit) with high quality and sensitive 160 microamp meter; 2000 ohm per volt on both AC and DC. Single selector switch, 1% precision resistors, 3" meter. Features extreme versatility, accuracy and ruggedness. In attractive plastic front panel, with metal bottom for ruggedness and shielding. First capacity range requires 50 volt AC source. Second capacity range requires 10 volt AC source. Size $4\frac{1}{4} \times 3\frac{1}{2} \times 1\frac{1}{2}$ ". Complete with test leads and batteries. Shipping weight 4 lbs.

RW-27A Complete **8.95**

HIGH SENSITIVITY 20,000 OHM PER VOLT DC 10,000 OHM PER VOLT AC MULTITESTER

LOOK AT THESE FULL SCALE RANGES!

D.C. Volts: 0-6; 0-30; 0-120; 0-600; 0-1200; 0-6000 Volts—A.C. Volts: 0-6; 0-30; 0-120; 0-600; 0-1200 Volts—Resistance: 0-10K; 0-100K; 0-1 Meg; 0-10 Megohms—D.C. Current: 0.60 Microamp; 0-6; 0-60; 0-600 Milliamps—Decibel: -20 to +17 db (0db -0.774V)—Capacity: .0001-.01; .005-.15 mfd—Inductance: 20-2000 millihenry—Output Ranges: 0-6; 0-30; 0-120; 0-600; 0-1200 Volts.

The new Lafayette high sensitivity Multitester is a complete instrument (not a kit). In addition to its unusual sensitivity of 20,000 OHMS PER VOLT ON D.C. AND 10,000 OHMS PER VOLT ON A.C., and the extraordinary number and scope of its ranges. It is packed with features that would make it cost at least twice as much if made in this country. Uses 1% precision resistors, silver contacts on selector switch, 35 ua 3" meter. Dependable, rugged and accurate. Even the test leads are heavy duty with high voltage insulation. Voltage source required for low capacity range is 120V for high range capacity and inductance scale is 6V A.C. Attractive plastic front with metal bottom. Size $6\frac{1}{4} \times 4\frac{1}{4} \times 2\frac{1}{2}$ ". Complete with batteries and leads. Shipping weight $4\frac{1}{2}$ lbs.

RW-30A Singly, Each **19.95**

In lots of 3, Each **19.25**

Lafayette Radio

165-08 Liberty Ave.
JAMAICA 33; N. Y.

100 SIXTH AVE., NEW YORK, N. Y.

BOSTON, MASS., 110 Federal St. PLAINFIELD, N. J., 139 West 2nd St.
NEWARK, N. J., 24 Central Ave. BRONX, N. Y., 542 E. Fordham Rd.

FREE!
LAFAYETTE
CATALOG

JUST
OFF
THE
PRESS!



**NEW 180 PAGE ELECTRONIC
CATALOG FEATURING
THE BEST BUYS IN THE BUSINESS**

The newest and largest assortment of Electronic, Radio and TV parts, Hi-Fi and Public Address Components and systems, Test Equipment, tubes, Transistor Kits and miniaturized components for transistor circuitry, Ham Equipment, Builders Kits, Tools, Books, Microscopes, Binoculars, Telescopes, Cameras, and Drafting Equipment.—**ALL AT LOWEST PRICES**—Catering to the economy minded dealer, serviceman, engineer, technician, experimenter and hobbyist. **CRAMMED FULL OF MONEY SAVING BUYS.** SEND FOR YOUR FREE COPY TODAY.

Lafayette

Introduces Hi-Fi Gems
... at prices everyone can afford

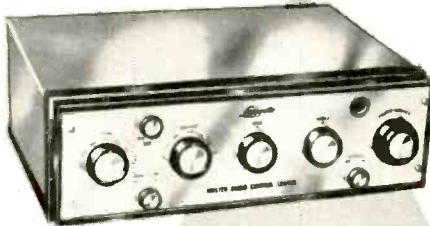

**KT-300
IN KIT
FORM
39.50**



**KT-400
IN KIT
FORM
69.50**



**LA-22
WIRED
12 WATT
AMPLIFIER
33.50
WITH
CASE**

NEW! MATCHED TUNER AND AMPLIFIER

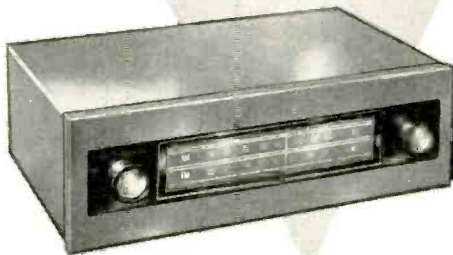

**LT-25
WIRED
FM-AM
TUNER
49.50
WITH
CASE**

LAFAYETTE MASTER AUDIO CONTROL CENTER
with **BINAURAL CHANNEL AND DUAL VOLUME CONTROL.**
Years Ahead of Every Other Control Unit ... Ahead In Sound ... Ahead In Styling

Ahead In Design ... Ahead In Features ... Available In Kit and Wired Form
This is not only the finest hi-fi preamp characterized by unmatched features, but it has been functionally designed to keep pace with the conversion of your present hi-fi system to binaural (Stereophonic) sound. Incorporates an extra channel and dual volume control for binaural reproduction. Features include DC on all tube filaments, negative feedback in every stage, dual cathode follower output stages and latest printed circuit construction. Less than 0.09% IM distortion and less than 0.07 harmonic distortion at 1V. Hum and noise level better than 80 db below 3V. Uniformly flat frequency response over entire audible spectrum. 7 inputs for every type of phono, tuner or tape. Tasteful styling, brilliantly executed. Size 12 1/4" x 9 1/8" x 3 3/4". Shpg. wt., 10 1/2 lbs.

KT-300—Lafayette Master Audio Control Kit Complete with cage and detailed assembly instructions. Net **39.50**
LT-30—Same as above completely wired and tested with cage and instruction manual. Net **59.50**

DELUXE 70 WATT BASIC AMPLIFIER

• Conservatively Rated At 70 Watts • Ultra-Stable • Variable Damping
• Metered Balance And Bias Adjust Controls • Available In Kit And Wired Form
Here's ultra-stability in a 70 watt basic power amplifier employing highest quality components conservatively rated to insure performance and long life. Features matched pair KT 88's and wide range linear output transformer, variable damping control, meter for bias and balance and chrome plated chassis. Frequency response 10-100,000 cps ± 1db. Hum and noise 90db below full output. IM distortion less than 1 1/2% at 70 watts, less than 0.3% below 30 watts. Harmonic distortion less than 2% at 70 watts from 20 to 20,000 cps ± 1db. Output impedance 4, 8 and 16 ohms. Handsome decorative cage perforated for proper ventilation. Size 14 1/2" x 10" x 7 3/8" including cage and knobs. Shpg. wt., 40 lbs.

KT-400—Lafayette 70 watt Deluxe Basic Amplifier Kit complete with cage and detailed assembly instructions. Net **69.50**
LA-70—Same as above completely wired and tested with cage and instruction manual. Net **94.50**

LAFAYETTE 12 WATT AMPLIFIER WITH CASE

Complete 12 Watt Power Amplifier with Built-In Preamplifier-Equalizer
Brings Real Hi-Fi at Low Cost

The Lafayette LA-22 amplifier features wide range frequency response and low hum and distortion. Utilizes premium quality EL84 tubes in a pentode connected balanced output circuit. Five inputs provided for every type of phono cartridge, tuner, tape head, TV, crystal phono, etc. Function selector and equalization switch give instant choice of proper equalization for all types of records and tape head. Loudness control approximates Fletcher-Munson characteristics for tonal balance at low listening levels. Bass and treble controls afford wide variation of cut or boost of highs and lows. Frequency response 30-20,000 cps ± 1 db. Sensitivity, for full output 1/2 V on tuner, crystal or aux., 8 mv for magnetic phono or tape head. I.M. Distortion less than 1 1/2%. Attractively finished to harmonize with both modern and traditional decor, its appearance matches the Lafayette LT-25 tuner. Size 13 3/8" x 6 3/8" x 4 1/2". Shpg. wt., 15 lbs.
LA-22 Amplifier, Complete With Removable Case.....Net **33.50**

LAFAYETTE HI-FI FM-AM TUNER WITH CASE

• Armstrong Circuit With Limiter • Foster-Seeley Discriminator
• Temperature Compensation and AFC • Custom Styled

Like its matching amplifier, the Lafayette LT-25 FM-AM tuner is a most unusual value with outstanding specifications and superlative performance. Circuit features temperature compensation for stability and low drift, AFC to "lock-in" the station and AFC defeat for precision tuning of weak stations. Inertia flywheel makes tuning smooth. High selectivity and sensitivity. Meets FCC requirements for radiation. Distortion less than 1% on FM and AM. Frequency Response 20-20,000 cps ± 1 db on FM; 20-5000 cps ± 3 db on AM. Hum level 60 db below 100% modulation. Attractively finished to match the LA-22 amplifier. Comes complete with removable cover, with provisions for mounting either in cabinet or on panel. Size 13 1/2" x 8-3/16" x 4 1/2". Shpg. wt., 15 lbs.

LT-25 FM-AM Tuner, Complete With Case.....Net **49.50**

**NEW
"DYNA-SLIM" MICROPHONE**

- HIGH IMPEDANCE — 50,000 OHMS
- ON-OFF SWITCH
- "QUICK-SLIP" ADAPTER

New dynamic, high output microphone with all the features of "mikes" costing 3 times Lafayette's price! Output level —55db. Smooth response from 60 to 10,000 cycles. Omnidirectional head. External on-off switch. Slips on or off stand adapter in a wink. Standard 3/8" — 27 adapter permits tilting mike for multi-angle use. Satin black and chrome finish. Complete with detachable cable and connector. 8" long, 1 1/4" max. dia. tapered panel. Shpg. wt., 2 lbs.

PA-43.....Net **6.95**



Lafayette Radio DEPT RK
165-08 LIBERTY AVE.
JAMAICA 33, N. Y.

NAME _____ SEND
ADDRESS _____ FREE
CITY _____ ZONE _____ CATALOG
STATE _____ 305

CUT OUT AND MAIL TODAY!

FM and TV Sound Tuner

By
BRUCE A. MORRISSETTE

Continuous coverage tuner employing the FreModyne uses tuning circuit from any continuous-tuning TV booster.

ITS sensitivity and economy of parts make the FreModyne circuit uniquely adapted to the construction of compact, inexpensive units for the reception of FM and TV sound. By choosing one of several makes of continuous-tuning TV boosters, the builder may simplify his construction task and produce a receiver of professional appearance that will cover all v.h.f. sound channels, FM broadcast sta-

tions, the 152-174 mc. emergency FM band, taxicab, police, and all other AM and FM services between 50 and 215 mc. Use of a u.h.f. converter ahead of the unit will extend the coverage to television channels 14 through 83 (470-890 mc.). The original booster cabinet will house the entire receiver and its calibrated dial can be used to indicate TV channels and FM frequencies.

If a booster is to be purchased espe-

cially for this construction, only a continuous-tuning type should be considered, since it will be just as much work to convert a skip-band or turret-tuned type yet it won't provide the 50-215 mc. coverage that, say, a "Super-Sonic" tuner or the Mallory "Inductuner" will.

Typical of the "Inductuner" type of booster is the *Astatic* BT-1 which uses a tuned-grid, tuned-plate circuit. Although the BT-1 has a smaller cabinet than the "Super-Sonic" and thus will not accommodate the additional components as readily, it has a quiet tuner with very little contact noise and forms the basis of an excellent unit. If the reader already owns a booster on the non-continuous-tuning variety and is not concerned with FM, police, or services other than TV sound, he may adapt his present unit to the FreModyne circuit by utilizing its ganged tuning devices. In some instances it may be possible for him to rewind or re-adjust the inductances or capacitances associated with TV channel 6 (or some other unused channel) to cover a desired FM station frequency or other service.

The basic construction project is to change the booster from its original circuit to the FreModyne superheterodyne superregenerative AM-FM detector circuit shown in the schematic. The unit may be used as a sound tuner for FM and TV with any available amplifier or a small, low-current-drain amplifier may be added to the chassis to make the unit self-contained and capable of feeding its own PM speaker.

Circuit Theory

FreModyne circuit theory has been covered in articles appearing in this and other magazines during 1948, but a brief account of the fundamentals may be useful here, especially for those who wish to adapt the design to other purposes. Incoming signals are tuned by L_1 and fed to the upper triode of the 12AT7 in the diagram. Here they are mixed with local oscillator signals (about 25 mc. below the signal frequency) generated in the Colpitts oscillator formed by L_2 and the lower triode. The 25 mc. difference frequency is tuned to resonance by L_3 , shunted by R_7 for bandpass control.

- R_1 —27,000 ohm, $\frac{1}{2}$ w. res.
- R_2 —1500 ohm, $\frac{1}{2}$ w. res.
- R_3 —22,000 ohm, $\frac{1}{2}$ w. res.
- R_4 —100,000 ohm, $\frac{1}{2}$ w. res.
- R_5 —100 ohm, $\frac{1}{2}$ w. res.
- R_6 —150,000 ohm, $\frac{1}{2}$ w. res.
- R_7 —68,000 ohm, $\frac{1}{2}$ w. res.
- R_8 —500,000 ohm carbon pot (with switch S_1)
- R_9 —2000 ohm, $\frac{1}{2}$ w. res.
- R_{10} —150 ohm, $\frac{1}{2}$ w. res.
- C_1 —2 μ fd. twisted wire "gimmick"
- C_2 —500 μ fd. ceramic capacitor
- C_3 , C_{10} —5000 μ fd. ceramic capacitor
- C_4 —35 μ fd. ceramic capacitor
- C_5 —2000 μ fd. ceramic capacitor
- C_6 —8-16 μ fd., 150 v. elec. capacitor
- C_7 , C_{16} —500 μ fd. feedthrough capacitor
- C_8 , C_9 —20 μ fd. ceramic capacitor
- C_{11} —1000 μ fd. ceramic capacitor
- C_{12} , C_{13} —1 μ fd., 400 v. capacitor
- C_{14} , C_{15} —10/20 μ fd., 150 v. elec. capacitor (C_{15} must be 20 μ fd. section)
- C_{17} —2 μ fd. (approx.) ceramic capacitor (if needed)
- L_1 , L_2 —Input and output tuner coils of original booster unit
- L_3 —20 to 30 mc. slug-tuned coil (20 t. #30 en. wire closewound on $\frac{1}{4}$ " ferrite antenna coil form)
- RFC_1 —100 t. #30 en. wire closewound on $\frac{1}{4}$ " ceramic cheke form
- RFC_2 —125 t. #30 en. wire closewound on $\frac{1}{4}$ " form
- RFC_3 , RFC_4 —30 t. #36 en. wire on $\frac{1}{8}$ " form.
- T_1 —Power trans. 117 and 6.3 v. secondaries
- S_1 —S.p.s.t. toggle switch (on R_8)
- PL_1 —117-volt pilot light
- SR_1 —35 ma. selenium rectifier
- J_1 —Mike connector or jack, as desired, to feed amplifier
- V_1 —12AT7 tube

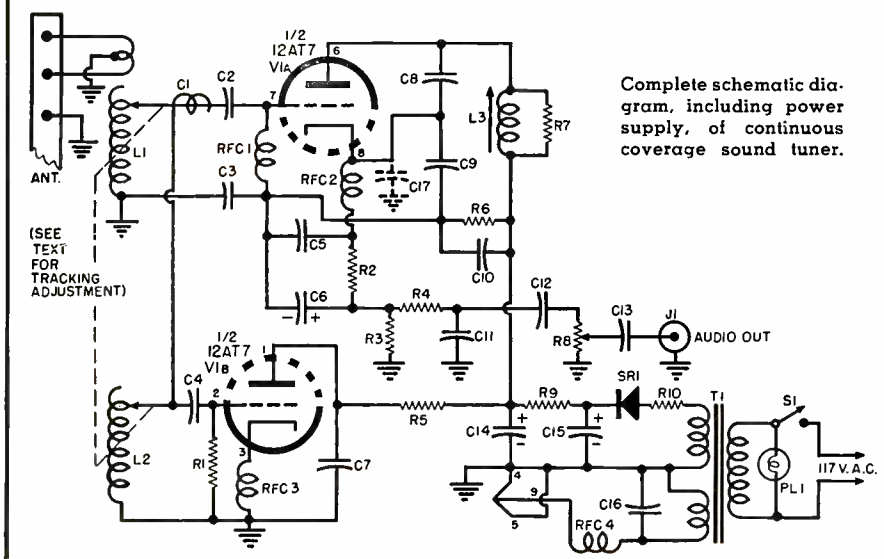

Complete schematic diagram, including power supply, of continuous coverage sound tuner.

JUST RECEIVED! ASB-5 'SCOPE INDICATOR



BRAND NEW, including all tubes, together with 5 B P 1 Scope Tube. Originally used in Navy Aircraft RADAR equipment. Easily converted for AC operation. **VALUE \$250.00!**
OUR LOW PRICE \$15.95

ASB-5 RECEIVER FOR 420 Mc BAND!

Complete with ten tubes: 2-955, 1-6H6, 5-6AC7, 1-6AG7, 1-6B6.
\$1495

OUR LOW PRICE.....
Tuning Knob for ASB-5 Receiver..... **\$1.29**

MN26Y BENDIX DIRECTION FINDER

150-325 Kc; 325-695 Kc; 3.4-7 Mc. Complete with tubes, motor. **\$26.95**

BRAND NEW, including tubes and dynamotor. \$18.95
Used, like new, incl. tubes and dynamotor. \$18.95

BENDIX DIRECTION FINDER

12-tube remote control Navigation Direction Finder and communications receiver. 150 to 1500 Kc in 3 bands, 28 V. DC input. Ideal for commercial navigation on boats and planes. Complete installation comprises:

- MN-26-C Receiver, used, with 12 tubes. **\$16.50**
 - MN-26-C With 12 Tubes, BRAND NEW **\$24.95**
 - MN-20-E Rotatable Loop. **4.25**
 - MN-52 Azimuth Control Box. **2.95**
- All necessary accessories for above in stock.

ARB NAVY RCVR-XMTR

The Receiver Four band, 195 to 9050 Kc. Low Freq. Ship, Broadcast, 40 to 80 meters. Includes tubes and dynamotor for 24 V operation. Easily converted for 110 V, 12 V or 6 V. Schematic included. BRAND NEW, Overall 8 1/4 x 7 1/4 x 15 1/4". Wt. 30 Lbs. Complete with all tubes.

The Transmitter, tunes 3000 to 9050 Kc and 2300 to 4200 Kc. Massive, fully enclosed unit, complete with all tubes. Three completely integrated tuning units included. All Brand New. The Xmitter Dynamotor has input of 27.5 V DC @ 7.4 A; output: 425 V DC @ .320 A, with Filter Base. Brand New.

Complete Assembly, **\$88.50**
OUR SPECIAL PRICE.....

RADIO RECEIVER NAVY TYPE RAY-3

Made by Doolittle Radio, this dandy receiver is a terrific buy at our low price.
Model AN-PRGN is for 14V DC operation. These receivers are supplied complete with built-in dynamotor, 11 tubes. Weston output meter on front panel, as well as coax antenna and output connection, phono jack, on-off switch.
WHILE THEY LAST.....Our Price **\$13.95**

BC1206-C BEACON RECEIVER

195 to 420 Kc, made by Satchel-Carlson. Works on 24-28 volts DC 135 Kc. IF. Complete with 5 tubes. Size 4" x 4" x 6". Wt. 4 lbs. BRAND NEW **\$8.88**
Brand New, less tubes. \$5.95
USED, with tubes. \$5.95
USED, less tubes. \$2.95

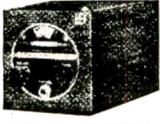

DYNAMIC HANDMIKE, with "Press-to-talk" Switch cord and plug. BRAND NEW, only **\$2.95**

DYNAMIC HEADPHONES, 600-ohm impedance, with large earphone cushions, cord and phone plug. BRAND NEW, special. **\$3.95**

HI-LO IMPEDANCE MATCHING TRANSFORMER for headphones, 600 ohms to 8000 ohms. With plug and Jack. Instructions included. BRAND NEW. **97c**

Hi-Fi DYNAMIC HEADSET with Cushions
Freq. Range: 40-14000 CPS. No Distortion. **\$6.95**
BRAND NEW.....

MICROPHONES

Model	Description	Used	BRAND NEW
T-17	Carbon Hand Mike	\$5.45	\$7.95
T-30	Carbon Throat Mike	.33	.79
T-45	Army and Navy Lip Mike	1.33	1.99
RS-38	Navy Type	2.45	4.95
T-24	Carbon Mike	5.95	9.95
TS-9	Handset	4.95	9.95

HEADPHONES

Model	Description	Used	BRAND NEW
HS-23	High Impedance	\$2.25	\$4.95
HS-33	Low Impedance	2.49	4.95
HS-30	Low Imp. (featherwt.)	1.49	2.25
H-16/U	High Imp. (2 units)	3.75	7.95
CD-307A	Cords, with PL55 plug and JK26 Jack		.99

2 VOLT BATTERY "PACKAGE"

- 1-2V, 20 Amp. Hr. Willard Storage Battery..... **\$2.79**
 - 1-2V, 7 prong Synchronous Plug-in Vibrator..... **1.49**
 - 1-Quart Bottle Electrolyte (for 2 cells)..... **1.45**
- ALL BRAND NEW!**
Combination Price..... **\$5.45**

Willard 6-Volt Midget Storage Battery
3 Amp. Hour. BRAND NEW. 3 3/8" x 1-13/16" x 2 3/8". Uses Standard Electrolyte..... **Only \$2.45**

ARC-5/R28 RECEIVER
2-meter Superhet, 100 to 150 Mc in 4 crystal channels. Complete with 10 Tubes.
BRAND NEW **\$20.45**
110 V AC Power Supply Kit for above **\$9.75**

ARC-5/T-23 TRANSMITTER
100-156 Mc Includes 2-839A, 2-1625 Tubes, BRAND NEW **\$19.95**
SPECIAL Limited quantity ARC-5/T23 xmitters. BRAND NEW, less tubes. **\$7.95**
OFFER! Excellent Used, less tubes. **\$5.95**

ARC-5 MARINE RECEIVER-TRANSMITTER
Navy Type Comm. Receiver 1.5 to 3 Mc BRAND NEW with 6 tubes. **\$16.95**
Navy Type Comm. Transmitter 2.1-3 Mc BRAND NEW with 4 tubes and Xtal **\$12.45**

Loran APN/4 Oscilloscope

Easily converted for use on radio-TV Service Bench!

BRAND NEW
Completely Assembled
Supplied with 5" Scope type 5CP1..... **\$15.95**

SCR-274 COMMAND EQUIPMENT

ALL COMPLETE WITH TUBES Excellent Brand Type Description Used Used New

BC-453	Receiver 190-550 KC.	\$10.95	\$12.95	\$16.95
BC-454	Receiver 3-6 Mc.	7.19	8.29	11.95
BC-455	Receiver 6-9 Mc.	5.25	7.95	11.95
BC-456	Modulator	2.95	3.45	4.95
BC-450	3-Receiver Control Box	1.49	1.95	
BC-451	Transmitter Control Box	1.25	1.49	
BC-696	Xmtr 3-4-Mc (like new)	6.95	8.88	
BC-457	TRANSMITTER-4-5.3 Mc. complete with all tubes and crystal.		\$7.88	
BC-458	TRANSMITTER-5-3 to 7 Mc. Complete with all tubes and crystal.		\$7.88	
BRAND NEW	BC-459 TRANSMITTER-7-9.1 Mc. complete with all tubes and crystal.		\$11.95	
BRAND NEW	ARC-5/T-19 TRANSMITTER-3 to 4 Mc. BRAND NEW complete with all tubes & crystal		\$8.88	

110 VOLT AC POWER SUPPLY KIT

For All 274-N and ARC-5 Receivers
Can be assembled quickly and easily, on pre-drilled chassis. Plug into the rear of any model 274-N receiver and delivers 24 volts, as well as "B" voltage. Complete kit of parts with metal case, instructions. Factory wired, tested, ready to operate **\$11.50**
SPLINED TUNING KNOB for 274-N and ARC-5 RECEIVERS. Fits BC-453, BC-454 and others. Only **49c**

SCR-522 2-METER RIG!

Terrific buy! VHF Transmitter-receiver, 100-156 Mc. 4 channels. Xtal-controlled. Amplitude modulated voice. They're going fast! Excellent condition.
SCR-522 Transmitter-Receiver, complete with all 18 tubes, top rack and metal case. COMBINATION..... Special \$33.33
Receiver Only, with all tubes... **\$19.50**
Transmitter Only, with all tubes. **\$22.25**
Accessories for above available.

234-258 MC RECEIVER

AN/ARR-2, BRAND NEW, tubes included: 7-6001, 3-6AK5, 1-12A6. Schematic included. Complete with 11 tubes, our low price: **\$9.99**
With 28 V. 1.6A Dynamotor, complete. **\$12.98**
110 VOLT AC POWER SUPPLY KIT for above..... **\$9.75**

SCHEMATIC DIAGRAMS

available, for any equipment **50c**
shown on this page, each.....

Please include 25% Deposit with order—Balance C.O.D. 50c Handling Charge on all orders under \$30.00 All shipments F.O.B. Our Warehouse, N.Y.C.

G & G Radio Supply Co.
Telephone: CO 7-4605
51 Vesey St., New York 7, N. Y.

Ham Special! Famous BC-645 XMITTER-RECEIVER

With MANUAL for Easy Conversion to CITIZENS' BAND!
Makes wonderful mobile rig for 420-500 Mc. Easy to convert for phone or CW 2-way communication. This swell rig originally cost over \$1000—yours for practically a song! You get it all, in original factory carton, BRAND NEW, complete with 17 tubes, less power supply. Conversion Instructions Included. **\$29.50**
Shpg. wt. 25 lbs.

PE-101C DYNAMOTOR for BC-645, has 12-24V input (easy to convert for 6V Battery operation)..... **\$7.95**
UHF ANTENNA ASSEMBLY, for BC-645..... **\$2.45**
Complete set of 10 Plugs for BC-645..... **\$5.50**
CONTROL BOX for above..... **\$2.25**
SHOCK MOUNT for above..... **1.25**
CONVERSION BOOKLET. Instructions for most useful surplus rigs..... **\$2.50**

LORAN APN-4 FINE QUALITY NAVIGATIONAL EQUIPMENT

Determine exact geographic position of your boat or plane! Complete, BRAND NEW installation consists of: ID-6B/APN-4 Indicator; R-9B/APN-4 Receiver; PE-206 Inverter; Set of Plugs; Visor for Indicator; Operation manual. **\$129.50**
APN-9A LORAN Receiver Indicator, less tubes, NEW **\$29.50**
SPECIAL

BC-221 FREQ. METER

Special Buy! Complete with operating manual, LIKE NEW..... only **\$119.50**

BC-221 FREQ. METER CASE

Aluminum Case for BC-221 or TS-164 Freq. Meters. Shock Mounted. BRAND NEW..... **\$3.99**
Original 1000 Kc Crystal for BC-221. BRAND NEW **\$8.45**

BC-906 FREQ. METER—SPECIAL!

Cavity type, 145 to 235 Mc. BRAND NEW in original factory packing, complete with antenna. Manual included. OUR LOW PRICE..... **\$9.99**

BRAND NEW SPECIAL PURPOSE TUBES

in Original Individual Packing
JAN CRP-730A MAGNETRON, Raytheon **\$3.45**

Type	Each	Per Dozen	Per Hundred
RK65	\$7.25		
2J724B	.35	\$3.95	\$29.50
VR105	.79	8.88	70.00
VR150	.79	8.88	70.00
717A	.29		
815	2.99		
826	.44		
829B	7.95	4.95	39.50
832A	5.95		
837	.26		
1625	.26	2.75	21.50
1626	.16	1.75	13.50
1625	.27	3.05	23.95
8002R	5.95		

NEW! Cathode Ray Tubes NEW!

3CP1	\$1.18	5BP4	\$2.22
3FP7	1.18	5BP1	2.45
5BP1	2.22	5FP7	1.44
		5LP7	1.88

DYNAMOTOR VALUES!

Type	Input	Output	Excellent Used	BRAND NEW
DA-19-A	28V 11A	400V .400A	\$4.99	\$6.95
DM-28	28V	224V .07A	2.95	4.95
DM-32A	28V 1.1A	250V .05A	2.95	5.95
DM-33A	28V 5A	575V .16A		
	28V 7A	540V .25A	1.95	3.95
DM-34D	12V 2A	220V .080A	4.25	5.50
DM-37	25.5V 9.2A	625V .225A	5.95	8.95
DM-40	14V 3.4A	172V .138A	1.75	3.45
DM-53A	28V 1.4A	220V .080A	3.95	5.95
DM-64A	12V 5.1A	275V .150A		7.95
PE-73C	28V 20A	1000V .350A	8.50	11.50
PE-86	28V 1.25A	250V .050A	2.95	5.24
BD-77C	DYNAMOTOR, input: 14V DC @ 39 A. output: 1000V DC @ .35 A. With Filter. Like New! Special..... \$22.50			

BC-442 ANTENNA RELAY

Wonderful Value! Consists of 3/4 amp 2 1/2 RF Ammeter (antenna current indicator), 0-10 scale, Transmitter-Receiver Switching relay, in aluminum case with associated components. BRAND NEW..... **\$2.24**

Your choice of school
is highly important
to your career in



**INDUSTRIAL
ELECTRONICS**



**RADIO-
TELEVISION**



**ELECTRONICS
COMMUNICATIONS**

Become an
**ELECTRICAL
ENGINEER**
or an
**ENGINEERING
TECHNICIAN**
at

MSOE in Milwaukee

Choose from courses in:

ELECTRICAL ENGINEERING

Bachelor of Science Degree
in 36 months—
Communications or
Electrical Power.

ENGINEERING TECHNICIAN

Associate in Applied Science
degree in 18 months—
Electronics Communications or
Electrical Power.

MSOE—located in Milwaukee, one of America's largest industrial centers—is a national leader in electronics instruction—with complete facilities, including the latest laboratory equipment, visual aid theater, amateur radio transmitter—offers 93 subjects in electrical engineering, electronics, radio, television, electrical power, and electricity.

Advisory committee of leading industrialists. Courses approved for veterans. Over 50,000 former students. Excellent placement record. Previous educational, military, and practical experience is evaluated for advanced credit.



QUARTERS BEGIN SEPTEMBER,
JANUARY, APRIL, JULY

Choose wisely—your
future may depend on it.
Mail coupon today!

MILWAUKEE

SCHOOL OF ENGINEERING

Dept. RT-1157, 1025 N. Milwaukee St.

Milwaukee, Wis.

Please send free illustrated career booklet

(please print)

I'm interested in.....

Name..... Age.....

Address.....

City..... State.....

Are you eligible for veterans educational

benefits?.....

Discharge date.....

MS-57

So far, both triodes have operated in standard superheterodyne fashion. Now superregeneration enters the picture. The upper triode, V_{1A} , has its cathode returned for r.f. to the junction of C_8 and C_9 , thus forming a Colpitts oscillator at the frequency of L_3 , or 25 mc. The oscillations are periodically damped as a result of the superregenerative action brought about by the return of the signal grid lead through R_6 to "B+". Optimum shape of the damping wave (an approximate saw-tooth of about 30 kc.) is assured by the RC filter, R_2-C_5 . Audio is recovered through the de-emphasis network R_1-C_{11} , stabilized by C_6 , and coupled to a high-impedance volume control, R_8 , through C_{12} .

Whereas a "straight" superregenerative receiver re-radiates strongly at the signal frequency and hence would be unacceptable for listening to sound on TV channels in a heavily populated neighborhood, the FreModyne re-radiates not at all at the signal frequency, only very slightly at the oscillator frequency (as do all oscillators in standard TV and FM tuners), and also at the much lower frequency of the plate circuit. This latter radiation may be strong enough to interfere with the i.f. system of an adjacent TV set, but adjustment of the coil L_3 may be used to move the interfering frequency out of the range of any given i.f. system.

Two factors affect the tracking of the FM-TV sound tuner. First, both of its sections were originally designed to function at equal frequencies throughout the tuning range, while now the oscillator section must "trail" the signal section by approximately 25 mc. (It could function as well at 25 mc. above the signal frequency and this method may be more applicable in the case of certain boosters.) Second, the change of tube has caused a new set of capacitances to be associated with each tuner section. Fortunately, neither difficulty is serious, at least in the type of tuner represented by the "Super-Sonic." Under each coil is a silver-plated contact which rides on a silver-plated rod. Slip the rod beneath oscillator section L_2 out from its mounting at the front of the chassis and move the sliding contact toward the dial one turn more than it was at a given setting. This places more inductance in L_2 than in L_1 and should approximate tracking sufficiently well to permit stations to be tuned in. The builder should experiment with different positions of the slider coupled with various settings of L_3 until stations come in at several points with good volume. If all adjustments are carefully made, tracking will be quite good over the whole tuning range. The dial indicator may be moved along its string to improve the relation between dial calibration and actual frequency.

To secure proper tracking with an "Inductuner," shunt a small tubular trimmer capacitor across the active portion of L_2 . With the plate circuit

POWER SUPPLY KIT BARGAIN

Primary 115V, 60 Cy. Sec. 400-0-400V. @ 200 Ma., 6.3V @ 5 Amp., 5V @ 4 Amp. Std. Mounting, plus 6 Hy, 200 Ma. choke and Two 8 Mfd. Oil Condensers...ea. **\$7.25**

G.E. SYNCHRONOUS MOTOR DRIVEN TIMER
Adjustable to 1 minute...ea. **\$6.50**

SELENIUM RECTIFIER
Full wave bridge, 30-36V input, 24-28V. DC output. 500 Ma...ea. **\$1.09**
3 for \$3.00

ISOLATION TRANSFORMER
Pri. 105/115/125V.—Sec 115V. 1500 Watts Dual AC receptacle. Stator...ea. **\$24.50**

FILAMENT TRANSFORMER
Primary 115 V. 60 Cy. Sec. 24 Volts @ 3 Amps. Full case, BRAND NEW... **\$2.49**

0-200 MICROAMMETER
2", Mounted in Rubber case with cable...Ea. **\$2.95**

FILAMENT TRANSFORMER
6.3V 10 Amp 115V-24V Primary—Each... **\$1.19**

VEEDER ROOT COUNTER
5 Digit resettable counter. **\$2.95**

15 MINUTE TIMER
MARK-TIME adjustable to 15 min. 10 Amp 115V. cord...ea. **\$2.89**

G. E. RELAY CONTROL

(Ideal for Model Controls, Etc.)
Contains a sigma midget 8,000 ohm. relay (trips at less than 2 MA), high impedance choke, bi-metal strip, neon pilot and many useful parts. The sensitive relay alone is worth much more than the total low price of... **\$1.10** Each 10 for **\$9.25**

SIG. CORPS EARPHONES
Hi-Impedance Dual Headset, Comp etc with Headband & Cord. Used. Ter- rific Value... 2 for **\$3.25**

AUTO TRANSFORMER
750 Watt—110/220 V. 60 Cycle. ea. **\$5.95**

ANTENNA RELAY
12 Volt DC, DPDT plus extra SPST 0 amp contact. Low loss ins...ea. **\$1.39**

PANEL METERS

2" METERS	3" METERS
0-1 Amp RF... \$2.95	0-100 Micro... \$5.95
0-5 Amp RF... 3.95	0-1 Ma DC... 4.95
0-10 Ma DC... 3.95	0-2 Ma DC... 3.95
0-15 Ma DC... 3.95	0-25 Ma DC... 3.95
0-120 Ma RF with external Thermo-couple... 3.95	0-150 VDC... 3.95
0-150 V. AC... 3.95	200-0-200 V. DC... 3.95
0-300 VAC... 3.95	0-2 Amps DC... 3.95
0-15 DC KV 3" with shunt... \$8.95	0-1.5 Amps DC... 2.95
2" Dual scale w/high and low/switch 0-150V. DC. 0-7.5V. DC... \$3.95	0-4 Amms DC... 3.95
	0-2 Amps RF... 4.95

OIL CONDENSER BARGAINS

1 mfd 600 vdc \$.25	4 mfd 1000 vdc. \$1.25
2 mfd 600 vdc. .45	4 mfd 1500 vdc. 1.75
4 mfd 600 vdc. .75	10 mfd 1500 vdc. 3.75
8 mfd 600 vdc. .95	2 mfd 2000 vdc. 1.50
10 mfd 600 vdc. 1.10	3 mfd 2000 vdc. 2.75
25 mfd 600 vdc. 3.40	4 mfd 2000 vdc. 2.25
20 mfd 600 vdc. 3.25	10 mfd 2500 vdc. 6.25
1 mfd 1000 vdc. .60	1 mfd 3000 vdc. 1.87
2 mfd 1000 vdc. .75	1 mfd 5000 vdc. 3.25

BIG BARGAINS IN LITTLE TYPE

- Kit of 10 ASSORTED SWITCHES... \$1.49
- Kit of 10 ASST'D WAFER SWITCHES... 1.49
- Kit of 25 WIRE WOUND RES. 5 to 50 watt... 1.95
- Kit of 10 TRANSMITTING MICAS... 1.00
- 500 MMF CERAMIC CONDENSERS... 10 for .50
- 15 MEG 1% METER MULTIPLIER... 1.49
- 1 MFD 400VDC OIL COND... 10 for .95

Min. Order \$3.00—25% with order F.O.B. New York
10 DAY GUAR. PRICE OF MDSE. ONLY

ADVANCE

ELECTRONICS COMPANY

6 WEST BROADWAY, NEW YORK 7, N. Y.

Phone REctor 2-0270

**GET INTO
ELECTRONICS**

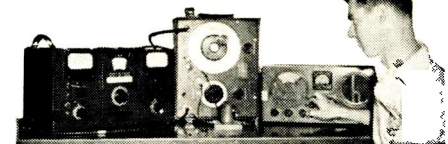

Valparaiso Tech trains for top flight positions. Technical representatives, field engineers, sales and specialists in communications, missiles, computers, radar, automation, color television. Basic and advanced theory and laboratory. Major companies visit school for our graduates. 21 months' course. High school graduate or equivalent. Dormitories—campus. Start February or September. G.I. approved. Write for catalog.

VALPARAISO TECHNICAL INSTITUTE
Dept. RD Valparaiso, Indiana

tuned approximately to resonance (or at an arbitrary setting), set the dial to the frequency of a local TV or FM broadcast and increase the trimmer capacity until the station is heard. Patience and ingenuity in the matter of tracking will be rewarded, although, of course, absolute accuracy must not be expected at all dial settings.

In tuning FM or TV sound programs on the FreModyne, two proper dial settings exist, one on each side of the center frequency. Use whichever gives the clearest, loudest signal with the least so-called "superregenerative hiss." A criterion of general circuit adjustment is the virtual disappearance of hiss which may be expected in metropolitan areas within 10 or 15 miles of FM or TV stations of high or average power. An indoor dipole usually gives excellent signal strength, and even a short length of antenna wire is often sufficient—but an outside antenna may be required in fringe areas.

This tuner may also be used as a mobile unit, when powered by a cigarette-lighter plug-in converter such as the "Trav-Electric" unit. Connect the center wire of the car antenna to one side of the L_1 coupling loop and the outer shield to chassis ground.

U.H.F. Stations

Any u.h.f. converter may be used with the FM-TV tuner to extend its range throughout the u.h.f. spectrum of channels 14-83. The u.h.f. antenna is connected to the converter, the converter output terminals to the receiver input, and the receiver tuned to the conversion channel (usually 5 or 6 but sometimes 12 or 13) of the particular converter. Use of a two-inch band of aluminum foil wrapped around the u.h.f. antenna lead and moved along the lead for best reception is highly recommended, sometimes resulting in as much as a four-fold increase in signal-to-noise ratio.

In areas where only u.h.f. stations are in operation, a small FreModyne detector taking its power from the u.h.f. converter and employing fixed-tuned coils for L_1 and L_2 with adjustable trimmers, could be constructed to operate at the output frequency of the u.h.f. converter. Such a unit may be made small enough to mount on the back of the converter, or even inside in some models, giving a compact u.h.f. sound tuner. It is not recommended that current for an audio amplifier be drawn from the converter in addition to that necessary for the FreModyne tube. If no separate audio amplifier is available, then for purposes of u.h.f. sound listening or experimentation, an amplifier could be constructed with a fixed-tuned FreModyne detector built in, with appropriate switching to permit use of the amplifier for general purposes as well.

Further possibilities, such as converting discarded TV front-end tuners, or those available on the bargain market, to FreModyne FM and TV sound units, are left to the resourcefulness of the individual reader.

TCS-13 TRANSMITTER
4 channel crystal controlled, plus one channel manual tuning. Complete coverage from 1.5 MC to 12.0 MC. **\$39.50**
Like New.....

TCS-13 RECEIVER
1.5 MC to 12 MC. Super-sensitive super het. Excellent sensitivity and selectivity characteristics with BF0 circuit for CW reception. **\$49.50**
Like New.....
Both receiver and transmitter.... **\$75.00**

ANTENNA—Monel Metal
TRAN. REC.—Telescopic Extended 8 foot, collapsed—17 1/2" x 1/2" Dia. **\$1.69**
Brand New.....

BC-659 FM Receiver-transmitter, xtal controlled, two channels, freq. range 27-38.9, 9 Mc, 13 tubes, built-in speaker, dual meter for testing filament and plate circuits. **\$14.95**
Exc.....

BC 620
Same as above except less spkr. and 20 to 27 Mc.... **\$6.95**

BC 603 Ten Channel Push-button or continuous tuning FM RECEIVER 20 to 28 Mc complete w/tubes, speaker, squelch circuit, 12 volt power supply. Exc..... **\$14.95**

BC 683, Same as above except 27 to 38.9 Mc.... **\$24.95**

BC 604—10 Channel, 30 Watt Crystal Controlled 20 to 27 Mc Transmitter. Complete with tubes and 24 Volt Dynamotor. Ship. wt. 30 lbs. **\$14.95**
Exc.....
F.O.B. Chicago or Sacramento, Calif.

ATR—11 TRANSCEIVER 2.5 Mc to 6.7 Mc complete w/12 tubes. **\$29.50**
Exc.....

12 Volt Dynamotor for above.... **\$14.95**
Both units for..... **\$39.50**

MN-26-C—Remote Controlled Navigational Direction finder and communications receiver Manual DF in any one of three freq. bands, 150 to 1500 KC. 24V. Self contained dynamotor supply. Complete installation, including receiver, control box, loop, azimuth control, Left-Right Indicator, plugs, loop transmission line and flex. shafts. Ideal for use in boats. **\$37.50**
etc.....

12 Volt Installation..... **\$47.50**
Receiver only..... **14.95**
Receiver, less Dynamotor and Tubes..... **4.95**

RA-10DB—9 TUBE SUPERHET
Rec. 150 Kc-1100 Kc 2 Mc to 10 Mc in four Bands. Exc.... **\$24.50**

Bendix 100 Watt Transmitter
Easily converted to 10-20-40-80 Meters. Has four separate output tanks. One 4 position selector which changes the ECO IPA and output tank simultaneously. Uses 2—807 4-12SK7. **\$22.95**
Complete w/tubes..... ea.

MP-28 modulation and Power supply for the TA-12 transmitter. Complete with 4 tubes. Dynamotor has an output of 540 V. DC @ 450 ma. Input at 28 V. **\$14.95**
DC. With dynamotor.....

3 CM-X Band Airborne Search Radar
Brand new RECEIVER and TRANSMITTER complete with Parabolic Antenna; Azimuth 75° each. Direction 150° complete with amplifiers, indicators, control box, less junc. box, connectors. **\$69.50**
Tube complement consists of:

2 ea.—723A8	30 ea.—8J6	1 ea.—725A
2 ea.—18Z2	9 ea.—6V6GT	1 ea.—807
4 ea.—3B24	11 ea.—6AK5	1 ea.—VR105
2 ea.—3EP7	4 ea.—6SL7GT	4 ea.—VR150
3 ea.—5U4	2 ea.—724A	

(govt. acquis. cost over \$4000.00). Ship. wt. 431 lbs. w/operating instructions. **\$69.50**
YOUR SPECIAL PRICE.....
F.O.B. Penna. warehouse.

TRANSCEIVER, only Exc..... **\$39.50**
Parabolic Antenna only..... **14.95**
60-TRANSCIEVER TUBES..... **29.95**
60 MC 1F Strip w/tubes..... **4.95**
MAGNETRON MAGNET Approx. 1800 Gauss..... ea. **7.95**

DYNAMOTORS

TYPE	INPUT	OUTPUT	CONDITION	PRICE
RC-1	6V	250V at 60 MA	EXC.	\$4.95
RC-2	6V	375V at 250 MA	EXC.	5.95
BD-77	12V	1000V at 350 MA	EXC.	14.95
DM-32	24V	250V at 60 MA	NEW	3.95
			EXC.	1.95
DM-32AZ	12V	250V at 60 MA	NEW	4.95
DM-33	24V	540V at 250 MA	EXC.	1.95
DM-34	12V	220V at 80 MA	EXC.	4.95
DM-35	12V	625V at 225 MA	EXC.	14.95
DM-37	24V	625V at 225 MA	EXC.	2.95
DM-00	28V	400V at 400 MA	EXC.	4.95
DM-42	12V	1060V at 250 MA	NEW	9.95
DA-1A	24V	220V at 100 MA	EXC.	3.95
DA-1B	12V	220V at 100 MA	NEW	7.95

LM FREQUENCY METER
Heterodyne, crystal calibrated, modulated with calibration book 125KC to 20,000KC—Exc. ea. **\$49.50**
less calibration book—**\$29.50**

LORAN APN-4
FINE QUALITY NAVIGATIONAL EQUIPMENT
Determine exact geographic position of your boat or plane! Complete, BRAND NEW installation consists of: 1D-6B/APN-4 Indicator; R-9B/APN-4 Receiver; PE-206 Inverter; Set of Plugs; Visor for Indicator; Operation manual; 12 or 24V installation, Brand New, **\$129.50**
Export packed.....
12 VDC Installation..... **\$149.50**

ID6B INDICATOR, R9B RECEIVER, Excellent..... **\$39.50**

SCR-522 TRANSCEIVER, 1 channel crystal controlled, 100 to 156 MC. Exc..... **\$29.50**

COAXIAL CABLE
50 ohm—330 ft. lengths..... New **\$9.95**
60 ft. lengths..... New **\$1.95 ea.**
T-23 100-156 MC
New..... **\$13.95** Used..... **\$7.95**

AMPLIFIER, complete with 2-6V6, 6SN7, 6SL7, 6X5. Ship. wt. 10 lbs. **\$2.95**
Exc.....
T-20, 4 to 5.3 MC—T-21, 5.3 to 7 MC. Used..... **\$3.95** **NEW** **\$5.95**
3 to 4 mc. like new..... **\$5.95**
T-23 100-156 MC New..... **\$13.95** Used..... **7.95**

BC 923 MOBILE FM RECEIVER, 27-38.9 MC
Complete with built-in loudspeaker, squelch control, speaker phone switch, sensitivity control, variable (Permeability) tuning for each channel of 4 channels permits pre-setting of 4 frequencies. Exc..... **\$34.50**
MODULATOR..... with tubes..... 2 ea. 813; 1 ea. 807; 1 ea. 5R4; 2 ea. 6AG7; 1 ea. 6D4. Exc. Ship. wt. 60 lbs. **\$14.95**
813, \$5.95 ea.; 2 for \$10.00; 807, 98c; 6AG7, 49c; 5R4, 49c.

SWEET OSCILLOSCOPE DEALS
INDICATOR UNIT. For conversion to test scope, paramadapter, analyzer, etc. Double deck chassis: 5CP1 mounted in tube shield. Less small tubes and crystal, but complete with 5CP1. **\$9.95**
Exc. Cond.
Compl. w/27 Tubes, Crystal & 100KC Crystal..... **\$19.95**
ASB-7 Radar Indicator Unit: For conversion to test scope or for use as modulation monitor. Has standard test-scope CR tube, H Cent. V. Cont. Brii. Foc. Gain, and range selection switch. External power source was used. Tubes: **\$6.95**
4-6AC7, 3-6H6, less 1-5BP1. New....

UHF TRANSCEIVER, APG-5
2400-2700 Mc complete with 2C43, 2C40, 3E29, 1B27, VR105, 5Y3, 6AL5, 2 each **\$19.95**
2X2 and 8 each 6AK5..... **\$4.95 ea.**
Cavity Only, New, less tubes.....
APG-27—3 CM Transceiver with magnetron—2J56, 829B, 2K25, 1F Strip, 86AK5, **\$39.50**
16AL5, 2—2N2. Exc.....
Radio Receiver 11-tube UHF tunable 234-258 MC receiver with schematic. Complete with tubes, 3 ea. of 6AK5, **\$6.95**
7 ea. of 9001, 1 ea. of 12A6, Like new
Less Tubes..... **\$2.95**

5AP1, 3EP1, 5CP1, 3IP1, 2AP1, 3CP1, 1.75, 4 for..... **\$6.00**

WRITE FOR NEW BULLETIN
ALL ITEMS F.O.B. CHICAGO
25% Deposit required with orders

R W ELECTRONICS
2430 S. Michigan Ave., Chicago 16, Ill.
Dept. N, PHONE: Calumet 5-1281-2-3

COMING SOON!

(compiled by the editors of *Popular Electronics* and *Radio & TV News*)

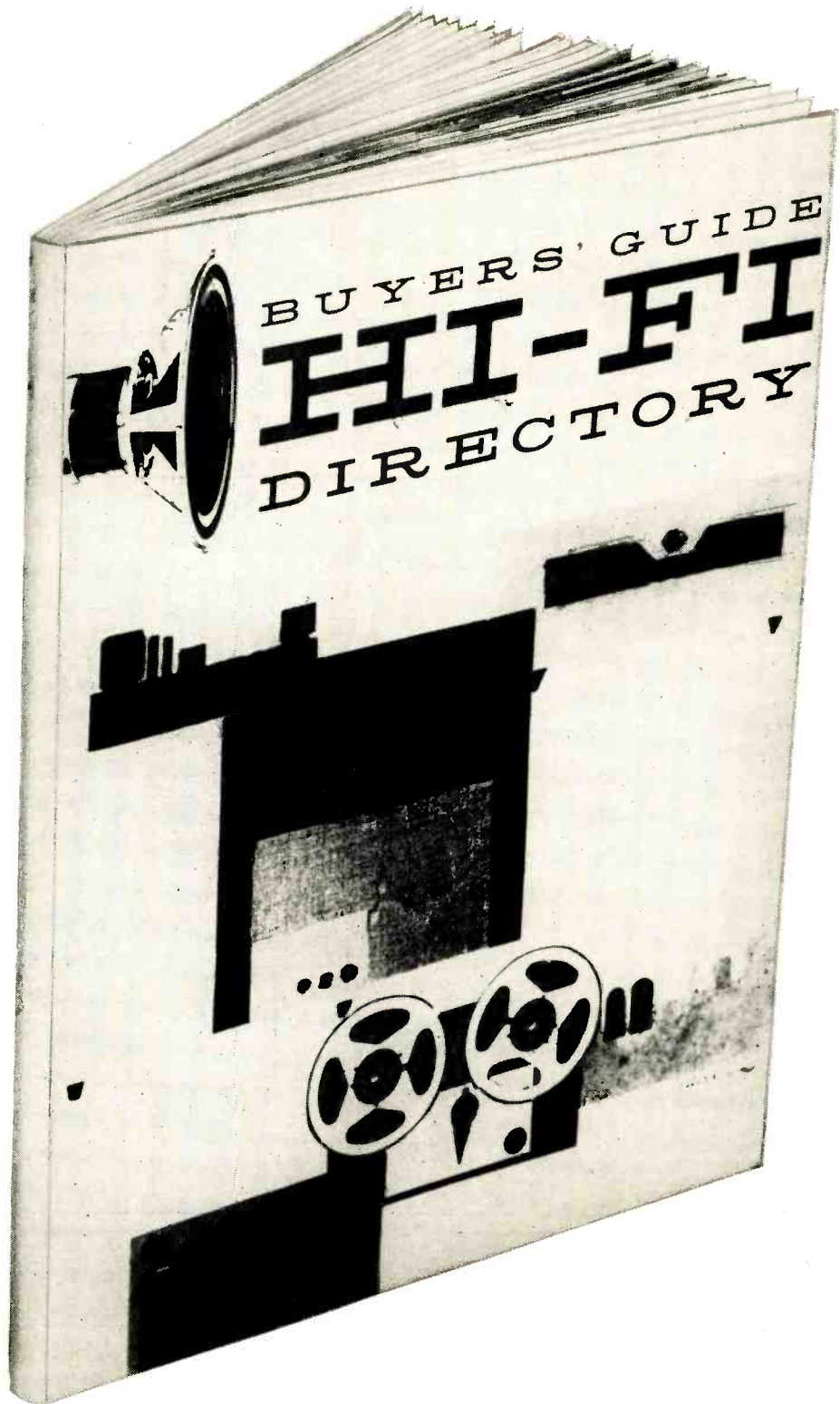

BUYERS' GUIDE **HI-FI** DIRECTORY

The world's first complete listings of all hi-fi equipment on the market—plus professional advice on how to pick the right unit for your own needs. If you're a hi-fi fan now—or want to get a rig soon, here's a publication that's tailor-made for you.

PARTIAL CONTENTS

- ★ **Turntables vs. record changers**
- ★ **How to buy a tone arm**
- ★ **How to buy AM and FM tuners**
- ★ **Full guide to tape recorders**
- ★ **Detailed facts on preamps and amplifiers**
- ★ **Latest information on speakers, crossover nets, speaker systems**
- ★ **Enclosures and consoles**
- ★ **Transformers, instruments, record clubs, books, controls, etc.**



**WATCH FOR THIS NEW ZIFF-DAVIS PUBLICATION
AT YOUR FAVORITE NEWSSTAND**

ONLY \$1.00

You'll enjoy . . .
**THE CHALLENGING NEW
 THEME OF THIS YEAR'S
 PHOTOGRAPHY
 ANNUAL!**

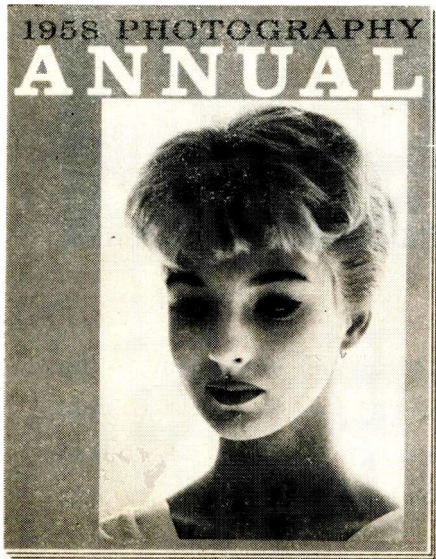

The 1958 edition of the PHOTOGRAPHY ANNUAL is the brightest and most imaginative ever published. Its theme, its contributors, its 250 pages of striking photographs are certain to delight you!

**"WHAT IS A CAMERA?"
 is the exciting theme.**

In answer to that question, the Editors of POPULAR PHOTOGRAPHY have compiled "an illustrated definition of photography"—including a selection of the most entertaining and original pictures you've ever seen.

The wonderful world of photography will be yours to enjoy through the lens of:

- The Roving Camera**
- The Playful Camera**
- The Workaday Camera**
- The Romantic Camera**
- The Realistic Camera**
- The Intimate Camera of Harold Feinstein**
- The Nighttime Camera**
- The Story-Telling Camera**
- The Portrait Camera**
- The Nature Camera**
- The Glamour Camera of Don Ornitz**
- The Casual Camera**
- The Color Camera**
- The Action Camera**
- The Imaginative Camera**
- The Adventurous Camera**

BEST OF ALL—you'll profit from a special section on the most important camera of all—*Your Camera*. A helpful guide to learning from the photo masterpieces of others!

**BUY YOUR COPY OF
 THE 1958
 PHOTOGRAPHY ANNUAL
 on sale now—only \$1.00.**



New Tube Tester Data

New data from Allied adds to September, 1956 chart and includes most tubes introduced since it was issued.

KNIGHT MODELS 83XY142 & 83XY143

TUBE TYPE	KNOBS			LEVER POSITION	
	A Cir.	B Fil.	C Load	Up	Down
2B3	3	2	100	0	2
	(Good Tube Reads 10)				
2B5	1	2	22-22	13-68	45-45
3BN4	2	3	20	27	136
4BC8	2	4.2	20	12	34
4BC8 (Test 2)	2	4.2	20	67	48
5BE8	2	5.0	20	12	35
5BE8 (Test 2)	2	5.0	20	679	358
5BQ7A	2	5.0	19	12	34
5BQ7A (Test 2)	2	5.0	19	67	48
5BZ7	3	5.0	19	12	34
5BZ7 (Test 2)	3	5.0	19	67	48
5CL8	2	5.0	21	12	34
5CL8 (Test 2)	2	5.0	21	679	48
6BA8-A	3	6.3	20	23	14
6BA8-A (Test 2)	3	6.3	16	789	46
6BU8	1	6.3	20	2789	15
6BU8 (Test 2)	1	6.3	20	2367	15
6BV8	2	6.3	20	23	15
6BV8 (Test 2)	1	6.3	60	9	57
6BV8 (Test 3)	1	6.3	60	6	58
6CM7	2	6.3	22	18	59
6CM7 (Test 2)	2	6.3	24	67	35
6CW5	3	6.3	16	126789	34
9AU7	2	5	23	12	345
9AU7 (Test 2)	2	5	23	67	458
12AB5	3	12.6	23	1368	57
12AC6	1	12.6	21	256	47
12AD6	1	12.6	32	6	12357
12AD6 (Test 2)	1	12.6	32	567	123
12AE6	1	12.6	22	17	23
12AE6 (Test 2)	1	12.6	40	6	23
12AE6 (Test 3)	1	12.6	40	5	23
12AF6	1	12.6	34	56	1237
12AJ6	1	12.6	20	17	23
12AJ6 (Test 2)	1	12.6	38	6	23
12AJ6 (Test 3)	1	12.6	38	5	23
12AL8	1	12.6	22	1	59
12AL8 (Test 2)	1	12.6	38	26	357
ECC81	2	6.3	21	12	39
ECC81 (Test 2)	2	6.3	21	67	89
EZ81	3	6.3	20	1	34
EZ81 (Test 2)	3	6.3	20	7	34
ECC82	2	6.3	25	12	39
ECC82 (Test 2)	2	6.3	25	67	89

Corrections for old chart:

1R5: A-circuit setting should be 1-1, not 1-2.

6AG7: C-load setting should be 20, not 14.

FEATURING FAMOUS FACTORY

TUBES

- INDIVIDUALLY BOXED!
- GUARANTEED ONE YEAR!
- FACTORY BOXED
- FACTORY IRREGULARS
- NEW JAN SURPLUS
- EQUIPMENT TUBES

**ALWAYS 1000
TYPES IN STOCK**

EXPORT ORDERS MANUFACTURERS
INVITED ORDERS INVITED

**We Are Not Selling Price—
We Sell Only Quality**

Used Tubes, Electrically Perfect Factory Seconds, Brand New Factory Seconds and New and Used Jan Surplus Tubes.

**REMEMBER—You Buy Quality When
You Buy Standard. Quality Never
Shouts—It Always Whispers.**

**FREE
12" TV SET**
with every receiving tube order of \$100.00 or more!

**FREE
16" TV SET**
with every receiving tube order of \$200.00 or more!

Bonus TV sets are shipped complete with cabinet and picture tube F.O.B. our warehouse. With slight adjustments and minimum labor they can be restored like new.

**Below Is A Partial List—Send For
FREE Complete List and Order Form**

QZ4	.42	5AT8	.79	6BK7	.75	7A4	.46	12J5	.39
1A7GT	.42	5J6	.79	6B17GT	.74	7A5	.52	12SA7	.47
1B3GT	.42	5T8	.79	6BN6	.57	7A6	.44	12SG7	.54
1C5GT	.40	5U4G	.48	6BQ6GT	.79	7A7	.44	12SJT	.44
1C6	.25	5U8	.79	6BQ7	.75	7A8	.44	12SK7	.47
1C7G	.46	5V4G	.57	6BY5G	.57	7AU7	.69	12SL7GT	.59
1D5GP	.42	5V6GT	.49	6BZ7	.75	7B4	.43	12S7GT	.59
1H4G	.45	5X8	.79	6C4	.50	7B5	.41	12SQ7	.39
1MGT	.46	5Y3	.38	6CB6	.50	7B7	.42	12V6GT	.44
1L4	.45	5Y4G	.42	6CD6G	1.17	7B8	.46	12W6	.36
1L6	.54	5Z3	.44	6CU6	.47	7C4	.40	14A7	.44
1L8	.55	6A7	.56	6D6	.47	7C5	.41	14B6	.44
1L8A	.46	6A8	.46	6E5	.43	7C6	.42	14Q7	.44
1L8A4	.58	6A8A	.44	6F5	.37	7E5	.44	19B6G	1.17
1LCS	.48	6AC7	.66	6F6	.37	7E6	.44	25BQ6GT	.84
1LCS2	.46	6AF4	.49	6G6	.47	7F7	.58	25CA5	.79
1LD5	.56	6AG5	.75	6H6	.37	7F8	.58	25CD6	1.29
1LE3	.56	6AG7	.68	6J4	1.59	7N7	.57	25CU6	.99
1LH4	.63	6AH4GT	.69	6J5	.38	7N7	.58	25L6GT	.46
1LNS	.46	6AH6	.70	6K6GT	.38	7P7	.64	25W4GT	.42
1NSGT	.49	6AK5	.53	6K7	.36	7Q7	.34	25Z6	.36
1RS	.50	6AL5	.41	6L6	.39	7Z4	.39	35B5	.47
1SS	.45	6AM8	.79	6N7	.57	12A4	.59	35C5	.47
1T4	.50	6AN8	.79	6Q7	.39	12A5	.59	35CS	.47
1U4	.46	6AQ5	.45	6S4GT	.70	12A6	.59	35L6GT	.46
1U5	.45	6ASS	.47	6S8GT	.70	12A7	.65	35W4	.38
1V2	.70	6AS7G	2.25	6SA7	.47	12A7	.65	35Y4	.38
1X2	.66	6AT6	.38	6SB7Y	.75	12A8	.59	35Z3	.40
2A3	.49	6B8	.79	6SC7	.47	12A9	.59	3Z5GT	.38
2A7	.54	6AU4GT	.64	6SG7	.40	12AB5	.40	39/44	.25
2D21	.95	6AU5GT	.69	6SH7	.42	12A05	.49	50A5	.47
3A4	.50	6AUG	.42	6SJ7	.42	12A16	.62	50B5	.47
3A5	.50	6AUR	.79	6SK7	.49	12A17	.62	50C5	.47
3AL5	.52	6AV5GT	.64	6SL7GT	.56	12A18	.67	50L6GT	.44
3AU6	.52	6AV6	.38	6SN7GT	.59	12A19	.64	50P6GT	.44
3BZ6	.57	6AW8	.89	6SO7	.40	12A20	.62	50R6	.44
3BC5	.57	6AX4GT	.65	6SS7	.40	12AX4GT	.64	50S5	.47
3BN6	.57	6AX5GT	.65	6ST7	.85	12A21	.62	50T5	.47
3C6	.57	6B46	.56	6TB	.67	12A22	.62	50U6GT	.44
3Q4	.55	6BC5	.49	6U5	.54	12A23	.62	50V6GT	.44
3Q5GT	.56	6BC8	.89	6U8	.79	12A24	.62	50W6GT	.44
3Q6	.56	6BD5GT	.52	6V3	.79	12A25	.62	50X6GT	.44
3V4	.55	6BE6	.45	6V6GT	.45	12A26	.62	50Y6GT	.44
4BQ7	.75	6BF5	.39	6W4GT	.52	12A27	.62	50Z6GT	.44
4BZ7	.75	6BG6G	1.17	6W6GT	.52	12B7	.59	51L7GT	1.25
5AW8	.79	6BH6	.50	6X4	.38	12B7	.59	51P7GT	1.25
5AN8	.79	6BJ6	.46	6X5	.38	12CA5	.59	51T7GT	1.25
5A95	.49	6BK5	.67	6X8	.74	12C6G	.79	51Z7GT	1.25

FREE! Receiving Tubes Sent Parcel Post
TWO SET COUPLER WITH EVERY TUBE ORDER OF
\$8.50 OR MORE!!

FREE POSTAGE! On All Orders Shipped in U. S. A., Territories and A.P.O.'s.
Send 25c for handling on orders under \$5.00. Please send approx. postage on
Canadian and foreign orders. Excess will be refunded.

STANDARD LINE

ELECTRIC COMPANY

432 HARRISON AVENUE, HARRISON, N. J. • Phone: HUmboldt 4-4997

Abraham Marcus,
co-author of famous
best-seller
"Elements of Radio"
makes amazing
offer!



TRY MY TV and RADIO REPAIR COURSE FREE FOR 1 MONTH

"If you haven't earned at least \$100 in spare time during that period you pay not a cent."

Here it is! The most amazing guarantee ever offered on any radio-TV course anywhere! We'll send you Abraham Marcus' course to use FREE for one full month! If in that time you haven't actually made \$100 fixing radios and TV sets, just return the books to us and pay not a penny!

Why do we make this sensational offer? First, because these books are so easy to use. They are written in the same clear, easy-to-understand language that made the author's "Elements of Radio" a 1,000,000-copy best-seller. Second, because these books get right to the point—tell you what to do in 1-2-3 fashion. For example, once you master the first few chapters of the TV book you are ready for business—ready to do service jobs in the field—jobs that account for over 80% of all service calls.

DON'T WAIT! you risk nothing when you send the coupon at right. You don't have to keep the books and pay for them unless you actually make extra money fixing radios and TV sets. Even when you decide to keep them, you pay on easy terms. Mail the coupon now.

WHAT YOU GET IN THESE 3 GIANT VOLUMES

ELEMENTS OF TELEVISION SERVICING. Analyzes and illustrates more TV defects than any other book, and provides complete step-by-step procedure for correcting each. You can actually SEE what to do by looking at the pictures. Reveals for the first time all details, theory and servicing procedures for the RCA 28-tube color television receiver, the CBS-Columbia Model 205 color set, and the Motorola 19-inch color receiver.

RADIO PROJECTS. Build your own receivers! Gives you 10 easy-to-follow projects, including crystal detector receiver—diode detector receiver—regenerative receiver—audio-frequency amplifier—tuned-radio-frequency tuner—AC-DC superheterodyne receiver—etc.

RADIO SERVICING Theory and Practice. Here is everything you need to know about radio repair, replacement, and readjustment. Easy-to-understand, step-by-step self-training handbook shows you how to locate and remedy defects quickly. Covers TRF receivers; superheterodyne receivers; Shortwave, portable, automobile receivers, etc. Explains how to use testing instruments such as meter, vacuum-tube voltmeters, tube checkers, etc., etc.

MAIL THIS COUPON

Prentice-Hall, Inc., Dept. 5741-P1
Englewood Cliffs, New Jersey

Please send me Abraham Marcus' TV & RADIO REPAIR COURSE (3 volumes) for 10 days FREE examination. Within 10 days I will either return it and owe nothing, or send my first payment of \$5.60. Then, after I have used the course for a FULL MONTH, if I am not satisfied I may return it and you will refund my first payment. Or I will keep the course and send you two more payments of \$5.60 a month for two months.

Name

Address

City..... Zone..... State.....

Install
them
good
and
fast...IRC®

Fixed Composition Resistors



The fact that servicemen use more IRC Type BT's than any other fixed composition resistor proves there's a difference in IRC performance. But there's another difference too. The leads of IRC Type BT Resistors have an exclusive coating that lets you make sound soldered joints at high or low soldering temperatures. You make the replacement fast. And you know it's there to last. So save time...save callbacks. Buy IRC Type BT Resistors. ¼ to 2 watt ratings. Values from 10 ohms to 22 megohms.

Low Wattage Wire-Wounds



At resistance values as low as .24 ohm up to 8200 ohms, no other wire-wound resistor combines the high stability and low cost of IRC Type BW's. IRC's unmatched winding skills make the wire-wound element a study in perfection. A molded plastic housing gives complete protection. ½, 1 and 2 watt ratings.

ORDER FROM YOUR IRC DISTRIBUTOR



INTERNATIONAL RESISTANCE COMPANY

Dept. 483
401 N. Broad St., Philadelphia 8, Pa.
In Canada: International Resistance Co.,
Ltd., Toronto, Licensee

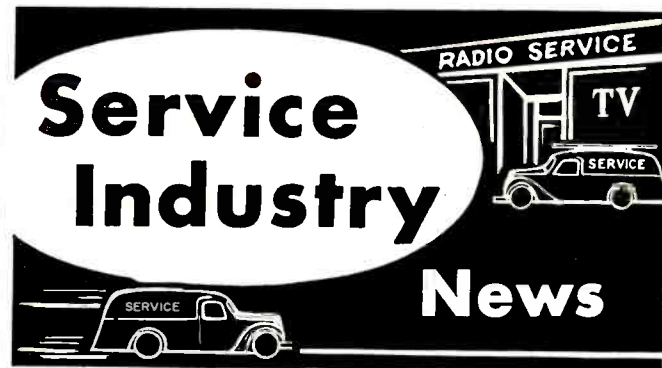

RUSSELL HARMON of *Weber's TV*, Cincinnati, Ohio, was elected president of the National Alliance of Television and Electronic Service Associations during the recent annual convention of NATESA. He succeeds Robert Hester of *Hester's TV*, Mission City, Kansas.

Mac Metoyer of *A-One TV Service*, Kansas City, was elected to the post of secretary general succeeding F. B. (Bob) Koepnick of *A-1 Certified Television*, Houston, Texas.

Gilbert P. Clark of *Centronic TV*, Boston, and editor-publisher of "NETS News," was elected to the post of eastern vice-president and Pascal P. Pratt of Buffalo was selected to serve as eastern regional secretary.

The east central vice-presidency went to Cordell Britt of *May TV*, Nashville, Tenn., and editor of the "MTTTA News." Marvin Miller of Springfield, Ohio, was named to the post of east central regional secretary.

Vincent J. Lutz of St. Louis was re-elected as west central vice-president and Joe Driscoll of St. Paul, Minn., was selected as secretary for that region.

Nelson Burns of Memphis, Tenn., was re-elected treasurer and Frank J. Moch of Chicago was re-appointed executive secretary.

A national public relations and business promotion program for the association was presented to the delegates by a Chicago advertising agency. The proposed program contemplates the use of national consumer magazines, such as "TV Guide," the "Saturday Evening Post," "Life," etc., with a campaign designed to create consumer confidence in service shops that are members of NATESA.

The cost of participating in the proposed NATESA advertising and public relations program is to be \$100 per year per shop plus \$10.00 per year for each technical service employee. The program will not be started until a minimum of three hundred members have signed up.

Future of Servicing

In his keynote talk at the annual banquet of the Texas Electronics Association in Fort Worth, Texas, H. F. Bershe, merchandising manager for the *RCA* Electron Tube Division, painted a glowing picture of the future opportunities in the TV-electronics servicing field.

"The fabulous growth of TV-electronics servicing during the past 20 years—rising from \$80 million to one billion, eight hundred million dollars annually," he said, "is expected to continue during the next two decades, reaching a record \$8 billion by 1975."

In analyzing the electronics industry, Mr. Bershe named five principal categories requiring the services of technicians. These are: home equipment, radio-TV broadcasting, communications, industrial and commercial applications, and defense electronics, all of which, he pointed out, are constantly increasing in scope and therefore requiring additional servicing talent.

New State Group

A state organization of independent radio-TV service associations was formed recently in Massachusetts. It was chartered under the name of the Electronic Technicians Guild of Massachusetts.

Officers of ETGM include Nicholas A. Averinos, owner of the *Colonial Radio & Appliance Co.*, of South Weymouth, president; Remo DiNicola, assistant to the president;

Albert N. Oiddis, treasurer; Gilbert Clark, newly elected eastern region vice-president of NATESA, vice-president; and Lawrence J. McEvoy, secretary.

The major objective of the Massachusetts Guild was stated to be the defense and perpetuation of the independent business status of the electronic service industry.

Mr. Averinos said the Guild was formed "to provide a central, statewide organization that will be concerned with the professional advancement and technical education of electronics servicemen, provide an effective program in public relations and education, and maintain active liaison with other service groups and segments of the industry."

Effective House Organs

"The Raster," the official publication of the Electronic Service Council of the Ozarks, recently celebrated its first year of existence with a sprightly 16-page issue. Edited by Wayne Lemons of Buffalo, Mo., the publication is widely circulated throughout southern Missouri.

The effectiveness of a good association house organ in creating a better understanding among service businessmen, was highlighted in a letter to the editor from one of their independent parts distributors:

"All of us at the *Reed Radio & Supply Company*," it said, "want to extend our congratulations to the Electronic Service Council of the Ozarks on the excellent job it has done toward bringing unity and understanding among the radio and television servicemen and to the industry.

"We think the monthly publication of ESCO, now well known to all of us as the 'Raster,' is the best publication of its kind that we have seen. The editor and his entire staff should be congratulated on a very successful first year of publication. The 'Raster' has indeed proved to be a remarkable publication for the radio and TV serviceman.

"We of the *Reed Radio & Supply Company* have always felt that there should be cooperation and unity among servicemen and technicians, and we are continually encouraging and sponsoring meetings and technical sessions and gatherings of servicemen in order that they may not only be well informed, but that they get together upon a common ground of friendship and understanding."

Emphasizing the advantage of association membership and intra-industry cooperation, Al Mirus, successful service dealer who is president of ATSCOTESA, said in the "Cincinnati TESA news":

"A great many TESA members have reported a sharp increase in service calls during the past several weeks. One of the advantages of being a member of an association such as ours is the continual contact with other members and the exchange of business ideas. These include how to keep costs down; how to increase sales and profits; discussions of new products being introduced by the industry and how they will affect your own business.

"Every member will tell you this *shop talk* is one of the best sources of new ideas directly applicable to your own business. When you can benefit from the experience of others, why do it the hard way? Present your business problems to us. You will probably find another member who has had the identical problem and found a workable solution."

Standards Available

An 18-page booklet covering the Radio and Television Apprenticeship Standards formulated by the Minnesota Service Engineers, Inc., is now available. Copies may be obtained at no charge from the TTLB Special Services Department, P. O. Box 1321, Indianapolis 6, Ind., or from John W. Hemack, secretary MINTSE, 339-13th Ave., N.E., Minneapolis 13, Minn.

NATESA and TESA

The wording of an item in this space in August was inadvertently misleading. In noting the NATESA New Orleans resolution to urge uniform adoption by its affiliates of the local designation of TESA, we mentioned a "preference for TESA in place of NATESA." Naturally, use of TESA on the local level re-inforces the national NATESA name.

-30-

Buy
and
find
them
fast...IRC®

Resistors in Resist-O-Cabinets



Time is money . . . and you save both when you buy IRC balanced resistor assortments in these handy RESIST-O-CABINETS. No more itemizing orders . . . all the resistors you most often need are pre-selected. No more "filing" resistors . . . they're already filed in 28 separate, four-drawer compartments. No more hunting resistors . . . you can find what you want when you want it. What's more, the sturdy all-metal cabinet is yours at no extra cost. Four assortments: No. 3A with 120 IRC 2 watt resistors . . . No. 4A with 150 IRC ½ watt resistors . . . No. 5A with 125 IRC 1 watt resistors . . . and No. 6A containing 139 IRC ½, 1 and 2 watt resistors including deposited carbon precistors.



ONLY \$4.50

Pocket-Sized Resist-O-Kits

Take them on the job! IRC RESIST-O-KITS contain popular IRC resistors all filed in ten compartments according to value. Assortment No. 7 includes 45 IRC ½ watt resistors. Assortment No. 8 offers 30 IRC 1 watt resistors.



INTERNATIONAL RESISTANCE COMPANY

Dept. 483, 401 N. Broad St., Philadelphia 8, Pa.

In Canada: International Resistance Co., Ltd., Toronto, licensee

Tell me about all the IRC bargains. Send copy of the IRC Replacement Parts Catalog DLR-57.

Name _____
Company _____
Street _____
City _____ Zone _____ State _____

Model TD-55 — Terms:
\$6.95 after 10 day trial then
\$5.00 per month for 4 months.

OPERATING INSTRUCTIONS
FOR MODEL TD-55
TUBE TESTER



Model TV-12 — Terms:
\$22.50 after 10 day trial then
\$10.00 per month for 5 months.

Model TV-40
— Terms: \$3.85
after 10 day trial
then \$4.00 per
month for 3
months.



Model TW-11 — Terms:
\$11.50 after 10 day trial then
\$6.00 per month for 6 months.

SHIPPED ON APPROVAL NO MONEY WITH ORDER NO C.O.D.

Superior's New Model TD-55 EMISSION TYPE TUBE TESTER

FOR { The Experimenter or Part-time Serviceman, who has delayed purchasing a higher priced Tube Tester.
The Professional Serviceman, who needs an extra Tube Tester for outside calls.
The busy TV Service Organization, which needs extra Tube Testers for its field men.

Speedy, yet efficient operation is accomplished by:
1. Simplification of all switching and controls.
2. Elimination of old style sockets used for testing obsolete tubes (26, 27, 57, 59, etc.) and providing sockets and circuits for efficiently testing the new Noval and Sub-Minar types.

You can't insert a tube in wrong socket. It is impossible to insert the tube in the wrong socket when using the new Model TD-55. Separate sockets are used, one for each type of tube base. If the tube fits in the socket it can be tested.

"Free-point" element switching system. The Model TD-55 incorporates a newly designed element selector switch system which reduces the possibility of obsolescence to an absolute minimum. Any pin may be used as a filament pin and the voltage applied between that pin and any other pin or even the "top-cap."

Checks for shorts and leakages between all elements. The Model TD-55 provides a super sensitive method of checking for shorts and leakages up to 5 Megohms between any and all of the terminals. Continuity between various sections is individually indicated. This is important, especially in the case of an element terminating at more than one pin. In such cases the element or internal connection often completes a circuit.

Elemental switches are numbered in strict accordance with R.M.A. specification. One of the most important improvements, we believe, is the fact that the 4 position fast-action snap switches are all numbered in exact accordance with the standard R.M.A. numbering system. Thus, if the element terminating in pin No. 7 of a tube is under test, button No. 7 is used for that test.

\$26⁹⁵ NET

Complete with carrying case.....

Superior's New Model TV-40 STANDARD PROFESSIONAL PICTURE TUBE TESTER

Not a Gadget—Not a Make-Shift Adapter, but a Wired Picture Tube Tester With a Meter for Measuring Degree of Emission—at Only \$15.85

Of course you can buy an adapter for about \$5—which theoretically will convert your standard tube tester into a picture-tube tester, or a neon type instrument which sells for a little more and is supposed to be "as good as" a metered instrument. Superior does not make nor do they recommend use of C.R.T. adapters or neon gadgets because a Cathode Ray Tube is a very complex device, and to properly test it, you need an instrument designed exclusively to test C. R. Tubes and nothing else.

Tests ALL magnetically deflected tubes . . . in the set . . . out of the set . . . in the car!!

- Tests all magnetically deflected picture tubes from 7 inch to 30 inch types.
- Tests for quality by the well-established emission method. All readings on "Good-Bad" scale.
- Tests for inter-element shorts and leakages up to 5 megohms.
- Test for open elements.

EASY TO USE: Simply insert line cord into any 110 volt A.C. outlet, then attach tester socket to tube base (ion trap need not be on tube). Throw switch up for quality test . . . read direct on Good-Bad scale. Throw switch down for all leakage tests.

\$15⁸⁵ NET

Only.....

Superior's New Model TV-12 TRANS-CONDUCTANCE TUBE TESTER

TESTING TUBES

- Employs improved TRANS-CONDUCTANCE circuit. An in-phase signal is impressed on the input section of a tube and the resultant plate current change is measured. This provides the most suitable method of simulating the manner in which tubes actually operate in Radio & TV receivers, amplifiers and other circuits. Amplification factor, plate resistance and cathode emission are all correlated in one meter reading.
- NEW LINE VOLTAGE ADJUSTING SYSTEM. A tapped transformer makes it possible to compensate for line voltage variations to a tolerance of better than 2%.
- SAFETY BUTTON—protects both the tube under test and the instrument meter against damage due to overload or other form of improper switching.
- NEWLY DESIGNED FIVE POSITION LEVER SWITCH ASSEMBLY. Permits application of separate voltages as required for both plate and grid of tube under test, resulting in improved Trans-Conductance circuit.

Extra Feature

Model TV-12 Also Tests Transistors!

A transistor can be safely and adequately tested only under dynamic conditions. The Model TV-12 will test all transistors in that approved manner, and quality is read directly on a special "transistor only" meter scale.

The Model TV-12 will accommodate all transistors including NPN's, PNP's Photo and Tetrodes, whether made of Germanium or Silicon, either point contact or junction contact types.

\$72⁵⁰ NET

Housed in hand-rubbed oak cabinet.....

Superior's New Model TW-11 STANDARD PROFESSIONAL TUBE TESTER

- Tests all tubes, including 4, 5, 6, 7, Octal, Lockin, Hearing Aid, Thyatron, Miniatures, Sub-miniatures, Novals, Sub-minars, Proximity fuse types, etc.
- Uses the new self-cleaning Lever Action Switches for individual element testing. Because all elements are numbered according to pin-number in the RMA base numbering system, the user can instantly identify which element is under test. Tubes having tapped filaments and tubes with filaments terminating in more than one pin are truly tested with the Model TW-11 as any of the pins may be placed in the neutral position when necessary.
- The Model TW-11 does not use any combination type sockets. Instead individual sockets are used for each type of tube. Thus it is impossible to damage a tube by inserting it in the wrong socket.
- Free-moving built-in roll chart provides complete data for all tubes. All tube listings printed in large easy-to-read type.

NOISE TEST: Phono-jack on front panel for plugging in either phones or external amplifier will detect microphonic tubes or noise due to faulty elements and loose internal connections.

EXTRAORDINARY FEATURE: SEPARATE SCALE FOR LOW-CURRENT TUBES. Previously, on emission-type tube testers, it has been standard practice to use one scale for all tubes. As a result, the calibration for low-current types has been restricted to a small portion of the scale. The extra scale used here greatly simplifies testing of low-current types.

\$47⁵⁰ NET

Housed in hand-rubbed oak cabinet.....

USE APPROVAL FORM ON NEXT PAGE ➡

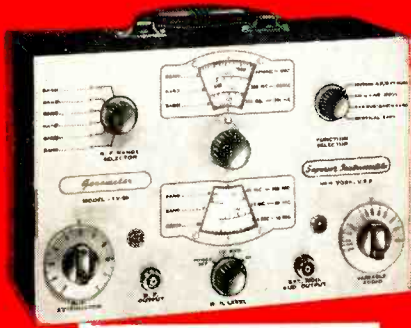

Model TV-50 — Terms:
\$11.50 after 10 day trial then
\$6.00 per month for 6 months.



Model 76—Terms: \$6.95
after 10 day trial then \$5.00
per month for 4 months.



Model 770-A — Terms:
\$3.85 after 10 day trial then
\$4.00 per month for 3 months.



Model 670-A — Terms:
\$7.40 after 10 day trial then
\$3.50 per month for 6 months.

TRY FOR 10 DAYS

before you buy! **then** if satisfactory pay in easy, interest free, monthly payments. See coupon below.

Superior's New Model TV-50 **GENOMETER**

7 Signal Generators in One!

- ✓ R.F. Signal Generator for A.M.
- ✓ R.F. Signal Generator for F.M.
- ✓ Audio Frequency Generator
- ✓ Bar Generator
- ✓ Cross Hatch Generator
- ✓ Color Dot Pattern Generator
- ✓ Marker Generator

R. F. SIGNAL GENERATOR: 100 Kilocycles to 60 Megacycles on fundamentals and from 60 Megacycles to 180 Megacycles on powerful harmonics.

VARIABLE AUDIO FREQUENCY GENERATOR: Provides a variable 300 cycle to 20,000 cycle peaked wave audio signal.

BAR GENERATOR: Pattern consists of 4 to 16 horizontal bars or 7 to 20 vertical bars.

CROSS HATCH GENERATOR: Pattern consists of non-shifting horizontal and vertical lines interlaced to provide a stable cross-hatch effect.

DOT PATTERN GENERATOR (FOR COLOR TV): The Dot Pattern projected on any color TV Receiver tube by the Model TV-50 will enable you to adjust for proper color convergence.

MARKER GENERATOR: The following markers are provided: 189 Kc., 262.5 Kc., 456 Kc., 600 Kc., 1000 Kc., 1400 Kc., 1600 Kc., 2000 Kc., 2500 Kc., 3579 Kc., 4.5 Mc., 5 Mc., 10.7 Mc., (3579 Kc. is the color burst frequency).

Complete with shielded leads.....

\$47⁵⁰
NET

Superior's New Model 670-A **SUPER-METER**

A Combination VOLT-OHM MILLIAMMETER **PLUS** Capacity, Reactance, Inductance and Decibel Measurements.

ADDED FEATURE: Built-in ISOLATION TRANSFORMER reduces possibility of burning out meter through misuse.

SPECIFICATIONS:

- D.C. VOLTS: 0 to 7.5/15/75/150/750/1,500/7,500 Volts
- A.C. VOLTS: 0 to 15/30/150/300/1,500/3,000 Volts
- OUTPUT VOLTS: 0 to 15/30/150/300/1,500/3,000 Volts
- D.C. CURRENT: 0 to 1.5/15/150 Ma. 0 to 1.5/15 Amperes
- RESISTANCE: 0 to 1,000/100,000 Ohms 0 to 10 Megohms
- CAPACITY: .001 to 1 Mfd. 1 to 50 Mfd. (Good-Bad scale for checking quality of electrolytic condensers.)
- REACTANCE: 50 to 2,500 Ohms 2,500 Ohms to 2.5 Megohms
- INDUCTANCE: .15 to 7 Henries 7 to 7,000 Henries
- DECIBELS: -6 db to + 18 db, + 14 db to + 38 db, + 34 db to + 58 db.

Complete with test leads.....

\$28⁴⁰
NET

We invite you to try before you buy any of the models described on this and the preceding page. If after a 10 day trial you are completely satisfied and decide to keep the Tester, you need send us only the down payment and agree to pay the balance due at the monthly indicated rate.

**NO INTEREST
OR FINANCE
CHARGES ADDED!**

If not completely satisfied, you are privileged to return the Tester to us, cancelling any further obligation.

Superior's New Model **76**

- ✓ IT'S A CONDENSER BRIDGE
- ✓ IT'S A RESISTANCE BRIDGE
- ✓ IT'S A SIGNAL TRACER
- ✓ IT'S A TV ANTENNA TESTER

SPECIFICATIONS

✓ CAPACITY BRIDGE SECTION 4 Ranges: .00001 Microfarad to .005 Microfarad; .001 Microfarad to .5 Microfarad; .1 Microfarad to 50 Microfarads; 20 Microfarads to 1000 Microfarads. Will also measure the power factor of all condensers from .1 to 1000 Microfarads.

✓ RESISTANCE BRIDGE SECTION 2 Ranges: 100 ohms to 50,000 ohms; 10,000 ohms to 5 megohms.

✓ SIGNAL TRACER SECTION With the use of the R.F. and A.F. Probes included with the Model 76, you can make stage gain measurements, locate signal loss in R.F. and Audio stages, localize faulty stages, locate distortion and hum, etc.

✓ TV ANTENNA TESTER SECTION Loss of sync., snow and instability are only a few of the faults which may be due to a break in the antenna, so why not check the TV antenna first? Locates a break in any TV antenna and measures the location of the break in feet from the set terminals.

Complete with R.F. and A.F. probes and test leads.....

\$26⁹⁵
NET

Superior's New Model 770-A **POCKET-SIZED VOLT-OHM MILLIAMMETER**

• USING THE NEW "FULL-VIEW" METER 71% MORE SCALE AREA—Occupies exactly the same space used by the older standard 2 1/2" Meters, yet provides 71% more scale area. As a result, all calibrations are printed in large easy-to-read type and for the first time it is now possible to obtain measurements instead of approximations.

• Compact—measures 3 1/8" x 5 7/8" x 2 1/4". • Uses "Full View" 2% accurate, 850 Microampere D'Arsonval type meter. • Housed in round-cornered, molded case. • Beautiful black etched panel.

Specifications: 6 A.C. VOLTAGE RANGES: 0-15/30/150/300/1500/3000 Volts. 6 D.C. VOLTAGE RANGES: 0-7.5/15/75/150/750/1500 Volts. 2 RESISTANCE RANGES: 0-10,000 Ohms, 0-1 Megohm. 3 D.C. CURRENT RANGES: 0-15/150 Ma., 0-1.5 Amps. 3 DECIBEL RANGES: -6 db to + 18 db, + 14 db to + 38 db, + 34 db to + 58 db.

Complete with test leads.....

\$15⁸⁵
NET

MOSS ELECTRONIC DISTRIBUTING CO., INC. Dept. D-400, 3849 Tenth Ave., New York 34, N. Y.

Please send me the units checked. I agree to pay down payment within 10 days and to pay the monthly balance as shown. It is understood there will be no finance or interest charges added. It is further understood that should I fail to make payment when due, the full unpaid balance shall become immediately due and payable.

Name

Address

City Zone State.....

All Prices net. F.O.B. N.Y.C.

- Model TW-11..... Total Price \$47.50
\$11.50 within 10 days. Balance \$6.00
monthly for 6 months.
- Model 76..... Total Price \$26.95
\$6.95 within 10 days. Balance \$5.00
monthly for 4 months.
- Model TD-55..... Total Price \$26.95
\$6.95 within 10 days. Balance \$5.00
monthly for 4 months.
- Model TV-50..... Total Price \$47.50
\$11.50 within 10 days. Balance \$6.00
monthly for 6 months.
- Model TV-40..... Total Price \$15.85
\$3.85 within 10 days. Balance \$4.00
monthly for 3 months.
- Model 670-A..... Total Price \$28.40
\$7.40 within 10 days. Balance \$3.50
monthly for 6 months.
- Model 770-A..... Total Price \$15.85
\$3.85 within 10 days. Balance \$4.00
monthly for 3 months.
- Model TV-12..... Total Price \$72.50
\$22.50 within 10 days. Balance \$10.00
monthly for 5 months.



COYNE
TRAINS YOU
IN SPARE TIME
AT HOME

COYNE QUALITY TRAINING AT LOWEST COST

TELEVISION

RADIO-COLOR TV

Only from famous COYNE do you get this modern up-to-the minute TV Home Training. Easy to follow instructions—fully illustrated with 2150 photos and diagrams. Not an old Radio Course with Television tacked on. Includes UHF and COLOR TV. Personal guidance by Coyne Staff. *Practical Job Guides* to help you EARN MONEY QUICKLY IN A TV-RADIO SALES AND SERVICE BUSINESS—part time or full time. COSTS MUCH LESS—pay only for training—no costly "put together kits."

SEND COUPON FOR FREE BOOK
SEND COUPON BELOW for Free Book and full details including EASY PAYMENT PLAN. NO COST OR OBLIGATION—NO SALESMAN WILL CALL.

B. W. COOKE, JR. **COYNE** FOUNDED 1899
PRES. **ELECTRICAL SCHOOL**

A TECHNICAL TRADE INSTITUTE OPERATED NOT FOR PROFIT
500 S. Paulina Dept. 87-HT5 Chicago 12, Illinois

COYNE ELECTRICAL SCHOOL
Television Home Training Div.
500 S. Paulina St., Chicago 12, Ill., Dept. 87-HT5

Send FREE BOOK and details of your Television Home Training offer.

Name _____
Address _____
City _____ State _____

The ALL NEW "20-POUNDER" MYSTERY PACKAGE

CARRYING ALL-PURPOSE CASE
Orig. Govt. Cost \$27.00
SALE PRICE \$4.95

Perfect Gift for:
• Photographers • Mechanics
• Adjustable Strap • Made of HARD RUBBER
• WATERPROOF • Size: 13" x 10" x 8 1/2"
• Sturdily built to support 300 pounds.

OF ELECTRONIC PARTS



Worth \$40.00
OUR PRICE ONLY \$3.95

It's Another THRILLING HERSHEL SURPRISE. 20 pounds of BRAND NEW usable Govt. Surplus. Perfect gift for Hams, etc.

TYPE FL
115V—400 Cycle
6700 R.P.M.
Westinghouse Electric.
\$3.95

BUTTERFLY CONDENSERS YOUR CHOICE \$4.95

TYPE A 4 1/4" Dia. 100-330 MC. Antenna Type

TYPE C 2 1/2" Dia. 100-330 1000 MC. Mini 35845 tube

These units make the finest tuners for Ultra-high frequency transmitters, receivers, frequency meters, and oscillators.

TYPE B 4 1/4" Dia. 100-330 485 MC

TYPE D 2 1/2" Dia. 100-330 1000 MC. Clip for Kist Det.

TERMS: Cash with order or 25% DOWN—BALANCE C.O.D.
ALL PRICES NET F.O.B. DETROIT—MINIMUM ORDER \$2.00
TYler 8-9400

HERSHEL RADIO CO.

5249 GRAND RIVER Detroit 8, Michigan

Transistorized Voltmeter

(Continued from page 67)

resistors in series with another of about 10 megohms chosen to give as close to 100 megohms as possible. The author used an HBF unit made by Resistance Products Co.

The batteries are all RM-1-R mercury cells made by Mallory, in a home-made plastic holder. Penlite cells are entirely satisfactory, although mercury cells were chosen because they maintain full voltage until almost dead. B_1 , the bias battery, is a single-cell unit (1.345 volts), which gives a bias current of about 25 microamperes. Since the maximum signal current for full-scale deflection is 10 microamperes, 25 microamperes of bias current is a good choice. B_2 can be anywhere from 2 to 10 volts, since collector current of transistors is not very dependent on collector voltage. Three cells, giving almost exactly 4 volts, were used because these Mallory mercury cells are sold in boxes of four, one of which was used for the bias battery!

A 100-microampere meter was used simply because a 4" square unit of this value was available at a surplus store. A 200-microampere meter would probably be as satisfactory. The whole meter was built into a 4" x 5" x 6" aluminum "Mini-box," as shown in Fig. 1. Almost any arrangement of parts would be acceptable at those frequencies up to which one may expect to employ a meter, without accessory probes, and also to which the transistors in the circuit are usable.

Although 2N35 transistors were employed, other types should be equally acceptable. For example, the 2N34 or the CK721 are of approximately equal gain. These two, however, are *p-n-p* units, and the battery polarities must therefore be reversed from those shown here. The rectifier used can be, as here, made up of four 1N34 diodes, or a full-wave meter rectifier can be used. Use the best quality you can get here in order not to waste power at this point in the circuit.

Also, although this meter was made with four voltage ranges—1, 10, 100, and 1000 volts—many people may prefer to put in intermediate ranges of 3, 30, and 300 volts. This depends on the constructor. While this 100,000 ohms-per-volt unit was found entirely satisfactory for any applications, a 200,000 ohms-per-volt meter could probably be developed on the principles shown, with 5 microamperes giving full scale deflection.

Nevertheless, built exactly as described in this article and as shown in Fig. 1, this meter has proved a useful one to its constructor, and has not shown any particular deficiencies in regular use. It has come to be accepted and relied upon to the same extent that one would depend on a multimeter or v.t.v.m. It is definitely not just a toy or an object simply in the "curiosity" class.

Enjoy the Prestige of A Field Assignment with BENDIX RADIO!

ELECTRONIC FIELD ENGINEERS
Engineering degree or equivalent experience in electronic systems required.

FIELD SERVICE TECHNICIANS
Technical school, plus three years experience required. Military experience acceptable.

Pride in your work and your recognition in the field—that's important to the "inner man". The opportunity to advance rapidly and to grow in your profession—that's important to your future! Excellent starting salaries

and field allowances—they're important to the family! You will obtain all these advantages when you choose a field assignment with the leader in its field—Bendix Radio!

Simply drop us a postal card stating education & experience. We'll arrange for a personal interview.

Address: MR. O. A. BOWMAN
Field Engineering, Dept. R



DIVISION OF BENDIX AVIATION CORP.
SMITH & GREENSPRING AVENUES
BALTIMORE 9, MARYLAND

ON SALE NOW!



only
\$1.00

(compiled by the editors of *Radio & TV News*)



Authoritative, comprehensive guide to hi-fi construction, maintenance and equipment . . . compiled by top authorities in the field. Includes complete instructions and plans for setting up your own system—covers preamps, equalizers, amplifiers, tape recorders, speakers, enclosures and stereophonic sound.

PARTIAL CONTENTS

- ★ *Why's and wherefore's of room acoustics, speakers, enclosures.*
- ★ *How to buy and install preamps, equalizers, tone controls.*
- ★ *Do's and don'ts of amplifiers.*
- ★ *Latest techniques and ideas on stereophonic sound.*
- ★ *Tape recording ideas and recorder guidance.*
- ★ *Transistor hi-fi.*
- ★ *All about speakers and enclosures.*
- ★ *Building, servicing and improving hi-fi systems.*

**LOOK FOR THIS NEW ZIFF-DAVIS PUBLICATION
AT YOUR FAVORITE NEWSSTAND**

SPECIAL SALE: REGULATED POWER SUPPLIES

... New Condition

A special purchase of a large quantity of Dressen-Barnes Regulated Power Supplies Offered at a real savings of \$ \$ \$ \$ \$

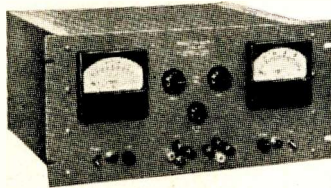

- Model D3-500B Dual Regulated Supply
2 0-300 VDC. 0-500 ma.
2 Bias Voltage 300 VDC. fixed
2 6.3 VAC. @ 10 amps unreg. **\$390.00**
- Model D5-300B Dual Reg. Supply
2 0-500 VDC. 0-300 ma.
2 Bias Voltage 300 VDC. fixed
2 6.3 VAC. @ 10 amps unreg. **\$390.00**
- Model DF-300F Reg. Supply
1 0-500 VDC. @ 0-300 ma.
1 0-300 VDC. @ 0-150 ma.
1 6.3 VAC. @ 10 amps unreg. **\$240.00**
- Model 3-1.5 MB Reg. Supply
1 0-300 VDC. @ 0-1500 ma.
1 0-150 VDC. @ 5 ma.
1 6.3 VAC. @ 10 amps unreg. **\$390.00**
- Model D50-.05B Dual Reg. Supply
2 0-50 VDC. @ 0-50 ma. **\$160.00**
- Model D1-100B Dual Reg. Supply
2 0-100 VDC. @ 0-100 ma. **\$270.00**
- Model 3-150B Regulated Supply
1 0-300 VDC. @ 0-150 ma.
1 0-150 neg. VDC. @ 5 ma.
1 6.3 VAC. @ 6 amps unreg. **\$120.00**
- Model D5-200C Dual Reg. Supply
2 30-500 VDC. @ 0-200 ma. **\$375.00**
- 2 6.3 VAC. @ 10 amps unreg.
- Model 4-200X Sub Chassis Mtg. Supply
1 400 VDC. 0-200 ma.
1 6.3 VAC. @ 6 amps unreg. **\$80.00**
- Model 3-150L Reg. Power Supply
1 0-300 VDC. @ 0-150 ma.
1 6.3 VAC. @ 6 amps unreg. **\$75.00**
- Model 1.5-150X Sub Chassis Mtg. Supply
1 150 VDC. @ 0-150 ma. **\$50.00**
- 1 6.3 VAC. @ 6 amps unreg.
- Model 2R-5MX Sub Chassis Mtg. Supply
1 25 VDC. @
0-5 amps unreg. **\$30.00**

- Several other models in limited quantities.
- APN4B Loran—New with mounts, plugs, and new PE-206 Inverter. **\$119.50 each**
- Kay Mega-Sweep Video Generator, Calif. Model—Excellent. **150.00 each**
- Ferris Noise & Field Strength Meter, Model 32B—Excellent. **200.00 each**
- Hewlett-Packard Test Oscillator Model 650A—Excellent. **150.00 each**
- Hewlett-Packard Audio Oscillator Model 205A—Excellent. **250.00 each**
- Hewlett-Packard Volt Meter DB Model 400C—Excellent. **100.00 each**
- TS-175/U Frequency Meter 85-1000 mc.—Excellent. **400.00 each**
- Dumont Type 324R Cathode-Ray Oscilloscope 50-400 cy.—Exc. **450.00 each**
- Teletronic Lab. Model 101 Oscilloscope—Excellent. **150.00 each**

PHOTOFLASH SPECIALS

- G.E. FT-524 Quartz Photoflash Tubes 3000 W.S.—New. **\$ 20.00 each**
- G.E. 80 mfd. @ 4000 V. Photoflash Capacitors 640 W.S.—New. **49.50 each**
- Sprague 100 mfd. @ 4000 V. Photoflash Capacitors 800 W.S.—New. **62.50 each**
- F.O.B. Pasadena, California

PHOTOCON SALES

421 North Altadena Drive
PASADENA, CALIFORNIA
SYcamore 2-4131 RYan 1-6751

What's



New in Radio

TUBE TESTER IMPROVEMENT

Affiliated Television Laboratories, Inc., Queens Village 29, N. Y. has

announced the incorporation of a new 50-volt filament supply in its "U-Check-Em" do-it-yourself tube testers, thus greatly extending the versatility and scope of these units.

According to the firm, the ease with which customers can check their tubes as well as the number of tube types capable of being tested on the device have contributed greatly to improved replacement tube sales.

The company recommends the use of nationally advertised standard-brand tubes in the tester. There are no tie-in deals with tubes and the testers are being sold through accredited parts jobbers.



TINY PHOTODIODE

The Semiconductor Division of Sylvania Electric Products Inc. has just introduced a tiny photodiode which is designed to be used in a wide variety of applications ranging from computers to headlight dimmers.

The new 1N77B junction photodiode, with a diameter of only .077 inch, is especially suitable for extremely compact assemblies where space is at a premium. It is designed for rapid, highly sensitive scanning and reading applications, such as in computer tape

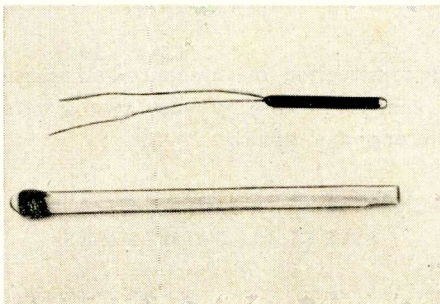

or punched-card "readout." The unit may be readily adapted to infrared detection and heat-seeking devices since it is sensitive to light waves extending from near ultraviolet into infrared.

The unit is hermetically sealed in glass with a built-in lens that focuses light on the sensitive portion of the junction. The light interruption frequency response of the photodiode is

flat from 300 cycles to 15 kc. at 100 per-cent with 260 lumens per square foot. At 25 degrees C, operating voltage is 50 volts d.c., power dissipation is 40 mw., forward current 10 ma. d.c. and light sensitivity is 18.7 peak-to-peak volts minimum and 37.5 peak-to-peak volts maximum. Maximum ambient temperature is 75 degrees C.

85-WATT POWER TRANSISTOR

The Semiconductor Products Department, General Electric Company, Electronics Park, Syracuse, N. Y. has developed a new 85-watt silicon power transistor which is thought to have the highest power rating of any high-temperature transistor available today.

JETEC type-designated 2N451, the new 65-volt silicon transistor is expected to find application in d.c. to d.c. or d.c. to a.c. converters; servo-amplifiers in autopilots and engine controls and for driving amplidyne fields; power supplies as series regula-



tors; and replacement of mechanical contactors and switches.

The unit is capable of dissipating 85 watts at 25 degrees C mounting base temperature. It has a nominal collector saturation resistance of 2 ohms. Beta is specified as a minimum of 10 while beta cut-off is 400 kc. Input impedance at a collector current of 1 amp. is 25 ohms with a mounting base temperature of 25 degrees C. Maximum collector current rating is 5 amps.

The transistor is now in pilot production and will be generally available early next year.

ATR "UNIVERSAL" INVERTERS

American Television & Radio Co., 300 E. 4th St., St. Paul 1, Minn. is now offering a complete new line of "universal" inverters which are actually a combination of four inverter designs in one unit.

Especially designed for operating standard a.c. tape recorders, TV sets, dictating machines, p.a. systems, record players, electric razors, vacuum cleaners, food mixers, electric drills, etc. from d.c. voltages in autos, buses,

trucks, boats, trains, planes, and in direct current areas, the new units provide 110 volt a.c. output at 60 cycles with output wattages ranging from 80 to 600. No auxiliary power-factor-correction capacitors are required.

The inverters feature complete r.f. interference suppression, instant starting, frequency stability, and built-in power factor corrector utilizing a simple toggle switch. Write the company for complete descriptive literature.

V.H.F. MONITOR RECEIVER

Gonset, 801 S. Main St., Burbank, Calif. has announced the production of an entirely new series of FM and

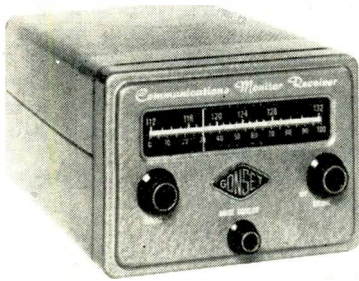

AM receivers for communications monitoring within the v.h.f. ranges in regular use by aircraft and airports, police, fire, taxis, trucks, etc.

All receivers have r.f. stages, meet the new FCC requirements for low oscillator radiation, have good sensitivity and stability, as well as a.v.c. systems for eliminating blocking due to strong signals from nearby mobile units. Each model has eight tubes plus rectifier and includes adjustable squelch and automatic noise limiter. The units will operate from 115 volt a.c. and the speakers are built-in. Audio power output is approximately 2 watts.

The tunable models have full-vision, calibrated tuning dials and are available in the following ranges: 30-50 mc. FM; 112-132 mc. AM; 132-154 mc. AM, and 154-174 mc. FM. Crystal-controlled, fixed-frequency models in various ranges are available where extremely low frequency drift is required.

NEW KLEIN PLIER

Mathias Klein & Sons, 7200 McCormick Road, Chicago 45, Ill. has recently introduced a new long-nose plier de-

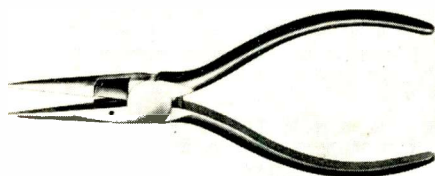

signed specifically to speed up wiring where the cut, hook, and crimp method is employed.

November, 1957

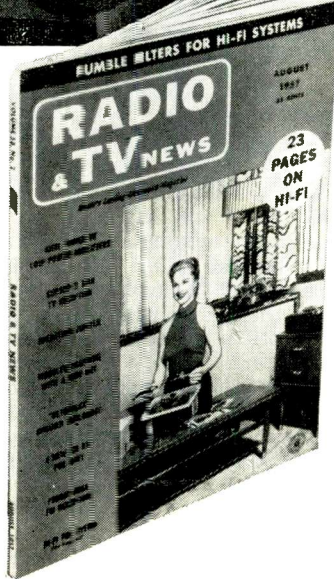
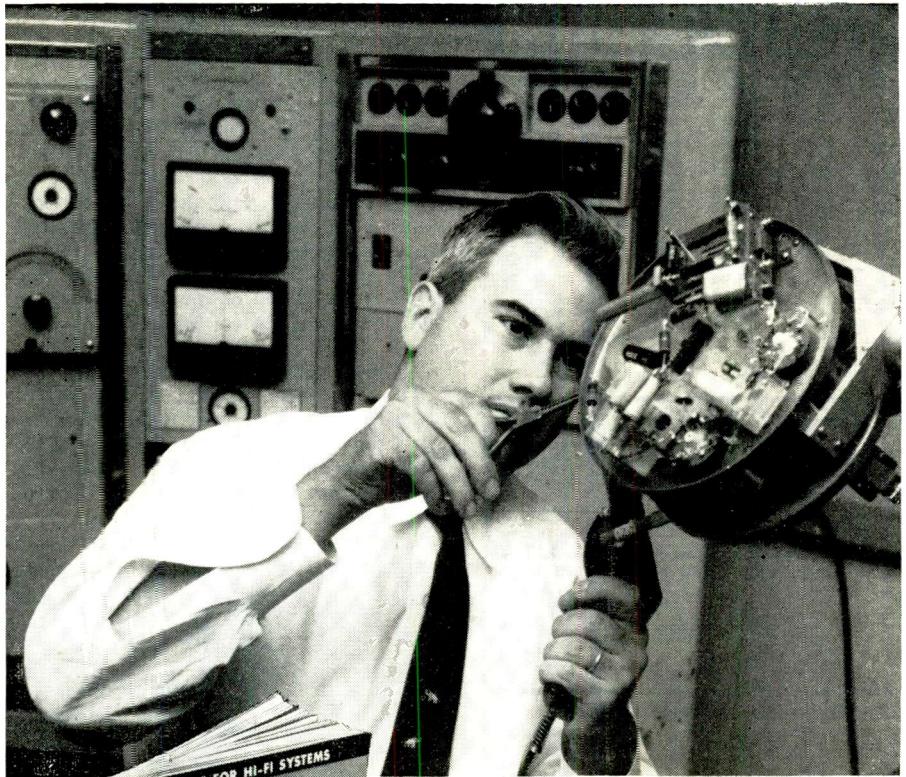

IF THIS MAN IS ON YOUR CHRISTMAS LIST —

A subscription to RADIO & TV NEWS will make a perfect gift for him, and every other man with a stake in electronics.

If he makes his living in electronics or is an advanced hobbyist who loves Hi-Fi, Radio, TV, Audio, R/C, ham radio and communications, he'll be delighted to get RADIO & TV NEWS as a gift. For RADIO & TV NEWS offers the best technical coverage in the field. It provides men in electronics with tips and techniques on repairing, installing and maintaining radio and TV sets and circuits, latest Hi-Fi developments, newest ham techniques, fresh audio ideas, test equipment, and current industry news. There is no more thoughtful Christmas gift, or flattering one, than a subscription to RADIO & TV NEWS, the first and most authoritative magazine in the field. Each of your gift subscriptions will be announced by an attractive card, inscribed with your name. What's more, you can enter or extend your own subscription to RADIO & TV NEWS at these special Christmas gift subscription rates, too!

First 1-year gift subscription \$4
Each additional 1-year gift subscription \$3

Fill in and return the postage-paid envelope facing this page for your own and gift subscriptions. List additional gift orders on an extra sheet of paper.

WRAP UP YOUR CHRISTMAS GIVING NOW! DO IT EASILY, AND APPROPRIATELY, WITH RADIO & TV NEWS



RADIO & TV NEWS • 64 EAST LAKE ST. • CHICAGO 1, ILLINOIS

STAN-BURN

CATHODE RAY TUBE SPECIALS

ONE YEAR GUARANTEE

G.E.	Type	STAN BURN	G.E.	Type	STAN BURN
\$15.80	.10BP4	\$10.00	\$24.75	.171P4	\$18.00
19.10	.12AP4	13.95	27.00	.19AP4	24.00
11.50	.120P4	11.50	28.35	.20CP4A	18.95
30.25	.12UP4	15.00	33.60	.20CP4B*	21.95
20.75	.14CP4	13.75	36.00	.21AP4	25.00
13.00	.13BP4	9.75	29.75	.21EP4	20.15
33.75	.16AP4	18.50	34.85	.21EP4B*	23.25
32.20	.16DP4A	15.25	30.90	.21FP4	21.15
23.50	.16KP4	15.75	37.00	.21MP4	26.25
28.40	.16KP4A*	18.75	29.75	.21YP4	22.00
33.75	.16GP4	18.75	34.85	.21YP4A*	25.00
31.50	.16EP4	16.25	33.60	.21ZP4B*	24.00
31.50	.16WP4	16.25	33.60	.21ZP4B*	24.00
23.50	.17HP4	15.75	100.00	.24AP4	56.00
28.40	.17BP4B*	18.75	48.40	.24CP4A*	38.00
30.75	.17CP4	20.50	50.00	.24DP4A*	39.00
33.90	.17GP4	21.50			

*Aluminized—INQUIRE FOR ANY TUBE TYPE NOT LISTED. STAN-BURN CRT TUBES RCA LICENSED—MFD. BY LINCOLN. All orders of 6 or more STAN-BURN CRT are subject to additional 10% discount. PRICES SUBJECT TO CHANGE WITHOUT NOTICE.

WHY PAY MORE?

HI-FI COMPONENTS • KITS
• RECORD PLAYERS • TAPE RECORDERS • TUNERS • AMPLIFIERS • SPEAKERS • ELECTRONIC PARTS & TUBES • Etc.

Top brand nationally adv. merchandise in this and other Radio & TV mags. is yours at low cost. Send us your list. Give Mfr's name and Model No. of item. Write for '57 catalogs to Dept. RTV-11 today.

BRAND NEW IMPORTED TAPE RECORDERS

Clear, sharp music and speech reproduction. Dual track, 5 tube amp., 6" tape reel, Magic Eye tube, numerical footage counter, 2 tone maroon & grey leatherette case, portable, compact mechanism, weighs under 17 lbs. AMAZING VALUE!
Single Speed (3 3/4) \$64.95
Dual Speed (3 3/4 and 7 1/2) 74.95
FREE reel of tape with each recorder!

HI-FI DIAMOND NEEDLES—1 Yr. Guar.

Diamond needles reduce record wear and needle noise thus retaining full frequency response and tonal qualities of your records for a longer period of time.
SINGLE DIAMOND needle \$7.95
DIAMOND SAPP dual needle 8.95
Shipment PPD. (specify cartridge make)

RECORD CHANGERS

COLLARO RC-456 4 speed changer \$33.81
GARRARD RC-88 4 speed changer 53.41
GARRARD RC-98 4 speed changer 66.15
Free wood mounting base, record wiping cloth and 45 RPM spindle with all orders for Collaro and Garrard changers, with this ad.

VM 4 SPEED HI-FI CHANGER—Model 1210 with Ronette or Astatic flip-over cartridge \$22.95

MONARCH Model U48U 4 SPEED AUTO. INTERMIX CHANGER less crystal cartridge \$19.95

RONETTE (phono fluid) cartridge flip-over type \$2.98
SONOTONE cartridge, flip-over \$2.98
45 RPM SPINDLE for V.M. or Monarch \$1.98
WOOD MOUNTING BASE for V.M. or Monarch 3.95
MOUNTING BOARD unfinished for V.M. or Monarch 1.50

NEW ITEM!

NEW GENERAL ELECTRIC HI-FI VARIABLE RELUCTANCE CARTRIDGE. Replaces discontinued RPX050 type. Full range reproduction 20-20,000 cycles. Four gram tracking force for minimum record and stylus wear.
4G050—Dual Sapphire needles \$8.77
4G052—Diamond, Sapphire needles \$18.99

KITS!

We stock the following manufacturers complete line of kits—see Advertisers Index for reference pages.

EICO QUALITY ELECTRO-VOICE
DYNA BOGEN CABINART
ARKAY PRICISE GROMMES

All domestic orders will be shipped prepaid. Send us your list. Order by Mfr. and Model No. of item.

\$20 WORTH OF ELECTRONIC PARTS IN GRAB-BAG consisting of: Porcelain sockets, coils, speaker, transistor cond. ONLY \$1.98 (plus 50¢ postage)

1957 PHONOLA PHONOGRAPHS

4 speed automatic changers in portable carrying cases, shuts off after last record, jam proof, turnover cartridge, sapp needles, attractive modern styling with tone and volume controls:

No. 757 ECONOMY MODEL—mist blue and white simulated leatherette, crystal cart. \$37.50
No. 857 DUO-FI—2 speakers, 2 tone grey leatherette, 45 RPM spindle, ceramic cart. 49.00
No. 957 HI-FI—2 special HI-FI speakers, ebony starlite leatherette, 45 RPM spindle, ceramic cart. 56.50
No. 1057 HI-FI—3 special HI-FI speakers, 3 controls (base, treble & Vol.), ceramic cart., Diamond/Sapp needles, 45 RPM spindle, Lugage Tan leatherette 78.00

NATIONALLY ADVERTISED IN LIFE, POST, ESQUIRE

YOU NAME IT—WE HAVE IT

Complete line of T.V. & Radio receiving tubes, coils, transp. controls, antennas & accessories—No Minimum Order—DEALER DISCOUNTS! Thousands of satisfied HI-FI enthusiasts and dealers will vouch that STAN-BURN GIVES THE BEST DEAL POSSIBLE!

Export inquiries and offers invited.

Terms: 20% with order. Balance C.O.D. All prices F.O.B. NEW YORK Warehouse.

Write for our latest price list and HI-FI Catalog RTV-11. All Prices Subject to Change Without Notice.

STAN-BURN RADIO and ELECTRONICS CO.
558 CONEY ISLAND AVE. • B'KLYN 18, N. Y.

Acting on a shear principle, this new unit cuts hard or "dead" soft wire cleanly. The shear blade is removable and may be replaced if it becomes worn. The reverse side of the plier has a milled section behind the knife so designed that when the wire is cut it is held in position and a turn of the hand forms a hook in one operation. This is an especially valuable feature when wiring resistors.

The plier is catalogued as the No. 208-6-NC and the company will supply additional details on request.

TINY INSULATED TERMINALS

To meet the needs of makers of ultra-miniaturized assemblies, Sealectro Corporation of 610 Fayette Ave., Mamaroneck, N. Y. has introduced a micro-miniature version of its "Press-Fit" insulated terminal.

The Types ST-SM-16 stand-offs and

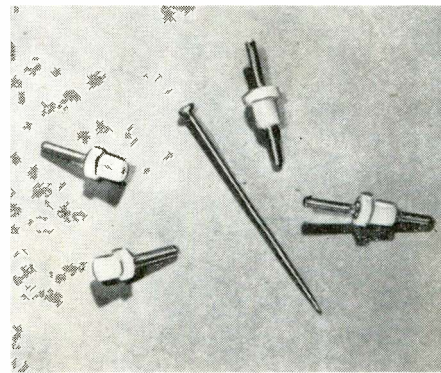

FT-SM-16 feedthroughs are really tiny, even when compared with a conventional straight pin. The Teflon bushing is only .093" diameter for both types while the over-all length for the stand-off is .350" and the feedthrough .515". Lugs are brass, electroplated solder finish. The terminals are rated at 750 volts r.m.s. at sea level; 3000 volts flashover; and 1300 volts actual flashover at 50,000 feet, at a temperature range of -65 to +200 degrees C.

They are available in any one of the eight ELA (RETMA) code colors.

The manufacturer will supply complete information on this new line upon direct request.

I.F. TRANSFORMERS

Radio Industries, Inc., 5225 N. Ravenswood Ave., Chicago 40, Ill. is now offering a line of i.f. transformers for transistor circuit applications.

Available in three sizes, 3/4", 1/2", and

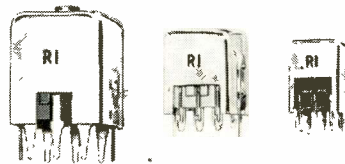

3/8", the latter version resulted from several years of development work in miniaturization for both i.f. and oscillator applications.

All three sizes are engineered and mass-produced to meet any specific requirements of unloaded "Q," ranging from 40 to 200 for the 3/4" and 1/2" and as high as 140 for the 3/8" model. Built-in shunt capacitors provide capacities ranging from 65 to 470.

Engineering data and layout sheets are available from the company on request.

"CONTACARE KIT"

Standard Coil Products Company, Inc. of Chicago, maker of TV tuners, has introduced a new product designed especially to eliminate the common problem of oxidized contacts in TV tuners.

Known as "ContaCare Kit," the unit consists of a specially developed sulphur-free oil which cleans the contacts without leaving a residue which will cause new oxidization. Supplied with the cleaning oil are special cleaning cloths. The kit is housed in a small package which will fit easily into the toolbox or tube caddy.

The product is now available from radio parts distributors.

LAFAYETTE'S R/C UNITS

Lafayette Radio, 165-08 Liberty Ave., Jamaica 33, N. Y. is now catering to the needs of the budget-minded radio-control enthusiast with the introduction of three new units.

The newly designed, crystal-controlled, single-channel transmitter

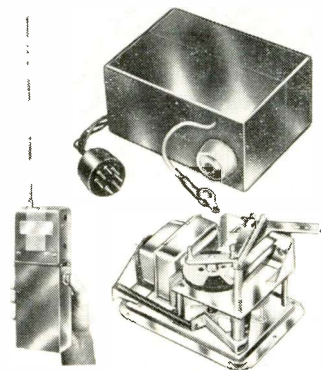

measures only 8 1/2" x 2 3/4" x 1 3/4". Range is a mile or more. Fully assembled and including the 27.255 mc. crystal and tube, the unit is available for under \$15.00. The companion receiver, completely enclosed, measures 3" x 2 1/4" x 1 1/2". It comes completely wired and the price includes the 3S4 tube.

For "mariners," the company is offering a motor-driven electro servo-mechanism for quick positive steering. Single pulse operation and electronic return to neutral are featured in this R/C actuator. It can be used with model boats or land vehicles.

NEW "CODETYPER"

Codetyper Laboratories, 1027 Casa Vista Drive, Pomona, Calif. is now offering a new, improved low-cost Model EBC3 "Codetyper" which will automatically key a radio transmitter as any of the keys on the typewriter-like keyboard are touched.

With this new unit, untrained oper-

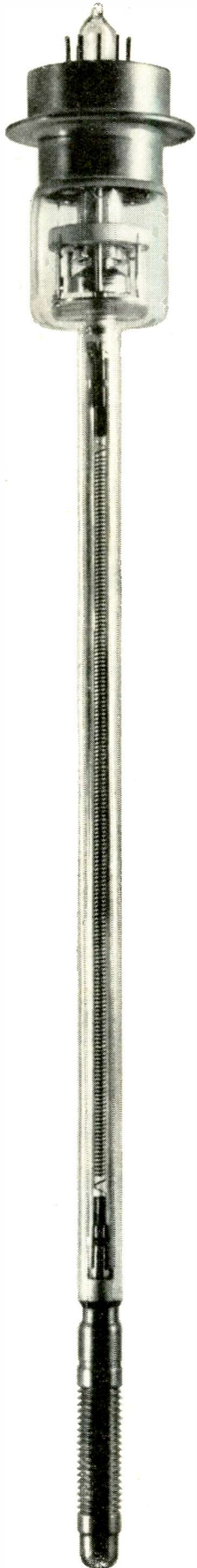

A GREAT AMPLIFIER TUBE IS PERFECTED FOR TELEPHONY

A new transcontinental microwave system capable of carrying four times as much information as any previous microwave system is under development at Bell Laboratories. A master key to this development is a new traveling-wave tube of large frequency bandwidth.

The traveling-wave amplifying principle was discovered in England by Dr. Rudolf Kompfner, who is now at Bell Laboratories; the fundamental theory was largely developed by Labs scientist Dr. John Pierce. Subsequently the tube has been utilized in various ways both here and abroad. At the Laboratories it has been perfected to meet the exacting performance standards of long distance telephony. And now for the first time a traveling-wave tube will go into large-scale production for use in our nation's telephone systems.

The new amplifier's tremendous bandwidth greatly simplifies the practical problem of operating and maintaining microwave communications. For example, in the proposed transcontinental system, as many as 16 different one-way radio channels will be used to transmit a capacity load of more than 11,000 conversations or 12 television programs and 2500 conversations. Formerly it would have been necessary to tune several amplifier tubes to match each channel. In contrast, a single traveling-wave tube can supply all the amplification needed for a channel. Tubes can be interchanged with only very minor adjustments.

The new amplifier is another example of how Bell Laboratories research creates new devices and new systems for telephony.

Left: A traveling-wave tube. *Right:* Tube being placed in position between the permanent magnets which focus the electron beam. The tube supplies uniform and distortionless amplification of FM signals over a 500 Mc band. It will be used to deliver an output of five watts.

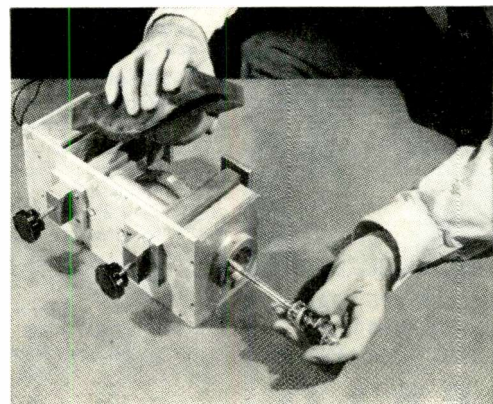

BELL TELEPHONE LABORATORIES

WORLD CENTER OF COMMUNICATIONS RESEARCH AND DEVELOPMENT



NOW!

**Step ahead faster
as an
INDUSTRIAL
ELECTRONICS
TECHNICIAN**



Turn your experience into a big, new better-paying career!

Day by day industrial plants are adding more electronic devices—for sorting, counting, checking almost any control job you can name. Cash in on industry's great need for men who can keep these devices in top working order. Make more money, feel more secure, doing work that is second nature to you. With what you already know about electronics you have a long head start in a field just beginning to boom. GET INTO IT RIGHT NOW with the help of

**PRACTICAL INDUSTRIAL
ELECTRONICS LIBRARY**

No long sessions on math or theory! These 4 practical volumes show you how to keep the plant's electronic equipment working... how to locate and correct tube and circuit troubles... how to install, service, and maintain even brand new equipment without being stumped by new circuits.

4 volumes (1369 pp., 1109 illus.)
Chitt's Electronics in Industry

Miller's Maintenance Manual of Electronic Control

Markus & Zeluff's Handbook of Industrial Electronic Circuits

Hennev & Fahnestock's Electron Tubes in Industry

FREE TRIAL—EASY TERMS

McGraw-Hill Book Co., Dept. RTN-11,
327 W. 41 St., N. Y. C. 36

Send me the Practical Industrial Electronics Library for 10 days' examination on approval. In 10 days I will send \$2.50, then \$4.00 a month until \$22.50 is paid. (A saving of \$4.50 under the regular price of \$27.00.) Otherwise I will return books postpaid. (Print)

Name
Address
City Zone State
Company
Position RTN-11

For price and terms outside U. S. write McGraw-Hill Int'l., N. Y. C.

**RADIO ELECTRONIC
SURPLUS**

APG 15 INDICATOR



Easily converted to a MODULATION INDICATOR unit, contains a 2AP1 tube with shield; also 9006 tube, miscellaneous potentiometers and resistors.

Brand new \$5.00 each
Conversion data to miniature modulation indicator with schematic \$1.00

WALKIE TALKIES

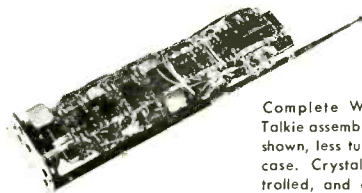

Complete Walkie Talkie assemblies as shown, less tubes & case. Crystal controlled, and covers 3500kc to 6000kc.

Brand new \$9.95 each
2 for \$17.95

OIL CONDENSERS

10 mfd 600 volt D.C. with mounting brackets. Mfgd. by G.E. 95c each
4 mfd 600 volt D.C. 50c each
2 mfd 600 volt D.C. 35c each
Minimum order \$2.50.
Write for quantity prices.

BC603 FM RECEIVERS

20 - 27 mc. Used, good condition. \$6.95

C & H SALES CO.

2176 E. Colorado St. - Pasadena 8, Calif.

ators can be used in an emergency. Speed is continuously adjustable from 10 to 75 words-per-minute. Containing only 12 miniature tubes, the unit is smaller and lighter than a portable



typewriter. The output is simply clipped across the normally used transmitting key, making for convenient, quick hook-up.

The keying relay and power supply are self-contained and allow operation on a.c. or d.c. The complete circuit is printed, including the keyboard switches. A built-in monitor allows audible signals to be heard as the instrument is operated. It makes machine-perfect code and can be used for teaching code reading, if desired.

MATCHED TRANSISTORS

General Transistor Corporation has announced the availability of specially selected matched pairs of *p-n-p* and *n-p-n* transistors for use in complementary symmetry circuits.

These pairs, designated as the "SMP" series, are matched in five contiguous *beta* categories and have a wide variety of applications, especially in transformerless class B push-pull output stages, d.c. coupled amplifiers, and balanced modulators.

A data sheet covering this new series is available from the Promotion Department of the company at 91-27 138th Place, Jamaica 35, N. Y.

"VIKING NAVIGATOR"

E. F. Johnson Company, Waseca, Minn. has added a new transmitter-exciter to its "Viking" line of equipment for the radio amateur.

The unit is designed for the c.w.



operator who requires a flexible, highly stable v.f.o., a first-rate keying system, a means for rapid QSY, and bandswitching with substantial r.f. output. There is ample r.f. power to excite most high-powered final ampli-

TELEVISION

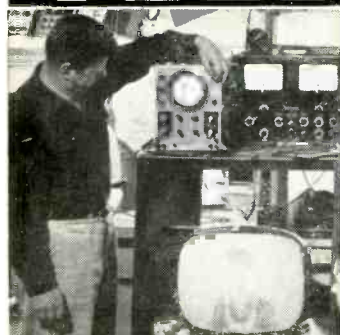

AT HEALDS YOU LEARN
BY DOING IN MODERN
ELECTRONICS LABORATORIES

**HEALD
ENGINEERING COLLEGE**

Established 1863
Van Ness at Post, RTN
San Francisco, Calif.

Industry needs Electronic Trained Men Now! Qualify for BIG PAY JOB, 9 short months. No other type of training can compare with actual shop practice you get at Healds under expert instructors.

Bachelor of Science Degree, 27 Months

- Electronics Engineering (B.S. Degree)
- Electrical Engineering (B.S. Degree)
- Television Technician (9 Months) Color TV
- Electronics Technician (12 Months)
- Mechanical Engineering (B.S. Degree)
- Civil Engineering (B.S. Degree)
- Architecture (B.S. Degree)

Heald College ranks FIRST West of the Mississippi in "Who's Who in America"

Approved for Veterans
DAY AND EVENING CLASSES
Register Now. Write for Catalog.
(No Obligation.)

Your Name
Address
City
State

fiers on c.w. or AM. A wide-range pi-network output will match transmission line impedances from approximately 40 to 600 ohms. Bandswitching is provided from 160 through 10 meters. Internal v.f.o. or crystal-control provides flexibility with full TVI suppression and filtering.

The 40-watt "Navigator" is being offered in kit form as the 240-126-1 and wired as the 240-126-2. Write the company direct for a "design file" giving complete specs.

SERVICE BENCH LAMP

Faries Lamp Division, Elmwood, Ind. has developed a new series of

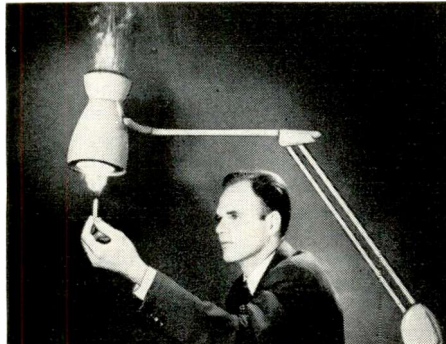

lamps to meet the special needs of the electronic servicing field.

The high light intensity "Kold" lamp has been incorporated in a new line of adjustable flexible arm lamps. With the new "Kold" shade, the user is safe from burns. Even after continuous

burning of a 75-watt bulb, the outside shade is cold to the touch. A flue effect in the design draws off heat with a fast up current.

A universal "friction free" feature employs the gravity principle providing virtually unlimited adjustments. Each lamp extends from a minimum of 12" to a maximum of 38". Eight types in both fluorescent and incandescent are being offered for service bench applications.

The manufacturer will supply full details on request.

"GC" COLOR TV AIDS

Two new service aids for color television work have been introduced by General Cement Mfg. Co., 400 S. Wyman St., Rockford, Ill.

The "Degaussing Coil," catalogue No. 9317, serves to demagnetize the fields set up in a color picture tube prior to color purity alignments. This tool concentrates the CRT field and readily dissipates the heat generated. It comes complete with 9-foot cord and switch.

The second item is the "Color TV Tool" (catalogue No. 9299) which is intended for use on concentric potentiometer controls and convergence controls. The outer sleeve fits into the outside diameter adjusting slot while the inner drive penetrates to the inside slot, making dual adjustment quick, easy, and accurate.

Write the company direct for additional details and prices on this new line of service helps.



FIX OLD RADIOS IN A JIFFY!

Fix 'em good as new . . . without lost time or needless testing

Often it takes more time than it's worth to fix old radios . . . but NOT when you own this 3½ pound, 744-page Ghirardi RADIO TROUBLESHOOTER'S HANDBOOK! The only service guide of its kind still in print! Gives common trouble symptoms and remedies for over 4,800 old-time receiver models made by 202 manufacturers prior to 1942—also auto radios. Even beginners can use it to repair old sets that might otherwise be thrown away because service data is lacking or because testing takes too long.

CUTS SERVICE TIME IN HALF

This famous Handbook more than pays for itself the first time you use it. Covers 85% of the things that are apt to go wrong. Shows exactly where the trouble is likely to be. Explains step by step how to fix it without lost time or useless testing.

Gives full service details on old sets made by Airline, Apex, Arvin, Atwater Kent, Belmont, Bosc, Brunswick, Clarion, Crosley, Emerson, Fada, G-E, Kolster, Majestic, Motorola, Philco, Pilot, RCA, Silverstone, Sparton, Stromberg and dozens more. Includes hundreds of pages of old tube, transformer and other component data.

10 DAY FREE EXAMINATION

Dept. RN-117, RINEHART & CO., Inc.
232 Madison Avenue, New York 16, N. Y.

Send RADIO TROUBLESHOOTER'S HANDBOOK for 10-day examination. If I decide to keep book, I will then send \$6.95 plus postage. Otherwise, I will return book promptly and owe you nothing. (SAVE! Send \$6.95 with order and we pay postage. Same 10-day return privilege with money refunded.)

Name

Address

City, Zone, State

OUTSIDE U.S.A.—Price \$7.50 cash with order only. Money back if you return book in 10 days.

Now! Mr. Dealer... PHILCO Fidelitape

Philco Fidelitape will bring new customers into your store. Tape recorders are now in wide use and recording tape is one of the fastest growing businesses in America today. Make sure you get your share!

- Unequaled in uniformity of output. Guaranteed not to exceed $\pm 1/4$ db within the reel and $\pm 1/2$ db from reel to reel.
- Guaranteed splice-free. Continuous output uniformity and freedom from distortion. Excellent response at high and low frequencies.
- Has a drier-type formula which prevents oxide rub off. Low surface friction reduces wear on heads.
- Has exceptionally low background noise through better dispersing of finer oxide particles. These oxides are magnetically oriented to provide increased output and reduced distortion.
- Has special anti-tack agent which eliminates possibility of sticking on hot erase and record heads.
- Has a moisture-repellent binder which assures smooth, quiet tape travel even under hot, humid conditions.

MAIL THIS COUPON OR CALL YOUR LOCAL PHILCO DISTRIBUTOR FOR FURTHER INFORMATION.



- A. Extra strength in 1½-MIL Cellulose Acetate. 7" reel—1200 ft. . . 5" reel—600 ft.
- B. Extra length in 1-MIL Cellulose Acetate . . . 50% more tape on standard reel. 7" reel—1800 ft. . . 5" reel—900 ft.
- C. Extra length and extra strength in 1-MIL Mylar* . . . Polyester Film. 7" reel—1800 ft. . . 5" reel—900 ft.

*DU FONT TRADEMARK

PHILCO Accessory Division

WORLD'S LARGEST DISTRIBUTOR OF

- Service Parts • Accessories • Universal Components
- Power Packed Batteries • Long Life Tubes • Heavy Duty Rotors • Star Bright 20/20 Picture Tubes
- Long Distance Antennas

PHILCO CORPORATION
"A" STREET AND ALLEGHENY AVE.
PHILADELPHIA 34, PA.

Please send me further information on the brand new, exciting PHILCO Fidelitape

Name

Address

City Zone State

RT-1157A

SAMS "BEST SELLER" BOOKS

FOR THE TECHNICIAN • STUDENT
EXPERIMENTER • HOBBYIST



USE THIS HANDY ORDER FORM

- Pinpoint TV Troubles in 10 Minutes.** Amazingly practical procedures for solving TV troubles. Includes over 50 time-saving check charts, dozens of diagrams and test Methods, circuit explanations, etc.—a real time-saver for TV repairs. 299 pages; 5½ x 8½"; fully illustrated. Only **\$3.95**
- TV Servicing Guide.** Quick reference guide for Technicians. Trouble symptoms are illustrated by picture tube screen photos and proper repair procedures are clearly described. Covers all sections of the TV circuit. 132 pages; 8½ x 11"; illust. Only **\$2.00**
- Tape Recorders.** Explains recorder theory, tape characteristics, how recorders work; covers motorboard mechanisms, drive motors, volume indicators, bias oscillators, amplifiers, magnetic heads, equalization circuits. 176 pages; 5½ x 8½"; illust. Only **\$2.75**
- Transistor Circuit Handbook.** The authoritative book on transistor types, construction, characteristics, applications, circuitry, techniques for wiring and testing. Covers every phase of the subject. 430 pages; 6 x 9"; illust. Only **\$4.95**
- Hi-Fi Handbook.** Invaluable data on Hi-Fi design, selection and installation, including fidelity, sound theory, analysis of all components (speakers, enclosures, amplifiers, tuners, etc.), systems design, proper selection and installation. 240 pages; 5½ x 8½"; illust. Only **\$3.00**
- Servicing AGC Systems.** Describes operation and circuit variations of AGC systems; explains applicable servicing techniques. Illustrated by actual case histories and photos of symptoms. 132 pages; 5½ x 8½"; illust. Only **\$1.75**
- Learning Electricity Fundamentals.** The complete, fascinating story of electricity: history, electron theory, static electricity, uses of switches and fuses, resistance, Ohm's Law, magnetism, electro-magnetism, transformers, generators and motors, circuits and controls, practical wiring, etc. 416 pages; 6 x 9"; illust. Only **\$5.95**
- Transistors.** A very practical, complete book on Transistors and their application in TV-Radio-Electronics. Explains theory, circuitry, installation, testing techniques and servicing. 100 pages; 5½ x 8½"; illust. Only **\$1.50**
- Color Television.** An outstanding training course for Technicians. Covers principles of the color TV system; color receiver circuits; installation and servicing of color receivers. Includes color blocks outlining use of color test equipment. 260 pages; 8½ x 11"; profusely illustrated. Only **\$6.95**
- Electronic Metal Locators.** Explains basic types and their operation; tells how to construct your own units; describes applications. Covers interesting uses in industry as well as in prospecting and mine location. 124 pages; 5½ x 8½"; illust. Only **\$2.50**

HOWARD W. SAMS & CO., INC.

Order from your Parts Jobber, or mail to Howard W. Sams & Co., Dept. 1-L7, 2201 E. 46th St., Indianapolis 5, Ind.

Send books checked above. My (check) (money order) for \$..... is enclosed.

Name _____

Address _____

City _____ Zone _____ State _____

(outside U.S.A. priced slightly higher)

In Defense of the Split-Load Phase Inverter

By DANIEL P. PETERS

A very simple modification of the split-load phase inverter greatly improves the high-frequency balance.

THE SPLIT-LOAD phase inverter has been rather widely used in high-fidelity power amplifiers as the driver stage for push-pull amplifiers. Its popularity is certainly well deserved because of its simplicity and good balance over most of the audio range. The operation of the circuit may be readily seen from Fig. 1A below. An input signal is applied to the grid in series with a bias source (often obtained from the cathode resistor). When the incoming signal swings in a positive direction, the current flowing through the tube increases. Since this current flows through both cathode and plate resistors, the voltage drops across both resistors increase, hence, the output voltage at the cathode goes more positive and this output is in-phase with the input signal. Because of the cathode-follower action here, the amplitude of the output at this point is somewhat less than the input. At the plate output terminal, however, the output voltage is 180 degrees out-of-phase with the input. This is because the increased voltage drop across the plate resistor reduces the available plate supply voltage, causing the actual voltage at the plate to go less positive (or in a negative direction). By reducing the value of the plate resistor to that of the cathode resistor, the signal voltage output at the plate is reduced to that value obtainable at the cathode. As a result two equal-amplitude but opposite-polarity voltages are available to drive a push-pull stage.

Unfortunately, designers often avoid using the split-load phase inverter due to a rather widely held impression of an inherently poor high-frequency balance. Referring to Fig. 1A, it may be

seen that this prejudice grows from the apparent differences in source impedance seen by the plate and cathode output loads. The cathode source impedance, being that of an amplifier with degenerative voltage feedback, is low. At the plate terminal, an amplifier with degenerative current feedback is seen, and the source impedance here is high.

The shunting effects of inverter tube capacitances, wiring capacitances, and input capacitance of the following stage are then supposed to reduce the high-frequency gain more rapidly at the plate, than at the cathode terminal.

However, an analysis of the circuit shows that as long as these shunt capacitances are equal, and shunt both terminals simultaneously, as is usually the case, the actual situation is rather favorable.

If there is no grid current, the plate and cathode currents must be identical. By nothing more complicated than Ohm's Law it therefore follows that if the impedances in series with the plate and cathode are equal, the voltage drops across them will also be equal.

To verify this, the circuit shown in Fig. 1B was bread-boarded to investigate the performance with various values of C_s in the two-decade frequency range from 2000 cycles to 200 kc.

The two outputs were monitored simultaneously on two identical meters to remove the possibility of the meters unbalancing the circuit. Each meter represented a resistance of 10 megohms in parallel with 50 μ fd. Resistors R_p and R_k matched within 1.0% as did the capacitors used for C_s . The meters were pre-calibrated to

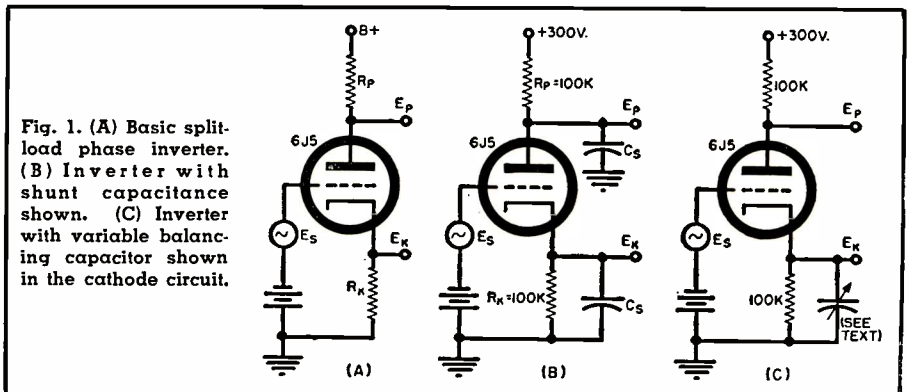

Fig. 1. (A) Basic split-load phase inverter. (B) Inverter with shunt capacitance shown. (C) Inverter with variable balancing capacitor shown in the cathode circuit.



FREE OLSON CATALOG

Thousands of terrific bargains in Hi-Fi, TV, Electronics. Great values in Nationally advertised brands for the Ham, Equipment builder, Engineer, Tinkerer, Serviceman and Hobbyist. **SAVE MONEY!** Send for your free copy today.

BARGAINS FROM OLSON

2 For 1 SALE!

Buy an Olson "Quality" Hi-Fi Amplifier and we'll include the new \$59.97 9762M Norelco 12" speaker at NO CHARGE.

Norelco Hi-Fi 12" SPEAKER



Famous the World Over
Model 9762M

\$59⁹⁷

Stock No. S-202

Has twin cones that reproduce low, middle & high frequencies even beyond audible range. Reasons for this exceptional performance are: High flux density, "Ticonal" magnet, Air gap, twice normal depth, fitted with copper ring which keeps impedance constant. Response 40 to 20,000 cps. 8 ohm V.C. Handles up to 20 watts. Shipping weight 12 lbs.

Olson "Quality" 10 Watt

HI-FI AMPLIFIER

New 1958 Model

Reg. Retail \$99.50

\$59⁹⁷
Less Case

Stock No. AM-39



Attractive steel case with swivel legs. Stock No. AM-40. \$64.3

18 watts peak output. Contains every modern feature you expect: most beautiful style, sloping instrument panel, tape head equalization, loudness control switch, dual tone controls, variable damping control. No expense was spared to make this the finest performing amplifier.

Distortion less than .9%. Response, -1 db. 20-20,000 cps. Controls: Selector-equalizer (LP, EUP, 78, TAPE, TUNER, AUX.) Bass & treble controls, off-on types, Inputs for all types of cartridges including low gain variable reluctance. Output impedances 4, 8 and 16 ohms. Size 13 3/4" L. x 8" W. x 4 3/8" H. For operation on 115 volts AC 50-60 cycles. Shipping weight 12 lbs.

GET BOTH—AMPLIFIER & NORELCO SPEAKER FOR THE PRICE OF ONE

Why does Olson make such an astonishing offer? Instead of spending thousands of dollars on advertising to praise the virtues of our new 1958 Hi-Fi Amplifier, we prefer to make you a deal that you can't pass up. **YOU JUDGE THE QUALITY OF THIS EQUIPMENT.** Money back if not satisfied 100%.

Powerful POCKET RADIO

With Crystal Earphone

\$11⁶²

less batteries

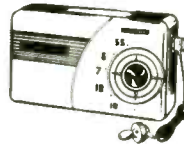

Stock No. RA-278

Portable and lightweight. Only 5 1/2" x 3 1/4" x 1 1/2". 14 ounces with batteries. Delivers tremendous volume to the crystal earphone. Provides sensitivity and selectivity which only vacuum tube superhets can deliver. Case is attractive ivory with gold trim. Three tubes are

employed in an efficient circuit which is the equivalent of many 5 tube sets. Complete with earphone & connecting cable.

BATTERIES

(One Each Required)

Stock No. BA-13—45V Burgess U-30. \$1.75

Stock No. BA-41—1 1/2 V Burgess No. 1.13

New Magnavox 15" HI-FI SPEAKER

Stock No. S-287

\$15⁸³

Each Only **\$3** for \$45



A genuine Magnavox 15" PM Speaker with a 1 pound Alnico 5 Magnet. Delivers beautiful wide range fully rounded tones. Frequency response 30-15,000 cps. Voice coil diameter 1 1/2". Impedance 8 ohms. Power handling capacity 18 watts.

Miniature SPEAKER and BAFFLE

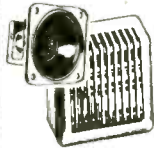

New! Ideal for Extensions

A beautifully designed maroon plastic baffle case with back cover and built in jack with plug. Size only 3" x 2 3/8" x 1 3/8". Speaker is 2 1/2" square, voice coil 8 ohms. Fits into baffle with use of mounting screws.

BAFFLE

Stock No. CA-49 **\$96^c** Ea.
3 for \$2.75

SPEAKER

Stock No. S-294 **\$194** Ea.
3 for \$5.50

12" HI-FI CO-AXIAL SPEAKER

At a New Low Price!



Stock No. S-270 **\$77¹** 2 for \$15.00

Heavy frame finished in silver-zinc. 12" woofer section. 3 1/2" tweeter section. Built-in crossover network frequency response from 35 to 15,000 cycles. Capacity full 12 watts. Voice Coil impedance—8 ohms. Shipped in factory sealed cartons.

SALE! PANEL METERS



Mounts in hole 2-1/16" dia. Choose from these popular types.

Stock No.	Scale	Each	Stock No.	Scale	Each
ME-13	20-0-20 DC Amps	\$2.11	ME-17	0-300 DC MA	\$2.11
ME-19	0-10 AC Amps	3.23	ME-18	0-10 DC Volts	2.11
ME-14	0-1 DC MA	3.87	ME-20	0-15 AC Volts	3.23
ME-15	0-50 DC MA	2.11	ME-21	0-300 AC Volts	4.41
ME-16	0-100 DC MA	2.11			



SPEAKER AND CORNER BAFFLE

COMPLETELY ASSEMBLED

Ready To Install

\$5⁹³

Stock No. S-288

An RCA 8"x9" PM speaker with Alnico 5 magnet, combined with engineered and acoustically balanced corner baffle. Baffle constructed of reinforced plywood covered with mahogany grained plastic material. Attractive matching grille. **SPEAKER BAFFLES ONLY**

Stock No. CA-47. \$4.33

STYLUS MICROSCOPE

Reg. \$3.50 value



Stock No. N-92

\$190
3 for \$5.50

Designed for examining phono needles. Shows the most minor flaws on needle tips. Also useful for record grooves, fibers, specimens, etc. Front lens is threaded for fine focusing adjustments. Nickel trim, black body, 3 3/4" long, 1/2" diam.

STYLUS Pressure GAUGE



\$193 Ea.

Stock No. X-671

Reg. Price \$3.50 3 for \$5.00

Accurately measures weight exerted by stylus on record. Helps reduce record wear. Can be used over turntable so actual "in operation" pressure is shown. Scientifically calibrated in 1 to 30 gram intervals. All parts light weight aluminum. Alloy steel pivot points.

New Wilcox-Gay

Brand New Models

TAPE RECORDERS

YOU GET

Reg. \$99.95
Stock No. AM-28

\$69⁹⁹



Model 750

Dual channel. Records at 7 1/2 IPS. Takes up to 7" reels. 4 tube amplifier and built-in Alnico 5 speaker. Radio-TV-Phono jack and external speaker jack. Erases previous recording automatically when recording. Can be used as PA system with external speaker. With 3" reel of tape and 5" empty reel, microphone, cable and plug. Case with removable cover, 14x12x8".

- Push-button Keyboard
- Record Level Indicator
- Fast Rewind
- Records 2 Hours

How To Order From OLSON

Mail your order to 1157-T S. Forge St., Akron 8, Ohio. Send remittance with order (add for postage 5c for each dollars worth ordered—10c for each dollars worth if you are more than 1000 miles away). **OLSON REFUNDS EVERY CENT NOT USED.** Or—send no money—we'll ship C.O.D. and you pay mail or expressman for merchandise and postage. **ALL MERCHANDISE 100% GUARANTEED. PLEASE—MINIMUM ORDER \$5.00.**

1157-T S. Forge St.
AKRON 8, OHIO

Olson Radio Warehouse

YOU SAVE WHEN YOU BUY FROM OLSON!

AC VOLTMETER

2" 0-150 Volt, AC 60 cycle.
Westinghouse and G. E. . . . ea. **\$3.49**

MICROAMPERE METER

3" 0-50 Microamps, Scale 0-100 (50 Microamp scale supplied) SPECIAL **\$6.95**

FILAMENT TRANSFORMER

HIGH VOLTAGE INSULATION

Primary 220 V. AC Secondary 5V 10 amps ea. \$14.95
35 KV Insul. each
Prim. 115 V. AC Secondary two 5 V windings
6 amps each, 12.5 KV Insul. (G.E.), ea. \$8.95
Prim. 115V. AC Secondary $\pm 1 2\frac{1}{2}$ V 25 amps
Secondary $\pm 2 2\frac{1}{2}$ V 25 amps 7 Volts 7 amps
on same windings. 16 KV Insul. (Sub-signal)
each **\$10.95**

PLATE TRANSFORMER

Primary 110 V.-60 cy. or 220 V. 11½ KW.
Secondary 2350-0-2350 V. AC @ 680 mils full
wave by using two transformers. Each—Size:
7"x7"x7". Weight 40 lbs. each with
Porcelain Insulator. 2 FOR **\$24.95**
1 of above 2350 V. AC @ 340 MA ½ wave.
Each **\$14.95**

SIGMA 5F RELAY

16,000 ohm in dual 8,000 ohm coils. (Can be
paralleled) SPDT adjustable silver contacts. Ad-
justable armature tension. Operates on 500
microamperes or less. Ultimate in a sensitive
relay. Ideal for precision control
work ea. **\$3.95**
Write for quantity prices.

REDMOND BLOWER

110V. 60 cyc. .3 Amp. 1600 Rpm. 3¾" Blower
wheel—Outlet 2" Diameter. Suitable for
cooling Transm. tubes, etc. ea. **\$7.95**
2 for **\$15.00**

RELAYS

Sealed Claire SPST. Norm. closed 3000 ohm
coil 4 ma. ea. **95c**
Claire Telephone Type 11,300 ohm coil
DPDT cont. 10 amp 125V. Sens. 4MA. ea. **\$3.95**
Cutler Hammer Contactor—110V 60 cy. 4
pole s.t. Norm. open 25 amp contacts. ea. **\$6.95**
Hermetically Sealed Relay Coil 110V AC
60 cy SPDT Contacts 5 Amps ea. **\$1.85**
12 Volt DPDT DC Relay ea. **\$1.35**
Each
Cramer Time Delay Relay, 220V 60 cy.
45 sec. adj. 2 pole DT. ea. **\$6.95**
G.E. Plug in Relay 5 prong 2000 ohm
coil 4 mil. SPDT (Sigma 4F). ea. **\$2.50**
Telephone type relay 12 V. DC @ 10 ma.
triple pole single throw. Normally open.
Dynamotor Starting Relay, 12VDC 30
amp contacts ea. **\$1.50**
G.E. Relay control, contains 8000 ohm
relay, sensitivity 2 mils. 10 for \$9.25. ea. **\$1.10**

OIL CONDENSER SPECIALS

BRAND NEW

10 MFD 500 VDC	3.50	2 MFD 2000 VDC	1.50
2 MFD 600 VDC	.75	4 MFD 2000 VDC	3.50
6 MFD 600 VDC	.85	2 MFD 2500 VDC	2.50
1 MFD 600 VDC	.85	1 MFD 3000 VDC	1.85
10 MFD 600 VDC	1.19	4 MFD 3000 VDC	6.95
12 MFD 600 VDC	1.50	1 MFD 7500 VDC	6.95
1 MFD 1000 VDC	.60	.5 MFD 7500 VDC	2.95
2 MFD 1000 VDC	.85	2 MFD 10,000	VDC 39.95
4 MFD 1000 VDC	1.35	1 MFD 15,000	VDC 29.50
10 MFD 1000 VDC	2.95	1 MFD 25,000	VDC 49.50
1 MFD 1200 VDC	.45	8 MFD 660 AC	2.35
1 MFD 1500 VDC	.75	16 MFD 660 AC	.395
2 MFD 1500 VDC	1.10		
6 MFD 1500 VDC	1.95		
8 MFD 1500 VDC	2.95		
10 MFD 1500 VDC	3.50		
24 MFD 1500 VDC	6.95		
1 MFD 2000 VDC	.85		

CHOKES—FULLY CASED

10 HENRY 150 Mil (unshielded)	90c
6 HENRY 150 Mil	\$1.50
8 HENRY @ 200 Ma	1.95
10 HENRY @ 315 Ma	3.50
3 HENRY @ 315 Ma	3.50
6 HENRY 450 Mil	4.95
8 HENRY 500 Mil	5.95
20 HENRY 500 Mil	9.95
7.5 HENRY 650 Mil (Thorarsen com. series)	6.95

PANEL METERS

G.E., WESTINGHOUSE, W.E., SIMPSON, etc.		
2" METERS		
0-1 Mil (Dual scale	0-50 Micro DC . . . 7.95	
0-500V, 0-1000	0-100 Micro 5.95	
Ma) 3.49	(Scale 0-3)	5.95
0-50 Micro DC . . . 5.95	0-1 Mil 3.5 KV	4.50
0-25 Ma DC 2.95	Scale 4.50	
0-200 Ma DC 2.95	0-5 Mil DC 3.95	
0-300 Mil DC 2.95	5-0.5 Mil DC 3.95	
1-0-1 Amps DC . . . 2.95	0-50 Mil DC 3.95	
0-5 Amps DC 2.95	0-100 Mil DC 3.95	
0-25 Amps DC . . . 2.95	0-200 Mil DC 3.95	
0-50 Amps DC . . . 2.95	0-1 Amp DC 3.95	
18-36 Volts DC . . . 1.99	0-15 Amp DC 3.95	
0-50 Volts DC 2.95	0-25 Amp DC 3.95	
0-300 V. DC 3.25	50-0-50 Amp DC . . . 4.50	
0-4 Amps RF 3.49	0-50 Volts DC 3.95	
0-9 Amps RF 2.95	0-1 KV DC 5.00	
	0-1 KV DC 5.50	
	0-7.5 V. AC 3.95	
	0-30 Amps RF with Ext. Thermo- couple 12.95	

MISCELLANEOUS SPECIALS

NON-INDUCTIVE RESISTORS

100 ohm 100 watt 2 for \$1.75
50 ohm 6 watt ea. 35c
HEINEMANN CIRCUIT BREAKER
AM12MT 110V. 60 cy 20 Amps ea. \$1.10

All merchandise sold on a 10 day money back guarantee basis

Min. Order \$3.00—25% with Order—F.O.B. New York

PEAK

ELECTRONICS COMPANY
66 W. Broadway, New York 7, N. Y., WO-2-5439

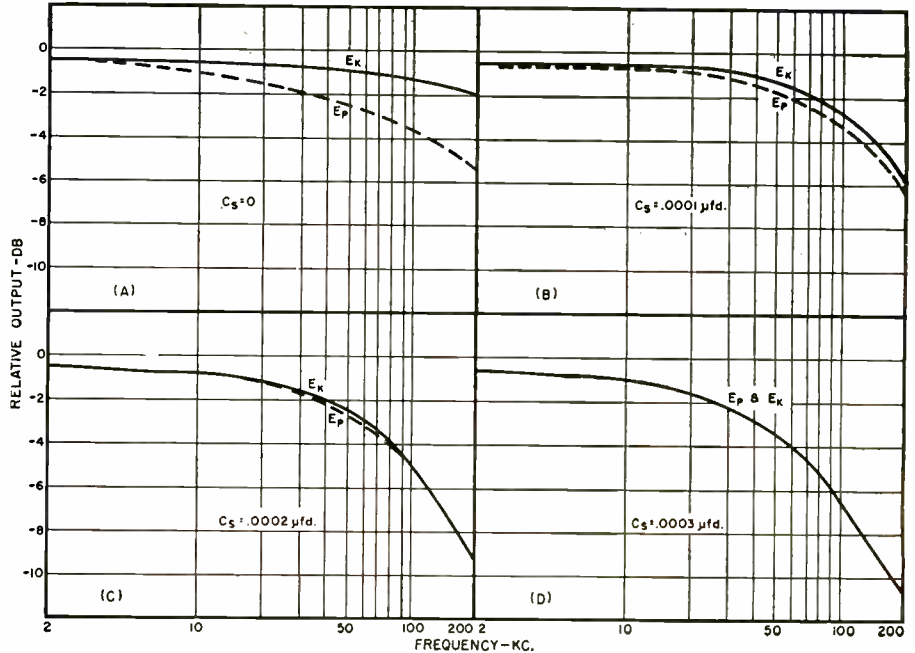

Fig. 2. Response of circuit in Fig. 1B with various amounts of shunt capacitance.

read the same, at a deflection of 0 db, on the range used.

Having taken these precautions the tests were performed and the results summarized in the graphs of Fig. 2. As shown, the balance between the two outputs improved as the shunt capacitance increased. This agrees with the theory but disagrees with the popular conception of the operation of this circuit.

In view of these facts, it is obvious that any unbalance at the high frequencies is due to a difference between the plate and cathode effective capacitances.

Having proved the foregoing, the author next set out to improve the balance, for the unshunted case. Since the unbalance was attributed to a difference between shunt capacitances, it seemed logical to connect a small capacitor in shunt with the output having the higher output voltage.

This was accomplished by connecting a 100 µµfd. trimmer capacitor between cathode and ground as shown in Fig. 1C. With the oscillator set at 200 kilocycles the capacitor was adjusted until the outputs from plate and cathode were equal. In this particular circuit, balance occurred at a capacitor setting of 50 µµfd. Fig. 3 shows the results of a frequency run on this circuit. There was no difference between the

outputs, at any frequency in the range tested.

A comparison of the results in Fig. 3 with the comparable unshunted case of Fig. 2 shows that the additional cathode shunting capacitor has actually improved the frequency response of the plate circuit by a factor of 2.7 db at 200 kilocycles. This is achieved with a drop of only 0.5 db in the cathode output is to be expected, since the capacitor is acting as a partial cathode bypass, thereby increasing the plate circuit gain.

The split-load phase inverter has always been an excellent circuit since the mid-frequency balance depends upon only two resistors and is not affected by tube parameters as are other inverters. It only requires one triode and has an over-all gain of slightly less than two. Unfortunately it has often been shunned because of a reputed high-frequency unbalance and many complicated circuits have been devised to replace it. Now, simply by the addition of a capacitor we achieve a circuit whose balance is as good, if not better, than the most complicated of its replacements. The addition of such a component is certainly worth at least a trial.

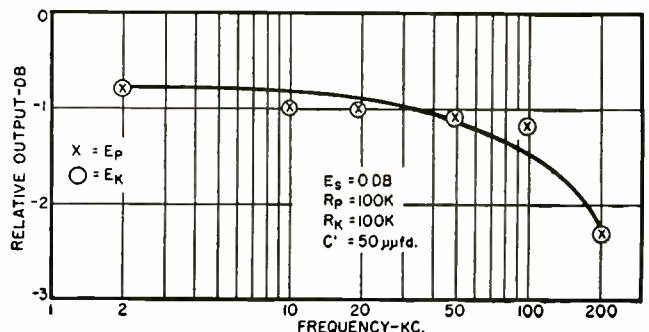

Fig. 3. Frequency response of the circuit shown in Fig. 1C with variable trimmer capacitor C' connected across the cathode resistor.

Are You Losing Money?

(Continued from page 70)

costs have gone up. It costs a whale of a lot more to operate and replace a service car or truck. This means his cost of doing business has gone up. He should be getting more money for his time than he charged two or three years ago.

The major barrier to raising the charges for service is fear on the part of the average dealer. He is afraid that if he raises his charges to the point where his work will pay him a decent income, he will lose all his business to his low-price competitors. Such fears are groundless. Dealers who, out of necessity, raise their charges to an equitable level without regard to what their competitors would do, quickly discover that their fears of competition are all a mirage.

A few years ago a dealer who discovered he was slowly going broke discussed his dilemma with a successful service operator from another city. The first question his friend asked was, "What do you charge for a service call?"

"Two dollars and fifty cents," was the reply.

"You are losing money at that price," the successful dealer said.

"I know it," was the reply. "But I can't do anything about it. All of my competitors charge two-fifty and if I

raise my charges I'll lose what little business I have left."

"At the rate you are going," the successful service dealer said, "You will be bankrupt and out of business within three months. Now why don't you try an experiment as a last resort. Forget about your competitors and raise your charge to five dollars per call. You are headed for bankruptcy as it is. The worst that could happen is that you may be out of business in six weeks instead of three months."

The hard-pressed dealer took his friend's advice and raised his charges to five dollars per call. He was amazed to discover that within two weeks his volume of business started to increase.

Later, in analyzing the rejuvenation of his business, he said, "When we raised our charges to five dollars and discovered that we did not lose all of our business overnight, it lifted my morale and gave me an entirely new slant on selling service. The fact that we could get adequate charges gave us a new enthusiasm for the work. I think our customers felt our reborn enthusiasm because our relations with them improved steadily. We lost most of the chronic grippers who felt that service at any price was highway robbery. But we picked up lots of new customers who did not complain about the service as long as we were prompt and did a good job on their TV and radio sets."

-30-

ROUND, SQUARE, KEY and "D" OPENINGS QUICKLY MADE with Greenlee Radio Chassis Punches

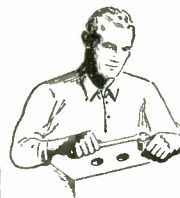
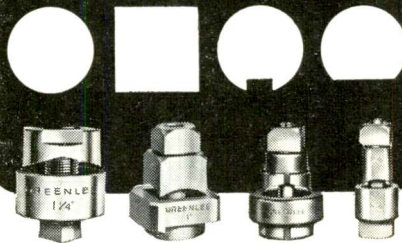

Save hours of hard, tedious work . . . cut accurate holes in chassis for sockets, plugs, controls, meters, panel lights, etc. with GREENLEE Punches. In 1-1/2 minutes or less make a smooth hole in metal, bakelite or hard rubber. Easy to operate . . . simply turn with ordinary wrench. Wide range of sizes. Write for details. Greenlee Tool Co., 1891 Columbia Avenue, Rockford, Ill.



FIX ANY RADIO

Amazing New Invention

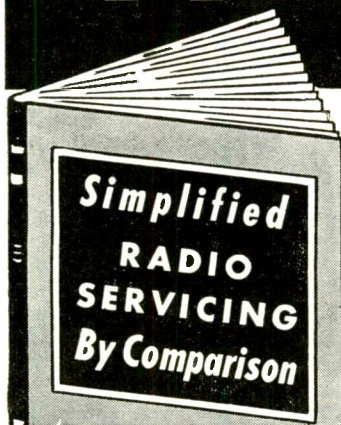

NO TESTERS NEEDED

Find and fix radio faults without any test equipment. Simplified point-to-point, cross-reference circuit suggestions show you what is wrong. Make needed tests, measure voltage, trace the signal, by using only a 5¢ resistor, small condenser, and a crystal detector. Inject signals without any signal generator. Test parts and tubes by the new COMPARISON method. Repair any radio expertly following simplified picture plans. Data on all sets, portables, auto, AC-DC, FM, clock radios, transistor, inter-coms. New edition. Send trial coupon.

CHARTS, HINTS, DIAGRAMS, TESTS

New, revolutionary different COMPARISON method cuts radio repairs to minutes. Explains time-saving trouble-shooting short-cuts. Suggests tests for 24 typical circuits. Gives over 1,000 practical repair hints. For all types of radios, introductory material to help beginners. Several sections on test equipment. Complete plan in manual form, 61 job-sheets, tube charts, 92 large pages of service data, 8 1/2 x 11". Schematics, pictures, charts, repair hints, circuits. Price, only . . . **\$1.50**



TELEVISION SERVICING COURSE

Companion television training manual. Amazing bargain. Giant in size, topics just like a \$200.00 correspondence course. Lessons on picture faults, circuits, adjustments, short-cuts, UHF, alignment facts, trouble-shooting, picture analysis. Special, only **\$3**

NO-RISK TRIAL ORDER COUPON

SUPREME PUBLICATIONS, 1760 Balsam Rd., Highland Park, ILL.

- 1957 Radio Manual, \$2.50
- 1956 Radio Diagrams, \$2.50
- 1955 Radio Manual, only \$2
- 1954
- 1953
- 1952
- 1951
- 1950
- 1949
- 1948
- 1947
- 1946
- 1942
- 1941
- 1940
- 1939
- 1926-1938 Manual, \$2.50
- Radio & TV Master Index, 25¢

These annual RADIO volumes specially priced at only **\$2.50** each . . . **THIS GROUP ONLY \$2 EACH**

- Rush Radio and TV manuals checked in coupon.
 - Simplified Radio Servicing by Comparison . . . \$1.50
 - New Television Servicing Course, complete . . . \$3.
 - Additional 1957 TV, \$3. Early 1957 TV, \$3.
 - 1956 Television Manual, \$3. Early 1955 TV, \$3.
 - Additional 1955 TV, \$3. 1954 TV Manual, \$3.
 - 1953 Television Manual, \$3. 1952 TV, \$3.
 - 1951 Television Manual, \$3. 1950 TV, \$3.
 - 1949 TV Manual, \$3. 1948 TV Manual, \$3.
 - I am enclosing \$ Send postpaid.
 - Send C.O.D., I am enclosing \$ deposit.
- Name:
Address:

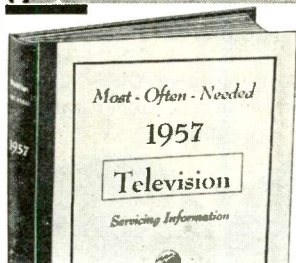

RADIO and TV Manuals

Your complete, best source for all needed RADIO and TV diagrams and servicing data. Most amazing values. Still sold at pre-Korean prices. Only \$2 to \$3 per volume. Every RADIO manual contains large schematics, all needed alignment facts, parts lists, voltage values, trimmers, dial stringing, and many repair hints. Each TV volume is a practical treatise on servicing a full year's sets, with giant blueprints, waveforms, hints, alignment and voltage charts, production changes. See trial coupon at right for a complete list of these low-priced Supreme Service Manuals. →

Supreme Publications
Sold by All Leading Parts Jobbers

EARN TOP SALARIES! BUILD AN EXCITING FUTURE! READ:

YOUR CAREER IN ELECTRONICS

A NEW
ZIFF-DAVIS
PUBLICATION

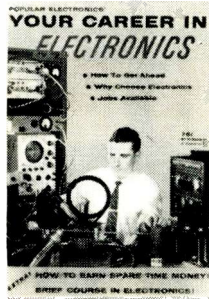

This fact-filled volume prepared by the combined staffs of RADIO & TV NEWS and POPULAR ELECTRONICS is written for men who have a stake in the fastest-growing industry in the world—electronics! If you're eager and ready to move into a more advanced, higher-paying electronics specialty or want to begin an electronics career, don't miss this informative 132-page publication.

IT TELLS YOU

- what job opportunities are available in electronics
- how to prepare for a job in electronics
- how to get a job in electronics

CONTENTS

ELECTRONS, SLIDE RULES AND YOU—Careers in Electronics . . . Am I Too Old to Learn Electronics . . . Women in Electronics . . . What About Tech Writing? . . . Electronics Stands Guard

CAREERS IN PROGRESS—I am an Atomic Engineer . . . I Ride the Satellites and Rockets . . . I Make Electronic Brains . . . Thank Me for Safe Air Travel . . . We Make Color TV . . . We're Looking for Tomorrow

SURVEY OF THE JOB MARKET—Personnel requirements of the largest electronic manufacturing firms—number of technicians, engineers needed, kind of background required, salaries offered, training given and opportunities for advancement.

COURSES, CREDITS AND DEGREES—Training for a Career . . . Home Study . . . College Training . . . Resident Schools

ELECTRONICS IS A PROFITABLE HOBBY—Spare Time TV Servicing . . . Use Your Hi-Fi Know-How . . . Build Gadgets for Money . . . Kits For Sale . . . Profit From P.A. Rentals

BASIC ELECTRONICS—A brief course in the fundamentals of electronics. It gives the beginner a knowledge of terminology and some familiarity with the electronics field.

Buy a Copy of
**YOUR CAREER IN
ELECTRONICS**
ON SALE NOW AT ALL
NEWSSTANDS—only 75c



Use Your Scope Daily

(Continued from page 55)

in Fig. 2 at C_3 output of the filter.

Still using the horizontal sweep frequency setting of the oscilloscope, a check should now be made at the sync take-off point, a typical one being indicated in Fig. 3. While this waveform is observed, the contrast control should be varied from minimum to maximum to determine whether any clipping is taking place. A gassy video output tube is the most likely cause of such clipping, a condition which is not likely to be detected by routine tube testing.

Turning now to the audio section of the TV chassis, with the scope sweep selector in the audio frequency range, a check should be made at the cathode of the audio output tube. In the case of a stacked "B" supply, this will determine whether or not the cathode bypass filter is adequate to prevent audio feedback into the low "B+" line. If this filtering is adequate, then no waveform will be produced.

A final check-point, which will be useful only if a test pattern and test tone are being received, is at the speaker connection. It will be necessary to adjust the scope to show a single sine wave. Misalignment of the

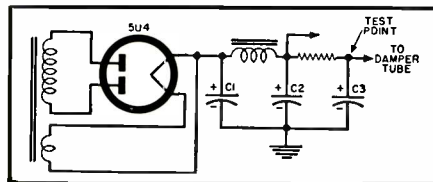

Fig. 2. Test point for the scope at the filter output of a "B+" supply.

FM detector will produce a distorted waveform or a series of "pips" moving along the sine wave. Slight re-adjustment of the FM alignment to produce a sinusoidal output will often correct this condition without resort to a complete alignment procedure. Severe clipping will probably be noticed if the receiver volume control is advanced too far; however, this is produced in the audio stages and has no connection with FM alignment.

Use in Radio Service

Using the scope in radio service is considered a waste of time by many technicians. However, unfamiliarity is often the real reason for not using it. A difficult radio fault can often be located faster with visual methods than by ear, if the technician knows how to interpret what he sees and knows what the correct waveforms

Fig. 4. (A) Normal vibrator may produce small "pips," not shown on this idealized waveform, on square wave edges. (B) Waveform with defective points. (C) Waveform obtained with an open buffer capacitor.

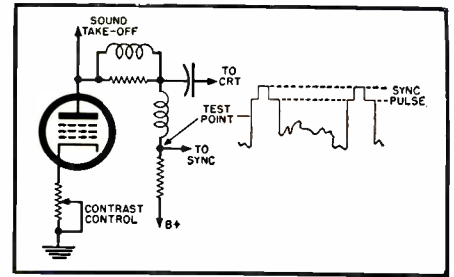
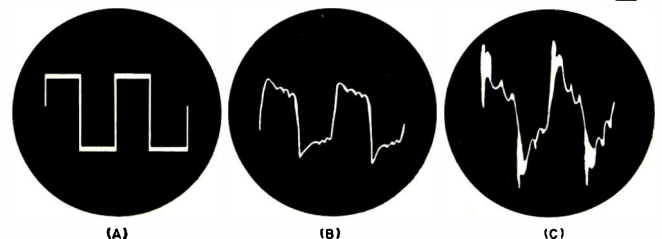

Fig. 3. The sync take-off point should be checked for signs of pulse clipping.

are that he should find in the circuit.

Locating an open capacitor is a natural application for a scope. If no waveform is produced when the probe is applied to the "hot" end of a bypass capacitor, then that capacitor is not open. If a shape of any frequency is seen, then the source of that frequency is not being bypassed and the capacitor must be open or too low in value. The reverse of this condition will hold when checking for an open coupling capacitor. In this case the probe must be applied to the grid end of the capacitor.

A routine check of capacitors in this way on all radio bench jobs will soon make the scope a normal radio service tool. The time-proven method of "snipping and substituting" may be a perfectly sound approach to radio work but, with use, the scope will become faster.

Visual technique can be used to advantage when servicing car radios. A scope can be used to determine the condition of a vibrator and buffer capacitor without any special test equipment. With the scope connected across the primary winding of the vibrator transformer one of the waveforms shown in Fig. 4 will be seen. A vibrator and buffer in good condition will produce the square wave of Fig. 4A; defective or bouncing vibrator points will show up in the jagged trace of Fig. 4B. An open buffer capacitor will produce the effect shown in Fig. 4C due to the reduced time constant of the circuit without capacity.

Routine checking of vibrators in all sets serviced on the bench will soon acquaint the technician with the various waveforms to be expected, until rejection or acceptance of a vibrator or buffer, in a matter of seconds, becomes a normal part of car-radio service.

Only constant use will make the scope an everyday service tool, rather than special equipment reserved for solving the tough ones. In fact the "tough" part of many of these jobs is the technician's lack of experience in handling the equipment.



Manufacturers' Literature

NEW EIA (RETMA) STANDARDS

The Engineering Department of EIA, 650 Salmon Tower, 11 W. 42nd St., New York 36, N. Y. has announced publication of five new standards of interest to the industry.

The new material includes "Dimensional and Electrical Characteristics Defining Miniature Receiver Type Tube Sockets for Printed Circuits" (RS-185) at \$2.80 a copy; "Vibrators for Auto Radio" (RS-187) at \$1.65; "Standard Dimensional System for Automation Requirements" (RS-188) at 25 cents; "Pin Straighteners and Wiring Jigs for Electron Tubes" (RS-190) at 50 cents; and "Measurement of Direct Interelectrode Capacitance" (RS-191) at \$1.50.

Those desiring any or all of these standards should place orders direct with the Engineering Department. Payment should accompany the order.

ELECTRICAL PRODUCTS

Sittler Corporation, 18 N. Ada St., Chicago 7, Ill., has just published the most complete catalogue in its 20-year history—20 pages covering a variety of products and equipment for the electrical industry.

Included in this fully illustrated catalogue is an extensive line of wire and cable, connectors and wiring harnesses, portable spot welders and wire strippers, voltage testers, and commutator maintenance equipment.

Copies of this new publication are available without charge upon request.

PERMA-POWER DATA SHEETS

Perma-Power Company, 3100 N. Elston Ave., Chicago 18, Ill. is now offering multicolored technical data sheets on four of its new products.

The new line of picture tube restorers is described and pictured in an attractive brochure which is designed to be used as an envelope stuffer. Another brochure describes and illustrates the firm's color service aids. The new color gun killer and color kinescope adapter are featured and a technical catalogue sheet is now available which describes the A-400 transistor power supply and shows its outstanding features.

Write the company direct for free copies of any or all of these brochures.

TRIAD TV REPLACEMENTS

Triad Transformer Corporation, 4055 Redwood Ave., Venice, Calif. has announced publication of a new television replacement guide for the professional TV technician.

Designated as Catalogue TV-57, this 108-page guide provides the technician

4 IDEAS

for getting even more use from your
Weller SOLDERING GUN

Your Weller Soldering Gun is the most useful tool in your shop. Service technicians find new, practical uses for it every day. Here are some time-saving applications:

1 CIRCUIT AND COMPONENT DEFECT ANALYSIS. Energizec tip of Weller Gun is substituted for signal generator to find defective components in both audio amplifier section and picture circuit. Quickly uncovers thermal intermittence trouble.

2 REACHES COMPONENTS THROUGH CHASSIS CUT-OUTS. Weller Guns, with their long, thin electrodes, reach recessed tube sockets and connections through small chassis cut-outs. Pre-focused twin spotlights light up this hard-to-get-at work.

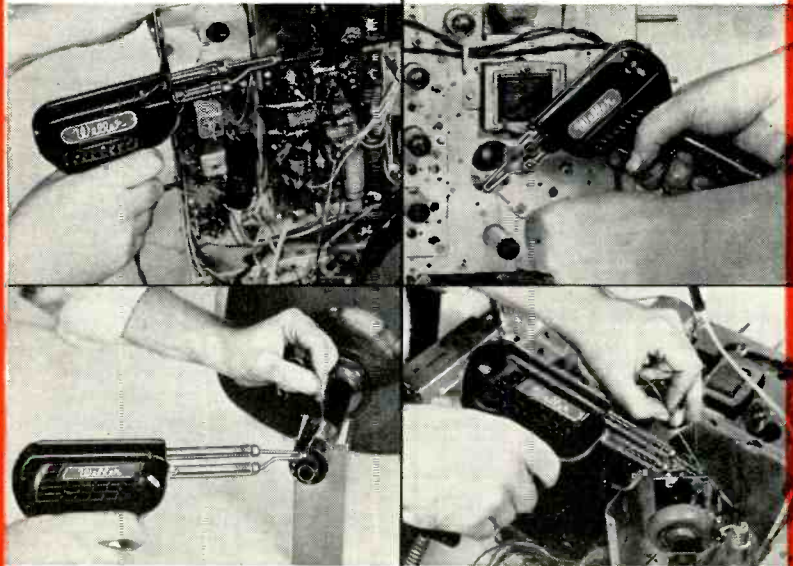

3 NEW SOLDER FOR CATHODE TUBE BASE FIN. Defectively soldered (or loose) base pin is re-sweated to remove imperfections. New solder is then applied to establish uninterrupted contact. Weller Gun is ideal for this type of repair.

4 SOLDERING BROKEN TERMINAL LEADS. Weller Soldering Gun permits controlled application of heat. Solder is maintained at correct viscosity. This enables serviceman to produce rounded joints and prevent corona discharge in high-voltage compartment.

Weller SOLDERING KIT 8100K IDEAL FOR

ALL SERVICE WORK



Complete kit for the price of the gun alone! Latest type Weller Gun—Model 8100, over 100 watts, with triggermatic heat control. 2 pre-focused spotlights. Reaches through small openings into dark places. Kit includes Wire Soldering Brush, wire-twisting Soldering Aid, Kester Solder. Top value at \$7.95 list.

SEE THE FULL LINE OF PROFESSIONAL MODEL WELLER GUNS AT YOUR ELECTRONIC PARTS DISTRIBUTOR

Weller ELECTRIC CORP. • EASTON, PA.
601 Stone's Crossing Road

QUALITY CUT QUARTZ FOR EVERY SERVICE

All crystals made from Grade "A" imported quartz—ground and etched to exact frequencies. Unconditionally guaranteed! Supplied in:

FT-243 holders
Pin spacing 1/2" pin diameter .093



DC-34 holders
Pin spacing 3/4" pin diameter .156

MC-7 holders
Pin spacing 3/4" pin diameter .125

FT-171 holders
Pin spacing 3/4" Banana pins

MADE TO ORDER CRYSTALS

1001KC to 2500KC:
.01% Tolerance. \$1.75 .005% Tolerance. \$2.50

2501KC to 9000KC:
.01% Tolerance. \$1.50 .005% Tolerance. \$2.50
Specify holder wanted.

ANY AMATEUR BAND CRYSTAL
.05% Tolerance

NOVICE BAND CRYSTALS

80 meters 3701-3749KC
40 meters 7152-7198KC
15 meters 7034-7082KC

99c
each

6 METER TECHNICIAN BAND CRYSTALS

SEALED OVERTONE CRYSTALS supplied in metal HC/6U holders—pin spacing .486, diameter .050.
10 to 30 MC .005 tolerance. \$3.85 ea.
30 to 54 MC .005 tolerance. \$4.10 ea.
55 to 75 MC .005 tolerance. \$4.25 ea.
75 to 90 MC .005 tolerance. \$5.50 ea.

STOCK OVERTONE CRYSTALS in FT-243 holders \$1.00. Frequencies listed in megacycles:

15.01	16.7	17.15	18.225
15.11	16.8	17.16	18.325
16.335	16.9	18.025	18.475
16.435	17.0	18.125	18.925

MARINE FREQUENCY CRYSTALS

All marine frequencies from 2000-3200KC
.005 tolerance. \$2.50
(Supplied in either FT-243, MC-7, or FT-171 holders.)

RADIO CONTROL CRYSTALS

27.255 MC sealed crystals. \$2.50 ea.
Stock crystals in FT-243 holders from 5675KC to 8650KC in 25KC steps. \$5.00

FT-241 lattice crystals in all frequencies from 370KC to 540KC. \$5.00
Matched pairs ± 25 cycles \$2.50 per pair.

200KC Crystals. \$2.00 500KC Crystals. \$1.00
455KC Crystals. \$1.00
1000KC Frequency Standard Crystals. \$3.50
Dual Socket for FT-243 Crystals. \$1.50
Ceramic socket HC/6U Crystals. \$1.15

ASK YOUR LOCAL PARTS DISTRIBUTOR FOR TEXAS CRYSTALS. LOOK FOR THE YELLOW AND RED DISPLAY BOARD.

(Add 5¢ per crystal for postage and handling.)
WRITE FOR CATALOG AND QUANTITY PRICES.

Texas Crystals

The Biggest Buy in the U.S.

8538 W. GRAND AVENUE • RIVER GROVE, ILL.
ALL PHONES—GLADSTONE 3-3555

Terms: All items subject to prior sale and change of price without notice. All crystal orders MUST be accompanied by check, cash or M.O. WITH PAYMENT IN FULL. NO C.O.D.s. Postpaid shipments made in U.S. and possessions only. Add 5¢ per crystal for postage and handling charge.

or parts distributor with a new indexing system designed to reduce the location of specific replacement recommendations to a matter of seconds. An expanded service information section provides the user with the company's recommendations for all current receivers, as well as complete, detailed installation data.

The company's authorized distributors or the company itself will supply free copies of the catalogue on request.

RECTIFIER STACKS

A 6-page folder which describes a new series of 170 degree C silicon rectifier stacks has been issued by the Semiconductor Products Department of General Electric Company, Syracuse, N. Y.

The publication describes the special features of the product; selection tips; specifications for single-phase, half-wave; single-phase, center tap; single-phase, bridge; single-phase, magnetic amplifier bridge; and three-phase, half-wave applications; and outline drawings of mounting positions.

Berkeley Instruments

A short-form catalogue which describes seventeen new instruments is now available from the Berkeley Division of Beckman Instruments, 2200 Wright Ave., Richmond 3, Calif.

Included among the new items are preset "EPUT" meters with variable time base for direct digital read-out without conversion and a series of moderately priced portable "EPUT" meters. Expanded scale volt and frequency meters, transformation ratio meters, and resistance bridges are also covered along with nuclear scalars, recorders, read-outs, and the 1100 analogue computer with digital input and output.

Department 7119 will supply copies of this catalogue upon request.

Berkshire Product Data

Berkshire Laboratories, 566 Bank Village, Greenville, N. H. is offering a condensed catalogue sheet, G-110, which includes data on instruments and components made by the firm.

The publication carries photographs and text covering five pulse transformers, an inexpensive 60-cycle stroboscope, a resistor kit containing 153 different 1/2-watt, 5% units, as well as data on the company's "Labmarkers" for generating time markers for CR oscillography, and "Labcases" which are convenient plug-in type housings for three- and four-terminal networks.

Converter Catalogue

An entire new line of d.c.-to-a.c. converters is included in the "Converter Catalogue #557" recently issued by Carter Motor Co., 2711 W. George St., Chicago, Ill.

The publication carries illustrated listings of the new "Mark II" super converters just introduced by the firm including special models engineered for railroad, marine, and industrial

TORSIONAL RELAY—Wallace & Tiernan Frequency selective. For use in applications where radio waves are control medium. Precision construction, unique principles used permit this relay to be used for most existing conditions. Gov't acq. cost \$30.00. Special, while they last. \$3.95

POWER SUPPLY—RA-2B input 115V/1/60, output 110-1420VDC. .450A. circuit breaker, fused, time delay. Cased, potted components. Black wrinkle loured cabinet. Signal Corps specs on door. Br. new. Ship. wt. 125 lbs. \$99.50

WESTERN ELECTRIC DEMODULATOR (CW50125). Converts modulated carrier current into pulses of DC voltage. All W.E. components, relays, filters, Xformers. 15V 60CPS. W/tubes —6SL7, 6V6, 807 (2), 5U4G. Brand new. \$29.95

SWITCHBOARD—BD-72 12 line. Exc. cond. \$25.00

ARC-5 XMTR—3-4ML, w/all tubes, xtal, Exc. \$5.95

RC456 MODULATOR (screen) tubes, dyna. good. \$5.95

DUAL RECEIVER RACK (ARC-5) Br. new METERS: 0-1 Mil (3KV scale) 3/4" rd. Marion—new \$3.95

METERS: 0-1 Mil (0-1000u/a scale) 1/2" clear plastic—new. \$5.95

METERS: 0-15 Mil (1000u/a scale)—new. \$2.95

CARBON DEPOSIT PRECISION RESISTOR —Kit \$1.00

CERAMICONS & DISCS—Kit of 100. \$1.00

115VAC POWER RELAY—Leach 6104-DPST 30A—new. \$4.95

SSB XFORMERS (QST article)—set of 3 ISOLATION & FILAMENT XFORMER—115V to 115V +6.3V winding. Special—new \$1.00

COLLINS 20 Watt MODULATION XFORMER—cased \$1.95

807W/5933—Ruggedized 807—worth \$14.00. Br. new. Sylvania—ea. \$1.59

doz. \$15.00

HANDSET—Br. new TS-13 w/cables. \$4.95

SCOPE, SIGNAL GENERATOR & POW. SUPPLY (115V 60CPS) all in one unit—w/tubes, meter, L.N. 60 lbs. \$19.95

COLLINS CARBON MIKE XFORMER—for small. Cased. 75-12500 ohm CT. 3 for \$2.00

TUBE TYPE 1625 (for SSB Conv.) doz. \$2.75

RADIO SONDB TRANSMITTER—T69F/AM-2—390-410MC—w/2 tubes, ant. New. \$1.95

INTEGRATOR TUBES: 6107/BS212—worth over \$10.00—new. \$2.95

INTEGRATOR TUBES: 6108/BS212—worth over \$10.00—new. \$2.95

BETA GAMMA COUNTER TUBE BS-6—worth \$40.00—new. \$6.95

GAS SWITCHING TUBE—type 1960—new \$1.00

RCA INVERTER DYNAMOTOR ASSEMBLY. For TRC-421 Inverter. Input 115VDC 1A. Output 115VAC 60 Cy. 5A; Dynamotor. Input 115VDC 2A. Output 630VDC .230A. On single chassis with relays & filters. Brand New. \$79.95

REX RADIO SUPPLY CO.

88 Corlandt Street New York 7, N. Y.

BUILD 16 RADIO

CIRCUITS AT HOME WITH THE NEW 1958 DELUXE PROGRESSIVE RADIO "EDU-KIT"



A Complete Home Radio Course ONLY \$22.95

NOW also includes:
• TRANSMITTER
• SIGNAL TRACER
• CODE OSCILLATOR
• SIGNAL INJECTOR

There is no need to spend hundreds of dollars for a radio course. The "Edu-Kit" offers you an outstanding PRACTICAL HOME RADIO COURSE at a rock-bottom price. You will learn radio theory, construction and servicing. You will learn to build radios, solder and wire in a professional manner, troubleshoot radios. You will build 16 Receiver, Transmitter, Code Oscillator, Signal Tracer and Signal Injector circuits, and learn how to operate them. You will receive an excellent background for T. In brief, you will receive a basic education in Radio and Radio, worth many times the small price you pay. Operates on house current.

You will receive all parts, tools and instructions necessary to build 16 different radio and electronic circuits, each guaranteed to operate. Our kits contain tubes, tube sockets, variable, electrolytic and paper dielectric condensers, resistors, coils, hand ware, tubing, punched metal chassis, Instruction Manuals, wire, solder, etc. In addition, you receive Printed Circuit materials, including Printed Circuit chassis, special tube sockets, hardware and instructions. You also receive a useful set of tools, pliers-cutters, an alignment tool, a professional electric soldering iron, and a self-powered dynamic Radio and Electronics Tester. The "Edu-Kit" also includes Code instructions and the Progressive Code Oscillator. You will also receive lessons for servicing with the Progressive Signal Tracer and the Progressive Signal Injector. TV. Radio, Hi-Fi and Quiz Books. FCC Amateur License Training.

All parts, components, etc. of the "Edu-Kit" are 100% unconditionally guaranteed, brand new, carefully selected, tested and matched. Everything is yours to keep. The complete price of this practical home radio and electronics course is only \$22.95. There is nothing extra to buy.

FREE: set of Tools, Soldering Iron, Tester, Membership in Radio-TV Club; Consultation Service, TV. Radio, Hi-Fi, Quiz Books, FCC Amateur License Training, Printed Circuitry, Pliers, Cutters, Alignment Tool, Certificate of Merit, sent for your kit.

UNCONDITIONAL MONEY-BACK GUARANTEE

□ "Edu-Kit" Postpaid. Enclose full payment of \$22.95.
□ "Edu-Kit" C.O.D. will pay \$22.95 plus postage.
□ Send me FREE additional information describing "Edu-Kit". Include FREE valuable Radio & TV Servicing Manual. No obligation.

Name.....

Address.....

.....

.....

.....

PROGRESSIVE "EDU-KITS" INC.
497 Union Ave., Dept. 71E, Brooklyn 11, N.Y.

service. A new "Geneverter" is also listed and described as well as full specs on other units in the company's line. A complete list of the firm's sales representatives is also included.

MORE EIA (RETMA) STANDARDS

The Engineering Department of the Electronics Industries Association (formerly RETMA), 11 W. 42nd St., New York 36, N. Y., has issued five new standards of interest to the industry.

Standard RS-189, entitled "Encoded Color Bar Signals," is available for 30 cents a copy; RS-192 on the "Definitions and Dimensional Characteristics of Quartz Crystal Units" is 50 cents; RS-193 on "Designation System for Cathode Ray Tubes" is 25 cents; RS-194 on "Microwave Relay System Towers" is 40 cents; and RS-195 on "Mechanical Characteristics for Microwave Relay System Antennas and Passive Reflectors" is 50 cents. Standards RS-189, 194, and 195 constitute new material while the other two standards are revisions.

Place orders for any or all of these standards direct with the Association. Payment should accompany all orders.

BUSINESS COST SURVEY

The "Costs-of-Doing-Business Committee" of NARDA has announced that extra copies of its recent survey are now available in booklet form.

The survey results are based on information submitted by members of the Association and comprise a factual, authentic report of the dealers' typical operating experiences in 1956. Information includes dealers' 1956 turnover costs, per-cent of sales involving trade-ins, volume per square foot of selling space, and a regional breakdown of business costs. The report is illustrated with numerous charts.

Orders should be placed direct with NARDA, 1141 Merchandise Mart, Chicago 54, Illinois. In quantities of 1-49 the surveys are \$1.00 each. For bulk prices contact the Association.

SELENIUM RECTIFIER DATA

General Electric Company, Schenectady 5, N. Y., has just released a two-page bulletin which describes its new miniature double-diode "Vac-u-sel" selenium rectifier for TV horizontal-phase-detector diode.

The publication also notes that with minor modifications in the basic circuit the unit may also replace the 6AL5 tube now used. Applications, models, mechanical and environmental specifications, and ratings are discussed.

Specify Bulletin GEA-6538B when requesting this publication from the company.

CLOSED-CIRCUIT TV

The Kin Tel division of Cohu Electronics, Inc., 5725 Kearny Villa Rd., San Diego 11, Calif., is now offering a multi-colored brochure which describes its basic wired, closed-circuit industrial television system in some detail.

The publication contains data on remotely controlled pan-tilt, iris-focus, and other camera accessories; special

GIVE YOUR EARNINGS A BIG B-O-O-S-T!

Let these 2 Great Manuals Train You to Service any Radio or TV Set faster... more profitably

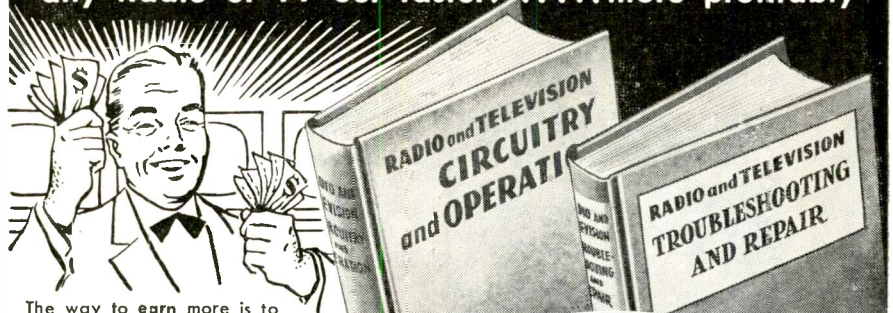

The way to earn more is to learn more! These Ghirardi manuals make it easy for you to be a well-paid expert on all types of Radio-TV service. And they cost only a fraction of the price you might expect for such complete, easily understood training. If sold as a course, you'd regard them as a bargain at \$100.00 or more. Instead, you buy both big books for only \$13.00... and don't risk a cent until you see how good they really are!

SAVE \$1.25

Get this complete 1500-page modern service training library for only \$13.00. Use coupon.

3 MONTHS TO PAY

1 COMPLETE 889-PAGE TRAINING IN TIME-SAVING PROFESSIONAL METHODS

TELLS YOU HOW! SHOWS YOU HOW!

Handy "Quick Guide" Charts cover practically every type of troubleshooting and servicing... from television testing to AM and FM realignment, IF and Detector Sections, car radios... and many more.

For beginners, this famous **RADIO & TV TROUBLESHOOTING AND REPAIR** manual is a complete, top-notch course in money-making professional service methods. For experienced servicemen, it is the ideal way to develop better troubleshooting techniques and shortcuts, find quick answers to puzzling problems, and to handle tough jobs faster.

Block diagrams, response curves, 417 illustrations and other features speed your work... make each step doubly clear. Here are some of the subjects: Component Troubles; "Static" and "Dynamic" and "Visual" Troubleshooting Methods; Shortcuts and Tips; Complete Guide to Television Service; Realignment Made Easy; FM, Communications Receivers, Record Players, etc.; Auto Radios; Loudspeakers; Servicing Tuner and Switching Mechanisms... and many more. Price \$7.50 separately. See MONEY-SAVING OFFER in coupon.

2 THE COMPLETE 'KNOW-HOW' OF CIRCUITS AND THEIR SERVICE PROBLEMS

You can repair any radio or TV set ever made far better, faster and more profitably when you know its circuits from A to Z. That's where this 669-page **RADIO & TV CIRCUITRY AND OPERATION** manual is worth its weight in gold.

You locate troubles quicker... because circuitry "know-how" teaches you exactly what to look for and where. Useless testing and guesswork are eliminated. Covers every receiver circuit and variation in common use. Teaches you their peculiarities and likely trouble spots. Over 110 pages explain every detail of Television circuitry for all receiver sections.

Throughout, this famous book brings you the kind of above-average training that really pays off. Price \$6.75 separately... or see MONEY-SAVING OFFER in coupon.

'GOODBYE' TO SERVICE HEADACHES!

Become an expert on circuits... and watch your service headaches disappear! This book contains the kind of training that counts big in helping you work faster and make more money.

PRACTICE 10 DAYS FREE!

Dept. RN-117, RINEHART AND COMPANY, INC. 232 Madison Ave., New York 16, N. Y.

Send books checked for 10-DAY FREE EXAMINATION. In 10 days, I will either remit price indicated (plus postage) or return books postpaid and owe you nothing. (NOTE: Send cash with order and we pay postage. Same 10-day return privilege with money refunded.)

MONEY-SAVING COMBINATION!

Both books only \$13.00... you save \$1.25. Payable at rate of \$4 (plus postage) after 10 days and \$3 a month thereafter until \$13.00 has been paid.

- Radio & TV Circuitry and Operation (\$6.75)
- Radio & TV Troubleshooting and Repair (\$7.50)

Name.....
Address.....
City, Zone, State.....



OUTSIDE U.S.A.—\$8.00 for TROUBLESHOOTING AND REPAIR; \$7.25 for CIRCUITRY AND OPERATION; \$14.00 for both. Cash with order only. Money refunded if you return book in 10 days.

SPORTS CAR ENTHUSIASTS!

✓ Check these features in the new

SPORTS CARS ILLUSTRATED DIRECTORY
on sale now

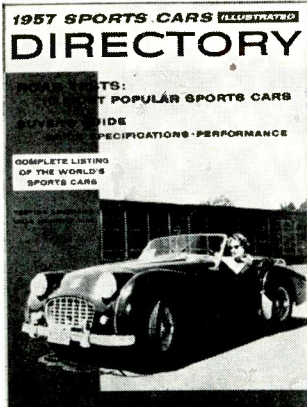

- ✓ Complete road tests of the ten most popular sports cars—Corvette, Thunderbird, AC Ace, Austin-Healey 100-Six, Jaguar XK-140MC, MG-A, Mercedes-Benz 190SL, Morgan TR-3, Porsche 1600, Triumph TR-3
- ✓ Road tests of the four American "Gran Turismo" cars: Chrysler 300-C, Dodge D-500, Plymouth Fury and Studebaker Golden Hawk!
- ✓ BUYER'S GUIDE for all available sports cars—listing names of distributors, prices, specifications
- ✓ BUYER'S GUIDE for limited production cars—names of factories where cars are ordered, factory prices and specifications
- ✓ BUYER'S GUIDE for plastic sports car bodies—fiberglass bodies to fit standard American frames. Dimensions, prices, where obtainable.

PLUS: A complete SERVICE DIRECTORY . . . which lists dealers and garages that specialize in sports car repairs and spare parts.

If you're a sports car owner—or plan to be one soon . . .

DON'T MISS
THE 1958
SPORTS CARS ILLUSTRATED
DIRECTORY
ON SALE NOW AT ALL
NEWSSTANDS—only \$1.00



ruggedized equipment for operation under adverse environmental conditions of noise, heat, shock, and extremes of temperature and humidity; and lists and describes a number of potential and actual installations in which industrial television is saving time, money, and providing more efficient use of equipment and personnel.

Copies of "Industrial Television Catalogue No. 6-42" will be forwarded on written request.

PANEL METER DATA

Waters Mfg., Inc., Boston Post Road, Wayland, Mass., has compiled a 16-page catalogue covering its line of round and square panel instruments which it is offering without charge to interested persons.

Dimensional details and performance specifications are provided on D'Arsonval-type ammeters, millivoltmeters, and voltmeters as well as a.c. rectifier-type microammeters, milliammeters, and voltmeters. Instruments described include meters in 2½" square transparent plastic cases, 2½" and 3½" round, 3½" and 4½" square thermostatting plastic cases, and 2½" x 3½" round metal cases which are hermetically sealed. Data on custom meters is also included.

INDUSTRIAL EQUIPMENT

Precision Equipment Co., 4411B Ravenswood Ave., Chicago 40, Ill., has just issued a colorful 16-page catalogue which is designed to be of help to executives in planning factory and office layouts.

A wide variety of standard storage equipment is pictured and described in detail along with the more specialized items needed by certain industries. A special "library" section of the catalogue is devoted to offerings of free brochures describing several new products.

Copies of this catalogue will be supplied without charge upon written request to the company.

BATTERY BOXES

Austin Craft Co., 431 S. Victory Blvd., Burbank, Calif., is currently offering a four-page, two-color brochure covering its line of spring-clip battery holders.

Included in the new publication is a circuit chart and diagram showing hookups for many voltage combinations using dry and mercury miniature cells. The company stocks over 60 sizes and types of battery holders which can be shipped immediately. Copies of the brochure are available from Dept. RN of the company.

PIEZOELECTRIC HANDBOOK

A revised edition of the Air Force's "Handbook of Piezoelectric Crystals for Radio Equipment Designers" has just been released to industry through the Office of Technical Services, U. S. Department of Commerce, Washington 25, D. C.

Prepared as a guide for designers of military electronic devices, the 702-page illustrated volume (PB 111586R)

A... Always
B... Buy
C... Columbia

RCA TV CAMERA! NEW!
1846 iconoscope, 6-stage video amplifier and clipper. Dozens of uses for lab work, industry, closed circuit TV, etc. **\$149.50 ONLY**

TV CAMERA AND TRANSMITTER
Less tubes and lens. **\$14.95**
Fair condition

BC-604 TRANSMITTER
20-27 MC. 30 W. output. Less input xfmr. tubes. New and like new cond. Wt. **\$3.95**
Approx. 30 lbs

MOTOROLA 6 V. FM TRANSMITTER
25 W. input. 150-170 MC. Complete with tubes and power unit. Excel. cond. **\$34.95**
SWEET BUY!
SAME AS ABOVE except range is 30-50 MC. Good cond. **\$34.95**

FRA FREQUENCY SHIFT RECEIVER CONVERTER: For teletype. Has 400 kc. IF. Excellent cond. Only **\$39.95**

TS-355 SYNCHROSCOPE & SIGNAL GENERATOR. 150-240 MC. 2" cathode ray tube. RF output meter. 110 V. 60 cyc. Like new. Wt. 50 lbs. **\$19.50**

T-19 ARC-5 TRANSMITTER
3000-4000 Kc. AM or CW. Excel. cond. **\$4.88**

RECORDING TAPE
First Quality! 1,200 ft. reels. Boxed, brand new and guaranteed. Reg. price \$2.00 ea. This month only! **\$3.55**
2 (TWO) ROLLS.

GN-39F DUAL VOLTAGE GENERATOR. Outputs: 1,000 VDC @ 350 MA; 12 VDC @ 25 amps. NEW—original boxes, Shp. wt. approx. 100 lbs. **\$8.88**
A COLUMBIA SUPER BUY

1½" SQUARE PANEL METERS
Jewel Movements. Brand New. Boxed!

0-1 MA	.. \$3.50	0-30 VDC	.. \$3.95
0-100 MA	.. 3.50	0-500 VDC	.. 3.95
0-500 MA	.. 3.50	0-50 Microamps	5.95
0-15 VAC	.. 3.95	0-100 "	5.50
0-15 VDC	.. 3.95	0-200 "	4.95
		0-500 "	4.50

BEDEE METER: 0-1 MA, 4" square. Cased in Lucite. A beauty! Orig. cost \$18.00. **\$5.88**
NOW! Reduced to only

All orders FOB Los Angeles. 25% deposit required. All items subject to prior sale. NOTE: MINIMUM ORDER \$3.00. TO EXPEDITE YOUR ORDER MAIL TO DEPT. R.

Columbia ELECTRONICS
2251 W. WASHINGTON BLVD.
LOS ANGELES 18, CALIFORNIA

LEARN
Television
RADIO-COLOR-TV
Electricity
ELECTRONICS
IN THE GREAT SHOPS OF **COYNE**

TRAIN QUICKLY! OLDEST, BEST EQUIPPED SCHOOL of ITS KIND in U.S.

Veterans and Non-Veterans—Get practical training in top opportunity fields. Prepare now for a better job and a real future. Advanced education or previous experience not needed. Employment service to graduates.

Enroll NOW—Pay Later
Finance Plan and Easy Payment Plan. Also Part Time Employment help for students. Training in Refrigeration and Electric Appliances can be included.

FREE BOOK Clip coupon for Big Free Illustrated Book. No obligation and No Salesman Will Call. Act NOW.

B. W. Cooke, Jr., President
COYNE ELECTRICAL SCHOOL
OPERATED NOT FOR PROFIT
Established 1899
500 S. Paulina, Chicago
Dept. 87-85H

B. W. COOKE, Jr., Pres.
COYNE Electrical School
500 S. Paulina St., Chicago 12, Ill. Dept. 87-85H
Send FREE BOOK and full details on:

TELEVISION-RADIO
 ELECTRICITY-ELECTRONICS

NAME.....
ADDRESS.....
CITY.....STATE.....

was written by J. P. Buchanan of Philco for Wright Air Development Center. The new edition is priced at \$7.00 a copy and supersedes one of the same title dated December 1954.

Orders should be sent direct to OTS. Payment must accompany all orders.

NUCLEAR SCIENCE GLOSSARY

The American Standards Association, 70 West 45th Street, New York 17, N. Y., has announced publication of a 188-page volume entitled "Glossary of Terms in Nuclear Science and Technology"—a joint undertaking of the ASA and The American Society of Mechanical Engineers.

The book is designed to provide a common language among medical men, engineers, chemists, physicists, biologists, and others working with the atom. It includes three categories of terms: those invented expressly for the field of nuclear energy; those borrowed from other fields and employed here with different meanings; and those used elsewhere but which may be unfamiliar to nuclear workers. Definitions, tables, charts, and formulas considered useful are also included.

Copies of the glossary (ASA N1.1-1957) are available at \$5.00 each from the Association.

ELECTRICAL WIRING DEVICES

Eagle Electric Mfg. Co., Inc., 23-10 Bridge Plaza South, Long Island City 1, N. Y., has issued a new 76-page catalogue which illustrates and describes over 1500 electrical wiring devices, lamps, and specialty products.

Covering the most complete line in the company's 35 year history, the publication features a number of new items being made by the firm. Included are details on a complete line of self-selling merchandising displays.

All products are grouped in categories, cross-indexed to facilitate quick and easy location of the item. Three time-saving indexes are included. —30—

MOBILE IN MEXICO

DR. KIRKLAND A. BUSH, KØGZ, has written us about a recently revised Mexican ruling which will now permit licensed U.S. amateurs to operate mobile in that country.

According to the new regulations, U.S. amateurs may apply for a mobile license by writing Lega Mexicano Radio des Experimentores, Apartado Postal 907, Mexico 1, D.F., Mexico.

To obtain a mobile license, the request for application should be sent via air mail at least a month to six weeks prior to entry into Mexico. An application, in Spanish, and an English translation will be forwarded. The original Spanish application form is to be filled in and returned.

The fee is \$8.00 (U.S.) plus membership in the League (dues \$5.00) for a total of \$13.00 (U.S.).

For the mobile license, the Communications Dept. will assign an XEØ sign and use the last letters of the ham's U.S. license. For a permanent license for a fixed station, a U.S. citizen would have to live in Mexico for three years.

Mobile licenses are forfeited when the holder leaves Mexico. —30—



AMPLIFIER

Using 2/6V6 Tubes, Carbon Mic. Input and tapped output Transformer. Audio Oscillator for signaling. Complete with Tubes & Case (less Dynamotor) BC-667—New \$2.95

BC-212 AMPLIFIER, Using 2/6C5 Tubes, New: \$1.95

DYNAMOTORS & POWER SUPPLIES:

DYNAMOTORS—See our last month's Ad—or write us your needs!

117 V 60 cycle Power Supply For BC-1206 \$18.95
 117 V 60 cycle Power Supply For 274/ARC-5 18.95
 117 V 60 cycle Power Supply F/BC-603-683-3050... 17.95
 117 V 60 cycle Power Supply F/BC-348-312 etc... 18.95
 GN-45 Hand Generator—6 V 3 A; 500 V 140 MA w/Leads & Seats 9.95
 PE-110 Power Supply—117 V 60 cycle—BC-669, New: 49.50

Frequency Standard OSCILLATOR TS-385

Shown at left of picture—Crystal controlled, 376 to 418 MC; 115 V 60 cycle input; Tubes: 6X5, 6X7, 6L5, 6V6, 6AB, & 3070. KC Crystal w/Schematic. Prices: Used, \$9.95—New, \$12.95

SIGNAL GENERATOR 1-198—Shown in right corner of picture—8 to 15 MC, with Modulation. Complete with 3 Tubes, 115 V 60 cycle. Size: 10 1/2" L x 7" D x 8" H. With Cover. Used \$6.95—New \$9.95

TRANSMITTER

Crystal Control—3.5 to 4 MC, 50 Watts, MO—PA for CW. With Automatic Keyer Motor & Code Wheels. 2/1625 & 1/25L6 Tubes. Complete with Instruction Book & Conversion. T-121—New \$7.95

RANGE BEAM FILTER

1020 cycle acceptance or rejection. W/PL-55 Plug & Cord for plugging into Rec. Two output jacks. New: \$1.95
 FL-8 Filter, Used: \$1.50
 FL-5 Filter, Used: \$1.00

FM COMMUNICATION EQUIP.

FM RECEIVER—10 Tubes, continuous Tuning & Push Button Tuning on 10 preset channels, complete with Tubes, Speaker, Squelch Circuit, & 2 Phone Jacks. Power required: 220 VDC 80 MA & 12 VDC.
 BC-3050 REC.—30 to 50 MC, Converted, ready to operate. Used, Checked—Specify Freq., \$34.95
 BC-683 REC.—27 to 39.9 MC. Used, Checked, \$39.95
 BC-603 REC.—20 to 27.9 MC. Used, Checked, \$19.95
 BC-604 TRANS.—30 Watt, 20 to 27.9 MC Crystal Control. Ten Preset Channels. Power required: 625 VDC 225 MA & 12 VDC. Prices: Used, \$14.95—New, \$19.95
 BC-924 TRANS.—30 Watt, 27 to 39.1 MC. Four Preset Channels. Power required: 400 VDC 400 MA. Not Crystal Control. Prices: Used, \$14.95—New, \$19.95
 OUTPUT & INPUT PLUGS for Rec. & Transmitter \$1.00
 FT-237 BASE to hold Rec. & Trans. Used: \$9.95—New: \$14.95
 DM-34 12 V Dynamotor For BC-3050, 603, 683—Used, Checked: \$2.95
 117 Volt 60 Cycle Power Supply f/BC-3050, 603, 683 \$17.95
 DM-35 12 V Dynamotor For BC-604. Used: \$12.95
 DM-65 12 V Dynamotor For BC-924. Used: \$12.95

BC-659 TRANS. & REC.

BC-659 Trans. & Rec. FM—27 to 39.9 MC—Crystal Control on Two Preselected Channels, 5 to 10 Watt—Complete with Tubes, Speaker, etc.—Used \$29.95
 POWER SUPPLY for BC-659—6 or 12 VDC. Used: \$9.95; New: \$24.95
 1-208 FM SIGNAL GENERATOR—Standard of Voltage Frequency and Frequency Deviation for the test alignment, calibration, sensitivity measurements of FM Receivers. Frequency Range 1.9 to 4.5 MC & 19 to 45 MC. Frequency Deviation can be adjusted 0 to 5 KC for 1.9 to 4.5 MC and 0 to 50 KC each side for the 19 to 45 MC Band. Stability .03 percent through use of crystal calibrator. Modulation Freq.: 150-400, 1000, 2500, & 5000 CPS. With Output Meter & Speaker; 115 Volt 60 cycle or 12 VDC input—Used: \$59.50

G. E. PYRANOL COND. G. E. PYRANOL CONDENSER—25.6 MFD, 1000-2000 Volt Operating. Size: 3 3/4" x 3 1/4" x 6 1/4". Can negative. Prices: \$4.95 ea. — Or 2 for \$9.00

MISCELLANEOUS:

ID-60/APA-10—3" Scope, 21 Tubes—New: \$40.50
 SCR-625 Mine Detector—Reconditioned: 39.95
 AM/PDR-T2 Geiger Counter—Used, Checked: 14.95
 Crime Detector—Ultraviolet & Mercury Vapor, Light Assy.—New: 60.50
 Visual Identification Flash Assy.—6 or 12 Volt, New: 29.50
 EE-8 Field Telephone Set—Reconditioned: 14.95
 RM-52 Remote Control Unit—Used: 3.95—New: 2.95
 RM-53 Remote Control Unit—Used: 2.95—New: 4.95
 RM-12 Remote Control Unit—Used: \$14.95—New: 19.95
 RM-13 Remote Control Unit—Used: \$18.95—New: 23.95
 RM-29 Remote Control Unit—Used: \$ 3.95—New: 4.95

Address Dept. RN • \$5.00 Order Minimum • 25% Deposit on C.O.D.'s • All Prices F.O.B., Lima, Ohio

ROCKET TRANSMITTER

1330 to 1850 KC—with 18 Ft. circumference Parachute, Spark Gap Transmitter, used for jamming; battery operated and with mechanical timer control. Size: 40" H x 7" Dia. T-95/CRT-2... NEW: \$7.95

POWER SUPPLY PP-111/APS-10

Complete with Tubes: VR-105, 6X5, 5R4, 6Y5, 6SH7, & 2X2. Input 115 V 400 cycle & 24 VDC. Output 4000 VDC, 105 VDC & 300 VDC. Shock-mounted Chassis, Size: 9" W x 11" H x 12" D. NEW: \$8.95—USED: \$5.95

INDICATOR

ID-99/APS-10

With 5FP7 Scope Tube, 6AL5, & Includes Video, Deflection, Focusing, & Brilliance Controls. Used: \$4.95
 ID-11/APS-4—3" Scope Tube 3FP7 & 2/6J6 Tubes... New: \$3.95

MAGNETS — MAGNETRON MAGNETS, as pictured—Approx. 1800 Gauss, shown at left: \$12.95—A approx. 4800 Gauss, shown at right: \$14.95

HIGH FREQ. RECEIVER

53 to 88 MC—For remotely controlled radio systems on preselected fixed Freq. Complete with 6 Tubes: 1/65N7, 3/65L7, 1/65G7, 1/615 and 24 Volt Dynamotor. Price: \$7.95—New: \$7.95

ANTENNA RADAR

AS-N/APS-3—With 18" Reflector, 24 VDC Motor, Position Indicator and Wave Guides... NEW: \$19.95

BC-221 FREQUENCY

CASE OR TS-164 Meter Case. With Voltage Regulator Tube VR-105 & two Ballast, Relay, etc. Front Comp. 9 3/4" x 7 1/2" x 7 3/8". Rear Compartment 2" Deep. NEW: \$3.95

PULSE ANALYZER INDICATOR

ID-228 APA-64—Contains two 200 Microammeters, 2 1/2" Meters. Pulse rate Freq.: 0-500 & 0-100 scale, and Multiplier Switch x1-x2 & x10. Other Meter Pulse Width w 0-5 & 0-20 scale Multiplier x1 & x4; plus On & Off and Reset Switch. USED: \$6.95—NEW: \$9.95

PANADAPTOR OSCILLOSCOPE

10-100 APT-17—Indicator with 5" Scope Tube, 5JP2, 6V6, 6SH7, 6SJ7, 2 6AC7, 2 6H6 Tubes. Scope Controls Focus, Horizontal, Vertical, Intensity, & Gain. Also 400 cycle Selsyn Motor. Prices: NEW: \$14.95—USED: \$9.95

INTERPHONE KIT

Interphone Kit—Consisting of H-22 Handset with recoil Cord, Handset Holder in metal box, 35 Ft. 7 Cond. Cable, 14 Ft. Flex. Conduit, Switch Box, Tape, Instruction Book & Extra Parts—NEW: \$9.95

RECEIVERS—TRANSMITTERS:

SCR-522 Rec-Trans. 100 to 156 MC... Used: \$34.95
 RT-19/ARC-4 Rec-Trans. 144 to 148 MC. Less Tubes... Used: 12.05
 BC-375 Trans. 100 Watt; 200-500 KC: 1500-12000 KC... Used: 29.95
 TA-12 Trans. 100 Watt; 300-600; 3000-7000 KC... Used: 32.95
 T-23 Trans. 100 to 156 MC... Used: 14.95
 BC-625 Trans. 100-156 MC (Part of SCR-522). U... 22.50
 BC-457 Trans. 4 to 5.3 MC... Used: 4.95
 BC-458 Trans. 5.3 to 7 MC... Used: 4.95
 BC-696 Trans. Navy Type—3 to 4 MC... Used: 4.95
 Navy Type Comm. Trans.—2.1 to 3 MC: New: \$9.95; Used: 7.95
 BC-230 Trans. w/Coils—2500-7700 KC... Used: 8.95
 BC-624 Rec. 100-156 MC (Part of SCR-522) Used—W/Tubes: 19.95
 Used—No Tubes: 8.95
 RA-10 Rec. 150-1100 KC & 2-10 MC w/Control Box & Cable... Used: 34.95
 BC-1206 Rec. 200-400 KC... Used: \$4.95; New: 9.95
 R-4 ARR-2 Rec. 234 to 258 MC... Used: 6.95
 R-24/ARC-5 Rec. 500 to 1500 KC... New: 19.95
 Navy Type Rec. 1.5 to 3 MC... Used: 7.95
 BC-454 Rec. 3 to 6 MC... Used: 7.95
 BC-455 Rec. 6 to 9 MC... Used: 7.95
 BC-229 Rec/w/Coils—2500 to 7700 KC... Used: 6.95
 BC-966 IFF Rec. 160-211 MC—13 Tubes... Used: 5.95

NOTE: For Items previously advertised but not listed here, please write for Catalog. Sent free on request!

FAIR RADIO SALES 132 SOUTH MAIN ST. LIMA, OHIO

HQ for the 5 TOP QUALITY brands of

TUBES

AT SENSIBLE PRICES!

● Individually boxed ● First quality only
WRITE FOR LATEST TUBE CATALOG FREE!

1B35	3.35	6C21 450TL	957	.30	
1B40	2.00		958A	.35	
1P25A	1.50	6J4	1.70	.20	
1P29	1.50	F32	4.25	CK1005	.30
1P30	1.25	*35T6	2.00	CK1007	.45
CL-2	10.00	VC50 32V	8.00	5517	1.35
0A2	.75	RK-65/5D23		5636	2.75
0B2	.70		7.50	5642	1.00
2B1	3.95	HY69	2.10	5646	4.00
2C35	2.00	RKR72 or 73	.30	5651	1.00
2C39A	10.00	WX-130	1.50	5915	1.20
2C40	6.75	GL299	1.50	5676	.65
2C53	9.75	28D7	.80	5687WA	4.50
2E22	2.90	307A	.60	5693	4.50
2E24	2.25	357A	14.00	5703WA	3.95
2K25	13.50	371B	.75	5718	1.75
2K45	35.00	90A	.90	5726	1.50
2K55	15.00	403B	2.90	5725	1.50
12N155		404A	12.50	5726	.65
(CB5)	3.75	416B	2.25	5749	1.00
12N255		417A	2.25	5749	.95
(CB5)	2.90	417A 5842		5763	1.25
0A3 VR75	.88		12.00	5812	1.00
0B3 VR90	.80	KU610	3.50	5814	1.00
0C3	.75	GL673	12.50	5819	23.95
0D3	.75	703A	.95	5840	3.50
3B24	1.50	807W	1.50	5876	7.50
3B24W	4.25	1CK722	.85	5881	2.80
3B29	4.75	750TL	30.00	5910	.45
3B31	1.50	803	.75	5917	5.50
3C23	3.95	805	4.00	6004	2.00
3C31	1.00	807	1.10	6111	4.50
3C45	6.75	813	8.75	6130/3C45	4.50
3K30	25.00	814	2.50	6161	45.00
3K2000LK		830B	2.00	6201	2.50
	Write	836	2.00	6350	5.00
*4-65A	15.00	837	1.25	6539	9.00
*4-125A	30.25	838	.40	8008	3.25
*4-250A	35.00	856A	1.20	8020	1.00
*4-400A	45.00	872A	.90	9001	.70
4-1000A	95.00	872A (GE)	2.75	9002	.50
4B24 EL3C	4.50	892Z	25.00	9003	1.25
4K500A	Write	927	.95	9004	.25
*4PR60A	30.00	954	.10	9005	.30
5C22	24.00	955	.30	† (Transistor)	
6AK5W	1.00	956	.30	* (Surplus)	

And 1,000 more types. Write for complete list.

LAB SPECIAL

SHALLCROSS KILOVOLT METER

BRAND NEW, portable DC model with 0-5, 0-10, and 0-20 KV ranges. Features reverse polarity switch; internal metering binding posts; metering switch for external and internal measuring; 4 1/2" micrometer; and built into a sturdy industrial grade carrying case that is worth as much as we are asking for the entire instrument. Uses precision resistances throughout; seatite insulation and best grade engraved bakelite panel. Measures 1 3/8" x 1 1/2" x 3 3/8". Accurate to within 2%. Ruggedly built for use in field or laboratory. (Regular price about \$255).

OUR SPECIAL PRICE ONLY—JOBBER-BOXED **\$37.50**

RCA POWER TRANSFORMER

Primary: 115 volts—60 cy. Sec: 550-0-550 @ 250 Ma. 5v. @ 3 amps. 6.3 volts @ 8 amps. (Also has 125 volt winding for bias, etc.) Brand New—Original Boxed. Only \$6.95—#901754-501.

Filter Choke—Westinghouse herm. sealed—10 Hy @ 200 Ma.—New—Only \$1.95

WE ARE FACTORY AUTHORIZED DISTRIBUTORS OF CBS-HYTRON, EIMAC, PENTA, etc.

2 COLOR TUBE CARTONS

Keeps your tube stock neat. New safety partition prevents tube breakage. Distinctively lithographed in glossy red and black. The most distinctive tube cartons available today. Minimum quantity: 100 of any one size. Write for case lot prices.

SIZE	FOR TUBE	PER 100
Miniature	6AU6, etc.	\$1.00
GT	6SN7, etc.	1.25
Large GT	1B3, etc.	1.50
Large G	5U4G, etc.	2.00

WHITE GLOSSY BOXES

Completely blank. No printing or color. Otherwise same as above. Same high quality, same low prices. Specify "WHITE" when ordering. When color is not stated, 2 color cartons will be shipped.

TUBE STACKERS

White glossy only. Ministacker holds 10 Mini. tube cartons; "GT" stacker holds 10 "GT" cartons.

SIZE	PER EACH
Ministacker	1 1/2
GT	2

\$10.00 Per Case of 1,000 F.O.B. N.Y.C.
(All cartons & stackers f.o.b. NYC)

400 MA. COLLINS FILTER CHOKE

6 Henrys at 400 ma. Made by Chicago Xfmr. Co. for Collins transmitters. Hermetically sealed. Grey enamel finish. 10 Kv. insulation. Meas. 4 3/4" x 5" x 6" high. Worth over \$35.00

BRAND NEW! Reduced to **\$8.50**
(3 for \$21.00)

WRITE FOR SEPT., 1957 GREEN SHEET

TERMS: 25% deposit with order, balance C.O.D. All merchandise guaranteed for cost of merchandise only. F.O.B. N.Y.C. Subject to price variation and stock depletion

MINIMUM ORDER \$10.00

BARRY ELECTRONICS CORP.
512 Broadway, Dept. RN, N.Y. 12, N.Y.
Phone: Walker 5-7000

Standard Coil Tuners

(Continued from page 47)

attenuator. Then increase the output to the point where the screen produces a snow-free pattern, as shown in Fig. 8. Mark or record this setting for a pentode tuner. Repeat this process on a set with a cascade tuner and again mark these two attenuator settings. It will be found that a cascade tuner requires considerably less signal for both points.

Thereafter, when there is doubt as to whether the snow or excessive snow is caused by a defective tuner or a defective antenna system, the tuner can be checked with the same generator by taking comparative readings. If the receiver under test requires considerably more signal from the gen-

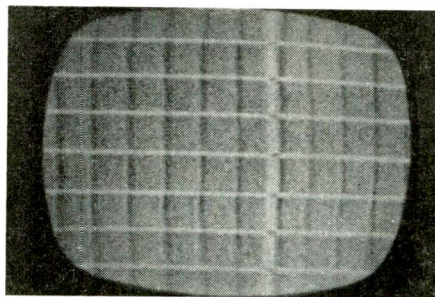

Fig. 7. Faint, snowy pattern used in first step of tuner sensitivity check.

erator for the two tests than do normally operating receivers, it is very likely to contain a tuner defect. Extreme accuracy is not necessary as tuners vary a bit from set to set.

Incidentally, most cross-hatch generators designed for Channels 2 to 6 only, will, nevertheless, produce usable harmonic signals on the high channels. Because tuner gain is usually less on the high channels, defective operation will be more noticeable on these. Therefore, comparative testing should be performed on the high channels for best results.

Quite naturally this sensitivity test is not limited to tuners of one make only. However, a tuner of one make and type should be compared only to another of like make and type if the conclusions are to be valid.

Also, "normal" performance on other tuners may vary too much on one channel because of the interdependence of channel adjustments. —30—

Fig. 8. Snow-free generator pattern used in checking tuner's sensitivity.

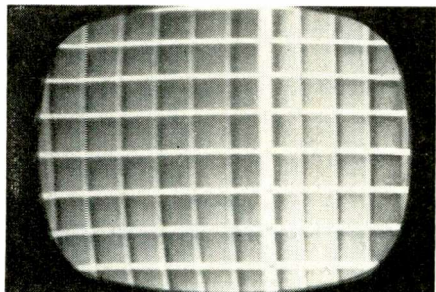

DON'T BUY A THING—

until you send for our

CATALOG #16!

DON'T SELL A THING—

until you offer it to us!



We will pay \$\$\$\$ for an AN/ARN-6 or AN/ARC-3 or any of their components. Also for AS-313 LOOP

Phone us collect on ABOVE ITEMS
Stanley 7-0406
SIMILAR FABULOUS PRICES FOR:

APR-9 . . . ARC-1
ARN-7 . . . ART-13 PARTS
. . . BC-788-C . . . I-152-C
. . . LP-21-AM . . . LM, or
MO-18A or MC-507 from
these loops . . . R-65 APN-9
. . . TEST SETS 1-100,
TS-117, -125, -147, -148,

-488. What else have you? ? ?

ARROW SALES, INC.

Western Mailing Address:

Box 3007-R NORTH HOLLYWOOD, CALIF.
Central Mailing Address & Sales Showroom:
2534 S. MICH. AV., Dept. R., CHICAGO 16, ILL.
California Distributors' Stores
G. L. Electronics, Inc., 1632 Venice, Los Angeles
P.A.R.T.S., 8905 San Fernando Rd., Sun Valley

SCHEMATICS—CONVERSIONS FOR SURPLUS GEAR

NEW LIST! MANY ADDITIONS!

Send stamped, self-addressed envelope for List D. Add 25c for chart explaining AN nomenclature. DO IT TODAY!

R. E.

BOX 1220

GOODHEART

BEVERLY HILLS, CAL.

a TERRIFIC BARGAIN in a

SOLA CONSTANT-VOLTAGE TRANSFORMER

Ends fluctuating line voltage!

Big Discount Off . . .

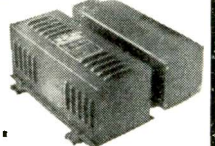

the factory price at a 1-input, 2,000 VA unit! And here's another bonus! This Air Forces 2,000 VA overstock, Sola Cat. No. 30768, has 4 inputs! 90-125 V., 190-250 V., 60 cy. or 50 cy. Isolated secondary is constant 115.0 V. ± 1% from no-load to full-load of 17.4 amp. So, if you choose, use it as a 220-115 V. step-down. And stash \$97.50 off the factory 1-input price!

Brand new in original wood box.
4 cu. ft. Ship. wt. 25 1/2 lbs.
F.O.B. Pasco, Wash., Only.

\$147.50

THE M. R. COMPANY

P. O. Box 1220-A

Beverly Hills, Calif.

WANT TO BUY?

See page 199

CAPACITOR KIT

handles 90% of ceramic capacitor needs

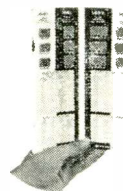

The Sprague "Universal" Ceramic Capacitor Kit CK-4 contains 12 "Universal" Ceramic Capacitors . . . just four of these capacitors take the place of forty-two regular capacitors, with capacitance values from 400 nuf to .015 uF. Handy card tells how to connect leads to get capacitance you need. Only \$3.96 net. See your jobber or send check or money order to SPRAGUE PRODUCTS CO., 51 Marshall St., North Adams, Mass.

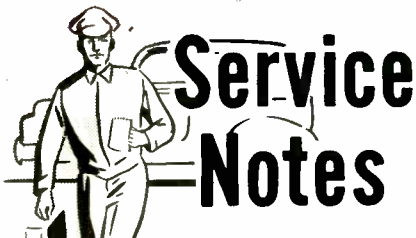

VIDEO SMEAR, RINGING

Westinghouse V-2311 (14") and V-2370 (17") portables have been producing smeary pictures in some instances. Before tearing into the tuner or i.f. circuits, the manufacturer suggests checking the leads to the a.c. switch on the volume control. These leads, particularly the green one, may be resting near the r.f. input transformer (T_1) in passing the tuner. Dressing the leads away from this transformer will often eliminate the smear without further difficulty.

If ringing in the picture occurs on these sets, it may be due to undesired coupling between the 4.5-mc. coil and the picture tube. The green and black leads to the picture tube should be checked to make certain that they are not touching or near the 4.5-mc. coil. They can be taped as close to the printed-circuit board as possible to keep them dressed away from the coil.

G-E VERTICAL LIN. CHANGE

If you have occasion to work on the vertical-oscillator stage in the "Q2" series of chassis, which includes the 14" 110-degree portables, don't get thrown off by a production change. If the set seems to be mis-wired, check against the schematics in Fig. 1. Current schematics for the receivers show the circuit as at (A), which is correct for early production. In later chassis,

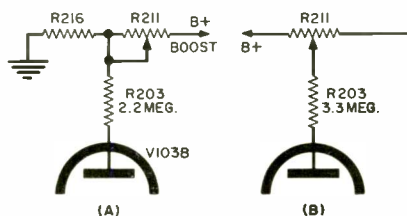

Fig. 1

R_{216} , a 1.5-megohm resistor, was removed from the circuit. R_{203} , in the oscillator plate, was changed from 2.2 megohms to 3.3 megohms. The vertical linearity control (R_{211}) was re-wired and returned to "B+" in the manner shown in Fig. 1B.

There is no need for revising one circuit to look like the other. *G-E* states the change was made because of the cost reduction in eliminating R_{216} , and either circuit should work properly.

RCA TRANSISTOR REPLACEMENT

Transistor radio models 7-BT-9 make use of the type 235 transistor as a converter. If this transistor should become defective, the technician may

November, 1957

Burroughs

is creating

New Careers

in the field
of the future

Data Processing

for Defense

Burroughs Continues To Grow!

Complementing Burroughs' recognized leadership in the commercial research, development and manufacture of machines for business, is the sound expansion of the Military Field Service Division

TECHNICIANS

Here's How
You Can

ADVANCE

to

ENGINEERING STATUS

As a successful applicant you will attend a 22-week formalized training program in Philadelphia, Pa., leading to nation-wide field assignments as a digital computer specialist. You will receive full salary during the entire training program. Generous benefits including educational assistance (in addition to above training).

New Classes Are Being Formed Monthly

If you have technical institute or military training in electronics (preferably combined with pulse circuitry) you are invited to address your inquiry to:

MR. ROBERT LEVINSON
Employment Manager
Dept. M789A



Burroughs Corporation

Military Field Service Division

511 NORTH BROAD ST. PHILADELPHIA 23, PA

"The Foremost Name In Computation"

Examine FREE

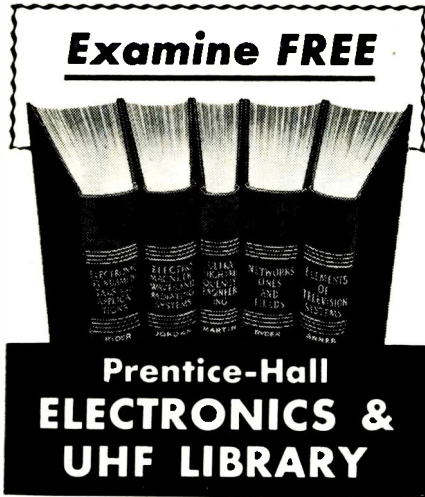

**Prentice-Hall
ELECTRONICS &
UHF LIBRARY**

Edited by **W. L. EVERITT**

5 VOLUMES 1662 ILLUSTRATIONS

Pay Easy Installments If You Keep the Set

Turn to this new, up-to-date Library with complete confidence, for dependable facts on any phase of modern electronic theory and practice. These volumes, by outstanding authorities, give you thorough guidance—clearly written, logically arranged, profusely illustrated.

Electronic Fundamentals and Applications
By Prof. John D. Ryder, Dean, College of Engineering,
Michigan State University

Complete, logical, easy-to-follow treatment of (a) physical principles underlying electron tubes, (b) characteristics of vacuum tubes, (c) all basic tube circuits. Includes: Electron Ballistics. Cathode-Ray Tubes. Emission of Electrons. Space Charge in Vacuum Tubes. Diode Rectifiers. Triodes. Multi-Element Tubes. Small-Signal Amplifier Circuits. Audio-Frequency Amplifiers. Radio-Frequency Amplifiers. Oscillator Circuits. Modulation Systems. Wave-Shaping Circuits. Gaseous Conduction. Gas Diodes. Gas Control Tubes and Circuits. Photocathode Cells. Solid-State Electronics.

Electromagnetic Waves and Radiating Systems

By Prof. Edward C. Jordan, Head, Dept. of Electrical Engineering, Univ. of Illinois

Covers entire field of electromagnetic engineering. Includes propagation as well as radiation and transmission. Full treatment of UHF transmission lines, wave guides, antennas, slot antennas, radiation and diffraction, ground-wave and sky-wave propagation.

Ultra High Frequency Engineering

By Thomas L. Martin, Head, Dept. of Electrical Engineering, Univ. of Arizona

Theory and technique of ALL the new fields of electronic engineering: Radar, Telemetering, Electronic computing, Facsimile, Television, Blind landing systems, Pulse-time modulation, Ionosphere measurements . . . and the others.

Networks, Lines and Fields

By Prof. John D. Ryder, Dean, College of Engineering,
Michigan State University

Network transformations and theorems. Resonance. Impedance transformation and coupled circuits. Filters. General transmission line. High frequency line. Equations of the electromagnetic field. Radiation. Transmission and reflection of plane waves at boundaries. Guided waves between parallel planes. Wave guides.

Elements of Television Systems

By George E. Anner, Univ. of Illinois

Complete basic theory, plus current practice, covering: Closed TV systems. Commercial Teletexting Systems. Color TV Systems. Gives clear exposition of all phases of picture transmission, including the new technique of dot interlace.

SEND NO MONEY—EXAMINE FREE

Just mail coupon below to get complete 5-Volume Set on 10 DAYS' FREE TRIAL. If not completely satisfactory, return in ten days and owe nothing. Or keep the set and pay only \$7.50 down and \$8 a month for five months until full price of \$47.50 is paid. Decide for yourself—without risk or obligation—just mail coupon to examine Library ten days free.

Prentice-Hall, Inc., Dept. 5741-P2
Englewood Cliffs, N. J.

Send me the Prentice-Hall **ELECTRONICS & UHF LIBRARY** (5 Volumes) for ten days' free examination. If fully satisfied in ten days I will send you \$7.50 plus few cents postage and then \$8 a month for five months until full price of \$47.50 is paid. Or I will return the Library in ten days and owe nothing.

Name

Address

City and State

run into a replacement problem. Type 235, no longer being made available as a replacement, may be unobtainable. However, transistor type 2N212 is satisfactory in this circuit. The latter is available through RCA channels as Stock No. 103443. When it is used to replace the type 235, note that the manufacturer points out the importance of doing a re-alignment job on the receiver after such a change has been made. This is necessary to bring the radio up to its maximum performance potential.

YOKE FAILURE, MAGNAVOX

When the yoke goes bad on a *Magnavox* TV receiver of recent manufacture, it will probably pay dividends to look twice before deciding that replacement is necessary. If the symptoms indicate that there are internal shorts in the windings and the yoke happens to be designated as type 360617, the probability is that the yoke itself is still in good condition. This

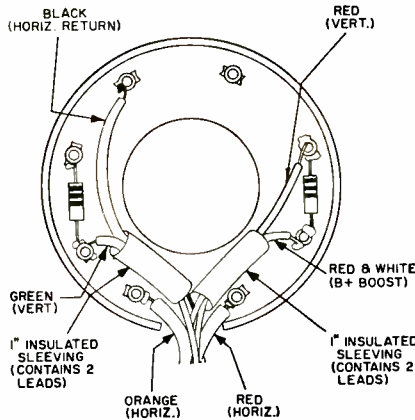

Fig. 2

deflection unit is used in all recent production except the 19 Series.

In most cases, it will be found that the breakdown of insulation on the leads going to the deflection coils, rather than the shorting of windings, has been responsible for the leakage and maloperation. The answer, of course, is a local repair: splicing new leads in place of the burned out sections and slipping 1-inch sections of insulated sleeving over them, as shown in Fig. 2, will complete the repair. Steps have been taken in production of the 360617 yokes to prevent the occurrence of shorting in the future by making certain that the leads susceptible to breakdown are properly insulated at the start against such a hazard.

INTERMITTENT ON HOFFMAN TV

The symptom in question may take the form of intermittent loss of picture and sound, or intermittent oscillation in the picture giving the appearance of ghosting and poor i.f. alignment, on the Hoffman "Mark 10" 14-inch portables using the 326 chassis. Tuner trouble is the first thought that comes to mind. Actually, a defective ground connection in the tube socket of the 2nd video i.f. stage (V₂₀₂, 5U8) is prob-



This ear will change your whole needle business . . . for the better . . .

See Duotone's ear story in the October issue of HIGH FIDELITY—

Also see other exciting Duotone news in September 28 ad in BILLBOARD.

DUOTONE CO., INC.

Keyport, New Jersey
In Canada,
Charles W. Pointon, Ltd., Toronto
The Originator of the
First Commercial Diamond Needle

**WHY WIRE IT?
USE A DANCO**

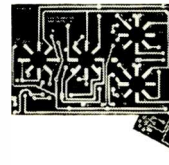

**PRINTED
CIRCUIT
BOARD**

Build a Hi-Fi Williamson type amplifier. There are no design problems. You save wiring time and eliminate the chance of errors. Mount your parts on the board as marked, make a few external connections, solder, and your amplifier is complete. Made of high quality phenolic board, with etched copper wiring securely bonded, the Danco Printed Circuit Board is pre-drilled ready to accept your components. Full instructions and tube sockets included. **\$4.95**

Preamp boards. Build your preamp exactly the way you want it. Layout and design assured—your choice of components—eliminate mistakes—precision engineered—ease of construction—choice of combinations. Model 21 preamp equalizer, Model 31 input selector tone control stage, Model 41 gain compensator output stage, each. **\$2.25**

Each model of preamps includes full instructions and tube socket also.

DANCO MFG. CO., P. O. Box 533, Van Nuys, California

ELECTRONICS

PREPARE FOR A GOOD JOB!
BROADCAST ENGINEER
RADIO SERVICING AUTOMATION

TELEVISION SERVICING
BLACK & WHITE—COLOR

APPROVED FOR VETERANS AND SURVIVORS
OF VETERANS
BUILDING AIR CONDITIONED
SEND FOR FREE LITERATURE

BALTIMORE TECHNICAL INSTITUTE
1425 EUTAW PLACE, BALTIMORE 17, MD.



**BARGAIN
HUNTING?**

**TV
SERVICEMEN!**

Write for **SENSATIONAL CATALOG**
HENSHAW RADIO SUPPLY
3619 TROOST KANSAS CITY, MO.

TAPE RECORDERS

Tapes—Accessories
Nationally Advertised Brands
UNUSUAL VALUES
Send for Free Catalog

DRESSNER
69-02 RA-174 St.
Flushing 65, N. Y.

MERITAPE
Low Cost, High
Quality Re-
cording Tape—
in boxes or
cans.

WANT TO SELL?
See page 199

ably causing the trouble, especially if the receiver's serial number is prior to A821000.

The remedy is simply the installation of a short ground jumper from the center terminal of the tube socket to the ground terminal on the adjacent terminal strip. In production models with a higher serial number, another type of tube socket was used.

CAR RADIO BLOWS FUSES

Motorola reports an interesting puzzler that has come up in connection with its Model 75MF auto radio, used in Ford cars. The same problem might arise in any "hybrid" type of auto radio, using 12-volt tubes and audio-output transistors without a vibrator-powered supply. The radio kept blowing fuses while in the car, but showed consistent normal operation on the service bench.

Cause of the symptom did not lie in the radio itself, but in the battery. The latter had recently gone dead and been subjected to a quick charge or hot charge. It is possible to reverse the polarity of a storage battery by inadvertently charging it backwards, since the reverse current can re-form the plates. All equipment in the auto other than the radio was able to operate normally with reversed battery polarity, with the receiver being the only clue to the condition. The remedy, of course, was to reverse battery polarity.

NO SIGNAL AFTER WARM-UP

Some Firestone TV receivers, in the series bearing Stock Nos. 13-G-210 to 13-G-217, fire up well after they are turned on, then suffer from a sudden loss of picture and sound signal after warm-up. If you run into this symptom, the cause is likely to be the shorting to ground of signal in the video detector. The culprit is the second-detector diode itself, CK706A,

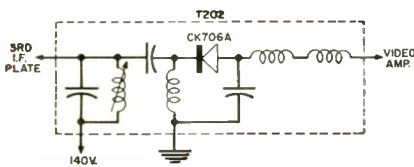

Fig. 3

which is located inside the can for the 3rd i.f. transformer, as shown in Fig. 3. The body of this diode is not an insulating shell, but merely a painted metal tube. As the receiver heats up, this body may come into contact with the top of the i.f. can on the inside, or it may touch the adjacent wiring, which is the ground bus. To prevent a recurrence, simply dress the diode so that it clears the inside surfaces of the can as well as the wiring. For access to this component, the i.f. can will of course have to be removed first. The can is held in place by two-prong mounting clips. Squeeze the prongs and pull the can away from the chassis.

-30-



YOU NEED THIS...

FREE GIANT ALL NEW 1958 BA CATALOG

A COMPLETE BUYING GUIDE FOR EVERYTHING IN

RADIO • TV ELECTRONICS

BA 1958

ANNUAL CATALOG 581

SINCE 1927

Guarantee
We guarantee everything in our Catalog to be of the quality and value represented to conform exactly to the illustration and description to perform in the manner and give the service intended for such purposes.

172 KING-SIZED PAGES

EVERYTHING IN RADIO TV AND ELECTRONICS

100'S OF NEW ITEMS LISTED HERE FOR 1st TIME

21 PAGES OF BARGAINS NOT IN ANY OTHER CATALOG

RUSH COUPON TODAY!

INDEX PAGE 170 PHONE BALTIMORE

BURSTEIN-APPLEBEE CO.

**BURSTEIN-APPLEBEE CO. Dept. M,
1012-14 McGee St., Kansas City 6, Mo.**

Send Free 1958 B-A Catalog No. 581.

NAME _____

ADDRESS _____

CITY _____ STATE _____

WANT TO TRADE?

See page 199

Castle TV Tuner Service

ANY TUNER REBUILT **\$995**
(EXTRA IF MUTILATED)

1723 W. Lunt Chicago 26, Ill. 152 MAIN ST. TORONTO 13

in U.S.A. or CANADA

ADAPTER

Write for Bull. 354B

TYPE 7B \$2.25
TYPE 8B \$2.50
TYPE 9B \$2.75
(ILLUSTRATED) plus shipping chgs.



- Min. size for use in crowded spaces
- RETMA color coded terminals
- Uses (All above chassis)

1. Modify circuits for max. performance and testing without soldering or unsoldering.
2. Break into any circuit for trouble shooting.
3. Measure voltage, resistance and current in conjunction with standard instruments.

A. L. PRODUCTS CO., INC.

—311 Hickory St., Kearny, N. J.—

"TAB" Tubes Tested, Inspected, Boxed

Guaranteed New **FIRST QUALITY** Surplus

0A2	.72	12AT6	.69
0B2	.72	12AT7	1.10
0C3	.84	6B8L7	1.95
0D3	.80	6B8N6	1.08
0Z4	.50	806	2.00
1A7	1.00	6BZ7	1.25
1B3	.78	6C4	.49
1R5	.78	6C5	.78
1S4	.78	6CB6	.80
1T4	.78	6CD6	1.49
1U4	.68	6H6	.59
1U5	.68	6J5	.59
1X2A	.68	6J6	.59
3Q4	.68	6K6	.59
3Q5	.86	6K7	.79
3S4	.68	6L6	1.19
3V4	.99	6S4	.59
SR4	1.25	6S8	.99
SU4	.59	6S8A7	.69
SV4	.89	6S8B7	1.19
5Y3	.59	6SC7	.89
6AB4	.59	6SG7	.79
6AC7	.79	6SH7	.69
6AG7	.89	6S7	.79
6AH6	.99	6SK7	.89
6AK5	.69	6SL7	.89
6AL5	.59	6L5	2.79
6AQ5	.66	6SQ7	.74
6AS7	3.00	6SR7	.79
6AT6	.49	6T6	.98
6AU4	1.29	6UR	.98
6AU5	1.19	6V6	1.39
6AV6	.59	6W4	.79
6AX4	.79	6W6	.89
6B7	3.99	6X5	.49
6B7A	1.00	6X5	.49
6B8	.69	6V6	.89
6B8E	.59	7M7	.79
6B8G	1.50	12AL5	.59
6BH6	.79	12AX5	.80

Write for Complete Tube List. Discounts to Qty. Buyers TUBES WANTED! WE BUY! SELL & TRADE!

NEW TYPE "GE" PHONO CARTRIDGES

ORIGINAL BOXED G.E. MONEY BACK GTD.	
4G061/LP or 4G063/75 DIAMOND	\$15
4G050/LP&78 TRI-PLAY SAPPHIRE	\$7
4G032/LP&78 TRI-PLAY DIAMOND & SAP.	\$17
4G033/LP&78 TRI-PLAY DIAMONDS	\$25

NEW IMPROVED "TAB" HI-FI SPEAKERS

With inbuilt Network Ticonal Alnico 5 Plus Magnet, 4 to 8 ohms V.C.	
15 TRIAX, 25 Watt/20-20,000 Cycles.	\$36
MODEL F12HX	\$27
12" TRIAX, 20 Watt/40-20,000 Cycles.	\$27
MODEL F12HX	\$27
12" COAX, 20 Watt/35-18,000 Cys.	\$22

NEW PREAMP & AMP 60 WATT HI-FI

U-Build-It Preamplifier and Amplifier Model T80, 20 to 10000 cycles at 60 watts with minimum distortion. Bass & Treble Tone Controls, 5 point Record Selector, Phono-Pickup Selector, Internal Selector, Tape Recorder Input, 25lb Hi-Fi Output Transformer feeds 4, 8 or 16 ohm speakers & electrostatic units also. 2 power outlets. The Newest, Latest & Finest design easily built.
KIT—Less Grill Cover. \$69; Grill Cover Extra..\$7.50
50 Watt Super HiFi Amplifier Kit.....\$59



1ST QUALITY DIAMOND PHONO-NEEDLES

REGISTERED & ONE YEAR GUARANTEED*
FOR ALL MAKES & CARTRIDGES LP&78
ONE DIAMOND \$7; TWO DIAMONDS \$14
DIAMOND & SAPPHIRE \$10; SAPPHIRE \$2.39
ONE SAPPHIRE
SPECIFY LP OR 78. PHONO-CARTRIDGE.
NAME & NUMBER

WORKMANSHIP & MATERIAL BY THE FACTORY.

NEW TEST EQUIPMENT KITS

TIK VTVM KIT \$24; TSK SCOPE 5" KIT.....\$42
RES/CAP BRIDGE KIT \$19; TUBE TESTER KIT \$34
HFI 2-WAY SPEAKER KIT \$19; DYNAMIC KIT \$19
DYNAMIC TUBE & TRANSISTOR TEST KIT.....\$68
ARCS-274N EQUIPMENT SPECIALS
BC457 As Is \$1.39; BC457 4 to 5 TESTED.....\$3.95
BC458 As Is \$1.98; BC458 5 to 7 TESTED.....\$4.95
AN-ARR2/RVCR As Is \$3.89
ARCS/719 3 to 4 TESTED.....\$6.89
TRANSFORMER/FWB RECTIFIER 120R24VDC COMBO
INTP/115VAC/60CY. OUTPUT 10VDC 2 AMP OR
24VDC @ 1 1/4 AMP. SPECIAL BOK KIT.....\$4.70
NEW ELECTRONIC FLASH AC & BATTERIES
ASSEMBLED & READY TO WORK. GUIDE-COLOR 60+
AW200+ "TABLITE" 400A.....\$25
IN KIT FORM TABLITE 400A.....\$20
NEW 600A/120VSECS. COLOR 70+. BAW225+ \$20
NEW 1000A/240VSECS. COLOR 150.....\$35
P&W450.....\$50
*NEW FRESH BATTERIES TWO 240V EACH.....\$5.50
*"TAB" PHOTOFLASH DATA & CIRCUIT \$4.50
FRESH NEW GTD 525 MFD/450VDC LO-LEAKAGE
53W-SECS CAPACITORS \$20 VALUE SPECIAL \$5 @ 4/\$18

INFRARED SNOOPSCOPE

See In Dark Tube
Selected GTD. Image Converter Tube. Hi-sensitivity. Simplified design 2" dia. Willemite screen. Hi Resolution. Tube & Data. Special @ \$5. 2 for \$9
Snooperscope Power Supply
P52002K Kit 4500VDC Incls Transformer, Rectifiers, Sockets, Resistors, Capacitors and diagram 115V/60cy oper.
P52002 Built in Metal Cabinet.....\$13.50
P52002.....\$32

FINEST HI-FI RECORDING TAPE

1200 Ft.—7" Reel
Money Back Gtd. **\$1.45** Lots of 12
Highest quality controlled plastic base tape made by new Erin Sheen process. Precision coated & Silt. Gtd. Constant output. Splice Free. Freq. 7 1/4 IPS 40-15KC Oxide Wind In. 3 1/2" \$4.50
New 1st Quality "Mylar" 2400 Ft.—7" Reel Ferron Erin Processed Recording tape.....\$4.49. 3 for \$12

KITS! "TAB" THE BEST KITS!

All Kits Contain Most Popular Values & Sizes	
Kit 35 Precision Resistors	Kit 35 Power Resistors
Kit 18 Switches	Kit 75 Microswitches
Kit 3 Transistor Transf.	Kit 6 Crystal Diodes
Kit 150 Carbon Resistors	Kit 250 Ft. Hookup Wire
Kit 42 Panel Lamps	Kit 100 Ceramic Cond
Kit 12 Electrolytic Cond's	Kit 18 Rotary Switches
Kit 15 Volume Controls	Kit 6 Crystals & Holders
Kit 36 Tube Sockets	Kit 65 Inductors & Coils
Kit 50 Tubular Cond's	Kit 5 Microswitches
Kit 500 Lugs & Eyelets	Kit 10 Power Lamps
Kit 10 Xmit Mico Cond's	Kit 40 Insulated Resist.
Kit 5 Lds. Surprise Kit	Kit 85 Insulated Resist.
Kit 10 Xmit Mica Cond's	Kit 71 Knobs
Kit Encapsulation Fluid	Kit 130 Fuses
Kit Volume Control Fluid	Kit Gypsum Cement & Varnish

BUY 10 KITS GET ONE FREE! EACH KIT 99c

"TAB" TERMS: Money Back Guarantee. Our 12th year. \$2 min order. O.B. N.C. Add shpg charges or for C.O.D. 25% Prices shown subject to change.
111XR LIBERTY ST., N. Y. C., N. Y.
PHONE: RECTOR 2-6245

INDEX OF Advertisers

NOVEMBER 1957

[While every precaution is taken to insure accuracy, we cannot guarantee against the possibility of an occasional change or omission in the preparation of this index.]

ADVERTISER	PAGE	ADVERTISER	PAGE
A & L Products.....	195	Kester Solder Company.....	116
Admiral.....	143	Key Electronics Company.....	94
Advance Electronics Company.....	164	Klein & Sons, Mathias.....	96
Airex Radio Corp.....	148	Kopelove Electronics Company.....	100
Allied Radio Corp.....	148	Krauter & Co., Inc.....	121
9, 129, 130, 131, 132, 133, 134, 135, 136		Lafayette Radio.....	160, 161
Altec Lansing Corporation.....	34	Lampkin Laboratories, Inc.....	126
American Elite, Inc.....	108	Lansing Sound, Inc., James B.....	93
American Television & Radio Co.....	152	Lektron.....	158
Amperex Electronics Corp.....	92	McGee Radio Company.....	145, 146, 147
Ampex Audio, Inc.....	100	McGraw-Hill Book Co.....	180
Arday.....	139	M. R. Company, The.....	192
Arrow Sales, Inc.....	192	Madison Fielding Corporation.....	104
Ashe Radio Co., Walter.....	149	Mallory & Co., Inc., P. R.....	Fourth Cover
Audel Publishers.....	122	Merit Coil & Transformer Corp.....	140
B & K Manufacturing Co.....	125	Milwaukee School of Engineering.....	164
Baltimore Technical Institute.....	194	Moss Electronics Distributing Co., Inc.....	172, 173
Barry Electronics Corp.....	192	MusiCraft.....	159
Bell Telephone Laboratories.....	179	National Radio Institute.....	3, 27, 28
Bendix Radio.....	174	National Schools.....	31
Blonder-Tongue Labs., Inc.....	127	Newark Electric Company.....	118
Bogen Company, David.....	12	North American Phillips Co., Inc.....	96
Bozak Sales Company, The R. T.....	142	North Electric Company.....	18
Brand Products, Inc.....	30	Olson Radio Warehouse.....	183
British Industries Corporation.....	94	Orradio Industries, Inc.....	140
Burroughs Corporation.....	193	PACO Electronics Co., Inc.....	119
Burstein-Applebee Co.....	195	Pacific International University.....	197
C. B. C. Electronics Co., Inc.....	124	Peak Electronics Company.....	184
CBS-Hytron.....	29, 118	Phaestron Instrument & Electronics Co.....	113
C & H Sales Co.....	180	Philco Corporation.....	7, 181
Canadian Institute of Science and Technology, Ltd.....	159	Photocon Sales.....	176
Candler System Co.....	140	Photography Annual, Inc.....	168
Capitol Radio Engineering Institute.....	19, 200	Pickering & Company, Inc.....	105
Carston.....	94	Pilot Radio Corp.....	102, 103
Castle TV Tuner Service.....	195	Prentice Hall, Inc.....	169, 194
Champion De Arment Tool Co.....	8	Progressive "Edu-Kits" Inc.....	188
Channel Master Corp.....	14	Quality-Electronics.....	140
Chicago Standard Transformer Corporation.....	128	R. C. A. Institutes, Inc.....	23
Cleveland Institute of Radio Electronics.....	33	RW Electronics.....	165
Columbia Electronics.....	190	Radio Corporation of America.....	26
Coyne Electrical School.....	174, 190	Radio-Television Training Association.....	13
Cutick Electronics.....	196	Rad-Tel Tube Co.....	116
Danco Mfg. Co.....	194	Rauland-Borg Corporation.....	108
Delco Radio.....	117	Raytheon Manufacturing Company.....	Second Cover
De-Ro Electronics.....	139	Reeves Soundcraft Corp.....	17
DeVry Technical Institute.....	5	Reg-O-Kut Co., Inc.....	99, 108, 141
Dressner.....	194	Rex Radio Supply Co.....	188
Duotone Inc.....	194	Rider Publisher, Inc., John F.....	124
Dyna Company.....	95	Rinehart & Company, Inc.....	156, 181, 189
Dynamic Electronics-New York, Inc.....	142	Rockbar Corporation.....	15
Edmund Scientific Co.....	126	Sams & Co., Inc., Howard W.....	151, 182
EICO.....	35, 36	Scott, H. H.....	101
Electronic Chemical Corp.....	118	Scott-Mitchell House, Inc.....	122
Electronic Measurements Corp.....	122	Service Instruments Corp.....	116
Electro-Voice, Inc.....	109, 110, 111, 112	Shure Brothers, Inc.....	138
Fairchild Recording Equipment Co.....	137	Sonotone Corporation.....	32
Fair Radio Sales.....	191	Sports Cars Illustrated Directory.....	190
Fisher Berkeley Corporation.....	97	Sprague Products Co.....	192
Fisher Radio Corp.....	106, 107	Sprayberry Academy of Radio-Television.....	21
G & G Radio Supply Co.....	163	Springfield Enterprises.....	124
Garfield Co., Oliver.....	126	Stan-Burn Radio and Electronics Co.....	178
General Electric Company.....	120	Standard Electrical Products Co.....	124
Glaser-Steers Corp.....	24	Standard Line Electric Company.....	169
Goodheart, R. E.....	192	Supreme Publications.....	185
Grantham Schools.....	196	Sylvania Electric Products, Inc.....	10, 11
Greenlee Tool Co.....	185	"TAB" Telematic Industries, Inc.....	198
Hallcrafters.....	115	Tele-Test Instrument Corp.....	114
Harvey Radio Co., Inc.....	150	Texas Crystals.....	188
Heald Engineering College.....	180	Thorens Company.....	20
Heath Company.....	76, 77, 78, 79, 80, 81, 82, 83, 84, 85, 86, 87, 88, 89, 90, 91	Transvision, Inc.....	142
Henshaw Radio Supply.....	94, 114, 194, 197	Triplett Electrical Instrument Co., Third Cover	158
Hershel Radio Co.....	174	Tri-State College.....	158
Hi-Fi Annual & Audio Handbook.....	175	United Audio Products.....	22
Hi-Fi Directory & Buyers' Guide.....	166, 167	United Radio Company.....	196
Indiana Technical College.....	128	University Loudspeakers, Inc.....	6
Instructograph Company.....	114	Valparaiso Technical Institute.....	164
International Business Machines Corp.....	154, 155	Video Electric Company.....	157
International Correspondence Schools.....	25	Ward Products Corporation.....	153
International Radio & Electronics Corp.....	196	Weller Electric Corp.....	187
International Resistance Co.....	170, 171	Western Radio.....	197
J. J. Candee Co.....	158	World Radio Labs, Inc.....	197
Jerrold Electronics Corporation.....	123	Wuerth Tube-Saver Corporation.....	114
		Your Career in Electronics.....	98, 186
		Ziff-Davis Publishing Company.....	177
		Zyltron Tube Corporation.....	128

CLASSIFIED

RATE: 50¢ per word. Minimum 10 words. January Issue closes November 8th. Send order and remittance to: RADIO & TV NEWS, 366 Madison Ave., N. Y. C. 17, N. Y.

RADIO ENGINEERING

COMPLETE radio, electronics theory & practice; television; broadcasting; servicing; aviation, marine, police radio. 18 or 21 months. Catalog. Valparaiso Technical Institute, Dept. N, Valparaiso, Ind.

FOR SALE

RADIO & TV Tubes at manufacturers prices. Guaranteed—Send for free price list. Edison Electronic Tube Co., Menlo Park, N. J.

200 UNMARKED Ceramicons—Mixed Values. \$1.00. D. Schneider, 3763 New York Ave., Seaford, N. Y.

DIAGRAMS—Radios, Amplifiers, Chargers, \$1.00 Each. Television Service Data \$2.00. Unknown Models. Give Tube Layout And Part Numbers. Cable Electronics Corp., 851 10th Ave., New York, N. Y. (Formerly Kramer's Radio Service.)

DIAGRAMS for repairing radios \$1.00. Television \$2.00. Give make, model. Diagram Service, Box 672-RN, Hartford 1, Conn.

TUBES—TV, Radio, Transmitting And Industrial Types At Sensibly Low Prices. New, Guaranteed, 1st Quality, Top Name Brands Only. Write For Free Catalog or Call Walker 5-7000, Barry Electronics Corp., 512 Broadway, New York 12N, N. Y.

DIAGRAMS! Service Data! Radios \$1.00. Televisions \$1.50. TV Tube Layouts, with First Aid Service Hints, 50¢. Give Make, Model. TV Miltie, Box 101 Rt., Hicksville, New York.

COMPLETE Television Sets \$11.95. Jones TV, 1115 Rambler, Pottstown, Pa.

TRADE-IN TV Sets Ship Anywhere. 10in \$10, 12in \$12, 16in \$17, 17in \$21. Justis Bros., Newport, Del.

6C21/150TL SURPLUS @ \$8.00 each—2 for \$15.00; 2C26 @ \$3.00 each; 5BP1 @ \$3.98, F.O.B. Oil Electronic Supply, 6009 Eastern Ave., Balto, 24, Md.

GOVERNMENT Sells—Surplus Electronics; Walkie-Talkies; Transceivers; Test Equipment; Oscilloscopes; Radar; Voltmeters; Misc.—Fraction of Army costs—Buy direct now from U. S. Government—Depot List & Procedure \$1.00—Brody, Box 8-RT, Sunnyside 4, New York.

TUBES—Television, Radio, New, Guaranteed. Boxed. Approximately 80% off. Transmitting, Special Purpose Tubes, write Bell Electronics, 40 Canal, New York City 2.

FREQUENCY Modulation Tuners, 88-108 Megacycle, Complete with 4 tubes, \$12.95. Grutman, One East 167th Street, Bronx, New York.

GONSET, Monitoradio and other Communications Receivers. Ladd Electronics, 111 North 41st, Omaha, Nebraska.

ARMY Throat Microphone, New 50¢. Surplex, Box 118, Jersey City 4, New Jersey.

HI-FI Amplifiers, Speaker, Tape Recorders, Turntables. Ham transmitters and Receivers W.R.L., National, Hallcrafters, Hammarlund, Johnson S. Collins. Easy Terms, Ken-Els Radio Supply, 428 Central Ave., Ft. Dodge, Iowa or 67-16th Ave. S. W. Cedar Rapids, Iowa.

BUILDER—Experimenters subscribe to "Radio Workbench" magazine. Special transistor issue for 25¢. Smith Electronics, Carlsbad, New Mexico.

PRINTED Circuits: Design your own. Copper boards, etchant, and complete instructions \$2.00. Dawntronic, 2051 Lansing, Denver 8, Colorado.

DON'T buy anything until you write for and receive our new catalog 116. The most interesting electronics at the lowest prices. Catalog includes circuit diagrams!

TV-DRY Eliminates TV Burnout Repairs Caused By Dampness. Send \$1.00 To TV Miltie, Box 101X, Hicksville, New York.

FOR Sale: 1 two-way radio system complete with mobiles. Will divide.

WANTED

TAPE recorder mechanisms wanted. Manufacturers please send specs to Classified Box 560, c/o Radio & TV News, 366 Madison Ave., New York 17, N. Y.

CYLINDER and old disc phonographs. Edison, Conqueror, Idelia, and Oratorio models. Berliner Gramophones and Zono-o-phones, Columbia cylinder Phonographs, and coin-operated cylinder phonos prior to 1919. Will pay cash or trade late hi-fi components. Box 50 % RADIO & TV NEWS.

CASH Paid! Sell your surplus electronic tubes. Want unused, clean transmitting, special purpose, receiving, TV types, magnetrons, Klystrons, broadcast, etc. Also want military & commercial lab test and communications gear. We swap too, for tubes or choice equipment. Send specific details in first letter. For a fair deal write, wire or telephone: Barry, 512 Broadway, New York 12, N. Y. Walker 5-7000.

WANTED: Receiver R5/ARN-7, MN-62A Transceivers, RT18/ARC-1, AN/ARC-3, BC-788C, I-152C, Collins, Bendix equipment, Test Sets, Dynamotors, Inverters. We pay highest prices. Advise quantity, condition, price first letter. Aircraft Radio Industries, Inc., 15 East 40th St., New York City, telephone LExington 2-6254.

AIRCRAFT and ground radios. Will better best offer. Dames, W2KUW 308 Hickory, Arlington, N. J.

CRYSTAL-RADIO experimenters, Write to Hulet, 305 Hope, Lakewood, New Jersey.

LABORATORY Quality Equipment and Military Surplus Electronics bought, sold. Engineering Associates, 432 Patterson Road, Dayton 9, Ohio.

WANTED: Measurements Corp. Signal Generator, Model 78B. Cherry Radio, 1438 Belfield, Phila. 40, Pa.

ELECTRICAL EQUIPMENT & SUPPLIES

GOVERNMENT Surplus Receivers, Transmitters, Parabolic Reflectors, Picture Catalog 10¢. Meshna, Malden 48, Mass.

REPAIRS & SERVICING

HIGH Fidelity Speakers Repaired. Amprite Speaker Service, 70 Vesey St., N. Y. 7, N. Y. Ba. 7-2580.

HIGH FIDELITY

DISGUSTED of "HI" HI-FI Prices? Unusual Discounts on Your High Fidelity Requirements. Write Now. Key Electronics, 120 Liberty St., New York 6, N. Y. Evergreen 4-6071.

FAIRCHILD 225A Cartridges, New in factory sealed cases. \$37.50 Net, yours at \$27.50. A. Gebaide, 356 South 1st St., Brooklyn, N. Y.

SAVE! Save! The finest of Hi-Fi components and Records. All brand new. Write for free list today. Downey Hi-Fi, P.O. Box 2065, Dept. "RT," Downey, Calif.

TAPE RECORDERS

RECORDERS, HiFi, Tapes, Free Wholesale Catalog. Carston, 215-R E. 88 St., N. Y. C. 28.

TAPE Recorders, Tape. Unusual Values. Free catalog. Dressner 69-02 R, 174 St., Flushing 65, N. Y.

WHOLESALE Catalog 10¢. Recorders! Tapes! Typewriters! Radios! Towers, #155, Philadelphia 5.

HIGHEST Quality Tape Postpaid—on 7" reels in boxes: 1800' Acetate 1 \$2.25, 3 \$6.00, 6 \$11.50. Double Playing ½ Mil. Mylar 2400' 1 \$4.50, 3 \$11.75, 6 \$22.00. Satisfaction Guaranteed. Fidelatape, Dept. D, 1575 Thierlot Ave., N. Y. C. 60, N. Y.

RECORDING Tape—1800' \$1.84, 1200' \$1.44. Guaranteed. Catalogue. Broadcast Tape, P.O. Box 231A, Wallingford, Conn.

DIAGRAMS, kits for Shutoff Controls, 10½" Reel Adapters. Details free. Lerol Engineering, Box 251A, Elmhurst, Illinois.

STEREOPHONIC tapes—low cost! Demonstration recording, \$2.50: Check or COD. Free catalog. John Paul Jones, 655 Main, Lafayette, Indiana.

RECORDS

PHONOGRAPH Records cheap, postpaid. Catalogue. Paramount, Box 242-N, Williamsport, Penna.

HELP WANTED

WANTED—instructor with a major interest in small transmitter service to teach in a two year post high school service program. Write or call Jon P. Adams, Ferris Institute, Big Rapids, Michigan.

BUSINESS OPPORTUNITIES

AMERICA'S largest wholesale sources. Dealers, agents, salesmen write Associated Wholesalers, Box 52-GM, Burlington, Iowa.

EQUIPMENT for re-necking TV tubes: 16 and 6 KW bombardiers, sealing machines, and pumps. Complete set-up for sale or lease to qualified men. Windsor Co., 999 N. Main, Glen Ellyn, Ill.

CORRESPONDENCE COURSES

USED Correspondence Courses and Books sold and rented. Money back guarantee. Catalog free. (Courses bought.) Lee Mountain, Pisgah, Ala.

INSTRUCTION

ENGINEERING Degrees, EE Option Electronics earned by home study. Residence classes also available. Pacific International University, 5719-C Santa Monica Boulevard, Hollywood 38, California.

COMPUTER plans \$3.00. New transistor robot plans \$1.00. Robot construction manual \$5.00. Only complete course in electronics under \$100.00; for complete information on automation computers, robots, write E.B.E., 1015 Atkin Ave., Salt Lake City 6, Utah.

MATHEMATICS. All levels. Correspondence. UCSM, 6605 N. 13 St., Philadelphia 26, Pennsylvania.

BUILD FM-TV Antenna. Plans 50¢. Hed, 6925 Janchl, Minneapolis, Minn.

USED Correspondence Courses Educational Books Bought, Sold, Rented, Catalog Free, Vernon's, 624 Mohawk, Rossville, Ga.

MISCELLANEOUS

COMPLETE Instructions for making Wine! Beer! \$1.00. ABC Publications, Box 849, San Francisco 1-RN, California.

Want to sell? Want to buy? Want to trade?

A small ad in these classified columns will help you buy, sell or trade. Classified ads are reasonably priced . . . and have worked effectively for thousands of RADIO & TV NEWS readers!

For further details and rates, write to:

Martin Lincoln
Classified Advertising Manager
Ziff-Davis Publishing Company
366 Madison Avenue
New York 17, N. Y.

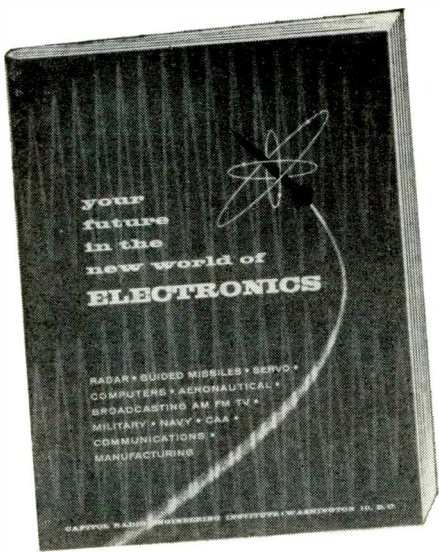

The data that Launched
Thousands of Careers
is yours **FREE**

Tells how you can be successful
in **RADIO-TV-ELECTRONICS**

Send for Your Free Copy Today!

This is a brand new edition of the book which has launched thousands of men on good-paying careers in radio-tv-electronics.

It brings you completely up to date—answers important questions on newest career developments in electronics, including Radar, Guided Missiles, Servomechanisms, Computers, as well as Aeronautical Electronics, Broadcasting (AM, FM, TV), Military, Navy and CAA Electronics, Communications and Electronics Manufacturing.

This book, "Your Future in the New World of Electronics," also shows you how CREI Home Study leads the way to greater earnings in the booming electronics world.

However, CREI does not promise you a "snap." With an accredited technical school such as this you must study to convert your ambition into technical knowledge you can sell in the fabulous Electronics market.

Since its founding in 1927, CREI has provided thousands of professional electronics men with technical educations. During World War II, CREI trained thousands for the Armed Services. Leading firms choose CREI courses for group training in electronics, at company expense, among them United Air Lines, Canadian Broadcasting Corporation, Trans-Canada Airlines, Douglas Aircraft Co., Glenn L. Martin Co., Columbia Broadcasting System, All-American Cables and Radio, Inc., Gates Radio Co., Canadair Ltd., Federal Electric Corp., and U. S. Information Agency. CREI courses are prepared by recognized experts, in a practical, easily understood manner. You get the benefit of time-tested study assignments under the personal supervision of a CREI staff instructor. This is accomplished on your own time, during hours selected by you, and controlled by your own will power. This com-

plete training is the reason that graduates find their CREI diplomas keys-to-success in radio, TV and Electronics. CREI alumni hold top positions in America's leading firms. At your service is the CREI Placement Bureau, which finds positions for advanced students and graduates. Although CREI does not guarantee jobs, requests for personnel far exceed current supply. Now is the time of decision for you. Luck will not

propel you forward unless it finds you trained. Contacts won't budge you an inch unless you have the skill to back them up. The answer is: Technical Training . . . and willingness to learn. Together they will bring you increased earnings in this new Age of Electronics. Fill out the coupon below and mail it now. We'll promptly send you your free copy of "Your Future in the New World of Electronics." The rest—your future—is up to you!

ELECTRONIC TECHNICIANS

Growing Peninsula Co. has openings for 1st class electronic technicians to work directly with engineering in development of new products. Only those with CREI or equal training and 3 years minimum commercial experience will be considered. Top salaries to qualified applicants. Call Mr. McQueeney, DA. 4-4733 for appointment. **ALTO SCIENTIFIC Co., Inc.**
855 COMMERCIAL ST.
PALO ALTO

CREI also offers Residence Training at same high technical level in Washington, D.C. Classes start at regular intervals. Qualified residence school graduates earn degree "Associate in Applied Science." Check coupon if you prefer residence study.

KOREAN WAR VETERANS: If eligible for training under the new G.I. Bill of Rights, check the coupon for full information.

Industry Calls for CREI training By Name . . . SO SHOULD YOU!

Here you see an actual help wanted ad from the *San Francisco Examiner*, April 1, 1956, one of many which specify "CREI or equal" training. This shows that industry approves CREI training, even insists on it.

FILL OUT AND MAIL TODAY—BEFORE YOU FORGET IT!

CAPITOL RADIO ENGINEERING INSTITUTE

Dept. 1111-W, 3224 16th St., N.W., Washington 10, D.C.
ECPD Accredited Technical Institute Curricula Founded 1927

Please send me your course outline and **FREE** Illustrated Booklet "Your Future in the New World of Electronics" . . . describing opportunities and CREI home study courses in Electronics Engineering Technology.

- CHECK FIELD OF GREATEST INTEREST
- Electronic Engineering Technology
 - Broadcast (AM, FM, TV) Engineering Technology
 - Television Engineering Technology
 - Aeronautical Electronic Engineering Technology

Name..... Age.....

Street

City..... Zone..... State.....

CHECK: Home Study Residence School Veteran

To help us answer your request intelligently, please give the following information:

EMPLOYED BY.....

TYPE OF PRESENT WORK.....

SCHOOL BACKGROUND.....

ELECTRONICS EXPERIENCE.....

IN WHAT BRANCH OF ELECTRONICS ARE YOU MOST INTERESTED?

triple news

from triplett

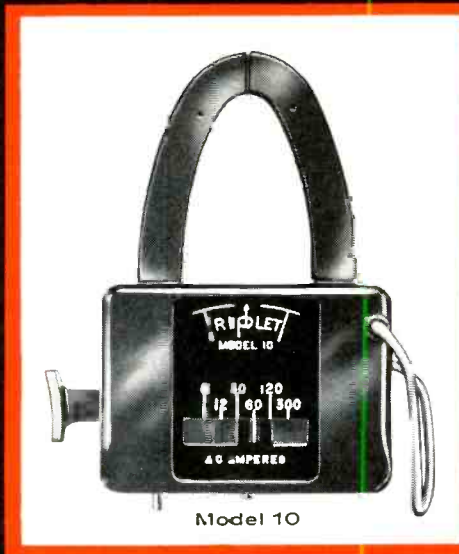

Here is a real value—much more value than in any other clamp-on ammeter. Remember, in Triplet Model 100 you get not only a clamp-on ammeter but a genuine Triplet complete Volt-Ohm-Milliammeter with which you can measure AC volts, DC volts, AC and DC current, and Ohms.

BURTON BROWNE ADVERTISING

1st news: Triplet Model 10 Clamp-On Adapter

Just plug into any Triplet Model 310 Miniature VOM it becomes an AC clamp-on ammeter to measure AC amperes without cutting or opening current carrying wires. The split transformer yoke opens at the touch of a lever to fit around a single conductor or bus-bar for direct readings of AC amperes from 6 to 300 in 6 steps. Model 10 \$14.50 net.

The Model 10 can be separated from the Model 310 as shown in the drawing at left by No. 311 lead attachment. This permits readings in difficult locations. No. 311 leads \$1.90 net.

2nd news: Triplet Model 101 Line Separator

Serves to plug in at outlet to divide 2 conductor cords for clamp-on measuring. Makes accurate, rapid-testing of radio and TV sets, phonographs, appliances, motors, etc. possible without opening or splitting double conductors. Also serves to increase ammeter sensitivity 10X and 20X, if desirable, for easier reading. Model 101 \$5.50 net.

3rd news: All four parts are available conveniently packaged in one handy, durable, high-quality carrying case. This complete package is known as Triplet Model 100 and is priced at \$61.90 net.

Model 100 consists of Model 310 VOM, Model 10 Clamp-On Adapter, Model 101 Line Separator, No. 311 leads and carrying case with provision for all parts.

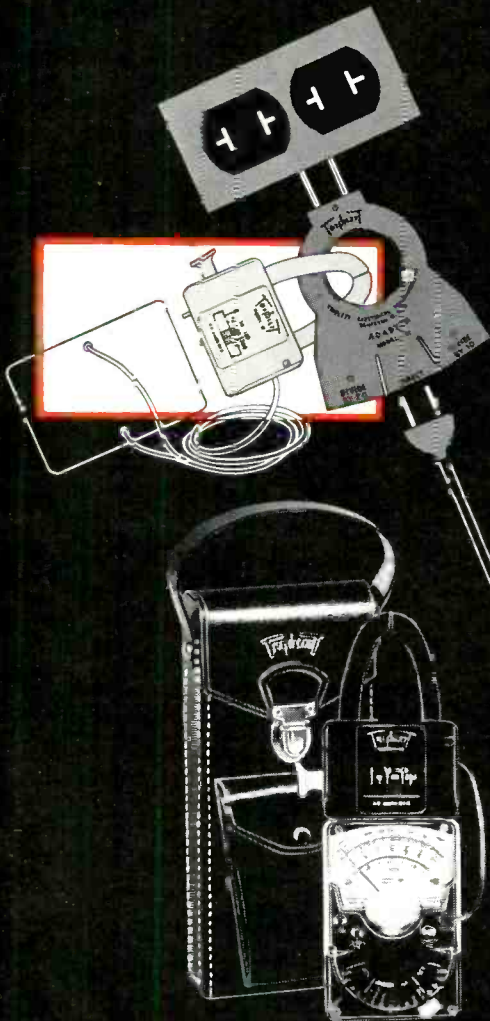

TRIPLET

Triplet Electrical
Instrument Company
Bluffton, Ohio

53 years of experience

In addition, to use with the Model 310, the Model 10 Adapter also can be used as a Clamp-On Ammeter with any Volt-Ohm-Milliammeter having a 3 AC volt scale at 5000 Ohms per volt such as Triplet Models 630, 630-A, 630-NA, 631, etc., by employing Triplet No. 611 leads, \$1.90 net.

Triplet Model 100 gives you the world's most flexible test equipment for all electrical and electronic applications.



631



630-NA

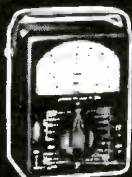

630



630-A



310



630-T



636-HH



625-NA



666-R



Build today's profits with

MALLORY

Mercury BATTERIES

— the batteries of tomorrow !

The amazing mercury battery, pioneered by Mallory, helped make practical the remarkable new pocket-size transistor radios. Tiny, powerful, long-lasting, Mallory Mercury Batteries are the fast-growing line that will bring you profitable sales today . . . even greater sales tomorrow.

Mallory Mercury Batteries excel in long shelf life . . . in service life and economy in transistor portables. To help spark your sales, you get the backing of year 'round promotion and strong advertising in magazines like The Saturday Evening Post, Time, Newsweek, Business Week and TV Guide.

See your Mallory distributor today, and get full facts on the *full* line of Mallory Mercury and Zinc-Carbon Batteries.

For vacuum-tube portables,
sell Mallory Zinc-Carbon
Batteries . . . unsurpassed
for performance.



P. R. MALLORY & CO. Inc.
MALLORY

P. R. MALLORY & CO. Inc., INDIANAPOLIS 6, INDIANA

- Capacitors • Vibrators • Switches • Controls
- Resistors • Rectifiers • Power Supplies
- Filters • Mercury and Zinc-Carbon Batteries